

此文件及附页属公司机密文件, 版权属通力科技股份有限公司所有, 任何人未经允许不得复制、抄袭。任何部门如有需求, 须向通力科技研发申请。
 These files are confidential documents in company, The copyright totally belongs to Tonly Technology Co., Ltd., Anybody who are unauthorized is forbidden to copy and plagiarize the files. Any Department must get permission from the Tonly R&D if they need to use them.

ART WORK FORM

(密级: C级)

品牌名称 (BRAND NAME): HARMAN

工艺说明 (尺寸单位: 毫米 (mm)):

08/02/49/54/55/56/57/59/67/79类:

| 工艺、颜色 | |
|------------------------------------|--|
| 成型及颜色 (直接注塑颜色) | N/A |
| 喷油及颜色 | N/A |
| 丝印颜色 /移印颜色 | N/A |
| 电镀/真空镀 及颜色 | N/A |
| 针对整个工艺栏中涉及到的油漆, 油墨, 镀层是否需要非导电的要求说明 | 油漆: 否 <input type="checkbox"/> 是 <input type="checkbox"/> 油漆要求完全绝缘不导电, 即阻值无穷大 是 <input type="checkbox"/> 油漆阻值大于_____ |
| | 油墨: 否 <input type="checkbox"/> 是 <input type="checkbox"/> 油墨要求完全绝缘不导电, 即阻值无穷大 是 <input type="checkbox"/> 油墨阻值大于_____ |
| | 镀层: 否 <input type="checkbox"/> 是 <input type="checkbox"/> 镀层要求完全绝缘不导电, 即阻值无穷大 是 <input type="checkbox"/> 镀层阻值大于_____ |
| 镭 雕 | N/A |
| 氧化及颜色 | N/A |
| 其他工艺 | N/A |
| 备 注 | N/A |

74/76/89类:

| | |
|------|---|
| 印刷方式 | XXXX |
| 表面工艺 | N/A |
| 样板需求 | 签正式样板 <input type="checkbox"/> |
| | 签彩稿样板 <input type="checkbox"/> 基础机型彩盒样板参考料号: 76-XXXXXX-XXXXX |
| 备 注 | N/A |

制作要求 (* FOR ALL):

- 条码扫描等级达到C级以上;
- 美国走向必须满足CP65要求;
- 必须满足RoHS2.0、REACH要求;
- 必须符合TCL通力《公司环境管理物质标准》要求;
- 所有用于包装材料印刷的油墨都禁止含有矿物油;
- 中国境内生产和/或使用的涂料、油墨、胶粘剂、清洗剂必须符合中国国标VOC的要求;
- QR Code的制作或打印过程中需选择模型2 (M2);
- 所用油墨必须达到TCL质量部门检测标准;
- 胶袋材质、胶袋上透气孔的大小、位置以结构认可书为准;
- PE材质的胶袋其上面的丝印内容整体长度可允许3mm误差;
- 珍珠棉等材质的胶袋其上面的丝印内容整体长度可允许5mm误差;

71类:

| | | |
|-------|--|------------|
| 表纸材质 | 型号: XXXX | 厚度: XXXX |
| 胶水材质 | 型号: XXXX | 是否可移: XXXX |
| 尺 寸 | 长: XXXX | 宽: XXXX |
| 印刷方式 | XXXX | |
| 碳带打印 | 无需打印 <input type="checkbox"/> 供应商打印 <input type="checkbox"/> 在线打印 <input type="checkbox"/> | |
| 表面工艺 | XXXX | |
| 粘贴位置 | XXXX | |
| 材质库编码 | N/A | |
| 样板需求 | 需要签样 <input type="checkbox"/> | |
| | 不需要签样 <input type="checkbox"/> 参考料号: 71-XXXXXX-XXXXX | |
| 备 注 | N/A | |

72/99 (说明书光盘) 类:

| | | |
|----------|---|------------|
| 材 质 | 封面: 80g铜板纸 | 内页: 80g铜板纸 |
| 尺 寸 | 折前尺寸: 长: 148mm 宽: 105mm 折后/成品尺寸: 长: 148mm 宽: 105mm | |
| 印刷方式 | 40+1专 双面印刷 | |
| 表面工艺 | 过水油 | |
| 装订方式 | 骑马钉 | |
| 页 数 (P数) | 折叠前页数 (P数): N/A | |
| | 钉装/胶装页数 (P数): 24P | |
| 备 注 | N/A | |

73类:

| | |
|------|---------|
| 印刷方式 | 在通力产线镭雕 |
| 备 注 | N/A |

* FOR HUAWEI:

- 满足无卤要求;
- 满足不含有邻苯二甲酸盐要求。

* FOR SAMSUNG:

- VD类产品需满足三星的SS要求, AI类产品需满足三星SA要求。

* FOR SONY:

- 禁止使用SS-00259中规定的1级环境管理物质。
- 再生树脂、被覆线材必须从索尼的绿色伙伴认定供应商处采购。



QUICK START GUIDE

BAR 700







EN Before using this product, read the safety sheet carefully.

FR Avant d'utiliser ce produit, lisez attentivement la fiche de sécurité.

ES Antes de usar este producto, lee la hoja de seguridad atentamente.



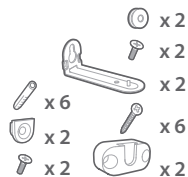
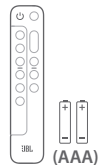
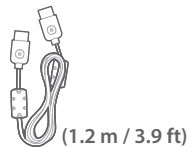
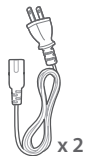
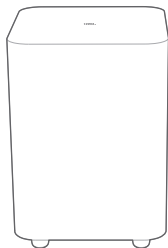

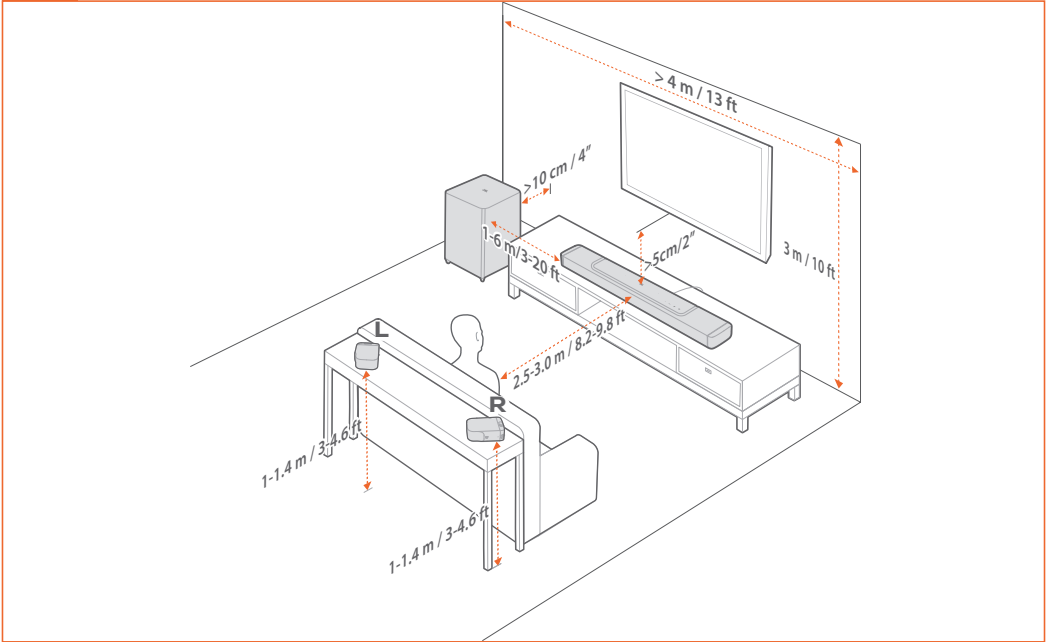



EN To move the soundbar, first remove the two detachable speakers to avoid accidental damage.

FR Pour déplacer la barre de son, retirez d'abord les deux enceintes détachables afin d'éviter tout dommage accidentel.

ES Para cambiar la barra de sonido de lugar, quita primero los dos altavoces desmontables para evitar daños por accidente.



TV (HDMI eARC)

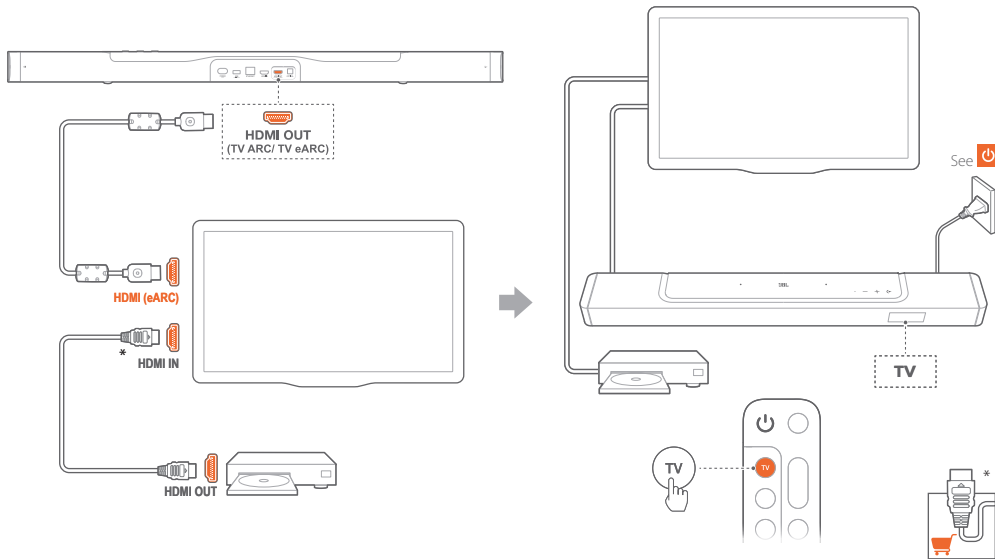

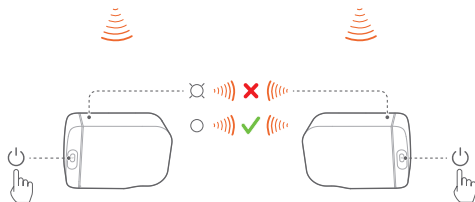
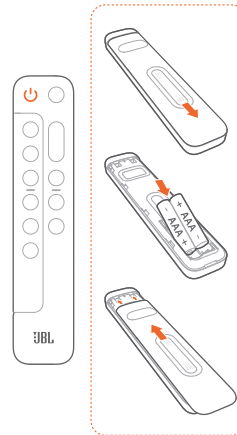
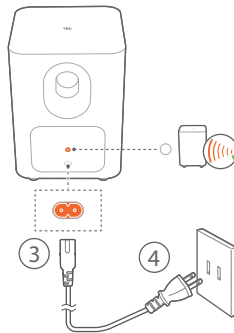
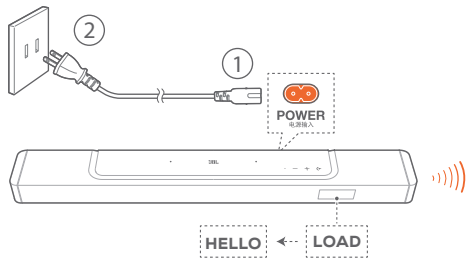

EN The soundbar will pair with the two detachable speakers and the subwoofer automatically when they are powered on.

FR La barre de son se jumellera automatiquement avec les deux enceintes détachables et le caisson de basses lors de leur allumage.

ES La barra de sonido se emparejará con los dos altavoces desmontables y el subwoofer automáticamente en cuanto se enciendan.

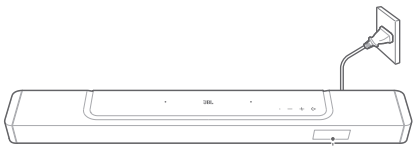

REAR SPKR LOW BATT

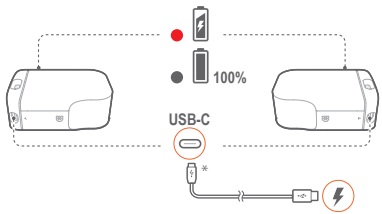
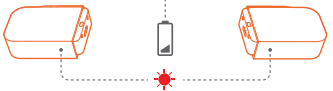



1

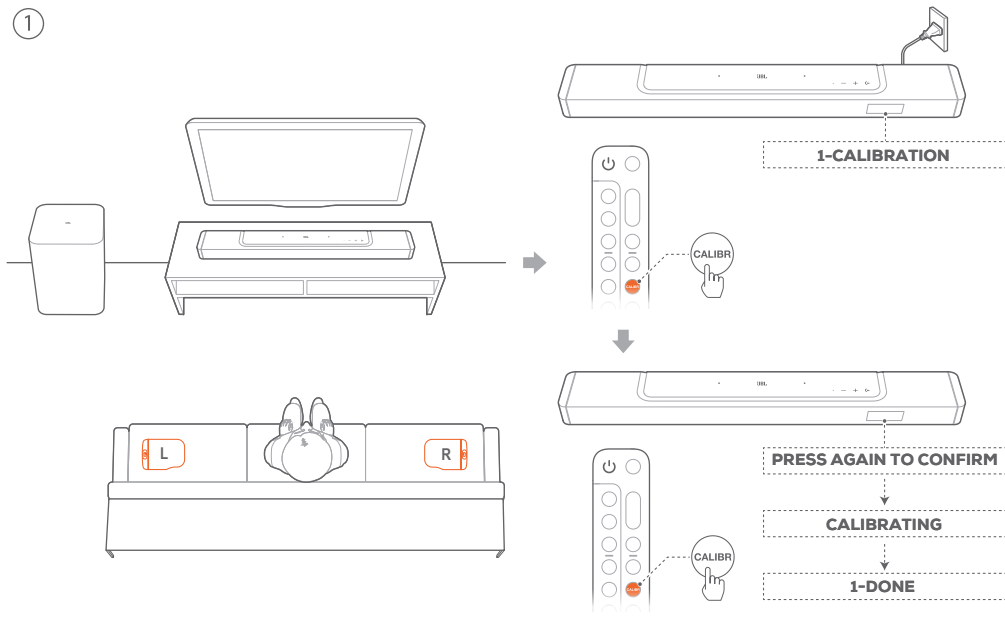



②

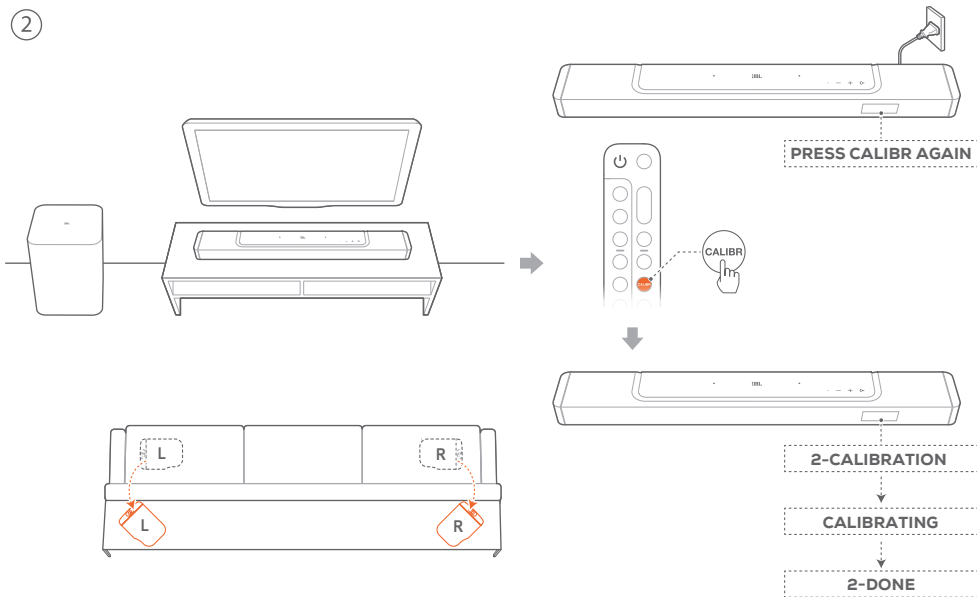

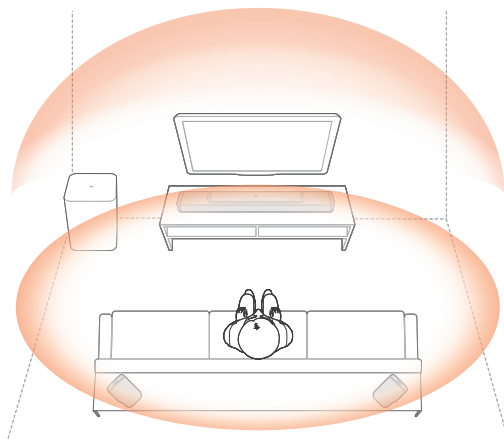

EN Sound Calibration

Optimize your 3D surround sound experience for your unique listening environment.

FR Étalonnage du son

Optimisez votre expérience de son surround 3D dans votre environnement d'écoute spécifique.

ES Calibración del sonido

Optimiza la experiencia de sonido envolvente 3D para un entorno auditivo único.

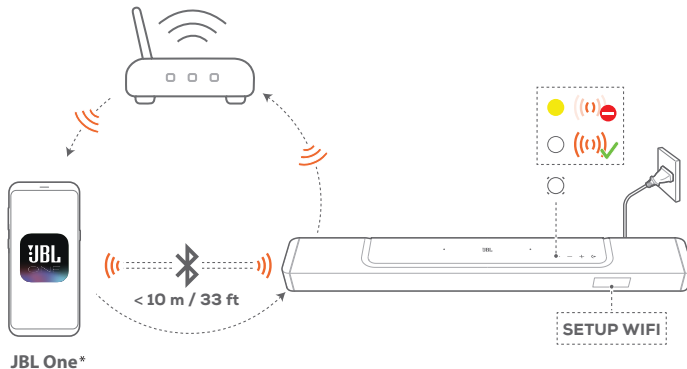

EN On an Android™ or iOS device, add the soundbar to your home Wi-Fi network through the JBL One app. Follow the app instructions to complete setup.

* Some features require subscriptions or services not available in all countries.

FR Sur un appareil Android™ ou iOS, ajoutez la barre de son au réseau Wi-Fi de votre domicile via l'application JBL One. Suivez les instructions de l'application pour terminer la configuration.

* Certaines fonctionnalités nécessitent des abonnements ou des services non disponibles dans tous les pays.

ES En un dispositivo Android™ o iOS, añade la barra de sonido a la red Wi-Fi doméstica mediante la aplicación JBL One. Sigue las instrucciones de la aplicación para completar la configuración.

* Algunas funciones requieren suscripciones o servicios que no están disponibles en todos los países.

**EN**

General Specification

- Model: BAR 700 (soundbar unit)
BAR 700 SURROUND (detachable speaker)
BAR 700 SUB (subwoofer unit)
- Sound system: 5.1 channel
- Power supply: 100 - 240V AC, ~ 50/60Hz
- Total speaker power output (Max @THD 1%): 620W
- Soundbar output power (Max @THD 1%): 240W
- Surround speaker output power (Max @THD 1%): 2x 40W
- Subwoofer output power (Max. @THD 1%): 300 W
- Soundbar transducer: 3x (46x90)mm racetrack drivers, 3x 0.75" (20mm) tweeters
- Surround speaker transducer: 1x (46x90)mm racetrack driver
- Subwoofer transducer: 10" (260mm)
- Networked standby power: < 2.0W
- Operating temperature: 0°C - 45°C
- Lithium battery: 3.635V, 3283mAh
- Detachable surround speaker playtime: up to 10 Hours (may vary according to content type and volume level)

HDMI Specification

- HDMI video input: 1
- HDMI video output (with Enhanced Audio Return Channel, eARC): 1
- HDMI HDCP version: 2.3
- HDR pass through: HDR10, Dolby Vision

Audio Specification

- Frequency response: 35Hz - 20kHz (-6dB)
- Audio inputs: 1 Optical, Bluetooth, Chromecast Built-in, AirPlay and Alexa MRM, USB (USB playback is available in US version. For other versions, USB is for Service only.)

USB specification

- USB port: Type A
- USB rating: 5V DC, 0.5A
- Supporting file format: MP3
- MP3 codec: MPEG 1 Layer 2/3, MPEG 2 Layer 3, MPEG 2.5 Layer 3
- MP3 sampling rate: 16 - 48 kHz
- MP3 bitrate: 80 - 320 kbps

Wireless specification

- Bluetooth version: 5.0
- Bluetooth profile: A2DP 1.2, AVRCP 1.5
- Bluetooth transmitter frequency range: 2400MHz - 2483.5MHz
- Bluetooth transmitter power: <15dBm (EIRP)
- Wi-Fi network:
IEEE 802.11 a/b/g/n/ac/ax (2.4GHz/5GHz)
- 2.4G Wi-Fi transmitter frequency range: 2412 - 2462 MHz (2.4GHz ISM Band, USA 11 Channels)
- 2.4G Wi-Fi transmitter power: < 20dBm (EIRP)
- 5G Wi-Fi transmitter frequency range: 5.15 - 5.35GHz, 5.470-5.725GHz, 5.725 - 5.825GHz

- 5G Wi-Fi transmitter power: 5.15-5.25GHz <23dBm, 5.25-5.35GHz & 5.47-5.725GHz <20dBm, 5.725-5.825GHz <14dBm (EIRP)
- 2.4G wireless transmitter frequency range: 2406 - 2474MHz
- 2.4G wireless transmitter power: <10dBm (EIRP)

Dimensions

- Total soundbar dimensions (W x H x D): 1174 x 56 x 120 mm / 46.2" x 2.2" x 4.7"
- Main soundbar dimensions (W x H x D): 884 x 56 x 120 mm / 34.8" x 2.2" x 4.7"
- Detachable surround speaker dimensions (each) (W x H x D): 145 x 56 x 120 mm / 5.7" x 2.2" x 4.7"
- Subwoofer dimensions (W x H x D): 305 x 440.4 x 305 mm / 12" x 17.3" x 12"
- Soundbar weight: 3.2 kg / 7.04 lbs
- Detachable surround speaker weight (each): 0.65 kg / 1.4 lbs
- Subwoofer weight: 10 kg / 22 lbs
- Packaging dimensions (W x H x D): 1000 x 375 x 475 mm/ 39.4" x 14.8" x 18.7"
- Packaging Weight: 18.7 kg / 41.1 lbs

**FR**

Spécifications générales :

- Modèle : BAR 700 (unité barre de son)
BAR 700 SURROUND (enceinte détachable)
BAR 700 SUB (unité caisson de basses)
- Système audio : canal 5.1
- Alimentation : 100 à 240 V CA, ~ 50/60 Hz
- Puissance de sortie totale du haut-parleur (maximale à un taux de distorsion harmonique de 1 %) : 620 W
- Puissance de sortie de la barre de son (maximale à un taux de distorsion harmonique de 1 %) : 240 W
- Puissance de sortie du haut-parleur surround (maximale à un taux de distorsion harmonique de 1 %) : 2 x 40 W
- Puissance de sortie du caisson de basses (maximale à un taux de distorsion harmonique de 1 %) : 300 W
- Transducteur de la barre de son : 3 haut-parleurs en forme de circuit automobile (46 x 90 mm), 3 tweeters (20 mm)
- Transducteur du haut-parleur surround : 1 pilote de circuit (46 x 90 mm)
- Transducteur du caisson de graves : 260 mm
- Puissance réseau en mode veille : < 2,0 W
- Température de fonctionnement : 0 °C à 45 °C
- Batterie lithium : 3,635 V, 3283 mAh
- Autonomie de l'enceinte surround amovible : jusqu'à 10 heures (peut varier en fonction du type de contenu et du niveau de volume)

Spécification HDMI

- Entrée vidéo HDMI : 1
- Sortie vidéo HDMI (avec canal de retour audio amélioré, eARC) : 1

- Version HDCP HDMI : 2.3
- Intercommunication HDR : HDR10, Dolby Vision

Spécifications audio

- Réponse en fréquence : 35 Hz – 20 kHz (-6 dB)
- Entrées audio : 1 optique, Bluetooth, Chromecast Built-in, AirPlay et Alexa MRM, USB (la lecture USB est disponible en version US. Pour les autres versions, USB est réservé à l'entretien uniquement.)

Spécification USB

- Port USB : type A
- Valeur nominale du port USB : 5 V CC, 0,5 A
- Format de fichier pris en charge : MP3
- Codec MP3 : MPEG 1 Layer 2/3, MPEG 2 Layer 3, MPEG 2.5 Layer 3
- Taux d'échantillonnage MP3 : 16 - 48 kHz
- Bit par seconde MP3 : 80 – 320 kpbs

Spécifications radio

- Version Bluetooth : 5.0
- Profil Bluetooth : A2DP 1.2, AVRCP 1.5
- Plage de fréquences de l'émetteur Bluetooth : 2 400 MHz à 2 483,5 MHz
- Puissance de l'émetteur Bluetooth : < 15 dBm (puissance isotrope rayonnée équivalente, PIRE)
- Réseau Wi-Fi :
IEEE 802.11 a/b/g/n/ac/ax (2,4 GHz/5 GHz)
- Plage de fréquences de l'émetteur Wi-Fi 2,4G : 2 412 - 2 462 MHz (bande ISM 2,4 GHz, USA 11 canaux)

- Puissance de l'émetteur Wi-Fi 2,4G : < 20 dBm (puissance isotrope rayonnée équivalente, PIRE)
- Plage de fréquences de l'émetteur Wi-Fi 5G : 5,15 – 5,35 GHz ; 5,470 – 5,725 GHz ; 5,725 – 5,825 GHz
- Puissance de l'émetteur Wi-Fi 5G : 5,15 - 5,25 GHz < 23 dBm, 5,25 - 5,35 GHz et 5,47 - 5,725 GHz < 20 dBm, 5,725 - 5,825 GHz < 14 dBm (puissance isotrope rayonnée équivalente, PIRE)
- Gamme de fréquence de l'émetteur sans fil 2,4G : 2 406 - 2 474 MHz
- Puissance de l'émetteur sans fil 2,4G : < 10 dBm (puissance isotrope rayonnée équivalente, PIRE)

Dimensions

- Dimensions de la barre de son (L x H x P) : 1 174 x 56 x 120 mm
- Dimensions de la barre de son principale (L x H x P) : 884 x 56 x 120 mm
- Dimensions de l'enceinte surround détachable (chacune) (L x H x P) : 145 x 56 x 120 mm
- Dimensions du caisson de basses (L x H x P) : 305 x 440,4 x 305 mm
- Poids de la barre de son : 3,2 kg
- Poids de l'enceinte surround détachable (chacune) : 0,65 kg
- Poids du caisson de basses : 10 kg
- Dimensions de l'emballage (L x H x P) : 1 000 x 375 x 475 mm
- Poids de l'emballage : 18,7 kg

ES

Especificaciones generales:

- Modelo: BAR 700 (unidad de barra de sonido)
BAR 700 SURROUND (altavoz desmontable)
BAR 700 SUB (unidad de subwoofer)
- Sistema de sonido: canales 5.1
- Cable de alimentación: 100 - 240 V CA, ~ 50/60 Hz
- Potencia total de salida del altavoz (1 % THD máx.): 620W
- Potencia de salida de la barra de sonido (1 % THD máx.): 240W
- Potencia de salida del altavoz envolvente (1 % THD máx.): 2 x 40W
- Potencia de salida del subwoofer (1 % THD máx.): 300W
- Transductor de barra de sonido: 3 unidades de tipo racetrack (46x90) mm, 3 altavoces de agudos de 0,75 pulgadas (20 mm)
- Transductor de altavoz envolvente: 1x (46x90) mm unidades de tipo racetrack
- Transductor de subwoofer: 10 pulgadas (260 mm)
- Energía de reserva en red: < 2.0W
- Temperatura de funcionamiento: 0 °C - 45 °C
- Batería de litio: 3,635 V, 3283mAh
- Tiempo de reproducción del altavoz envolvente extraíble: hasta 10 horas (puede variar según el tipo de contenido y el volumen)

Especificaciones de HDMI

- Entrada de video HDMI: 1
- Salida de video HDMI (con canal de retorno de audio mejorado [eARC]): 1

- Versión de HDCP para HDMI: 2.3
- Paso directo HDR: HDR10, Dolby Vision

Especificaciones de audio

- Respuesta en frecuencia: 35 Hz - 20 kHz (-6 dB)
- Entradas de audio: 1 Óptica, Bluetooth, Chromecast Built-in, AirPlay y Alexa MRM, USB (la reproducción USB está disponible en la versión para EE. UU. Para otras versiones, el USB es solo para servicio).

Especificaciones de USB

- Puerto USB: Tipo A
- Clasificación de USB: 5 V CC, 0,5 A
- Formato de archivo compatible: MP3
- Códec MP3: MPEG 1 capa 2/3, MPEG 2 capa 3, MPEG 2.5 capa 3
- Velocidad de muestreo de MP3: 16 - 48 kHz
- Velocidad de bits de MP3: 80 - 320 kpbs

Especificaciones del sistema inalámbrico

- Versión de Bluetooth: 5.0
- Perfiles Bluetooth: A2DP 1.2, AVRCP 1.5
- Rango de frecuencia del transmisor Bluetooth: 2400 MHz - 2483,5 MHz
- Potencia del transmisor Bluetooth: <15 dBm (EIRP)
- Red wifi: IEEE 802.11 a/b/g/n/ac/ax (2.4 GHz/5 GHz)
- Rango de frecuencia del transmisor wifi 2.4G: 2412 - 2462 MHz (Banda ISM 2.4 GHz, EE. UU. 11 Canales)
- Potencia del transmisor wifi 2.4G: < 20 dBm (EIRP)
- Rango de frecuencia del transmisor wifi 5G: 5,15 - 5,35 GHz, 5,470-5,725 GHz, 5,725 - 5,825 GHz

- Potencia del transmisor wifi 5G: 5,15-5,25 GHz <23 dBm, 5,25-5,35 GHz y 5,47-5,725 GHz <20 dBm, 5,725-5,825 GHz <14 dBm (EIRP)
- Rango de frecuencia del transmisor wifi 2.4G: 2406 - 2474 MHz
- Potencia del transmisor inalámbrico de 2.4 G: <10 dBm (EIRP)

Dimensiones

- Dimensiones totales de la barra de sonido (ancho x altura x profundidad): 1174 x 56 x 120 mm / 46,2" x 2,2" x 4,7"
- Dimensiones de la barra de sonido principal (ancho x altura x profundidad): 884 x 56 x 120 mm / 34,8" x 2,2" x 4,7"
- Dimensiones de altavoces envolventes extraíbles (cada uno) (ancho x altura x profundidad): 145 x 56 x 120 mm / 5,7" x 2,2" x 4,7"
- Dimensiones del subwoofer (ancho x altura x profundidad): 305 x 440,4 x 305 mm / 12" x 17,3" x 12"
- Peso de la barra de sonido: 3,2 kg/7,04 lb
- Peso del altavoz envolvente extraíble (cada uno): 0,65 kg / 1,4 lbs
- Peso del subwoofer: 10 kg/22 lb
- Peso del embalaje (ancho x altura x profundidad): 1000 x 375 x 475 mm/ 39,4" x 14,8" x 18,7"
- Peso del embalaje: 18,7 kg / 41,1 lb

EN

1. Information on power consumption

This equipment complies with European Commission Regulation (EC) No 1275/2008 and (EU) No 801/2013.

- Off: N/A
- Standby (when all wireless connections are deactivated): < 0.5 W
- Networked standby for Soundbar: < 2.0 W

2. The period of time after which the power management function switches the equipment automatically into:

| | | |
|-------------------|--|---|
| Off | N/A | |
| Standby | When all wired ports are disconnected and all wireless network connections are deactivated | Switched to standby mode after 10 minutes. |
| Networked standby | When any wireless network connection is activated | Switched to networked standby mode after 10 minutes of inactivity in operational mode |

3. If this equipment has the wireless network connections:

How to activate wireless network connections:

- Set up the equipment properly;
- Switch into wireless mode (Bluetooth, Chromecast built-in™, AirPlay 2 casting audio, Alexa Multi-Room Music & etc);
- Connect with energy using products (e.g. players/ game consoles/ STB (Set-Top Boxes)/ phones/ tablets /PCs).

How to deactivate wireless network connections:

- Press and hold  on the remote control for more than 5 seconds firstly;
- Then long press  on the remote control for more than 5 seconds.

FR

1. Informations sur la consommation électrique

L'équipement est conforme au règlement de la Commission européenne (CE) n° 1275/2008 et (UE) n° 801/2013.

- Off : S. O.
- Veille (lorsque toutes les connexions sans fil sont désactivées) : < 0,5 W
- Veille en réseau pour la barre de son : < 2,0 W

2. La durée après laquelle la fonction de gestion de l'énergie commute automatiquement l'équipement dans l'état :

| | | |
|--------|---|----------------------------------|
| Éteint | S. O. | |
| Veille | Lorsque tous les ports câblés sont déconnectés et que toutes les connexions réseau sans fil sont désactivées. | Mise en veille après 10 minutes. |



| | | |
|------------------|---|---|
| Veille en réseau | Lorsqu'une connexion réseau sans fil est activée. | Passage en veille en réseau après 10 minutes d'inactivité en état opérationnel. |
|------------------|---|---|

3. Si cet équipement a des connexions réseau sans fil :

Activation des connexions réseau sans fil :

- Installez l'équipement correctement ;
- Sélectionnez un mode sans fil (Bluetooth, Chromecast built-in™, diffusion audio AirPlay 2, Alexa MultiRoom Musique et autres) ;
- Connectez-vous avec les produits consommateurs d'énergie (par ex. lecteurs / consoles de jeux / récepteurs/décodeurs / téléphones / tablettes / PCs).

Désactivation des connexions réseau sans fil :

- Appuyez d'abord pendant plus de 5 secondes sur  de la télécommande ;
- Appuyez ensuite pendant plus de 5 secondes sur  de la télécommande.

ES

1. Información sobre consumo de energía

Este equipo cumple las normas de la Comisión Europea (CE) N° 1275/2008 y (UE) N° 801/2013.

- Apagar: N/A
- En espera (con todas las conexiones inalámbricas desactivadas) <0,5 W
- Barra de sonido en espera en red: <2,0 W

2. El período de tiempo después del cual la función de ahorro de energía pone el equipo automático en estado:



| | | |
|------------------|---|--|
| Apagado | N/A | |
| En espera | Cuando todos los puertos con cables están desconectados y todas las conexiones de red inalámbricas están desactivadas | Cambia al modo de espera al cabo de 10 minutos. |
| En espera en red | Todas las conexiones inalámbricas están activadas | Cambia al modo de espera en red al cabo de 10 minutos de inactividad en modo de funcionamiento |

3. Si el equipo tiene las conexiones de red inalámbricas:

Cómo activar las conexiones de red inalámbricas:

- Configura el equipo correctamente;
- Cambia al modo inalámbrico (Bluetooth, Chromecast built-in™, difusión de audio mediante AirPlay 2, música multialta de Alexa, etc.);
- Conéctalo con productos que consuman energía (como reproductores, consolas de juegos, receptores de sobremesa, teléfonos, tabletas u ordenadores).

Cómo desactivar las conexiones de red inalámbricas:

- Mantén pulsado  en el control remoto durante más de 5 s en primer lugar;
- A continuación, mantén pulsado  en el control remoto durante más de 5 s.

FCC RF Radiation Exposure Statement Caution: To maintain compliance with the FCC's RF exposure guidelines, place the product at least 20cm from nearby persons.

Cet équipement est conforme aux limites d'exposition aux radiations FCC/ IC CNR-102 établies pour un environnement non contrôlé. Cet équipement doit être installé et utilisé avec une distance minimale de 20 cm entre le radiateur et votre corps.

This product contains open source software licensed under GPL. For your convenience, the source code and relevant build instruction are also available at https://harman-webpages.s3.amazonaws.com/JBL_BAR_Gen3_package_license_list.htm

Please feel free to contact us at:

Harman Deutschland GmbH

ATT: Open Source, Gregor Krapf-Gunther, Parking 3

85748 Garching bei Munchen, Germany

or OpenSourceSupport@Harman.com if you have additional question regarding the open source software in the product.



The Bluetooth® word mark and logos are registered trademarks owned by Bluetooth SIG, Inc. and any use of such marks by HARMAN International Industries, Incorporated is under license. Other trademarks and trade names are those of their respective owners.



The terms HDMI, HDMI High-Definition Multimedia Interface, HDMI trade dress and the HDMI Logos are trademarks or registered trademarks of HDMI Licensing Administrator, Inc.



Wi-Fi CERTIFIED 6™ and the Wi-Fi CERTIFIED 6™ Logo are trademarks of Wi-Fi Alliance®.

COMPATIBLE WITH



Dolby, Dolby Vision, Dolby Atmos, and the double-D symbol are registered trademarks of Dolby Laboratories Licensing Corporation. Manufactured under license from Dolby Laboratories. Confidential unpublished works. Copyright © 2012–2021 Dolby Laboratories. All rights reserved.



Google, Android, Chromecast built-in are trademarks of Google LLC.
Google Assistant is not available in certain languages or countries.



Apple®, AirPlay®, iPad®, iPad Air®, iPad Pro®, and iPhone® are trademarks of Apple Inc., registered in the U.S. and other countries. Use of the Works with Apple badge means that an accessory has been designed to work specifically with the technology identified in the badge and has been certified by the developer to meet Apple performance standards. To control this AirPlay 2-enabled speaker, iOS 13.4 or later is required.



Amazon, Alexa, and all related marks are trademarks of Amazon.com, Inc. or its affiliates.



Use your phone, tablet or computer as a remote control for Spotify. Go to spotify.com/connect to learn how. The Spotify Software is subject to third party licenses found here: <https://www.spotify.com/connect/third-party-licenses>.



720102-020266
HA_JBL_Bar700_QSG_US_PV_V2