



# UNISEN™

## IMMERSIVE SOUND LCD HDTV with Integrated Sound Projector

### MODELS

---

#### 151 Series

*LT-40151, LT-46151, LT-52151*

#### 153 Series

*LT-40153, LT-46153, LT-52153*

#### 249 Series

*LT-46249, LT-52249*

---

## OWNER'S GUIDE

- **Guidelines for setting up and using your new widescreen TV start on page 7.**
- For questions:
  - Visit our website at [www.mitsubishi-tv.com](http://www.mitsubishi-tv.com).
  - E-mail us at [MDEAservice@mdea.com](mailto:MDEAservice@mdea.com).
  - Call Consumer Relations at 800-332-2119.
- For information on **System Reset**, please see the back cover.
- To order replacement or additional remote controls, visit our website at [www.mitsuparts.com](http://www.mitsuparts.com) or call 800-553-7278.
- **153 and 249 Series.** IR emitter cables for NetCommand home-theater control are available for purchase from Mitsubishi. Call 800-553-7278 and request either part number 242D483020 (two-ended cable) or part number 299P254020 (four-ended cable).



### For Your Records

Record the model number, serial number, and purchase date of your TV. The model and serial numbers are on the back of the TV. Refer to this page when requesting assistance with the TV.

**MODEL NUMBER** \_\_\_\_\_

**SERIAL NUMBER** \_\_\_\_\_

**PURCHASE DATE** \_\_\_\_\_

**RETAILER NAME** \_\_\_\_\_

**LOCATION** \_\_\_\_\_



### CAUTION

RISK OF ELECTRIC SHOCK  
DO NOT OPEN



CAUTION: TO REDUCE THE RISK OF ELECTRIC SHOCK, DO NOT REMOVE COVER (OR BACK). NO USER SERVICEABLE PARTS INSIDE. REFER SERVICING TO QUALIFIED SERVICE PERSONNEL.



The lightning flash with arrowhead symbol within an equilateral triangle is intended to alert the user of the presence of uninsulated "dangerous voltage" within the product's enclosure that may be of sufficient magnitude to constitute a risk of electric shock to persons.



The exclamation point within an equilateral triangle is intended to alert the user to the presence of important operating and maintenance (servicing) instructions in the literature accompanying the product.

**WARNING:** This product shall be connected to a MAINS socket outlet with a protective earthing connection.

**MAINS DISCONNECTION:** The mains plug is used as the disconnect device. The mains plug shall remain readily operable.

**TV WEIGHT:** This TV is heavy. Exercise extreme care when lifting or moving it. Lift or move the TV with a minimum of two adults. To prevent damage to the TV, avoid jarring or moving it while it is turned on. Always power off your TV, unplug the power cord, and disconnect all cables before moving it.

**WARNING:** To reduce the risk of fire or electric shock, do not expose this apparatus to rain or moisture.

**WARNING:** This product contains chemicals known to the State of California to cause cancer and/or birth defects or other reproductive harm.

### FCC Declaration of Conformity

Product: LCD Flat Panel HDTV  
Models: LT-40151, LT-46151, LT52151  
LT-40153, LT-40153, LT-52153  
LT-46249, LT-52249

Responsible Party: Mitsubishi Digital Electronics  
America, Inc.  
9351 Jeronimo Road  
Irvine, CA 92618-1904

Telephone: (800) 332-2119

This device complies with Part 15 of the FCC Rules. Operation is subject to the following two conditions:

- (1) This device may not cause harmful interference, and
- (2) This device must accept any interference received, including interference that may cause undesired operation.

**Note:** This equipment has been tested and found to comply with the limits for a Class B digital device, pursuant to part 15 of the FCC Rules. These limits are designed to provide reasonable protection against harmful interference in a residential installation. This equipment generates, uses and can radiate radio frequency energy and, if not installed and used in accordance with the instructions, may cause harmful interference to radio communications. However, there is no guarantee that interference will not occur in a particular installation. If this equipment does cause harmful interference to radio or television reception, which can be determined by turning the equipment off and on, the user is encouraged to try to correct the interference by one or more of the following measures:

- Reorient or relocate the receiving antenna.
- Increase the separation between the equipment and the receiver.
- Connect the equipment into an outlet on a circuit different from that to which the receiver is connected.
- Consult the dealer or an experienced radio/TV technician for help.

**Changes or modifications not expressly approved by Mitsubishi could cause harmful interference and would void the user's authority to operate this equipment.**

Features and specifications described in this owner's guide are subject to change without notice.

# Contents

Important Safety Instructions . . . . .	4
Important Information About Your TV . . . . .	5
Special Features of Your TV . . . . .	6
<hr/>	
<b>1 Basic Setup and Operation</b>	
Package Contents . . . . .	7
Stand Installation . . . . .	8
Wall-Mounting . . . . .	8
Before You Begin . . . . .	9
First-Time Power-On . . . . .	9
TV Controls . . . . .	10
Setting Up TV Inputs . . . . .	12
Basic TV Operation . . . . .	14
<hr/>	
<b>2 TV Connections</b>	
Before You Begin . . . . .	16
Cable Management . . . . .	16
Inputs and Outputs . . . . .	17
Y Pb Pr Component Video Device . . . . .	20
HDMI Device . . . . .	20
DVI Video Device . . . . .	21
Composite Video Device . . . . .	21
Antenna or Cable TV Service . . . . .	21
VCR or DVD Recorder to an Antenna or Wall Outlet Cable . . . . .	22
VCR or DVD Recorder to a Cable Box . . . . .	22
A/V Receiver . . . . .	23
A/V Receiver with HDMI Output . . . . .	23
Subwoofer . . . . .	24
Audio-Only Device . . . . .	24
<hr/>	
<b>3 Using TV Features</b>	
Selecting an Input . . . . .	25
Sleep Timer . . . . .	25
ChannelView Channel Listings . . . . .	26
Redirecting Audio Output . . . . .	26
Controlling A/V Receiver Volume . . . . .	26
Status Display . . . . .	27
TV Signals and Display Formats . . . . .	28
Using the TV with a Personal Computer . . . . .	29
Camera Images and Music Files . . . . .	31
Sound Projector . . . . .	34
Streaming Internet Movies with VUDU . . . . .	37
Introduction to Home-Theater Control . . . . .	39
<hr/>	
<b>4 TV Menus</b>	
Main Menu . . . . .	40
Menu Navigation . . . . .	40
Adjust . . . . .	41
Captions . . . . .	46
Initial . . . . .	47
Inputs . . . . .	50
Lock . . . . .	52
<hr/>	
<b>5 NetCommand IR Control</b>	
About NetCommand IR Control . . . . .	55
IR Emitter Placement . . . . .	56
Initial NetCommand Setup . . . . .	57
Operating NetCommand-Controlled Devices . . . . .	58
<hr/>	
<b>6 NetCommand IR Control of an A/V Receiver</b>	
Controlling an A/V Receiver after NetCommand Setup . . . . .	61
Setting Up A/V Receiver Control Power and Volume . . . . .	62
Automatic Switching (Audio or Audio/Video) . . . . .	63
<hr/>	
<b>Appendices</b>	
Appendix A: Programming the Remote Control . . . . .	68
Appendix B: HDMI Control of CEC Devices . . . . .	75
Appendix C: TV Care . . . . .	78
Appendix D: Bypassing the Parental Lock . . . . .	79
Appendix E: Troubleshooting . . . . .	81
<b>Trademark and License Information</b> . . . . .	88
<b>Network Service Disclaimer</b> . . . . .	88
<b>Warranty</b> . . . . .	92
<b>Index</b> . . . . .	94

# Important Safety Instructions

Please read the following safeguards for your TV and retain for future reference. Always follow all warnings and instructions marked on the television.

- 1) Read these instructions.
- 2) Keep these instructions.
- 3) Heed all warnings.
- 4) Follow all instructions.
- 5) Do not use this apparatus near water.
- 6) Clean only with dry cloth.
- 7) Do not block any ventilation openings. Install in accordance with the manufacturer's instructions.
- 8) Do not install near any heat sources such as radiators, heat registers, stoves, or other apparatus (including amplifiers) that produce heat.
- 9) Do not defeat the safety purpose of the polarized or grounding-type plug. A polarized plug has two blades with one wider than the other. A grounding type plug has two blades and a third grounding prong. The wide blade or the third prong are provided for your safety. If the provided plug does not fit into your outlet, consult an electrician for replacement of the obsolete outlet.
- 10) Protect the power cord from being walked on or pinched particularly at plugs, convenience receptacles, and the point where they exit from the apparatus.
- 11) Only use attachments/accessories specified by the manufacturer.
- 12) Use only with the cart, stand, tripod, bracket, or table specified by the manufacturer, or sold with the apparatus. When a cart is used, use caution when moving the cart/apparatus combination to avoid injury from tip-over.
- 13) Unplug this apparatus during lightning storms or when unused for long periods of time.
- 14) Refer all servicing to qualified service personnel. Servicing is required when the apparatus has been damaged in any way, such as power-supply cord or plug is damaged, liquid has been spilled or objects have fallen into the apparatus, the apparatus has been exposed to rain or moisture, does not operate normally, or has been dropped.



EXAMPLE OF ANTENNA GROUNDING

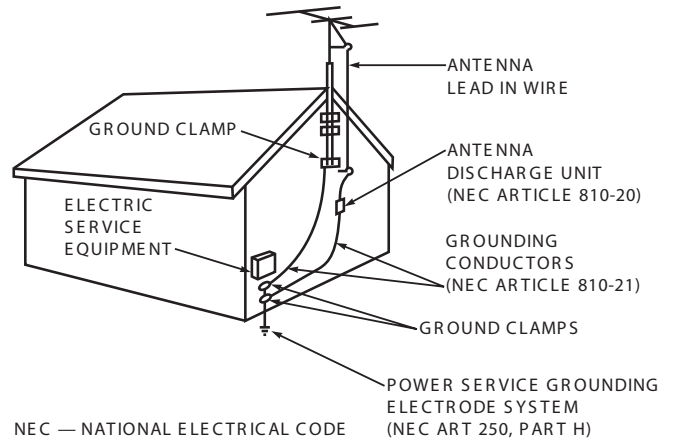

## Outdoor Antenna Grounding

If an outside antenna or cable system is connected to the TV, be sure the antenna or cable system is grounded so as to provide some protection against voltage surges and built-up static charges.

## Replacement Parts

When replacement parts are required, be sure the service technician has used replacement parts specified by the manufacturer or have the same characteristics as the original part. Unauthorized substitutions may result in fire, electric shock or other hazards.

## Important Information About Your TV

### Installation Notes

For stand installation and wall-mounting, see page 8.

**Use with other than the authorized accessories may cause the TV to become unstable, which can cause damage to the product or possible injury.**

**Custom cabinet installation must allow for proper air circulation around the television.**

**NOTE TO CATV SYSTEM INSTALLER:** THIS REMINDER IS PROVIDED TO CALL THE CATV SYSTEM INSTALLER'S ATTENTION TO ARTICLE 820-40 OF THE NEC THAT PROVIDES GUIDELINES FOR THE PROPER GROUNDING AND, IN PARTICULAR, SPECIFIES THAT THE CABLE GROUND SHALL BE CONNECTED TO THE GROUNDING SYSTEM OF THE BUILDING, AS CLOSE TO THE POINT OF CABLE ENTRY AS PRACTICAL.

### TV Software

Do not attempt to update the software of this TV with software or USB drives not provided by or authorized by Mitsubishi Digital Electronics America, Inc. Non-authorized software may damage the TV and will not be covered by the warranty.

### If Your TV Gets Damaged

Crystalline liquid may leak from the LCD panel and broken glass may be scattered.

**CAUTION: The crystalline liquid is toxic. Avoid contact with your skin, eyes, or mouth. DO NOT touch the broken glass or crystalline liquid. DO NOT get glass fragments or crystalline liquid into eyes or mouth. Should either contact your eyes or mouth, rinse the contacted area thoroughly with water and consult your doctor.**

### Disposal of Your TV

 = MERCURY

The LCD panel contains a small amount of crystalline liquid and the fluorescent tube in the panel contains mercury. Both are toxic and should not be touched.

**DO NOT dispose of the TV with general household waste. THE LAMPS INSIDE THIS PRODUCT CONTAIN MERCURY AND MUST BE RECYCLED OR DISPOSED OF ACCORDING TO LOCAL, STATE, AND FEDERAL LAWS. For disposal or recycling information, contact your local authorities or the Electronic Industries Alliance at [www.eiae.org](http://www.eiae.org).**

## Special Features of Your TV

Your new high-definition widescreen television has many special features that make it the perfect center of your home entertainment system, including:

### 1080p High-Definition LCD Display System

Your Mitsubishi LCD Flat Panel HDTV uses a full 1920 x 1080 LCD panel to create the picture you see on the screen. All images are displayed at 1080p. The TV uses new Plush 1080p<sup>®</sup> 5G digital video processing to convert lower-resolution signals to 1080p for display.

### Smooth120Hz<sup>™</sup> Film Motion

Smooth120Hz<sup>™</sup> Film Motion makes fast-moving images appear smoother and more fluid, free from motion blur. It does this by doubling the traditional progressive scan frame rate and creates new frames of video between the traditional frames to create smoother moving images. Smooth120Hz<sup>™</sup> Film Motion also smooths film judder (image vibration) that may be present in film-based content such as movies.

### 16:9 Widescreen Picture Format

Enjoy a full theatrical experience in the comfort of your home. View pictures as film directors intended them. Digital TV broadcasts, DVDs and newer video game consoles support this widescreen format.

### Integrated HDTV Tuner

Your widescreen Mitsubishi HDTV has an internal HDTV tuner able to receive both over-the-air HDTV broadcasts (received via an antenna) and non-scrambled digital cable broadcasts, including non-scrambled HDTV cable programming.

### High-Definition Video Inputs

- **Component Video Inputs.** Also called Y/Pb/Pr inputs, these inputs receive standard analog video formats of 480i, 480p, 720p, and 1080i high-definition signals. This provides a high level of flexibility when connecting DVD players/recorders, cable boxes, and satellite receivers.
- **HDMI Inputs.** These inputs accept digital 480i, 480p, 720p, 1080i, and 1080p video signals plus bitstream and PCM digital stereo signals. The HDMI<sup>™</sup> inputs can also accept a variety of PC signals and resolutions. These inputs support HDMI 1.3 Deep Color (up to 36 bits) and the **x.v.Color** extended color gamut.

Used with an adapter, these inputs also accept compatible digital DVI video signals. HDMI inputs provide additional high-performance, high-definition connections for maximum flexibility in your choice of home theater products. The HDMI inputs are HDCP copy-protection compatible.

### Easy Connect Auto Input Sensing

Easy Connect<sup>™</sup> Auto Input Sensing automatically recognizes when you plug in a device and prompts you to assign a name to it.

### Home-Theater Control

#### HDMI Control

**Available for all models.** HDMI devices with Consumer Electronics Control (CEC) capabilities may be compatible with the TV's HDMI Control feature. Compatible devices can receive control signals through the HDMI connection, allowing the TV's remote control to operate some functions of these devices.

#### NetCommand with IR Learning

**153 and 249 Series.** Your Mitsubishi HDTV offers a new level of networking that seamlessly integrates selected older A/V products with new and future digital products. NetCommand<sup>®</sup> supports IR (infrared) control of products such as VCRs, DVD players, cable boxes, and satellite receivers. NetCommand can "learn" remote control signals directly from many devices, allowing you to create a customized NetCommand-controlled home-theater system.

### Sound Projector

Sound Projector technology uses the TV's bank of speakers to create a simulated surround sound effect by reflecting sound off the room walls.

### Internet Video Streaming with VUDU<sup>™</sup>

**249 Series.** VUDU offers the largest on-demand HD movie selection anywhere, featuring full 1080p and 5.1 surround sound. VUDU allows you to enjoy movies with no store visits, no mailing, no late fees and no subscriptions.

### ENERGY STAR<sup>®</sup>









This is an ENERGY STAR<sup>®</sup> qualified TV. Products that earn the ENERGY STAR prevent greenhouse gas emissions by meeting strict energy efficiency guidelines set by the U.S. Environmental Protection Agency and the U.S. Department of Energy. This TV consumes power in excess of ENERGY STAR guidelines under the following conditions:

TV Feature Active	TV Power Status
Picture Mode set to <b>Brilliant</b>	On
<b>Fast Power On</b> enabled	Off
<b>153 and 249 Series.</b> External Controller Input enabled	

# 1 Basic Setup and Operation

## Package Contents

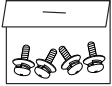
Please take a moment to review the following list of accessory items to ensure that you have received everything.

1. Remote Control	
2. Two AA Batteries	
3. Basic Owner's Guide	
4. HDTV Quick Setup Guide	
5. Product Registration Card	
6. Power Cord	
7. Cable Tie	
8. Stand Screws	
9. 153 and 249 Series. Calibration Microphone	

## Remote Control Batteries

1. Remove the remote control back cover.

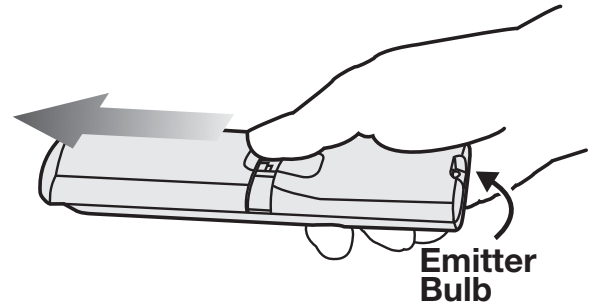

2. Load the batteries, making sure the polarities (+) and (-) are correct. Insert the negative (-) end first.

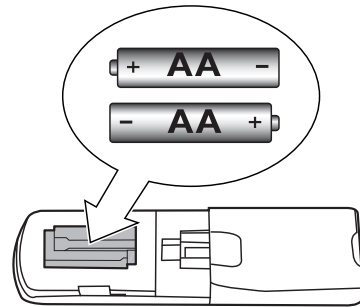

3. Slide the cover back into place.

**CAUTION:** Using this TV with other than the authorized accessories may cause the TV to become unstable, which can cause damage to the product or possible injury.

## Stand Installation

Required: Phillips Screwdriver

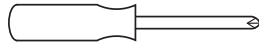

**1**

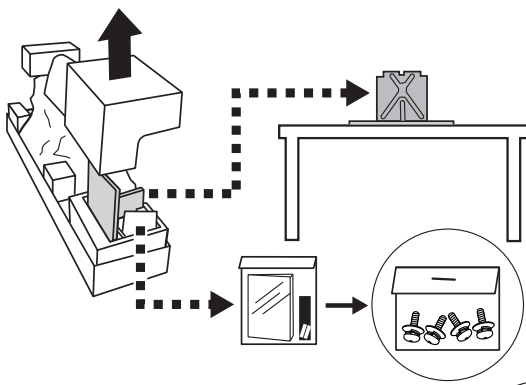

Extension pieces  
on back of stand

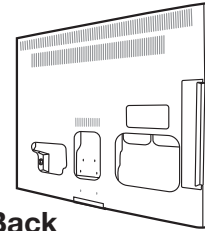
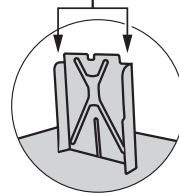

Back

**CAUTION**  
At least **TWO PEOPLE** are required to install the stand. Support the TV near the corners as shown. Failure to follow these recommendations may result in personal injury and damage to the product.

**2**

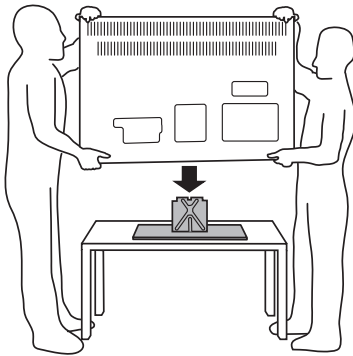

**DO** support the TV under the corners.

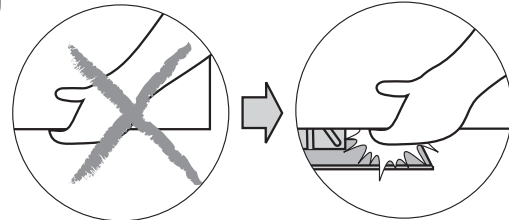
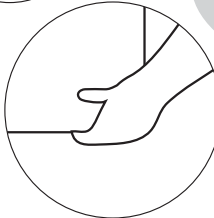

**DON'T** place your hand where it can get caught between the TV and stand.

Two adults are required to lift the TV.

**3**

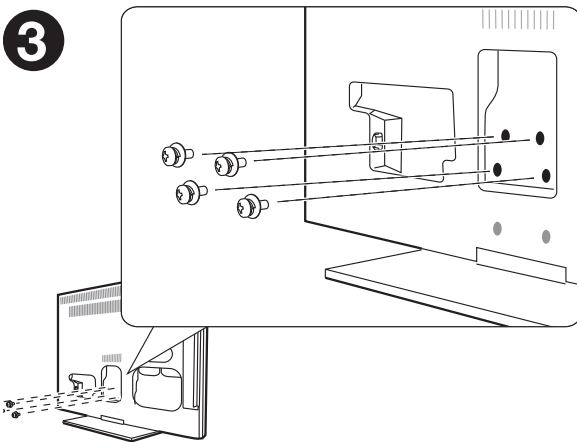

### Repacking the Stand

**CAUTION.** Place the stand in the foam insert with the extension pieces facing away from the TV. Otherwise, the TV will be damaged in transit.

Protect the TV and stand with the original packing material.

TV in protective wrapping

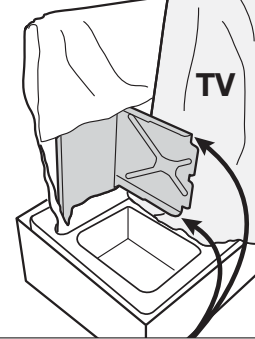

Extension pieces on stand must face out, away from TV.

## Wall-Mounting

If planning to wall-mount the TV, do not install the stand. To order a wall-mount kit, please contact Peerless Industries, Inc. at (800) 473-3753 or visit [www.peerlessmounts.com](http://www.peerlessmounts.com). Order wall-mount kit model ST650.

To order a wall-mount kit from Mitsubishi Digital Electronics America, Inc., please visit [www.mitsuparts.com](http://www.mitsuparts.com) or call (800) 553-7278.

Complete installation instructions are included with the kit.



### Before You Begin

1. Review the important safety, installation, and operating information at the beginning of this book.
2. Choose a location for your TV.
  - See the stand-installation or wall-mounting requirements on the opposite page.
  - Allow at least four inches of space on all sides of the TV to help prevent overheating. Overheating may cause premature failure of the TV.
  - Avoid locations where light may reflect off the screen.
3. Install the batteries in the remote control.
4. Plug the TV into an AC power outlet.

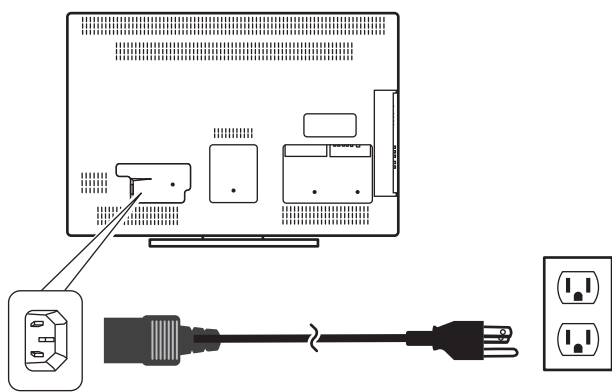

TV power connection

### First-Time Power-On

1. Confirm that the remote control is in TV mode.
  - Press the side button once to light the mode indicator and confirm that TV mode is active.
  - To change, press the side button additional times to activate TV mode.
2. Aim the remote control at the TV and press the **POWER** key . Wait for the **Welcome** screen.
3. Press **▼** if you wish to change the menu language to **Español**.
4. Press **▶** to move to the energy-mode selections. See the information box for details.
5. Press **▶** to highlight **EXIT**. Press **ENTER** to clear the menu.

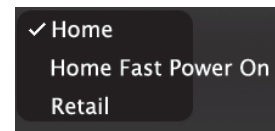
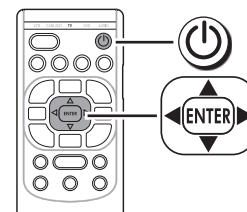
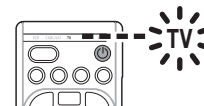
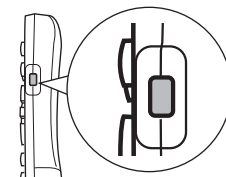

#### Welcome Screen Energy Options

- Mitsubishi recommends the **Home** setting, which uses power within ENERGY STAR® guidelines.
- **Home Fast Power On** allows the TV to power up quickly. While powered off, however, the TV uses power in excess of ENERGY STAR guidelines for a powered-down device.
- The **Retail** setting looks best under bright lighting. In this mode, the TV uses power in excess of ENERGY STAR guidelines.

This table compares energy choices offered in the **Welcome** screen.

	Home	Home Fast Power On	Retail
<b>Picture Mode</b>	<b>Bright</b>	<b>Bright</b>	<b>Brilliant</b>
<b>Backlight Level</b>	Reduced Brightness	Reduced Brightness	Full Brightness
<b>Time to Power On</b>	Normal	Fast	Normal

## TV Controls

### Remote Control

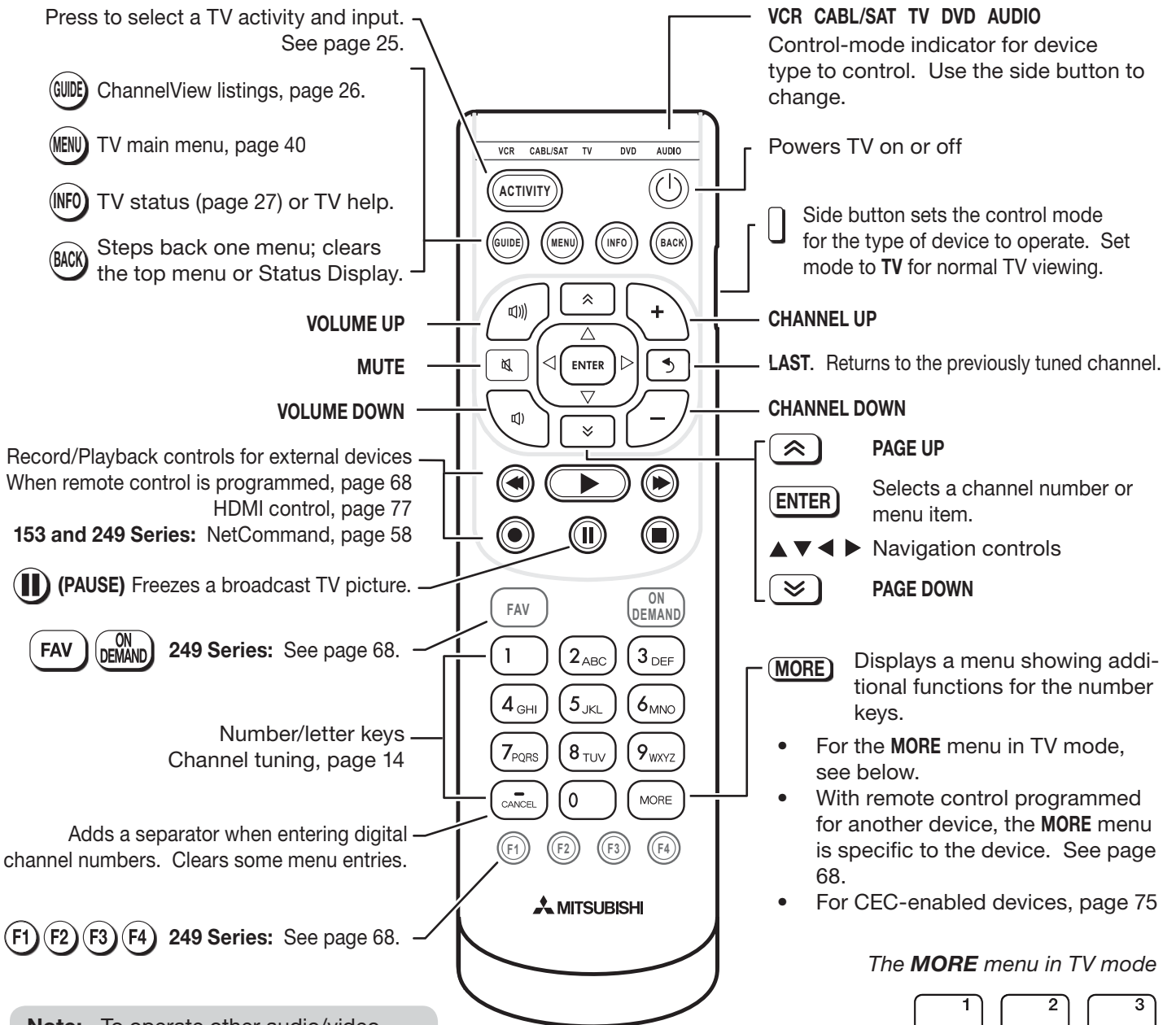

**Note:** To operate other audio/video devices using the TV's remote control:

- See Appendix A, "Programming the Remote Control."
- For HDMI devices compatible with the TV's HDMI Control feature, see Appendix B.
- **153 and 249 Series**
  - See page 55 for NetCommand IR "Learning" of device keys.
  - For use of specific keys with NetCommand-controlled devices, see "Special Operation Methods," page 58.

- CC** Closed Captions, page 46
- VIDEO** Video adjustments, page 41
- AUDIO** Audio adjustments, page 42

#### The **MORE** menu in TV mode

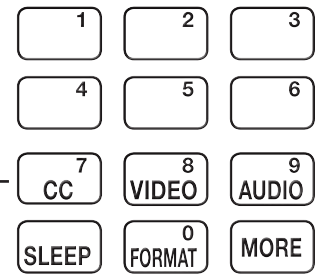

- SLEEP** Sleep Timer, page 25
- FORMAT** Picture shape (aspect ratio), page 28
- MORE** Clears the **MORE** menu.

## TV Controls, continued

### TV Control Panel

Buttons on the control panel duplicate some keys on the remote control.

- **ACTIVITY**, **CH**, and **VOL** are available when no TV menus are displayed.
- **▲▼◀▶** and **ENTER** are available when using TV menus or after activating a special function.

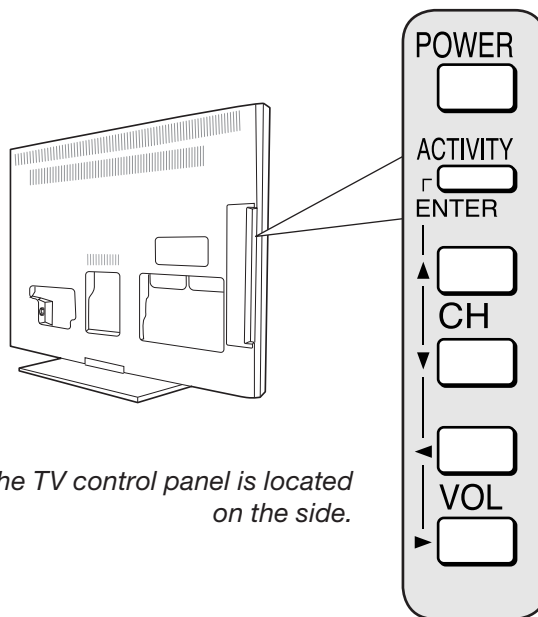

The TV control panel is located on the side.

### System Reset

If the TV fails to respond to the remote control, the control-panel buttons, or will not power on/off, perform System Reset. Recent setting changes made before using System Reset may be lost.

To perform System Reset, press and hold the **POWER** button on the control panel for ten seconds.

### Panel-Lock Release

- To release the Panel Lock using the TV control panel, press and hold the **ACTIVITY** button on the control panel for ten seconds. If the TV is off, press the **POWER** button to have it power on.
- To activate the Panel Lock, use the **Lock** menu, page 54.

### IR Sensor



The TV's IR (infrared) sensor receives signals from the remote control. Do not cover the sensor.

### POWER Indicator

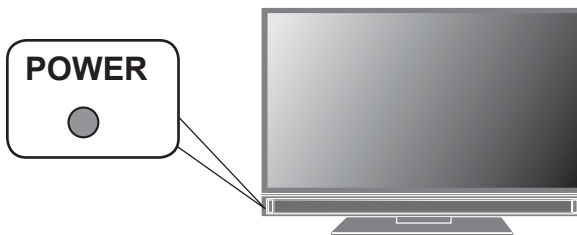

#### Key

- Off
- Steady On
- ◐ Slow Blinking

LED Color	TV Condition	Additional Information
None ○	TV is powered off.	Normal operation.
Green ●	TV is powered on.	Normal operation.
Green ◐	TV powered off, auto-on TV Timer is set.	Normal operation. TV can be turned on at any time.
Red ●	TV may require service.	Turn off the TV and unplug the set from the AC power source. Wait one minute and then plug the set back in. See Appendix E. If the red LED is still on, contact your dealer or a Mitsubishi Authorized Service Center. Go to <a href="http://www.mitsubishi-tv.com">www.mitsubishi-tv.com</a> or call 1-800-332-2119 to receive Authorized Service Center information.

## Setting Up TV Inputs

### Channel Scan for Digital Channels

If you skip this step, the TV cannot receive digital channels.

If using an antenna or direct cable service (no cable box), connect the incoming coaxial cable to the TV's **ANT** input. Refer to page 21.

You must perform a channel scan to enable reception of all available high-definition and standard-definition digital channels. The channel scan will search for channels available locally and save them to memory.

#### Memorizing Channels with Channel Scan For the ANT input

##### To start channel memorization

1. Power on the TV.
2. Press **MENU** and open the **Initial > Channel** menu.



Start channel memorization from the **Initial > Channel** menu.

3. Press **ENTER** to enter the menu.
4. Select **Ant Air** if connected to an over-the-air antenna. Select **Ant Cable** for direct cable (service without a cable box).
5. Highlight **Scan** and press **ENTER**. Channel memorization may take up to 15 minutes to complete.

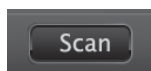
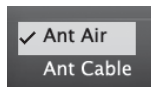

**To stop channel memorization before completion, press CANCEL.**

Use the **Initial > Channel > Edit** menu (page 48) for additional channel options, such as adding or deleting channels from memory.

### Setting Up Other Inputs

1. Connect your devices to the TV, making note of which TV input jack is used for each device. See "TV Connections," page 16, for recommendations.
2. Power on the devices to ensure detection.
3. Power on the TV.  
The TV will display the **New Device Found** screen for each new connection it detects. Learn more about Auto Input/Auto Output Sensing on the opposite page.
4. Select the device type if the device is not recognized automatically.

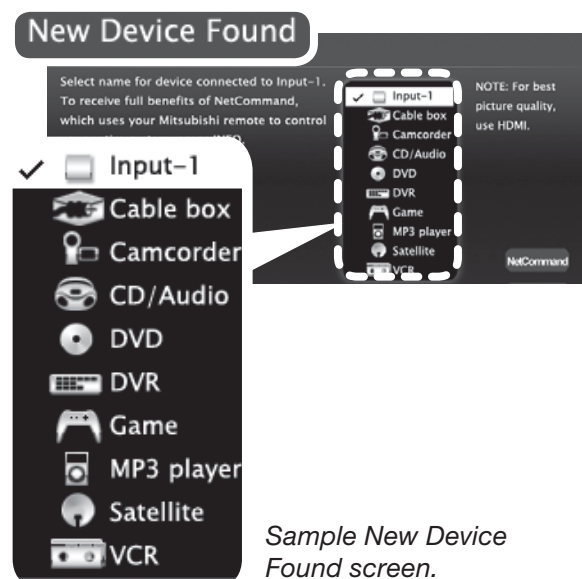

Sample **New Device Found** screen.

5. **153 and 249 Series.** You can perform NetCommand IR "learning" after selecting the device type or at a later time when convenient. To perform now, highlight **NetCommand** and press **ENTER**. See "Initial NetCommand Setup," page 57 or "Setting Up A/V Receiver Control," page 62.

#### Important Note for NetCommand IR Users

**153 and 249 Series.** Be sure to select the correct device type here. Although you can change the device type later in the **Inputs > Name** menu, any "learned" NetCommand IR codes will be erased when you make the change.

6. Press **BACK** to close the **New Device Found** screen. The TV will then display the **New Device Found** screen for the next connection it finds.

## Setting Up TV Inputs, continued

### About Auto Input Sensing/ Auto Output Sensing

This TV's Easy Connect™ Auto Input Sensing feature detects most connections automatically. The exceptions are:

- A connection on the **ANT** input
- An HDMI device that is powered off. Power on the device to ensure detection.

### Auto Sensing for Most Devices

When you first connect a device, the TV will:

- Detect the connected device and automatically switch to it.
- Prompt you to identify the device type.
- 153 and 249 Series.** Prompt you to perform NetCommand set-up for the device, if available.
- Repeat these steps for any other newly detected devices.

### When You First Connect a Device

- **Most Device Types.** Select the device type from the on-screen list. The device type you select here will appear as a device icon in the **Activity** menu.
- **A/V Receiver**
  - The TV detects audio connections on the **DIGITAL AUDIO OUTPUT** jack and the right (red) **AVR AUDIO OUTPUT** jack.
  - For an HDMI A/V receiver, select **AVR** from the list of device types if the A/V receiver is not recognized automatically.
- **HDMI CEC Devices Compatible with the TV's HDMI Control Feature.** Compatible CEC-enabled HDMI devices are often recognized automatically by the TV. HDMI Control may allow you to control some functions of a CEC-enabled device. See Appendix B, "HDMI Control of CEC Devices."

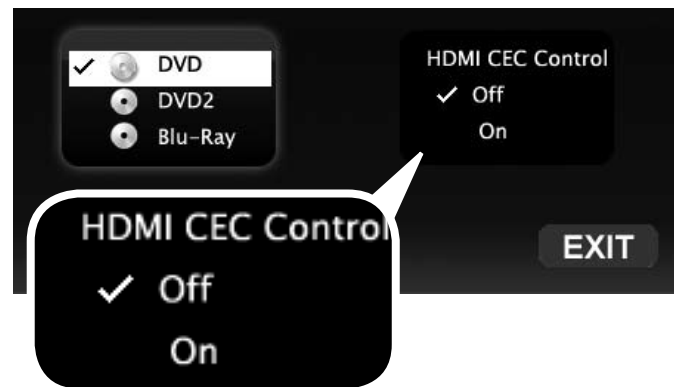

*New Device Found* screen for a device with HDMI control enabled. Select **On** to enable the TV's CEC control of the device. In some cases, as in the example above, you will also be prompted to select a device name.

### Tips on Auto Sensing

- Choose a different name for each input.
- The antenna input (**ANT**) is never detected, although you can turn off the unused antenna input in the **Inputs > Name** menu.
- Change the device type displayed in the **Activity** menu in the **Inputs > Name** menu (page 50). You must switch to a different input before changing the device type.
- **153 and 249 Series.** Any "learned" NetCommand IR codes will be erased if you change the device type in the **Inputs > Name** menu.

### Reactivating Auto Sensing for an HDMI Input

When you disconnect an HDMI device, Auto Sensing is disabled until you perform these steps.

1. Switch to any input other than the one to be disconnected.
2. Disconnect the HDMI device.
3. Delete the removed HDMI device in the **Inputs > Name** menu (see "Removing an HDMI Device," page 77).
4. Connect the new HDMI device and the **New Device Found** screen will display.

## Basic TV Operation

### Watching Broadcast TV

TV Connected to an Antenna, Direct Cable Service, Cable Box, Set-Top Box, or Satellite Receiver

1. Press **ACTIVITY**.
2. Press **▼▲** and **▶** to select a broadcast source. If you named devices during Auto Input Sensing, select an input from the **Watch TV** group. **Note:** Your TV may have only one group (**Watch TV**).

**Note:** For more about the **Activity** menu, see page 25.



Activity menu, antenna input selected

3. Press **ENTER** to switch to the input.
4. Tune to a channel on the ANT input using any of these methods.
  - Enter the channel number using the number keys on the remote control and press **ENTER**. For a two-part digital channel, such as 3-1, press 3 **CANCEL** 1 to enter a dash (separator).
  - Press **CHANNEL UP/CHANNEL DN (+, -)** to change channels one channel at a time.
  - Press **↶ (LAST)** to switch back to the previously tuned channel.
  - **Antenna or Direct Cable Only.** Press **GUIDE** to display ChannelView channel listings, highlight a channel number, and press **ENTER** to tune.

### Watching DVDs or Videos

TV Connected to a DVD Player, DVR, or VCR

1. Press **ACTIVITY**.
2. Press **▼▲** and **▶** to select a movie source. If you named devices during Auto Input Sensing, select an input from the **Watch Movie** group.

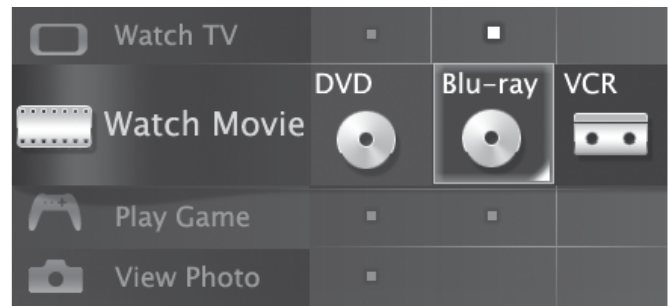

Activity menu, DVD input selected

3. Press **ENTER** to switch to the input.

## Basic TV Operation, continued

### Making Picture Adjustments

To get the best picture under different viewing conditions, set the Picture Mode before changing other video settings. Basic picture adjustments are described on page 41.

1. Press **MORE**.
2. Press **8 (VIDEO)**.
3. Press **▼ ▲** to display the **Picture Mode** adjustment.
4. Press **◀ ▶** to select a Picture Mode using these guidelines:

Name	When to Use
<b>Brilliant</b>	Under bright light
<b>Game</b>	With gaming consoles
<b>Bright</b>	For most daytime viewing
<b>Natural</b>	For most nighttime viewing

5. Press **▼ ▲** to display the name of the next adjustment you want.
6. Press **◀ ▶** to make the adjustment.
7. Press **BACK** to clear or just wait for the display to clear after a few seconds of inactivity.

Additional picture adjustments are described on pages 44 and 45.

### Audio Settings

#### Changing Audio Settings

1. Press **MORE**.
2. Press **9 (AUDIO)**.
3. Press **▼ ▲** to display the name of the adjustment you want.
4. Press **◀ ▶** to change the setting.

#### Changing the Audio Output

To switch audio output from the internal TV speakers to a connected external sound system or headphones:

1. Press **MORE**.
2. Press **9 (AUDIO)**.
3. Press **▼ ▲** until the **Speakers** option is displayed. The **Speakers** option will display only if an A/V receiver connection has been detected.
4. Press **▶** to switch between **TV** and either **AV Receiver** or **Headphones**.

### Other TV Features

- To set the TV Clock see page 47. Set the TV Clock if you plan to use the TV Timer (page 47) or ChannelView (page 26) features.
- To set parental controls, see the **Lock** menu, page 52.  
**Note: 249 Series.** To set parental controls for VUDU™ service, use the VUDU **Info & Settings** menu.
- To change the input names that appear in the **Activity** menu, see **Inputs > Name** options, page 50.
- To program the remote control to operate other A/V devices, see Appendix A, “Programming the Remote Control,” page 68.
- To activate Audio Lock to control an external sound system with the TV’s remote control left in **TV** mode. See page 69.
- To control compatible devices using HDMI CEC control, see Appendix B, “HDMI Control of CEC Devices,” page 75.
- To view still and moving digital camera images on the TV, see “Camera Images and Music Files,” page 31.
- **153 and 249 Series.** To control A/V devices with NetCommand, see chapter 5, “NetCommand IR Control for Most Devices” on (page 55).
- **249 Series.** See page 37 for internet video streaming with VUDU™.

### Other Information

- **General Cleaning.** See “Cleaning Recommendations,” page 78.
- **Troubleshooting, Service, and Product Support.** See Appendix E, page 81.
- **Warranty Information.** See the TV warranty on page 92.

# 2 TV Connections

## Before You Begin

### Auto Input/Auto Output Sensing

The TV's Auto Sensing feature automatically recognizes most connections and prompts you to identify the type of device connected. See page 13 for more on Auto Sensing.

### Connection Types

Use the connection types available on your input devices that will give the best video quality. For example, choose HDMI over component video, and choose component video over composite video.

### Picture Quality

For best picture quality, route signals directly from the input device to the TV whenever possible.

### Surround Sound

For best surround sound audio quality, route audio or HDMI cables from the source device directly to your TV (for Sound Projector) or directly to your A/V receiver if using an external sound system.

### IMPORTANT

**Accessory items such as cables, adapters, splitters, or combiners required for TV connections are not supplied with the TV. These items are available at most electronics stores.**

## Cable Management

Install the cable tie (supplied) in one of the four mounting holes on the back.

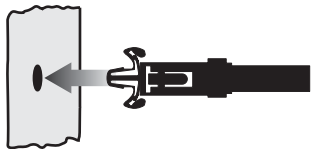
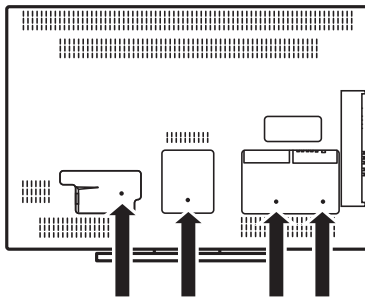

Lock the cable tie in place by pushing the end into the mounting hole.

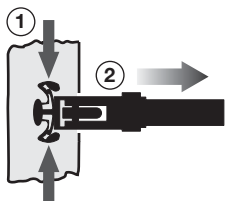

To remove the cable tie, squeeze the side tabs and pull out.

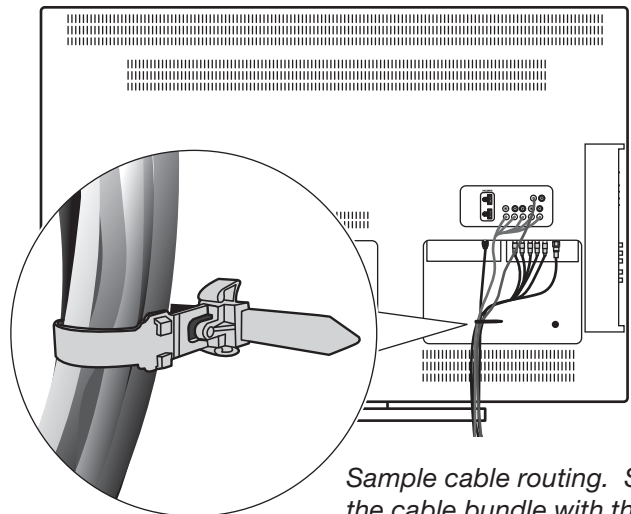

Sample cable routing. Secure the cable bundle with the release tab facing out.

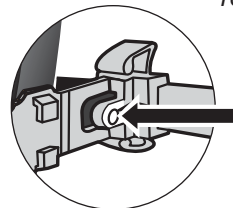

Press the release tab to loosen the cable tie.



# Inputs and Outputs

## Connector Panels

**IR-NetCommand Output/  
External Controller Input**  
153 and 249 series  
NetCommand, page 56  
External Controller Input,  
page 19

**RS-232C**  
249 series

**LAN**  
(Ethernet, port  
page 37)

**USBa, USBb**  
(power only,  
page 37)

249 Series. Additional ports are  
located in the central recessed area.

**VIDEO**  
(composite video,  
page 22)

**Y Pb Pr**  
(component video,  
page 20)

**HDMI**  
(page 20)

**ANT**  
(page 21)

HDMI1 HDMI2

Pr Pb Y/VIDEO R-AUDIO-L ANT

INPUT 1

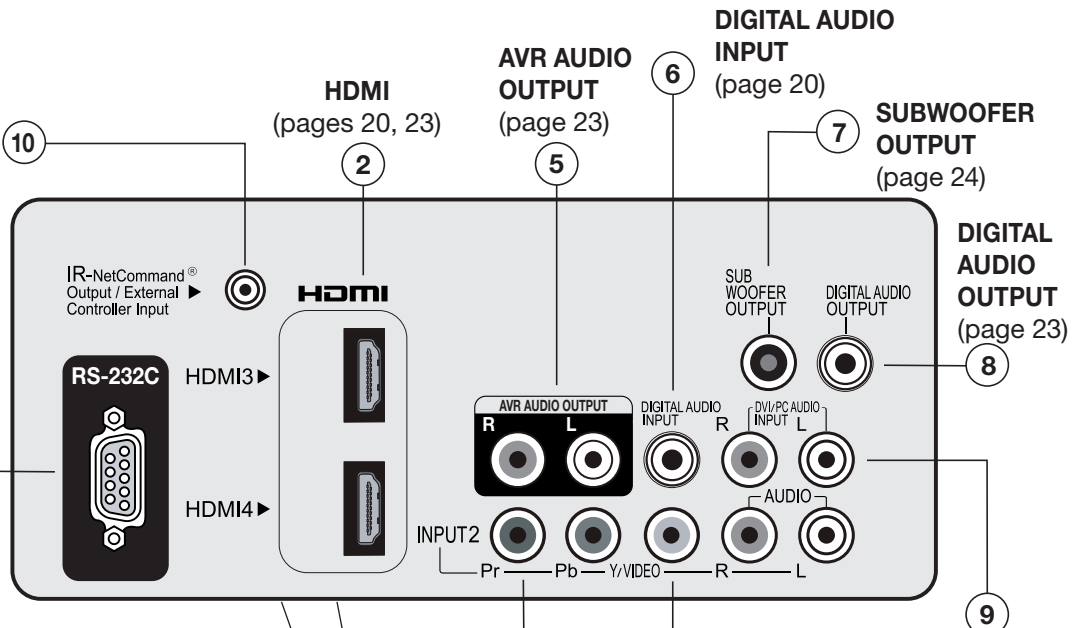

**AVR AUDIO  
OUTPUT**  
(page 23)

**DIGITAL AUDIO  
INPUT**  
(page 20)

**SUBWOOFER  
OUTPUT**  
(page 24)

**DIGITAL  
AUDIO  
OUTPUT**  
(page 23)

AVR AUDIO OUTPUT  
R L  
INPUT 2  
Pr Pb Y/VIDEO R L

DIGITAL AUDIO INPUT  
R L  
DVI/PC AUDIO INPUT  
L  
AUDIO  
R L

**Y Pb Pr**  
(component  
video, page 20)

**VIDEO**  
(composite video,  
page 22)

**DVI/PC AUDIO  
INPUT**  
(page 21)

Pr  
Pb  
**Y Pb Pr**  
(component video,  
page 20)

Y  
VIDEO  
R  
L  
**VIDEO**  
(composite video,  
page 22; with an audio-  
only device, page 24)

--- Calibration  
Microphone Input,  
153 and 249 series  
(page 36)

USB  
**11 USB**  
(page 31)

## Inputs and Outputs, continued

### 1. ANT (Antenna)

Connect your main antenna or direct cable service (no cable box) to **ANT**. The **ANT** input can receive digital and analog over-the-air channels from a VHF/UHF antenna or non-scrambled digital/analog cable source.

### 2. HDMI™ Inputs (High-Definition Multimedia Interface)

The HDMI inputs support uncompressed standard and high-definition digital video formats, PCM digital stereo audio, and digital 5.1 surround sound. These inputs are HDCP (High-Bandwidth Digital Copy Protection) compliant.

**Mitsubishi recommends you use category 2 HDMI cables**, also called high-speed HDMI cables, to connect HDMI 1.3 source devices. High-speed category 2 cables bring you the full benefits of Deep Color and **x.v.Color**.

The TV's HDMI inputs are compatible with many DVI-D and HDMI computer video signals.

Use the HDMI inputs to connect to CEA-861 HDMI compliant devices such as a high-definition receiver or DVD player. These inputs support 480i, 480p, 720p, 1080i, and 1080p video formats.

These HDMI inputs can also accept digital DVI video signals. To connect a device's DVI output to the TV's HDMI input, use an HDMI-to-DVI adapter or cable plus analog audio cables. Connect the analog audio cables to the **DVI/PC INPUT AUDIO** jacks on the TV to receive left and right stereo audio from your DVI device.

#### HDMI Cable Categories

HDMI cables are available as Category 1 and Category 2 types.

- **Category 2 Cables** (also called high-speed HDMI cables). Newer, HDMI 1.3-compliant DVD players, video games, and set-top boxes require Category 2 cables, suitable for clock frequencies up to 340 MHz or data rates of up to 10.2 gigabits per second. Use category 2 cables for high-speed 1080p HD signals carrying extended color encodings (i.e., 30 or more bits, also called Deep Color). Category 2 cables are also suitable for standard HDTV signals.
- **Category 1 Cables** (also called standard HDMI cables). Category 1 cables may be unmarked. They are suitable for standard HDTV 720p, 1080i, and 1080p signals with 8-bit color depth. Use category 1 cables for clock frequencies up to 74.25 MHz or data rates of up to 2.23 gigabits per second.

### 3. Y Pb Pr (Component Video)

Connect devices with component video outputs to this jack. Use the adjacent **AUDIO R** and **L** jacks if you wish to send audio to the TV.

### 4. VIDEO (Composite Video)

Connect a VCR, DVD player, standard satellite receiver, or other A/V device to the TV. Use the adjacent **AUDIO R** and **L** inputs if you wish to send audio to the TV.

### 5. AVR AUDIO OUTPUT

Use **AVR AUDIO OUTPUT** to send analog audio of the current program to an analog A/V surround sound receiver or stereo system. Digital audio from digital channels and HDMI devices is converted to analog audio by the TV for output on this jack. This is the only audio connection needed to the TV if using an analog A/V receiver or stereo system.

**Headphones.** These jacks can also be used for headphones that accept standard line level audio signals. An adapter may be needed.

### 6. DIGITAL AUDIO INPUT

This input sends digital surround sound to the TV's speaker array from a device, such as a DVD player, connected to **INPUT 2**.

### 7. SUBWOOFER OUTPUT

Connect a powered subwoofer to complement Sound Projector speaker effects.

### 8. DIGITAL AUDIO OUTPUT

This output sends Dolby Digital or PCM digital audio to your digital A/V surround sound receiver. Incoming analog audio is converted by the TV to PCM digital audio. If you have a digital A/V receiver, in most cases this is the only audio connection needed between the TV and your A/V receiver.

### 9. DVI/PC AUDIO INPUT

When connecting a DVI device to one of the TV's HDMI inputs, use these jacks to send left and right analog audio to the TV.

## ***Inputs and Outputs, continued***

### **10. IR–NetCommand Output/External Controller Input**

**153 and 249 Series.** Use an IR emitter cable with this jack to send control signals to external IR remote-controlled devices. Alternatively, your professional installer can use this jack as the input for an external controller.

Connect to this jack and when the ***New Device Found*** screen appears, select operation of the jack as either an input (for an external controller) or as an output (for NetCommand IR control). See page 56.

### **11. USB**

The TV can read JPEG photo files and mp3 music files from a USB device.

### **12. RS-232C**

**249 Series.** Use the RS-232C interface to receive control signals from compatible home-theater control devices. See [www.mitsubishi-tv.com](http://www.mitsubishi-tv.com) for a list of control signals for this interface.

### **13. LAN**

**249 Series.** Use the **LAN** Ethernet jack for streaming internet video to the TV. See page 37 for setup. Visit [www.VUDU.com](http://www.VUDU.com) for details about VUDU™ service.

### **14. USBa, USBb**

**249 Series.** Standard USB 5-volt, 500-milliamp power outputs you can use to supply power to an accessory device. For use with the VUDU wireless adapter, see page 37.

## Y Pb Pr Component Video Device

### HDTV Cable Box, Satellite Receiver, DVD/Blu-ray Player

Suitable for use with Sound Projector surround sound.

If your source device has an HDMI output, use the connections for HDMI devices described on this page instead of component video.

Required:

1. RCA-type component video cables
2. Audio cable(s)
  - 2a. Digital audio cable  
or
  - 2b. Left/right analog stereo audio cables.

#### Note:

- To hear digital surround sound from the TV's Sound Projector speaker array, connect the digital audio output from the device to the TV's **DIGITAL AUDIO INPUT** jack.
- To hear digital surround sound from an external sound system, connect the digital audio output from the device directly to your digital A/V receiver instead of the TV.

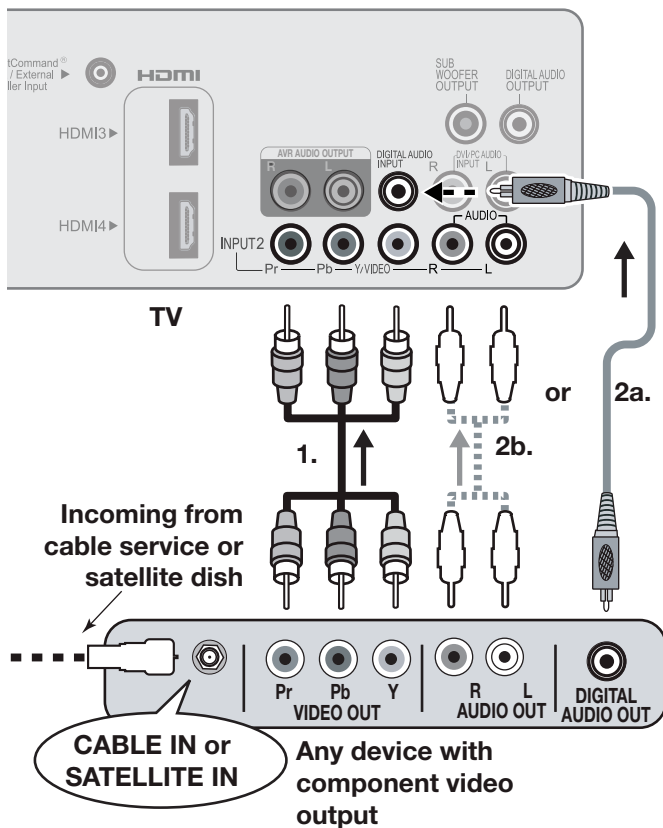

## HDMI Device

### HDTV Cable Box, Satellite Receiver, DVD/Blu-ray Player

Suitable for use with Sound Projector surround sound.

Required: HDMI-to-HDMI cable.

Connect an HDMI cable from the TV back panel to the HDMI device output. HDMI devices provide video and audio through the single cable. This connection sends digital surround sound from the source device to the TV's speaker array.

Mitsubishi recommends you use category 2 (high-speed) HDMI cables to connect HDMI 1.3 source devices. High-speed category 2 cables bring you the full benefits of Deep Color and **x.v.Color**. See "HDMI Cable Categories" on page 18 for more on HDMI cable types.

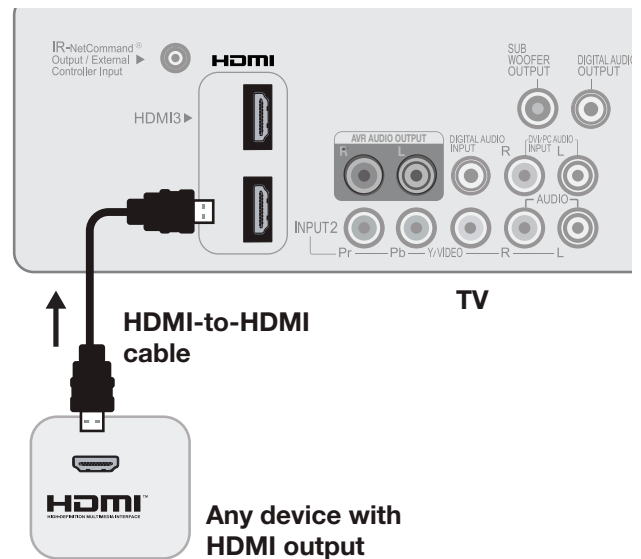

### DVI Video Device

#### Cable Box, Satellite Receiver, DVD Player

Connect DVI devices (digital only) to the TV's HDMI input jacks.

Required:

1. DVI-to-HDMI cable or DVI/HDMI adapter and HDMI cable
2. Left/right analog audio cables.

Some devices require connection to an analog input first in order to view on-screen menus and to select DVI as the output. Please review your equipment instructions for DVI connectivity and compatibility.

**Note:** The HDMI connection supports copy protection (HDCP).

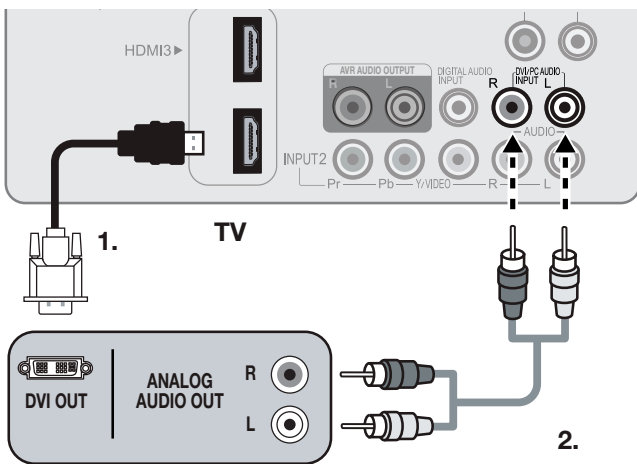

Any device with DVI output

### Antenna or Cable TV Service

Connect the incoming cable to the TV's ANT input.

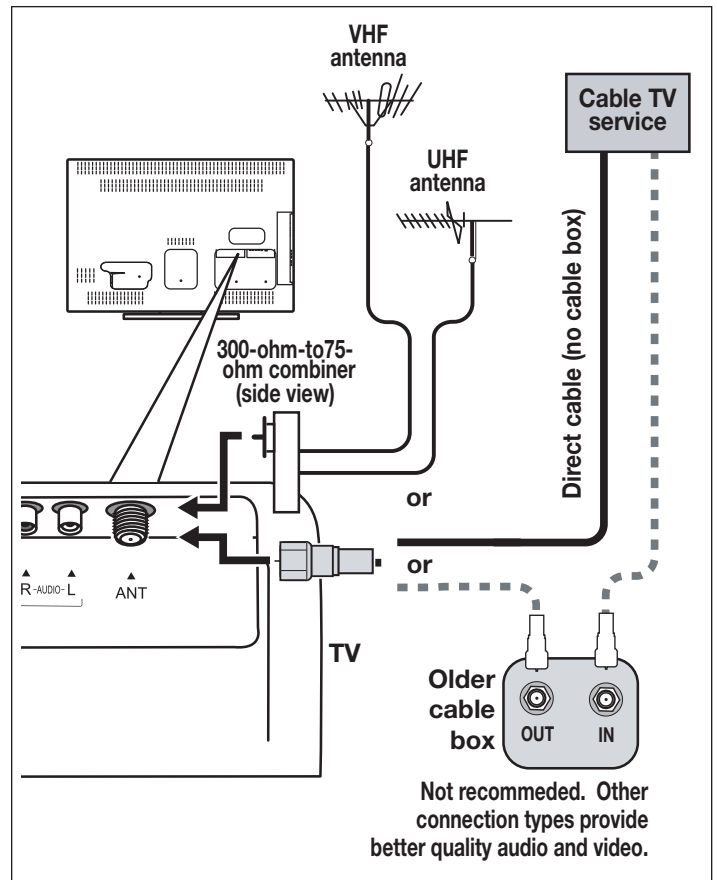

### Composite Video Device

#### VCR or other device with composite video output

Required:

1. Composite video cable (usually yellow)
2. Analog stereo audio cables.

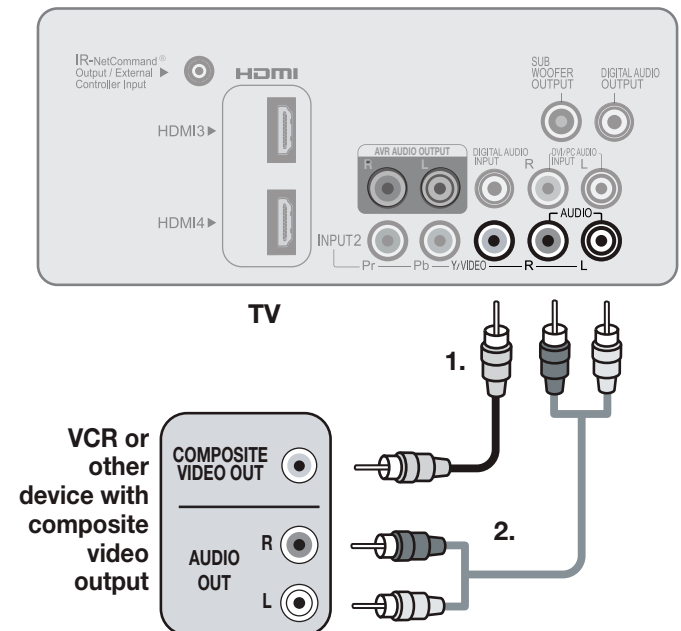

## VCR or DVD Recorder to an Antenna or Wall Outlet Cable

Required:

1. Video cables
  - 1a. Component video cables (red/blue/green)
  - or
  - 1b. Composite video cable (usually yellow)
2. Left/right analog audio cables.
3. Two-way RF splitter
4. Two coaxial cables

**Note:**

- Use composite video only if component video or HDMI are unavailable. For an HDMI connection between the TV and recorder, see page 20.
- If your recording device has an analog-only tuner, you must use a digital converter box to enable recording of digital broadcasts.

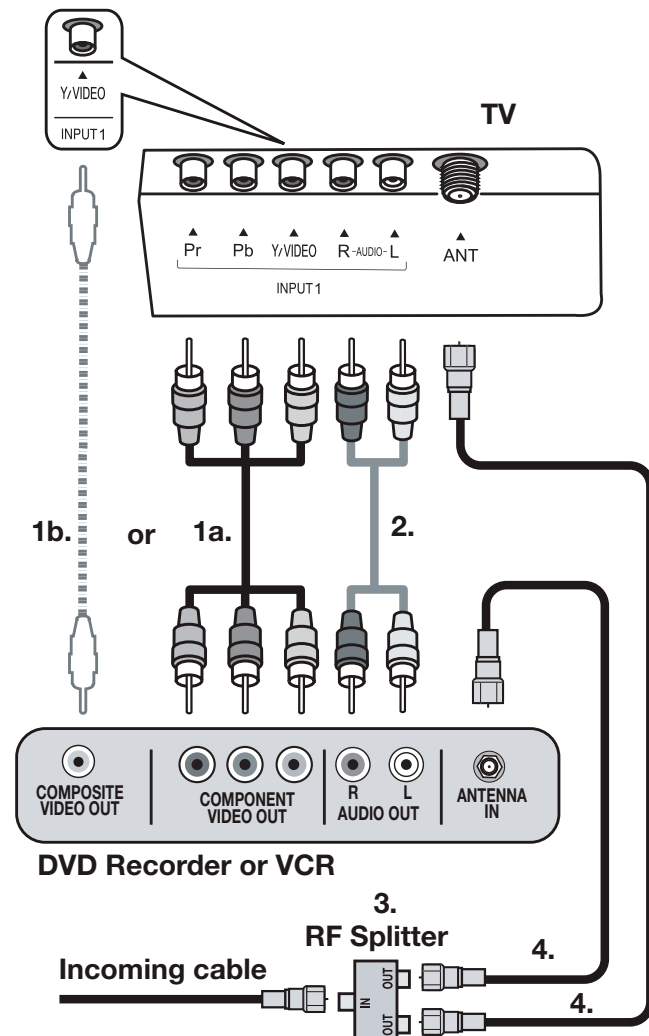

## VCR or DVD Recorder to a Cable Box

Required:

- Video cables
  - 1a. Component video cables (red/blue/green)
  - or
  - 1b. Composite video cable (usually yellow)
- 2. Left/right analog audio cables.
- 3. Two-way RF splitter
- 4. Three coaxial cables
- 5. Video and audio cables required to connect the TV to the cable box.

**Notes:** Use composite video if only if component video or HDMI are unavailable. For an HDMI connection between the TV and recorder, see page 20.

When using this connection configuration, it is possible to view live cable programs through the recording device. For best picture quality always view live cable programs directly from the TV input connected to the cable box device.

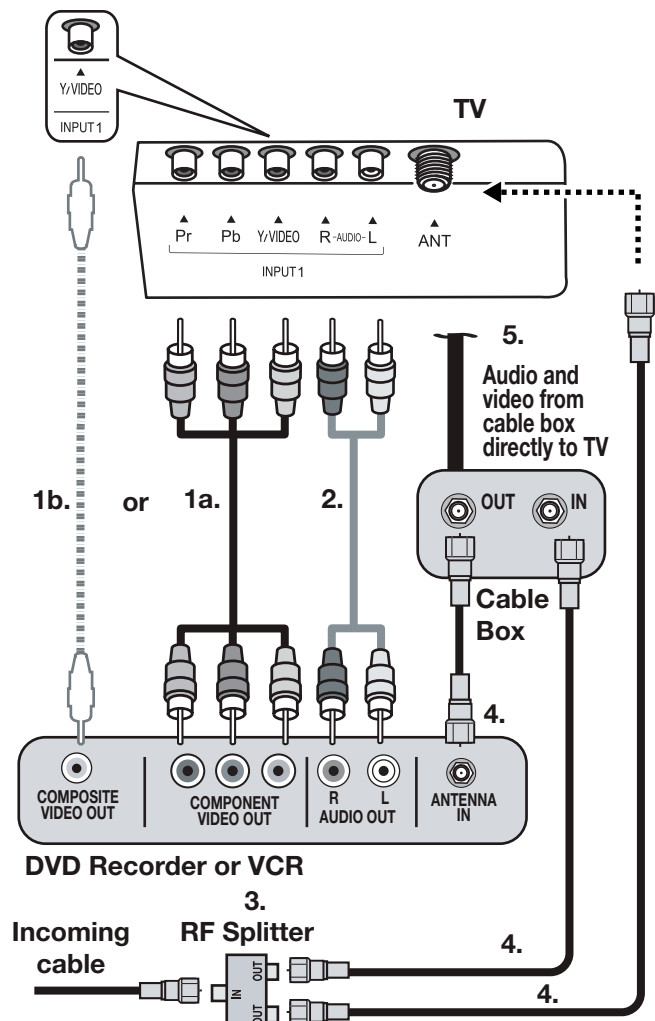

## A/V Receiver

Most setups require either a digital audio cable or analog stereo audio cables. To send audio from TV channels received on the **ANT** input or devices connected directly to the TV, you must use one of the connections shown below. Usually, only one of these connections is required.

The TV makes all audio available in digital and analog formats:

- Analog audio coming into the TV is available as output in digital stereo format on the **DIGITAL AUDIO OUTPUT** jack.
- Digital incoming audio is available as analog output on the **AVR AUDIO OUTPUT L** and **R** jacks.

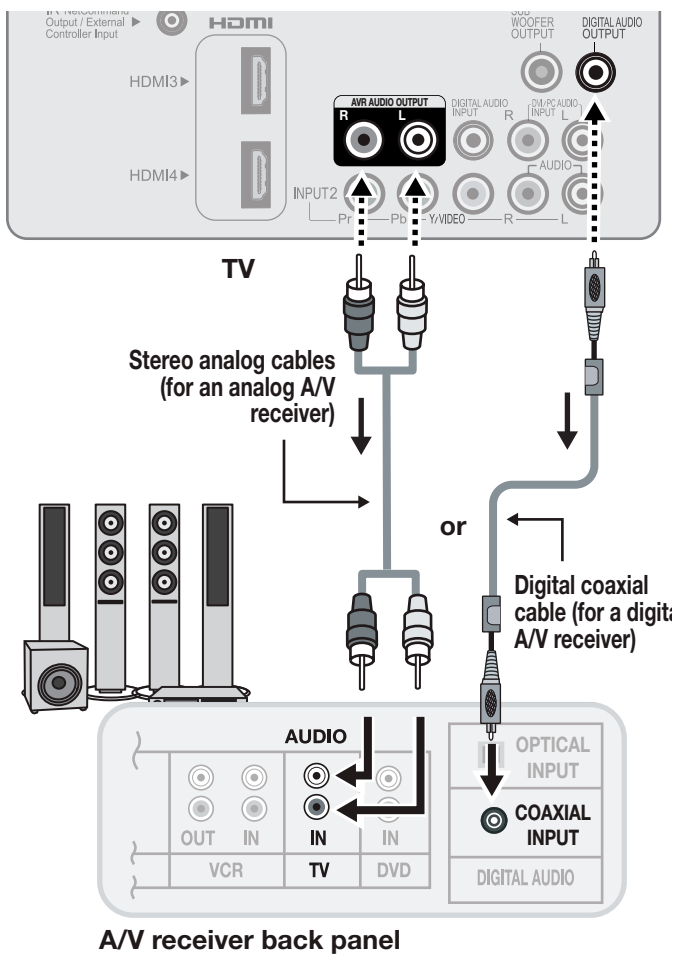

### Note:

- On rare occasions, an HDMI signal may be copy-restricted and cannot be output from the TV as a digital signal. To hear these copy-protected signals through the A/V receiver, use the connection for an analog A/V receiver.
- Check the A/V receiver's Owner's Guide for information concerning use of the digital input and switching between digital sound and analog stereo sound from the TV.

## A/V Receiver with HDMI Output

Required: One HDMI-to-HDMI cable

This option allows you to view content from devices connected to an A/V receiver over a single HDMI cable going to the TV. The HDMI cable can transmit both audio and video to the TV.

You can use an HDMI connection as described here in addition to an audio connection from the TV's audio output. The optional audio connection allows you to hear, through the A/V receiver, devices connected to the TV only, e.g., an antenna on the **ANT** input.

You may be able to use the TV's remote control (in **TV mode**) to operate connected CEC-enabled HDMI devices. Experiment with your equipment to determine which functions are available to the TV's remote control. See Appendix B, page 75.

**153 and 249 Series:** This setup allows you to use NetCommand-controlled audio and video switching over the HDMI cable. See "Case 3: Automatic Audio and Video Switching via HDMI" on page 65.

To use NetCommand to supplement HDMI control of a CEC-enabled A/V receiver, note the recommendations under "More About Using an HDMI Connection," page 65.

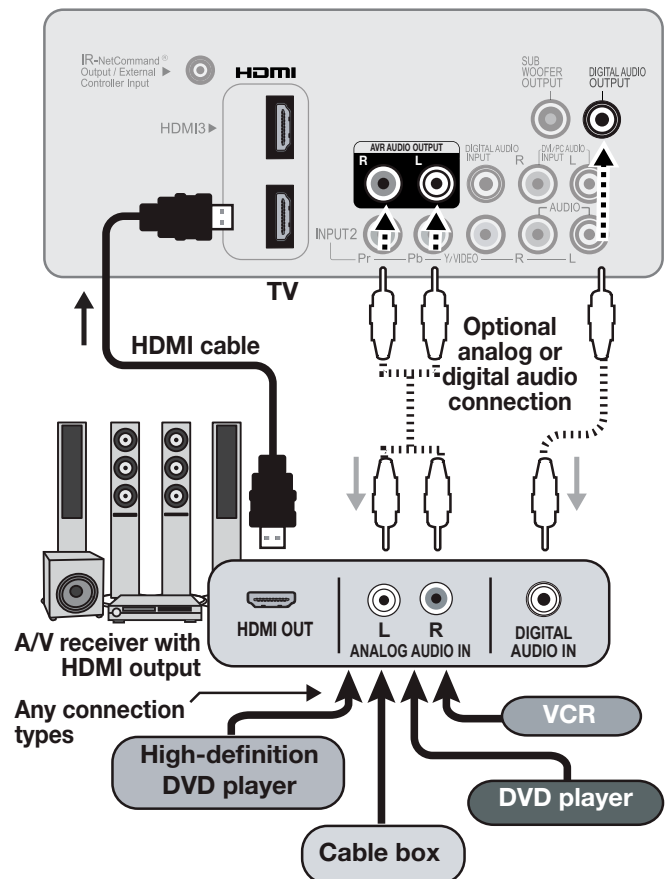

## Subwoofer

Required: Audio cable with RCA-style plug

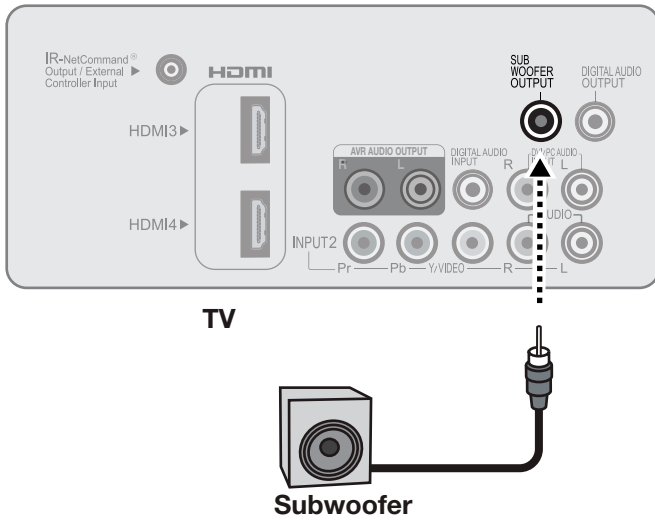

## Audio-Only Device

Keep an unused RCA-style connector in the **Y/VIDEO** jack while using an audio-only device such as an MP3 or CD player.

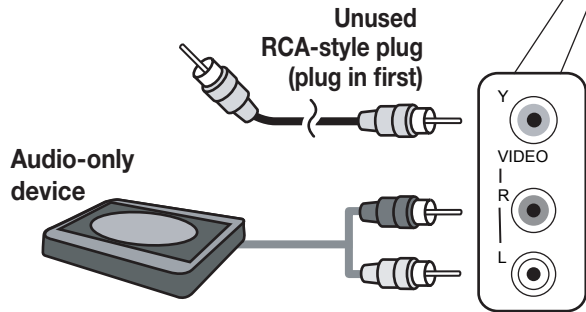



# 3 Using TV Features

## Selecting an Input

The **Activity** menu lets you switch TV inputs. If you named devices during Auto Input Sensing, the inputs are organized into groups based on possible ways to use each device.

1. Press the **ACTIVITY** key.
2. Use **▲▼** to move through groups of TV inputs.
3. Use **◀▶** to select an input.
4. Press **ENTER** to switch to the input.

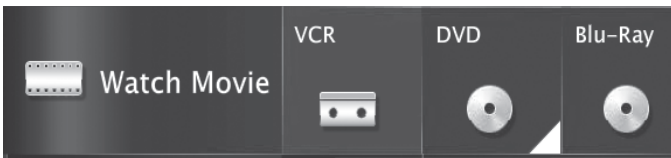

- To change the list of inputs shown in each activity group, see **Inputs > Activity**, page 50.
- To assign or change the names of input icons, use the **Inputs > Name** menu, page 50.

## Sleep Timer

The Sleep Timer turns the TV off after the length of time you set.

To set the TV to turn on at a certain time of day, see the **Initial > Timer** menu on page 47.

### Setting the Sleep Timer

1. Press **MORE** on the remote control. The TV's **MORE** menu will display.
2. Press **CANCEL (SLEEP)** repeatedly to increase the time in 30-minute increments. The maximum is 120 minutes.
3. Press **BACK** or wait five seconds without pressing any keys for the message to disappear.

### Viewing or Changing the Sleep Timer

1. Press **MORE**.
2. Press **CANCEL (SLEEP)**.
3. Press **CANCEL (SLEEP)** additional times to change the number of minutes before the TV powers off.

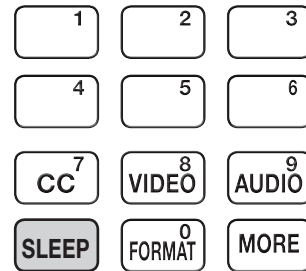

With the **MORE** menu displayed, press the **CANCEL** key on the remote control to activate or deactivate the Sleep feature.

## ChannelView Channel Listings



ChannelView. Programs for the tuned channel are listed on right side of screen.

ChannelView™ shows memorized channels on the **ANT** input. It displays channel names and program information for digital channels as sent by broadcasters or your local cable service provider (information may be incomplete). No program information is displayed for analog channels.

**Note:** You must set the TV Clock (page 47) to receive ChannelView listings for the current channel.

### Using ChannelView

Feature	Instructions
Receive updates for a digital channel.	<ol style="list-style-type: none"> <li>1. Press ▲ ▼ to highlight a channel number.</li> <li>2. Press the <b>INFO</b> key (the screen may briefly go blank).</li> </ol>
Display/hide ChannelView listings from the <b>ANT</b> input.	<b>GUIDE</b>
Scan channels one by one.	Hold ▲ or ▼.
Scan channels quickly.	Hold <b>PAGE UP/PAGE DN</b>
Jump to listings for a specific channel.	<ol style="list-style-type: none"> <li>1. Enter the channel number.</li> <li>2. Press <b>ENTER</b>.</li> </ol>
See more of the program description for the current channel (if available).	<b>INFO</b>
Tune to the highlighted channel.	<b>ENTER</b>

## Redirecting Audio Output

### Selecting an Audio Output Device

1. Press **MORE** and then **9 (AUDIO)**.
2. Press ▲ to show the **Speakers** option. The **Speakers** option will display only if there is a recognized audio device on an audio or HDMI output.
3. Press ► to select either **AV Receiver**, **Headphones**, or **TV**.

### Adjusting an External Subwoofer

1. Play sample video or music containing low-frequency bass sound.
2. Press **MORE** and then **9 (AUDIO)**. Use ▲ ▼ to display the **Subwoofer** option.
3. With **Subwoofer** set to **On**, press **ENTER** to display a slider for volume.
4. Press ◀ ▶ to adjust the subwoofer volume level.

### Disconnecting an Analog A/V Receiver

When you disconnect an analog A/V receiver, change the **Speakers** setting to **TV** to hear sound from the TV speakers. Change the setting using the remote control's **MORE > 9 (AUDIO)** key or the **Adjust > Audio > Speakers** menu.

## Controlling A/V Receiver Volume

### With a Standard TV Setup

- **Recommended Method:** Program the TV's remote control for your A/V receiver and enable the Audio Lock feature. See page 69.
- Program the TV's remote control for your A/V receiver and set the TV remote control's mode to **AUDIO**. Return the control mode to **TV** to control the TV.
- Use the remote control that came with the A/V receiver.

### With HDMI Control (CEC-Enabled HDMI A/V Receiver)

The TV's remote control may control some functions of the A/V receiver. See Appendix B, "HDMI Control of CEC Devices," page 75.

### With NetCommand IR Control

**153 and 249 Series.** Set up NetCommand control of the A/V receiver's volume functions in the **Inputs > AVR** menu. The TV's remote will then control A/V receiver volume. See page 62.

## Status Display

Press the **INFO** key to see the on-screen status display. The most common displays are shown here.

Sample information from the on-screen status display

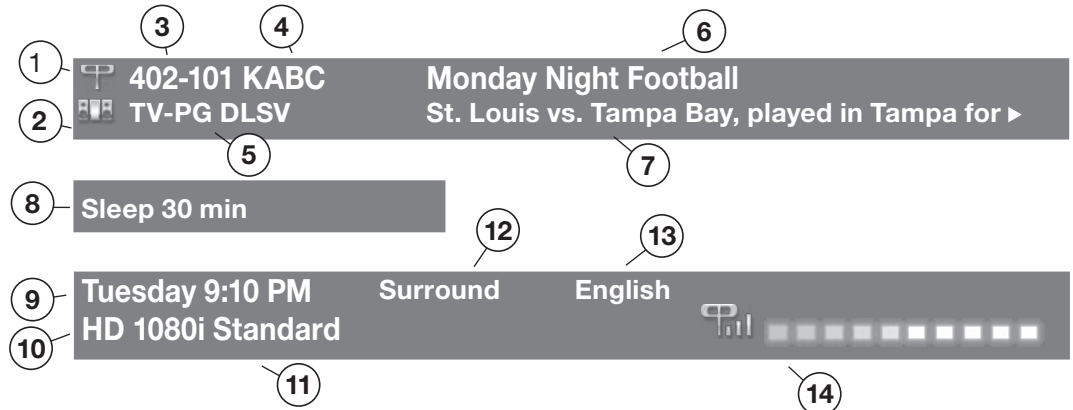

### About Channel Numbers

#### Channel Numbers for Over-the-Air Reception or Reception by Direct Cable

**Note:** All signals are automatically converted to 1080p for display.

#### Standard-Definition Analog Channels



480i Stretch

Receiving Standard-Definition Analog Signal (480i)

#### Standard-Definition Digital Channels



SD 4:3 Stretch

Receiving Standard-Definition Digital Signal (SD)

#### High-Definition Digital Channels



HD 16:9 Stretch

Receiving High-Definition Digital Signal (HD)

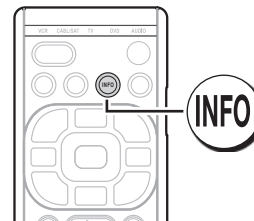

1. Current Input
2. Audio Indicator. Key:
  - TV speakers
  - External sound system
  - Headphones
  - Mute
3. Channel number (antenna source only)  
Digital channel includes major and sub-channel numbers.
4. Digital channel name (if broadcast); antenna source only.
5. V-Chip rating
  - Antenna source only for digital signal
  - Antenna or **VIDEO** composite jack for analog signal
6. Program name (if broadcast); digital source only
7. Program description (if broadcast); digital source, antenna only. Press the **INFO** key additional times to see more of the description.
8. Sleep Timer remaining time
9. Day and time
10. Signal type being received
11. Screen format in use
12. **Program Audio** indicator (antenna source only)
  - Digital source: Stereo, Surround
  - Analog source: Stereo, Stereo SAP, SAP
13. Available language (digital source, antenna only)
14. Signal-strength indicator (digital source, antenna only)

## TV Signals and Display Formats

This is a 16:9 widescreen TV suitable for images available from HDTV and many DVDs. You can view older-style, squarish images (4:3 aspect ratio) using one of the display formats described on this page. Press the **MORE** key and then the **0** key (**FORMAT**) to cycle through available display formats. The TV remembers the format you last used for each input.

### DVD Image Definitions

Image information may be stated on the DVD case. Some DVDs support both formats described below.

**Anamorphic (or Enhanced for WideScreen TV).** Indicates DVDs recorded to show widescreen images properly on 16:9 TV sets using the TV's Standard format mode (recommended).

**Non-Anamorphic (or 4:3, 1.33:1, Letter Box, or Full Screen).** Indicates DVDs recorded for viewing on squarish TV screens. They may be full screen (4:3 or 1.33:1) which crops movies to fit the narrow TV, or letter box, which adds black top and bottom bars.

### Signal Definitions

**480i:** Older type of interlaced signals from the **ANT** input, composite **VIDEO**, component **Y Pb Pr**, or **HDMI** jacks.

**480p:** Progressive-scan DVD signals on component **Y Pb Pr** or **HDMI** jacks.

**720p and 1080i:** High-definition signals received through component **Y Pb Pr** or **HDMI** jacks. These signals are always 16:9 (widescreen).

**1080p:** High-definition signals from a PC or Blu-ray player, **HDMI** inputs only.

**SD 4:3:** Standard-definition squarish-screen-format signals from digital channels on the **ANT** input.

**SD 16:9:** Standard-definition widescreen-format signals from digital channels on the **ANT** input.

**HD 16:9:** High-definition 16:9 widescreen signals from digital channels on the **ANT** input.









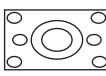
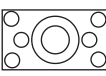

### TV Display Format Definitions

**Standard:** The full-screen format used by HDTV signals. Use this format to display anamorphic DVDs with a 1.78:1 or 1.85:1 aspect ratio. Anamorphic DVDs with a 2.35:1 aspect ratio are displayed correctly but with top and bottom black bars. Squarish (4:3) images are stretched evenly from side to side. Available for all signals.

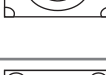



**Expand:** Enlarges the picture to fill the screen by cropping the top and bottom; useful for reducing the letter box top and bottom bars of non-anamorphic DVD images.

**Zoom:** Enlarges the picture to fill the screen by cropping the sides, top, and bottom to eliminate black bars.

- **480i/480p and SD 4:3 signals:** Eliminates top and bottom bars on anamorphic DVDs with a 2.35:1 aspect ratio.
- **720p, 1080i, SD 16:9, and HD signals:** Eliminates bars added to squarish 4:3 images.

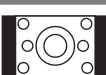
Original Signal	TV Display	
	Non-anamorphic or SD 4:3	Anamorphic DVD
<b>Standard</b>	 Distorted. Not recommended.	 Recommended
<b>Expand</b>	 Recommended for letterbox. See Note 1.	 Distorted; not recommended. See Note 1.
<b>Zoom</b>	 Distorted. Not recommended. See Note 1.	 Recommended for anamorphic 2.35:1 images. See Note 1.
<b>Stretch</b>	 Recommended for standard broadcasts. See Note 1.	 Distorted; not recommended. See Note 1.
<b>Stretch Plus</b>	 Recommended for standard broadcasts. See Note 1.	 Distorted; not recommended. See Note 1.
<b>Narrow</b>	 See Note 1	 Distorted; not recommended. See Note 1.

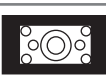
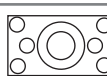
**Note 1:** Available for 480i, 480p, and digital SD 4:3 signals only.

Original Signal	Display Formats		
<b>SD 16:9 or HD Digital 720p, 1080i, 1080p Signal</b>			<b>Wide Expand</b> Recommended to remove side bars.
			<b>Zoom</b> Recommended to remove bars from the top, bottom, and sides.
(except 720p)			<b>Full Native</b> Best for computer or game images (component and HDMI only)

**TV Display Formats.** Press **MORE** and then **0 (FORMAT)** to see the displays available for the current program. Press **INFO** to see the name of the display format in use.

**Stretch:** Stretches squarish 4:3 images across the screen to display the entire image with less distortion than Standard.

**Stretch Plus:** Similar to Stretch, but minimizes distortion on the sides by expanding the picture to crop off portions of the top and bottom. Use **▲ ▼** to adjust the vertical position of the picture.

**Narrow:** Displays narrow 4:3 images in their original shape. Adds black side bars to fill the screen.

**Wide Expand:** Enlarges the picture, cropping the image on both sides. Removes or reduces black side bars added to narrow images converted to 16:9 signals for digital broadcast.

**Note:** All high-definition channels send widescreen (16:9) signals, but not all programming was created for the widescreen format. The broadcaster may stretch the image or add side bars to fill the widescreen area.

**Full Native:** Displays all pixels in the original image

## Using the TV with a Personal Computer

### Connecting a Computer to the TV

Use one of the connection methods listed below based on your computer's video output.

Computer Video Output	Video Connection	Audio Connection
<b>Digital DVI</b>	DVI-to-HDMI cable or an HDMI cable with an HDMI-to-DVI adapter	Stereo audio cables
	<b>Note:</b> If the computer's audio output is a single mini jack, a mini audio-to-RCA-male "Y" adapter cable is also required.	
<b>HDMI</b>	HDMI-to-HDMI cable	No additional audio connection is required.

#### IMPORTANT

This TV accepts digital computer signals only.

1. Connect the computer's digital signal output to one of the TV's **HDMI** jacks. See the connection diagrams for the method suited to your equipment.
2. Connect the computer's audio output using one of these options:
  - For digital DVI signals, connect analog left/right audio to the TV's **DVI/PC INPUT AUDIO** jacks.
  - For HDMI signals, no additional audio connection is required.
3. Power on the TV and computer. The TV will detect the connection and display the **New Device Found** screen.
4. In the **New Device Found** screen, press **▲▼** to highlight **PC** in the list of device types. It is important to use the name **PC** so that the TV processes the video signal correctly.
5. Press **BACK** to close the **New Device Found** screen.

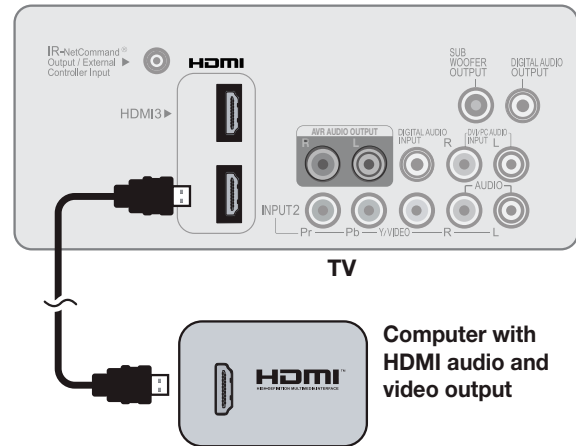

An HDMI-to-HDMI connection carries all video and audio on a single cable.

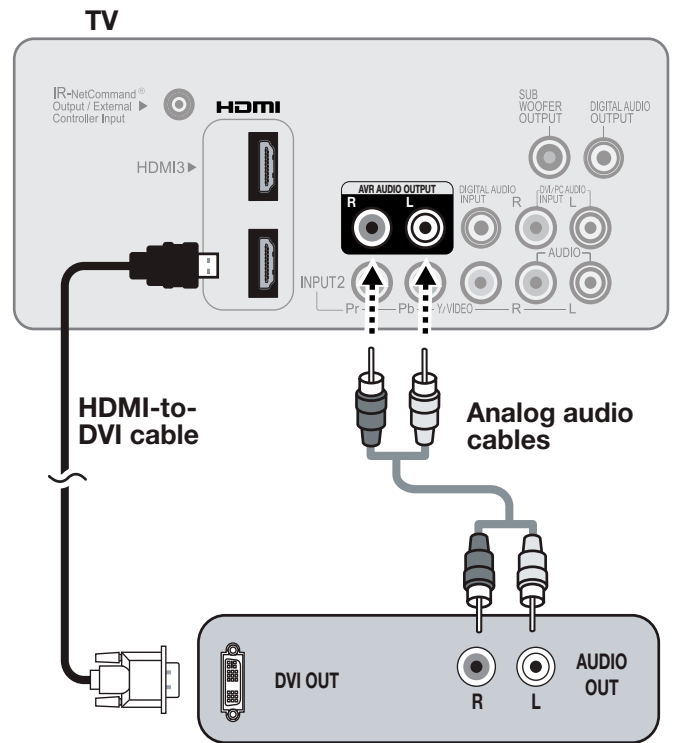

A DVI connection from a personal computer requires a separate audio connection.

**Note:** If your computer provides digital audio output (coaxial or optical), you can connect it directly to a digital A/V receiver and bypass the TV.

## Using the TV with a Personal Computer

### Computer Video Adjustments

1. Power on the computer.
2. Select **PC** from the **Activity** menu. To do this, press **ACTIVITY** to open the **Activity** menu, move the highlight to the PC icon, and press **ENTER**.
3. Working from the computer, change the resolution of the computer image. View the computer image on the TV and maximize the computer resolution while maintaining a suitable aspect ratio for the image.
4. Perform TV video adjustments. Press **MORE** then press **8 (VIDEO)** repeatedly to access video-adjustment options.
5. Press **MORE** then press **0 (FORMAT)** repeatedly to find the picture format (aspect ratio) best suited to the image. See the chart on this page showing how different computer resolutions can be displayed on the TV.

#### Distortion in Computer Images

Computer images may show distortion when viewed on the TV, e.g., lines that should be straight may appear slightly curved.

### Image Resolution

Your Mitsubishi TV can display the resolutions shown in the chart from standard VGA (640 x 480) through 1920 x 1080 signals at a refresh rate of 60 Hz.

In most cases, the computer will select the best resolution match to display on the TV. You can override this setting if you wish. Refer to your computer operating system's instructions for information on changing the screen resolution.













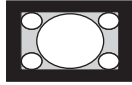
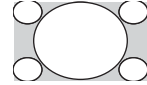

You may need to restart the computer for changes to take effect.



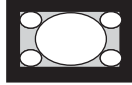

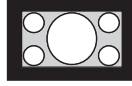

#### Tip

Set the computer's screen saver to display a pattern after several minutes of inactivity. This acts as a reminder that the TV is powered on

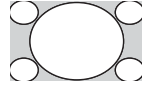
### Computer Display Formats

Press **MORE** then press **0 (FORMAT)** repeatedly to cycle through the TV displays available for your computer's video signal.

Computer Signal	As Displayed on TV Screen			
	Original Format	4 X 3 Standard	16 X 9 Standard	Zoom
VGA 640 X 480				
WVGA 848 X 480				
SVGA 800 X 600				
WSVGA 1064 X 600				

Original Format	Standard	Zoom
XGA 1024 X 768		
PC 720p 1280 X 720		
WXGA 1360 X 768		
SXGA 1280 X 1024		

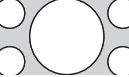
Original Format	Standard
PC 1080p 1920 X 1080	

## Camera Images and Music Files

- The TV can read photo or music files from a USB drive. Photos must be in JPEG format and music files must be in mp3 format. To play music files while displaying a photo slide show, see “USB Media Setup Menu” on the next page.
- The TV can display files of still or moving images from a camera through the **Y/VIDEO** port.

### The USB Media Player Menu

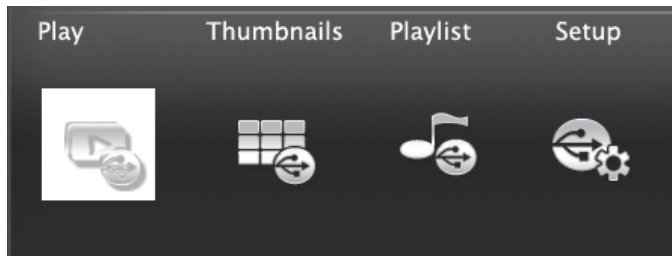

#### Displaying the Menu

1. Back up the data on your USB drive before connecting it to the TV. Mitsubishi is not responsible for any file damage or data loss.
2. Connect your USB drive to the TV's USB port. The **USB Media Player** menu displays while files are being read. Wait until the **Play** icon appears highlighted and in full color.

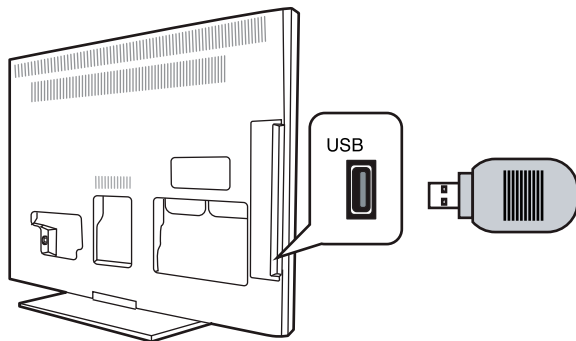

The TV can read photo and music files from the USB port.

3. From the USB Menu you can:





Activate any of the menu options	Highlight an icon and press <b>ENTER</b> .
Display the <b>Activity</b> menu.	Press <b>ACTIVITY</b> . Press again to clear.
Display the main menu.	Press <b>MENU</b> . Press again to clear.
Display status for the file source.	Press <b>INFO</b> . Press <b>BACK</b> to clear.

4. To resume use of the USB port after switching the TV to a different input, press **ACTIVITY**, choose **View Photos**, and select the USB port.



#### Playing a Slide Show or Playlist

Use these keys while playing a slide show or playlist.

 or <b>ENTER</b>	Replays the slide show or playlist.
	Pauses a slide show or playlist.
	Stops a slide show or playlist.
	Displays the previous or next slide. Plays the previous or next track.
<b>GUIDE</b>	Rotates an image clockwise in 90° increments.
<b>BACK</b>	Displays the <b>USB Media Player</b> menu.
<b>MENU</b>	Displays the main menu and stops play.
<b>ACTIVITY</b>	Displays the <b>Activity</b> menu and stops play.
<b>INFO</b>	Displays slide name or track name. Press <b>BACK</b> to clear.

#### IMPORTANT

Always stop playback with  (STOP) or change to a different TV input before disconnecting your USB device.

The TV can read JPEG files as created by the camera. If you edit a picture file on a computer and resave the image, the TV may be unable to read the resaved file.

## Camera Images and Music Files, continued



### Thumbnail and Playlist Menus

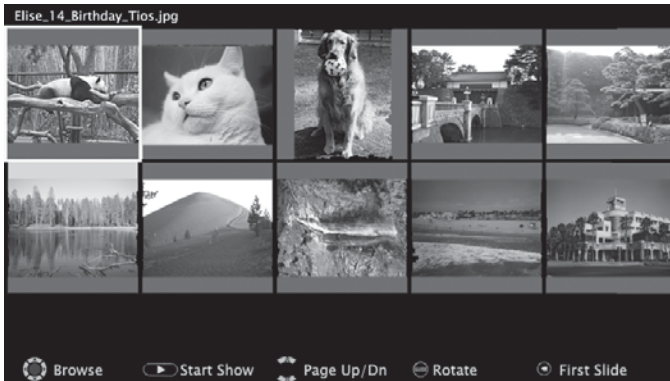

#### JPEG Thumbnail Menu

Use these keys while viewing JPEG thumbnail images or the music tracks in a playlist.

▲ ▼ ◀ ▶	Moves the highlight from item to item.
GUIDE	Rotates a thumbnail clockwise in 90° increments
▶ or ENTER	Plays the slide show or playlist starting with the highlighted item.
▶	Selects the last item on the current page.
◀	Selects the first item on the current page.
⏪ ⏩	Displays the next or previous page of items.
BACK	Displays the <b>USB Media Player</b> menu.
MENU	Displays the main menu.
ACTIVITY	Displays the <b>Activity</b> menu.

#### Picture Files Compatible with the USB Port

- Still images recorded on digital cameras using the Exchangeable Image File Format, version 2.1 (EXIF 2.1) standard for digital still cameras and Design Rules for Camera File Systems version 1.0 (DCF 1.0)
- Some images opened and resaved on a computer may not play back or may not display in the thumbnail list. This happens if the files were resaved in an incompatible format.
- Full path file names can be no longer than 50 characters and must end in a .jpg extension. Only the first 20 of the 50 characters will display.



### USB Media Setup Menu

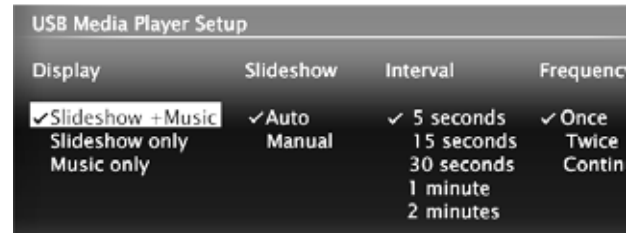

Use the USB **Media Setup** menu set up play of a slide show or playlist.

- If JPEG image files and mp3 files are on the USB device, choose:
  - **Slideshow + Music**
  - **Slideshow**
  - **Music only**
- **Slideshow.** Select either **Auto** or **Manual** advance for the slide show. During manual operation, press **ENTER** to advance to the next slide.
- **Interval.** For automatic advance, select the time interval for display of each slide. The interval you select here is the minimum time between slides; actual time may be longer for larger files.
- **Frequency.** For automatic advance, select the number of times (frequency) to play the complete slide show and/or playlist: **Once**, **Twice**, or **Continuous**.
- Press **BACK** to close the **Media Setup** menu and return to the **Media Player** menu.

#### Notes on Using the USB Port

- The TV ignores all commands while reading files. Wait until the **Play** icon appears highlighted and in full color before continuing.
- Large files or high-capacity storage devices may take a long time to display.
- The TV can read files up to 10 MB in size with a maximum of 2,500 files stored on the device. The FAT16 or FAT32 file system is recommended.
- Use a USB drive instead of a card reader.
- Back up the data on your USB drive before connecting it to the TV. Mitsubishi is not responsible for any file damage or data loss.
- Some manufacturers' devices may be incompatible with the TV. If the TV is unable to display your photos, you can:
  - Transfer files to a different USB drive.
  - Use your digital camera's composite video output. See page 33.



## Photos and Moving Video as Composite Video

Connect the camera to the TV using a composite video cable if:

- You are unable to see images using the USB port.
- You wish to view moving video from the camera.

Control the slide show or movie through the camera as the TV's **USB Media Player** menu will be unavailable. The display resolution will be standard-definition (480i).

1. Refer to the owner's manual supplied with the camera for instructions needed for this setup.
2. Set the camera's output signal type to **NTSC** and put the camera into playback mode.
3. With the camera still turned on, connect your digital camera's composite video cable (usually yellow) to the TV's **Y/VIDEO** jack. To hear audio, connect the camera's audio output cable to the **AUDIO L** jack.

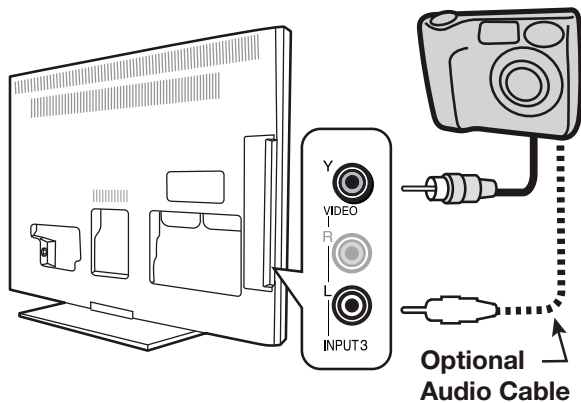

Camera connection using a composite video cable

4. When the **New Device Found** screen displays, assign the name **Camcorder**.
5. Press **BACK** to close the **New Device Found** screen.
6. Press **ACTIVITY**, select **Watch Movie > Cam**, and press **ENTER**.



7. If viewing photos, advance through the images manually or set the camera to advance automatically.

## Sound Projector

### Sound Projector Technology

The TV's bank of speakers can be adjusted to reflect sound off the room walls to create a surround sound effect.

Setup can be performed manually and/or automatically, depending on your TV model:

Manual setup only	151 series
Manual or Auto setup	153 and 249 series

- To create the surround sound effect, the room walls must reflect sound and not be covered with sound-absorbent material.
- Repeat the setup procedure if you reconfigure the room's walls or furnishings.

### Before You Begin

#### Positioning the TV

- Center the seating area in front of the TV and at least six feet away from it.
- Arrangements that give good results:

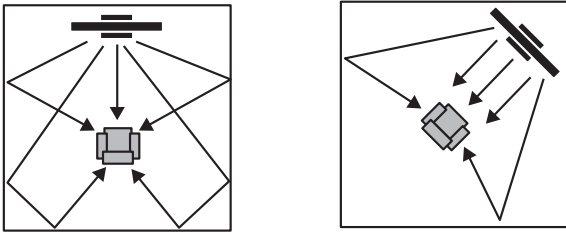

- If the room is an odd shape, locate the TV to take best advantage of wall reflections.

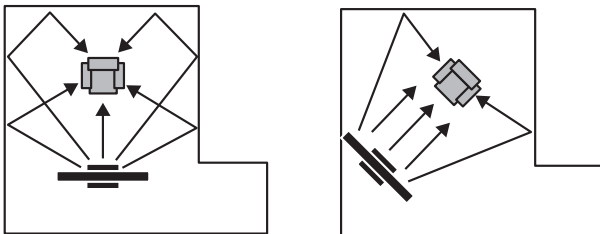

- Avoid locations that may distort sound reflections.

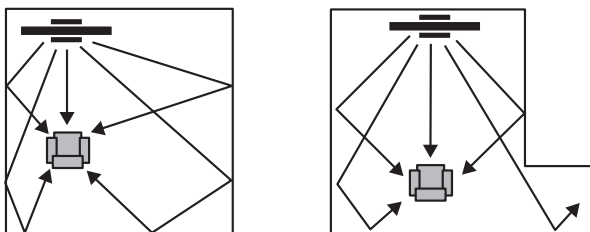

### Connecting the TV

To get the full benefit of the TV's Sound Projector, the TV must be connected to a source input providing digital surround sound. The TV can receive digital surround sound on:

- Any HDMI jack
- The **DIGITAL AUDIO INPUT** jack (when used in conjunction with **INPUT 2**)
- The **ANT** input (from some digital broadcasts)

See page 20 for suggestions on connecting your devices.

### Basic Setup

**Note: 153 and 249 Series.** If you have already performed Auto setup, any manual adjustments will erase all settings created during Auto setup.

- Press **MENU** and go to **Initial > SoundPro**. Press **ENTER** to enter the menu.



- Enter the room dimensions and layout information requested in the screen. To change measurements, press **▲▼**.

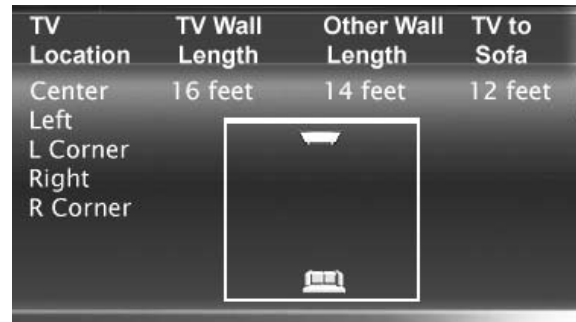

- Press **MENU** to exit.
- Play some sample audio to check sound quality. If further adjustment is needed, use the **Custom** menu as described below.

### Custom Menu

Use the **Custom** menu after defining the room layout.

For a room with large areas of curtains that might affect sound reflection, do the following:

- Open the curtains fully to improve sound reflection.
- Set angles by performing the procedure in "Adjusting Beam Angles."

## Sound Projector, continued

- c. Close the curtains.
  - d. Set levels by performing the procedure in “Adjusting Levels.”
1. From the **Initial > SoundPro** menu go to the **Custom** menu.
  2. Position yourself in your usual viewing location. Remain in this position, looking at the TV, while making the following adjustments.
  3. **Adjusting Beam Angles**
    - a. Adjust **Center Beam Angle** until sound is about equal in both ears.
    - b. Adjust **Left Beam Angle** to maximize sound heard from the front left side.
    - c. Adjust **Right Beam Angle** to maximize sound heard from the front right side.
    - d. Adjust **Left Surround Beam Angle** to where the sound seems to come from the left rear side. If this cannot be achieved, make the setting the same as that for Left Beam Angle.
    - e. Adjust **Right Surround Beam Angle** to where the sound seems to come from the right rear side. If this cannot be achieved, make the setting the same as that for Right Beam Angle.
  4. **Adjusting Levels**
    - a. Adjust **Center Level** to the mid level.
    - b. Adjust the following levels one at a time so that each one sounds about the same as the center level:
      - Left Level**
      - Right Level**
      - Left Surround Level**
      - Right Surround Level**
    - c. Check all sound levels by quickly switching between them using ▲▼.
    - d. Readjust individual levels in small increments and recheck as above until all sound levels seem about the same.
  5. **Adjusting an External Subwoofer**
    - a. Play sample video or music containing low-frequency bass sound.
    - b. Press **MORE** and then **9 (AUDIO)**. Use ▲▼ to display the **Subwoofer** option.
    - c. With **Subwoofer** set to **On**, press **ENTER** to display a slider for the volume.
    - d. Press ◀▶ to adjust the subwoofer volume.

### How to Make Adjustments in the Custom Menu

- Press ▲▼ to select an audio beam; colors of the adjusters correspond to audio beams in the on-screen diagram.
- Press ◀▶ to redirect the audio beam or change the sound level.

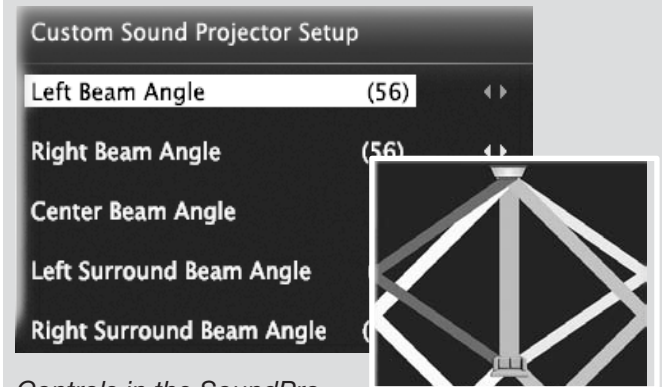

Controls in the **SoundPro > Custom** menu adjust the direction and focus of the TV's sound output.

At extreme beam angles, adjustment may be limited and the image on screen may not accurately represent the sound beams.

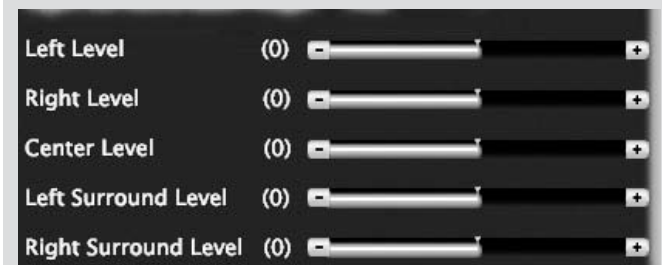

Adjust the volume level of individual audio beams using sliders in the **SoundPro > Custom** menu.

### Resetting Angle and Level Values in the Custom Menu

1. Press **BACK** to clear all menus.
2. Press **MENU**. Go to the **Initial > SoundPro** menu and press **ENTER**.
3. Change any setting (e.g., **TV Location**).
4. Press **BACK** to clear all menus.
5. Press **MENU**. Go to the **Initial > SoundPro** menu and press **ENTER**.
6. Enter the correct values for the room layout.
7. Return to the **Custom** menu to adjust angles and levels.

## Sound Projector, continued

### Auto Setup

#### 153 and 249 Series

Auto setup uses a calibration microphone to optimize Sound Projector performance for most room conditions. If the room is very large or has many obstacles affecting the sound beams, you may wish to try manual setup, which is done without the microphone.

#### Initial Preparation

1. Position and connect the TV as described under "Before You Begin," page 34.
2. Power on the TV and external subwoofer, if any.
3. Plug the microphone cable into the TV's **INPUT 3** left audio jack.

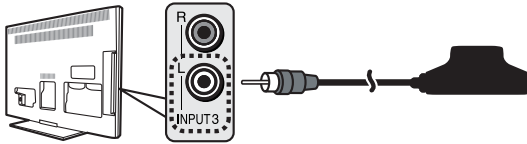

4. Place the microphone as described in the guidelines on this page.

#### Start Auto Setup

1. Press **MENU** and go to *Initial > SoundPro.*



2. Press **ENTER**. Set **Mode** to **Auto**.

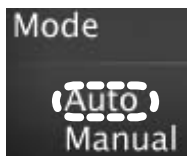

3. Highlight **START** and press **ENTER**.



5. Quietly exit the room right away. The calibration sequence will start in a few seconds and may be loud. It is important to leave the room as your presence will interfere with the calibration process.
6. Wait for completion of setup before returning to the room.
7. Play some sample audio material to check the sound quality.

**Note:** Do not perform manual adjustments after running Auto setup, as doing so will erase all settings defined during Auto setup.

8. Store the microphone out of direct sunlight and away from heat.

### Microphone Placement

- Make sure there are no large obstacles between the TV and microphone.
- Place the microphone
  - On a flat, level surface at least six feet away from the front of the TV.
  - On a tripod or on the backrest of your seating.
  - At the same height yours ears would be when watching TV. The height must be within 3 vertical feet of the height of the TV's speaker array.
  - Centered in front of the TV, not off to the side.

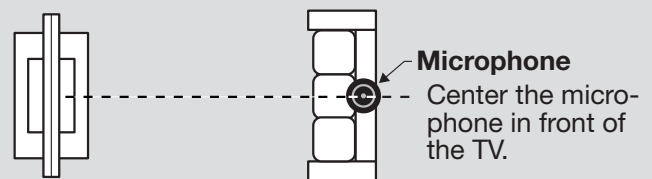
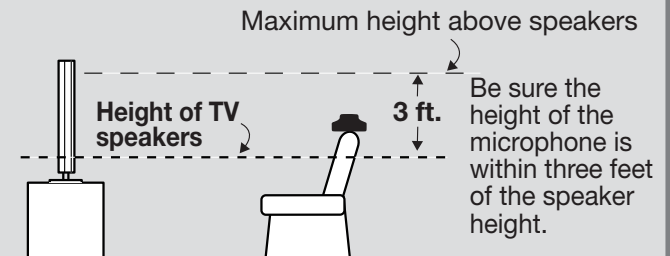
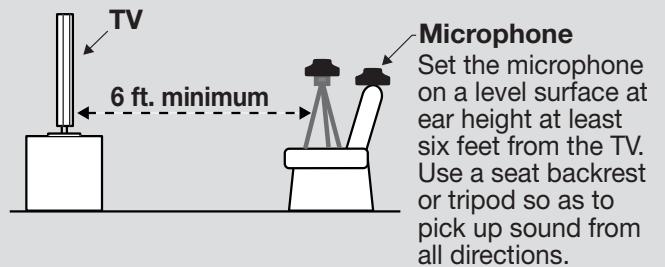

## Streaming Internet Movies with VUDU

**249 Series.** This TV's built-in VUDU™ capabilities allow you to access your own personal home video store right on your TV. VUDU's service offers you:

- The largest on-demand HD movie selection anywhere, featuring full 1080p and 5.1 surround sound.
- All of Hollywood's latest hits and classics. Movies are available to rent or buy the same day the movie comes out on DVD.
- VUDU allows you to enjoy movies with no store visits, no mailing, no late fees and no subscriptions.
- Parental controls allow you to restrict access to content according to MPAA ratings. See the VUDU **Info & Settings** menu.
- VUDU features popular internet applications like Pandora, Picasa, and many others.

Visit [www.VUDU.com](http://www.VUDU.com) to learn more about available titles, prices, recommended bandwidth, and services offered. At the time of this writing, VUDU requires an internet bandwidth of 4.0 Mbps or higher for instant HD video and 2.0 Mbps or higher for instant SD video. These specifications are subject to change. For a list of recommended routers and switches, see the **Support > FAQ** section at VUDU.com.

### Required for VUDU Service

- Broadband internet service
- Ethernet cable **or** the VUDU wireless kit.
- Computer access to the VUDU.com website (required for one-time account activation).
- A credit card for rental and purchase transactions.

### Standard Connection

Connect the TV to your network router or directly to a high-speed internet modem using an Ethernet cable (not supplied).

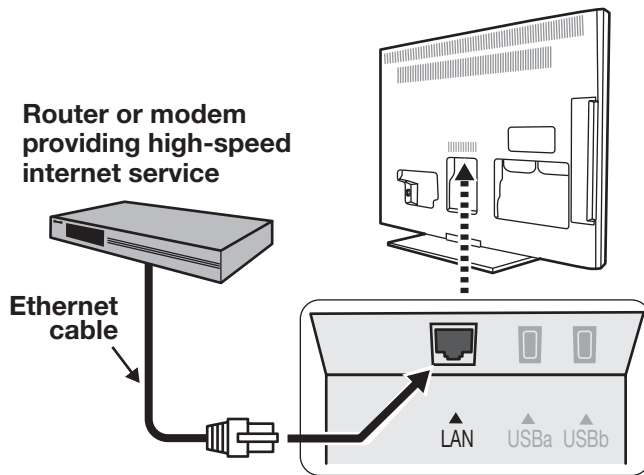

Standard VUDU connection via Ethernet

### VUDU Wireless Kit

The VUDU wireless kit is available for purchase from **VUDU.com**. The kit includes the two wireless boxes, two power cables, and two Ethernet cables shown in the diagram below. VUDU capabilities are built right into the TV, so connect VUDU Wireless Box 2 directly to the TV as shown.

- The LED indicators for **POWER** and **ETHERNET** will light up once power is applied to the boxes.
- After a few seconds, the LED indicator for **WIRELESS** will start to blink, indicating the wireless adapters have been set up successfully.
- The LED indicators for **WIRELESS** and **ETHERNET** will blink when data is being transmitted.

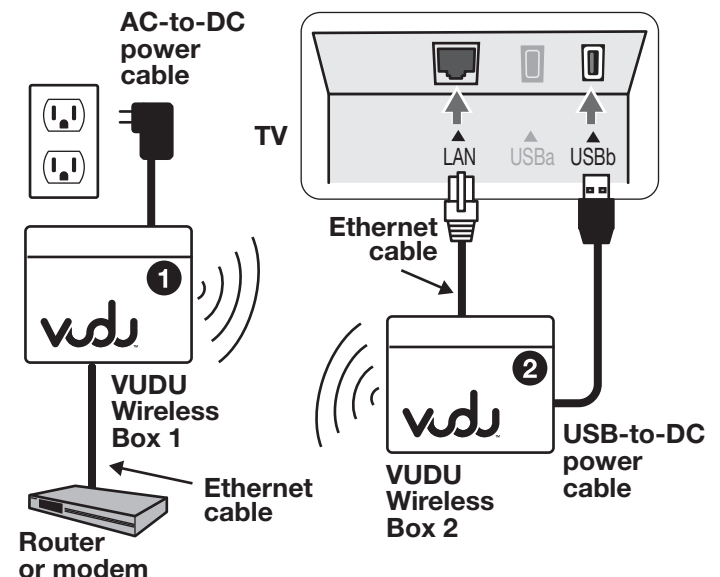

Connecting the VUDU wireless kit. Connect VUDU Wireless Box 2 directly to the TV.

## Streaming Internet Movies with VUDU, continued

### Getting Started

1. To start using VUDU, connect your TV to the internet as described in the previous section.
2. Power on the TV.
3. Press **ACTIVITY** to display the **Activity** menu.

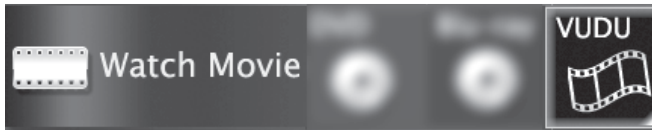

4. In the **Watch Movie** activity, highlight the VUDU icon and press **ENTER**.
5. Browse the VUDU catalog and offerings.
6. When you are ready to rent or buy a movie, you will be prompted to activate your VUDU account. Follow the on-screen instructions and use a computer to go to [www.VUDU.com/activation](http://www.VUDU.com/activation). A credit card is required for activation.

Once your account is activated, you can rent and buy movies using only the TV and the TV's remote control.

### Troubleshooting

#### If the VUDU Screen Is Not Responding

Press **MORE** and then **2 (RESET)** to reset VUDU. This resets VUDU only and does not affect TV settings.

#### If You Are Unable to Connect to VUDU

- Check all power and data connections.
- If you can reach the internet with a computer or other device on the same internet service used by the TV, consult the router or modem owner's guide for reset instructions.
- If you cannot reach the internet, contact your service provider. You may be asked for network information such as the TV's IP address. Press the **MORE** key and then press **1 (NETWORK)**.

#### For Further Assistance

- If you are having trouble connecting your TV or accessing internet applications, contact Mitsubishi Customer Care at 1-800-332-2119.
- If you are having difficulty with your VUDU account, contact VUDU Customer Care at [www.VUDU.com/support](http://www.VUDU.com/support).
- See more troubleshooting tips in the TV Reset Comparison Guide starting on page 81.

**Using VUDU** Navigate VUDU's menus with the keys on the TV's remote control. Browse the movie catalog, watch movie previews, set parental controls, and rent or buy movies.

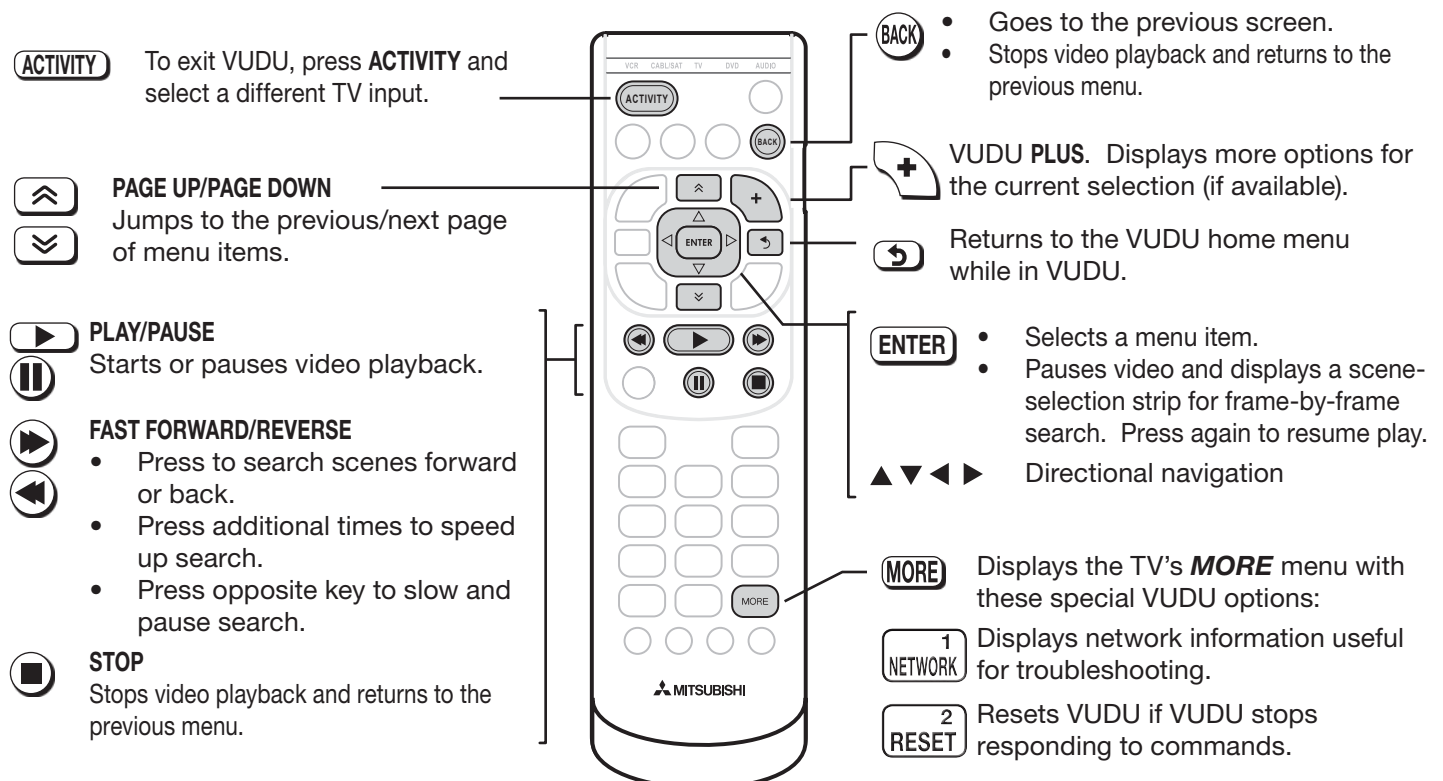

## Introduction to Home-Theater Control

This summary offers some examples of control methods available using the **TV's remote control**. You may wish to use one or more of these methods in your home theater after completing Auto Input Sensing.

### Source device connected directly to the TV

#### Remote Control Programming (Any Connection Type)

Program the remote control to operate the A/V device. To control the device, set the remote control to the correct mode for the device type. See Appendix A, "Programming the Remote Control." In the case of an A/V receiver, use the Audio Lock feature, page 69.

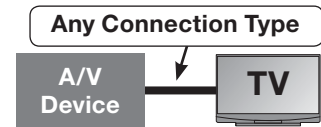

#### CEC-Enabled HDMI Device (HDMI Connection Only)

See Appendix B, "HDMI Control of CEC Devices," page 75.

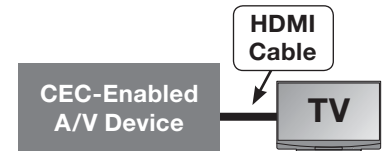

#### 153 and 249 Series: NetCommand IR Control (Any Connection Type)

Set up NetCommand IR control of the device's keys as desired. See "IR Emitter Placement," page 56, and "Initial NetCommand Setup," page 57.

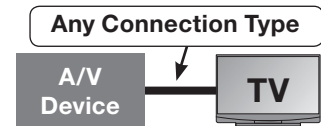

### Source device connected to an A/V receiver connected to the TV

#### CEC-Enabled HDMI A/V Receiver

The TV's remote control may operate some functions of a connected A/V device. You can switch to the device by selecting its icon in the TV's **Activity** menu. See Appendix B, "HDMI Control of CEC Devices," page 75.

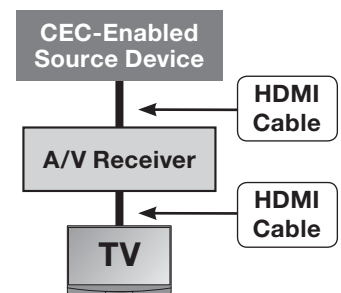

#### 153 and 249 Series: A/V Receiver with HDMI Output (no CEC)



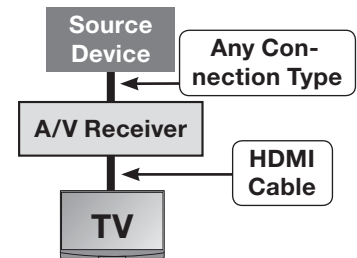

1. Set up NetCommand IR control of the **A/V receiver's** keys as desired. See "IR Emitter Placement," page 56, and "Setting Up A/V Receiver Control," page 62.
2. Set up NetCommand IR control of the **source device's** keys as desired. See "NetCommand Control of a Device Connected to an HDMI A/V Receiver," page 66.







# 4 TV Menus

## Main Menu

Press **MENU** on the remote control to open the main menu and then select from one of these categories.

	<b>Adjust</b>	Customize picture and sound settings.	41
	<b>Captions</b>	Turn closed captions on and off; customize caption displays.	46
	<b>Initial</b>	Perform basic TV setup. Set language, scan (memorize) channels and edit channel options, set the TV clock, set Energy Mode, set auto-on TV Timer, set up Sound Projector.	47
	<b>Input</b>	Assign names to TV inputs, enable HDMI Control, assign activities to inputs. <b>153 and 249 Series.</b> Perform NetCommand IR “learning.”	50
	<b>Lock</b>	Restrict TV use. Disable the control-panel buttons. Set a pass code.	52

## Menu Navigation

	Displays or clears the main menu.
	<ul style="list-style-type: none"> <li>Moves navigation into the options area.</li> <li>Selects an item.</li> </ul>
	<ul style="list-style-type: none"> <li>Moves up one menu level.</li> <li>Clears the current menu.</li> </ul>
	Moves the highlight within menus.
	Makes adjustments in some menus.

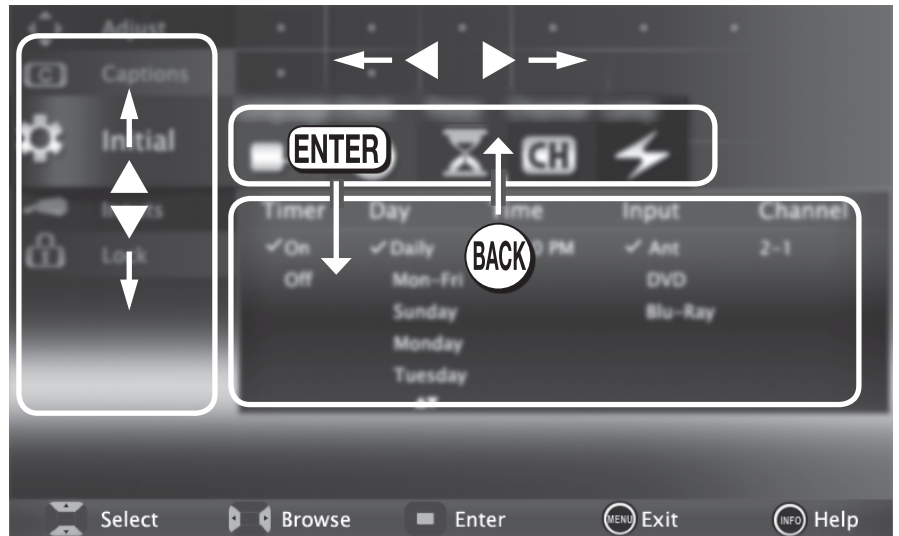

Look for the key guide at the bottom of each menu. →





## Adjust



### Picture

Assign names to TV inputs before making video adjustments (**New Device Found** or **Inputs > Name** menu). Adjustments will be reset to the defaults if you name or rename inputs afterwards. To make picture adjustments:

- **From the Adjust > Picture menu:**
  1. Press ▲▼ to highlight an option.
  2. Press ◀▶ to adjust.

- **While watching TV:** Press the MORE key and then 8 (VIDEO) in the on-screen menu. Press ▲▼ to select the video option you want to change. Press ◀▶ to change settings.

**Note:** Changing Picture settings from the default values used in **Home** mode may increase energy use above ENERGY STAR® guidelines.

Picture Mode	<b>Brilliant</b>	For use under bright light; unavailable when the current input is named <b>Game</b> or <b>PC</b> . When Picture Mode is Brilliant, energy use is greater than ENERGY STAR® guidelines.	Set the Picture Mode first before changing other video settings, as some settings are stored independently for each Picture Mode. Use Picture Modes to get the best image under different viewing conditions.
	<b>Game</b>	Optimizes picture and video processing for gaming consoles. Available only when the name of the input is <b>Game</b> or <b>PC</b> .	
	<b>Bright</b>	For most daytime viewing and <b>x.v.Color</b> sources	
	<b>Natural</b>	For most nighttime viewing and <b>x.v.Color</b> sources	
	<b>Special</b>	Advanced Picture Modes. Contact your professional installer for setup or see page 45.	
	<b>ISF Day, ISF Night</b>	<b>151, 153 series: Special/ADV</b> <b>249 series: ISF Day/ADV1, ISF Night/ADV2</b>	
Contrast	<ul style="list-style-type: none"> <li>• Low contrast shows a variety of shades in darker images</li> <li>• In most home lighting situations, medium contrast looks best.</li> <li>• High contrast shows darker images more uniformly black and makes colors appear more vibrant. High contrast is good for brightly lit environments.</li> </ul>	Adjusts the white-to-black level. Settings are stored independently for each Picture Mode.	
Brightness	Adjusts overall picture brightness. Settings are stored independently for each Picture Mode.		
Color	Adjusts overall color intensity from no color to fully saturated.		
Tint	Adjusts the red-to-green ratio.		
Sharpness	Adjusts picture detail and clarity.		
Color Temp	<b>High</b>	Gives white images a cool cast. May provide the most realistic picture under bright lighting.	Adjusts the white balance. Settings are stored independently for each Picture Mode.
	<b>Low</b>	Gives white images a warm cast. Natural/Color Temp at the low setting displays video at approximately the 6500K industry standard for NTSC pictures.	
Video Noise	<b>High, Medium, Low, Off</b>	Reduces minor noise (graininess) in the picture. Saved by input. This adjustment is not available if the current input is named PC or Game. Use <b>High</b> with poor-quality signals. Use <b>Medium</b> for moderate noise reduction. Use <b>Low</b> with good-quality signals. Use <b>Off</b> to leave the picture unaltered.	
SharpEdge	<b>On, Off</b>	SharpEdge™ adds special edge enhancements to make the image appear sharper. Saved by input.	
DeepField Imager	<b>On, Off</b>	<b>153, 249 Series.</b> DeepField™ Imager dynamically enhances black levels in portions of the screen to provide strong contrast with detail over mixed screen content.	
	<b>Demo</b>	For comparison, displays a split picture to show <b>On</b> (right side) and <b>Off</b> (left side).	
Backlight	Adjusts peak brightness of the backlight. Press <b>ENTER</b> to turn off the backlight.		



## Adjust, continued



### Audio

To make audio adjustments:

- **From the *Adjust > Audio* menu:**
  1. Press ▲ ▼ to highlight an option
  2. Press ◀ ▶ to adjust.
- **While watching TV:** Press the MORE key and then 9 (**AUDIO**) in the on-screen menu. Press ▲ ▼ to select the audio option you want to change. Press ◀ ▶ to change settings.

<b>Speakers</b>	The <b>Speakers</b> option displays only if an A/V receiver or headphone connection has been detected. Detection occurs on the right <b>AVR AUDIO OUTPUT</b> jack or the <b>DIGITAL AUDIO OUT</b> jack. An A/V receiver can also be detected on an HDMI jack.	
	<b>TV</b>	Turns on the internal TV speakers.
	<b>AV Receiver</b>	Turns off the TV speakers so you hear sound only from a connected A/V receiver. <b>Note:</b> When you disconnect an analog A/V receiver, be sure to change the <b>Speakers</b> setting to <b>TV</b> to hear sound from the TV speakers.
	<b>Headphones</b>	Turns off the TV speakers so you hear sound only from connected headphones. See page 18. This option is not available if <b>DIGITAL AUDIO OUTPUT</b> is connected.
<b>Subwoofer</b>	<b>Off, On</b>	The <b>Subwoofer</b> option displays only if a subwoofer connection has been identified on the <b>SUBWOOFER OUTPUT</b> jack. The setting you select is applied to all TV inputs. Use <b>Off</b> to turn off audio to a connected subwoofer.
	<b>[Subwoofer level adjustment]</b>	To adjust the subwoofer volume level, highlight <b>Subwoofer</b> and press <b>ENTER</b> to display an adjustment slider.
<b>Bass</b>	Controls volume of low-pitched sound from the TV speakers.	
<b>Treble</b>	Controls volume of high-pitched sound from the TV speakers.	
<b>Balance</b>	Controls audio balance between the left and right TV speakers; available only when Sound Mode is <b>Stereo</b> .	
<b>Sound Mode</b>	<b>Stereo</b>	No special audio effects from the TV speakers; monaural programs are played as mono, stereo and surround sound are played as stereo.
	<b>Surround</b>	<ul style="list-style-type: none"> <li>• Programs with surround sound are played with Sound Projector surround sound.</li> <li>• Other audio is modified: <ul style="list-style-type: none"> <li>- For monaural (non-stereo) programs, creates a simulated stereo effect.</li> <li>- For stereo programs, creates a simulated surround sound effect.</li> </ul> </li> </ul>
	<b>Music</b>	<b>153 and 249 Series.</b> Optimizes Sound Projector speakers for music listening.
	<b>Night</b>	Directs sound to a specific area to lessen the disturbance to others outside the room. Settings are reset to the default when you power down the TV. <ol style="list-style-type: none"> <li>1. Position yourself in the seating area.</li> <li>2. Press <b>ENTER</b> to display an adjustment slider.</li> <li>3. Press ◀ ▶ to adjust the direction of the sound beams until sound seems the loudest.</li> </ol>



## Adjust, continued







### Audio, continued

<b>Listen To</b> Applies only to analog channels from the <b>ANT</b> input	<b>Stereo</b>	The TV plays stereo broadcasts in stereo and mono broadcasts in mono. The word <b>Stereo</b> is displayed when you tune to a channel broadcasting in stereo.
	<b>Mono</b>	Reduces background noise. Use when receiving a weak stereo audio signal. All audio is played as mono with this setting.
	<b>SAP</b> (Second Audio Program)	Selects an additional monaural sound track not audible during normal TV viewing. The SAP signal might be related to the program (such as a sound track in a foreign language), or it might be unrelated (such as a weather report). If an SAP signal is broadcast, the letters <b>SAP</b> are displayed when you tune to the channel.
<b>Language</b>	Selects the current language for a digital program from the <b>ANT</b> input. Each digital program may include from zero to seven language choices.  Applies only to digital channels from the <b>ANT</b> input.	
<b>Level Sound</b>	<b>On, Off</b>	Reduces differences in sound volume between programming segments, such as the difference between regular broadcast programs and commercial segments.



## Adjust, continued

<b>Reset</b> 	<ul style="list-style-type: none"> <li>Resets audio and picture adjustments for the current input. Highlight the <b>Reset</b> icon and press <b>ENTER</b> twice.</li> <li><b>Reset</b> has no effect on global settings (<b>Balance</b>, <b>Listen To</b>, <b>Language</b>, <b>Film Mode</b>, and <b>Advanced Picture</b>).</li> </ul>		
<b>Global</b>	Global settings apply to all inputs.		
	<b>Video Mute</b> (non-antenna inputs only)	<b>On</b>          <b>Off</b>	Displays a solid colored background when there is no video signal from the current input. The colored screen reminds you that the TV is powered on when there is no picture. The TV will power off after five minutes without receiving a video signal.  The screen appears black when there is no video signal from the current input.
	<b>Screensaver</b>	<b>On, Off</b>	Select <b>On</b> to display a random pattern while playing an audio-only input. To use this feature, the input must be either <ul style="list-style-type: none"> <li>Named as an audio source (e.g., <b>CD</b> or <b>MP3 Player</b>)</li> <li>or</li> <li>Be the <b>ANT</b> input.</li> </ul>
	<b>Film Mode</b> (480i and 1080i signals only)	<b>Auto, Off</b>	In <b>Auto</b> , the TV automatically detects and applies film-decoding correction to movies filmed at 24 frames per second. Try the <b>Off</b> setting if images show many jagged edges.
	<b>Smooth 120 Film Motion</b> (151 series)	<b>Standard, High, Off</b>	<ul style="list-style-type: none"> <li><b>Standard:</b> Removes judder (image vibration) and smooths motion scenes in film-based content such as movies.</li> <li><b>High:</b> Removes more judder in motion scenes in movies.</li> <li><b>Off:</b> Use this setting if <b>Standard</b> or <b>High</b> create image noise.</li> </ul>
	<b>Smooth 120 Film Motion</b> (153 and 249 series)		Removes judder (image vibration) and smooths motion scenes in film-based content such as movies. <ol style="list-style-type: none"> <li>Highlight the icon and press <b>ENTER</b> to display an adjustment screen.</li> <li>Press <b>▲▼</b> to change the amount of correction or set to zero to turn off the correction.</li> <li>Press <b>BACK</b> to return to normal TV viewing.</li> </ol>
	<b>Blue Glow</b> (249 series)	<b>On, Off</b>	Select <b>On</b> to see blue accent lighting when the TV is powered on.
	<b>Test Picture</b>	Displays a test picture for use by TV servicers. Press any key on the remote control to clear the test picture.	



## Adjust, continued

Picture+



PerfectColor

**PerfectColor Sliders**

Adjusts the saturation (intensity) of six colors for the current image source.

**PerfectTint Sliders**  
(153 or 249 series)

Adjusts six hues for the current image source

### Using PerfectColor:

Highlight the PerfectColor™ icon and press **ENTER** to display the **PerfectColor** menu. Settings are retained independently for each TV input.

- Press **▲ ▼** to move from one color bar to the next.
- Press **◀ ▶** to change settings.
- Press **CANCEL** to restore default settings.
- Press **MENU** to return to the main menu.

### Using PerfectTint (153 or 249 Series):

To switch between PerfectColor™ and PerfectTint™ adjustments, highlight **Adjust Mode** and press **◀ ▶**.



Advanced  
Picture



**Advanced Picture** allows you to save highly customized picture adjustments for each input. **Mitsubishi recommends these adjustments be made by a professional installer.**

1. Press **MENU**. Under **Picture+**, highlight the **Advanced Picture** icon and press **ENTER**.
2. With **Picture Mode** highlighted, press **ENTER** to change from blank (undefined) to **ADV**.  
**249 Series:** Choose **ADV1** (daytime settings) or **ADV2** (nighttime settings)
3. Use **▲ ▼** to highlight an option you wish to change and press **ENTER** to see the adjustment display.

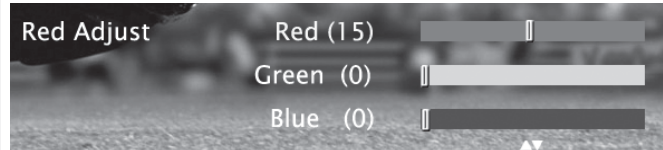

*Sample adjustment display for Advanced Picture options*

4. Press **◀ ▶** to change settings.
5. Use **▲ ▼** to navigate to additional options and press **◀ ▶** to change settings.
6. Press **MENU** to return to the **Advanced Picture** menu. The **Advanced Picture** adjustments will be in effect for the current input.

### To use the custom Picture Mode at a later time

Press **MENU** and go to **Adjust > Picture > Picture Mode** and:

#### 151 or 153 Series

- Select **SPECIAL** if settings were saved by your professional installer.
- Otherwise select **ADV**.

#### 249 Series

- Select **ISF Day** or **ISF Night** if settings were saved by your professional installer.
- Otherwise select **ADV1** or **ADV2**.

### To return to the default values for Advanced Picture

Display the **Picture+ > Advanced Picture** menu and:

#### 151 or 153 Series

Highlight **RESET Pic Mode** and press **ENTER**.

#### 249 Series

1. Highlight the **Advanced Picture** mode to change.
2. Highlight **RESET Pic Mode** and press **ENTER**. Perform this step individually for both **ADV1** and **ADV2**.



## Captions

### Captions on Analog Channels

The TV can decode captions from the **ANT INPUT** and the composite **VIDEO** jacks. Broadcasters can send either standard closed captions or text service. Standard closed captions follow the dialogue of the program and display in a small section of the screen. Text-service closed captions often contain information such as weather or news and cover a large portion of the screen.



### Captions on Digital Channels

The TV can decode captions from the **ANT** input only. Broadcasters can send up to six different captioning selections or can send analog captions for a program that originated in analog format. A TV station may broadcast only one or two types of captions or none at all.

#### IMPORTANT



- **Analog text-service options display a large black or gray box on the screen when no signal is being broadcast.**
- **The content of captions is determined by the broadcaster. If captions show strange characters, misspellings, or odd grammar, it is not a malfunction of the TV.**
- **Closed-caption signals are not available through HDMI or component jacks. See the menus for devices connected to these inputs for closed-caption decoding.**

**Note:** **249 Series.** The TV's **Captions** menu does not control closed captions for content received from the VUDU™ internet service.

<b>Services</b> 	<b>Digital</b>	<b>On if Mute Caption 1– Caption 6 Off</b>	<ul style="list-style-type: none"> <li>• <b>On if Mute:</b> Displays digital closed-caption signal Caption 1 when audio from the TV speakers is muted. When watching TV, press <b>MUTE</b> to turn closed captions on/off.</li> <li>• <b>Caption 1–Caption 6:</b> Caption signals sent by the broadcaster</li> </ul>
	<b>Analog</b>	<b>On if Mute CC 1–CC 4 Text 1–Text 4 Off</b>	<ul style="list-style-type: none"> <li>• <b>On if Mute:</b> Displays analog closed captions signal CC 1 when audio from the TV speakers is muted. When watching TV, press <b>MUTE</b> to turn captions on/off.</li> <li>• <b>CC 1–CC 4:</b> Standard closed-caption signals</li> <li>• <b>Text 1–Text 4:</b> Text-service signals</li> </ul>
	<b>Analog Back- ground</b>	<b>Gray, Black</b>	Selects either a gray or black text background to make analog closed captions easier to read.
<b>Effects</b>  (for captions from digital channels)	<b>Font</b>	<b>Default Font 1–Font 7</b>	<b>Default</b> changes settings to those selected by the captions provider, or, if none, to the TV's own caption defaults. Use Fonts 1 through 7 to give captions on digital channels a custom appearance.
	<b>Font Size</b>	<b>Large Medium Small</b>	<b>Large</b> is the recommended size.
	<b>Font Color</b>	<b>White, Black, Magenta, etc.</b>	Guidelines for setting digital captions: <ul style="list-style-type: none"> <li>• <b>A white font on a black translucent background makes an easy-to-read combination.</b></li> <li>• Use contrasting colors for captions and background.</li> </ul>
	<b>Font Opacity</b>	<b>Translucent, Opaque, Flashing, Transparent</b>	
	<b>Background Color</b>	<b>White, Black, Magenta, etc.</b>	
	<b>Background Opacity</b>	<b>Translucent, Opaque, Flashing, Transparent</b>	



## Initial

<b>Language</b> 	<b>English</b> <b>Spanish</b>	Displays on-screen menus in either English or Spanish. <b>Note:</b> To listen to audio in other languages (when available), see <b>Adjust &gt; Audio &gt; Listen To &gt; SAP</b> (analog signal) or <b>Language</b> (digital signal) on page 43.	
<b>Clock</b> 	Set the TV clock to: <ul style="list-style-type: none"> <li>• Use the TV Timer to power on the TV automatically at a preset time</li> <li>• Receive correct updates to ChannelView listings</li> </ul> <b>Note:</b> When the Daylight Savings Time change occurs, you must open this menu and set the TV's clock ahead or back.		
<b>Time</b>	<ol style="list-style-type: none"> <li>1. With the hour highlighted, press ▲ ▼ to change the hour and the <b>AM/PM</b> indicator. Press and hold to change the hour display quickly.</li> <li>2. Press <b>ENTER</b> to set the hour.</li> <li>3. With the minutes highlighted, press ▲ ▼ to change the minutes. Press and hold to change the minutes display quickly.</li> </ol>		
<b>Date</b>	<ol style="list-style-type: none"> <li>1. With the month highlighted, press ▲ ▼ to select. Press <b>ENTER</b> to set.</li> <li>2. With the day highlighted, press ▲ ▼ to select. Press <b>ENTER</b> to set.</li> <li>3. With the year highlighted, press ▲ ▼ to select the current year.</li> </ol>		
<b>Time Zone</b>	<b>Eastern, Central, Mountain, Pacific</b> , etc. The correct time zone is required for accurate ChannelView updates.		
<b>DST</b>	<b>On, Off</b>	Daylight Savings Time. Select the setting for your area. The correct DST setting is required for accurate ChannelView updates.	
<b>Timer</b> 	<b>Timer</b>	<b>On, Off</b>	Select <b>On</b> to enable the Timer.
The Timer tells the TV to power on automatically at a time you set. Use this menu to set a day, time, input, and channel for the Timer. If the TV is already on at the requested time, the TV will automatically change to the designated channel or input. <ul style="list-style-type: none"> <li>• The TV clock must be set before you can use the Timer feature.</li> <li>• To remind you that the TV Timer has been set, the <b>POWER</b> indicator on the front of the TV flashes slowly while the TV is powered off.</li> <li>• When the Timer turns on the TV, press any key on the remote control to keep it on. Otherwise, the TV will turn off after five minutes.</li> </ul>			
<b>Day</b>	<b>Daily, Mon-Fri</b> , (every) <b>Sunday</b> , (every) <b>Monday</b> , (every) <b>Tuesday</b> , etc. Select the day or days of the week for the Timer to turn on the TV.		
<b>Time</b>	To set the time for the TV to come on: <ol style="list-style-type: none"> <li>4. With the hour highlighted, press ▲ ▼ repeatedly to change the hour and the <b>AM/PM</b> indicator. Press and hold to change the hour display quickly.</li> <li>5. Press <b>ENTER</b> to highlight the minutes.</li> <li>6. Press ▲ ▼ to change the minutes. Press and hold to change the minutes display quickly.</li> </ol>		
<b>Input</b>	<b>Ant, DVD, VCR</b> , etc. Select the input you want displayed when the TV comes on. Choose from the defined and enabled inputs that appear in the <b>Activity</b> menu.		
<b>Channel</b>	If the source is the <b>ANT</b> input, select a channel number by pressing ▲ ▼ or press and hold to scroll through channels.		



## Initial, continued

<b>Channel</b>  <b>(Channel Management)</b>	<b>Ant Air, Ant Cable</b>	<p><b>You must perform a channel scan to receive digital channels.</b> <b>Scan</b> searches for broadcast channels and adds them to TV memory. To start channel scan:</p> <ol style="list-style-type: none"> <li>Highlight one of the input selections based on your connection to the <b>ANT input</b>: <ul style="list-style-type: none"> <li><b>Air</b> when connected to an indoor or outdoor antenna.</li> <li><b>Cable</b> when connected to direct cable (no cable box)</li> </ul> </li> <li>Press <b>▶</b> to highlight <b>SCAN</b>.</li> <li>Press <b>ENTER</b> to start channel memorization.</li> </ol>
	<b>Scan</b>	
	<b>Edit</b>	<p>After channel scan, <b>Edit</b> lets you add and delete memorized channels.</p> <ul style="list-style-type: none"> <li>Press <b>PAGE DN/UP</b> to jump to the next or previous page of channel numbers.</li> <li>Press <b>▲▼◀▶</b> to move through all channel numbers, one at a time.</li> </ul>

### Notes on Scan and channel memorization

- Channel memorization may take up to 15 minutes to complete.
- To stop channel memorization before completion, press **CANCEL**. Channels already added are retained.
- When watching TV, press **CH ▲▼** to move through memorized channels.
- To add a digital channel that does not appear in the **Edit** menu without repeating channel memorization:
  - Look up the physical channel number for the new digital channel. See the website [www.antennaweb.org](http://www.antennaweb.org) for help.
  - Press **ACTIVITY** and select the **ANT** input.

- Use the number keys and **CANCEL** key to enter the physical channel number followed by “-1” and **ENTER**. For example, for physical channel 36, press

**3 6 CANCEL 1 ENTER.**

The TV will search for a digital channel on the channel 36 frequency. When it finds the channel, it will:

- Add the channel to memory.
  - Change the channel number to the virtual channel number sent by the broadcaster.
  - Add to memory any associated sub-channels.
- Rememorize channels if you move the TV to a different geographic area with a different channel line-up.

### Adding/Deleting Channels Using the Channel Edit Menu

- Channels marked with a check are in memory.
- To add or delete a channel from memory, highlight the channel number and press **ENTER**.
- To add a single digital channel not in the list, see the notes under **Scan** on this page.
- Digital channels are listed by virtual channel number with the physical channel number shown in small gray text. See below for an explanation of these terms.
  - Virtual Channel Number** (digital channels only). A channel number sent by a local broadcaster. Usually the virtual number is associated with the corresponding analog channel number. For example, a broadcaster may associate digital channel 2-1 with their analog channel 2.
  - Physical Digital Channel Number**. The channel number officially assigned to the actual broadcast frequency; shown on screen in gray text.

<b>Energy</b> 	<b>Energy Usage</b>	<b>Standard, Fast Power On</b>	<p>Options for power consumption while the TV is powered off.</p> <ul style="list-style-type: none"> <li><b>Standard</b> keeps the TV's energy use within ENERGY STAR® guidelines while powered off.</li> <li><b>Fast Power On</b> lets the TV power up quickly. The TV uses power while in the off state in excess of ENERGY STAR guidelines for a powered-down device.</li> </ul>
--	---------------------	--------------------------------	---





## Initial, continued

### Sound Projector

For full setup instructions, see page 34.

#### Basic Screen

 SoundPro	<b>Mode</b> (153, 249 series)	<b>Auto</b>	<b>START</b>	Perform Auto setup using the supplied calibration microphone. See page 36.
		<b>Manual</b>	<b>Custom</b>	To perform manual setup, see page 34.  <b>Note:</b> Do not perform manual adjustments after running Auto setup. Doing so will erase all settings created during Auto setup.
	<b>TV Location</b>	<b>Center, Left, L Corner, Right, R Corner</b>		Highlight the item that best describes the TV's location relative to the wall. Required for Manual setup.
	<b>TV Wall Length</b> (in feet)	<b>[Enter digits]</b>		Press ▲ ▼ to change the number or enter digits. Required for Manual setup.
	<b>Other Wall Length</b> (in feet)	<b>[Enter digits]</b>		Press ▲ ▼ to change the number or enter digits. Required for Manual setup.
	<b>TV to Sofa</b> (in feet)	<b>[Enter digits]</b>		Press ▲ ▼ to change the number or enter digits. Enter the distance from the TV to the primary seating area. Required for Manual setup.
	<b>Custom</b> (all models)	After defining the room layout, highlight <b>Custom</b> and press <b>ENTER</b> . Use this option to fine-tune Sound Projector to your unique room layout. See details on page 35.		

#### Adjustments in the Custom Menu

Left Beam Angle  
 Right Beam Angle  
 Center Beam Angle  
 Left Surround Beam Angle  
 Right Surround Beam Angle  
 Left Level  
 Right Level  
 Center Level  
 Left Surround Level  
 Right Surround Level

- Press ▲ ▼ to select an audio beam; colors of the adjusters correspond to audio beams in the on-screen diagram.
- Press ◀ ▶ to redirect the audio beam or change the sound level.
- To reset these adjustments, see "Resetting Angle and Level Values in the Custom Menu," page 35.

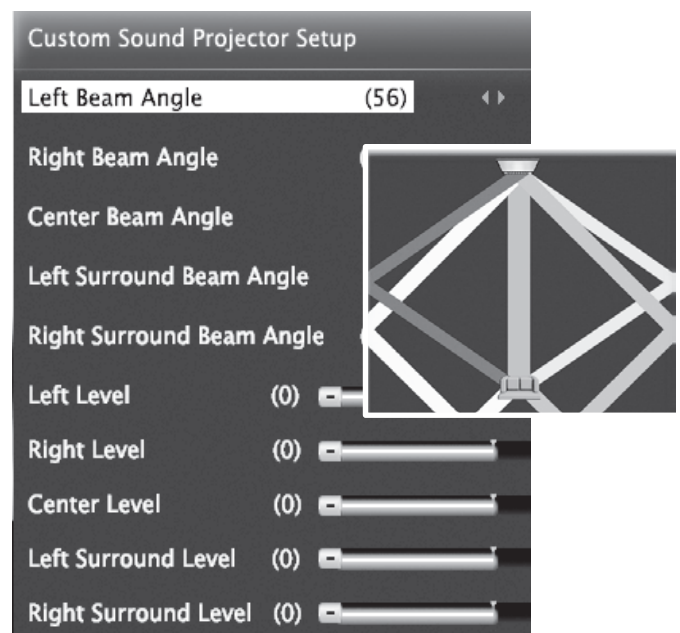

Controls in the SoundPro > Custom menu adjust the direction and focus of the TV's sound output.

At extreme beam angles, adjustment may be limited and the image on screen may not accurately represent the sound beams.

 **Inputs**

<b>Name</b> 	<b>Cablebox, Cam(corder), CD, DVD (DVD, DVD2, Blu-ray), DVR, Game (Game, PS, Xbox, Wii), MP3 Player, PC, Satellite, VCR, AVR</b> <b>Delete</b> (deactivated HDMI only) <b>On/Off</b> (ANT only)	<ul style="list-style-type: none"> <li>• Lets you assign or change names of inputs appearing in the <b>Activity</b> menu. <ul style="list-style-type: none"> <li>- Press ◀ ▶ to move between inputs.</li> <li>- Press ▲ ▼ to select a name.</li> <li>- You cannot change the name of the current input; you must first switch to another input. If you have only one input, such as a cable box, make sure the <b>Ant</b> input is <b>On</b> and switch to <b>Antenna</b> in the <b>Activity</b> menu before renaming the single input.</li> </ul> </li> <li>• Lets you turn the <b>Ant</b> input <b>On/Off</b> (to display/hide it in the <b>Activity</b> menu).</li> <li>• Lets you delete unused HDMI inputs from the <b>Activity</b> menu.</li> <li>• A CEC-enabled tuner can be named either <b>Cable Box</b> or <b>Satellite</b>.</li> <li>• A CEC-enabled DVD player can be named <b>DVD</b>, <b>DVD2</b>, or <b>Blu-ray</b>.</li> </ul>
--	---	---

**General Notes**





When you change an input name in the **Name** menu and then exit the **Name** menu:

- The name is changed
- The icon in the **Activity** menu is changed
- Audio and video settings are changed to the defaults for the new device type.
- **153 and 249 Series:** All previous NetCommand IR “learning” for the input is erased.

**Notes for HDMI devices**

- **Disconnecting an HDMI device:** When you disconnect an HDMI device, the icon remains in the **Activity** menu until you remove it. Select **Delete** in the **Inputs > Name** menu to remove an unwanted icon for an HDMI input.
- If the **New Device Found** screen does not display as expected when you connect an HDMI device, see the reset instructions under “Reactivating Auto Sensing for an HDMI Input,” page 13.
- **HDMI Control and CEC-Enabled Devices:** See Appendix B, “HDMI Control of CEC Devices,” page 75.
- **If case of CEC conflicts:** Turn off CEC signals in one of these ways:
  - Turn off the TV’s HDMI Control signals to the device (see below for **HDMI Control**).
  - Turn off each device’s internal CEC capability.

See Appendix B for the TV’s HDMI Control or, to turn on/off a specific device’s response to CEC signals, see the device owner’s manual.

<b>Learn</b> 	<b>153 and 249 Series</b> Sets up or changes NetCommand IR control of the current viewing device. See “About NetCommand IR Control,” page 55.	
<b>AVR</b> 	<b>153 and 249 Series</b> Sets up or changes NetCommand IR control of an A/V receiver. See “NetCommand IR Control of an A/V Receiver” on page 61.	
<b>HDMI Control</b> 	<b>On, Off</b>	Select <b>On</b> or <b>Off</b> to enable or disable the TV’s control of a CEC-enabled device. See Appendix B for use of this feature.
<b>Activity</b> 	<ul style="list-style-type: none"> <li>• Lets you customize the <b>Activity</b> menu choices for the current input.</li> <li>• Highlight the activity name and press <b>ENTER</b> to make changes.</li> <li>• See “How is the Activity Menu Generated?” on the opposite page.</li> </ul>	



## Inputs, continued

### How is the Activity Menu Generated?

The TV automatically generates the **Activity** menu. The TV groups recognized device types based on how they can be used. The device names used for the groupings are those you assigned in the **New Device Found** menu or the **Inputs > Name** menu, or in some cases, the name the device itself communicated to the TV. The table below summarizes the device groupings that can appear in the **Activity** menu.

#### Key

- ✓ Activity assignments made automatically by the TV.
- X Activity assignments you can make using the **Inputs > Activity** menu.

	Watch TV	Watch Movie	Play Game	View Photos	Listen Music
Antenna	✓				
AV Receiver	✓				✓
Blu-ray		✓		X	X
Cable Box	✓				
Camcorder		✓			
CD/Audio					✓
DVD		✓			X
DVD2		✓			X
DVR	✓				
Game			✓		
MP3 Player		✓			✓
PC	✓	X	✓	X	X
PS		✓	✓	X	
Satellite	✓				
USB				✓	X
VCR		✓			
VUDU (249 Series)		✓		X	X
Wii		X	✓		
Xbox		X	✓		



## Lock

### TV Locks

	<b>Parental</b> <b>Lock by Program Ratings</b> Restricts access using U.S.-based ratings sent by broadcasters.
	<b>Time</b> <b>Lock by Time</b> Restricts TV use by time of day.
	<b>Panel</b> <b>Lock Control Panel</b> Disables the buttons on the TV's control panel. Use this option if small children in the home try to press control-panel buttons.
	<b>Other</b> <b>Lock by Other Program Ratings</b> Restricts access using non-U.S.-based ratings sent by broadcasters.

### Pass Codes

#### Setting a Pass Code

You are prompted to enter a pass code whenever you select **Lock** on the main menu. To set a pass code for the first time:

1. Press **MENU** and highlight **Lock**. A screen prompting you for a pass code will display.
2. Input a four-digit pass code using the number keys on the remote control.
  - Press **CANCEL** to delete a number and move back one space.
  - Press **MENU** or **BACK** to close the menu without setting a pass code.
3. Press **ENTER** to set the pass code.

#### Resetting a Pass Code

See the procedure in Appendix D.

#### Important Notes on Rating Locks

- **Parental** menu rating locks apply only to channels and signals received on the **ANT** and composite **VIDEO** jacks.
- **Other** menu rating locks apply only to digital channels received on **ANT**.
- When viewing a cable box, satellite receiver, or other device connected to the component **Y Pb Pr** or **HDMI** inputs, check the device's owner's guide for parental locks.

### Parental Menu

The TV comes from the factory with the rating locks turned off and with pre-set U.S. ratings TV-PG and movie rating PG. Turn on blocking for U.S. ratings to activate these rating restrictions. Use the **Lock** > **Parental** menu to change the level of blocking with U.S. ratings.

Any time you change the channel or device, it may take up to five seconds for the rating restrictions to take effect.

**Note:** **249 Series.** To set parental controls for VUDU™ service, use the VUDU **Info & Settings** menu. The TV's **Parental** menu does not control content accessible through VUDU.

### Other Menu (Alternate Rating System)

This TV can recognize new rating systems that may come into effect in the future. The **Other** menu allows you to block digital programming when such systems come into effect.

The first time you tune to a channel broadcasting an alternate rating system, the TV defaults to the most restrictive setting if the **Lock** menu > **Other Lock** option is set to **On**. Use this menu to change the allowed rating if you are unable to watch a program rated with an alternate system.

### Bypassing TV Locks

- If you try to watch a blocked program or the TV is locked by time, a notice will appear prompting you for a pass code. To use the TV, input your four-digit pass code and press **ENTER**.
  - To reactivate the locks after using a pass code, power the TV off and then on.
  - To reactivate only the parent ratings lock, change to a different channel or device.
- If a program is blocked, you can still use the TV without entering a pass code. Change to a channel airing an allowed program or change to another device.



## Lock, continued





## Parental

<b>Lock</b>	<b>Off, On</b>	Disables or enables blocking based on V-Chip signals and the U.S. rating system.	
<b>Start Time</b>	Sets the time of day for enforcement of rating restrictions set in the <b>Parental</b> menu.		
<b>Stop Time</b>	<ol style="list-style-type: none"> <li>1. Highlight the hour digits for <b>Start Time</b>.</li> <li>2. Press ▲ ▼ repeatedly to change the hour and associated <b>AM/PM</b> indicator. You can also just press and hold to move quickly through the numbers.</li> <li>3. Press <b>ENTER</b> to highlight the minutes.</li> <li>4. With the minutes digits highlighted, press ▲ ▼ repeatedly to change the minutes. You can also just press and hold to move quickly through the numbers.</li> <li>5. Highlight the <b>Stop Time</b> digits and set the time as described above.</li> </ol> <p><b>Note:</b> To make rating restrictions active 24 hours a day, make <b>Start Time</b> and <b>Stop Time</b> the same.</p>		
<b>TV Rating</b>	<b>TV-Y</b>	<b>Youth.</b> For children under 7.	Highlight the rating level you wish to change and press <b>ENTER</b> to block it (🔒) or allow it (🔓).  You can apply supplemental content blocking to the age-based ratings by using the TV content categories listed below.
	<b>TV-Y7</b>	<b>Youth 7</b> and older.	
	<b>TV-G</b>	<b>General Audience.</b> For the entire family.	
	<b>TV-PG</b>	<b>Parental Guidance.</b> Parental Guidance recommended; may not be suitable for some children.	
	<b>TV-14</b>	<b>Adolescent 14 and older.</b> Not recommended for children under 14.	
	<b>TV-MA</b>	<b>Mature Audience.</b> For adults only.	
<b>FV</b>	<b>Fantasy Violence.</b> Applies to TV-Y7 only.		<b>TV Content Categories</b>
<b>D</b>	<b>Sexual Dialog.</b> Applies in differing degrees to TV-PG and TV-14.		
<b>L</b>	<b>Adult Language.</b> Applies in differing degrees to TV-PG, TV-14, and TV-MA.		
<b>S</b>	<b>Sexual Situations.</b> Applies in differing degrees to TV-PG, TV-14, and TV-MA.		
<b>V</b>	<b>Violence</b> (graphic or realistic). Applies in differing degrees to TV-PG, TV-14, and TV-MA.		
<b>Movie Rating</b>	<b>G</b>	<b>General Audience.</b> Designed for the entire family.	
	<b>PG</b>	<b>Parental Guidance.</b> Parental Guidance recommended; may not be suitable for some children.	
	<b>PG-13</b>	<b>Parental Guidance, 13 and Older.</b> Not recommended for children under 13.	
	<b>R</b>	<b>Restricted.</b> Restricted in theaters to 17 years old and older unless accompanied by an adult.	
	<b>NC-17</b>	<b>No Children 17 or Under.</b> Restricted in theaters to 18 years old and older.	
	<b>X</b>	<b>Adult.</b> Designed for and restricted in theaters to adult audiences only.	
	<b>Not Rated</b>	No MPAA rating assigned	



## Lock, continued

 <b>Time</b>	Blocks all use of the TV during the time period you specify. You must enter a pass code to use the TV when the time lock is in effect.	
	<b>Lock by Time</b>	Enables/disables <b>Lock by Time</b> .
 <b>Time</b>	<b>Lock Time, Unlock Time</b>	<p>To set the lock and unlock times:</p> <ol style="list-style-type: none"> <li>1. Highlight the hour digits for the <b>Lock Time</b>.</li> <li>2. Press <b>▲ ▼</b> repeatedly to change the hour and associated <b>AM/PM</b> indicator. To move quickly through the numbers, just press and hold.</li> <li>3. Press <b>ENTER</b> to set the hour and highlight the minutes.</li> <li>4. With the minutes highlighted, press <b>▲ ▼</b> repeatedly to change the minutes. To move quickly through the numbers, just press and hold.</li> <li>5. Highlight the <b>Unlock Time</b> digits and set the time as described above.</li> </ol> <p><b>Note:</b> To make Lock by Time active 24 hours a day, make <b>Start Time</b> and <b>Stop Time</b> the same.</p>
	<b>Off, On</b>	<p><b>On</b> locks and <b>Off</b> unlocks the buttons on the TV's control panel. Use this option if small children try to press TV buttons.</p> <ul style="list-style-type: none"> <li>• To release the Panel Lock from the TV's control panel, press and hold the <b>ACTIVITY</b> button for ten seconds. If the TV is powered off, press <b>POWER</b> after the lock releases to make the TV power on.</li> <li>• To reactivate the lock, return to this menu and change the setting to <b>On</b>.</li> </ul>
 <b>Other</b>	<b>Other Menu Options (alternate rating system)</b>	
	This TV can recognize new rating systems that may come into effect in the future. The <b>Other</b> option remains grayed out until the TV receives a signal using an alternate rating system. Such alternate rating systems will apply only to digital programming received on the <b>ANT</b> input.	
	<b>Lock</b>	<b>On, Off</b> Enables/disables program blocking.
	<b>System Name</b>	The rating system available for the channel
	<b>Group</b>	Rating groups available in the rating system shown on the screen. Rating groups are defined by the rating system in effect.
<b>Rating</b>	Rating restrictions available in the selected rating system and group. Highlight the rating and press <b>ENTER</b> to check (block) or uncheck (allow) rated content.	

# 5 NetCommand IR Control

## *About NetCommand IR Control*

- **NetCommand IR home-theater control is available on 153 and 249 series TVs.**
- **IR emitter cables are available for purchase from Mitsubishi.** Visit [www.mitsuparts.com](http://www.mitsuparts.com) or call 800-553-7278 and request one of the following:
  - **242D483020** (two-ended cable)
  - **299P254020** (four-ended cable).
- NetCommand setup is optional.
- You can perform NetCommand setup when the TV first recognizes a device during Auto Input Sensing or at any convenient time afterward.
- NetCommand operates by sending remote control signals from the TV to your other devices via the IR (infrared) emitters, telling the devices to play, record, change inputs, adjust volume, change channels, or perform other functions. All this is accomplished with the TV's remote control left in TV mode.
- You may wish to use NetCommand IR control to supplement control of CEC-enabled devices.

### ***Important Note on NetCommand***

**Be sure to connect the IR emitter cable to the TV and properly place the emitters so that NetCommand can control your devices.**

## IR Emitter Placement

The NetCommand system uses emitters connected to the **IR–NetCommand Output** jack to control other devices such as DVD players, cable boxes, satellite receivers, and VCRs.

**IR emitter cables are available for purchase from Mitsubishi.** Call (800) 553-7278 and request either part number 242D483020 (two-ended cable) or part number 299P254020 (four-ended cable).

1. Connect the plug end of the IR emitter cable to the **IR–NetCommand Output** jack on the TV back panel.
2. When the **New Device Found** screen displays, leave **IR–NetCommand Output** selected.
3. Highlight **EXIT** and press **ENTER**.

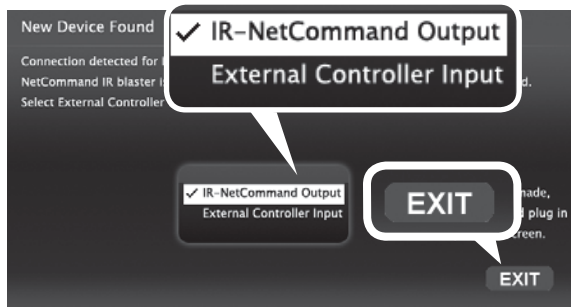

The **New Device Found** screen displays when you connect the IR emitter.

4. Position the emitter end with the emitter bulb facing the device's remote control sensor. The bulb emits infrared light in a cone-shaped pattern. Place the bulb far enough from the sensor to allow the cone pattern to reach the sensor.

In some cases, the emitter works better facing downward from the top of the device. Experiment to find what works best.

5. Secure the emitter ends in place using double-sided tape.
6. Place any unused ends behind the devices to prevent stray signals from reaching the IR sensors.

### IMPORTANT

Position IR emitters so that each device's sensor "sees" the signal from only one emitter. Otherwise, a device receiving signals from multiple sources (remote controls, IR emitters) may not respond at all.

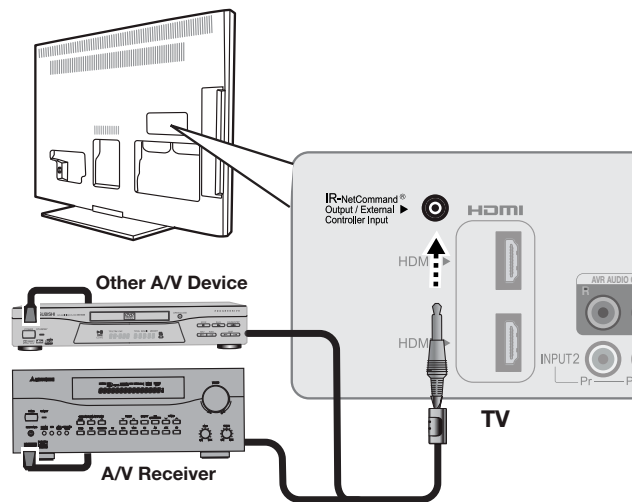

### Connecting IR–NetCommand Output

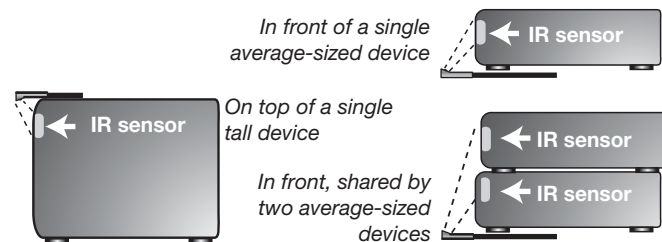

Place IR emitters so the signal can be "seen" by the IR sensor on each device.

### If You are Unable to Locate a Device's IR Sensor

- The IR sensor is usually behind the plastic window of the front display panel. Using a flashlight, you may be able to see it as a round or square cutout.
- If you cannot see the sensor and the device's Owner's Guide does not specify the location, do the following using the device's remote control.
  1. Starting at one end of the plastic window, hold the device's remote control about one-half inch from the front of the device and press the **POWER** key.
  2. If the device does not respond, move the remote control one inch toward the center and try again. Repeat until the device responds.
  3. Repeat the previous steps starting at the other end of the window. The sensor will be between these two points.



## Initial NetCommand Setup

To perform this procedure, you need:

- The remote controls for both the TV and the device you want to control.
- An IR emitter cable available from Mitsubishi.

**Note:** To set up an A/V receiver, see “Setting Up A/V Receiver Control,” page 62.

1. Connect and position the IR emitters for the devices you wish to control. See “IR Emitter Placement” on the opposite page.
  2. Set the **TV’s** remote control to **TV** mode and power on the TV.
  3. Open the NetCommand **Learn** screen as follows:
    - If working from the **New Device Found** screen after the device is first detected, highlight **NetCommand** and press **ENTER** to open the **Learn** screen for the device.
    - If performing NetCommand setup at any time after the device has been recognized through Auto Input Sensing:
      - a. Press **ACTIVITY**.
      - b. Highlight the desired input icon and press **ENTER** to switch to that input.
      - c. Press **MENU**, highlight **Inputs**, and highlight **Learn** to open the **Inputs > Learn** screen for the device.
  4. The first function highlighted in the **Learn** screen is always **Power On**. Aim the **TV’s** remote control at the TV and press **ENTER** to begin learning for that function.
  5. When the **Power On** text starts flashing, aim the **device’s** remote control at the TV and hold the **POWER** key until a check mark appears next to **Power On**.
    - If the text stops flashing before the check mark appears, repeat the previous step.
    - To remove the key from NetCommand control, press the **CANCEL** key while the key name is highlighted.
  6. Press the **▲ ▼ ◀ ▶** keys on the **TV’s** remote control to highlight other keys on the list. Repeat steps 4 and 5 for each additional function you wish to control through NetCommand.
- Note:** Device keys in the far right column will be associated with the remote control’s **MORE** key when “learned.” See the table on page 59.
7. If the device has a separate **POWER OFF** key, press **▲ ▼ ◀ ▶** on the **TV’s** remote to highlight **Power Off**. Repeat the earlier steps to “learn” the **POWER OFF** key. **If the device has no POWER OFF key, skip this step.**
  8. Press **BACK** to finish NetCommand “learning” for the current device.

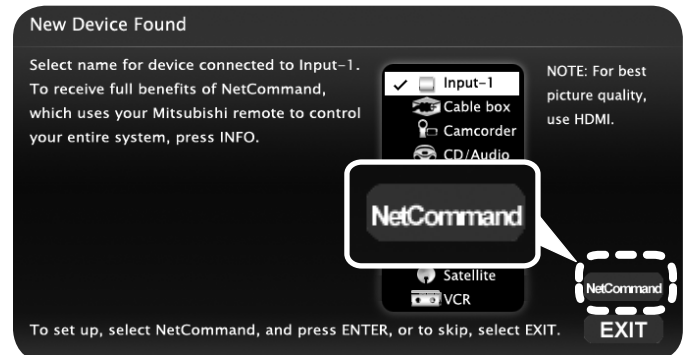

From the **New Device Found** screen, highlight **NetCommand** and press **ENTER** to open the **Learn** screen.

Device-specific keys in the rightmost column can be accessed with the **MORE** key after “learning.”

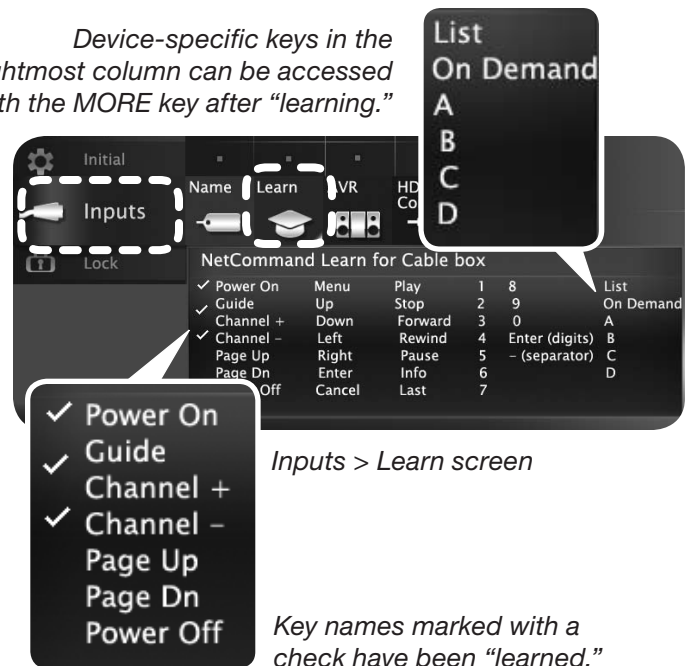

*Inputs > Learn screen*

*Key names marked with a check have been “learned.”*

## Adding or Removing Device Keys from NetCommand Control

1. Switch the TV to the device. Press **ACTIVITY**, highlight the device’s icon, and press **ENTER**.
2. Open the **Inputs** menu and highlight the **Learn** icon.
3. When the **Learn** screen displays:
  - **To add keys:** Continue as described earlier under “Initial NetCommand Setup” on this page.
  - **To delete keys:** Highlight the name of the key you wish to delete and press **CANCEL** on the **TV’s** remote control to clear the check mark.

## Operating NetCommand-Controlled Devices

### Controlling Most Device Types

As an example of NetCommand control, if you are watching your cable box and you wish to tune to the next channel higher, press **CHANNEL UP**. NetCommand then sends the “learned” channel-up control signal to the cable box.

1. Perform NetCommand setup for the device as described in this chapter.
2. When you wish to use the device, press **ACTIVITY**.
3. Press **▲▼◀▶** to highlight the icon for the device.
4. Press **ENTER** to switch the TV to the device.

**Note:** if you have set up automatic input switching for the A/V receiver, the A/V receiver will automatically switch to the correct input for the device.

5. To operate the device using the **TV's** remote control, press the side button to put the remote control into **TV** mode.
6. Point the remote control at the **TV** (not the device) and press the key for the desired function.
7. Press the **MORE** key to access additional key functions you may have “learned” for the device.

### Special Operation Methods

Key Name in Learning Screen	Special Operation Description and Setup	How to Use
<b>Power On</b>	<p><b>Manual Power On/Off</b></p> <p>Use for devices that have only one <b>POWER</b> key.</p>	<ol style="list-style-type: none"> <li>1. Press <b>ACTIVITY</b>.</li> <li>2. Press <b>▲▼◀▶</b> to highlight the icon for the device to be powered on or off.</li> <li>3. With the <b>Activity</b> menu still displayed, press <b>POWER</b> to send the power signal; you may need to press <b>POWER</b> twice.</li> </ol> <p><b>Note:</b> If you press <b>POWER</b> without the <b>Activity</b> menu displayed, the TV will turn off.</p> <ol style="list-style-type: none"> <li>4. Press <b>ENTER</b> to switch the TV to the device.</li> </ol>
<b>Power On</b> <b>Power Off</b>	<p><b>Automatic Power On/Off</b></p> <p>This feature is only for devices that have separate <b>POWER ON</b> and <b>POWER OFF</b> keys on their original remote controls. If your device does not have a separate <b>POWER OFF</b> key, do not use the <b>Power Off</b> learning position; use only the Manual Power ON/OFF method described above.</p> <p>In the NetCommand <b>Learn</b> screen:</p> <ol style="list-style-type: none"> <li>a. “Learn” the <b>Power On</b> command in the <b>Power On</b> learning position.</li> <li>b. “Learn” the <b>Power Off</b> command in the <b>Power Off</b> learning position.</li> </ol>	<ul style="list-style-type: none"> <li>• <b>To Power On the Device</b> <ol style="list-style-type: none"> <li>1. Press <b>ACTIVITY</b>.</li> <li>2. Press <b>▲▼◀▶</b> to highlight the icon for the device to be powered on or off.</li> <li>3. Press <b>ENTER</b> to switch the TV to the device and NetCommand will send the <b>Power On</b> command to the device.</li> </ol> </li> <li>• <b>To Power Off the Device</b> When you turn the TV off, the TV sends all learned <b>Power Off</b> commands to all devices.</li> </ul>
<b>Menu</b>	<p><b>Displaying a Menu for the Current Device</b></p> <p>“Learn” the <b>MENU</b> key on the original remote in the <b>Menu</b> learning position.</p>	<p>Press <b>MORE</b> and then 1 to send the menu command to the current device.</p>
<b>Guide</b>	<p><b>Displaying the On-Screen Program Guide (cable box or satellite receiver)</b></p> <ol style="list-style-type: none"> <li>1. “Learn” the <b>GUIDE</b> key on the original remote in the <b>Guide</b> learning position.</li> <li>2. Learn the <b>PAGE UP</b> and <b>PAGE DOWN</b> keys of the original remote in the <b>Page Up</b> and <b>Page Down</b> learning positions.</li> </ol>	<ol style="list-style-type: none"> <li>1. While watching the device, press <b>GUIDE</b> to display the guide.</li> <li>2. Press <b>PAGE UP/DOWN</b> (<b>⤴</b> <b>⤵</b>) to send the <b>Page Up/Dn</b> commands for the guide.</li> </ol>

Key Name in Learning Screen	Special Operation Description and Setup	How to Use
<b>Enter</b>	<p><b>ENTER-Key Functions (cable boxes, satellite receivers, etc.)</b></p> <p>Some devices have two keys that have “enter” functions. One key is for menus and is often labelled <b>SELECT</b> or <b>OK</b>. A second key is for use with number keys for direct channel selection. NetCommand uses the same <b>ENTER</b> key for both operations.</p> <p>When <b>ENTER</b> has a menu or guide function or when the original remote control uses the same key for menus and channel selection: Learn the <b>ENTER</b>, <b>SELECT</b>, or <b>OK</b> key in the NetCommand <b>Enter</b> learning position.</p>	<ol style="list-style-type: none"> <li>1. Press <b>MENU</b> or <b>GUIDE</b> to display the device’s menu or guide.</li> <li>2. Press <b>ENTER</b> within the menu and NetCommand will send the <b>Enter</b> signal for menus.</li> </ol>
<b>Enter (digits)</b>	<p>When <b>ENTER</b> is for channel changes, i.e., the original remote control has a separate <b>ENTER</b> key for this function):</p> <p>Learn the <b>ENTER</b> key for channel selection in the NetCommand <b>Enter (digits)</b> learning position. Use this learning position only if the original remote control has separate keys for <b>Enter</b> in menus and <b>Enter</b> for channel selection.</p>	<p>Press digit key(s) and then press <b>ENTER</b>. NetCommand will send the <b>Enter</b> signal for channel selection.</p>
<b>Cancel</b>	<p><b>CANCEL as the Cancel or Exit Function</b></p> <p>“Learn” the <b>Cancel</b> or <b>Exit</b> function in the NetCommand <b>Cancel</b> learning position</p>	<ol style="list-style-type: none"> <li>1. Press <b>MENU</b> or <b>GUIDE</b> to display the menu or guide.</li> <li>2. Press <b>CANCEL</b> and NetCommand will send the <b>Cancel</b> or <b>Exit</b> signal.</li> </ol>
<b>— (separator)</b>	<p>The symbol “—” can serve as the separator between a digital channel’s main and sub-channel digits, e.g., digital channel 12-1 (main channel is 12, sub-channel is 1).</p> <p>“Learn” the channel separator function in the NetCommand <b>— (separator)</b> learning position.</p>	<p>Press digit key(s) and press <b>CANCEL</b>. NetCommand will send the channel-separator signal.</p>

## The MORE Key Menu and NetCommand

Perform NetCommand setup for these device-specific keys and then access their functions with the **MORE** key.

Device Key	VCR	Cable/ SAT	DVD/ DVR	A/V Receiver
<b>Menu</b>	✓	✓		✓
<b>Input</b>	✓			✓
<b>SP/EP</b>	✓			
<b>List</b>		✓		
<b>On Demand</b>		✓		
<b>A</b>		✓		
<b>B</b>		✓		
<b>C</b>		✓		
<b>D</b>		✓		























Device Key	VCR	Cable/ SAT	DVD/ DVR	A/V Receiver
<b>Top Menu</b>			✓	
<b>Angle</b>			✓	
<b>Audio (DVD)</b>			✓	
<b>Subtitle</b>			✓	
<b>Repeat</b>			✓	
<b>Bonus View</b>			✓	
<b>Setup</b>			✓	
<b>Surround</b>				✓
<b>Night</b>				✓

## Operating NetCommand-Controlled Devices, continued

### NetCommand Specialized Device Keys

Refer to this chart when “learning” device keys. “Learn” some, all, or none of the keys used for each device type.

See page 58 for more on keys marked in the “Special Operation Method” column.

Key Name in Learning Screen	Function	Name on TV Remote Control	See Special Operation Method Table
<b>Power On</b>	Power On or Power ON/OFF (toggle)		✓
<b>Guide</b>	On-Screen Program Guide or DVD Disc Menus		✓
<b>Channel +/Skip +</b>	Next Channel Higher/ Skip Forward (Disc)		
<b>Channel -/Skip -</b>	Next Channel Lower/ Skip Backward (Disc)		
<b>Page Up</b>	Page Up in Guides		
<b>Page Dn</b>	Page Down in Guides		
<b>Up</b>	Arrow up		
<b>Down</b>	Arrow down		
<b>Left</b>	Arrow left		
<b>Right</b>	Arrow right		
<b>Enter</b>	Enter or Select (menus)		✓
<b>Cancel</b>	Cancel or erase (menus)		✓
<b>Play</b>	Start playback		
<b>Stop</b>	Stop playback		
<b>Forward</b>	Fast Forward		
<b>Rewind</b>	Rewind/Fast Reverse		
<b>Pause</b>	Pause playback		
<b>Record</b>	Start Recording		
<b>1, 2, 3, 4, 5, 6, 7, 8, 9, 0</b>	Digits	1, 2, 3, 4, 5, 6, 7, 8, 9, 0	
<b>Enter (digits)</b>	Use after entering digits to tune directly to a channel by number		✓
<b>- (separator)</b>	Add digital channel separator between main channel number and sub-channel number		✓
<b>Last</b>	Last Channel Recall		
<b>Info</b>	On-screen status display or information display		May require two keypresses
<b>Power Off</b>	Power Off		✓

# 6 NetCommand IR Control of an A/V Receiver

NetCommand IR home-theater control is available on 153 and 249 series TVs.

Several types of A/V receiver control can be set up using the **Inputs > AVR** menu.

- **Power and volume.** See the next page.
- **Audio switching.** For most equipment setups, see “Case 1: Automatic A/V Receiver Switching to the TV Audio Input” page 63.
- **Audio switching and surround sound.** To set up switching to a surround sound device, see “Case 2: Automatic A/V Receiver Switching to a Surround Sound Device” page 64
- **Audio and video switching over HDMI.** If your A/V receiver has an HDMI output, it may be convenient to send audio and video to the TV over a single HDMI cable through the A/V receiver. See “Case 3: Automatic Audio and Video Switching via HDMI,” page 65.

**Note:** To set up control of other device types, see “Initial NetCommand Setup,” page 57.

## *Controlling an A/V Receiver after NetCommand Setup*

### Switching Audio to and from the A/V Receiver

1. Press **MORE** and then 9 (**AUDIO**).
2. Press **▲** to show the **Speakers** option.
3. Press **▶** to select either **AV Receiver** or **TV**.

### Controlling A/V Receiver Power

#### With Any Connection Type

1. Press **MORE** and then 9 (**AUDIO**).
2. Press **▲▼** to show the **Speakers** option.
3. Press **▶** to select **AV Receiver**.
4. Point the remote control at the **TV** (not the A/V receiver) and press **POWER** to power the A/V receiver on or off.

#### With an HDMI Connection

1. Press **ACTIVITY**.
2. Highlight the A/V receiver icon.
3. Press **POWER**.

### Controlling Other A/V Receiver Functions

With the A/V receiver powered on and selected, the TV's remote control operates the volume and mute functions. Also, when you switch to a device in the **Activity** menu, the A/V receiver automatically switches to the correct audio input for the device.

## Setting Up A/V Receiver Control

### Power and Volume

Perform this setup to control the A/V receiver power and volume with the TV's remote control.

To perform this setup you need:

- The remote controls for both the TV and the A/V receiver.
- An IR emitter cable available from Mitsubishi.

#### Before You Begin

1. Connect your A/V receiver to the TV and any additional devices. See "Setting Up TV Inputs," page 12 and "TV Connections," page 16.
2. Connect the IR emitter cable to the TV and position the IR emitter where it can send signals to the A/V receiver. See "IR Emitter Placement," page 56.
3. Set the **TV's** remote control to **TV** mode using the side button.

#### Setup to Control A/V Receiver Power and Volume

1. Open the **Inputs > AVR** screen in one of two ways:
  - If using the **New Device Found** screen for the A/V receiver, highlight **NetCommand** and press **ENTER** to open the **AVR** screen.
  - If performing NetCommand setup at any time after Auto Sensing: Press **MENU**, highlight **Inputs**, and highlight **AVR** to open the **AVR** menu.
2. The first function highlighted in the **AVR** screen is always **Power**. Aim the **TV's** remote control at the TV and press **ENTER** to begin learning for **Power**.

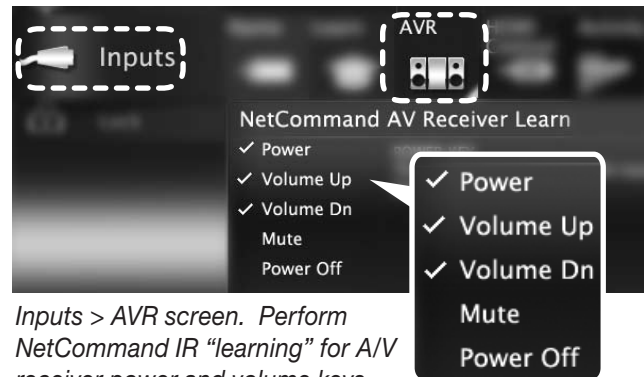

*Inputs > AVR screen. Perform NetCommand IR "learning" for A/V receiver power and volume keys.*

3. When the **Power** text starts flashing, aim the **A/V receiver's** remote control at the TV and hold the **POWER** or **POWER ON** key until a check mark appears next to **Power**.
  - If the text stops flashing before the check mark appears, repeat this step.
  - To remove the key from NetCommand control, press the **CANCEL** key while the key name is highlighted.
4. Press the **▼** key on the **TV's** remote control to highlight other keys in the list. Repeat steps 2 and 3 for each additional function you wish to control through NetCommand.
5. If the A/V receiver has a separate **POWER OFF** key, press **▼** on the **TV's** remote to highlight **Power Off**. Repeat steps 2 and 3 to "learn" the **POWER OFF** key. **If the device has no POWER OFF key, skip this step.**
6. When finished "learning" the power and volume keys, either
  - To watch TV, press **BACK**.
  - To continue with NetCommand setup to control switching of A/V receiver inputs, highlight **NEXT** and press **ENTER**.

#### IMPORTANT

To hear audio sent from the TV to the A/V receiver, you must have:

- Physically connected the TV to the A/V receiver.
- Assigned, if needed, the name AVR if using an HDMI A/V receiver.
- "Learned" the IR codes for the A/V receiver inputs.
- Assigned the TV's audio output to the correct input in the NetCommand **Inputs > AVR** menu.
- Selected the A/V receiver as the audio source. Press **MORE** then **9 (AUDIO)**, then **▲ ▼** to show the Speakers option, then **▶** to select the A/V Receiver.

## Setting Up A/V Receiver Control, continued

### Automatic Switching (Audio or Audio/Video)

The following setups enable the A/V receiver to switch automatically to the correct input when you select a device in the TV's **Activity** menu.

Three different connection arrangements are described here. Review the descriptions to find the setup needed for your equipment.

**To hear digital surround sound from a source device you must use the setup described for Case 2.**

To set up control of an A/V receiver you need:

- The remote controls for the TV and A/V receiver.
- An IR emitter cable available from Mitsubishi.
- Connecting cables

#### IMPORTANT

All audio from what you are watching on the TV is always available from both the TV's **AVR AUDIO OUTPUT** and **DIGITAL AUDIO OUTPUT** jacks.

To use the digital surround sound capabilities of your A/V receiver however, you must connect the audio output from your DVD player, satellite receiver, or cable box directly to the A/V receiver.

#### Before You Begin

1. Connect your A/V devices to the TV and connect your A/V receiver to the audio outputs on the TV and the DVD player. Note the name of the device connected to each A/V receiver input. See initial setup, page 12, and "TV Connections," page 16.
2. Position NetCommand IR emitters as described in "IR Emitter Placement," page 56.
3. Set the TV's remote control to **TV** mode using the side button.
4. Open the **Inputs > AVR** menu, highlight **NEXT** and press **ENTER** to display the device-key-learning menu.

#### Case 1: Automatic A/V Receiver Switching to the TV Audio Input

Most devices are set up to use the TV's audio output like the VCR in this example; analog audio from the device is sent through the TV to the A/V receiver's TV audio input.

Use this setup for:

- **Analog Stereo Audio.** Audio from sources with only analog stereo output (such as a VCR) can be sent either directly to the A/V receiver or through the TV first. Mitsubishi recommends you send audio through the TV as shown in the example. The TV converts analog audio to digital format to send to a digital A/V receiver.

- **Audio Available from TV only.** Send audio from the **ANT** input to the A/V receiver from the TV's analog or digital audio output. Use this setup to make the A/V receiver switch to its designated TV audio input when viewing programming from the **ANT** input.
- **HDMI Digital Stereo Audio.** Digital stereo audio from an HDMI connection is available both in digital and analog format from the TV's analog and digital audio output jacks.

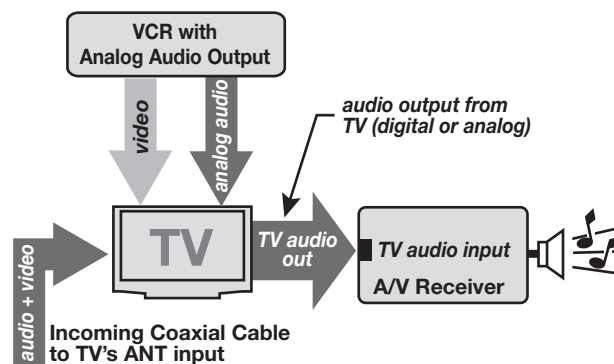

**Important:** To use this setup, you must connect the TV's audio output to the A/V receiver's TV audio input jack.

1. In the **Inputs > AVR** menu, press **▲ ▼** to highlight **TV audio out** as the A/V receiver input to control.
2. Press **ENTER** on the **TV's** remote control.
3. While the text **TV audio out** is flashing, press and hold the **TV INPUT** key on the **A/V receiver's** remote control.
4. When a check appears next to **TV audio out**, release the **TV INPUT** key.
  - If the text stops flashing before the check mark appears, repeat this step.
  - To erase the IR code just "learned," press **CANCEL** while the name is highlighted.
5. Press **MENU** if finished or continue with Case 2 setup if you want to control surround sound switching for another audio source.

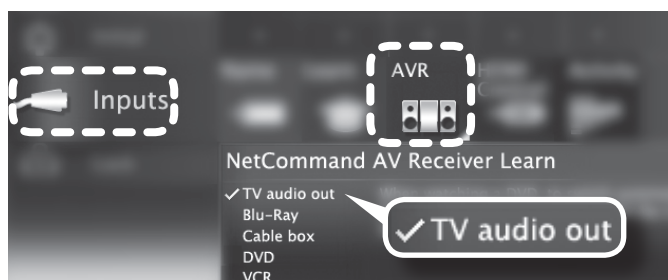

**Case 1: NetCommand setup for controlling A/V receiver switching to the A/V receiver's audio input from the TV.** The list displayed represents inputs in use. The device names are those you assigned in the New Device Found screen or in the **Inputs > Name** menu.

## Setting Up A/V Receiver Control, continued

### Case 2: Automatic A/V Receiver Switching to a Surround Sound Device

**Note:** Use this setup to send digital surround sound from a source device directly to your external sound system. For non-surround sound source devices, Mitsubishi recommends using the setup for Case 1, in which audio is sent through the TV.

A device can send digital surround sound such as Dolby Digital or DTS directly to the A/V receiver. The device might be a DVD player, cable box, or satellite receiver, and could have HDMI output. A DVD player is used in this example.

Your setup may include additional devices with digital surround sound connected directly to the A/V receiver. These devices might be a DVD player plus a cable box or satellite receiver.

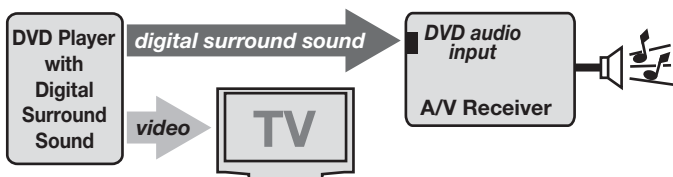

**Case 2:** A/V receiver audio from a device providing surround sound directly to the A/V receiver

1. In the **Inputs > AVR** menu, press **▲ ▼** to highlight the name of the A/V receiver input to control. In this example, it is the **DVD** input.
2. Press **ENTER** on the **TV's** remote control.

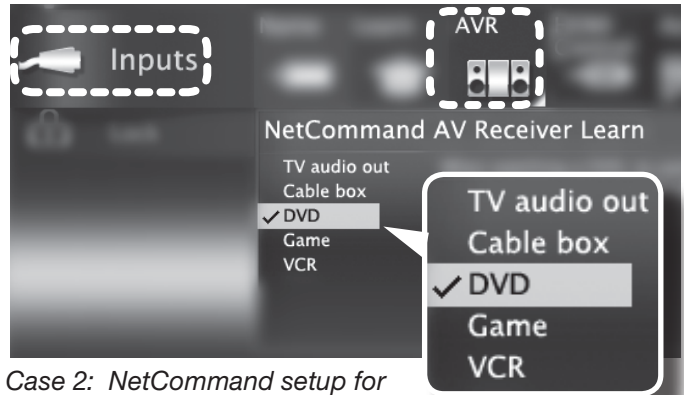

*Case 2: NetCommand setup for controlling A/V receiver switching to the A/V receiver's DVD input. The list contains connected inputs with names assigned during Auto Input Sensing.*

3. While the text **DVD** is flashing, press and hold the **DVD INPUT** key on the **A/V receiver's** remote control.
4. When a check appears next to **DVD**, release the **DVD INPUT** key.
  - If the text stops flashing before the check mark appears, repeat this step.
  - To erase the IR code just "learned," press **CANCEL** while the name is highlighted.
5. If finished, highlight **EXIT** and press **ENTER** or continue to set up additional A/V receiver audio sources.



## Setting Up A/V Receiver Control, continued

### Case 3: Automatic Audio and Video Switching via HDMI

If your A/V receiver has an HDMI output, it may be convenient to route video signals from multiple devices over a single cable to the TV. Use this procedure to set up NetCommand control of the A/V receiver's audio and video switching over a single HDMI cable. The connected source devices can be analog, digital, or a mixture of the two. When this setup is complete, you can use the TV's **Activity** menu to select a video device connected to the A/V receiver.

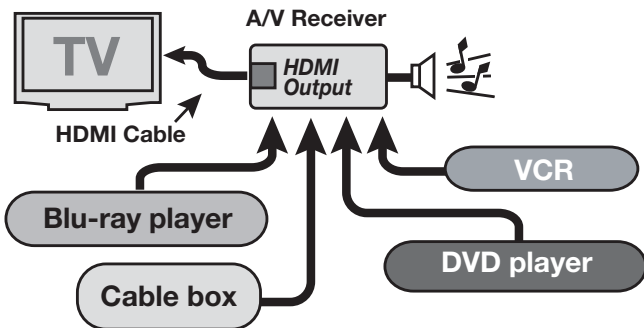

### More About Using an HDMI Connection

- Audio from devices connected directly to the TV can be heard from the TV speakers only. To send audio to the A/V receiver from such devices, use one of the optional audio connections shown in the diagram on this page. For example, use an optional audio connection if you wish to use the A/V receiver speakers to hear audio from:
  - The **ANT** input
  - A game or camcorder connected to the convenience input (**INPUT 3**).
- To use NetCommand to supplement HDMI control of a CEC-enabled A/V receiver, the recommended setup sequence is:
  1. Connect the HDMI cable.
  2. Enable HDMI control (**New Device Found** screen).
  3. Connect the secondary digital audio cable, if desired.
  4. Perform NetCommand setup.

If you connect to HDMI after performing NetCommand setup for the A/V receiver, the NetCommand setup will be lost.
- In some circumstances, audio from a device connected to the A/V receiver may not be passed over the HDMI cable to the TV speakers. In these cases you must use the A/V receiver speakers to hear audio.

### Before You Begin

To complete these steps you will need:

- The remote controls for both the TV and the A/V receiver.
  - An IR emitter cable available from Mitsubishi.
  - An HDMI-to-HDMI cable to connect the A/V receiver to the TV and cables necessary to connect devices to the A/V receiver.
1. Connect the A/V receiver to the TV with an HDMI-to-HDMI cable. Do not connect the optional audio cable at this time.
  2. If desired, enable HDMI Control of a CEC-enabled A/V receiver. See Appendix B, "HDMI Control of CEC Devices."
  3. Connect your audio/video devices to the A/V receiver. Note the name of the device connected to each A/V receiver input. This information will be needed later to set up NetCommand's automatic input switching.

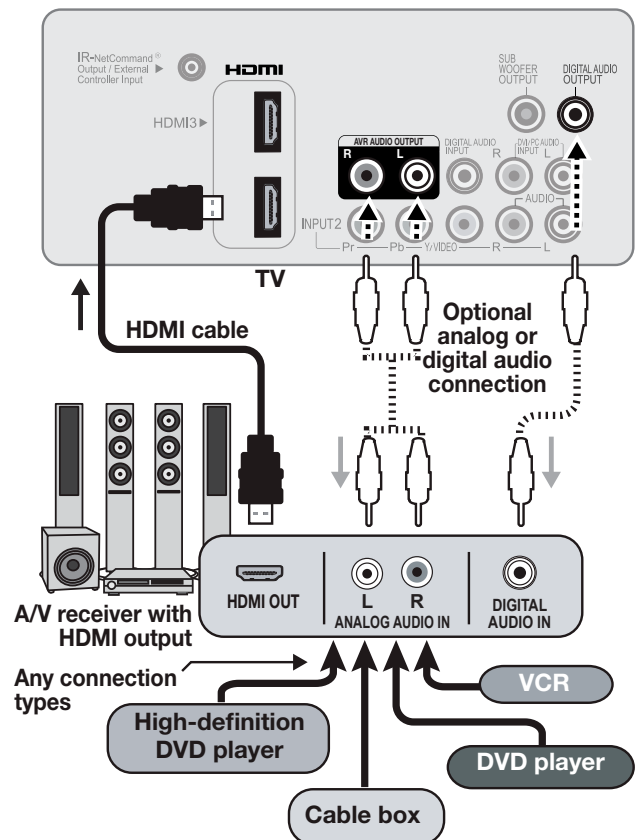

*Multiple video inputs through a single HDMI cable. You can connect multiple video devices to an A/V receiver that has an HDMI output. The optional audio connection allows you to hear, through the A/V receiver, devices connected to the TV only, e.g., an antenna on the **ANT** input.*

## Setting Up A/V Receiver Control, continued

- If using an optional audio cable between the TV and A/V receiver, connect it.
- Connect the IR emitter cable to the TV and position the IR emitter where it can send signals to the A/V receiver. See “IR Emitter Placement,” page 56.

### Setup to Control Automatic Audio and Video Switching via HDMI

When this setup is complete, the “learned” A/V receiver input will appear in the TV’s **Activity** menu as a selectable input.

- Power on the A/V receiver.
- Set the **TV’s** remote control to **TV** mode using the side button.
- Power on the TV.
- When the **New Device Found** screen displays, select device name **AVR** if it is not recognized automatically.
- Navigate to the **Inputs > AVR** menu or, from within the **New Device Found** screen, highlight **NetCommand** and press **ENTER**.



To set up A/V switching over HDMI, choose your devices from a list. Unlike the device list described for Case 2, this is a generic list containing more than just the devices detected in your setup.

- In the **Inputs > AVR** menu, press **▲▼** to highlight the name of the A/V receiver input to control. In this example, it is the **DVD** input.
- Press **ENTER** on the **TV’s** remote control.
- While the text **DVD** is flashing, press and hold the **DVD INPUT** key on the **A/V receiver’s** remote control.
- When a check appears next to **DVD**, release the **DVD INPUT** key.
  - If the text stops flashing before the check mark appears, repeat this step.
  - To erase the IR code just “learned,” press **CANCEL** while the name is highlighted.
- If there are no more devices to set up, highlight **EXIT** and press **ENTER** or continue to set up additional A/V receiver audio/video sources.

### NetCommand Control of a Device Connected to an HDMI A/V Receiver

Use this setup to have NetCommand control a device sending audio and video through the A/V receiver to the TV via HDMI.

You must have already completed the procedure under “Setup to Control Automatic Audio and Video Switching via HDMI” on this page. That procedure places an icon in the **Activity** menu for the device (input) connected to the A/V receiver.

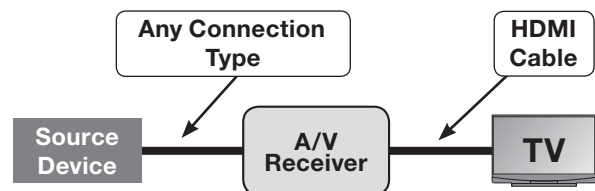

- Set up NetCommand control of A/V receiver audio/video switching via HDMI as described on this page.
- Press **BACK** to close any open menus and return to normal TV viewing.
- Press **ACTIVITY**.
- Highlight the icon for the A/V receiver input you wish to control.
- Press **ENTER** to switch the TV to the A/V receiver and the A/V receiver to the input.
- Open the **Inputs > Learn** menu.
- Perform NetCommand “learning” for the connected device by following the steps in “Initial NetCommand Setup,” page 57.

# Appendices

---

- Appendix A: Programming the Remote Control . . . . . 68**
- Appendix B: HDMI Control of CEC Devices . . . . . 75**
- Appendix C: TV Care . . . . . 78**
- Appendix D: Bypassing the Parental Lock . . . . . 79**
- Appendix E: Troubleshooting . . . . . 81**

## Appendix A: Programming the Remote Control

This appendix explains programming the TV's remote control to operate other A/V devices. This is distinct from NetCommand control.

### Functions Available for Other A/V Devices

The TV's remote control can be programmed to operate other types and brands of A/V products. The functions performed in each switch position vary depending on the product. Not all functions work for all models. The most common functions available are listed on this page.

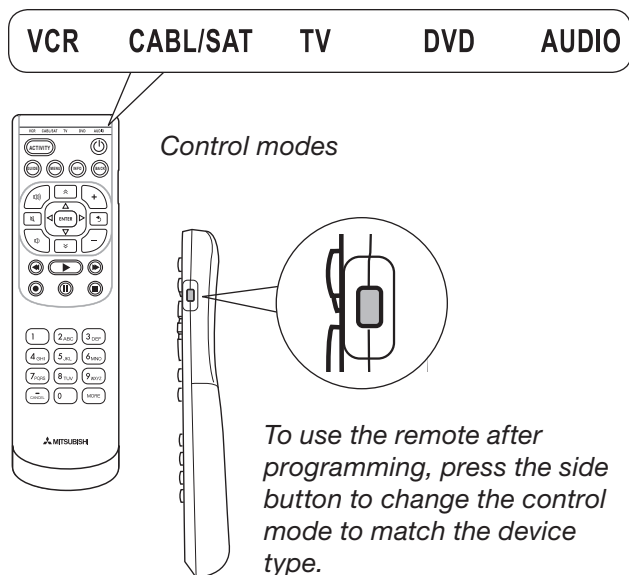

### The MORE Menus

Press the **MORE** key to display a menu showing additional key functions available after programming the remote control for a device.

### 249 Series Supplemental Keys

The supplemental cable box keys offered with the 249 series may provide additional controls. Program the remote control for your cable box and test the keys.



The TV's remote control may operate the Favorites and On Demand features of your cable box.



The F1–F4 keys work like the A, B, C, D buttons on some cable boxes.

#### IMPORTANT

Some manufacturers may change their products or they may use more than one remote control system. The TV's remote control may be unable to operate your A/V equipment in these cases.

### VCRs and DVRs

- |  |   |
|--|---|
| <ul style="list-style-type: none"> <li>• CHANNEL UP/DN</li> <li>• POWER</li> <li>• SLEEP (from MORE menu)</li> <li>•  (FAST FORWARD)</li> <li>•  (PAUSE)</li> <li>•  (PLAY)</li> </ul> | <ul style="list-style-type: none"> <li>•  (RECORD)</li> <li>•  (REVERSE)</li> <li>•  (STOP)</li> <li>• GUIDE (DVR only)</li> <li>• MENU (DVR only)</li> <li>• 0–9 Number Buttons</li> </ul> |
|--|---|

Mitsubishi VCRs are compatible with some additional keys.

### Cable Boxes and Satellite Receivers

(not all functions for all models)

- |  |   |
|--|---|
| <ul style="list-style-type: none"> <li>• PAGE UP/DOWN</li> <li>• CANCEL</li> <li>• CHANNEL UP/DN</li> <li>• ENTER</li> <li>• GUIDE</li> <li>• POWER</li> <li>• </li> <li>• LAST (ENTER; for channels on some models)</li> <li>• 0–9 Number Keys</li> </ul> | <p>The record/playback keys:</p> <ul style="list-style-type: none"> <li>•  (FAST FORWARD)</li> <li>•  (PAUSE)</li> <li>•  (PLAY)</li> <li>•  (RECORD)</li> <li>•  (REVERSE)</li> <li>•  (STOP)</li> </ul> <p><b>249 Series Keys for Cable Boxes</b></p> <ul style="list-style-type: none"> <li>• FAV</li> <li>• ON DEMAND</li> <li>• F1–F4</li> </ul> |
|--|---|

### A/V Receivers

- |   |  |
|---|--|
| <ul style="list-style-type: none"> <li>• MUTE</li> <li>• POWER</li> <li>• SLEEP (from MORE menu)</li> <li>• VOLUME</li> <li>• 0–9 Number Buttons</li> </ul> | <ul style="list-style-type: none"> <li>• Direct Input Selection buttons: numbers and LAST (on some Mitsubishi models)</li> </ul> |
|---|--|

### CD Players

(not all functions for all models)

- |  |   |
|--|---|
| <ul style="list-style-type: none"> <li>• SLEEP (from MORE menu)</li> <li>•  (FAST FORWARD)</li> <li>•  (PAUSE)</li> <li>•  (PLAY)</li> </ul> | <ul style="list-style-type: none"> <li>•  (REVERSE)</li> <li>•  (STOP)</li> <li>• 0–9 Number Buttons</li> </ul> |
|--|---|

### DVD Players

(not all functions for all models)



- |  |   |
|--|---|
| <ul style="list-style-type: none"> <li>• CANCEL (on some models)</li> <li>• CHANNEL UP/DN (for track skip on some models)</li> <li>• ENTER</li> <li>• MENU</li> <li>• POWER</li> <li>• SLEEP (from MORE menu)</li> <li>• </li> </ul> | <ul style="list-style-type: none"> <li>•  (FAST FORWARD)</li> <li>•  (PAUSE)</li> <li>•  (PLAY)</li> <li>•  (RECORD)</li> <li>•  (REVERSE)</li> <li>•  (STOP)</li> <li>• 0–9 Number Keys</li> </ul> |
|--|---|

## Appendix A: Programming the Remote Control, continued

### Programming the Remote Control

1. Press the side button on the remote control to change to the correct mode for the product you want to control. Refer to the table below. Only one of each device type can be controlled in each mode.

Mode	Affected Device
CABLE/SAT	Cable Box DTV Receiver Satellite Receiver
VCR	VCR DVR DVD Player/Recorder
DVD	DVD Player/Recorder DVR VCR
AUDIO	A/V Receiver Audio Amplifier CD Player

2. Press and hold **POWER** on the remote control for several seconds until the mode indicator blinks twice and goes off.
3. Release the **POWER** key.
4. Enter the first five-digit code listed for your equipment.
  - The mode indicator blinks twice when you start to enter the code and then once for each additional keypress.
  - The mode indicator blinks twice when you finish entering a valid code.
  - If you need to start over or wish to exit programming mode, temporarily change to a different mode using the side button.
5. Point the remote control at the equipment and press **POWER**. If the product has no power on/off function, press a different key, such as  (**PLAY**),  (**STOP**), **VOLUME UP**, or **MUTE**.
  - If the equipment responds, the remote control is properly programmed.
  - If the equipment does not respond, repeat steps 2–4 with the next five-digit code listed for your equipment.
6. Once you have found the correct code, write it in the space below for future reference.

Mode	Device Type	Code
CABLE/SAT		
VCR		
DVD		
AUDIO		

### IMPORTANT

You may need to reprogram the remote control after changing the batteries. Record the codes for each mode in the space provided to make this faster.

### Code Verification

To determine the code programmed for any mode:

1. Set the mode to the one you wish to verify.
2. Press and hold **POWER** on the remote control for several seconds until the mode indicator blinks twice and goes off.
3. Press keys **9 9 0**
4. Press **1** and count the blinks of the power key. Write down the number of blinks as the first digit of the code.
5. Repeat step 4 for the second, third, fourth, and fifth digits of the code.

### Audio Lock: Universal A/V Receiver Control

With Audio Lock enabled, the remote control operates volume and mute on the A/V receiver in all modes set by the side button. Activate Audio Lock if you normally use an A/V receiver with your TV and other A/V equipment.

1. Program **AUDIO** mode for your A/V receiver as described in “Programming the Remote Control” on this page.
2. With the remote control in **AUDIO** mode, hold **POWER** on the remote control for several seconds until the mode indicator blinks twice and goes off.
3. Press keys **9 9 3 ENTER**  
The mode indicator will blink twice to indicate Audio Lock is active.

### To Reset the Remote Control to Operate Volume and Mute for the TV Speakers

1. Press and hold **POWER** for several seconds until the mode indicator blinks twice and goes off.
2. Press keys **9 9 3 VOLUME UP**.  
The mode indicator will blink four times to indicate Audio Lock has cleared.

## Appendix A: Programming the Remote Control, continued

### Programming Codes

#### Audio Amplifiers

Adcom	41100, 40577
Altec Lansing	41742
Bel Canto	41583
Design	
Bose	40674
Carver	40892
Cary Audio	41879
Design	
Classe	41461
Flextronics	41879
Halcro	41934
Harman/	40892
Kardon	
JVC	40331
Krell	41837
Left Coast	40892
Lexicon	41802, 41145
Marantz	40892
Mark	41483
Levinson	
Parasound	41934
Philips	40892
Polk Audio	40892
Victor	40331
Yamaha	40354

#### Cable Boxes

A-Mark	10144, 10008
ABC	10237, 10008
Acorn	10237
Action	10237
Active	10237
Americast	10899
Amino	11822, 11602
Archer	10237
Bell South	10899
Century	10008
Cisco	11982, 11877, 10877
Comcast	11982
Digeo	12187
Director	10476
GE	10144
General	10476
Instrument	
GoldStar	10144
Hitachi	10008
i3 Micro	11602
Insight	10476
Jerrold	10476
Memorex	10000
Motorola	11376, 11254, 10476
Myrio	11822, 11602
Nova Vision	10008
Novaplex	10008
Pace	11877, 10877, 10237, 10008
Panasonic	11982, 10144, 10008, 10000

#### Cable Boxes

Paragon	10525, 10008, 10000
Penney	10000
Philips	11305
Pioneer	11877, 10877, 10533, 10144
Pulsar	10000
Quasar	10000
Runco	10000
Samsung	10144
Scientific	11877, 10877, 10477, 10237, 10008, 10000
Atlanta	10237, 10008, 10000
Sejin	11602
Sony	11006
Sprucer	10144
Toshiba	10000
US Elec- tronics	10008
Videoway	10000
Zenith	10899, 10525, 10000

#### CD Players

Acoustic	40420
Research	
Akai	40083
Burmester	40420
California	40029
Audio Labs	
DKK	40000
Fisher	40000
Garrard	40420
Hafler	40173
Harman/	41202, 40173, 40100,
Kardon	40083
Inkel	40180
Integra	40101
JVC	41294, 40072
Kenwood	40626, 40190, 40037, 40029, 40000
KLH	41711, 41318
Koss	41317
LG	41208
Magnavox	40038
Marantz	40626, 40435, 40180, 40038, 40029
McIntosh	41703
MCS	40029
Memorex	40420, 40000
MGA	40083
Miro	40000
Mitsubishi	40098, 40083
Modulaire	40420, 40180, 40087, 40000
MTC	40420
NAD	41208
Onkyo	41327, 40101
Optimus	40420, 40087, 40037, 40000
Panasonic	40752, 40388, 40029

#### CD Players

Parasound	40420
Penney	40029
Philips	40626
Pioneer	41087
Proceed	40420
Quasar	40029
RadioShack	40420, 40180, 40000
RCA	40420
Realistic	40420, 40180, 40087, 40000
Roksan	40435
Rotel	40420
Sansui	40000
Sanyo	40087, 40000
Sharp	40180, 40037
Sherwood	41950, 40180
Sony	41364, 40490, 40185, 40100, 40000
Symphonic	40180
Tascam	40420
TDK	41208
Teac	40490, 40420, 40180
Technics	40029
Victor	40072
Wards	40087
Yamaha	41292, 40490, 40036
Yorx	40000

#### A/V Receivers

ADC	40531
Aiwa	41641, 41405, 41388, 41243, 40189, 40121
Alco	41390
AMC	41077
Anam	41609, 41074
Arcam	41189
Audiotronic	41189
Audiovox	41390
Bose	41933, 41841, 41629, 41253, 41229, 40639
Cairn	40189
Capetronic	40531
Carver	41289, 41189, 40189, 40121
Curtis	40014
Mathes	
Daewoo	41250
Denon	41360, 41306, 41142, 40121
Emerson	40531
Fisher	41801
Grundig	40189
Harman/	41306, 41304, 41289,
Kardon	40891, 40189, 40110
Hitachi	41801
Insignia	42169, 41893, 41077, 41030

## Appendix A: Programming the Remote Control, continued

### Programming Codes, continued

A/V Receivers		A/V Receivers		Satellite Receivers	
Integra	41805, 41320, 41298, 40842	Technics	41518, 41308	SKY	10099
JBL	41306, 40110	Thorens	41189	Sony	11640, 11639, 10639
JVC	42331, 41643, 41495, 41374, 41282, 41058	Toshiba	41788, 41123, 40842	Thomson	10566, 10392
Kawasaki	41390	Venturer	41390	Tivo	11442, 11142
Kenwood	41570, 41569, 41313	Wards	40189, 40014	Toshiba	11749, 10790, 10749
KLH	41428, 41390	Yamaha	41815, 41476, 41376, 41375, 41331, 41276, 41176, 41023, 40176	UltimateTV	11640, 11392
LG	42197, 41293	YBA	41921	Uniden	10722
Linn	40189	Zenith	41293	Zenith	11856, 11810
Magnavox	41514, 41269, 41266, 41189, 40531, 40189	Satellite Receivers		A-Mark	20278, 20046, 20037, 20000
Marantz	41289, 41269, 41189, 40891, 40189	Bell ExpressVu	11170, 10775	ABS	21972
McIntosh	41289	Chaparral	10216	Accurian	20000
Micromega	41189, 40189	Crossdigital	11109	Admiral	20479, 20209, 20060, 20048, 20047, 20039
Mitsubishi	41957, 41922, 41921, 41920, 41393	DirectTV	11856, 11749, 11640, 11639, 11609, 11442, 11414, 11392, 11377, 11142, 11109, 10819, 10749, 10639, 10566, 10392, 10247, 10099	Adventura	20037, 20000
Myryad	41189	Dish	11775, 11505, 11170, 10775	Aiko	20278
Nakamichi	41313	Network System	10775	Aiwa	20124, 20037, 20000
Onkyo	41905, 41805, 41320, 41298, 40842	Dishpro	11775, 11505, 10775	Akai	20242, 20175
Optimus	41074, 41023, 40531, 40121, 40014	Echostar	11775, 11505, 11170, 10775	Alba	20278, 20209
Panasonic	42967, 41764, 41763, 41633, 41548, 41518, 41509, 41316, 41308, 41288, 41275	Expressvu	11775, 10775	Alienware	21972
Philips	41269, 41266, 41189, 40891, 40531, 40189	Fortec Star	11821	Allegro	20039
Pioneer	41935, 41384, 41123, 41023, 40630, 40531, 40150, 40014	Funai	11377	America	20278
Polaroid	41508	GE	10566	Action	
Polk Audio	41289, 40189	GOI	11775, 10775	American	20081, 20035
Proscan	41254	Hitachi	11250, 10819, 10749	High	
RadioShack	41609	Houston	10775	Amstrad	20000
RCA	41609, 41511, 41390, 41254, 41123, 41074, 41023, 40531	HTS	11775, 10775	Astra	20035
Realistic	41609, 40121	Hughes	11749, 11442, 11142, 10749	Audiovox	20278, 20038, 20037
Revox	40189	Network Systems		Avis	20000
Rio	41869	Humax	11790, 11781	Bell &	20479, 20048, 20046, 20039, 20035, 20000
Samsung	41500, 41304, 41295	Innova	10099	Bell	21944
Sansui	41189, 40189	JVC	11775, 11170, 10775	ExpressVu	
Sanyo	41801	LG	11414	Broksonic	20479, 20209, 20184, 20121
Sherwood	42169, 41905, 41077	Magnavox	10722	Calix	20037
Sherwood	42169	Mitsubishi	10749	Candle	20038, 20037
Newcastle		Netsat	10099	Canon	20035
Sonic Blue	41869	Panasonic	10701, 10247	Carver	20081, 20035
Sony	41858, 41822, 41759, 41758, 41658, 41622, 41558, 41441, 41382, 41258, 41131, 41058	Pansat	11807	CCE	20278
Stereophonics	41023	Philips	11749, 11442, 11142, 10775, 10749, 10722, 10099	Cineral	20278
Sunfire	41313	Proscan	10566, 10392	Citizen	20479, 20278, 20209, 20037, 20035, 20000
Teac	41390, 41074	RadioShack	10775, 10566	Classic	20037
		RCA	11442, 11392, 11142, 10855, 10775, 10566, 10392, 10143	Colortyme	20278, 20060, 20045, 20035
		Samsung	11609, 11442, 11377, 11276, 11142, 11109	Colt	20000
				Craig	20047, 20037
				Criterion	20000
				Crosley	20081, 20035, 20000
				Crown	20278
				Curtis	20432, 20278, 20162, 20060, 20035, 20000
				Mathes	20060, 20035, 20000
				CyberPower	21972
				Daewoo	20278, 20046, 20045, 20037

## Appendix A: Programming the Remote Control, continued

### Programming Codes, continued

VCRs		VCRs		VCRs	
Daytron	20278, 20037	HTS	21944	Nikkodo	20278, 20037
Dell	21972	Hughes	20739, 20042	Niveus	21972
Denon	20081, 20042	Network		Media	
DirecTV	20739	Systems		Northgate	21972
Dish	21944	Humax	21988, 21797, 20739	Olympus	20162, 20035
Network		Hush	21972	Onkyo	20222
System		Hytek	20047, 20000	Optimus	21062, 21048, 20593, 20432, 20162, 20048, 20047, 20037, 20035, 20000
Dishpro	21944	iBUYPOWER	21972	Orion	20479, 20278, 20209, 20184, 20121, 20000
Dual	20000	Instant	20035	Panama	20035
Durabrand	20039, 20038	Replay		Panasonic	21062, 20616, 20614, 20225, 20162, 20035, 20000
Dynatech	20000	Jensen	20067	Penney	20162, 20081, 20067, 20047, 20042, 20038, 20037, 20035, 20000
Echostar	21944	JVC	21944, 20067	Pentax	20042
Electrohome	20209, 20060, 20043, 20037, 20000	KEC	20278, 20037	Philco	20479, 20209, 20081, 20035, 20000
Electroponic	20037	Kenwood	20067, 20046, 20038	Philips	21181, 21081, 20739, 20618, 20616, 20209, 20162, 20081, 20048, 20045, 20035, 20000
Emerald	20184, 20121	Kodak	20037, 20035	Pilot	20037
Emerex	20032	KTV	20000	Pioneer	20162, 20081, 20067, 20042
Emerson	21593, 20593, 20479, 20278, 20209, 20184, 20121, 20043, 20037, 20000	LG	20038, 20037	Polk Audio	20081
Expressvu	21944	Linksys	21972	Portland	20278
Fisher	20047, 20046, 20039, 20000	Lloyd's	20038, 20000	Presidian	21593
Fuji	20035, 20033	Loewe	20081	Proscan	20060
Fujitsu	20000	Logik	20000	Protec	20000
Funai	21593, 20593, 20278, 20037, 20000	Lumatron	20278	Pulsar	20278, 20039
Garrard	20000	Luxor	20046	Quarter	20046
Gateway	21972	LXI	20067, 20042, 20037, 20000	Quartz	20047, 20046, 20035
GE	20060, 20048, 20035, 20000	Magnasonic	20593, 20278, 20037, 20000	Quasar	20162, 20035
Gemini	20060	Magnavox	21593, 20618, 20593, 20563, 20081, 20048, 20039, 20037, 20035, 20000	RadioShack	20162, 20048, 20047, 20046, 20037, 20035, 20000
Genexxa	20278, 20037, 20000	Marantz	20081, 20038, 20035	Radix	20037
GFM	21593	Marta	20037	Randex	20037
Go Video	20614, 20432	Matsui	20209, 20037	RCA	20880, 20060, 20048, 20045, 20042, 20035, 20000
GOI	21944	Matsushita	20162, 20081, 20035	Realistic	20278, 20162, 20121, 20048, 20047, 20046, 20037, 20035, 20000
GoldStar	20278, 20039, 20038, 20037, 20035, 20000	Media	21972	ReplayTV	20616, 20614
Goodmans	20278, 20081, 20037, 20000	Center PC		Ricavision	21972
Gradiente	20000	MEI	20035	Runco	20039
Granada	20081, 20042	Memorex	20479, 20278, 20209, 20162, 20048, 20047, 20046, 20039, 20037, 20035, 20000	Salora	20075
Grundig	20081	Metz	20037	Samsung	20739, 20432, 20060, 20045, 20038, 20000
Harley	20000	MGA	20060, 20043	Sanky	20048, 20039
Davidson		Microsoft	21972		
Harman/	20081, 20075, 20038	Mind	21972		
Kardon		Minolta	20042		
Headquarter	20046	Mitsubishi	20443, 20242, 20214, 20173, 20075, 20067, 20060, 20048, 20047, 20043, 20042, 20000		
Hewlett	21972	Motorola	20048, 20035		
Packard		MTC	20000		
HI-Q	20047, 20035, 20000	MTX	20000		
Hitachi	20089, 20045, 20042, 20037, 20035, 20000	Multitech	20039, 20000		
Howard	21972	NEC	20067, 20038		
Computers		Nikko	20278, 20037		
HP	21972				



## Appendix A: Programming the Remote Control, continued

### Programming Codes, continued

VCRs		VCRs		DVD and Blu-ray Players	
Sansui	20479, 20209, 20067, 20000	Touch	21972	B & K	30662, 30655
Sanyo	20479, 20159, 20047, 20046, 20000	Trix	20037	BBK	31224
Scott	20184, 20121, 20045, 20043	Ultra	20278, 20045	Bel Canto	31571
Sears	20209, 20162, 20067, 20060, 20048, 20047, 20046, 20045, 20043, 20042, 20039, 20037, 20035, 20033, 20000	Vector	20045	Design	
Sharp	20848, 20048, 20047, 20032, 20000	Vector	20184, 20038	Blaupunkt	30717
Shintom	20039, 20000	Research		Blue Parade	30571
Siemens	20037	Victor	20067	Blue Sky	30699, 30695
Signature	20479, 20060, 20048, 20046, 20037, 20035, 20000	Video Concepts	20242, 20045	Bose	32023, 31895
Singer	20037	Videomagic	20037	Brandt	30651
Sonic Blue	20616, 20614	Videosonic	20000	Broksonic	30695
Sonographe	20046	Viewsonic	21972	California	30490
Sony	21972, 21032, 20636, 20067, 20047, 20046, 20035, 20033, 20032, 20000	Villain	20000	Audio Labs	
Soundmaster	20000	Voodoo	21972	Celestial	31020
Stack 9	21972	Wards	20479, 20081, 20060, 20048, 20047, 20046, 20045, 20043, 20042, 20038, 20037, 20035, 20033, 20000	Centrex	31004, 30672
STS	20042	Wharfedale	20593	Cinea	30831
SV2000	20000	White	20479, 20278, 20209, 20000	CineVision	30869, 30833
SVA	20000	Westinghouse	20000	Citizen	32116, 31587, 31277, 31003, 30695
Sylvania	21593, 20593, 20081, 20043, 20035, 20000	World	20479, 20209	Clairtone	30571
Symphonic	21593, 20593, 20000	XR-1000	20035, 20000	Coby	31351, 31177, 31165, 31107, 31086, 31077, 30852, 30778
Systemax	21972	Yamaha	20038	Craig	30831
Tagar	21972	Zenith	21139, 20479, 20278, 20209, 20039, 20037, 20033, 20000	Creative	30539, 30503
Systems		ZT Group	21972	Curtis	31087
Tandy	20000	<b>DVD and Blu-ray Players</b>		Mathes	
Tashiko	20037	3D LAB	30539, 30503	CyberHome	31537, 31502, 31129, 31117, 31024, 31023, 30874, 30816
Tatung	20081, 20067, 20048, 20000	Accurian	31416, 30675	Cytron	30705
Teac	20067, 20000	Acoustic	30730	Daewoo	31242, 31234, 31172, 31169, 30869, 30833, 30784, 30770, 30705
Technics	20162, 20037, 20035, 20000	Solutions		Dansai	30770
Teknika	20037, 20035, 20000	Adcom	31094	Daytek	30872
Tevion	20479	Afreedy	30698	Decca	30770
Thomas	20000	Aiwa	30641, 30533	Denon	32258, 30634, 30490
Thomson	20060	Akai	31089, 30770, 30705, 30695	Denver	30778
Tisonic	20278	Alba	30717, 30672	Desay	31407
Tivo	21944, 20739, 20636, 20618	Alco	30790	DigitalMax	31738
TMK	20000	Allegro	30869	Digitrex	30672
TNIX	20037	Amphion	30872	Disney	31270, 30675
Toshiba	21988, 21972, 21008, 20209, 20045, 20043, 20000	Media		DiViDo	30705
Tosonic	20278	Works		Dual	31068, 30675
Totevision	20037	AMW	30872	Durabrand	31127, 31023
		Apex Digital	31061, 31056, 31020, 31004, 30797, 30796, 30794, 30755, 30717, 30672, 30533	DVD2000	30521
		Arrgo	31023	Electrohome	32116, 31003
		Aspire	31168, 31407	Emerson	31268, 30675, 30591
		Digital		Enterprise	30591
		Astar	31489	Entivo	30539, 30503
		Audiovox	31041, 30790, 30717	Enzer	30770
		Awa	30730	ESA	31268
				Firstline	30651
				Fisher	30670
				Funai	31268, 30675
				Gateway	31158, 31077, 31073
				GE	30815, 30717, 30522

## Appendix A: Programming the Remote Control, continued

### Programming Codes, continued

DVD and Blu-ray Players		DVD and Blu-ray Players		DVD and Blu-ray Players	
GFM	31268, 30675	Myryad	30894	Sharp	32250, 31256, 30752, 30675, 30630
Go Video	31730, 31304, 31158, 31144, 31099, 31075, 31044, 30869, 30833, 30783, 30744, 30741, 30717, 30715, 30573	NAD	30741	Sharper	31117
GoldStar	30869, 30741	Naiko	30770	Image	
Goodmans	30790	NEC	30869, 30785	Sherwood	31077, 31043, 30770, 30633
GPX	30769, 30699	Nesa	30717	Sherwood	31077
Gradiente	30651, 30490	NexxTech	31402	Newcastle	
Greenhill	30717	Norcent	31265, 31107, 31003, 30872	Shinsonic	30839, 30533
Grundig	30705, 30539	Onkyo	31769, 30627, 30503	Slim Art	30784
Harman/Kardon	30702, 30582	Oppo	31224, 30575	SM Electronic	30730
Hello Kitty	30831	Optimus	30571	Sonic Blue	31099, 30869, 30783, 30715, 30573
Hitachi	30664, 30573	Oritron	30651	Sony	31536, 31533, 31516, 31431, 31070, 31033, 30864, 30533
Hiteker	30672	Palsonic	30852, 30672	Sungale	31074
Humax	31588, 31500	Panasonic	31762, 31641, 30703, 30632, 30571, 30503, 30490	SVA	30860, 30717
iLo	31348	Philco	30675	Sylvania	31268, 30675
Initial	30717	Philips	32084, 32056, 31506, 31354, 31340, 31267, 31158, 30675, 30646, 30539, 30503	Symphonic	31268, 30675
Insignia	32095, 31268, 30675	Phonotrend	30699	TAG	30894
Integra	31769, 30627, 30571	PianoDisc	31024	McLaren	
IRT	30783	Pioneer	31571, 31512, 31460, 30632, 30631, 30571, 30525, 30142	Tatung	30770
JBL	30702	Polaroid	31086, 31061, 31020	Teac	30790, 30717, 30571
JMB	30695	Polk Audio	30539	Technics	30703, 30490
JSI	31423	Portland	30770	Technika	30770
JVC	31550, 31275, 31164, 30867, 30623, 30558	Presidian	31738, 30675	Technosonic	30730
jWin	31049	Proceed	30672	Tevion	30651
Kawasaki	30790	Proscan	30522	Theta Digital	30571
Kenwood	30534, 30490	Prosonic	30699	Thomson	30522, 30511
KLH	31149, 31020, 30790, 30717	ProVision	30778	Tivo	31588, 31512, 31503
Kloss	30533	Qwestar	30651	Toshiba	31769, 31608, 31588, 31515, 31510, 31503, 31154, 30695, 30573, 30539, 30503
Koss	31423, 31061, 30769, 30651	Radionette	30741	Tredex	30800
Lasonic	30798, 30627	RadioShack	30571	Unimax	30770
Lecson	31533	RCA	31769, 30822, 30790, 30717, 30571, 30522	United	30730
Lenoxx	31127	Realistic	30571	Universum	30591
LG	30869, 30741, 30591	Reoc	30752	Urban Concepts	30539, 30503
LiteOn	31738, 31656, 31440, 31416, 31158, 31058	Revoy	30699	US Logic	30839
Loewe	30741, 30511	Rio	30869	V	31226, 31064
Logix	30783	Rotel	31178, 30623	Venturer	30790
Magnasonic	30675, 30651	Rowa	31004	Vizio	31226, 31064
Magnavox	31506, 31354, 31268, 30675, 30646, 30539, 30503	Saba	30651	Wesder	30699
Marantz	30675, 30539, 30503	Sampo	30752, 30698	Xbox	32083, 30522
McIntosh	31533, 31273	Samsung	31075, 31044, 30820, 30744, 30573, 30490, 30199	Yamaha	30646, 30545, 30539, 30497, 30490
Medion	30651	Sansui	30695	Yamakawa	30872
Memorex	31270, 30831, 30695	Sanyo	30873, 30695, 30675, 30670	Zenith	30869, 30741, 30591, 30503
Microsoft	32083, 30522	Schneider	30783	Zeus	30784
Minato	30752	Schwaiger	30752	Zoece	31265
Mintek	30839, 30717	Sensory	31158		
Mitsubishi	31521, 30521	Science			
Mustek	30730				

## Appendix B: HDMI Control of CEC Devices

Many new HDMI devices have a feature called Consumer Electronics Control (CEC) or HDMI Control. HDMI Control allows one device, such as the TV, to control other devices, such as an A/V receiver or disc player. Use of CEC is optional.

Each manufacturer chooses which CEC functions to support so it is difficult to predict which devices and features are compatible with Mitsubishi's HDMI Control. You may find that CEC functions for a specific device are limited.

**To use HDMI Control, you must enable it in both the TV and the device.**

- **In the TV.** Enable HDMI control from the **New Device Found** screen or from the **Inputs > HDMI Control** menu.
- **In the Device.** Most devices with HDMI CEC compatibility let you turn it on or off in the device menus, where it is typically listed as "HDMI Control."

### Enabling HDMI Control of CEC Devices

To ensure proper detection

- Power on HDMI devices before connecting them to the TV.
  - Connect and set up HDMI devices one at a time.
1. Power on the device and allow it to complete the power-on sequence (boot up). Stop any playback.
  2. Connect the device to one of the TV's HDMI inputs.
  3. When the TV detects the connection, the **New Device Found** screen will appear.

**Note:** See "If the New Device Found Screen Displays No HDMI Control Option" on this page if there is no HDMI Control option.



*New Device Found screen with HDMI Control option. This screen displays only if the device's HDMI Control is enabled.*

4. If prompted for a name, highlight the name you want to assign the device.



5. Highlight **On**.

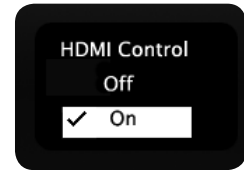

7. Highlight **EXIT** and press **ENTER** to close the **New Device Found** screen.

**Note:** At any time after completing Auto Input Sensing, you can set the TV's HDMI control on or off in the **Inputs > HDMI Control** menu.

8. **153 or 249 Series.** To supplement HDMI control with NetCommand IR control, see page 55.

### If the New Device Found Screen Displays No HDMI Control Option

If the **New Device Found** screen shows no option for HDMI Control, one of these conditions applies:

- **HDMI Control is turned off in the menus of the new device**  
**Action:**
  - a. Highlight **EXIT** and press **ENTER** to close the **New Device Found** screen.
  - b. Display the device's setup menus and enable the device's CEC capabilities.
  - c. Wait for the TV's **New Device Found** screen to appear again.
  - d. If the **New Device Found** screen does not appear, power off the device. Power on the device and wait for the **New Device Found** screen to display with the HDMI Control option.
- **The device does not have CEC compatibility**  
**Action:**
  - Control the device with its own remote control or program the TV's remote control to operate the device.
  - **153 and 249 Series.** Use the TV's NetCommand IR control (page 55).

## HDMI Control of an HDMI A/V Receiver and Connected Devices

**Note:** Connect the A/V receiver to the TV with an HDMI cable before making other connections.

1. Enable HDMI Control for the A/V receiver as described in “Enabling HDMI Control of CEC Devices” on the previous page.
2. Power on the HDMI device you wish to connect to the A/V receiver (such as a disc player, cable box, or satellite receiver). Allow the device to complete the power-on sequence (boot up). Stop playback if the device starts playing.
3. Connect the device to the A/V receiver with an HDMI cable.
4. Select the device's HDMI input on the A/V receiver's front panel controls or remote control.
5. When the TV detects the connection, the **New Device Found** screen will appear.

**Note:** If the TV is unable to detect the device, either the device's CEC capability is not enabled or the device is not CEC compatible. Enable HDMI control through the device's menus before continuing. You may need to temporarily connect the device directly to the TV to view device menus.

6. Highlight **On**.

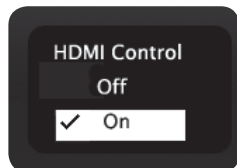

7. Highlight **EXIT** and press **ENTER** to close the **New Device Found** screen.
8. Optional: Connect the TV's **DIGITAL AUDIO OUTPUT** to an input on the A/V receiver. Use this additional connection if:
  - You want the ability to switch between the A/V receiver speakers and the TV speakers.
  - You want to use the A/V receiver to listen to devices connected to the TV only, e.g., an antenna input or camcorder.
9. **153 Series.** If desired, perform NetCommand IR Learning to supplement CEC functions. You must first connect and place IR emitters for the devices. See page 55.

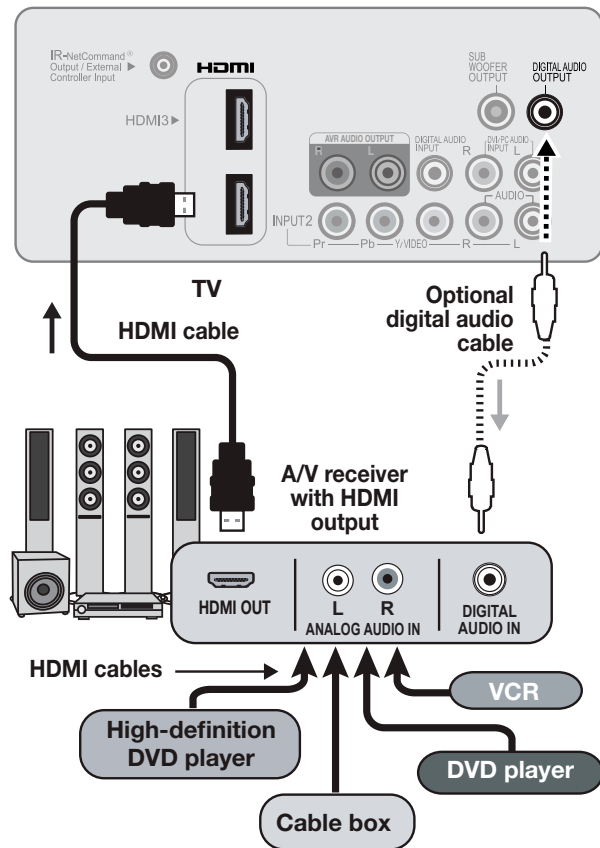

*Connecting HDMI devices. The optional digital audio connection allows you to hear audio through the A/V receiver from devices connected to the TV only.*

## Resolving CEC Conflicts

Because each manufacturer selects which CEC functions to support, some devices can conflict with other devices. If control conflicts arise, you can:

- Turn off TV control of an individual CEC-enabled device (see below).
- Turn off CEC in the setup menu of one of the devices.

### Turning Off the TV's HDMI Control of a CEC Device

1. Press **MENU** on the TV remote control.
2. Highlight **Inputs > HDMI Control** and press **ENTER** to open the menu.
3. Move to the device name and press **▲▼** to select **Off** to turn off the TV's ability to control the device.
4. Press **MENU** to clear the menu.

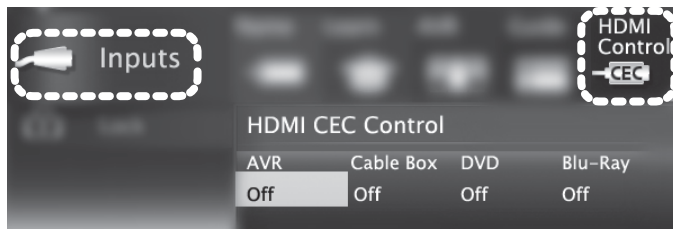

Inputs > HDMI Control menu

### Removing an HDMI Device

1. Power off the device.
2. Disconnect the HDMI cable.
3. Press **MENU** on the TV remote control to enter the TV main menu.
4. Highlight **Inputs > Name** and press **ENTER** to open the menu.
5. Select **Delete** from the HDMI input names.
6. Press **MENU** to clear the menus.

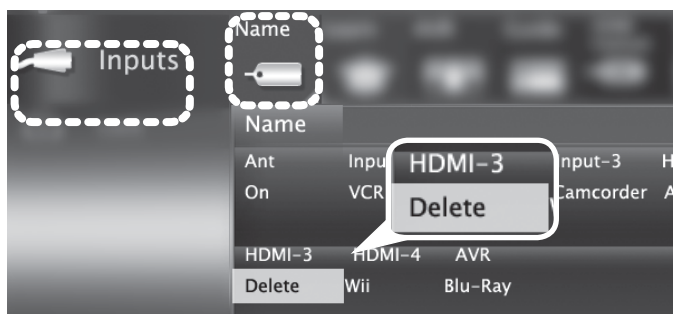

Inputs > Name menu with **Delete** selected for HDMI-3.

## Using HDMI Control

As an example of using HDMI Control, press **PLAY** on the device itself to:

- Power on the TV
- Switch to the device (no need to display the **Activity** menu)
- Begin play of the device

### Direct Keys

Test your equipment with the TV's remote control to find additional supported commands. See the table below for commands that may be available, depending on the individual device.

### CEC-enabled VCR, DVD, and DVR functions that may be available:

Record/Playback	Menu Navigation	Channel Tuning	Other
▶	◀ ▶ ▲ ▼	CHANNEL UP/DN	GUIDE
● ■	ENTER	Digits 0-9, CANCEL	MENU
◀ ▶	CANCEL (to cancel)	ENTER	

If you have a CEC-enabled A/V receiver, CEC-enabled devices connected to the A/V receiver with an HDMI cable may also be controllable. They can be selected from the TV's **Activity** menu.

### CEC-enabled A/V receiver functions that may be available:

- Try the **VOLUME UP/DOWN**, **MUTE**, and menu-navigation keys.
- To open the A/V receiver menu, follow these steps:
  1. While watching TV, press **MORE** then **9 (AUDIO)**.
  2. Press **▲** until the **Speakers** option displays.
  3. Press **▶** to select **AVR** as the source.
  4. Press **MORE** and then **1 (MENU)** to display the menu.

### The MORE Menu and HDMI Control

Press **MORE** on the TV's remote control to see a menu of additional supported functions for the current CEC-enabled device. To issue a command, press the number key indicated in the menu.

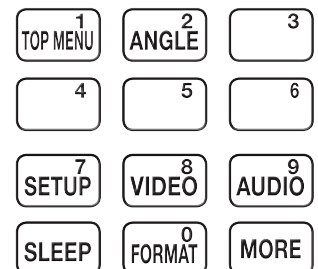

MORE key: Sample menu for a CEC-enabled DVD player

## Appendix C: TV Care

### Cleaning Recommendations

Normally, light dusting with a dry, non-scratching duster will keep your TV clean. If cleaning beyond this is needed, please use the following guidelines:

First, turn off the TV and unplug the power cord from the power outlet.

#### Top and Sides of the TV

- Occasionally clean dust build-up from the air-intake grilles on the back and sides of the TV. Clean using a vacuum cleaner with a brush attachment.
- Gently wipe down your TV with a soft, non-abrasive cloth such as cotton flannel, microfiber, or a clean cloth diaper, lightly moistened with water. Dry with a second dry, soft, non-abrasive cloth.

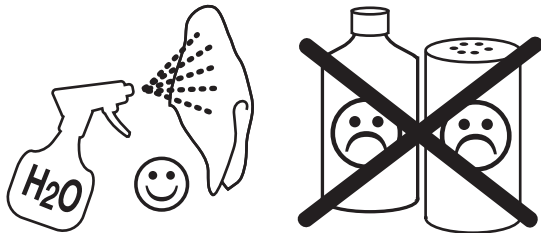

- For oily dirt, add a few drops of mild liquid detergent, such as dishwashing detergent, to the water used to moisten the cloth. Rinse with a second cloth moistened only with water. Dry with a third dry, soft, non-abrasive cloth.
- **Glossy Surfaces:** Take special care when cleaning the TV's glossy surfaces.
  - Always shake or brush the cleaning cloth first to remove any dirt particles.
  - Wipe the glossy areas gently, without applying pressure.
  - If necessary, lightly dampen the cloth with water. Use no chemical or abrasive cleaners.

#### LCD Screen Cleaning

##### **IMPORTANT**

**DO NOT apply any type of liquid to the surface of the TV screen.**

- **Use only a soft, dry cloth to clean the LCD screen. Do not use any liquids.**
- Wipe the screen gently with an up and down motion.
- Clean the entire screen evenly, not just sections of the screen.

#### General Cleaning Precautions

- DO NOT allow liquid to enter the TV through the ventilation slots or any crevice.
- DO NOT use any strong or abrasive cleaners, as these can scratch the surfaces.
- DO NOT use any cleaners containing ammonia, bleach, alcohol, benzene, or thinners, as these can dull the surfaces.
- DO NOT spray liquids or cleaners directly on the TV's surfaces.
- DO NOT scrub or rub the TV harshly. Wipe it gently.

### Care of the Remote Control

#### Remote Control Tips

- For longer life, use alkaline batteries.
- Do not mix old and new batteries.
- Be within 20 feet of the equipment.
- Do not press two or more keys at the same time unless instructed to do so.
- Do not allow the unit to get wet or become heated.
- Keep the unit out of direct sunlight.
- Avoid dropping on hard surfaces.
- Do not use harsh chemicals to clean. Use only a soft, lightly moistened cloth.

#### Resetting the Remote Control

If **TV** mode is selected and the TV does not respond properly, reset the remote control.

1. Press and hold **POWER** for several seconds until the mode indicator blinks twice and goes off.
2. Release the **POWER** key.
3. Press keys **0 0 9 3 5** and the mode indicator will blink twice when you finish entering the code. When entering the code, pause for a moment between each key press to ensure it is recognized.

#### Low-Battery Indicator

If you press a key and the mode indicator blinks five times, replace the remote control's batteries.

## Appendix D: Bypassing the Parental Lock

# Lock Bypass Instructions Have Been Filed for Future Reference

### IMPORTANT

Cut along the dotted line and file bypass instructions in a safe place for future reference.

## Mitsubishi Unisen LCD HDTV

151 Series  
153 Series  
249 Series

### Bypassing the Parental Lock

After you set the lock, you must use your pass code to:

- View a locked program
- View the locked TV
- Cancel the lock
- Enter the **Lock** menus

If you forget your pass code, you can view the locked TV without entering your pass code. When prompted for the pass code, press the number **9** and  (**LAST**) keys on the TV remote control at the same time. This process temporarily unlocks the TV.

When entering the **Lock** menu, you are prompted to enter a pass code.

- To change the pass code, press **9** and  (**LAST**) at the same time. Either enter a new pass code to open the **Lock** menu and make changes or press **BACK** to close the menu.
- If any of the locks are turned on and you exit the menus when prompted for a new code, the old code and all lock settings are retained.
- If all locks are turned off and you exit the menus when prompted for a new code, then the previous code is erased.

### IMPORTANT

When changing or deleting your pass code, you must use the remote control included with this TV. You cannot use a Mitsubishi remote control from another component or a “universal” remote.

*This page intentionally left blank*



## Appendix E: Troubleshooting

### TV Reset Comparison Guide

You can resolve many common TV problems using the reset functions described in the following table. See also the troubleshooting suggestions later in this appendix.

#### IMPORTANT

**Before you change sound or picture settings:** If picture or sound settings seem wrong for a broadcast channel

(a channel from the **ANT** input, a cable box, or satellite receiver), first check other channels from the same input before changing settings. If most other channels from the same input seem correct, there is likely a problem with the broadcast rather than with the TV. Use care in this case, as changes you make to fix problems on individual channels also affect all other channels on the same input.

Reset Name	When to Use	How to Use	Resulting Action
<b>Format</b>	When the picture shape seems incorrect, use <b>MORE &gt; 0 (FORMAT)</b> to change the shape of the picture.	Press the <b>MORE</b> key and then repeatedly press <b>0 (FORMAT)</b> to cycle through the available aspect ratios.	The last-used format for a signal type is memorized for each input. The next time the same input and the same signal type is viewed, the last-used format will be recalled.
<b>PerfectColor™ Reset</b> or <b>PerfectColor™/ PerfectTint™ Reset (153 and 249 Series)</b> (for the single input currently being watched)	When the color intensities seem out of balance, use the PerfectColor/PerfectTint reset to reset the color balances to the original factory settings. Both PerfectColor and PerfectTint are reset at the same time.	<ol style="list-style-type: none"> <li>1. While viewing the input to be reset, press <b>MENU</b> and go to <b>Adjust &gt; Picture+ &gt; PerfectColor</b>.</li> <li>2. Press <b>ENTER</b> to display the PerfectColor adjustment screen.</li> <li>3. Press <b>CANCEL</b> to reset the colors.</li> </ol>	All PerfectColor/PerfectTint sliders are reset to the original center position. The PerfectColor/PerfectTint settings for other inputs remain unchanged.
<b>A/V Memory Reset</b> (for the single input currently being watched)	When audio and/ or video settings for a single input seem incorrect, use A/V Memory Reset to return the input to the original factory settings.	<ol style="list-style-type: none"> <li>1. While viewing the input to reset, press <b>MENU</b> and go to <b>Adjust &gt; Reset</b>.</li> <li>2. Press <b>ENTER</b> to highlight the Reset icon.</li> <li>3. Press <b>ENTER</b> again to reset.</li> </ol>	All Audio and Video settings for the individual input are reset except for the Listen To, Language, audio Balance, Closed Caption, and Advanced Picture settings.
<b>A/V Reset</b> (for all inputs)	To reset audio and video adjustments for all inputs to the original factory settings.	While viewing the TV, press the control-panel buttons <b>ACTIVITY</b> and <b>VOLUME DOWN</b> at the same time for at least two seconds.	All Audio and Video settings are returned to the original factory settings, including Listen To, Language, audio Balance, Closed Captions, and Format.

### Service and Customer Support

#### Service

If you are unable to correct a problem with your TV, consult your Mitsubishi dealer or Mitsubishi Consumer Relations at (800) 332-2119.

- DO NOT adjust any controls other than those described in this Owner's Guide.
- DO NOT remove the protective back cover of your TV.

#### Customer Support

- To order replacement or additional remote controls or to purchase an IR emitter cable, visit our website at [www.mitsuparts.com](http://www.mitsuparts.com) or call (800) 553-7278.
- For questions:
  - ◆ Call Consumer Relations at 800-332-2119.
  - ◆ E-mail: [MDEAservice@mdea.com](mailto:MDEAservice@mdea.com)
  - ◆ Website: [www.mitsubishi-tv.com](http://www.mitsubishi-tv.com)
- **249 Series.** If you are having difficulty with your VUDU account, contact VUDU Customer Care at [www.VUDU.com/support](http://www.VUDU.com/support).

## Appendix E: Troubleshooting, continued

Reset Name	When to Use	How to Use	Resulting Action
<b>Channel Memorization</b>	To erase and re-memorize channels on the <b>ANT</b> input.	<ol style="list-style-type: none"> <li>1. While viewing the TV, press <b>MENU</b> to display the main menu.</li> <li>2. Navigate to the <b>Initial &gt; Channel</b> menu.</li> <li>3. Press <b>ENTER</b>.</li> <li>4. Highlight the reception mode, e.g. <b>Ant Air</b>.</li> <li>5. Highlight <b>Scan</b>.</li> <li>6. Press <b>ENTER</b> to start channel memorization.</li> </ol>	All previously memorized channels for the antenna input are erased and a new set of memorized channels is created. To add or delete individual channels, see <b>Initial &gt; Channel &gt; Edit</b> menu instructions on page 48.
<b>Lock Menu Pass Code</b>	To change your <b>Lock</b> menu pass code	See the cutout page from Appendix D, page 79.	Allows establishment of a new code.
<b>Control-Panel Lock Release</b>	To re-enable the control-panel buttons after activation of the Control-Panel Lock	Press and hold the <b>ACTIVITY</b> button on the control panel for ten seconds. If the TV is powered off, you can now press the <b>POWER</b> button to turn it on.	Allows the control panel to be unlocked if the remote control is misplaced.
<b>Auto Input Sensing for HDMI</b>	If the <b>New Device Found</b> screen does not appear when you connect an HDMI device.	<ol style="list-style-type: none"> <li>1. Disconnect the HDMI device.</li> <li>2. Delete the HDMI input in the <b>Inputs &gt; Name</b> menu (see page 50).</li> <li>3. Power on and connect the new device.</li> </ol>	The <b>New Device Found</b> screen will display.
<b>System Reset</b>	If the TV does not turn on or off, does not respond to the remote control or control-panel buttons, or has audio but no video.	Press and hold the <b>POWER</b> button on the control panel for ten seconds.	The TV will turn off. Power on the TV and the green LED will flash quickly for about one minute. The changes you made most recently, before using <b>SYSTEM RESET</b> , may be lost.
<b>TV Reset</b> <b>IMPORTANT:</b> Use this reset only if other troubleshooting has been unsuccessful.	<p>To reset all consumer-accessible settings and all memories to the original factory defaults.</p> <p>Use TV Reset if the TV can respond to controls but TV behavior is abnormal.</p> <p><b>CAUTION:</b> All owner-performed setups and adjustments will be erased.</p>	<ol style="list-style-type: none"> <li>1. While viewing the TV, press <b>MENU</b> to display the TV main menu.</li> <li>2. With the main menu displayed, press number keys <b>1 2 3</b> to display the <b>Reset</b> menu.</li> <li>3. <b>READ THE ON-SCREEN WARNING AND INSTRUCTIONS.</b> <ul style="list-style-type: none"> <li>• If you do not wish to use this reset, press <b>BACK</b> or <b>MENU</b> to back out.</li> <li>• If you do wish to use the reset, press <b>ENTER</b> to erase all memories and settings.</li> </ul> </li> </ol>	The TV will start the initialization process and then turn off. Power on the TV and the front green LED will start flashing. All memory and settings outlined in this Owner's Guide will need to be set again.
<b>VUDU™ Reset VUDU Connection (249 Series)</b>	<ul style="list-style-type: none"> <li>• VUDU does not respond to commands.</li> <li>• The selection does not play (e.g., screen is black or the "Loading" message is frozen on screen).</li> </ul>	<ol style="list-style-type: none"> <li>1. Press the MORE Key.</li> <li>2. Press the 2 key.</li> </ol>	The screen will briefly go blank while VUDU initializes. This reset does not reset the TV or any TV settings.

**Appendix E: Troubleshooting, continued**

Reset Name	When to Use	How to Use	Resulting Action
<b>VUDU Reset VUDU Account Password (249 Series)</b>	You have forgotten your account password.	Using a computer, go to <a href="http://www.VUDU.com">www.VUDU.com</a> .	Reset your account password from the VUDU website (requires access to e-mail).
<b>VUDU Reset Parental Controls Passcode (249 Series)</b>	You have forgotten your passcode.	Call VUDU Customer Care at 1-888-554-VUDU (8838).	VUDU Customer Care will reset your passcode.

General TV Operation		
	Symptom	Remarks
1.	The TV remote control does not work.	<ul style="list-style-type: none"> <li>• Check that the batteries are fresh and installed correctly.</li> <li>• Check that the control mode on the remote is set to TV.</li> <li>• Be no more than 20 feet from the TV when using the remote control.</li> <li>• Program the remote control to operate the TV or other device.</li> <li>• Reset the remote control.</li> </ul>
2.	When I try to use the remote control, the POWER key blinks five times.	Replace the batteries.
3.	TV does not respond to the remote control or to control-panel buttons and TV will not power on or off.	<ul style="list-style-type: none"> <li>• Unplug the AC power cord for 10 seconds.</li> <li>• Press and hold the POWER button on the control panel to perform system reset.</li> </ul>
4.	When a device is selected from the Activity menu, the screen is blue or black (no signal source).	<ul style="list-style-type: none"> <li>• Make sure the selected device is turned on.</li> <li>• Begin play of the device.</li> </ul>
5.	You have forgotten your Lock menu pass code.	See “Bypassing the Parental Lock”, Appendix D.
6.	Rating restrictions are not working.	Open the Lock > Parental Lock menu and: <ul style="list-style-type: none"> <li>• Verify that the ratings locks are active.</li> <li>• Check the Lock Time/Unlock Time to check if rating restrictions are disabled.</li> <li>• Rating restrictions apply only to content on the ANT input.</li> </ul>
7.	On-screen displays appear each time you change a function.	Normal TV operation.
8.		
9.	I have turned on CEC for my HDMI devices but control is erratic and I wish to disable it.	<ul style="list-style-type: none"> <li>• First turn off the TV’s HDMI control for the specific device. Open the Inputs &gt; HDMI Control menu, select the device, select Off.</li> <li>• Disable CEC on the device itself. See the device’s instructions.</li> <li>• If the problem persists, do the following:                             <ol style="list-style-type: none"> <li>1. Disconnect the device from the TV.</li> <li>2. Open the Inputs &gt; Name menu and select Delete for the device.</li> <li>3. Reconnect the device to the TV and Auto Input Sensing will recognize the device with CEC disabled.</li> </ol> </li> </ul>

## Appendix E: Troubleshooting, continued

TV Channels		
	Symptom	Remarks
1.	The TV takes several seconds to respond to channel changes.	<ul style="list-style-type: none"> <li>It is normal for digital channels to take longer to tune in.</li> <li>Press ENTER after entering a channel number to avoid delays.</li> <li>Use a 4-digit number for an over-the-air digital channel.</li> <li>Use a 6-digit number for digital cable channels if your cable service is able to recognize 6-digit channel numbers.</li> </ul>
2.	You cannot access a channel.	<ul style="list-style-type: none"> <li>Use number keys instead of CHANNEL Up/Down.</li> <li>Be sure the channel you want to view is in memory.</li> <li>Check that the TV is switched to the correct device or antenna for that channel by pressing the ACTIVITY key.</li> <li>Make sure the Lock &gt; Parent menu lock is set to Off.</li> <li>If you cannot tune to a virtual digital channel even though the TV has already memorized digital channels, tune to the physical channel number used by the broadcaster. The virtual channel will then be automatically added to memory.</li> <li>You may be trying to tune to an analog channel that is no longer broadcasting.</li> </ul>
3.	When ChannelView list is displayed, information appears incomplete	<ul style="list-style-type: none"> <li>Press INFO to update the display for the highlighted channel.</li> <li>Program information is displayed only for the currently tuned channel.</li> <li>Available information is sent from the broadcaster or cable provider. No other data is available.</li> <li>Make sure the TV clock is set correctly.</li> </ul>

TV Power On/Off		
	Symptom	Remarks
1.	TV takes an excessively long time to power on.	<ul style="list-style-type: none"> <li>When powered on, the TV needs time to boot up, just as does a computer.</li> <li>For faster power-up, change the Energy setting to Fast Power On (Initial &gt; Energy menu). With this setting the TV's power usage when off exceeds ENERGY STAR<sup>®</sup> recommended levels for a powered-down device.</li> </ul>
2.	You cannot program the TV to turn on automatically (Timer function)	<ul style="list-style-type: none"> <li>The TV may be locked.</li> <li>The clock may not be set.</li> </ul>
3.	TV turned itself off and the light on the front panel started to blink.	<ul style="list-style-type: none"> <li>Momentary power fluctuation caused the TV to turn off to prevent damage. Wait for the green light to stop flashing and turn the TV on again.</li> <li>If the TV does not stay on, press the POWER button on the control panel for at least eight seconds to perform System Reset. If this happens frequently, obtain an AC line power conditioner/surge protector.</li> <li>An unusual digital signal may have been received, triggering a protection circuit. Wait for the light to stop flashing and turn TV on.</li> </ul>
4.	TV will not power off.	Press the POWER button on the control panel for ten seconds to perform System Reset.

## Appendix E: Troubleshooting, continued

Picture		
	Symptom	Remarks
1.	Picture does not look like a high-definition picture.	Not all signals are high-definition signals. To receive high-definition programming from your cable or satellite provider, you must subscribe to the provider's high-definition service. Some over-the-air broadcasts are in high-definition and can be received with a high-quality antenna suited to your location.
2.	TV has sound but no picture.	<ul style="list-style-type: none"> <li>• Check that all video inputs are plugged in firmly.</li> <li>• Press and hold the POWER button on the control panel for ten seconds to perform System Reset.</li> </ul>
3.	Picture has become dimmer.	Adjust picture brightness and contrast to maximum levels.
4.	There is a large black or gray rectangle on the screen.	The TV's analog closed captioning has been set to "text" mode in the Captions menu. Turn off because there is no text information being broadcast.
5.	You cannot view a picture when playing a VHS tape.	Check your VCR's owner's guide for further troubleshooting.
6.	VCR or DVD player's on-screen menus jitter up and down.	Stop playback. Possible cause: Many VCRs and DVD players provide on-screen menus at only half-resolution that may appear to jitter up and down.
7.	When viewing a stopped VCR, white lines are rolling on the screen.	<ul style="list-style-type: none"> <li>• Turn off video mute for the VCR.</li> <li>• Begin playing the tape.</li> <li>• Change the VCR input from Line 1 to the VCR antenna input.</li> </ul>
8.	A color program appears as a black and white image, or the colors are dim, or the screen is black.	The PerfectColor color balance has been incorrectly set. Reset the PerfectColor balance.
9.	Picture from an HDMI input is noisy (poor quality).	Upgrade a Category 1 (unmarked) HDMI cable to a Category 2 high-speed HDMI cable.
10.	The image from a computer appears distorted when viewed on the TV.	<ul style="list-style-type: none"> <li>• Normal TV operation. The TV does not correct distortion in the picture from a computer because the correction process may cut off the edges of the image.</li> <li>• The aspect ratio may be wrong for the image. Press MORE and then 0 (FORMAT) to change.</li> </ul>

Sound		
	Symptom	Remarks
1.	There is no sound even when the volume is turned up.	<ul style="list-style-type: none"> <li>• Check if the MUTE key is on.</li> <li>• The TV's "Listen to:" setting may be set to SAP (analog program from the ANT input) but no SAP is being broadcast.</li> <li>• Check that the Speakers option is set to TV to hear sound from the TV speakers. Possibly sound is being sent to one of the audio outputs for an A/V receiver or headphones.</li> <li>• If using an A/V receiver, check that the Speakers option is set to AV Receiver to hear sound from the A/V receiver speakers.</li> <li>• Press and hold the POWER button on the control panel for 10 seconds to perform System Reset.</li> </ul>

## Appendix E: Troubleshooting, continued

Sound		
	Symptom	Remarks
2.	The sound does not match the screen picture.	The TV's "Listen to:" setting may be set to SAP (analog program from the ANT input).
3.	The sound from my A/V receiver does not match the screen picture (I should hear the correct audio from my A/V receiver).	<ul style="list-style-type: none"> <li>Check that DIGITAL AUDIO OUTPUT and/or AVR AUDIO OUTPUT on TV's main panel is connected to the A/V receiver. Without this connection, devices connected only to the TV (and not the A/V receiver) can be heard only from the TV speakers. Note that this includes the ANT input, a device (such as a camcorder) connected to the convenience panel, and any other device sending audio to the TV only.</li> <li>If using a NetCommand-controlled A/V receiver, NetCommand may be selecting the wrong A/V receiver audio input. Check the A/V receiver's NetCommand setup in the Inputs &gt; AVR menu.</li> </ul>
4.	Cannot select an audio-only device; it does not appear in the Activity menu.	Plug an unused video plug into the <b>Y/VIDEO</b> jack to activate Auto Input Sensing and make the audio device selectable in the Activity menu.
5.	Sound is coming from the TV speakers instead of the A/V receiver.	Disconnect headphones. Connect the TV's AUDIO OUT to the A/V receiver and select AV Receiver from the New Device Found screen.

NetCommand IR Control (NetCommand-equipped models only)		
	Symptom	Remarks
1.	Cannot see the menu from the A/V Receiver.	<ul style="list-style-type: none"> <li><b>A/V Receiver Set Up for Audio-Only Switching</b> The A/V Receiver is not connected to any video input of the TV. To check the A/V Receiver menu, temporarily plug into an unused input of the TV, such as Input 3. Exit the New Device Found screen and select Input 3 from the Activity menu. Press MENU on the A/V receiver's remote control.</li> <li><b>A/V Receiver Set Up for Audio and Video Switching over HDMI</b> Use the MENU key on the A/V receiver's remote control.</li> <li><b>A/V Receiver with HDMI Control</b> Switch the remote control to AUDIO mode. Press the MORE key and then 1 (Menu).</li> </ul>
2.	NetCommand unable to learn specific device keys.	<ul style="list-style-type: none"> <li>A/V Device does not use IR format for remote control signal. ITT and RF formats cannot be learned.</li> <li>Room lighting may affect the signal. Have the remotes very close (6 inches or less) to the TV during Learning.</li> <li>If learning a Mitsubishi remote control, make sure mode is not set to TV.</li> <li>Some, but not all, device key functions can be learned by NetCommand. For example, POWER and PLAY may be learned, but other functions may not.</li> <li>The signal from the remote control may not be strong enough. Insert fresh batteries and try Learning again.</li> </ul>

**Appendix E: Troubleshooting, continued**

NetCommand IR Control (NetCommand-equipped models only)	
Symptom	Remarks
3. The A/V receiver is the selected audio source but there is no sound.	<ul style="list-style-type: none"> <li>• A/V Receiver Set Up for Audio-Only Switching                             <ul style="list-style-type: none"> <li>- Check to see if the A/V Receiver power is turned on.</li> <li>- With A/V receiver power turned on, redisplay the Activity menu and press ENTER to allow NetCommand to correctly select the A/V Receiver input.</li> <li>- Incorrect setup in the Inputs &gt; AVR menu. Check the device connection assigned in the AVR menu.</li> </ul> </li> <li>• A/V Receiver Set Up for Audio and Video Switching over HDMI                             <ul style="list-style-type: none"> <li>- Check to see if the A/V Receiver power is turned on.</li> <li>- If the device is connected only to the TV (e.g., on ANT or a front panel input), verify that the TV's AUDIO OUTPUT is connected to the A/V receiver.</li> <li>- The A/V receiver is not switching properly because you have not learned the IR codes for the A/V receiver inputs to which your devices are connected.</li> </ul> </li> </ul>
4. There is no sound from the A/V receiver for my DVD player or other surround sound device even though I learned the IR code for the A/V receiver's DVD input or other input. (A/V Receiver Set Up for Audio-Only Switching)	NetCommand A/V receiver setup for the DVD player or digital surround sound device or other device is not switching properly. See "Automatic Switching (Audio or Audio/Video)," page 63, and perform A/V receiver setup for a digital surround sound device.
5. There is no sound or picture from the A/V receiver for my DVD player or other device connected to the A/V receiver; the A/V receiver should be sending video to the TV over an HDMI cable. (A/V Receiver Set Up for Audio and Video Switching over HDMI)	The NetCommand A/V receiver setup is not switching audio and video inputs properly because you did not "learn" the A/V receiver's IR codes for the device inputs. See "Case 3: Automatic Audio and Video Switching via HDMI," page 65.
6. I've selected my DVD player or other surround sound device in combination with the TV speakers but hear no sound from the TV speakers.	<ul style="list-style-type: none"> <li>• A/V Receiver Set Up for Audio-Only Switching If you have only an audio connection from the device to the A/V receiver, a physical audio connection from the device to the TV is also required.                             <ul style="list-style-type: none"> <li>- Connect the left and right audio output from the device to the appropriate TV audio input. Now you can hear audio from the device through either the TV speakers or the A/V receiver.</li> <li>- To switch audio sources, press MORE 9 (Audio), press ▲▼ to show the Speakers option, then press ► to select AV Receiver or TV.</li> </ul> </li> <li>• A/V Receiver Set Up for Audio and Video Switching over HDMI With your DVD player connected to the A/V receiver, only video is passed from the A/V receiver to the TV because of copy-protection restrictions on the HDMI signal</li> </ul>
7. I "learned" the RECORD key for my VCR/DVR but when I pressed the RECORD key, the VCR/DVR did not record anything.	Check that the VCR or DVR is receiving a signal directly from your cable box or satellite receiver.

## Trademark and License Information

LICENSOR'S SUPPLIERS DO NOT MAKE OR PASS ON TO END USER OR ANY OTHER THIRD PARTY, ANY EXPRESS, IMPLIED OR STATUTORY WARRANTY OR REPRESENTATION ON BEHALF OF SUCH SUPPLIERS, INCLUDING, BUT NOT LIMITED TO THE IMPLIED WARRANTIES OF NON-INFRINGEMENT, TITLE, MERCHANTABILITY OR FITNESS FOR A PARTICULAR PURPOSE.



Manufactured under license from Cambridge Mechatronics Ltd.  
Rapidfire and the 1... logo are trademarks of Cambridge Mechatronics Ltd

Manufactured under license from Dolby Laboratories. Dolby is a trademark of Dolby Laboratories.

ENERGY STAR® and the ENERGY STAR mark are registered U.S. marks. ENERGY STAR is a registered mark owned by the U.S. government.

HDMI™ the HDMI logo and High-Definition Multimedia Interface are trademarks or registered trademarks of HDMI Licensing LLC.



Imaging Science Foundation Certified Calibration Controls

The software in this TV is based in part on the work of the Independent JPEG Group, copyright © 1991-1998, Thomas G. Lane, all rights reserved.

**x.v.Color** and the **x.v.Color** logo are trademarks of Sony Corporation.

VUDU™ is a trademark of VUDU, Inc.

ChannelView™, DeepField™ Imager, Easy Connect™, NetCommand®, PerfectColor™, PerfectTint™, Plush 1080p® 5G, SharpEdge™, Smooth120Hz™ Film Motion, Unisen™ are trademarks of Mitsubishi Digital Electronics America, Inc.

## Network Service Disclaimer

Third party content and services, including without limitation home entertainment services by VUDU, Inc., are provided in accordance with whatever terms and conditions are established by the third party providers and agreed to by you. Mitsubishi Digital Electronics America ("MDEA") has no control over any such third parties or any agreement you reach with them. MDEA has no control over the networks or transmission facilities by which content and services are provided by third parties. Your connection to the internet may vary in availability and quality. Customer service questions are to be directed to the third-party provider, not MDEA.

MDEA DOES NOT WARRANT CONTENT OR SERVICES PROVIDED BY ANY THIRD PARTY, EITHER EXPRESSLY OR IMPLIEDLY, FOR ANY PURPOSE. MDEA DOES NOT WARRANT THAT ANY THIRD PARTY SERVICE WILL REMAIN AVAILABLE FOR ANY PERIOD OF TIME OR THAT IT WILL BE SATISFACTORY, UNINTERRUPTED OR ERROR FREE. MDEA EXPRESSLY DISCLAIMS ANY IMPLIED WARRANTIES, INCLUDING BUT NOT LIMITED TO, WARRANTIES OF MERCHANTABILITY OR FITNESS FOR A PARTICULAR PURPOSE WITH RESPECT TO ANY THIRD PARTY CONTENT AND SERVICES.

MDEA WILL NOT, UNDER ANY CIRCUMSTANCES, BE LIABLE, WHETHER IN CONTRACT OR TORT OR OTHER LEGAL THEORY, FOR ANY DIRECT, INDIRECT, INCIDENTAL, SPECIAL OR CONSEQUENTIAL DAMAGES, ATTORNEY FEES, EXPENSES, OR ANY OTHER DAMAGES ARISING OUT OF, OR IN CONNECTION WITH, YOUR USE OF ANY CONTENT OR SERVICE THAT IS PROVIDED TO YOU BY ANY THIRD PARTY, EVEN IF ADVISED OF THE POSSIBILITY OF SUCH DAMAGES.



# Mitsubishi TV Software

## END-USER LICENSE AGREEMENT FOR EMBEDDED SOFTWARE

**IMPORTANT – READ CAREFULLY:** This License Agreement is a legal agreement between you (either an individual or an entity) and Mitsubishi Digital Electronics America, Inc. (MDEA) for all software pre installed and/or provided along with this television (“Software”). By utilizing this television and Software, you agree to be bound by the terms of this License Agreement.

The Software is protected by United States copyright laws and international treaty provisions, as well as other intellectual property laws and treaties. The Software is licensed, not sold.

1. **LICENSE GRANT.** MDEA grants you a non-exclusive, non-transferable, limited right and license to use one copy of the Software only with the Mitsubishi television model that included this owner’s guide and owned by you.

2. **RIGHTS AND LIMITATIONS.**

Software Not for Resale. You may not resell or otherwise transfer for value the Software, except in conjunction with a sale of the TV that Software has been pre installed.

Prohibition on Reverse Engineering, Decompilation and Disassembly. The Software contains trade secrets or other proprietary material in its human perceivable form and to protect them, you may not reverse engineer, decompile, or disassemble, or otherwise reduce the Software to any human perceivable form, except to the extent that the foregoing restriction is expressly prohibited by applicable law.

Separation of Components. The Software is licensed as a single product. Its component parts may not be separated for use on more than one TV.

No Rental. You may not rent, lease, lend, or sublicense the Software.

Trademarks. This License Agreement does not grant you any rights to any trademarks of MDEA.

3. **VIOLATIONS.** You understand that any use, copying or transfer of the Software, except as permitted pursuant to this License, may subject you to serious criminal and civil penalties including damages and an award to MDEA of attorneys’ fees in connection with any violation of this License. You further understand that you may be held legally responsible for any copyright infringement or other violation of intellectual property rights that is caused, encouraged, or induced by your failure to abide by the terms of the License. This license is effective until terminated, and will terminate immediately without notice from MDEA or judicial resolution if you fail to comply with any provision of this License.

4. **COPYRIGHT.** All title and intellectual property rights in and to the Software (including but not limited to any images, photographs, animations, video, audio, music, text, and “applets” incorporated into the Software), and any accompanying printed materials are owned by or licensed to MDEA. All title and intellectual property rights in and to the content which may be accessed through use of the Software is the property of the respective content owner and may be protected by applicable copyright or other intellectual property laws and treaties. This License Agreement grants you no rights to use such content, except that you own the media on which the Software is recorded, but MDEA and its licensors retain ownership of the Software itself. All rights not expressly granted are reserved by MDEA.

5. **EXPORT RESTRICTIONS.** MDEA is licensing the Software for use within the United States. You agree that you will not export or re-export the Software. You specifically agree not to export or re-export the Software: (i) to any country to which the U.S. has embargoed or restricted the export of goods or services, which currently include, but are not necessarily limited to Cuba, Iran, Iraq, Libya, North Korea, Sudan, and Syria, or to any national of any such country, wherever located, who intends to transmit or transport the Software back to such country; (ii) to any person or entity who you know or have reason to know will utilize the Software in the design, development, or production of nuclear, chemical, or biological weapons; or (iii) to any person or entity who has been prohibited from participating in U.S. export transactions by any federal agency of the U.S. government. You warrant and represent that neither the BXA nor any other U.S. federal agency has suspended, revoked, or denied your export privileges.

6. **DISCLAIMER OF WARRANTY. EXCEPT AS OTHERWISE PROVIDED IN THIS LICENSE OR IN THE LIMITED WARRANTY APPLICABLE TO THE TV, MDEA MAKES NO OTHER WARRANTIES OF ANY KIND WHATSOEVER REGARDING THE SOFTWARE AND HEREBY EXPRESSLY DISCLAIMS ALL WARRANTIES OF ANY KIND WHATSOEVER, EXPRESS OR IMPLIED, WITH RESPECT TO THE SOFTWARE. ALL IMPLIED WARRANTIES, INCLUDING, WITHOUT LIMITATION, THE IMPLIED WARRANTIES OF MERCHANTABILITY AND FITNESS FOR A PARTICULAR PURPOSE ARE HEREBY EXPRESSLY DISCLAIMED BY MDEA. IN NO EVENT SHALL MDEA BE LIABLE TO YOU OR ANY THIRD PARTIES, IN CONTRACT, IN TORT OR OTHERWISE, FOR ANY DIRECT, INDIRECT, SPECIAL, INCIDENTAL OR CONSEQUENTIAL DAMAGES OF ANY KIND OR NATURE. BECAUSE SOME JURISDICTIONS DO NOT ALLOW THE EXCLUSION OR LIMITATION OF IMPLIED WARRANTIES, THE ABOVE LIMITATION MAY NOT APPLY TO YOU.**

7. **LIMITATION OF LIABILITY. MDEA SHALL NOT, UNDER ANY CIRCUMSTANCES BE LIABLE TO YOU OR ANY THIRD PARTIES FOR ANY DAMAGES OF ANY NATURE, WHETHER INDIRECT, SPECIAL, INCIDENTAL, CONSEQUENTIAL OR OTHERWISE, INCLUDING, BUT NOT LIMITED TO, ANY CLAIMS FOR LOST PROFITS, LOSS OF GOOD WILL OR EXPENDITURES MADE OR COMMITTED FOR IN RELIANCE ON THE CONTINUATION OF THIS LICENSE. YOU AGREE THAT NEITHER MDEA’S BREACH OF THIS LICENSE NOR ITS FAILURE TO REPAIR A DEFECT, ERROR OR BUG SHALL CONSTITUTE A FAILURE OF THE ESSENTIAL PURPOSE OF THIS LICENSE. BECAUSE SOME JURISDICTIONS DO NOT ALLOW THE EXCLUSION OR LIMITATION OF LIABILITY FOR CONSEQUENTIAL OR INCIDENTAL DAMAGES, THE ABOVE LIMITATIONS MAY NOT APPLY TO YOU. MDEA’s liability to you for direct damages for any cause whatsoever and regardless of the form of the action, will be limited to the money paid by you for the TV (based on fair market value of the TV) that caused the damages.**

8. **GENERAL.** This License Agreement will be governed by the laws of the State of California.

**WARNING:** This product contains chemicals known to the State of California to cause cancer and/or birth defects or other reproductive harm.

# GNU General Public License

Version 2, June 1991

Copyright (C) 1989, 1991 Free Software Foundation, Inc.  
675 Mass Ave, Cambridge, MA 02139, USA

Everyone is permitted to copy and distribute verbatim copies of this license document, but changing it is not allowed.

## Preamble

The licenses for most software are designed to take away your freedom to share and change it. By contrast, the GNU General Public License is intended to guarantee your freedom to share and change free software--to make sure the software is free for all its users. This General Public License applies to most of the Free Software Foundation's software and to any other program whose authors commit to using it. (Some other Free Software Foundation software is covered by the GNU Library General Public License instead.) You can apply it to your programs, too.

When we speak of free software, we are referring to freedom, not price. Our General Public Licenses are designed to make sure that you have the freedom to distribute copies of free software (and charge for this service if you wish), that you receive source code or can get it if you want it, that you can change the software or use pieces of it in new free programs; and that you know you can do these things.

To protect your rights, we need to make restrictions that forbid anyone to deny you these rights or to ask you to surrender the rights. These restrictions translate to certain responsibilities for you if you distribute copies of the software, or if you modify it.

For example, if you distribute copies of such a program, whether gratis or for a fee, you must give the recipients all the rights that you have. You must make sure that they, too, receive or can get the source code. And you must show them these terms so they know their rights.

We protect your rights with two steps: (1) copyright the software, and (2) offer you this license which gives you legal permission to copy, distribute and/or modify the software.

Also, for each author's protection and ours, we want to make certain that everyone understands that there is no warranty for this free software. If the software is modified by someone else and passed on, we want its recipients to know that what they have is not the original, so that any problems introduced by others will not reflect on the original authors' reputations.

Finally, any free program is threatened constantly by software patents. We wish to avoid the danger that redistributors of a free program will individually obtain patent licenses, in effect making the program proprietary. To prevent this, we have made it clear that any patent must be licensed for everyone's free use or not licensed at all.

The precise terms and conditions for copying, distribution and modification follow.

## GNU GENERAL PUBLIC LICENSE

### TERMS AND CONDITIONS FOR COPYING, DISTRIBUTION AND MODIFICATION

0. This License applies to any program or other work which contains a notice placed by the copyright holder saying it may be distributed under the terms of this General Public License. The "Program", below, refers to any such program or work, and a "work based on the Program" means either the Program or any derivative work under copyright law: that is to say, a work containing the Program or a portion of it, either verbatim or with modifications and/or translated into another language. (Hereinafter, translation is included without limitation in the term "modification".) Each licensee is addressed as "you".

Activities other than copying, distribution and modification are not covered by this License; they are outside its scope. The act of running the Program is not restricted, and the output from the Program is covered only if its contents constitute a work based on the Program (independent of having been made by running the Program). Whether that is true depends on what the Program does.

1. You may copy and distribute verbatim copies of the Program's source code as you receive it, in any medium, provided that you conspicuously and appropriately publish on each copy an appropriate copyright notice and disclaimer of warranty; keep intact all the notices that refer to this License and to the absence of any warranty; and give any other recipients of the Program a copy of this License along with the Program.

You may charge a fee for the physical act of transferring a copy, and you may at your option offer warranty protection in exchange for a fee.

2. You may modify your copy or copies of the Program or any portion of it, thus forming a work based on the Program, and copy and distribute such modifications or work under the terms of Section 1 above, provided that you also meet all of these conditions:

- a) You must cause the modified files to carry prominent notices stating that you changed the files and the date of any change.
- b) You must cause any work that you distribute or publish, that in whole or in part contains or is derived from the Program or any part thereof, to be licensed as a whole at no charge to all third parties under the terms of this License.
- c) If the modified program normally reads commands interactively when run, you must cause it, when started running for such interactive use in the most ordinary way, to print or display an announcement including an appropriate copyright notice and a notice that there is no warranty (or else, saying that you provide a warranty) and that users may redistribute the program under these conditions, and telling the user how to view a copy of this License. (Exception: if the Program itself is interactive but does not normally print such an announcement, your work based on the Program is not required to print an announcement.)

These requirements apply to the modified work as a whole. If identifiable sections of that work are not derived from the Program, and can be reasonably considered independent and separate works in themselves, then this License, and its terms, do not apply to those sections when you distribute them as separate works. But when you distribute the same sections as part of a whole which is a work based on the Program, the distribution of the whole must be on the terms of this License, whose permissions for other licensees extend to the entire whole, and thus to each and every part regardless of who wrote it.

Thus, it is not the intent of this section to claim rights or contest your rights to work written entirely by you; rather, the intent is to exercise the right to control the distribution of derivative or collective works based on the Program.

In addition, mere aggregation of another work not based on the Program with the Program (or with a work based on the Program) on a volume of a storage or distribution medium does not bring the other work under the scope of this License.

3. You may copy and distribute the Program (or a work based on it, under Section 2) in object code or executable form under the terms of Sections 1 and 2 above provided that you also do one of the following:

## GNU General Public License, continued

- a) Accompany it with the complete corresponding machine-readable source code, which must be distributed under the terms of Sections 1 and 2 above on a medium customarily used for software interchange; or,
- b) Accompany it with a written offer, valid for at least three years, to give any third party, for a charge no more than your cost of physically performing source distribution, a complete machine-readable copy of the corresponding source code, to be distributed under the terms of Sections 1 and 2 above on a medium customarily used for software interchange; or,
- c) Accompany it with the information you received as to the offer to distribute corresponding source code. (This alternative is allowed only for noncommercial distribution and only if you received the program in object code or executable form with such an offer, in accord with Subsection b above.)

The source code for a work means the preferred form of the work for making modifications to it. For an executable work, complete source code means all the source code for all modules it contains, plus any associated interface definition files, plus the scripts used to control compilation and installation of the executable. However, as a special exception, the source code distributed need not include anything that is normally distributed (in either source or binary form) with the major components (compiler, kernel, and so on) of the operating system on which the executable runs, unless that component itself accompanies the executable.

If distribution of executable or object code is made by offering access to copy from a designated place, then offering equivalent access to copy the source code from the same place counts as distribution of the source code, even though third parties are not compelled to copy the source along with the object code.

4. You may not copy, modify, sublicense, or distribute the Program except as expressly provided under this License. Any attempt otherwise to copy, modify, sublicense or distribute the Program is void, and will automatically terminate your rights under this License. However, parties who have received copies, or rights, from you under this License will not have their licenses terminated so long as such parties remain in full compliance.

5. You are not required to accept this License, since you have not signed it. However, nothing else grants you permission to modify or distribute the Program or its derivative works. These actions are prohibited by law if you do not accept this License. Therefore, by modifying or distributing the Program (or any work based on the Program), you indicate your acceptance of this License to do so, and all its terms and conditions for copying, distributing or modifying the Program or works based on it.

6. Each time you redistribute the Program (or any work based on the Program), the recipient automatically receives a license from the original licensor to copy, distribute or modify the Program subject to these terms and conditions. You may not impose any further restrictions on the recipients' exercise of the rights granted herein. You are not responsible for enforcing compliance by third parties to this License.

7. If, as a consequence of a court judgment or allegation of patent infringement or for any other reason (not limited to patent issues), conditions are imposed on you (whether by court order, agreement or otherwise) that contradict the conditions of this License, they do not excuse you from the conditions of this License. If you cannot distribute so as to satisfy simultaneously your obligations under this License and any other pertinent obligations, then as a consequence you may not distribute the Program at all. For example, if a patent license would not permit royalty-free redistribution of the Program by all those who receive copies directly or indirectly through you, then the only way you could satisfy both it and this License would be to refrain entirely from distribution of the Program.

If any portion of this section is held invalid or unenforceable under any particular circumstance, the balance of the section is intended to apply and the section as a whole is intended to apply in other circumstances.

It is not the purpose of this section to induce you to infringe any patents or other property right claims or to contest validity of any such claims; this section has the sole purpose of protecting the integrity of the free software distribution system, which is implemented by public license practices. Many people have made generous contributions to the wide range of software distributed through that system in reliance on consistent application of that system; it is up to the author/donor to decide if he or she is willing to distribute software through any other system and a licensee cannot impose that choice.

This section is intended to make thoroughly clear what is believed to be a consequence of the rest of this License.

8. If the distribution and/or use of the Program is restricted in certain countries either by patents or by copyrighted interfaces, the original copyright holder who places the Program under this License may add an explicit geographical distribution limitation excluding those countries, so that distribution is permitted only in or among countries not thus excluded. In such case, this License incorporates the limitation as if written in the body of this License.

9. The Free Software Foundation may publish revised and/or new versions of the General Public License from time to time. Such new versions will be similar in spirit to the present version, but may differ in detail to address new problems or concerns.

Each version is given a distinguishing version number. If the Program specifies a version number of this License which applies to it and "any later version", you have the option of following the terms and conditions either of that version or of any later version published by the Free Software Foundation. If the Program does not specify a version number of this License, you may choose any version ever published by the Free Software Foundation.

10. If you wish to incorporate parts of the Program into other free programs whose distribution conditions are different, write to the author to ask for permission. For software which is copyrighted by the Free Software Foundation, write to the Free Software Foundation; we sometimes make exceptions for this. Our decision will be guided by the two goals of preserving the free status of all derivatives of our free software and of promoting the sharing and reuse of software generally.

### NO WARRANTY

11. BECAUSE THE PROGRAM IS LICENSED FREE OF CHARGE, THERE IS NO WARRANTY FOR THE PROGRAM, TO THE EXTENT PERMITTED BY APPLICABLE LAW. EXCEPT WHEN OTHERWISE STATED IN WRITING THE COPYRIGHT HOLDERS AND/OR OTHER PARTIES PROVIDE THE PROGRAM "AS IS" WITHOUT WARRANTY OF ANY KIND, EITHER EXPRESSED OR IMPLIED, INCLUDING, BUT NOT LIMITED TO, THE IMPLIED WARRANTIES OF MERCHANTABILITY AND FITNESS FOR A PARTICULAR PURPOSE. THE ENTIRE RISK AS TO THE QUALITY AND PERFORMANCE OF THE PROGRAM IS WITH YOU. SHOULD THE PROGRAM PROVE DEFECTIVE, YOU ASSUME THE COST OF ALL NECESSARY SERVICING, REPAIR OR CORRECTION.

12. IN NO EVENT UNLESS REQUIRED BY APPLICABLE LAW OR AGREED TO IN WRITING WILL ANY COPYRIGHT HOLDER, OR ANY OTHER PARTY WHO MAY MODIFY AND/OR REDISTRIBUTE THE PROGRAM AS PERMITTED ABOVE, BE LIABLE TO YOU FOR DAMAGES, INCLUDING ANY GENERAL, SPECIAL, INCIDENTAL OR CONSEQUENTIAL DAMAGES ARISING OUT OF THE USE OR INABILITY TO USE THE PROGRAM (INCLUDING BUT NOT LIMITED TO LOSS OF DATA OR DATA BEING RENDERED INACCURATE OR LOSSES SUSTAINED BY YOU OR THIRD PARTIES OR A FAILURE OF THE PROGRAM TO OPERATE WITH ANY OTHER PROGRAMS), EVEN IF SUCH HOLDER OR OTHER PARTY HAS BEEN ADVISED OF THE POSSIBILITY OF SUCH DAMAGES.

## Mitsubishi LCD Flat Panel HDTV Limited Warranty

MITSUBISHI DIGITAL ELECTRONICS AMERICA, INC. ("MDEA") warrants to the original purchaser of this LCD Flat Panel HDTV that if purchased from an authorized MITSUBISHI Audio/Video Dealer, should it prove defective by reason of improper workmanship and/or material:

**a. Parts.** All parts (except any software incorporated into this HDTV) are warranted for a period of one year from the date of the original purchase at retail. We will repair or replace, at our option, any defective part without charge for the part. Parts used for replacement may be replaced with those of like kind and quality and may be new or remanufactured. Parts used for replacement are warranted for the remainder of the original warranty period.

**b. Embedded Software.** MDEA warrants that all software incorporated into this HDTV (the "Embedded Software") will perform in accordance with the functional description of Embedded Software in all material respects, but MDEA does not warrant that the Embedded Software is error-free. The warranty contained in this section shall continue for a period of one year, from the date of the original purchase from the authorized dealer. If, after prompt notice within the warranty period, MDEA determines that the Embedded Software has failed to perform in accordance with such functional description in all material respects and if such failure is not due to accident, misuse, modification or misapplication of the Embedded Software, then MDEA shall modify or replace the nonconforming Embedded Software at no charge to you, which at MDEA's sole discretion may be fulfilled by means of modification or replacement software contained on a replacement memory card for Consumer installation. The foregoing shall be MDEA's sole obligation to you under this limited warranty. All rights under this limited warranty on the Embedded Software also subject to your compliance with the terms of the Software License Agreement applicable to this HDTV, and this limited warranty on the Embedded Software shall be null and void if the Embedded Software is modified or changed in any manner except as specifically authorized by MDEA.

**c. Labor.** For certain items that are designed to be replaced by the consumer, including (but not limited to) some Embedded Software, the consumer is solely responsible for any replacement labor. For all other parts, we will provide the labor for a warranty repair by an authorized MITSUBISHI service center without charge for one year from the original date of purchase at retail.

**d. Notice.** To obtain warranty service, you must notify an authorized MITSUBISHI service center of any defect within the applicable warranty time period.

**BEFORE REQUESTING SERVICE, please review the TV owner's guide to insure proper installation and correct customer control adjustment. If the problem persists, please arrange for warranty service.**

### 1. TO OBTAIN WARRANTY SERVICE:

**a.** Contact your nearest authorized MITSUBISHI service center whose name and address can be obtained from your MITSUBISHI dealer, by writing to the address provided below, calling MDEA at 800-332-2119, or using the support feature of our website at [www.Mitsubishi-tv.com](http://www.Mitsubishi-tv.com).

**b.** Warranty service will be provided in your home or, if required, at an authorized service shop, provided that your television is located within the geographic territory customarily covered by an authorized MITSUBISHI service center. If not, you must either deliver your television to an authorized service location at your own expense, or pay for any travel and/or transportation costs the service center may charge to and from you home. Actual service labor will be provided without charge.

**c.** Proof of purchase from an authorized MITSUBISHI dealer is required when requesting warranty service. Present your sales receipt or other document which establishes proof and date of purchase. **THE RETURN OF THE OWNER REGISTRATION CARD IS NOT A CONDITION OF WARRANTY COVERAGE.** However, please return the Owner Registration Card so that we can contact you should a question of safety arise which could affect you.

### 2. THIS LIMITED WARRANTY DOES NOT COVER:

**a.** Up to .01% pixel outages (small dot picture elements that are dark or incorrectly illuminated).

**b.** Cosmetic damage or any other damage where such damage is caused by unauthorized modification, alteration, repairs to or service of the product by anyone other than an authorized MITSUBISHI service center; physical abuse to or misuse of the product (or any product damaged by excessive physical or electrical stress); any products that have had a serial number or any part thereof altered, defaced or removed; product use in any manner contrary to the Owner's Guide; freight damage; or any damage caused by acts of God or other factors beyond the reasonable control of MDEA, such as power surge damage caused by electrical system or damages caused by use of third party mounting brackets or stands. This limited warranty also excludes service calls where no defect in the product covered under this warranty is found, service calls related to unsatisfactory audio or visual reception or signal unless caused by a defect in the product that is covered under this limited warranty, all costs, expenses or any other damages arising from product installation, removal from or re-installation into custom installations or on

wall mountings, or set-ups, any adjustments of user controls (including contrast, brightness, color, tint, fine tuning, sharpness), other adjustment necessary to prepare the unit for display or use, connection with any external audio receiver, antenna, cable or satellite systems, or service of products purchased or serviced outside the U.S.A. Please consult the operating instructions contained in the Owner's Guide furnished with the product for information regarding user controls.

**3.** ANY EXPRESS WARRANTY NOT PROVIDED HEREIN, AND ANY REMEDY WHICH, BUT FOR THIS PROVISION, MIGHT ARISE BY IMPLICATION OR OPERATION OF LAW, IS HEREBY EXCLUDED AND DISCLAIMED. THE IMPLIED WARRANTIES OF MERCHANTABILITY AND OF FITNESS FOR ANY PARTICULAR PURPOSE ARE EXPRESSLY LIMITED TO A TERM OF ONE YEAR.

**4.** UNDER NO CIRCUMSTANCES SHALL MDEA BE LIABLE TO PURCHASER OR ANY OTHER PERSON FOR ANY INCIDENTAL, SPECIAL OR CONSEQUENTIAL DAMAGES, WHETHER ARISING OUT OF BREACH OF WARRANTY, BREACH OF CONTRACT, OR OTHERWISE.

**5.** Some states do not allow limitations on how long an implied warranty lasts, or the exclusion or limitation of incidental, special, or consequential damages, so the above limitations or exclusions may not apply to you.

**6.** This limited warranty gives you specific legal rights, and you may also have other rights which vary from state to state.

**7.** In the event of any dispute under this limited warranty, jurisdiction and venue for resolving that dispute will be in the state where the television was purchased and the laws of such state will govern. In no event shall Mitsubishi have any liability, including with out limitation, for general, consequential, incidental, or special damages for loss, destruction, damage or corruption of recorded data, media or software resulting from use of this television, or cost of recovery of lost data, media or software therefore.



MITSUBISHI DIGITAL ELECTRONICS AMERICA, INC.  
9351 Jeronimo Road  
Irvine, CA 92618-1904

# Index

## A

- Accent Lighting 44
- Activity Menu 25
  - Automatic Generation 51
  - Change Input Name 50
  - Customizing 50
  - NetCommand-Controlled Switching of A/V Receiver Inputs 58
  - Removing a Disconnected HDMI Device 50
- Anamorphic Picture Format 28
- Antenna Input (ANT) 17, 18
  - Signal Strength for Digital Channels 27
- Audio Lock (A/V receiver control) 69
- Audio Output Jacks 17, 18
- Auto Input Sensing 13
- Auto-Off (Sleep Timer) 25
- Auto-On (Timer) 47
- A/V Receiver
  - and Speakers Option 42
  - and TV's Remote Control 68
  - Audio Lock 69
  - Connecting 18, 23, 65, 76
  - Controlling Sound Volume 26
  - Disconnecting Analog 26
  - NetCommand IR Control 61, 62
    - Controlling a Device Connected to the A/V Receiver 39, 66
    - Video and Audio Switching via HDMI 66

## B

- Backlight 9, 41
- Batteries 7
- Blue Glow 44
- Brightness (picture adjustment) 41

## C

- Cable Box
  - and TV's Remote Control 68
  - Connecting 20, 21, 22
- Camera Files 31
- Captions Menu 46
- CEC (Consumer Electronics Control) 6, 39, 75
  - A/V Receiver 26, 76, 86
  - Troubleshooting 83
- Channels
  - antennaweb.org 48
  - Physical/Virtual Channel Numbers 48
  - Scan (memorize) 12, 48
  - Troubleshooting 84
- ChannelView™ Channel Listings 26
- Cleaning 78

- Clock, Set Date and Time 47
- Closed Captions 46
- Color Adjustments 45
  - Reset Color 45, 81
- Computer
  - and Display Formats 30
  - Connecting 29
- Contrast 41
- Control Panel 11
- Control Panel Lock 11, 54

## D

- Date. *See* Clock
- Default Settings, Returning to 81
- DIGITAL AUDIO INPUT 18
- DIGITAL AUDIO OUTPUT 18
- Digital Camera Video Output 33
- DVD Player
  - and TV's Remote Control 68
  - Connecting 20, 21
- DVI Device, Connecting 21

## E

- Energy Usage 48

## F

- Fast Power On 48
- Film Mode 44
- Font (digital closed captions) 46
- FORMAT (aspect ratio, MORE menu) 28
- Freeze Picture (PAUSE key) 10
- Front Panel 11
  - Blue Glow Accent Lighting 44
- Full Native 28

## G

- Game
  - Game Picture Mode 41
  - HDMI Cables for Games 18
- GUIDE Key
  - ChannelView 26
  - HDMI Control 77
  - NetCommand Control 58, 60

## H

- HD (High-Definition) Signal) 28
- HDMI
  - Changing Out an HDMI Device and Auto Input Sensing 13
  - Connecting an HDMI Device 20
    - A/V Receiver with HDMI 23
  - HDMI Cable Categories 18
  - HDMI Control of CEC Devices 75
  - HDMI Jack 18
  - Removing an HDMI Device from the Activity Menu 50
- Headphones
  - Jack 18
  - Speakers Option 42

## I

- INFO Key
  - ChannelView 26
  - Status Display 27
  - USB Menu 31
- Internet Video 37
- IR Emitter Placement 56
- IR NetCommand Output (jack) 19

## L

- Language
  - Changing the Menu Language 47
    - in Digital Programs 43
    - SAP (Second Audio Program) 43
- Learn 50. *See also* NetCommand IR Control
- Letter Box Image Display 28
- Level Sound 43
- Listen To 43
- Listings (ChannelView) 26
- Lock TV
  - Bypassing the Lock 79
  - Lock by Ratings 53
  - Lock by Time 54
  - Lock Control Panel 54
  - Preset V-Chip Blocking 52

## M

- Memorizing Channels 12, 48
  - Add Single Channel to Memory 48
- MP3 Player (audio-only connection) 24
- Music Files 31
- Mute
  - Closed Captions 46
  - MUTE Key 10
  - Video Mute 44

## N

- Name (for inputs; Inputs > Name menu) 50
- NetCommand IR Control
  - About 55
  - A/V Receiver Control 62
  - Initial Setup for Most Devices 57
  - Operating 58
  - Troubleshooting 86

## P

- Parental Menu (TV locks) 53
- Pass Code
  - Resetting 79
  - Setting 52
  - VUDU Password 83
- PAUSE Key 10
- PerfectColor/PerfectTint 45
  - Reset 81

- Photo Viewing 32
- Picture
  - Global Picture Adjustments 44
  - Picture+ Adjustments 45
  - Picture Menu Adjustments 41
  - Picture Quality and Film Mode 44
  - Troubleshooting 85
- R**
- Ratings (TV and Movie) 53
- Remote Control
  - Batteries 7
  - Keys and Functions 10
  - Programming Codes (reference chart) 70
  - Programming Instructions 69
  - Reset 78
- Reset
  - A/V Memory Reset (for the current input) 81
  - A/V Reset (for all inputs) 81
  - HDMI Auto Input Sensing 13
  - Pass Code 79
  - PerfectColor/PerfectTint 81
  - Remote Control 78
  - Remote Control Audio Lock 69
  - System Reset 11
  - TV Reset Comparison Guide 81
  - VUDU 82
- RS-232C 19
- S**
- Safety Instructions 4, 5
- SAP (second audio program) 43
- Satellite Receiver
  - and the Remote Control 68
  - Connecting 20, 21
- Scan (memorize channels) 48
- ScreenSaver 44
- SD (Standard-Definition Signal) 28
- Service and Support 81
- Signal Definitions 28
- Signal Strength Indicator 27
- Sleep Timer 25
- Sound
  - Controlling A/V Receiver Volume (NetCommand) 62
  - Audio Lock 69
  - Level Sound 43
- Sound Mode (audio effects) 42
- Sound Projector
  - Connecting Source Devices 20
  - Sound Projector Setup 34
- Speakers Option 42
- Standard-Definition Signal 28
- Stand Installation 8
- Status Display 27
- Stereo System. *See* A/V Receiver
- Subwoofer 26, 42
- Surround Sound
  - External Sound System 23
  - Simulated Surround Sound 42
  - Sound Projector 34
  - TV Audio Outputs 18
- System Reset 11, 82
- T**
- Test Picture 44
- Time. *See* Clock
- Timer (auto-on) 47
- Time Zone. *See* Clock
- Troubleshooting 81
- U**
- USB Menu 31, 32
- V**
- V-Chip Ratings
  - Definitions 53
  - In Status Display 27
- VCR
  - Connecting 22
  - Troubleshooting 85
- Video Game. *See* Game
- Video Mute 44
- Viewing Device. *See* Activity Menu
- VUDU Movie Service 37
  - VUDU Help 82, 83
- W**
- Wall-Mounting 8
- X**
- x.v.Color 18, 20, 41



**Website:**

[www.mitsubishi-tv.com](http://www.mitsubishi-tv.com)

**E-mail:**

[MDEAservice@mdea.com](mailto:MDEAservice@mdea.com)

**For questions, call Consumer Relations at**

**800-332-2119**

**To order replacement or additional  
remote controls or IR emitter cables,**

**Visit our website [www.mitsuparts.com](http://www.mitsuparts.com)**

**or call**

**800-553-7278**

**SYSTEM RESET**

If the TV does not respond to the remote control, control-panel buttons, or will not power on/off, press and hold the **POWER** button on the control panel for ten seconds.

The TV will turn off. Power on the TV and the green LED will flash quickly for about one minute. The changes you made most recently, before using **SYSTEM RESET**, may be lost.