



LCD Monitor User Manual

60S / 60P (LED Backlight)

Safety.....	4
National Conventions.....	4
Power	5
Installation.....	6
Cleaning.....	7
Other.....	8
Setup	9
Contents of the Box	9
Setup Stand & Base	10
Adjusting Viewing Angle.....	12
Connecting the Monitor.....	14
Wall Mounting	16
Adjusting	17
Setting Optimal Resolution	17
Windows 10	17
Windows 8	19
Windows 7	21
Hotkeys.....	23
OSD Setting.....	26
Luminance	27
Image Setup	29
Color Setup.....	30
Picture Boost	31
OSD Setup	32
Extra	33
Exit.....	34
LED Indicator.....	35
Driver	36
Monitor Driver	36
Windows 10	36
Windows 8	40
Windows 7	44
i-Menu.....	48
e-Saver	49
Screen+	50
Troubleshoot.....	51
Specification.....	53
General Specification.....	53
Preset Display Modes	60
Pin Assignments	67
Plug and Play.....	69
Regulation.....	70
FCC Notice	70
WEEE Declaration	71
Reduction in the use of hazardous substances (India)	71
E-Waste Declaration for India	71

EPA Energy Star	72
TCO DOCUMENT	73
EPEAT Declaration	74
AOC Pixel Policy ISO 9241-307 Class 1	79
Warranty Statement for North & South America (excluding Brazil)	80

Safety

National Conventions

The following subsections describe notational conventions used in this document.

Notes, Cautions, and Warnings

Throughout this guide, blocks of text may be accompanied by an icon and printed in bold type or in italic type. These blocks are notes, cautions, and warnings, and they are used as follows:



NOTE: A NOTE indicates important information that helps you make better use of your computer system.





CAUTION: A CAUTION indicates either potential damage to hardware or loss of data and tells you how to avoid the problem.





WARNING: A WARNING indicates the potential for bodily harm and tells you how to avoid the problem. Some warnings may appear in alternate formats and may be unaccompanied by an icon. In such cases, the specific presentation of the warning is mandated by regulatory authority.

Power

 The monitor should be operated only from the type of power source indicated on the label. If you are not sure of the type of power supplied to your home, consult your dealer or local power company.

 The monitor is equipped with a three-pronged grounded plug, a plug with a third (grounding) pin. This plug will fit only into a grounded power outlet as a safety feature. If your outlet does not accommodate the three-wire plug, have an electrician install the correct outlet, or use an adapter to ground the appliance safely. Do not defeat the safety purpose of the grounded plug.

 Unplug the unit during a lightning storm or when it will not be used for long periods of time. This will protect the monitor from damage due to power surges.

 Do not overload power strips and extension cords. Overloading can result in fire or electric shock.

 To ensure satisfactory operation, use the monitor only with UL listed computers which have appropriate configured receptacles marked between 100 - 240V ~, Min. 5A

 The wall socket shall be installed near the equipment and shall be easily accessible.

 For use only with the attached power adapter (Output 12Vdc) which have UL, CSA listed license (Only for monitors with power adapter).

Installation

! Do not place the monitor on an unstable cart, stand, tripod, bracket, or table. If the monitor falls, it can injure a person and cause serious damage to this product. Use only a cart, stand, tripod, bracket, or table recommended by the manufacturer or sold with this product. Follow the manufacturer's instructions when installing the product and use mounting accessories recommended by the manufacturer. A product and cart combination should be moved with care.

! Never push any object into the slot on the monitor cabinet. It could damage circuit parts causing a fire or electric shock. Never spill liquids on the monitor.

! Do not place the front of the product on the floor.

! If you mount the monitor on a wall or shelf, use a mounting kit approved by the manufacturer and follow the kit instructions.

! Leave some space around the monitor as shown below. Otherwise, air-circulation may be inadequate hence overheating may cause a fire or damage to the monitor.

See below the recommended ventilation areas around the monitor when the monitor is installed on the wall or on the stand:

Installed on the wall

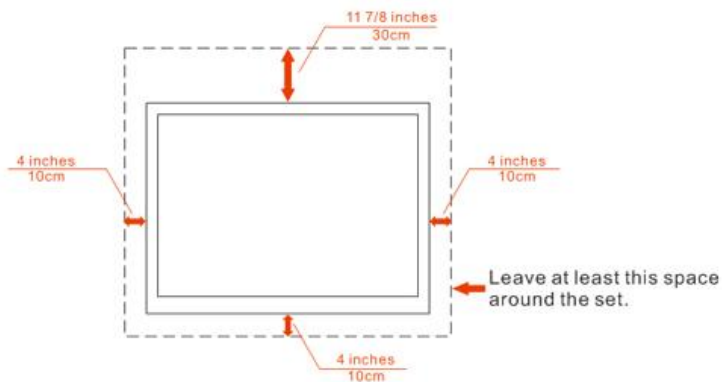

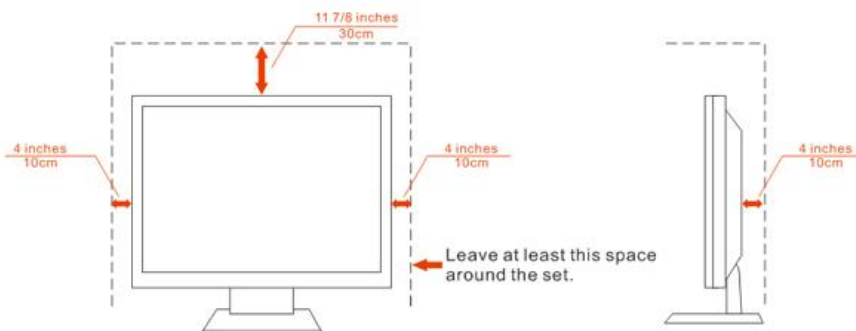

Installed with stand



Cleaning

 Clean the cabinet regularly with cloth. You can use soft-detergent to wipe out the stain, instead of strong-detergent which will cauterize the product cabinet.

 When cleaning, make sure no detergent is leaked into the product. The cleaning cloth should not be too rough as it will scratch the screen surface.

 Please disconnect the power cord before cleaning the product.



Other

 If the product is emitting a strange smell, sound or smoke, disconnect the power plug IMMEDIATELY and contact a Service Center.

 Make sure that the ventilating openings are not blocked by a table or curtain.

 Do not engage the LCD monitor in severe vibration or high impact conditions during operation.

 Do not knock or drop the monitor during operation or transportation.

Setup

Contents of the Box

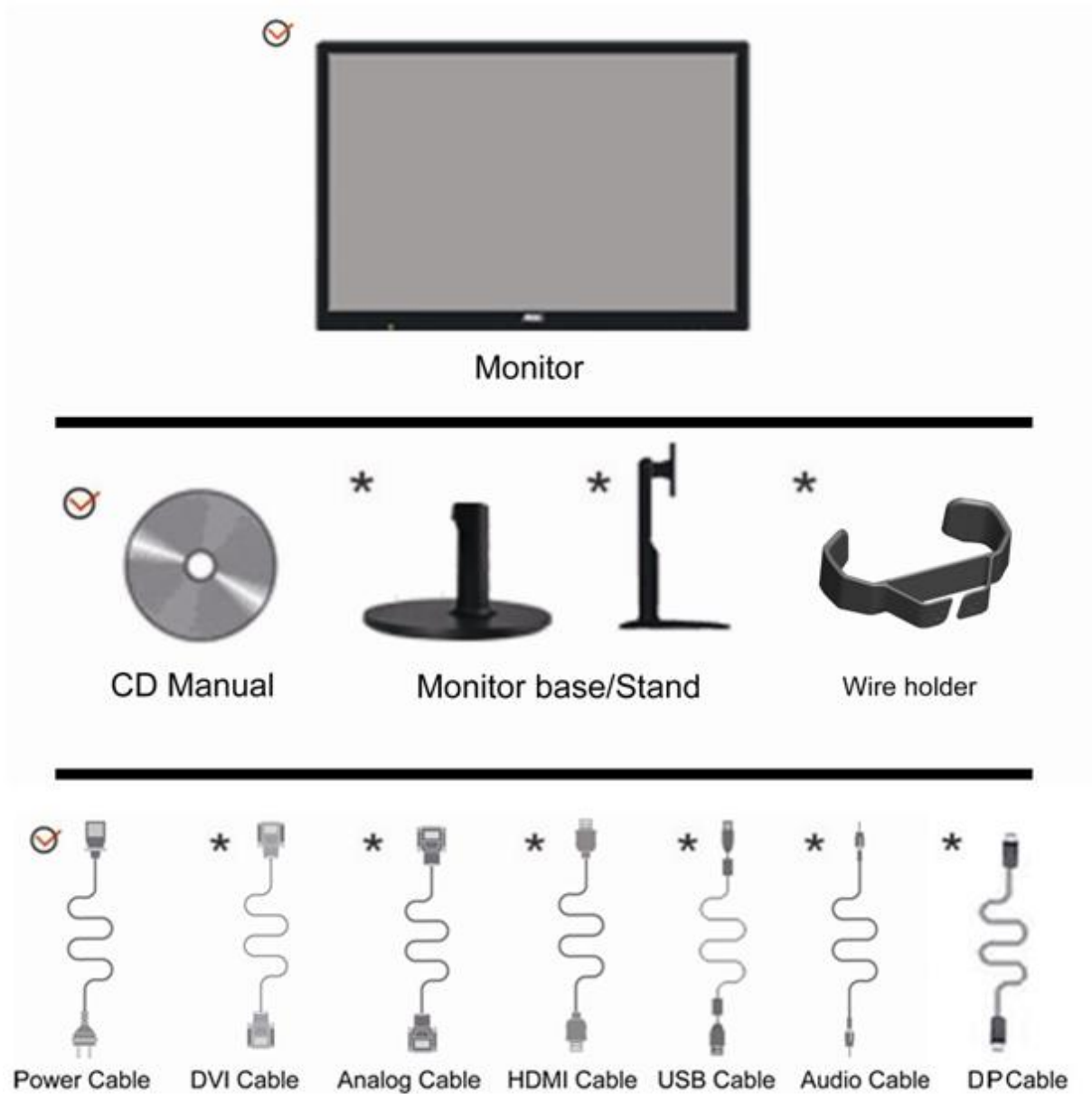

*Not all signal cables (Analog , Audio, DVI,USB 、 DP and HDMI cables) will be provided for all countries and regions. Please check with the local dealer or AOC branch office for confirmation.

Setup Stand & Base

Please setup or remove the base following the steps as below.

1>.Setup:



Remove:



2>.Setup:



Remove:



Adjusting Viewing Angle

For optimal viewing it is recommended to look at the full face of the monitor, then adjust the monitor's angle to your own preference.

Hold the stand so you will not topple the monitor when you change the monitor's angle.

1> You are able to adjust the monitor's angle from -5° to 22° .

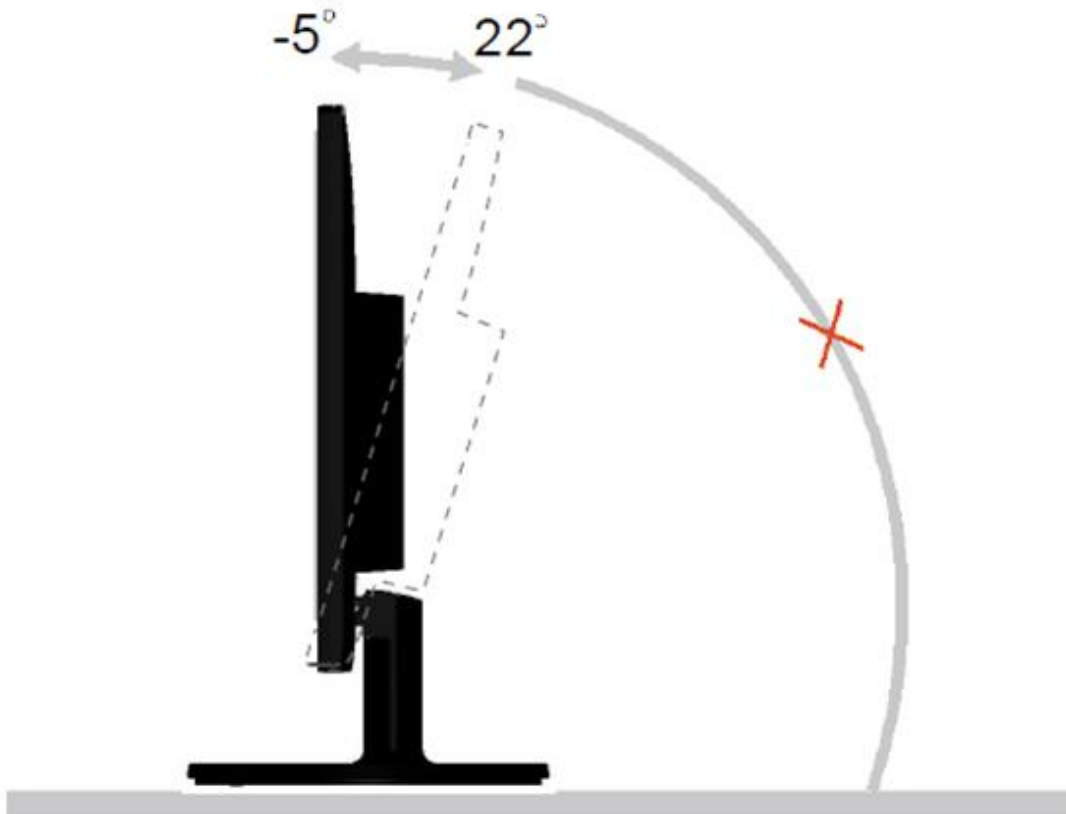

2> You are able to adjust the monitor's angle from -5° to 22° .

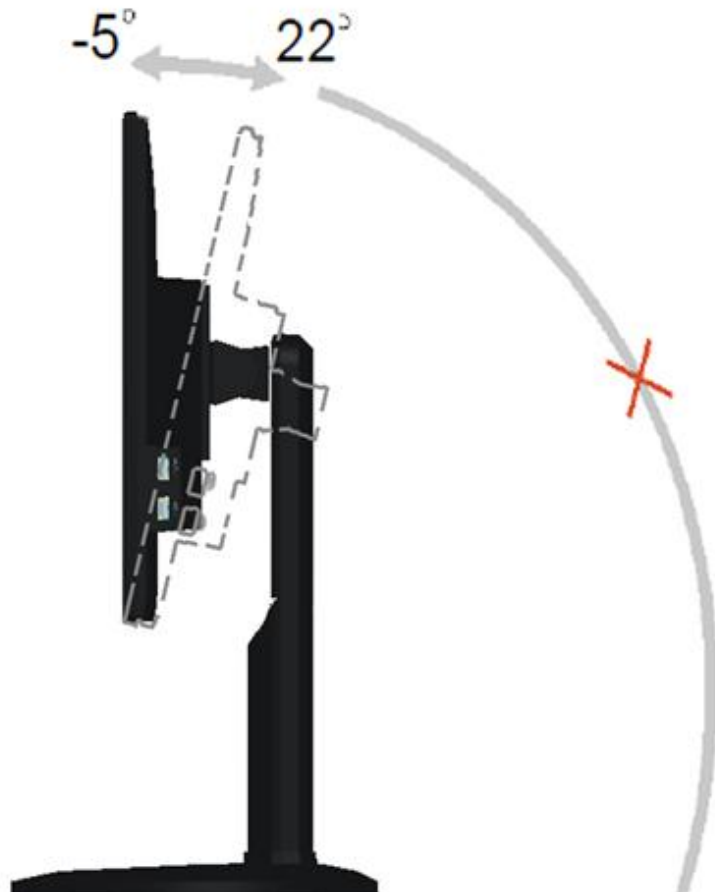

NOTE:

Do not touch the LCD screen when you change the angle. It may cause damage or break the LCD screen.

Connecting the Monitor

Cable Connections In Back of Monitor and Computer:

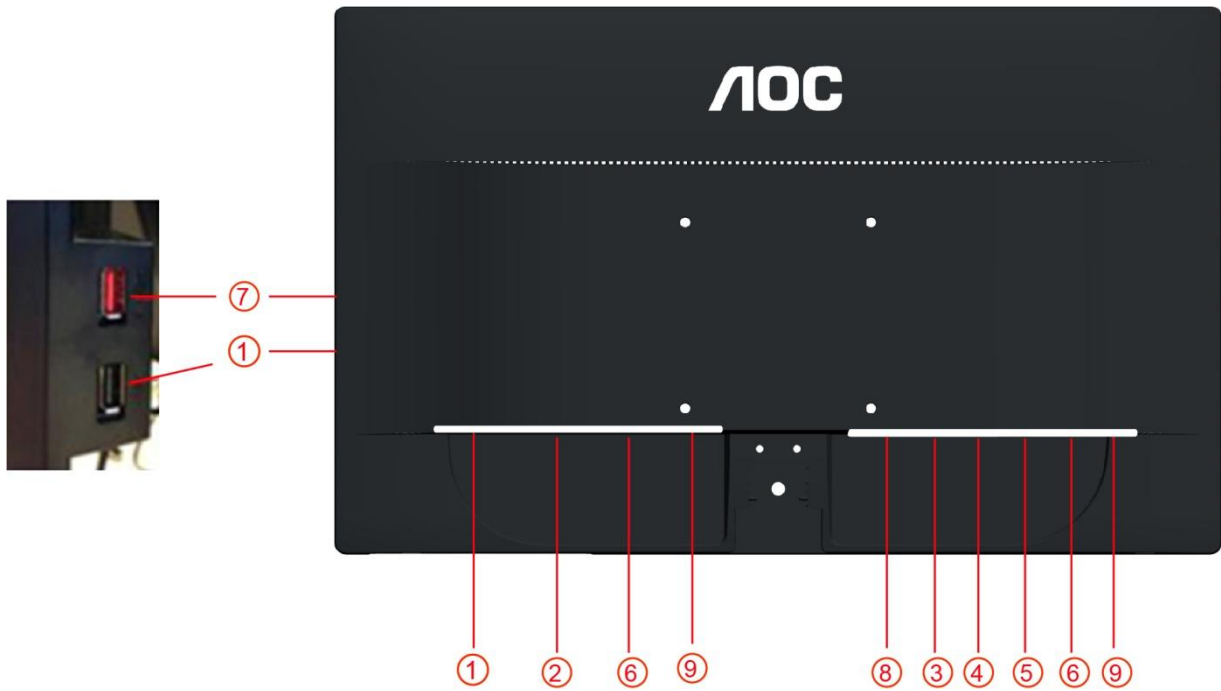

E2060SL

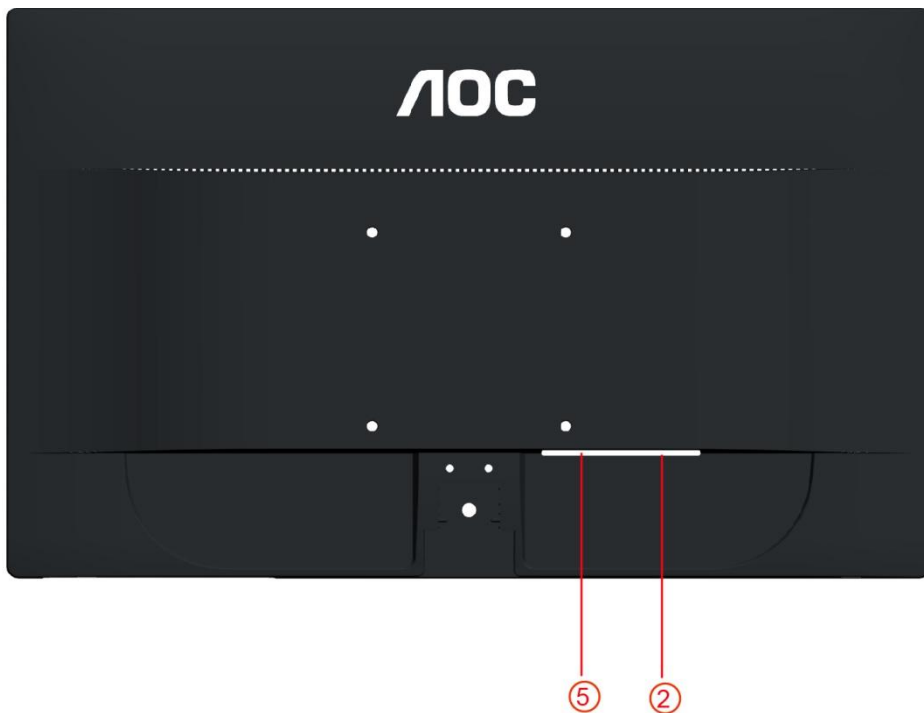

- 1. USB (Optional)
- 2. Power
- 3 HDMI (Optional)
- 4 .DVI (Optional)
- 5. Analog (DB-15 VGA cable)
- 6. Line in (Optional)

7. USB fast charging port (Optional)
8. Display port (Optional)
9. Earphone out(Optional)

To protect equipment, always turn off the PC and LCD monitor before connecting.

1. Connect the power cable to the AC port on the back of the monitor.
2. Connect one end of the 15-pin D-Sub cable to the back of the monitor and connect the other end to the computer's D-Sub port.
3. (Optional – Requires a video card with DVI port) Connect one end of the DVI cable to the back of the monitor and connect the other end to the computer's DVI port.
4. (Optional – Requires a video card with HDMI port) - Connect one end of the HDMI cable to the back of the monitor and connect the other end to the computer's HDMI port.
5. (Optional – Requires a video card with DP port) - Connect one end of the DP cable to the back of the monitor and connect the other end to the computer's DP port.
6. (Optional) Connect the audio cable to audio in port on the back of the monitor
7. Turn on your monitor and computer.
8. USB fast charging port (Optional) .

If your monitor displays an image, installation is complete. If it does not display an image, please refer Troubleshooting.

Wall Mounting

Preparing to Install An Optional Wall Mounting Arm.



This monitor can be attached to a wall mounting arm you purchase separately. Disconnect power before this procedure. Follow these steps:

- 1 Remove the base.
- 2 Follow the manufacturer's instructions to assemble the wall mounting arm.
- 3 Place the wall mounting arm onto the back of the monitor. Line up the holes of the arm with the holes in the back of the monitor.
- 4 Insert the 4 screws into the holes and tighten.
- 5 Reconnect the cables. Refer to the user's manual that came with the optional wall mounting arm for instructions on attaching it to the wall.

Noted : VESA mounting screw holes are not available for all models, please check with the dealer or official department of AOC.

Adjusting

Setting Optimal Resolution

Windows 10

For Windows 10:

- Right click **START**.
- Click "**CONTROL PANEL**".

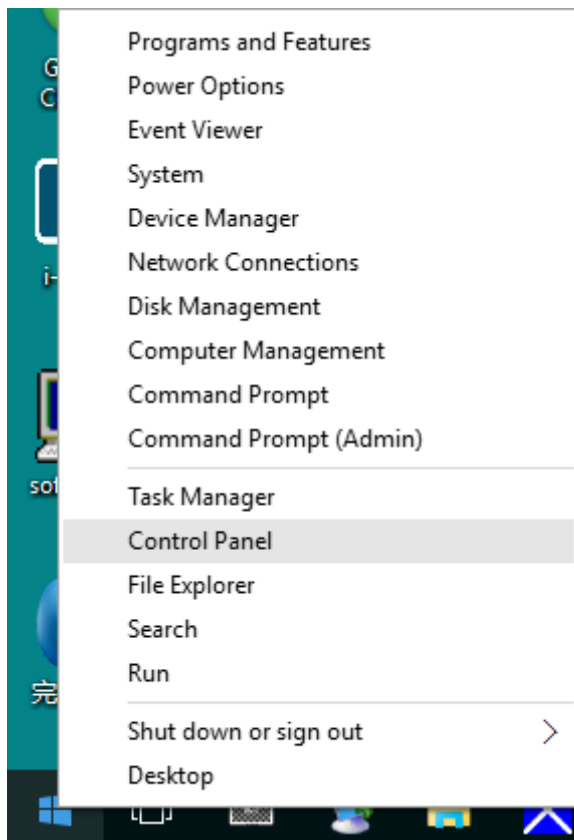

- Click "**DISPLAY**".

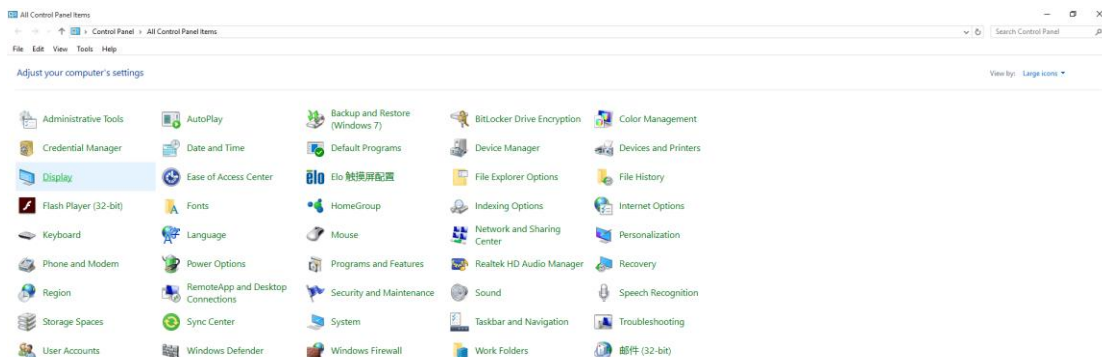

- Click on the "**Change display settings**" button.

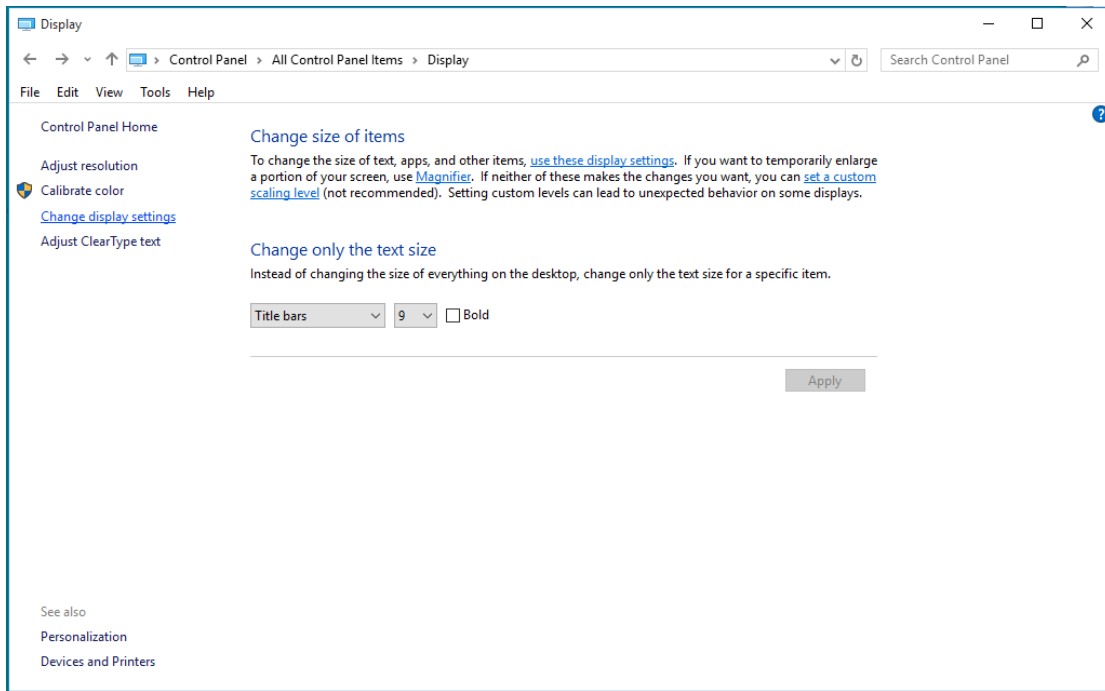

- Set the resolution **SLIDE-BAR** to Optimal preset resolution.

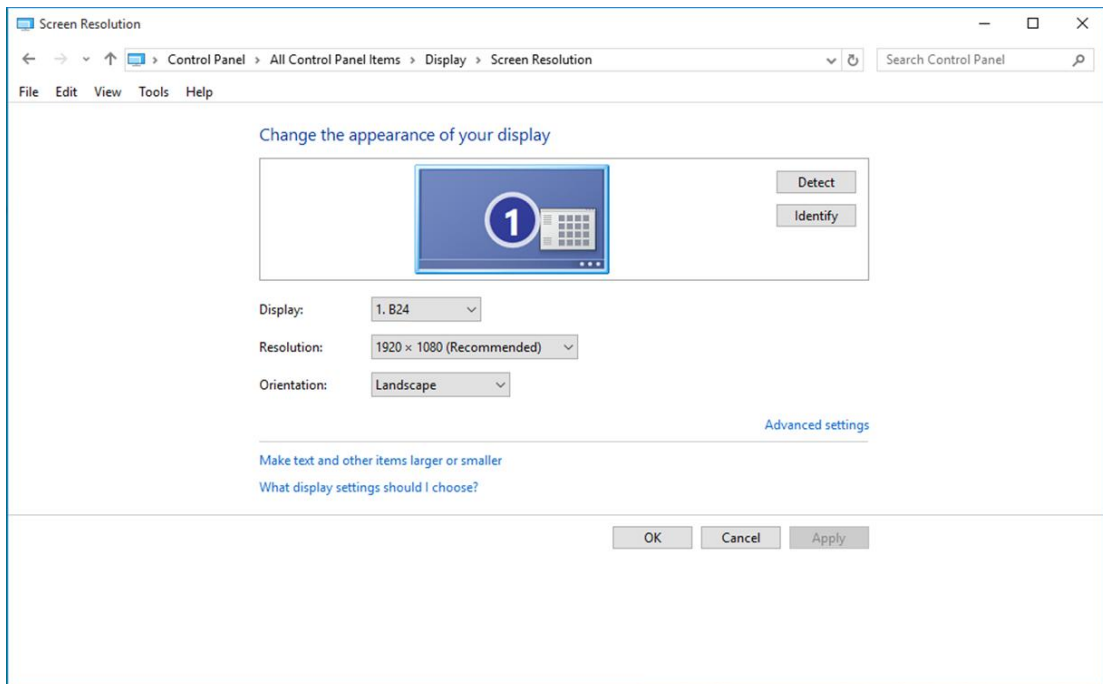

Windows 8

For Windows 8:

- Right click and click **All apps** at the bottom-right of the screen.

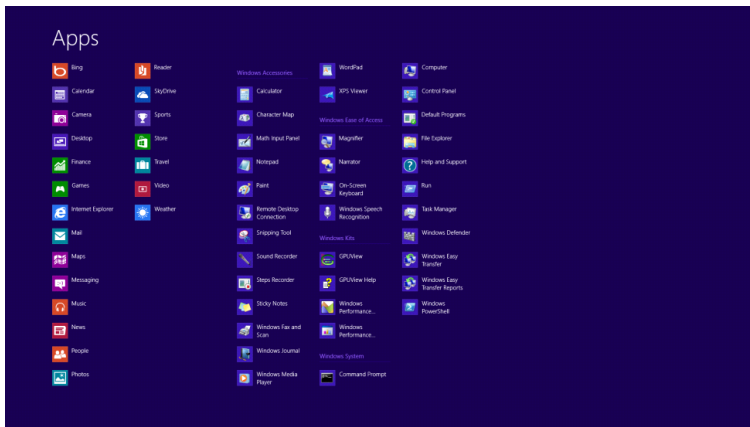
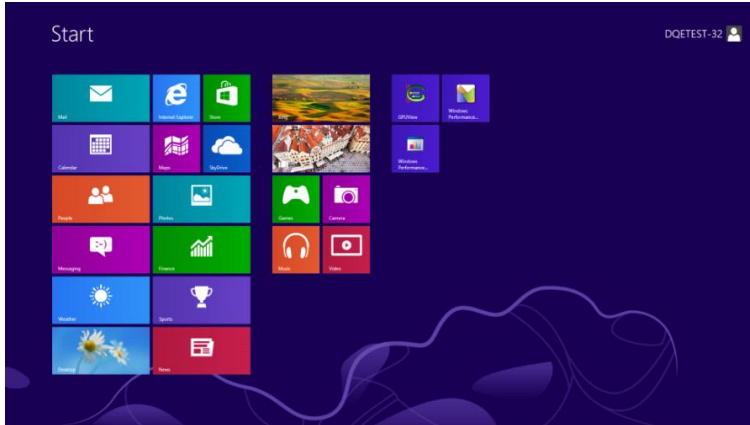

- Set the "View by" to "Category".
- Click "Appearance and Personalization".

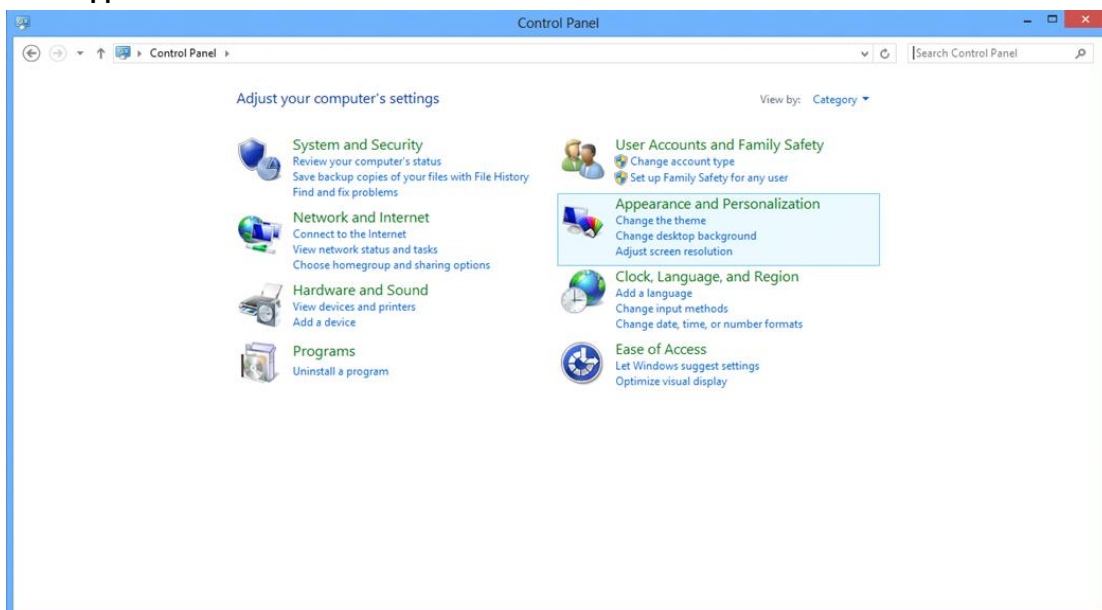

- Click "DISPLAY".

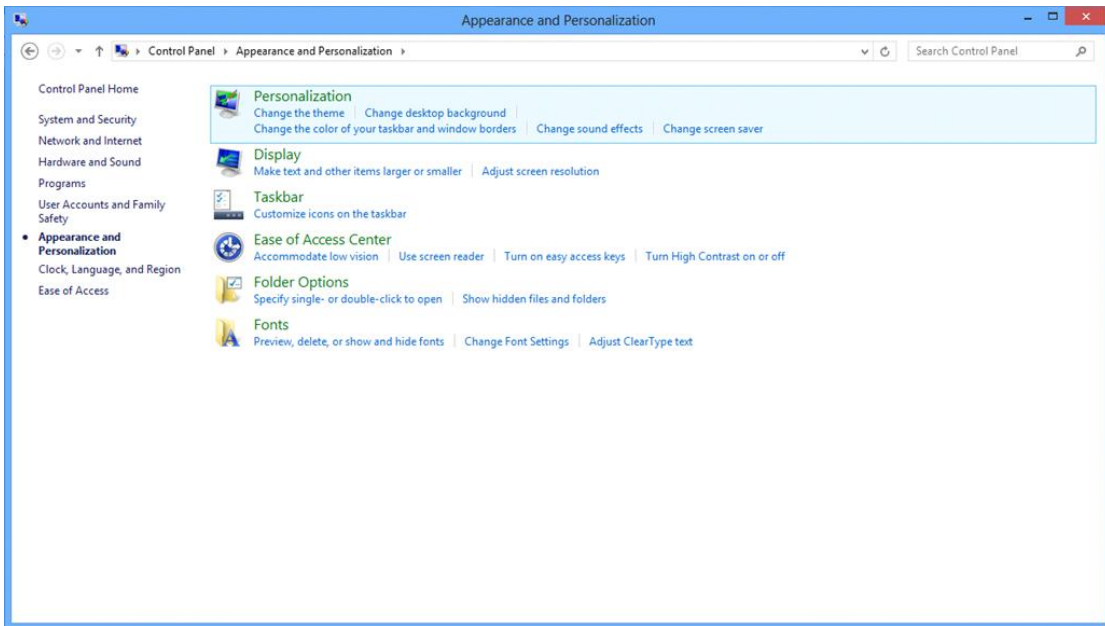

- Set the resolution **SLIDE-BAR** to Optimal preset resolution

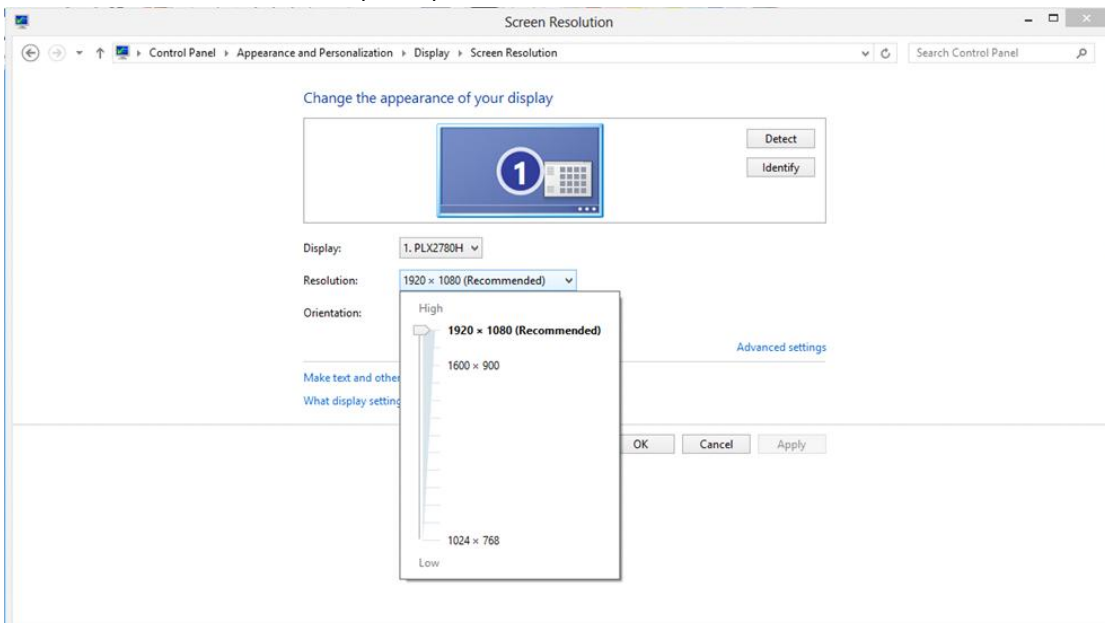

Windows 7

For Windows 7:

- Click **START**.
- Click **"CONTROL PANEL"**.

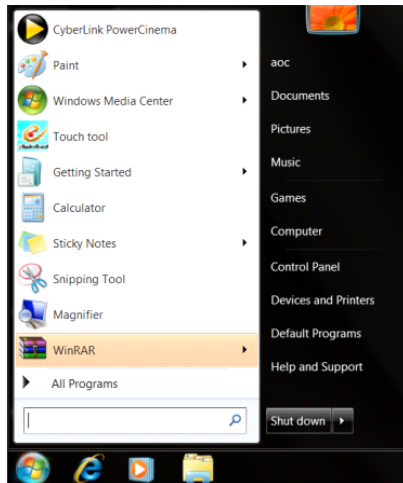

- Click **"Appearance"**.

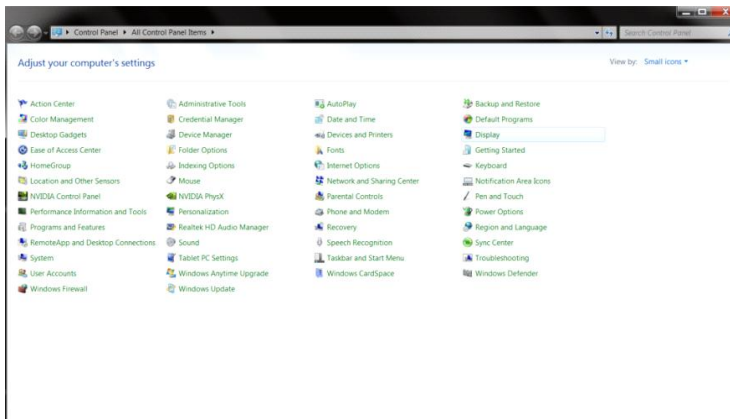

- Click **"DISPLAY"**.

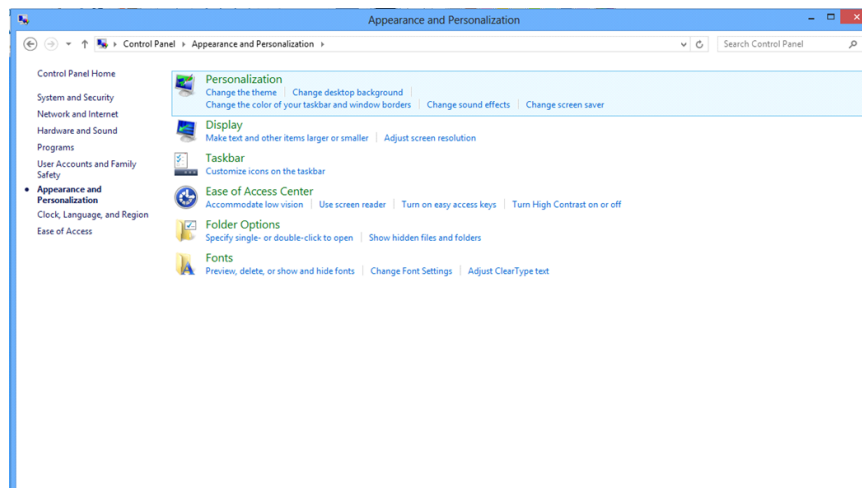

- Click on the "**Change display settings**" button.

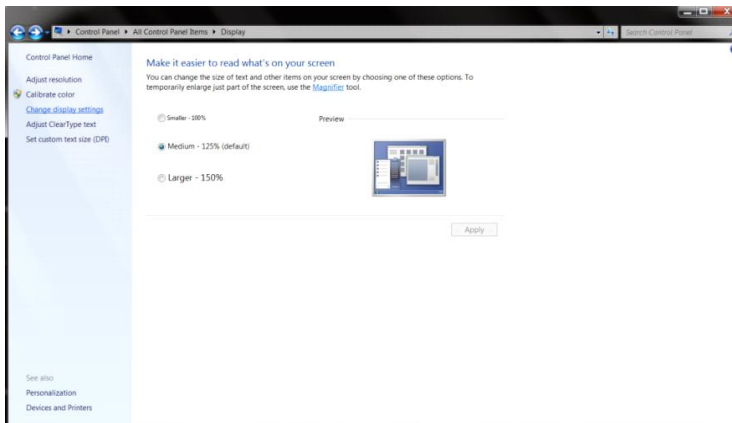

- Set the resolution **SLIDE-BAR** to Optimal preset resolution

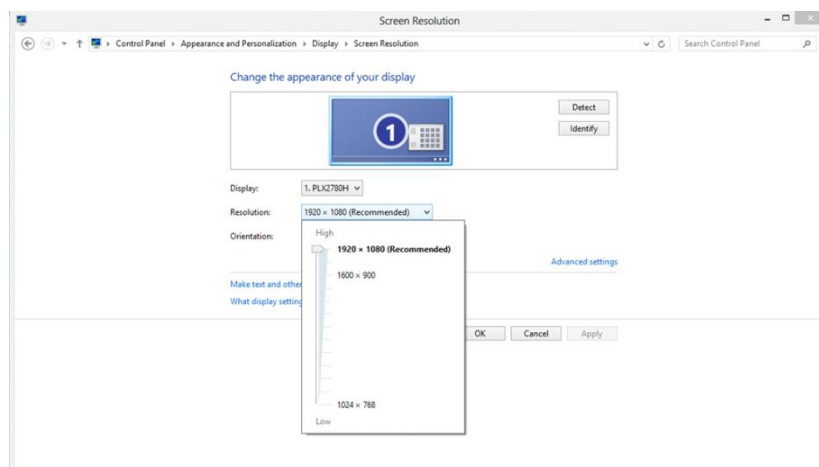

Hotkeys

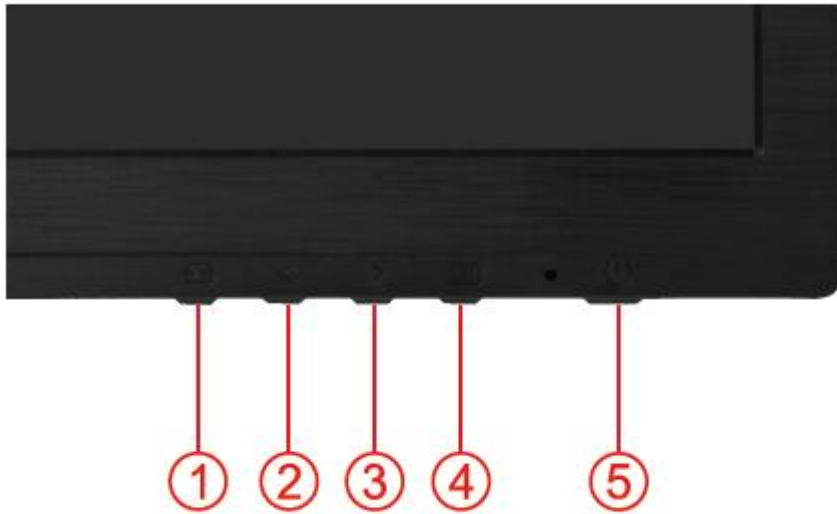

E2260P_{HU}/E2260S_{HU} /E2460P_{WHU}/E2460S_{WHU}/E2460S_{HU}/E2460P_{HU}

1	Source/Auto/Exit
2	ECO(DCR/I-Care)/<
3	Volume / >
4	Menu/Enter
5	Power

I960SRDA/I960SRDA+/I960PRDA/I960PRDAS/I960PRDA+/E2060S_{WDU}/E2060S_{WDAN}/E960SRDA/
E960PRDA/E960PRDAS /E2060S_{WDA}/E2060P_{WDA} / E2260S_{DA}/ E2260P_{DA}/E2260P_{DAS}

1	Source/Auto/Exit
2	ECO(DCR)/<
3	Volume / >
4	Menu/Enter
5	Power

E2060S_{WDN} /E2060S_{WDI}/ E2260S_D/M2060S_{WD}

1	Source/Auto/Exit
2	ECO(DCR)/<
3	4:3 or Wide / >
4	Menu/Enter
5	Power

E2060S_{WN} /E2060S_W/M2060S_W

1	Auto/Exit
2	ECO(DCR)/<
3	4:3 or Wide / >
4	Menu/Enter
5	Power

E960S_{RD}

1	Source/Auto/Exit
2	ECO(DCR)/<
3	>
4	Menu/Enter
5	Power

E2060S_L

1	Auto/Exit
2	Clear Vision /<
3	4:3 or Wide / >
4	Menu/Enter
5	Power

M2060S_{WDA2}/M2060P_{WDA2}/ M2060P_{WQ}/M2060S_{WQ}/E2260P_Q

1	Source/Auto/Exit
2	Clear Vision /<
3	Volume / >
4	Menu/Enter
5	Power

M2060S_{WD2}

1	Source/Auto/Exit
2	Clear Vision /<
3	4:3 or Wide / >
4	Menu/Enter
5	Power

Power

Press the Power button to turn on/off the monitor.

Eco (DCR/I-Care) / <

Press the Eco key continuously to select the Eco mode of brightness and DCR/I-Care on when there is no OSD.
(Eco mode hot key may not be available in all models).

Volume / >

When there is no OSD, Press Volume button to active volume adjustment bar, Press < or + to adjust volume (Only for the models with speakers)

Auto / Exit

When there is no OSD, press Auto/Source button continuously about 3 second to do auto configure .

Source hot key

When the OSD is closed, press Source button will be Source hot key function. Press Source button continuously to select the input source showed in the message bar , press Menu/Enter button to change to the source selected

Clear Vision

1. When there is no OSD, Press the “-” button to activate Clear Vision.
2. Use the “-” or “+” buttons to select between weak, medium, strong, or off settings. Default setting is always “off”.

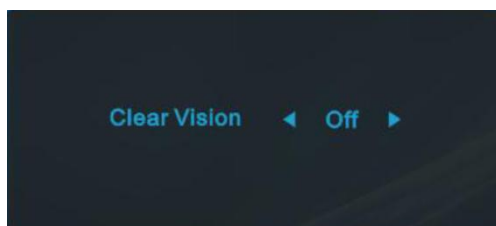

3. Press and hold “-” button for 5 seconds to activate the Clear Vision Demo, and a message of “Clear Vision Demo: on” will be display on the screen for a duration of 5 seconds. Press Menu or Exit button, the message will disappear. Press and hold “-” button for 5 seconds again, Clear Vision Demo will be off.

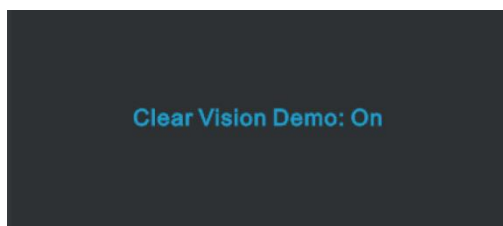









Clear Vision function provides the best image viewing experience by converting low resolution and blurry images into clear and vivid images.

OSD Setting

Basic and simple instruction on the control keys.



- 1) Press the  **MENU-button** to activate the OSD window.
- 2) Press **< or >** to navigate through the functions. Once the desired function is highlighted, press the  **MENU-button** to activate it. Press **< or >** to navigate through the sub-menu functions. Once the desired function is highlighted, press  **MENU-button** to activate it.
- 3) Press **< or >** to change the settings of the selected function. Press  **AUTO** to exit. If you want to adjust any other function, repeat steps 2-3.
- 4) OSD Lock Function: To lock the OSD, press and hold the  **MENU button** while the monitor is off and then press  **power button** to turn the monitor on. To un-lock the OSD - press and hold the  **MENU button** while the monitor is off and then press  **power button** to turn the monitor on.

Notes:

- 1) If the product has only one signal input, the item of "Input Select" is disable to adjust.
- 2) If the product screen size is 4:3 or input signal resolution is wide format, the item of "Image Ratio" is disable to adjust.
- 3) One of DCR, Color Boost, and Picture Boost functions is active, the other two function is turned off accordingly.

Luminance



1 Press  (Menu) to display menu.

2 Press < or > to select  (Luminance), and press  to enter.

3 Press < or > to select submenu, and press  to enter.

4 Press < or > to adjust.

5 Press  to exit.















	Brightness	0-100		Backlight Adjustment
	Contrast	0-100		Contrast from Digital-register.
	Eco mode	Standard		Standard Mode
		Text		Text Mode
		Internet		Internet Mode
		Game		Game Mode
		Movie		Movie Mode
		Sports		Sports Mode
	Gamma	Gamma1		Adjust to Gamma1
		Gamma2		Adjust to Gamma 2
		Gamma3		Adjust to Gamma 3
	DCR	Off		Disable dynamic contrast ratio
		On		Enable dynamic contrast ratio
	Overdrive	Weak		Adjust the response time (only for E2260PHU/E2260SHU/ E2460PWHU/E2460SWHU/E2460SHU/E2460PHU/E226 0PQ/M2060SWDA2/M2060PWDA2/ M2060SWD2/ M2060PWQ/M2060SWQ)
		Medium		
		Strong		
		Off		
	i-Care	On		adjusts the brightness according to light intensity (only for E2260PHU/E2260SHU/ E2460PWHU/E2460SWHU/E2460SHU/E2460PHU)
		Off		
	DPS	On		(only for M2060SWD/M2060SWDA2/M2060PWDA2)
Off				

Image Setup

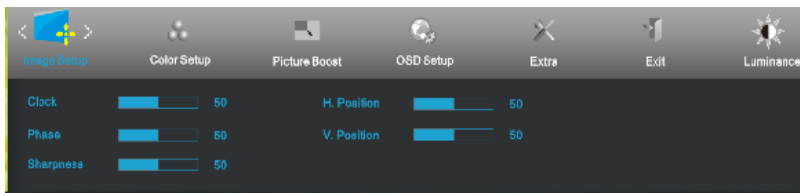





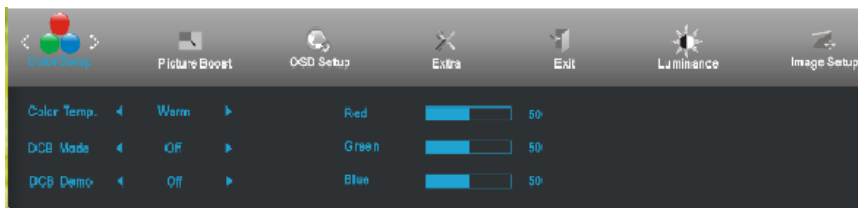

- 1 Press  to display menu.
- 2 Press < or > to select  (Image Setup), and press  to enter.
- 3 Press < or > to select submenu, and press  to enter.
- 4 Press < or > to adjust.
- 5 Press  to exit.

	Clock	0-100	Adjust picture Clock to reduce Vertical-Line noise.
	Phase	0-100	Adjust Picture Phase to reduce Horizontal-Line noise
	Sharpness	0-100	Adjust picture sharpness
	H.Position	0-100	Adjust the horizontal position of the picture.
	V.Position	0-100	Adjust the vertical position of the picture.

Color Setup







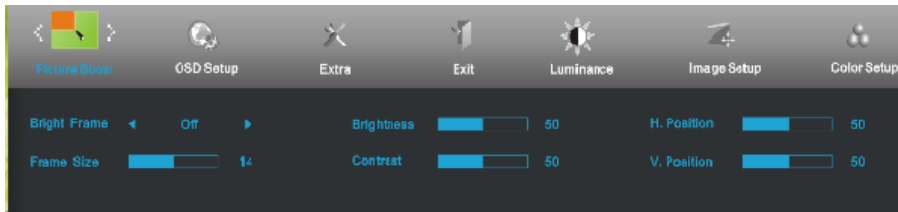

- 1 Press  (Menu) to display menu.
- 2 Press < or > to select , and press  to enter.
- 3 Press < or > to select submenu, and press  to enter.
- 4 Press < or > to adjust.
- 5 Press  to exit.

	Color setup.	Warm		Recall Warm Color Temperature from EEPROM.	
		Normal		Recall Normal Color Temperature from EEPROM.	
		Cool		Recall Cool Color Temperature from EEPROM.	
		sRGB		Recall SRGB Color Temperature from EEPROM.	
		User	Red		Red Gain from Digital-register
			Green		Green Gain Digital-register.
			Blue		Blue Gain from Digital-register
		DCB Mode	Full Enhance	on or off	Disable or Enable Full Enhance Mode
			Nature Skin	on or off	Disable or Enable Nature Skin Mode
	Green Field		on or off	Disable or Enable Green Field Mode	
	Sky-blue		on or off	Disable or Enable Sky-blue Mode	
	AutoDetect		on or off	Disable or Enable AutoDetect Mode	
	DCB Demo		On or off	Disable or Enable Demo	

Picture Boost









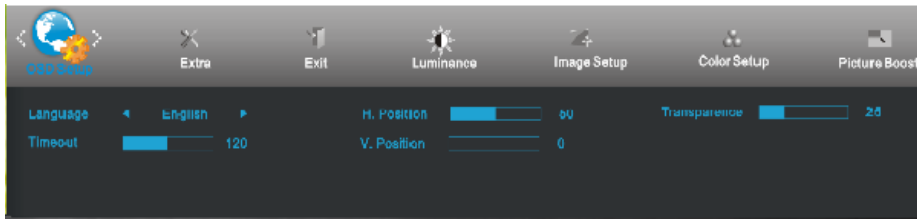





- 1 Press  (Menu) to display menu.
- 2 Press < or > to select  (Picture Boost), and press  to enter.
- 3 Press < or > to select submenu, and press  to enter.
- 4 Press < or > to adjust.
- 5 Press  to exit.

	Frame Size	14-100	Adjust Frame Size
	Brightness	0-100	Adjust Frame Brightness
	Contrast	0-100	Adjust Frame Contrast
	H. position	0-100	Adjust Frame horizontal Position
	V. position	0-100	Adjust Frame vertical Position
	Bright Frame	on or off	Disable or Enable Bright Frame

OSD Setup









- 1 Press  (Menu) to display menu.
- 2 Press  or  to select  (OSD Setup), and press  to enter.
- 3 Press  or  to select submenu, and press  to enter.
- 4 Press  or  to adjust.
- 5 Press  to exit.

	H.Position	0-100	Adjust the horizontal position of OSD
	V.Position	0-100	Adjust the vertical position of OSD
	Timeout	5-120	Adjust the OSD Timeout
	Transparence	0-100	Adjust the transparence of OSD
	Language		Select the OSD language

Extra



- 1 Press  (Menu) to display menu.
- 2 Press < or > to select  (Extra), and press  to enter.
- 3 Press < or > to select submenu, and press  to enter.
- 4 Press < or > to adjust.
- 5 Press  to exit.

	Input Select	Auto / Analog / DVI / HDMI	Select input signal source. (E2260PHU/E2260SHU/E2460PWHU/E2460SWHU/E2460SHU/E2460PHU)
	Input Select	Auto / Analog / DVI	Select input signal source. (E2060SWDN/E2060SWDAN /E960SRDA/E960PRDA/E960PRDAS/I960SRDA/I960SRDA+/I960PRDA/I960PRDAS/I960PRDA+/E960SRD/E2060SWDA/E2060PWDA/E2060SWD/E2260SD/E2260SDA/E2260PDA/E2260PDAS/E2060SWDU/M2060SWD/M2060SWDA2/M2060PWA2/ M2060SWD2)
	Input Select	Analog	Select input signal source. (E2060SW /E2060SWN /E2060SL/M2060SW)
	Input Select	Auto / Analog / DVI /DP	Select input signal source. (E2260PQ)
	Input Select	Auto / Analog /DP	Select input signal source. (M2060PWQ/M2060SWQ)
	Auto Config	yes or no	Auto adjust the picture to default.
	Off timer	0-24hrs	Select DC off time.
	Image Ratio	wide or 4:3	Select wide or 4:3 format for display.
	DDC-CI	yes or no	Turn ON/OFF DDC-CI Support.
	Reset	yes or no	Reset the menu to default.
	Information		Show the information of the main image and sub-image source.

Exit

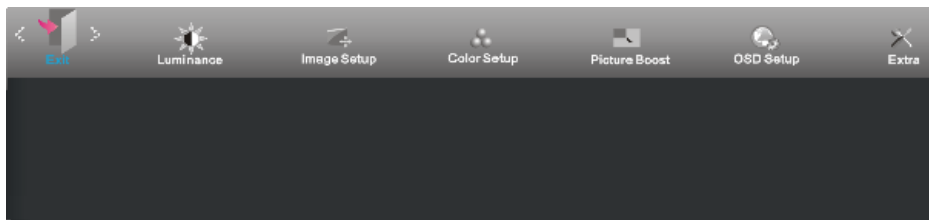

1 Press  (Menu) to display menu.

2 Press < or > to select  (Exit), and press  to enter.

3 Press  to exit

	Exit		Exit the main OSD
--	------	--	-------------------

LED Indicator

Status

LED Color

Full Power Mode

Green or Blue



Active-off Mode

Orange or red



Driver

Monitor Driver

Windows 10

- Start Windows® 10
- Right click **START**.
- Click "**Control Panel**".

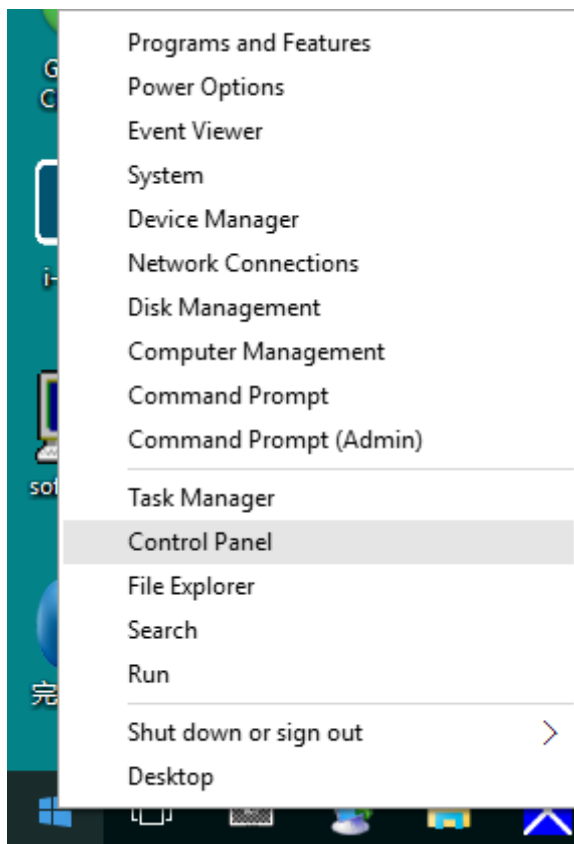

- Click on the "**Display**" icon.

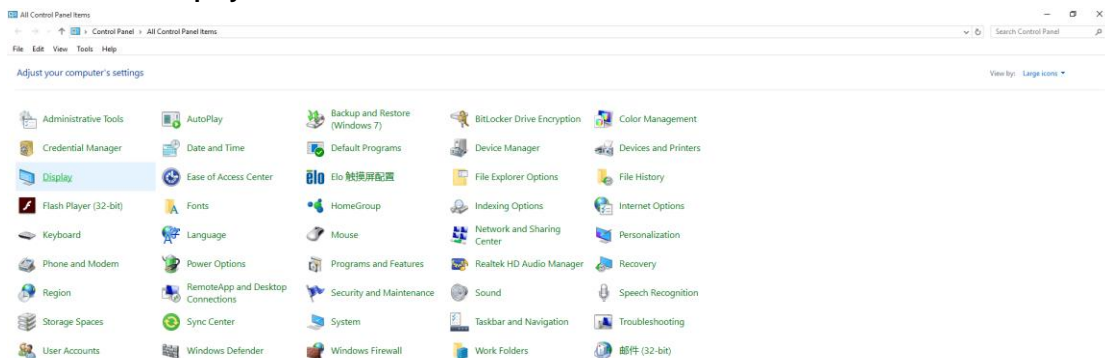

- Click on the **"Change display settings"** button

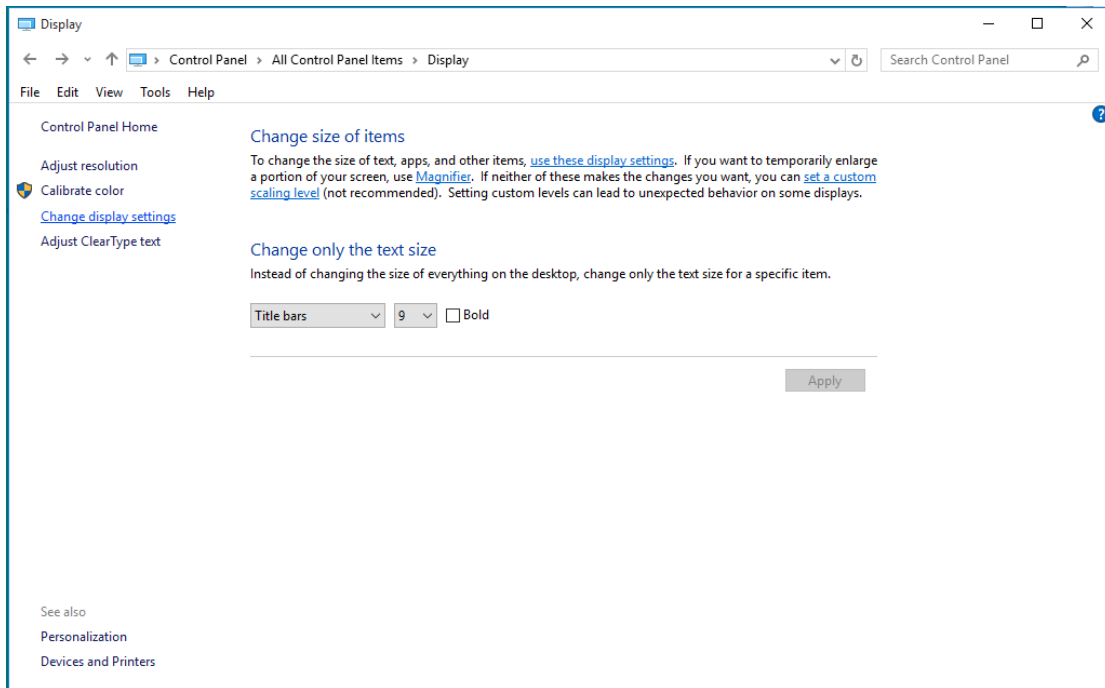

- Click the **"Advanced Settings"** button.

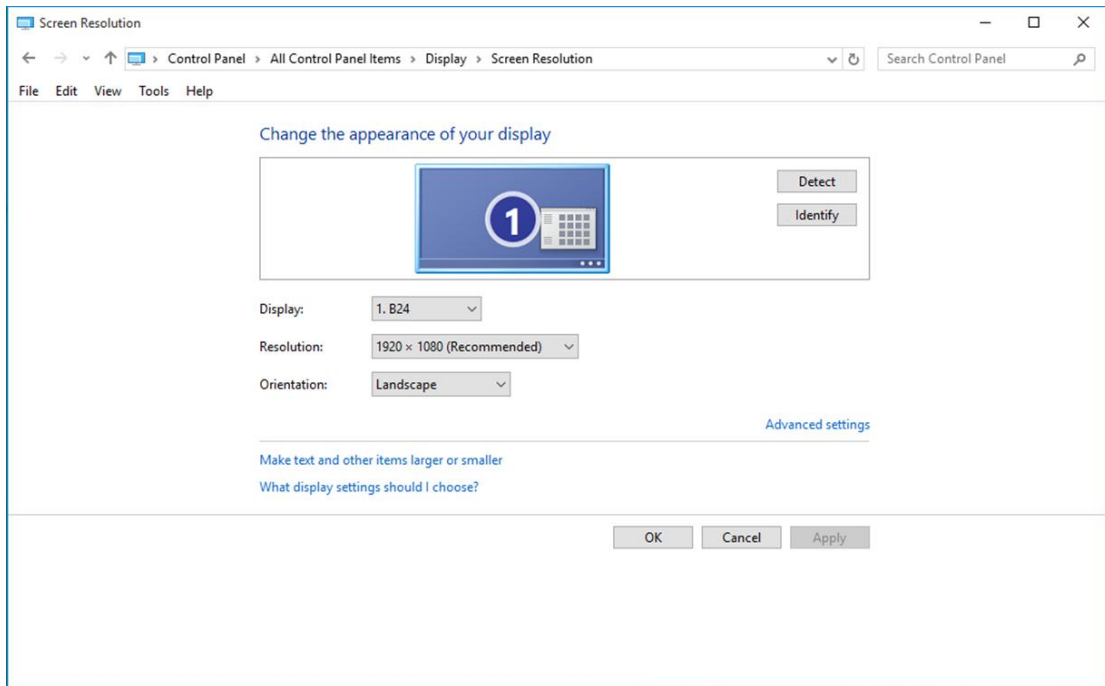

- Click the "**Monitor**" tab and then click the "**Properties**" button.

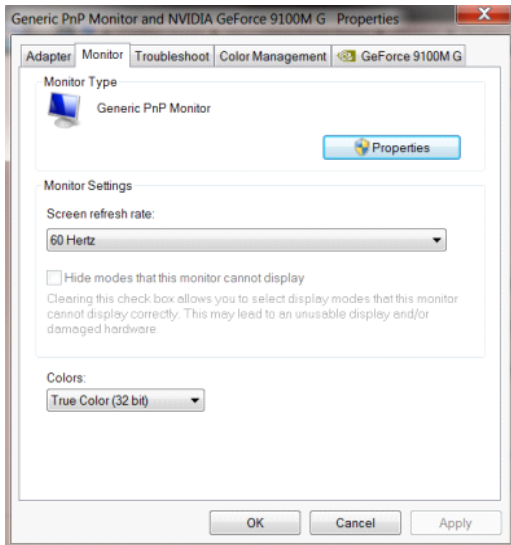

- Click the "**Driver**" tab.

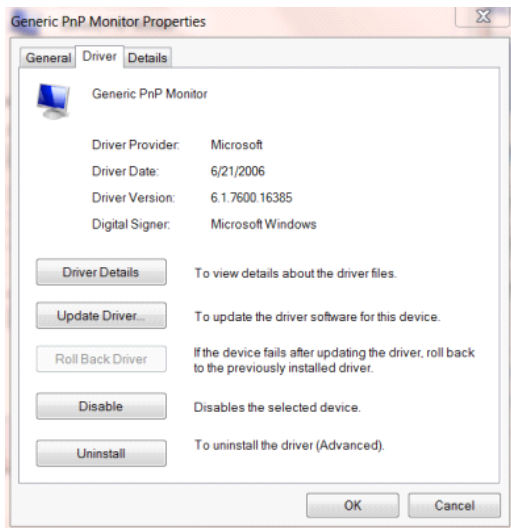

- Open the "Update Driver Software-Generic PnP Monitor" window by clicking on "**Update Driver...**" "and then click the "**Browse my computer for driver software**" button.

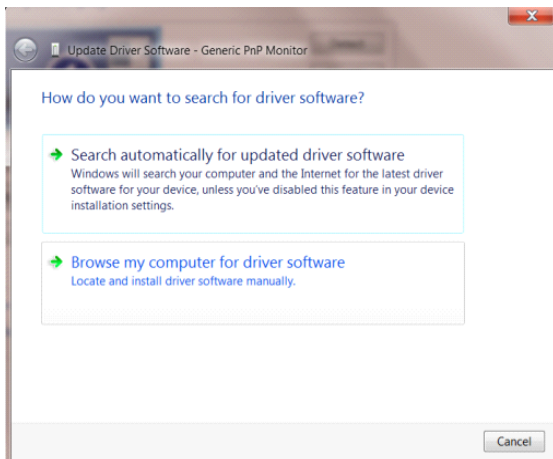

- Select **"Let me pick from a list of device drivers on my computer"**.

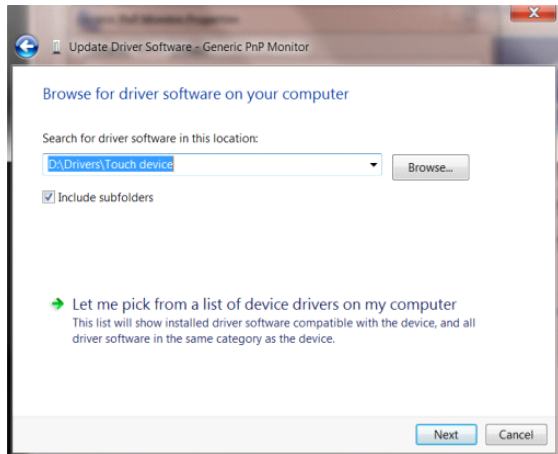

- Click the **"Have Disk"** button. Click on the **"Browse"** button and navigate to the following directory: X:\Driver\module name(where X is the drive letter designator for the CD-ROM drive).

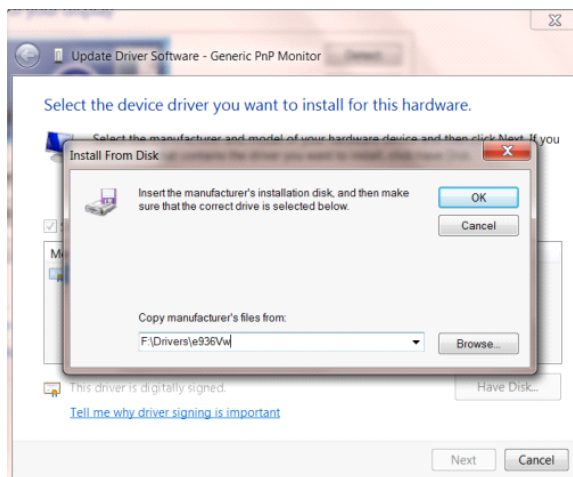

- Select the **"xxx.inf"** file and click the **"Open"** button. Click the **"OK"** button.
- Select your monitor model and click the **"Next"** button. The files will be copied from the CD to your hard disk drive.
- Close all open windows and remove the CD.
- Restart the system. The system will automatically select the maximum refresh rate and corresponding Color Matching Profiles.

Windows 8

- Start Windows® 8
- Right click and click **All apps** at the bottom-right of the screen.

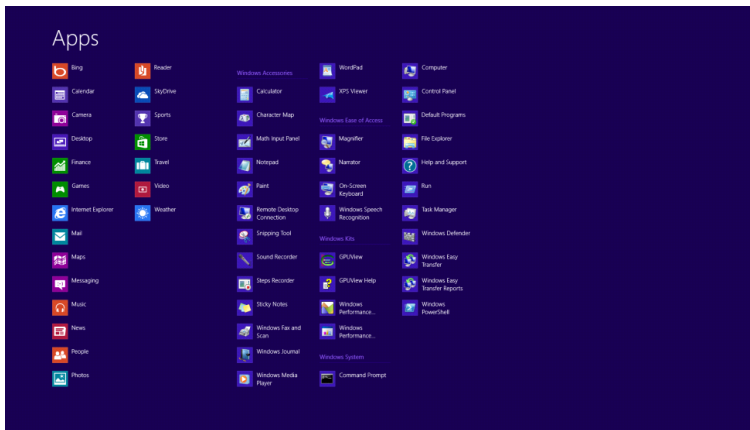
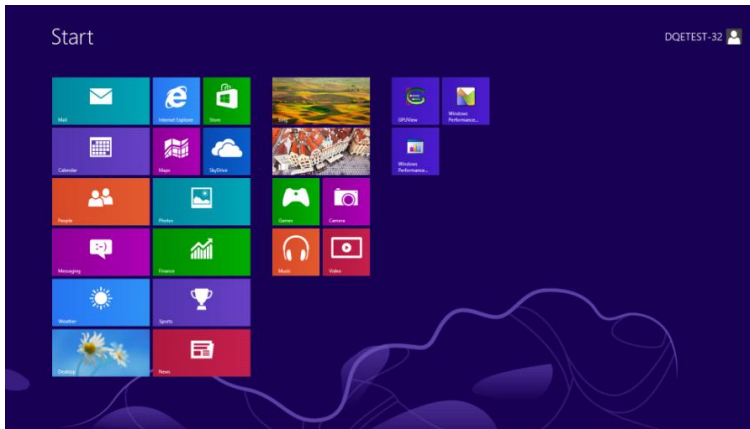

- Click on the "Control Panel" icon
- Set the "View by" to "Large icons" or "Small icons".

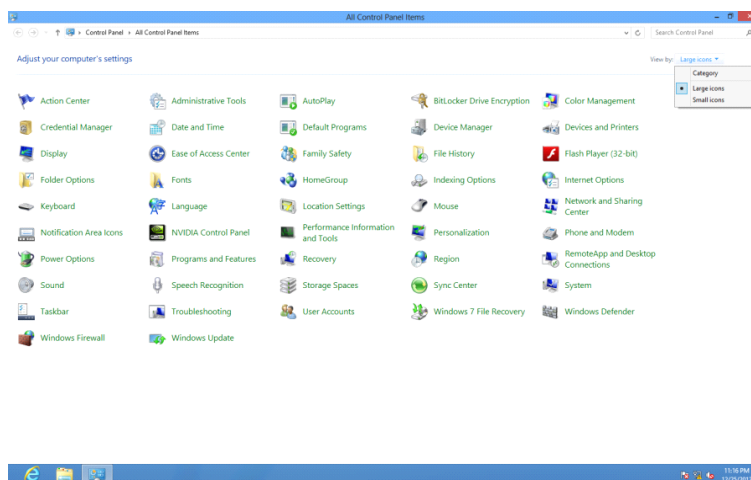

- Click on the "**Display**" icon.

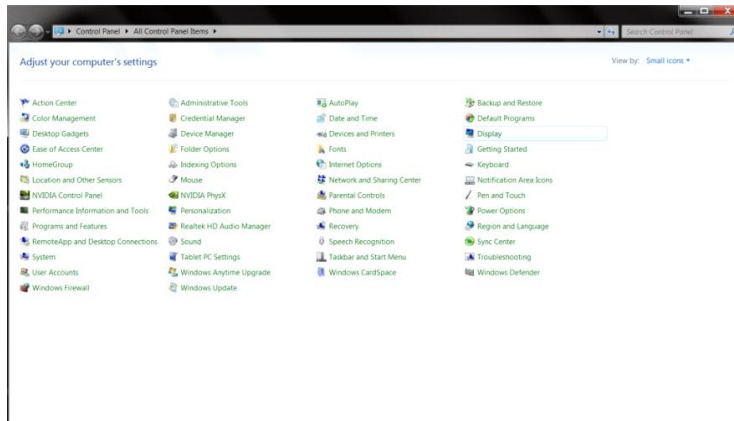

- Click on the "**Change display settings**" button.

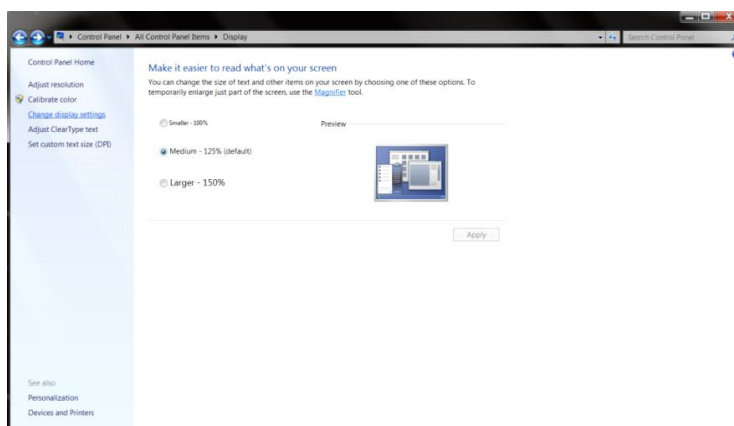

- Click the "**Advanced Settings**" button.

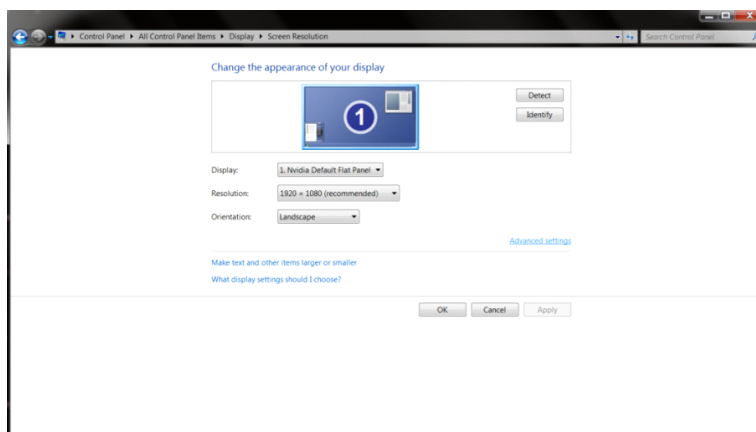

- Click the **"Monitor"** tab and then click the **"Properties"** button.

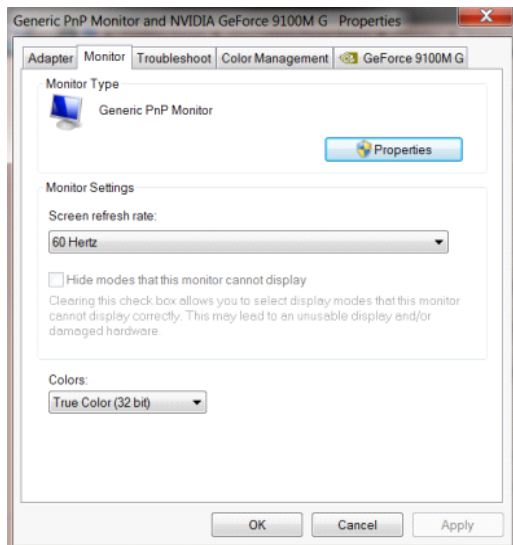

- Click the **"Driver"** tab.

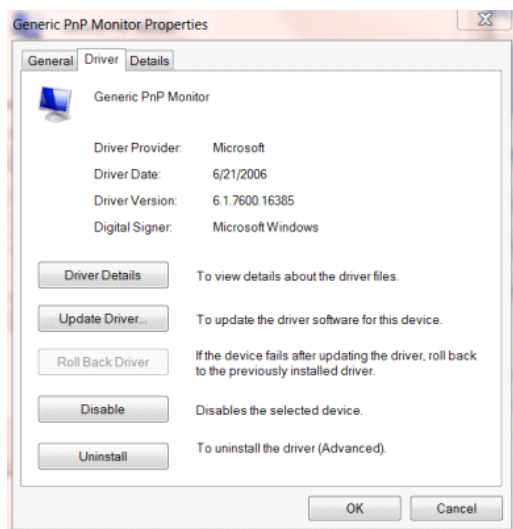

- Open the **"Update Driver Software-Generic PnP Monitor"** window by clicking on **"Update Driver..."** and then click the **"Browse my computer for driver software"** button.

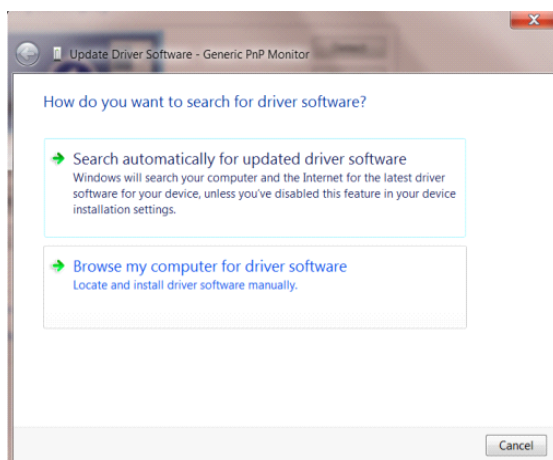

- Select **"Let me pick from a list of device drivers on my computer"**.

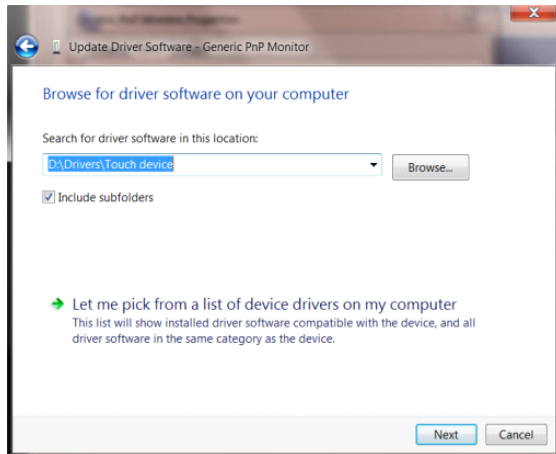

- Click the **"Have Disk"** button. Click on the **"Browse"** button and navigate to the following directory:
X:\Driver\module name (where X is the drive letter designator for the CD-ROM drive).

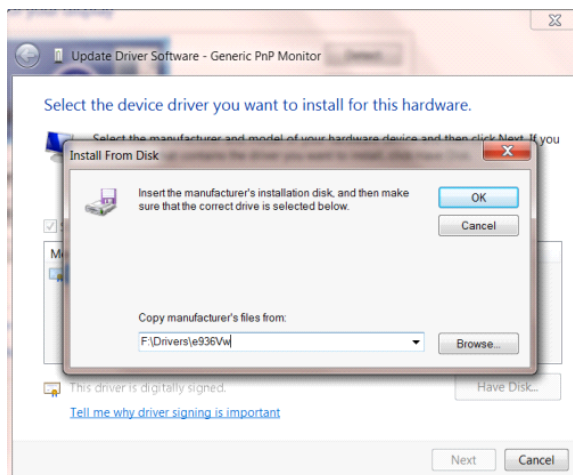

- Select the **"xxx.inf"** file and click the **"Open"** button. Click the **"OK"** button.
- Select your monitor model and click the **"Next"** button. The files will be copied from the CD to your hard disk drive.
- Close all open windows and remove the CD.
- Restart the system. The system will automatically select the maximum refresh rate and corresponding Color Matching Profiles.

Windows 7

- Start Windows® 7
- Click on the **"Start"** button and then click on **"Control Panel"**.

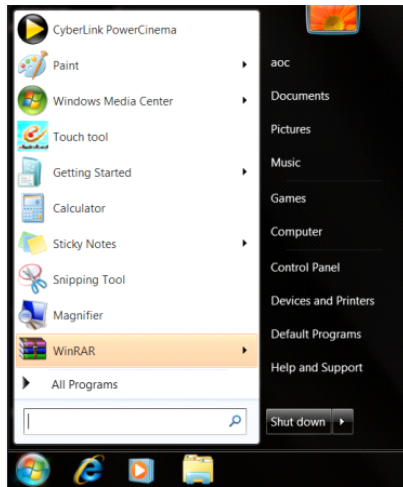

- Click on the **"Display"** icon.

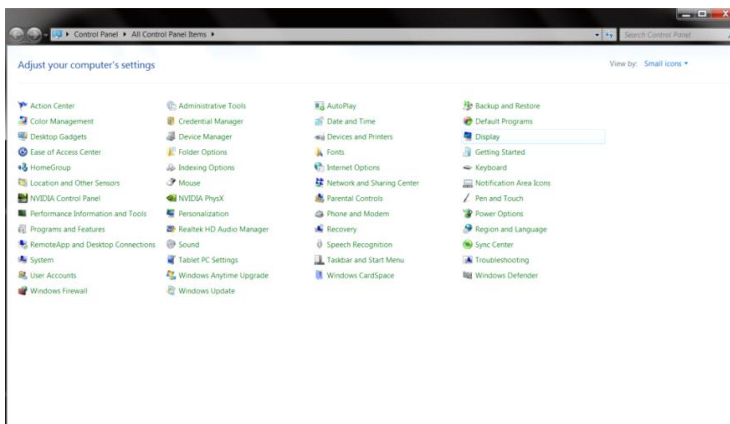

- Click on the **"Change display settings"** button.

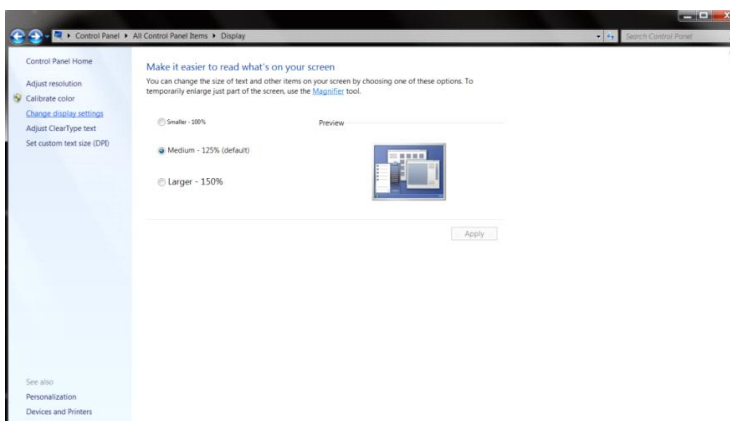

- Click the **"Advanced Settings"** button.

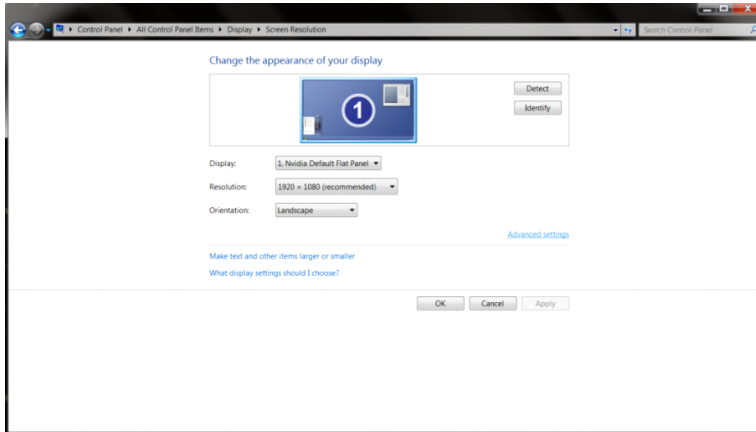

- Click the **"Monitor"** tab and then click the **"Properties"** button.

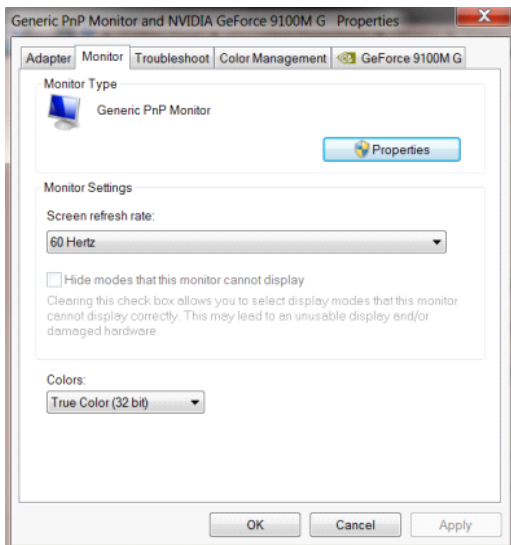

- Click the **"Driver"** tab.

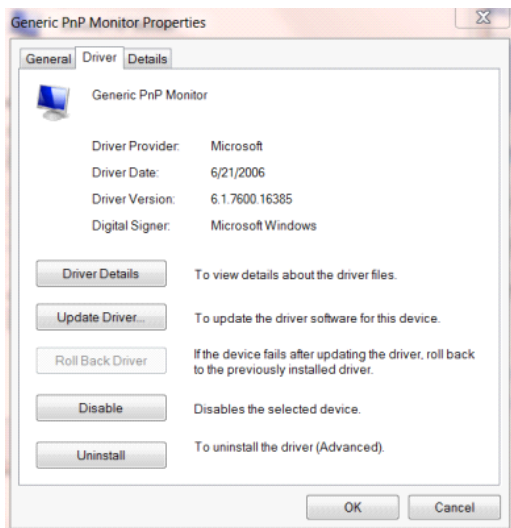

- Open the "Update Driver Software-Generic PnP Monitor" window by clicking on "Update Driver..." and then click the "Browse my computer for driver software" button.

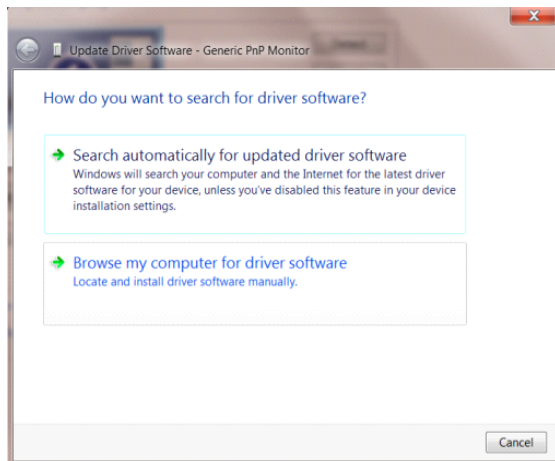

- Select "Let me pick from a list of device drivers on my computer".

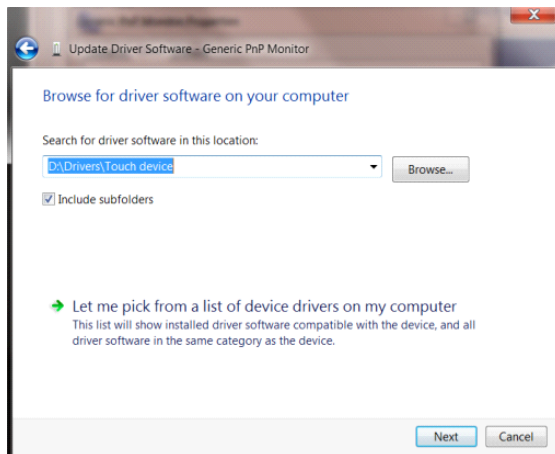

- Click the "Have Disk" button. Click on the "Browse" button and navigate to the following directory: X:\Driver\module name(where X is the drive letter designator for the CD-ROM drive).

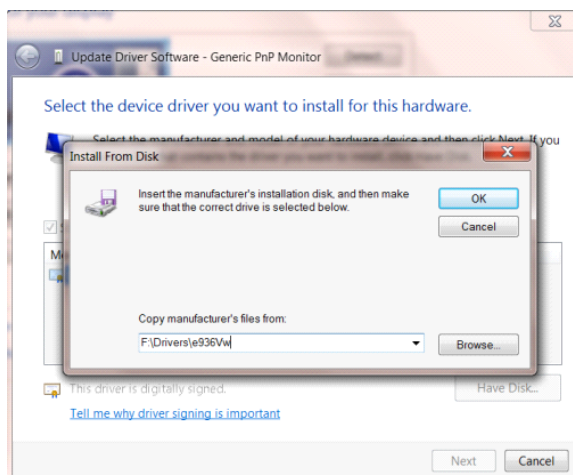

- Select the "**xxx.inf**" file and click the "**Open**" button. Click the "**OK**" button.
- Select your monitor model and click the "**Next**" button. The files will be copied from the CD to your hard disk drive.
- Close all open windows and remove the CD.
- Restart the system. The system will automatically select the maximum refresh rate and corresponding Color Matching Profiles.

i-Menu



Welcome to "i-Menu" software by AOC. i-Menu makes it easy to adjust your monitor display setting by using on screen menus instead of the OSD button on the monitor. To complete installation, please follow the installation guide.



e-Saver



Welcome to use AOC e-Saver monitor power management software! The AOC e-Saver features Smart Shutdown functions for your monitors, allows your monitor to timely shutdown when PC unit is at any status (On, Off, Sleep or Screen Saver); the actual shutdown time depends on your preferences (see example below).

Please click on "driver/e-Saver/setup.exe" to start installing the e-Saver software, follow the install wizard to complete software installation.

Under each of the four PC status, you may choose from the pull-down menu the desired time (in minutes) for your monitor to automatically shutdown. The example above illustrated:

- 1) The monitor will never shutdown when the PC is powered on.
- 2) The monitor will automatically shutdown 5 minutes after the PC is powered off.
- 3) The monitor will automatically shutdown 10 minutes after the PC is in sleep/stand-by mode.
- 4) The monitor will automatically shutdown 20 minutes after the screen saver appears.

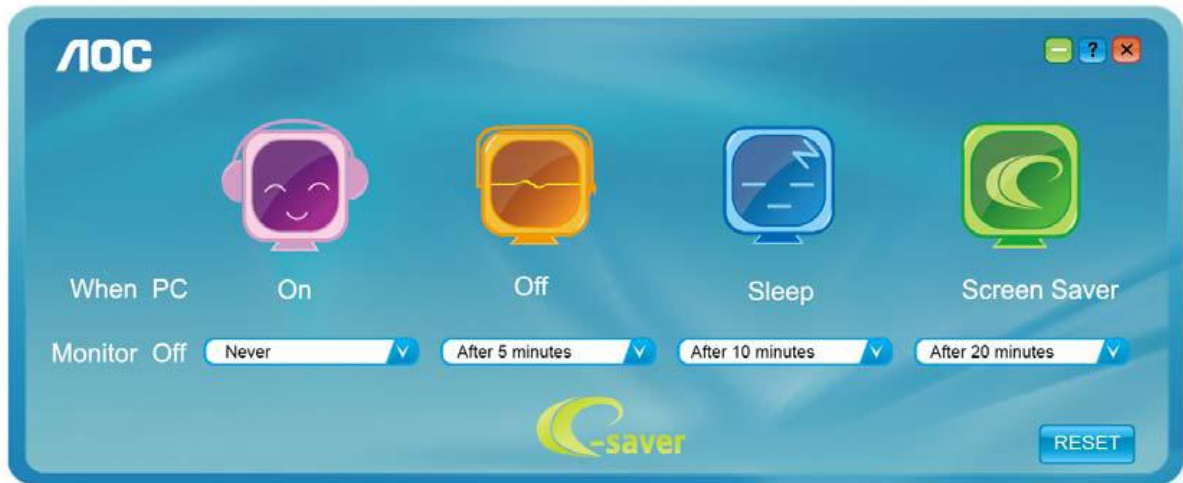

You can click "RESET" to set the e-Saver to its default settings like below.

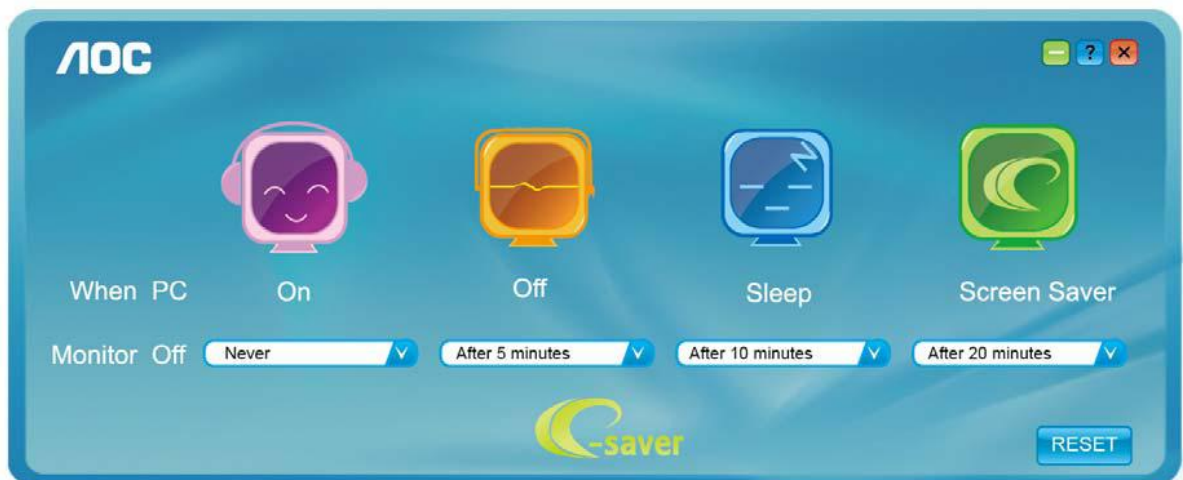

Screen+



Welcome to "Screen+" software by AOC, Screen+ software is a desktop screen splitting tool, it splits the desktop into different panes, each pane displays a different window. You only need to drag the window to a corresponding pane, when you want to access it. It supports multiple monitor display to make your task easier. Please follow the installation software to install it.

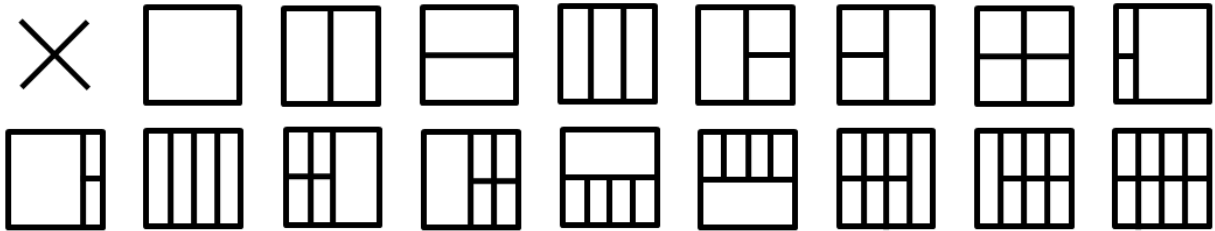

Troubleshoot

Problem & Question	Possible Solutions
Power LED Is Not ON	Make sure the power button is ON and the Power Cord is properly connected to a grounded power outlet and to the monitor.
No images on the screen	<ul style="list-style-type: none"> • Is the power cord connected properly? Check the power cord connection and power supply. • Is the cable connected correctly? (Connected using the D-sub cable) Check the DB-15 cable connection. (Connected using the DVI cable) Check the DVI cable connection. <p>* DVI input is not available on every model.</p> <ul style="list-style-type: none"> • If the power is on, reboot the computer to see the initial screen (the login screen), which can be seen. If the initial screen (the login screen) appears, boot the computer in the applicable mode (the safe mode for Windows ME/XP/2000) and then change the frequency of the video card. (Refer to the Setting the Optimal Resolution) If the initial screen (the login screen) does not appear, contact the Service Center or your dealer. • Can you see "Input Not Supported" on the screen? You can see this message when the signal from the video card exceeds the maximum resolution and frequency that the monitor can handle properly. Adjust the maximum resolution and frequency that the monitor can handle properly. • Make sure the AOC Monitor Drivers are installed.
Picture Is Fuzzy & Has Ghosting Shadowing Problem	Adjust the Contrast and Brightness Controls. Press to auto adjust. Make sure you are not using an extension cable or switch box. We recommend plugging the monitor directly to the video card output connector on the back .
Picture Bounces, Flickers Or Wave Pattern Appears In The Picture	Move electrical devices that may cause electrical interference as far away from the monitor as possible. Use the maximum refresh rate your monitor is capable of at the resolution your are using.

<p>Monitor Is Stuck In Active Off-Mode"</p>	<p>The Computer Power Switch should be in the ON position. The Computer Video Card should be snugly fitted in its slot. Make sure the monitor's video cable is properly connected to the computer. Inspect the monitor's video cable and make sure no pin is bent. Make sure your computer is operational by hitting the CAPS LOCK key on the keyboard while observing the CAPS LOCK LED. The LED should either turn ON or OFF after hitting the CAPS LOCK key.</p>
<p>Missing one of the primary colors (RED, GREEN, or BLUE)</p>	<p>Inspect the monitor's video cable and make sure that no pin is damaged. Make sure the monitor's video cable is properly connected to the computer.</p>
<p>Screen image is not centered or sized properly</p>	<p>Adjust H-Position and V-Position or press hot-key (AUTO).</p>
<p>Picture has color defects (white does not look white)</p>	<p>Adjust RGB color or select desired color temperature.</p>
<p>Horizontal or vertical disturbances on the screen</p>	<p>Use Windows 95/98/2000/ME/XP shut-down mode Adjust CLOCK and FOCUS. Press to auto-adjust.</p>

Specification

General Specification

Panel	Model name	I960SRDA/I960SRDA+/I960PRDA/I960PRDAS/I960PRDA+/E960SRDA/ E960PRDA/E960PRDAS/E960SRD
	Driving system	TFT Color LCD
	Viewable Image Size	48.2cm diagonal/ 48.0cm diagonal (I960SRDA/I960SRDA+/I960PRDA/I960PRDAS/I960PRDA+)
	Pixel pitch	0.294mm(H)X0.294mm(V)/ 0.0976mm(H)X0.2928mm(V)(I960SRDA/I960SRDA+/I960PRDA/I960PRDAS/I960PRDA+)
	Video	R, G, B Analog Interface & Digital Interface
	Separate Sync.	H/V TTL
	Display Color	16.7M Colors
	Dot Clock	108MHz
Resolution	Horizontal scan range	30 kHz - 83 kHz
	Horizontal scan Size(Maximum)	376.32mm/374.784mm (I960SRDA/I960SRDA+/I960PRDA/I960PRDAS/I960PRDA+)
	Vertical scan range	50 Hz - 76 Hz
	Vertical scan Size(Maximum)	301.056mm/299.827mm (I960SRDA/I960SRDA+/I960PRDA/I960PRDAS/I960PRDA+)
	Optimal preset resolution	1280x 1024 (60 Hz)
	Plug & Play	VESA DDC2B/CI
	Input Connector	D-Sub 15pin; DVI 24pin
	Input Video Signal	Analog: 0.7Vp-p(standard), 75 OHM, TMDS
	Power Source	100-240V~, 50/60Hz
	Typical power consumption	18W(Test condition: set Contrast = 50, Brightness = 90)
	Power Consumption	23W(Test condition: Set Brightness and Contrast to maximum)
	Power consumption @power-saving	≅ 0.5W
	Off timer	0-24 hrs
	Speakers	2WX2(I960SRDA/I960SRDA+/I960PRDA/I960PRDAS/I960PRDA+/E960SRDA/ E960PRDA/E960PRDAS)
Physical Characteristics	Connector Type	15-pin D-Sub ; DVI-D
	Signal Cable	Detachable

	Type	
Environmental	Temperature:	
	Operating	0° to 40°
	Non-Operating	-25° to 55°
	Humidity:	
	Operating	10% to 85% (non-condensing)
	Non-Operating	5% to 93% (non-condensing)

Panel	Model name	E2060S _{WN} /E2060S _{WDN} /E2060S _{WDAN} /E2060S _{WDA} / E2060P _{WDA} /E2060S _W /E2060S _{WD} /E2060S _{WDU} /E 2060SL/M2060S _{WD} /M2060S _{WDA2} /M2060P WDA2/M2060S _W /M2060S _{WD2} /M2060P WQ/M2060S _{WQ}
	Driving system	TFT Color LCD
	Viewable Image Size	49.5cm diagonal
	Viewable Image Size (M2060S _{WD} /M2060S _{WDA2} /M2060P WDA2/M2060S _W /M2060S _{WD2} /M2060P WQ/M2060S _{WQ})	49.6cm diagonal
	Pixel pitch	0.27mm(H)X0.27mm(V)
	Pixel pitch (E2060SL)	0.3177mm(H) x 0.307mm(V)
	Pixel pitch (M2060S _{WD} /M2060S _{WDA2} /M2060P WDA2/M2060S _W /M2060S _{WD2} /M2060P WQ/M2060S _{WQ})	0.2265 mm(H) x 0.221mm(V)
	Video (E2060S _{WDU} /E2060S _{WDN} /E2060S _{WDAN} /E2060S _{WDA} /E2060P _{WDA} /E2060S _{WD} /M2060S _{WD} / M2060S _{WDA2} /M2060P WDA2/M2060S _{WD2})	R, G, B Analog Interface & Digital Interface
	Video (E2060S _W / E2060S _{WN} /E2060SL/M2060S _W)	R, G, B Analog Interface
	Video (M2060P WQ/M2060S _{WQ})	R, G, B Analog Interface & DP Interface
	Separate Sync.	H/V TTL
	Display Color	16.7M Colors
	Dot Clock	108MHz
	Dot Clock (E2060SL)	90MHz
	Dot Clock (M2060S _{WD} /M2060S _{WDA2} /M2060P WDA2/M2060S _W /M2060S _{WD2} / M2060P WQ/M2060S _{WQ})	148.5MHz
Resolu tion	Horizontal scan range	30 kHz - 83 kHz
	Horizontal scan range (E2060SL)	30 kHz - 60 kHz
	Horizontal scan Size(Maximum)	432mm
	Horizontal scan Size(Maximum) (E2060SL)	434mm
	Horizontal scan Size(Maximum) (M2060S _{WD} /M2060S _{WDA2} /M2060P WDA2/M2060S _W /M2060S _{WD2} / M2060P WQ/M2060S _{WQ})	434.88mm

	Vertical scan range	50 Hz - 76 Hz
	Vertical scan Size(Maximum)	239.76mm
	Vertical scan Size(Maximum) (E2060SL)	235.8mm
	Vertical scan Size(Maximum) (M2060SWD/M2060SWDA2/M2060PWDA2/M2060SW/M2060SWD2)	238.68mm
	Optimal preset resolution (M2060SWD/M2060SWDA2/M2060PWDA2/M2060SW/M2060SWD2/ M2060PWQ/M2060SWQ)	1920×1080@60Hz
	Optimal preset resolution	1600×900@60Hz
	Optimal preset resolution (E2060SL)	1366×768@60Hz
	Plug & Play	VESA DDC2B/CI
	Input Connector (E2060SWDU/E2060SWDN/E2060SWDAN /E2060SWDA/ E2060PWDA/E2060SWD/M2060SWDA2/M2060PWA2/M2060SWD2)	D-Sub 15pin; DVI 24pin
	Input Connector(E2060SW/E2060SWN/E2060SL/M2060SW)	D-Sub 15pin;
	Input Connector(M2060PWQ/M2060SWQ)	D-Sub 15pin;DP
	Input Video Signal	Analog: 0.7Vp-p(standard), 75 OHM, TMDS
	Power Source	100-240V~, 50/60Hz
	Typical power consumption	23W 13W(E2060SL) 35W(E2060SWDU) (Test condition: set Contrast = 50, Brightness = 90)
	Power Consumption	28W 18W(E2060SL) 40W(E2060SWDU) (Test condition: Set Brightness and Contrast to maximum)
	Power consumption @power-saving	≦ 0.5W ≦ 1W(E2060SWDU)
	Off timer	0-24 hrs
	Speakers(E2060SWDU/E2060SWDA/ E2060PWDA /E2060SWDAN/M2060SWDA2/M2060PWDA2 /M2060PWQ/M2060SWQ)	2W X2
Physical Characteristics	Connector Type (E2060SWDU/E2060SWDN/E2060SWDAN /E2060SWDA/ E2060PWDA/E2060SWD/M2060SWD/M2060SWDA2 /M2060PWDA2/M2060SWD2)	15-pin D-Sub DVI-D
	Connector Type (E2060SW /E2060SWN E2060SL/M2060SW)	15-pin D-Sub
	Connector Type (M2060PWQ/M2060SWQ)	15-pin D-Sub ,DP
	Signal Cable Type	Detachable
Enviro	Temperature:	

nment al	Operating	0° to 40°
	Non-Operating	-25° to 55°
	Humidity:	
	Operating	10% to 85% (non-condensing)
	Non-Operating	5% to 93% (non-condensing)

Panel	Model name	E2260PHU/E2260SHU/E2260PDA/E2260PDAS/E2260SDA/E2260SD/E2260PQ
	Driving system	TFT Color LCD
	Viewable Image Size	55.86 cm diagonal
	Pixel pitch	0.282mm(H) x 0.282mm(V)
	Video (E2260PQ)	R, G, B Analog Interface & Digital Interface & DP Interface
	Video (E2260PHU/E2260SHU)	R, G, B Analog Interface & Digital Interface & HDMI Interface
	Video (E2260PDA/E2260PDAS/E2260SDA/E2260SD)	R, G, B Analog Interface & Digital Interface
	Separate Sync.	H/V TTL
	Display Color	16.7M Colors
	Dot Clock	146 MHz
Resolution	Horizontal scan range	30 kHz - 83 kHz
	Horizontal scan Size(Maximum)	473.76mm
	Vertical scan range	50Hz - 76 Hz
	Vertical scan Size(Maximum)	296.1mm
	Optimal preset resolution	1680 x 1050@60Hz
	Plug & Play	VESA DDC2B/CI
	Input connector (E2260PQ)	D-Sub 15pin DVI 24pin, DP
	Input connector (E2260PHU/E2260SHU)	D-Sub 15pin DVI 24pin, HDMI
	Input connector (E2260PDA/E2260PDAS/E2260SDA/E2260SD)	D-Sub 15pin DVI 24pin
	Input Video Signal	Analog: 0.7Vp-p(standard), 75 OHM, TMDS
	Power Source	100-240V~, 50/60Hz
	Typical power consumption	38W(Test condition: set Contrast = 50, Brightness = 90)
	Power Consumption	43W(Test condition: Set Brightness and Contrast to maximum)
	Power consumption @power-saving	≦ 0.5W
	Off timer	0-24 hrs
	Speakers(E2260PDA/E2260PDAS/E2260SDA/E2260PHU/E2260SHU/E2260PQ)	2W x 2
Physical Characteristics	Connector type(E2260PHU/E2260SHU)	15-pin D-Sub DVI-D,HDMI
	Connector type (E2260PQ)	15-pin D-Sub DVI-D,DP
	Connector type (E2260PDA/E2260PDAS/E2260SDA/E2260SD)	15-pin D-Sub DVI-D
	Signal Cable Type	Detachable

Environmental	Temperature:	
	Operating	0° to 40°
	Non-Operating	-25° to 55°
	Humidity:	
	Operating	10% to 85% (non-condensing)
	Non-Operating	5% to 93% (non-condensing)

Panel	Model name	E2460PWHU / E2460SWHU	
	Driving system	TFT Color LCD	
	Viewable Image Size	59.8 cm diagonal	
	Pixel pitch	0.2715 mm(H) x 0.2715 mm(V)	
	Video	R, G, B Analog Interface & Digital Interface & HDMI Interface	
	Separate Sync	H/V TTL	
	Display Color	16.7M Colors	
	Dot Clock	170 MHz	
Resolution	Horizontal scan range	30 kHz - 83 kHz	
	Horizontal scan Size(Maximum)	521.28 mm	
	Vertical scan range	50 Hz - 76 Hz	
	Vertical scan Size(Maximum)	293.22 mm	
	Optimal preset resolution	1920 x 1080 (60 Hz)	
	Plug & Play	VESA DDC2B/CI	
	Input Connector	D-Sub 15pin DVI 24pin, HDMI	
	Input Video Signal	Analog: 0.7Vp-p(standard), 75 OHM, TMDS	
	Power Source	100-240V~, 50/60Hz	
	Typical power consumption	42W(Test condition: set Contrast = 50, Brightness = 90)	
	Power Consumption	47W(Test condition: Set Brightness and Contrast to maximum)	
	Power consumption @power-saving	≅ 0.5W	
	Off timer	0~24 hrs	
Speakers	2W x 2		
Physical Characteristics	Connector Type	15-pin D-Sub DVI-D,HDMI	
	Signal Cable Type	Detachable	
Environmental	Temperature	Operating	0° to 40°
		Non-Operating	-25°to 55°
	Humidity	Operating	10% to 85% (non-condensing)
		Non-Operating	5% to 93% (non-condensing)

Preset Display Modes

19R

STANDARD	RESOLUTION	HORIZONTAL FREQUENCY(kHZ)	VERTICAL FREQUENCY(Hz)
VGA	640x480@60Hz	31.469	59.940
VGA	640x480@67Hz	35.000	66.667
VGA	640x480@72Hz	37.861	72.809
VGA	640x480@75Hz	37.500	75.000
Dos-mode	720x400@70Hz	31.469	70.087
SVGA	800x600@56Hz	35.156	56.250
SVGA	800x600@60Hz	37.879	60.317
SVGA	800x600@72Hz	48.077	72.188
SVGA	800x600@75Hz	46.875	75.000
SVGA	832x624@75Hz	49.725	74.551
XGA	1024x768@60Hz	48.363	60.004
XGA	1024x768@70Hz	56.476	70.069
XGA	1024x768@75Hz	60.023	75.029
SXGA	1280x1024@60Hz	63.981	60.020
SXGA	1280x1024@75Hz	79.976	75.025

STAND	RESOLUTION	HORIZONTAL FREQUENCY(KHZ)	VERTICAL FREQUENCY(Hz)
VGA	640x480 @60Hz	31.469	59.940
VGA	640x480 @67Hz	35.000	66.667
VGA	640x480 @72Hz	37.861	72.809
VGA	640x480 @75Hz	37.500	75.000
Dos-mode	720x400 @70Hz	31.469	70.087
SVGA	800x600 @56Hz	35.156	56.250
SVGA	800x600 @60Hz	37.879	60.317
SVGA	800x600 @72Hz	48.077	72.188
SVGA	800x600@75Hz	46.875	75.000
SVGA	832x624 @75Hz	49.725	74.500
XGA	1024x768 @60Hz	48.363	60.004
XGA	1024x768 @70Hz	56.476	70.069
XGA	1024x768 @75Hz	60.023	75.029
SXGA	1280x1024@60Hz	63.981	60.020
SXGA	1280x1024@75Hz	79.976	75.025
WSXGA	1600x900 @60Hz	55.540	59.978

19.5w(E2060SL)

Standard	Resolution	H. Frequency (kHz)	V. Frequency (Hz)
VGA	640x480 @60Hz	31.469	59.940
VGA	640x480 @67Hz	35.000	66.667
VGA	640x480 @72Hz	37.861	72.809
VGA	640x480 @75Hz	37.500	75.000
Dos-mode	720x400 @70Hz	31.469	70.087
SVGA	800x600 @56Hz	35.156	56.250
SVGA	800x600 @60Hz	37.879	60.317
SVGA	800x600 @72Hz	48.077	72.188
SVGA	800x600@75Hz	46.875	75.000
SVGA	832x624 @75Hz	49.725	74.500
XGA	1024x768 @60Hz	48.363	60.004
XGA	1024x768 @70Hz	56.476	70.069
XGA	1024x768 @75Hz	60.023	75.029
***	1280x720 @60Hz	44.772	59.855
WXGA	1360x768 @60Hz	47.712	60.015
WXGA	1366x768 @60Hz	47.712	59.790

STANDARD	RESOLUTION	HORIZONTAL FREQUENCY(kHZ)	VERTICAL FREQUENCY(Hz)
VGA	640x480 @60Hz	31.469	59.940
VGA	640x480 @67Hz	35.000	66.667
VGA	640x480 @72Hz	37.861	72.809
VGA	640x480 @75Hz	37.500	75.000
Dos-mode	720x400 @70Hz	31.469	70.087
SVGA	800x600 @56Hz	35.156	56.250
SVGA	800x600 @60Hz	37.879	60.317
SVGA	800x600 @72Hz	48.077	72.188
SVGA	800x600 @75Hz	46.875	75.000
SVGA	832x624 @75Hz	49.725	74.551
XGA	1024x768 @60Hz	48.363	60.004
XGA	1024x768 @70Hz	56.476	70.069
XGA	1024x768 @75Hz	60.023	75.029
***	1280x960 @60Hz	60.000	60.000
SXGA	1280x1024 @60Hz	63.981	60.02
SXGA	1280x1024 @75Hz	79.976	75.025
WXGA+	1440x900 @60Hz	55.935	59.887
WSXGA	1680X1050 @60Hz	65.290	59.954
HD	1920x1080@60Hz	67.500	60.000

STANDARD	RESOLUTION	HORIZONTAL FREQUENCY(kHZ)	VERTICAL FREQUENCY(Hz)
VGA	640x480@60Hz	31.469	59.940
VGA	640x480@72Hz	37.861	72.809
VGA	640x480@75Hz	37.500	75.000
SVGA	800x600@56Hz	35.156	56.250
SVGA	800x600@60Hz	37.879	60.317
SVGA	800x600@72Hz	48.077	72.188
SVGA	800x600@75Hz	46.875	75.000
XGA	1024x768@60Hz	48.363	60.004
XGA	1024x768@75Hz	60.023	75.029
SXGA	1280x1024@60Hz	63.981	60.020
SXGA	1280x1024@75Hz	79.976	75.025
WXGA	1440x900@60Hz	55.935	59.887
WSXGA	1680x1050@60Hz	65.290	59.954
IBM-MODE DOS	720x400@70Hz	31.469	70.087
MAC MODE VGA	640x480@67Hz	35.000	66.667
MAC MODE SVGA	832x624@75Hz	49.725	74.551

STANDARD	RESOLUTION	HORIZONTAL FREQUENCY(KHZ)	VERTICAL FREQUENCY(Hz)
VGA	640x480 @60Hz	31.469	59.940
VGA	640x480 @67Hz	35.000	66.667
VGA	640x480 @72Hz	37.861	72.809
VGA	640x480 @75Hz	37.500	75.000
Dos-mode	720x400 @70Hz	31.469	70.087
SVGA	800x600 @56Hz	35.156	56.250
SVGA	800x600 @60Hz	37.879	60.317
SVGA	800x600 @72Hz	48.077	72.188
SVGA	800x600 @75Hz	46.875	75.000
SVGA	832x624 @75Hz	49.725	74.551
XGA	1024x768 @60Hz	48.363	60.004
XGA	1024x768 @70Hz	56.476	70.069
XGA	1024x768 @75Hz	60.023	75.029
XGA	1024x768 @75Hz	60.241	74.927
***	1280x960 @60Hz	60.000	60.000
SXGA	1280x1024 @60Hz	63.981	60.02
SXGA	1280x1024 @75Hz	79.976	75.025
WXGA+	1440x900 @60Hz	55.935	59.887
WSXGA	1680x1050 @60Hz	65.290	59.954
HD	1920x1080@60Hz	67.500	60.000

STAND	RESOLUTION	Horizontal	Vertical
VGA	640x480@60Hz	31.469	59.94
	640x480@72Hz	37.861	72.809
	640x480@75Hz	37.5	75
SVGA	800x600@56Hz	35.156	56.25
	800x600@60Hz	37.879	60.317
	800x600@72Hz	48.077	72.188
	800x600@75Hz	46.875	75
XGA	1024x768@60Hz	48.363	60.004
	1024x768@70Hz	56.476	70.069
	1024x768@75Hz	60.023	75.029
SXGA	1280x1024@60Hz	63.981	60.02
SXGA	1280x1024@75Hz	79.976	75.025
WXGA	1440x900@60Hz	55.935	59.887
WSXGA+	1680x1050@60Hz	65.29	59.954
HDTV	1920x1080@60Hz	67.5	60
DOS	720x400@70Hz	31.469	70.087
VGA	640x480@67Hz	35	66.667
SVGA	832x624@75Hz	49.725	74.551

Pin Assignments

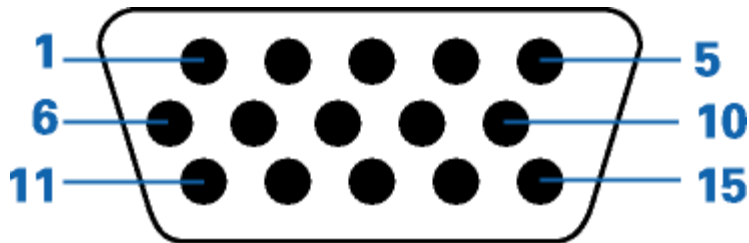

Pin Number	15-Pin Side of the Signal Cable
1	Video-Red
2	Video-Green
3	Video-Blue
4	N.C.
5	Detect Cable
6	GND-R
7	GND-G
8	GND-B
9	+5V
10	Ground
11	N.C.
12	DDC-Serial data
13	H-sync
14	V-sync
15	DDC-Serial clock

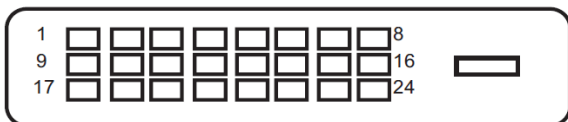

Pin Number	24-Pin Color Display Signal Cable	Pin Number	24-Pin Color Display Signal Cable
1	TMDS data 2-	13	TMDS data 3+
2	TMDS data 2+	14	+5V Power
3	TMDS data 2/4 Shield	15	Ground (for+5V)
4	TMDS data 4-	16	Hot Plug Detect
5	TMDS data 4+	17	TMDS data 0-
6	DDC Clock	18	TMDS data 0+
7	DDC Data	19	TMDS data 0/5 Shield
8	N.C.	20	TMDS data 5-
9	TMDS data 1-	21	TMDS data 5+
10	TMDS data 1+	22	TMDS Clock Shield
11	TMDS data 1/3 Shield	23	TMDS Clock +
12	TMDS data 3-	24	TMDS Clock -



Pin No.	Signal Name	Pin No.	Signal Name	Pin No.	Signal Name
1	TMDS Data 2+	9	TMDS Data 0	17	DDC/CEC Ground
2	TMDS Data 2 Shield	10	TMDS Clock +	18	+5V Power
3	TMDS Data 2	11	TMDS Clock Shield	19	Hot Plug Detect
4	TMDS Data 1+	12	TMDS Clock		
5	TMDS Data 1Shield	13	CEC		
6	TMDS Data 1	14	Reserved (N.C. on device		
7	TMDS Data 0+	15	SCL		
8	TMDS Data 0 Shield	16	SDA		

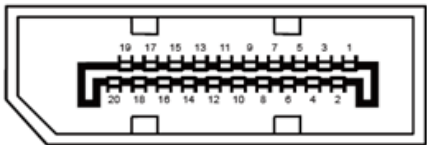

Pin No.	Signal Name	Pin No.	Signal Name
1	ML_Lane 3 (n)	11	GND
2	GND	12	ML_Lane 0 (p)
3	ML_Lane 3 (p)	13	CONFIG1
4	ML_Lane 2 (n)	14	CONFIG2
5	GND	15	AUX_CH(p)
6	ML_Lane 2 (p)	16	GND
7	ML_Lane 1 (n)	17	AUX_CH(n)
8	GND	18	Hot Plug Detect
9	ML_Lane 1 (p)	19	Return DP_PWR
10	ML_Lane 0 (n)	20	DP_PWR

Plug and Play

Plug & Play DDC2B Feature

This monitor is equipped with VESA DDC2B capabilities according to the VESA DDC STANDARD. It allows the monitor to inform the host system of its identity and, depending on the level of DDC used, communicate additional information about its display capabilities.

The DDC2B is a bi-directional data channel based on the I2C protocol. The host can request EDID information over the DDC2B channel.

Regulation

FCC Notice

FCC Class B Radio Frequency Interference Statement WARNING: (FOR FCC CERTIFIED MODELS)

NOTE: This equipment has been tested and found to comply with the limits for a Class B digital device, pursuant to Part 15 of the FCC Rules. These limits are designed to provide reasonable protection against harmful interference in a residential installation. This equipment generates, uses and can radiate radio frequency energy, and if not installed and used in accordance with the instructions, may cause harmful interference to radio communications. However, there is no guarantee that interference will not occur in a particular installation. If this equipment does cause harmful interference to radio or television reception, which can be determined by turning the equipment off and on, the user is encouraged to try to correct the interference by one or more of the following measures:

Reorient or relocate the receiving antenna.

Increase the separation between the equipment and receiver.

Connect the equipment into an outlet on a circuit different from that to which the receiver is connected.

Consult the dealer or an experienced radio/TV technician for help.

NOTICE :

The changes or modifications not expressly approved by the party responsible for compliance could void the user's authority to operate the equipment.

Shielded interface cables and AC power cord, if any, must be used in order to comply with the emission limits.

The manufacturer is not responsible for any radio or TV interference caused by unauthorized modification to this equipment. It is the responsibilities of the user to correct such interference. It is the responsibility of the user to correct such interference.

WEEE Declaration

Disposal of Waste Equipment by Users in Private Household in the European Union.



This symbol on the product or on its packaging indicates that this product must not be disposed of with your other household waste. Instead, it is your responsibility to dispose of your waste equipment by handing it over to a designated collection point for the recycling of waste electrical and electronic equipment. The separate collection and recycling of your waste equipment at the time of disposal will help to conserve natural resources and ensure that it is recycled in a manner that protects human health and the environment. For more information about where you can drop off your waste equipment for recycling, please contact your local city office, your household waste disposal service or the shop where you purchased the product .

Reduction in the use of hazardous substances (India)

This product complies with the “E-Waste (Management) Rules, 2016” CHAPTER V, rule 16, sub-rule (1) . Whereas New Electrical and Electronic Equipment and their components or consumables or parts or spares do not contain Lead, Mercury, Cadmium, Hexavalent Chromium, polybrominated biphenyls and polybrominated diphenyl ethers beyond a maximum concentration value of 0.1% by weight in homogenous materials for lead, mercury, hexavalent chromium, polybrominated biphenyls and polybrominated diphenyl ethers and of 0.01% by weight in homogenous materials for cadmium. except of exemptions set in Schedule 2 of the Rule.

E-Waste Declaration for India



This symbol on the product or on its packaging indicates that this product must not be disposed of with your other household waste. Instead it is your responsibility to dispose of your waste equipment by handing it over to a designated collection point for the recycling of waste electrical and electronic equipment . The separate collection and recycling of your waste equipment at the time of disposal will help to conserve natural resources and ensure that it is recycled in a manner that protects human health and the environment. For more information about E -waste please visit

<http://www.aocindia.com/ewaste.php> and to know where you can drop off your waste equipment for recycling in India please contact on below given contact details.

Helpline number: 080-6788-6788 / 080-3323-1313 (*Monday to Saturday, 10 a.m. to 6 p.m.*)

Centralized E-waste collection center

Address: *TPV Technology India Private Limited, 59, Maheswari Nagar, 1st Main Road, Mahadevapura Post, Whitefield Road, Bangalore, Karnataka, PIN: 560048, Tel: 080-3023-1000*

E-mail: serviceindia@aoc.com

EPA Energy Star



ENERGY STAR® is a U.S. registered mark. As an ENERGY STAR® Partner, AOC International (Europe) BV and Envision Peripherals, Inc. have determined that this product meets the ENERGY STAR® guidelines for energy efficiency.

(FOR EPA CERTIFIED MODELS)

TCO DOCUMENT



Congratulations!

This product is TCO Certified – for Sustainable IT



TCO Certified is an international third party sustainability certification for IT products. TCO Certified ensures that the manufacture, use and recycling of IT products reflect environmental, social and economic responsibility. Every TCO Certified product model is verified by an accredited independent test laboratory.

This product has been verified to meet all the criteria in TCO Certified, including:

Corporate Social Responsibility

Socially responsible production - working conditions and labor law in manufacturing country

Energy Efficiency

Energy efficiency of product and power supply. Energy Star compliant, where applicable

Environmental Management System

Manufacturer must be certified according to either ISO 14001 or EMAS

Minimization of Hazardous Substances

Limits on cadmium, mercury, lead & hexavalent chromium including requirements for mercury-free products, halogenated substances and hazardous flame retardants

Design for Recycling

Coding of plastics for easy recycling. Limit on the number of different plastics used.

Product Lifetime, Product Take Back

Minimum one-year product warranty. Minimum three-year availability of spare parts. Product takeback

Packaging

Limits on hazardous substances in product packaging. Packaging prepared for recycling

Ergonomic, User-centered design

Visual ergonomics in products with a display. Adjustability for user comfort (displays, headsets)

Acoustic performance – protection against sound spikes (headsets) and fan noise (projectors, computers)

Ergonomically designed keyboard (notebooks)

Electrical Safety, minimal electro-magnetic Emissions

Third Party Testing

All certified product models have been tested in an independent, accredited laboratory.

A detailed criteria set is available for download at www.tcodevelopment.com, where you can also find a searchable database of all TCO Certified IT products.

TCO Development, the organization behind TCO Certified, has been an international driver in the field of Sustainable IT for 20 years. Criteria in TCO Certified are developed in collaboration with scientists, experts, users and manufacturers. Organizations around the world rely on TCO Certified as a tool to help them reach their sustainable IT goals. We are owned by TCO, a non-profit organization representing office workers. TCO Development is headquartered in Stockholm, Sweden, with regional presence in North America and Asia.

For more information, please visit
www.tcodevelopment.com

(FOR TCO CERTIFIED MODELS)

EPEAT Declaration



EPEAT is a system to help purchasers in the public and private sectors evaluate, compare and select desktop computers, notebooks and monitors based on their environmental attributes. EPEAT also provides a clear and consistent set of performance criteria for the design of products, and provides an opportunity for manufacturers to secure market recognition for efforts to reduce the environmental impact of its products.

AOC believes in protecting the environment.

With a key concern for the conservation of natural resources, as well as landfill protection, AOC announces the launch of AOC monitor's packaging recycling program. This program is designed to help you discard of your monitor carton and filler materials properly. If a local recycling center is not available, AOC will recycle the packaging material for you, including foam filler and carton. AOC Display solution will only recycle AOC monitor packaging. Please refer to the following website address:

For North America:

<http://us.aoc.com/aoc-corporation/?page=environmental-impact>

For Germany:

<http://aoc-europe.com/de/content/environment>

For Brazil:

<http://www.aoc.com.br/pg/embalagem-verde>

(FOR EPEAT GOLD CERTIFIED MODELS)

Service

Warranty Statement for Europe

LIMITED THREE-YEAR WARRANTY*

For AOC LCD Monitors sold within Europe, AOC International (Europe) B.V. warrants this product to be free from defects in material and workmanship for a period of Three (3) years after the original date of consumer purchase. During this period, AOC International (Europe) B.V. will, at its option, either repair the defective product with new or rebuilt parts, or replace it with a new or rebuilt product at no charge except as *stated below. In the absent of the proof of purchase, the warranty will start 3 months after the date of manufacturing indicated on the product.

If the product appears to be defective, please contact your local dealer or refer to the service and support section on www.aoc-europe.com for the warranty instructions in your country. The freight cost for the warranty is pre-paid by AOC for the delivery and return. Please ensure you provide a dated proof of purchase along with the product and deliver to the AOC Certified or Authorized Service Center under the following condition:

- Make sure the LCD Monitor is packed in a proper carton box (AOC prefers the original carton box to protects your monitor well enough during transport).
- Put the RMA number on the address label
- Put the RMA number on the shipping carton

AOC International (Europe) B.V. will pay the return shipping charges within one of the countries specified within this warranty statement. AOC International (Europe) B.V. is not responsible for any costs associated with the transportation of product across international borders. This includes the international border within the European Union. If the LCD Monitor is not available for collection when the carrier attends, you will be charged a collection fee.

*** This limited warranty does not cover any losses or damages that occur as a result of:**

- Damages during transport due to improper packaging
- Improper installation or maintenance other than in accordance with AOC's user manual
- Misuse
- Neglect
- Any cause other than ordinary commercial or industrial application
- Adjustment by non-authorized source
- Repair, modification, or installation of options or parts by anyone other than an AOC Certified or Authorized Service Center
- Improper environments like humidity, water damage and dusts
- Damaged by violence, earthquake and terrorist attacks
- Excessive or inadequate heating or air conditioning or electrical powers failures, surges, or other irregularities

This limited warranty does not cover any of the product firmware or hardware that you or any third party have modified or altered; you bear the sole responsibility and liability for any such modifications or alteration.

All AOC LCD Monitors are produced according to the ISO 9241-307 Class 1 pixel policy standards.

If your warranty has expired, you still have access to all available service options, but you will be responsible for the cost of service, including parts, labor, shipping (if any) and applicable taxes. AOC Certified or Authorized Service Center will provide you with an estimate of service costs before receiving your authorization to perform service.

ALL EXPRESS AND IMPLIED WARRANTIES FOR THIS PRODUCT (INCLUDING THE WARRANTIES OF MERCHANTABILITY AND FITNESS FOR A PARTICULAR PURPOSE) ARE LIMITED IN DURATION TO A PERIOD OF THREE (3) YEARS FOR PARTS AND LABOR FROM THE ORIGINAL DATE OF CONSUMER PURCHASE. NO WARRANTIES (EITHER EXPRESSED OR IMPLIED) APPLY AFTER THIS PERIOD. AOC INTERNATIONAL (EUROPE) B.V. OBLIGATIONS AND YOUR REMEDIES HEREUNDER ARE SOLELY AND EXCLUSIVELY AS STATED HERE. AOC INTERNATIONAL (EUROPE) B.V. LIABILITY, WHETHER BASED ON CONTRACT, TORT, WARRANTY, STRICT LIABILITY, OR OTHER THEORY, SHALL NOT EXCEED THE PRICE OF THE INDIVIDUAL UNIT WHOSE DEFECT OR DAMAGE IS THE BASIS OF THE CLAIM. IN NO EVENT SHALL AOC INTERNATIONAL (EUROPE) B.V. BE LIABLE FOR ANY LOSS OF PROFITS, LOSS OF USE OR FACILITIES OR EQUIPMENT, OR OTHER INDIRECT, INCIDENTAL, OR CONSEQUENTIAL DAMAGE. SOME STATES DO NOT ALLOW THE EXCLUSION OR LIMITATION OF INCIDENTAL OR CONSEQUENTIAL DAMAGES, SO THE ABOVE LIMITATION MAY NOT APPLY TO YOU. ALTHOUGH THIS LIMITED WARRANTY GIVES YOU SPECIFIC LEGAL RIGHTS, YOU MAY HAVE OTHER RIGHTS, WHICH MAY VARY FROM COUNTRY TO COUNTRY. THIS LIMITED WARRANTY IS ONLY VALID FOR PRODUCTS PURCHASED IN THE MEMBER COUNTRIES OF THE EUROPEAN UNION.

Information in this document is subject to change without notice. For more information, please visit:

<http://www.aoc-europe.com>

Warranty Statement for Middle East and Africa (MEA)

And

The Commonwealth of Independent States (CIS)

LIMITED ONE to THREE YEARS WARRANTY*

For AOC LCD Monitors sold within the Middle East and Africa (MEA) and the Commonwealth of Independent States (CIS), AOC International (Europe) B.V. warrants this product to be free from defects in material and workmanship for a period of One (1) to Three (3) years from the manufacture date depending on sale country. During this period, AOC International (Europe) B.V. offers a Carry-In (return to Service Center) Warranty Support at an AOC's Authorized Service Center or Dealer and at its option, either repair the defective product with new or rebuilt parts, or replace it with a new or rebuilt product at no charge except as *stated below. As a Standard Policy, the warranty will be calculated from the manufacture date identified from the product ID serial number, but the total warranty will be Fifteen (15) months to Thirty Nine (39) months from MFD (manufacture date) depending on sale country. Warranty will be considered for exceptional cases that are out of warranty as per the product ID serial number and for such exceptional cases; Original Invoice/Proof Of Purchase Receipt is mandatory.

If the product appears to be defective, please contact your AOC authorized dealer or refer to the service and support section on AOC's website for the warranty instructions in your country:

- Egypt: http://aocmonitorap.com/egypt_eng
- CIS Central Asia: <http://aocmonitorap.com/ciscentral>
- Middle East: <http://aocmonitorap.com/middleeast>
- South Africa: <http://aocmonitorap.com/southafrica>
- Saudi Arabia: <http://aocmonitorap.com/saudiarabia>

Please ensure you provide a dated proof of purchase along with the product and deliver to the AOC Authorized Service Center or Dealer under the following condition:

- Make sure the LCD Monitor is packed in a proper carton box (AOC prefers the original carton box to protect your monitor well enough during transport).
- Put the RMA number on the address label
- Put the RMA number on the shipping carton

* This limited warranty does not cover any losses or damages that occur as a result of:

- Damages during transport due to improper packaging
- Improper installation or maintenance other than in accordance with AOC's user manual
- Misuse
- Neglect

- Any cause other than ordinary commercial or industrial application
- Adjustment by non-authorized source
- Repair, modification, or installation of options or parts by anyone other than an AOC Certified or Authorized Service Center
- Improper environments like humidity, water damage and dusts
- Damaged by violence, earthquakes and terrorist attacks
- Excessive or inadequate heating or air conditioning or electrical powers failures, surges, or other irregularities

This limited warranty does not cover any of the product firmware or hardware that you or any third party have modified or altered; you bear the sole responsibility and liability for any such modifications or alteration.

All AOC LCD Monitors are produced according to the ISO 9241-307 Class 1 pixel policy standards.

If your warranty has expired, you still have access to all available service options, but you will be responsible for the cost of service, including parts, labor, shipping (if any) and applicable taxes. AOC Certified, Authorized Service Center or dealer will provide you with an estimate of service costs before receiving your authorization to perform service.

ALL EXPRESS AND IMPLIED WARRANTIES FOR THIS PRODUCT (INCLUDING THE WARRANTIES OF MERCHANTABILITY AND FITNESS FOR A PARTICULAR PURPOSE) ARE LIMITED IN DURATION TO A PERIOD OF ONE (1) to THREE (3) YEARS FOR PARTS AND LABOR FROM THE ORIGINAL DATE OF CONSUMER PURCHASE. NO WARRANTIES (EITHER EXPRESSED OR IMPLIED) APPLY AFTER THIS PERIOD. AOC INTERNATIONAL (EUROPE) B.V. OBLIGATIONS AND YOUR REMEDIES HEREUNDER ARE SOLELY AND EXCLUSIVELY AS STATED HERE. AOC INTERNATIONAL (EUROPE) B.V. LIABILITY, WHETHER BASED ON CONTRACT, TORT, WARRANTY, STRICT LIABILITY, OR OTHER THEORY, SHALL NOT EXCEED THE PRICE OF THE INDIVIDUAL UNIT WHOSE DEFECT OR DAMAGE IS THE BASIS OF THE CLAIM. IN NO EVENT SHALL AOC INTERNATIONAL (EUROPE) B.V. BE LIABLE FOR ANY LOSS OF PROFITS, LOSS OF USE OR FACILITIES OR EQUIPMENT, OR OTHER INDIRECT, INCIDENTAL, OR CONSEQUENTIAL DAMAGE. SOME STATES DO NOT ALLOW THE EXCLUSION OR LIMITATION OF INCIDENTAL OR CONSEQUENTIAL DAMAGES, SO THE ABOVE LIMITATION MAY NOT APPLY TO YOU. ALTHOUGH THIS LIMITED WARRANTY GIVES YOU SPECIFIC LEGAL RIGHTS, YOU MAY HAVE OTHER RIGHTS, WHICH MAY VARY FROM COUNTRY TO COUNTRY. THIS LIMITED WARRANTY IS ONLY VALID FOR PRODUCTS PURCHASED IN THE MEMBER COUNTRIES OF THE EUROPEAN UNION.

Information in this document is subject to change without notice. For more information, please visit:

<http://www.aocmonitorap.com>

AOC Pixel Policy ISO 9241-307 Class 1



AOC International (Europe) B.V.
 Prins Bernhardplein 200 / 6th floor, Amsterdam, The Netherlands
 Tel: +31 (0)20 504 6962 • Fax: +31 (0)20 5046933

AOC Pixel Policy ISO 9241-307 Class 1

July 25th, 2013

AOC strives to deliver the highest quality products. We use some of the industry's most advanced manufacturing processes and practice stringent quality control. However, pixel or sub pixel defects on the TFT monitor panels used in flat panel monitors are sometimes unavoidable. No manufacturer can guarantee that all panels will be free from pixel defects, but AOC guarantees that any monitor with an unacceptable number of defects will be repaired or replaced under warranty. This Pixel Policy explains the different types of pixel defects and defines acceptable defect levels for each type. In order to qualify for repair or replacement under warranty, the number of pixel defects on a TFT monitor panel must exceed these acceptable levels.

Pixels and Sub Pixel Definition

A pixel, or picture element, is composed of three sub pixels in the primary colors of red, green and blue. When all sub pixels of pixel are lit, the three colored sub pixel together appear as a single white pixel. When all are dark, the three colored sub pixels together appear as a single black pixel.

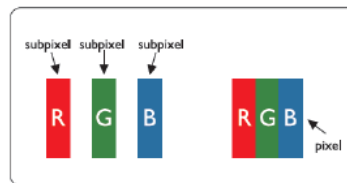

Types of Pixel Defects

- Bright Dot Defects: the monitor displays a dark pattern, sub pixels or pixels are always lit or “on”
- Black Dot Defects: the monitor displays a light pattern, sub pixels or pixels are always dark or “off”

ISO 9241-307 Pixel Defect Class	Defect Type 1 Bright Pixel	Defect Type 2 Black Pixel	Defect Type 3 Bright Sub pixel	Defect Type 4 Black Sub pixel
Class 1	1	1	2 1 0	+ + +
				1 3 5

AOC International (Europe) B.V.

Warranty Statement for North & South America (excluding Brazil)

WARRANTY STATEMENT

for AOC Color Monitors

Including those Sold within North America as Specified

Envision Peripherals, Inc. warrants this product to be free from defects in material and workmanship for a period of three (3) years for parts & labor and one (1) year for CRT Tube or LCD Panel after the original date of consumer purchase. During this period, EPI (EPI is the abbreviation of Envision Peripherals, Inc.) will, at its option, either repair the defective product with new or rebuilt parts, or replace it with a new or rebuilt product at no charge except as *stated below. The parts or product that are replaced become the property of EPI.

In the USA to obtain service under this limited warranty, call EPI for the name of the Authorized Service Center closest to your area. Deliver the product freight pre-paid, along with the dated proof of purchase, to the EPI Authorized Service Center. If you cannot deliver the product in person:

- Pack it in its original shipping container (or equivalent)
- Put the RMA number on the address label
- Put the RMA number on the shipping carton
- Insure it (or assume the risk of loss/damage during shipment)
- Pay all shipping charges

EPI is not responsible for damage to inbound product that was not properly packaged.

EPI will pay the return shipment charges within one of the countries specified within this warranty statement. EPI is not responsible for any costs associated with the transportation of product across international borders. This includes the international borders of the countries within this warranty statements.

In the United States and Canada contact your Dealer or EPI Customer Service, RMA Department at the toll free number (888) 662-9888. Or you can request an RMA Number online at www.aoc.com/na-warranty.

* This limited warranty does not cover any losses or damages that occur as a result of:

- Shipping or improper installation or maintenance
- Misuse
- Neglect
- Any cause other than ordinary commercial or industrial application
- Adjustment by non-authorized source
- Repair, modification, or installation of options or parts by anyone other than an EPI Authorized Service Center
- Improper environment
- Excessive or inadequate heating or air conditioning or electrical power failures, surges, or other irregularities

This three-year limited warranty does not cover any of the product's firmware or hardware that you or any third party have modified or altered; you bear the sole responsibility and liability for any such modification or alteration.

ALL EXPRESS AND IMPLIED WARRANTIES FOR THIS PRODUCT (INCLUDING THE WARRANTIES OF MERCHANTABILITY AND FITNESS FOR A PARTICULAR PURPOSE) ARE LIMITED IN DURATION TO A PERIOD OF THREE (3) YEARS FOR PARTS AND LABOR AND ONE (1) YEAR FOR CRT TUBE OR LCD PANEL FROM THE ORIGINAL DATE OF CONSUMER PURCHASE. NO WARRANTIES (EITHER EXPRESSED OR IMPLIED) APPLY AFTER THIS PERIOD. IN THE UNITED STATES OF AMERICA, SOME STATES DO NOT ALLOW LIMITATIONS ON HOW LONG AN IMPLIED WARRANTY LASTS, SO THE ABOVE LIMITATIONS MAY NOT APPLY TO YOU.

EPI OBLIGATIONS AND YOUR REMEDIES HEREUNDER ARE SOLELY AND EXCLUSIVELY AS STATED HERE. EPI' LIABILITY, WHETHER BASED ON CONTRACT, TORT, WARRANTY, STRICT LIABILITY, OR OTHER THEORY, SHALL NOT EXCEED THE PRICE OF THE INDIVIDUAL UNIT WHOSE DEFECT OR DAMAGE IS THE BASIS OF THE CLAIM. IN NO EVENT SHALL ENVISION PERIPHERALS, INC. BE LIABLE FOR ANY LOSS OF PROFITS, LOSS OF USE OR FACILITIES OR EQUIPMENT OR OTHER INDIRECT, INCIDENTAL, OR CONSEQUENTIAL DAMAGE. IN THE UNITED STATES OF AMERICA, SOME STATES DO NOT ALLOW THE EXCLUSION OR LIMITATION OF INCIDENTAL OR CONSEQUENTIAL DAMAGES. SO THE ABOVE LIMITATION MAY NOT APPLY TO YOU. ALTHOUGH THIS LIMITED WARRANTY GIVES YOU SPECIFIC LEGAL RIGHTS. YOU MAY HAVE OTHER RIGHTS WHICH MAY VARY FROM STATE TO STATE.

In the United States of America, this limited warranty is only valid for Products purchased in the Continental United States, Alaska, and Hawaii.

Outside the United States of America, this limited warranty is only valid for Products purchased in Canada.

Information in this document is subject to change without notice.

For more details, please visit:

USA: <http://us.aoc.com/support/warranty>
ARGENTINA: <http://ar.aoc.com/support/warranty>
BOLIVIA: <http://bo.aoc.com/support/warranty>
CHILE: <http://cl.aoc.com/support/warranty>
COLOMBIA: <http://co.aoc.com/warranty>
COSTA RICA: <http://cr.aoc.com/support/warranty>
DOMINICAN REPUBLIC: <http://do.aoc.com/support/warranty>
ECUADOR: <http://ec.aoc.com/support/warranty>
EL SALVADOR: <http://sv.aoc.com/support/warranty>
GUATEMALA: <http://gt.aoc.com/support/warranty>
HONDURAS: <http://hn.aoc.com/support/warranty>
NICARAGUA: <http://ni.aoc.com/support/warranty>
PANAMA: <http://pa.aoc.com/support/warranty>
PARAGUAY: <http://py.aoc.com/support/warranty>
PERU: <http://pe.aoc.com/support/warranty>
URUGUAY: <http://pe.aoc.com/warranty>
VENEZUELA: <http://ve.aoc.com/support/warranty>
IF COUNTRY NOT LISTED: <http://latin.aoc.com/warranty>