



Figure 948 - Core 0 (A) 5745 MHz (CH149) 99% Bandwidth



Figure 949 - Core 0 (A) 5745 MHz (CH149) 6 dB Bandwidth



Figure 950 - Core 1 (B) 5745 MHz (CH149) 99% Bandwidth

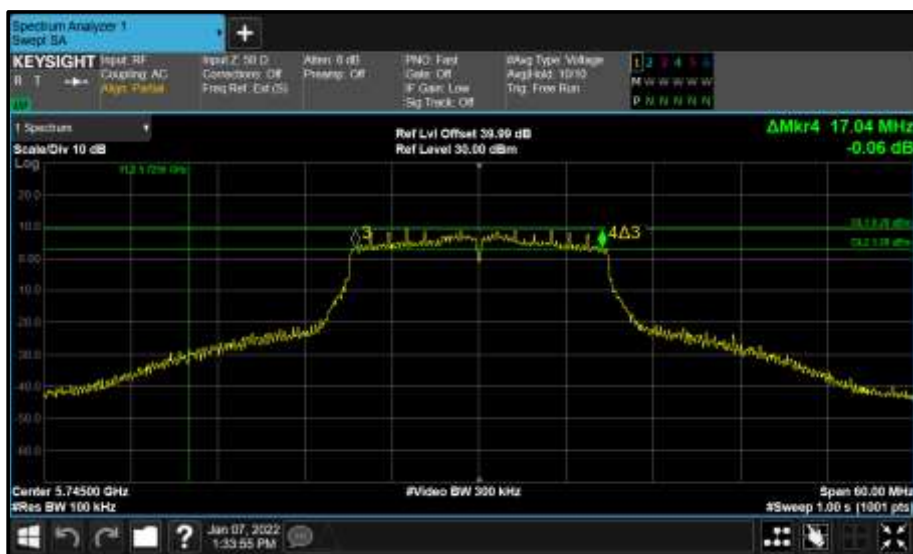


Figure 951 - Core 1 (B) 5745 MHz (CH149) 6 dB Bandwidth



Figure 952 - Core 0 (A) 5785 MHz (CH157) 99% Bandwidth

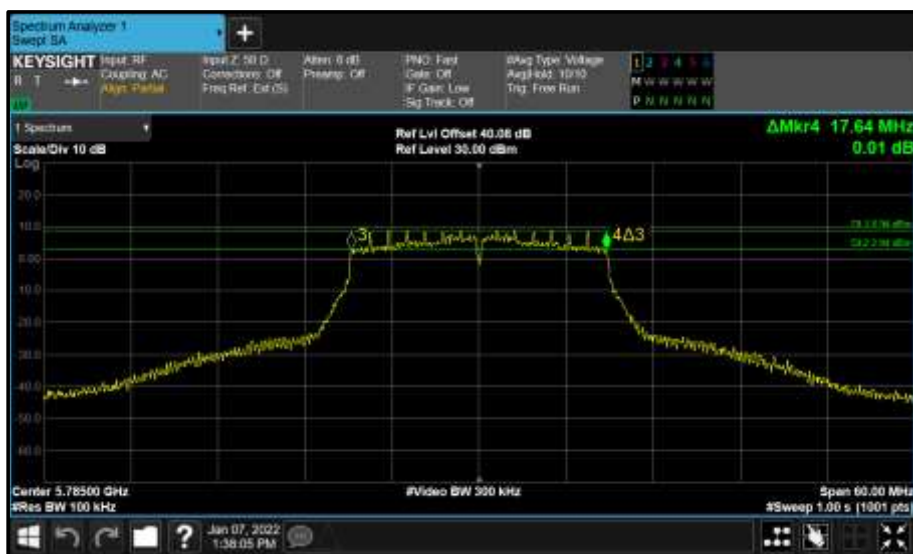


Figure 953 - Core 0 (A) 5785 MHz (CH157) 6 dB Bandwidth

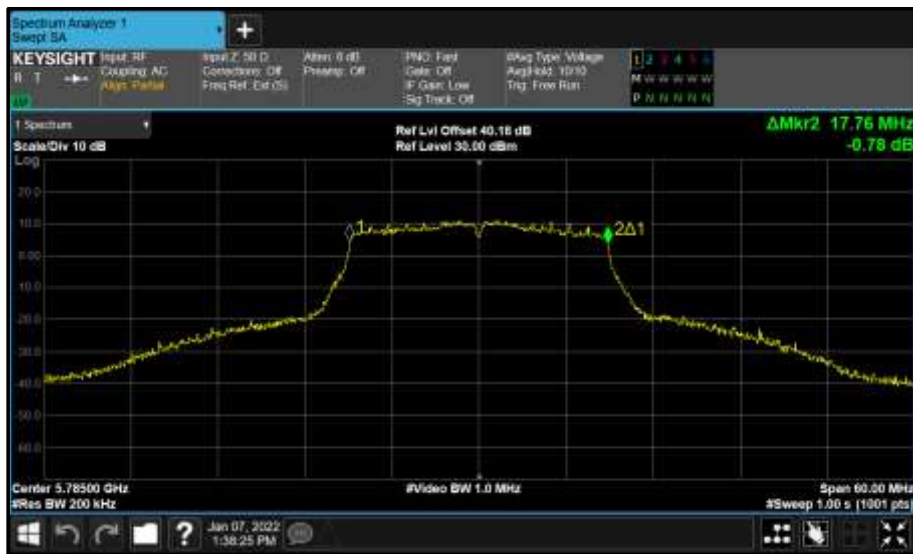


Figure 954 - Core 1 (B) 5785 MHz (CH157) 99% Bandwidth

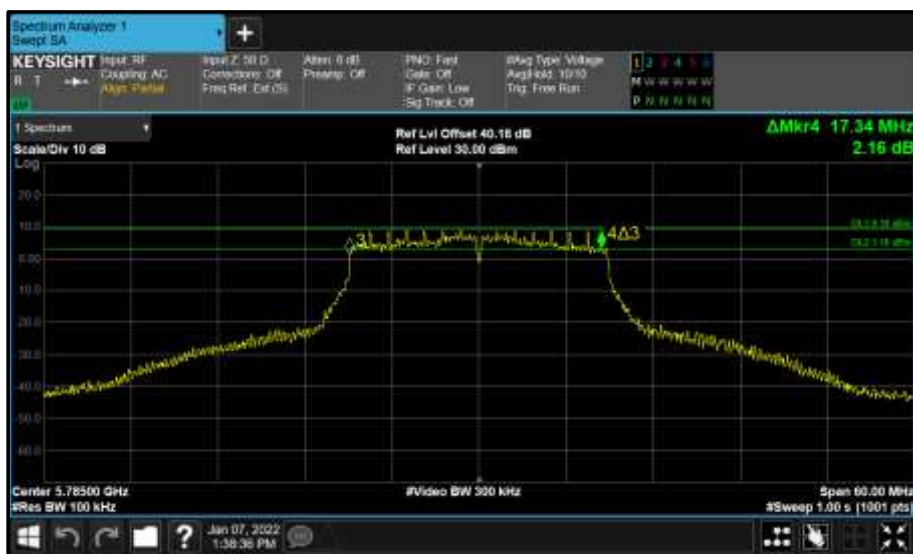


Figure 955 - Core 1 (B) 5785 MHz (CH157) 6 dB Bandwidth



Figure 956 - Core 0 (A) 5825 MHz (CH165) 99% Bandwidth



Figure 957 - Core 0 (A) 5825 MHz (CH165) 6 dB Bandwidth



Figure 958 - Core 1 (B) 5825 MHz (CH165) 99% Bandwidth



Figure 959 - Core 1 (B) 5825 MHz (CH165) 6 dB Bandwidth



Test Configuration			
Frequency Range:	5.725-5.850 GHz	Band:	U-NII-3
Limit Clause(s):	15.407(e) RSS-247 6.2.4.1	Test Method(s):	C63.10 6.9.3 789033 D02 v02r01 II.C.2.
Additional Reference(s):	-		

DUT Configuration			
Mode:	802.11n HT40	Duty Cycle (%):	-
Modulation Coding Scheme:	MCS2	DCCF (dB):	-
Antenna Configuration:	TxBF	Peak Antenna Gain (dBi):	-
Active Port(s):	A+B (Core 0 + Core 1)	Active Chain(s):	0+1

Test Frequency (MHz)	6 dB Bandwidth (MHz)					Limit (kHz)
	A	B	C	D	Minimum	
5710	3.360	2.900	-	-	2.900	≥500.0
5755	35.880	34.080	-	-	34.080	≥500.0
5795	35.280	35.520	-	-	35.280	≥500.0

**Table 666 - 6 dB Bandwidth Results**

Test Frequency (MHz)	99% Bandwidth (MHz)					Limit (kHz)
	A	B	C	D	Minimum	
5710	4.560	4.600	-	-	4.560	-
5755	36.360	36.360	-	-	36.360	-
5795	36.360	36.600	-	-	36.360	-

**Table 667 - 99% Bandwidth Results**



Figure 960 - Core 0 (A) 5710 MHz (CH142) 99% Bandwidth

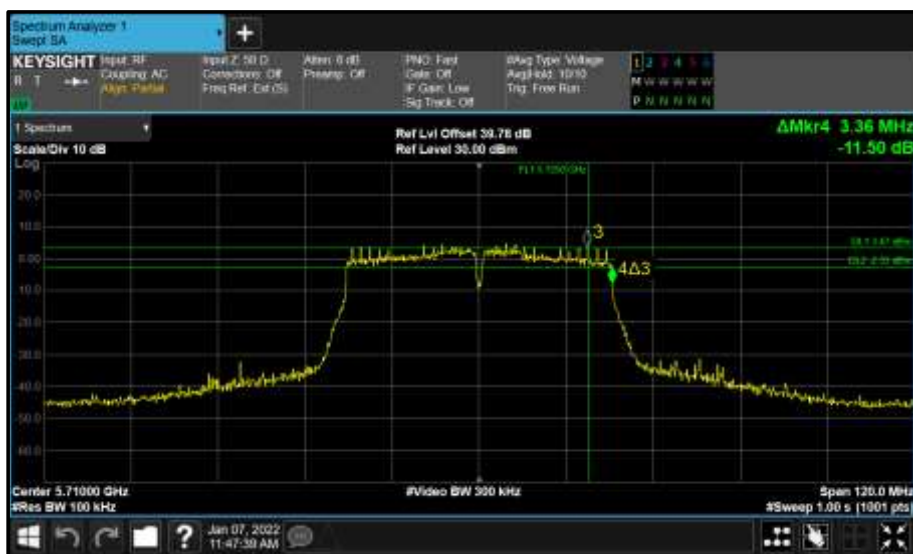


Figure 961 - Core 0 (A) 5710 MHz (CH142) 6 dB Bandwidth





Figure 962 - Core 1 (B) 5710 MHz (CH142) 99% Bandwidth

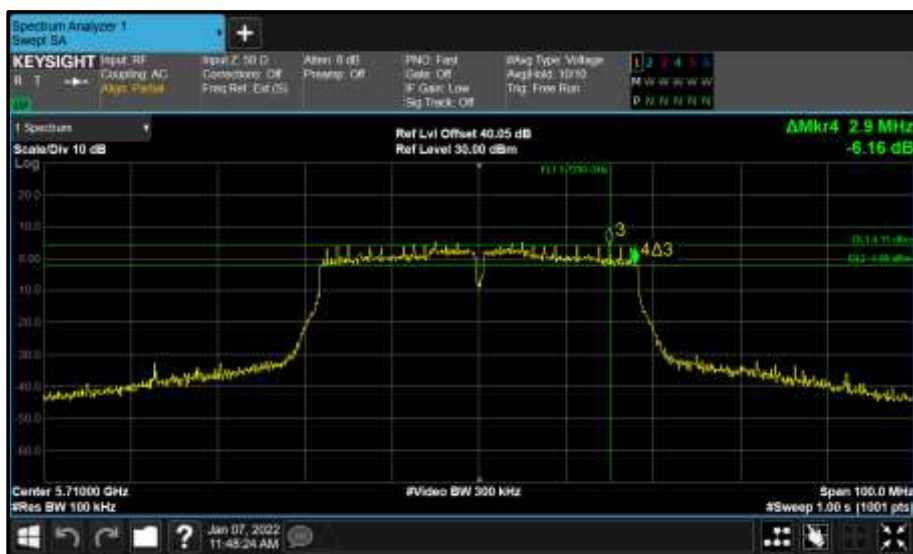


Figure 963 - Core 1 (B) 5710 MHz (CH142) 6 dB Bandwidth



Figure 964 - Core 0 (A) 5755 MHz (CH151) 99% Bandwidth



Figure 965 - Core 0 (A) 5755 MHz (CH151) 6 dB Bandwidth



Figure 966 - Core 1 (B) 5755 MHz (CH151) 99% Bandwidth



Figure 967 - Core 1 (B) 5755 MHz (CH151) 6 dB Bandwidth



Figure 968 - Core 0 (A) 5795 MHz (CH159) 99% Bandwidth

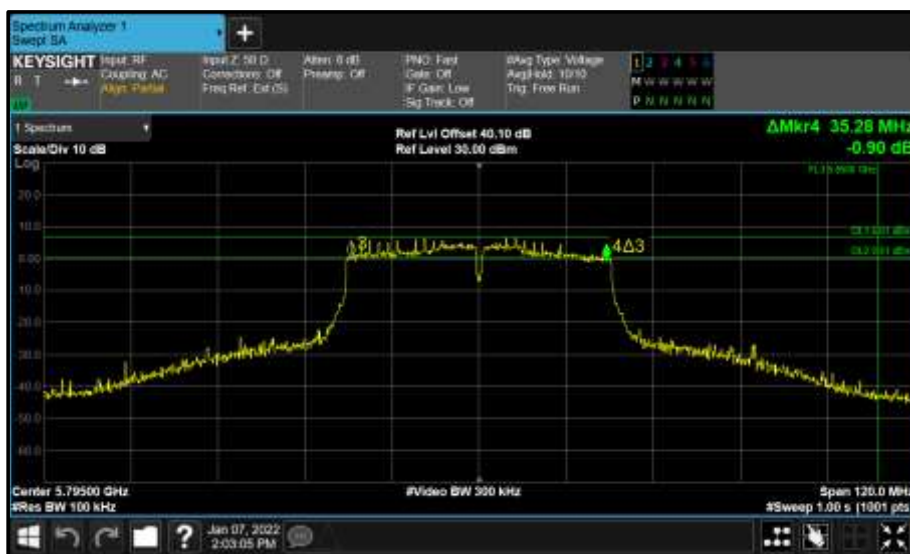


Figure 969 - Core 0 (A) 5795 MHz (CH159) 6 dB Bandwidth



Figure 970 - Core 1 (B) 5795 MHz (CH159) 99% Bandwidth



Figure 971 - Core 1 (B) 5795 MHz (CH159) 6 dB Bandwidth



Test Configuration			
Frequency Range:	5.725-5.850 GHz	Band:	U-NII-3
Limit Clause(s):	15.407(e) RSS-247 6.2.4.1	Test Method(s):	C63.10 6.9.3 789033 D02 v02r01 II.C.2.
Additional Reference(s):	-		

DUT Configuration			
Mode:	802.11ac VHT80	Duty Cycle (%):	-
Modulation Coding Scheme:	MCS2x1	DCCF (dB):	-
Antenna Configuration:	TxBF	Peak Antenna Gain (dBi):	-
Active Port(s):	A+B (Core 0 + Core 1)	Active Chain(s):	0+1

Test Frequency (MHz)	6 dB Bandwidth (MHz)					Limit (kHz)
	A	B	C	D	Minimum	
5690	3.280	3.500	-	-	3.280	≥500.0
5775	75.680	75.460	-	-	75.460	≥500.0

**Table 668 - 6 dB Bandwidth Results**

Test Frequency (MHz)	99% Bandwidth (MHz)					Limit (kHz)
	A	B	C	D	Minimum	
5690	6.580	14.940	-	-	6.580	-
5775	75.680	75.460	-	-	75.460	-

**Table 669 - 99% Bandwidth Results**



<ImageCaption> - Core 0 (A) 5690 MHz (CH138) 99% Bandwidth



<ImageCaption> - Core 0 (A) 5690 MHz (CH138) 6 dB Bandwidth







Figure 972 - Core 0 (A) 5775 MHz (CH155) 99% Bandwidth



Figure 973 - Core 0 (A) 5775 MHz (CH155) 6 dB Bandwidth



Figure 974 - Core 1 (B) 5775 MHz (CH155) 99% Bandwidth



Figure 975 - Core 1 (B) 5775 MHz (CH155) 6 dB Bandwidth



FCC Part 15E, Limit Clause 15.407

5150 MHz to 5250 MHz: None specified.  
5250 MHz to 5350 MHz: None specified.  
5470 MHz to 5725 MHz: None specified.  
5725 MHz to 5850 MHz: > 500 kHz.

ISED RSS-247, Limit Clause 6.2.1.1, 6.2.2.1, 6.2.3.1 and 6.2.4.1

5150 MHz to 5250 MHz: None specified.  
5250 MHz to 5350 MHz: None specified.  
5470 MHz to 5725 MHz: None specified.  
5725 MHz to 5850 MHz: The minimum 6 dB bandwidth shall be at least 500 kHz.  
  
5725 MHz to 5850 MHz: The minimum 6 dB bandwidth shall be at least 500 kHz.



## 2.4.7 Test Location and Test Equipment Used

This test was carried out in RF Laboratory 1.

Instrument	Manufacturer	Type No	TE No	Calibration Period (months)	Calibration Expires
Multimeter	Fluke	79 Series II	3057	12	23-Aug-2022
Hygrometer	Rotronic	I-1000	3220	12	05-Nov-2022
Network Analyser	Rohde & Schwarz	ZVA 40	3548	12	29-Jan-2022
Calibration Unit	Rohde & Schwarz	ZV-Z54	4368	12	30-Dec-2021
Frequency Standard	Spectracom	SecureSync 1200-0408-0601	4393	6	03-Jan-2022
Cable (40 GHz)	Rosenberger	LU1-001-1000	5022	12	13-Dec-2022
Cable (18 GHz)	Rosenberger	LU7-071-2000	5106	12	13-Dec-2022
AC Programmable Power Supply	iTech	IT7324	5225	-	O/P Mon
AC Programmable Power Supply	iTech	IT7324	5226	-	O/P Mon
Power Splitter, 2 way	Mini-Circuits	ZN2PD2-63-S+	5237	-	O/P Mon
Attenuator 5W 30dB DC-18GHz	Aaren	AT40A-4041-D18-30	5502	12	14-Apr-2022
Data Logger	Pico Technology Ltd	PicoLog 1012	5526	12	09-Dec-2022
MXA Signal Analyser	Keysight Technologies	N9020B	5528	24	04-Mar-2022
MXA Signal Analyser	Keysight Technologies	N9020B	5529	24	04-Mar-2022
Signal Commissioning Unit	TUV SUD	SCU001	5546	12	16-Apr-2022
2-Way Power Divider (2 to 8 GHz)	Aaren	AT30A-TE0208-2-AF	5684	12	20-Dec-2022
2-Way Power Divider (2-8 GHz)	Aaren	AT30A-TE0208-2-AF	5687	12	20-Dec-2022
Signal Commissioning Unit	TUV SUD	SCU002	5759	12	30-Jun-2022

**Table 670**

O/P Mon – Output Monitored using calibrated equipment



## 2.5 Authorised Band Edges

### 2.5.1 Specification Reference

FCC 47 CFR Part 15E, Clause 15.407 (b)  
ISED RSS-247, Clause 6.2

### 2.5.2 Equipment Under Test and Modification State

A2615, S/N: P1F4F29DL4 - Modification State 0

### 2.5.3 Date of Test

18-October-2021 to 24-October-2021

### 2.5.4 Test Method

The test was performed in accordance with ANSI C63.10, clause 6.6.

For U-NII-2C channels, the limit line on the following plots equated to -27 dBm/MHz. EIRP and was converted to field strength at 3 m using the following formula:

Field Strength (dB $\mu$ V/m at 3 m) = EIRP (dBm) + 95.2 dB

Authorised band edge measurements were performed, with the device operating in SISO and MIMO configurations, across the various modes supported by the device.

The measurements displayed within this report, have been limited to those modes which have been shown to be worst case.

Further measurements are held on file by TÜV SÜD and are available if required.

### 2.5.5 Environmental Conditions

Ambient Temperature	19.3 - 22.1 °C
Relative Humidity	46.1 - 62.1 %



**2.5.6 Test Results**

5 GHz WLAN

Mode	Data Rate /MCS	Resource size	Resource Index	TX Frequency (MHz)	Band Edge Frequency (MHz)	Level (dBµV/m)
802.11a, Core 1	24 Mbps	-	-	5500	5470	63.16
802.11n, HT20 Core 1	MCS 7	-	-	5500	5470	63.10
802.11ax HE20, Core 1	MCS 4	SU	-	5500	5470	62.74
802.11ax HE20, Core 1	MCS 11	52	37	5500	5470	57.70
802.11a, Core 1	54 Mbps	-	-	5700	5725	63.12
802.11n, HT20 Core 1	MCS 4	-	-	5700	5725	63.01
802.11ax HE20, Core 1	MCS 11	SU	-	5700	5725	62.97
802.11ax HE20, Core 1	MCS 11	52	40	5700	5725	59.36
802.11a, Core 1	12 Mbps	-	-	5745	5725	57.80
802.11n HT20, Core 1	MCS 2	-	-	5745	5725	58.34
802.11ax HE20, Core 1	MCS 11	SU	-	5745	5725	57.47
802.11ax HE20, Core 1	MCS 11	26	0	5745	5725	56.90
802.11a, Core 1	54Mbps	-	-	5825	5850	58.19
802.11n HT20, Core 1	MCS 2	-	-	5825	5850	58.17
802.11ax HE20, Core 1	MCS 2	SU	-	5825	5850	58.06
802.11ax HE20, Core 1	MCS 11	26	8	5825	5850	57.89

**Table 671 - 20 MHz Bandwidth SISO Authorised Band Edge results**

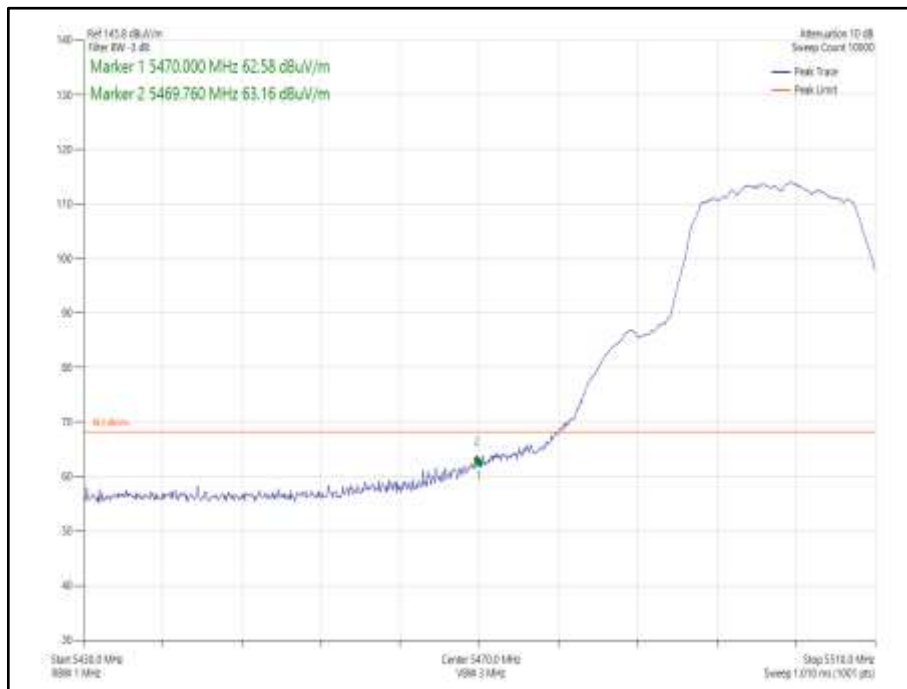


Figure 976 - 802.11a, Core 1 - 5500 MHz  
Band Edge Frequency 5470 MHz

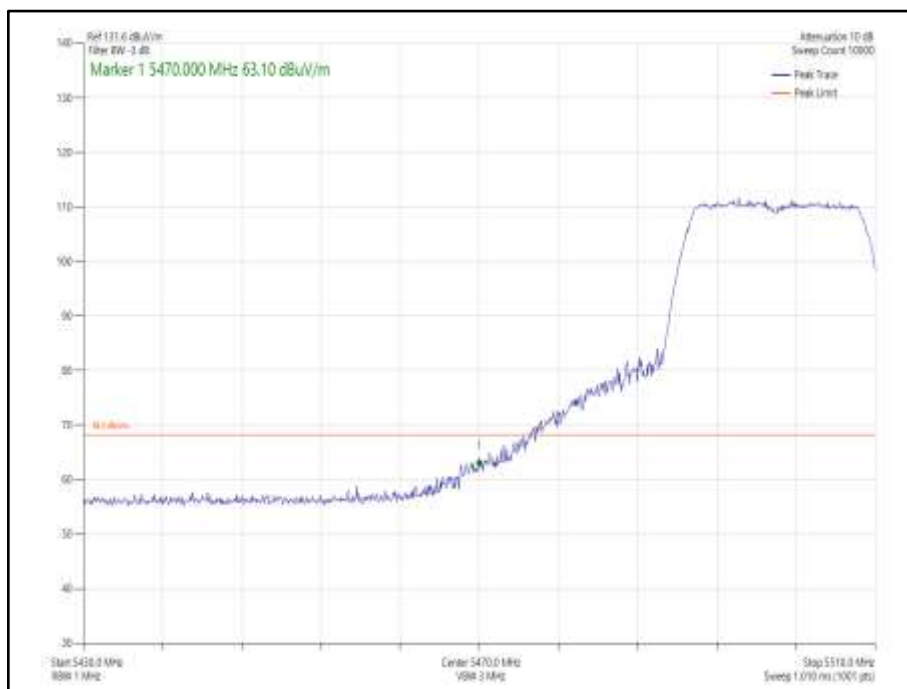


Figure 977 - 802.11n HT20, Core 1 - 5500 MHz  
Band Edge Frequency 5470 MHz

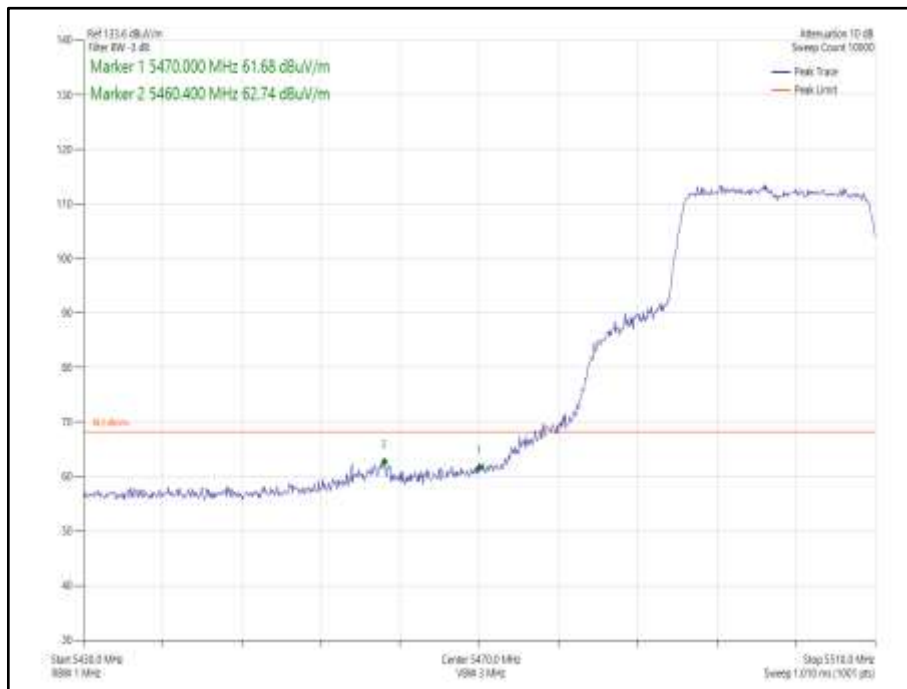


Figure 978- 802.11ax HE20, Core 1, SU - 5500 MHz  
Band Edge Frequency 5470 MHz

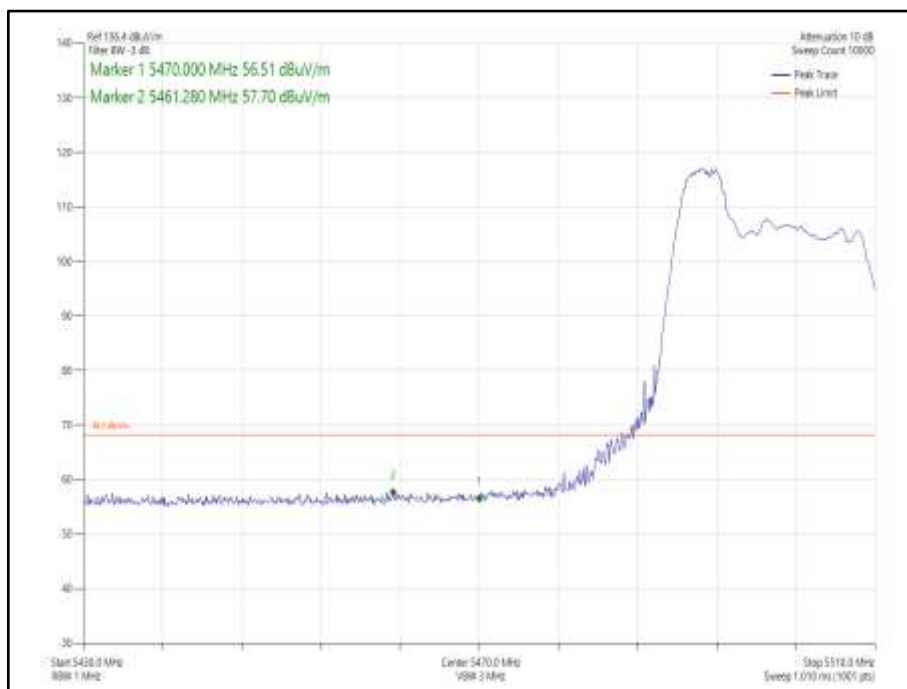


Figure 979- 802.11ax HE20, Core 1, 52-37 - 5500 MHz  
Band Edge Frequency 5470 MHz



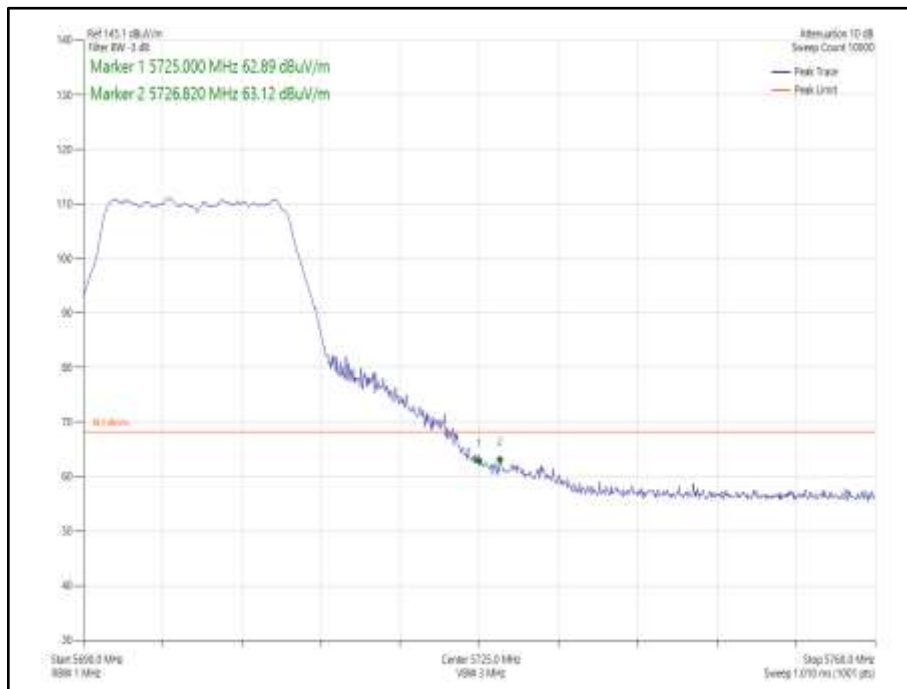


Figure 980 - 802.11a, Core 1 - 5700 MHz  
Band Edge Frequency 5725 MHz

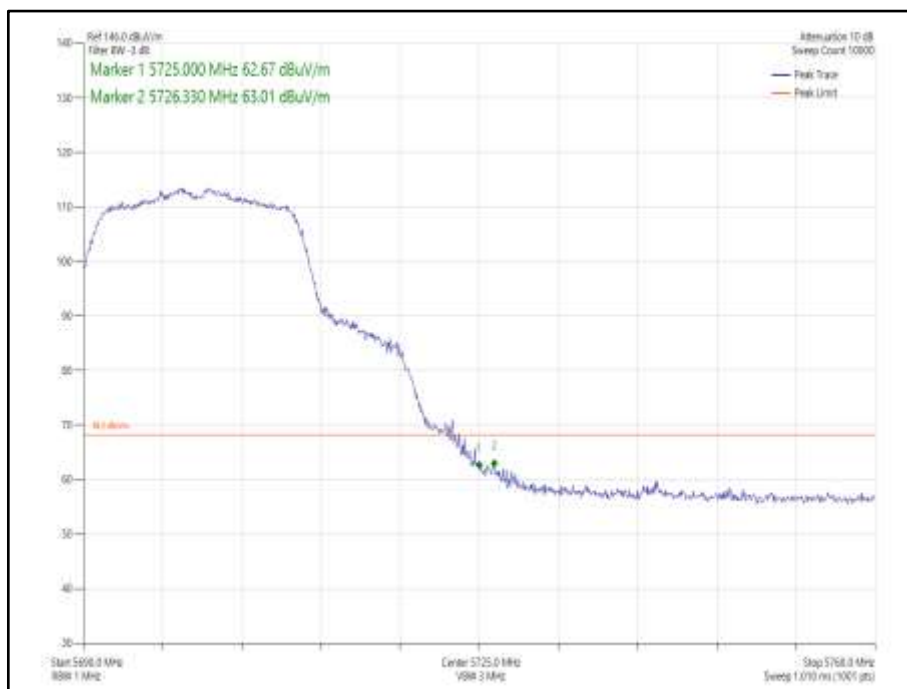


Figure 981 - 802.11n HT20, Core 1 - 5700 MHz  
Band Edge Frequency 5725 MHz

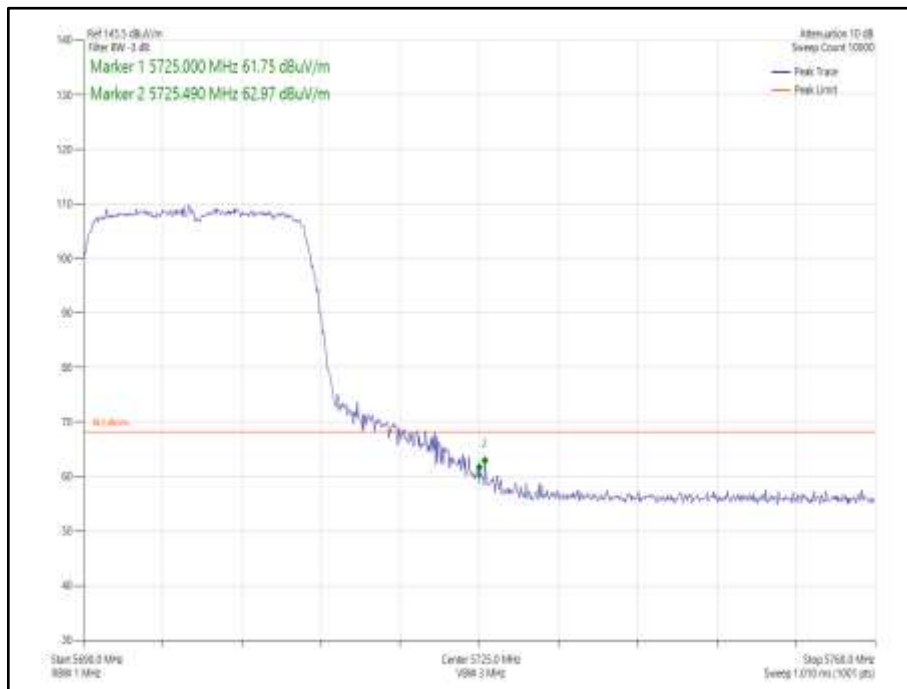


Figure 982- 802.11ax HE20, Core 1, SU - 5700 MHz  
Band Edge Frequency 5725 MHz

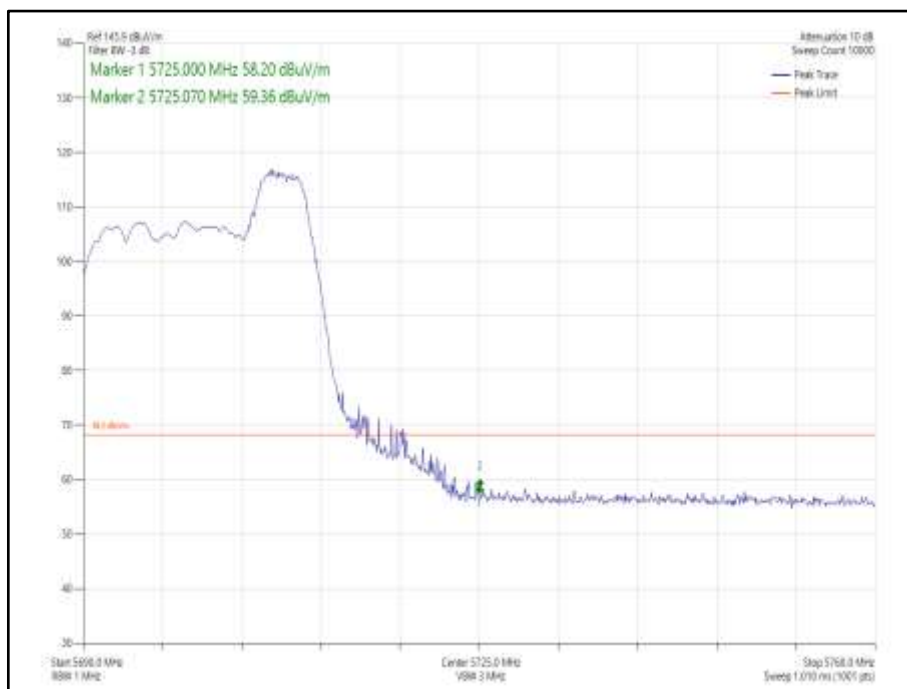
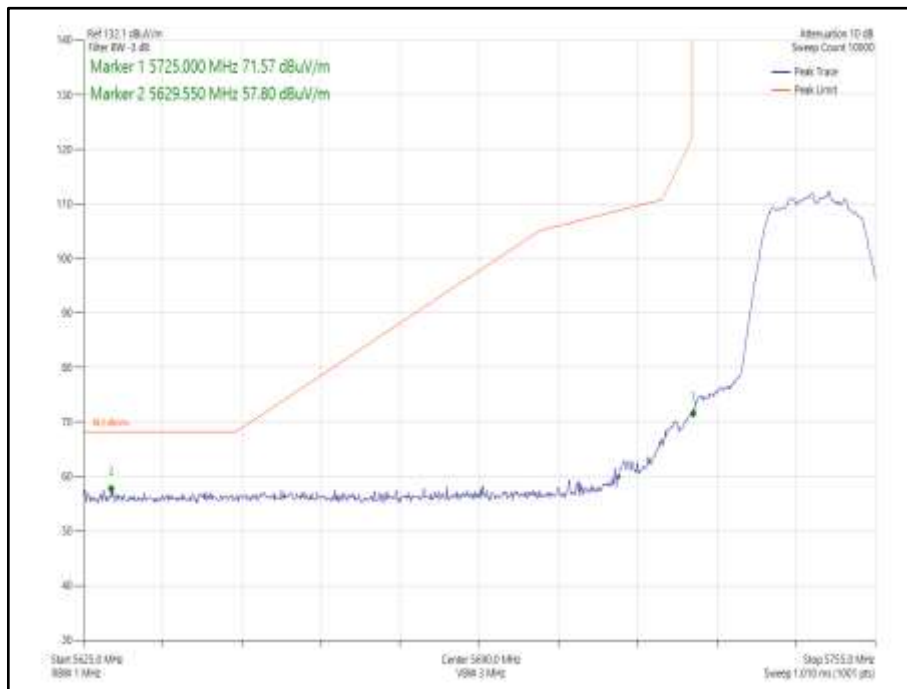
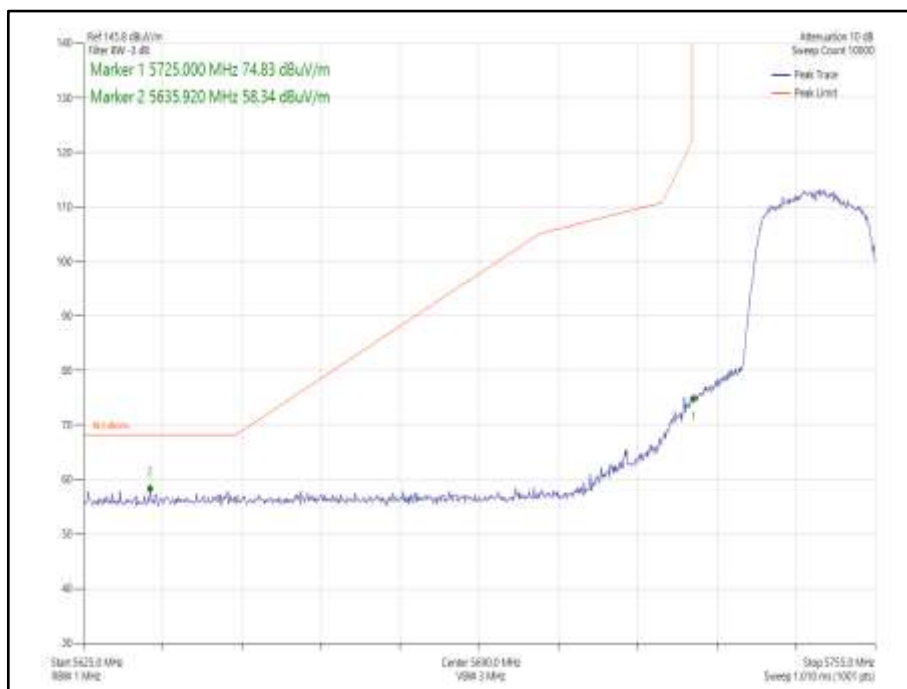


Figure 983- 802.11ax HE20, Core 1, 52-40 - 5700 MHz  
Band Edge Frequency 5725 MHz



**Figure 984 - 802.11a, Core 1 - 5745 MHz  
Band Edge Frequency 5725 MHz**



**Figure 985 - 802.11n HT20, Core 1 - 5745 MHz  
Band Edge Frequency 5725 MHz**

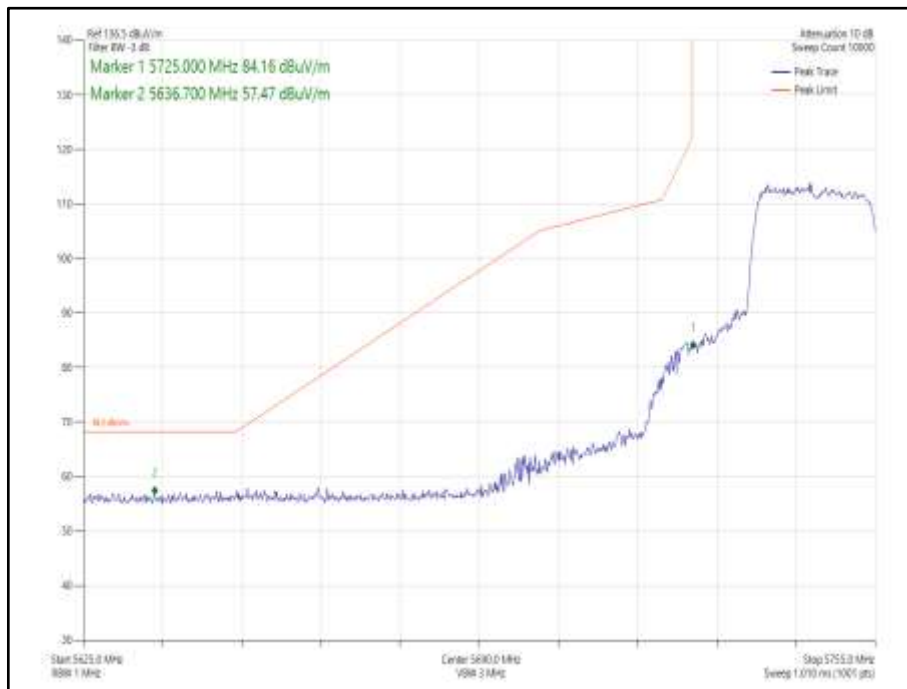


Figure 986- 802.11ax HE20, Core 1, SU - 5745 MHz  
Band Edge Frequency 5735 MHz

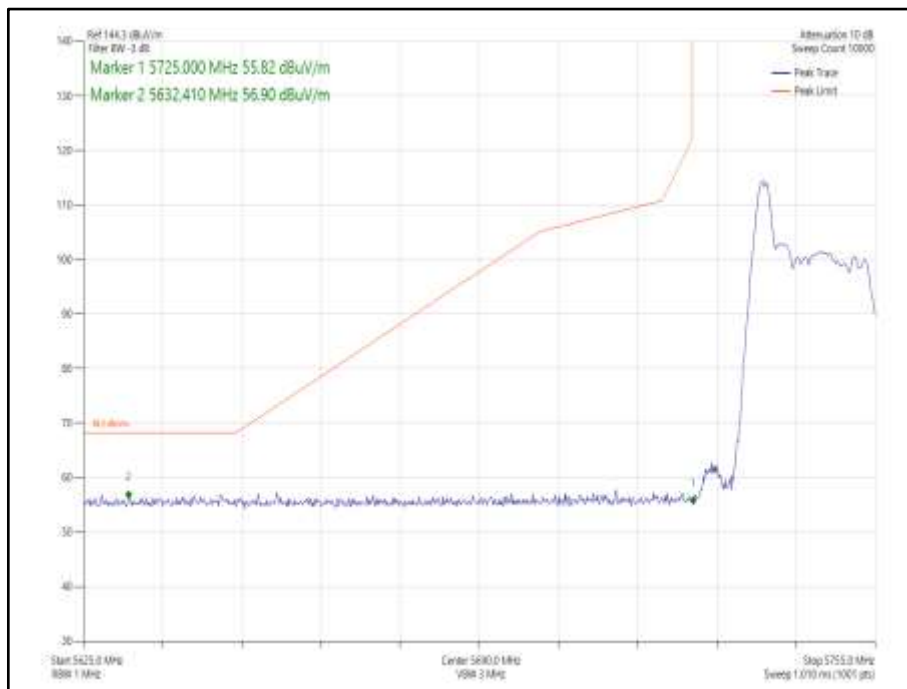


Figure 987- 802.11ax HE20, Core 1, 26-0 - 5745 MHz  
Band Edge Frequency 5735 MHz

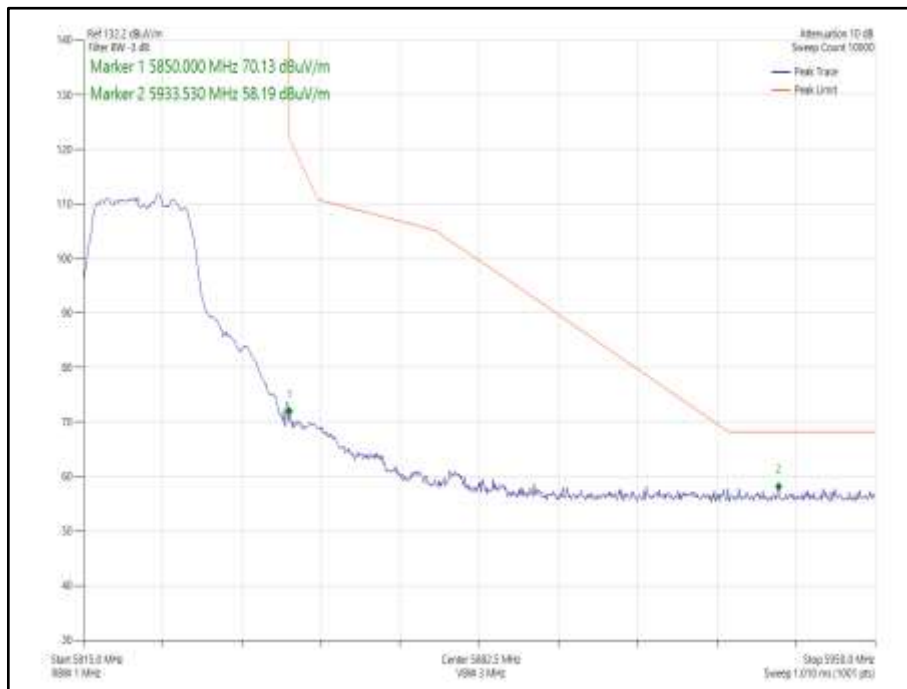


Figure 988 - 802.11a, Core 1, - 5825 MHz  
Band Edge Frequency 5850 MHz

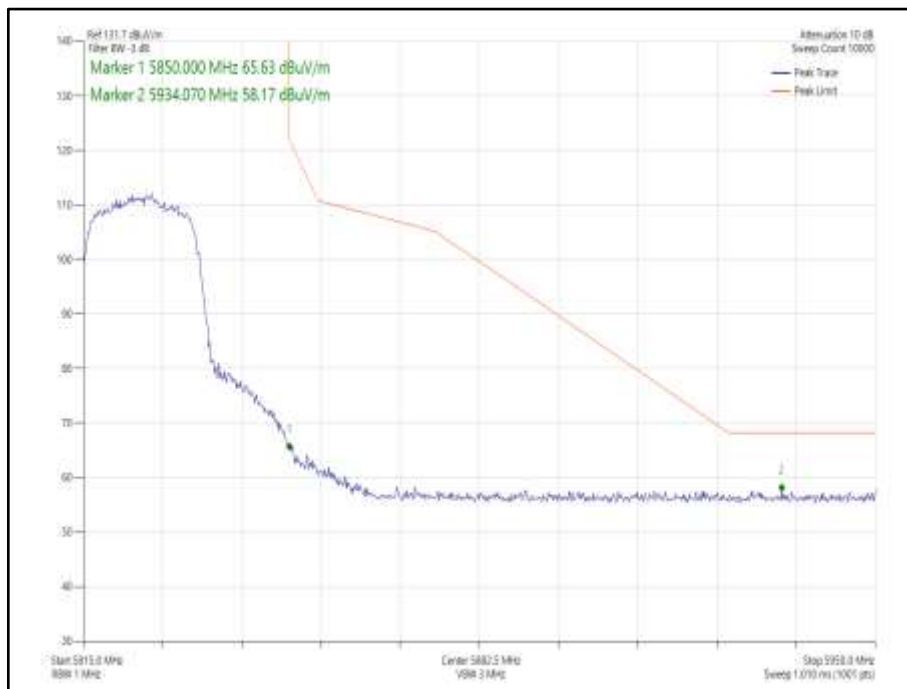
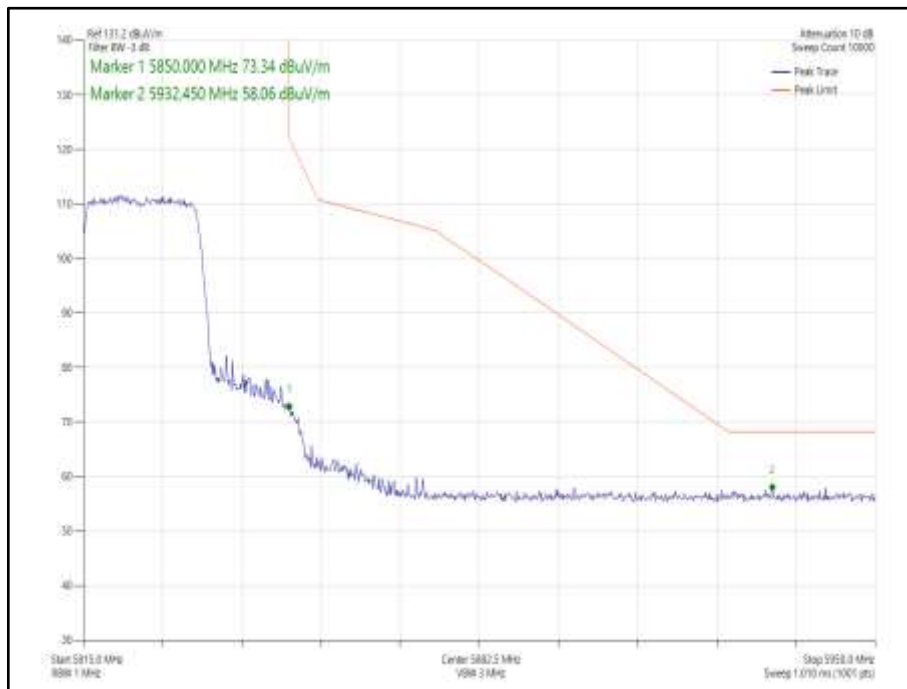
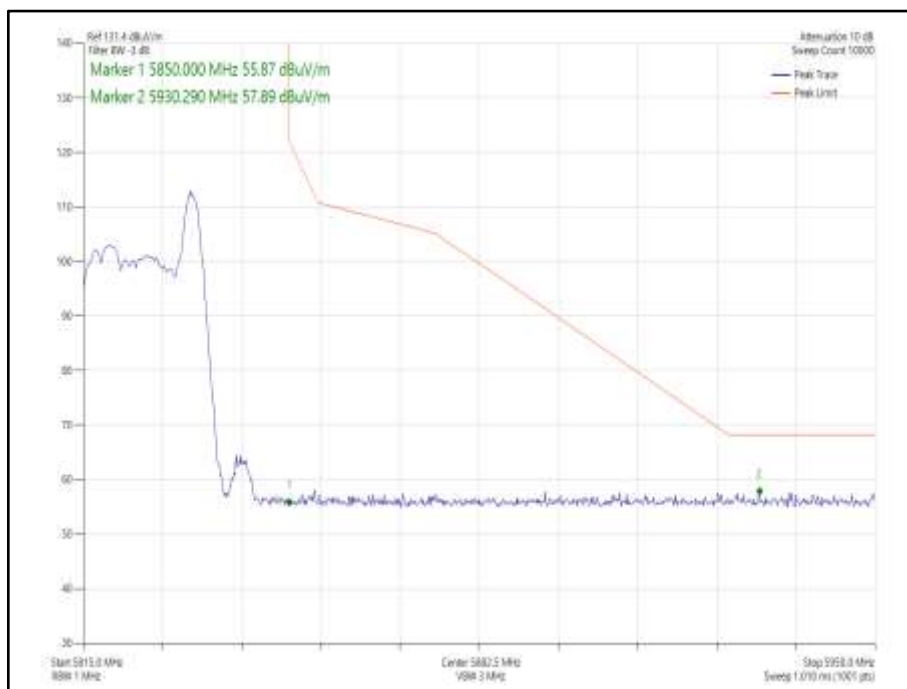


Figure 989 - 802.11n HT20, Core 1 - 5825 MHz  
Band Edge Frequency 5850 MHz



**Figure 990- 802.11ax HE20, Core 1, SU - 5825 MHz  
Band Edge Frequency 5850 MHz**

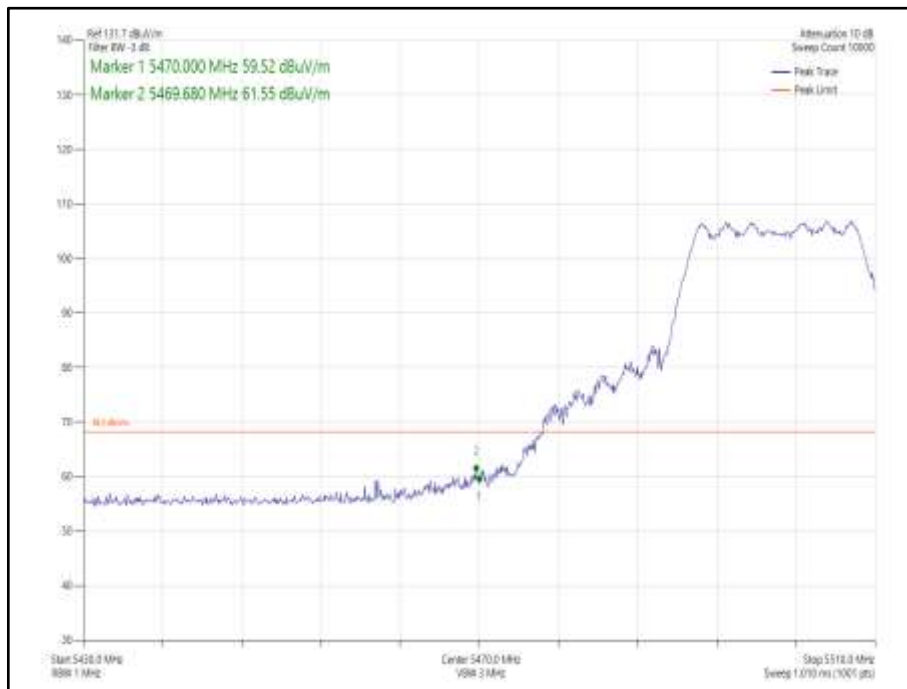


**Figure 991- 802.11ax HE20, Core 1, 26-8 - 5825 MHz  
Band Edge Frequency 5850 MHz**

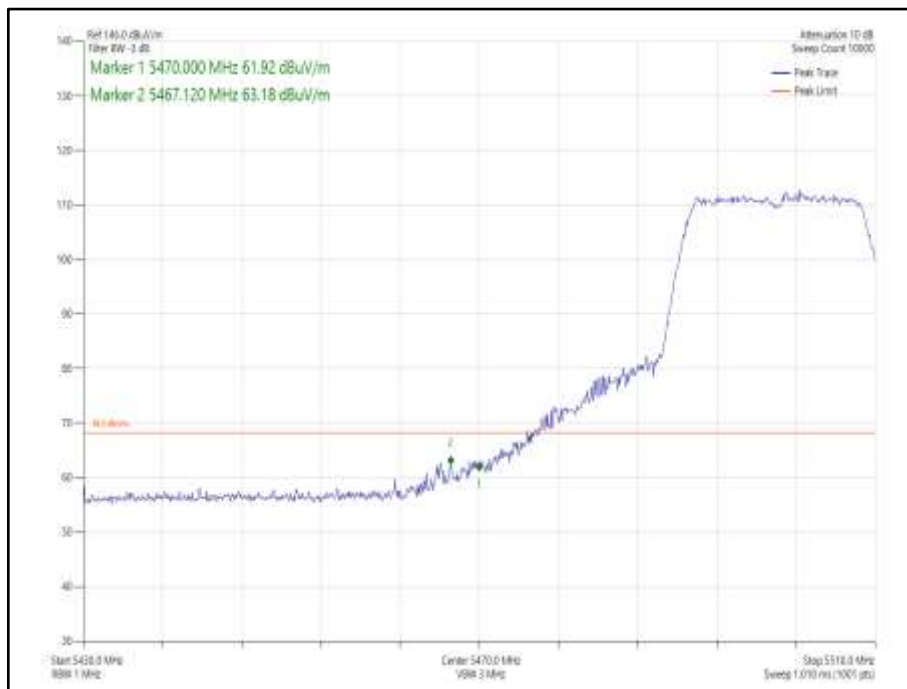


Mode	Data Rate/ MCS	Resource size	Resource Index	TX Frequency (MHz)	Band Edge Frequency (MHz)	Level (dBuV/m)
802.11n HT20 CDD, Cores 0-1	MCS 7	-	-	5500	5470	61.55
802.11n HT20 SDM, Cores 0-1	MCS 12	-	-	5500	5470	63.18
802.11ax HE20 CDD, Cores 0-1	MCS 4	SU	-	5500	5470	61.14
802.11ax HE20 CDD, Cores 0-1	MCS 11	52	37	5500	5470	57.45
802.11ax HE20 SDM, Cores 0-1	MCS 11	SU	-	5500	5470	62.47
802.11ax HE20 SDM, Cores 0-1	MCS 11	52	37	5500	5470	58.38
802.11n HT20 CDD, Cores 0-1	MCS 7	-	-	5700	5725	62.77
802.11n HT20 SDM, Cores 0-1	MCS 10	-	-	5700	5725	62.65
802.11ax HE20 CDD, Cores 0-1	MCS 2	SU	-	5700	5725	62.94
802.11ax HE20 CDD, Cores 0-1	MCS 11	52	40	5700	5725	59.61
802.11ax HE20 SDM, Cores 0-1	MCS 2	SU	-	5700	5725	62.69
802.11ax HE20 SDM, Cores 0-1	MCS 11	52	40	5700	5725	59.72
802.11n HT20 CDD, Cores 0-1	MCS 7	-	-	5745	5725	58.37
802.11n HT20 SDM, Cores 0-1	MCS 15	-	-	5745	5725	58.54
802.11ax HE20 CDD, Cores 0-1	MCS 4	SU	-	5745	5725	58.10
802.11ax HE20 CDD, Cores 0-1	MCS 11	26	0	5745	5725	56.82
802.11ax HE20 SDM, Cores 0-1	MCS 2	SU	-	5745	5725	58.54
802.11ax HE20 SDM, Cores 0-1	MCS 11	26	0	5745	5725	58.85
802.11n HT20 CDD, Cores 0-1	MCS 4	-	-	5825	5850	58.39
802.11n HT20 SDM, Cores 0-1	MCS 12	-	-	5825	5850	57.99
802.11ax HE20 CDD, Cores 0-1	MCS 4	SU	-	5825	5850	58.31
802.11ax HE20 CDD, Cores 0-1	MCS 11	26	8	5825	5850	57.81
802.11ax HE20 SDM, Cores 0-1	MCS 2	SU	-	5825	5850	58.71
802.11ax HE20 SDM, Cores 0-1	MCS 11	26	8	5825	5850	58.14

**Table 672 – 20 MHz Bandwidth 2TX MIMO Authorised Band Edge Results**



**Figure 992 - 802.11n HT20 CDD, Cores 0-1 - 5500 MHz  
Band Edge Frequency 5470 MHz**



**Figure 993 - 802.11n HT20 SDM, Cores 0-1 - 5500 MHz  
Band Edge Frequency 5470 MHz**



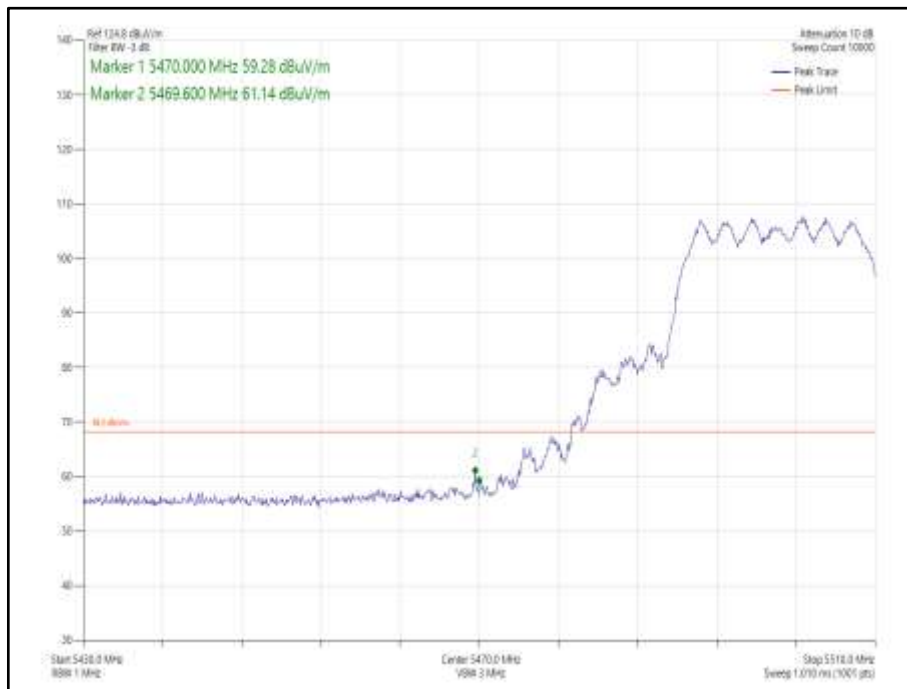


Figure 994 - - 802.11ax HE20 CDD, Cores 0-1, SU - 5500 MHz  
Band Edge Frequency 5470 MHz

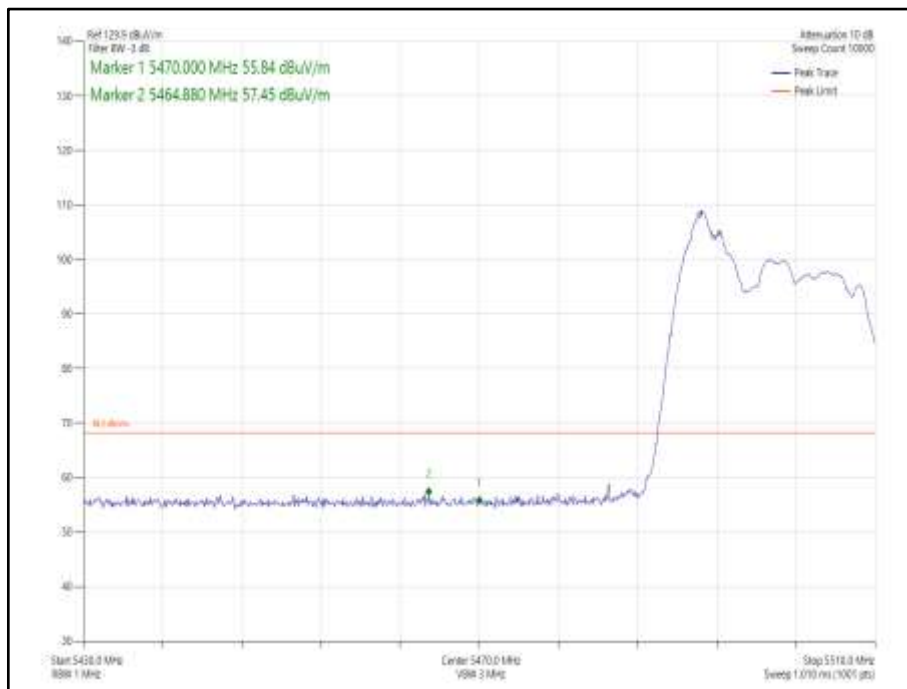


Figure 995 - 802.11ax HE20 CDD, Cores 0-1 52-37 - 5500 MHz  
Band Edge Frequency 5470 MHz

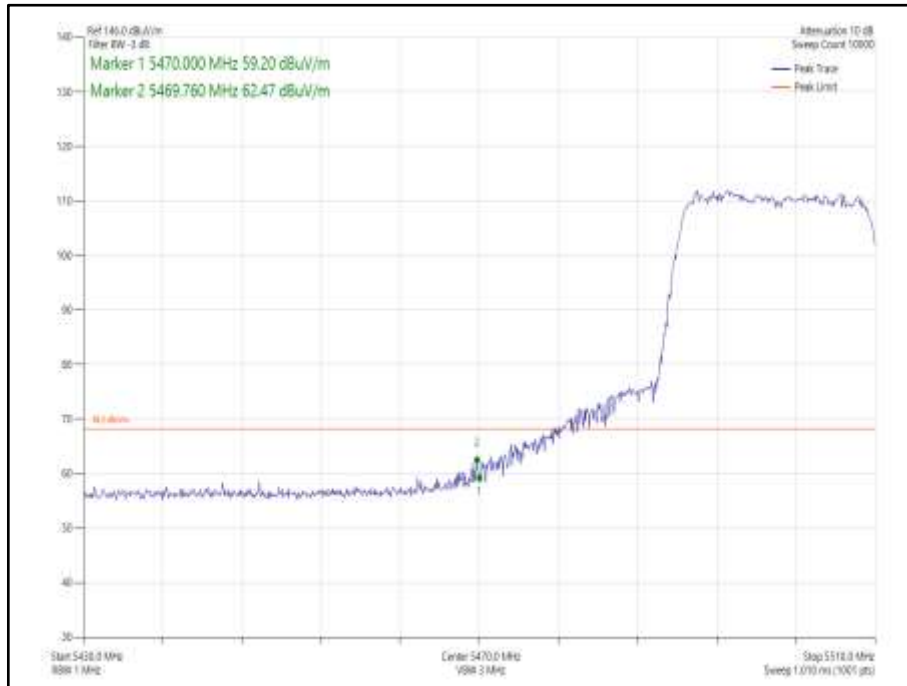


Figure 996 - - 802.11ax HE20 SDM, Cores 0-1 SU - 5500 MHz  
Band Edge Frequency 5470 MHz

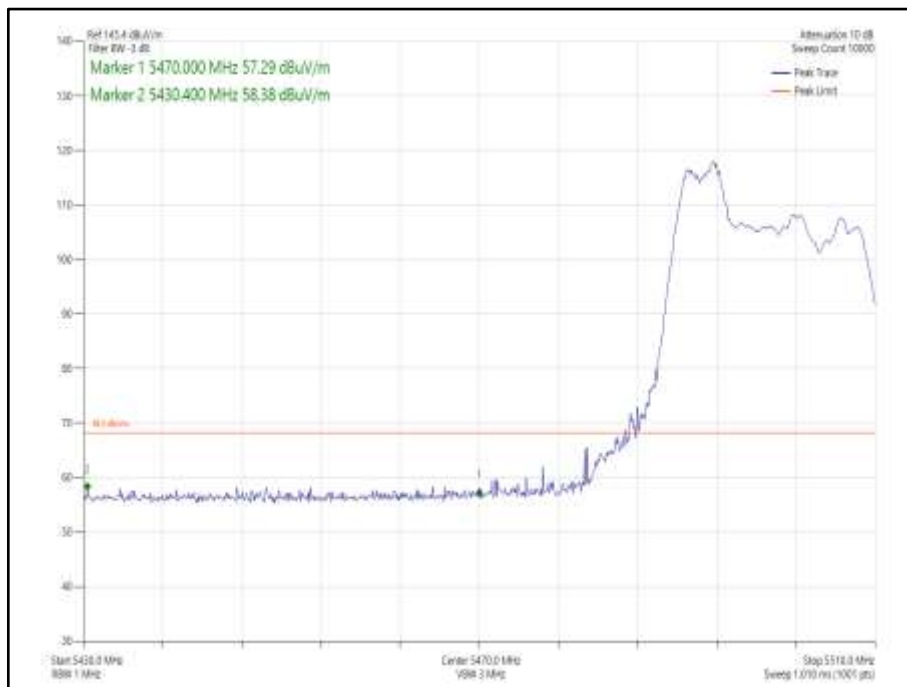
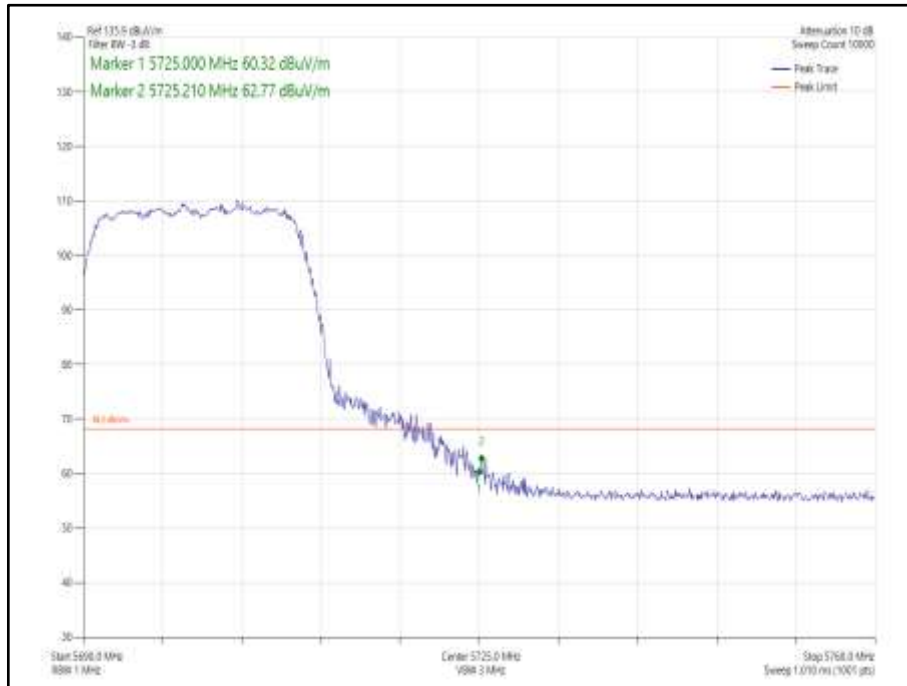
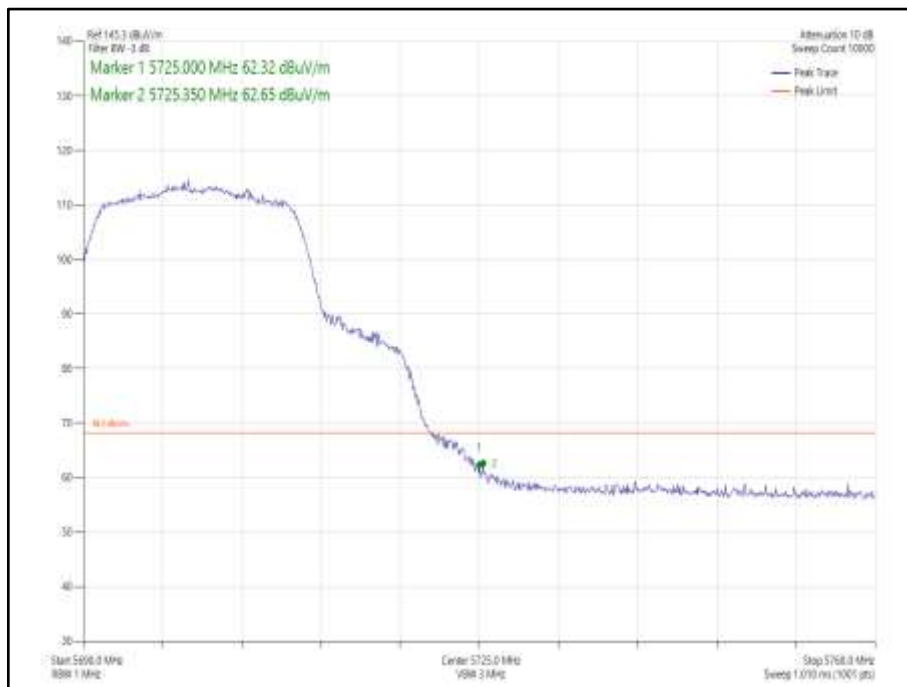


Figure 997 - 802.11ax HE20 SDM, Cores 0-1 52-37 - 5500 MHz  
Band Edge Frequency 5470 MHz



**Figure 998 - 802.11n HT20 CDD, Cores 0-1 - 5700 MHz  
Band Edge Frequency 5725 MHz**



**Figure 999 - 802.11n HT20 SDM, Cores 0-1 - 5700 MHz  
Band Edge Frequency 5725 MHz**

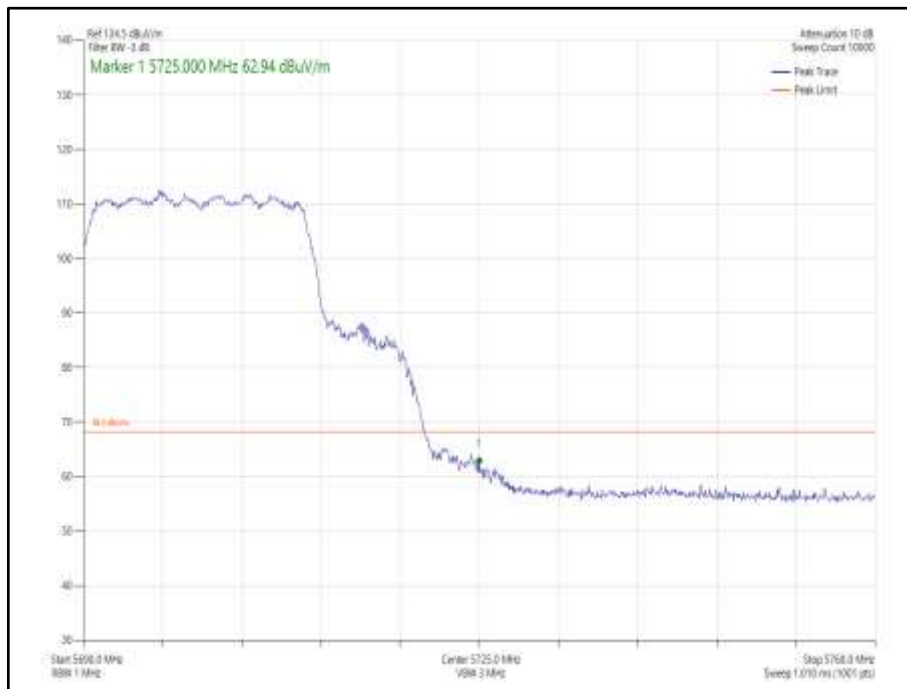


Figure 1000 - - 802.11ax HE20 CDD, Cores 0-1, SU - 5700 MHz  
Band Edge Frequency 5725 MHz

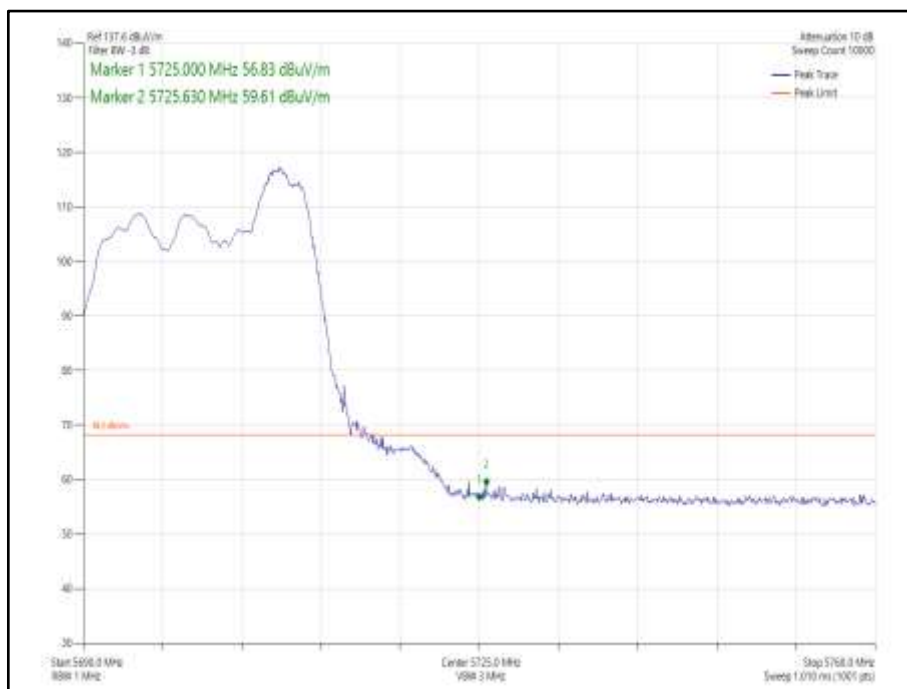


Figure 1001 - 802.11ax HE20 CDD, Cores 0-1, 52-40 - 5700 MHz  
Band Edge Frequency 5725 MHz

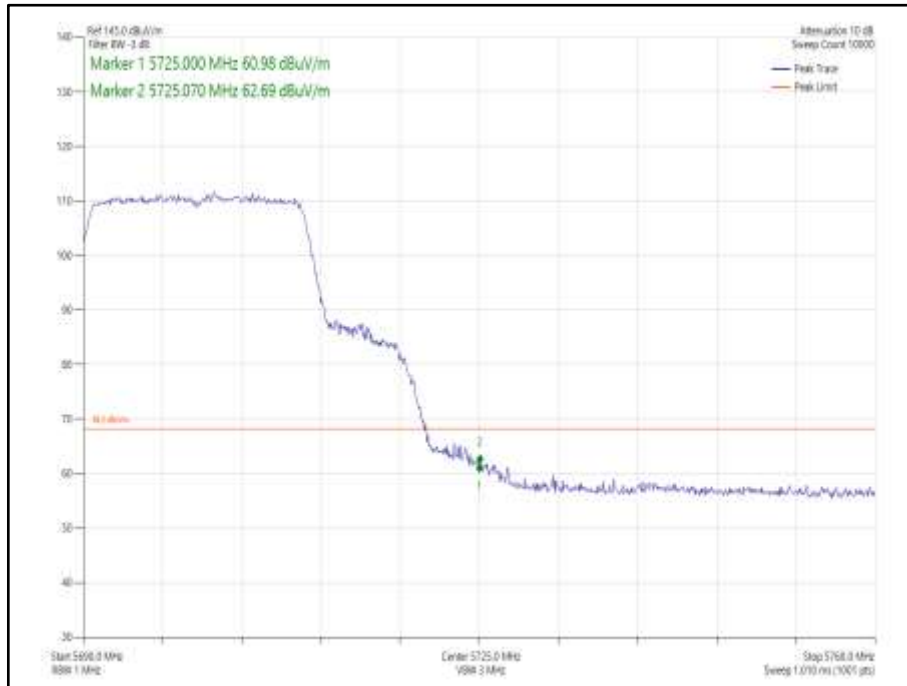


Figure 1002 - - 802.11ax HE20 SDM, Cores 0-1, SU - 5700 MHz  
Band Edge Frequency 5725 MHz

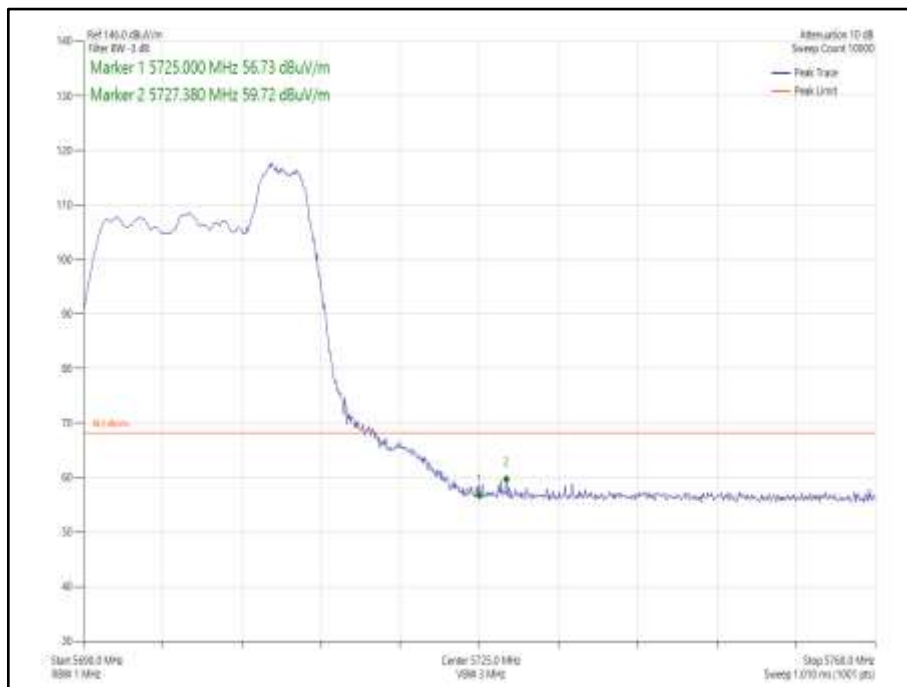
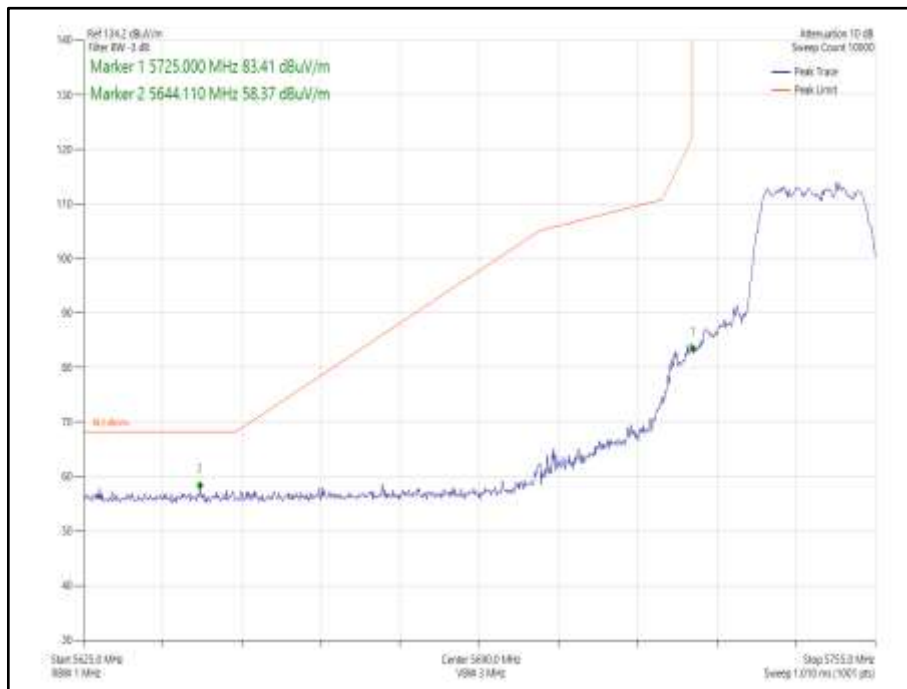
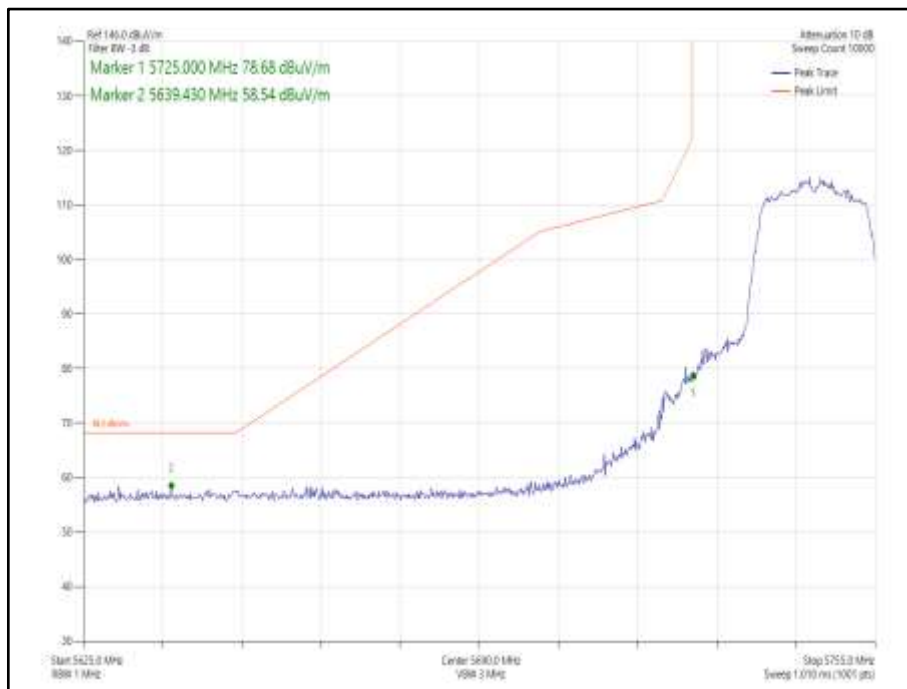


Figure 1003 - 802.11ax HE20 SDM, Cores 0-1, 52-40 - 5700 MHz  
Band Edge Frequency 5725 MHz



**Figure 1004 - 802.11n HT20 CDD, Cores 0-1 - 5745 MHz  
Band Edge Frequency 5725 MHz**



**Figure 1005 - 802.11n HT20 SDM, Cores 0-1 - 5745 MHz  
Band Edge Frequency 5725 MHz**

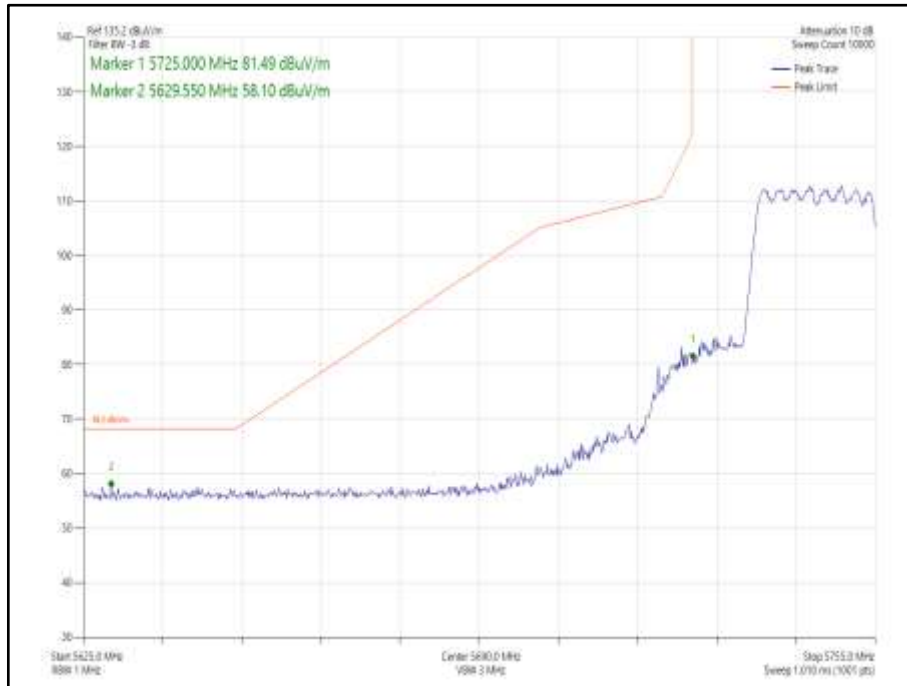


Figure 1006 - - 802.11ax HE20 CDD, Cores 0-1, SU - 5745 MHz  
Band Edge Frequency 5725 MHz

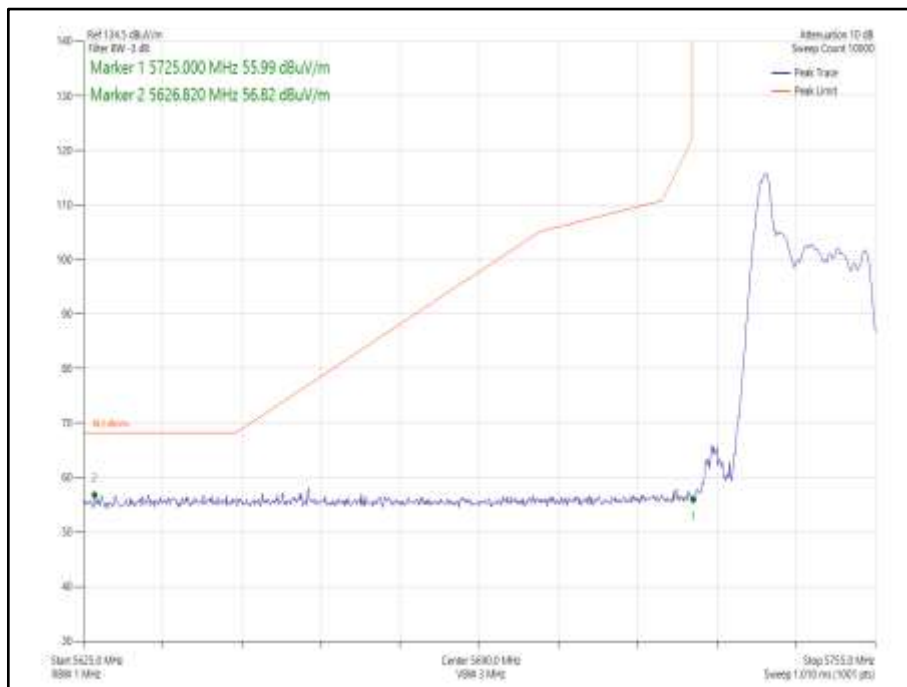


Figure 1007 - 802.11ax HE20 CDD, Cores 0-1, 26-0 - 5745 MHz  
Band Edge Frequency 5725 MHz

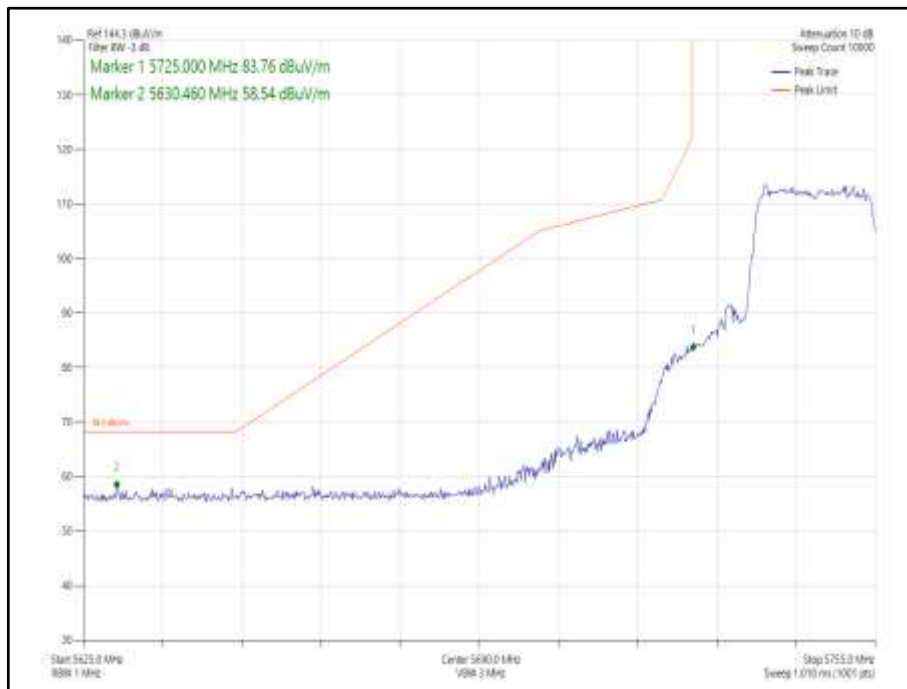


Figure 1008 - 802.11ax HE20 SDM, Cores 0-1, SU - 5745 MHz  
Band Edge Frequency 5725 MHz

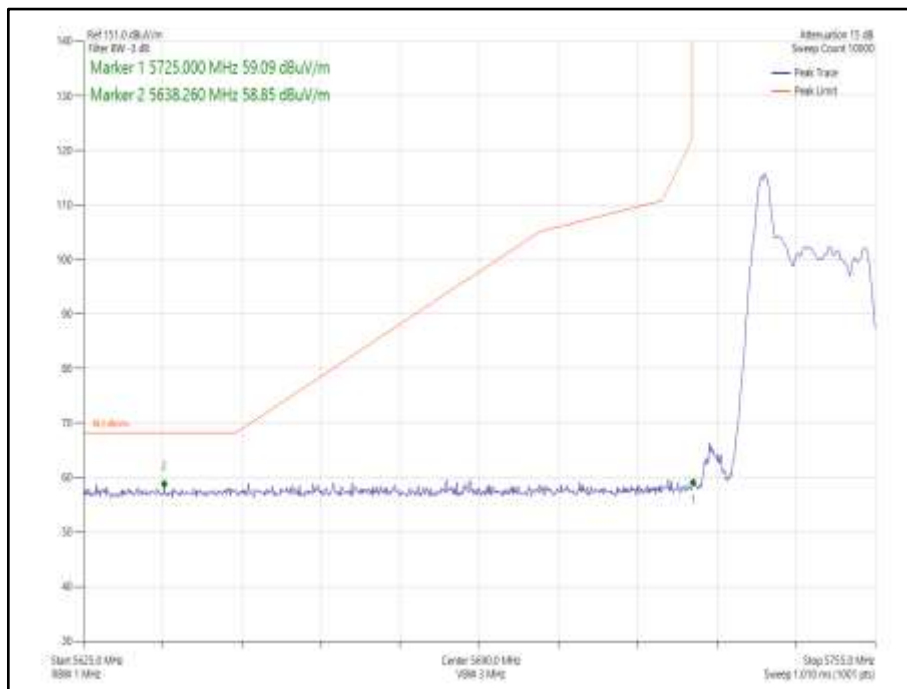


Figure 1009 - 802.11ax HE20 SDM, Cores 0-1, 26-0 - 5745 MHz  
Band Edge Frequency 5725 MHz



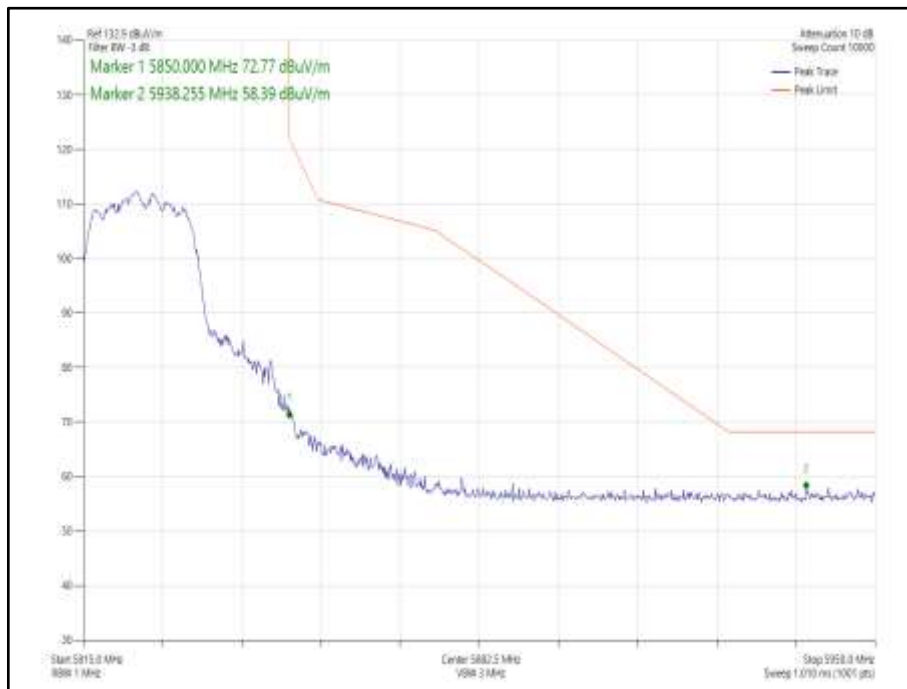


Figure 1010 - 802.11n HT20 CDD, Cores 0-1 - 5825 MHz  
Band Edge Frequency 5850 MHz

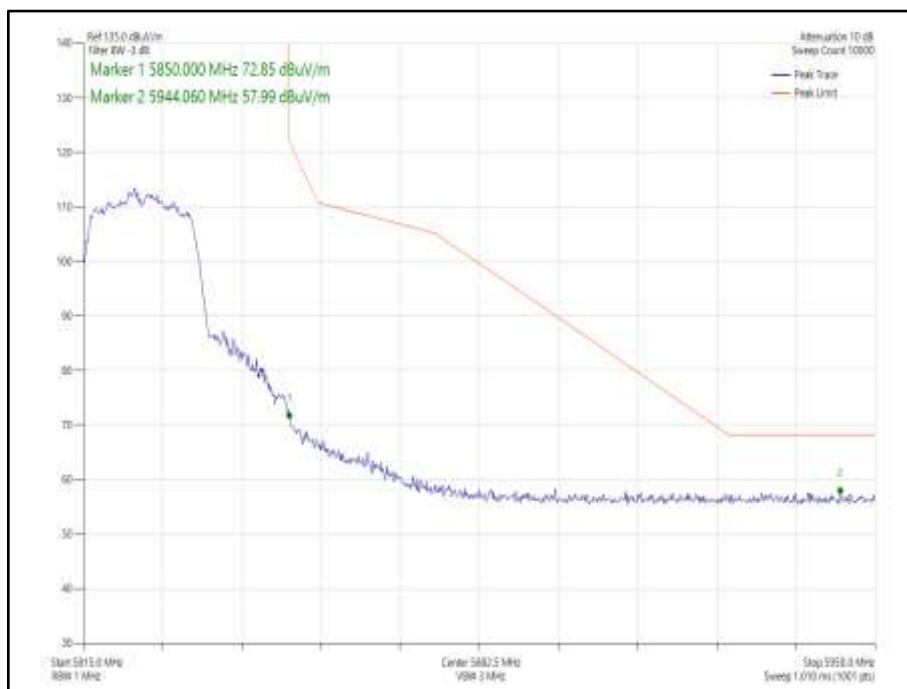


Figure 1011 - 802.11n HT20 SDM, Cores 0-1 - 5825 MHz  
Band Edge Frequency 5850 MHz

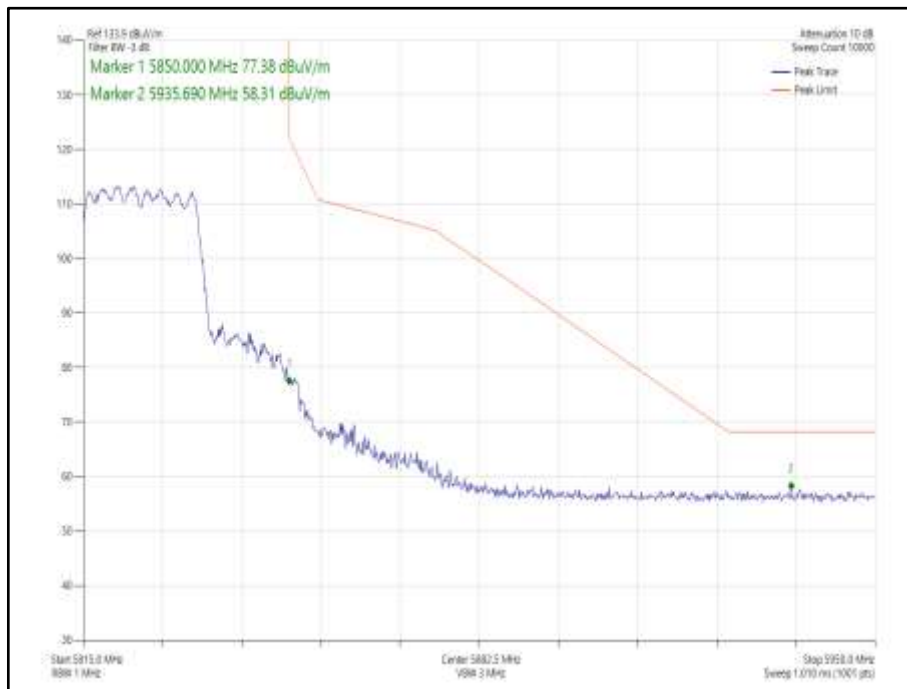


Figure 1012 - 802.11ax HE20 CDD, Cores 0-1, SU - 5825 MHz  
Band Edge Frequency 5850 MHz

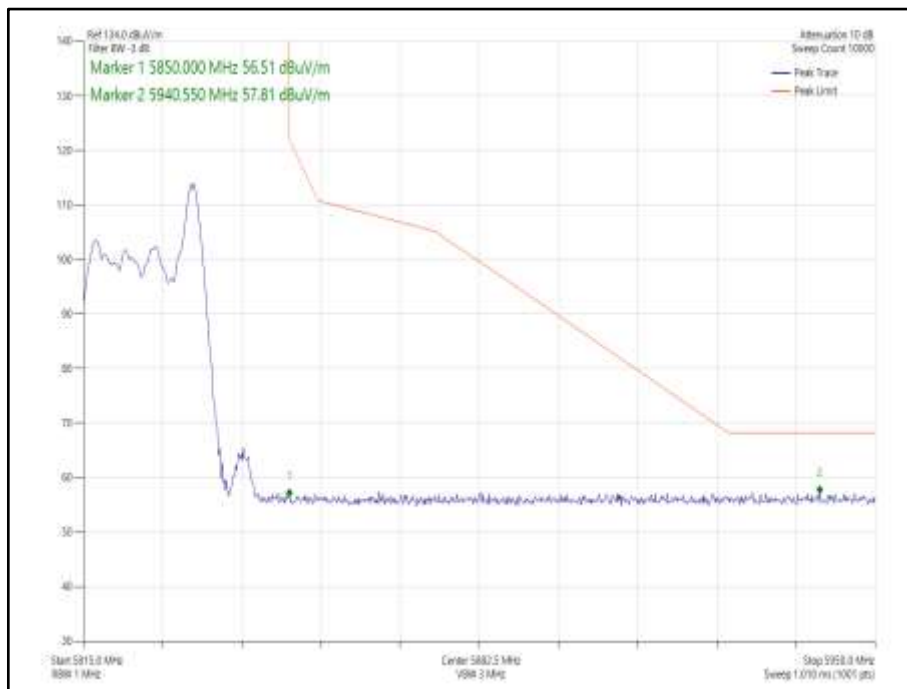
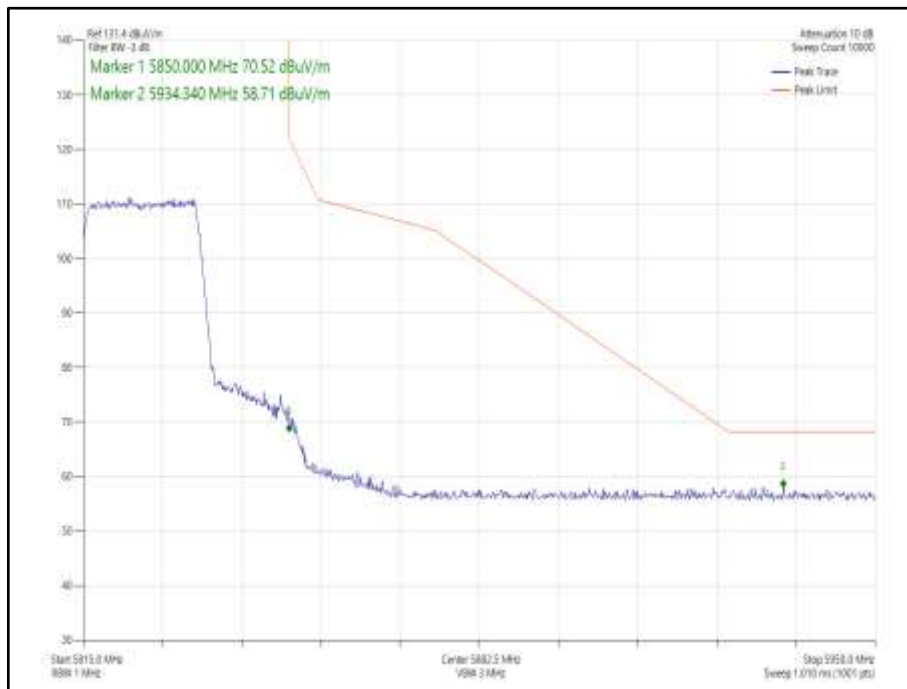
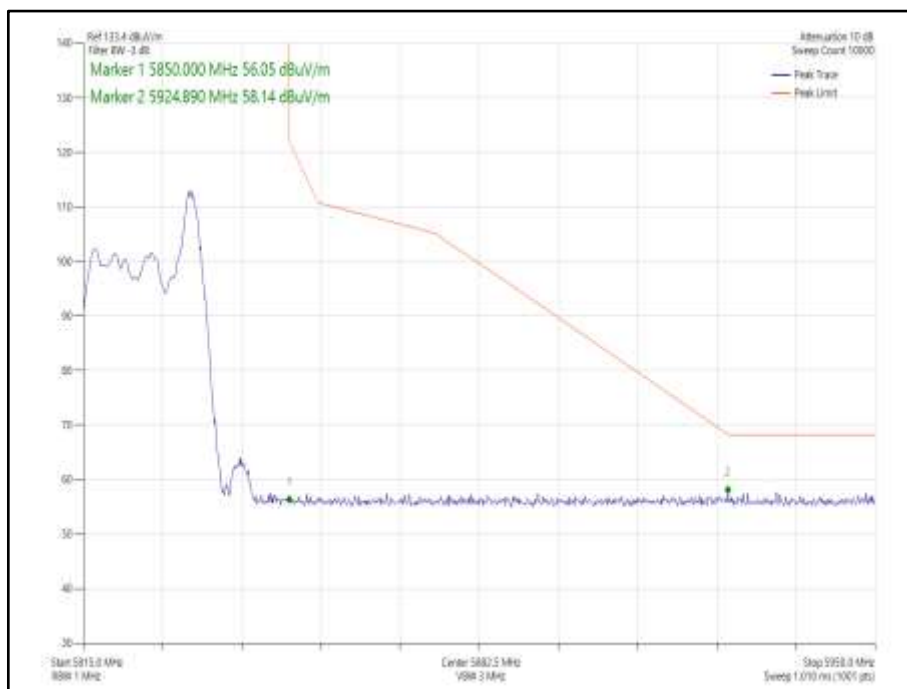


Figure 1013 - 802.11ax HE20 CDD, Cores 0-1, 26-8 - 5825 MHz  
Band Edge Frequency 5850 MHz



**Figure 1014 - 802.11ax HE20 SDM, Cores 0-1, SU - 5825 MHz  
Band Edge Frequency 5850 MHz**

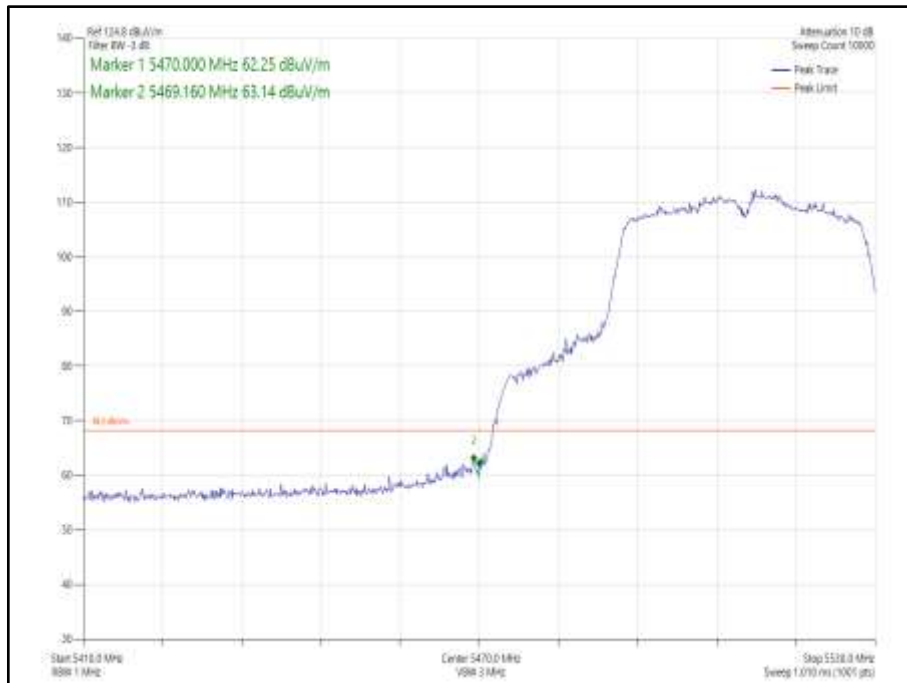


**Figure 1015 - 802.11ax HE20 SDM, Cores 0-1, 26-8 - 5825 MHz  
Band Edge Frequency 5850 MHz**

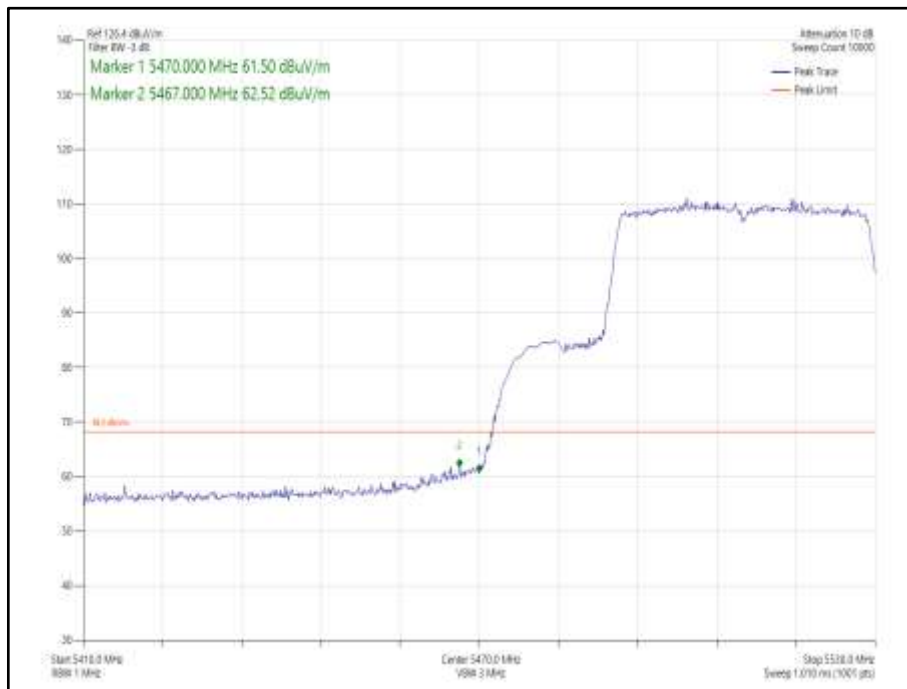


Mode	Data Rate /MCS	Resource size	Resource Index	TX Frequency (MHz)	Band Edge Frequency (MHz)	Level (dBμV/m)
802.11n HT40, Core 1	MCS 4	-	-	5510	5470	63.14
802.11ax HE40, Core 1	MCS 4	SU	-	5510	5470	62.52
802.11ax HE40, Core 1	MCS 11	52	37	5510	5470	59.67
802.11n HT40, Core 1	MCS 4	-	-	5670	5725	62.84
802.11ax HE40, Core 1	MCS 11	SU	-	5670	5725	62.35
802.11ax HE40, Core 1	MCS 11	52	44	5670	5725	57.79
802.11n HT40, Core 1	MCS 4	-	-	5755	5725	58.27
802.11ax HE40, Core 1	MCS 11	SU	-	5755	5725	58.11
802.11ax HE40, Core 1	MCS 11	26	0	5755	5725	57.15
802.11n HT40, Core 1	MCS 2	-	-	5795	5850	58.34
802.11ax HE40, Core 1	MCS 4	SU	-	5795	5850	59.04
802.11ax HE40, Core 1	MCS 11	26	17	5795	5850	57.43

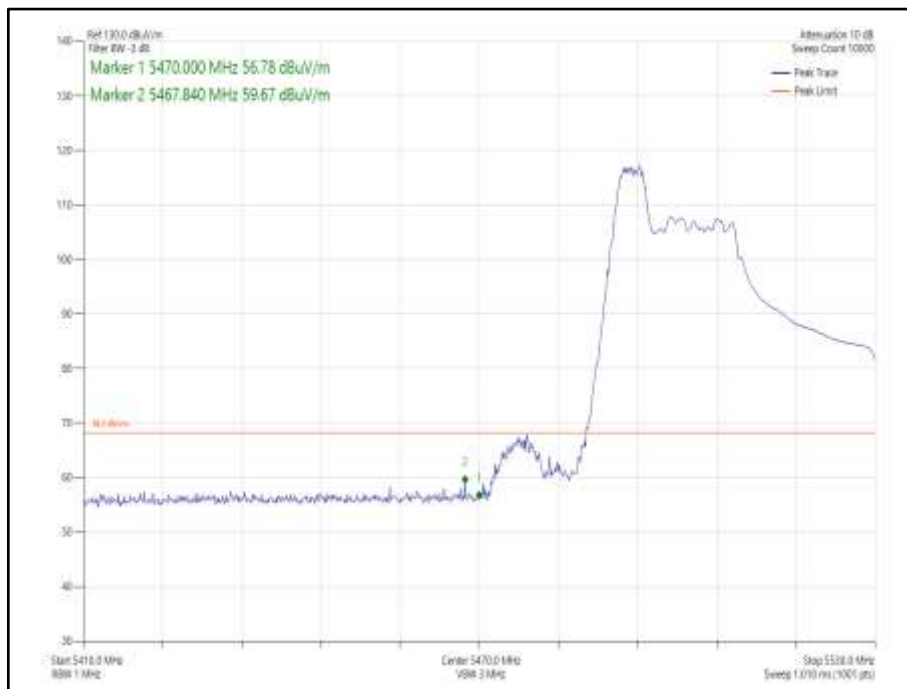
**Table 673 - 40 MHz Bandwidth SISO Authorized Band Edge Results**



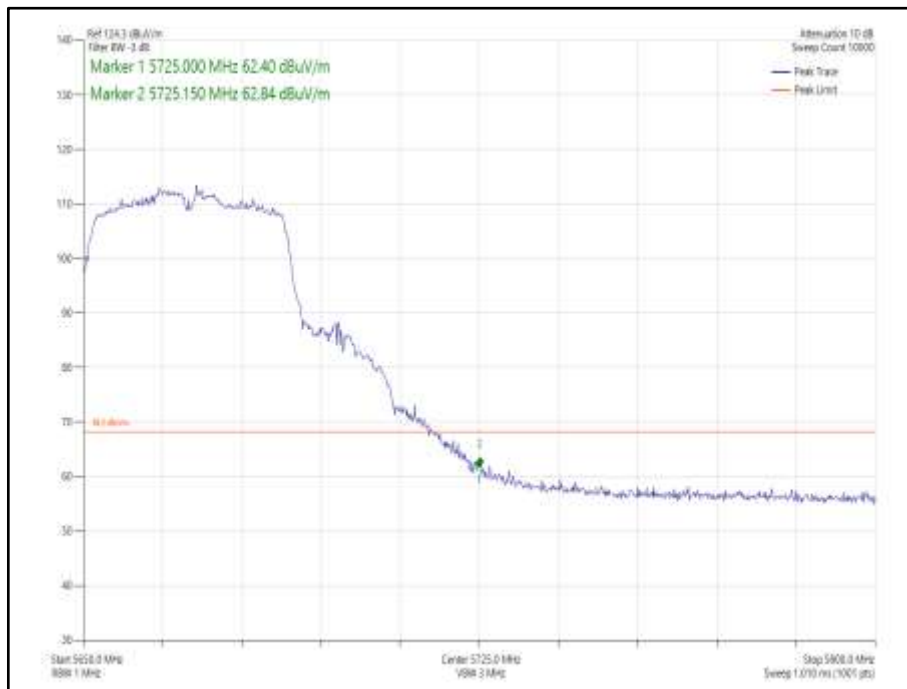
**Figure 1016 - 802.11n HT40, Core 1 - 5510 MHz  
 Band Edge Frequency 5470 MHz**



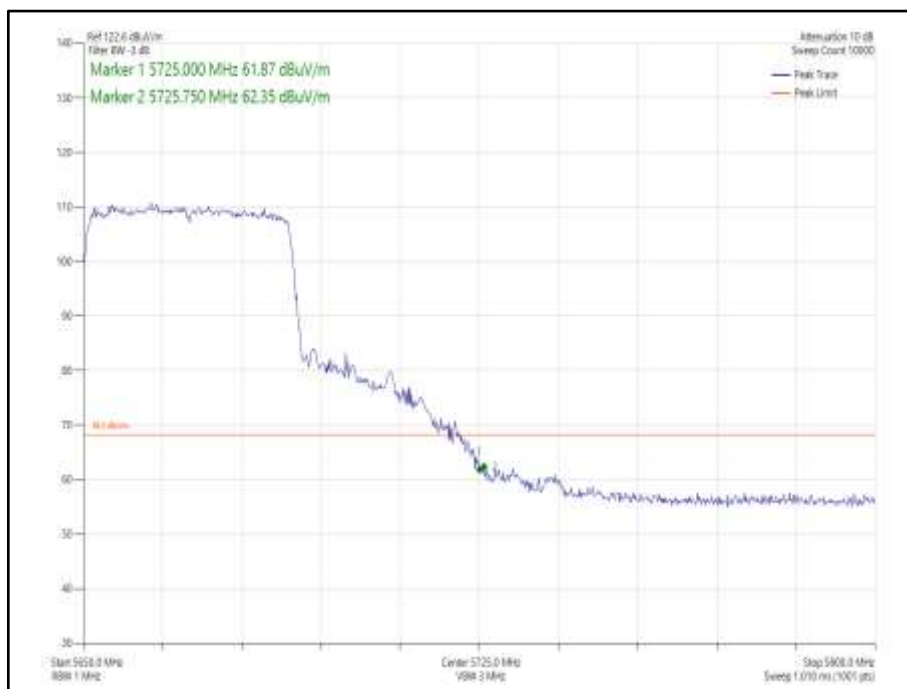
**Figure 1017 - 802.11ax HE40, Core 1, SU - 5510 MHz  
Band Edge Frequency 5470 MHz**



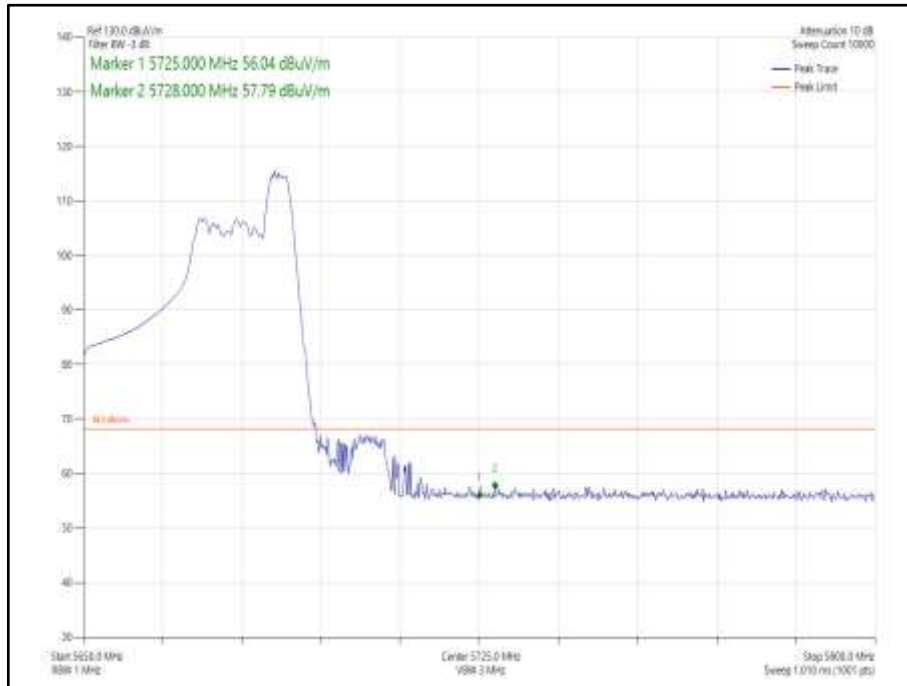
**Figure 1018 - 802.11ax HE40, Core 1, 52-37 - 5510 MHz  
Band Edge Frequency 5470 MHz**



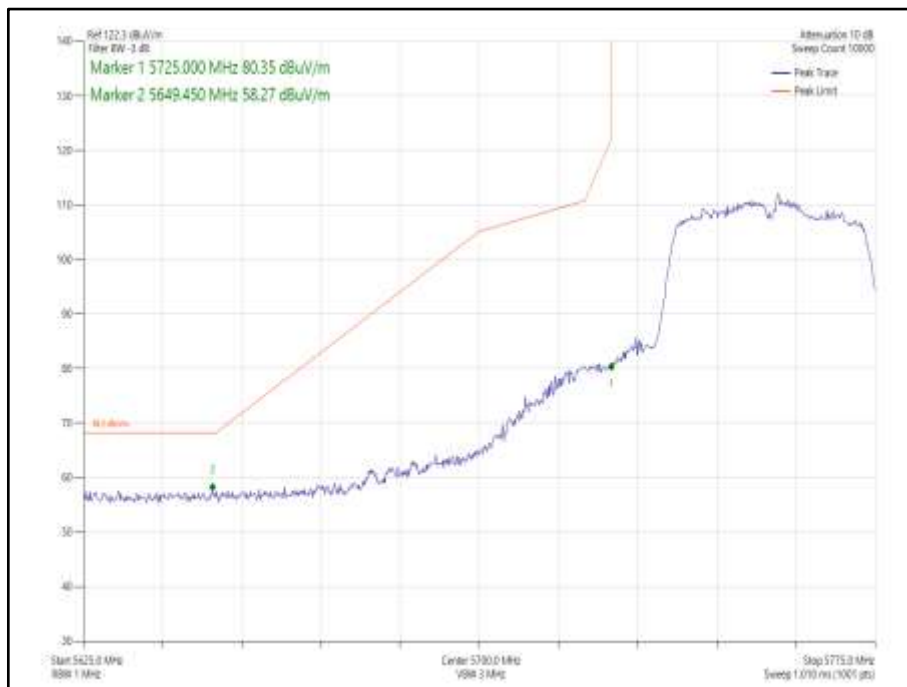
**Figure 1019 - 802.11n HT40, Core 1 - 5670 MHz  
Band Edge Frequency 5725 MHz**



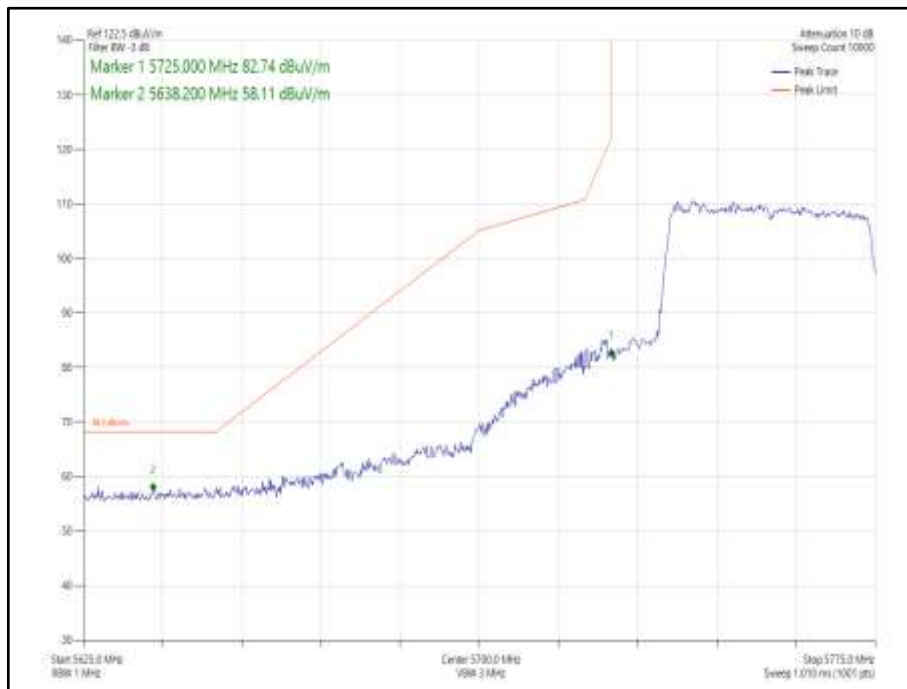
**Figure 1020 - 802.11ax HE40, Core 1, SU - 5670 MHz  
Band Edge Frequency 5725 MHz**



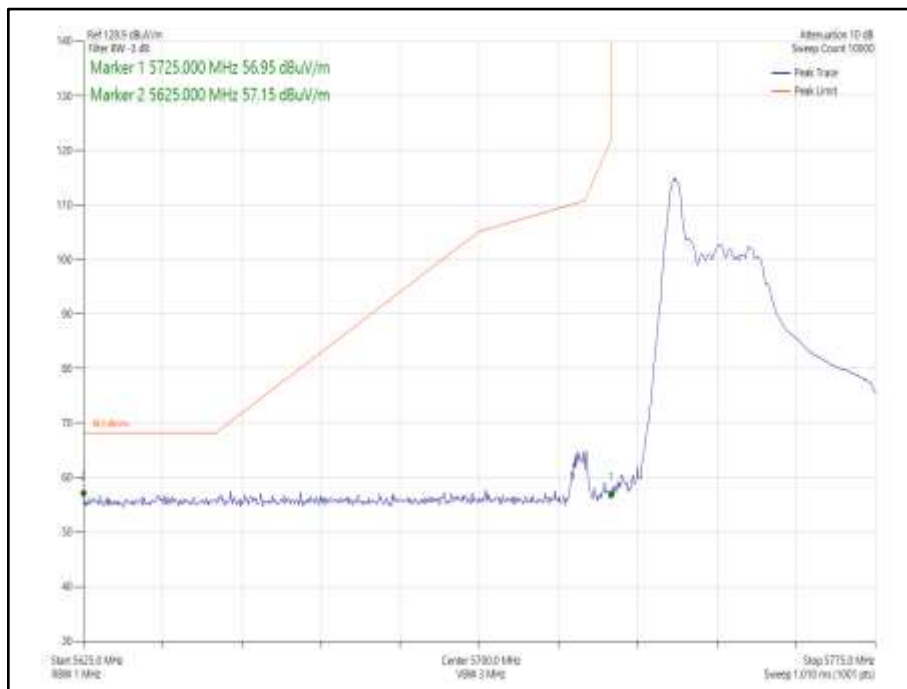
**Figure 1021 - 802.11ax HE40, Core 1, 52-44 - 5670 MHz  
Band Edge Frequency 5725 MHz**



**Figure 1022 - 802.11n HT40, Core 1 - 5755 MHz  
Band Edge Frequency 5725 MHz**

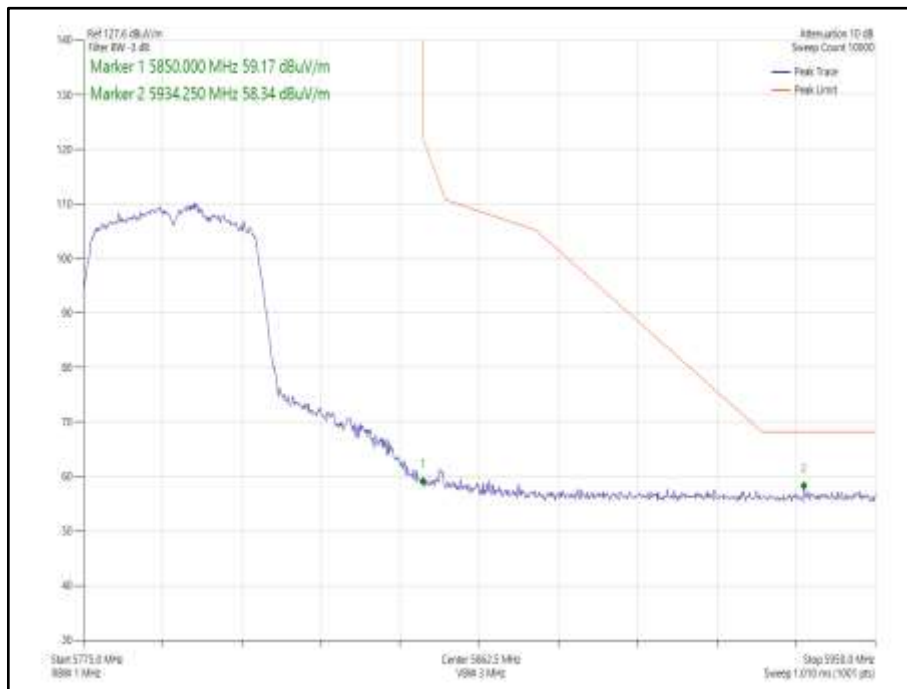


**Figure 1023 - 802.11ax HE40, Core 1, SU - 5755 MHz  
Band Edge Frequency 5725 MHz**

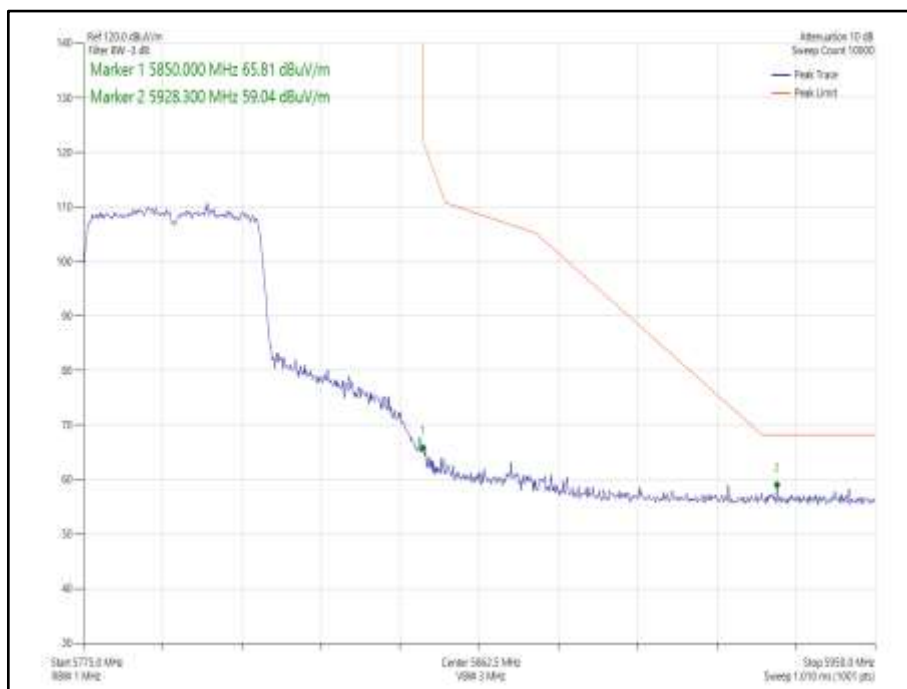


**Figure 1024 - 802.11ax HE40, Core 1, 26-0 - 5755 MHz  
Band Edge Frequency 5725 MHz**

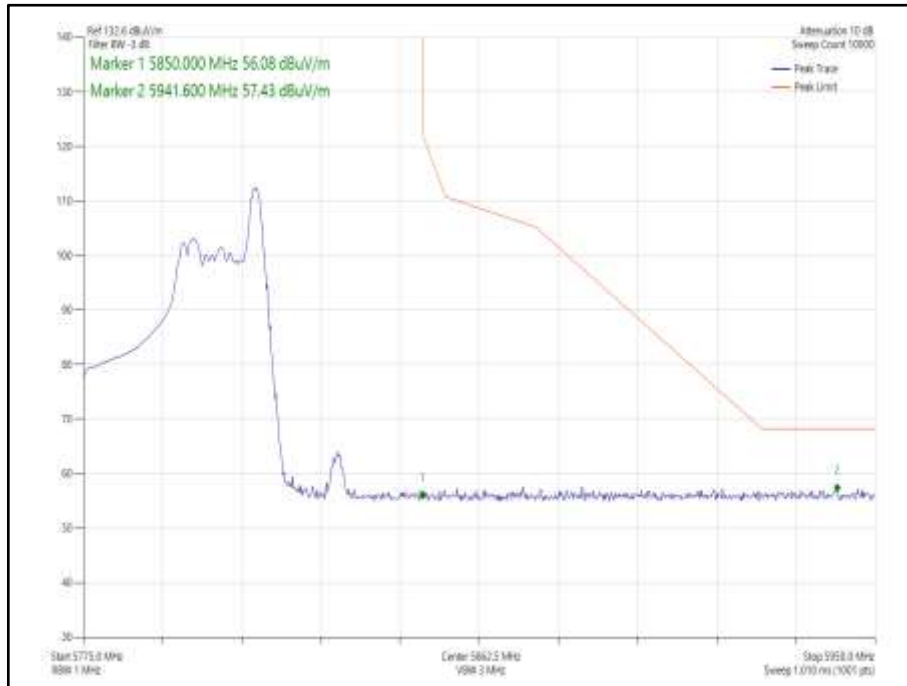




**Figure 1025 - 802.11n HT40, Core 1 - 5795 MHz  
Band Edge Frequency 5850 MHz**



**Figure 1026 - 802.11ax HE40, Core 1, SU - 5795 MHz  
Band Edge Frequency 5850 MHz**



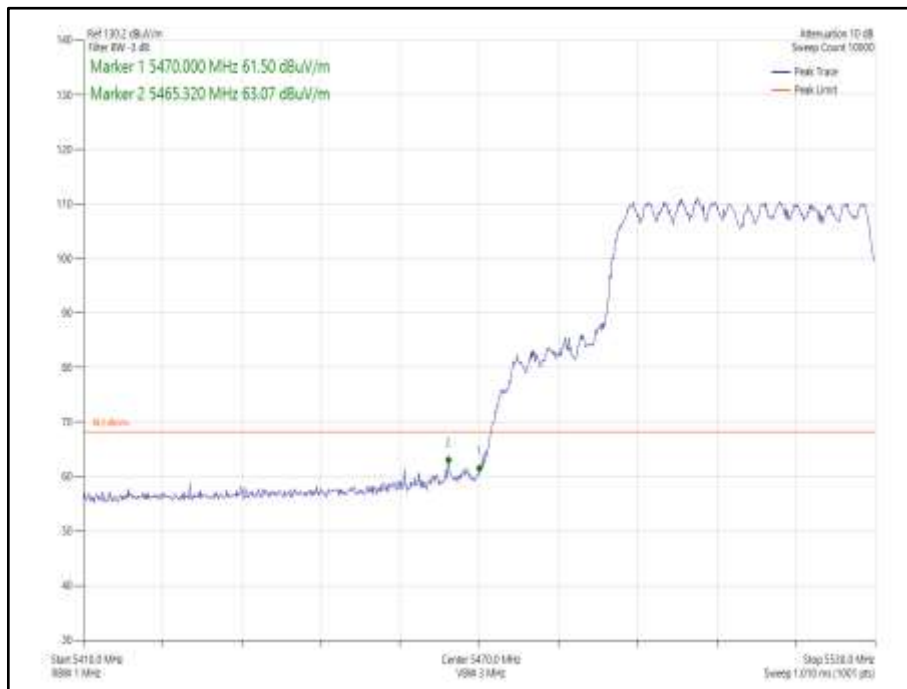
**Figure 1027 - 802.11ax HE40, Core 1, 26-17 - 5795 MHz  
Band Edge Frequency 5850 MHz**



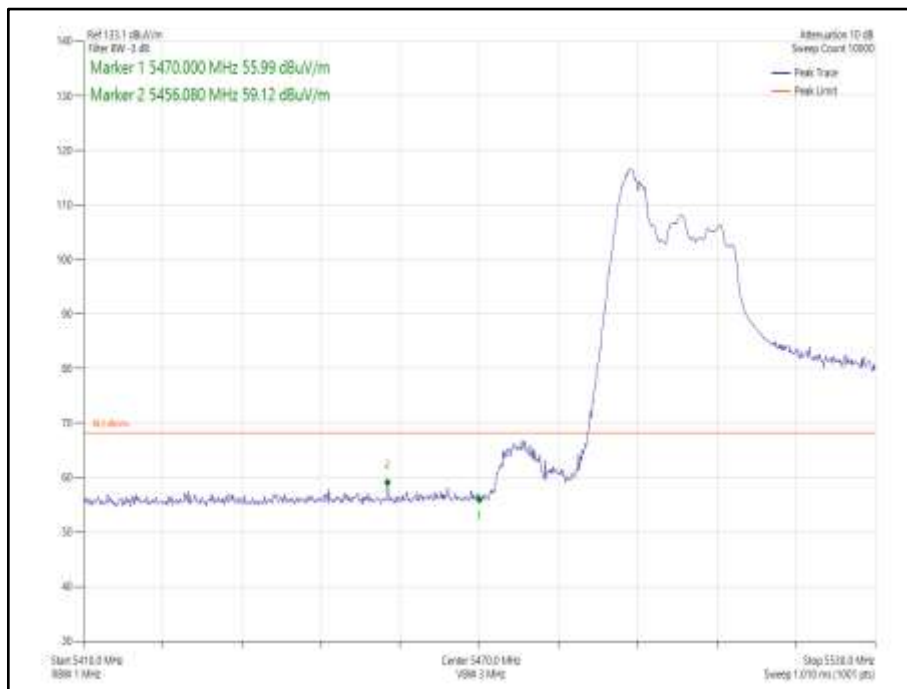
Mode	Data Rate/ MCS	Resource size	Resource Index	TX Frequency (MHz)	Band Edge Frequency (MHz)	Level (dBµV/m)
802.11n HT40 CDD, Cores 0-1	MCS 4	-	-	5510	5470	62.84
802.11n HT40 SDM, Cores 0-1	MCS 10	-	-	5510	5470	63.11
802.11ax HE40 CDD, Cores 0-1	MCS 2	SU	-	5510	5470	63.07
802.11ax HE40 CDD, Cores 0-1	MCS 11	52	37	5510	5470	59.12
802.11ax HE40 SDM, Cores 0-1	MCS 4	SU	-	5510	5470	62.53
802.11ax HE40 SDM, Cores 0-1	MCS 11	52	37	5510	5470	58.58
802.11n HT40 CDD, Cores 0-1	MCS 4	-	-	5670	5725	62.90
802.11n HT40 SDM, Cores 0-1	MCS 12	-	-	5670	5725	63.07
802.11ax HE40 CDD, Cores 0-1	MCS 2	SU	-	5670	5725	62.85
802.11ax HE40 CDD, Cores 0-1	MCS 11	52	44	5670	5725	57.75
802.11ax HE40 SDM, Cores 0-1	MCS 11	SU	-	5670	5725	62.56
802.11ax HE40 SDM, Cores 0-1	MCS 11	52	44	5670	5725	57.68
802.11n HT40, CDD Cores 0-1	MCS 7	-	-	5755	5725	58.42
802.11n HT40, SDM Cores 0-1	MCS 4	-	-	5755	5725	58.80
802.11ax HE40 CDD, Cores 0-1	MCS 4	SU	-	5755	5725	59.18
802.11ax HE40 CDD, Cores 0-1	MCS 11	26	0	5755	5725	57.48
802.11ax HE40 SDM, Cores 0-1	MCS 11	SU	-	5755	5725	58.00
802.11ax HE40 SDM, Cores 0-1	MCS 11	26	0	5755	5725	57.83
802.11n HT40 CDD, Cores 0-1	MCS 4	-	-	5795	5850	57.94
802.11n HT40 SDM, Cores 0-1	MCS 12	-	-	5795	5850	58.80
802.11ax HE40 CDD, Cores 0-1	MCS 11	SU	-	5795	5850	57.85
802.11ax HE40 CDD, Cores 0-1	MCS 11	26	17	5795	5850	57.11
802.11ax HE40 SDM, Cores 0-1	MCS 11	SU	-	5795	5850	58.00
802.11ax HE40 SDM, Cores 0-1	MCS 11	26	17	5795	5850	57.24

**Table 674 - 40MHz Bandwidth 2TX MIMO Authorised Band Edge Results**

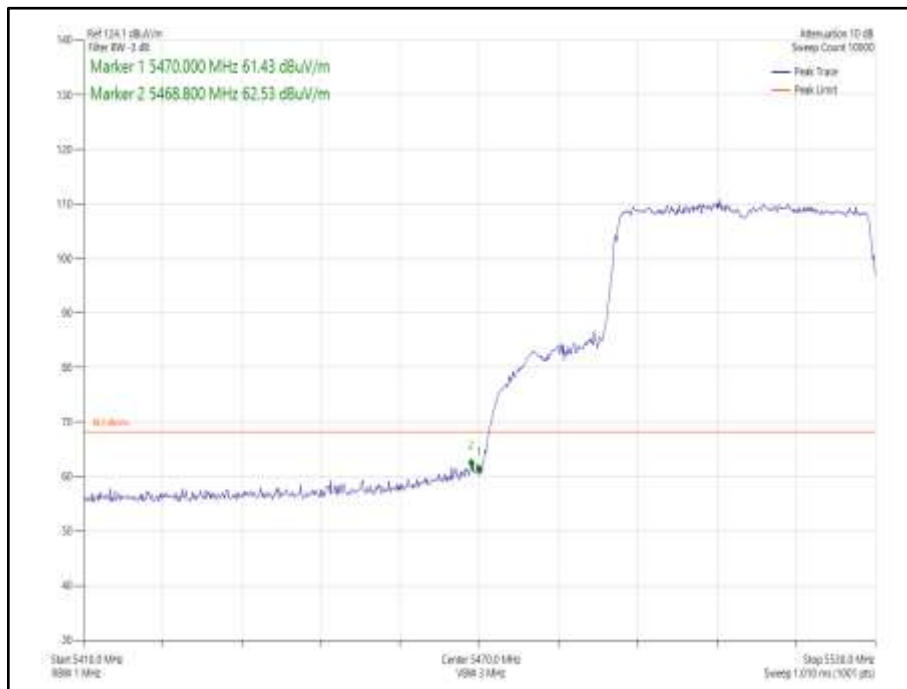




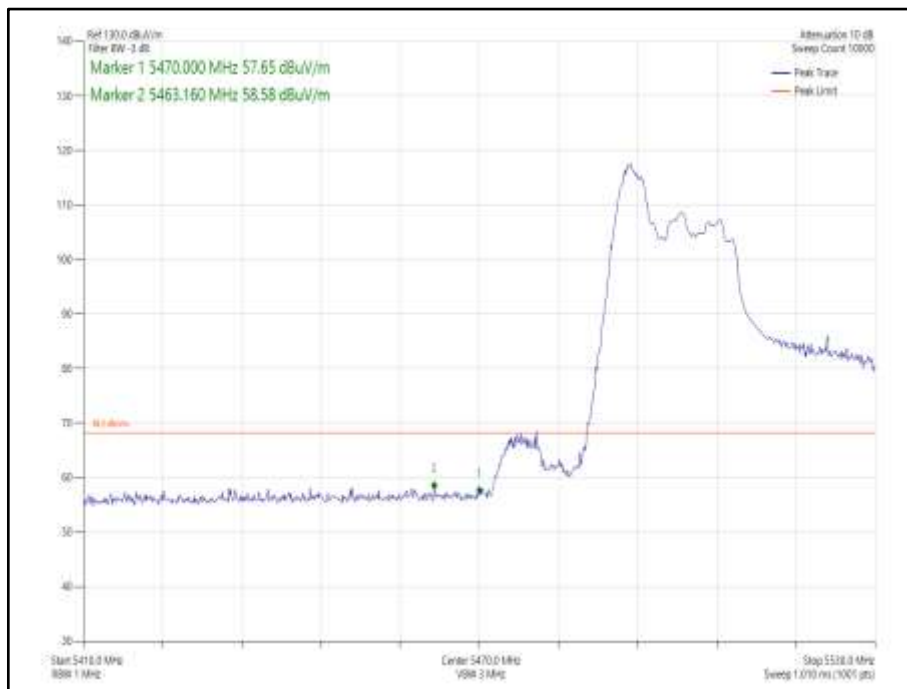
**Figure 1030 - 802.11ax HE40 CDD, Cores 0-1, SU - 5510 MHz  
Band Edge Frequency 5470 MHz**



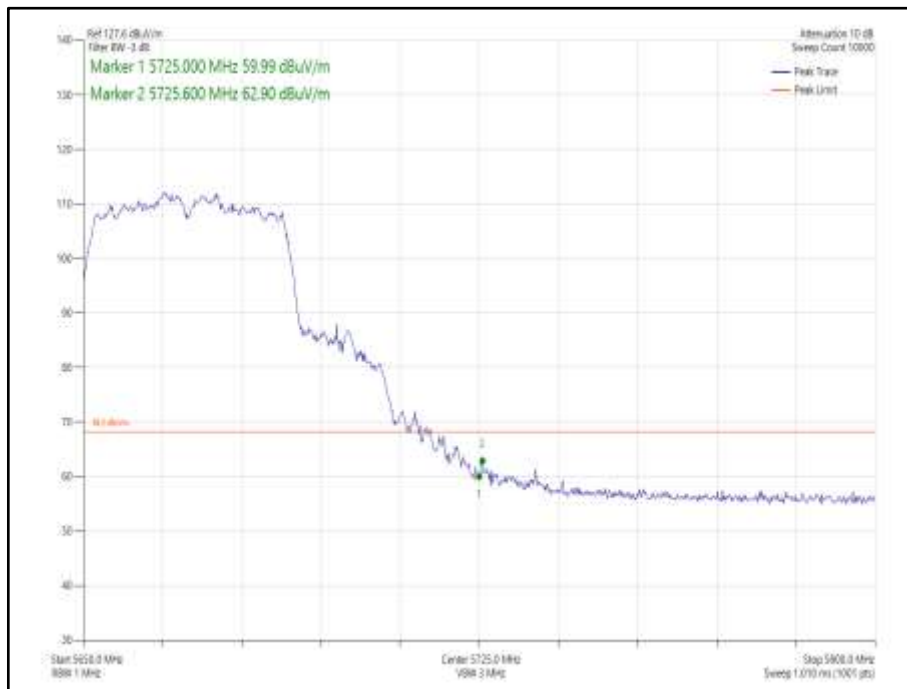
**Figure 1031 - 802.11ax HE40 CDD, Cores 0-1, 26-0 - 5510 MHz  
Band Edge Frequency 5470 MHz**



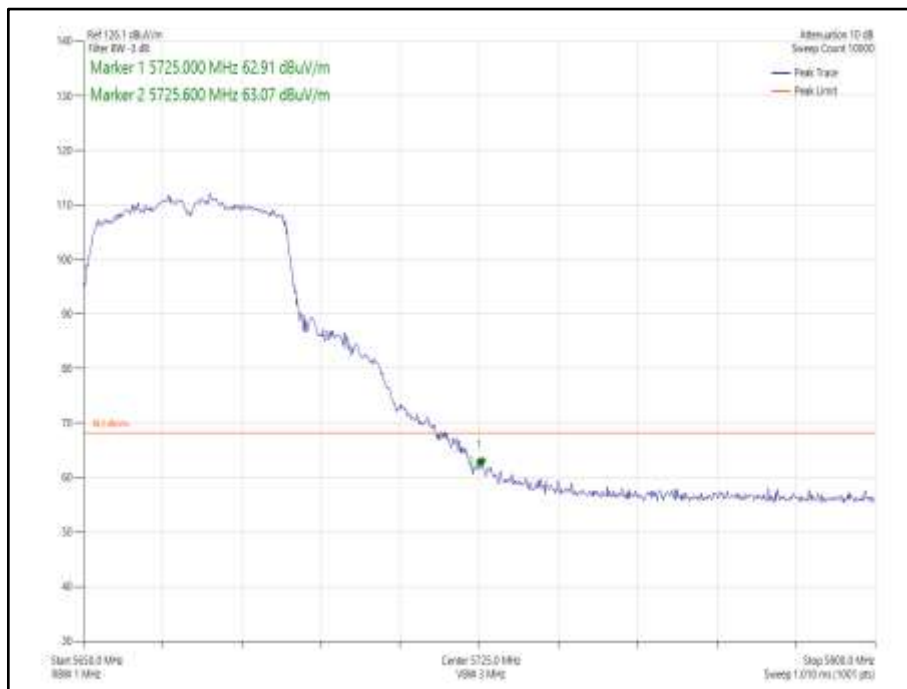
**Figure 1032 - 802.11ax HE40 SDM, Cores 0-1, SU - 5510 MHz  
Band Edge Frequency 5470 MHz**



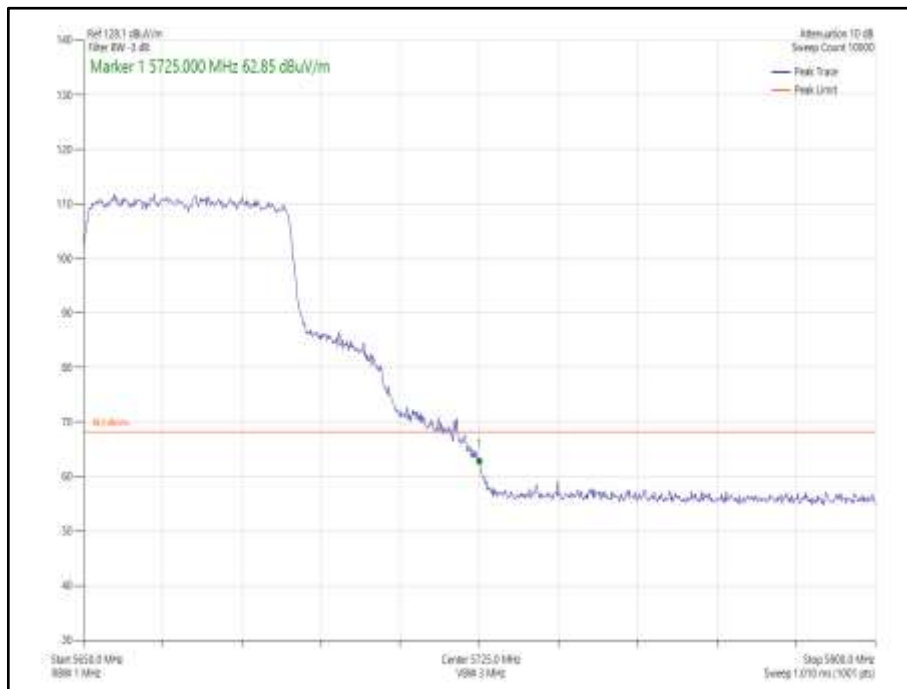
**Figure 1033 - 802.11ax HE40 SDM, Cores 0-1, 26-0 - 5510 MHz  
Band Edge Frequency 5470 MHz**



**Figure 1034 - 802.11n HT40 CDD, Cores 0-1 - 5670 MHz  
Band Edge Frequency 5725 MHz**



**Figure 1035 - 802.11n HT40 SDM, Cores 0-1 - 5670 MHz  
Band Edge Frequency 5725 MHz**

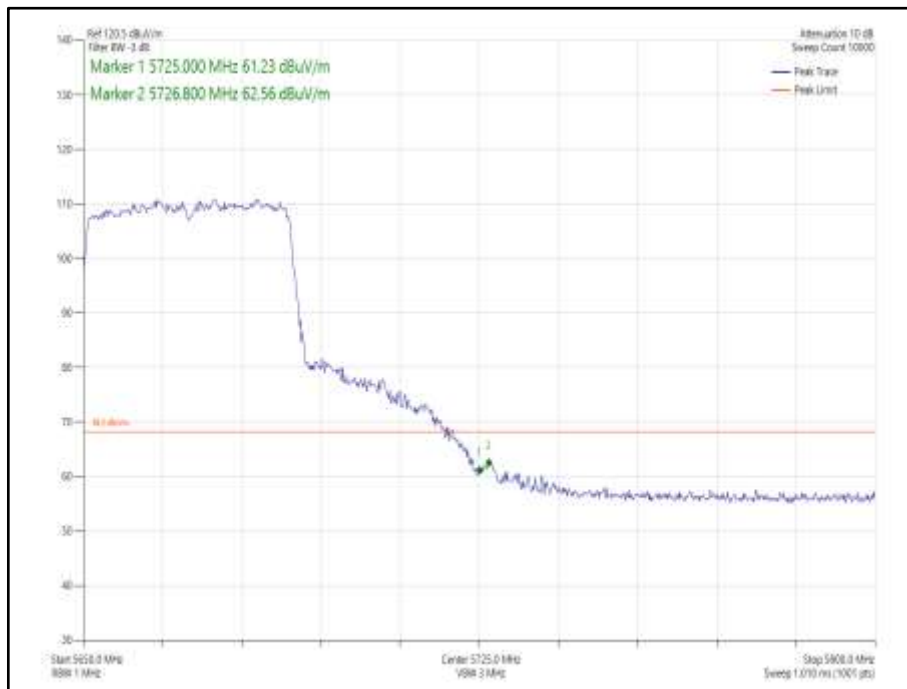


**Figure 1036 - 802.11ax HE40 CDD, Cores 0-1, SU - 5670 MHz  
Band Edge Frequency 5725 MHz**

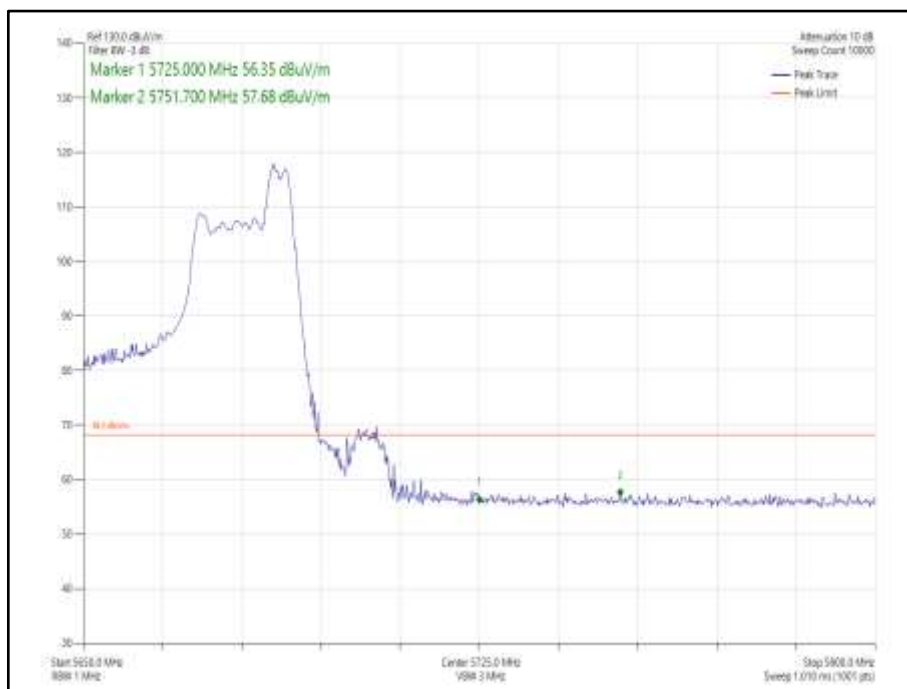


**Figure 1037 - 802.11ax HE40 CDD, Cores 0-1, 52-44 - 5670 MHz  
Band Edge Frequency 5725 MHz**





**Figure 1038 - 802.11ax HE40 SDM, Cores 0-1, SU - 5670 MHz  
Band Edge Frequency 5725 MHz**



**Figure 1039 - 802.11ax HE40 SDM, Cores 0-1, 52-44 - 5670 MHz  
Band Edge Frequency 5725 MHz**

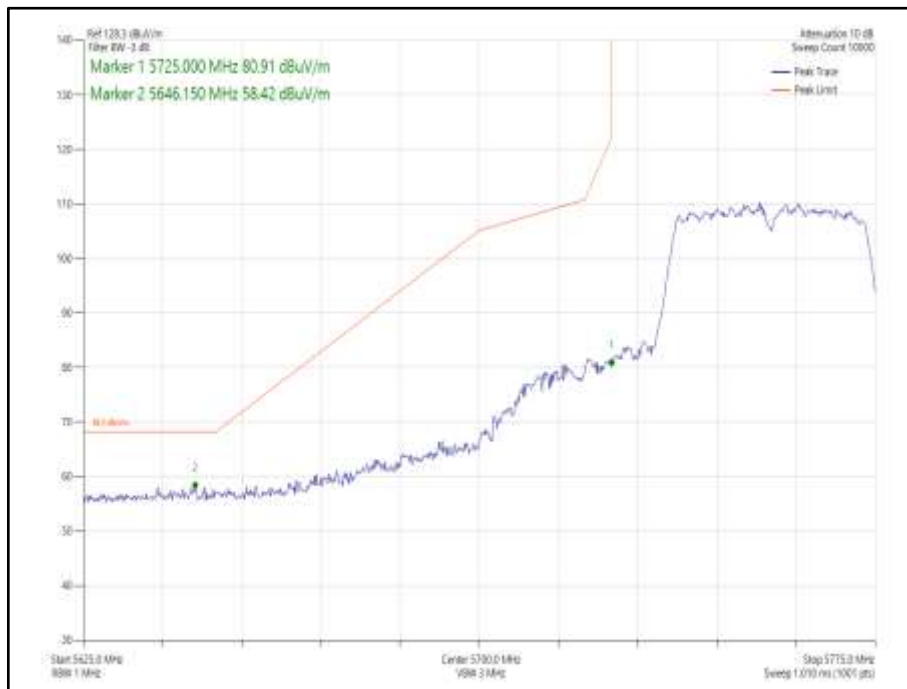


Figure 1040 - 802.11n HT40 CDD, Cores 0-1 - 5755 MHz  
Band Edge Frequency 5725 MHz

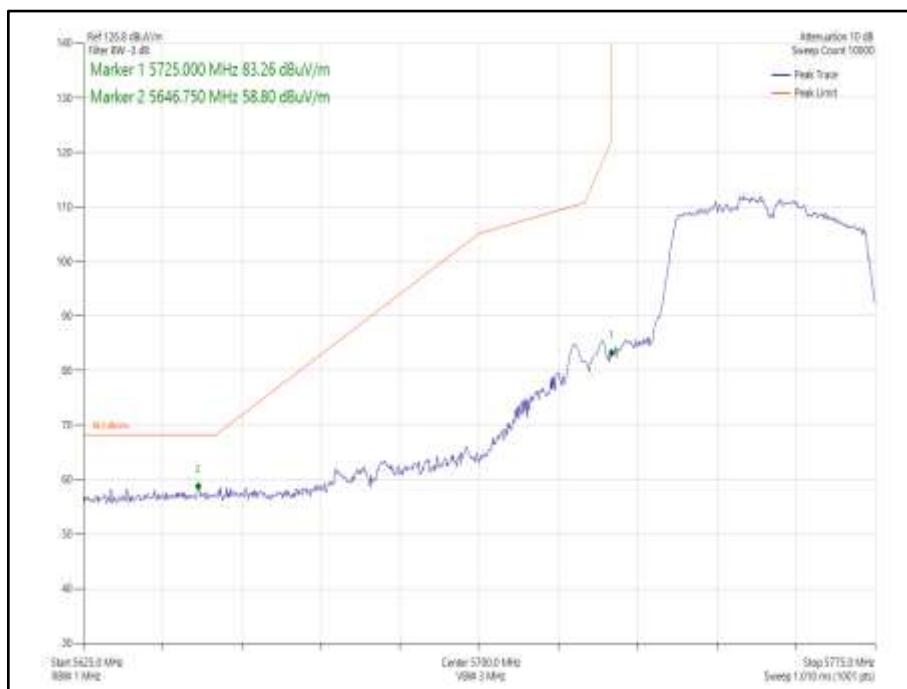


Figure 1041 - 802.11n HT40 SDM, Cores 0-1 - 5755 MHz  
Band Edge Frequency 5725 MHz

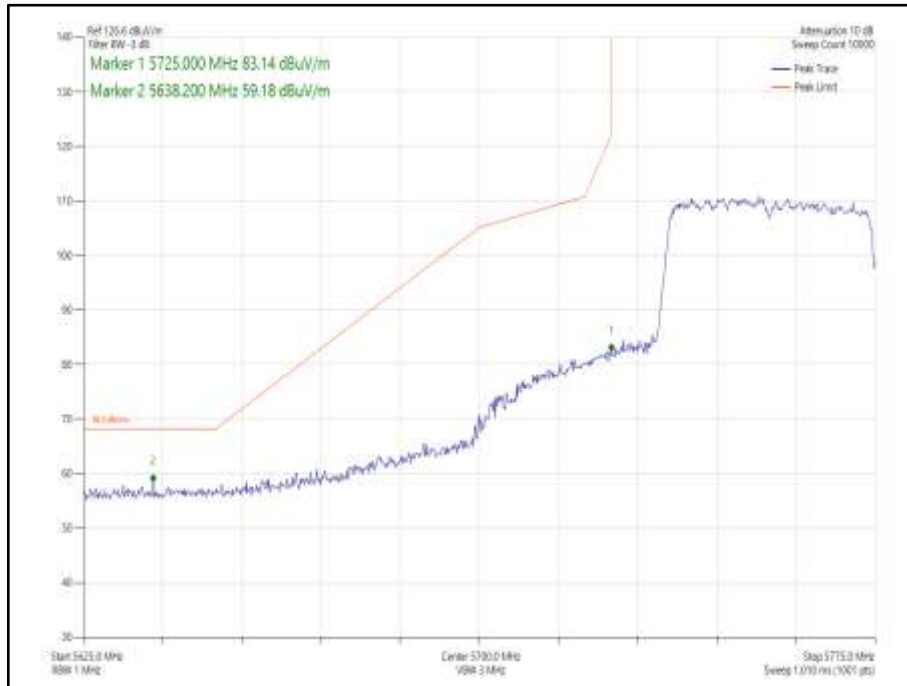


Figure 1042 - 802.11ax HE40 CDD, Cores 0-1, SU - 5755 MHz  
Band Edge Frequency 5725 MHz

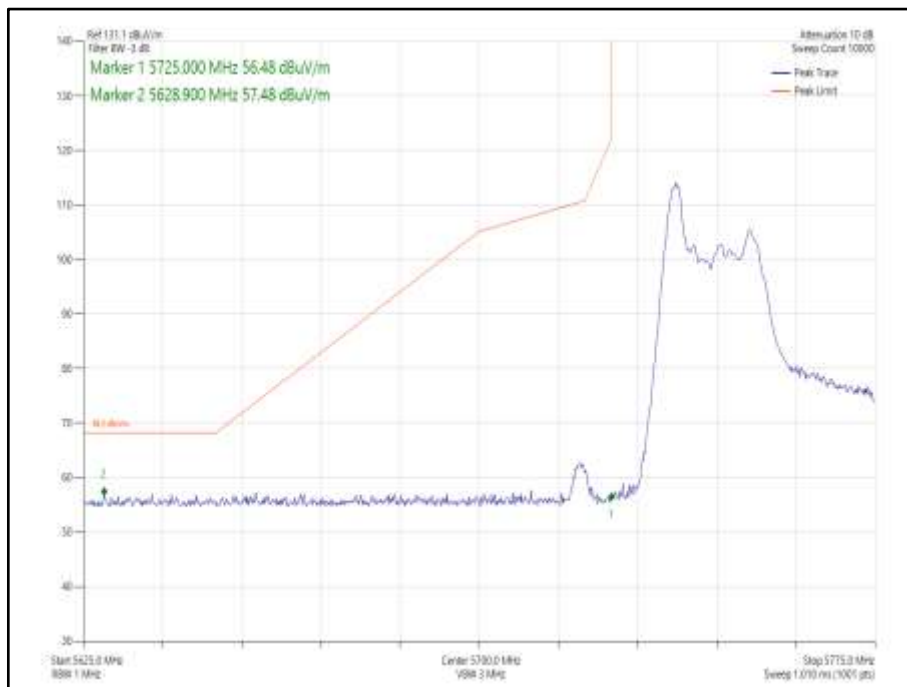
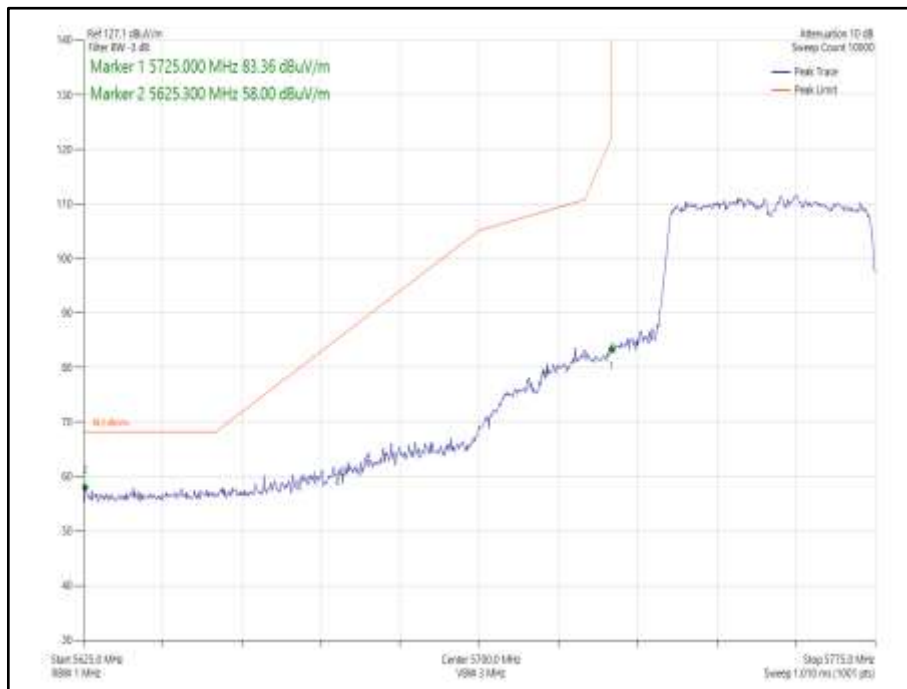
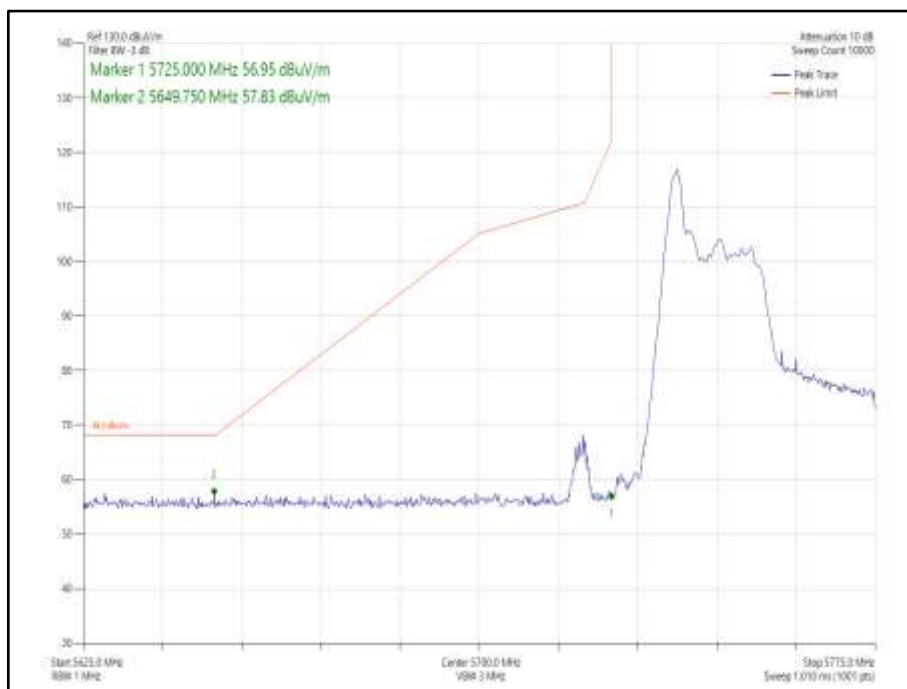


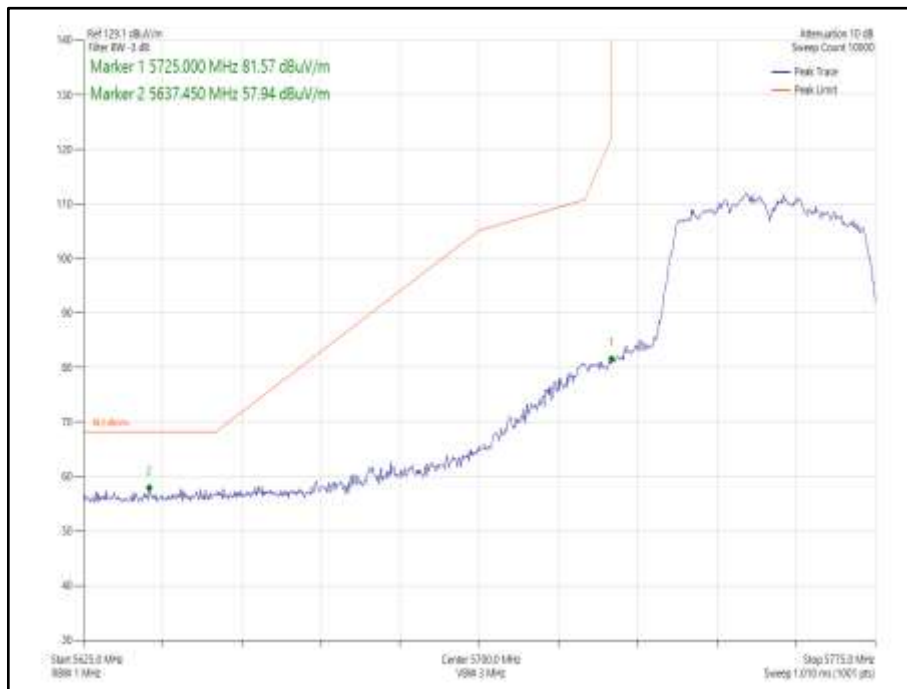
Figure 1043 - 802.11ax HE40 CDD, Cores 0-1, 26-0 - 5755 MHz  
Band Edge Frequency 5725 MHz



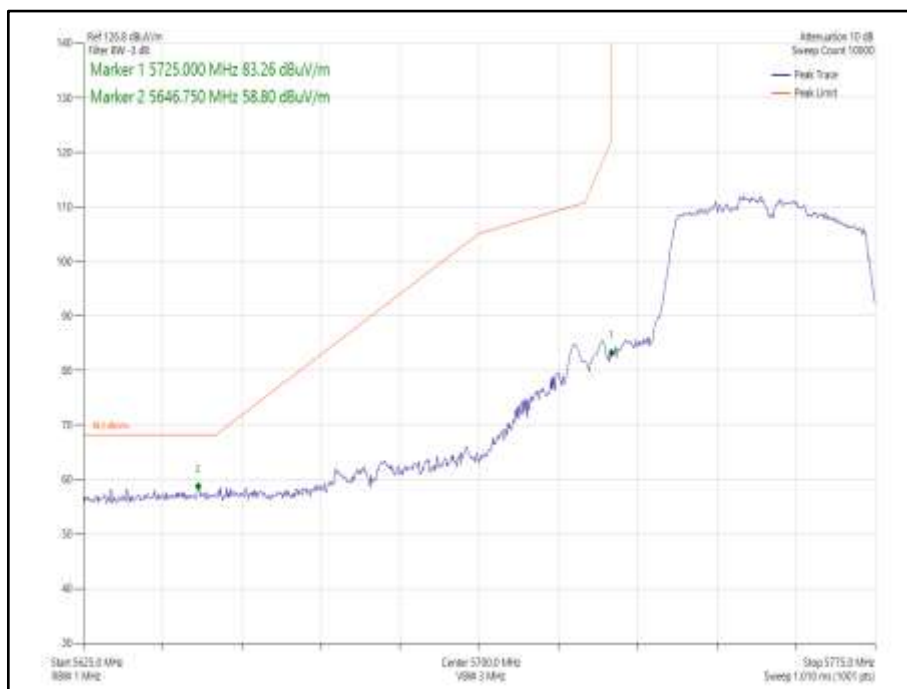
**Figure 1044 - 802.11ax HE40 SDM, Cores 0-1, SU - 5755 MHz  
Band Edge Frequency 5725 MHz**



**Figure 1045 - 802.11ax HE40 SDM, Cores 0-1, 26-0 - 5755 MHz  
Band Edge Frequency 5725 MHz**



**Figure 1046 - 802.11n HT40 CDD, Cores 0-1 - 5795 MHz  
Band Edge Frequency 5850 MHz**



**Figure 1047 - 802.11n HT40 SDM, Cores 0-1 - 5795 MHz  
Band Edge Frequency 5850 MHz**

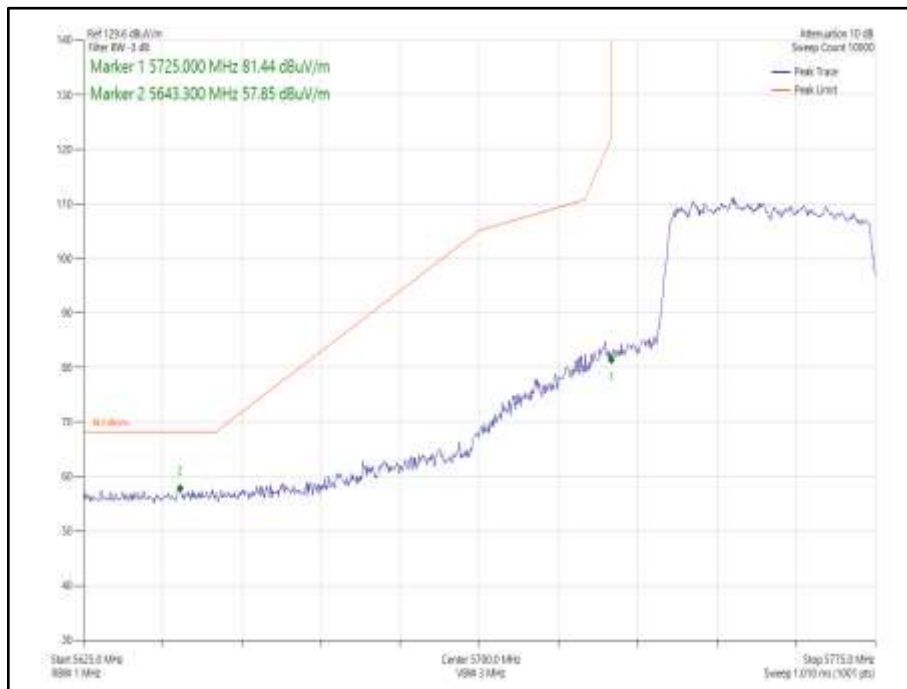


Figure 1048 - 802.11ax HE40 CDD, Cores 0-1, SU - 5795 MHz  
Band Edge Frequency 5850 MHz

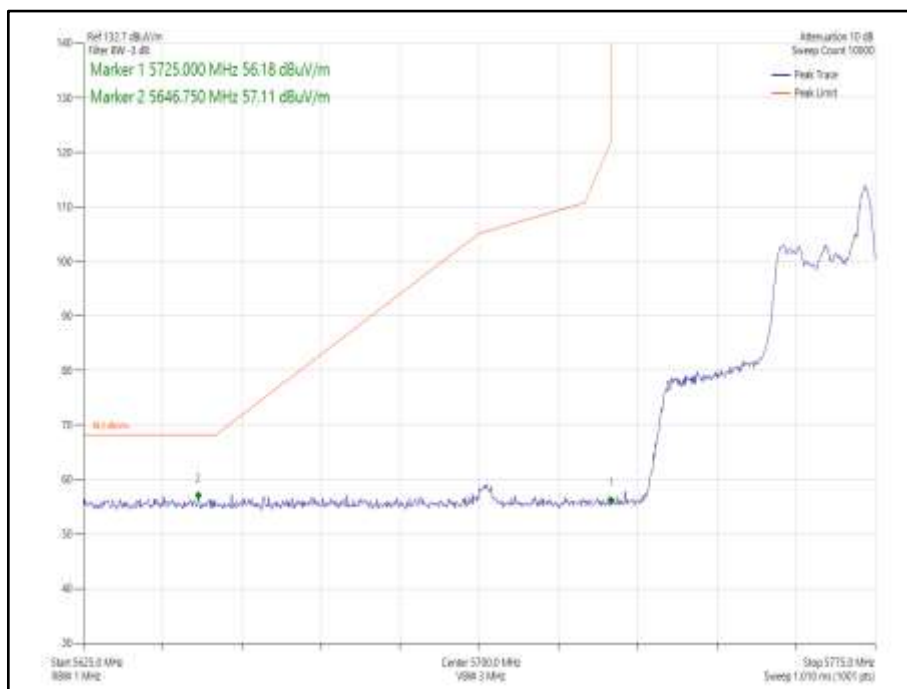


Figure 1049 - 802.11ax HE40 CDD, Cores 0-1, 26-17 - 5795 MHz  
Band Edge Frequency 5850 MHz

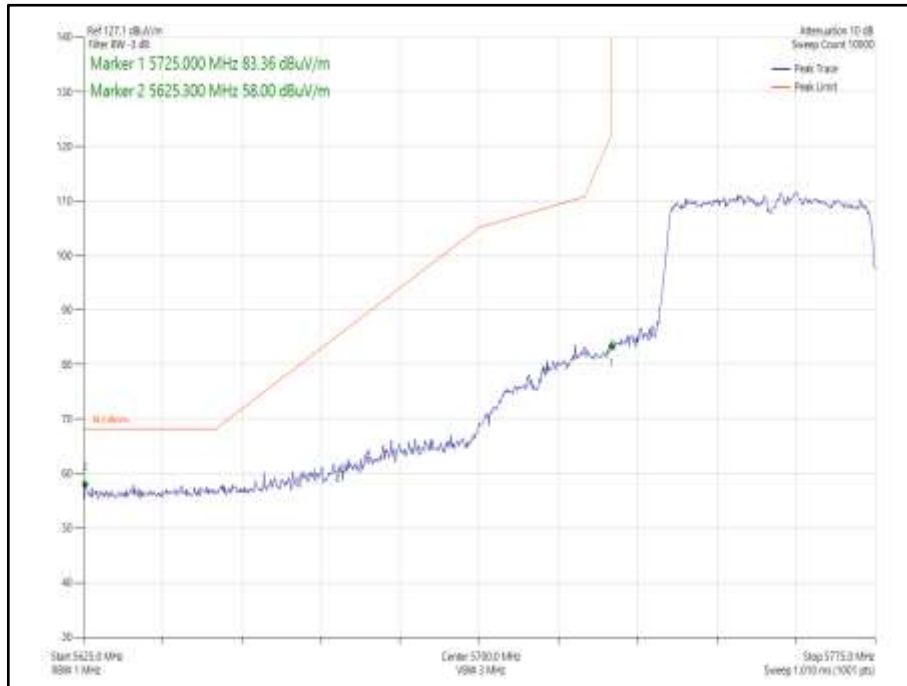


Figure 1050 - 802.11ax HE40 SDM, Cores 0-1, SU - 5795 MHz  
Band Edge Frequency 5850 MHz

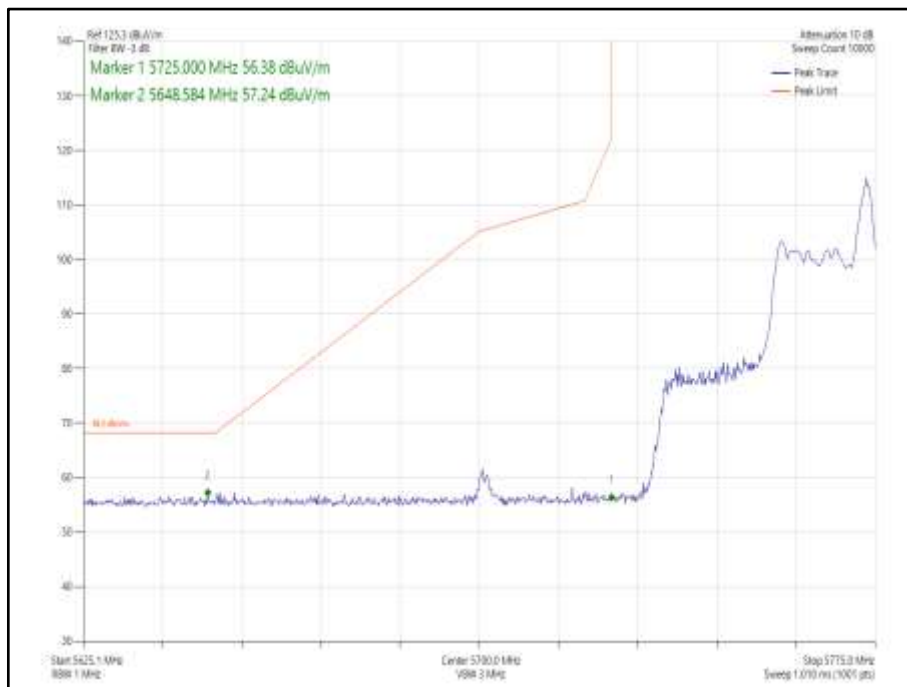
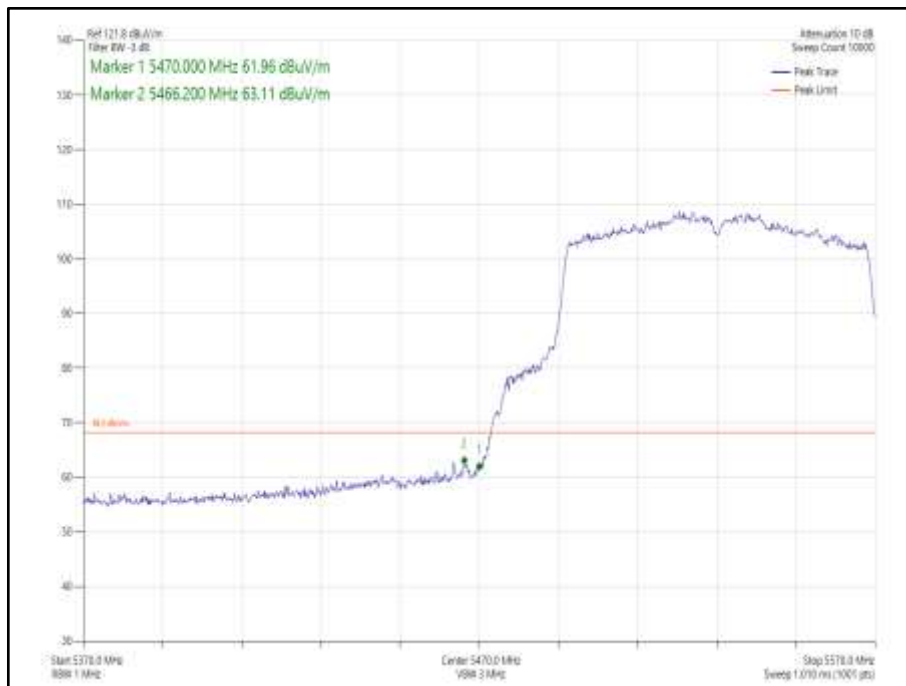


Figure 1051 - 802.11ax HE40 SDM, Cores 0-1, 26-17 - 5795 MHz  
Band Edge Frequency 5850 MHz



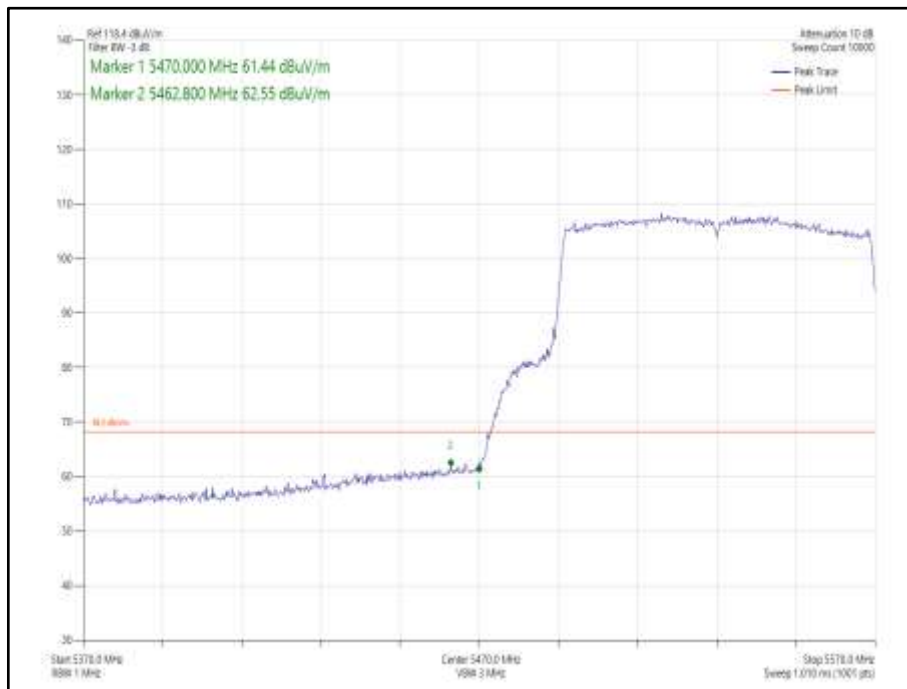
Mode	Data Rate /MCS	Resource size	Resource Index	TX Frequency (MHz)	Band Edge Frequency (MHz)	Level (dBμV/m)
802.11ac VHT80, Core 1	MCS2	-	-	5530	5470	63.11
802.11ax HE80, Core 1	MCS2	SU	-	5530	5470	62.55
802.11ax HE80, Core 1	MCS11	52	37	5530	5470	63.13
802.11ac VHT80, Core 1	MCS7	-	-	5610	5725	60.08
802.11ax HE80, Core 1	MCS11	SU	-	5610	5725	61.48
802.11ax HE80, Core 1	MCS11	52	52	5610	5725	57.65
802.11ac VHT80, Core 1	MCS7	-	-	5775	5725	61.76
802.11ax HE80, Core 1	MCS11	SU	-	5775	5725	62.86
802.11ax HE80, Core 1	MCS11	26	0	5775	5725	56.87
802.11ac VHT80, Core 1	MCS7	-	-	5775	5850	58.64
802.11ax HE80, Core 1	MCS4	SU	-	5775	5850	58.01
802.11ax HE80, Core 1	MCS11	26	36	5775	5850	57.65

**Table 675 - 80 MHz Bandwidth SISO Authorised Band Edge Results**

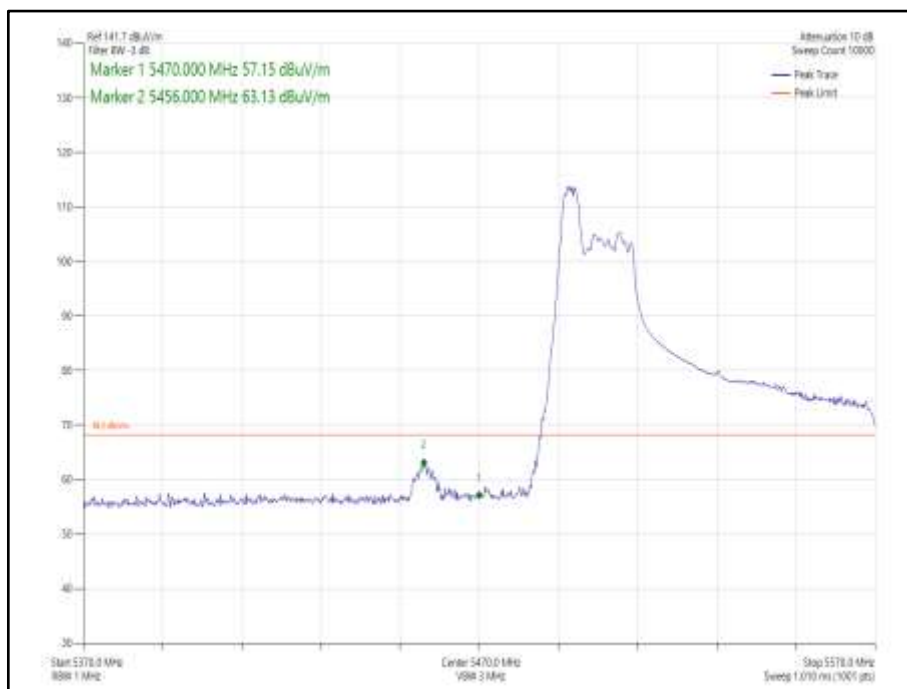


**Figure 1052 - 802.11ac VHT80 Core 1 - 5530 MHz  
 Band Edge Frequency 5470 MHz**

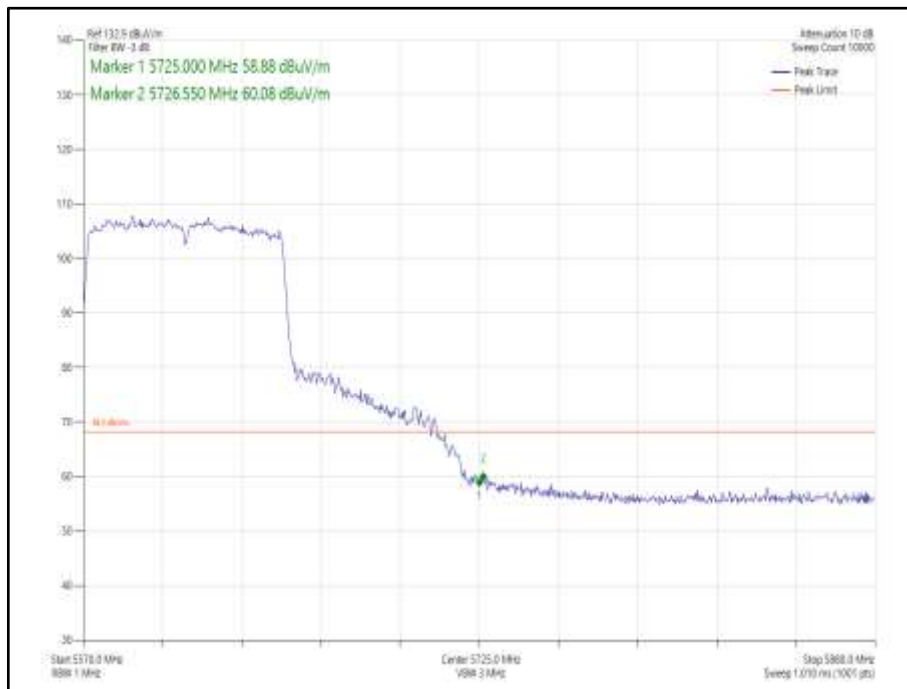




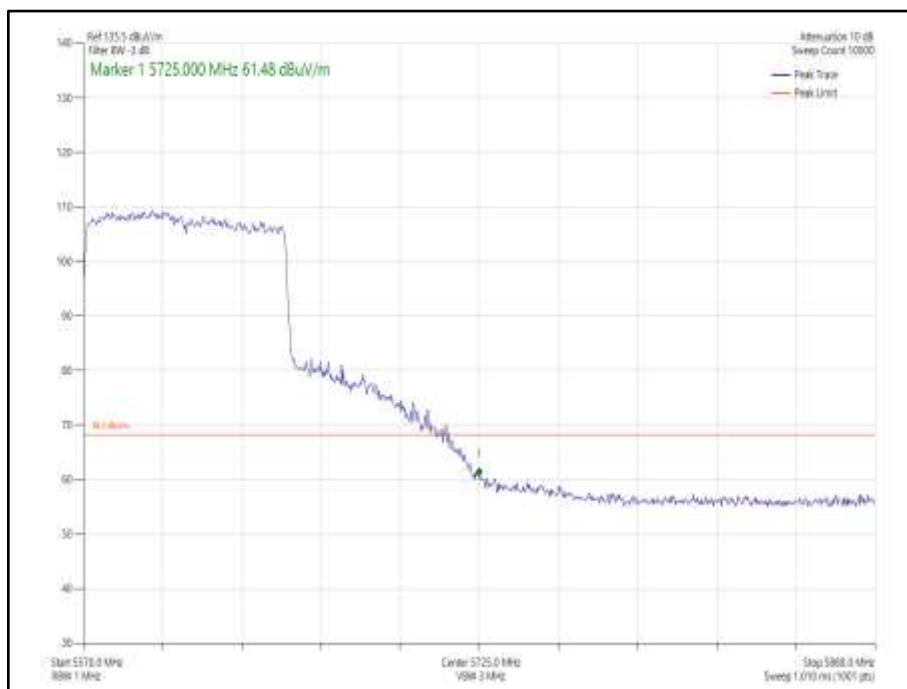
**Figure 1053 - 802.11ax HE80 Core 1 SU - 5530 MHz  
Band Edge Frequency 5470 MHz**



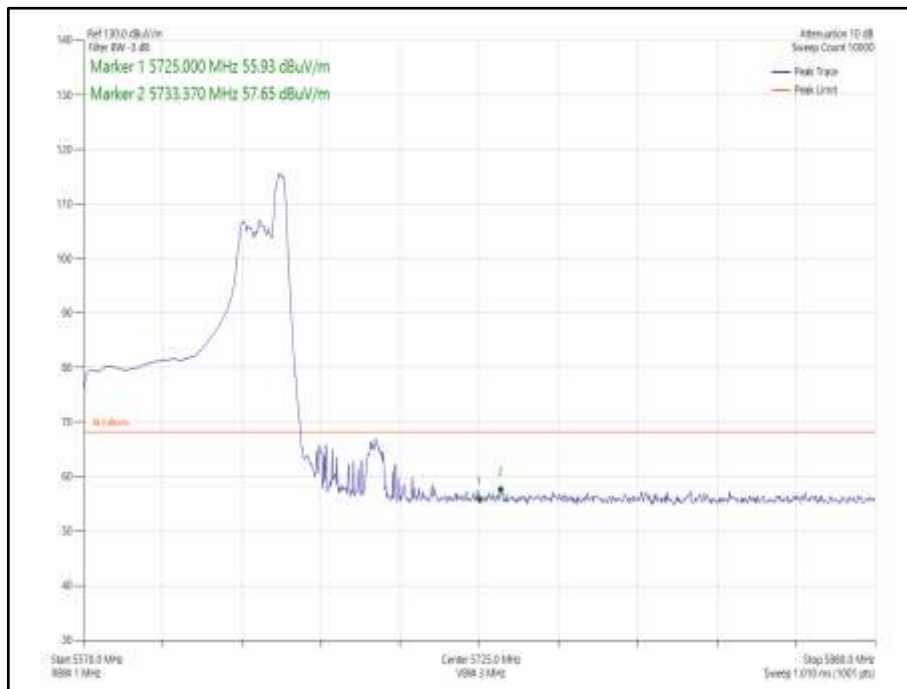
**Figure 1054 - 802.11ax HE80 Core 1 52-37- 5530 MHz  
Band Edge Frequency 5470 MHz**



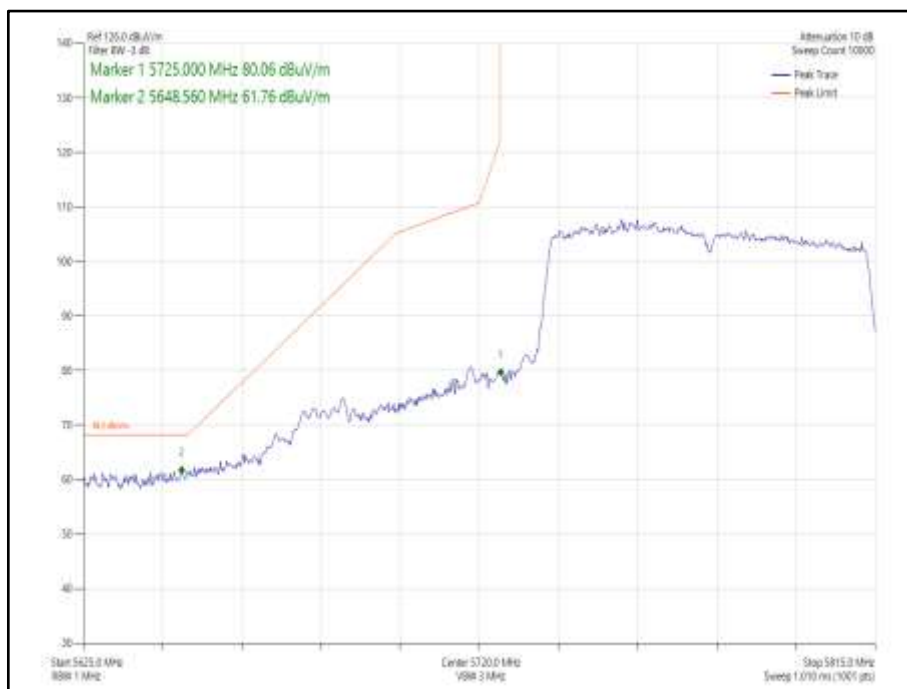
**Figure 1055 - 802.11ac VHT80 Core 1 - 5610 MHz  
Band Edge Frequency 5725 MHz**



**Figure 1056 - 802.11ax HE80 Core 1 SU - 5610 MHz  
Band Edge Frequency 5725 MHz**



**Figure 1057 - 802.11ax HE80 Core 1 52-52 - 5610 MHz  
Band Edge Frequency 5725 MHz**



**Figure 1058 - 802.11ac VHT80 Core 1 - 5775 MHz  
Band Edge Frequency 5725 MHz**

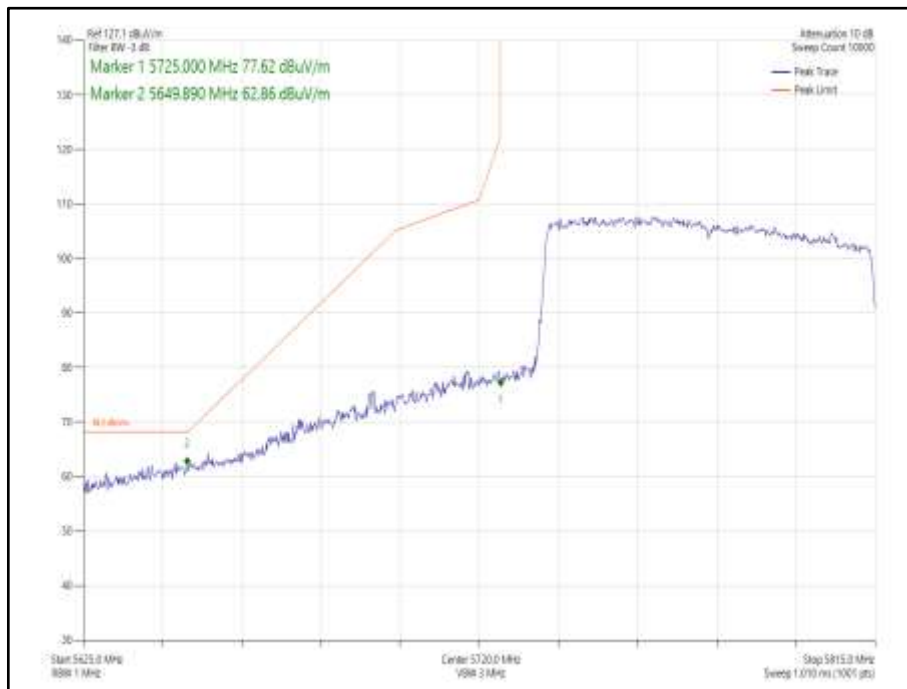


Figure 1059 - 802.11ax HE80 Core 1 SU - 5775 MHz  
Band Edge Frequency 5725 MHz

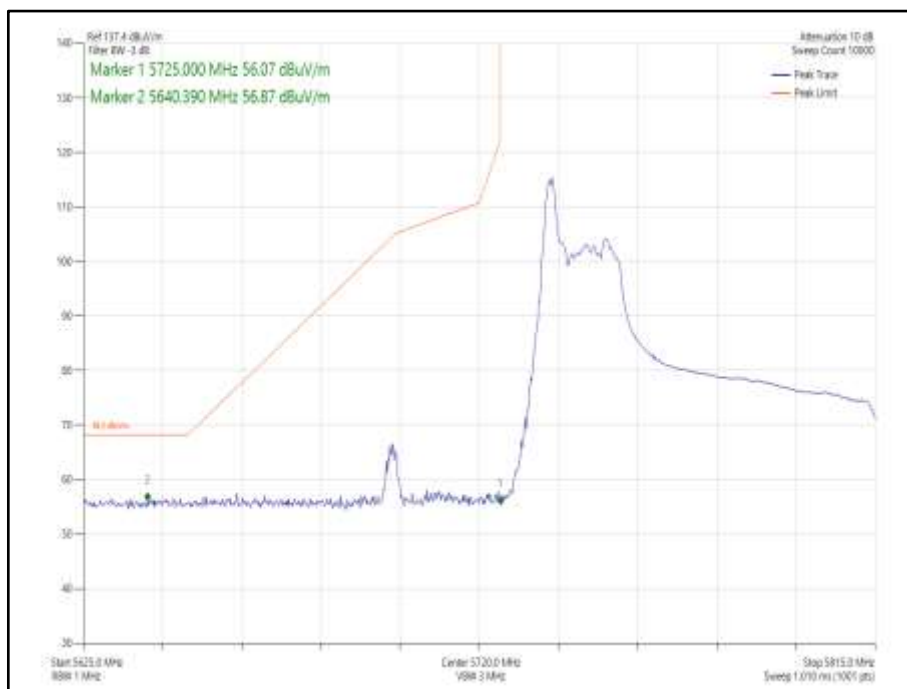
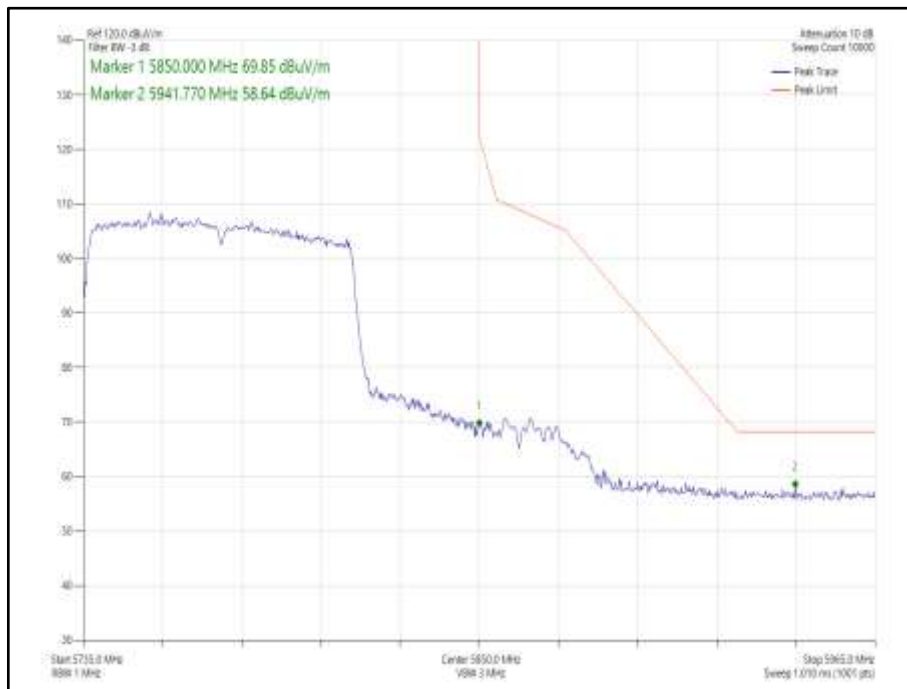
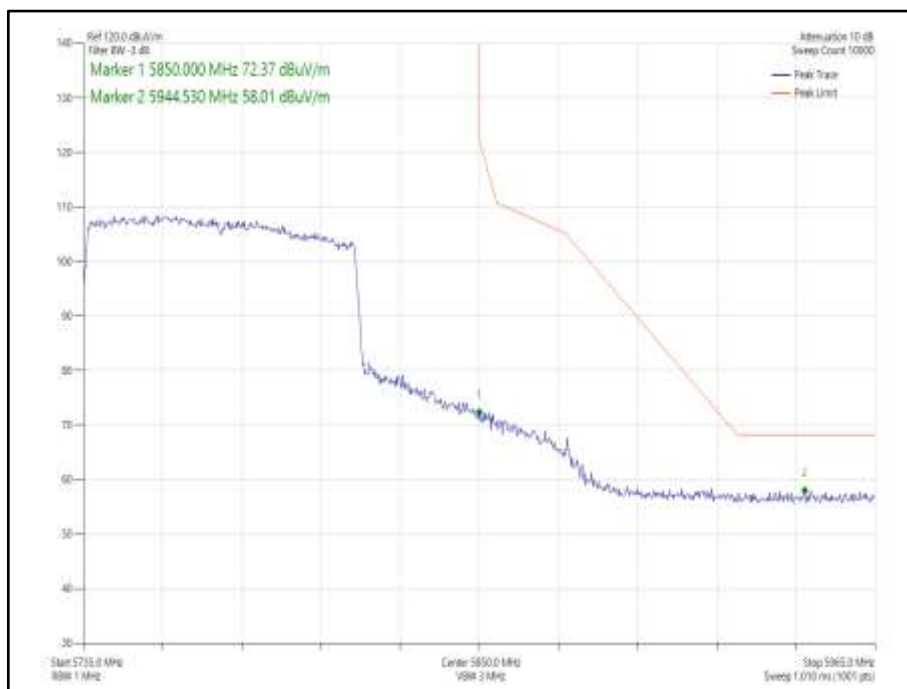


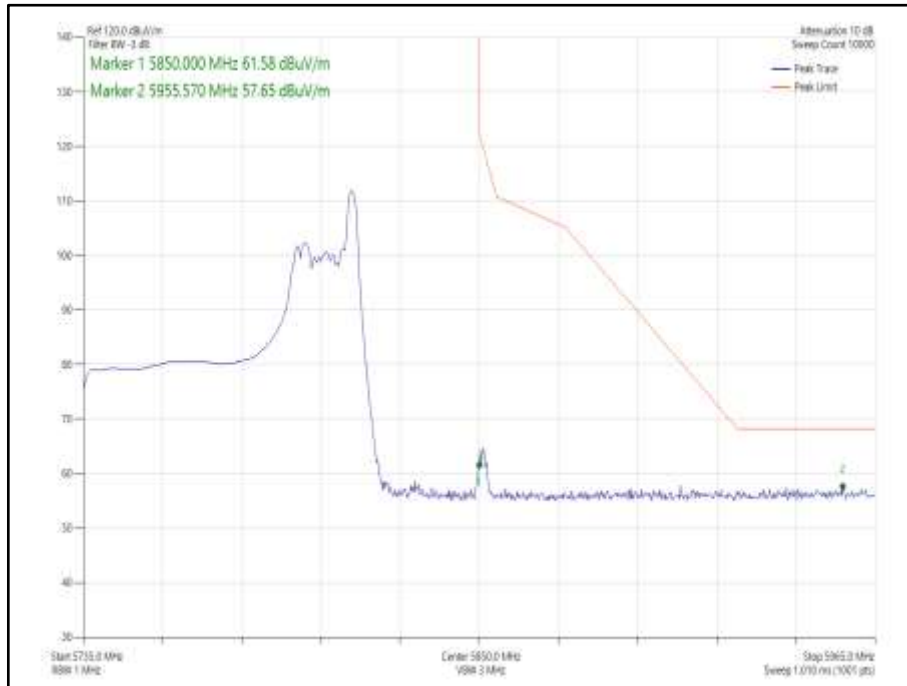
Figure 1060 - 802.11ax HE80 Core 1 26-0 - 5775 MHz  
Band Edge Frequency 5725 MHz



**Figure 1061 - 802.11ac VHT80 Core 1 - 5775 MHz  
Band Edge Frequency 5850 MHz**



**Figure 1062 - 802.11ax HE80 Core 1 SU - 5775 MHz  
Band Edge Frequency 5850 MHz**

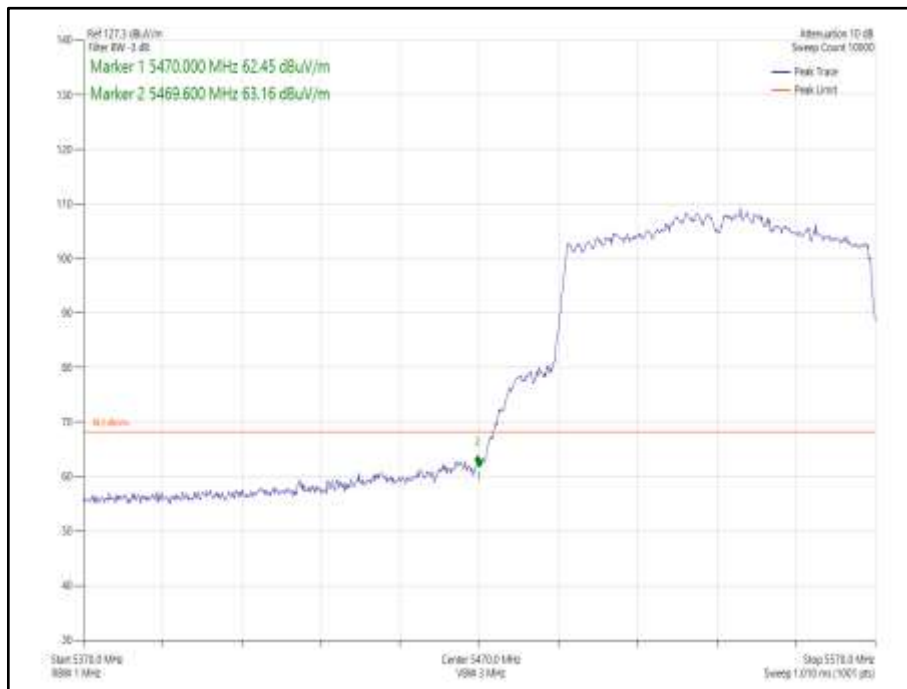


**Figure 1063 - 802.11ax HE80 Core 1 26-36 - 5775 MHz  
Band Edge Frequency 5850 MHz**

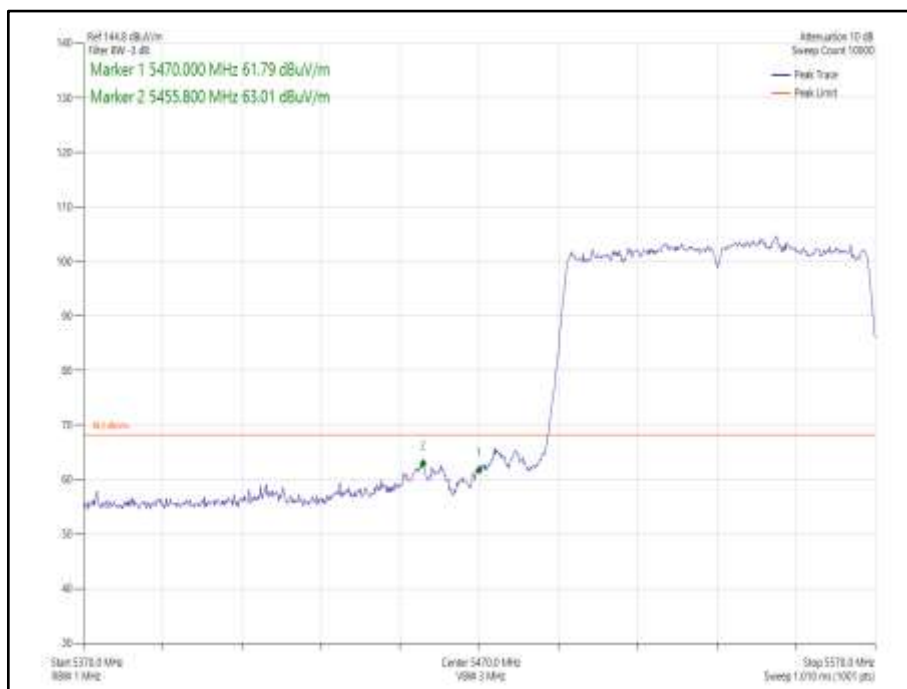


Mode	Data Rate/ MCS	Resource size	Resource Index	TX Frequency (MHz)	Band Edge Frequency (MHz)	Level (dBµV/m)
802.11ac VHT80 CDD, Cores 0-1	MCS 4	-	-	5530	5470	63.16
802.11ac VHT80 SDM, Cores 0-1	MCS 7	-	-	5530	5470	63.01
802.11ax HE80 CDD, Cores 0-1	MCS 11	SU	-	5530	5470	63.11
802.11ax HE80 CDD, Cores 0-1	MCS 11	52	37	5530	5470	63.19
802.11ax HE80 SDM, Cores 0-1	MCS 2	SU	-	5530	5470	62.65
802.11ax HE80 SDM, Cores 0-1	MCS 11	52	37	5530	5470	62.22
802.11ac VHT80 CDD, Cores 0-1	MCS 7	-	-	5610	5725	60.49
802.11ac VHT80 SDM, Cores 0-1	MCS 7	-	-	5610	5725	62.89
802.11ax HE80 CDD, Cores 0-1	MCS 11	SU	-	5610	5725	62.35
802.11ax HE80 CDD, Cores 0-1	MCS 11	52	52	5610	5725	58.82
802.11ax HE80 SDM, Cores 0-1	MCS 4	SU	-	5610	5725	62.35
802.11ax HE80 SDM, Cores 0-1	MCS 11	52	52	5610	5725	57.38
802.11ac VHT80 CDD, Cores 0-1	MCS 7	-	-	5775	5725	61.87
802.11ac VHT80 SDM, Cores 0-1	MCS 7	-	-	5775	5725	61.72
802.11ax HE80 CDD, Cores 0-1	MCS 11	SU	-	5775	5725	62.66
802.11ax HE80 CDD, Cores 0-1	MCS 11	26	0	5775	5725	56.79
802.11ax HE80 SDM, Cores 0-1	MCS 11	SU	-	5775	5725	62.03
802.11ax HE80 SDM, Cores 0-1	MCS 11	26	0	5775	5725	57.44
802.11ac VHT80 CDD, Cores 0-1	MCS 7	-	-	5775	5850	58.24
802.11ac VHT80 SDM, Cores 0-1	MCS 2	-	-	5775	5850	58.10
802.11ax HE80 CDD, Cores 0-1	MCS 2	SU	-	5775	5850	58.77
802.11ax HE80 CDD, Cores 0-1	MCS 11	26	36	5775	5850	57.50
802.11ax HE80 SDM, Cores 0-1	MCS 11	SU	-	5775	5850	58.22
802.11ax HE80 SDM, Cores 0-1	MCS 11	26	36	5775	5850	58.05

**Table 676 – 80 MHz Bandwidth 2TX MIMO Authorised Band Edge Results**

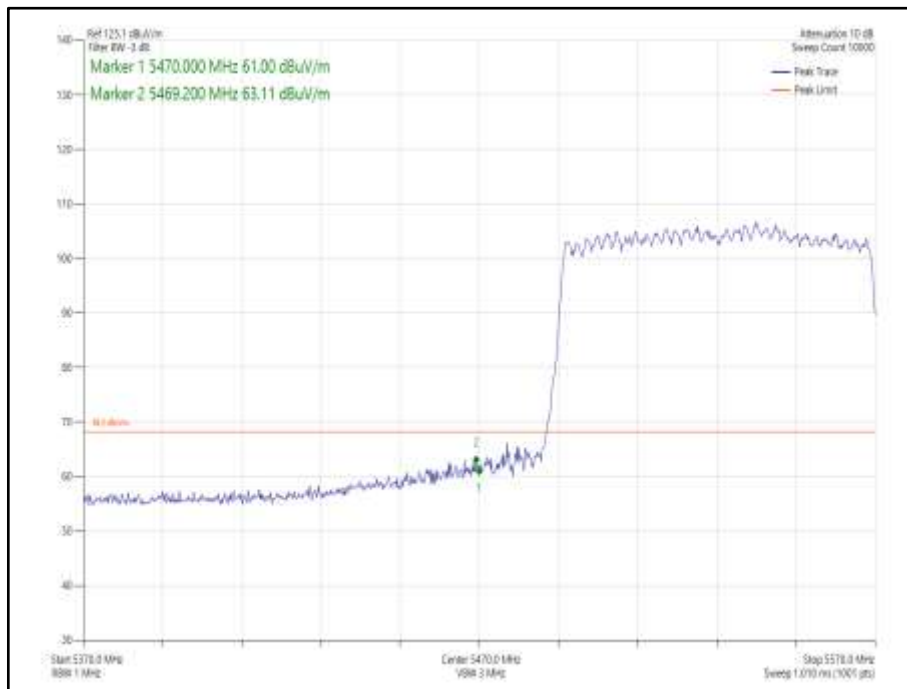


**Figure 1064 - 802.11ac VHT80 CDD, Cores 0-1 - 5530 MHz  
Band Edge Frequency 5470 MHz**

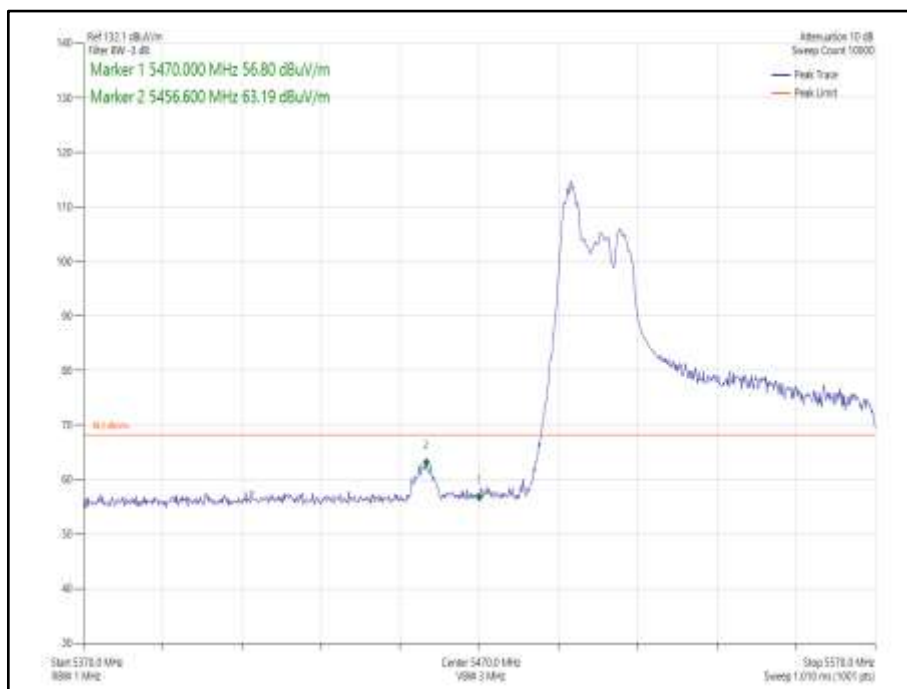


**Figure 1065 - 802.11ac VHT80 SDM, Cores 0-1 - 5530 MHz  
Band Edge Frequency 5470 MHz**





**Figure 1066 - 802.11ax HE80 CDD, Cores 0-1, SU - 5530 MHz  
Band Edge Frequency 5470 MHz**



**Figure 1067 - 802.11ax HE80 CDD, Cores 0-1, 52-37- 5530 MHz  
Band Edge Frequency 5470 MHz**

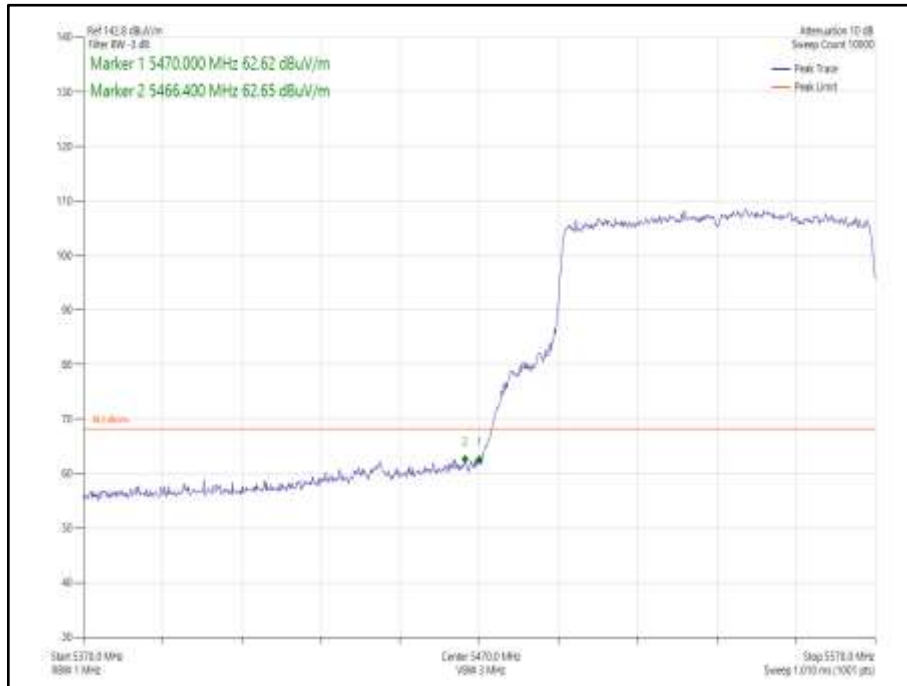


Figure 1068 - 802.11ax HE80 SDM, Cores 0-1, SU - 5530 MHz  
Band Edge Frequency 5470 MHz

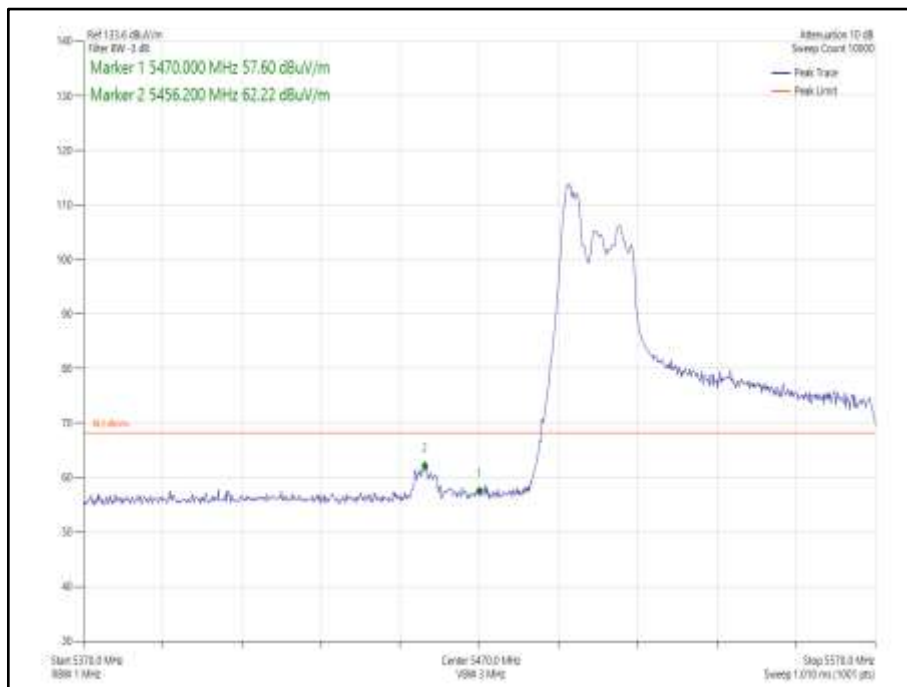
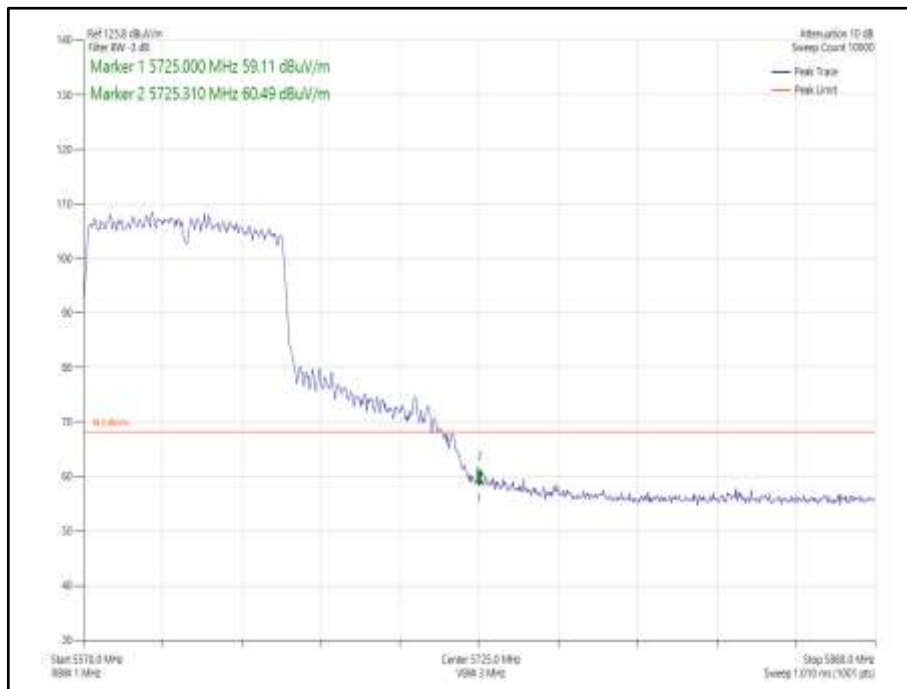
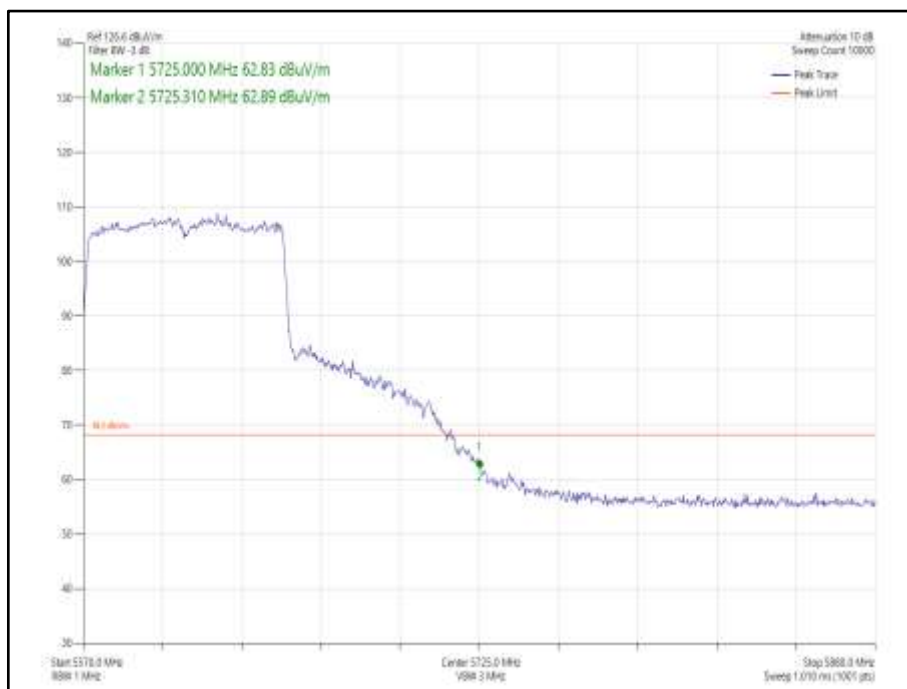


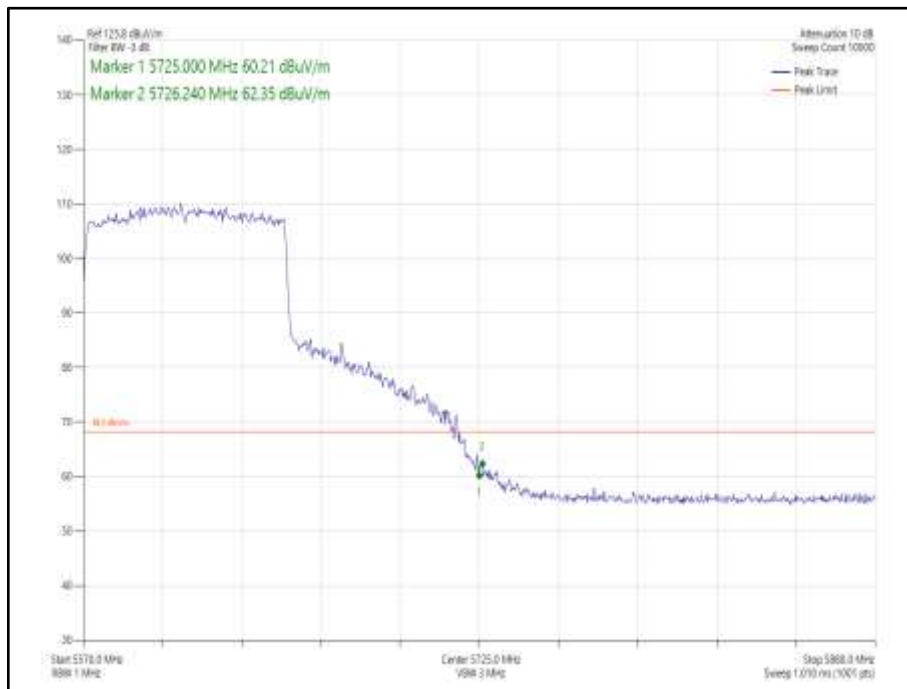
Figure 1069 - 802.11ax HE80 SDM, Cores 0-1, 52-37 - 5530 MHz  
Band Edge Frequency 5470 MHz



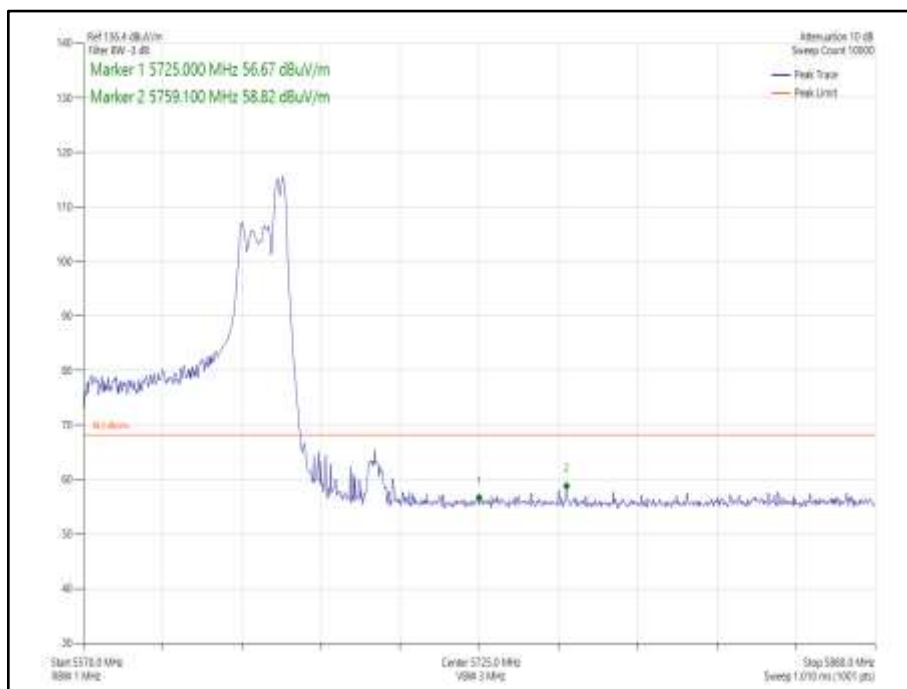
**Figure 1070 - 802.11ac VHT80 CDD, Cores 0-1 - 5610 MHz  
Band Edge Frequency 5725 MHz**



**Figure 1071 - 802.11ac VHT80 SDM, Cores 0-1 - 5610 MHz  
Band Edge Frequency 5725 MHz**



**Figure 1072 - 802.11ax HE80 CDD, Cores 0-1, SU - 5610 MHz  
Band Edge Frequency 5725 MHz**



**Figure 1073 - 802.11ax HE80 CDD, Cores 0-1, 52-52- 5610 MHz  
Band Edge Frequency 5725 MHz**

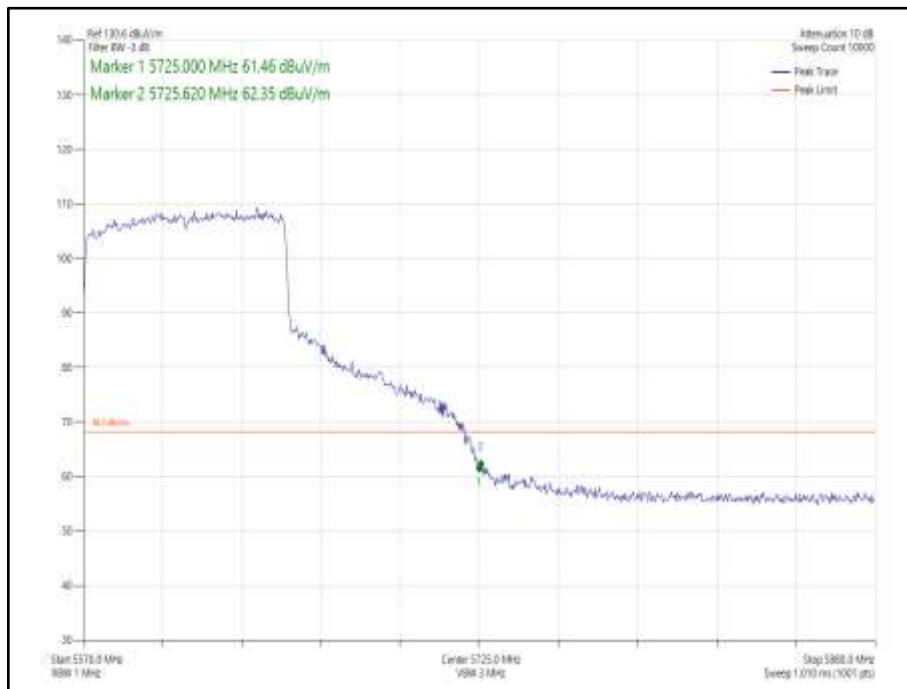


Figure 1074 - 802.11ax HE80 SDM, Cores 0-1, SU - 5610 MHz  
Band Edge Frequency 5725 MHz

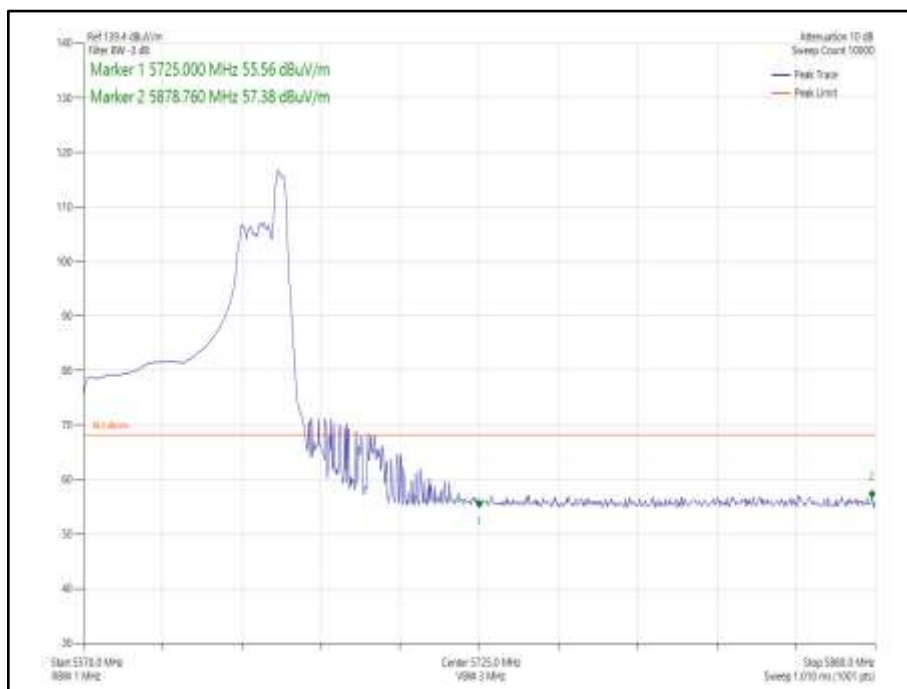
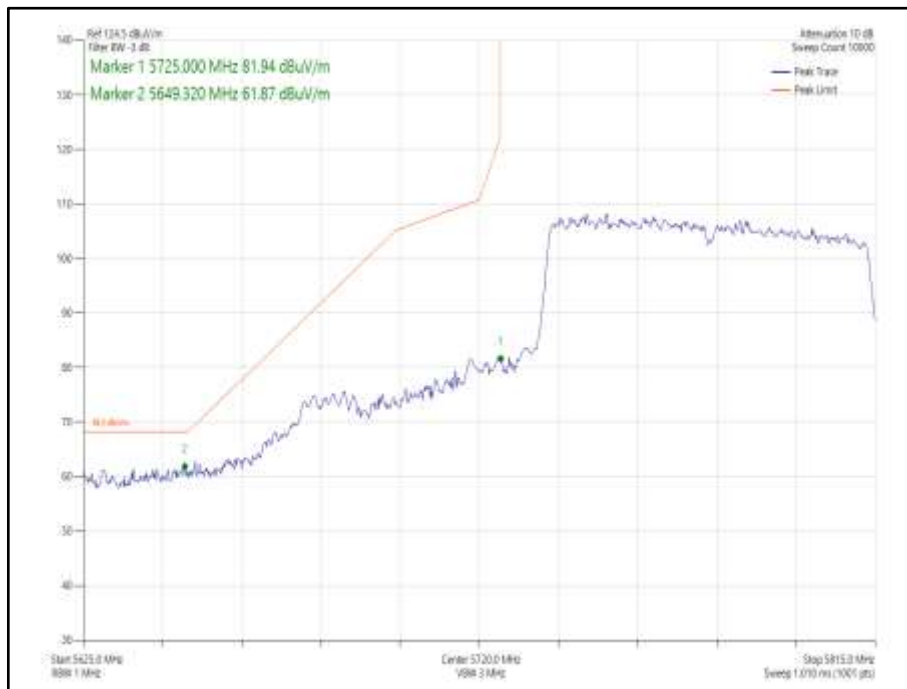
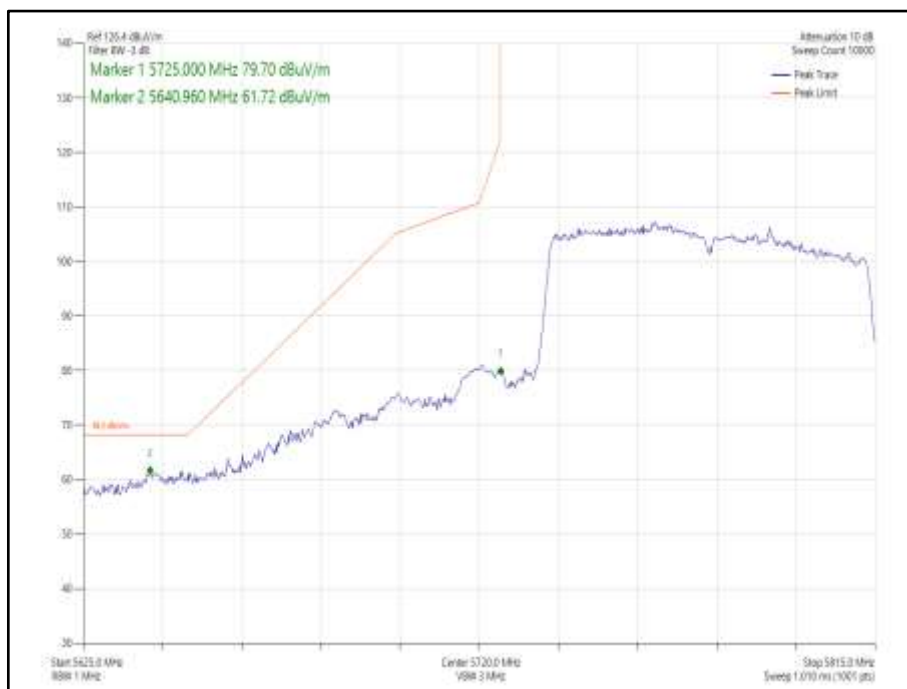


Figure 1075 - 802.11ax HE80 SDM, Cores 0-1, 26-36 - 5610 MHz  
Band Edge Frequency 5725 MHz



**Figure 1076 - 802.11ac VHT80 CDD, Cores 0-1 - 5775 MHz  
Band Edge Frequency 5725 MHz**



**Figure 1077 - 802.11ac VHT80 SDM, Cores 0-1 - 5775 MHz  
Band Edge Frequency 5725 MHz**

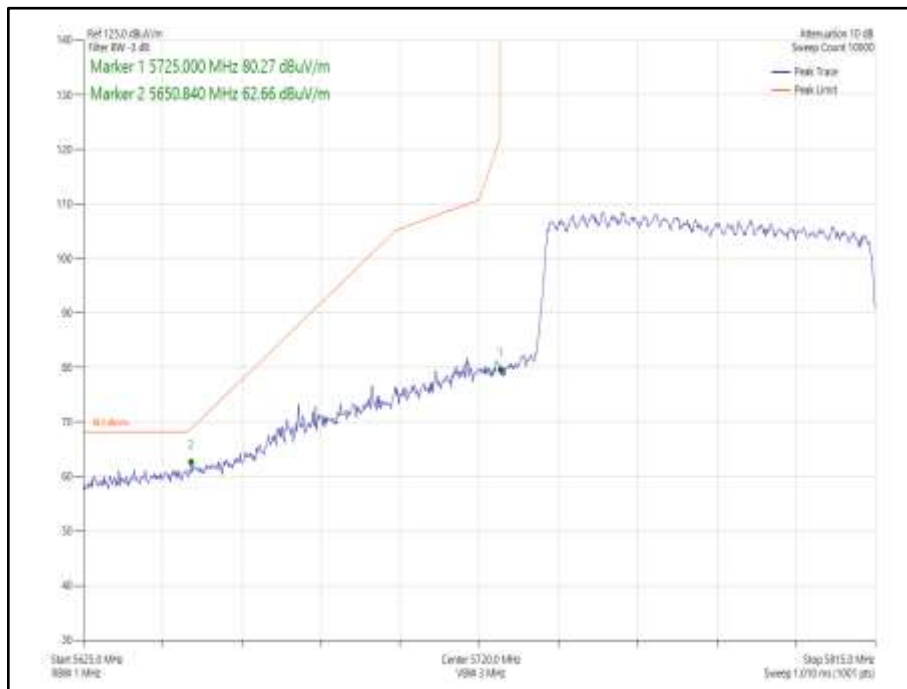


Figure 1078 - 802.11ax HE80 CDD, Cores 0-1, SU - 5775 MHz  
Band Edge Frequency 5725 MHz

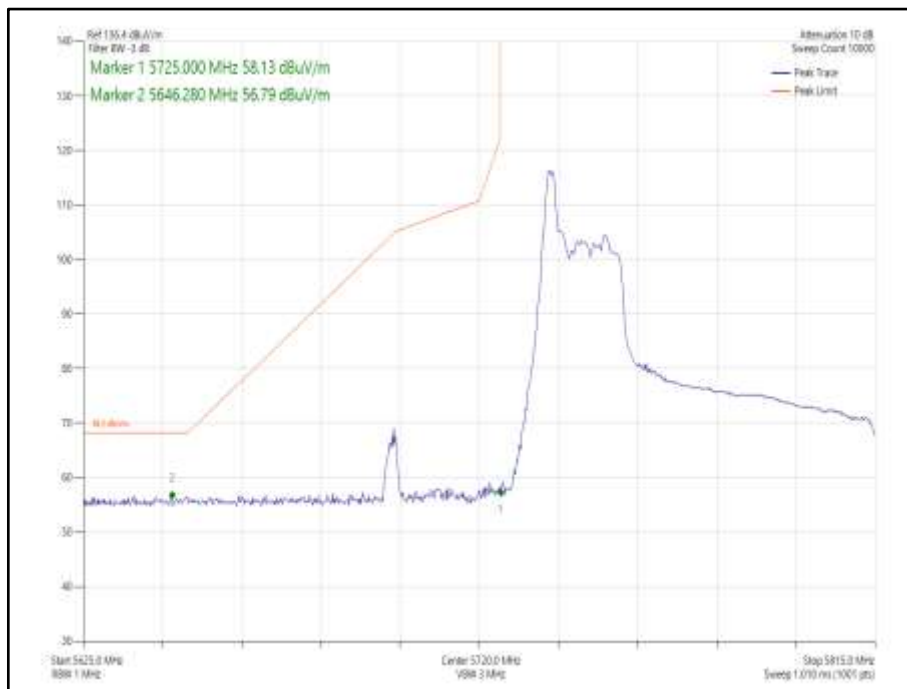
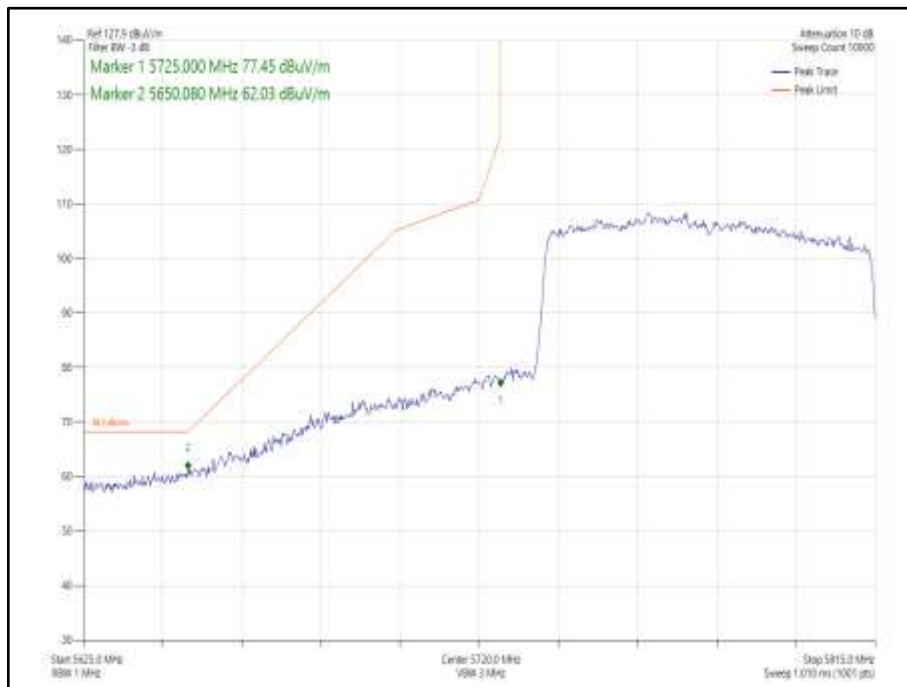
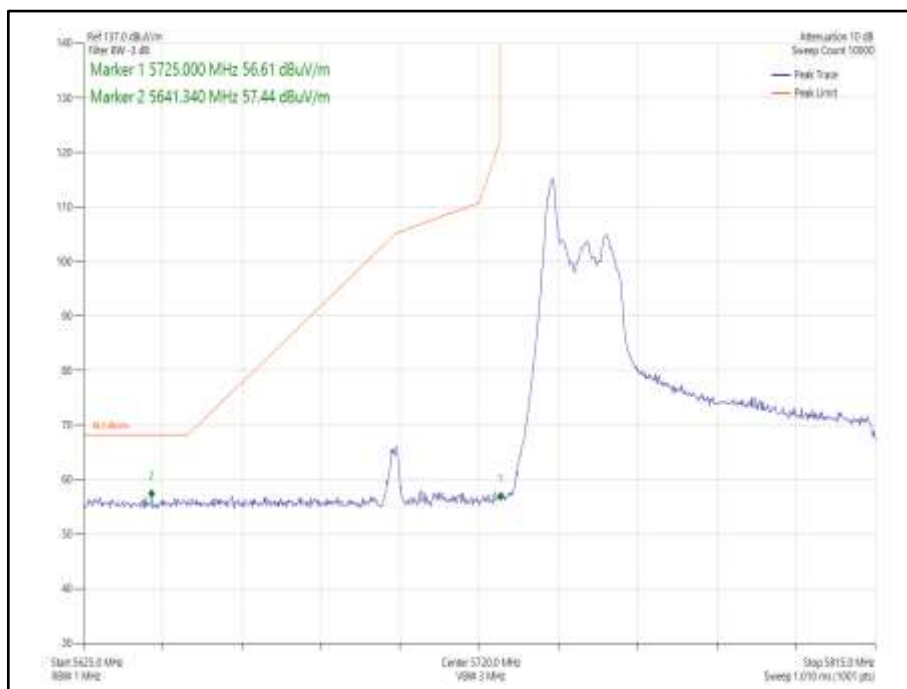


Figure 1079 - 802.11ax HE80 CDD, Cores 0-1, 26-0 - 5775 MHz  
Band Edge Frequency 5725 MHz

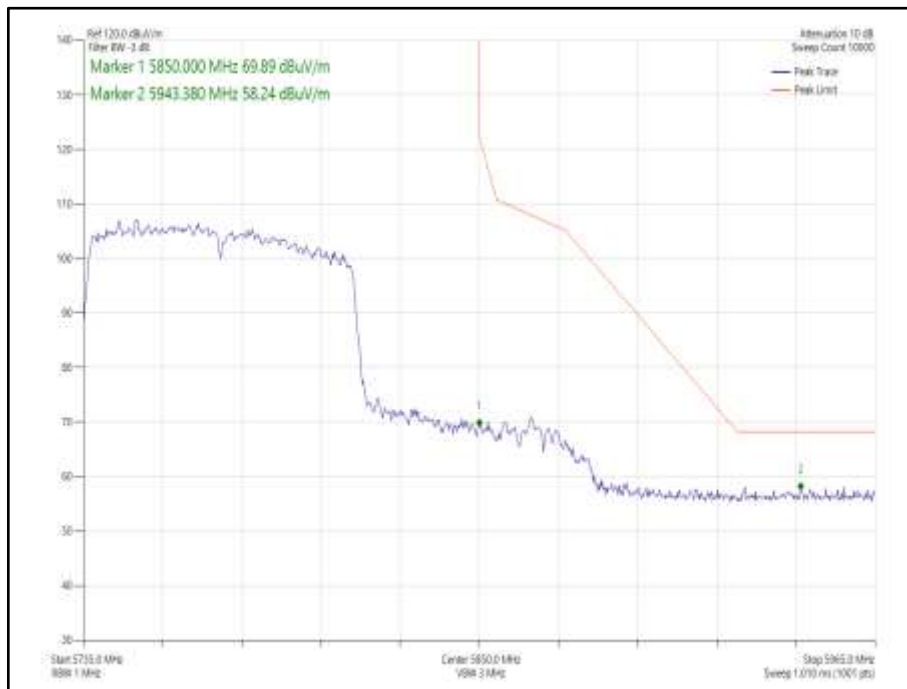


**Figure 1080 - 802.11ax HE80 SDM, Cores 0-1, SU - 5775 MHz  
Band Edge Frequency 5725 MHz**

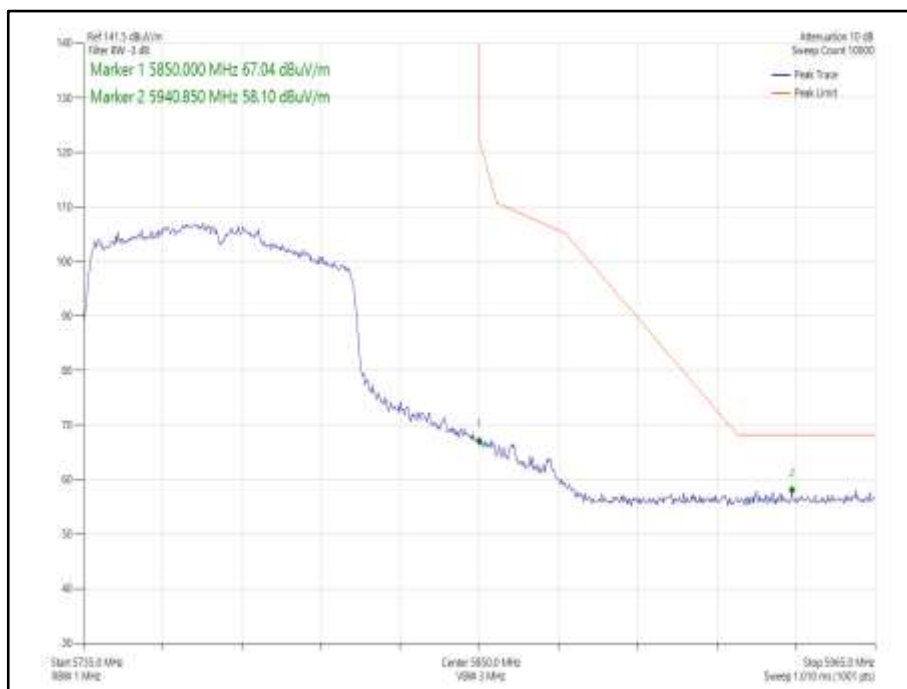


**Figure 1081 - 802.11ax HE80 SDM, Cores 0-1, 26-0 - 5775 MHz  
Band Edge Frequency 5725 MHz**





**Figure 1082 - 802.11ac VHT80 CDD, Cores 0-1 - 5775 MHz  
Band Edge Frequency 5850 MHz**



**Figure 1083 - 802.11ac VHT80 SDM, Cores 0-1 - 5775 MHz  
Band Edge Frequency 5850 MHz**

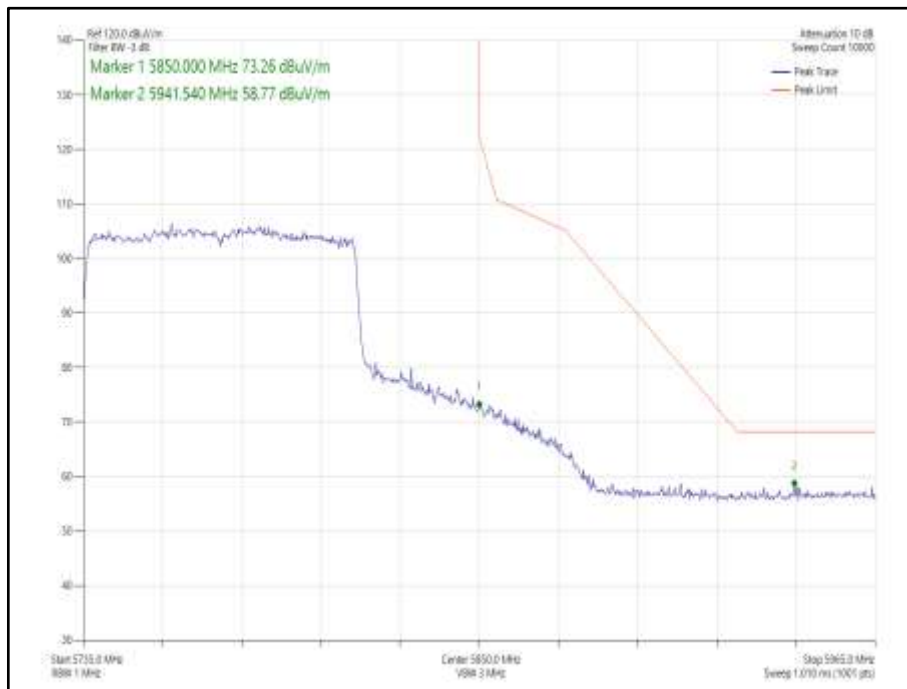


Figure 1084 - 802.11ax HE80 CDD, Cores 0-1, SU - 5775 MHz  
Band Edge Frequency 5850 MHz

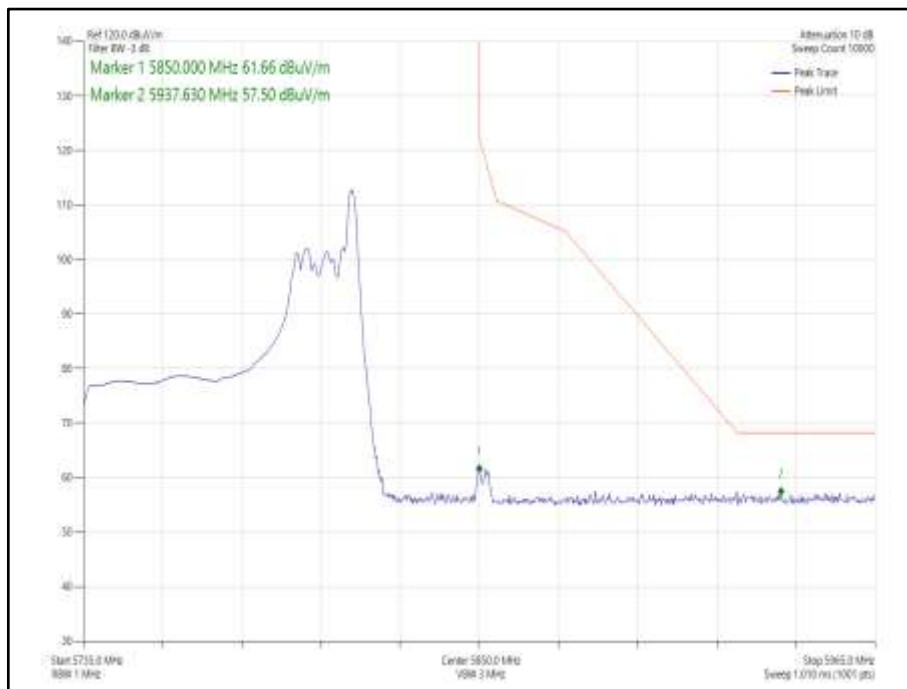


Figure 1085 - 802.11ax HE80 CDD, Cores 0-1, 2d 6-36 - 5775 MHz  
Band Edge Frequency 5850 MHz

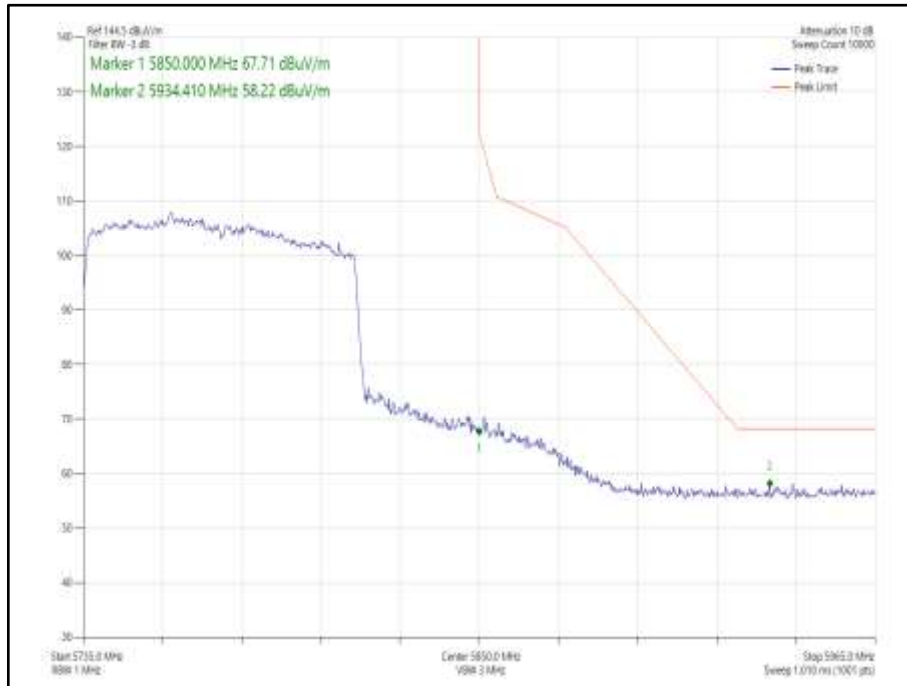


Figure 1086 - 802.11ax HE80 SDM, Cores 0-1, SU -- 5775 MHz  
Band Edge Frequency 5850 MHz

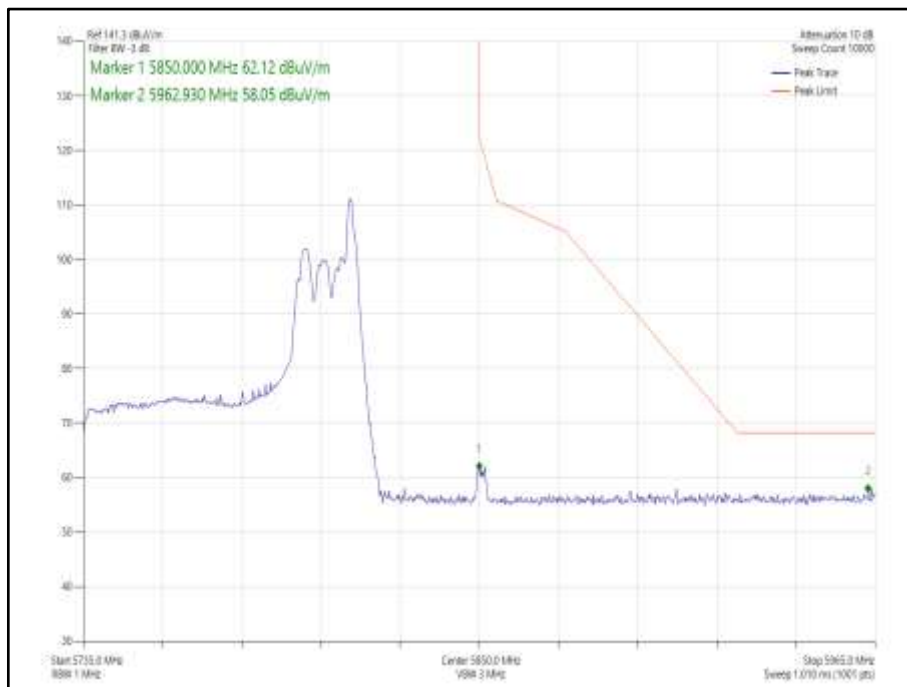


Figure 1087 - 802.11ax HE80 SDM, Cores 0-1, 26-36 - 5775 MHz  
Band Edge Frequency 5850 MHz



FCC 47 CFR Part 15E, Limit Clause 15.407(b)(1)(2)(3)(4)

For transmitters operating in the 5.15-5.25 GHz band:  $\leq -27$  dBm/MHz outside 5150-5350 MHz.

For transmitters operating in the 5.25-5.35 GHz band:  $\leq -27$  dBm/MHz outside 5150-5350 MHz.

For transmitters operating in the 5.47-5.725 GHz band:  $\leq -27$  dBm/MHz outside 5470-5725 MHz

For transmitters operating in the 5.725-5.85 GHz band: All emissions shall be limited to a level of -27 dBm/MHz at 75 MHz or more above or below the band edge increasing linearly to 10 dBm/MHz at 25 MHz above or below the band edge, and from 25 MHz above or below the band edge increasing linearly to a level of 15.6 dBm/MHz at 5 MHz above or below the band edge, and from 5 MHz above or below the band edge increasing linearly to a level of 27 dBm/MHz at the band edge.

ISED RSS-247, Limit Clause 6.2.1.2, 6.2.2.2, 6.2.3.2 and 6.2.4.2

For transmitters with operating frequencies in the band 5150-5250 MHz, all emissions outside the band 5150-5350 MHz shall not exceed -27 dBm/MHz e.i.r.p. Any unwanted emissions that fall into the band 5250-5350 MHz shall be attenuated below the channel power by at least 26 dB.

For transmitters with operating frequencies in the bands 5250-5350 MHz and 5470-5725 MHz, all emissions outside the band 5250-5350 MHz and 5470-5725 MHz shall not exceed -27 dBm/MHz e.i.r.p.

Devices operating in the band 5725-5850 MHz shall have e.i.r.p. of unwanted emissions comply with the following:

- a) 27 dBm/MHz at frequencies from the band edges decreasing linearly to 15.6 dBm/MHz at 5 MHz above or below the band edges;
- b) 15.6 dBm/MHz at 5 MHz above or below the band edges decreasing linearly to 10 dBm/MHz at 25 MHz above or below the band edges;
- c) 10 dBm/MHz at 25 MHz above or below the band edges decreasing linearly to -27 dBm/MHz at 75 MHz above or below the band edges; and

-27 dBm/MHz at frequencies more than 75 MHz above or below the band edges.



**2.5.7 Test Location and Test Equipment Used**

This test was carried out in RF Chamber 11.

Instrument	Manufacturer	Type No	TE No	Calibration Period (months)	Calibration Expires
EMI Test Receiver	Rohde & Schwarz	ESW44	5084	12	08-Mar-2022
Emissions Software	TUV SUD	EmX V2.1.11	5125	-	Software
Mast and Turntable Controller	Maturo	Maturo NCD	5159	-	TU
Horn Antenna (1-10GHz)	Schwarzbeck	BBHA 9120 B	5215	12	01-Apr-2022
Preamp 1 - 26.5 GHz	Agilent Technologies	8449B	5445	12	6-May-2022
1m SMA Cable	Junkosha	MWX221-01000AMSAMS/A	5513	12	9-Apr-2022
2m SMA Cable	Junkosha	MWX221-02000AMSAMS/A	5518	12	09-Apr-2022
8m N Type Cable	Junkosha	MWX221-08000NMSNMS/B	5522	12	24-Mar-2022
Thermo-Hygro-Barometer	PCE Instruments	PCE-THB 40	5604	12	22-Sep-2022

**Table 677**

TU - Traceability Unscheduled



## **2.6 Spurious Radiated Emissions**

### **2.6.1 Specification Reference**

FCC 47 CFR Part 15E Clause 15.407 (b)  
ISED RSS-247, Clause 6.2 and 6.13  
ISED RSS-GEN, Clause 8.9

### **2.6.2 Equipment Under Test and Modification State**

A2615, S/N: P1F4F29DL4 - Modification State 0

### **2.6.3 Date of Test**

11-November-2021 to 19-November-2021

### **2.6.4 Test Method**

Testing was performed in accordance with ANSI C63.10, clause 6.3, 6.5 and 6.6.

Tests were performed in HT20 CDD in 2TX MIMO mode on the Main Radio, with measurements undertaken from 30 MHz to 40 GHz, on channel 36 (5180 MHz) and channel 165 (5825 MHz).

All testing was performed using the lowest data rate/modulation scheme for the applicable mode since this was declared worst case by the customer.

For the purpose of this testing, spurious emissions were limited to 1 GHz to 40 GHz on all other test channels.

Plots for average measurements were taken in accordance with ANSI C63.10, clause 12.7.7.2 with max-hold trace to characterize the EUT. Where emissions were detected, final average measurements were taken in accordance with ANSI C63.10, clause 4.1.4.2.2.

The plots shown are the characterization of the EUT. The limits on the plots represent the most stringent case for restricted bands, (54/74 dBuV/m @ 3 m and 64/84 dBuV/m @ 1m) when compared to -27 dBm/MHz EIRP outside restricted bands. The limits shown have been used as a threshold to determine where further measurements are necessary. Where results are within 10dB of the limits shown on the plots, further investigation was carried out and reported in results tables.

Final measurements in the plots are not duty cycle corrected. These have been corrected in the result tables in cases where the EUT was operating at <98% duty cycle and the emission is temporally related to the fundamental.

The following conversion can be applied to convert from dBuV/m to uV/m:  
 $10^{(\text{Field Strength in dB}\mu\text{V/m}/20)}$ .

EIRP was converted to field strength at 3m using the following formula:  
Field Strength (dBuV/m at 3 m) = EIRP (dBm) + 95.2 dB

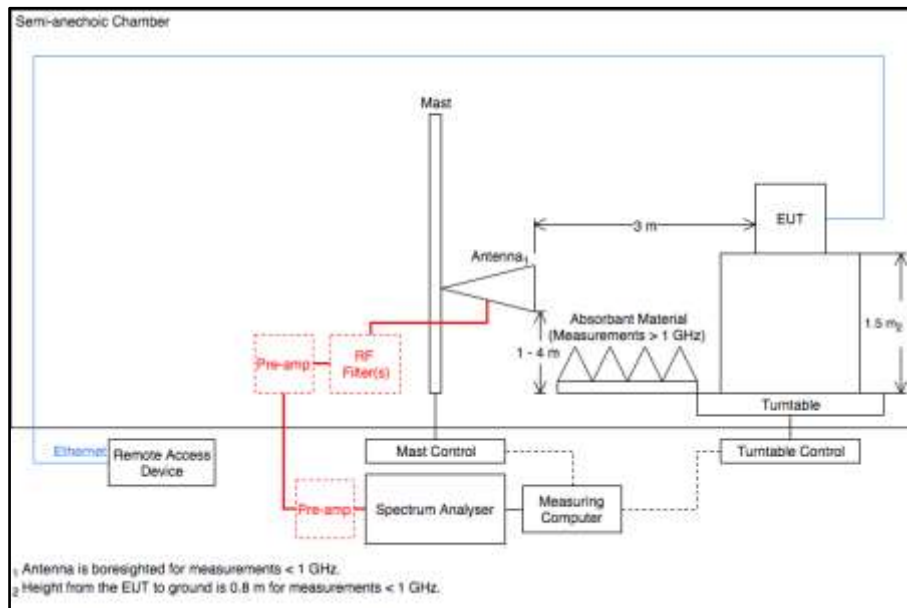


Figure 1088 - Radiated Emissions Test Setup Diagram

### 2.6.5 Environmental Conditions

Ambient Temperature	20.3 – 22.8°C
Relative Humidity	22.8 – 51.1%



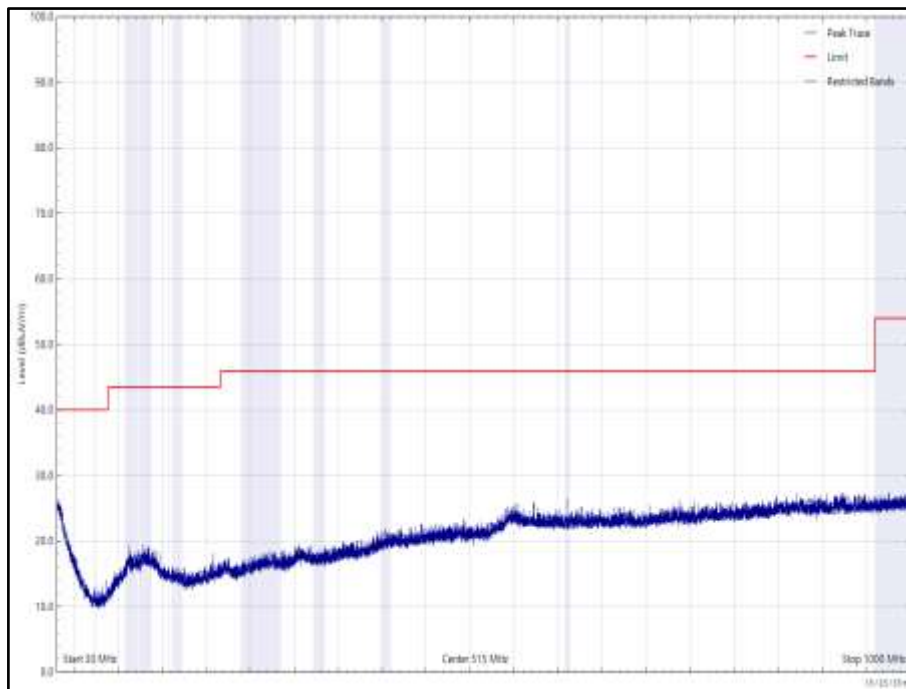
**2.6.6 Test Results**

5 GHz WLAN

Frequency (MHz)	Level (dBµV/m)	Limit (dBµV/m)	Margin (dB)	Detector	Angle (°)	Height (cm)	Polarisation
*							

**Table 678 - 5180 MHz (CH36), 802.11a, Core 0, 30 MHz to 40 GHz**

\*No emissions found within 6 dB of the limit.



**Figure 1089 - 5180 MHz (CH36), 802.11a, Core 0, 30 MHz to 1 GHz, Horizontal (Peak)**



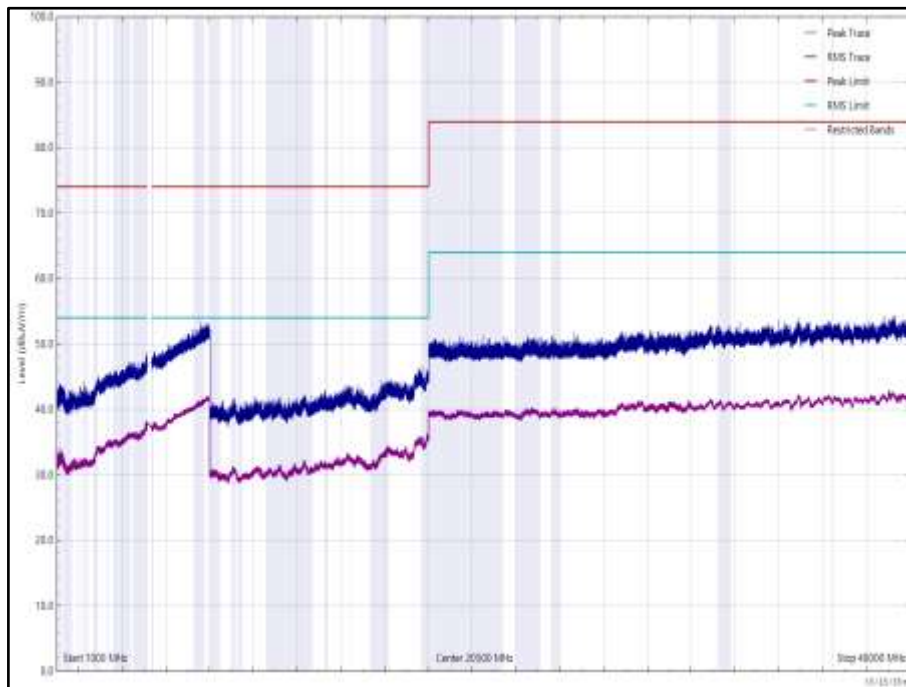


Figure 1090 - 5180 MHz (CH36), 802.11a, Core 0, 1 GHz to 40 GHz, Horizontal

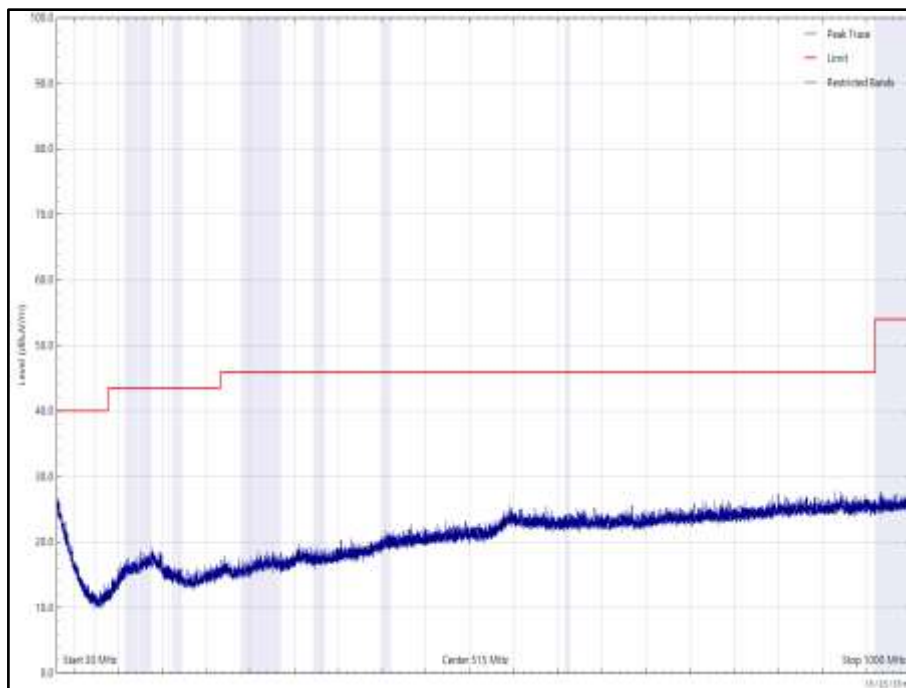


Figure 1091 - 5180 MHz (CH36), 802.11a, Core 0, 30 MHz to 1 GHz, Vertical (Peak)

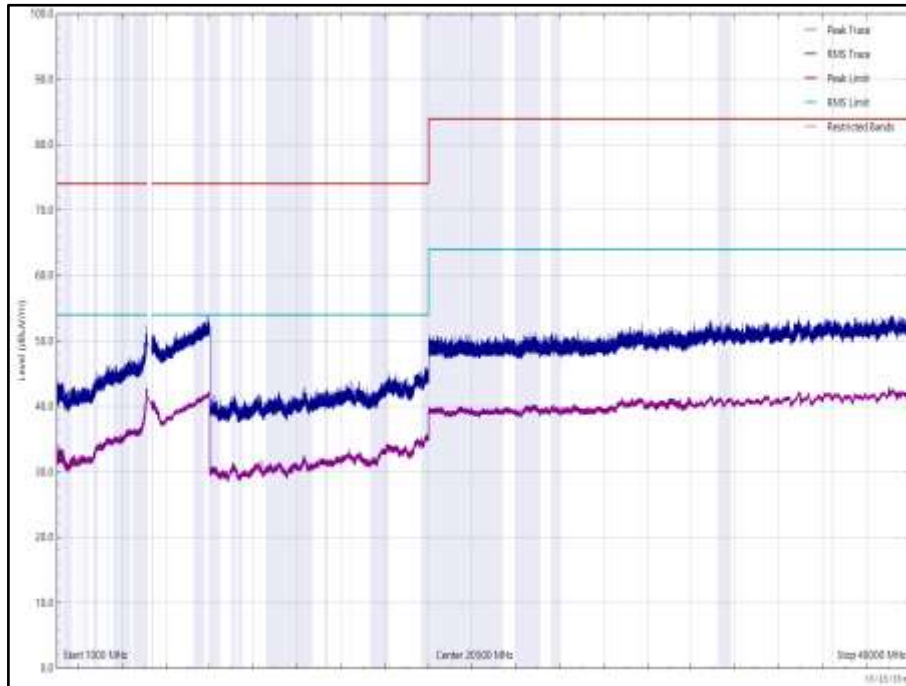


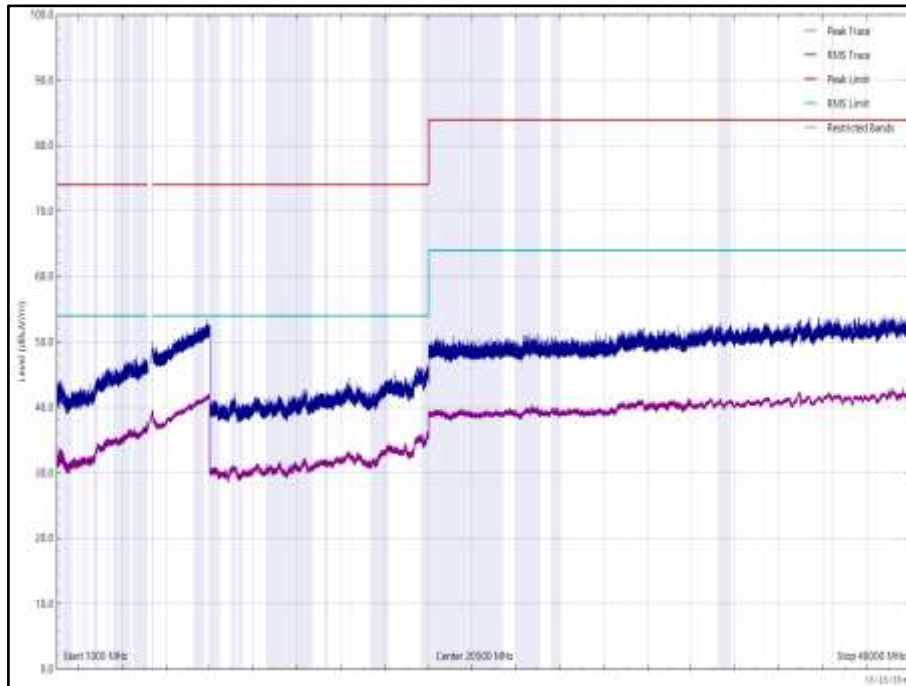
Figure 1092 - 5180 MHz (CH36), 802.11a, Core 0, 1 GHz to 40 GHz, Vertical



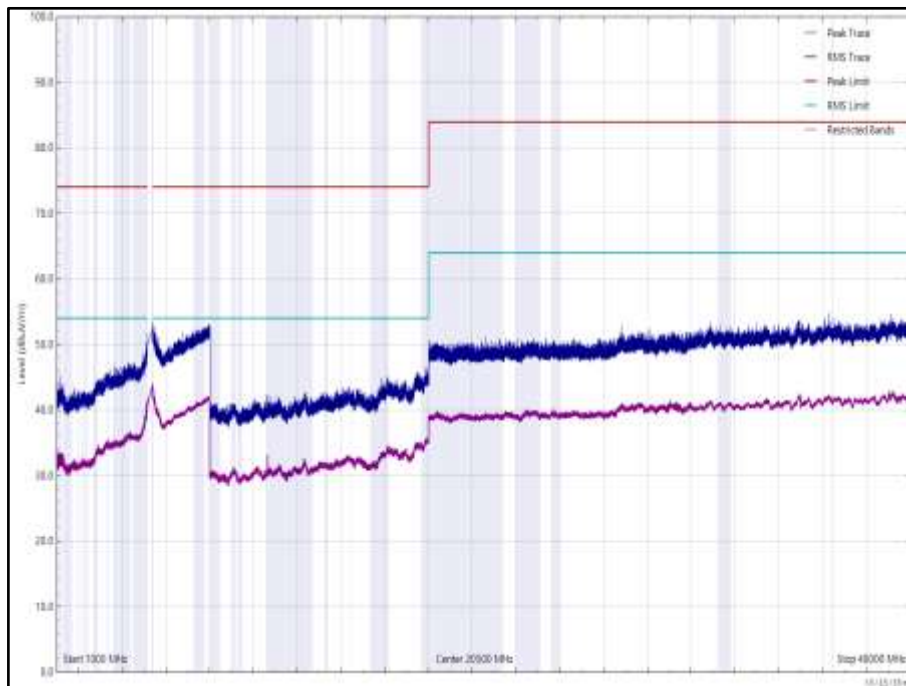
Frequency (MHz)	Level (dBµV/m)	Limit (dBµV/m)	Margin (dB)	Detector	Angle (°)	Height (cm)	Polarisation
*							

**Table 679 - 5320 MHz (CH64), 802.11a, Core 0, 1 GHz to 40 GHz**

\*No emissions found within 6 dB of the limit.



**Figure 1093 - 5320 MHz (CH64), 802.11a, Core 0, 1 GHz to 40 GHz, Horizontal**



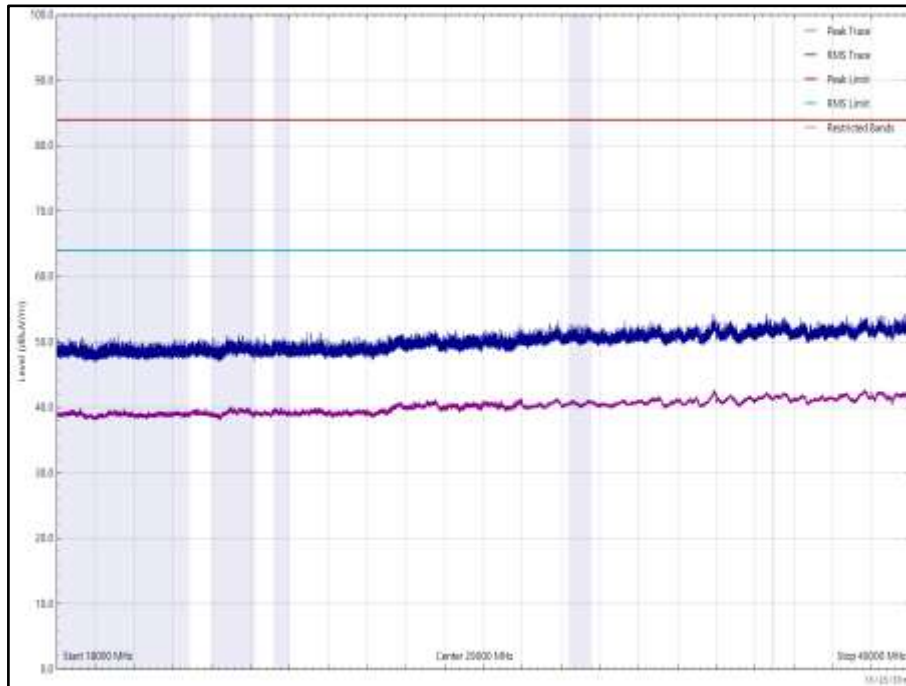
**Figure 1094 - 5320 MHz (CH64), 802.11a, Core 0, 1 GHz to 40 GHz, Vertical**



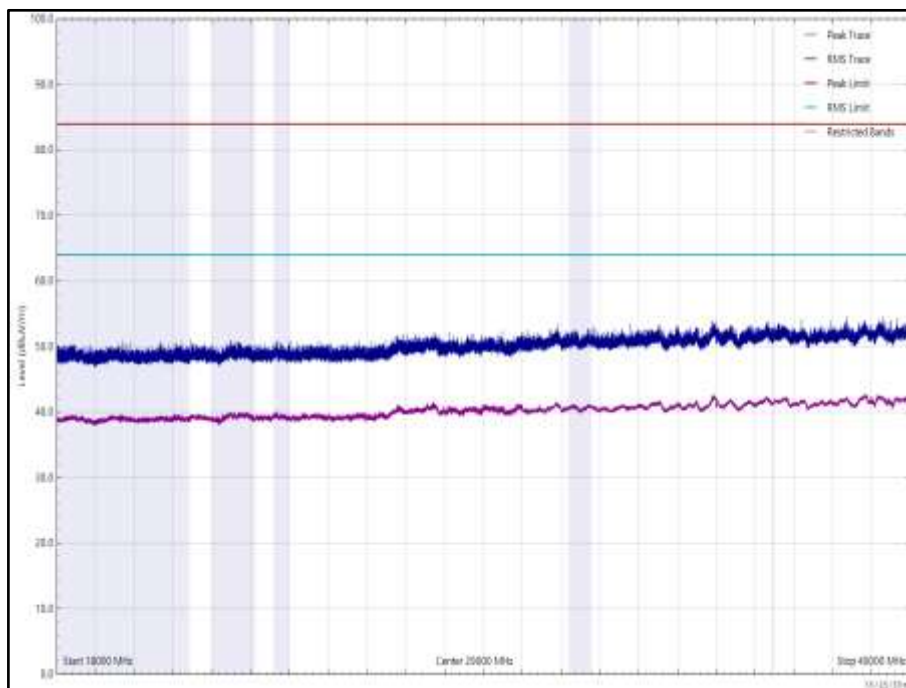
Frequency (MHz)	Level (dBµV/m)	Limit (dBµV/m)	Margin (dB)	Detector	Angle (°)	Height (cm)	Polarisation
*							

**Table 680 - 5180 MHz (CH100), 802.11a, Core 0, 18 GHz to 40 GHz**

\*No emissions found within 6 dB of the limit.



**Figure 1095 - 5180 MHz (CH100), 802.11a, Core 0, 18 GHz to 40 GHz, Horizontal**



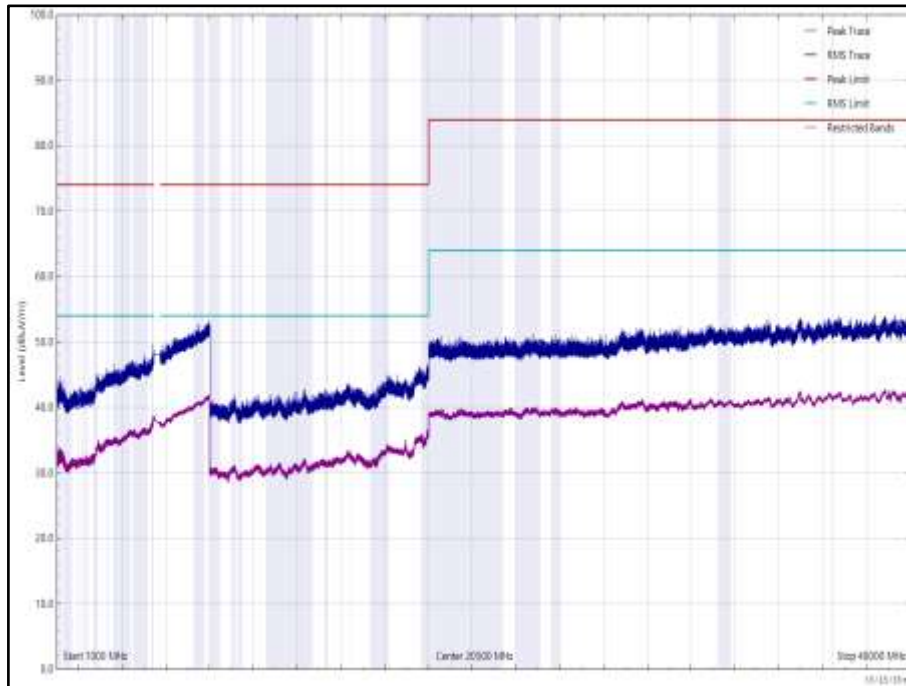
**Figure 1096 - 5180 MHz (CH100), 802.11a, Core 0, 18 GHz to 40 GHz, Vertical**



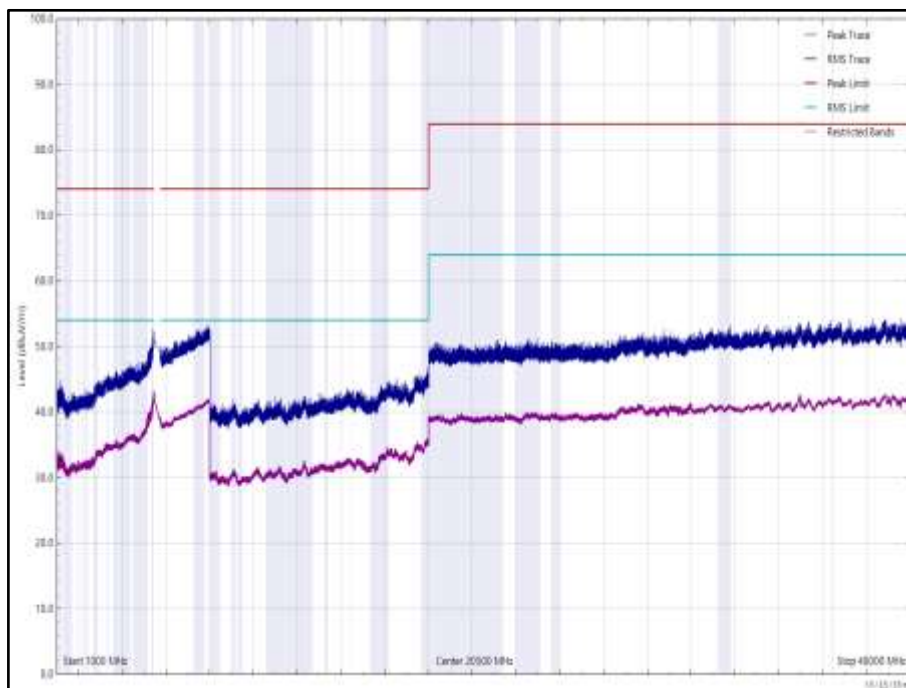
Frequency (MHz)	Level (dBµV/m)	Limit (dBµV/m)	Margin (dB)	Detector	Angle (°)	Height (cm)	Polarisation
*							

**Table 681 - 5500 MHz (CH100), 802.11a, Core 0, 1 GHz to 40 GHz**

\*No emissions found within 6 dB of the limit.



**Figure 1097 - 5500 MHz (CH100), 802.11a, Core 0, 1 GHz to 40 GHz, Horizontal**



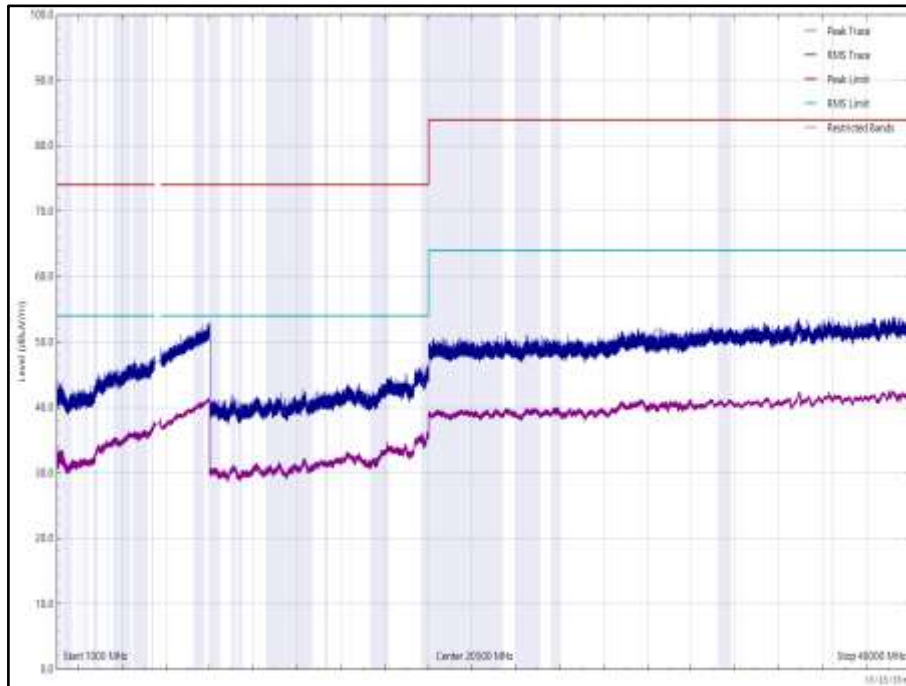
**Figure 1098 - 5500 MHz (CH100), 802.11a, Core 0, 1 GHz to 40 GHz, Vertical**



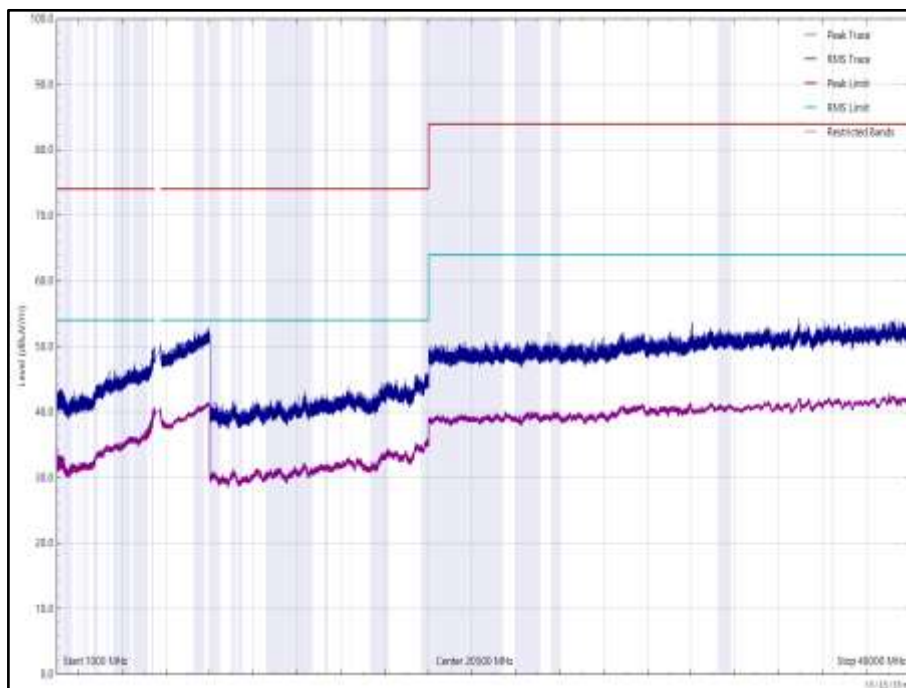
Frequency (MHz)	Level (dBµV/m)	Limit (dBµV/m)	Margin (dB)	Detector	Angle (°)	Height (cm)	Polarisation
*							

**Table 682 - 5700 MHz (CH140), 802.11a, Core 0, 1 GHz to 40 GHz**

\*No emissions found within 6 dB of the limit.



**Figure 1099 - 5700 MHz (CH140), 802.11a, Core 0, 1 GHz to 40 GHz, Horizontal**



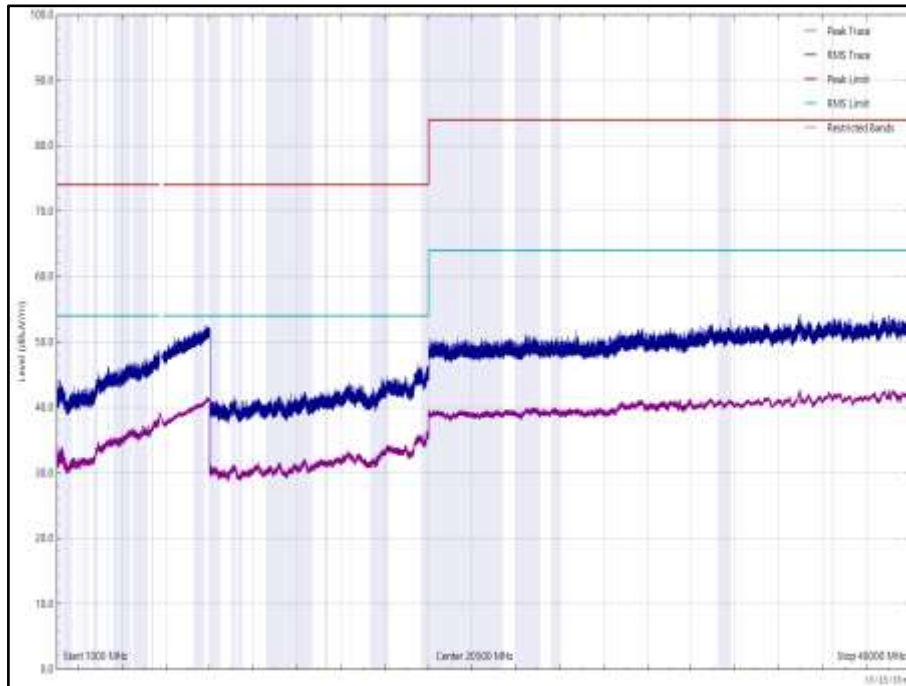
**Figure 1100 - 5700 MHz (CH140), 802.11a, Core 0, 1 GHz to 40 GHz, Vertical**



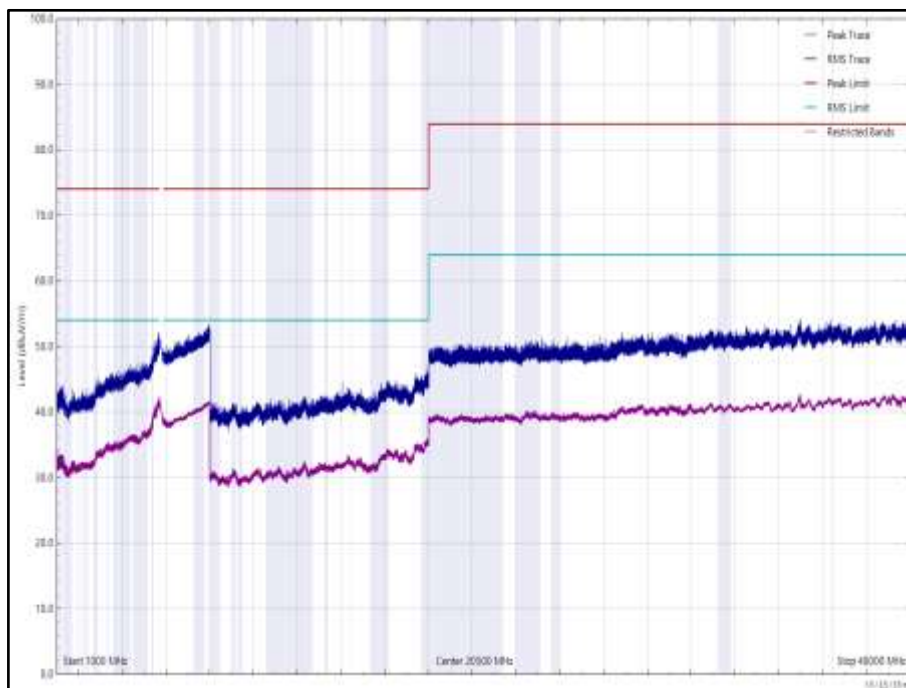
Frequency (MHz)	Level (dBµV/m)	Limit (dBµV/m)	Margin (dB)	Detector	Angle (°)	Height (cm)	Polarisation
*							

**Table 683 - 5745 MHz (CH149), 802.11a, Core 0, 1 GHz to 40 GHz**

\*No emissions found within 6 dB of the limit.



**Figure 1101 - 5745 MHz (CH149), 802.11a, Core 0, 1 GHz to 40 GHz, Horizontal**



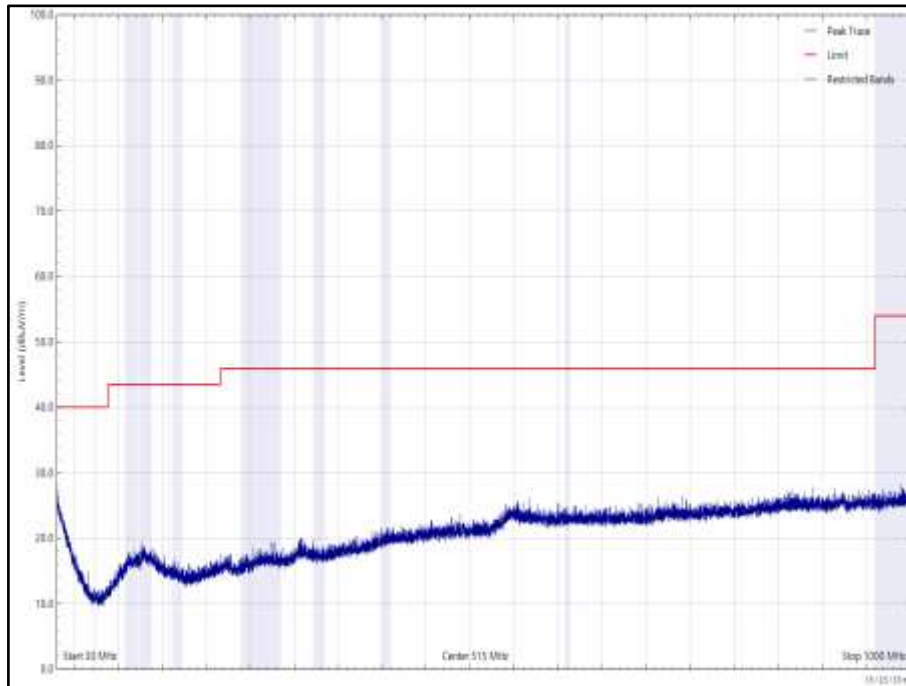
**Figure 1102 - 5745 MHz (CH149), 802.11a, Core 0, 1 GHz to 40 GHz, Vertical**



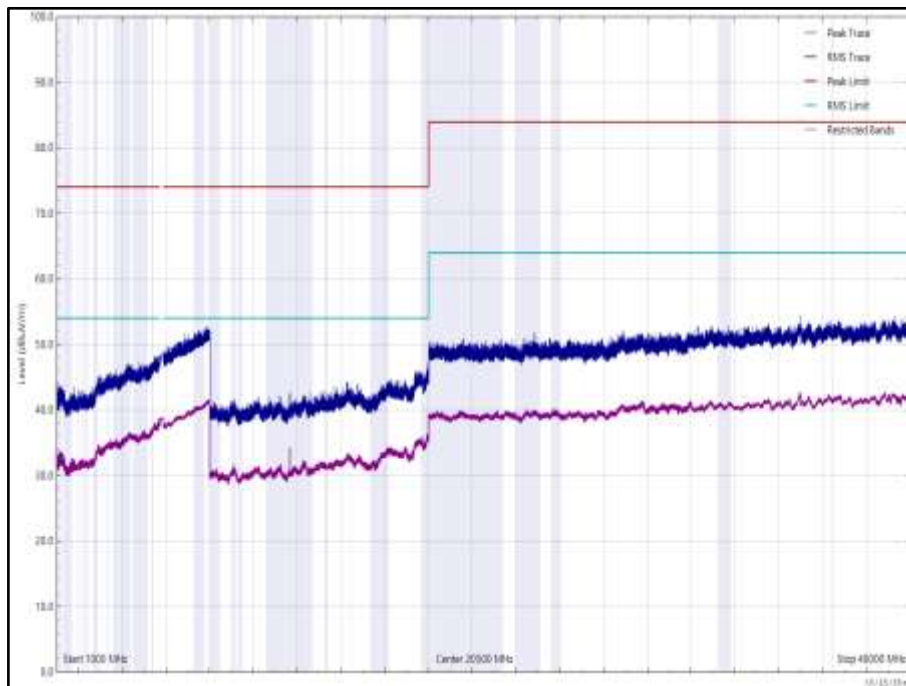
Frequency (MHz)	Level (dBµV/m)	Limit (dBµV/m)	Margin (dB)	Detector	Angle (°)	Height (cm)	Polarisation
11651.090	37.8	54.0	-16.2	RMS	204	128	Vertical

**Table 684 - 5825 MHz (CH165), 802.11a, Core 0, 30 MHz to 40 GHz**

No other emissions found within 6 dB of the limit.



**Figure 1103 - 5825 MHz (CH165), 802.11a, Core 0, 30 MHz to 1 GHz, Horizontal (Peak)**



**Figure 1104 - 5825 MHz (CH165), 802.11a, Core 0, 1 GHz to 40 GHz, Horizontal**



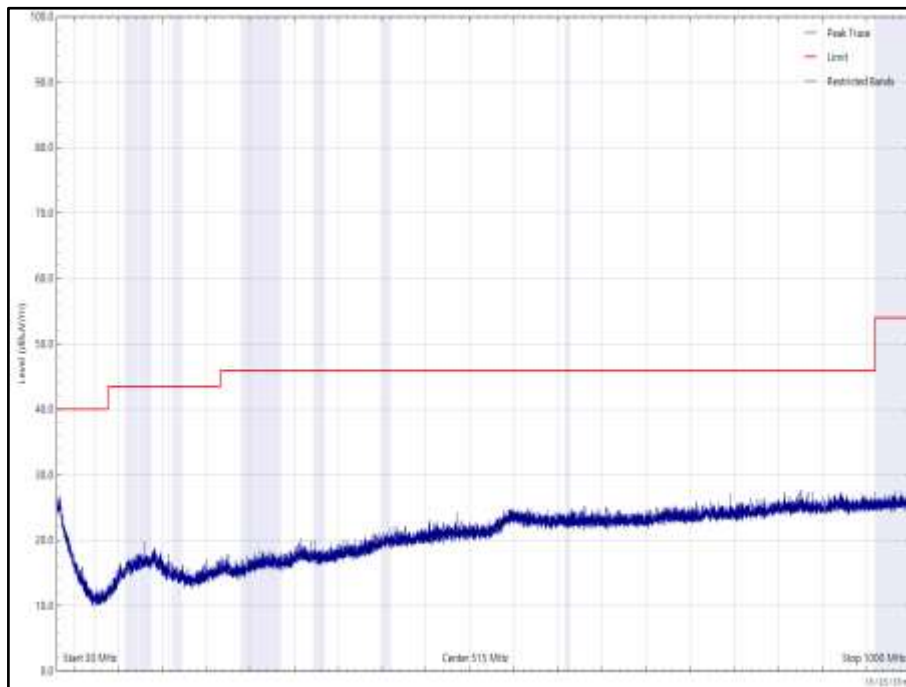


Figure 1105 - 5825 MHz (CH165), 802.11a, Core 0, 30 MHz to 1 GHz, Vertical (Peak)

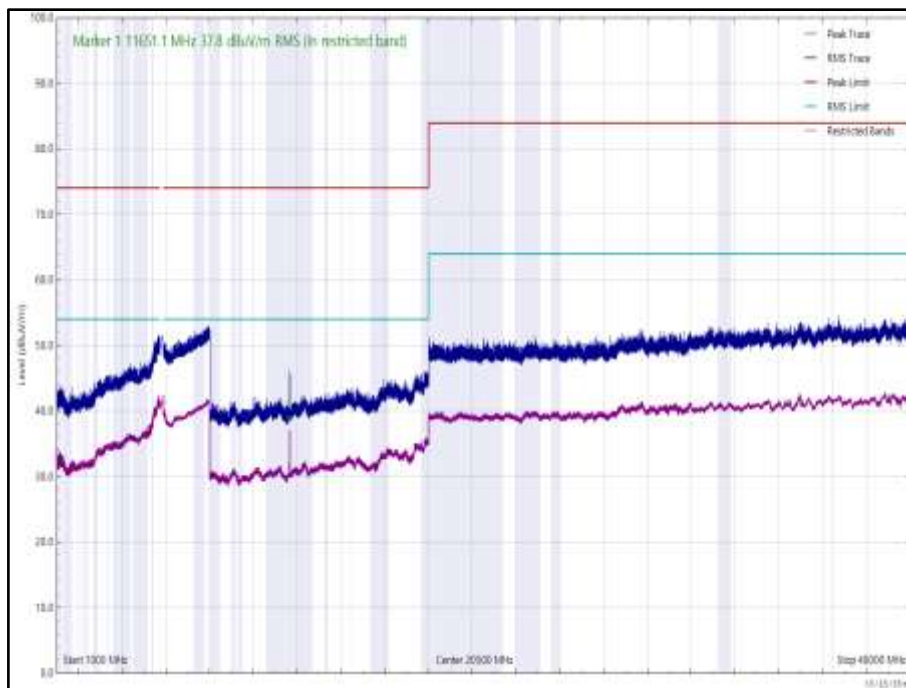


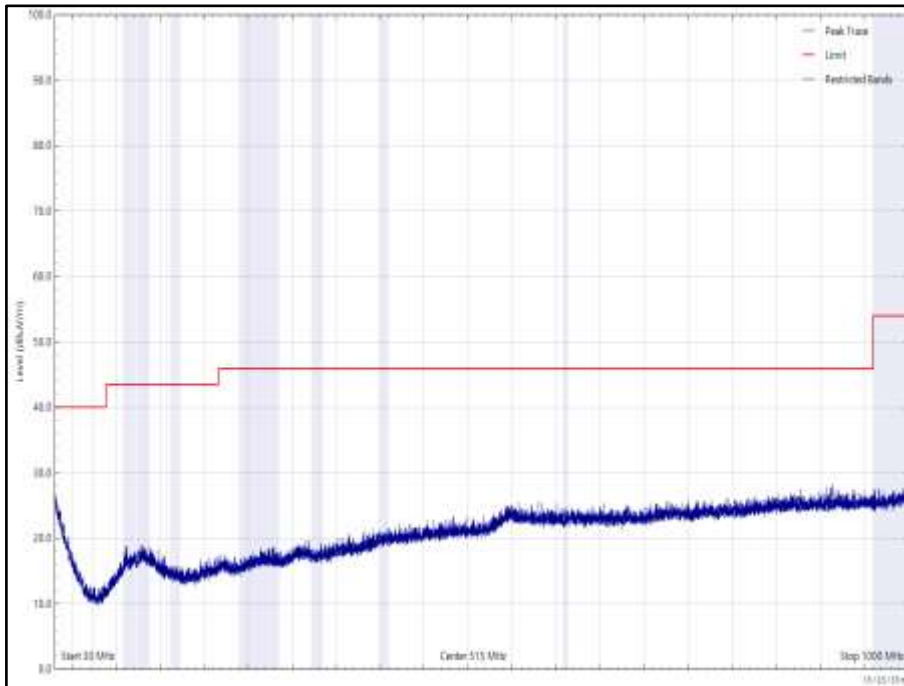
Figure 1106 - 5825 MHz (CH165), 802.11a, Core 0, 1 GHz to 40 GHz, Vertical



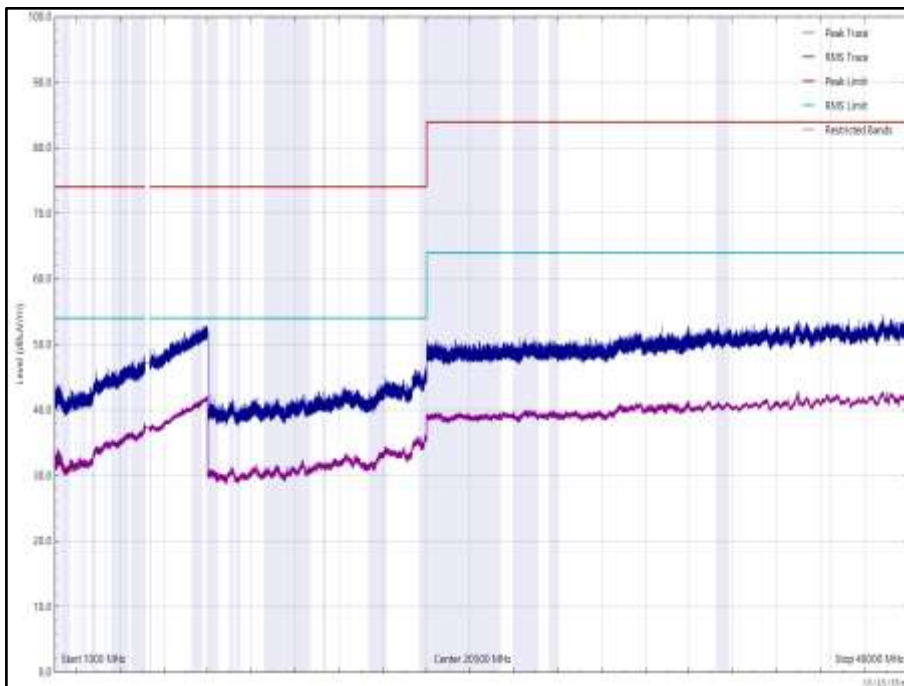
Frequency (MHz)	Level (dBµV/m)	Limit (dBµV/m)	Margin (dB)	Detector	Angle (°)	Height (cm)	Polarisation
*							

**Table 685 - 5180 MHz (CH36), 802.11a, Core 1, 30 MHz to 40 GHz**

\*No emissions found within 6 dB of the limit.



**Figure 1107 - 5180 MHz (CH36), 802.11a, Core 1, 30 MHz to 1 GHz, Horizontal (Peak)**



**Figure 1108 - 5180 MHz (CH36), 802.11a, Core 1, 1 GHz to 40 GHz, Horizontal**

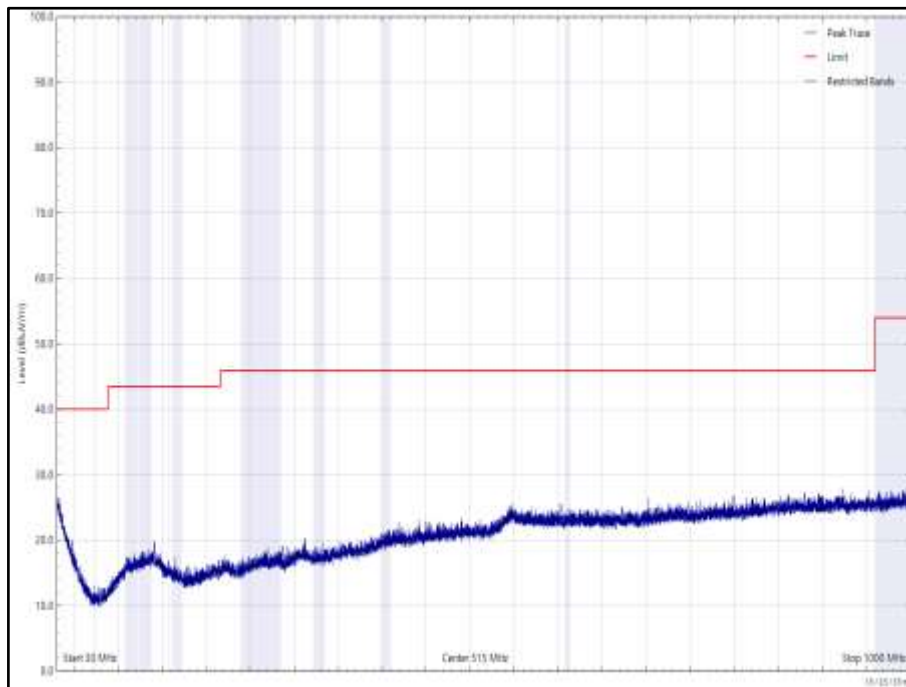


Figure 1109 - 5180 MHz (CH36), 802.11a, Core 1, 30 MHz to 1 GHz, Vertical (Peak)

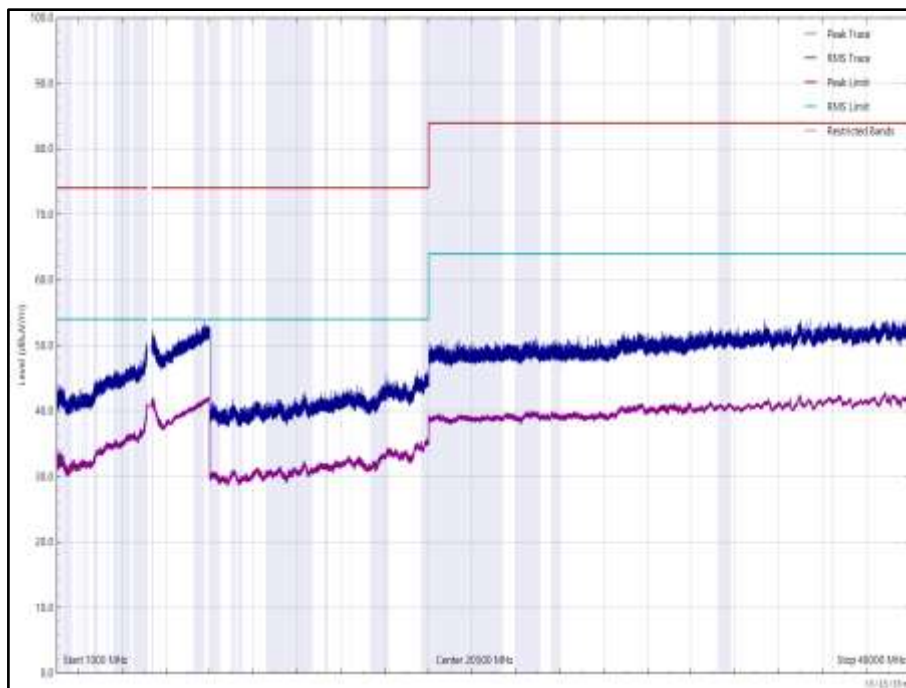


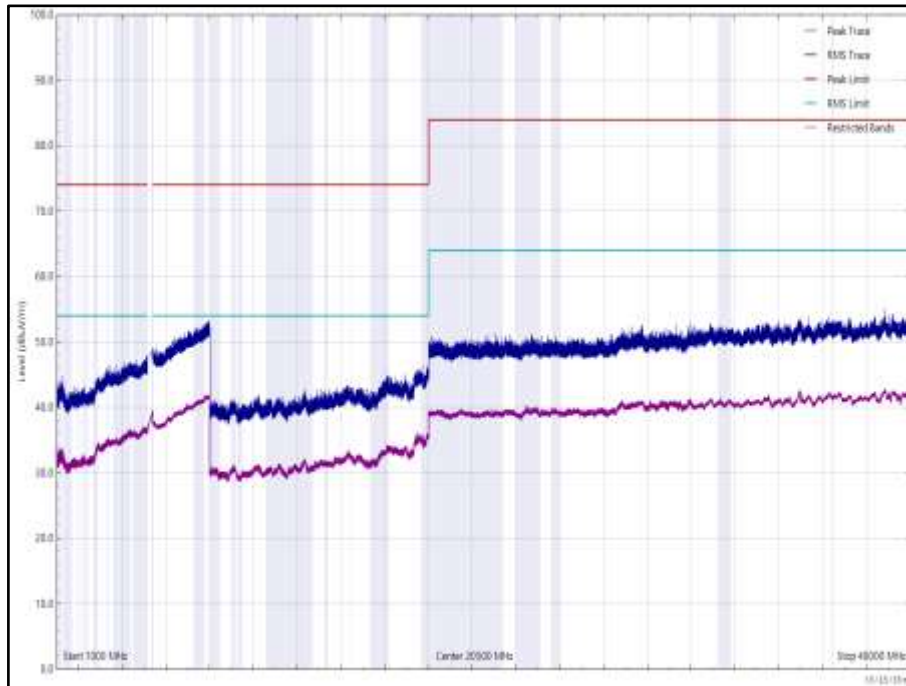
Figure 1110 - 5180 MHz (CH36), 802.11a, Core 1, 1 GHz to 40 GHz, Vertical



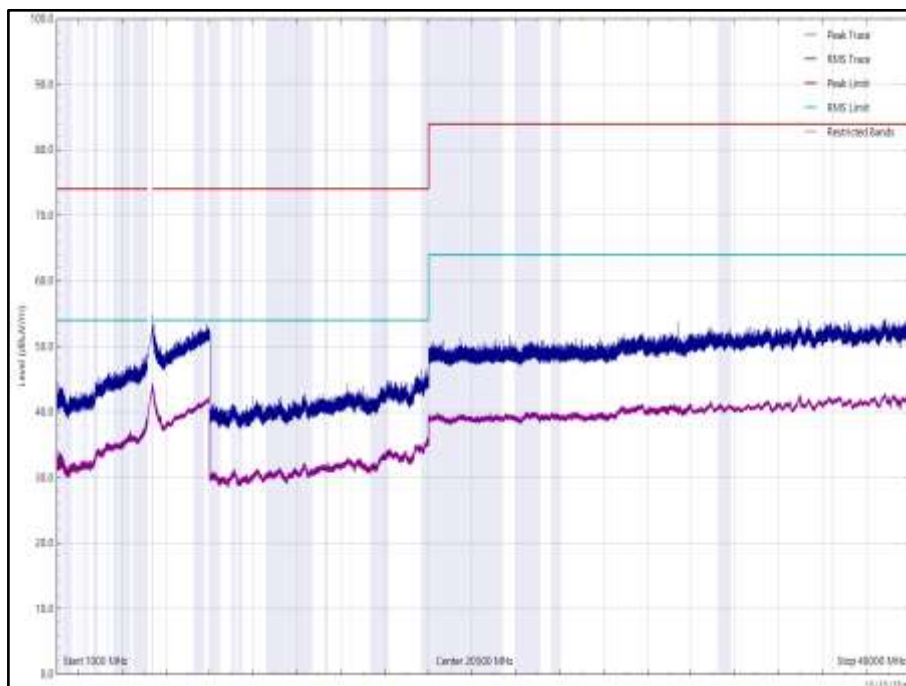
Frequency (MHz)	Level (dBµV/m)	Limit (dBµV/m)	Margin (dB)	Detector	Angle (°)	Height (cm)	Polarisation
*							

**Table 686 - 5320 MHz (CH64), 802.11a, Core 1, 1 GHz to 40 GHz**

\*No emissions found within 6 dB of the limit.



**Figure 1111 - 5320 MHz (CH64), 802.11a, Core 1, 1 GHz to 40 GHz, Horizontal**



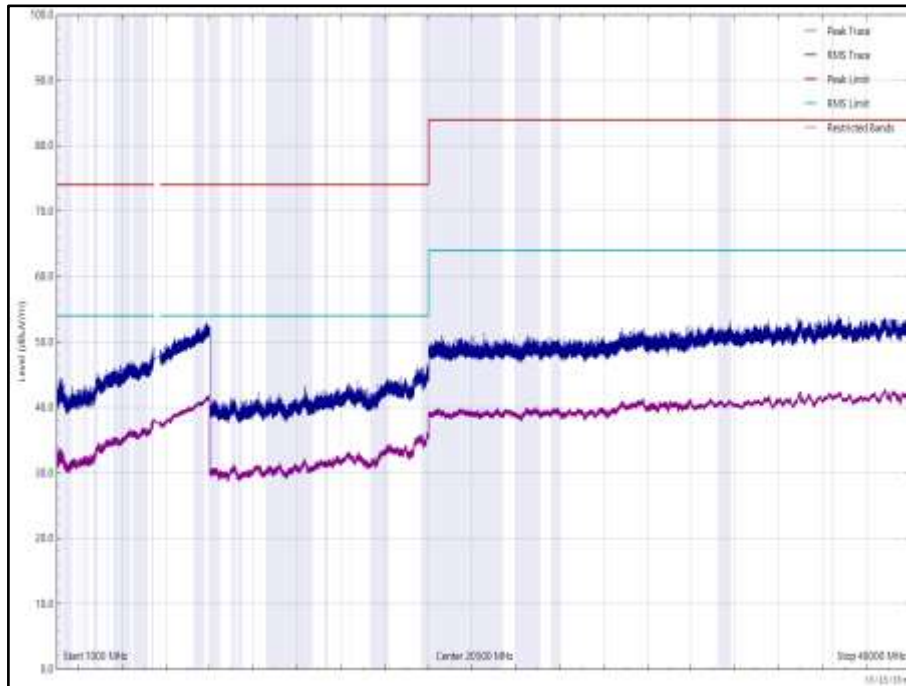
**Figure 1112 - 5320 MHz (CH64), 802.11a, Core 1, 1 GHz to 40 GHz, Vertical**



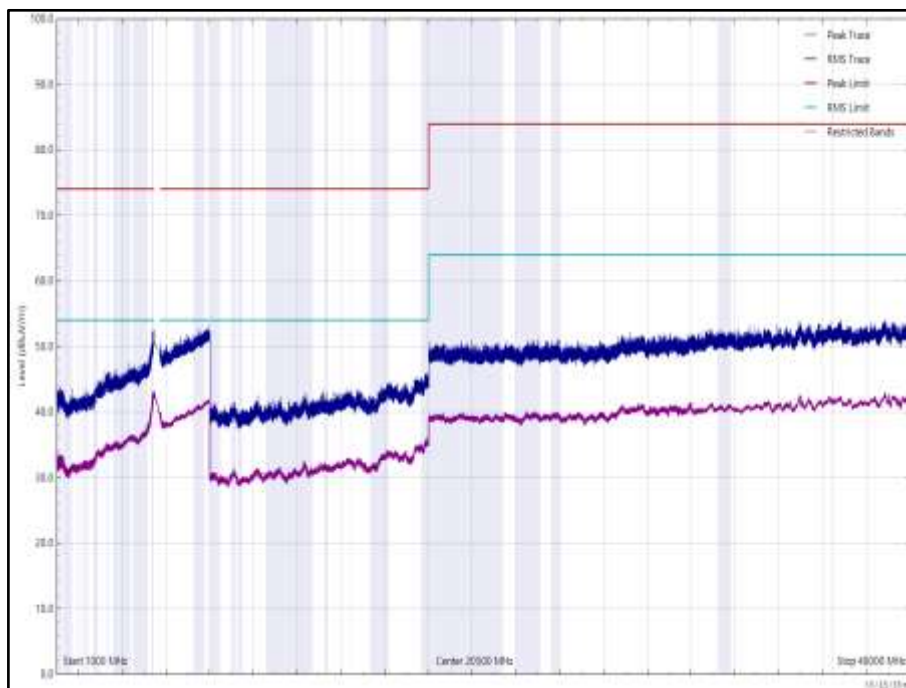
Frequency (MHz)	Level (dBµV/m)	Limit (dBµV/m)	Margin (dB)	Detector	Angle (°)	Height (cm)	Polarisation
*							

**Table 687 - 5500 MHz (CH100), 802.11a, Core 1, 1 GHz to 40 GHz**

\*No emissions found within 6 dB of the limit.



**Figure 1113 - 5500 MHz (CH100), 802.11a, Core 1, 1 GHz to 40 GHz, Horizontal**



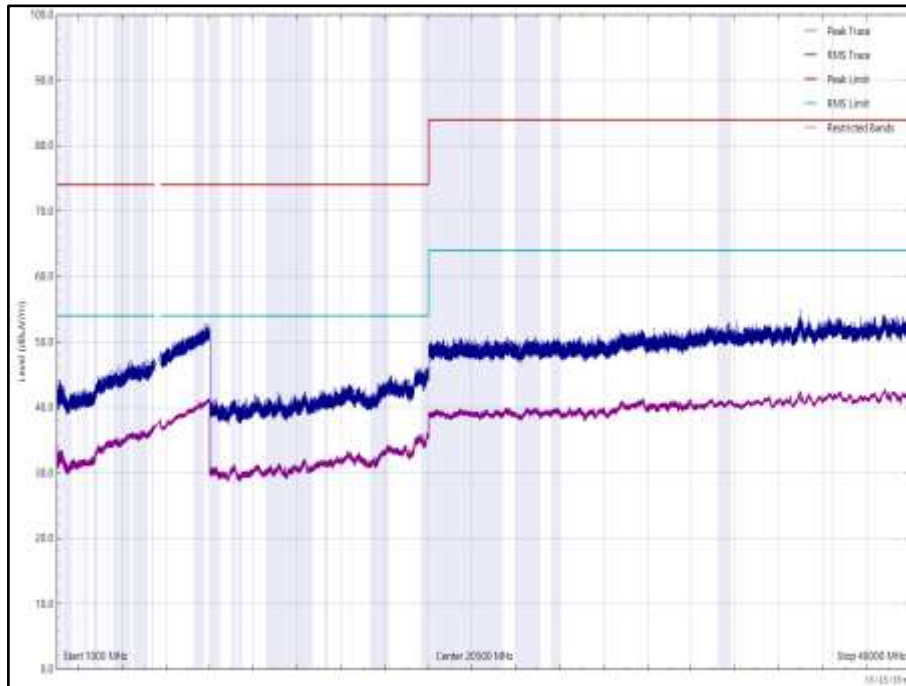
**Figure 1114 - 5500 MHz (CH100), 802.11a, Core 1, 1 GHz to 40 GHz, Vertical**



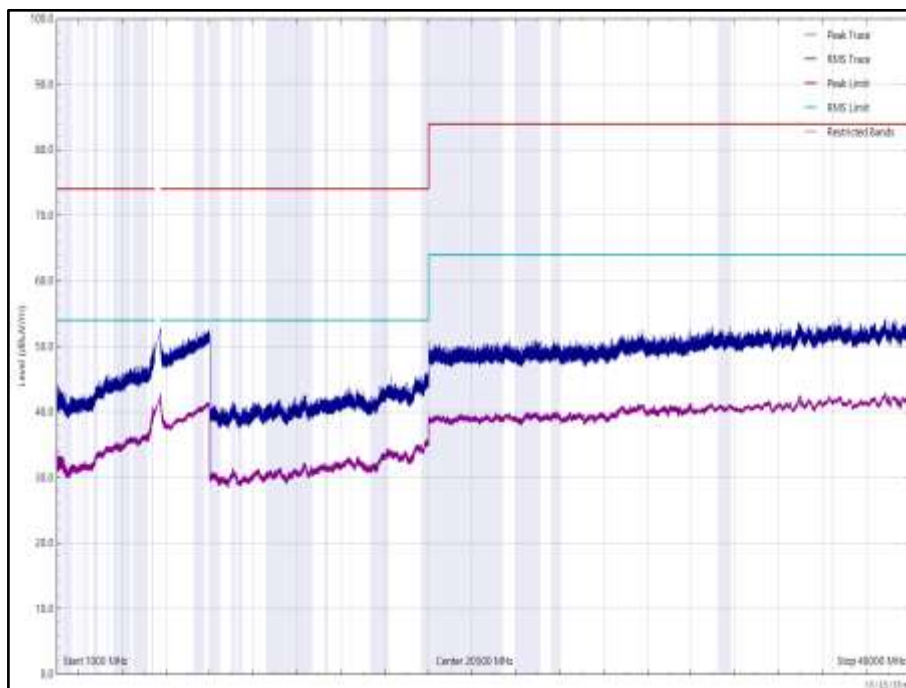
Frequency (MHz)	Level (dBµV/m)	Limit (dBµV/m)	Margin (dB)	Detector	Angle (°)	Height (cm)	Polarisation
*							

**Table 688 - 5700 MHz (CH140), 802.11a, Core 1, 1 GHz to 40 GHz**

\*No emissions found within 6 dB of the limit.



**Figure 1115 - 5700 MHz (CH140), 802.11a, Core 1, 1 GHz to 40 GHz, Horizontal**



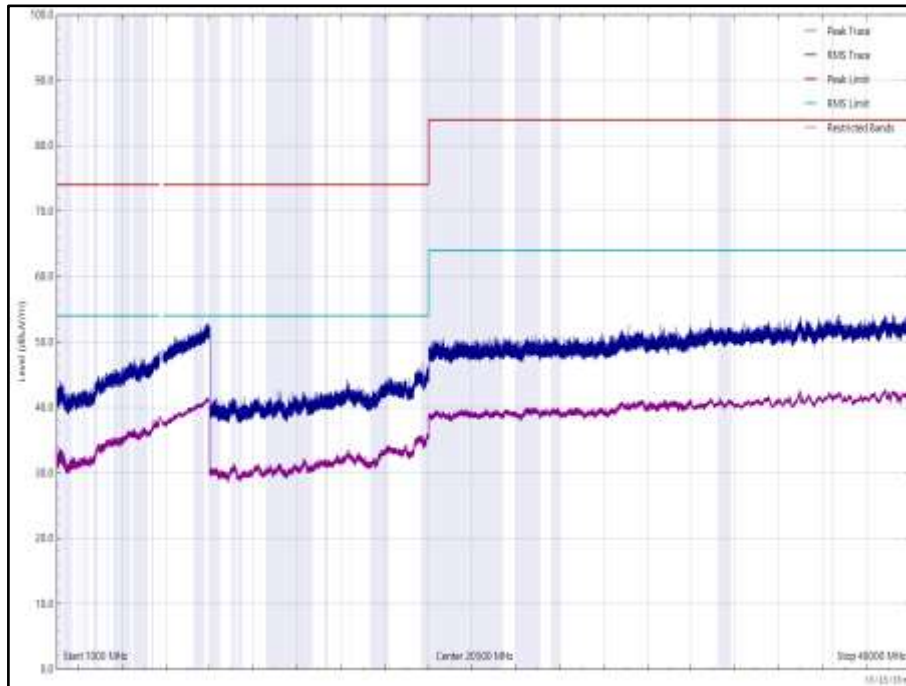
**Figure 1116 - 5700 MHz (CH140), 802.11a, Core 1, 1 GHz to 40 GHz, Vertical**



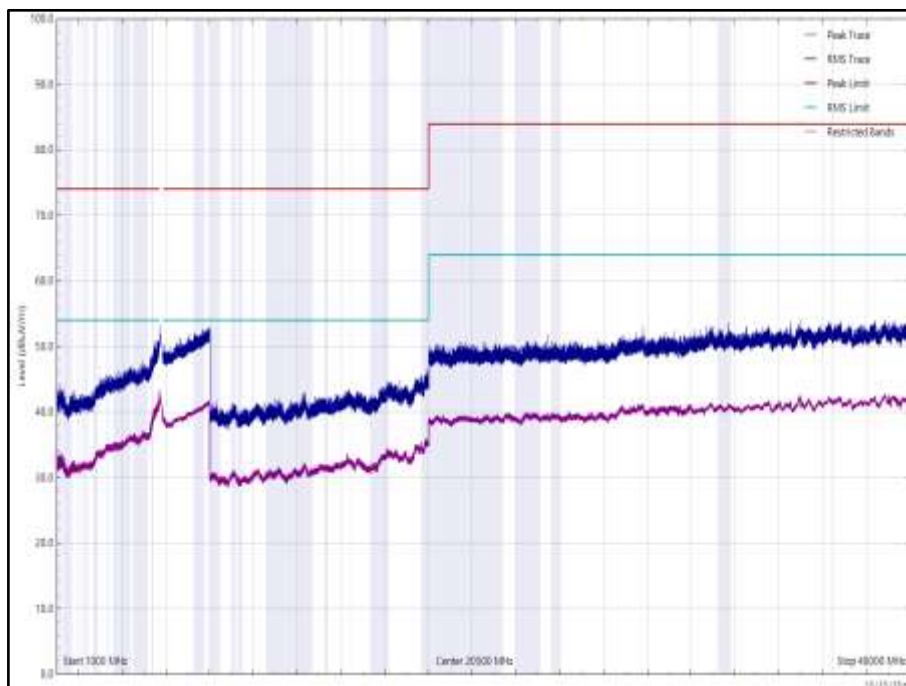
Frequency (MHz)	Level (dBµV/m)	Limit (dBµV/m)	Margin (dB)	Detector	Angle (°)	Height (cm)	Polarisation
*							

**Table 689 - 5745 MHz (CH149), 802.11a, Core 1, 1 GHz to 40 GHz**

\*No emissions found within 6 dB of the limit.



**Figure 1117 - 5745 MHz (CH149), 802.11a, Core 1, 1 GHz to 40 GHz, Horizontal**



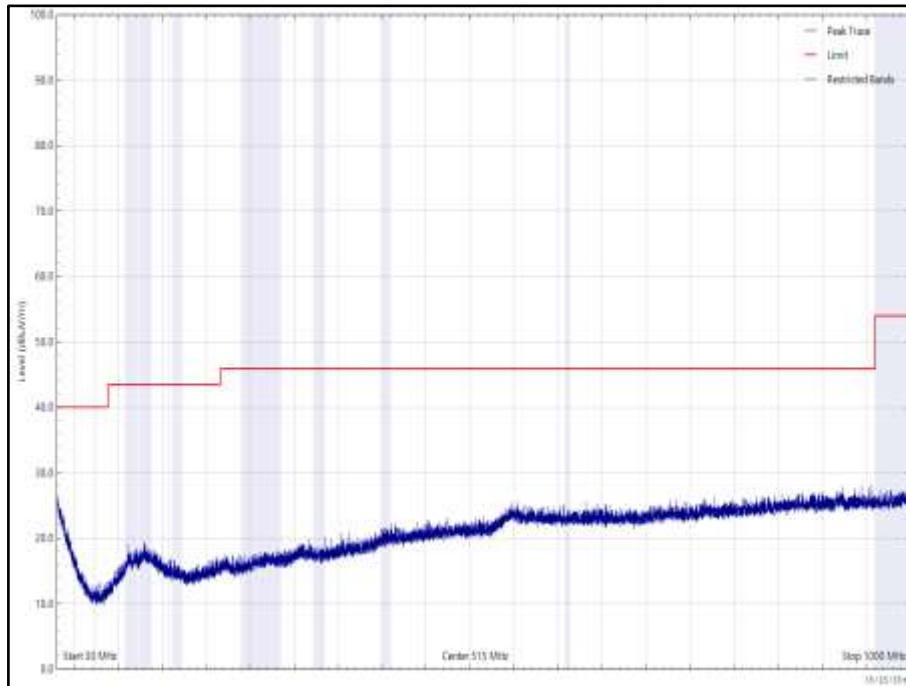
**Figure 1118 - 5745 MHz (CH149), 802.11a, Core 1, 1 GHz to 40 GHz, Vertical**



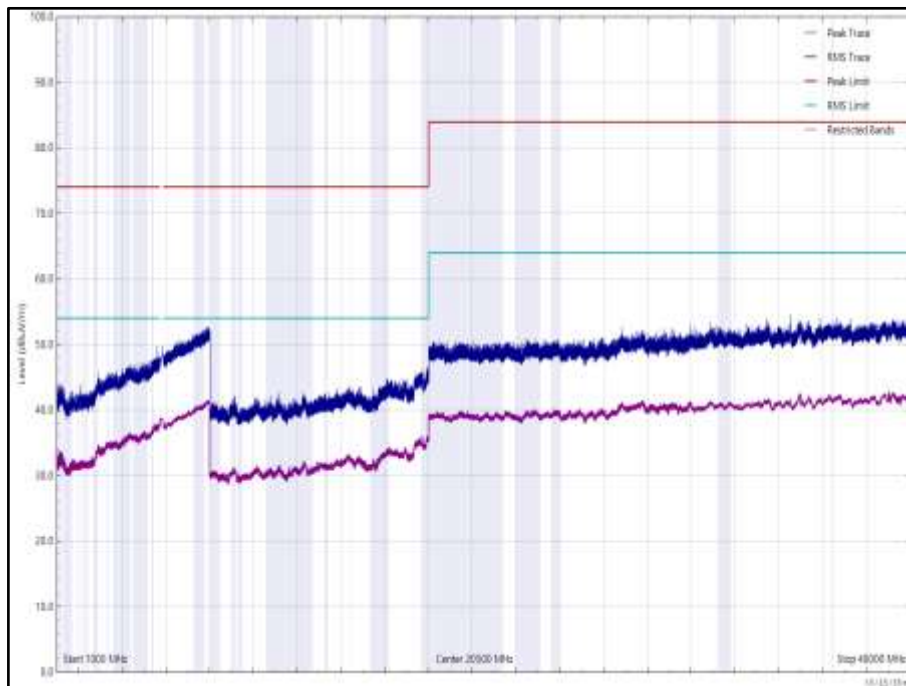
Frequency (MHz)	Level (dBµV/m)	Limit (dBµV/m)	Margin (dB)	Detector	Angle (°)	Height (cm)	Polarisation
11650.930	35.0	54.0	-19.0	RMS	205	103	Vertical

**Table 690 - 5825 MHz (CH165), 802.11a, Core 1, 30 MHz to 40 GHz**

No other emissions found within 6 dB of the limit.



**Figure 1119 - 5825 MHz (CH165), 802.11a, Core 1, 30 MHz to 1 GHz, Horizontal (Peak)**



**Figure 1120 - 5825 MHz (CH165), 802.11a, Core 1, 1 GHz to 40 GHz, Horizontal**



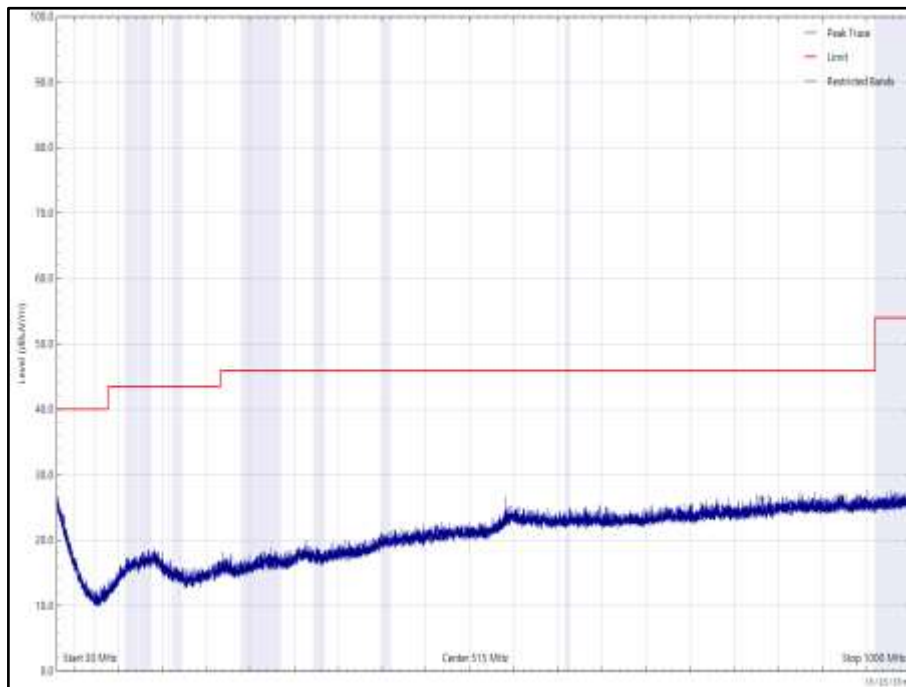


Figure 1121 - 5825 MHz (CH165), 802.11a, Core 1, 30 MHz to 1 GHz, Vertical (Peak)

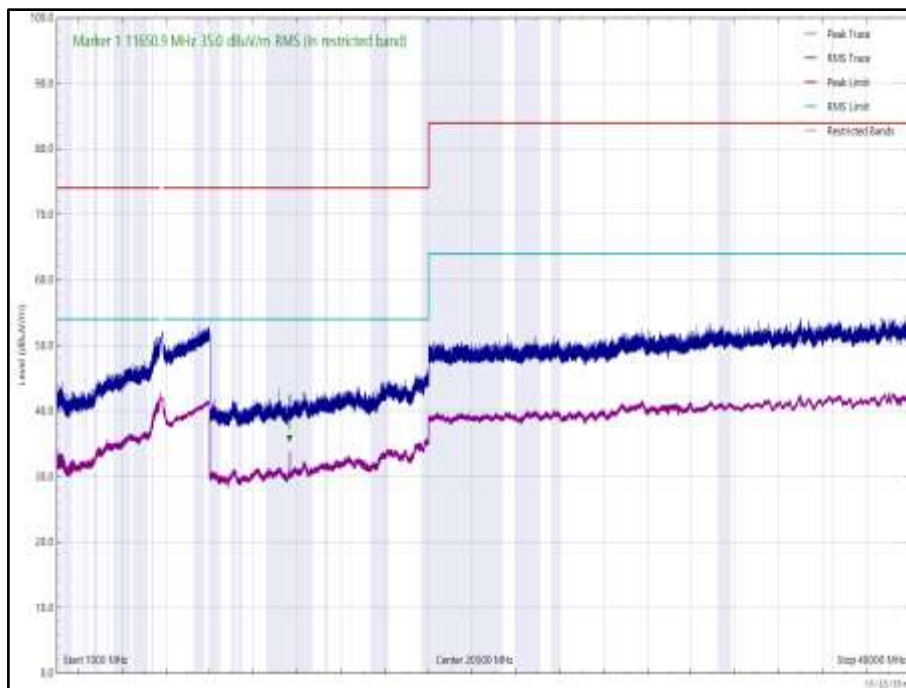


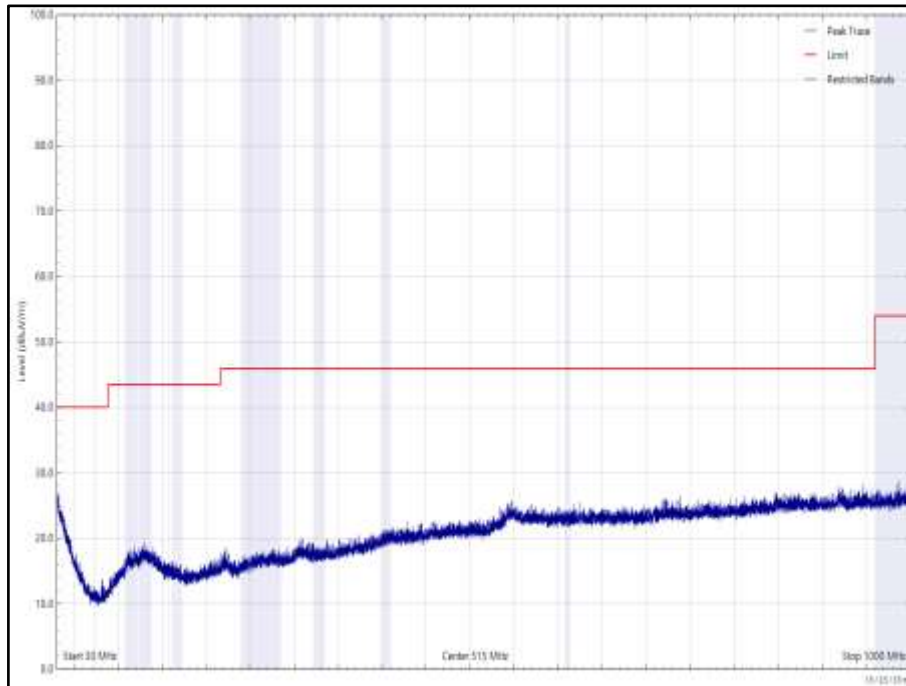
Figure 1122 - 5825 MHz (CH165), 802.11a, Core 1, 1 GHz to 40 GHz, Vertical



Frequency (MHz)	Level (dBµV/m)	Limit (dBµV/m)	Margin (dB)	Detector	Angle (°)	Height (cm)	Polarisation
*							

**Table 691 - U-NII-1 - 5180 MHz (CH36), HT20, CDD, Core 0 + Core 1, 30 MHz to 40 GHz**

\*No emissions found within 6 dB of the limit.



**Figure 1123 - U-NII-1 - 5180 MHz (CH36), HT20, CDD, Core 0 + Core 1, 30 MHz to 1 GHz, Horizontal (Peak)**

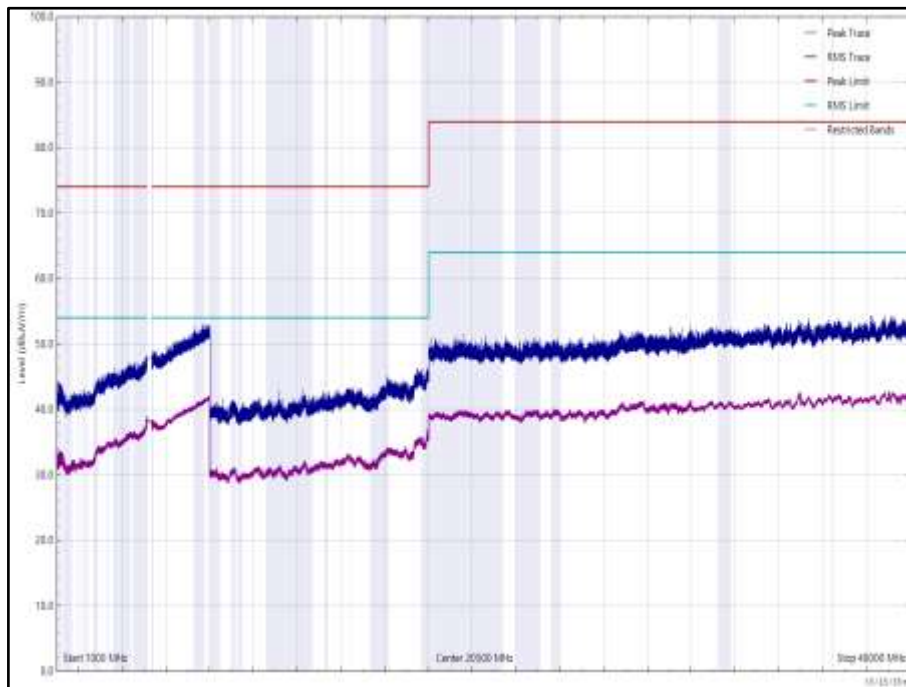


Figure 1124 - U-NII-1 - 5180 MHz (CH36), HT20, CDD, Core 0 + Core 1, 1 GHz to 40 GHz, Horizontal

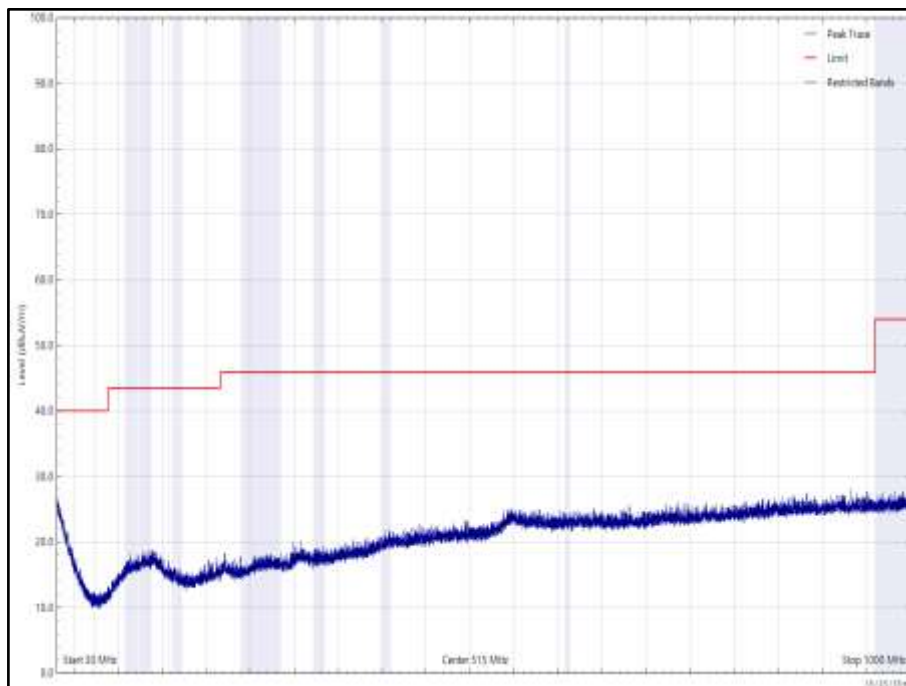


Figure 1125 - U-NII-1 - 5180 MHz (CH36), HT20, CDD, Core 0 + Core 1, 30 MHz to 1 GHz, Vertical (Peak)

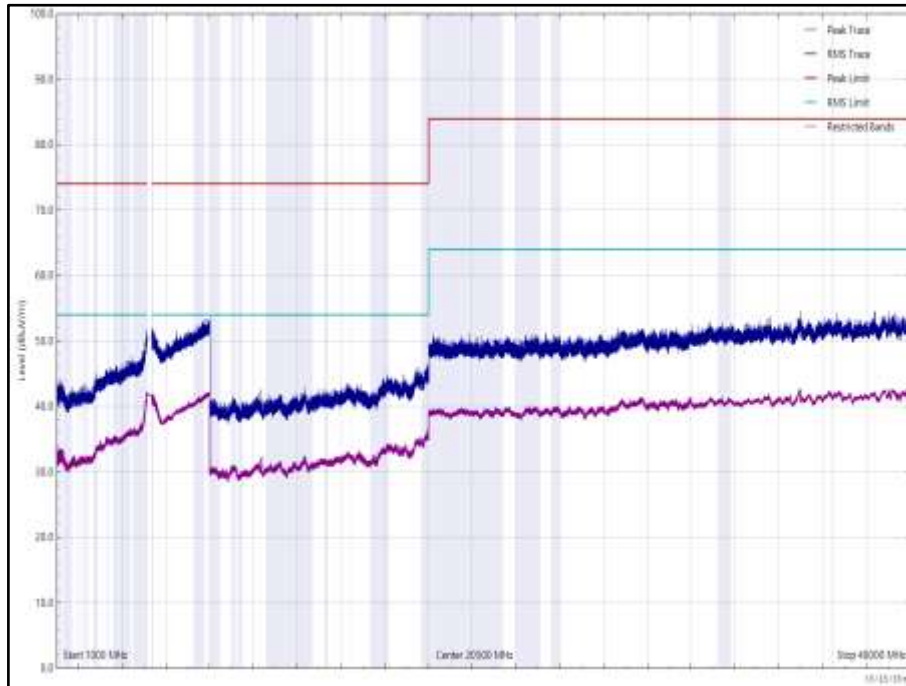


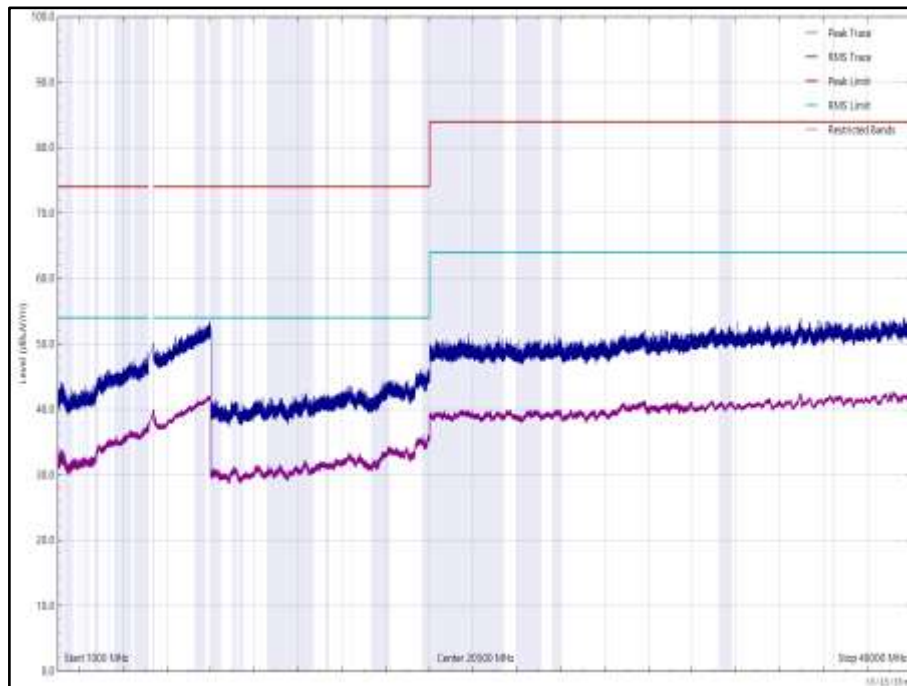
Figure 1126 - U-NII-1 - 5180 MHz (CH36), HT20, CDD, Core 0 + Core 1, 1 GHz to 40 GHz, Vertical



Frequency (MHz)	Level (dBµV/m)	Limit (dBµV/m)	Margin (dB)	Detector	Angle (°)	Height (cm)	Polarisation
5415.866	55.2	74.0	-18.9	Peak	336	107	Vertical

**Table 692 - U-NII-2A - 5320 MHz (CH64), HT20, CDD, Core 0 + Core 1, 1 GHz to 40 GHz**

No other emissions found within 6 dB of the limit.



**Figure 1127 - U-NII-2A - 5320 MHz (CH64), HT20, CDD, Core 0 + Core 1, 1 GHz to 40 GHz, Horizontal**

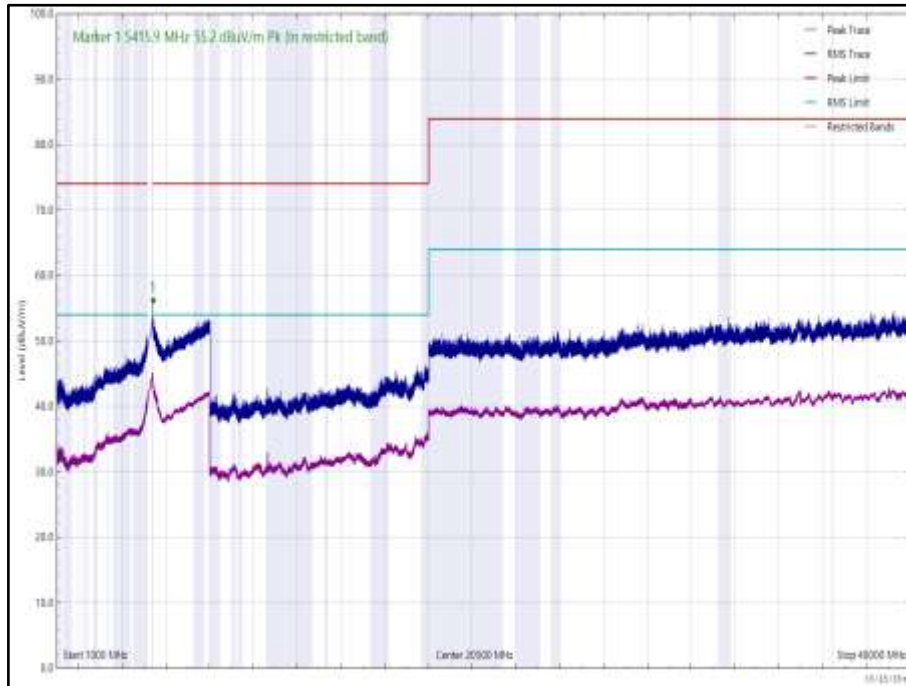


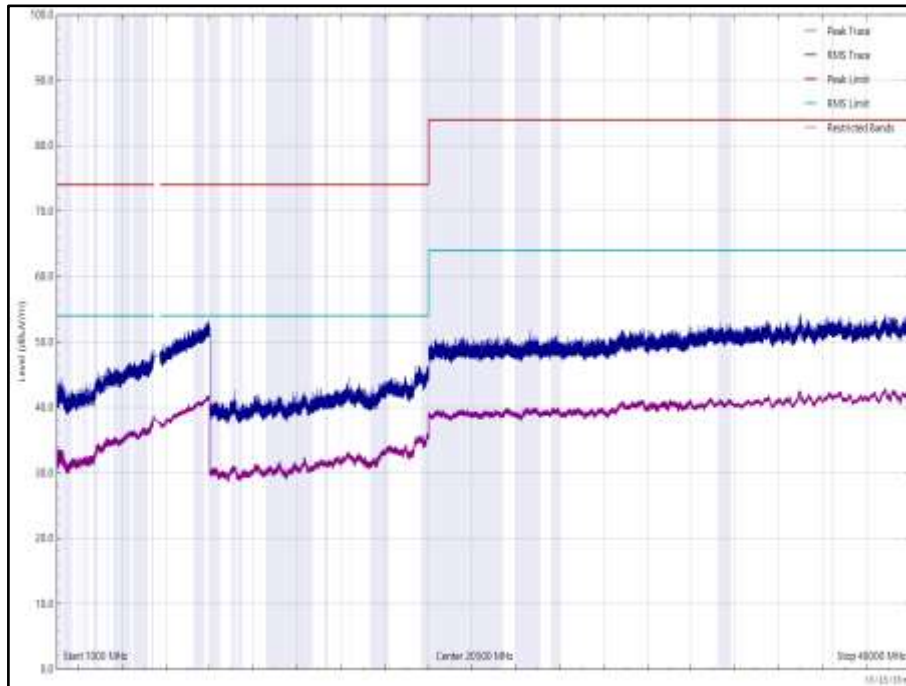
Figure 1128 - U-NII-2A - 5320 MHz (CH64), HT20, CDD, Core 0 + Core 1, 1 GHz to 40 GHz, Vertical



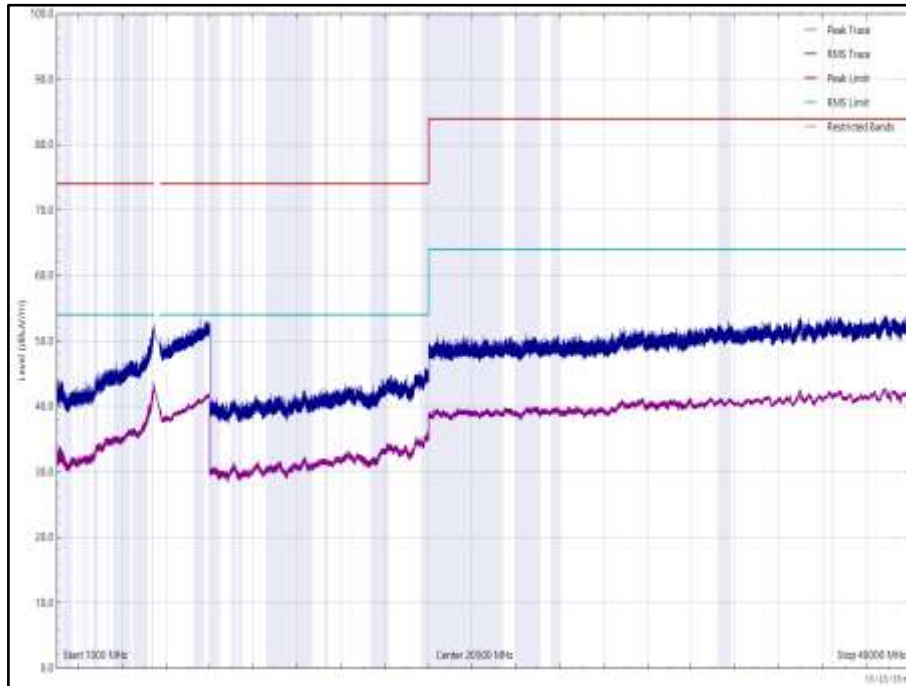
Frequency (MHz)	Level (dBµV/m)	Limit (dBµV/m)	Margin (dB)	Detector	Angle (°)	Height (cm)	Polarisation
*							

**Table 693 - U-NII-2C - 5500 MHz (CH100), HT20, CDD, Core 0 + Core 1, 1 GHz to 40 GHz**

\*No emissions found within 6 dB of the limit.



**Figure 1129 - U-NII-2C - 5500 MHz (CH100), HT20, CDD, Core 0 + Core 1, 1 GHz to 40 GHz, Horizontal**



**Figure 1130 - U-NII-2C - 5500 MHz (CH100), HT20, CDD, Core 0 + Core 1, 1 GHz to 40 GHz, Vertical**

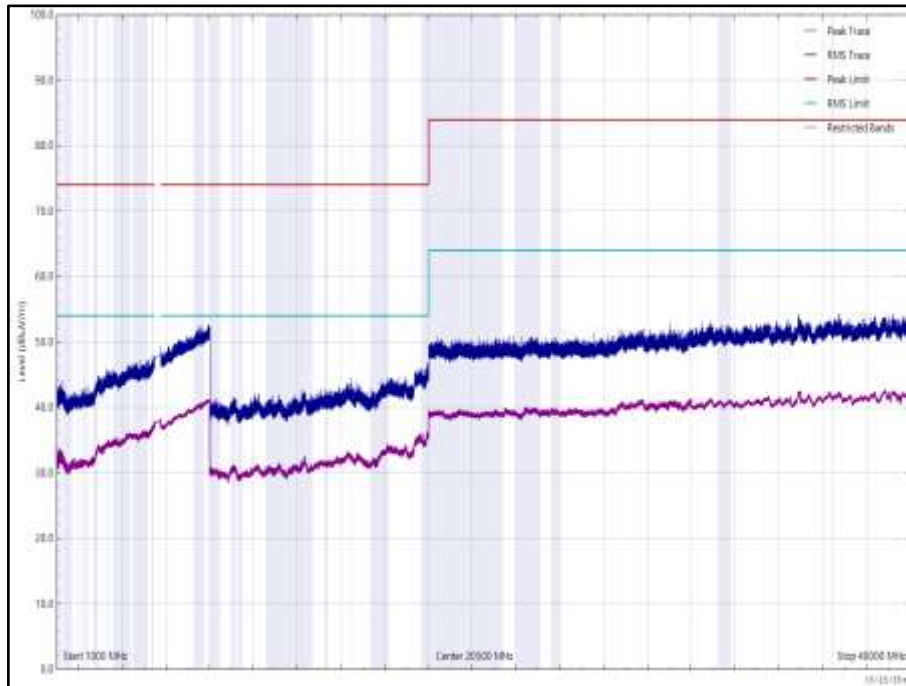




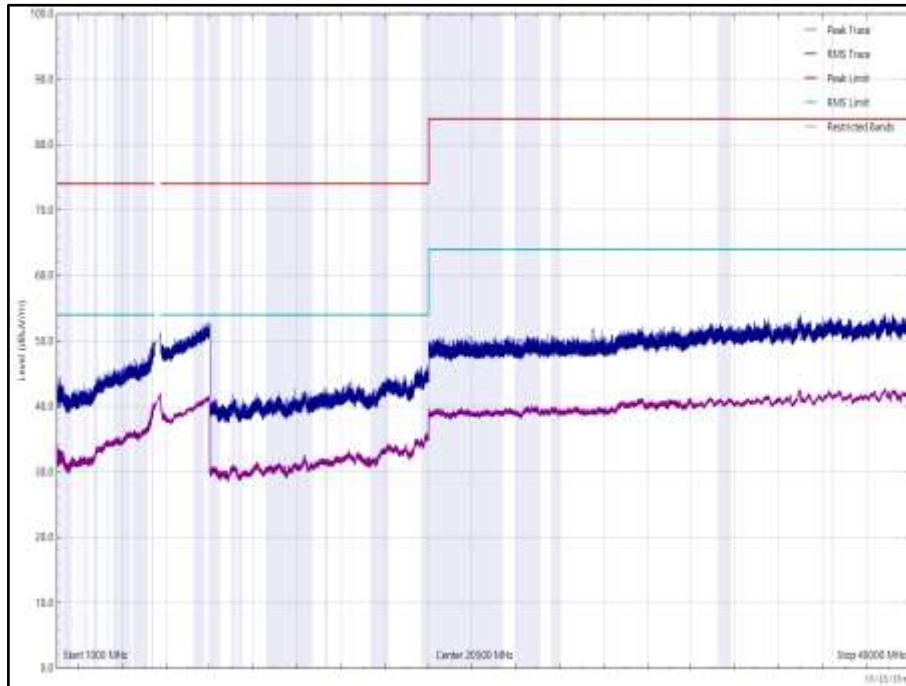
Frequency (MHz)	Level (dBµV/m)	Limit (dBµV/m)	Margin (dB)	Detector	Angle (°)	Height (cm)	Polarisation
*							

**Table 694 - U-NII-2C - 5700 MHz (CH140), HT20, CDD, Core 0 + Core 1, 1 GHz to 40 GHz**

\*No emissions found within 6 dB of the limit.



**Figure 1131 - U-NII-2C - 5700 MHz (CH140), HT20, CDD, Core 0 + Core 1, 1 GHz to 40 GHz, Horizontal**



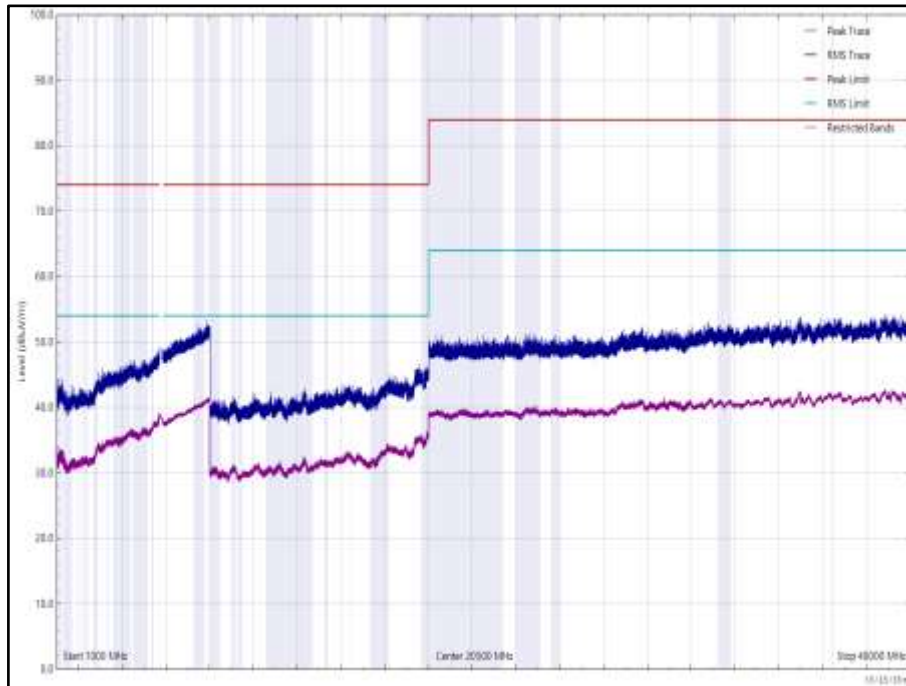
**Figure 1132 - U-NII-2C - 5700 MHz (CH140), HT20, CDD, Core 0 + Core 1, 1 GHz to 40 GHz, Vertical**



Frequency (MHz)	Level (dBµV/m)	Limit (dBµV/m)	Margin (dB)	Detector	Angle (°)	Height (cm)	Polarisation
*							

**Table 695 - U-NII-3 - 5745 MHz (CH149), HT20, CDD, Core 0 + Core 1, 1 GHz to 40 GHz**

\*No emissions found within 6 dB of the limit.



**Figure 1133 - U-NII-3 - 5745 MHz (CH149), HT20, CDD, Core 0 + Core 1, 1 GHz to 40 GHz, Horizontal**

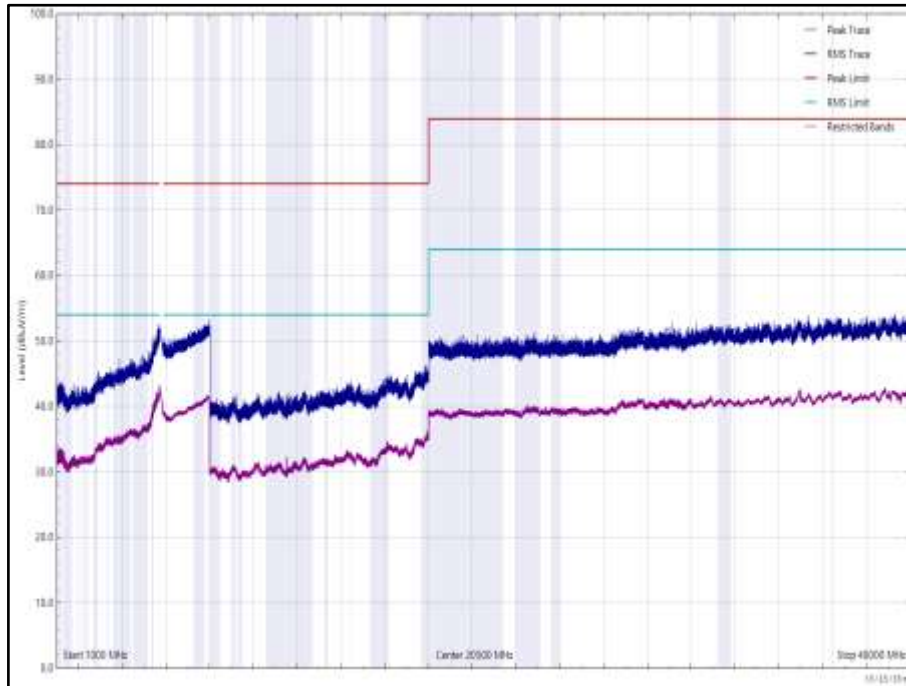


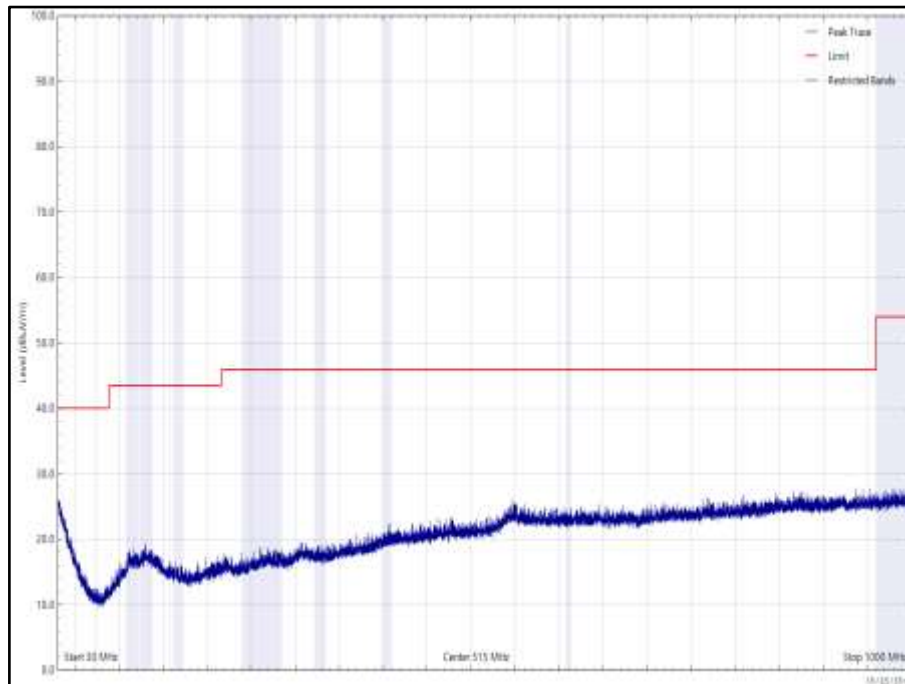
Figure 1134 - U-NII-3 - 5745 MHz (CH149), HT20, CDD, Core 0 + Core 1, 1 GHz to 40 GHz, Vertical



Frequency (MHz)	Level (dBµV/m)	Limit (dBµV/m)	Margin (dB)	Detector	Angle (°)	Height (cm)	Polarisation
11649.642	36.96	54.0	-17.0	RMS	161	109	Horizontal
11649.735	37.86	54.0	-16.4	RMS	163	106	Vertical

**Table 696 - U-NII-3 - 5825 MHz (CH165), HT20, CDD, Core 0 + Core 1, 30 MHz to 40 GHz**

No other emissions found within 6 dB of the limit.



**Figure 1135 - U-NII-3 - 5825 MHz (CH165), HT20, CDD, Core 0 + Core 1, 30 MHz to 1 GHz, Horizontal (Peak)**

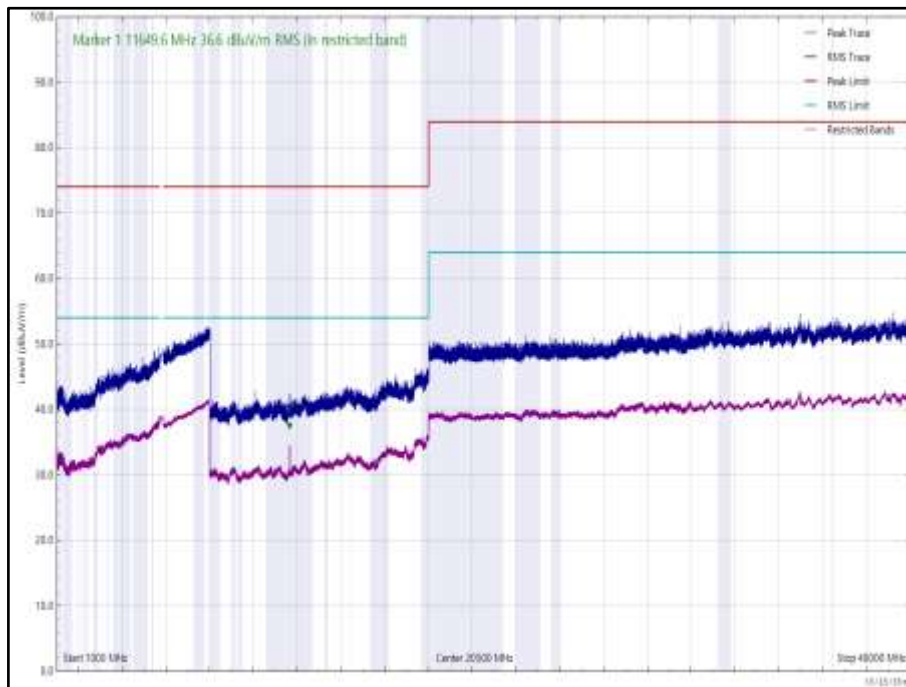


Figure 1136 - U-NII-3 - 5825 MHz (CH165), HT20, CDD, Core 0 + Core 1, 1 GHz to 40 GHz, Horizontal

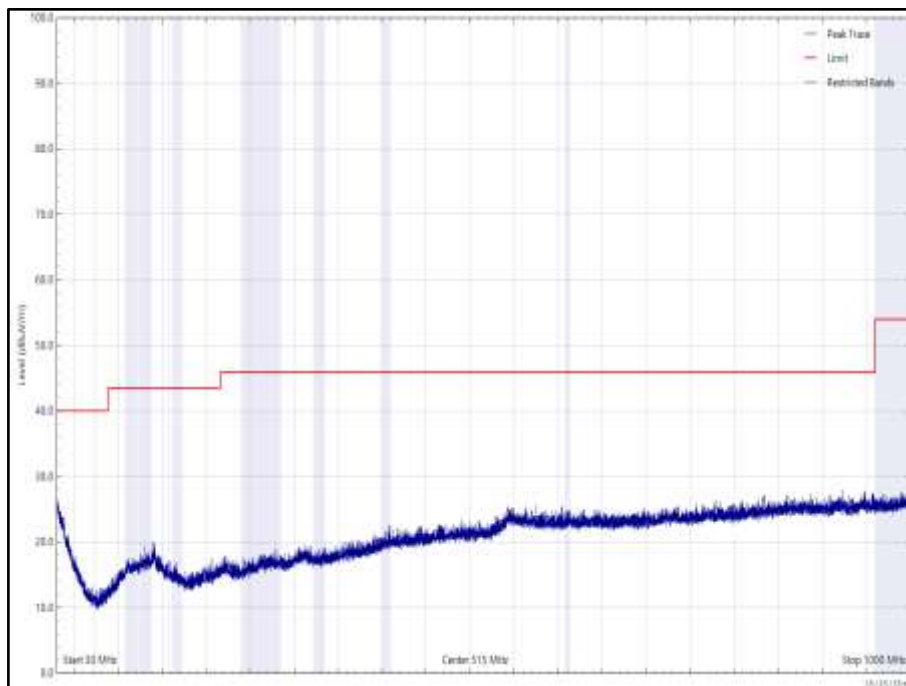


Figure 1137 - U-NII-3 - 5825 MHz (CH165), HT20, CDD, Core 0 + Core 1, 30 MHz to 1 GHz, Vertical (Peak)

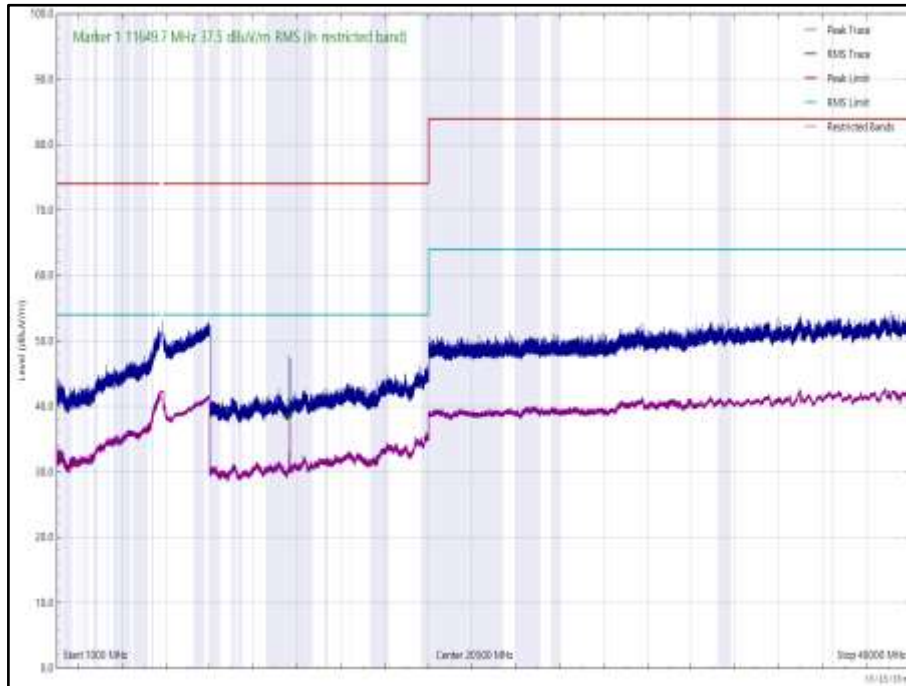


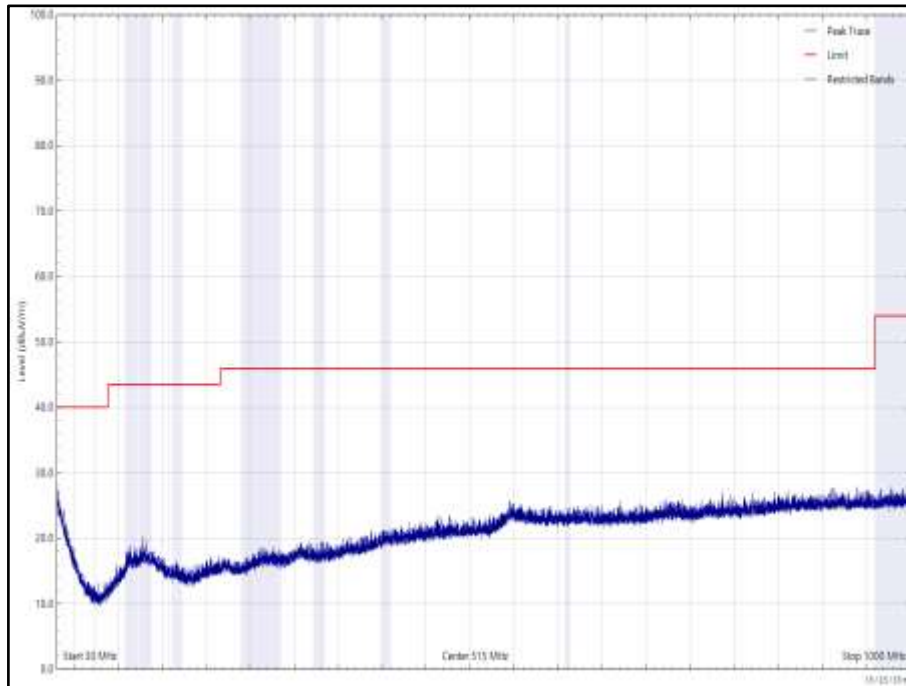
Figure 1138 - U-NII-3 - 5825 MHz (CH165), HT20, CDD, Core 0 + Core 1, 1 GHz to 40 GHz, Vertical



Frequency (MHz)	Level (dBµV/m)	Limit (dBµV/m)	Margin (dB)	Detector	Angle (°)	Height (cm)	Polarisation
15514.768	41.56	54.0	-12.44	RMS	158	110	Vertical

**Table 697 - 5180 MHz (CH36), HE20, RU26-0, Core 0 + Core 1, 30 MHz to 40 GHz**

No other emissions found within 6 dB of the limit.



**Figure 1139 - 5180 MHz (CH36), HE20, RU26-0, Core 0 + Core 1, 30 MHz to 1 GHz, Horizontal (Peak)**



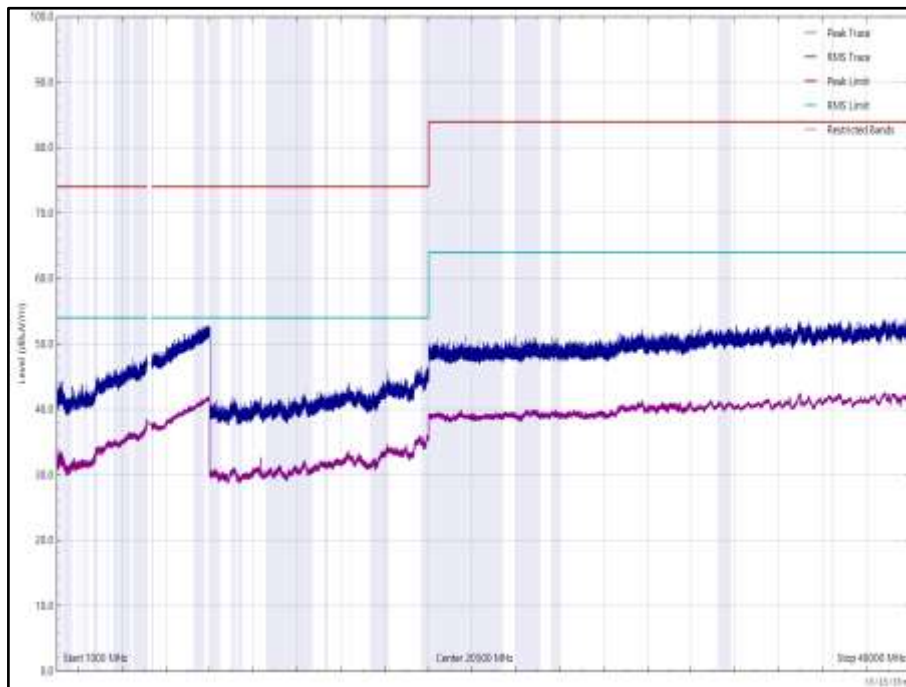


Figure 1140 - 5180 MHz (CH36), HE20, RU26-0, Core 0 + Core 1, 1 GHz to 40 GHz, Horizontal

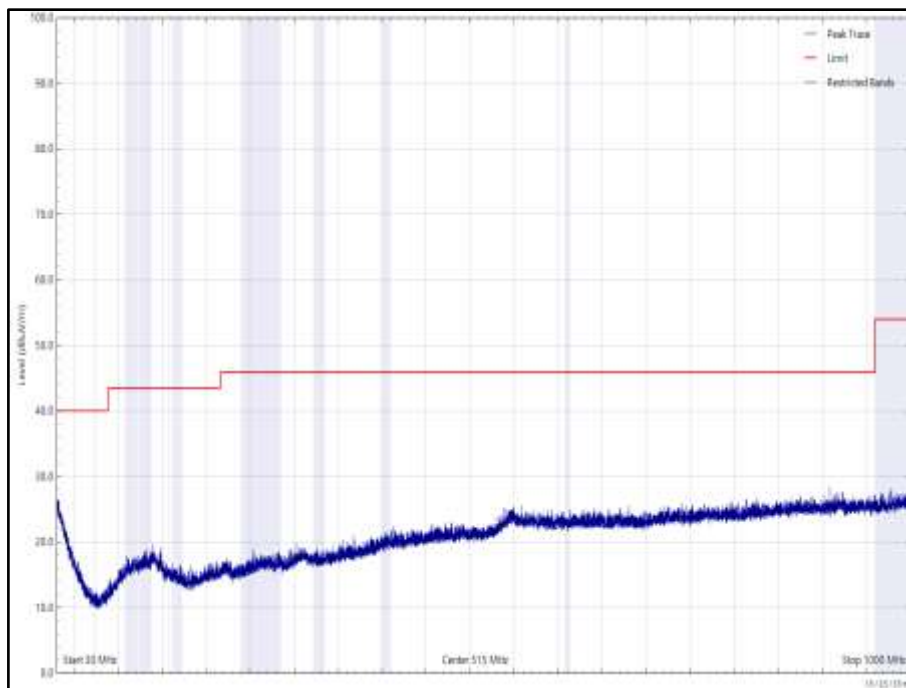


Figure 1141 - 5180 MHz (CH36), HE20, RU26-0, Core 0 + Core 1, 30 MHz to 1 GHz, Vertical (Peak)

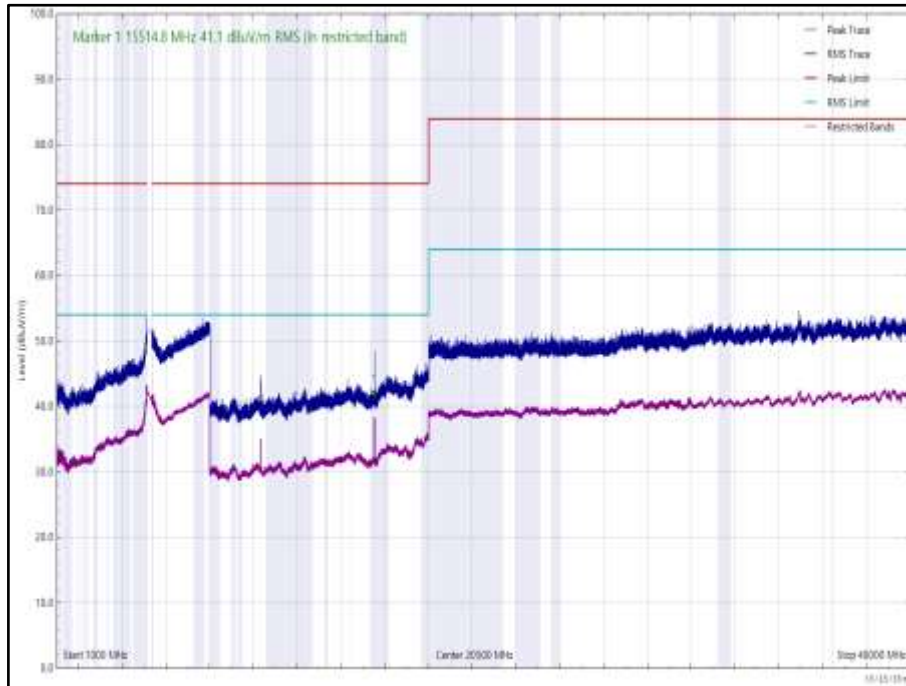


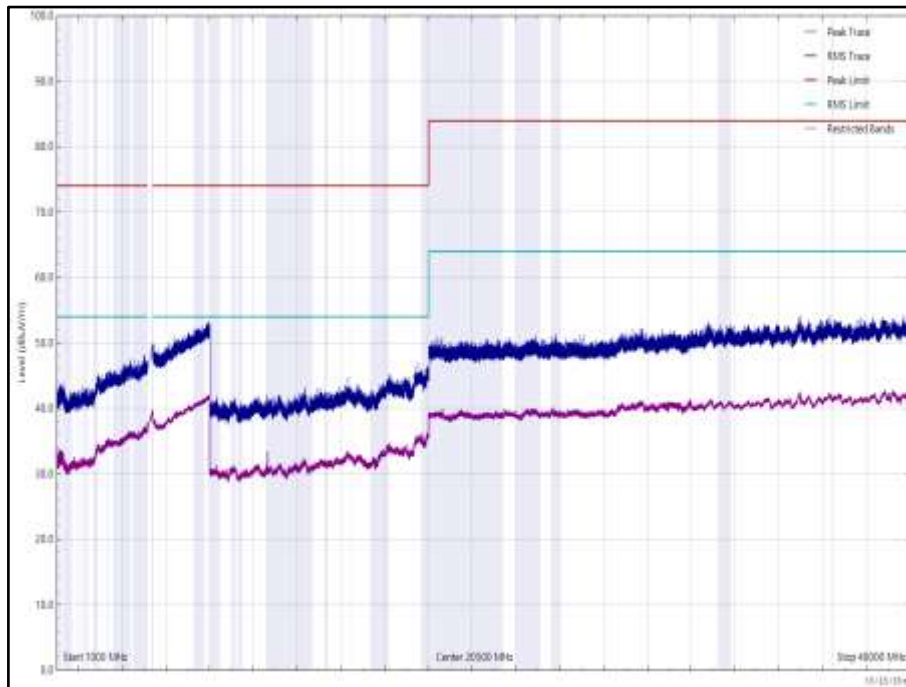
Figure 1142 - 5180 MHz (CH36), HE20, RU26-0, Core 0 + Core 1, 1 GHz to 40 GHz, Vertical



Frequency (MHz)	Level (dBµV/m)	Limit (dBµV/m)	Margin (dB)	Detector	Angle (°)	Height (cm)	Polarisation
10624.955	37.76	54.0	-16.24	RMS	236	101	Vertical
15938.419	38.66	54.0	-15.34	RMS	159	102	Vertical

**Table 698 - 5320 MHz (CH64), HE20, RU52-37, Core 0 + Core 1, 1 GHz to 40 GHz**

No other emissions found within 6 dB of the limit.



**Figure 1143 - 5320 MHz (CH64), HE20, RU52-37, Core 0 + Core 1, 1 GHz to 40 GHz, Horizontal**

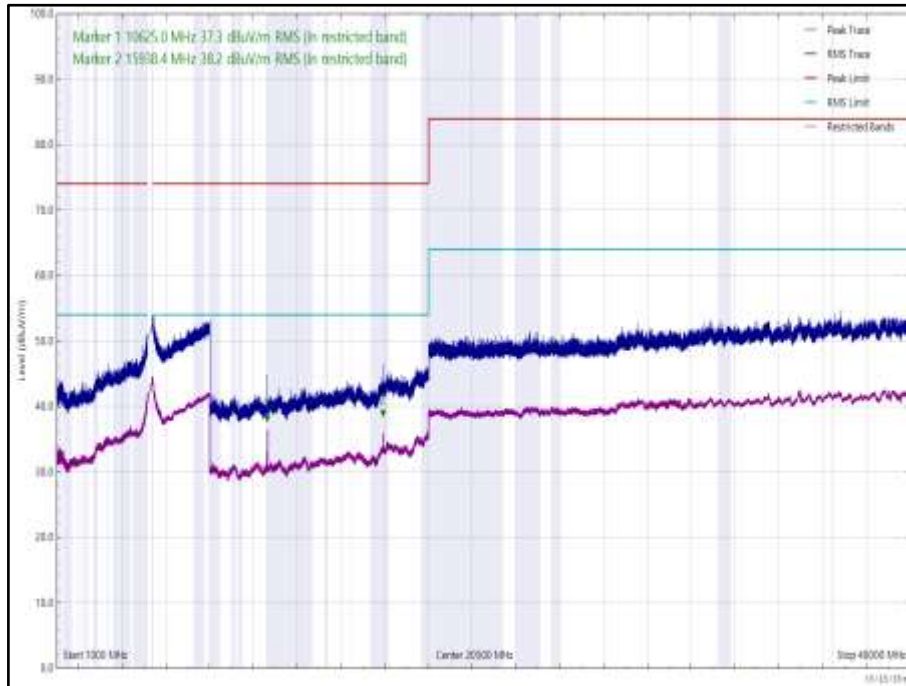


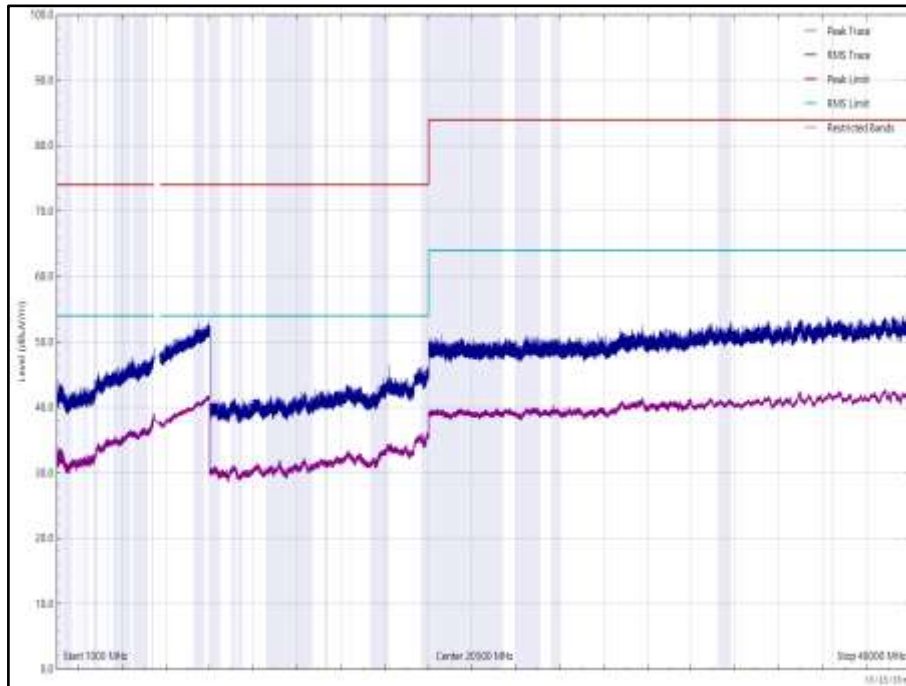
Figure 1144 - 5320 MHz (CH64), HE20, RU52-37, Core 0 + Core 1, 1 GHz to 40 GHz, Vertical



Frequency (MHz)	Level (dBµV/m)	Limit (dBµV/m)	Margin (dB)	Detector	Angle (°)	Height (cm)	Polarisation
*							

**Table 699 - 5500 MHz (CH100), HE20, RU52-37, Core 0 + Core 1, 1 GHz to 40 GHz**

\*No emissions found within 6 dB of the limit.



**Figure 1145 - 5500 MHz (CH100), HE20, RU52-37, Core 0 + Core 1, 1 GHz to 40 GHz, Horizontal**

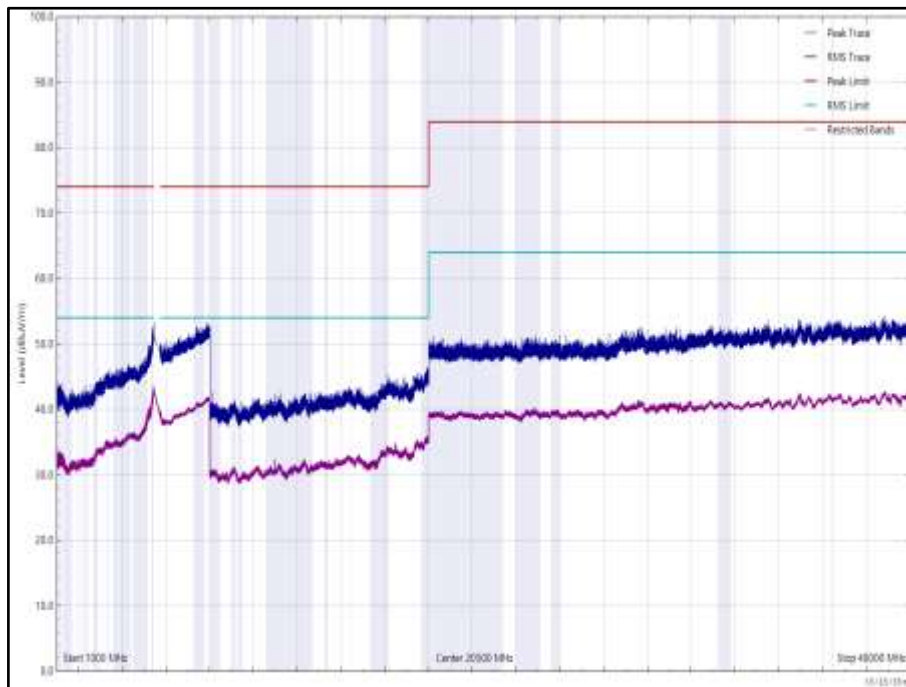


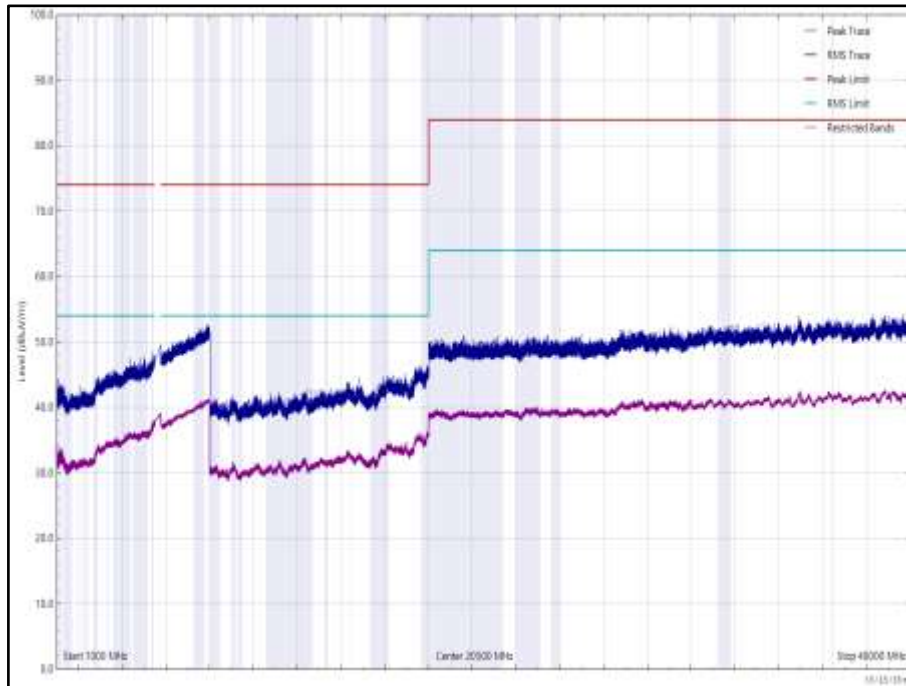
Figure 1146 - 5500 MHz (CH100), HE20, RU52-37, Core 0 + Core 1, 1 GHz to 40 GHz, Vertical



Frequency (MHz)	Level (dBµV/m)	Limit (dBµV/m)	Margin (dB)	Detector	Angle (°)	Height (cm)	Polarisation
*							

**Table 700 - 5700 MHz (CH140), HE20, RU52-37, Core 0 + Core 1, 1 GHz to 40 GHz**

\*No emissions found within 6 dB of the limit.



**Figure 1147 - 5700 MHz (CH140), HE20, RU52-37, Core 0 + Core 1, 1 GHz to 40 GHz, Horizontal**

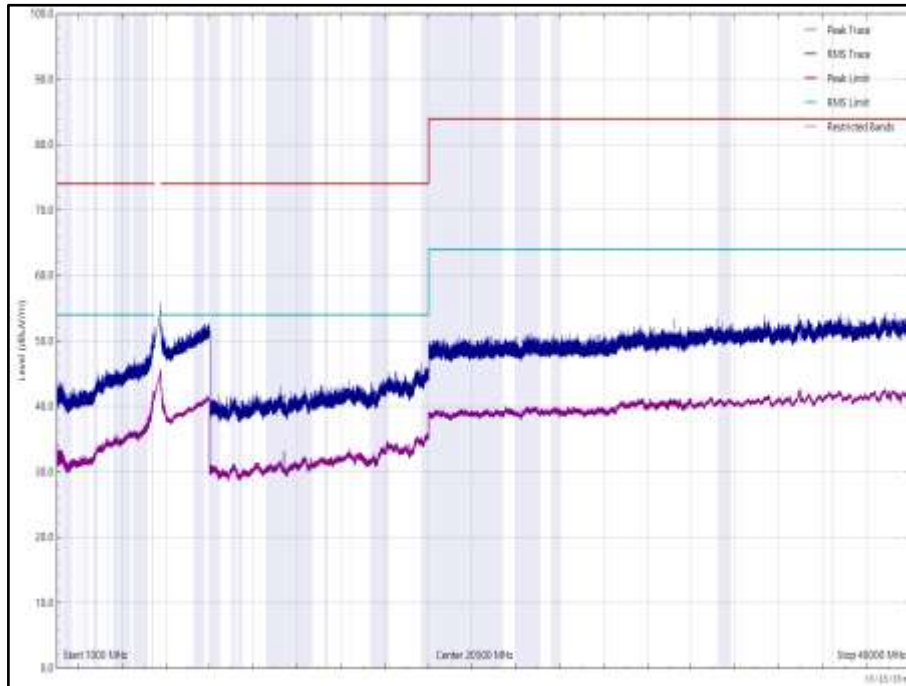


Figure 1148 - 5700 MHz (CH140), HE20, RU52-37, Core 0 + Core 1, 1 GHz to 40 GHz, Vertical

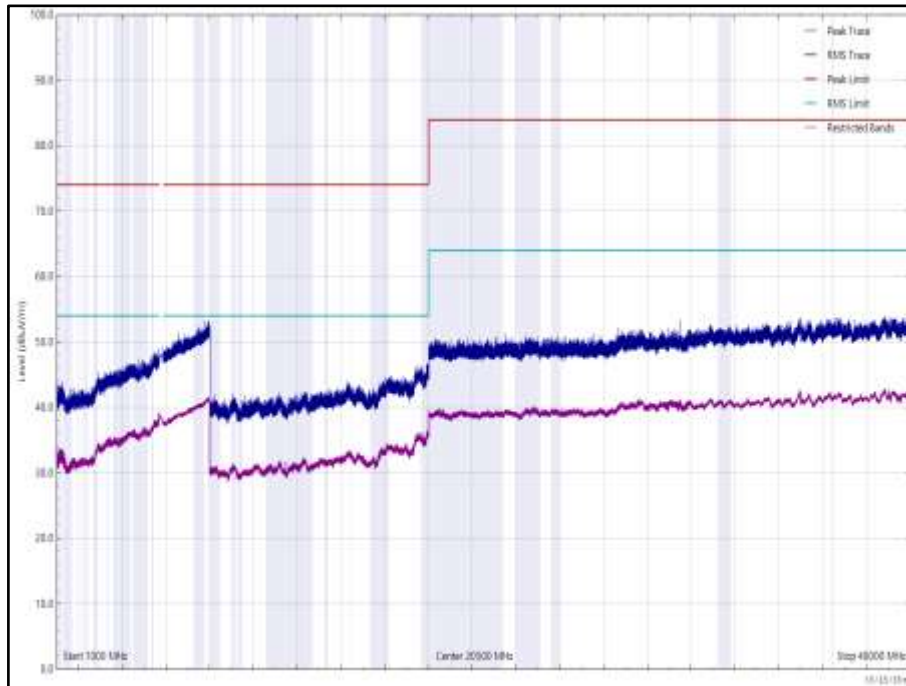




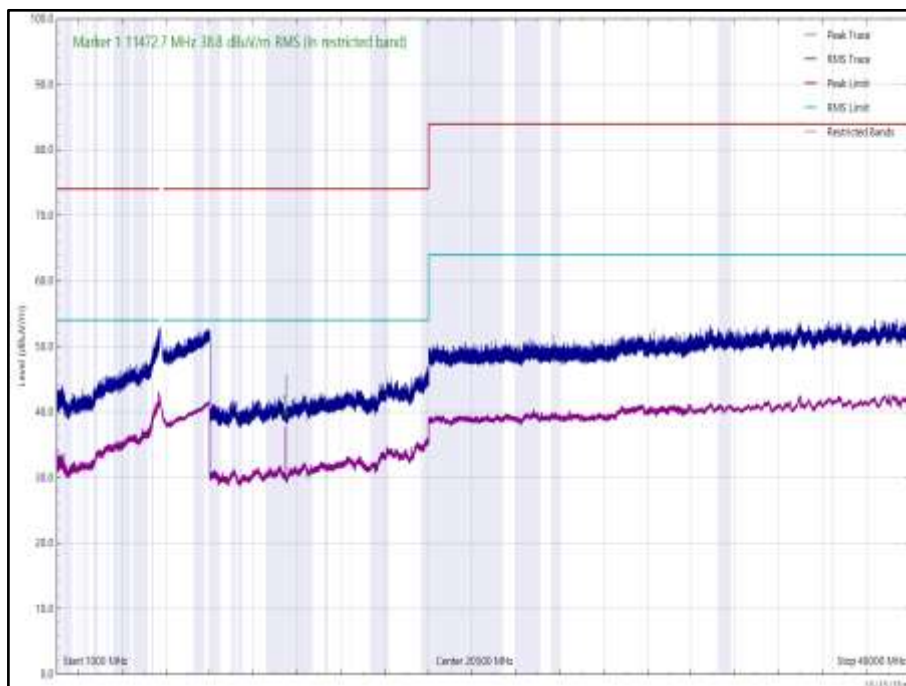
Frequency (MHz)	Level (dBµV/m)	Limit (dBµV/m)	Margin (dB)	Detector	Angle (°)	Height (cm)	Polarisation
11472.732	39.26	54.0	-14.74	RMS	205	112	Vertical

**Table 701 - 5745 MHz (CH149), HE20, RU26-0, Core 0 + Core 1, 1 GHz to 40 GHz**

No other emissions found within 6 dB of the limit.



**Figure 1149 - 5745 MHz (CH149), HE20, RU26-0, Core 0 + Core 1, 1 GHz to 40 GHz, Horizontal**



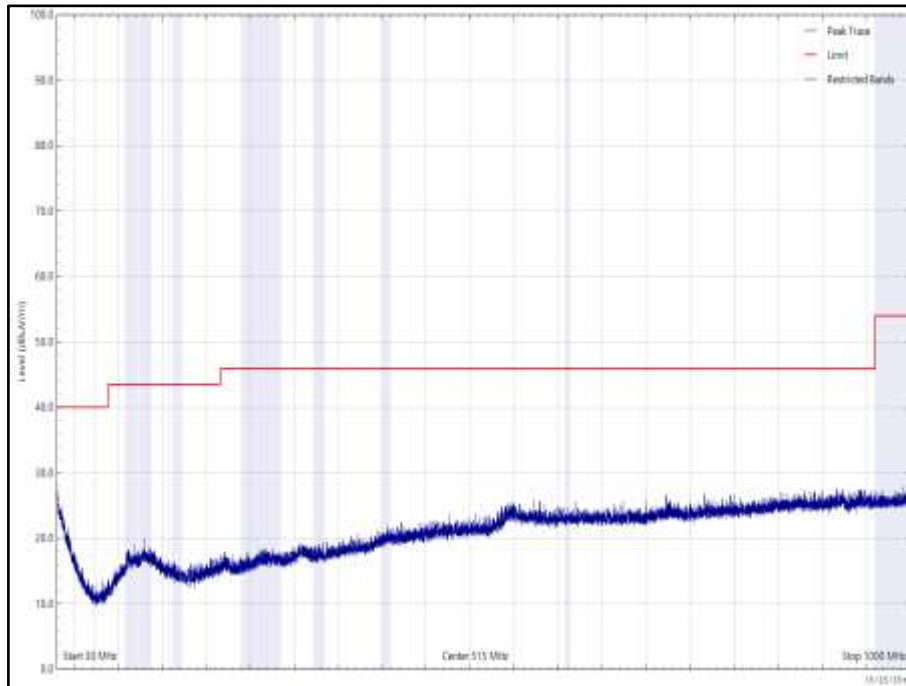
**Figure 1150 - 5745 MHz (CH149), HE20, RU26-0, Core 0 + Core 1, 1 GHz to 40 GHz, Vertical**



Frequency (MHz)	Level (dBµV/m)	Limit (dBµV/m)	Margin (dB)	Detector	Angle (°)	Height (cm)	Polarisation
11632.534	37.76	54.0	-16.24	RMS	157	100	Vertical

**Table 702 - 5825 MHz (CH165), HE20, RU26-0, Core 0 + Core 1, 30 MHz to 40 GHz**

No other emissions found within 6 dB of the limit.



**Figure 1151 - 5825 MHz (CH165), HE20, RU26-0, Core 0 + Core 1, 30 MHz to 1 GHz, Horizontal (Peak)**

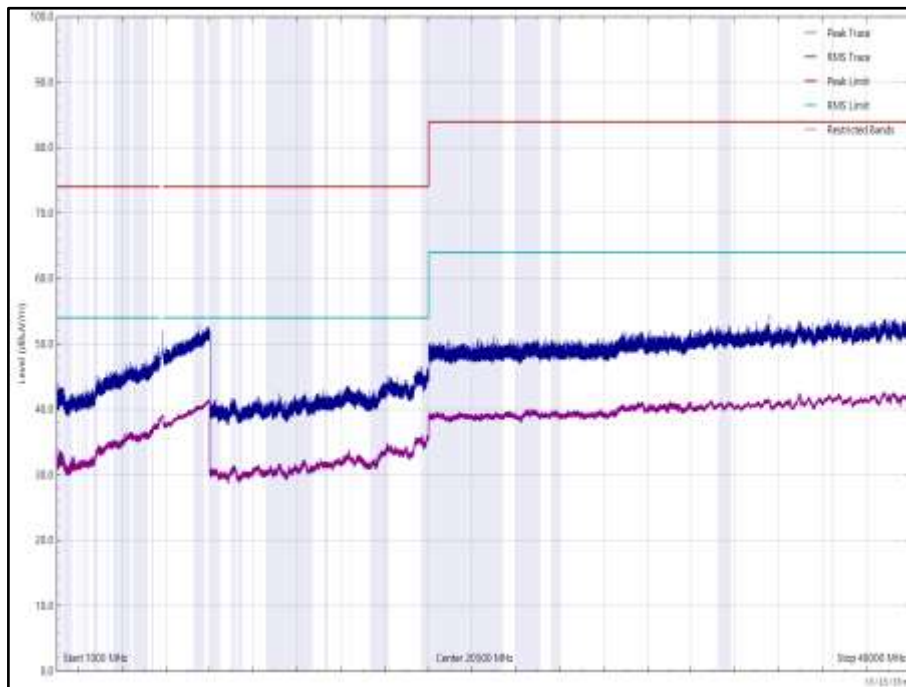


Figure 1152 - 5825 MHz (CH165), HE20, RU26-0, Core 0 + Core 1, 1 GHz to 40 GHz, Horizontal

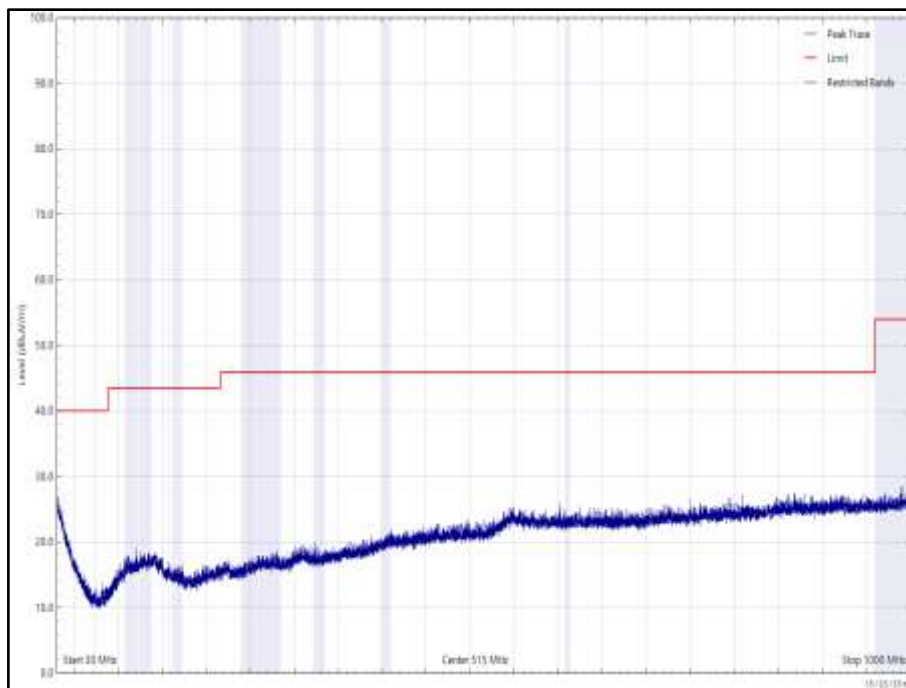
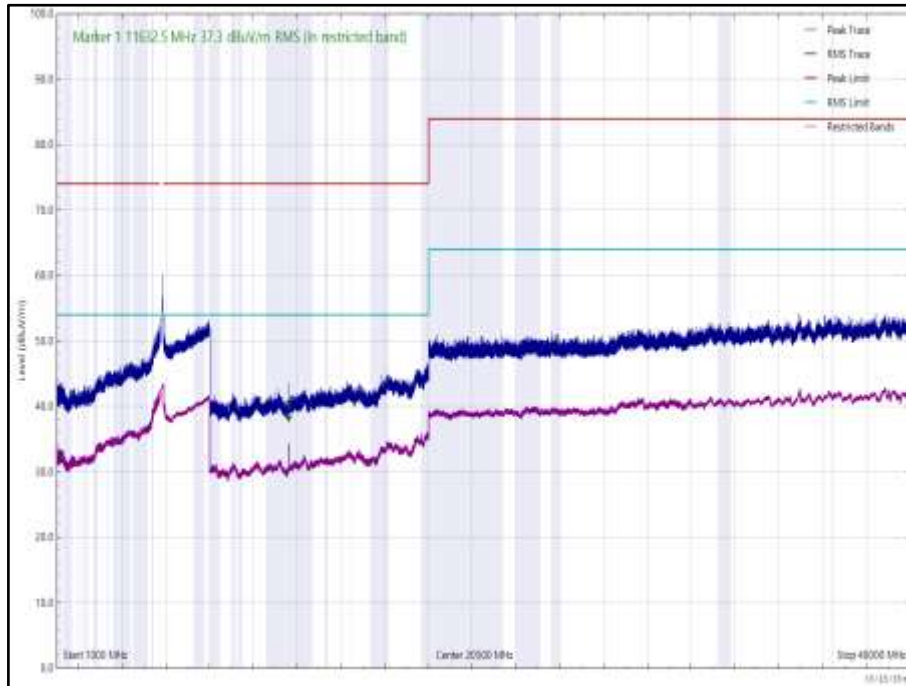


Figure 1153 - 5825 MHz (CH165), HE20, RU26-0, Core 0 + Core 1, 30 MHz to 1 GHz, Vertical (Peak)



**Figure 1154 - 5825 MHz (CH165), HE20, RU26-0, Core 0 + Core 1, 1 GHz to 40 GHz, Vertical**  
FCC 47 CFR Part 15, Limit Clause 15.407(b)(1)(2)(3)(4)

Emissions not falling within the restricted bands listed in FCC 47 CFR Part 15.209:

For transmitters operating in the 5.15-5.25 GHz band:  $\leq -27$  dBm/MHz outside 5150-5350 MHz.

For transmitters operating in the 5.25-5.35 GHz band:  $\leq -27$  dBm/MHz outside 5150-5350 MHz.

For transmitters operating in the 5.47-5.725 GHz band:  $\leq -27$  dBm/MHz outside 5470-5725 MHz

For transmitters operating in the 5.725-5.85 GHz band: All emissions shall be limited to a level of -27 dBm/MHz at 75 MHz or more above or below the band edge increasing linearly to 10 dBm/MHz at 25 MHz above or below the band edge, and from 25 MHz above or below the band edge increasing linearly to a level of 15.6 dBm/MHz at 5 MHz above or below the band edge, and from 5 MHz above or below the band edge increasing linearly to a level of 27 dBm/MHz at the band edge.

Emissions within the restricted bands listed in FCC 47 CFR Part 15.209:

Frequency (MHz)	Field Strength ( $\mu$ V/m) at 3m	Field Strength Limit (dB $\mu$ V/m) at 3m
30 to 88	100	40.00
88 to 216	150	43.52
216 to 960	200	46.02
Above 960	500	53.98

**Table 703 - Radiated Emissions Limit Table (FCC)**



ISED RSS-247, Limit Clause 6.2.1.2, 6.2.2.2, 6.2.3.2 and 6.2.4.2 and ISED RSS-GEN, Limit Clause 8.9

Emissions not falling within the restricted bands listed in ISED RSS-GEN, Clause 8.10:

For transmitters with operating frequencies in the band 5150-5250 MHz, all emissions outside the band 5150-5350 MHz shall not exceed -27 dBm/MHz e.i.r.p. Any unwanted emissions that fall into the band 5250-5350 MHz shall be attenuated below the channel power by at least 26 dB.

For transmitters with operating frequencies in the bands 5250-5350 MHz and 5470-5725 MHz, all emissions outside the band 5250-5350 MHz and 5470-5725 MHz shall not exceed -27 dBm/MHz e.i.r.p.

Devices operating in the band 5725-5850 MHz shall have e.i.r.p. of unwanted emissions comply with the following:

- a) 27 dBm/MHz at frequencies from the band edges decreasing linearly to 15.6 dBm/MHz at 5 MHz above or below the band edges;
- b) 15.6 dBm/MHz at 5 MHz above or below the band edges decreasing linearly to 10 dBm/MHz at 25 MHz above or below the band edges;
- c) 10 dBm/MHz at 25 MHz above or below the band edges decreasing linearly to -27 dBm/MHz at 75 MHz above or below the band edges; and
- d) -27 dBm/MHz at frequencies more than 75 MHz above or below the band edges.

Emissions not falling within the restricted bands listed in ISED RSS-GEN, Clause 8.10:

Frequency (MHz)	Field Strength ( $\mu\text{V}/\text{m}$ ) at 3m	Field Strength Limit (dB $\mu\text{V}/\text{m}$ ) at 3m
30 to 88	100	40.00
88 to 216	150	43.52
216 to 960	200	46.02
Above 960	500	53.98

**Table 704 - Radiated Emissions Limit Table (ISED)**

**2.6.7 Test Location and Test Equipment Used**

This test was carried out in RF Chamber 11.

Instrument	Manufacturer	Type No	TE No	Calibration Period (months)	Calibration Expires
Antenna (DRG, 18 GHz to 40 GHz)	Link Microtek Ltd	AM180HA-K-TU2	230	24	27-Jul-2022
Antenna with attenuator (Bilog, 30 MHz to 3 GHz)	Schaffner	CBL6143	287	24	14-Oct-2022
Pre-Amplifier (18 GHz to 40 GHz)	Phase One	PSO4-0087	1534	12	02-Aug-2022
7 GHz High pass Filter	Wainwright	WHKX12	5549	12	20-May-2022
Band Reject Filter - 5.690 GHz	Wainwright	WRCJV8	5081	12	29-Sept-2022
Band Reject Filter - 5.28 GHz	Wainwright	WRCJV12	5075	12	29-Sept-2022
Band Reject Filter - 5.570 GHz	Wainwright	WRCJV10	5079	12	15-Nov-2022
Band Reject Filter - 5.775 GHz	Wainwright	WRCJV10	5077	12	15-Nov-2022



Instrument	Manufacturer	Type No	TE No	Calibration Period (months)	Calibration Expires
Band Reject Filter - 5.795 GHz	Wainwright	WRCJV10	5071	12	29-Sept-2022
Band Reject Filter - 5.22 GHz	Wainwright	WRCJV12	5073	12	29-Sept-2022
Antenna (DRG Horn 7.5-18GHz)	Schwarzbeck	HWRD750	5348	12	15-Oct-2022
8 - 18 GHz Amplifier	Wright Technologies	APS06-0061	5596	12	24-Aug-2022
Cable	Junkosha	MWX221	5514	12	09-Apr-2022
EMI Test Receiver	Rohde & Schwarz	ESW44	5084	12	08-Mar-2022
Cable (18 GHz)	Rosenberger	LU7-071-1000	5102	12	20-Oct-2022
Cable (18 GHz)	Rosenberger	LU7-071-1000	5103	12	17-Nov-2022
Cable (18 GHz)	Rosenberger	LU7-071-1000	5104	12	10-Dec-2021
Cable (18 GHz)	Rosenberger	LU7-071-2000	5107	12	10-Dec-2021
Emissions Software	TUV SUD	EmX V2.1.11	5125	-	Software
Mast	Maturo	TAM 4.0-P	5158	-	TU
Mast and Turntable Controller	Maturo	Maturo NCD	5159	-	TU
Turntable	Maturo	TT 15WF	5160	-	TU
Horn Antenna (1-10GHz)	Schwarzbeck	BBHA 9120 B	5215	12	01-Apr-2022
Preamp 1 - 26.5 GHz	Agilent Technologies	8449B	5445	12	06-May-2022
Cable (K-Type to K-Type, 1 m)	Junkosha	MWX241-01000KMSKMS/A	5511	12	09-Apr-2022
2m SMA Cable	Junkosha	MWX221-02000AMSAMS/A	5518	12	09-Apr-2022
8m N Type Cable	Junkosha	MWX221-08000NMSNMS/B	5522	12	24-Mar-2022
2m K Type Cable	Junkosha	MWX241-02000KMSKMS/A	5524	12	24-Mar-2022
Thermo-Hygro-Barometer	PCE Instruments	PCE-THB 40	5604	12	22-Sep-2022

**Table 705**

TU - Traceability Unscheduled



## 2.7 Channel Move Time, Channel Closing Transmission Time and Non-Occupancy Period

### 2.7.1 Specification Reference

FCC 47 CFR Part 15E, Clause 15.407 (h)(2)(iii)(iv)  
ISED RSS-247, Clause 6.3.2(c)(d)(e)

### 2.7.2 Equipment Under Test and Modification State

A2615, S/N: QJ07J4XMCW - Modification State 0

### 2.7.3 Date of Test

03-December-2021 to 10-February-2022

### 2.7.4 Test Method

This test was performed in accordance with FCC KDB 905462 D02, clause 7.8.3.

A computer was connected via an Ethernet cable to the Master device and the FCC defined audio/video file was streamed from the Client device using Windows Media Player.

Radar Pulse Type 0 was then transmitted, and the Spectrum monitored. The transmissions from the UUT were observed for a period of 12 seconds after the final injected Radar Pulse.

It was checked that all transmissions stopped within the 10 second period defined from the point of the end of the final Radar pulse + 10 seconds. In addition, the aggregate on time during the first 200ms and the following 9.8 seconds of the Channel Move Time was computed by the Aeroflex DFS Software.

The markers on the trace data correspond to the following time periods:

Red - End Of Radar Burst, (T0)  
Purple - End Of 200ms Period, (T0 + 200 ms)  
Orange - End Of Channel Move Time, (T0 + 10 seconds)

To verify the non-occupancy period, the PXI digitiser was replaced with a Spectrum Analyser. The external trigger from the Aeroflex DFS test system was used to trigger a 30-minute sweep from the moment the radar burst sequence was injected. It was verified that no transmissions occurred on the test channel during this time period.

### 2.7.5 Environmental Conditions

Ambient Temperature	21.4 - 25.1 °C
Relative Humidity	25.8 - 46.7 %

**2.7.6 Test Results**

5 GHz WLAN - 802.11a

The equipment was set up as shown in the diagram below. The EUT was configured to run iPerf, transmitting UDP to the client laptop. The channel loading was set to >17% by adjusting the bandwidth specified in the iPerf UDP transfer.

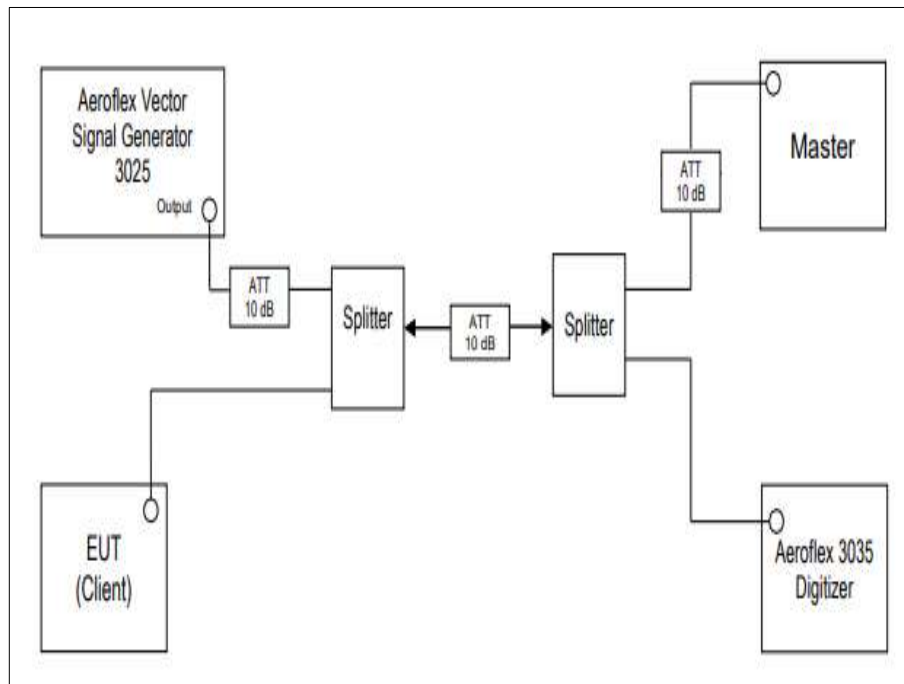
To calibrate the level of the radar at the input to the companion device, the companion device was replaced by the spectrum analyser and the output of the PXI RF generator adjusted to give -62 dBm.

Radar Type	Pulse Width ( $\mu$ s)	PRI ( $\mu$ s)	Number of Pulses
0	1	1428	18

**Table 706 - Radar Pulse Type 0 Characteristics**

Manufacturer	Model	Serial Number	FCC ID
ASUS	RT-AC68U	GAIU0H002628	MSQ-RTAC68U

**Table 707 - Details of Master Device used to support testing**



**Figure 1155 - Test Equipment Setup Diagram for Client without Radar Detection with Injection at the Master**



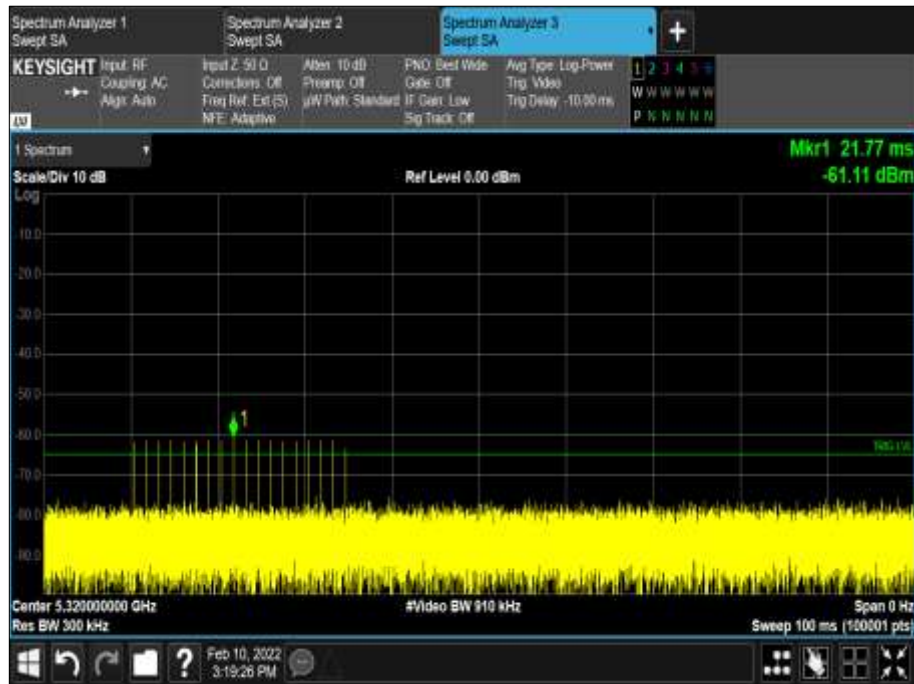


Figure 1156 - Verification of Radar Type 0

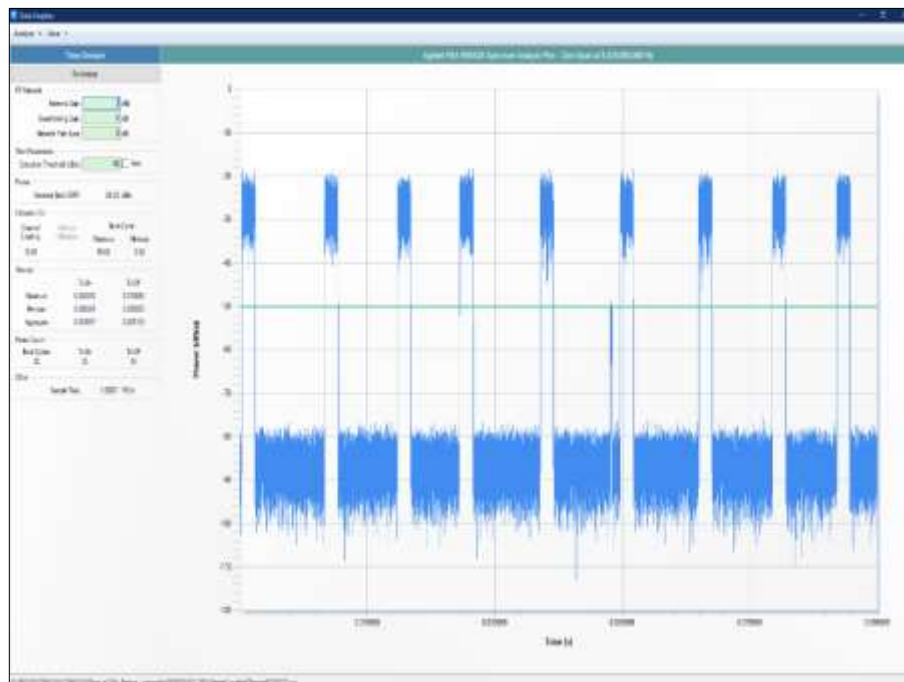


Figure 1157 - Channel Loading

The channel loading was 18.88%

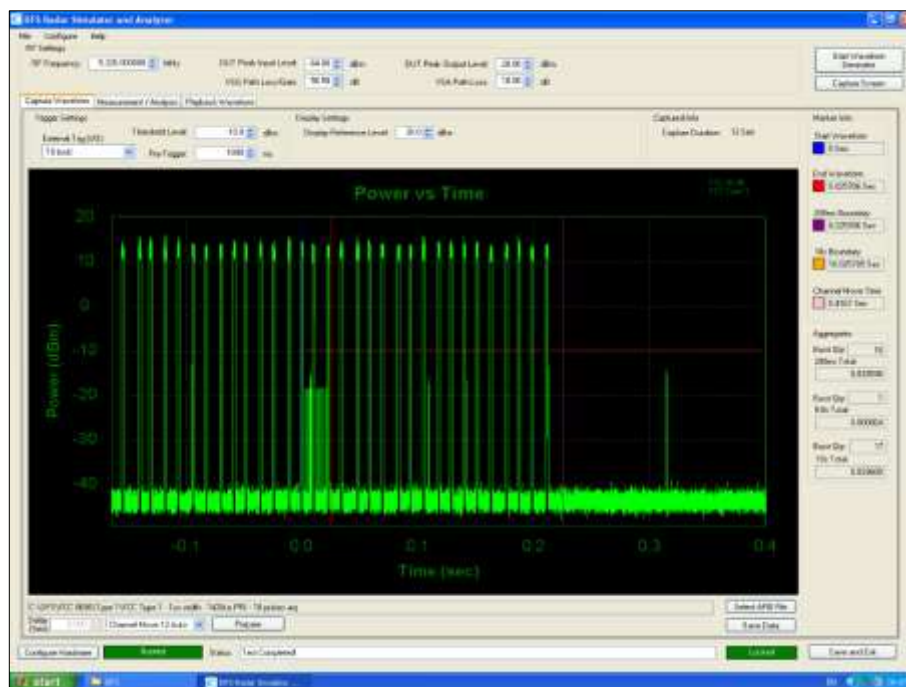


Maximum Transmit Power	Value (Notes 1 and 2)
≥ 200 milliwatt	-64 dBm
< 200 milliwatt	-62 dBm
Note 1: This is the level at the input of the receiver assuming a 0 dBi receive antenna. Note 2: Throughout these test procedures an additional 1 dB has been added to the amplitude of the test transmission waveforms to account for variations in measurement equipment. This will ensure that the test signal is at or above the detection threshold level to trigger a DFS response.	

**Table 708 - DFS Detection Thresholds for Master Devices and Client Devices with Radar Detection**

Test Parameter	Result
Test Channel	Ch64 5.32GHz
Channel Move Time	416.7 ms
Channel Closing Time (Aggregate Time During 200 ms)	33.5 ms
Channel Closing Time (Aggregate Time During 200 ms to 10 s)	0.1 ms
Channel Closing Time (Aggregate Time During 10 s)	33.6 ms
Transmission Observed During Non-Occupancy Period	0

**Table 709 - In-Service Monitoring Test Results**



**Figure 1158 - First 200 ms of Channel Shutdown Period**

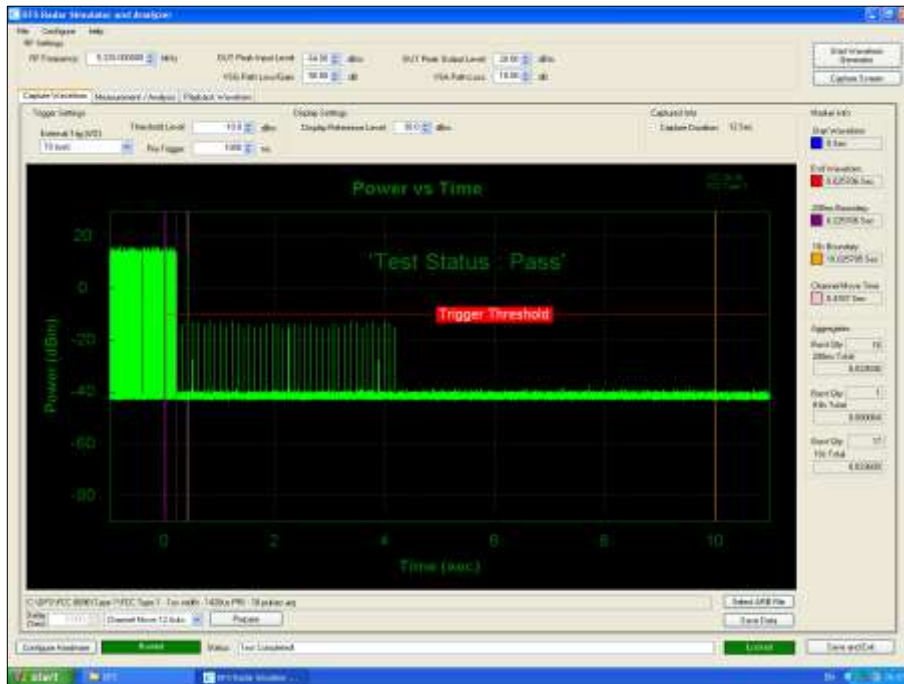


Figure 1159 - First 12 s of Channel Shutdown Period

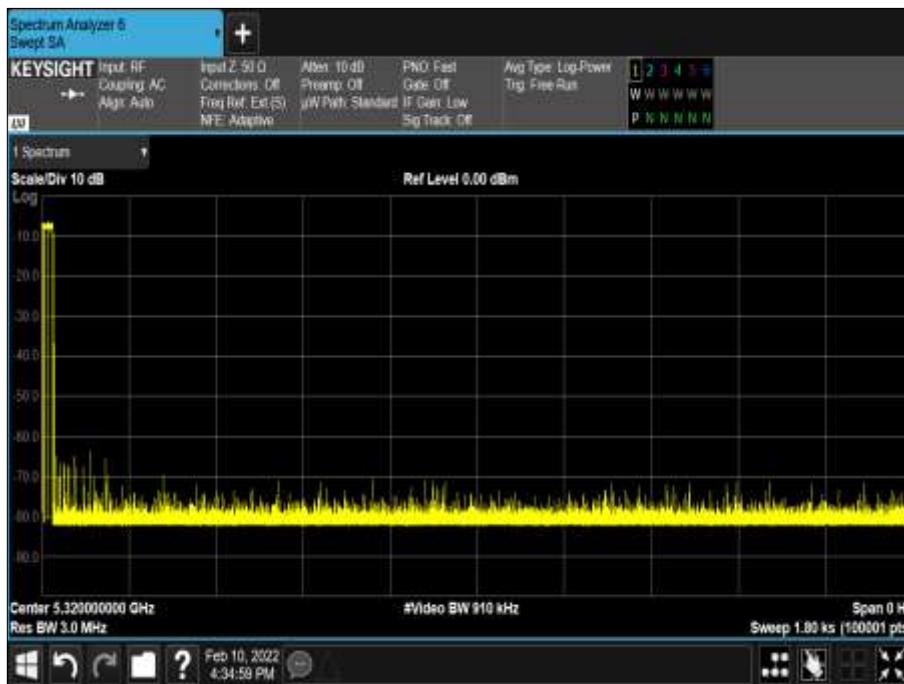


Figure 1160 - 30 minute Non-Occupancy Period

5 GHz WLAN - Client to Client - 802.11ac VHT80

The equipment was set up as shown in the diagram below. The EUT was configured to run iPerf, transmitting UDP to the client laptop. The channel loading was set to >17% by adjusting the bandwidth specified in the iPerf UDP transfer.

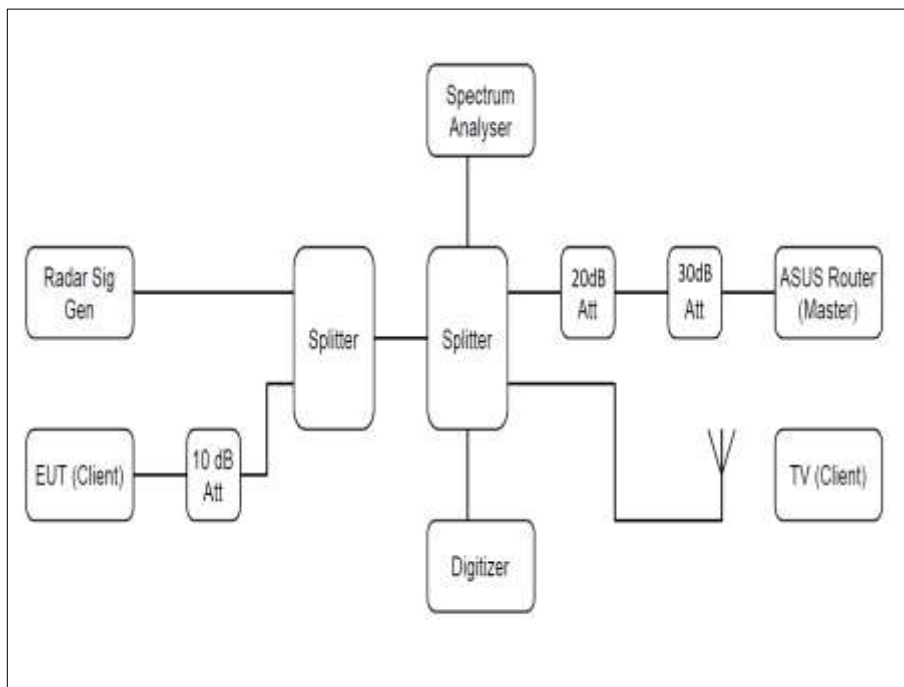
To calibrate the level of the radar at the input to the companion device, the companion device was replaced by the spectrum analyser and the output of the PXI RF generator adjusted to give -62 dBm.

Radar Type	Pulse Width ( $\mu$ s)	PRI ( $\mu$ s)	Number of Pulses
0	1	1428	18

**Table 710 - Radar Pulse Type 0 Characteristics**

Manufacturer	Model	Serial Number	FCC ID
ASUS	RT-AC68U	GAIU0H002628	MSQ-RTAC68U

**Table 711 - Details of Master Device used to support testing**



**Figure 1161 - Test Equipment Setup Diagram for Client without Radar Detection with Injection at the Master**

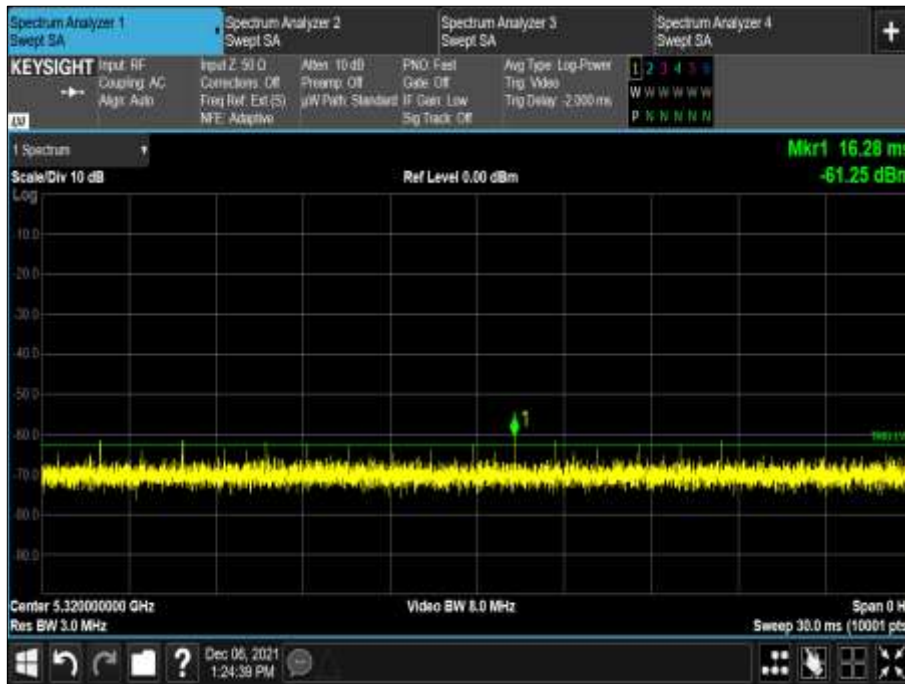


Figure 1162 - Verification of Radar Type 0

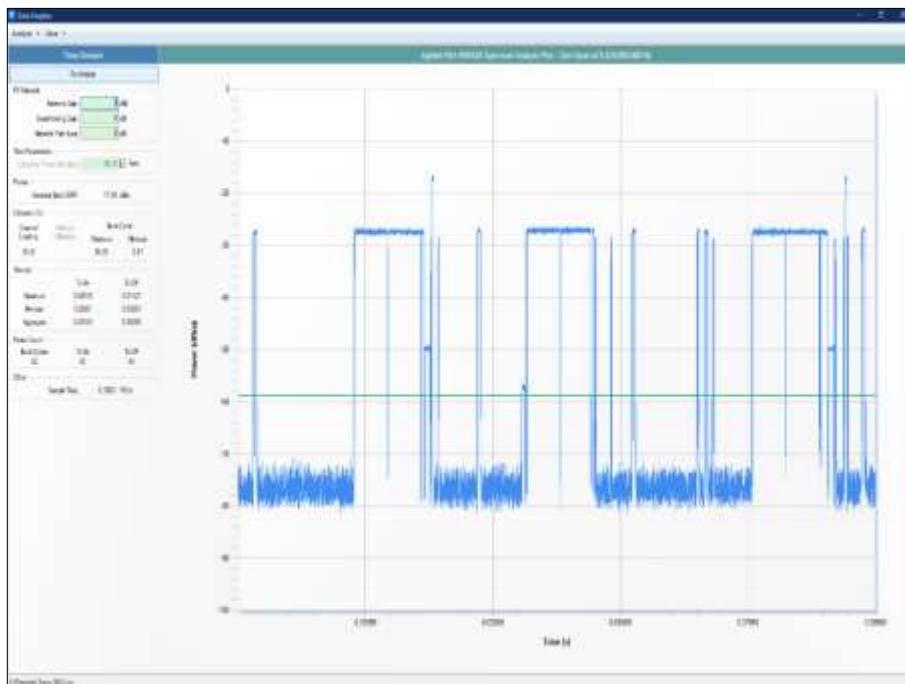


Figure 1163 - Channel Loading

The channel loading was 20.97%

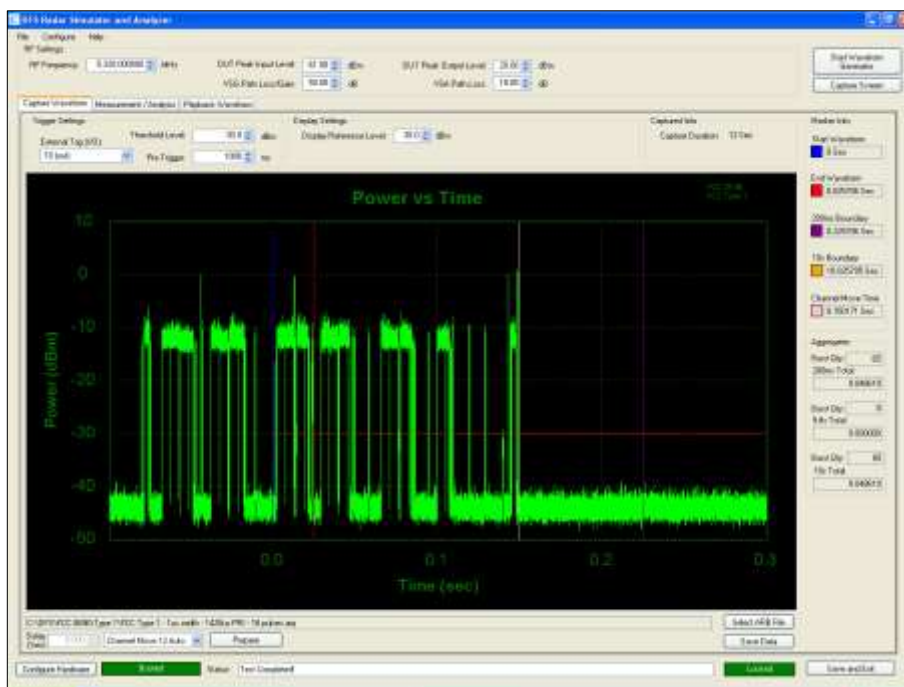


Maximum Transmit Power	Value (Notes 1 and 2)
≥ 200 milliwatt	-64 dBm
< 200 milliwatt	-62 dBm
Note 1: This is the level at the input of the receiver assuming a 0 dBi receive antenna. Note 2: Throughout these test procedures an additional 1 dB has been added to the amplitude of the test transmission waveforms to account for variations in measurement equipment. This will ensure that the test signal is at or above the detection threshold level to trigger a DFS response.	

**Table 712 - DFS Detection Thresholds for Master Devices and Client Devices with Radar Detection**

Test Parameter	Result
Test Channel	CH58 (5290 MHz), Control CH64 (5320 MHz)
Channel Move Time	0.150 s
Channel Closing Time (Aggregate Time During 200 ms)	48.169 ms
Channel Closing Time (Aggregate Time During 200 ms to 10 s)	0 ms
Channel Closing Time (Aggregate Time During 10 s)	48.169 ms
Transmission Observed During Non-Occupancy Period	0

**Table 713 - In-Service Monitoring Test Results**



**Figure 1164 - First 200 ms of Channel Shutdown Period**

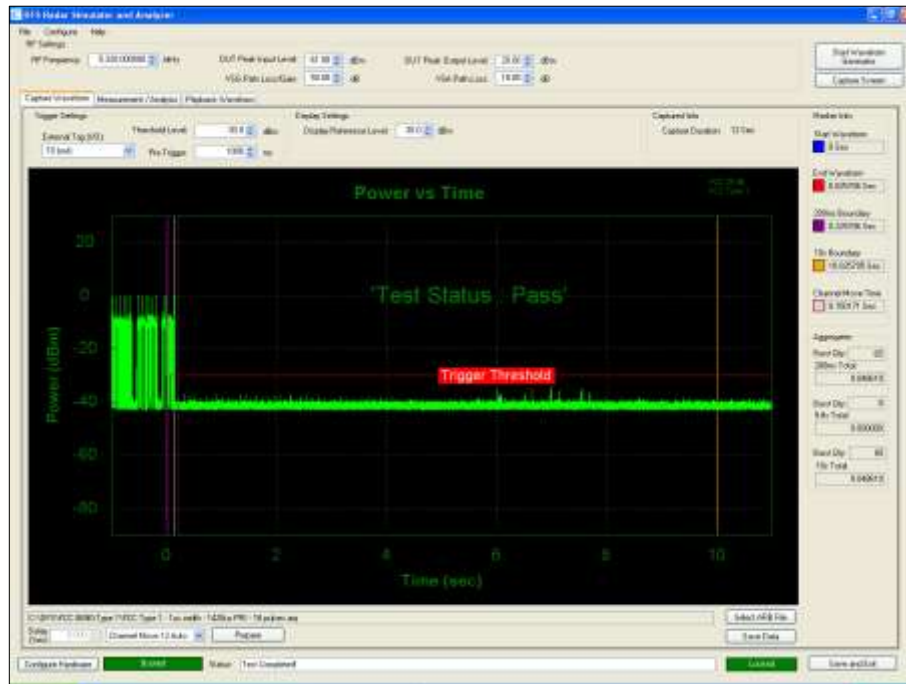


Figure 1165 - First 12 s of Channel Shutdown Period



Figure 1166 - 30 minute Non-Occupancy Period



FCC 47 CFR Part 15, Limit Clause 15.407 (h)(2)(iii)

Channel Move Time	<10 seconds
Channel Closing Time (Aggregate Time During 200ms)	<200 ms
Channel Closing Time (Aggregate Time During +200ms to 10s)	<60 ms

**Table 714 - Channel Move Time and Channel Closing Transmission Time Limit**

FCC 47 CFR Part 15, Limit Clause 15.407 (h)(2)(iv)

Non-occupancy Period	> 30 minutes
----------------------	--------------

**Table 715 - Non-Occupancy Limit**

ISED RSS-247, Limit Clause 6.3.2

Devices shall comply with the following requirements, however, the requirement for in-service monitoring does not apply to slave devices without radar detection.

In-service monitoring: an LE-LAN device shall be able to monitor the operating channel to check that a co-channel radar has not moved or started operation within range of the LE-LAN device. During in-service monitoring, the LE-LAN radar detection function continuously searches for radar signals between normal LE-LAN transmissions.

Channel availability check time: the device shall check whether there is a radar system already operating on the channel before it initiates a transmission on a channel and when it moves to a channel. The device may start using the channel if no radar signal with a power level greater than the interference threshold value specified in Section 6.3.1 above is detected within 60 seconds. This requirement only applies in the master operational mode.

Channel move time: after a radar signal is detected, the device shall cease all transmissions on the operating channel within 10 seconds.

Channel closing transmission time: is comprised of 200 ms starting at the beginning of the channel move time plus any additional intermittent control signals required to facilitate a channel move (an aggregate of 60 ms) over the remaining 10-second period of the channel move time.

Non-occupancy period: a channel that has been flagged as containing a radar signal, either by a channel availability check or in-service monitoring, is subject to a 30-minute non-occupancy period where the channel cannot be used by the LE-LAN device. The non-occupancy period starts from the time that the radar signal is detected.





**2.7.7 Test Location and Test Equipment Used**

This test was carried out in RF Laboratory 1.

Instrument	Manufacturer	Type No	TE No	Calibration Period (months)	Calibration Expires
Hygrometer	Rotronic	I-1000	3220	12	05-Nov-2022
PXI RF Digitizer	Aeroflex	3035	4012	24	12-Nov-2022
PXI RF Synthesizer	Aeroflex	3010	4013	24	12-Nov-2022
PXI RF Synthesizer	Aeroflex	3011	4014	24	12-Nov-2022
PXI Digital RF Signal Generator	Aeroflex	3025	4015	24	12-Nov-2022
Frequency Standard	Spectracom	SecureSync 1200-0408-0601	4393	6	30-Jun-2022
Wireless Cable & Fibre Router - AC 1900, Dual-band	Asus	RT-AC68U	4881	-	TU
Power Splitter, 2 way	Mini-Circuits	ZN2PD2-63-S+	5237	-	O/P Mon
Power Splitter, 2 way	Mini-Circuits	ZN2PD2-63-S+	5239	-	O/P Mon
3.5 mm 1m Cable	Junkosha	MWX221-01000DMS	5418	12	23-Jun-2022
3.5 mm 2m Cable	Junkosha	MWX221-02000DMS	5429	12	23-Jun-2022
Signal Analyzer	Keysight Technologies	PXA N9030B	5432	12	20-Aug-2022
Attenuator 5W 20dB DC-18GHz	Aaren	AT40A-4041-D18-20	5498	12	10-May-2022
Attenuator 5W 20dB DC-18GHz	Aaren	AT40A-4041-D18-20	5499	12	14-Apr-2022
Attenuator 2W 10dB DC-10GHz	Telegartner	J01156A0031	5580	-	O/P Mon
Attenuator 2W 10dB DC-10GHz	Telegartner	J01156A0031	5581	-	O/P Mon

**Table 716**

TU - Traceability Unscheduled  
 O/P Mon – Output Monitored using calibrated equipment



### 3 Measurement Uncertainty

For a 95% confidence level, the measurement uncertainties for defined systems are:

Test Name	Measurement Uncertainty
Restricted Band Edges	$\pm 6.3$ dB
Maximum Conducted Output Power	$\pm 3.2$ dB
Maximum Conducted Power Spectral Density	$\pm 3.2$ dB
Emission Bandwidth	$\pm 886.93$ kHz
Authorised Band Edges	$\pm 6.3$ dB
Spurious Radiated Emissions	30 MHz to 1 GHz: $\pm 5.2$ dB 1 GHz to 40 GHz: $\pm 6.3$ dB
Channel Move Time, Channel Closing Transmission Time and Non-Occupancy Period	Time: $\pm 0.47$ % Power: $\pm 1.29$ dB

**Table 717**

#### Measurement Uncertainty Decision Rule

Determination of conformity with the specification limits is based on the decision rule according to IEC Guide 115:2007, Clause 4.4.3 and 4.5.1. (Procedure 2). The measurement results are directly compared with the test limit to determine conformance with the requirements of the standard.

Risk: The uncertainty of measurement about the measured result is negligible with regard to the final pass/fail decision. The measurement result can be directly compared with the test limit to determine conformance with the requirement (compare IEC Guide 115). The level of risk to falsely accept and falsely reject items is further described in ILAC-G8.