

ULTIMA

Manual

V.1.1



Chord Electronics Ltd.

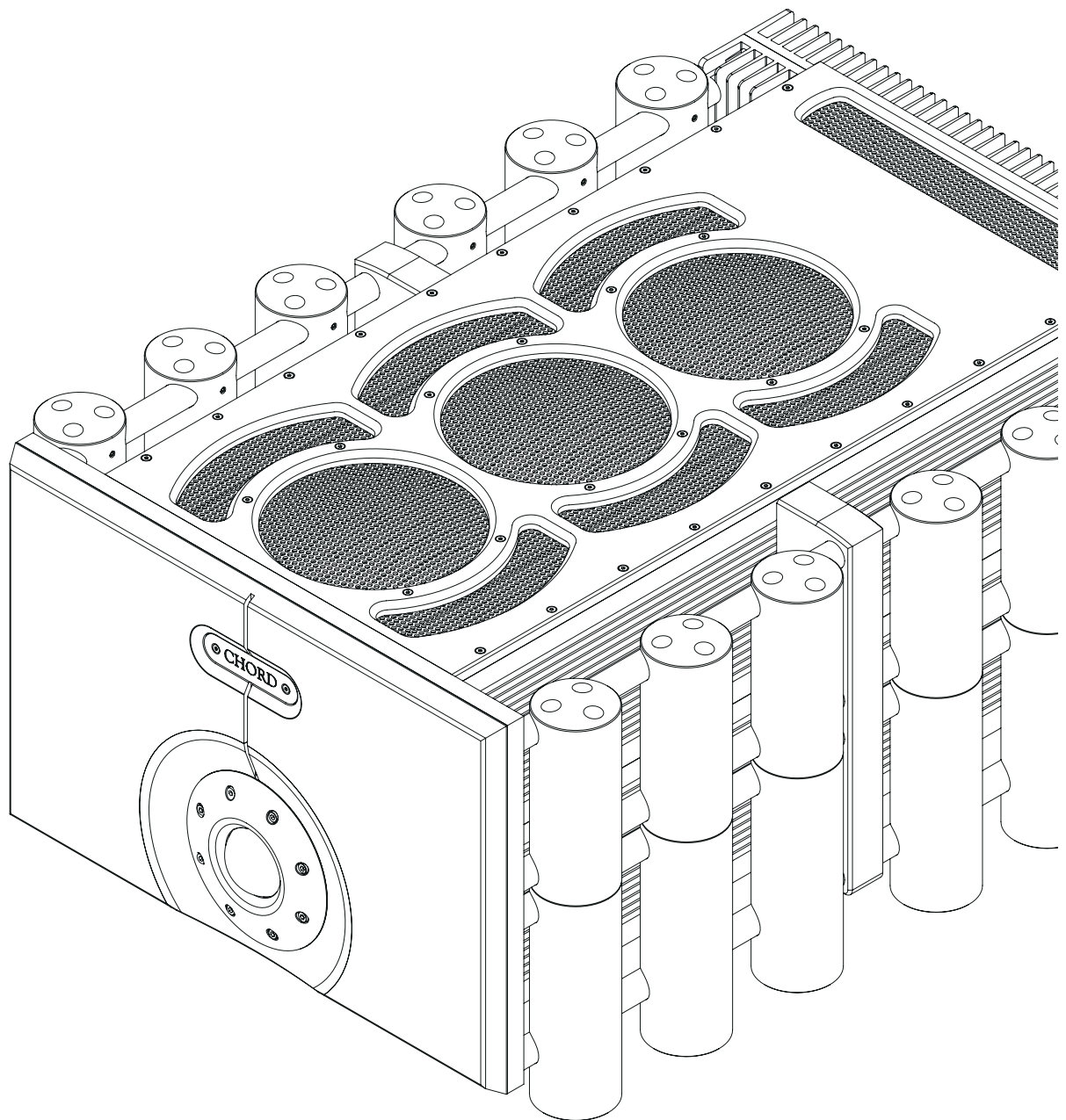

Contents

0.0

| | | | |
|--|-----------|---|-----------|
| 1.0 Safety instructions | 03 | 2.0 Warranty | 08 |
| 1.1 Introduction | 04 | 2.1 Warranty period & registering your purchase | 09 |
| 1.2 Protection against liquids & heat | 05 | 2.2 Making a claim & warranty exclusions | 10 |
| 1.3 Dismantling & Radio frequency interference | 06 | | |
| 1.4 Connecting your equipment | 07 | | |
| | | | |
| 3.0 Getting to know ULTIMA | 11 | 4.0 Setting up ULTIMA | 16 |
| 3.1 Getting to know ULTIMA | 12 | 4.1 Placement | 17 |
| 3.2 The front panel | 13 | 4.2 Connecting ULTIMA to ancillary equipment | 18 |
| 3.3 The top panel | 14 | 4.3 Audio inputs | 19 |
| 3.4 The rear panel | 15 | 4.4 Audio outputs | 20 |
| | | 4.5 Power-on sequence and 12V trigger | 21 |
| | | 4.6 Earthing issues in Europe | 22 |
| | | 4.7 Adjusting the brightness of the LED's | 23 |

0.0

Contents

Safety instructions

1.0

- 1.1 Introduction
- 1.2 Protection against liquids & heat
- 1.3 Dismantling & Radio Frequency interference
- 1.4 Connecting your equipment

1.0 *Safety instructions*

Introduction

1.1



ULTIMA is the cornerstone of Chord Electronics' amplification, standing as our ultimate reference amplification - beaten by none.

Before operation, we strongly advise that you read this user manual thoroughly, storing it in a safe place along with your original receipt of purchase, in case you should require assistance in the future.



 *Made in* **BRITAIN**

Protection against liquids & heat

1.2



The ULTIMA is not protected against liquids of any kind. Never place containers of liquid on ULTIMA. Never allow ULTIMA to come into contact with moisture or liquids; doing so could result in electrocution or damage to the ULTIMA internal circuitry.

Be aware that liquids, including water that has dried, can leave minerals that can affect the PCB and other components, which could eventually lead to oxidation and short-circuiting.

If the ULTIMA comes into contact with moisture or liquids, immediately disconnect from the mains power supply, and connected equipment, and contact Chord Electronics for further advice.



The ULTIMA has internal thermal protection that will cut the power supply if reached.

Never operate the ULTIMA near sources of heat or naked flames as this will decrease the lifespan of the internal components. It is advised that you do not operate the ULTIMA in an area of direct sunlight or on top of significant heat-producing devices.

Please be aware that it is entirely normal for the ULTIMA to become warm during use, particularly within a stacked configuration. If you are concerned about the temperatures, please switch the device off and consider a different placement.

Dismantling & radio frequency interference

1.3



There are no user-serviceable components within the ULTIMA or its power supply. Dangerous voltages/currents exist within the ULTIMA and its power supply, posing a severe risk of electrocution and/or fire.



Never attempt to open, dismantle or apply internal third-party devices to it or insert anything other than the listed interconnects or speaker cables within this user manual.

If the ULTIMA develops a fault or the casework becomes damaged, immediately disconnect from the mains power supply and connected equipment and contact Chord Electronics for further advice.

With a thick, solid aluminium chassis, the ULTIMA's casework largely protects the sensitive internal circuitry from radio frequency interference. However, for optimal performance, it is recommended that the following points are observed:



1. Consider placing the ULTIMA away from wireless routers.



2. Separate the ULTIMA from amplifiers using toroidal transformers.



3. Operate mobile phones at a distance to avoid interference.



Although the ULTIMA is largely shielded, it can generate radio frequency interference that may have an effect on radio and television reception. If this occurs, please reconsider your placement.

Connecting your equipment 1.4

Before connecting the ULTIMA to any equipment, consult the manufacturer's user guide to confirm compatibility.

When connecting the ULTIMA to any equipment, make sure that all devices are off, including the ULTIMA.

Once connected, switch all equipment on starting with the source and ending with the amplification.

Initially, operate the any connected equipment on its lowest gain setting and lowest volume setting, gently increasing to a comfortable listening level.

Never operate connected equipment to the ULTIMA at excessive sound levels; permanent hearing damage and loss can occur.

The included 15 amp IEC mains lead plugs into the ULTIMA.

If the power supply is prematurely disconnected ULTIMA may still remain active for up to 15 seconds, however, this may cause damage to connected equipment.



WARNING: Never disconnect the power cable during operation. Only disconnect when ULTIMA is off. If the power cable is disconnected during operation there is a risk of damage to connected equipment.



Warranty

2.0

- 2.1 Warranty period & registering your purchase
- 2.2 Making a claim & warranty exclusions

2.0 *Warranty*

Warranty period & registering your purchase

2.1

At point of sale, Chord Electronics Ltd. provides ULTIMA with a comprehensive five-year warranty* which covers defects in materials and workmanship through fair wear and tear. The warranty will be void if any other PSU other than that supplied is used.

*The warranty is transferable with proof of purchase, however, warranty on ex-demonstration units begins from the retailer's date of purchase.



Please use the form below to record the details of your purchase in the event that these are required at a later date, we further advise that all purchases are registered with Chord Electronics at: chordelectronics.co.uk/register-product/



| | |
|-------------------|--|
| RETAILER: | |
| PURCHASE PRICE: | |
| UNIT COLOUR: | |
| DATE OF PURCHASE: | |
| TRANSACTION ID: | |

Making a claim & warranty exclusions

2.2

In the unlikely event of a claim, you must provide Chord Electronics with the details of the claim, including your original proof of purchase and serial number in order to validate the nature of the repair.

Upon receipt, Chord Electronics will make an assessment within 30 days and provide a reasonable solution.

All warranty repairs must be carried out by Chord Electronics or an approved service centre to guarantee the quality and safety of the repair.

WARRANTY EXCLUSIONS: The warranty does not cover connected equipment, personal injury or development natural patina of the metalwork and will be null and void if the following is applied: wilful neglect; modification or tampering of the product; improper use of the product; acts of God; damage caused by a connected device; mechanical shock; fire or application of excessive heat or repair/modification by a non-authorized third-party vendor.

**Getting to know
ULTIMA**

3.0

- 3.1 Getting to know ULTIMA
- 3.2 The front panel
- 3.3 The top panel
- 3.4 The rear panel

3.0 *Getting to know
ULTIMA*

Getting to know ULTIMA

3.1

ULTIMA is our absolute reference amplifier which uses a brand new analogue topology, Chord Electronics' first all-new design since its inception. Before operation, we strongly advise you read this user manual thoroughly, storing it in a safe place along with your original receipt of purchase, should you require assistance in the future.



The front panel

3.2

With only two buttons, everyday operation of ULTIMA is simple and you can tailor the brightness of the feature lighting to suit the ambience of your listening room.



WARNING: You must keep all vents clear.

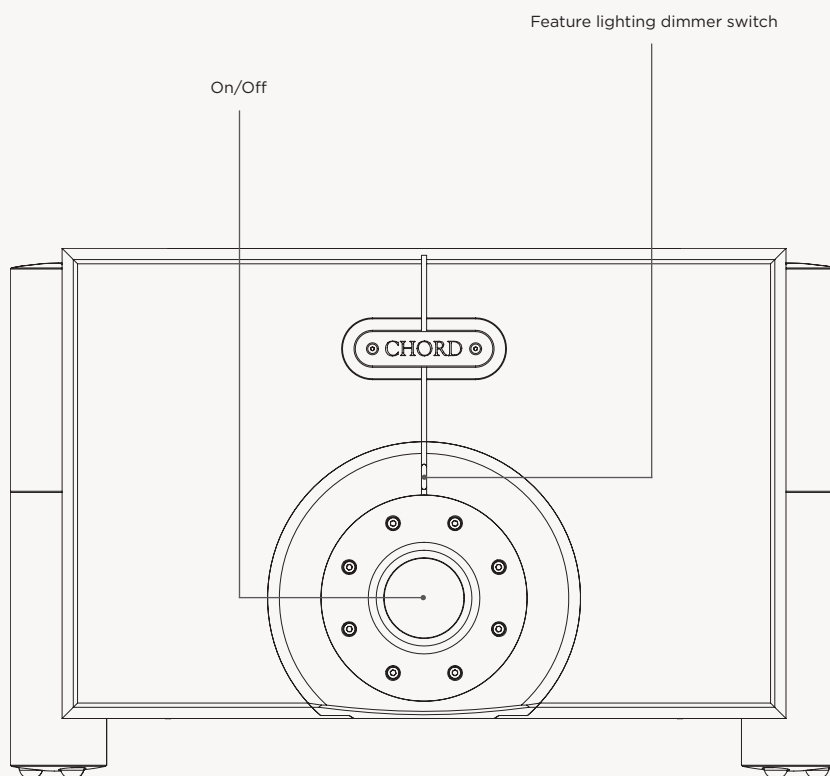

The top panel

3.3

The top panel has no user configurable options. Instead, three teal feature light rings illuminate. If you find that these rings are too bright for your listening room you can control the brightness via the front panel.

 **WARNING:** You must keep all vents clear.

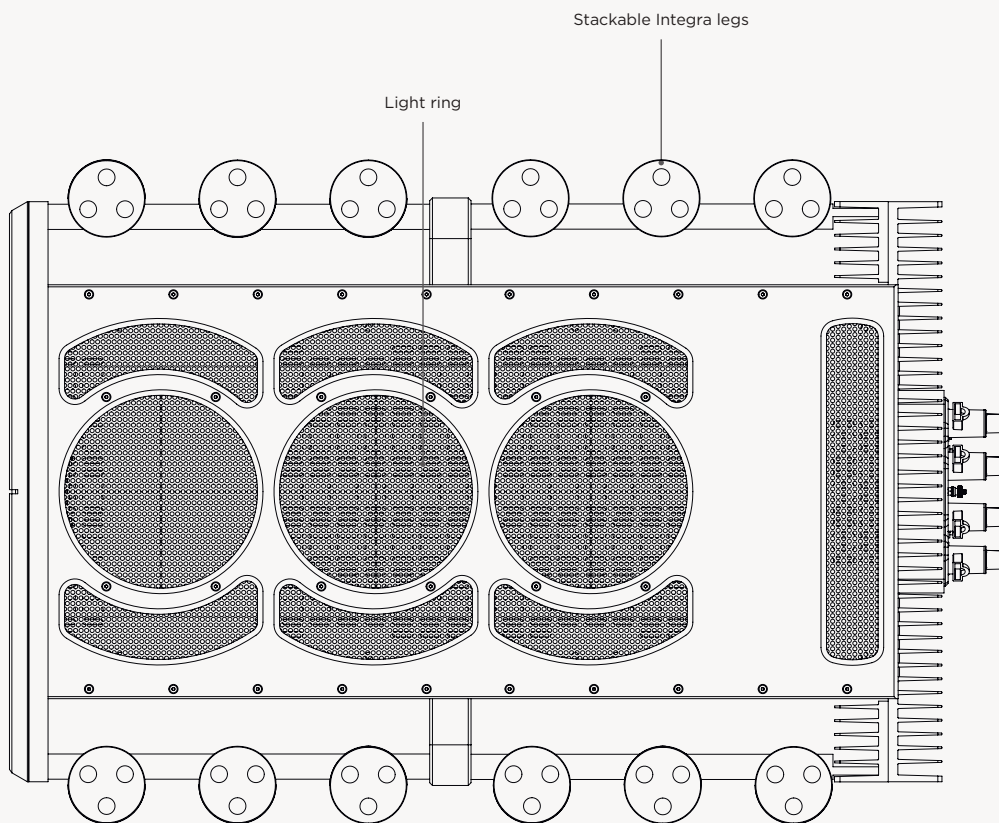

The rear panel

3.4

The rear panel offers a comprehensive connectivity suite, featuring both standard connections and those which are used with other Chord Electronics' devices.

When installing any cable, you must make sure that they securely click into place, especially optical.

 **WARNING:** You must keep all vents clear.

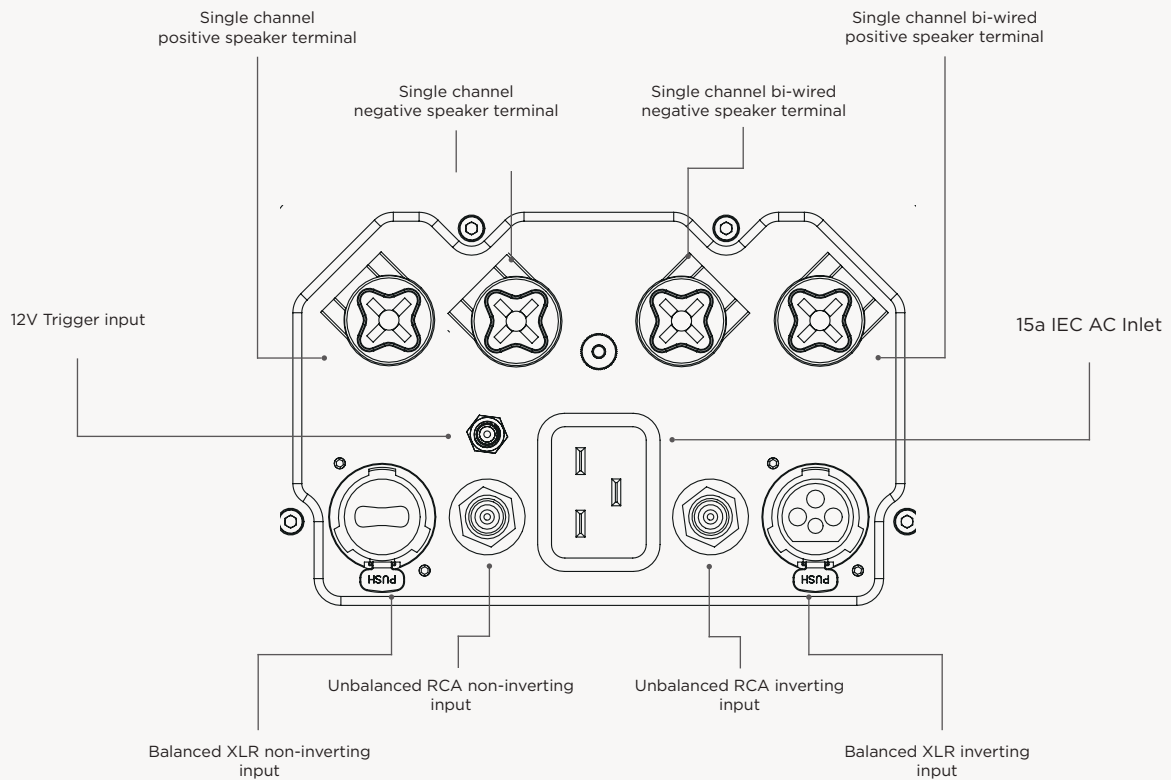

Setting up ULTIMA

4.0

- 4.1 Placement
- 4.2 Connecting ULTIMA to ancillary equipment
- 4.3 Audio inputs
- 4.4 Audio outputs
- 4.5 Power-on sequence and 12V trigger
- 4.6 Earthing issues in Europe

4.0

Setting up ULTIMA

| | | | |
|-----|--|-----|---------------------------------------|
| 4.1 | Placement | 4.5 | Power-on sequence and 12V trigger |
| 4.2 | Connecting ULTIMA to ancillary equipment | 4.6 | Earthing issues in Europe |
| 4.3 | Audio inputs | 4.7 | Adjusting the brightness of the LED's |
| 4.4 | Audio outputs | | |

Placement

4.1

Whilst ULTIMA will operate normally within a Chord Electronics Reference configuration stacked via the Integra legs, it is recommended that ULTIMA is allowed to 'breathe' with 10cm of space around it to convection-cool during operation.



Connecting ULTIMA to ancillary equipment 4.2

When connecting the ULTIMA to equipment within the signal path, ensure all devices are switched off. It is recommended that once all equipment is properly connected, that the volume setting is operated to its lowest setting, before slowly being raised to a comfortable listening level. Always observe partnering manufacturers' guidelines.

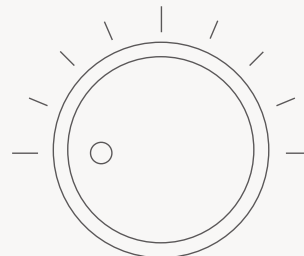
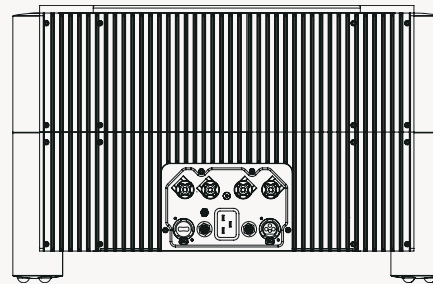

Audio inputs

4.3

ULTIMA is equipped with both inverted and non-inverted balanced XLR inputs as well as inverted and non-inverted unbalanced RCA inputs. ULTIMA has no ability to switch between the inputs therefore, only one must be used.

Inversion relates to the phase of the incoming signal. During normal operation for Chord Electronics products, the use of the inverted inputs is advised, however, you may select non-inverting if desired by removing the cap covering the XLR input.

If you remove the cap please take great care to connect both amplifiers with the same inversion to avoid an out-of-phase configuration.

If using ULTIMA with older models of Chord Electronics monoblocks please note the inputs will be reversed.

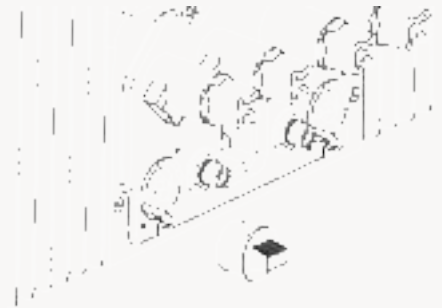

WARNING: ULTIMA must be connected to a dedicated preamplifier, or a device capable of attenuating its output. Failure to attenuate the volume before it enters ULTIMA could result in irreversible hearing damage, speaker damage and could void the warranty.

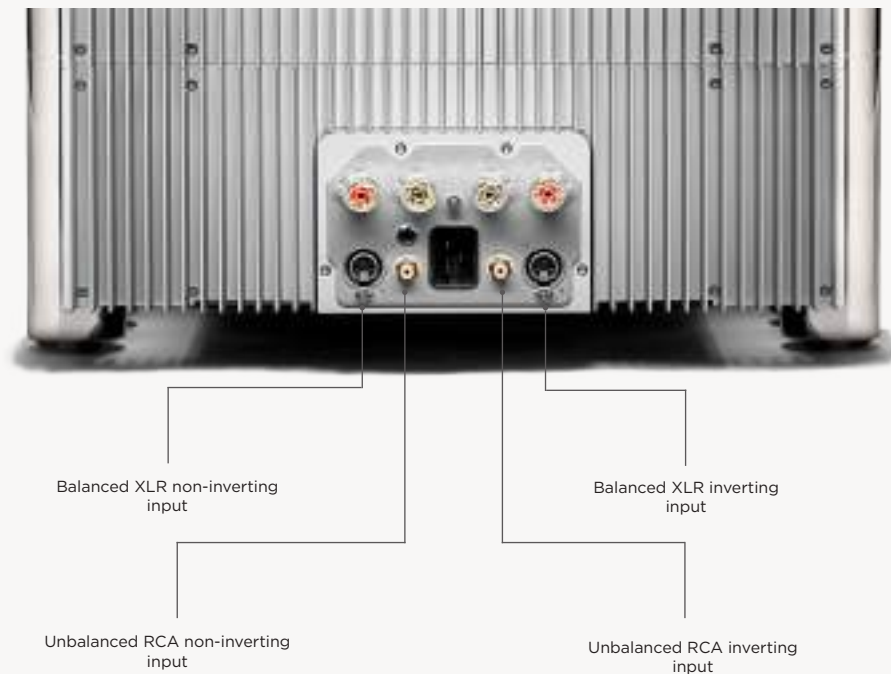

Audio outputs

4.4

As ULTIMA is a mono amplifier, it only supports a single speaker output, however, it has four speaker terminals. Both positive speaker terminals originate from the same source, as does the negative speaker terminals. Do use the additional two positive and negative terminals if you wish to bi-wire your speakers.

In order to connect ULTIMA to loudspeakers, use high-quality loudspeaker cable terminated with 4mm banana plugs or 6mm spades. Bare wire can be used, but it is not recommended.

Connect the black (negative) terminal from ULTIMA to the negative terminal on your loudspeaker and the red (positive) terminal from ULTIMA to the red positive terminal on your loudspeaker. Repeat if you wish to bi-wire the same speaker.



Power-on sequence and 12V trigger

4.5



POWER-ON SEQUENCE:

During normal operation, when ULTIMA is in standby mode the large power button on the front panel will illuminate an red colour. To power-on ULTIMA press the large power button once until you feel a click. ULTIMA's power button will now change to a green colour whilst it begins its initial safety checks.

During this phase do not increase the gain on the input device as you cannot determine its final amplified volume which can damage the connected speakers.

Once the amplifier has passed the safety check and is operational, after approximately ten seconds, the amplifier will display a teal colour.

12V Trigger: A 12V trigger can be used to remotely turn ULTIMA on or off. Please refer to the below diagram to correctly wire your 12V trigger.

When a 12V trigger is sensed by ULTIMA the colours displayed on power button will be different.

During standby the large power button on the front panel will illuminate an orange colour, however just like the power sequence without the 12V trigger a green colour will be displayed once you switch the unit on and it performs its safety checks. You should still not increase the gain on the input device.

Once the amplifier becomes operational the power button will display a continuous purple glow.



WARNING: In the rare event that a fault is detected the amplifier will switch itself off. If this occurs discontinue use immediately and seek help from your Chord Electronics retailer.

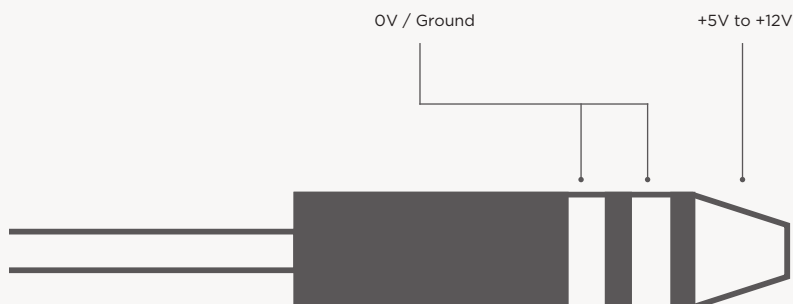

Earthing issues in Europe

4.6



In some European countries, a hum or buzz may occur if the amplifier is connected to mains sockets that do not have an earth or adequate earth. If this occurs, please ensure that your equipment is connected via a good-quality multi-way mains block which contains an earth point at every socket outlet.

We recommend that an earthing method for your building is implemented.

Adjusting the brightness of the LED's 4.7

At any time, you can adjust the brightness of the LEDs to suit your listening environment. Simply locate the hidden button in the middle of the faceplate as indicated below, insert a thin object and push until you hear an audible 'click'. The light ring and power button will cycle between low and high brightness modes.

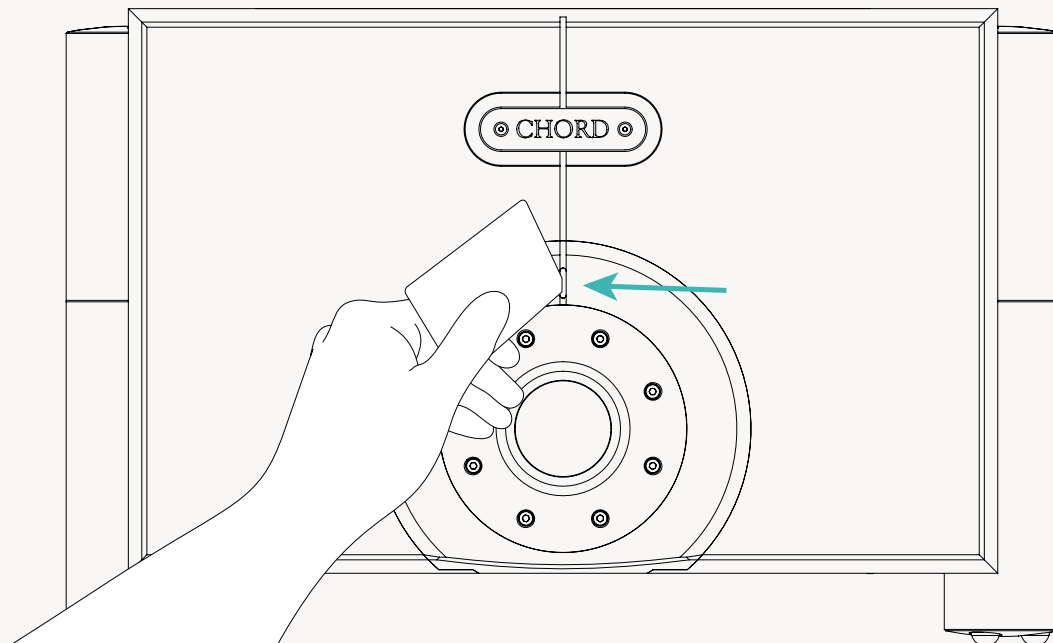



Chord Electronics Ltd.

