

INSTRUCTION MANUAL

MICROWAVE OVEN

TC142A2SV

Please review this instruction manual before operating.

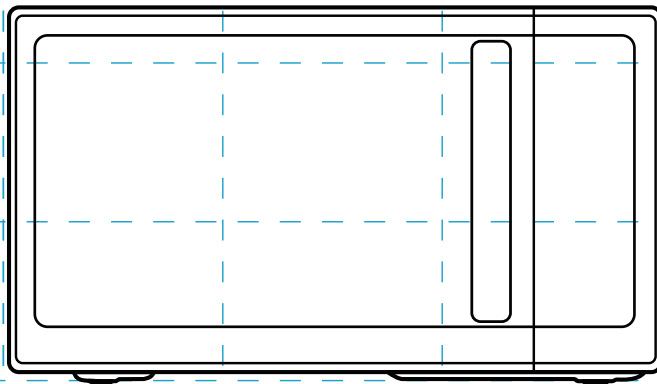

PRODUCT SAFETY

Precautions to avoid possible exposure to excessive microwave energy	EN-01
Specifications	EN-02
Important safety instructions	EN-03
Grounding instructions.....	EN-07
Radio interference	EN-09
Utensils.....	EN-10
Materials you can use in microwave oven	EN-11
Materials can not be used in microwave oven	EN-13

PRODUCT SETTING

Names of microwave oven parts and accessories	EN-14
Door opening guidance	EN-15
Turntable installation.....	EN-16
Countertop installation	EN-17
Installation	EN-17

INSTRUCTION FOR USE

Before using for the first time	EN-18
Operation.....	EN-19
Control panel and features	EN-19
1. Setting the clock	EN-20
2. Setting the kitchen timer	EN-20
3. Power levels	EN-21
4. Microwave cooking	EN-21
5. Convection cooking with preheat function	EN-22
6. Convection cooking without preheat function	EN-23
7. Combination cooking (convection+microwave)	EN-23

8. Warm hold function	EN-24
9. Speedy cooking	EN-24
10. Defrost by time	EN-25
11. Auto defrost	EN-25
12. Auto bake & roast function	EN-26
13. Sensor cook	EN-27
14. Sensor reheat	EN-27
15. Popcorn	EN-28
16. Air fry	EN-28
17. Memory function	EN-30
18. Multi-stage cooking	EN-31
19. Mute mode	EN-32
20. ECO function	EN-32
21. Lock function for children	EN-32
22. Turntable reset function	EN-33
23. Inquiring function	EN-33

CLEANING AND MAINTENANCE

Cleaning.....	EN-34
Trouble shooting	EN-36



BEFORE OPERATING THIS PRODUCT, READ, UNDERSTAND, AND FOLLOW THESE INSTRUCTIONS. BE SURE TO SAVE THIS BOOKLIST FOR FUTURE REFERENCE.

PRECAUTIONS TO AVOID POSSIBLE EXPOSURE TO EXCESSIVE MICROWAVE ENERGY

- (a). Do not attempt to operate this oven with the door open since open door operation can result in harmful exposure to microwave energy.

It is important not to defeat or tamper with the safety interlocks.

- (b). Do not place any object between the oven front face and the door or allow soil or cleaner residue to accumulate on sealing surfaces.

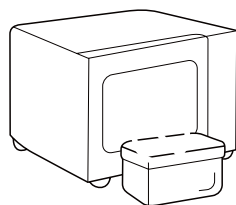

- (c). Do not operate the oven if it is damaged. It is particularly important that the oven door closes properly and that there is no damage to the:

- (1). DOOR (bent)
- (2). HINGES AND LATCHES (broken or loosened)
- (3). DOOR SEALS AND SEALING SURFACES

- (d). The oven should not be adjusted or repaired by anyone except properly qualified service personnel.

MODEL	TC142A2SV-SSHA
RATED VOLTAGE/FREQUENCY	120VAC 60Hz
RATED INPUT POWER (MICROWAVE)	1250 W
RATED OUTPUT POWER (MICROWAVE)	1100 W
CONVECTION	1500 W
GRILL	1500 W



NOTE

All pictures in this manual are for illustrative purposes only; these may be slightly different from the purchased equipment, please refer to the actual product.

IMPORTANT SAFETY INSTRUCTIONS



When using electrical appliances basic safety precautions should be followed, including the following. To reduce the risk of burns, electric shock, fire, injury to persons or exposure to excessive microwave energy.

Read all instructions before using the appliance.

Read and follow the specific:
"PRECAUTIONS TO AVOID POSSIBLE EXPOSURE TO EXCESSIVE MICROWAVE ENERGY" found on page 1.

This appliance must be grounded. Connect only to properly grounded outlet. See **"GROUNDING INSTRUCTIONS"** found on page 7.

Install or locate this appliance only in accordance with the provided installation instructions.

HOT CONTENTS CAN CAUSE SEVERE BURNS. DO NOT ALLOW CHILDREN TO

USE THE MICROWAVE.

Use caution when removing hot items.

When cleaning surfaces of door and oven that comes together on closing the door, use only mild, nonabrasive soaps, or detergent applied with a sponge or soft cloth. Please keep the wave guide area clean. Use soft damp cloth to clean it up when there is food splash residue on the wave guide area or the cavity. Failure to clean food residue may cause innocuous sparking or some smoke in the microwave cavity, discoloration of the cavity may also occur.

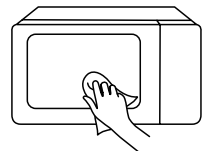

IMPORTANT SAFETY INSTRUCTIONS

Keep cord away from heated surface.

Liquids, such as water, coffee, or tea are able to overheat beyond the boiling point without appearing to be boiling. Visible bubbling or boiling when the container is removed from the microwave oven is not always present.

THIS COULD RESULT IN VERY HOT LIQUID SUDDENLY BOILING OVER WHEN THE CONTAINER IS DISTURBED OR A SPOON OR OTHER UTENSIL IS INSERTED INTO THE LIQUID. To reduce the risk of injury to persons:

1. Do not overheat the liquid.
2. Stir the liquid both before and halfway through heating it.
3. Do not use straight-sided containers with narrow necks.
4. After heating, allow

the container to stand in the microwave oven for a short time before removing the container.

5. Use extreme care when inserting a spoon or other utensil into the container.

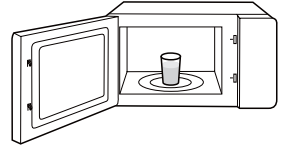

Oversized food or oversized metal utensils should not be inserted in a microwave/toaster oven as they may create a fire or risk of electric shock.

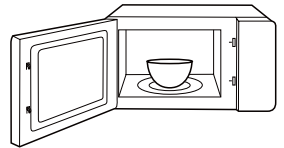

This appliance should be serviced only by qualified service personnel. Contact nearest authorized service facility for examination, repair, or adjustment.

IMPORTANT SAFETY INSTRUCTIONS

To reduce the risk of fire in the oven cavity:

1. Do not overcook food. Carefully attend appliance when paper, plastic, or other combustible materials are placed inside the oven to facilitate cooking.
2. Remove wire twist-ties from paper or plastic bag before placing bag in oven.
3. If material inside of the oven ignite, keep oven door closed, turn oven off, and disconnect the power cord, or shut off power at the fuse or circuit breaker panel.
4. Do not use the cavity for storage purposes. Do not leave paper products, cooking utensils, or food in the cavity when not in use.

Some products such as whole eggs and sealed containers, for example, closed glass jars are able to explode and should not be heated in this oven.

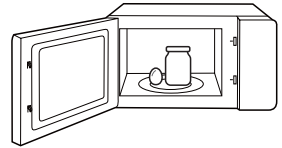

Do not store this appliance outdoors. Do not use this product near water - for example, near a kitchen sink, in a wet basement, near a swimming pool, or similar location.

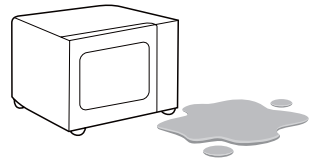

Do not immerse cord or plug in water or any other liquid.



IMPORTANT SAFETY INSTRUCTIONS

Use this appliance only for its intended use as described in the manual. Do not use corrosive chemicals or vapors in this appliance. This type of oven is specifically designed to heat, cook or dry food. It is not designed for industrial or laboratory use.

Do not operate this appliance if it has a damaged cord or plug, if it is not working properly, or if it has been damaged or dropped.

Do not clean with metal scouring pads. Pieces can burn off the pad and touch electrical parts involving a risk of electric shock.

Do not cover or block any openings on the appliance.

Do not let cord hang over edge of table or counter.

Do not use paper products when appliance is operated in the toaster mode.

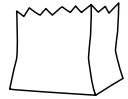

Do not store any materials, other than manufacturer's recommended accessories, in this oven when not in use.

Do not cover racks or any other part of the oven with metal foil. This will cause over-heating of the oven.

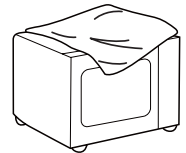

**SAVE THESE INSTRUCTIONS
HOUSEHOLD USE ONLY(NOT FOR
COMMERCIAL USE)**

GROUNDING INSTRUCTIONS

This appliance must be grounded. In the event of an electrical short circuit, grounding reduces the risk of electric shock by providing an escape wire for the electric current. This appliance is equipped with a cord having a grounding wire with a grounding plug. The plug must be plugged into an outlet that is properly installed and grounded.

WARNING - Improper use of the grounding can result in a risk of electric shock. Consult a qualified electrician or serviceman if the grounding instructions are not completely understood, or if doubt exists as to whether the appliance is properly grounded. If it is necessary to use an extension cord, use only a 3-wire extension cord that has a 3-blade grounded plug, and 3-slot receptacle that will accept the plug on the appliance. The marked rating of the extension cord shall be equal to or greater than the electrical rating of the appliance.



Electric Shock Hazard:
Touching some of the internal components can cause serious personal injury or death. Do not disassemble this appliance.

GROUNDING INSTRUCTIONS



Electric Shock Hazard:

Improper use of the grounding can result in electric shock. Do not plug into an outlet until appliance is properly installed and grounded.

1. A short power-supply cord is provided to reduce the risks resulting from becoming entangled in or tripping over a longer cord.
2. Longer cord sets or extension cords are available and may be used if care is exercised in their use.
3. If a long cord or extension cord is used:
 - (1). The marked electrical rating of the cord set or extension cord should be at least as great as the electrical rating of the appliance.
 - (2). The extension cord must be a grounding-type 3-wire cord.
 - (3). The longer cord should be arranged so that it will not drape over the counter top or tabletop where it can be pulled on by children or tripped over unintentionally.

RADIO INTERFERENCE

1. Operation of the microwave oven may cause interference to your radio, TV or similar equipment.
2. When there is interference, it may be reduced or eliminated by taking the following measures:
 - (1).Clean door and sealing surface of the oven.
 - (2).Reorient the receiving antenna of radio or television.
 - (3).Relocate the microwave oven with respect to the receiver.
 - (4).Move the microwave oven away from the receiver.
 - (5).Plug the microwave oven into a different outlet so that microwave oven and receiver are on different branch circuits.
3. This equipment generates, uses and can radiate radio frequency energy and, if not installed and used in accordance with the instructions, may cause harmful interference to radio communications. However, there is no guarantee that interference will not occur in a particular installation. If this equipment does cause harmful interference to radio or television reception, which can be determined by turning the equipment off and on, the user is encouraged to try to correct the interference by one or more of the following measures:
 - (1) Reorient or relocate the receiving antenna.
 - (2) Increase the separation between the equipment and receiver.
 - (3) Connect the equipment into an outlet on a circuit different from that to which the receiver is connected.
 - (4) Consult the dealer or an experienced radio/TV technician for help.

FCC RF Exposure Requirements

This device complies with FCC RF radiation exposure limits set forth for an uncontrolled environment. The antenna(s) used for this transmitter must not be co-located or operating in conjunction with any other antenna or transmitter and must be installed to provide a separation distance of at least 20cm from all persons.

This device complies with part 18 of the FCC Rules.

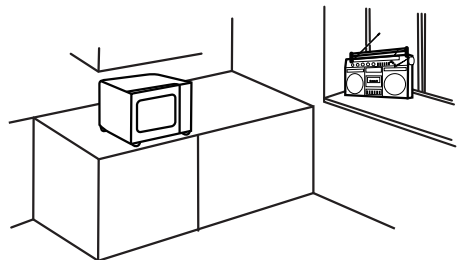

UTENSILS



Personal Injury Hazard:

Tightly-closed utensils could explode. Closed containers should be opened and plastic pouches should be pierced before cooking.

See the instructions on "**Materials you can use in microwave oven.**" or "**Materials can not be used in microwave oven .**"

There may be certain non-metallic utensils that are not safe to use for microwaving. If in doubt, you can test the utensil in question following the procedure below.

Utensil Test:



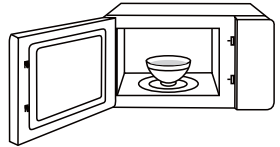

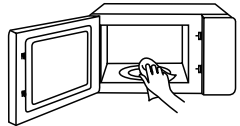

1. Fill a microwave-safe container with 1 cup of cold water (250ml) along with the utensil in question.
2. Cook on maximum power for 1 min.
3. Carefully feel the utensil. If the empty utensil is warm, do not use it for microwave cooking.
4. Do not exceed 1 min cooking time.







KEEP THE CAVITY AND
WAVEGUIDE AREA CLEAN

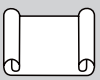







MATERIALS YOU CAN USE IN MICROWAVE OVEN

UTENSILS	REMARKS
 <p data-bbox="136 427 273 454">Browning dish</p>	<p data-bbox="349 351 698 375">Follow manufacturer's instructions.</p> <p data-bbox="349 379 906 462">The bottom of browning dish must be at least 3/16 inch (5mm) above the turntable. Incorrect usage may cause the turntable to break.</p>
 <p data-bbox="147 558 262 582">Dinnerware</p>	<p data-bbox="349 518 857 566">Microwave-safe only. Follow manufacturer's instructions. Do not use cracked or chipped dishes.</p>
 <p data-bbox="158 710 251 734">Glass jars</p>	<p data-bbox="349 638 868 718">Always remove lid. Use only to heat food until just warm. Most glass jars are not heat resistant and may break.</p>
 <p data-bbox="152 845 256 869">Glassware</p>	<p data-bbox="349 790 895 845">Heat-resistant oven glassware only. Make sure there is no metallic trim. Do not use cracked or chipped dishes.</p>
 <p data-bbox="109 989 300 1013">Oven cooking bags</p>	<p data-bbox="349 917 879 965">Follow manufacturer's instructions. Do not close with metal tie.</p> <p data-bbox="349 973 704 997">Make slits to allow steam to escape.</p>
 <p data-bbox="98 1101 316 1125">Paper plates and cups</p>	<p data-bbox="349 1061 906 1117">Use for short-term cooking/warming only. Do not leave oven unattended while cooking.</p>
 <p data-bbox="141 1260 273 1284">Paper towels</p>	<p data-bbox="349 1197 889 1252">Use to cover food for reheating and absorbing fat. Use with supervision for a short-term cooking only.</p>
 <p data-bbox="120 1396 294 1420">Parchment paper</p>	<p data-bbox="349 1348 846 1396">Use as a cover to prevent splattering or a wrap for steaming.</p>

MATERIALS YOU CAN USE IN MICROWAVE OVEN

UTENSILS	REMARKS
 <p data-bbox="169 454 240 478">Plastic</p>	<p data-bbox="349 359 900 494">Microwave-safe only. Follow the manufacturer's instructions. Should be labeled "Microwave Safe". Some plastic containers soften, as the food inside gets hot. "Boiling bags" and tightly closed plastic bags should be slit, pierced or vented as directed by package.</p>
 <p data-bbox="147 638 262 662">Plastic wrap</p>	<p data-bbox="349 558 900 638">Microwave-safe only. Use to cover food during cooking to retain moisture. Do not allow plastic wrap to touch food.</p>
 <p data-bbox="131 805 278 829">Thermometers</p>	<p data-bbox="349 750 889 774">Microwave-safe only (meat and candy thermometers).</p>
 <p data-bbox="152 965 256 989">Wax paper</p>	<p data-bbox="349 901 819 949">Use as a cover to prevent splattering and retain moisture.</p>

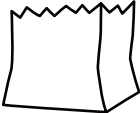
MATERIALS CAN NOT BE USED IN MICROWAVE OVEN

UTENSILS	REMARKS
 <p>Aluminum tray</p>	May cause arcing. Transfer food into microwave-safe dish.
 <p>Food carton with metal handle</p>	May cause arcing. Transfer food into microwave-safe dish.
 <p>Metal or metal trimmed utensils</p>	Metal shields the food from microwave energy. Metal trim may cause arcing.
 <p>Metal twist ties</p>	May cause arcing and could cause a fire in the oven.
 <p>Paper bags</p>	May cause a fire in the oven.
 <p>Plastic foam</p>	Plastic foam may melt or contaminate the liquid inside when exposed to high temperature.
 <p>Wood</p>	Wood will dry out when used in the microwave oven and may split or crack.

Remove the oven and all materials from the carton and oven cavity.

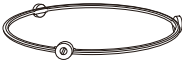

Turntable Ring Assembly

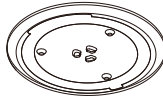

Glass turntable



Instruction Manual

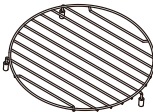

Grill Rack

(Can only be used without microwave function and must be placed on the glass turntable.)

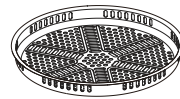

Grill Tray (Option)

(Can only be used without microwave function and must be placed on the grill rack.)

Glass turntable

Observation window

Oven cavity

Waveguide cover

Safety interlock system

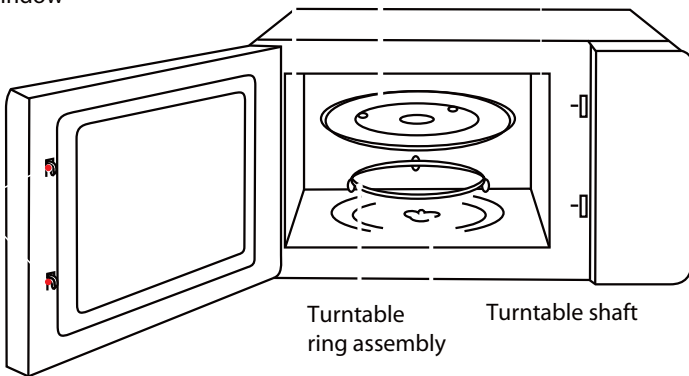

Control panel

Turntable ring assembly

Turntable shaft

Door assembly



In case of any differences between the appliance and the pictures in this manual, the product shall prevail.

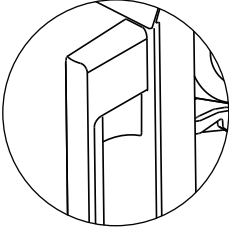

The button of opening the door

(Note: In any mode, you should press upwards the button first, then pull the handle to open the door.)

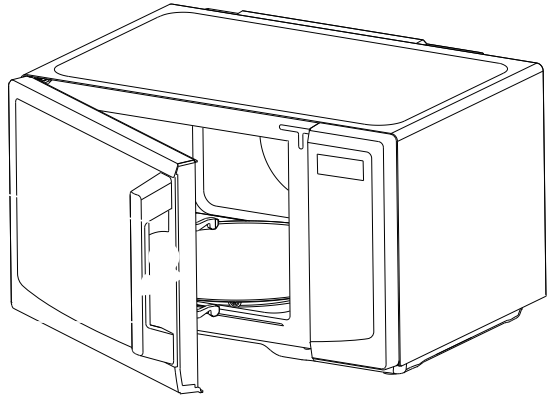

Handle of door



NOTE

In case of any differences between the appliance and the pictures in this manual, the product shall prevail.

Cleaning the cooking compartment and putting the turntable in place.

For new installations, make sure all packaging and shipping tape has been removed from the turntable shaft.

Before using the appliance to prepare food for the first time, you will need to put the turntable in place correctly. You must clean the cooking compartment and accessories.

How to put the turntable in place:

1. Place the turntable ring assembly^③ into the recess in the cooking compartment.
2. Place the glass turntable^① on the turntable ring assembly^③. Fit the raised, curved lines in the center of the glass turntable bottom between the three spokes of the shaft. Make sure that the glass turntable^① engages in the turntable shaft^② in the center of the cooking compartment floor. The rollers on the shaft should fit inside the turntable bottom ridge.

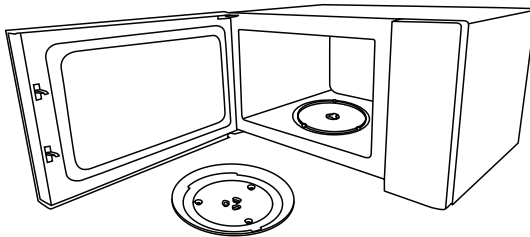
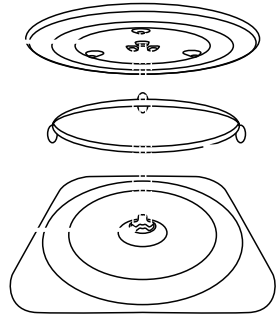



NOTE

- Never use the appliance without the turntable. Make sure that it is properly engaged. The turntable can turn clockwise or anti-clockwise.
- Never place the glass turntable upside down. The glass turntable should never be restricted.
- Both glass turntable and turntable ring assembly must always be used during cooking.
- All food and containers of food are always placed on the glass turntable for cooking.
- Never restrict the movement of the turntable.
- If glass turntable or turntable ring assembly cracks or breaks, contact your nearest authorized service center.

Remove all packing material and accessories. Examine the oven for any damage such as dents or broken door. Do not install if the oven is damaged.

Cabinet: Remove any protective film found on the microwave oven cabinet surface. Do not remove the waveguide cover that is attached to the oven cavity to protect the magnetron.

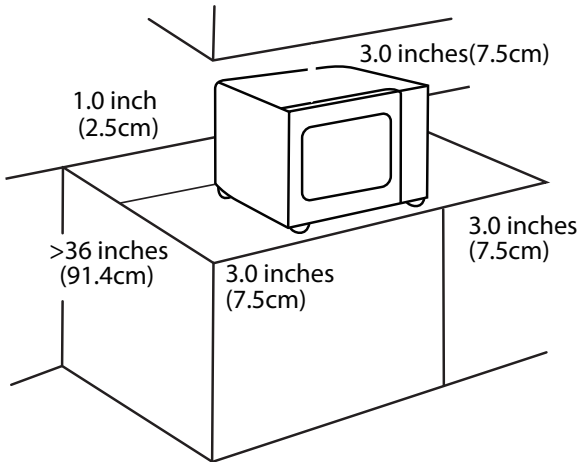
1. Select a level surface that provides enough open space for the intake and/or outlet vents.
 - a. The minimum installation height is 36 inches.
 - b. Leave a minimum clearance of 3.0 inches on each side, 3.0 inches on top, and 1.0 inch on the rear.
 - c. Do not remove the legs from the bottom of the oven.
 - d. Blocking the intake and/or outlet openings can damage the oven.
 - e. Operation of microwave oven may cause interference to your radio or TV reception.
Please place the oven as far away from the radios and TV as possible.



2. Plug microwave oven into a standard household outlet. Be sure the voltage and the frequency are the same as the voltage and the frequency on the rating label.



- Do not install oven over a range cooktop or other heat-producing appliance. If installed near or over a heat source, the oven could be damaged and the warranty would be avoided.

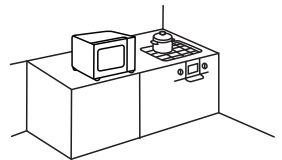

The accessible surface may be hot during operation

BEFORE USING FOR THE FIRST TIME

This section tells you what you need to do before using your microwave to prepare food for the first time. Read the section entitled "**PRODUCT SAFETY**" beforehand.

Before you can use your new appliance, you will need to put the turntable in place correctly. You must also clean the cooking compartment and accessories.



- Never use the appliance without the turntable.
- Make sure that it is properly engaged. The turntable can turn clockwise or anti-clockwise.

OPERATION

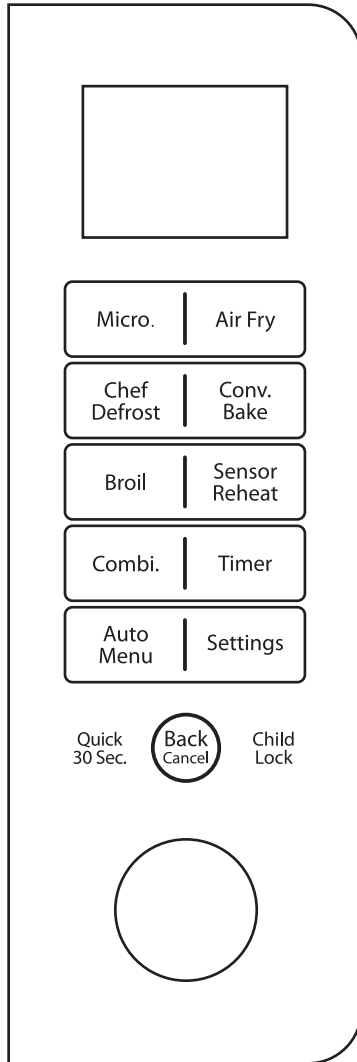

NOTE



- App control: Download the TSmartLife first, then connect the app to your oven by the insert of the TSmartLife APP connection guide.
- Voice control: Ensure that there is an Alexa speaker in your home, and then microwave oven and speaker are connected to the home wireless network, then connect them by the insert of Alexa home setup guide.

Press  twice, "00:00" will display.

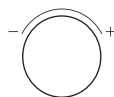

Turn the knob to set the hour figures.



Press  or  to confirm the hour figures.



Turn the knob to set the minute figures.



Press  or  to confirm. The clock is set.

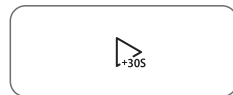

- The clock is a 24-hour display. If the clock is not set, it will not work when powered.
- To reset the clock, please repeat step a to step e.

Press  once, "00:00" will display.



Turn the knob to set the desired time.
The maximum time value is "95:00".



Press  to confirm. The timer starts counting down.



- The kitchen timer is a timer.
- Any other program can't be set during the kitchen timer.

5 power levels are available.

POWER	100%	80%	50%	30%	10%
DISPLAY	P100	P80	P50	P30	P10

Press  repeatedly to choose the power level.



Press  once, and then turn the knob to set the power level.

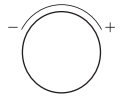



The 5 power levels are available.

Press  to confirm the power level.

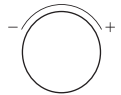

Turn the knob to set the cooking time, the maximum time value is "95:00".



Press  to start cooking.



App Control:



NOTE

- To ensure safety, the APP remote control function is not allowed.

Tap the  icon to enter the cooking function setting page.

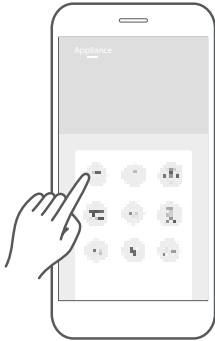

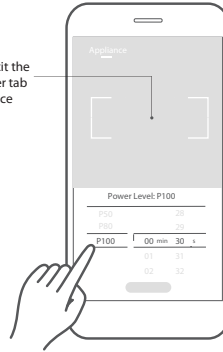

Swipe up and down to set the power level.

Tap this area to exit the cooking parameter tab and return to device function page.

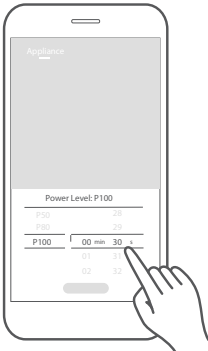

Swipe up and down to set the cooking time.



Tap "Start" to confirm, then press " 30s" on the appliance to start cooking.

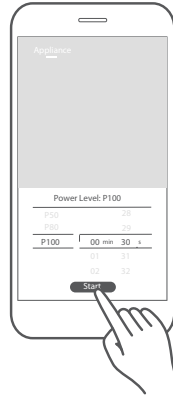

NOTE

- Do not swipe too fast when sliding the wheel up and down to select parameters. Tap the "Start" button when the numbers stop scrolling.

Press  once, "G-1" will display.



Press  to confirm the mode.



Turn the knob to set the cooking time, the maximum time value is "95:00".

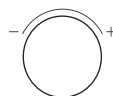

Press  to start cooking.



NOTE

- The buzzer will sound to remind you to turn the food over during grilling. If no operation, the oven will continue working.

App Control:



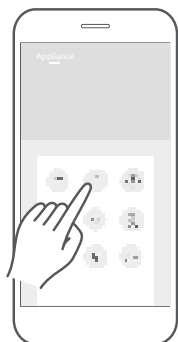

- To ensure safety, the APP remote control function is not allowed.

Tap the  icon to enter the cooking function setting page.

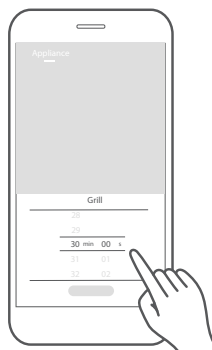

Swipe up and down to set the cooking time.



Tap "Start" to confirm, then press  on the appliance to start cooking.





- Do not swipe too fast when sliding the wheel up and down to select parameters. Tap the "Start" button when the numbers stop scrolling.

Press  repeatedly to choose the cooking mode you want. "C-1, C-2, C-3, C-4" are available.

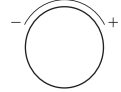

Press  once, and then turn the knob to choose the cooking mode.



Press  to confirm the mode.



Turn the knob to set the cooking time, the maximum time value is "95:00".

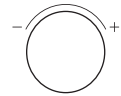

Press  to start cooking.



COMBINATION COOKING CHART

FUNCTION	DISPLAY	MICROWAVE POWER	GRILL POWER	CONVECTION POWER
Combi. 1	C-1	●		●
Combi. 2	C-2	●	●	
Combi. 3	C-3		●	●
Combi. 4	C-4	●	●	●

App Control:



- To ensure safety, the APP remote control function is not allowed.

For example: To choose the cooking mode "C-1".

Tap the  icon to enter the cooking function setting page.

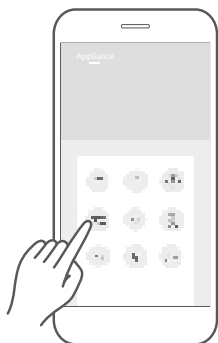

Swipe up and down to set the cooking time.

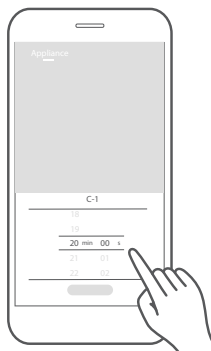

Tap "Start" to confirm, then press " 30s" on the appliance to start cooking.

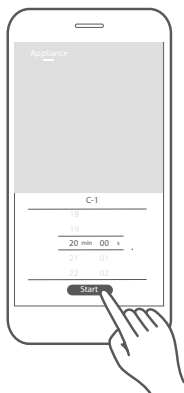

- Do not swipe too fast when sliding the wheel up and down to select parameters. Tap the "Start" button when the numbers stop scrolling.

Press  repeatedly to set the temperature.
"150, 160, 170, 180, 190, 200, 210, 220, 230, 240" °C are available.



Press  once, and then turn the knob to set the temperature.

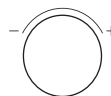

Press  to confirm.



Press  again to start preheating.



When preheating is completed, the oven will beep twice.
Open the door and place food in the oven. And then close the oven door.

Turn the knob to set the cooking time, the maximum time value is "95:00".

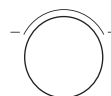

Press  to start cooking.



Press  repeatedly to set the temperature.
"150, 160, 170, 180, 190, 200, 210, 220, 230, 240" °C are available.



Press  once, and then turn the knob to set the temperature.

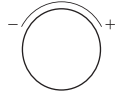

Press  to confirm.



Turn the knob to set the cooking time, the maximum time value is "95:00".

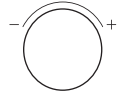

Press  to start cooking.



App Control:



- To ensure safety, the APP remote control function is not allowed.

Tap the  icon to enter the cooking function setting page.

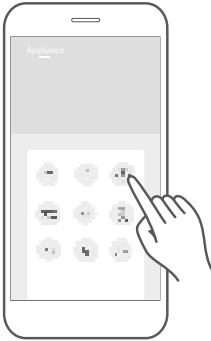

Swipe up and down to set the cooking temperature.

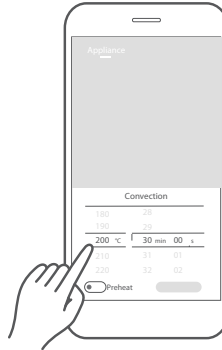

Swipe up and down to set the cooking time.

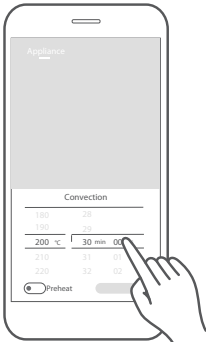

Tap the  icon to choose the preheating on/off.

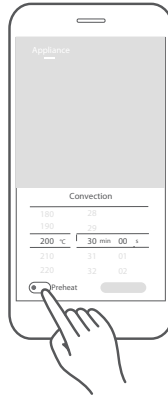

Tap "Start" to confirm, then press " 305" on the appliance to start cooking.

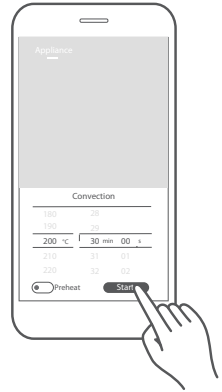

- Do not swipe too fast when sliding the wheel up and down to select parameters. Tap the "Start" button when the numbers stop scrolling.

Turn the knob left to set a cooking time with 100% power.

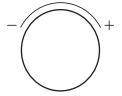

Continue to turn the knob to adjust the cooking time, the maximum time value is "95:00".

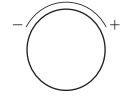

Press  to start cooking.



Press  to cook food with 100% power level for 30 seconds. Each press on the same key can increase 30 seconds and the maximum time value is "95:00".



Press  twice, and then "dEF2" will display.



Turn the knob to set the desired defrost time, the maximum time value is "95:00".

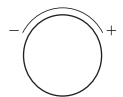

Press  to start defrosting.



- The defrost power is P30 and it cannot be changed.

App Control:



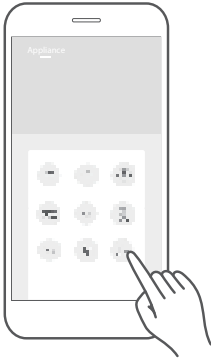

• To ensure safety, the APP remote control function is not allowed.

Tap the  icon to enter the cooking function setting page.

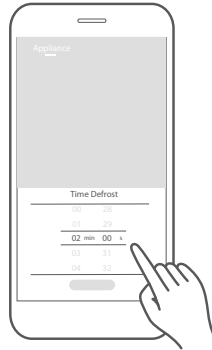

Swipe up and down to set the cooking time.



Tap "Start" to confirm, then press  on the appliance to start defrosting.

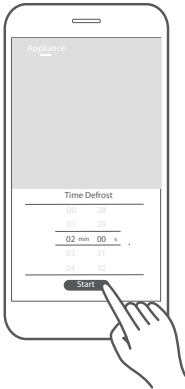



• Do not swipe too fast when sliding the wheel up and down to select parameters. Tap the "Start" button when the numbers stop scrolling.

Press  once, and then "dEF1" will display.

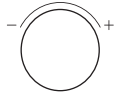

Turn the knob to set the weight of the food, it should be within "100g-2000g".



Press  to start defrosting.



NOTE

- The buzzer will sound to remind you of turning over the food during defrosting. If no operation, the oven will continue working.

App Control:



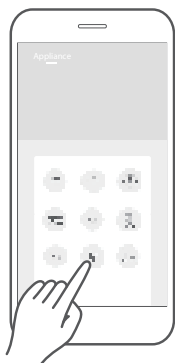

- To ensure safety, the APP remote control function is not allowed.

Tap the  icon to enter the cooking function setting page.

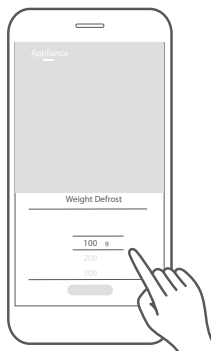

Swipe up and down to set the weight of the food.



Tap "Start" to confirm, then press  on the appliance to start defrosting.

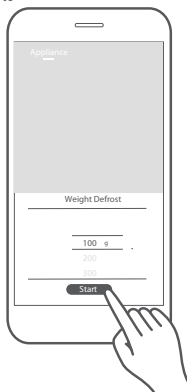

- Do not swipe too fast when sliding the wheel up and down to select parameters. Tap the "Start" button when the numbers stop scrolling.

Example: Defrost food for 5 minutes and then cook with 80% microwave power for 7 minutes.

Press  twice, "dEF2" will display.



Turn the knob to set the desired defrost time to 5 minutes.

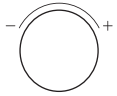

Press  repeatedly until "P80" displays.



Press  to confirm the power level.



Turn the knob to set the cooking time to 7 minutes.

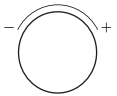

Press  to start cooking.



NOTE

- Two cooking stages can be set in multi-stage cooking.
- If you set the defrost function, it will work automatically in the first stage.
- The kitchen timer, auto menu, and preheat cannot be set as one of the multi-stage.

In standby mode, turn the knob right until "A-1" displays.

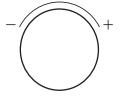

Press  to confirm.



Turn the knob to choose the menu you need.
The 10 auto menus are available.

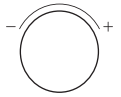

Press  to confirm.



Turn the knob to set the weight of the food.

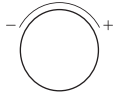

Press  to start cooking.



NOTE

- For the menu "A-8", please skip the step d and the step e.
- For the menu "A10", the buzzer will sound to remain you of turning over the food during cooking. If no operation, the oven will continue working.

AUTO MENU CHART

MENU	WEIGHT/ AMOUNT	POWER LEVEL
A-1 AUTO REHEAT	150g 250g 350g 450g 600g	P100
A-2 POTATO	1 (230g) 2 (460g) 3 (690g)	P100
A-3 MEAT	150g 300g 450g 600g	P80
A-4 VEGETABLE	150g 350g 500g	P100
A-5 FISH	150g 250g 350g 450g 650g	P80
A-6 PASTA	50g (with 450g cold water) 100g (with 800g cold water) 150g (with 1200g cold water)	P80
A-7 SOUP	200g 400g 600g	P100
A-8 CAKE	475g	Conv.160°C with preheating
A-9 PIZZA	100g 200g 300g	C-4
A10 CHICKEN	500g 750g 1000g 1200g	C-4

In standby mode, turn the knob right until "H-1" displays.

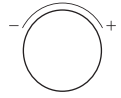

Press  to confirm.



Turn the knob to choose the menu you need.
The 9 menus are available.

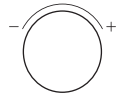

Press  to start cooking.



AIR FRY MENU CHART

Display	Air fry Menu	Weight	Power
H-1	Frozen French Fries	300g	Grill 100%+Conv.240 °C / Grill 60%+Conv.240 °C
H-2	Frozen Potato Balls	350g	Grill 60%+Conv.240 °C
H-3	Frozen Calamari Rings	250g	Grill 60%+Conv.240 °C
H-4	Frozen Onion Rings	250g	Grill 60%+Conv.240 °C
H-5	Frozen Chicken Nuggets	350g	Grill 60%+Conv.240 °C
H-6	Pork Chop	400g	Grill 60%+Conv.240 °C
H-7	Shrimps	250g	Grill 60%+Conv.240 °C
H-8	Vegetables	200g	Grill 60%+Conv.240 °C
H-9	Spring Rolls	300g	Grill 60%+Conv.240 °C



- Use the bake tray and grill rack. Put the food into the bake tray and place the bake tray on the grill rack.

In standby mode, turn the knob right until "C-1" displays.

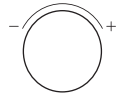

Press  to confirm.

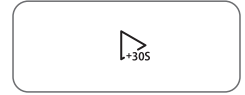

Turn the knob to choose the menu you need.
The 4 menus are available.

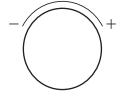

Press  to confirm.



Turn the knob to set the weight of the food.

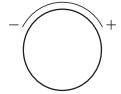

Press  to start cooking.



MENU CHART

Display	Menu	Weight	Power
C-1	Cordon Bleu (Fresh Mini Pizza)	300g	C-4
		600g	
		900g	
C-2	Lasagna	200g	C-4
		300g	
		400g	
C-3	Bread	100g	Grill 60%+Conv.240 °C
C-4	Pie/Tart	8 (about 350g)	Conv.220 °C with preheating



- For the menus "C-3, C-4", please skip the step d and the step e.
- Use the bake tray and grill rack. Put the food into the bake tray and place the bake tray on the grill rack.

App Control:



- To ensure safety, the APP remote control function is not allowed.

Tap the desired menu icon to enter the menu setting page.

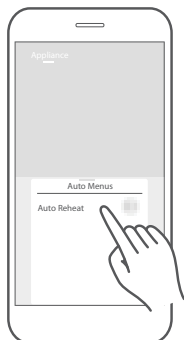

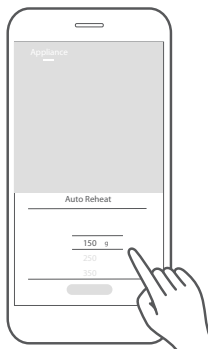

Swipe up and down to set the weight of the food.

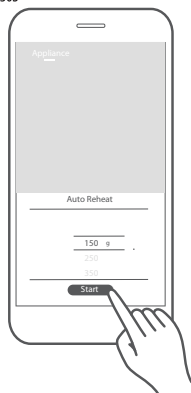

Tap "Start" to confirm, then press "▶" on the appliance to start cooking.



- For the menus which do not need to choose the weight, please skip the step 2.
- Do not swipe too fast when sliding the wheel up and down to select parameters. Tap the "Start" button when the numbers stop scrolling.

If the clock has been set, the current time will display for three seconds by pressing   in the cooking state.



In the microwave cooking state, press  to inquire about the power level. It will display for three seconds.



In the grilling, combination cooking and convection cooking state, press  to inquire the cooking mode or temperature. It will display for three seconds.



Connect the network

Press and hold " Settings " for 3 seconds, then "AP" and  will display.

If it connects to the network successfully, the oven will return to standby, and  will display.

If it fails, "NO" will display, and the oven will return to standby after 10 minutes.

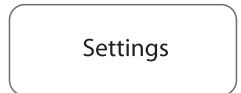

Disconnect from the network

Press and hold " Settings " for 8 seconds, then "--" displays for 5 seconds,

If the link has been removed successfully, the screen will display "8888" and then return to standby after 3 seconds.

If it fails, "FFFF" will display, and the oven will return to standby after 3 seconds.



You can use this function to disable the screen buttons and prevent your child from accidentally turning the oven on.

To activate the lock:

In standby mode, press and hold  for three seconds.

A beep sounds and the locked icon will display.



To deactivate the lock:

In the locked state, press and hold  for three seconds.

A beep sounds.



App Control:



NOTE

- To ensure safety, the APP remote control function is not allowed.

To activate the children lock:

Tap the  icon on the "Appliance" page of the APP.

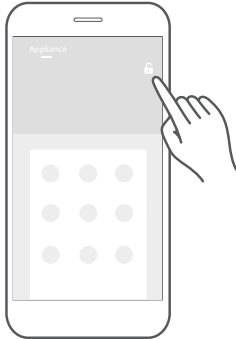

Tap the "Confirm" to activate the child lock function.

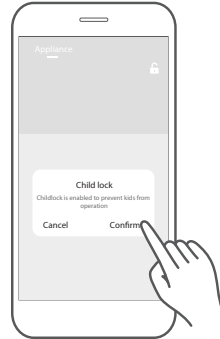

To deactivate the children lock: When the child lock is turned on, tap and hold the unlock icon for 3 seconds to release the child lock function.

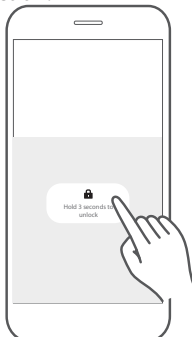

Other Function Of App Control:



- To ensure safety, the APP remote control function is not allowed.

The Recipes page displays cloud recipes, and cooking parameters have been verified by professional chefs. The recipe page is continuously being updated to provide more cooking variety.

Tap the recipe picture to enter the recipe details page.

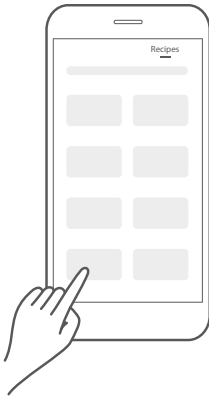

Swipe up and down to view the required ingredients and detailed cooking steps. Tap "Cook Now" to confirm, then press "" on the appliance to start cooking.

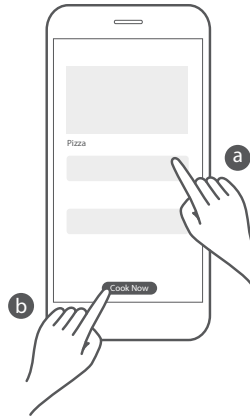

Q: Does the home appliance support 5G wireless routers?

A: This product does not support wireless routers in the 5G frequency band. Please ensure that the mobile phone is connected to the 2.4G wireless network before networking the home appliance.

Q: Why do I need to turn on the Bluetooth of my mobile phone before networking?

A: Turning on the Bluetooth of the mobile phone can improve the success rate of networking and avoid the failure of the home appliance networking.

Q: How many family members are allowed to use the APP at most for the same appliance?

A:

- 1) A home appliance only allows one account to be associated. If a new account is used to bind this home appliance, the previous account will be forced to disassociate and can't be used.
- 2) You can use the sharing function in the APP to grant permissions to use the home appliance to the users who need it, enter My Setup-My devices, select the device to be shared, and tap the button at the bottom of the APP to add the sharing user
- 3) There is no limit to the number of sharing users. The users shared to have all the operating permissions of the home appliance. Please use this function with caution
- 4) After the sharing user deletes the home appliance, the home appliance of the user shared is automatically deleted from the APP. If the user shares to delete the home appliance, it is only deleted from its account, without affecting other users.

Q: Why the product can't be searched by model in the APP?

A:

- 1) Check whether the region on the APP setting page is the same as the purchase region. If the address information is incorrect, the model can't be displayed.
- 2) If the area of the APP setting page is correct, contact the after-sales service or ask for assistance through the help portal on the APP.

Voice Control:

This model of microwave oven supports the voice control function of Alexa Home smart speaker. Before enabling the voice control of smart speaker, please ensure that the microwave oven and smart speaker are connected to the home wireless network.

Put the food to be defrosted into the microwave oven, then use the Alexa Home APP on the mobile phone or speak to the Alexa Home smart speaker:

Cooking	Alexa, microwave for x minutes (x=1-95)
	Alexa, run microwave for x minutes (x=1-95)
Edit time	Alexa, add x minutes to the microwave (x=1-95)
	Alexa, subtract x minutes from microwave timer (x=1-95)
	Alexa, decrease microwave timer by x minutes (x=1-95)
Pause/Restart/Stop	Alexa, pause the microwave
	Alexa, restart/resume the microwave
	Alexa, stop the microwave
Menu	Alexa, cook x potato (x=1, 2, 3)
	Alexa, cook x grams of meat (x=150, 300, 450, 600)
	Alexa, cook x grams vegetable (x=150, 350, 500)
	Alexa, cook x grams of fish (x=150, 250, 350, 450, 650)
	Alexa, cook x grams of pasta (x=50, 100, 150)
	Alexa, cook x grams of soup (x=200, 400, 600)
	Alexa, convection bake 475 grams of cake
	Alexa, convection bake x grams of pizza (x=100, 200, 300)
	Alexa, convection bake x grams of chicken (x=500, 750, 1000, 1200)
	Alexa, convection bake 300 grams of frozen french fries
	Alexa, convection bake 350 grams of frozen potato balls
	Alexa, convection bake 250 grams of frozen calamari rings
	Alexa, convection bake 250 grams of frozen onion rings
	Alexa, convection bake 350 grams of frozen chicken nuggets
	Alexa, convection bake 400 grams of pork chop
	Alexa, convection bake 250 grams of shrimp
	Alexa, convection bake 200 grams of vegetables
	Alexa, convection bake 300 grams of spring rolls
	Alexa, convection bake x grams of cordon bleu (x=300, 600, 900)
	Alexa, convection bake x grams of lasagna (x=200, 300, 400, 500)
	Alexa, convection bake 100 grams of bread
Alexa, convection bake 8 pie	
Alexa, convection bake 8 tart	

CLEANING

With good care and cleaning, your appliance will retain its appearance and remain fully functioning for a long time to come. Here are the instructions on how to properly care for the microwave oven.



WARNING

- Scratched glass in the appliance door may develop into a crack. Do not use a glass scraper, sharp or abrasive cleaning aids or detergents.
- The surface of the appliance may become damaged if it is not cleaned properly. Microwave energy may escape. Clean the appliance on a regular basis, and remove any food remnants immediately.
- Do not immerse the appliance in water or clean under a jet of water.

Cleaning agent

To ensure that the different surfaces are not damaged by using the wrong cleaning agent, see the information in the table. Wash new sponge or cloth thoroughly before use.

Do not use:



Harsh or abrasive cleaning agents



Metal or glass scrapers to clean the door panels



Metal or glass scrapers to clean the door seal



Hard scouring pads or sponges



Cleaning agents with a high alcohol content

Hot soapy water:

Clean using a dish cloth and then dry with a soft cloth. Do not use metal or glass scrapers for cleaning.

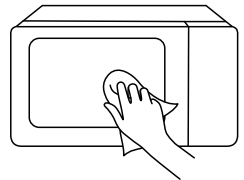

Hot soapy water:

Clean using a dish cloth and then dry with a soft cloth. Remove splashes and patches of limescale, grease, starch and albumin immediately. Corrosion can form under these patches or splashes. Do not use glass cleaners or metal or glass scrapers for cleaning.

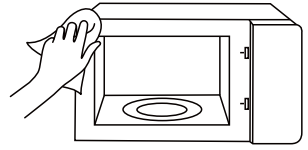

Hot soapy water or vinegar solution:

Clean using a dish cloth and then dry with a soft cloth. Do not use oven spray or any other aggressive oven cleaners or abrasive materials. Scouring pads, rough sponges and pan cleaners are also unsuitable. These items scratch the surface. Allow the interior surfaces to dry completely.

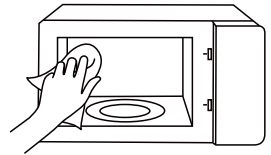

Damp cloth:

Water must not be allowed to run into the appliance through the turntable drive. Dry the turntable drive with a cloth.

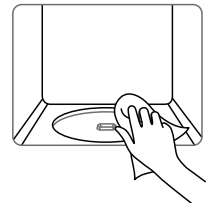

Hot soapy water:

When placing the turntable back into its recess, it must engage properly.



Glass cleaner:

Clean with a dish cloth. Do not use glass scrapers.

TROUBLE SHOOTING

Check your problem by using the chart below and try the solutions for each problem. If the microwave oven still does not work properly, contact the nearest authorized service center.

TROUBLE	POSSIBLE CAUSE	POSSIBLE REMEDY
Oven will not start	<ul style="list-style-type: none"> a. Electrical cord for oven is not plugged in. b. Door is open. c. Wrong operation is set. 	<ul style="list-style-type: none"> a. Plug into the outlet. b. Close the door and try again. c. Check instructions
Arcing or sparking	<ul style="list-style-type: none"> a. Materials to be avoided in microwave oven were used. b. The oven is operated when empty. c. Spilled food remains in the cavity. 	<ul style="list-style-type: none"> a. Use microwave-safe cookware only. b. Do not operate with oven empty. c. Clean cavity with soft damp cloth.
Unevenly cooked foods	<ul style="list-style-type: none"> a. Materials to be avoided in microwave oven were used. b. Food is not defrosted completely. c. Cooking time, power level is not suitable. d. Food is not turned or stirred. 	<ul style="list-style-type: none"> a. Use microwave-safe cookware only. b. Completely defrost food. c. Use correct cooking time, power level. d. Turn or stir food.
Overcooked foods	<ul style="list-style-type: none"> Cooking time, power level is not suitable. 	<ul style="list-style-type: none"> Use correct cooking time, power level.
Undercooked foods	<ul style="list-style-type: none"> a. Materials to be avoided in microwave oven were used. b. Food is not defrosted completely. c. Oven ventilation ports are restricted. d. Cooking time, power level is not suitable. 	<ul style="list-style-type: none"> a. Use microwave-safe cookware only. b. Completely defrost food. c. Check to see that oven ventilation ports are not restricted. d. Use correct cooking time, power level
Improper defrosting	<ul style="list-style-type: none"> a. Materials to be avoided in microwave oven were used. b. Cooking time, power level is not suitable. c. Food is not turned or stirred. 	<ul style="list-style-type: none"> a. Use microwave-safe cookware only. b. Use correct cooking time, power level. c. Turn or stir food.

Details**Matter**