

## DIMPR DIMPRX

\*See current catalogue for further detail

### Cleaning Guide:

Spraying cleaning products directly on to electrical switches or power points (sockets) is not recommended.

It is important to ensure that switches are turned off before cleaning.

Do not use any cleaning sprays - only wipe down with damp cloth or rub with dry cloth. (Do not use an abrasive cloth as it may scratch the plastic)

Do not use harsh chemical cleaners as these can break down the plastic and cause it to crack.

Do not wash the cover plates in water over 60°C.









## Dimpala Push Rotary Dimmers

Trader's NEW Dimpala PUSH Dimmer is mechanically switched and provides optimised dimming of LED lamps and drivers.

- 220-240Vac / 50Hz / 2W Min / 400W Max / <1% to > 95% (load dependent).
- Suitable for LED, incandescent and 12V dichroic lamps.
- Minimum dimming level, typically almost 0%.
- Push switch configuration with terminals similar to a standard switch for easy wiring.
- Integrated switch replaces the need for an additional control switch.
- Soft start for improved lamp & driver life.
- Thermal protection via NTC (negative temperature control).
- DIMPR is suitable for use with Australian wall plate apertures including Trader, HPM® & Clipsal\*.

Specifications			
Nominal Line Voltage Amplitude Range	220-240Vac		
Line Voltage Frequency	50Hz Nominal (47 - 53Hz)		
Load Brightness Control Range	< 1% to > 95% (load dependent)		
Rated Load	Refer Compatible Loads		
Minimum Load	2W		

Compatible Load types			
Load Symbol	Load Type	Maximum Load	Notes
	Dimmable LED Drivers	400W	Maximum permitted number of drivers is 400W divided by driver nameplate power rating.
	Dimmable LED Lamps	400W	Due to variety of LED lamp designs, maximum number of LED lamps is further dependent on power-factor result when connected to dimmer.
	Electronic Transformers	400W	
	Standard iron-core transformers	250W	Due to variety of transformer designs, max LV lighting load is further dependent on transformer efficiency
	Toroidal iron-core transformers	300W	
	Incandescent	400W	
	Dimmable CFLs	200W	Due to the variety of CFL designs, the maximum number of dimmable CFL lamps is make/model dependent
M.3 	Small Motor Load	100W	

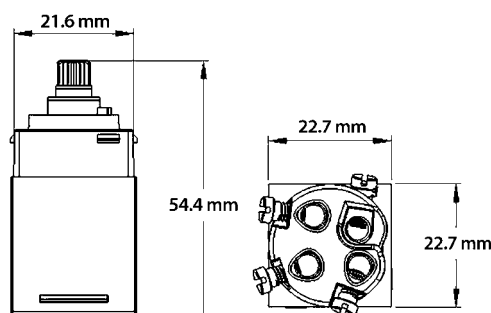

Catalogue Number	Description
DIMPR	Dimpala Push Rotary Dimmer
DIMPRX	Dimpala Push Rotary Dimmer No Glow

Unless otherwise stated the identified trademarks and copyrights are the property of GSM Electrical (Australia) Pty Ltd.

\*HPM is a registered trademark of Legrand Australia Pty Ltd.

\*Clipsal and Saturn are registered trademarks of Schneider Electric (Australia) Pty Ltd. Reference is made for suitability of use only.

GSM Electrical (Australia) Pty Ltd, the TRADER brand and it's products, have no endorsement or affiliation with Schneider Electric Pty Ltd. or Legrand Australia Pty Ltd.

### Certification Number:

TBC

### GSM Electrical (Australia) Pty Ltd

Level 2, 142-144 Fullarton Road, Rose Park SA 5067

P: 1300 301 838 F: 1300 301 778 E: service@gsme.com.au

www.gsme.com.au

