

# TEST REPORT

**Test Report No. : UL-RPT-RP14614879JD02A**

**Customer** : Apple Inc.  
**Model No. / HVIN** : A2992  
**PMN** : MacBook Pro  
**FCC ID** : BCGA2992  
**ISED Certification No.** : IC: 579C-A2992  
**Technology** : *Bluetooth* – BDR & EDR (High Power Mode)  
**Test Standard(s)** : FCC Parts 15.209(a) & 15.247  
Innovation, Science and Economic Development Canada  
RSS-247 Issue 2 February 2017  
RSS-Gen Issue 5 February 2021  
**Test Laboratory** : UL International (UK) Ltd, Basingstoke, Hampshire, RG24 8AH,  
United Kingdom

1. This test report shall not be reproduced except in full, without the written approval of UL International (UK) Ltd.
2. The results in this report apply only to the sample(s) tested.
3. The sample tested is in compliance with the above standard(s).
4. The test results in this report are traceable to the national or international standards.
5. Version 1.0.

**Date of Issue:** 03 October 2023

**Checked by:**



Ben Mercer  
Lead Project Engineer, Radio Laboratory

**Ben Mercer** Digitally signed  
by Ben Mercer  
Date: 2023.10.03  
15:29:22 +01'00'

**Company Signatory:**



Sarah Williams  
RF Operations Leader, Radio Laboratory

**Sarah Williams** Digitally signed  
by Sarah Williams  
Date: 2023.10.03  
15:29:45 +01'00'



The *Bluetooth*® word mark and logos are owned by the *Bluetooth* SIG, Inc. and any use of such marks by UL International (UK) Ltd is under licence. Other trademarks and trade names are those of their respective owners.

**UL International (UK) LTD**

Unit 1-3 Horizon, Kingsland Business Park, Wade Road, Basingstoke, Hampshire, RG24 8AH, UK  
Telephone: +44 (0)1256 312000

**Customer Information**

<b>Company Name:</b>	Apple Inc.
<b>Address:</b>	One Apple Park Way Cupertino, California 95014 U.S.A.
<b>Contact Name:</b>	Stuart Thomas

**Report Revision History**

<b>Version Number</b>	<b>Issue Date</b>	<b>Revision Details</b>	<b>Revised By</b>
1.0	03/10/2023	Initial Version	Ben Mercer

## **Table of Contents**

<b>Customer Information</b> .....	<b>2</b>
<b>Report Revision History</b> .....	<b>2</b>
<b>Table of Contents</b> .....	<b>3</b>
<b>1 Attestation of Test Results</b> .....	<b>4</b>
1.1 Description of EUT	4
1.2 General Information	4
1.3 Summary of Test Results	5
1.4 Deviations from the Test Specification	5
<b>2 Summary of Testing</b> .....	<b>6</b>
2.1 Facilities and Accreditation	6
2.2 Methods and Procedures	6
2.3 Calibration and Uncertainty	7
2.4 Test and Measurement Equipment	8
<b>3 Equipment Under Test (EUT)</b> .....	<b>10</b>
3.1 Identification of Equipment Under Test (EUT)	10
3.2 Modifications Incorporated in the EUT	11
3.3 Additional Information Related to Testing	12
3.4 Description of Available Antennas	12
3.5 Description of Test Setup	13
<b>4 Antenna Port Test Results</b> .....	<b>20</b>
4.1 Transmitter 99% Emission Bandwidth	20
4.2 Transmitter 20 dB Bandwidth	25
4.3 Transmitter Carrier Frequency Separation	31
4.4 Transmitter Number of Hopping Frequencies and Average Time of Occupancy	34
4.5 Transmitter Maximum Peak Output Power	37
<b>5 Radiated Test Results</b> .....	<b>42</b>
5.1 Transmitter Radiated Emissions <1 GHz	42
5.2 Transmitter Radiated Emissions >1 GHz	44
5.3 Transmitter Band Edge Radiated Emissions	46
<b>Appendix 1</b> .....	<b>83</b>
FHSS Duty Cycle Correction Factor Calculation	83

## **1 Attestation of Test Results**

### **1.1 Description of EUT**

The equipment under test (EUT) was a portable laptop computer.

### **1.2 General Information**

<b>Specification Reference:</b>	47CFR15.247
<b>Specification Title:</b>	Code of Federal Regulations Volume 47 (Telecommunications): Part 15 Subpart C (Intentional Radiators) – Section 15.247
<b>Specification Reference:</b>	47CFR15.209
<b>Specification Title:</b>	Code of Federal Regulations Volume 47 (Telecommunications): Part 15 Subpart C (Intentional Radiators) – Section 15.209
<b>Specification Reference:</b>	RSS-Gen Issue 5 February 2021
<b>Specification Title:</b>	General Requirements for Compliance of Radio Apparatus
<b>Specification Reference:</b>	RSS-247 Issue 2 February 2017
<b>Specification Title:</b>	Digital Transmission Systems (DTSs), Frequency Hopping Systems (FHSs) and Licence-Exempt Local Area Network (LE-LAN) Devices
<b>Site Registration:</b>	FCC: 685609, ISEDC: 20903
<b>FCC Lab. Designation No.:</b>	UK2011
<b>ISEDC CABID:</b>	UK0001
<b>Location of Testing:</b>	Unit 3 Horizon, Wade Road, Kingsland Business Park, Basingstoke, Hampshire, RG24 8AH, United Kingdom
<b>Test Dates:</b>	12 July 2023 to 06 September 2023

### **1.3 Summary of Test Results**

<b>FCC Reference (47CFR)</b>	<b>ISED Canada Reference</b>	<b>Measurement</b>	<b>Result</b>
N/A	RSS-Gen 6.7	Transmitter 99% Occupied Bandwidth	Complied
Part 15.247(a)(1)	RSS-Gen 6.7 / RSS-247 5.1(a)	Transmitter 20 dB Bandwidth	Complied
Part 15.247(a)(1)	RSS-247 5.1(b)	Transmitter Carrier Frequency Separation	Complied
Part 15.247(a)(1)(iii)	RSS-247 5.1(d)	Transmitter Number of Hopping Frequencies and Average Time of Occupancy	Complied
Part 15.247(b)(1)	RSS-Gen 6.12 / RSS-247 5.4(b)	Transmitter Maximum Peak Output Power	Complied
Part 15.247(d) & 15.209(a)	RSS-Gen 6.13 / RSS-247 5.5	Transmitter Radiated Emissions	Complied
Part 15.247(d) & 15.209(a)	RSS-Gen 6.13 / RSS-247 5.5	Transmitter Band Edge Radiated Emissions	Complied

### **1.4 Deviations from the Test Specification**

For the measurements contained within this test report, there were no deviations from, additions to, or exclusions from the test specification identified above.

## **2 Summary of Testing**

### **2.1 Facilities and Accreditation**

The test site and measurement facilities used to collect data are located at Unit 3 Horizon, Wade Road, Kingsland Business Park, Basingstoke, Hampshire, RG24 8AH, United Kingdom. The following table identifies which facilities were utilised for radiated emission measurements documented in this report. Specific facilities are also identified in the test results sections.

Site 1	X
Site 2	-
Site 17	X

UL International (UK) Ltd is accredited by the United Kingdom Accreditation Service (UKAS). UKAS is one of the signatories to the International Laboratory Accreditation Co-operation (ILAC) Arrangement for the mutual recognition of test reports. The tests reported herein have been performed in accordance with its terms of accreditation.

### **2.2 Methods and Procedures**

<b>Reference:</b>	ANSI C63.10-2013
<b>Title:</b>	American National Standard of Procedures for Compliance Testing of Unlicensed Wireless Devices
<b>Reference:</b>	KDB 558074 D01 15.247 Meas Guidance v05r02, April 2, 2019
<b>Title:</b>	Guidance for Compliance Measurements on Digital Transmission System, Frequency Hopping Spread Spectrum System, and Hybrid System Devices Operating Under Section 15.247 of the FCC Rules
<b>Reference:</b>	KDB 662911 D01 Multiple Transmitter Output v02r01 October 31, 2013
<b>Title:</b>	Emissions Testing of Transmitters with Multiple Outputs in the Same Band

## **2.3 Calibration and Uncertainty**

### **Measuring Instrument Calibration**

In accordance with UKAS requirements all the measurement equipment is on a calibration schedule. All equipment was within the calibration period on the date of testing.

### **Measurement Uncertainty & Decision Rule**

#### **Overview**

No measurement or test can ever be perfect and the imperfections give rise to error of measurement in the results. Consequently the result of a measurement is only an approximation to the value of the measurand (the specific quantity subject to measurement) and is only complete when accompanied by a statement of the uncertainty of the approximation.

The expression of uncertainty of a measurement result allows realistic comparison of results with reference values and limits given in specifications and standards.

#### **Decision Rule**

Measurement system instrumentation shall be used with an accuracy specification meeting the accuracy specification limits according to IEC/IECEE OD-5014.

As applicable, unless specified otherwise in this quotation, the compliance "Decision Rule" is based on Simple Acceptance. If the measured value is on the limit, the result is defined as a pass. In this case the risk of a false positive is 50%. For further information regarding risk assessment refer to ILAC G8:09/2019.

#### **Measurement Uncertainty**

The reported expanded uncertainties below are based on a standard uncertainty multiplied by an appropriate coverage factor such that a confidence level of approximately 95% is maintained. For the purposes of this document "approximately" is interpreted as meaning "effectively" or "for most practical purposes".

<b>Measurement Type</b>	<b>Range</b>	<b>Confidence Level (%)</b>	<b>Calculated Uncertainty</b>
99% Occupied Bandwidth	2.4 GHz to 2.4835 GHz	95%	±3.92 %
20 dB Bandwidth	2.4 GHz to 2.4835 GHz	95%	±4.59 %
Carrier Frequency Separation	2.4 GHz to 2.4835 GHz	95%	±4.59 %
Average Time of Occupancy	2.4 GHz to 2.4835 GHz	95%	±3.53 ns
Conducted Maximum Peak Output Power	2.4 GHz to 2.4835 GHz	95%	±0.58 dB
Radiated Spurious Emissions	9 kHz to 30 MHz	95%	±5.32 dB
Radiated Spurious Emissions	30 MHz to 1 GHz	95%	±3.30 dB
Radiated Spurious Emissions	1 GHz to 25 GHz	95%	±3.16 dB

The methods used to calculate the above uncertainties are in line with those recommended within the various measurement specifications. Where measurement specifications do not include guidelines for the evaluation of measurement uncertainty the published guidance of the appropriate accreditation body is followed.

## **2.4 Test and Measurement Equipment**

### **Test Equipment Used for Transmitter Conducted Tests**

<b>Asset No.</b>	<b>Instrument</b>	<b>Manufacturer</b>	<b>Type No.</b>	<b>Serial No.</b>	<b>Date Calibration Due</b>	<b>Cal. Interval (Months)</b>
M2071	Thermohygrometer	Testo	608-H1	45258132	08 Dec 2023	12
231909	Signal Analyser	Keysight	N9020B	MY63430168	01 Dec 2023	12
A237326	Attenuator	Pasternack	PE7013-10	#17	Calibrated before use	-
A237327	Attenuator	Pasternack	PE7013-10	#18	Calibrated before use	-
M2019	RF Power Sensor	Boonton	55006	10078	20 Mar 2024	12
M2020	RF Power Sensor	Boonton	55006	9970	17 Mar 2024	12
231993	Switching Unit	Mini-Circuits	ZT-400	12211020014	Calibrated before use	-
M1725	Network Analyser	Keysight	E5071c	MY46316169	09 Nov 2023	12

### **Test Measurement Software/Firmware Used for Transmitter Conducted Tests**

<b>Name</b>	<b>Version</b>	<b>Release Date</b>
Phoenix	1.3.5	30 May 2023



**Test and Measurement Equipment (continued)****Test Equipment Used for Transmitter Radiated Emissions Tests**

Asset No.	Instrument	Manufacturer	Type No.	Serial No.	Date Calibration Due	Cal. Interval (Months)
M2040	Thermohygrometer	Testo	608-H1	45124934	09 Dec 2023	12
K0001	3m RSE Chamber	Rainford EMC	N/A	N/A	05 Sep 2024	12
M236226	Test Receiver	Rohde & Schwarz	ESW26	103134	21 Apr 2024	12
A3165	Magnetic Loop Antenna	ETS-Lindgren	6502	00224383	13 Apr 2024	12
M2002	Thermohygrometer	Testo	608-H1	45041825	09 Dec 2023	12
K0017	3m RSE Chamber	Rainford EMC	N/A	N/A	08 Nov 2023	12
M1995	Test Receiver	Rohde & Schwarz	ESU40	100428	02 Nov 2023	12
A3167	Pre-Amplifier	Com Power	PAM-103	18020010	02 Nov 2023	12
A2863	Pre-Amplifier	Agilent	8449B	3008A02100	07 Nov 2023	12
A223628	Pre-Amplifier	Atlantic Microwave	A-LNAKX-380116-S5S5	210837001	03 Nov 2023	12
A3265	Pre-Amplifier	Schwarzbeck	BBV 9721	9721-069	31 Oct 2023	12
A490	Antenna	Chase	CBL6111A	1590	06 Oct 2023	12
A2889	Antenna	Schwarzbeck	BBHA 9120 B	00653	02 Nov 2023	12
A2890	Antenna	Schwarzbeck	HWRD 750	014	02 Nov 2023	12
A2892	Antenna	Schwarzbeck	BBHA 9170	9170-727	31 Oct 2023	12
A2148	Attenuator	AtlanTecRF	AN18-06	090202-06	06 Oct 2023	12
A2916	Attenuator	AtlanTecRF	AN18W5-10	832827#2	25 Jan 2024	12
A3036	Low Pass Filter	AtlanTecRF	AFL-02000	15062902848	25 Jan 2024	12
A2914	High Pass Filter	AtlanTecRF	AFH-03000	2155	25 Jan 2024	12
A212035	High Pass Filter	Micro-Tronics	HPS20722	001	25 Jan 2024	12

**Test Equipment Used for Transmitter Band Edge Radiated Emissions Tests**

Asset No.	Instrument	Manufacturer	Type No.	Serial No.	Date Calibration Due	Cal. Interval (Months)
M2002	Thermohygrometer	Testo	608-H1	45041825	09 Dec 2023	12
K0017	3m RSE Chamber	Rainford EMC	N/A	N/A	08 Nov 2023	12
M1995	Test Receiver	Rohde & Schwarz	ESU40	100428	02 Nov 2023	12
A2863	Pre-Amplifier	Agilent	8449B	3008A02100	07 Nov 2023	12
A2889	Antenna	Schwarzbeck	BBHA 9120 B	00653	02 Nov 2023	12
A2916	Attenuator	AtlanTecRF	AN18W5-10	832827#2	25 Jan 2024	12

### **3 Equipment Under Test (EUT)**

#### **3.1 Identification of Equipment Under Test (EUT)**

<b>Brand Name:</b>	Apple
<b>Model Name or Number / HVIN:</b>	A2992
<b>PMN:</b>	MacBook Pro
<b>Test Sample Serial Number:</b>	X14637VQLV ( <i>Conducted sample #1</i> )
<b>Hardware Version:</b>	REV 1.0
<b>Software Version:</b>	23A32391n
<b>FCC ID:</b>	BCGA2992
<b>ISED Canada Certification Number:</b>	IC: 579C-A2992
<b>Date of Receipt:</b>	04 August 2023

<b>Brand Name:</b>	Apple
<b>Model Name or Number / HVIN:</b>	A2992
<b>PMN:</b>	MacBook Pro
<b>Test Sample Serial Number:</b>	DCXLFPVWQL ( <i>Radiated sample #1</i> )
<b>Hardware Version:</b>	REV 1.0
<b>Software Version:</b>	23A32391n
<b>FCC ID:</b>	BCGA2992
<b>ISED Canada Certification Number:</b>	IC: 579C-A2992
<b>Date of Receipt:</b>	10 August 2023

<b>Brand Name:</b>	Apple
<b>Model Name or Number / HVIN:</b>	A2992
<b>PMN:</b>	MacBook Pro
<b>Test Sample Serial Number:</b>	L0942C4MWW ( <i>Radiated sample #2</i> )
<b>Hardware Version:</b>	REV 1.0
<b>Software Version:</b>	23A32391v
<b>FCC ID:</b>	BCGA2992
<b>ISED Canada Certification Number:</b>	IC: 579C-A2992
<b>Date of Receipt:</b>	21 August 2023

**Identification of Equipment Under Test (EUT) (continued)**

<b>Brand Name:</b>	Apple
<b>Model Name or Number / HVIN:</b>	A2992
<b>PMN:</b>	MacBook Pro
<b>Test Sample Serial Number:</b>	QL4WF71R27 ( <i>Radiated sample #3</i> )
<b>Hardware Version:</b>	REV 1.0
<b>Software Version:</b>	23A32391n
<b>FCC ID:</b>	BCGA2992
<b>ISED Canada Certification Number:</b>	IC: 579C-A2992
<b>Date of Receipt:</b>	07 July 2023

<b>Brand Name:</b>	Apple
<b>Model Name or Number / HVIN:</b>	A2992
<b>PMN:</b>	MacBook Pro
<b>Test Sample Serial Number:</b>	QLHJ2QWDF0 ( <i>Radiated sample #4</i> )
<b>Hardware Version:</b>	REV 1.0
<b>Software Version:</b>	23A32391n
<b>FCC ID:</b>	BCGA2992
<b>ISED Canada Certification Number:</b>	IC: 579C-A2992
<b>Date of Receipt:</b>	25 July 2023

**3.2 Modifications Incorporated in the EUT**

No modifications were applied to the EUT during testing.

### 3.3 Additional Information Related to Testing

<b>Technology Tested:</b>	Bluetooth		
<b>Type of Unit:</b>	Transceiver		
<b>Channel Spacing:</b>	1 MHz		
<b>Mode:</b>	Basic Data Rate	Enhanced Data Rate	
<b>Modulation:</b>	GFSK	$\pi/4$ -DQPSK	8DPSK
<b>Packet Type: (Maximum Payload)</b>	DH5	2DH5	3DH5
<b>Data Rate (Mbps):</b>	1	2	3
<b>Power Supply Requirement(s):</b>	Nominal	12 VDC via 120 VAC 60 Hz AC/DC supply	
<b>Maximum Conducted Output Power:</b>	19.69 dBm		
<b>Transmit Frequency Range:</b>	2400 MHz to 2483.5 MHz		
<b>Transmit Channels Tested:</b>	<b>Channel ID</b>	<b>Channel Number</b>	<b>Channel Frequency (MHz)</b>
	Bottom	0	2402
	Middle	39	2441
	Top	78	2480

### 3.4 Description of Available Antennas

The radio utilizes two integrated antennas, with the following maximum gains:

Antenna Port	Frequency Range (MHz)	Antenna Gain (dBi)
Core 0	2400 to 2480	5.4
Core 1	2400 to 2480	5.4

The EUT also supports TxBF with unequal gains and equal transmit powers. Calculations for directional gain were in accordance with KDB 662911 D01 v02r01 Section F)2)d)(i). Directional gain of Core 0 & Core 1 was calculated as:

$N_{SS}=1$ ,  $N_{ANT}=2$ ,  $G_1 = G_{Core 0} = 5.4$  dBi,  $G_2 = G_{Core 1} = 5.4$  dBi:

$$\begin{aligned} \text{Directional Gain} &= 10 \log \left[ \frac{\left( 10^{\frac{G_1}{20}} + 10^{\frac{G_2}{20}} + \dots + 10^{\frac{G_N}{20}} \right)^2}{N_{ANT}} \right] = 10 \log \left[ \frac{\left( 10^{\frac{G_1}{20}} + 10^{\frac{G_2}{20}} \right)^2}{2} \right] \\ &= 10 \log \left[ \frac{\left( 10^{\frac{5.4}{20}} + 10^{\frac{5.4}{20}} \right)^2}{2} \right] = 8.4 \text{ dBi} \end{aligned}$$

### **3.5 Description of Test Setup**

#### **Support Equipment**

The following support equipment was used to exercise the EUT during testing:

<b>Description:</b>	Test Laptop
<b>Brand Name:</b>	Apple
<b>Model Name or Number:</b>	MacBook Pro
<b>Serial Number:</b>	C02DJ0150H5F

<b>Description:</b>	USB Diagnostic Cable
<b>Brand Name:</b>	Apple
<b>Model Name or Number:</b>	Chimp
<b>Serial Number:</b>	30A99B

<b>Description:</b>	Test Laptop
<b>Brand Name:</b>	Apple
<b>Model Name or Number:</b>	MacBook Pro
<b>Serial Number:</b>	FVFDH03JQ05G

<b>Description:</b>	USB Diagnostic Cable
<b>Brand Name:</b>	Apple
<b>Model Name or Number:</b>	Chimp
<b>Serial Number:</b>	428CEB

<b>Description:</b>	Test Laptop
<b>Brand Name:</b>	Apple
<b>Model Name or Number:</b>	MacBook Pro
<b>Serial Number:</b>	C02C30TWMNHR

<b>Description:</b>	USB Diagnostic Cable
<b>Brand Name:</b>	Apple
<b>Model Name or Number:</b>	Chimp
<b>Serial Number:</b>	439430

<b>Description:</b>	AC to DC Power Adaptor
<b>Brand Name:</b>	Apple
<b>Model Name or Number:</b>	A2166
<b>Serial Number:</b>	Not marked or stated

**Support Equipment (continued)**

<b>Description:</b>	Personal Hands Free
<b>Brand Name:</b>	Not marked or stated
<b>Model Name or Number:</b>	Not marked or stated
<b>Serial Number:</b>	Not marked or stated

<b>Description:</b>	Micro SD Card
<b>Brand Name:</b>	SanDisk Edge
<b>Model Name or Number:</b>	Not marked or stated
<b>Serial Number:</b>	Not marked or stated

<b>Description:</b>	Micro SD Card Adaptor
<b>Brand Name:</b>	SanDisk Edge
<b>Model Name or Number:</b>	Not marked or stated
<b>Serial Number:</b>	Not marked or stated

<b>Description:</b>	USB-A to USB-C Adapters. Quantity 2.
<b>Brand Name:</b>	Not marked or stated
<b>Model Name or Number:</b>	Not marked or stated
<b>Serial Number:</b>	Not marked or stated

<b>Description:</b>	HDMI Cable. Length 3m
<b>Brand Name:</b>	Not marked or stated
<b>Model Name or Number:</b>	Not marked or stated
<b>Serial Number:</b>	Not marked or stated

<b>Description:</b>	USB-C Cable. Length 3m
<b>Brand Name:</b>	Not marked or stated
<b>Model Name or Number:</b>	Not marked or stated
<b>Serial Number:</b>	Not marked or stated

<b>Description:</b>	USB-A Cable. Quantity 2. Length 3m
<b>Brand Name:</b>	Not marked or stated
<b>Model Name or Number:</b>	Not marked or stated
<b>Serial Number:</b>	Not marked or stated

**Support Equipment (continued)**

<b>Description:</b>	Test Laptop
<b>Brand Name:</b>	Apple
<b>Model Name or Number:</b>	MacBook Pro
<b>Serial Number:</b>	H44PM7WY9L

<b>Description:</b>	USB Diagnostic Cable
<b>Brand Name:</b>	Apple
<b>Model Name or Number:</b>	Chimp
<b>Serial Number:</b>	439503

## **Operating Modes**

The EUT was tested in the following operating mode(s):

- Continuously transmitting at maximum power on bottom, middle and top channels in BDR (DH5 packets) or EDR (2DH5 or 3DH5 packets) as required.
- Continuously transmitting at maximum power in hopping mode on all channels in BDR (DH5 packets) or EDR (2DH5 or 3DH5 packets) as required.

## **Configuration and Peripherals**

The EUT was tested in the following configuration(s):

- Controlled in test mode using a set of commands entered into a terminal application on the test laptop supplied by the customer. The commands were used to enable a continuous transmission and to select the test channels as required. The customer supplied a document containing the setup instructions.
- The EUT has two cores which operate in both SISO and TxBF modes. Core 0 & Core 1 are identical and have equal gains therefore conducted tests have been performed on the below modes:
  - DH5 / SISO / Core 0
  - 2DH5 / SISO / Core 1
  - 3DH5 / SISO / Core 1
  - DH5 / Beamforming / Core 0 + Core 1
  - 2DH5 / Beamforming / Core 0 + Core 1
  - 3DH5 / Beamforming / Core 0 + Core 1
- The customer supplied U.FL RF cables with the EUT in order to perform conducted measurements. This measured additional path loss was included in any path loss calculations.
- The EUT was powered from a 120 VAC 60 Hz single phase mains supply.
- Transmitter radiated spurious emissions tests were performed with the EUT transmitting in 3DH5 Beamforming Core 0 + Core 1 mode as this mode was found to transmit the highest power.
- Radiated band edge and spurious emissions were performed with the EUT in the normal position of operation. Tests were performed with the EUT connected to its AC to DC power adaptor, HDMI, Micro SD card, PHF and USB adaptors. All ports were terminated with suitable terminations.



**Test Setup Diagrams**

**Conducted Tests:**

**Test Setup for Transmitter Conducted Tests**

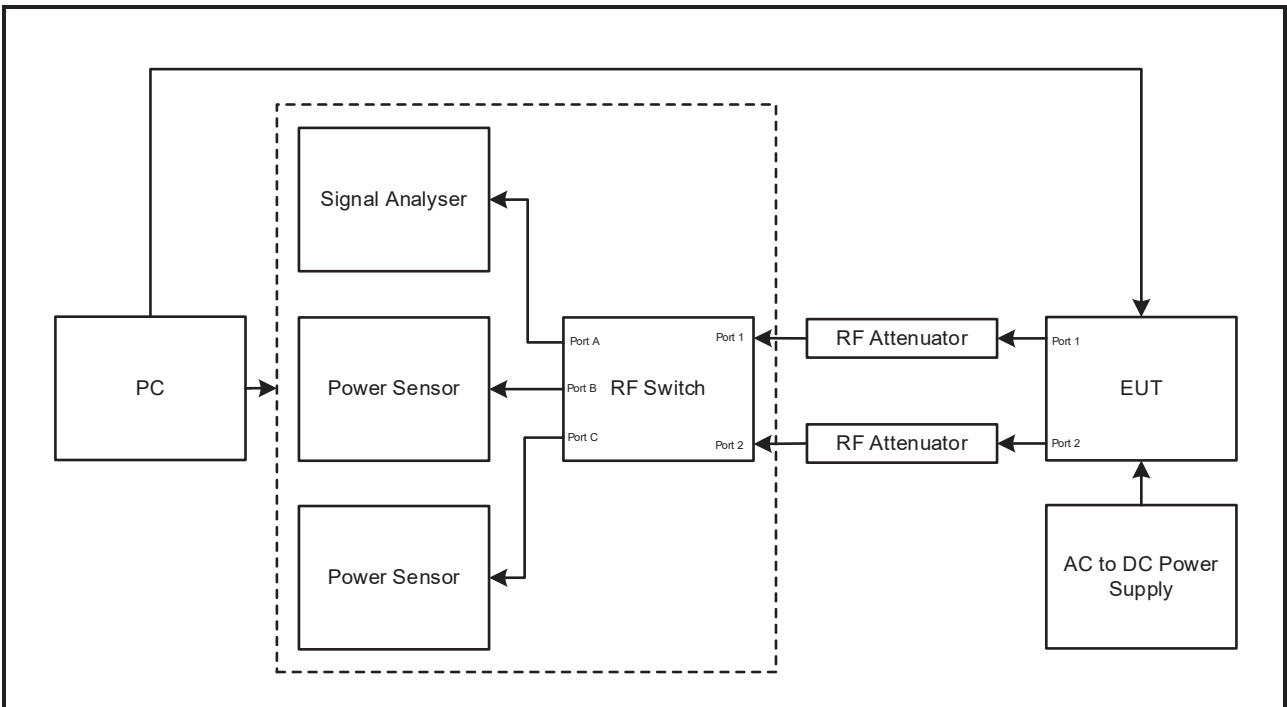

**Test Setup Diagrams (continued)**

**Radiated Tests:**

**Test Setup for Transmitter Radiated Emissions**

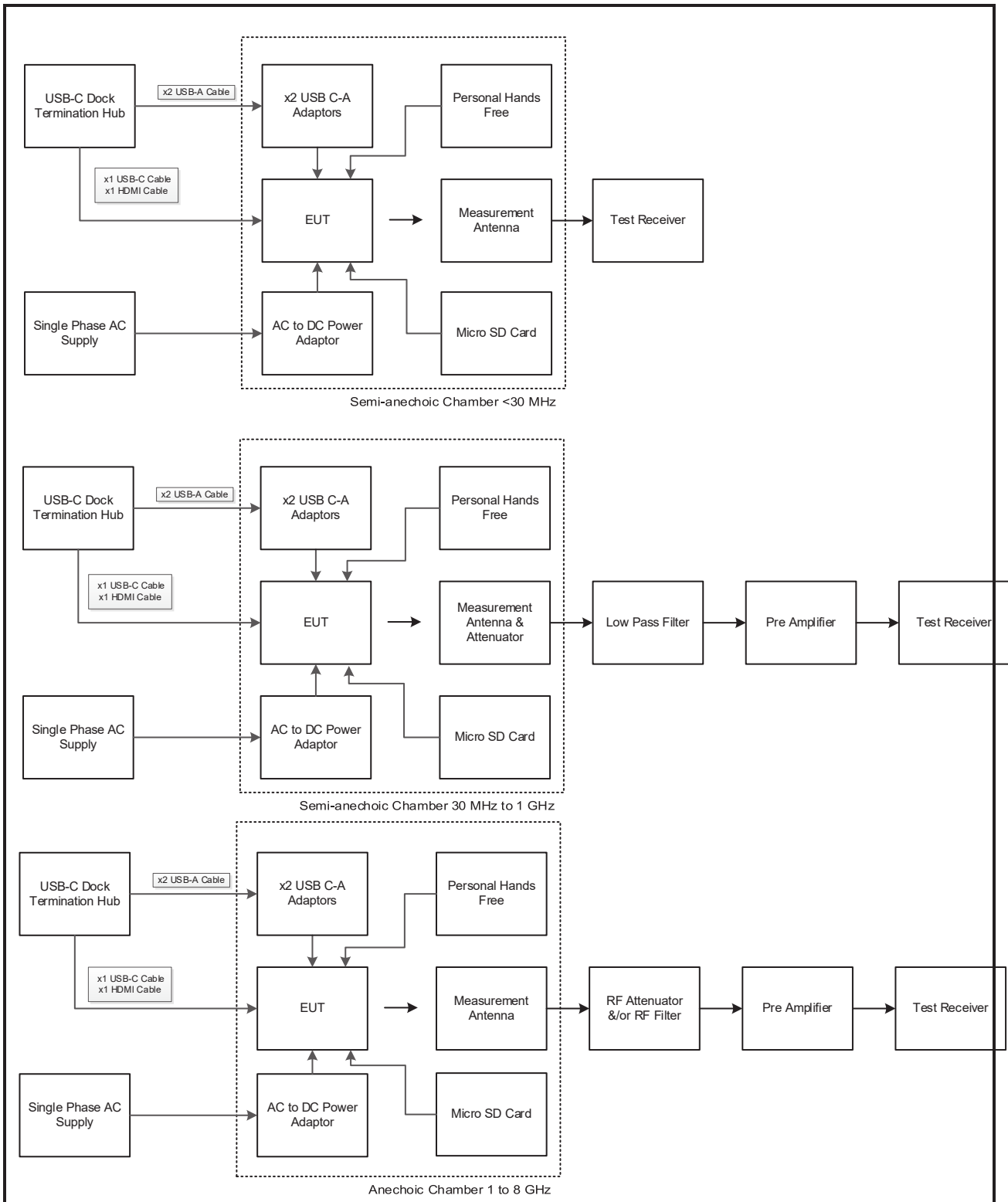

**Test Setup Diagrams (continued)**

**Test Setup for Transmitter Radiated Emissions (continued)**

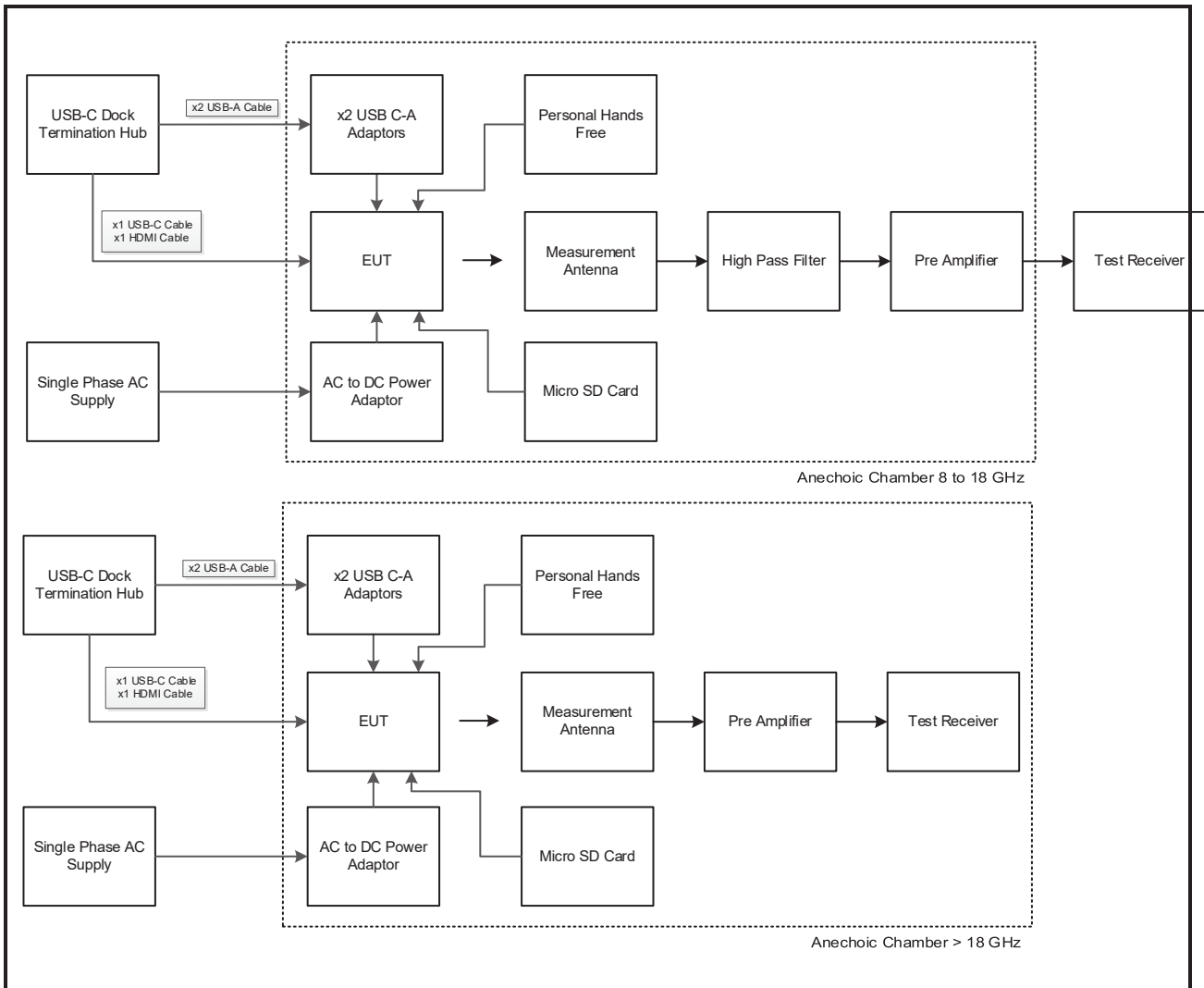

## **4 Antenna Port Test Results**

### **4.1 Transmitter 99% Emission Bandwidth**

#### **Test Summary:**

<b>Test Engineers:</b>	Benyamin Kordiboroujeni & Matthew Botfield	<b>Test Dates:</b>	21 August 2023 & 22 August 2023
<b>Test Sample Serial Number:</b>	X14637VQLV		

#### **Environmental Conditions:**

<b>Temperature (°C):</b>	21 to 23
<b>Relative Humidity (%):</b>	50 to 59

#### **Note(s):**

1. The 99% emission bandwidth was measured using the signal analyser occupied bandwidth function. The resolution bandwidth was set in the range of 1% to 5% of the occupied bandwidth and the video bandwidth set to 3 times the resolution bandwidth. The span was set to capture all products of the modulation process including emission skirts.
2. Example plots of each modulation on middle channel, for one antenna configuration, can be seen below to show setting parameters comply with testing method/procedure. All other plots are archived on the UL IT server and available for inspection if required.

**Transmitter 99% Emission Bandwidth (continued)**

**Results:**

<b>Frequency Range:</b>	2400-2483.5 MHz	<b>Band:</b>	2.4 GHz
<b>Limit Clause:</b>	RSS-Gen 6.7	<b>Test Method:</b>	RSS-Gen 6.7

<b>Antenna Configuration:</b>	SISO	<b>Mode:</b>	BDR
<b>Test Port:</b>	1 (Core 0-C0)	<b>Rate/Modulation:</b>	DH5 (GFSK)

Test Frequency (MHz)	99% Bandwidth (MHz)				Limit (kHz)
	1	2	3	4	
2402 (CH0)	0.856	-	-	-	-
2441 (CH39)	0.852	-	-	-	-
2480 (CH78)	0.855	-	-	-	-

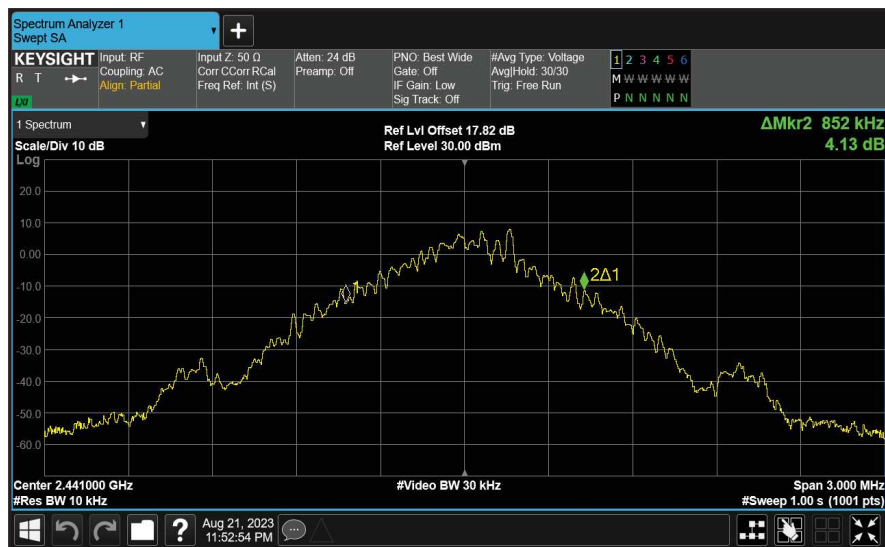

Channel 39

**Transmitter 99% Emission Bandwidth (continued)**

<b>Frequency Range:</b>	2400-2483.5 MHz	<b>Band:</b>	2.4 GHz
<b>Limit Clause:</b>	RSS-Gen 6.7	<b>Test Method:</b>	ANSI C63.10 6.9.3

<b>Antenna Configuration:</b>	SISO	<b>Mode:</b>	EDR
<b>Test Port:</b>	2 (Core 1-C1)	<b>Rate/Modulation:</b>	2-DH5 ( $\pi/4$ DQPSK)

Test Frequency (MHz)	99% Bandwidth (MHz)				Limit (kHz)
	1	2	3	4	
2402 (CH0)	-	1.184	-	-	-
2441 (CH39)	-	1.180	-	-	-
2480 (CH78)	-	1.184	-	-	-

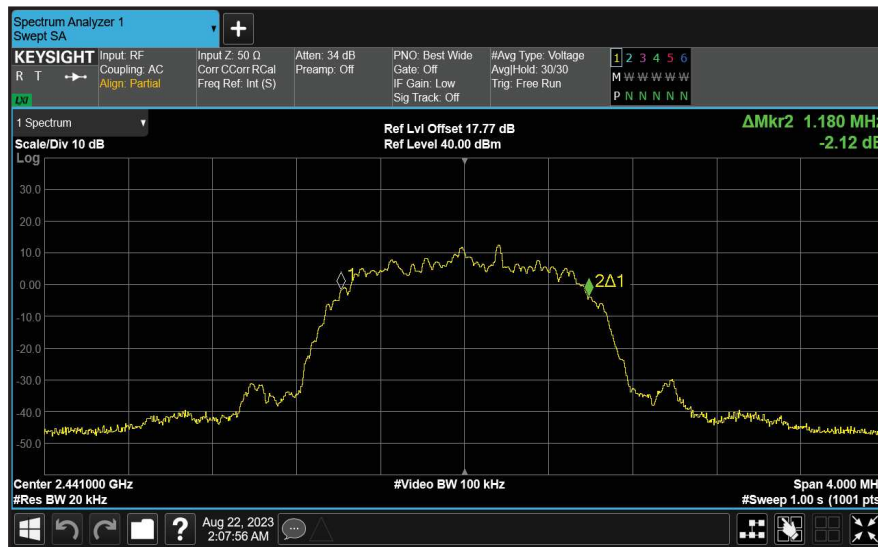

Channel 39

**Transmitter 99% Emission Bandwidth (continued)**

<b>Frequency Range:</b>	2400-2483.5 MHz	<b>Band:</b>	2.4 GHz
<b>Limit Clause:</b>	RSS-Gen 6.7	<b>Test Method:</b>	ANSI C63.10 6.9.3

<b>Antenna Configuration:</b>	SISO	<b>Mode:</b>	EDR
<b>Test Port:</b>	2 (Core 1-C1)	<b>Rate/Modulation:</b>	3-DH5 (8-DPSK)

Test Frequency (MHz)	99% Bandwidth (MHz)				Limit (kHz)
	1	2	3	4	
2402 (CH0)	-	1.184	-	-	-
2441 (CH39)	-	1.180	-	-	-
2480 (CH78)	-	1.184	-	-	-

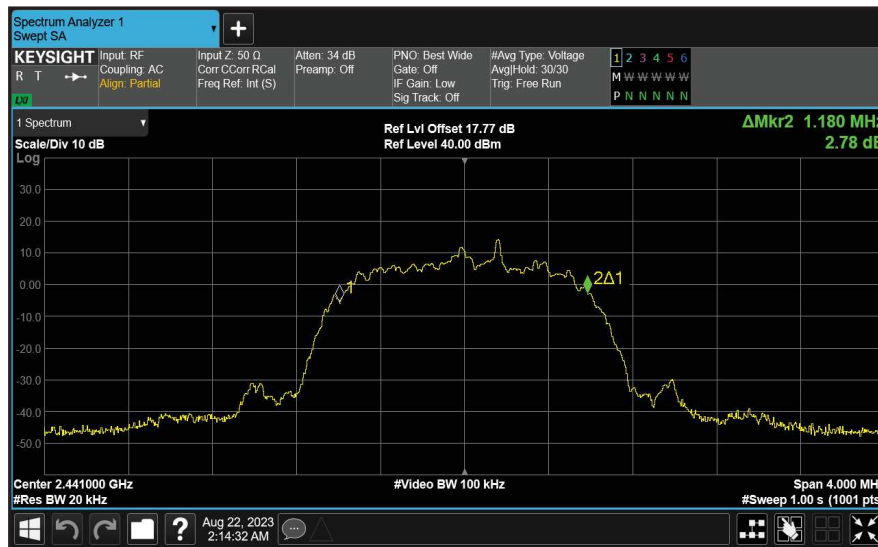

Channel 39

**Transmitter 99% Emission Bandwidth (continued)**

<b>Frequency Range:</b>	2400-2483.5 MHz	<b>Band:</b>	2.4 GHz
<b>Limit Clause:</b>	RSS-Gen 6.7	<b>Test Method:</b>	ANSI C63.10 6.9.3

<b>Antenna Configuration:</b>	Beamforming	<b>Mode:</b>	BDR
<b>Test Port:</b>	1+2 (Core 0-C0 + Core 1-C1)	<b>Rate/Modulation:</b>	DH5 (GFSK)

Test Frequency (MHz)	99% Bandwidth (MHz)				Limit (kHz)
	1	2	3	4	
2402 (CH0)	0.852	0.861	-	-	-
2441 (CH39)	0.852	0.861	-	-	-
2480 (CH78)	0.855	0.861	-	-	-

<b>Frequency Range:</b>	2400-2483.5 MHz	<b>Band:</b>	2.4 GHz
<b>Limit Clause:</b>	RSS-Gen 6.7	<b>Test Method:</b>	ANSI C63.10 6.9.3

<b>Antenna Configuration:</b>	Beamforming	<b>Mode:</b>	EDR
<b>Test Port:</b>	1+2 (Core 0-C0 + Core 1-C1)	<b>Rate/Modulation:</b>	2-DH5 ( $\pi/4$ DQPSK)

Test Frequency (MHz)	99% Bandwidth (MHz)				Limit (kHz)
	1	2	3	4	
2402 (CH0)	1.184	1.184	-	-	-
2441 (CH39)	1.180	1.180	-	-	-
2480 (CH78)	1.180	1.184	-	-	-

<b>Frequency Range:</b>	2400-2483.5 MHz	<b>Band:</b>	2.4 GHz
<b>Limit Clause:</b>	RSS-Gen 6.7	<b>Test Method:</b>	ANSI C63.10 6.9.3

<b>Antenna Configuration:</b>	Beamforming	<b>Mode:</b>	EDR
<b>Test Port:</b>	1+2 (Core 0-C0 + Core 1-C1)	<b>Rate/Modulation:</b>	3-DH5 (8-DPSK)

Test Frequency (MHz)	99% Bandwidth (MHz)				Limit (kHz)
	1	2	3	4	
2402 (CH0)	1.184	1.184	-	-	-
2441 (CH39)	1.184	1.184	-	-	-
2480 (CH78)	1.184	1.188	-	-	-



## **4.2 Transmitter 20 dB Bandwidth**

### **Test Summary:**

<b>Test Engineers:</b>	Benyamin Kordiboroujeni & Matthew Botfield	<b>Test Dates:</b>	21 August 2023 & 22 August 2023
<b>Test Sample Serial Number:</b>	X14637VQLV		

### **Environmental Conditions:**

<b>Temperature (°C):</b>	21 to 23
<b>Relative Humidity (%):</b>	50 to 59

### **Note(s):**

1. The test system signal analyser resolution bandwidth was set in the range of 1% to 5% of the OBW kHz and video bandwidth is three times of RBW. A peak detector was used, sweep time was set to auto and the trace mode was Max Hold. The span was set to capture all products of the modulation process including emission skirts. Normal and delta markers were placed 20 dB down from the peak of the carrier.
2. Example plots of each modulation on middle channel, for one antenna configuration, can be seen below to show setting parameters comply with testing method/procedure. All other plots are archived on the UL IT server and available for inspection if required.

**Transmitter 20 dB Bandwidth (continued)**

**Results:**

<b>Frequency Range:</b>	2400-2483.5 MHz	<b>Band:</b>	2.4 GHz
<b>Limit Clause:</b>	FCC 15.247 (a)(1) RSS-247 5.1 (a) / RSS-Gen 6.7	<b>Test Method:</b>	ANSI C63.10 Section 6.9.2

<b>Antenna Configuration:</b>	SISO	<b>Mode:</b>	BDR
<b>Test Port:</b>	1 (Core 0-C0)	<b>Rate/Modulation:</b>	DH5 (GFSK)

Test Frequency (MHz)	20 dB Bandwidth (MHz)				Limit (kHz)
	1	2	3	4	
2402 (CH0)	0.855	-	-	-	≥-
2441 (CH39)	0.855	-	-	-	≥-
2480 (CH78)	0.855	-	-	-	≥-



Channel 39

**Transmitter 20 dB Bandwidth (continued)**

<b>Frequency Range:</b>	2400-2483.5 MHz	<b>Band:</b>	2.4 GHz
<b>Limit Clause:</b>	FCC 15.247 (a)(1) RSS-247 5.1 (a) / RSS-Gen 6.7	<b>Test Method:</b>	ANSI C63.10 Section 6.9.2

<b>Antenna Configuration:</b>	SISO	<b>Mode:</b>	EDR
<b>Test Port:</b>	2 (Core 1-C1)	<b>Rate/Modulation:</b>	2-DH5 ( $\pi/4$ DQPSK)

Test Frequency (MHz)	20 dB Bandwidth (MHz)				Limit (kHz)
	1	2	3	4	
2402 (CH0)	-	1.330	-	-	$\geq$ -
2441 (CH39)	-	1.325	-	-	$\geq$ -
2480 (CH78)	-	1.330	-	-	$\geq$ -



Channel 39

**Transmitter 20 dB Bandwidth (continued)**

<b>Frequency Range:</b>	2400-2483.5 MHz	<b>Band:</b>	2.4 GHz
<b>Limit Clause:</b>	FCC 15.247 (a)(1) RSS-247 5.1 (a) / RSS-Gen 6.7	<b>Test Method:</b>	ANSI C63.10 Section 6.9.2

<b>Antenna Configuration:</b>	SISO	<b>Mode:</b>	EDR
<b>Test Port:</b>	2 (Core 1-C1)	<b>Rate/Modulation:</b>	3-DH5 (8-DPSK)

Test Frequency (MHz)	20 dB Bandwidth (MHz)				Limit (kHz)
	1	2	3	4	
2402 (CH0)	-	1.260	-	-	-
2441 (CH39)	-	1.260	-	-	-
2480 (CH78)	-	1.260	-	-	-



Channel 39

**Transmitter 20 dB Bandwidth (continued)**

<b>Frequency Range:</b>	2400-2483.5 MHz	<b>Band:</b>	2.4 GHz
<b>Limit Clause:</b>	FCC 15.247 (a)(1) RSS-247 5.1 (a) / RSS-Gen 6.7	<b>Test Method:</b>	ANSI C63.10 Section 6.9.2

<b>Antenna Configuration:</b>	Beamforming	<b>Mode:</b>	BDR
<b>Test Port:</b>	1+2 (Core 0-C0 + Core 1-C1)	<b>Rate/Modulation:</b>	DH5 (GFSK)

Test Frequency (MHz)	20 dB Bandwidth (MHz)				Limit (kHz)
	1	2	3	4	
2402 (CH0)	0.858	0.855	-	-	-
2441 (CH39)	0.855	0.858	-	-	-
2480 (CH78)	0.855	0.855	-	-	-

<b>Frequency Range:</b>	2400-2483.5 MHz	<b>Band:</b>	2.4 GHz
<b>Limit Clause:</b>	FCC 15.247 (a)(1) RSS-247 5.1 (a) / RSS-Gen 6.7	<b>Test Method:</b>	ANSI C63.10 Section 6.9.2

<b>Antenna Configuration:</b>	Beamforming	<b>Mode:</b>	EDR
<b>Test Port:</b>	1+2 (Core 0-C0 + Core 1-C1)	<b>Rate/Modulation:</b>	2-DH5 ( $\pi/4$ DQPSK)

Test Frequency (MHz)	20 dB Bandwidth (MHz)				Limit (kHz)
	1	2	3	4	
2402 (CH0)	1.330	1.325	-	-	-
2441 (CH39)	1.325	1.325	-	-	-
2480 (CH78)	1.325	1.325	-	-	-

**Transmitter 20 dB Bandwidth (continued)**

<b>Frequency Range:</b>	2400-2483.5 MHz	<b>Band:</b>	2.4 GHz
<b>Limit Clause:</b>	FCC 15.247 (a)(1) RSS-247 5.1 (a) / RSS-Gen 6.7	<b>Test Method:</b>	ANSI C63.10 Section 6.9.2

<b>Antenna Configuration:</b>	Beamforming	<b>Mode:</b>	EDR
<b>Test Port:</b>	1+2 (Core 0-C0 + Core 1-C1)	<b>Rate/Modulation:</b>	3-DH5 (8-DPSK)

Test Frequency (MHz)	20 dB Bandwidth (MHz)				Limit (kHz)
	1	2	3	4	
2402 (CH0)	1.255	1.260	-	-	-
2441 (CH39)	1.260	1.260	-	-	-
2480 (CH78)	1.260	1.255	-	-	-

### **4.3 Transmitter Carrier Frequency Separation**

#### **Test Summary:**

<b>Test Engineers:</b>	Benyamin Kordiboroujeni & Matthew Botfield	<b>Test Date:</b>	22 August 2023
<b>Test Sample Serial Number:</b>	X14637VQLV		

#### **Environmental Conditions:**

<b>Temperature (°C):</b>	22
<b>Relative Humidity (%):</b>	57

#### **Note(s):**

1. The 20 dB bandwidth measured for the middle channel operating at 2441 MHz was used to calculate the limit.
2. The test system signal analyser resolution bandwidth was set to set to approximately 30% of the channel spacing; adjust as required to best identify the centre of each individual channel and video bandwidth is 3 times to RBW. A peak detector was used, sweep time was set to auto and trace mode was Max Hold. The span was wide enough to capture the peaks of two adjacent channels. A marker was placed at the centre of one signal and then a delta marker was placed in the same place on the second signal.

**Transmitter Carrier Frequency Separation (continued)**

**Results:**

<b>Frequency Range:</b>	2400-2483.5 MHz	<b>Band:</b>	2.4 GHz
<b>Limit Clause:</b>	FCC 15.247 (a)(1) RSS-247 5.1 (b)	<b>Test Method:</b>	ANSI C63.10 Section 7.8.2

<b>Antenna Configuration:</b>	SISO	<b>Mode:</b>	BDR
<b>Test Port:</b>	1 (Core 0-C0)	<b>Rate/Modulation:</b>	-

Packet Type / Modulation	Hopping Frequency (MHz)		FHS (MHz)	20 dB Bandwidth (MHz)	Limit (MHz)	Margin (MHz)
	F1	F2				
DH5 (GFSK)	2441.019	2442.019	1.000	0.855	0.570	0.430



DH5



**Transmitter Carrier Frequency Separation (continued)**

<b>Frequency Range:</b>	2400-2483.5 MHz	<b>Band:</b>	2.4 GHz
<b>Limit Clause:</b>	FCC 15.247 (a)(1) RSS-247 5.1 (b)	<b>Test Method:</b>	ANSI C63.10 Section 7.8.2

<b>Antenna Configuration:</b>	SISO	<b>Mode:</b>	EDR
<b>Test Port:</b>	2 (Core 1-C1)	<b>Rate/Modulation:</b>	-

Packet Type / Modulation	Hopping Frequency (MHz)		Fhs (MHz)	20 dB Bandwidth (MHz)	Limit (MHz)	Margin (MHz)
	F1	F2				
2-DH5 ( $\pi/4$ DQPSK)	2441.000	2441.999	0.999	1.325	0.883	0.116
3-DH5 (8-DPSK)	2441.007	2442.007	1.000	1.260	0.840	0.160



2-DH5



3-DH5

<b>Frequency Range:</b>	2400-2483.5 MHz	<b>Band:</b>	2.4 GHz
<b>Limit Clause:</b>	FCC 15.247 (a)(1) RSS-247 5.1 (b)	<b>Test Method:</b>	ANSI C63.10 Section 7.8.2

<b>Antenna Configuration:</b>	Beamforming	<b>Mode:</b>	BDR
<b>Test Port:</b>	1+2 (Core 0-C0 + Core 1-C1)	<b>Rate/Modulation:</b>	-

Packet Type / Modulation	Hopping Frequency (MHz)		Fhs (MHz)	20 dB Bandwidth (MHz)	Limit (MHz)	Margin (MHz)
	F1	F2				
DH5 (GFSK)	2441.018	2442.017	0.999	0.858	0.572	0.427
2-DH5 ( $\pi/4$ DQPSK)	2440.998	2441.999	1.001	1.325	0.883	0.118
3-DH5 (8-DPSK)	2441.006	2442.006	1.000	1.260	0.840	0.160

#### **4.4 Transmitter Number of Hopping Frequencies and Average Time of Occupancy**

##### **Test Summary:**

<b>Test Engineers:</b>	Benyamin Kordiboroujeni & Matthew Botfield	<b>Test Date:</b>	22 August 2023
<b>Test Sample Serial Number:</b>	X14637VQLV		

##### **Environmental Conditions:**

<b>Temperature (°C):</b>	22
<b>Relative Humidity (%):</b>	57

##### **Note(s):**

1. Tests were performed to identify the average time of occupancy in number of channels (79) x 0.4 seconds. The calculated period is 31.6 seconds.
2. The test system signal analyser was set up for the Number of Hopping Frequencies measurement as follows: the resolution bandwidth was set to 100 kHz and video bandwidth of 300 kHz. A peak detector was used, sweep time was set to auto and trace mode was Max Hold. The span was set to 83.5 MHz.
3. The test system signal analyser was set up for the Average Time of Occupancy measurement as follows: the resolution bandwidth was set to 100 kHz and video bandwidth of 300 kHz. A peak detector was used and sweep time was set to 31.6 seconds. The EUT was set to transmit in a hopping mode with zero span. The total number of hopping frequencies were recorded in the table below.
4. Example plots of each modulation, for one antenna configuration, can be seen below to show setting parameters comply with testing method/procedure. All other plots are archived on the UL IT server and available for inspection if required.

**Transmitter Number of Hopping Frequencies and Average Time of Occupancy (continued)**

**Results:**

<b>Frequency Range:</b>	2400-2483.5 MHz	<b>Band:</b>	2.4 GHz
<b>Limit Clause:</b>	FCC 15.247(a)(1)(iii) RSS-247 5.1 d)	<b>Test Method:</b>	ANSI C63.10 7.8.3 & ANSI C63.10 7.8.4

<b>Antenna Configuration:</b>	SISO	<b>Mode:</b>	BDR
<b>Test Port:</b>	1 (Core 0-C0)	<b>Rate/Modulation:</b>	DH5 (GFSK)

<b>Burst Tx</b>	Stability: < ±2%	Duty Cycle (%): 77.01	Period (ms): 3.750	Width (ms): 2.888
-----------------	------------------	-----------------------	--------------------	-------------------

<b>Number of Hopping Frequencies</b>	<b>Limit</b>
79	≥ 15

Hopping Frequency Investigated (MHz)	Emission Width (ms)	Number of Hops	Average Time of Occupancy (ms)	Limit (ms)	Margin (ms)
2402	2.888	111	320.6	≤ 400.0	79.4

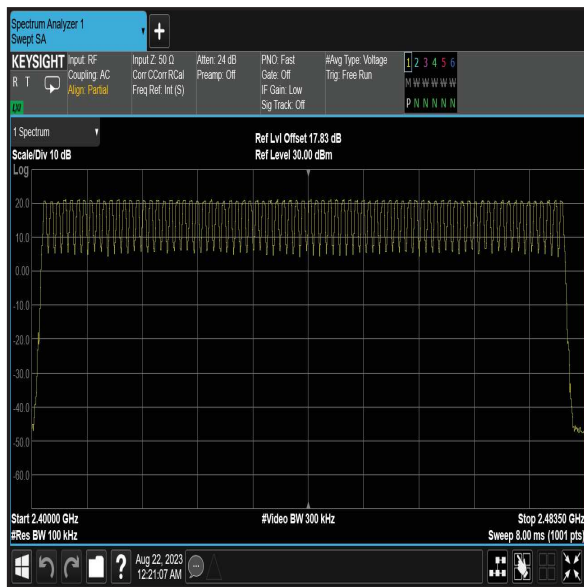

**Number of Hopping Frequencies**

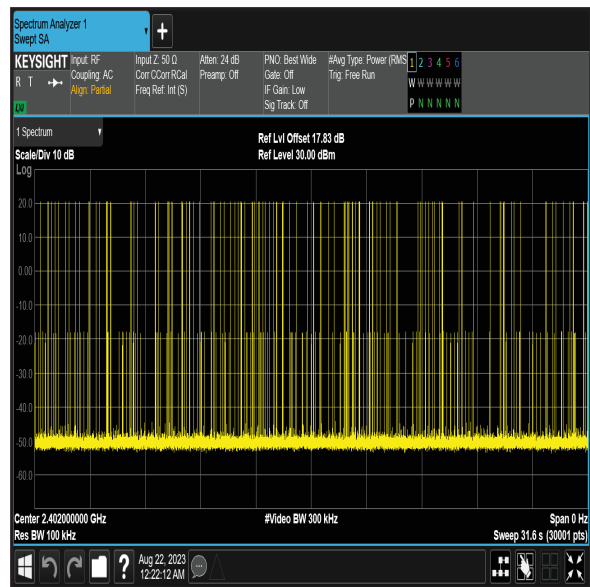

**Number of Hops in 32 s**

**Transmitter Number of Hopping Frequencies and Average Time of Occupancy (continued)**

<b>Antenna Configuration:</b>	Beamforming	<b>Mode:</b>	BDR
<b>Test Port:</b>	1+2 (Core 0-C0 + Core 1-C1)	<b>Rate/Modulation:</b>	DH5 (GFSK)

<b>Burst Tx</b>	Stability: < $\pm 2\%$	Duty Cycle (%): 77.00	Period (ms): 3.750	Width (ms): 2.888
-----------------	------------------------	-----------------------	--------------------	-------------------

<b>Number of Hopping Frequencies</b>	<b>Limit</b>
79	$\geq 15$

Hopping Frequency Investigated (MHz)	Emission Width (ms)	Number of Hops	Average Time of Occupancy (ms)	Limit (ms)	Margin (ms)
2402	2.888	112	323.4	$\leq 400.0$	76.6

## 4.5 Transmitter Maximum Peak Output Power

### Test Summary:

<b>Test Engineers:</b>	Benyamin Kordiboroujeni & Matthew Botfield	<b>Test Date:</b>	22 August 2023
<b>Test Sample Serial Number:</b>	X14637VQLV		

### Environmental Conditions:

<b>Temperature (°C):</b>	22
<b>Relative Humidity (%):</b>	57

### Note(s):

1. Tests were performed using a peak power sensor.
2. For beamforming modes, conducted power was measured on Core 0 & Core 1 and then combined using the measure-and-sum technique stated in FCC KDB 662911 D01 Section E)1). For EIRP, the directional antenna gain was added to the conducted output power.

For beamforming modes, the limit for conducted output power has been reduced by the same amount in dB that the directional gain of the antenna exceeds 6 dBi, in accordance with 15.247(b)(4).

### Results:

<b>Frequency Range:</b>	2400-2483.5 MHz	<b>Band:</b>	2.4 GHz
<b>Limit Clause:</b>	15.247 (b)(1) RSS-247 5.4 b)	<b>Test Method:</b>	ANSI C63.10 7.8.5

<b>Antenna Configuration:</b>	SISO	<b>Mode:</b>	BDR
<b>Test Port:</b>	1 (Core 0-C0)	<b>Rate/Modulation:</b>	DH5 (GFSK)

<b>Burst Tx</b>	Stability: < ±2%	Duty Cycle (%): 77.01	Period (ms): 3.750	Width (ms): 2.888
-----------------	------------------	-----------------------	--------------------	-------------------

Test Frequency (MHz)	Maximum Conducted Output Power (dBm)					Limit (dBm)	Margin (dB)	Antenna Gain (dBi)	EIRP (dBm)	EIRP Limit (dBm)	EIRP Margin (dB)
	1	2	3	4	Σ						
2402 (CH0)	13.89	-	-	-	-	30.00	16.11	5.40	19.29	36.00	16.71
2441 (CH39)	13.82	-	-	-	-	30.00	16.18	5.40	19.22	36.00	16.78
2480 (CH78)	13.66	-	-	-	-	30.00	16.34	5.40	19.06	36.00	16.94

**Transmitter Maximum Peak Output Power (continued)**

<b>Frequency Range:</b>	2400-2483.5 MHz	<b>Band:</b>	2.4 GHz
<b>Limit Clause:</b>	FCC 15.247 (b)(1) RSS-247 5.4 (b)	<b>Test Method:</b>	ANSI C63.10 7.8.5

<b>Antenna Configuration:</b>	SISO	<b>Mode:</b>	EDR
<b>Test Port:</b>	2 (Core 1-C1)	<b>Rate/Modulation:</b>	2-DH5 ( $\pi/4$ DQPSK)

<b>Burst Tx</b>	Stability: < $\pm 2\%$	Duty Cycle (%): 77.08	Period (ms): 3.750	Width (ms): 2.891
-----------------	------------------------	-----------------------	--------------------	-------------------

Test Frequency (MHz)	Maximum Conducted Output Power (dBm)					Limit (dBm)	Margin (dB)	Antenna Gain (dBi)	EIRP (dBm)	EIRP Limit (dBm)	EIRP Margin (dB)
	1	2	3	4	$\Sigma$						
2402 (CH0)	-	18.97	-	-	-	30.00	11.03	5.40	24.37	36.00	11.63
2441 (CH39)	-	19.09	-	-	-	30.00	10.91	5.40	24.49	36.00	11.51
2480 (CH78)	-	19.07	-	-	-	30.00	10.93	5.40	24.47	36.00	11.53

<b>Frequency Range:</b>	2400-2483.5 MHz	<b>Band:</b>	2.4 GHz
<b>Limit Clause:</b>	FCC 15.247 (b)(1) RSS-247 5.4 (b)	<b>Test Method:</b>	ANSI C63.10 7.8.5

<b>Antenna Configuration:</b>	SISO	<b>Mode:</b>	EDR
<b>Test Port:</b>	2 (Core 1-C1)	<b>Rate/Modulation:</b>	3-DH5 (8-DPSK)

<b>Burst Tx</b>	Stability: < $\pm 2\%$	Duty Cycle (%): 77.14	Period (ms): 3.750	Width (ms): 2.893
-----------------	------------------------	-----------------------	--------------------	-------------------

Test Frequency (MHz)	Maximum Conducted Output Power (dBm)					Limit (dBm)	Margin (dB)	Antenna Gain (dBi)	EIRP (dBm)	EIRP Limit (dBm)	EIRP Margin (dB)
	1	2	3	4	$\Sigma$						
2402 (CH0)	-	19.44	-	-	-	30.00	10.56	5.40	24.84	36.00	11.16
2441 (CH39)	-	19.69	-	-	-	30.00	10.31	5.40	25.09	36.00	10.91
2480 (CH78)	-	19.65	-	-	-	30.00	10.35	5.40	25.05	36.00	10.95

**Transmitter Maximum Peak Output Power (continued)**

<b>Frequency Range:</b>	2400-2483.5 MHz	<b>Band:</b>	2.4 GHz
<b>Limit Clause:</b>	FCC 15.247 (b)(1) RSS-247 5.4 (b)	<b>Test Method:</b>	ANSI C63.10 7.8.5

<b>Antenna Configuration:</b>	Beamforming	<b>Mode:</b>	BDR
<b>Test Port:</b>	1+2 (Core 0-C0 + Core 1-C1)	<b>Rate/Modulation:</b>	DH5 (GFSK)

<b>Burst Tx</b>	Stability: < ±2%	Duty Cycle (%): 77.00	Period (ms): 3.750	Width (ms): 2.888
-----------------	------------------	-----------------------	--------------------	-------------------

Test Frequency (MHz)	Maximum Conducted Output Power (dBm)					Antenna Gain (dBi)	Limit (dBm)	Margin (dB)
	1	2	3	4	Σ			
2402 (CH0)	13.31	13.20	-	-	16.24	8.41	27.59	11.35
2441 (CH39)	13.39	13.30	-	-	16.32	8.41	27.59	11.27
2480 (CH78)	13.24	13.25	-	-	16.21	8.41	27.59	11.38

**FCC Maximum Conducted (peak) Output Power Results**

Test Frequency (MHz)	Maximum Conducted Output Power (dBm)					Limit (dBm)	Margin (dB)	Antenna Gain (dBi)	EIRP (dBm)	EIRP Limit (dBm)	EIRP Margin (dB)
	1	2	3	4	Σ						
2402 (CH0)	13.31	13.20	-	-	16.24	30.00	13.76	8.41	24.65	36.00	11.35
2441 (CH39)	13.39	13.30	-	-	16.32	30.00	13.68	8.41	24.73	36.00	11.27
2480 (CH78)	13.24	13.25	-	-	16.21	30.00	13.79	8.41	24.62	36.00	11.38

**ISED Maximum Conducted (peak) Output Power Results**

**Transmitter Maximum Peak Output Power (continued)**

<b>Frequency Range:</b>	2400-2483.5 MHz	<b>Band:</b>	2.4 GHz
<b>Limit Clause:</b>	FCC 15.247 (b)(1) RSS-247 5.4 (b)	<b>Test Method:</b>	ANSI C63.10 7.8.5

<b>Antenna Configuration:</b>	Beamforming	<b>Mode:</b>	EDR
<b>Test Port:</b>	1+2 (Core 0-C0 + Core 1-C1)	<b>Rate/Modulation:</b>	2-DH5 ( $\pi/4$ DQPSK)

<b>Burst Tx</b>	Stability: < $\pm 2\%$	Duty Cycle (%): 77.08	Period (ms): 3.750	Width (ms): 2.890
-----------------	------------------------	-----------------------	--------------------	-------------------

Test Frequency (MHz)	Maximum Conducted Output Power (dBm)					Gain (dBi)	Limit (dBm)	Margin (dB)
	1	2	3	4	$\Sigma$			
2402 (CH0)	15.56	16.01	-	-	18.78	8.41	27.59	8.81
2441 (CH39)	15.92	16.10	-	-	19.00	8.41	27.59	8.59
2480 (CH78)	16.25	16.24	-	-	19.23	8.41	27.59	8.36

**FCC Maximum Conducted (peak) Output Power Results**

Test Frequency (MHz)	Maximum Conducted Output Power (dBm)					Limit (dBm)	Margin (dB)	Gain (dBi)	EIRP (dBm)	EIRP Limit (dBm)	EIRP Margin (dB)
	1	2	3	4	$\Sigma$						
2402 (CH0)	15.56	16.01	-	-	18.78	30.00	11.22	8.41	27.19	33.60	8.81
2441 (CH39)	15.92	16.10	-	-	19.00	30.00	11.00	8.41	27.41	33.60	8.59
2480 (CH78)	16.25	16.24	-	-	19.23	30.00	10.77	8.41	27.64	33.60	8.36

**ISED Maximum Conducted (peak) Output Power Results**



**Transmitter Maximum Peak Output Power (continued)**

<b>Frequency Range:</b>	2400-2483.5 MHz	<b>Band:</b>	2.4 GHz
<b>Limit Clause:</b>	FCC 15.247 (b)(1) RSS-247 5.4 (b)	<b>Test Method:</b>	ANSI C63.10 7.8.5

<b>Antenna Configuration:</b>	Beamforming	<b>Mode:</b>	EDR
<b>Test Port:</b>	1+2 (Core 0-C0 + Core 1-C1)	<b>Rate/Modulation:</b>	3-DH5 (8-DPSK)

<b>Burst Tx</b>	Stability: < ±2%	Duty Cycle (%): 77.13	Period (ms): 3.750	Width (ms): 2.892
-----------------	------------------	-----------------------	--------------------	-------------------

Test Frequency (MHz)	Maximum Conducted Output Power (dBm)					Gain (dBi)	Limit (dBm)	Margin (dB)
	1	2	3	4	Σ			
2402 (CH0)	16.49	16.58	-	-	19.52	8.41	27.59	8.07
2441 (CH39)	16.54	16.62	-	-	19.52	8.41	27.59	8.07
2480 (CH78)	16.17	16.35	-	-	19.26	8.41	27.59	8.33

**FCC Maximum Conducted (peak) Output Power Results**

Test Frequency (MHz)	Maximum Conducted Output Power (dBm)					Limit (dBm)	Margin (dB)	Gain (dBi)	EIRP (dBm)	EIRP Limit (dBm)	EIRP Margin (dB)
	1	2	3	4	Σ						
2402 (CH0)	16.49	16.58	-	-	19.52	30.00	10.48	8.41	27.93	36.00	8.07
2441 (CH39)	16.54	16.62	-	-	19.52	30.00	10.48	8.41	27.93	36.00	8.07
2480 (CH78)	16.17	16.35	-	-	19.26	30.00	10.74	8.41	27.67	36.00	8.33

**ISED Maximum Conducted (peak) Output Power Results**

## **5 Radiated Test Results**

### **5.1 Transmitter Radiated Emissions <1 GHz**

#### **Test Summary:**

<b>Test Engineers:</b>	Nick Steele & Lenny Hantz	<b>Test Dates:</b>	22 August 2023 & 06 September 2023
<b>Test Sample Serial Numbers:</b>	DCXLFPVWQL & L0942C4MWW		

<b>FCC Reference:</b>	Parts 15.247(d) & 15.209(a)
<b>ISED Canada Reference:</b>	RSS-Gen 6.13 / RSS-247 5.5
<b>Test Method Used:</b>	ANSI C63.10 Sections 6.3, 6.4 and 6.5
<b>Frequency Range</b>	9 kHz to 1000 MHz

#### **Environmental Conditions:**

<b>Temperature (°C):</b>	25 to 26
<b>Relative Humidity (%):</b>	48 to 49

#### **Note(s):**

1. The final measured value, for the given emission, in the table below incorporates the calibrated antenna factor and cable loss.
2. The preliminary scans showed similar emission levels below 1 GHz, for each channel of operation. Therefore final radiated emissions measurements were performed with the EUT set to the middle channel only.
3. All emissions shown on the pre-scans were investigated and found to be ambient, or > 20 dB below the appropriate limit or below the noise floor of the measurement system. Therefore the highest peak noise floor reading of the measuring receiver was recorded in the table below.
4. Measurements below 30 MHz were performed in a semi-anechoic chamber (Asset Number K0001) at 3 metres. The EUT was placed at a height of 80 cm above the reference ground plane in the centre of the chamber turntable. The limit was extrapolated to 3 metres in accordance with ANSI C63.10 clause 6.4.3 using the method described in clause 6.4.4.2. ANSI C63.10 clause 5.2 states an alternative test site that can demonstrate equivalence to an open area test site may be used for measurements below 30 MHz. Therefore, measurements were performed in a semi-anechoic chamber. The correlation data between semi-anechoic chamber and an open field test site is available upon request.
5. Measurements from 30 MHz to 1 GHz were performed in a semi-anechoic chamber (Asset Number K0017) at a distance of 3 metres. The EUT was placed at a height of 80 cm above the reference ground plane in the centre of the chamber turntable. Maximum emission levels were determined by height searching the measurement antenna over the range 1 metre to 4 metres.
6. Pre-scans were performed and markers placed on the highest measured levels. The test receiver was configured as follows: For 9 kHz to 150 kHz, the resolution bandwidth was set to 300 Hz and video bandwidth 1 kHz. A peak detector was used and trace mode was Max Hold. For 150 kHz to 30 MHz, the resolution bandwidth was set to 10 kHz and video bandwidth 30 kHz, trace mode was Max Hold. For 30 MHz to 1 GHz, the resolution bandwidth was set to 120 kHz and video bandwidth 500 kHz. A peak detector was used, sweep time was set to auto and trace mode was Max Hold.

**Transmitter Radiated Emissions (continued)**

**Results: Peak / Middle Channel / 3DH5 / Beamforming / Core 0 + Core 1**

Frequency (MHz)	Antenna Polarity	Level (dB $\mu$ V/m)	Limit (dB $\mu$ V/m)	Margin (dB)	Result
961.427	Vertical	33.1	46.0	12.9	Complied

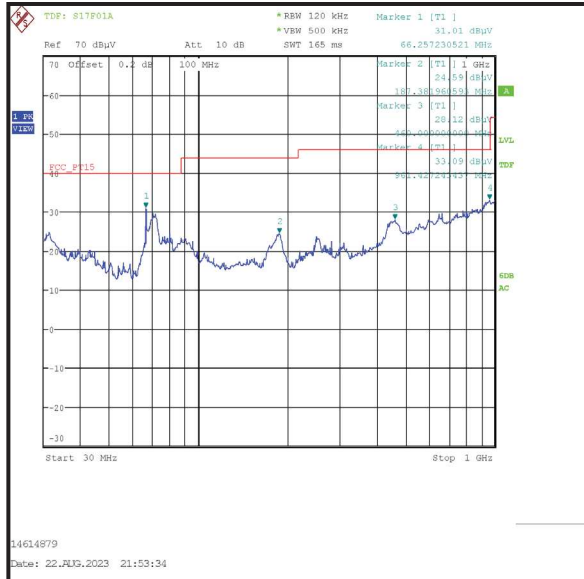
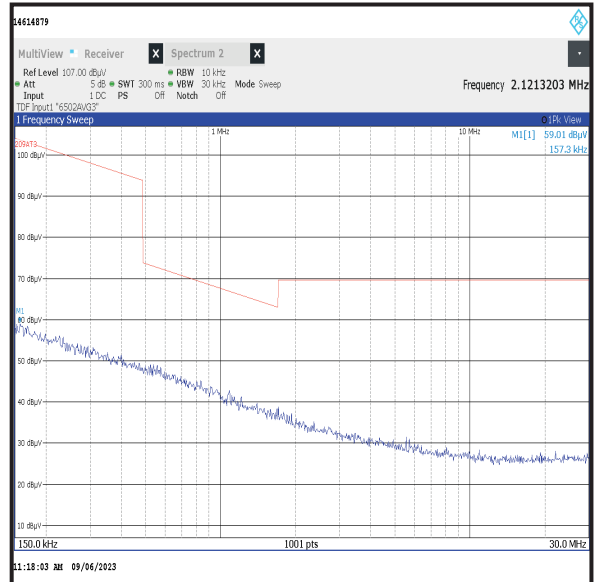
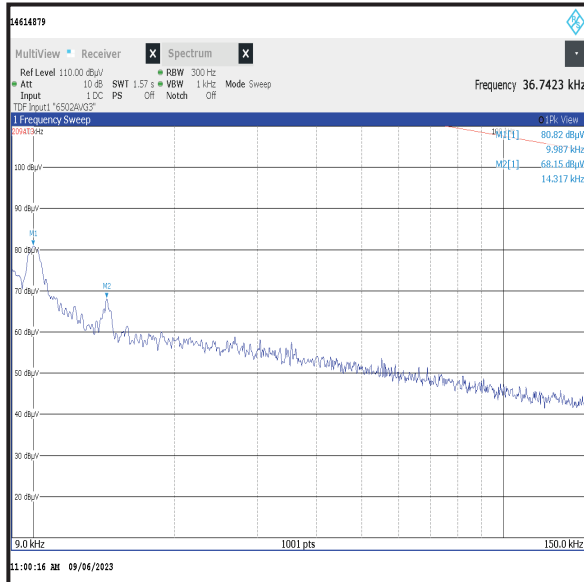

## 5.2 Transmitter Radiated Emissions >1 GHz

### Test Summary:

Test Engineer:	Nick Steele	Test Dates:	14 August 2023 & 18 August 2023
Test Sample Serial Number:	DCXLFPVWQL		

FCC Reference:	Parts 15.247(d) & 15.209(a)
ISED Canada Reference:	RSS-Gen 6.13 / RSS-247 5.5
Test Method Used:	ANSI C63.10 Sections 6.3 and 6.6
Frequency Range	1 GHz to 25 GHz

### Environmental Conditions:

Temperature (°C):	24
Relative Humidity (%):	47 to 49

### Note(s):

1. The final measured value, for the given emission, in the table below incorporates the calibrated antenna factor and cable loss.
2. No spurious emissions were detected above the noise floor of the measuring receiver therefore the highest peak and average noise floor readings of the measuring receiver were recorded as shown in the tables below.
3. The emission shown on the 1 GHz to 3 GHz plot at approximately 2441 MHz is the EUT fundamental.
4. Pre-scans above 1 GHz were performed in a fully anechoic chamber (Asset Number K0017) at a distance of 3 metres. The EUT was placed at a height of 1.5 metres above the test chamber floor in the centre of the chamber turntable. All measurement antennas were placed at a fixed height of 1.5 metres above the test chamber floor, in line with the EUT.
5. Pre-scans were performed and a marker placed on the highest measured level of the appropriate plot. The test receiver resolution bandwidth was set to 1 MHz and video bandwidth 3 MHz. The sweep time was set to auto. Peak and average measurements were performed with their own appropriate detectors during the pre-scan measurements.

### Results: Peak / Middle Channel / 3DH5 / Beamforming / Core 0 + Core 1

Frequency (MHz)	Antenna Polarity	Level (dB $\mu$ V/m)	Limit (dB $\mu$ V/m)	Margin (dB)	Result
2903.500	Vertical	56.4	74.0	17.6	Complied

### Results: Average / Middle Channel / 3DH5 / Beamforming / Core 0 + Core 1

Frequency (MHz)	Antenna Polarity	Level (dB $\mu$ V/m)	Limit (dB $\mu$ V/m)	Margin (dB)	Result
2909.000	Vertical	48.6	54.0	5.4	Complied

### Transmitter Radiated Emissions (continued)

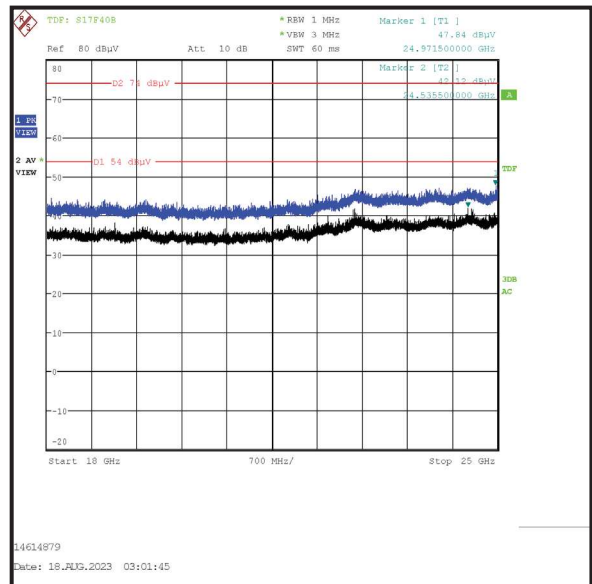
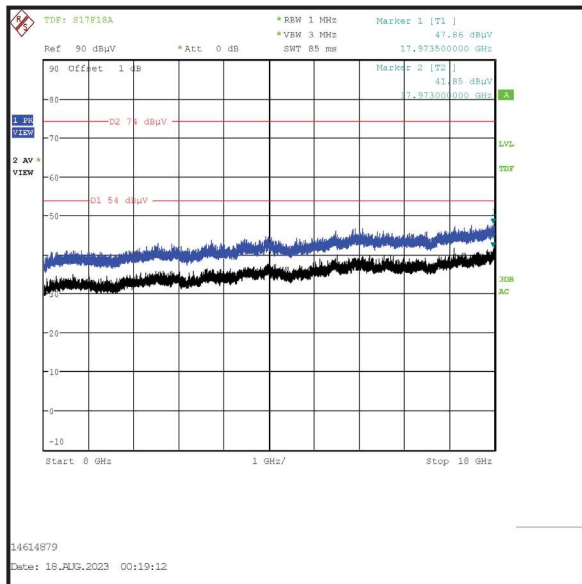
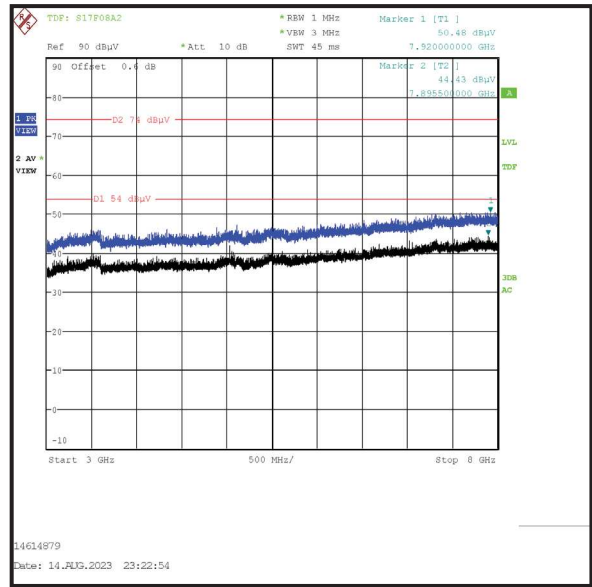
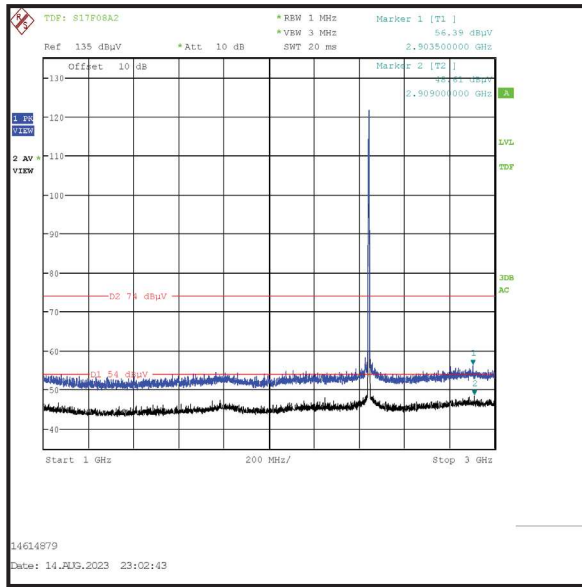

### **5.3 Transmitter Band Edge Radiated Emissions**

#### **Test Summary:**

<b>Test Engineers:</b>	John Ferdinand & Andrew Harding	<b>Test Dates:</b>	12 July 2023 to 26 July 2023
<b>Test Sample Serial Number:</b>	QLHJ2QWDF0 & QL4WF71R27		

<b>FCC Reference:</b>	Parts 15.247(d) & 15.209(a)
<b>ISED Canada Reference:</b>	RSS-Gen 6.13 / RSS-247 5.5
<b>Test Method Used:</b>	ANSI C63.10 Section 6.10 & FCC KDB 558074 Section 9) b)

#### **Environmental Conditions:**

<b>Temperature (°C):</b>	24
<b>Relative Humidity (%):</b>	44 to 47

#### **Note(s):**

1. The final measured value, for the given emission, in the table below incorporates the calibrated antenna factor and cable loss.
2. The lower band edge is adjacent to a non-restricted band. The test receiver resolution bandwidth was set to 100 kHz and video bandwidth 300 kHz. A peak detector was used, sweep time was set to auto and trace mode was Max Hold. The test receiver was left to sweep for a sufficient length of time in order to maximise the carrier level and out-of-band emissions. A marker and corresponding reference level line were placed on the peak of the carrier. A marker was placed on the band edge spot frequencies and a second marker placed on the highest emission level in the adjacent band (where a higher level emission was present). Marker frequencies and levels were recorded.
3. The upper band edge is adjacent to a restricted band. The test receiver resolution bandwidth was set to 1 MHz and video bandwidth 3 MHz. Peak and average measurements were performed with their respective detectors, sweep time was set to auto and trace mode was Max Hold. The test receiver was left to sweep for a sufficient length of time in order to maximise the carrier level and out-of-band emissions. A marker was placed on the band edge spot frequencies and a second marker placed on the highest emission level in the adjacent band (where a higher level emission was present). Marker frequencies and levels were recorded.
4. There is a restricted band 10 MHz below the lower band edge. The test receiver was set up as follows: the RBW set to 1 MHz, the VBW set to 3 MHz, with the sweep time set to auto couple. Peak and average measurements were performed with their respective detectors. Markers were placed on the highest point on each trace.
5. \* -20 dBc limit.
6. \*\* For the upper band edge average measurements: The corrected average level has been obtained by subtracting the calculated duty cycle correction factor from the measured peak level for any restricted band emissions related to the fundamental. See Appendix 1 for further information.

**Transmitter Band Edge Radiated Emissions (continued)****Results: Static Mode / DH5 / SISO / Core 0**

Frequency (MHz)	Antenna Polarity	Peak Level (dB $\mu$ V/m)	Limit (dB $\mu$ V/m)	Margin (dB)	Result
2399.750	Vertical	51.0	96.7*	45.7	Complied
2400.0	Vertical	49.2	96.7*	47.5	Complied
2483.5	Vertical	57.2	74.0	16.8	Complied
2483.550	Vertical	57.6	74.0	16.4	Complied

Frequency (MHz)	Antenna Polarity	Average Level (dB $\mu$ V/m)	Limit (dB $\mu$ V/m)	Margin (dB)	Result
2483.5	Vertical	38.2**	54.0	15.8	Complied

**Results: 2310 MHz to 2390 MHz Restricted Band / Peak**

Frequency (MHz)	Antenna Polarity	Level (dB $\mu$ V/m)	Limit (dB $\mu$ V/m)	Margin (dB)	Result
2386.400	Vertical	56.4	74.0	17.6	Complied

**Results: 2310 MHz to 2390 MHz Restricted Band / Average**

Frequency (MHz)	Antenna Polarity	Level (dB $\mu$ V/m)	Limit (dB $\mu$ V/m)	Margin (dB)	Result
2389.040	Vertical	49.0	54.0	5.0	Complied

### Transmitter Band Edge Radiated Emissions (continued)

#### Results: Static Mode / DH5 / SISO / Core 0

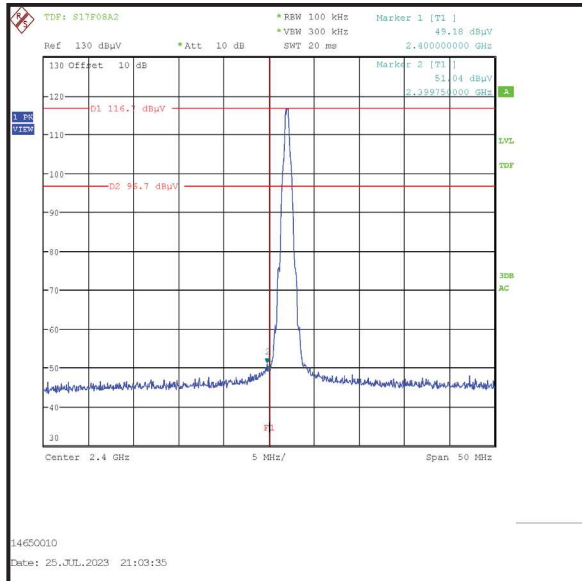

Lower Band Edge

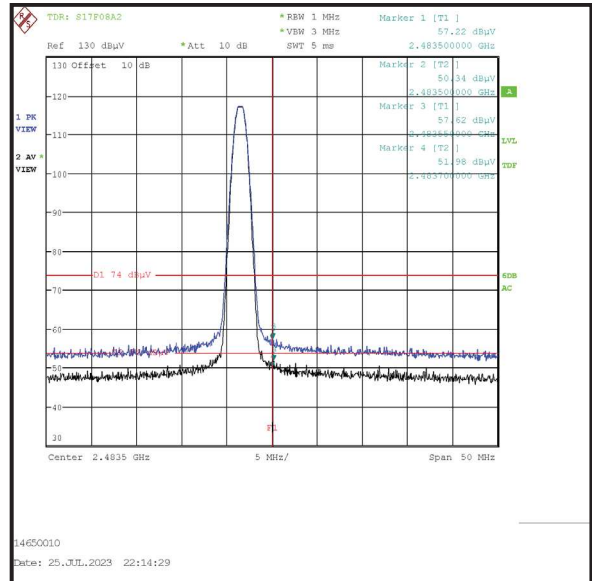

Upper Band Edge

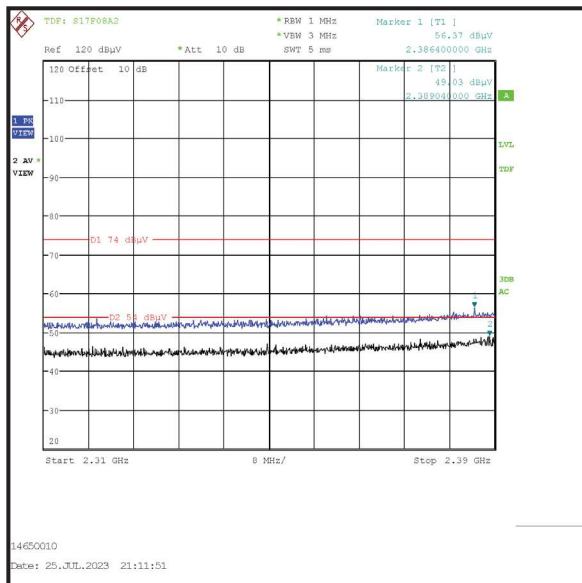

2310 MHz to 2390 MHz Restricted Band



**Transmitter Band Edge Radiated Emissions (continued)****Results: Hopping Mode / DH5 / SISO / Core 0**

Frequency (MHz)	Antenna Polarity	Peak Level (dB $\mu$ V/m)	Limit (dB $\mu$ V/m)	Margin (dB)	Result
2399.850	Vertical	51.3	99.0*	47.7	Complied
2400.0	Vertical	49.0	99.0*	50.0	Complied
2483.5	Vertical	56.0	74.0	18.0	Complied
2483.550	Vertical	57.2	74.0	16.8	Complied

Frequency (MHz)	Antenna Polarity	Average Level (dB $\mu$ V/m)	Limit (dB $\mu$ V/m)	Margin (dB)	Result
2483.5	Vertical	37.0**	54.0	17.0	Complied

**Results: 2310 MHz to 2390 MHz Restricted Band / Peak**

Frequency (MHz)	Antenna Polarity	Level (dB $\mu$ V/m)	Limit (dB $\mu$ V/m)	Margin (dB)	Result
2389.920	Vertical	56.2	74.0	17.8	Complied

**Results: 2310 MHz to 2390 MHz Restricted Band / Average**

Frequency (MHz)	Antenna Polarity	Level (dB $\mu$ V/m)	Limit (dB $\mu$ V/m)	Margin (dB)	Result
2389.360	Vertical	49.0	54.0	5.0	Complied

### Transmitter Band Edge Radiated Emissions (continued)

#### Results: Hopping Mode / DH5 / SISO / Core 0

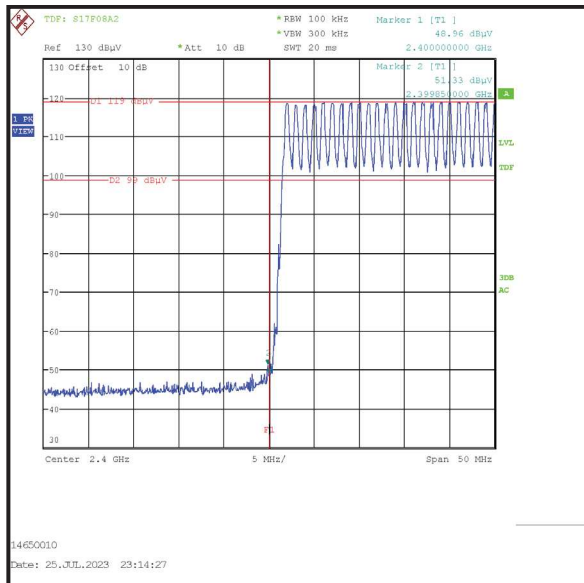

Lower Band Edge

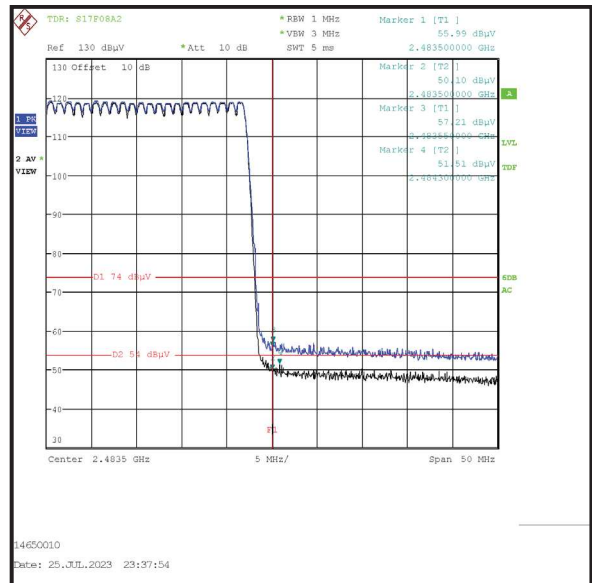

Upper Band Edge

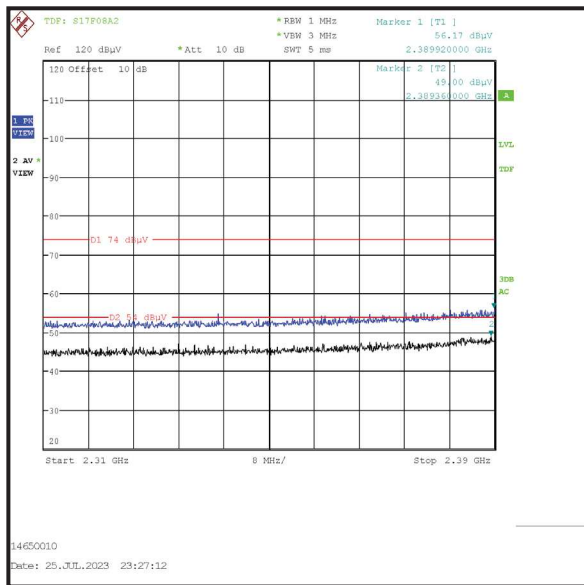

2310 MHz to 2390 MHz Restricted Band

**Transmitter Band Edge Radiated Emissions (continued)****Results: Static Mode / 2DH5 / SISO / Core 0**

Frequency (MHz)	Antenna Polarity	Peak Level (dB $\mu$ V/m)	Limit (dB $\mu$ V/m)	Margin (dB)	Result
2399.992	Vertical	55.8	97.0*	41.2	Complied
2400.0	Vertical	54.5	97.0*	42.5	Complied
2483.5	Vertical	57.3	74.0	16.7	Complied
2483.740	Vertical	57.6	74.0	16.4	Complied

Frequency (MHz)	Antenna Polarity	Average Level (dB $\mu$ V/m)	Limit (dB $\mu$ V/m)	Margin (dB)	Result
2483.5	Vertical	38.3**	54.0	15.7	Complied

**Results: 2310 MHz to 2390 MHz Restricted Band / Peak**

Frequency (MHz)	Antenna Polarity	Level (dB $\mu$ V/m)	Limit (dB $\mu$ V/m)	Margin (dB)	Result
2389.231	Vertical	57.3	74.0	16.7	Complied

**Results: 2310 MHz to 2390 MHz Restricted Band / Average**

Frequency (MHz)	Antenna Polarity	Level (dB $\mu$ V/m)	Limit (dB $\mu$ V/m)	Margin (dB)	Result
2385.641	Vertical	51.0	54.0	3.0	Complied

### Transmitter Band Edge Radiated Emissions (continued)

#### Results: Static Mode / 2DH5 / SISO / Core 0

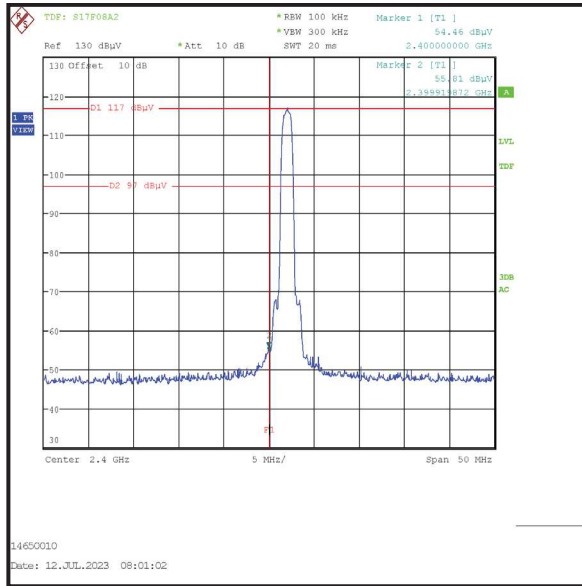

Lower Band Edge

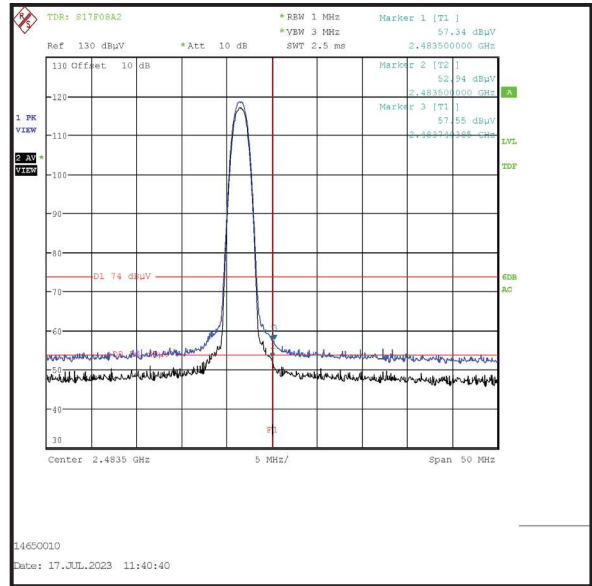

Upper Band Edge

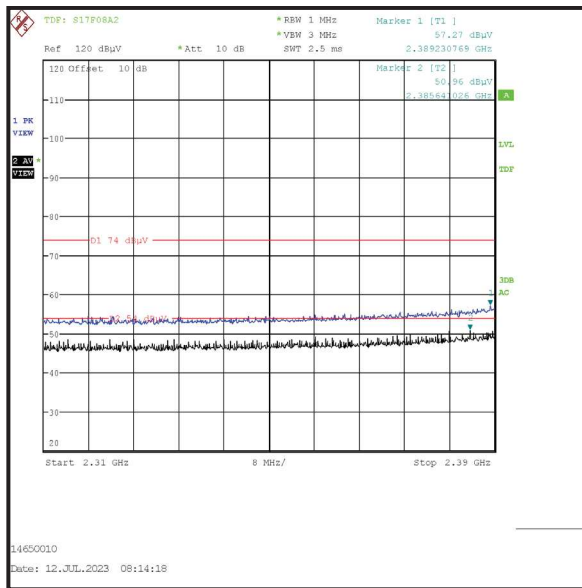

2310 MHz to 2390 MHz Restricted Band

**Transmitter Band Edge Radiated Emissions (continued)****Results: Hopping Mode / 2DH5 / SISO / Core 0**

Frequency (MHz)	Antenna Polarity	Peak Level (dB $\mu$ V/m)	Limit (dB $\mu$ V/m)	Margin (dB)	Result
2399.650	Vertical	53.7	98.3*	44.6	Complied
2400.0	Vertical	52.8	98.3*	45.5	Complied
2483.5	Vertical	56.2	74.0	17.8	Complied
2483.660	Vertical	56.9	74.0	17.1	Complied

Frequency (MHz)	Antenna Polarity	Average Level (dB $\mu$ V/m)	Limit (dB $\mu$ V/m)	Margin (dB)	Result
2483.5	Vertical	37.2**	54.0	16.8	Complied

**Results: 2310 MHz to 2390 MHz Restricted Band / Peak**

Frequency (MHz)	Antenna Polarity	Level (dB $\mu$ V/m)	Limit (dB $\mu$ V/m)	Margin (dB)	Result
2386.320	Vertical	55.4	74.0	18.6	Complied

**Results: 2310 MHz to 2390 MHz Restricted Band / Average**

Frequency (MHz)	Antenna Polarity	Level (dB $\mu$ V/m)	Limit (dB $\mu$ V/m)	Margin (dB)	Result
2389.680	Vertical	48.0	54.0	6.0	Complied

### Transmitter Band Edge Radiated Emissions (continued)

#### Results: Hopping Mode / 2DH5 / SISO / Core 0

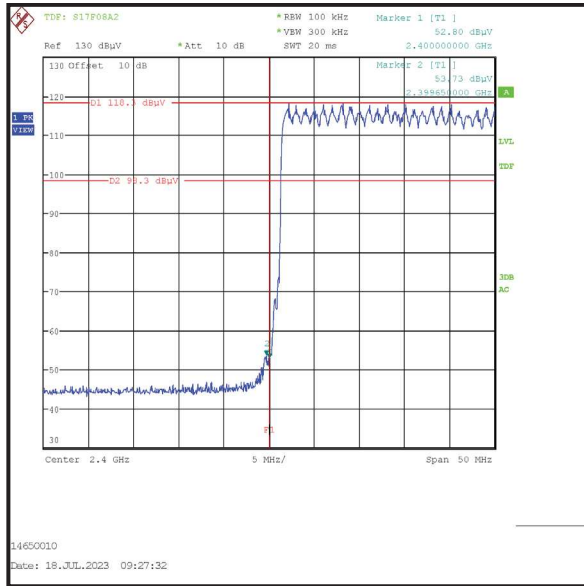

Lower Band Edge

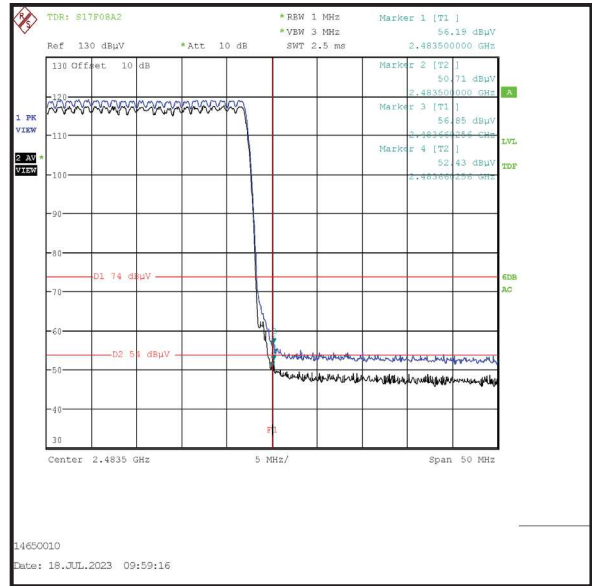

Upper Band Edge

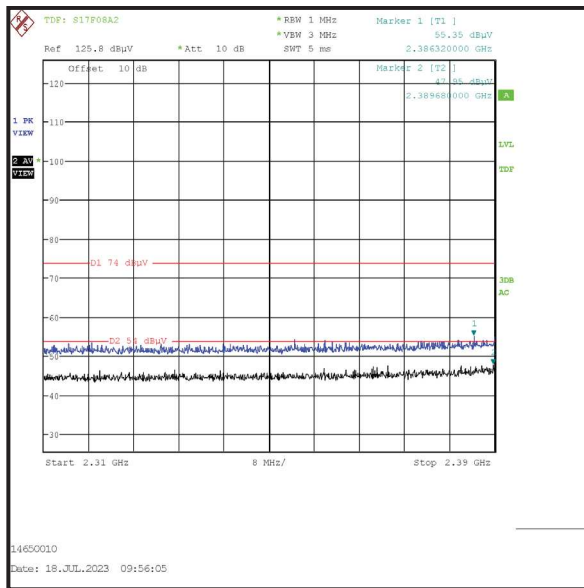

2310 MHz to 2390 MHz Restricted Band

**Transmitter Band Edge Radiated Emissions (continued)****Results: Static Mode / 3DH5 / SISO / Core 0**

Frequency (MHz)	Antenna Polarity	Peak Level (dB $\mu$ V/m)	Limit (dB $\mu$ V/m)	Margin (dB)	Result
2399.599	Vertical	55.5	96.8*	41.3	Complied
2400.0	Vertical	54.9	96.8*	41.9	Complied
2483.5	Vertical	60.0	74.0	14.0	Complied
2483.580	Vertical	60.3	74.0	13.7	Complied

Frequency (MHz)	Antenna Polarity	Average Level (dB $\mu$ V/m)	Limit (dB $\mu$ V/m)	Margin (dB)	Result
2483.5	Vertical	41.0**	54.0	13.0	Complied

**Results: 2310 MHz to 2390 MHz Restricted Band / Peak**

Frequency (MHz)	Antenna Polarity	Level (dB $\mu$ V/m)	Limit (dB $\mu$ V/m)	Margin (dB)	Result
2382.436	Vertical	56.8	74.0	17.2	Complied

**Results: 2310 MHz to 2390 MHz Restricted Band / Average**

Frequency (MHz)	Antenna Polarity	Level (dB $\mu$ V/m)	Limit (dB $\mu$ V/m)	Margin (dB)	Result
2388.333	Vertical	50.3	54.0	3.7	Complied

### Transmitter Band Edge Radiated Emissions (continued)

#### Results: Static Mode / 3DH5 / SISO / Core 0

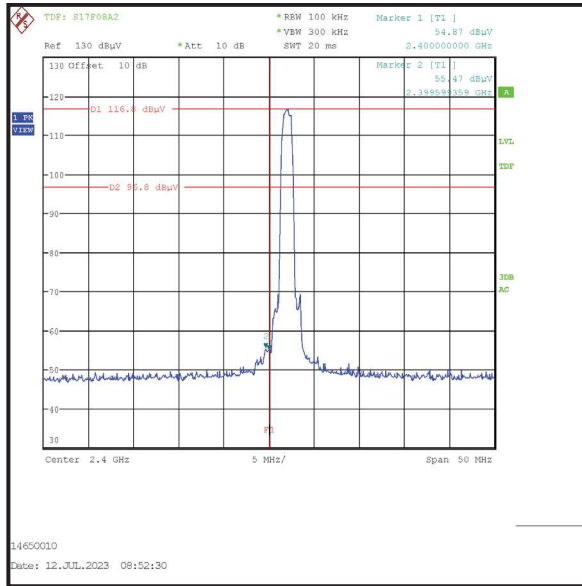

Lower Band Edge

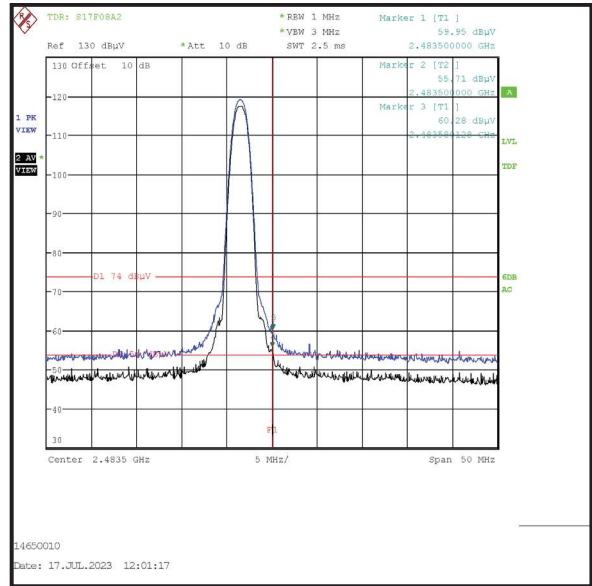

Upper Band Edge

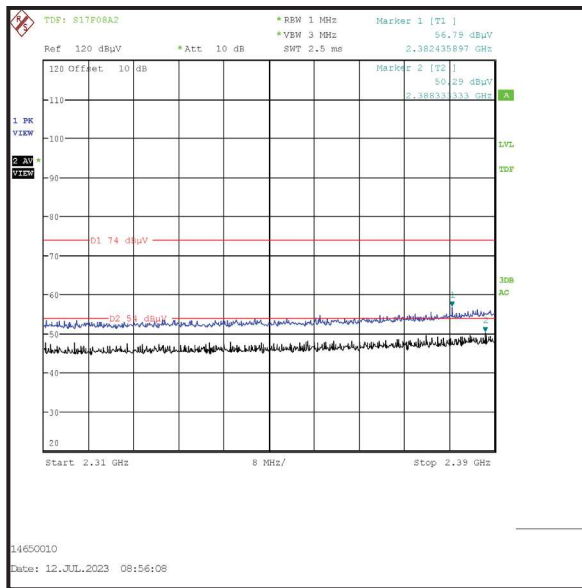

2310 MHz to 2390 MHz Restricted Band



**Transmitter Band Edge Radiated Emissions (continued)****Results: Hopping Mode / 3DH5 / SISO / Core 0**

Frequency (MHz)	Antenna Polarity	Peak Level (dB $\mu$ V/m)	Limit (dB $\mu$ V/m)	Margin (dB)	Result
2399.850	Vertical	54.5	98.3*	43.8	Complied
2400.0	Vertical	52.8	98.3*	45.5	Complied
2483.5	Vertical	59.0	74.0	15.0	Complied
2483.740	Vertical	59.2	74.0	14.8	Complied

Frequency (MHz)	Antenna Polarity	Average Level (dB $\mu$ V/m)	Limit (dB $\mu$ V/m)	Margin (dB)	Result
2483.5	Vertical	40.0**	54.0	14.0	Complied

**Results: 2310 MHz to 2390 MHz Restricted Band / Peak**

Frequency (MHz)	Antenna Polarity	Level (dB $\mu$ V/m)	Limit (dB $\mu$ V/m)	Margin (dB)	Result
2388.720	Vertical	55.5	74.0	18.5	Complied

**Results: 2310 MHz to 2390 MHz Restricted Band / Average**

Frequency (MHz)	Antenna Polarity	Level (dB $\mu$ V/m)	Limit (dB $\mu$ V/m)	Margin (dB)	Result
2388.560	Vertical	48.1	54.0	5.9	Complied

### Transmitter Band Edge Radiated Emissions (continued)

#### Results: Hopping Mode / 3DH5 / SISO / Core 0

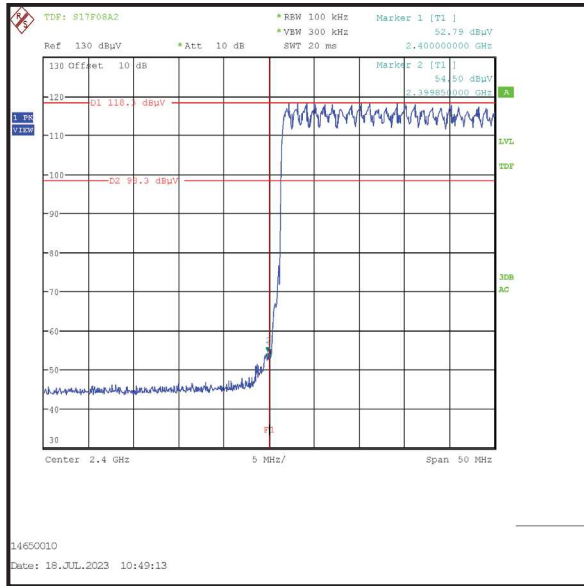

Lower Band Edge

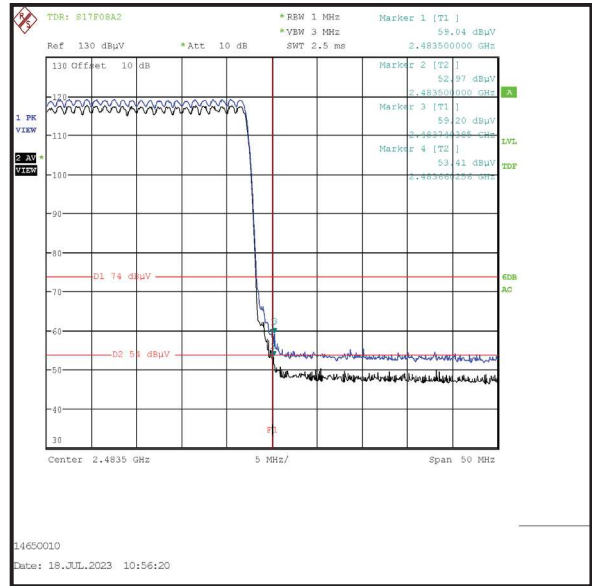

Upper Band Edge

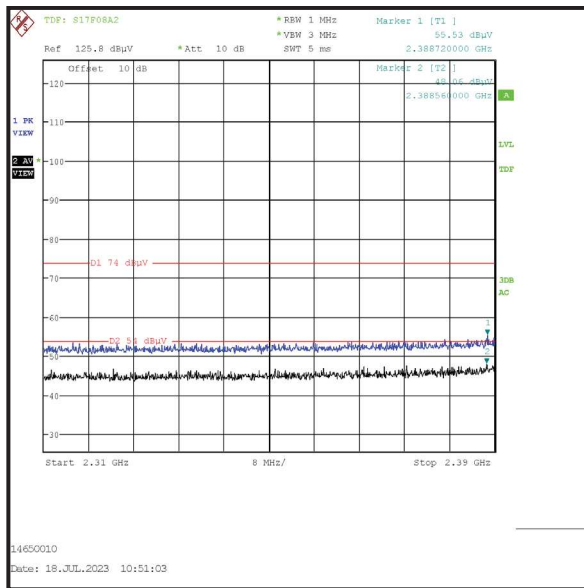

2310 MHz to 2390 MHz Restricted Band

**Transmitter Band Edge Radiated Emissions (continued)****Results: Static Mode / DH5 / SISO / Core 1**

Frequency (MHz)	Antenna Polarity	Peak Level (dB $\mu$ V/m)	Limit (dB $\mu$ V/m)	Margin (dB)	Result
2399.350	Vertical	50.4	94.9*	44.5	Complied
2400.0	Vertical	49.2	94.9*	45.7	Complied
2483.5	Vertical	57.7	74.0	16.3	Complied
2483.550	Vertical	58.1	74.0	15.9	Complied

Frequency (MHz)	Antenna Polarity	Average Level (dB $\mu$ V/m)	Limit (dB $\mu$ V/m)	Margin (dB)	Result
2483.5	Vertical	38.7**	54.0	15.3	Complied

**Results: 2310 MHz to 2390 MHz Restricted Band / Peak**

Frequency (MHz)	Antenna Polarity	Level (dB $\mu$ V/m)	Limit (dB $\mu$ V/m)	Margin (dB)	Result
2388.880	Vertical	55.8	74.0	18.2	Complied

**Results: 2310 MHz to 2390 MHz Restricted Band / Average**

Frequency (MHz)	Antenna Polarity	Level (dB $\mu$ V/m)	Limit (dB $\mu$ V/m)	Margin (dB)	Result
2389.040	Vertical	49.1	54.0	4.9	Complied

### Transmitter Band Edge Radiated Emissions (continued)

#### Results: Static Mode / DH5 / SISO / Core 1

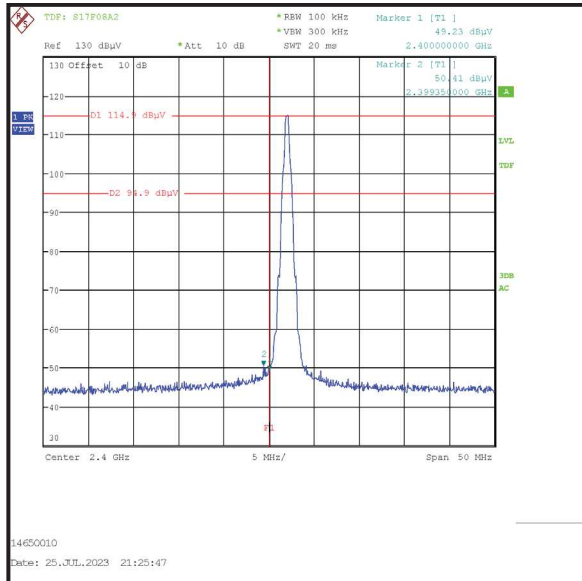

Lower Band Edge

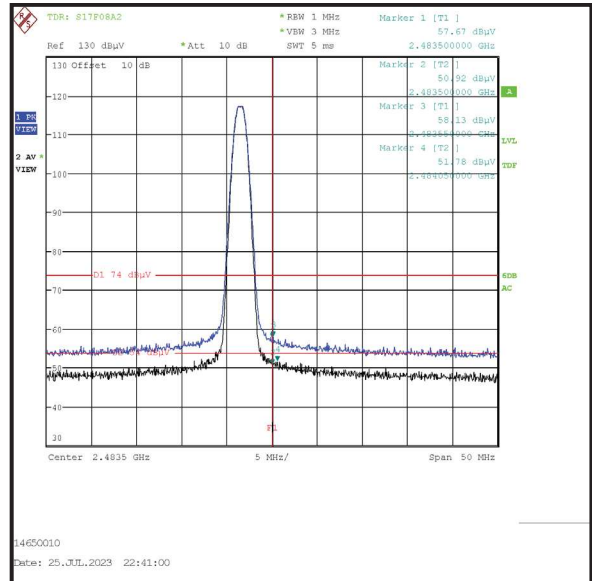

Upper Band Edge

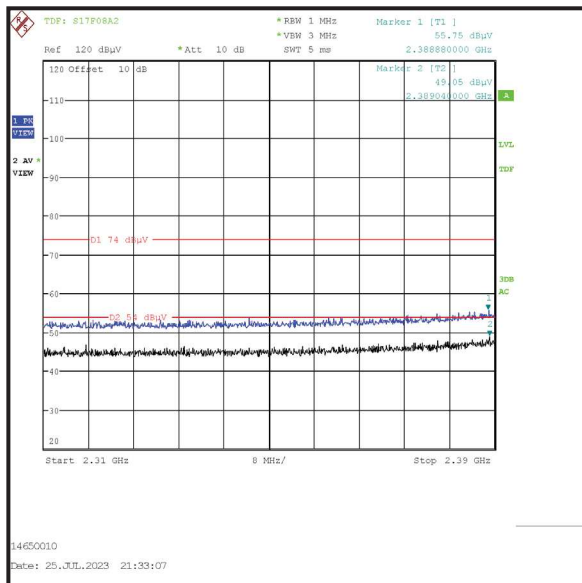

2310 MHz to 2390 MHz Restricted Band

**Transmitter Band Edge Radiated Emissions (continued)****Results: Hopping Mode / DH5 / SISO / Core 1**

Frequency (MHz)	Antenna Polarity	Peak Level (dB $\mu$ V/m)	Limit (dB $\mu$ V/m)	Margin (dB)	Result
2399.850	Vertical	54.2	99.8*	45.6	Complied
2400.0	Vertical	53.3	99.8*	46.5	Complied
2483.5	Vertical	56.2	74.0	17.8	Complied
2484.200	Vertical	57.9	74.0	16.1	Complied

Frequency (MHz)	Antenna Polarity	Average Level (dB $\mu$ V/m)	Limit (dB $\mu$ V/m)	Margin (dB)	Result
2483.5	Vertical	37.2**	54.0	16.8	Complied

**Results: 2310 MHz to 2390 MHz Restricted Band / Peak**

Frequency (MHz)	Antenna Polarity	Level (dB $\mu$ V/m)	Limit (dB $\mu$ V/m)	Margin (dB)	Result
2389.760	Vertical	56.2	74.0	17.8	Complied

**Results: 2310 MHz to 2390 MHz Restricted Band / Average**

Frequency (MHz)	Antenna Polarity	Level (dB $\mu$ V/m)	Limit (dB $\mu$ V/m)	Margin (dB)	Result
2386.880	Vertical	47.9	54.0	6.1	Complied

### Transmitter Band Edge Radiated Emissions (continued)

#### Results: Hopping Mode / DH5 / SISO / Core 1

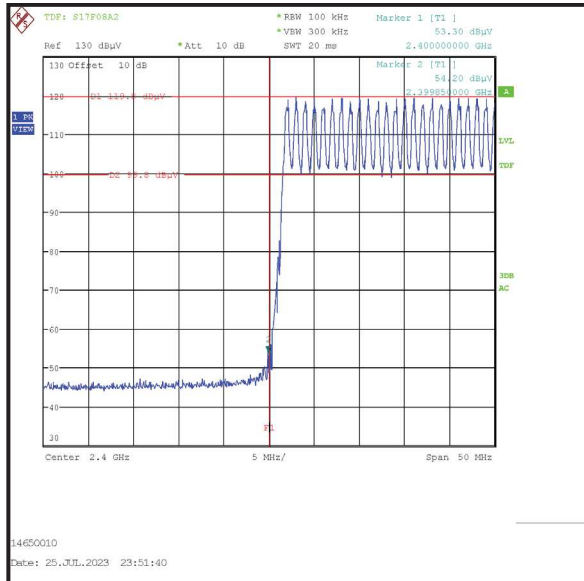

Lower Band Edge

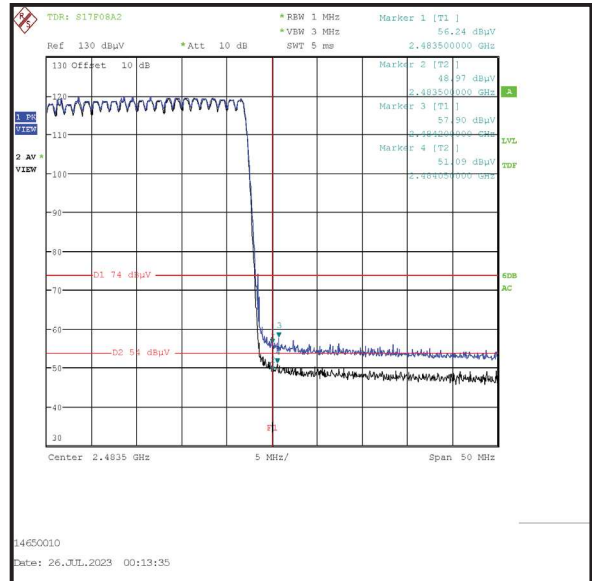

Upper Band Edge

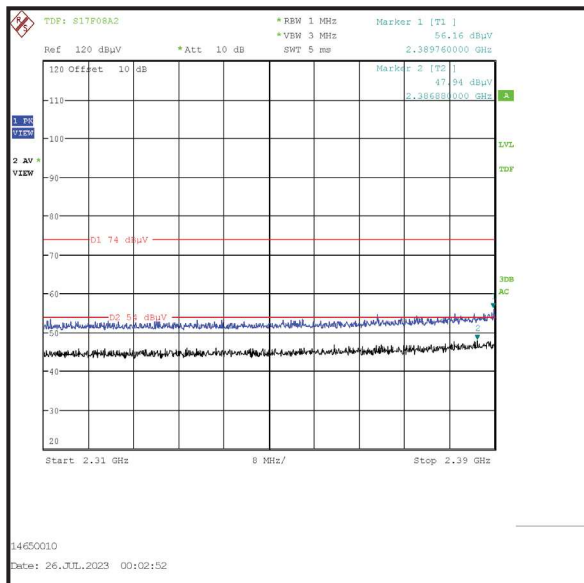

2310 MHz to 2390 MHz Restricted Band

**Transmitter Band Edge Radiated Emissions (continued)****Results: Static Mode / 2DH5 / SISO / Core 1**

Frequency (MHz)	Antenna Polarity	Peak Level (dB $\mu$ V/m)	Limit (dB $\mu$ V/m)	Margin (dB)	Result
2399.840	Vertical	53.9	94.2*	40.3	Complied
2400.0	Vertical	53.4	94.2*	40.8	Complied
2483.5	Vertical	58.8	74.0	15.2	Complied

Frequency (MHz)	Antenna Polarity	Average Level (dB $\mu$ V/m)	Limit (dB $\mu$ V/m)	Margin (dB)	Result
2483.5	Vertical	34.4**	54.0	19.6	Complied

**Results: 2310 MHz to 2390 MHz Restricted Band / Peak**

Frequency (MHz)	Antenna Polarity	Level (dB $\mu$ V/m)	Limit (dB $\mu$ V/m)	Margin (dB)	Result
2389.487	Vertical	56.2	74.0	17.8	Complied

**Results: 2310 MHz to 2390 MHz Restricted Band / Average**

Frequency (MHz)	Antenna Polarity	Level (dB $\mu$ V/m)	Limit (dB $\mu$ V/m)	Margin (dB)	Result
2388.974	Vertical	49.4	54.0	4.6	Complied

### Transmitter Band Edge Radiated Emissions (continued)

#### Results: Static Mode / 2DH5 / SISO / Core 1

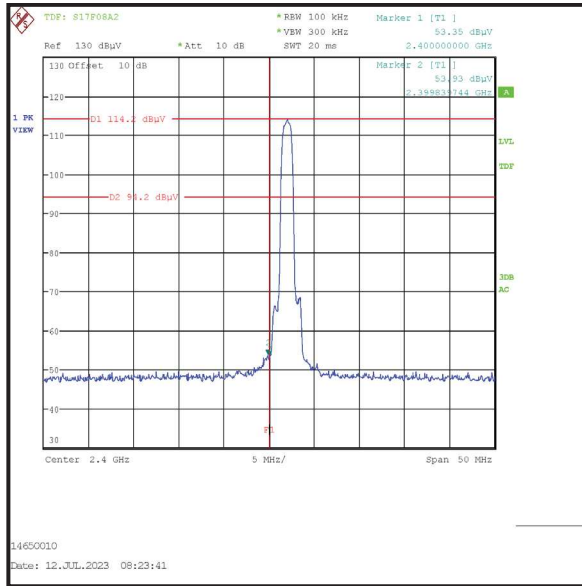

Lower Band Edge

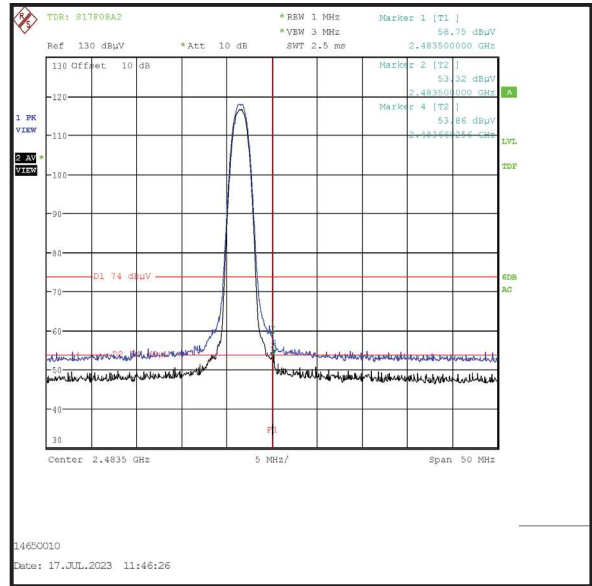

Upper Band Edge

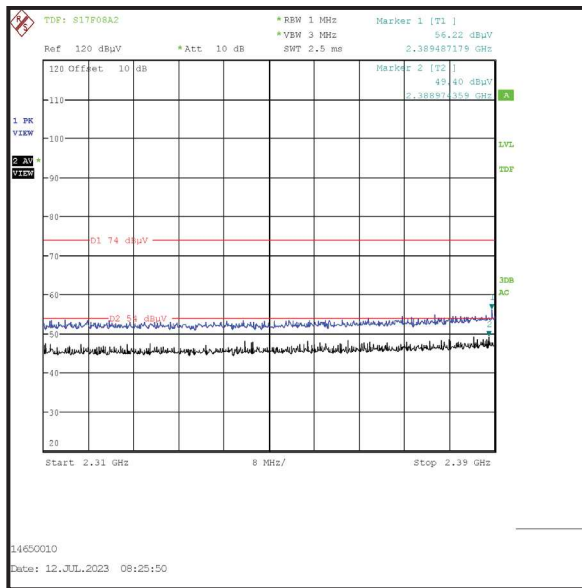

2310 MHz to 2390 MHz Restricted Band



**Transmitter Band Edge Radiated Emissions (continued)****Results: Hopping Mode / 2DH5 / SISO / Core 1**

Frequency (MHz)	Antenna Polarity	Peak Level (dB $\mu$ V/m)	Limit (dB $\mu$ V/m)	Margin (dB)	Result
2399.900	Vertical	52.6	95.4*	42.8	Complied
2400.0	Vertical	48.2	95.4*	47.2	Complied
2483.5	Vertical	56.7	74.0	17.3	Complied
2483.580	Vertical	56.8	74.0	17.2	Complied

Frequency (MHz)	Antenna Polarity	Average Level (dB $\mu$ V/m)	Limit (dB $\mu$ V/m)	Margin (dB)	Result
2483.5	Vertical	37.7**	54.0	16.3	Complied

**Results: 2310 MHz to 2390 MHz Restricted Band / Peak**

Frequency (MHz)	Antenna Polarity	Level (dB $\mu$ V/m)	Limit (dB $\mu$ V/m)	Margin (dB)	Result
2388.880	Vertical	54.9	74.0	19.1	Complied

**Results: 2310 MHz to 2390 MHz Restricted Band / Average**

Frequency (MHz)	Antenna Polarity	Level (dB $\mu$ V/m)	Limit (dB $\mu$ V/m)	Margin (dB)	Result
2361.120	Vertical	47.6	54.0	6.4	Complied

### Transmitter Band Edge Radiated Emissions (continued)

#### Results: Hopping Mode / 2DH5 / SISO / Core 1

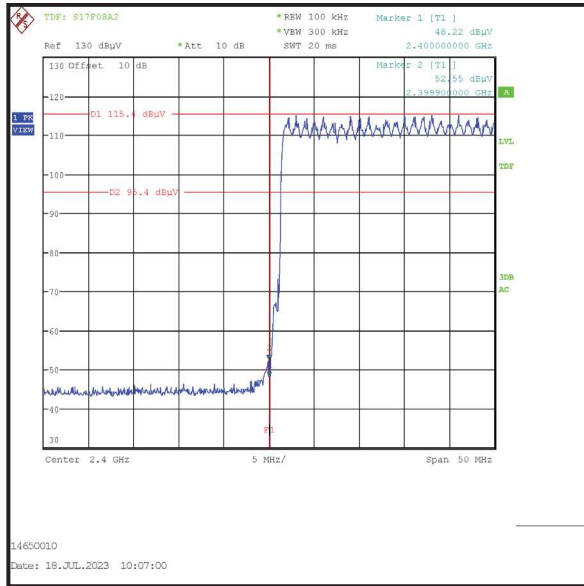

Lower Band Edge

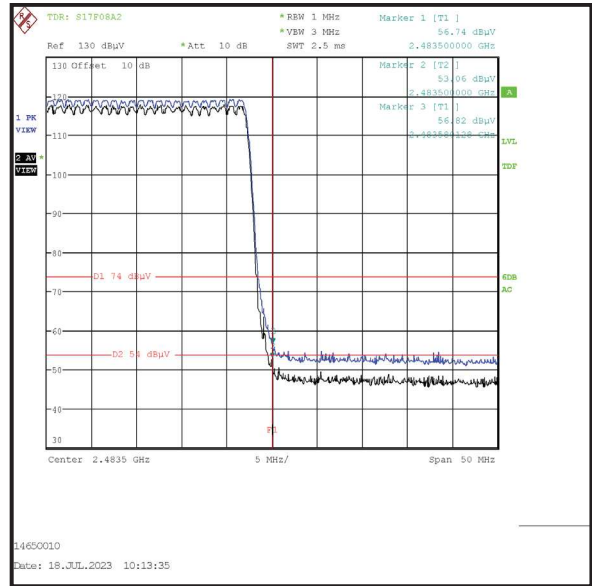

Upper Band Edge

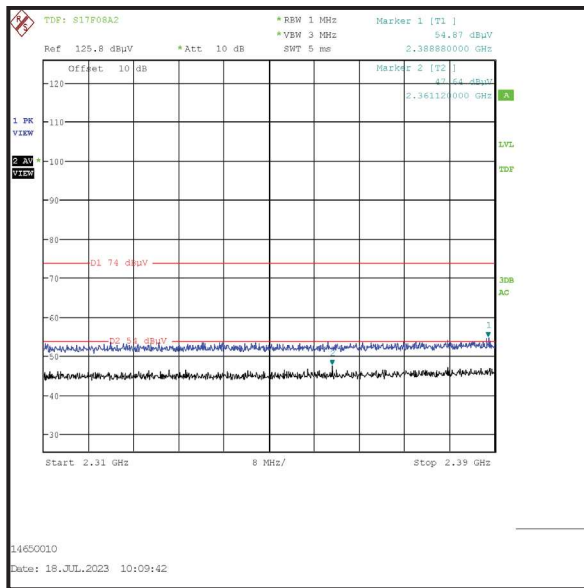

2310 MHz to 2390 MHz Restricted Band

**Transmitter Band Edge Radiated Emissions (continued)****Results: Static Mode / 3DH5 / SISO / Core 1**

Frequency (MHz)	Antenna Polarity	Peak Level (dB $\mu$ V/m)	Limit (dB $\mu$ V/m)	Margin (dB)	Result
2399.840	Vertical	54.3	94.3*	40.0	Complied
2400.0	Vertical	53.8	94.3*	40.5	Complied
2483.5	Vertical	59.8	74.0	14.2	Complied

Frequency (MHz)	Antenna Polarity	Average Level (dB $\mu$ V/m)	Limit (dB $\mu$ V/m)	Margin (dB)	Result
2483.5	Vertical	40.8**	54.0	13.2	Complied

**Results: 2310 MHz to 2390 MHz Restricted Band / Peak**

Frequency (MHz)	Antenna Polarity	Level (dB $\mu$ V/m)	Limit (dB $\mu$ V/m)	Margin (dB)	Result
2387.179	Vertical	55.6	74.0	18.4	Complied

**Results: 2310 MHz to 2390 MHz Restricted Band / Average**

Frequency (MHz)	Antenna Polarity	Level (dB $\mu$ V/m)	Limit (dB $\mu$ V/m)	Margin (dB)	Result
2387.949	Vertical	49.9	54.0	4.1	Complied

### Transmitter Band Edge Radiated Emissions (continued)

#### Results: Static Mode / 3DH5 / SISO / Core 1

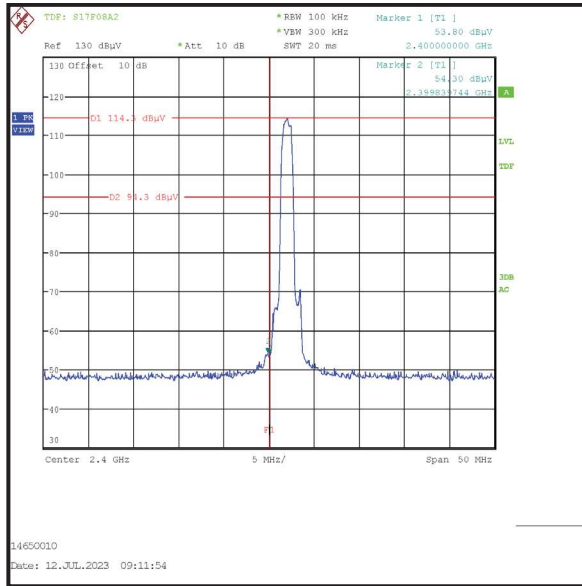

Lower Band Edge

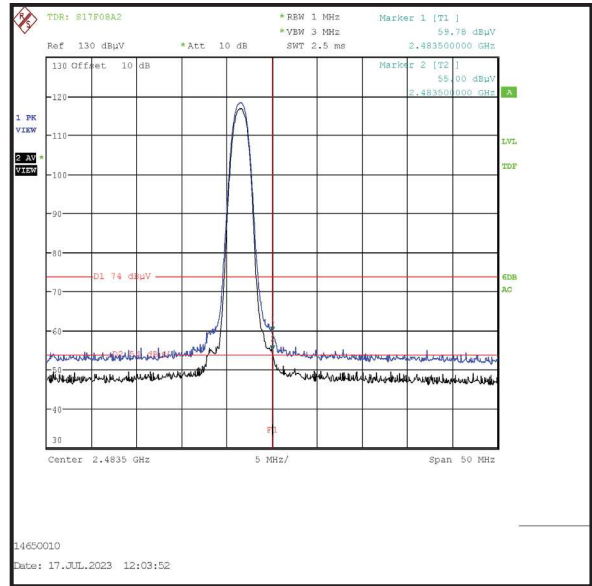

Upper Band Edge

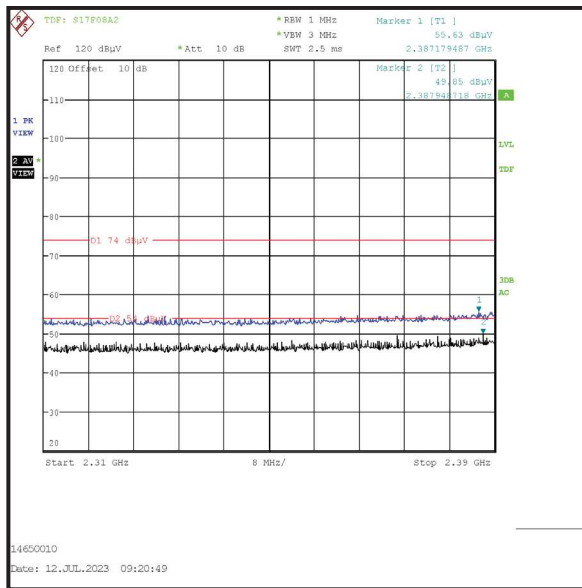

2310 MHz to 2390 MHz Restricted Band

**Transmitter Band Edge Radiated Emissions (continued)****Results: Hopping Mode / 3DH5 / SISO / Core 1**

Frequency (MHz)	Antenna Polarity	Peak Level (dB $\mu$ V/m)	Limit (dB $\mu$ V/m)	Margin (dB)	Result
2399.750	Vertical	51.5	95.3*	43.8	Complied
2400.0	Vertical	50.9	95.3*	44.4	Complied
2483.5	Vertical	59.7	74.0	14.3	Complied

Frequency (MHz)	Antenna Polarity	Average Level (dB $\mu$ V/m)	Limit (dB $\mu$ V/m)	Margin (dB)	Result
2483.5	Vertical	40.7**	54.0	13.3	Complied

**Results: 2310 MHz to 2390 MHz Restricted Band / Peak**

Frequency (MHz)	Antenna Polarity	Level (dB $\mu$ V/m)	Limit (dB $\mu$ V/m)	Margin (dB)	Result
2372.400	Vertical	54.7	74.0	19.3	Complied

**Results: 2310 MHz to 2390 MHz Restricted Band / Average**

Frequency (MHz)	Antenna Polarity	Level (dB $\mu$ V/m)	Limit (dB $\mu$ V/m)	Margin (dB)	Result
2387.760	Vertical	47.5	54.0	6.5	Complied

### Transmitter Band Edge Radiated Emissions (continued)

#### Results: Hopping Mode / 3DH5 / SISO / Core 1

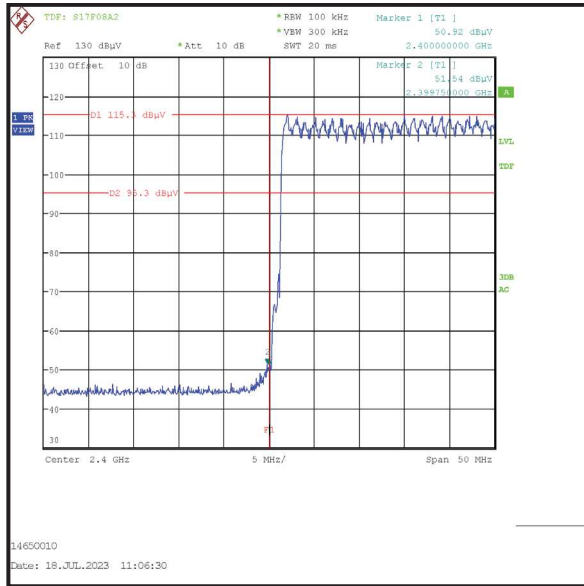

Lower Band Edge

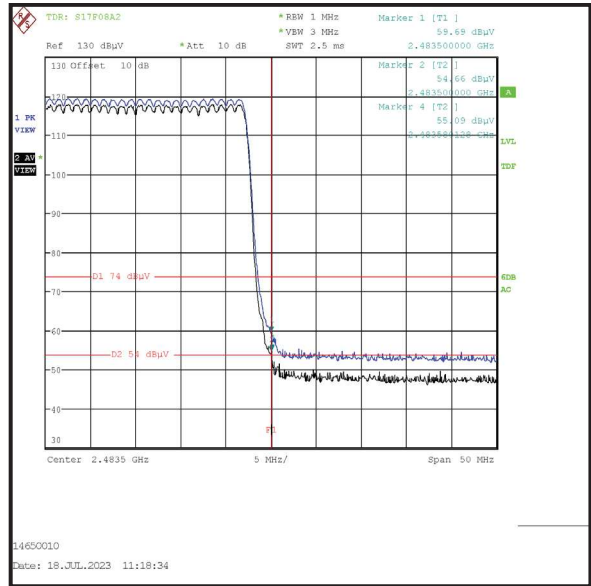

Upper Band Edge

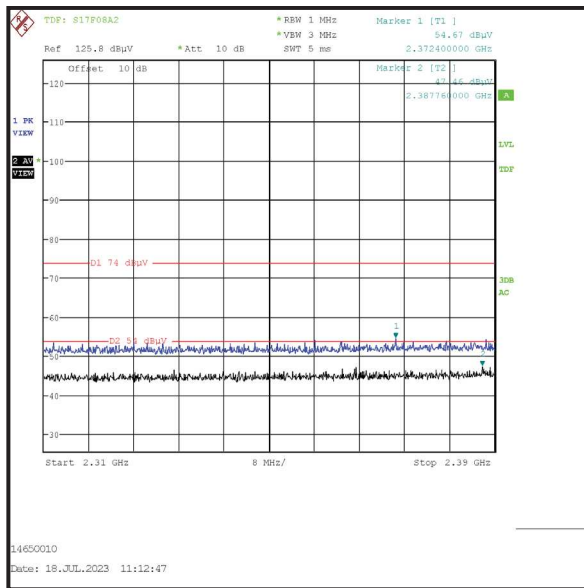

2310 MHz to 2399 MHz Restricted Band

**Transmitter Band Edge Radiated Emissions (continued)****Results: Static Mode / DH5 / Beamforming / Core 0 + Core 1**

Frequency (MHz)	Antenna Polarity	Peak Level (dB $\mu$ V/m)	Limit (dB $\mu$ V/m)	Margin (dB)	Result
2399.900	Vertical	53.0	100.3*	47.3	Complied
2400.0	Vertical	52.2	100.3*	48.1	Complied
2483.5	Vertical	59.9	74.0	14.1	Complied
2483.850	Vertical	60.7	74.0	13.3	Complied

Frequency (MHz)	Antenna Polarity	Average Level (dB $\mu$ V/m)	Limit (dB $\mu$ V/m)	Margin (dB)	Result
2483.5	Vertical	40.9**	54.0	13.1	Complied

**Results: 2310 MHz to 2390 MHz Restricted Band / Peak**

Frequency (MHz)	Antenna Polarity	Level (dB $\mu$ V/m)	Limit (dB $\mu$ V/m)	Margin (dB)	Result
2386.400	Vertical	56.9	74.0	17.1	Complied

**Results: 2310 MHz to 2390 MHz Restricted Band / Average**

Frequency (MHz)	Antenna Polarity	Level (dB $\mu$ V/m)	Limit (dB $\mu$ V/m)	Margin (dB)	Result
2384.000	Vertical	49.7	54.0	4.3	Complied

### Transmitter Band Edge Radiated Emissions (continued)

### Results: Static Mode / DH5 / Beamforming / Core 0 + Core 1

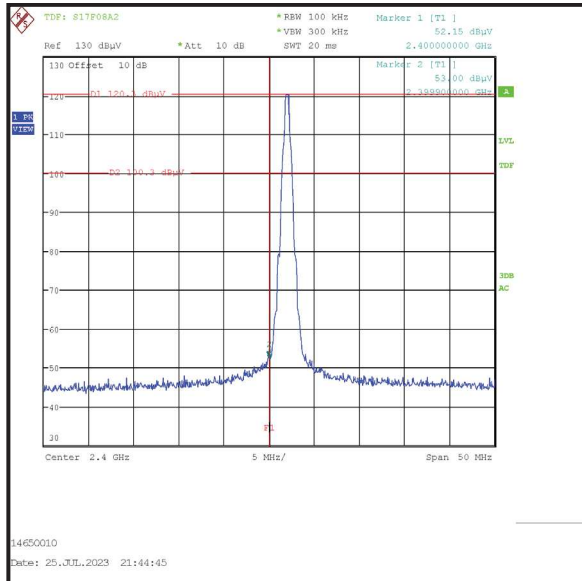

Lower Band Edge

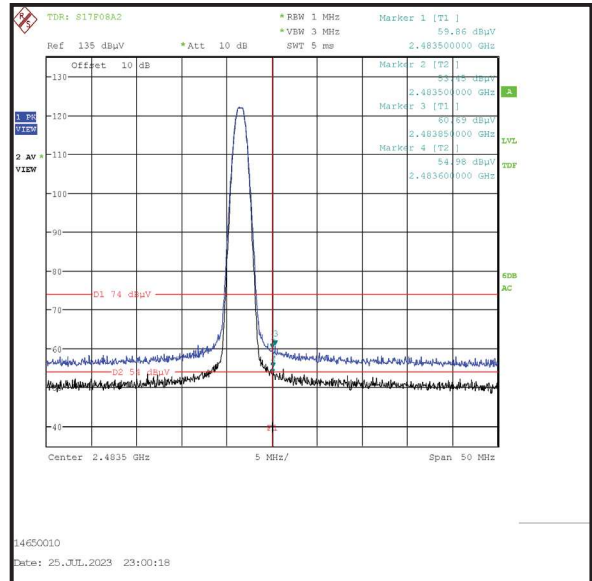

Upper Band Edge

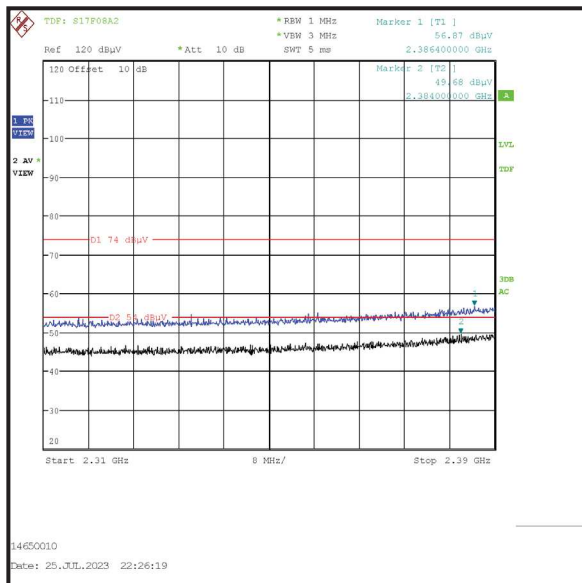

2310 MHz to 2390 MHz Restricted Band



**Transmitter Band Edge Radiated Emissions (continued)****Results: Hopping Mode / DH5 / Beamforming / Core 0 + Core 1**

Frequency (MHz)	Antenna Polarity	Peak Level (dB $\mu$ V/m)	Limit (dB $\mu$ V/m)	Margin (dB)	Result
2399.950	Vertical	53.8	102.8*	49.0	Complied
2400.0	Vertical	52.4	102.8*	50.4	Complied
2483.5	Vertical	59.7	74.0	14.3	Complied
2485.600	Vertical	63.2	74.0	10.8	Complied

Frequency (MHz)	Antenna Polarity	Average Level (dB $\mu$ V/m)	Limit (dB $\mu$ V/m)	Margin (dB)	Result
2483.5	Vertical	40.7**	54.0	13.3	Complied

**Results: 2310 MHz to 2390 MHz Restricted Band / Peak**

Frequency (MHz)	Antenna Polarity	Level (dB $\mu$ V/m)	Limit (dB $\mu$ V/m)	Margin (dB)	Result
2388.080	Vertical	58.4	74.0	15.6	Complied

**Results: 2310 MHz to 2390 MHz Restricted Band / Average**

Frequency (MHz)	Antenna Polarity	Level (dB $\mu$ V/m)	Limit (dB $\mu$ V/m)	Margin (dB)	Result
2388.800	Vertical	50.2	54.0	3.8	Complied

### Transmitter Band Edge Radiated Emissions (continued)

### Results: Hopping Mode / DH5 / Beamforming / Core 0 + Core 1

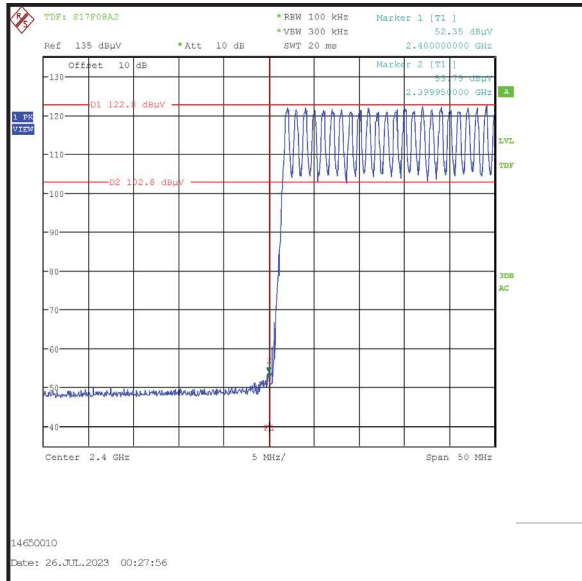

Lower Band Edge

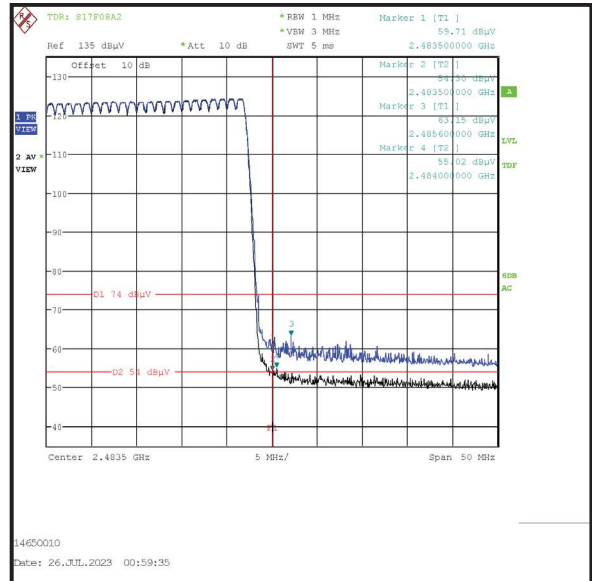

Upper Band Edge

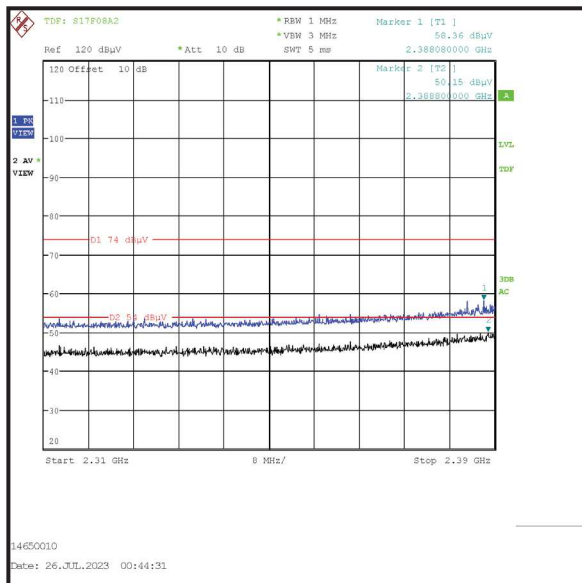

2310 MHz to 2390 MHz Restricted Band

**Transmitter Band Edge Radiated Emissions (continued)****Results: Static Mode / 2DH5 / Beamforming / Core 0 + Core 1**

Frequency (MHz)	Antenna Polarity	Peak Level (dB $\mu$ V/m)	Limit (dB $\mu$ V/m)	Margin (dB)	Result
2400.0	Vertical	56.6	99.8*	43.2	Complied
2483.5	Vertical	61.0	74.0	13.0	Complied
2483.580	Vertical	62.2	74.0	11.8	Complied

Frequency (MHz)	Antenna Polarity	Average Level (dB $\mu$ V/m)	Limit (dB $\mu$ V/m)	Margin (dB)	Result
2483.5	Vertical	42.0**	54.0	12.0	Complied

**Results: 2310 MHz to 2390 MHz Restricted Band / Peak**

Frequency (MHz)	Antenna Polarity	Level (dB $\mu$ V/m)	Limit (dB $\mu$ V/m)	Margin (dB)	Result
2389.487	Vertical	56.8	74.0	17.2	Complied

**Results: 2310 MHz to 2390 MHz Restricted Band / Average**

Frequency (MHz)	Antenna Polarity	Level (dB $\mu$ V/m)	Limit (dB $\mu$ V/m)	Margin (dB)	Result
2387.949	Vertical	50.2	54.0	3.8	Complied

**Transmitter Band Edge Radiated Emissions (continued)**

**Results: Static Mode / 2DH5 / Beamforming / Core 0 + Core 1**

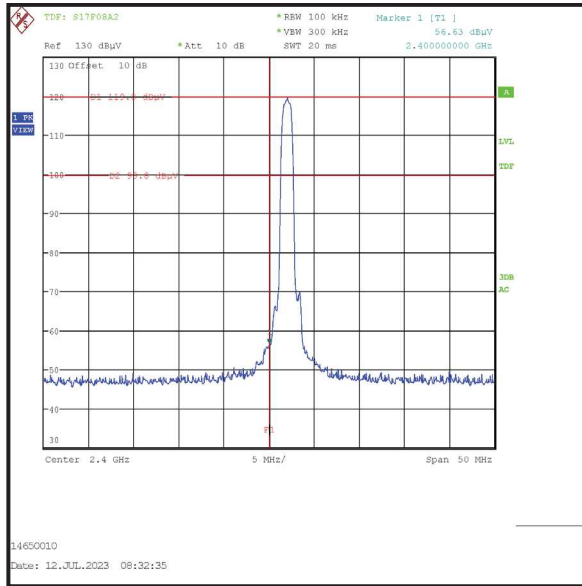

**Lower Band Edge**

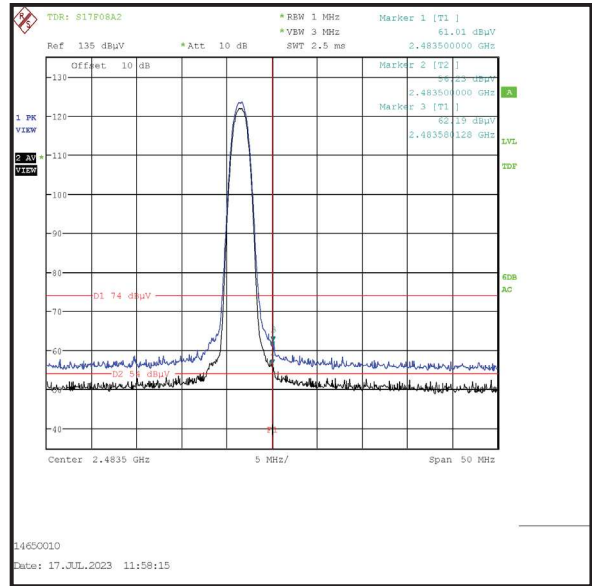

**Upper Band Edge**

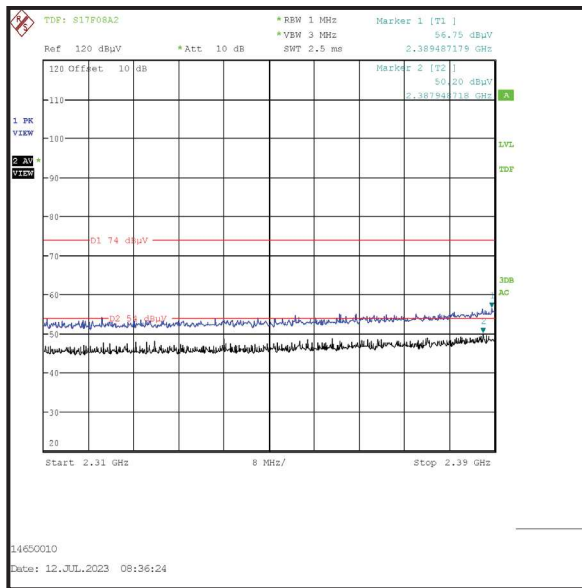

**2310 MHz to 2390 MHz Restricted Band**

**Transmitter Band Edge Radiated Emissions (continued)****Results: Hopping Mode / 2DH5 / Beamforming / Core 0 + Core 1**

Frequency (MHz)	Antenna Polarity	Peak Level (dB $\mu$ V/m)	Limit (dB $\mu$ V/m)	Margin (dB)	Result
2399.450	Vertical	58.3	101.1*	42.8	Complied
2400.0	Vertical	56.8	101.1*	44.3	Complied
2483.5	Vertical	61.6	74.0	12.4	Complied

Frequency (MHz)	Antenna Polarity	Average Level (dB $\mu$ V/m)	Limit (dB $\mu$ V/m)	Margin (dB)	Result
2483.5	Vertical	42.6**	54.0	11.4	Complied

**Results: 2310 MHz to 2390 MHz Restricted Band / Peak**

Frequency (MHz)	Antenna Polarity	Level (dB $\mu$ V/m)	Limit (dB $\mu$ V/m)	Margin (dB)	Result
2386.000	Vertical	55.8	74.0	18.2	Complied

**Results: 2310 MHz to 2390 MHz Restricted Band / Average**

Frequency (MHz)	Antenna Polarity	Level (dB $\mu$ V/m)	Limit (dB $\mu$ V/m)	Margin (dB)	Result
2387.840	Vertical	48.7	54.0	5.3	Complied

### Transmitter Band Edge Radiated Emissions (continued)

### Results: Hopping Mode / 2DH5 / Beamforming / Core 0 + Core 1



Lower Band Edge

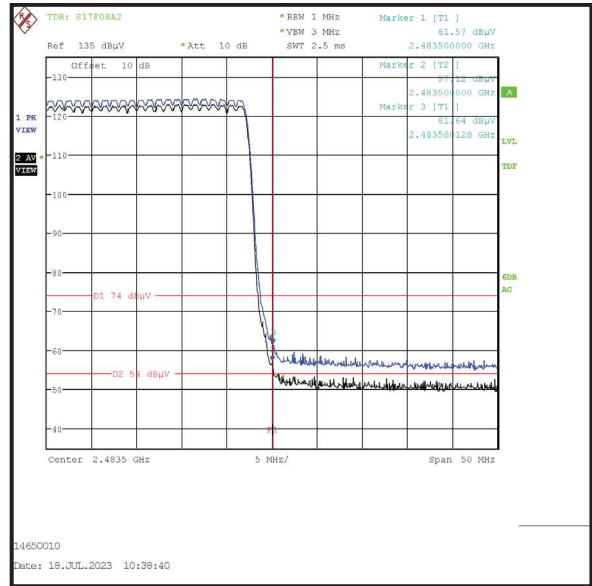

Upper Band Edge

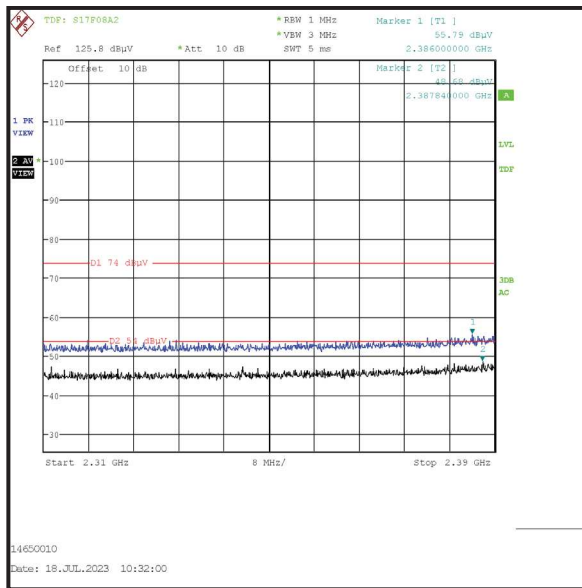

2310 MHz to 2390 MHz Restricted Band

**Transmitter Band Edge Radiated Emissions (continued)****Results: Static Mode / 3DH5 / Beamforming / Core 0 + Core 1**

Frequency (MHz)	Antenna Polarity	Peak Level (dB $\mu$ V/m)	Limit (dB $\mu$ V/m)	Margin (dB)	Result
2399.920	Vertical	57.9	99.9*	42.0	Complied
2400.0	Vertical	57.8	99.9*	42.1	Complied
2483.5	Vertical	63.3	74.0	10.7	Complied

Frequency (MHz)	Antenna Polarity	Average Level (dB $\mu$ V/m)	Limit (dB $\mu$ V/m)	Margin (dB)	Result
2483.5	Vertical	44.3**	54.0	9.7	Complied

**Results: 2310 MHz to 2390 MHz Restricted Band / Peak**

Frequency (MHz)	Antenna Polarity	Level (dB $\mu$ V/m)	Limit (dB $\mu$ V/m)	Margin (dB)	Result
2387.051	Vertical	57.4	74.0	16.6	Complied

**Results: 2310 MHz to 2390 MHz Restricted Band / Average**

Frequency (MHz)	Antenna Polarity	Level (dB $\mu$ V/m)	Limit (dB $\mu$ V/m)	Margin (dB)	Result
2387.949	Vertical	51.2	54.0	2.8	Complied

**Transmitter Band Edge Radiated Emissions (continued)**

**Results: Static Mode / 3DH5 / Beamforming / Core 0 + Core 1**

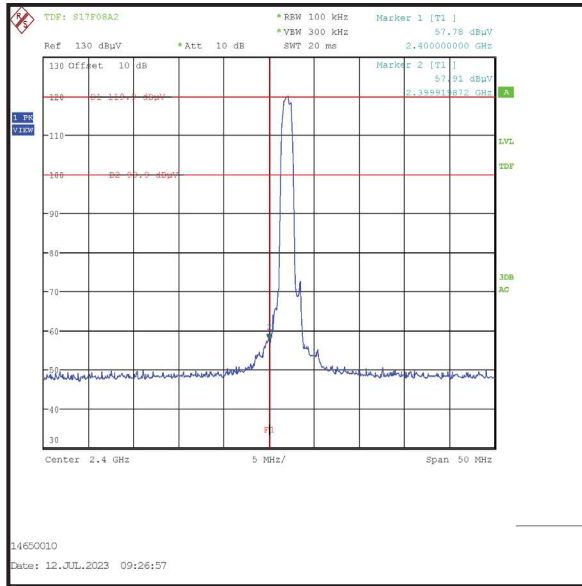

**Lower Band Edge**

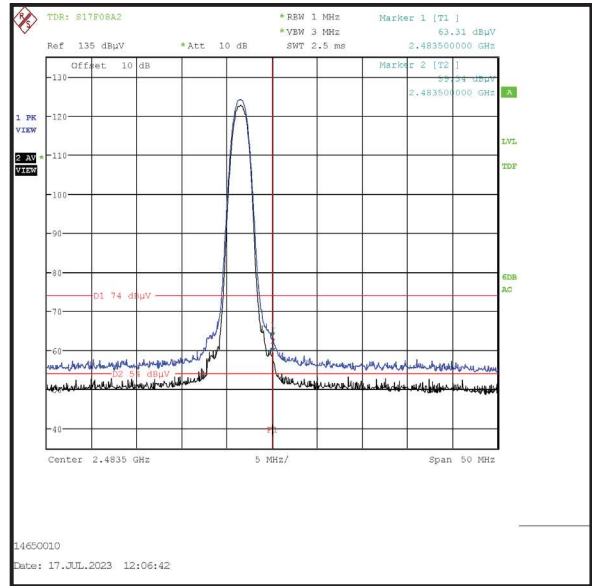

**Upper Band Edge**

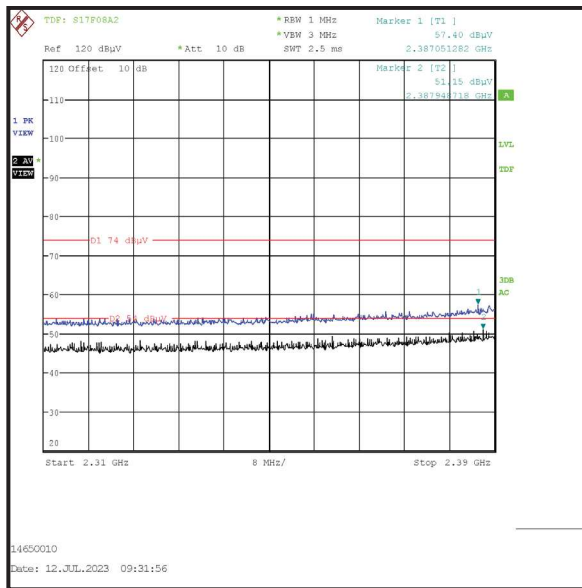

**2310 MHz to 2390 MHz Restricted Band**



**Transmitter Band Edge Radiated Emissions (continued)****Results: Hopping Mode / 3DH5 / Beamforming / Core 0 + Core 1**

Frequency (MHz)	Antenna Polarity	Peak Level (dB $\mu$ V/m)	Limit (dB $\mu$ V/m)	Margin (dB)	Result
2399.500	Vertical	62.7	101.5*	38.8	Complied
2400.0	Vertical	59.1	101.5*	42.4	Complied
2483.5	Vertical	62.9	74.0	11.1	Complied

Frequency (MHz)	Antenna Polarity	Average Level (dB $\mu$ V/m)	Limit (dB $\mu$ V/m)	Margin (dB)	Result
2483.5	Vertical	43.9**	54.0	10.1	Complied

**Results: 2310 MHz to 2390 MHz Restricted Band / Peak**

Frequency (MHz)	Antenna Polarity	Level (dB $\mu$ V/m)	Limit (dB $\mu$ V/m)	Margin (dB)	Result
2388.240	Vertical	56.0	74.0	18.0	Complied

**Results: 2310 MHz to 2390 MHz Restricted Band / Average**

Frequency (MHz)	Antenna Polarity	Level (dB $\mu$ V/m)	Limit (dB $\mu$ V/m)	Margin (dB)	Result
2388.880	Vertical	49.0	54.0	5.0	Complied

### Transmitter Band Edge Radiated Emissions (continued)

### Results: Hopping Mode / 3DH5 / Beamforming / Core 0 + Core 1

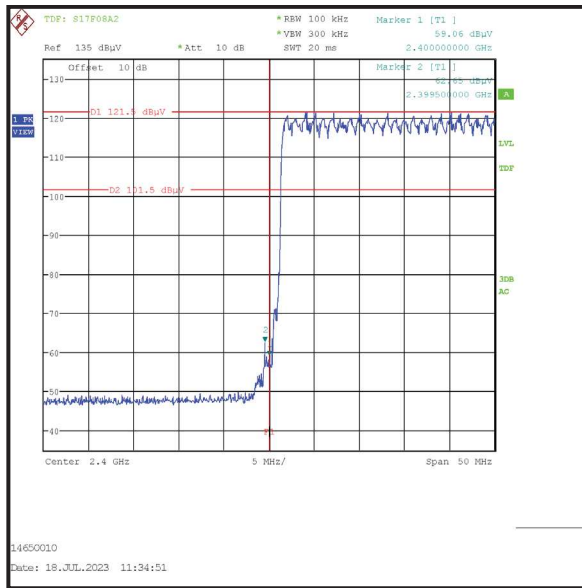

Lower Band Edge

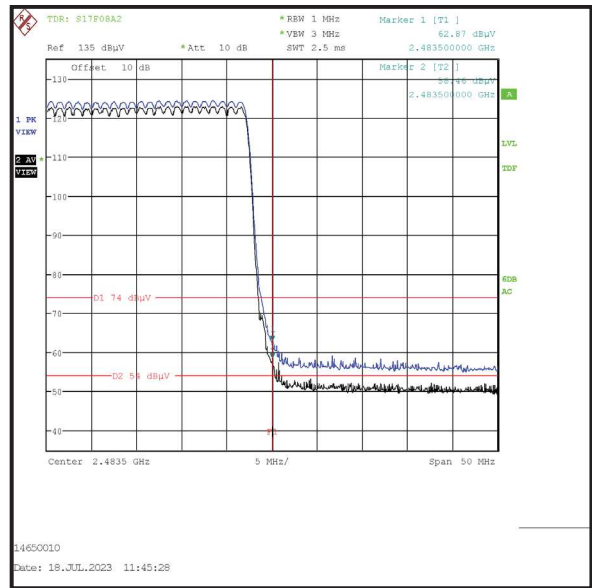

Upper Band Edge

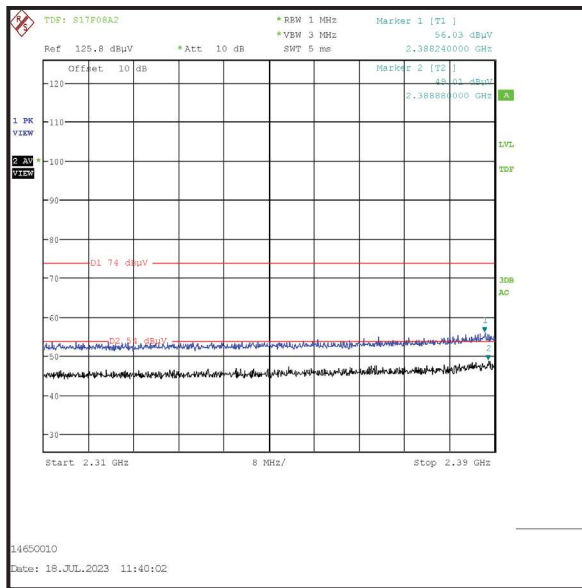

2310 MHz to 2390 MHz Restricted Band

## **Appendix 1**

### **FHSS Duty Cycle Correction Factor Calculation**

In accordance with KDB 558074 section 9 and ANSI C63.10 section 7.5, a duty cycle correction factor may be applied to calculate the average radiated field strength emission levels for an FHSS device.

The following values were taken from the *Bluetooth* Core Specification V5.0 to give the worst case correction:

Modulation	DH5, 2DH5 and 3DH5
Channel Hopping Rate (Hops/s)	1600
Tx Timeslots	5
Rx Timeslots	1
Adjusted Hopping Rate for Adaptive Frequency Hopping (Hops/s)	266.667
Time per Hop (ms)	3.75
Minimum Number of Channels	20
Time per Hop Sequence (ms)	75
Maximum Number of Hops on One Channel in any 100 ms Observation Period	3
Maximum Dwell Time on One Channel in any 100 ms Observation Period (ms)	11.25
Calculated Duty cycle correction factor applied (dB)	19.0
Maximum Duty cycle correction factor applied (dB)	19.0

The duty cycle correction factor was calculated based on the above values:

$$DH5, 2DH5 \text{ and } 3DH5: 20 * \text{Log}(11.25 \text{ ms} / 100 \text{ ms}) = 19.0 \text{ dB}$$

**--- END OF REPORT ---**