



# FCC RF Test Report

**APPLICANT** : TCL Communication Ltd.  
**EQUIPMENT** : Tablet PC  
**BRAND NAME** : alcatel  
**MODEL NAME** : 9015B  
**MARKETING NAME** : Alcatel POP™ 7 LTE  
**FCC ID** : 2ACCJB066  
**STANDARD** : FCC Part 15 Subpart C §15.247  
**CLASSIFICATION** : (DTS) Digital Transmission System

The product was received on Jul. 05, 2016 and testing was completed on Jul. 29, 2016. We, SPORTON INTERNATIONAL (SHENZHEN) INC., would like to declare that the tested sample has been evaluated in accordance with the test procedures and has been in compliance with the applicable technical standards.

The test results in this report apply exclusively to the tested model / sample. Without written approval of SPORTON INTERNATIONAL (SHENZHEN) INC., the test report shall not be reproduced except in full.

Prepared by: Ken Chen / Manager

Approved by: Jones Tsai / Manager



**SPORTON INTERNATIONAL (SHENZHEN) INC.**  
**1F & 2F, Building A, Morning Business Center, No. 4003 ShiGu Rd., Xili Town,**  
**Nanshan District, Shenzhen, Guangdong, P. R. China**



# TABLE OF CONTENTS

**SUMMARY OF TEST RESULT ..... 4**

**1 GENERAL DESCRIPTION..... 5**

1.1. Applicant ..... 5

1.2. Manufacturer..... 5

1.3. Product Feature of Equipment Under Test..... 5

1.4. Product Specification of Equipment Under Test..... 6

1.5. Specification of Accessory..... 6

1.6. Modification of EUT ..... 7

1.7. Testing Location ..... 7

1.8. Applicable Standards..... 8

**2 TEST CONFIGURATION OF EQUIPMENT UNDER TEST..... 9**

2.1. Descriptions of Test Mode ..... 9

2.2. Test Mode..... 10

2.3. Connection Diagram of Test System..... 11

2.4. Support Unit used in test configuration and system ..... 12

2.5. EUT Operation Test Setup ..... 12

2.6. Measurement Results Explanation Example..... 13

**3 TEST RESULT ..... 14**

3.1. 6dB and 99% Bandwidth Measurement ..... 14

3.2. Peak Output Power Measurement ..... 19

3.3. Power Spectral Density Measurement ..... 20

3.4. Conducted Band Edges and Spurious Emission Measurement ..... 25

3.5. Radiated Band Edges and Spurious Emission Measurement ..... 30

3.6. AC Conducted Emission Measurement..... 34

3.7. Antenna Requirements ..... 38

**4 LIST OF MEASURING EQUIPMENT..... 39**

**5 UNCERTAINTY OF EVALUATION..... 40**

**APPENDIX A. CONDUCTED TEST RESULTS**

**APPENDIX B. RADIATED TEST RESULTS**

**APPENDIX C. DUTY CYCLE PLOTS**

**APPENDIX D. SETUP PHOTOGRAPHS**



### REVISION HISTORY

REPORT NO.	VERSION	DESCRIPTION	ISSUED DATE
FR670507B	Rev. 01	Initial issue of report	Aug. 16, 2016



### SUMMARY OF TEST RESULT

Report Section	FCC Rule	IC Rule	Description	Limit	Result	Remark
3.1	15.247(a)(2)	RSS-247 5.2(1)	6dB Bandwidth	$\geq 0.5\text{MHz}$	Pass	-
3.1	-	RSS-Gen 6.6	99% Bandwidth	-	Pass	-
3.2	15.247(b)(1)	RSS-247 A5.4(4)	Peak Output Power	$\leq 30\text{dBm}$	Pass	-
3.3	15.247(e)	RSS-247 5.2(2)	Power Spectral Density	$\leq 8\text{dBm}/3\text{kHz}$	Pass	-
3.4	15.247(d)	RSS-247 5.5	Conducted Band Edges and Spurious Emission	$\leq 20\text{dBc}$	Pass	-
3.5	15.247(d)	RSS-247 5.5	Radiated Band Edges and Spurious Emission	15.209(a) & 15.247(d)	Pass	Under limit 4.7 dB at 42.610 MHz
3.6	15.207	RSS-GEN 8.8	AC Conducted Emission	15.207(a)	Pass	Under limit 11.77 dB at 0.160 MHz
3.7	15.203 & 15.247(b)	N/A	Antenna Requirement	N/A	Pass	-



# 1 General Description

## 1.1. Applicant

**TCL Communication Ltd.**

5F, C-Tower, No. 232, Liang Jing Road, ZhangJiang High-Tech Park, Pudong Area, Shanghai, 201203, P. R. China

## 1.2. Manufacturer

**TCL Communication Ltd.**

5F, C-Tower, No. 232, Liang Jing Road, ZhangJiang High-Tech Park, Pudong Area, Shanghai, 201203, P. R. China

## 1.3. Product Feature of Equipment Under Test

Product Feature	
Equipment	Tablet PC
Brand Name	alcatel
Model Name	9015B
Marketing Name	Alcatel POP™ 7 LTE
FCC ID	2ACCJB066
EUT supports Radios application	GPRS/EDGE/WCDMA/HSPA/DC-HSDPA/ HSPA+(16QAM uplink is not supported)/LTE WLAN 2.4GHz 802.11b/g/n HT20 WLAN 5.0GHz 802.11a/n HT20/HT40 Bluetooth v3.0 + EDR/Bluetooth v4.1 LE
IMEI Code	Conducted: 014732000100067 Radiation: 014732000100075 Conduction: 014732000100026
HW Version	Pixi4-7 4G TMO_MAIN_V03
SW Version	5RA2
EUT Stage	Production Unit

**Remark:** The above EUT's information was declared by manufacturer. Please refer to the specifications or user's manual for more detailed description.



## 1.4. Product Specification of Equipment Under Test

Standards-related Product Specification	
Tx/Rx Frequency Range	2402 MHz ~ 2480 MHz
Number of Channels	40
Carrier Frequency of Each Channel	40 Channel(37 hopping + 3 advertising channel)
Maximum Output Power to Antenna	2.140 dBm (0.0016 W)
99% Occupied Bandwidth	1.060MHz
Antenna Type/gain	PTFA Antenna with gain -3 dBi
Type of Modulation	Bluetooth LE : GFSK

## 1.5. Specification of Accessory

Specification of Accessory				
AC Adapter	Brand Name	ALCATEL onetouch	Model Name	UC13US
	Power Rating	I/P: 100-240Vac, 400mA, O/P: 5.0Vdc, 2A		
	P/N	CBA0059AG0C2		
Battery	Brand Name	ALCATEL onetouch	Model Name	TLp032B2
	Power Rating	3.7Vdc, 3240mAh		
USB Cable	Brand Name	N/A	Model Name	N/A
	Signal Line Type	0.8m shielded without core		
	P/N	N/A		



### 1.6. Modification of EUT

No modifications are made to the EUT during all test items.

### 1.7. Testing Location

<b>Test Site</b>	SPORTON INTERNATIONAL (SHENZHEN) INC.	
<b>Test Site Location</b>	1F & 2F, Building A, Morning Business Center, No. 4003 ShiGu Rd., Xili Town, Nanshan District, Shenzhen, Guangdong, P. R. China TEL: +86-755-8637-9589 FAX: +86-755-8637-9595	
<b>Test Site No.</b>	<b>Sporton Site No.</b>	
	TH01-SZ	CO01-SZ

<b>Test Site</b>	SPORTON INTERNATIONAL (SHENZHEN) INC.	
<b>Test Site Location</b>	No. 3 Building, the third floor of south, Shahe River west, Fengzeyuan warehouse, Nanshan District, Shenzhen, Guangdong, P. R. China TEL: +86-755- 3320-2398	
<b>Test Site No.</b>	<b>Sporton Site No.</b>	<b>FCC/IC Registration No.</b>
	03CH03-SZ	565805/4086F

**Note:** The test site complies with ANSI C63.4 2014 requirement.



## **1.8. Applicable Standards**

According to the specifications of the manufacturer, the EUT must comply with the requirements of the following standards:

- ♦ FCC Part 15 Subpart C §15.247
- ♦ FCC KDB Publication No. 558074 D01 DTS Meas. Guidance v03r05
- ♦ ANSI C63.10-2013
- ♦ IC RSS-247 Issue 1
- ♦ IC RSS-Gen Issue 4

**Remark:**

1. All test items were verified and recorded according to the standards and without any deviation during the test.
2. This EUT has also been tested and complied with the requirements of FCC Part 15, Subpart B, recorded in a separate test report.





## 2 Test Configuration of Equipment Under Test

### 2.1. Descriptions of Test Mode

The RF output power was recorded in the following table:

Channel	Frequency	Bluetooth 4.0 LE RF Output Power	
		Data Rate / Modulation	
		GFSK	
		1Mbps	
Ch00	2402MHz	2.14 dBm	
Ch19	2440MHz	1.89 dBm	
Ch39	2480MHz	1.38 dBm	

- a. The EUT has been associated with peripherals and configuration operated in a manner tended to maximize its emission characteristics in a typical application. Frequency range investigated: conduction (150 kHz to 30 MHz), radiation (9 kHz to the 10th harmonic of the highest fundamental frequency or to 40 GHz, whichever is lower). Pre-scanned tests, X, Y, Z in three orthogonal panels to determine the final configuration (X plane as worst plane) from all possible combinations.
- b. AC power line Conducted Emission was tested under maximum output power.



## 2.2. Test Mode

The following summary table is showing all test modes to demonstrate in compliance with the standard.

Summary table of Test Cases	
Test Item	Data Rate / Modulation
	Bluetooth 4.0 – LE / GFSK
Conducted TCs	Mode 1: Bluetooth Tx CH00_2402 MHz_1Mbps Mode 2: Bluetooth Tx CH19_2440 MHz_1Mbps Mode 3: Bluetooth Tx CH39_2480 MHz_1Mbps
Radiated TCs	Mode 1: Bluetooth Tx CH00_2402 MHz_1Mbps Mode 2: Bluetooth Tx CH19_2440 MHz_1Mbps Mode 3: Bluetooth Tx CH39_2480 MHz_1Mbps
AC Conducted Emission	Mode 1: GPRS850 Idle + Bluetooth Link + WLAN(2.4G) Link + Earphone + Battery + USB Cable (Charging from Adapter)
<b>Remark:</b> 1. The worst case of conducted emission is mode 1; only the test data of it was reported. 2. For Radiated TCs, The tests were performance with Adapter, Earphone, and USB Cable.	

## 2.3. Connection Diagram of Test System

<Bluetooth 4.0 LE Tx Mode>

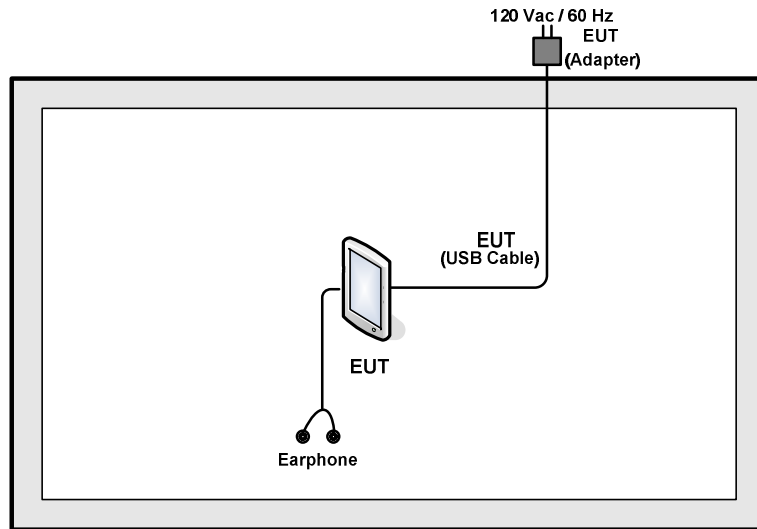

<AC Conducted Emission Mode>

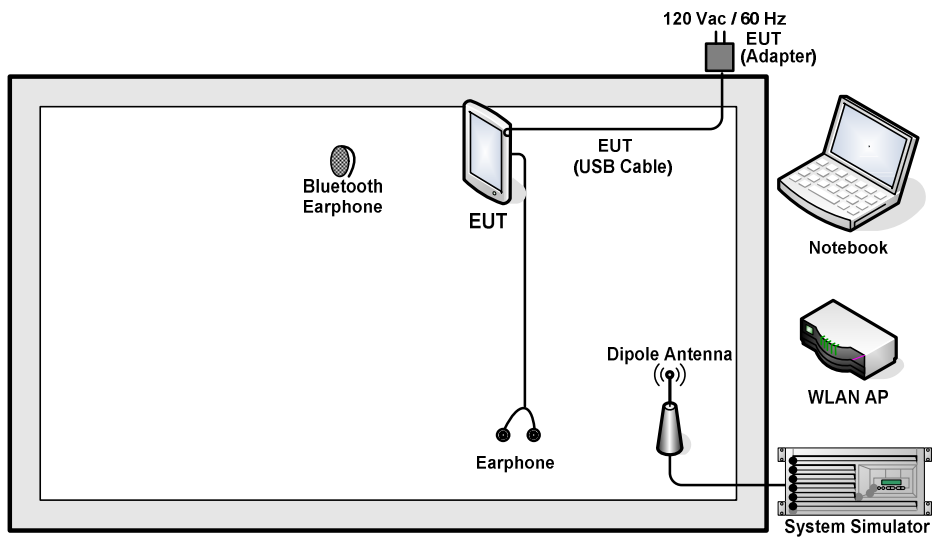



## 2.4. Support Unit used in test configuration and system

Item	Equipment	Trade Name	Model Name	FCC ID	Data Cable	Power Cord
1.	System Simulator	Anritsu	MT8820C	N/A	N/A	Unshielded, 1.8 m
2.	WLAPN AP	Dlink	DIR-820L	KA2IR820LA1	N/A	Unshielded, 1.8 m
3.	SD Card	SanDisk	4G Class 4	FCC DoC	N/A	N/A
4.	Bluetooth Earphone	Nokia	BH-108	PYAHS-107W	N/A	N/A
5.	iPod Earphone	Apple	MC690ZP/A	FCC DoC	Unshielded,1.6m	N/A
6.	Earphone	Apple	N/A	N/A	Unshielded,1.0m	N/A
7.	Notebook	Acer	ZG8	HLZUNDP-1Q	N/A	AC I/P: Unshielded, 1.8 m DC O/P: Shielded, 1.8 m

## 2.5. EUT Operation Test Setup

For Bluetooth v4.0 LE test items, an engineering test program was provided and enabled to make EUT transmitting and receiving signals.

For AC power line conducted emissions, the EUT was set to connect with the WLAN AP under large package sizes transmission.



## 2.6. Measurement Results Explanation Example

For all conducted test items:

The offset level is set in the spectrum analyzer to compensate the RF cable loss and attenuator factor between EUT conducted output port and spectrum analyzer. With the offset compensation, the spectrum analyzer reading level is exactly the EUT RF output level.

Example :

The spectrum analyzer offset is derived from RF cable loss and attenuator factor.

*Offset = RF cable loss + attenuator factor.*

Following shows an offset computation example with cable loss 5 dB and 10dB attenuator.

$$\begin{aligned} \text{Offset(dB)} &= \text{RF cable loss(dB)} + \text{attenuator factor(dB)}. \\ &= 5 + 10 = 15 \text{ (dB)} \end{aligned}$$

### 3 Test Result

#### 3.1. 6dB and 99% Bandwidth Measurement

##### 3.1.1 Limit of 6dB and 99% Bandwidth

The minimum 6 dB bandwidth shall be at least 500 kHz.

##### 3.1.2 Measuring Instruments

The section 4.0 of List of Measuring Equipment of this test report is used for test.

##### 3.1.3 Test Procedures

1. The testing follows FCC KDB Publication No. 558074 D01 DTS Meas. Guidance v03r05.
2. The RF output of EUT was connected to the spectrum analyzer by RF cable and attenuator. The path loss was compensated to the results for each measurement.
3. Set to the maximum power setting and enable the EUT transmit continuously.
4. Make the measurement with the spectrum analyzer's resolution bandwidth (RBW) = 100 kHz. Set the Video bandwidth (VBW) = 300 kHz. In order to make an accurate measurement. The 6 dB bandwidth must be greater than 500 kHz.
5. For 99% Bandwidth Measurement, the spectrum analyzer's resolution bandwidth (RBW) is set 30kHz and set the Video bandwidth (VBW) = 100kHz.
6. Measure and record the results in the test report.

##### 3.1.4 Test Setup

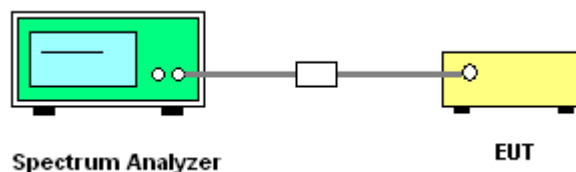



### 3.1.5 Test Result of 6dB Bandwidth

Test data refer to Appendix A.

6 dB Bandwidth Plot on Channel 00

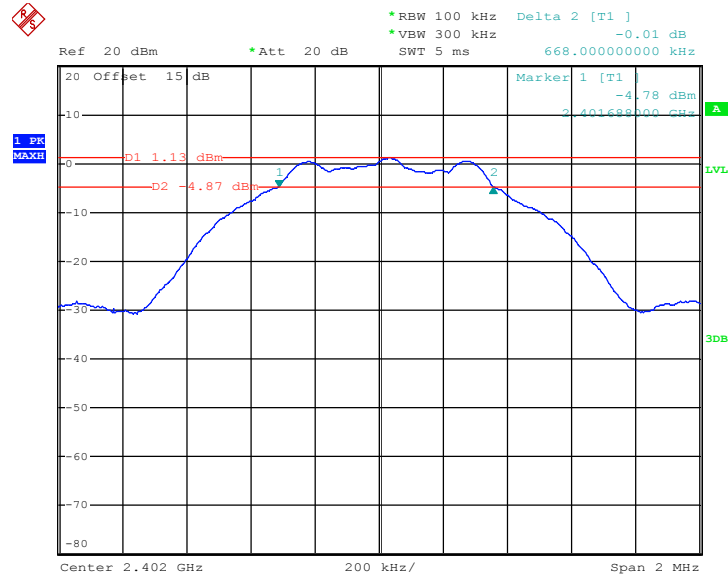

Date: 18.JUL.2016 15:26:55



6 dB Bandwidth Plot on Channel 19

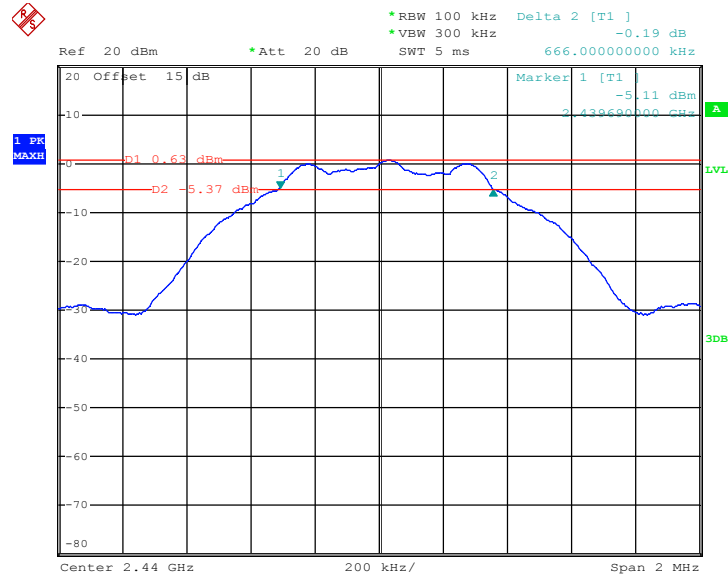

Date: 18.JUL.2016 15:33:33

6 dB Bandwidth Plot on Channel 39

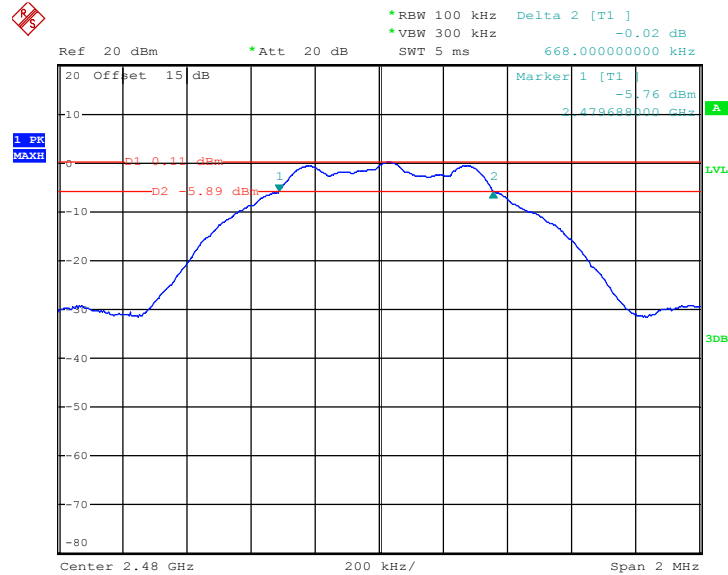

Date: 18.JUL.2016 15:38:22





### 3.1.6 Test Result of 99% Occupied Bandwidth

Test data refer to Appendix A.

#### 99% Bandwidth Plot on Channel 00

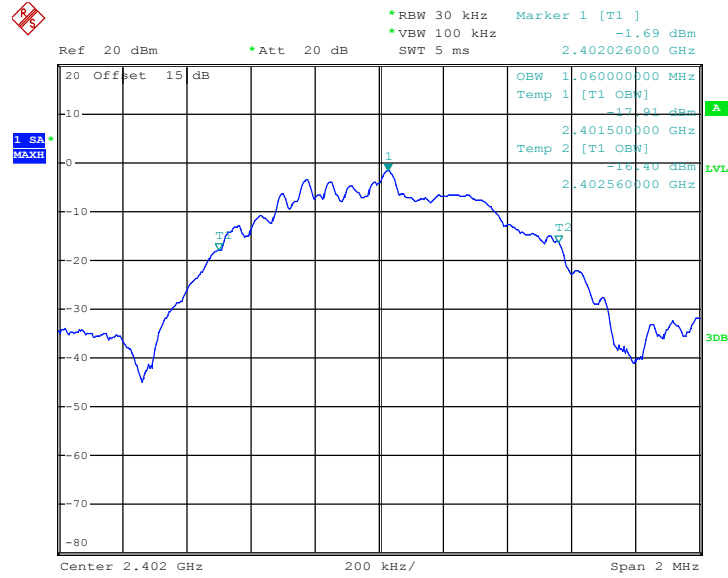

Date: 18.JUL.2016 15:31:24



99% Occupied Bandwidth Plot on Channel 19

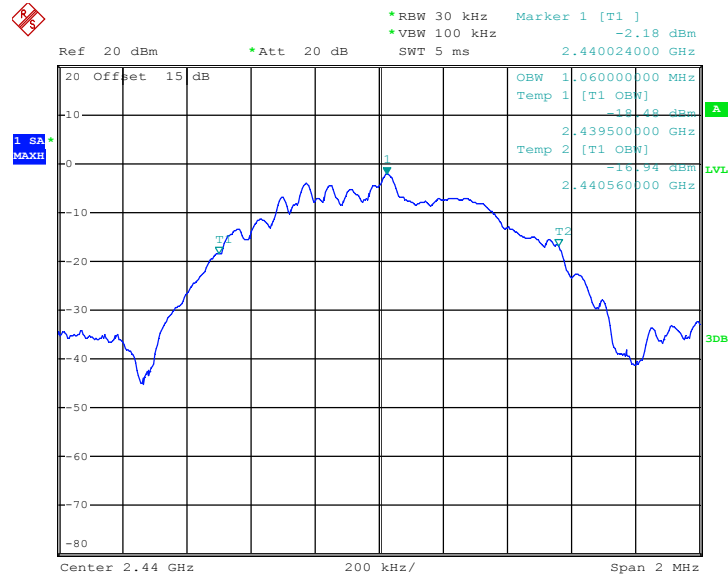

Date: 18.JUL.2016 15:36:19

99% Occupied Bandwidth Plot on Channel 39

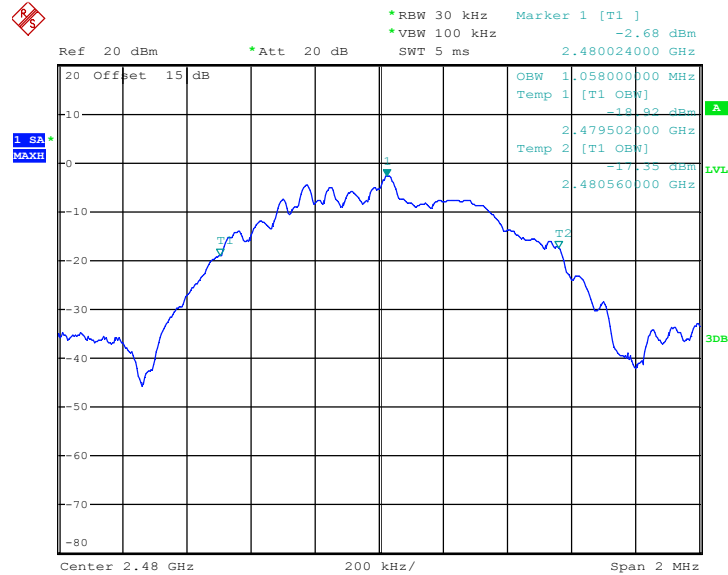

Date: 18.JUL.2016 15:41:48

Note : The occupied channel bandwidth is maintained within the band of operation for all of the modulations.

## 3.2. Peak Output Power Measurement

### 3.2.1 Limit of Peak Output Power

For systems using digital modulation in the 2400-2483.5MHz, the limit for peak output power is 30dBm. If transmitting antenna of directional gain greater than 6dBi is used, the peak output power from the intentional radiator shall be reduced below the above stated value by the amount in dB that the directional gain of the antenna exceeds 6 dBi. In case of point-to-point operation, the limit has to be reduced by 1dB for every 3dB that the directional gain of the antenna exceeds 6dBi.

### 3.2.2 Measuring Instruments

The section 4.0 of List of Measuring Equipment of this test report is used for test.

### 3.2.3 Test Procedures

1. The testing follows the Measurement Procedure of FCC KDB No. 558074 DTS D01 Meas. Guidance v03r05 section 9.1.2 PKPM1 Peak power meter method.
2. The RF output of EUT was connected to the power meter by RF cable and attenuator. The path loss was compensated to the results for each measurement.
3. Set to the maximum power setting and enable the EUT transmit continuously.
4. Measure the conducted output power and record the results in the test report.

### 3.2.4 Test Setup

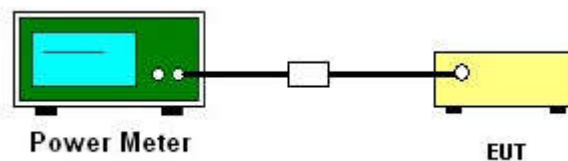

### 3.2.5 Test Result of Peak Output Power

Test data refers to Appendix A.



### 3.3. Power Spectral Density Measurement

#### 3.3.1 Limit of Power Spectral Density

The peak power spectral density shall not be greater than 8dBm in any 3kHz band at any time interval of continuous transmission.

#### 3.3.2 Measuring Instruments

The section 4.0 of List of Measuring Equipment of this test report is used for test.

#### 3.3.3 Test Procedures

1. The testing follows Measurement Procedure 10.2 Method PKPSD of FCC KDB Publication No. 558074 D01 DTS Meas. Guidance v03r05
2. The RF output of EUT was connected to the spectrum analyzer by RF cable and attenuator. The path loss was compensated to the results for each measurement.
3. Set to the maximum power setting and enable the EUT transmit continuously.
4. Make the measurement with the spectrum analyzer's resolution bandwidth (RBW) = 3 kHz. Video bandwidth VBW = 10 kHz In order to make an accurate measurement, set the span to 1.5 times DTS Channel Bandwidth. (6dB BW)
5. Detector = peak, Sweep time = auto couple, Trace mode = max hold, Allow trace to fully stabilize. Use the peak marker function to determine the maximum power level.
6. Measure and record the results in the test report.
7. The Measured power density (dBm)/ 100kHz is a reference level and used as 20dBc down limit line for Conducted Band Edges and Conducted Spurious Emission.

### 3.3.4 Test Setup

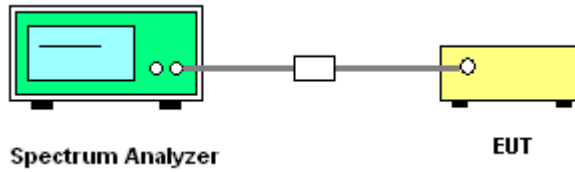

### 3.3.5 Test Result of Power Spectral Density Plots (100kHz)

Test data refers to Appendix A.

PSD 100kHz Plot on Channel 00

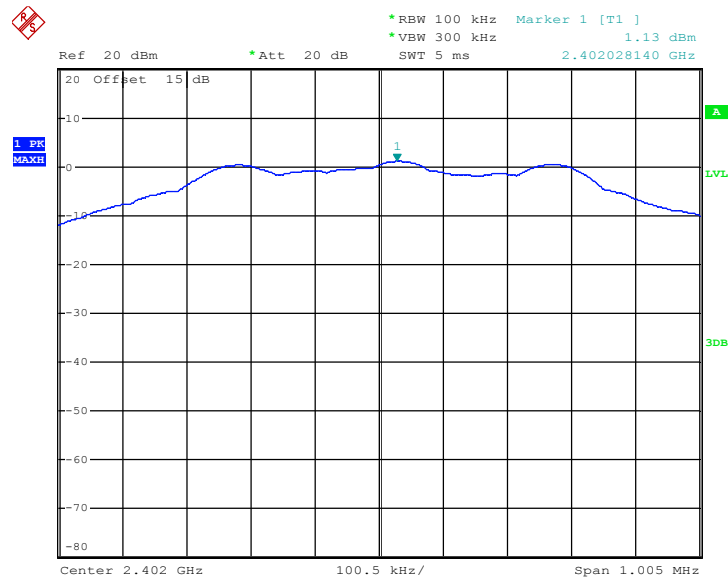

Date: 18.JUL.2016 15:28:38



PSD 100kHz Plot on Channel 19

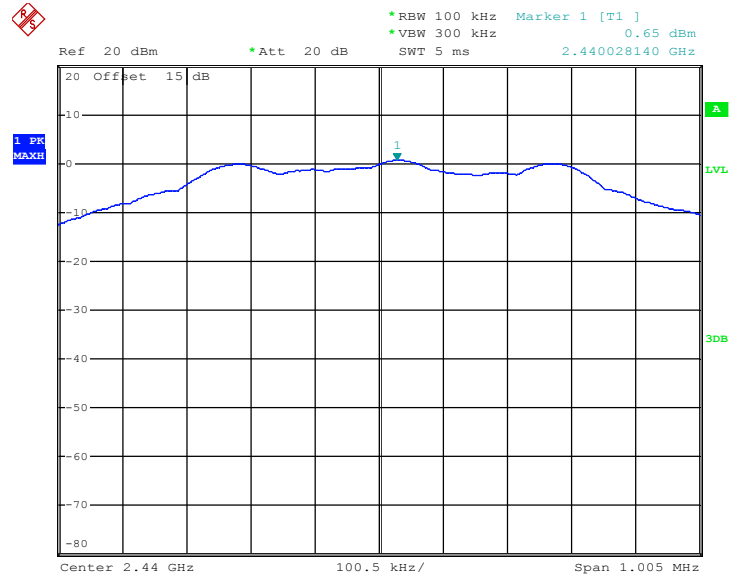

Date: 18.JUL.2016 15:34:48

PSD 100kHz Plot on Channel 39

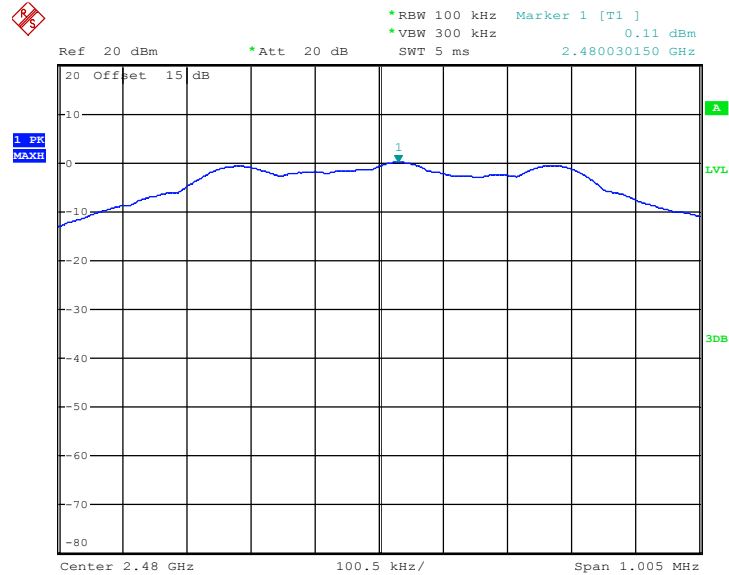

Date: 18.JUL.2016 15:39:36



### 3.3.6 Test Result of Power Spectral Density Plots (3kHz)

PSD 3kHz Plot on Channel 00

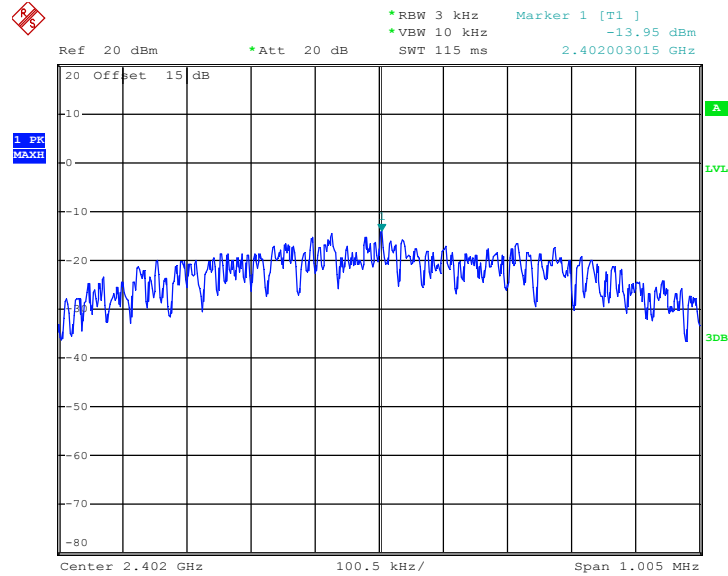

Date: 18.JUL.2016 15:27:35

PSD 3kHz Plot on Channel 19

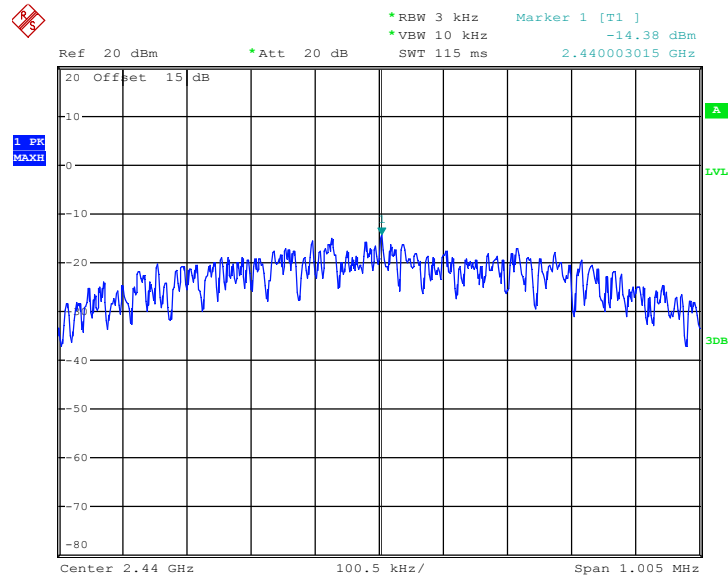

Date: 18.JUL.2016 15:34:17

PSD 3kHz Plot on Channel 39

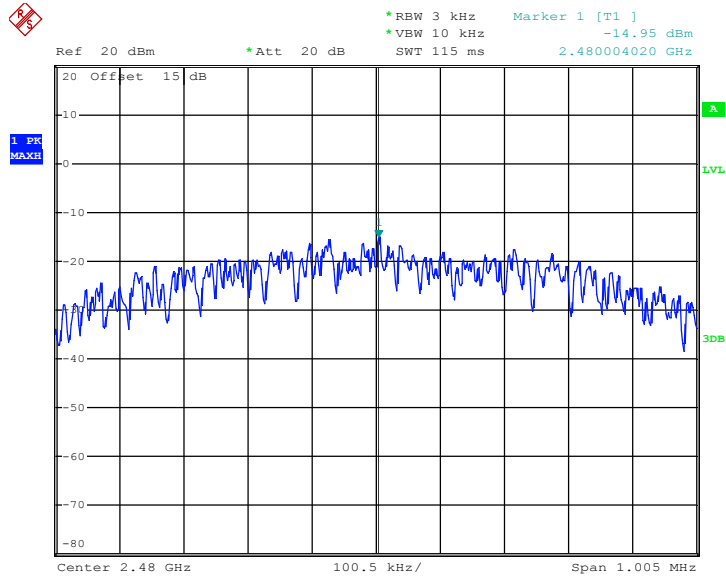

Date: 18.JUL.2016 15:38:58



### 3.4. Conducted Band Edges and Spurious Emission Measurement

#### 3.4.1 Limit of Conducted Band Edges and Spurious Emission

All harmonics/spurious must be at least 20 dB down from the highest emission level within the authorized band.

#### 3.4.2 Measuring Instruments

The section 4.0 of List of Measuring Equipment of this test report is used for test.

#### 3.4.3 Test Procedure

1. The testing follows FCC KDB Publication No. 558074 D01 DTS Meas. Guidance v03r05.
2. The RF output of EUT was connected to the spectrum analyzer by RF cable and attenuator. The path loss was compensated to the results for each measurement.
3. Set to the maximum power setting and enable the EUT transmit continuously.
4. Set RBW = 100 kHz, VBW=300 kHz, Peak Detector. Unwanted Emissions measured in any 100 kHz bandwidth outside of the authorized frequency band shall be attenuated by at least 20 dB relative to the maximum in-band peak PSD level in 100 kHz when maximum peak conducted output power procedure is used. If the transmitter complies with the conducted power limits based on the use of RMS averaging over a time interval, the attenuation required under this paragraph shall be 30 dB instead of 20 dB per 15.247(d).
5. Measure and record the results in the test report.
6. The RF fundamental frequency should be excluded against the limit line in the operating frequency band.

#### 3.4.4 Test Setup

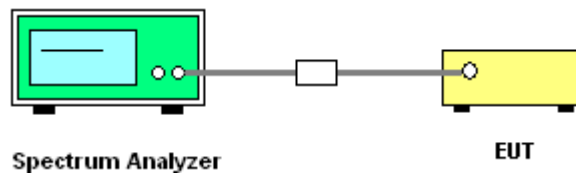



### 3.4.5 Test Result of Conducted Band Edges Plots

#### Low Band Edge Plot on Channel 00

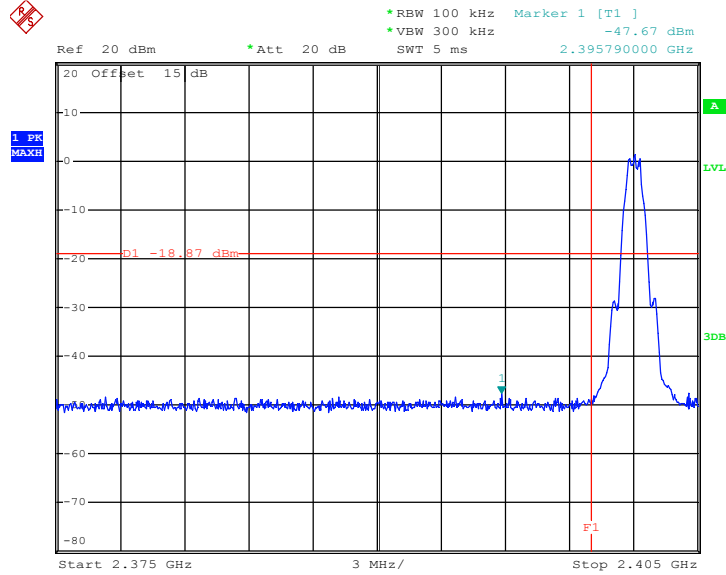

Date: 18.JUL.2016 15:29:38

#### High Band Edge Plot on Channel 39

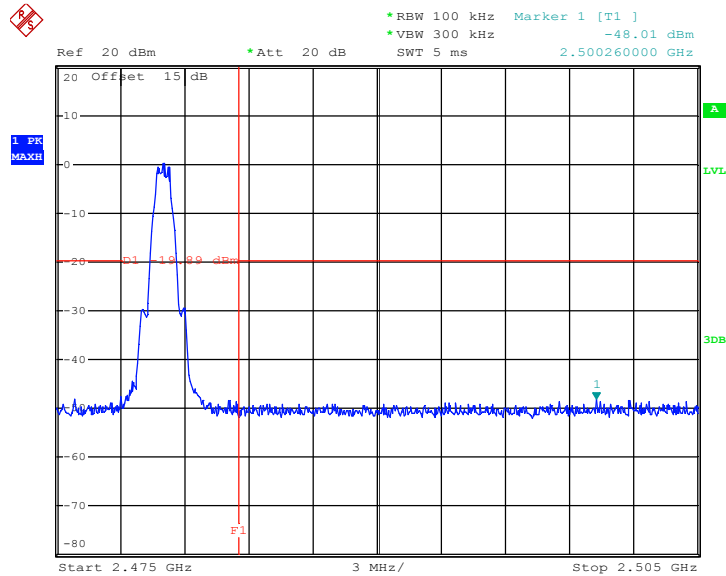

Date: 18.JUL.2016 15:40:14



### 3.4.6 Test Result of Conducted Spurious Emission Plots

#### Conducted Spurious Emission Plot on Bluetooth LE 1Mbps GFSK Channel 00

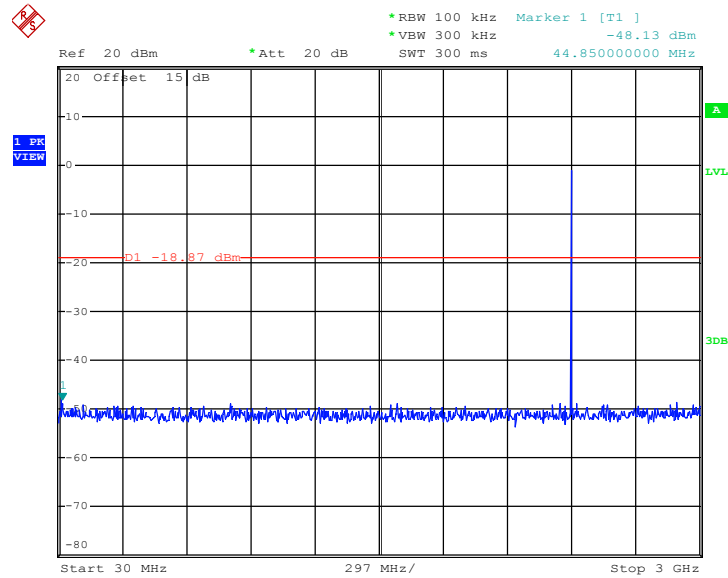

Date: 18.JUL.2016 15:29:55

#### Conducted Spurious Emission Plot on Bluetooth LE 1Mbps GFSK Channel 00

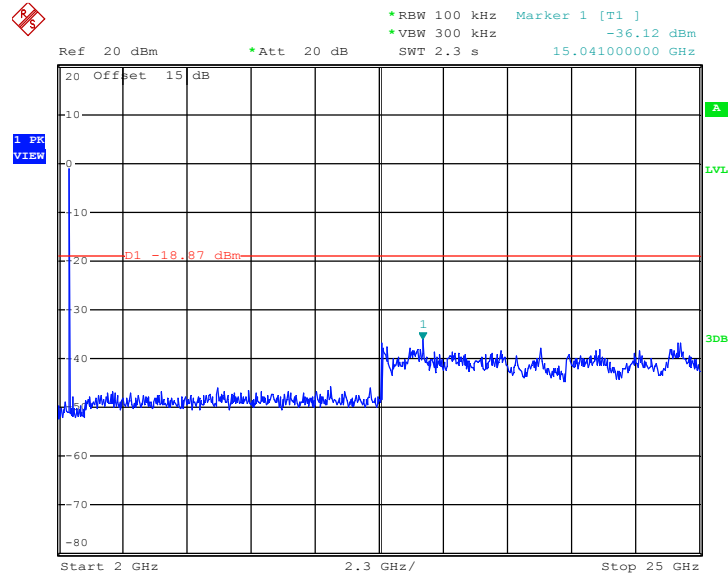

Date: 18.JUL.2016 15:30:03



### Conducted Spurious Emission Plot on Bluetooth LE 1Mbps GFSK Channel 19

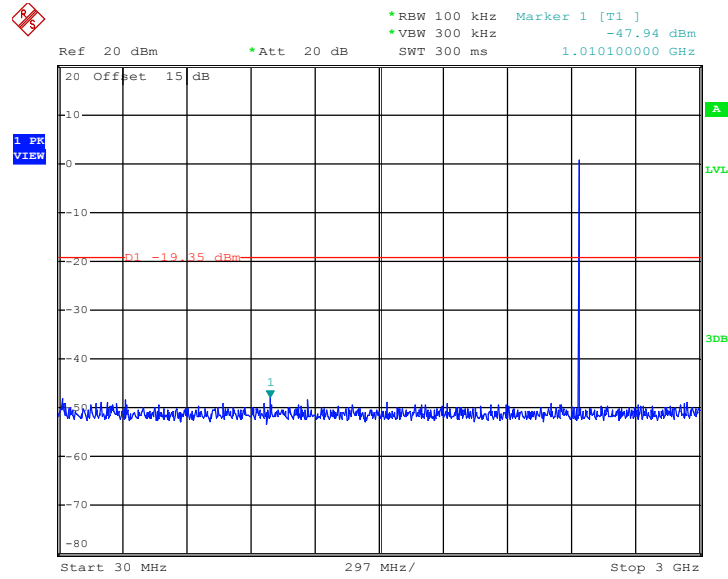

Date: 18.JUL.2016 15:36:31

### Conducted Spurious Emission Plot on Bluetooth LE 1Mbps GFSK Channel 19

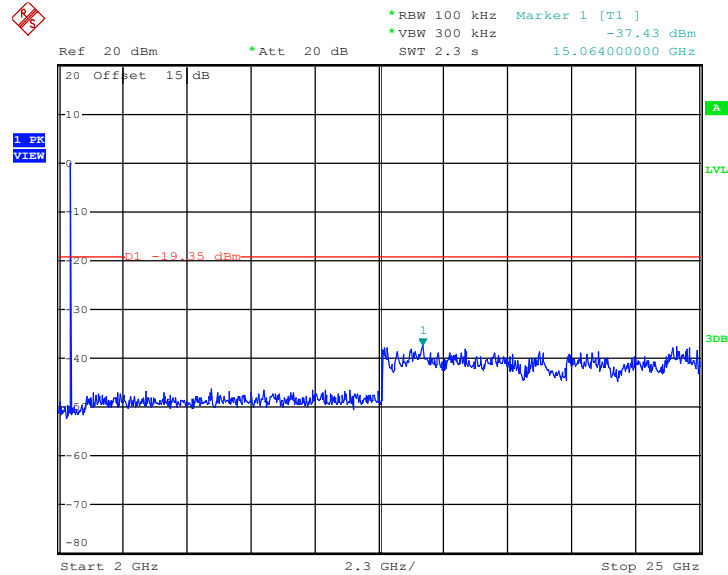

Date: 18.JUL.2016 15:36:40



### Conducted Spurious Emission Plot on Bluetooth LE 1Mbps GFSK Channel 39

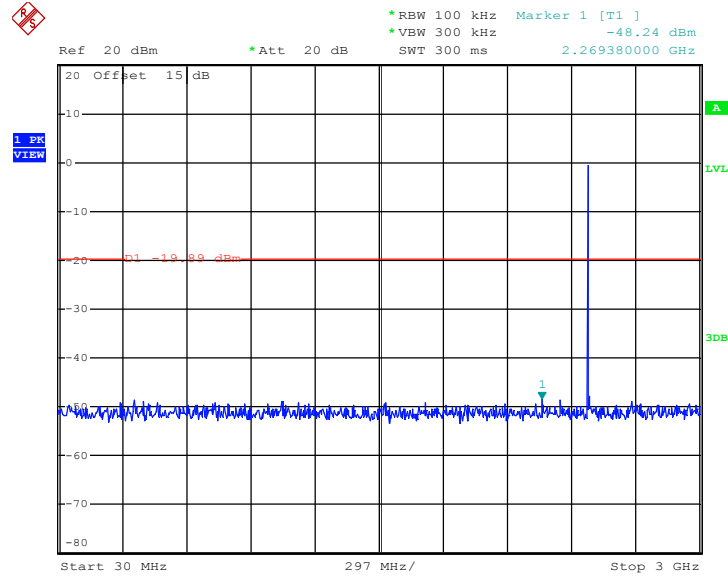

Date: 18.JUL.2016 15:42:01

### Conducted Spurious Emission Plot on Bluetooth LE 1Mbps GFSK Channel 39

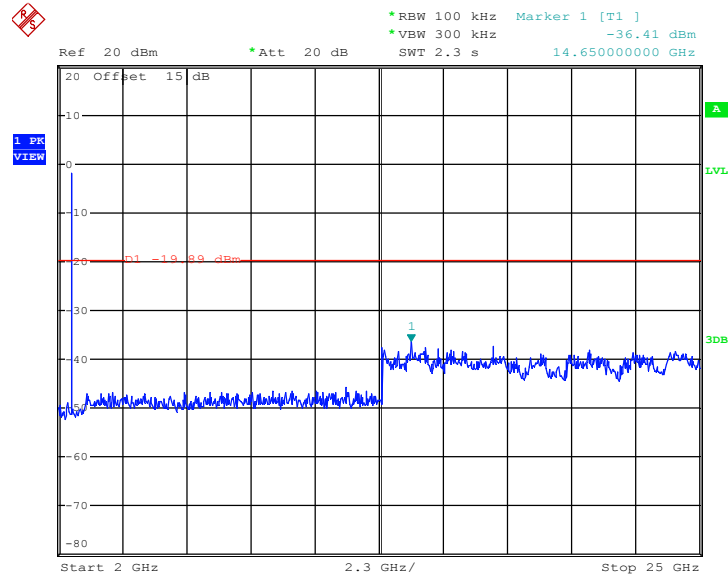

Date: 18.JUL.2016 15:42:09



### 3.5. Radiated Band Edges and Spurious Emission Measurement

#### 3.5.1 Limit of Radiated Band Edges and Spurious Emission

In any 100 kHz bandwidth outside the intentional radiator frequency band, all harmonics/spurious must be at least 20 dB below the highest emission level within the authorized band. If the output power of this device was measured by spectrum analyzer, the attenuation under this paragraph shall be 30 dB instead of 20 dB. In addition, radiated emissions which fall in the restricted bands must also comply with the FCC section 15.209 limits as below.

Frequency (MHz)	Field Strength (microvolts/meter)	Measurement Distance (meters)
0.009 – 0.490	2400/F(kHz)	300
0.490 – 1.705	24000/F(kHz)	30
1.705 – 30.0	30	30
30 – 88	100	3
88 – 216	150	3
216 - 960	200	3
Above 960	500	3

#### 3.5.2 Measuring Instruments

The section 4.0 of List of Measuring Equipment of this test report is used for test.



### 3.5.3 Test Procedures

1. The testing follows FCC KDB Publication No. 558074 D01 DTS Meas. Guidance v03r05.
2. The EUT was arranged to its worst case and then tune the antenna tower (from 1 m to 4 m) and turntable (from 0 degree to 360 degrees) to find the maximum reading. A pre-amp and a high pass filter are used for the test in order to get better signal level.
3. The EUT was placed on a turntable with 0.8 meter for frequency below 1GHz and 1.5 meter for frequency above 1GHz respectively above ground.
4. The EUT was set 3 meters from the interference receiving antenna, which was mounted on the top of a variable height antenna tower.
5. Corrected Reading: Antenna Factor + Cable Loss + Read Level - Preamp Factor = Level
6. For measurement below 1GHz, If the emission level of the EUT measured by the peak detector is 3 dB lower than the applicable limit, the peak emission level will be reported. Otherwise, the emission measurement will be repeated using the quasi-peak detector and reported.
7. Use the following spectrum analyzer settings:
  - (1) Span shall wide enough to fully capture the emission being measured;
  - (2) Set RBW=100 kHz for  $f < 1$  GHz; VBW  $\geq$  RBW; Sweep = auto; Detector function = peak; Trace = max hold;
  - (3) Set RBW = 1 MHz, VBW= 3MHz for  $f \geq 1$  GHz for peak measurement.  
For average measurement:
    - VBW = 10 Hz, when duty cycle is no less than 98 percent.
    - VBW  $\geq 1/T$ , when duty cycle is less than 98 percent where T is the minimum transmission duration over which the transmitter is on and is transmitting at its maximum power control level for the tested mode of operation.

### 3.5.4 Test Setup

For radiated emissions below 30MHz

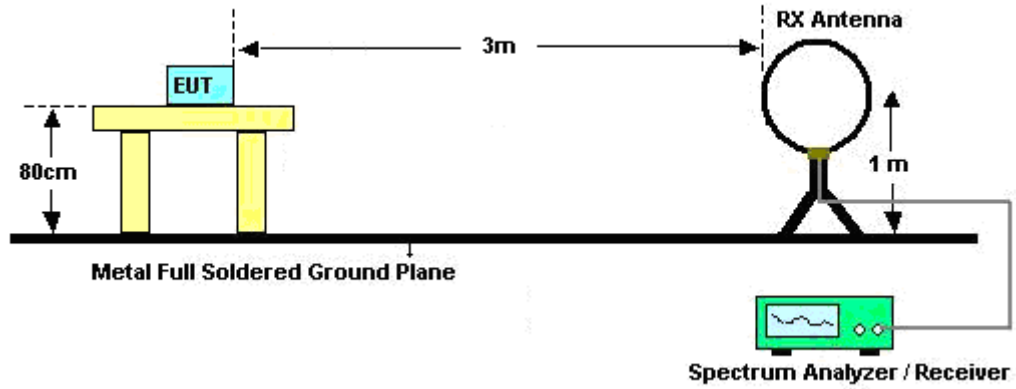

For radiated emissions from 30MHz to 1GHz

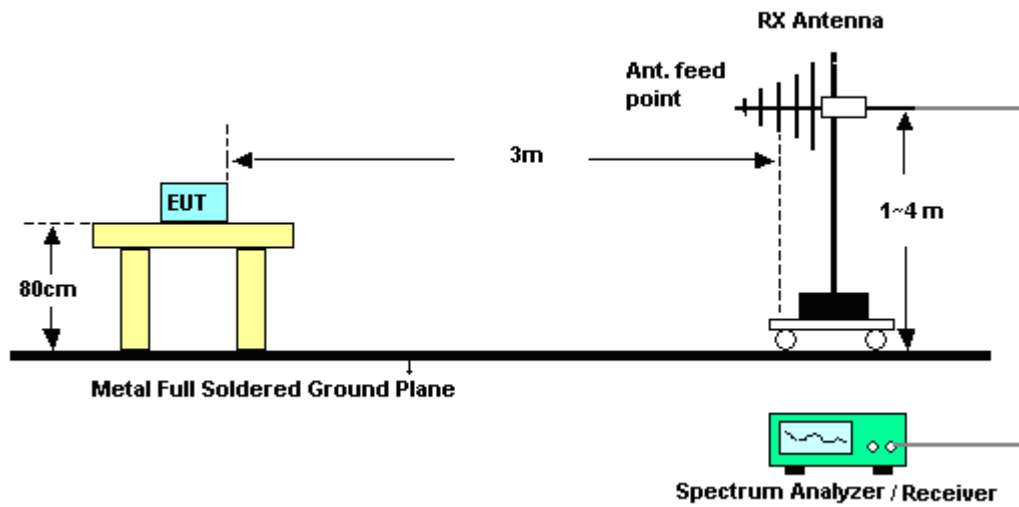



For radiated emissions above 1GHz

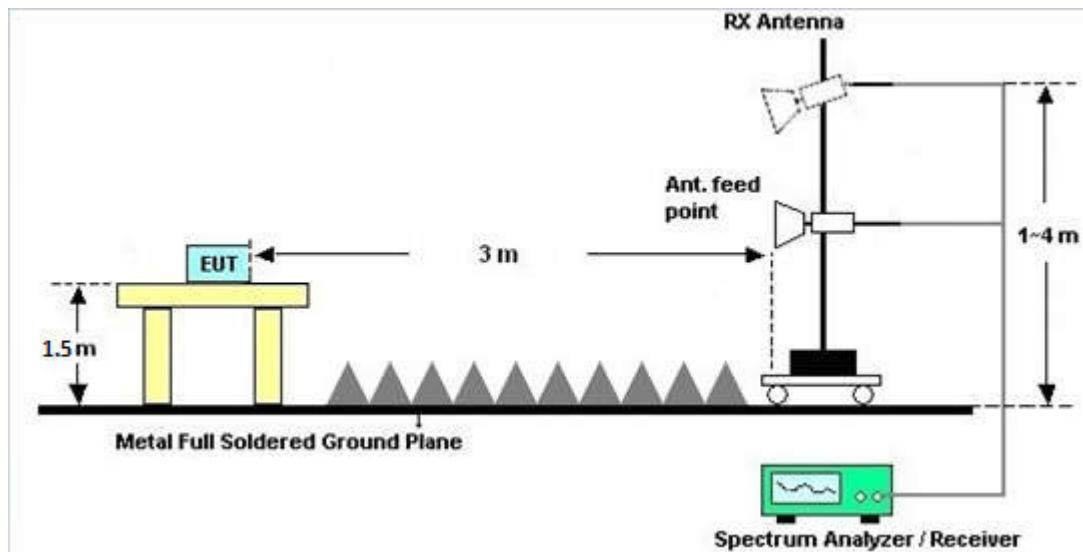

### 3.5.5 Test Results of Radiated Spurious Emissions (9 kHz ~ 30 MHz)

The low frequency, which started from 9 kHz to 30MHz, was pre-scanned and the result which was 20dB lower than the limit line per 15.31(o) was not reported.

### 3.5.6 Test Result of Radiated Spurious at Band Edges

Please refer to Appendix B

### 3.5.7 Duty Cycle

Please refer to Appendix C.

### 3.5.8 Test Result of Radiated Spurious Emission (30MHz ~ 10<sup>th</sup> Harmonic)

Please refer to Appendix B.



### 3.6. AC Conducted Emission Measurement

#### 3.6.1 Limit of AC Conducted Emission

For equipment that is designed to be connected to the public utility (AC) power line, the radio frequency voltage that is conducted back onto the AC power line on any frequency or frequencies within the band 150 kHz to 30 MHz shall not exceed the limits in the following table.

Frequency of emission (MHz)	Conducted limit (dBµV)	
	Quasi-peak	Average
0.15-0.5	66 to 56*	56 to 46*
0.5-5	56	46
5-30	60	50

\*Decreases with the logarithm of the frequency.

#### 3.6.2 Measuring Instruments

The section 4.0 of List of Measuring Equipment of this test report is used for test.

#### 3.6.3 Test Procedures

1. The EUT was placed 0.4 meter from the conducting wall of the shielding room was kept at least 80 centimeters from any other grounded conducting surface.
2. Connect EUT to the power mains through a line impedance stabilization network (LISN).
3. All the support units are connecting to the other LISN.
4. The LISN provides 50 ohm coupling impedance for the measuring instrument.
5. The FCC states that a 50 ohm, 50 microhenry LISN should be used.
6. Both sides of AC line were checked for maximum conducted interference.
7. The frequency range from 150 kHz to 30 MHz was searched.
8. Set the test-receiver system to Peak Detect Function and specified bandwidth (IF Bandwidth = 9kHz) with Maximum Hold Mode. Then measurement is also conducted by Average Detector and Quasi-Peak Detector Function respectively.

Test Setup

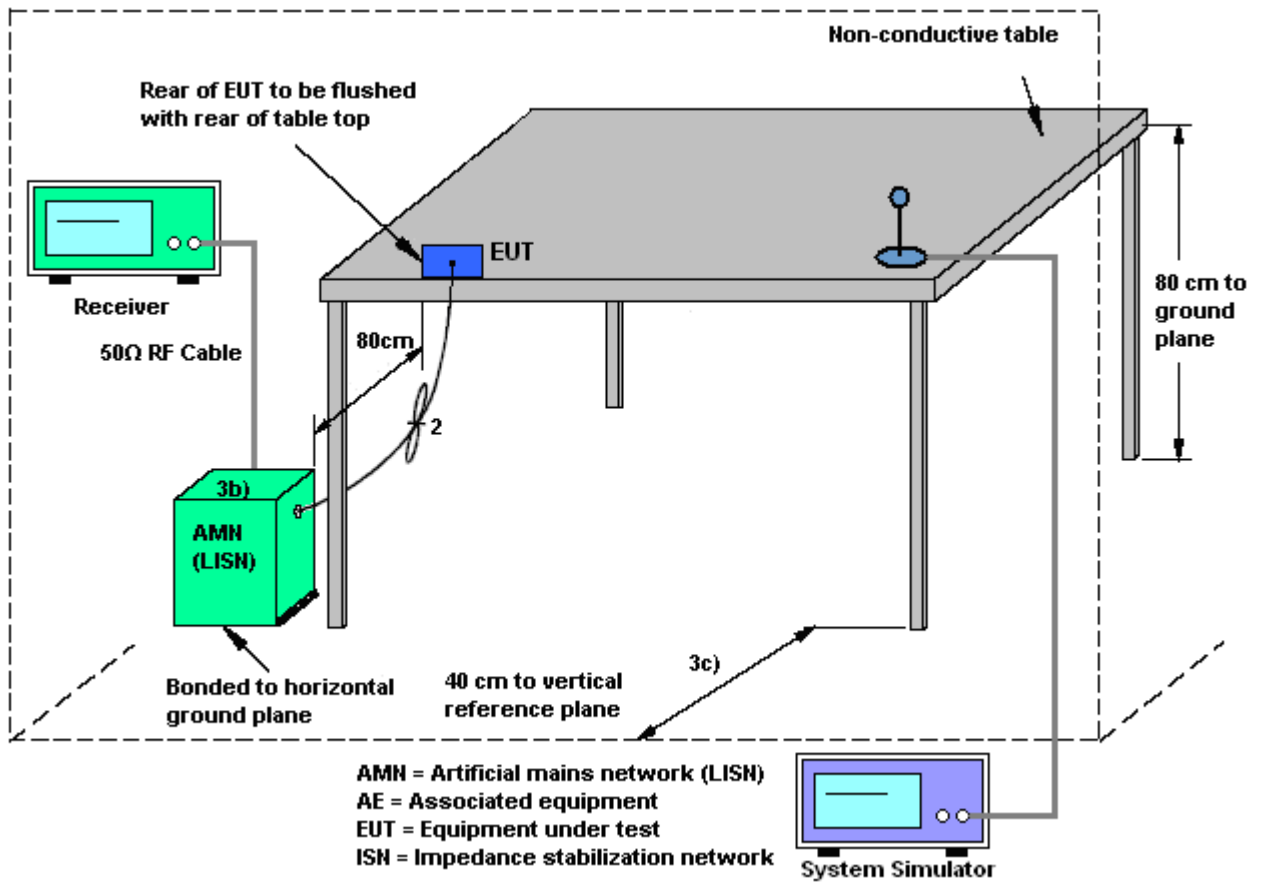



3.6.4 Test Result of AC Conducted Emission

Test Mode :	Mode 1	Temperature :	23~25°C
Test Engineer :	Jack Tian	Relative Humidity :	48~52%
Test Voltage :	120Vac / 60Hz	Phase :	Line
Function Type :	GPRS850 Idle + Bluetooth Link + WLAN(2.4G) Link + Earphone + Battery + USB Cable (Charging from Adapter)		

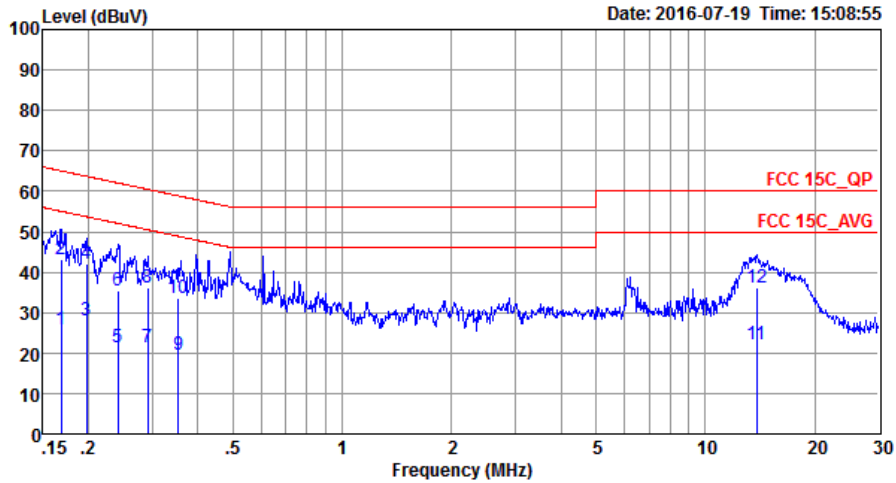

Site : CO01-SZ  
 Condition: FCC 15C QP LISN\_20160509 LINE

Mode : Mode 1  
 IMEI : 014732000100075

	Freq	Level	Over Limit	Limit Line	Read Level	LISN Factor	Cable Loss	Remark
	MHz	dBuV	dB	dBuV	dBuV	dB	dB	
1	0.17	25.69	-29.34	55.03	15.00	0.13	10.56	Average
2	0.17	43.19	-21.84	65.03	32.50	0.13	10.56	QP
3	0.20	28.21	-25.50	53.71	17.60	0.11	10.50	Average
4 *	0.20	42.21	-21.50	63.71	31.60	0.11	10.50	QP
5	0.24	21.27	-30.77	52.04	10.70	0.11	10.46	Average
6	0.24	35.37	-26.67	62.04	24.80	0.11	10.46	QP
7	0.29	21.54	-28.96	50.50	11.00	0.11	10.43	Average
8	0.29	36.14	-24.36	60.50	25.60	0.11	10.43	QP
9	0.35	19.43	-29.44	48.87	9.00	0.11	10.32	Average
10	0.35	33.43	-25.44	58.87	23.00	0.11	10.32	QP
11	13.84	22.18	-27.82	50.00	11.50	0.29	10.39	Average
12	13.84	36.18	-23.82	60.00	25.50	0.29	10.39	QP



Test Mode :	Mode 1	Temperature :	23~25°C
Test Engineer :	Jack Tian	Relative Humidity :	48~52%
Test Voltage :	120Vac / 60Hz	Phase :	Neutral
Function Type :	GPRS850 Idle + Bluetooth Link + WLAN(2.4G) Link + Earphone + Battery + USB Cable (Charging from Adapter)		

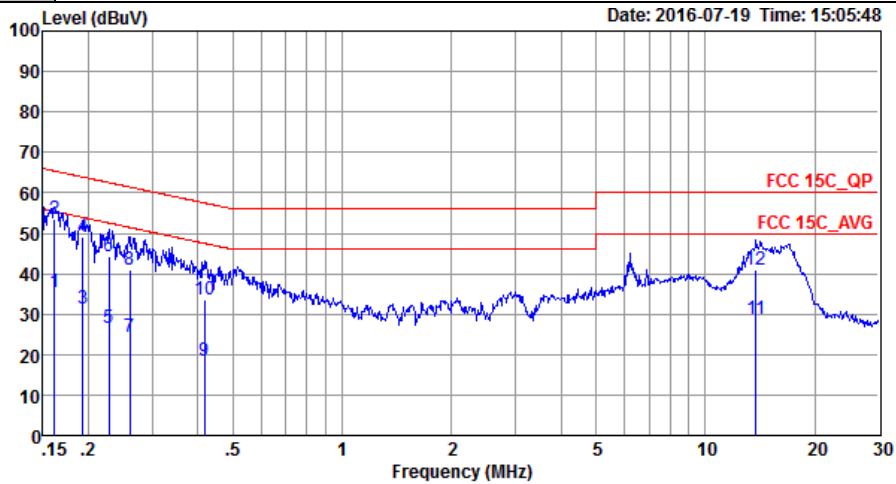

Site : CO01-SZ  
 Condition: FCC 15C\_QP LISN\_20160509 NEUTRAL

Mode : Mode 1  
 IMEI : 014732000100075

	Freq	Level	Over Limit	Limit Line	Read Level	LISN Factor	Cable Loss	Remark
	MHz	dBuV	dB	dBuV	dBuV	dB	dB	
1	0.16	35.61	-19.77	55.38	24.91	0.13	10.57	Average
2 *	0.16	53.61	-11.77	65.38	42.91	0.13	10.57	QP
3	0.19	31.22	-22.67	53.89	20.60	0.11	10.51	Average
4	0.19	49.02	-14.87	63.89	38.40	0.11	10.51	QP
5	0.23	26.38	-26.14	52.52	15.80	0.11	10.47	Average
6	0.23	44.28	-18.24	62.52	33.70	0.11	10.47	QP
7	0.26	24.26	-27.16	51.42	13.70	0.11	10.45	Average
8	0.26	41.06	-20.36	61.42	30.50	0.11	10.45	QP
9	0.42	18.55	-28.96	47.51	8.20	0.11	10.24	Average
10	0.42	33.75	-23.76	57.51	23.40	0.11	10.24	QP
11	13.77	28.78	-21.22	50.00	18.10	0.29	10.39	Average
12	13.77	40.98	-19.02	60.00	30.30	0.29	10.39	QP



### **3.7. Antenna Requirements**

#### **3.7.1 Standard Applicable**

If directional gain of transmitting antennas is greater than 6dBi, the power shall be reduced by the same level in dB comparing to gain minus 6dBi. The use of a permanently attached antenna or of an antenna that uses a unique coupling to the intentional radiator shall be considered sufficient to comply with the FCC rule.

#### **3.7.2 Antenna Anti-Replacement Construction**

An embedded-in antenna design is used.

#### **3.7.3 Antenna Gain**

The antenna peak gain of EUT is less than 6 dBi. Therefore, it is not necessary to reduce maximum peak output power limit.



## 4 List of Measuring Equipment

Instrument	Manufacturer	Model No.	Serial No.	Characteristics	Calibration Date	Test Date	Due Date	Remark
Spectrum Analyzer	R&S	FSP30	101400	9kHz~40GHz	Jan. 12, 2016	Jul. 18, 2016	Jan. 11, 2017	Conducted (TH01-SZ)
Pulse Power Sensor	Anritsu	MA2411B	1207253	30MHz~40GHz	Jan. 12, 2016	Jul. 18, 2016	Jan. 11, 2017	Conducted (TH01-SZ)
Power Meter	Anritsu	ML2495A	1218010	50MHz Bandwidth	Jan. 12, 2016	Jul. 18, 2016	Jan. 11, 2017	Conducted (TH01-SZ)
EMI Test Receiver&SA	KEYSIGHT	N9038A	MY54450083	20Hz~8.4GHz	May 07, 2016	Jul. 24, 2016~ Jul. 29, 2016	May 06, 2017	Radiation (03CH03-SZ)
EXA Spectrum Analyzer	KEYSIGHT	N9010A	MY55150246	10Hz~44GHz	May 07, 2016	Jul. 24, 2016~ Jul. 29, 2016	May 06, 2017	Radiation (03CH03-SZ)
Loop Antenna	R&S	HFH2-Z2	100354	9kHz~30MHz	May 07, 2016	Jul. 24, 2016~ Jul. 29, 2016	May 06, 2017	Radiation (03CH03-SZ)
Bilog Antenna	TeseQ	CBL6112D	35408	30MHz~2GHz	May 21, 2016	Jul. 24, 2016~ Jul. 29, 2016	May 20, 2017	Radiation (03CH03-SZ)
HF Amplifier	MITEQ	TTA1840-35-HG	1871923	18GHz~40GHz	Jul. 16, 2016	Jul. 24, 2016~ Jul. 29, 2016	Jul. 15, 2017	Radiation (03CH03-SZ)
SHF-EHF Horn	com-power	AH-840	101071	18Ghz~40GHz	Aug.19, 2015	Jul. 24, 2016~ Jul. 29, 2016	Aug. 18, 2016	Radiation (03CH03-SZ)
Amplifier	Burgeon	BPA-530	102210	0.01Hz~3000MHz	Oct. 20, 2015	Jul. 24, 2016~ Jul. 29, 2016	Oct. 19, 2016	Radiation (03CH03-SZ)
HF Amplifier	MITEQ	AMF-7D-00101800-30-10P-R	1943528	1GHz~18GHz	Oct. 20, 2015	Jul. 24, 2016~ Jul. 29, 2016	Oct. 19, 2016	Radiation (03CH03-SZ)
Amplifier	Agilent Technologies	83017A	MY39501302	500MHz~26.5GHz	Jan. 12, 2016	Jul. 24, 2016~ Jul. 29, 2016	Jan. 11, 2017	Radiation (03CH03-SZ)
AC Power Source	Chroma	61601	616010001985	N/A	NCR	Jul. 24, 2016~ Jul. 29, 2016	NCR	Radiation (03CH03-SZ)
Turn Table	EM	EM1000	N/A	0~360 degree	NCR	Jul. 24, 2016~ Jul. 29, 2016	NCR	Radiation (03CH03-SZ)
Antenna Mast	EM	EM1000	N/A	1 m~4 m	NCR	Jul. 24, 2016~ Jul. 29, 2016	NCR	Radiation (03CH03-SZ)
EMI Receiver	R&S	ESC17	100724	9kHz~3GHz;	Nov. 23, 2015	Jul. 19, 2016	Nov. 22, 2016	Conduction (CO01-SZ)
AC LISN	EMCO	3816/2SH	00103892	9kHz~30MHz	Jan. 12, 2016	Jul. 19, 2016	Jan. 11, 2017	Conduction (CO01-SZ)
AC LISN (for auxiliary equipment)	MessTec	3816/2SH	00103912	9kHz~30MHz	Jan. 12, 2016	Jul. 19, 2016	Jan. 11, 2017	Conduction (CO01-SZ)
AC Power Source	Chroma	61602	616020000891	100Vac~250Vac	Jul. 16, 2016	Jul. 19, 2016	Jul. 15, 2017	Conduction (CO01-SZ)
Pulse Limiter	COM-POWER	LIT-153 Transient Limiter	53139	150kHz~30MHz	Oct. 20, 2015	Jul. 19, 2016	Oct. 19, 2016	Conduction (CO01-SZ)



## 5 Uncertainty of Evaluation

### Uncertainty of Conducted Emission Measurement (150 kHz ~ 30 MHz)

Measuring Uncertainty for a Level of Confidence of 95% ( $U = 2Uc(y)$ )	2.5dB
---	-------

### Uncertainty of Radiated Emission Measurement (30 MHz ~ 1000 MHz)

Measuring Uncertainty for a Level of Confidence of 95% ( $U = 2Uc(y)$ )	5.0dB
---	-------

### Uncertainty of Radiated Emission Measurement (1GHz ~ 18GHz)

Measuring Uncertainty for a Level of Confidence of 95% ( $U = 2Uc(y)$ )	4.8dB
---	-------

### Uncertainty of Radiated Emission Measurement (18GHz ~ 40GHz)

Measuring Uncertainty for a Level of Confidence of 95% ( $U = 2Uc(y)$ )	5.0dB
---	-------





## **Appendix A. Conducted Test Results**

**Bluetooth Low Energy**

Test Engineer:	Sam Zheng	Temperature:	24~26	°C
Test Date:	2016/7/20	Relative Humidity:	50~53	%

**TEST RESULTS DATA**  
**6dB and 99% Occupied Bandwidth**

Mod.	Data Rate	NTX	CH.	Freq. (MHz)	99% Occupied BW (MHz)	6dB BW (MHz)	6dB BW Limit (MHz)	Pass/Fail
BLE	1Mbps	1	0	2402	1.06	0.67	0.50	Pass
BLE	1Mbps	1	19	2440	1.06	0.67	0.50	Pass
BLE	1Mbps	1	39	2480	1.06	0.67	0.50	Pass

**TEST RESULTS DATA**  
**Peak Power Table**

Mod.	Data Rate	NTX	CH.	Freq. (MHz)	Peak Conducted Power (dBm)	Conducted Power Limit (dBm)	DG (dBi)	EIRP Power (dBm)	EIRP Power Limit (dBm)	Pass /Fail
BLE	1Mbps	1	0	2402	2.14	30.00	-3.00	-0.86	36.00	Pass
BLE	1Mbps	1	19	2440	1.89	30.00	-3.00	-1.11	36.00	Pass
BLE	1Mbps	1	39	2480	1.38	30.00	-3.00	-1.62	36.00	Pass

**TEST RESULTS DATA**  
**Average Power Table**  
**(Reporting Only)**

Mod.	Data Rate	NTX	CH.	Freq. (MHz)	Duty Factor (dB)	Average Conducted Power (dBm)
BLE	1Mbps	1	0	2402	2.04	1.76
BLE	1Mbps	1	19	2440	2.04	1.44
BLE	1Mbps	1	39	2480	2.04	0.90

**TEST RESULTS DATA**  
**Peak Power Density**

Mod.	Data Rate	NTX	CH.	Freq. (MHz)	Peak PSD (dBm /100kHz)	Peak PSD (dBm /3kHz)	DG (dBi)	Peak PSD Limit (dBm /3kHz)	Pass/Fail
BLE	1Mbps	1	0	2402	1.13	-13.95	-3.00	8.00	Pass
BLE	1Mbps	1	19	2440	0.65	-14.38	-3.00	8.00	Pass
BLE	1Mbps	1	39	2480	0.11	-14.95	-3.00	8.00	Pass

Note: PSD (dBm/ 100kHz) is a reference level used for Conducted Band Edges and Conducted Spurious Emission 20dBc limit.



## Appendix B. Radiated Spurious Emission

2.4GHz 2400~2483.5MHz

BLE (Band Edge @ 3m)

BLE	Note	Frequency	Level	Over Limit	Limit Line	Read Level	Antenna Factor	Cable Loss	Preamp Factor	Ant Pos	Table Pos	Peak Avg.	Pol.
		( MHz )	( dBμV/m )	( dB )	( dBμV/m )	( dBμV )	( dB/m )	( dB )	( dB )	( cm )	( deg )	( P/A )	( H/V )
BLE CH 00 2402MHz		2320.395	48.25	-25.75	74	51.37	27.16	4.79	35.07	150	304	P	H
		2379.72	38.86	-15.14	54	41.76	27.26	4.86	35.02	150	304	A	H
	*	2402	96.74	-	-	99.59	27.29	4.86	35	150	304	P	H
	*	2402	95.69	-	-	98.54	27.29	4.86	35	150	304	A	H
		2313.78	47.73	-26.27	74	50.89	27.12	4.79	35.07	248	65	P	V
		2380.14	38.85	-15.15	54	41.75	27.26	4.86	35.02	248	65	A	V
	*	2402	88.13	-	-	90.98	27.29	4.86	35	248	65	P	V
	*	2402	87.19	-	-	90.04	27.29	4.86	35	248	65	A	V
BLE CH 19 2440MHz		2362.22	48.32	-25.68	74	51.33	27.22	4.82	35.05	150	322	P	H
		2379.44	39.01	-14.99	54	41.91	27.26	4.86	35.02	150	322	A	H
	*	2440	95.57	-	-	98.26	27.4	4.88	34.97	150	322	P	H
	*	2440	94.68	-	-	97.37	27.4	4.88	34.97	150	322	A	H
		2490.41	47.98	-26.02	74	50.48	27.5	4.92	34.92	150	322	P	H
		2492.93	39.29	-14.71	54	41.77	27.5	4.92	34.9	150	322	A	H
		2341.92	48.18	-25.82	74	51.22	27.19	4.82	35.05	235	145	P	V
		2364.88	39.13	-14.87	54	42.11	27.22	4.82	35.02	235	145	A	V
	*	2440	84.99	-	-	87.68	27.4	4.88	34.97	235	145	P	V
	*	2440	83.92	-	-	86.61	27.4	4.88	34.97	235	145	A	V
		2490.69	48.39	-25.61	74	50.89	27.5	4.92	34.92	235	145	P	V
		2491.81	39.34	-14.66	54	41.82	27.5	4.92	34.9	235	145	A	V



<b>BLE CH 39 2480MHz</b>	*	2480	93.35	-	-	95.9	27.47	4.9	34.92	150	327	P	H
	*	2480	92.35	-	-	94.9	27.47	4.9	34.92	150	327	A	H
		2485.96	48.56	-25.44	74	51.11	27.47	4.9	34.92	150	327	P	H
		2496.56	39.32	-14.68	54	41.8	27.5	4.92	34.9	150	327	A	H
	*	2480	85.64	-	-	88.19	27.47	4.9	34.92	230	357	P	V
	*	2480	84.16	-	-	86.71	27.47	4.9	34.92	230	357	A	V
		2494.56	48.72	-25.28	74	51.2	27.5	4.92	34.9	230	357	P	V
		2498.04	39.39	-14.61	54	41.87	27.5	4.92	34.9	230	357	A	V
<b>Remark</b>	1. No other spurious found. 2. All results are PASS against Peak and Average limit line.												



2.4GHz 2400~2483.5MHz

BLE (Harmonic @ 3m)

BLE	Note	Frequency ( MHz )	Level ( dBμV/m )	Over Limit ( dB )	Limit Line ( dBμV/m )	Read Level ( dBμV )	Antenna Factor ( dB/m )	Cable Loss ( dB )	Preamp Factor ( dB )	Ant Pos ( cm )	Table Pos ( deg )	Peak Avg. ( P/A )	Pol. ( H/V )
BLE CH 00 2402MHz		4804	41.32	-32.68	74	60.14	32.52	6.96	58.3	150	148	P	H
		4804	40.34	-33.66	74	59.16	32.52	6.96	58.3	150	148	P	V
BLE CH 19 2440MHz		4880	40.21	-33.79	74	59.22	32.66	6.99	58.66	150	245	P	H
		7320	48.66	-25.34	74	60.66	37.67	8.93	58.6	184	225	P	H
		4880	39.96	-34.04	74	58.97	32.66	6.99	58.66	150	245	P	V
BLE CH 39 2480MHz		7320	48.42	-25.58	74	60.42	37.67	8.93	58.6	184	225	P	V
		4960	41.87	-32.13	74	60.27	32.83	7.07	58.3	150	135	P	H
		7440	49.38	-24.62	74	60.99	37.69	9.15	58.45	175	260	P	H
		4960	41.84	-32.16	74	60.24	32.83	7.07	58.3	150	135	P	V
		7440	49.77	-24.23	74	61.38	37.69	9.15	58.45	175	260	P	V
Remark	1. No other spurious found. 2. All results are PASS against Peak and Average limit line.												



Emission below 1GHz

2.4GHz BLE (LF)

BLE	Note	Frequency	Level	Over	Limit	Read	Antenna	Cable	Preamp	Ant	Table	Peak	Pol.
				Limit	Line	Level	Factor	Loss	Factor	Pos	Pos	Avg.	
		( MHz )	( dBμV/m )	( dB )	( dBμV/m )	( dBμV )	( dB/m )	( dB )	( dB )	( cm )	( deg )	( P/A )	( H/V )
2.4GHz BLE LF		42.61	33.24	-6.76	40	43.55	20.82	0.62	31.75	100	264	P	H
		112.45	31.78	-11.72	43.5	43.78	18.55	0.99	31.54	-	-	P	H
		181.32	26.98	-16.52	43.5	40.59	16.42	1.28	31.31	-	-	P	H
		242.43	35.56	-10.44	46	47.81	17.63	1.4	31.28	-	-	P	H
		407.33	27.35	-18.65	46	30.93	25.83	1.82	31.23	-	-	P	H
		930.16	32.19	-13.81	46	31.53	29.05	2.88	31.27	-	-	P	H
		31.94	33.9	-6.1	40	39.2	25.86	0.62	31.78	-	-	P	V
		42.61	35.3	-4.7	40	45.61	20.82	0.62	31.75	103	87	P	V
		110.51	30.72	-12.78	43.5	42.68	18.59	0.99	31.54	-	-	P	V
		240.49	28.64	-17.36	46	40.98	17.54	1.4	31.28	-	-	P	V
		703.18	29.73	-16.27	46	30.83	27.68	2.44	31.22	-	-	P	V
		883.6	32.26	-13.74	46	32.45	28.37	2.71	31.27	-	-	P	V
Remark	1. No other spurious found. 2. All results are PASS against limit line.												

Note symbol

*	<b>Fundamental Frequency</b> which can be ignored. However, the level of any unwanted emissions shall not exceed the level of the fundamental frequency.
!	Test result is <b>over limit</b> line.
P/A	<b>Peak or Average</b>
H/V	<b>Horizontal or Vertical</b>



A calculation example for radiated spurious emission is shown as below:

WIFI	Note	Frequency	Level	Over	Limit	Read	Antenna	Cable	Preamp	Ant	Table	Peak	Pol.
Ant.				Limit	Line	Level	Factor	Loss	Factor	Pos	Pos	Avg.	
1+2		( MHz )	( dBμV/m )	( dB )	( dBμV/m )	( dBμV )	( dB/m )	( dB )	( dB )	( cm )	( deg )	( P/A )	( H/V )
802.11b		2390	55.45	-18.55	74	54.51	32.22	4.58	35.86	103	308	P	H
CH 01													
2412MHz		2390	43.54	-10.46	54	42.6	32.22	4.58	35.86	103	308	A	H

- Level(dBμV/m) =  
Antenna Factor(dB/m) + Cable Loss(dB) + Read Level(dBμV) - Preamp Factor(dB)
- Over Limit(dB) = Level(dBμV/m) – Limit Line(dBμV/m)

**For Peak Limit @ 2390MHz:**

- Level(dBμV/m)  
= Antenna Factor(dB/m) + Cable Loss(dB) + Read Level(dBμV) - Preamp Factor(dB)  
= 32.22(dB/m) + 4.58(dB) + 54.51(dBμV) – 35.86 (dB)  
= 55.45 (dBμV/m)
- Over Limit(dB)  
= Level(dBμV/m) – Limit Line(dBμV/m)  
= 55.45(dBμV/m) – 74(dBμV/m)  
= -18.55(dB)

**For Average Limit @ 2390MHz:**

- Level(dBμV/m)  
= Antenna Factor(dB/m) + Cable Loss(dB) + Read Level(dBμV) - Preamp Factor(dB)  
= 32.22(dB/m) + 4.58(dB) + 42.6(dBμV) – 35.86 (dB)  
= 43.54 (dBμV/m)
- Over Limit(dB)  
= Level(dBμV/m) – Limit Line(dBμV/m)  
= 43.54(dBμV/m) – 54(dBμV/m)  
= -10.46(dB)

**Both peak and average measured complies with the limit line, so test result is “PASS”.**



## Appendix C. Duty Cycle Plots

Band	Duty Cycle(%)	T(ms)	1/T(kHz)	VBW Setting
Bluetooth 4.1 LE	62.50	0.39	2.56	3kHz

### Bluetooth v4.1 LE

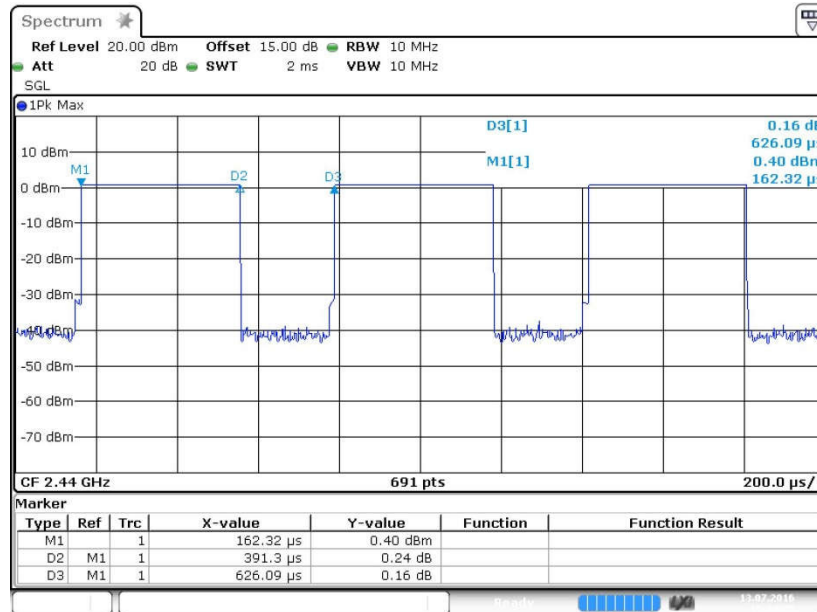

Date: 13 JUL 2016 15:24:26