

global sources

Consumer Electronics

October 2020

Smart home devices

Voice-controlled speakers, lighting & security products *page 217*



ANALYST'S CHOICE

LED gaming chair tilts, rocks
page 34



Trends & Analysis

Next-Gen Insider

217

Tips to efficiently use your PDF Reader

How to change display options

Click on “View >> Page Display” to customize the way you can view the e-magazine.

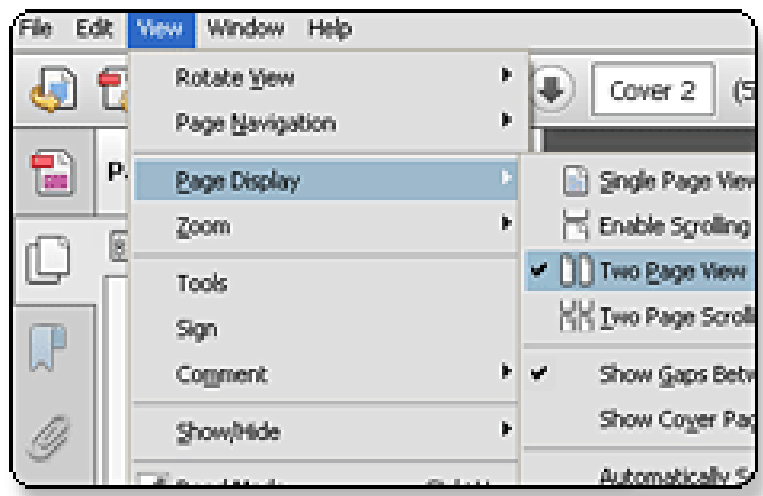

How to save a PDF

Press “Shift + Ctrl + S” or click on the “Save” icon. Confirm your save choice by clicking on “Save a blank copy”.

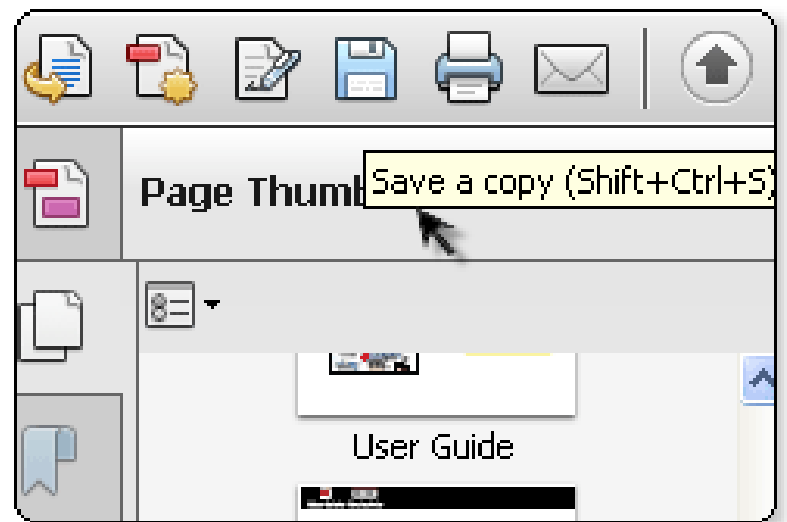

How to conduct a PDF text search

Press “Shift + Ctrl + F” and type in the keyword(s). If no match found, please broaden your keywords. The search is based on keyword exact match.

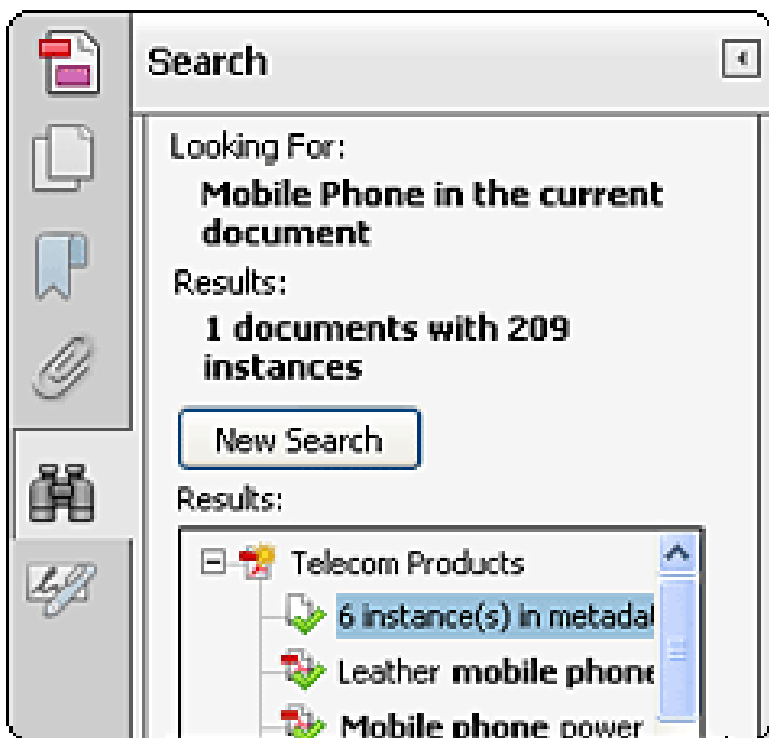

How to zoom/enlarge and move around a page

Click on either icon to zoom out of or zoom in on the page.

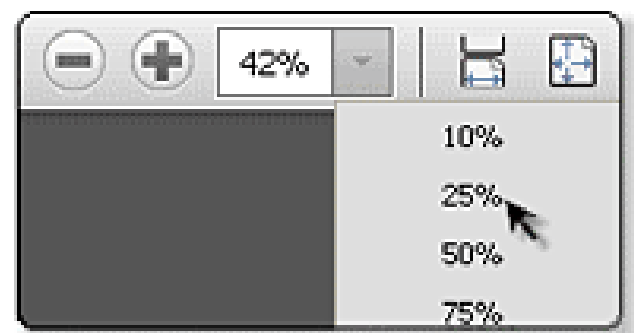

“Hand Tool” – to help move around an enlarged page.

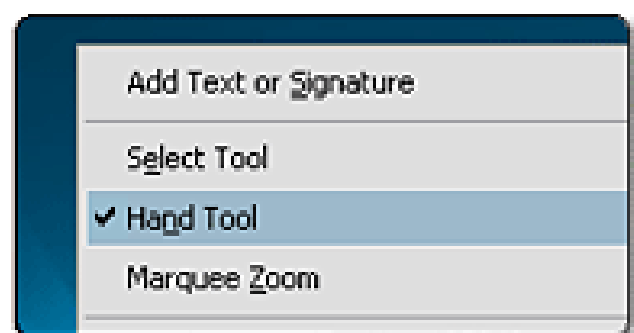

* These instructions are based on Adobe Reader. Users of other PDF readers: Check the “Help” function on your PDF reader for page display options. If you’re accessing the PDF online (for example, Chrome, Firefox or IE), enable Adobe Plug-in for better viewing.



NEW



LTE-DR880/LTE-DR880UV

- 4G LTE + DMR
- Wi-Fi/GPS/Bluetooth
- Supports telephone calls
- Record playback
- Dispatching management
- 2 time slots
- Dual-mode analog and DMR
- Dual bands, standbys and receivers



- Matte texture slim ergonomic design with affluent lines
- Comfortable touch and easy operation
- 36mm (D) built-in large speaker
- Utilizing advanced voice processing technology to ensure a crystal clear sound even in a noisy environment
- Utilizing polymer lithium battery technology to achieve 6,000 mAh high battery capacity



- Established in 1988
- R&D team with 20+ years' experience in walkie-talkies, 15 QC inspectors with 15+ years' experience
- Five JUK/SMT lines; 15,000m² production base
- Monthly output of two-way radios: 35,000 pieces
- 100% pre-shipping inspection

To source high-quality radios, contact us today.

NEW

Over 30-year manufacturer of OEM and ODM high-tech communication products



Wi-Fi radio (Q1)

- Self-build platform
- License-free; hands-free calls
- WLAN communication
- Unlimited talking range
- Worldwide network can be accessed via a single IP and computer

DMR series

- True 2-slot for direct communication
- 4,000 channels + VFO
- Private/group/all call
- AMBE + 2TM vocoder

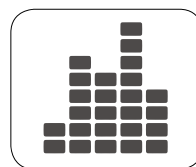

Digitized voice

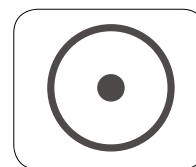

36mm larger diameter for clear audio

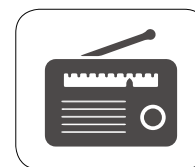

FM radio



200+ hours of recording

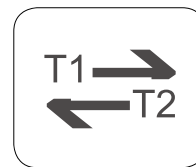

True 2-slot double frequency capacity



GPS optional

Kydera® Fujian New Century Communications Co. Ltd

1 Fengshou Rd, Zhaofeng Industrial Zone, Quanzhou, Fujian 362000, China
 Tel: (86-595) 2288 3777, 2289 9399 • Fax: (86-595) 2288 7666
 E-mail: kyd10@cnkyd.cn • Skype: goldenblue0521
 WhatsApp: (86)1379957 7029 • WeChat: kejinpengoo1
www.globalsources.com/centuryelec.co

17th year
with Global Sources



Global Sources Verified Supplier ★★★★★ **ISO 9001:2008 RoHS IEC CE FCC**

NEW

Supplying Walmart for 15 years

- Batteries, controllers and frames produced in-house
- Exporting 500,000 pieces of electric scooters yearly
- Products certified to ABE, UL, CE and RoHS standards
- QC staff with 10 years' experience
- R&D team staffed by 20 engineers
- 20-day delivery; small orders accepted

Inquire now to learn more.



Electric scooter (HY-B11)

- Private design with fashionable streamlined body
- 10" solid tire
- 350W motor
- 6Ah/8Ah/10Ah battery

FLYING-ANT

Shenzhen Uni-sun Electronics Co. Ltd

43 Lan'er Rd, Lanshui, Longdong, Longgang, Shenzhen,

Guangdong 518116, China

Tel/Fax: (86-755) 8484 7799

E-mail: richard@flying-ant.com

www.globalsources.com/uni-sun.co

www.flying-ant.com

Global Sources  Verified Supplier ★★★★★

RoHS  



Electric scooter (HY-B10)



NEW

Android Wi-Fi Ultra-short throw 4K smart projector

Zero distance • 100" plus image



CasTV 4K

CasTV - the world's shortest throw (ratio 0.19:1) projector

- Can be positioned at exactly the same spot a TV would be, eliminating the need to run cables any further than needed
- Projects a 60"-150" image when it is put on a regular family room TV cabinet
- If ceiling height allows, the projector can project up to a 240" (diagonal) image
- Communications:
 - Can connect to a set-top box, DVD player, camcorder, and game console or other devices
 - Can access the internet via Ethernet cable or its built-in Wi-Fi
 - Built with DLNA, Miracast and AirPlay casting programs to wirelessly mirror a mobile device
 - LED light source lasts 30,000 hours

Our innovative ultra-short throw projector can project an over 100-inch image from a very short distance against the wall. Users do not have to deal with the hassle of people blocking the projection, or getting tangled in power cord and signal cables.

Ultmost has been manufacturing consumer electronics products since 1987. Choose from our wide selection of LED pico/mini projectors, interactive whiteboards and home entertainment equipment. We design and produce optical engines ourselves and carry out plastic and metal molding, plastic injection, pressing/punching, wire bonding, SMT, optical (glass cutting, grinding, polishing and coating for PBS), printing, spray painting and assembly in-house to control quality and cost. Inquire today to begin sourcing our state-of-the-art products.

Ultmost

FUSS / Manufacturer & Exporter Since 1987

Ultmost Technology Group

Taiwan Office: New Taipei City, Taiwan Region

Chinese Mainland Office: World Electronic (Shenzhen) Co. Ltd

160 Longping West Rd, Longgang,

Shenzhen, Guangdong 518001, China

Direct Sales Line: (86-755) 8488 0719

Fax: (86-755) 8482 0817

E-mail: ut@ultmost.com.cn

www.globalsources.com/ultmost-sz.co

www.fussdigital.com • www.ultmost.com

Global Sources  Verified Supplier ★★★★★

All items shown here with various trademarks, brand names and logos ("Marks") are for reference purposes only, and are not for sale. The Marks are the property of the respective owners, and we are not authorized to manufacture or sell any items bearing such Marks to any third party.



NEW

12 years' experience in the mobile phone accessories industry



Travel chargers (TC151)

- Foldable US/EU plug
- Different surface texture
- QC 3.0 and Type-C PD ports included
- Power: QC 3.0 18W, 3.1A; PD 18W, 3.1A
- Dimensions: 6 x 7.5 x 3 cm

- Eight inspection processes conducted for each item before shipping out
- MOQ: 500 pcs
- Delivery time: 10-15 days
- Daily capacity: 10,000-20,000 pcs
- CE/RoHS/FCC/UL/CB/PSE/SAA/C-Tick certifications
- OEM/ODM services
- Package design, video and publicity pictures supported
- Working with Walmart, Hama, FIFO, Bytech and iHome
- Take part in IFA, CES, HKTDC and Global Sources exhibitions each year
- MFi-licensed manufacturer

Visit our website or contact us for more details.

NEW



- Wall/home chargers (TC182)
- Replaceable US/EU/UK/AU plug
 - Multi-port available
 - Power: PD 45W, 2.4A; PD 30W; QC 18W, 2.4A
 - Dimensions: 6 x 6 x 3 cm



Shenzhen Shenchuang Hi-tech Electronics Co. Ltd

5/F, Shabian East Industrial Zone, Nanchang Rd, Gushu, Xixiang, Bao'an, Shenzhen, Guangdong 518100, China

Mobile: (86) 136 1301 0823, 138 2651 5306 • Fax: (86-755) 2960 3651

E-mail: ceo@schitec.com

www.globalsources.com/schitec.co

www.schitec.com

Global Sources Verified Supplier ★★★★★

RoHS C-TICK CB CE FC SAA





NEW

Headshells for LP record players
 • Made of aluminum alloy
 • Suitable for all cartridges with 0.5" fixed centers

Carbon fiber record cleaner brush

ISO 9001:2015-certified supplier of LP record care and maintenance products

- LP record player accessories from a 44-year manufacturer
- Fully integrated automated facilities manufacture 5 million units yearly
- OEM customers from the US, Europe and Japan

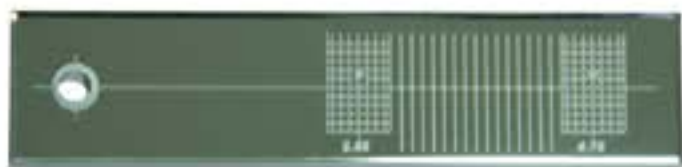

Cartridge alignment protractor (CA-001)



Carbon fiber record brush with ground wire (DC-06)



YUHYIH

Yuh Yih Industrial Co. Ltd

No. 609 Yan-Sin St, Yongkang District, Tainan City 71047, Taiwan Region

Tel: (886-6) 253 5507/9 • Fax: (886-6) 253 3467, 254 2527

E-mail: yuhyihco@ms24.hinet.net

www.globalsources.com/yuhyih.co • www.yuhyih.com.tw

Global Sources Verified Supplier ★★★★★

ISO 9001:2015



global sources Consumer Electronics

Publisher

Publishers Representatives Limited

EDITORIAL OFFICES

Publishers Representatives Limited

30th Floor, 41 Heung Yip Road,
Wong Chuk Hang, Hong Kong SAR

Tel: (852) 2555 4777

Manila

editor@globalsources.com

ADVERTISING INQUIRIES

Hong Kong SAR

Tel: (852) 2831 0222

Fax: (852) 2831 2727

Taiwan region

Tel: (886 2) 2570 6889

Fax: (886 2) 2570 6118

Chinese mainland

Changping

Tel: (86 769) 8390 8850

Fax: (86 769) 8960 1860

Tel: (86 769) 8117 8360

Changzhou

Tel: (86 519) 8158 1806

Fax: (86 519) 8158 1809

Dalian

Tel: (86 411) 8255 9557

Fax: (86 411) 8555 9559

Dongguan

Tel: (86 769) 2202 2920

Fax: (86 769) 2202 2923

Fuzhou

Tel: (86 591) 8330 6706

Fax: (86 591) 8330 6705

Guangzhou

Tel: (86 20) 8388 8777

Fax: (86 20) 8388 8722

Hangzhou

Tel: (86 571) 8810 2313

Fax: (86 571) 8810 2304

Longgang

Tel: (86 755) 8962 9680

Tel: (86 755) 8962 8806

Ningbo

Tel: (86 574) 8775 8902

Fax: (86 574) 8733 8374

Qingdao

Tel: (86 532) 6677 5251

Fax: (86 532) 6677 5239

Quanzhou

Tel: (86 595) 2219 3945

Fax: (86 595) 2298 6087

Shanghai

Tel: (86 21) 6263 8888

Fax: (86 21) 5306 8969

Shenzhen

Tel: (86 755) 8828 2666

Fax: (86 755) 8828 2803

Taizhou

Tel: (86 576) 8868 5680

Fax: (86 576) 8853 8702

Wenzhou

Tel: (86 577) 8895 6820

Fax: (86 577) 8892 0338

Xiamen

Tel: (86 592) 238 6868

Fax: (86 592) 238 6858

Xi'an

Tel: (86 29) 8577 9299

Fax: (86 29) 8577 9312

Yiwu

Tel: (86 579) 8555 4435

Fax: (86 579) 8558 2015

Zhongshan

Tel: (86 760) 8866 9266

Fax: (86 760) 8866 9299

Australia

Tel: (61 4) 2532 6668

Fax: (61 2) 9439 2157

India

Mumbai

Tel: (91 22) 6111 0711

Fax: (91 22) 4225 6113

New Delhi

Tel: (91 11) 4575 2500

Fax: (91 11) 4080 1157

Malaysia Kuala Lumpur

Tel: (60 3) 5192 8500

Fax: (60 3) 5192 8499

Singapore

Tel: (65) 6547 2800

Fax: (65) 6547 2888

South Korea Seoul

Tel: (82 2) 3473 9200

Fax: (82 2) 3473 6676

Thailand Bangkok

Tel: (66 2) 440 0363

Fax: (66 2) 440 0368

United States Panguitch

Tel: (1 435) 676 8788

Fax: (1 435) 676 8789

Vietnam

Tel: (84 8) 6250 2828

Fax: (84 8) 6291 1923

CUSTOMER SERVICE

Hong Kong SAR

Tel: (852) 8121 2000

Email: service@globalsources.com

All publishing rights and copyrights are held by Publishers Representatives Limited
 ISSN 2424-9750 (Print)
 ISSN 2424-9769 (Online)
 October 2020 Volume 1/Number 2

Printed by: C&C Offset Printing Co. Ltd
 14/F C&C Building, 36 Ting Lai Road, Tai Po, New Territories, Hong Kong SAR
 Tel: (852) 2666-4988 Fax: (852) 2666-4938

Copyright © 2020 by Publishers Representatives Limited
 All rights reserved.

NEW



K30 REAR 2H-1

Source CE-, RoHS- and FCC-certified wireless microphones and speakers from a 9-year manufacturer

- Mainly exporting to the US, Europe and Southeast Asia
- More than 400 models of product available for your choice
- We supply Sears, RadioShack and Best Buy
- Providing OEM/ODM services: designing new products according to customers' ideas

We guarantee product quality. The defect rate is lower than 0.1%. Don't hesitate to contact us now.



K31 HDMI wireless mic



Jiuyi Electronics Technology Co. Limited

3/F, Bldg 20, Rear Building, 3rd Alley, Shanggaotian Industrial Area, Haibing, Gushu, Xixian, Bao'an, Shenzhen, Guangdong 518120, China
Tel: (86-755) 3313 5366 • Fax: (86-755) 2736 9676

E-mail: Jiuyi0211@vip.163.com
www.globalsources.com/jiuyi.co

Global Sources  Verified Supplier ★★★★★



NEW

Own testing chambers ensure antennas meet 5G/4G LTE standards



On-glass adhesive-mount antenna

Magnetic-mount roof antenna

- IP67-rated outdoor vehicle antennas
- UV-resistant
 - Roof-mounted
 - Mounting screw



- R&D engineers averaging 25 years' experience
- Engineers can provide customized solutions
- We offer items with advanced dual-polarization technology
- 100% of products undergo QC inspections
- All goods are SGS-approved and RoHS-compliant
- Supporting 5G/4G LTE, GSM/CDMA/TDMA, Wi-Fi, Bluetooth, GPS and DVB-T
- OEM services available



Antenna testing chamber

Contact us today to find out more.



- RF cable assemblies
- SMA-U.FL/Murata GSC, IPEX MHF 2/3/4 and MCX/MMCX
 - 0.81, 1.13, 1.32 and 1.37mm
 - RG178, RG316, RG174 and RG58
 - Low loss cables: CFD200, CFD240 and CFD400



- PCB/FPC embedded antennas
- 2.4/5GHz, 3G UMTS or 4G-LTE™
 - Fly lead connectors
 - OEM/ODM requests welcome



- Monopole rubber antennas
- 2.4GHz, 3G/UMTS or 4G/LTE
 - 1/4 wave
 - Fixed straight or R/A SMA and swivel SMA
 - IP65-rated O-ring SMA



- Rubber dipole antennas for 5G/4G LTE, 3G GSM UMTS, LoRA, ISM and Wi-Fi



- Magnetic mount antennas for cellular 5G/4G-LTE™ or 2.4 GHz WLAN

TEKFUN Tekfun Co. Ltd
Tek makes life more fun!

4/F, 32 Kunming St, Zhongli Dist, Taoyuan City 32089, Taiwan Region
 Tel: (886-3) 428 0826 • Fax: (886-3) 428 0010 • E-mail: info@tekfun.com.tw
 www.globalsources.com/tekfun.co • www.tekfun.com.tw
 Global Sources Verified Supplier ★★★★★



global sources

Consumer Electronics

CONTENTS



On the cover: With many staying at home due to COVID-19, demand for voice-controlled smart home devices has grown since they help minimize virus transmission from commonly touched surfaces. See page 217 for more information.

Analyst's Choice

Consumer Electronics page 34

- LED gaming chair tilts, rocks
- Self-balancing hovershoes run up to 12kph
- Charging dock for Nintendo Switch
- Modular Bluetooth gamepad
- Bluetooth 5.0 DAB radio works as alarm clock
- Bluetooth 5.0 speaker emits 3D sound
- Bluetooth 5.0-ready vertical mouse

LED & Solar Products page 261

- Portable LED work light with power bank
- 200W solar panel
- Water-resistant 100W LED floodlight
- 150W red, blue portable solar warning light

Next-Gen Insider page 217

COVID-19 increases demand for smart, personal transporters

Product Index page 275

Advertiser Index page 284

Global Sources supplier rankings

★★★★★

Suppliers are ranked using a 6-star ranking system. Companies with a higher star ranking provide more business information and verification reports on their Global Sources online homepages. Suppliers rated 5 or 6 stars have a Credit Check report from First Advantage or Sino-Trust and a Supplier Capability Assessment report provided by Bureau Veritas online. The rankings are correct at the time of publication and may be subject to change.

NOTE TO READERS: All prices quoted in this magazine are in US dollars, unless otherwise specified. FOB prices were provided by the companies interviewed only as reference prices at the time of the interview and may have changed. Readers seeking firm quotes on products mentioned in this magazine should contact the manufacturers/traders directly. All product images are provided by the companies interviewed and are for reference purposes only. Those product images featuring products with trademarks, brand names or logos are not intended for sale. Products that are not the specific topics of editorial articles are shown for illustrative and/or demonstrative purposes only. We, our affiliates, and our affiliates' respective directors, officers, employees, representatives, agents or contractors do not accept and will not have any responsibility or liability for product images (or any part thereof) which infringe on any intellectual property or other rights of a third party.

All publishing rights and copyrights are held by Publishers Representatives Limited.

Consumer Electronics

3D & smart TVs
Home theater systems
Business electronic equipment
Video game accessories
Video players & recorders
Car electronic accessories

Pages 33-259

LED & Solar Products

Solar lighting fixtures
Solar HVAC systems & parts
Solar power systems & parts
Energy-efficient light bulbs & tubes
Energy-efficient lighting fixtures & accessories
LED bulbs & tubes

Pages 260-274

Online



www.globalsources.com/ConsumerElectronics

Find thousands of products and suppliers in an easy to compare format—updated daily

- Product Alerts—receive e-mails when new products go online
- Inquiry Basket—send inquiries quickly to multiple suppliers

NEW

Releasing 20 patented new products each year



Cute camera (ABS-168L)

- Anti-drop
- Changeable silicone case



Game camera (ABS-528It)

- 5MP dual lens
- Anti-drop silicone handles
- Supports more than 100 games



Walkie talkie camera (ABS-12)

- 2MP dual lens
- With flashlight
- Back clip design

NEW



100X magnifying camera (ABS-508)

- 5MP dual lens
- 60X digital zoom
- 3.5" HD LCD screen
- Bright fill lights

- 10-year manufacturer of sports and kids' cameras
- Offering OEM and ODM services
- Eight R&D senior engineers and six responsible QC staff
- Four assembly lines
- RoHS-compliant products; BSCI-audited factory
- Supplying online (Amazon, Wish, eBay) and offline (Carrefour, Walmart) customers
- Delivery time: within 15 days

Send your inquiries to us today.



Shenzhen Aobaisen Electronic Technology Co. Ltd

6/F, Yuanshuo Science Park, 8 South Lane, Xinshiqiao St, Guihua, Guanlan, Longhua, Shenzhen, Guangdong 518110, China
 Tel: (86-755) 2798 8633 • Fax: (86-755) 2798 8966

E-mail: sales@aobaisen.com

www.globalsources.com/aobaisen.co

www.aobaisen.com

Global Sources Verified Supplier ★★★★★

BSCI CE RoHS KC EN71 IEC62133 MSDS UN38.3



NEW

ISO 9001:2015-certified specialist producer of portable pure-sine wave inverters



Car power inverter with USB output (GK-12U)

- New design, lightweight and easy to hold
- USB output: DC 5V/30.1A
- USB output: DC 5V/2.1A
- DC output: DC 12 V /10A

Pure sine wave car power inverter (GK-12-150NS)

- AC output: 150W
- USB output: 5V DC/2.1A
- DC input: 12 V DC



Power electronics in-vehicle

NEW

- We are one of the top inverter suppliers to Japan
- In-house brand
- 120,000 units produced monthly
- OEM and ODM services available
- RoHS- and CE-marked products offered

Contact us today to know more about our products.



Modified sine wave inverter
(GP-12-5A-10A-15A-20A-30A)

- Electrically isolated design
- Modified sine wave
- German-type receptacle
- With protection for children
- 2A USB port with smart IC, compatible with most mobile phones
- Customized specifications are welcomed



DC to DC converter with energy conversion efficiency of up to 93% (GP-2412-50A)

- Input voltage: 24V
- Output voltage: 13.6V

Multi-stage in-vehicle battery charger (GW-3212 20A/GW-3212 30A/ GW-3212A 30A/GW-3212B 30A)

- DC to DC battery charger
- Wide charging range 9-32 VDC
- Built-in buck-boost automatic switching function to adjust input voltage to the appropriate charging voltage
- Stage charging modes (CC, CV and float)
- Output current 30A max. for quick charge
- Setting lead-acid/AGM/GEL battery charging mode by user
- LCD display to show the battery is charging and the input voltage, battery voltage and charging current

**GENIUS POWER****Drow Enterprise Co. Ltd**

No. 100, Alley 371, Lane 942, Ta Wan Rd, Yongkang Dist, Tainan 71070, Taiwan Region

Tel: (886-6) 272 8555 ext. 206, 223 • Fax: (886-6) 205 5426, 271 6310

E-mail: geniusc.com@msa.hinet.net

www.globalsources.com/drow.co • www.genius.com.tw

Global Sources Verified Supplier ★★★★★

REACH RoHS TÜV SASO



ISO 9001:2015 ISO 14001:2015

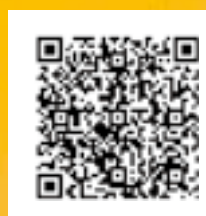

NEW

An expert in mobile phone accessories since 2005



Mobile phone adapter (C31/C32/C33)

- C31: one USB-A port + one Type-C port, 18W
- USB-A output: 3.6-6.5 V/0.3A, 6.6-9 V/2A, 9.1-12 V/1.5A
- Type-C output: 5V/3A, 9V/2A, 12V/1.5A
- C32: one QC port, 18W; 5V/3A, 9V/2A, 12V/1.5A
- C33: dual USB ports, 12W; 5V/2.4A

NEW



- Mobile phone adapter (C6)
- PD 3.0 + QC 3.0 dual output
 - 18W USB-C output, fast charging
 - Intelligent multi-protocol compatibility



- GaN mini charger (N1)
- GaN technology, PD 61W high power
 - Fully compatible with multiple devices



- Car mobile phone bracket (HO-96)
- 4.0"-6.5" airvent outlet
 - One-hand operation, easy to take off
 - Automatic clamping, 360° free rotation



- Car charger (MQC-61)
- 18W PD + QC 3.0 dual output
 - Aluminum alloy shell, good heat dissipation
 - Universal for multiple automobiles, compatible with multiple devices



- USB data cable (KDS-100)
- Liquid silica gel material
 - Safe and non-toxic; elastic and non-cracking
 - 10,000+ violent bending, sturdy and durable

- USB data cable (IP-190)
- PD 18W USB-C to Lightning fast charging
 - Thick copper core, aluminum magnesium shielding
 - Conductive wire, no damage to devices



- Product range includes USB cables, charger adapters, power banks, earphones, Bluetooth earphones, TWS headsets, USB flash drives, memory cards and auto series
- 10,000-square-meter factory
- 12 production lines; 300 employees
- Monthly production capacity: three million pcs
- Integrating R&D, design, manufacturing and sales
- R&D team develops 6-9 new products per month
- 24/7 after-sales services
- 100% inspection of all products

Contact us today to become our valued customer.

NEW



- Wireless charging power bank (P10)
- 10,000 mAh large capacity
 - PD + QC 10/18 W wireless output
 - LED display
 - Could be used as mobile phone holder



- Mini PD power bank (RM-130)
- 10,000 mAh practical capacity
 - PD 3.0 + QC 3.0 18W output
 - LED real-time power display



- PD power bank (RM-230)
- 20,000 mAh large capacity
 - PD 3.0 + QC 3.0 18W output
 - LED real-time power display

NEW

TWS headset (TWS1)

- 800 mAh battery charging case
- LED power display, IPX7-level waterproof



TWS headset (TWS5)

- LED display with super battery life
- Button-raised design, trendy, easy to use
- Hi-Fi sound quality



Bluetooth earphones (ST-51)

- Composite diaphragm speaker, bass sound
- HD mic with noise-reduction upgrade
- Small and light magnetic design, comfortable on-ear



Bluetooth earphones (ST-08)

- Hall-effect switch, magnetic necklace design
- 16g, waterproof
- HD sound, deep bass
- Charging time: 1.5 hours, playback time: seven hours

Shenzhen De Qin Sheng Technology Co. Ltd

Bldg A4, 112 Industrial Avenue, Fuchengao, Pinghu St, Longgang, Shenzhen, Guangdong 518000, China

Tel: (86-755) 8455 3060 • Fax: (86-755) 8455 3055

Mobile: (86) 159 2773 0353

E-mail: sales002@jellicohk.com

www.globalsources.com/deqinsheng.co

Global Sources  Verified Supplier ★★★★★



Illustrations shown here are drawings or other representations of products. They are not actual photographs of the products.

NEW



Showroom

**Focusing on gaming accessories
for more than 15 years**

NEW

- Facility covering 8,000 square meters; eight automatic assembly lines
- Conducting eight quality control procedures
- Participated in multiple exhibitions, including CES, GITEX, DataNet Mexico, Cairo ICT, IEAE, Vietnam International Trade Fair and Hong Kong Electronics Fair
- Distributors in 68 countries and regions around the world

Contact us today to negotiate business.

NEW

RGB gaming keyboard (K9520)

- 19 anti-ghost keys
- RGB backlight with adjustable brightness
- Ergonomic design with detachable magnetic wrist rest



Lightweight gaming mouse (GM015)

- Honeycomb shell design
- Adjustable RGB LED light
- High-performance optical sensor



One-handed gaming keyboard (KB015)

- Driver-free, plug-and-play
- Ergonomic shape with comfortable palm rest
- Macro recording keys

NEW

Leather gaming chairs (CHR15)

- 2D adjustable armrests: up and down, rotatable to the sides
- Adjustable headrests and lumbar pillows
- 180° reclining back angle adjustment



Programmable gaming mouse (G3360)

- Resolution up to 12,000 DPI
- Customized chromatic light, supports Macro programming
- Professional gaming sensor, suitable for various kinds of games



Z-shaped gaming desk (DSK10)

- Z-shaped structural mechanics table leg
- P2 environmental sheet: scentless, comfortable and wear-resistant
- Piano paint

NEW



GITEX Technology Week



Sponsored football team



Sponsored e-Sports team



Sponsored e-Sports tournament



DataNet Mexico



Shenzhen Meetion Tech Co. Ltd

Bldg 2, Hengchangrong High-tech Park, Huangtian, Xixiang St, Shenzhen, Guangdong 518126, China

Tel: (86-755) 2357 9736 • Fax: (86-755) 2357 9735

E-mail: info@meetion.com

www.globalsources.com/meetion.co • www.meetion.com

Global Sources  Verified Supplier ★★★★★

ISO 9001:2015 REACH PAHs POP BSCI



The **No. 1 site** for buyers of Consumer Electronics

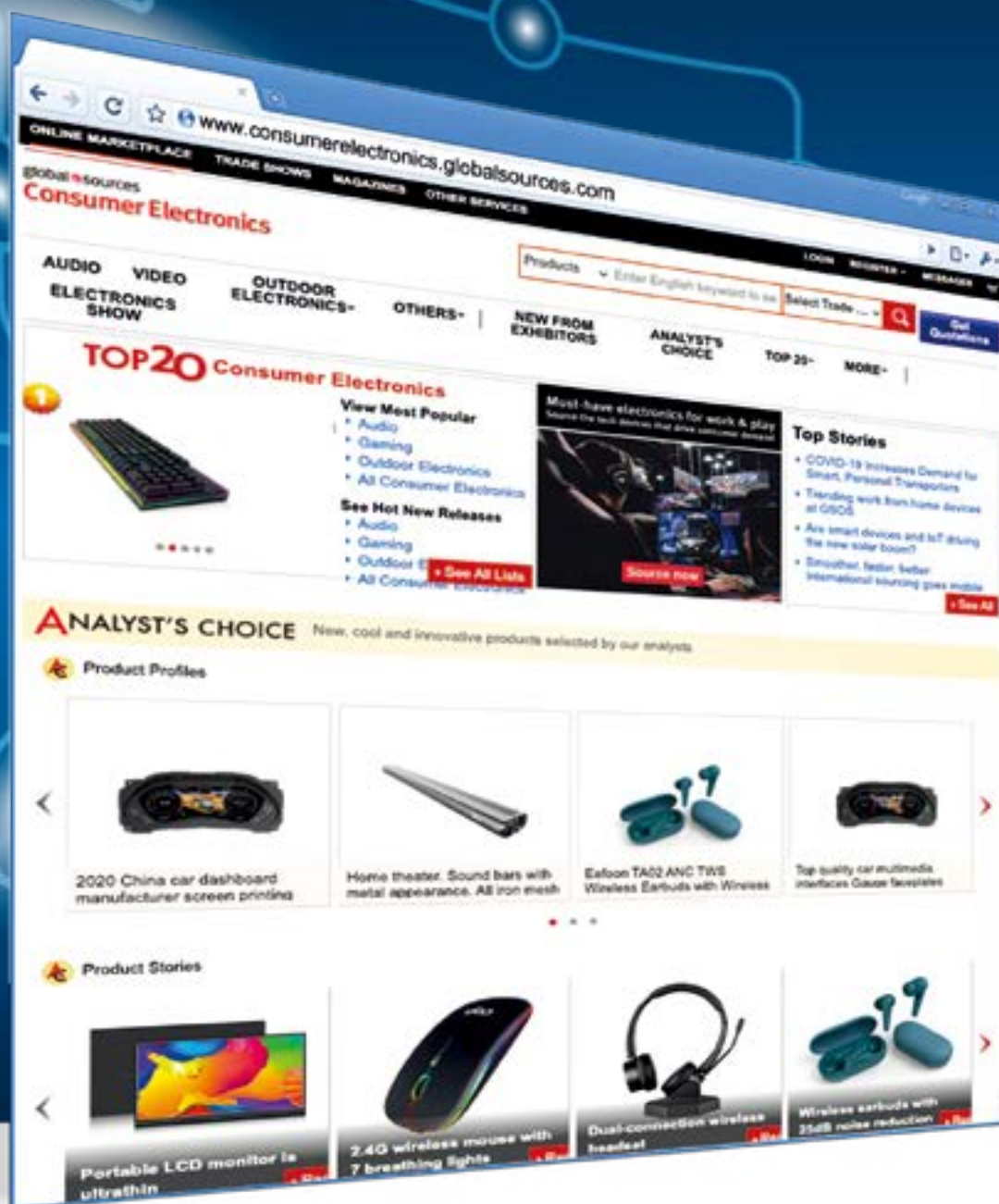

- ✓ 5 sections of extensive new product coverage — updated daily
- ✓ Most qualified supplier community – exporters, exhibitors, audited
- ✓ Exclusive reports, research and analysis



global  sources
Consumer Electronics

www.globalsources.com/ConsumerElectronics

NEW**Laptop power banks**

- Battery capacity: 19,200/38,400 mAh
- Micro USB input: DC 5V/2A, 9V/2A, 12V/1.5A
- USB-C input: DC 5V/20V, 2A/5A; PD 100W (max)
- USB-C output: DC 5V/20V, 2A/5A; PD 100W (max)
- USB-1 output: DC 5V/3A, 9V/2A, 12V/1.5A
- USB-2 output: DC 5V/3A
- Total output: 115W (max)
- PD 100W compatible with MacBook/Laptop (Samsung/Xiaomi/Huawei)/PSP/Switch and other USB-C-based devices

Over 10-year OEM/ODM factory provides a one-stop service for power banks

- 8,000m² working area with 150 staff
- Six production lines including two automated production lines
- Experienced supply chain management team and complete QC system
- An independent product testing laboratory
- CE-, RoHS-, REACH- and FCC-marked products

For more details, please contact us today.

NEW



FOXSKY[®]

Shenzhen Fudeng Technology Co. Ltd

4/F, Unit C, Yourong Technology Park, 13 Shuitian 1st Rd, Baolong St, Tongle Community, Longgang, Shenzhen, Guangdong 518116, China

Tel: (86-755) 6684 2198 • Fax: (86-755) 6684 1281

E-mail: foxsky@foxskychannel.com

www.globalsources.com/foxskychannel.co • www.foxskychannel.com

Global Sources  Verified Supplier ★★★★★



NEW

Working with CNAS-certified laboratory to ensure product safety and reliability

- Our products come with CE, FCC, RoHS, BIS and IEC62133 certifications
- Experienced supply chain management team and complete QC system
- Independent product testing laboratory
- Our USB-C output supports FC2.0/ FC3.0/AFC/FCP/PD2.0/PD3.0/PPS, and USB-A output supports FC2.0/FC3.0/AFC/FCP/SCP/VOOC

We can customize logos and packaging to your demands. Inquire now.



PD 27W USB-C mini power bank

- Battery capacity: 9,600 mAh
- USB-C input: DC 5V/2.4A, 9V/3A, 12V/2.25A
- USB-C output: DC 5V/2.4A, 9V/3A, 12V/2.25A
- USB-A output: DC 5V/4.5A, 9V/2A, 12V/2.0A



PD 60W USB-C laptop power bank

- Battery capacity: 19,200 mAh
- USB input: DC 5V/2A, 9V/2A, 12V/1.5A
- USB-C input: DC 5V/3A, 9V/3A, 12V/3A, 15V/3A, 20V/3A
- USB-C output: DC 5V/2.4A, 9V/3A, 12V/3A, 15V/3A, 20V/3A
- USB-1 output: DC 5V/4.5A, 9V/3A, 12V/2.0A
- USB-2 output: DC 5V/3A, 9V/2A, 12V/1.5A



PD 27W USB-C laptop power bank

- Battery capacity: 19,200 mAh
- USB-C input: DC 5V/2.4A, 9V/3A, 12V/2.25A
- USB-C output: DC 5V/2.4A, 9V/3A, 12V/2.25A
- USB-1 output: DC 5V/4.5A, 9V/2A, 12V/2.0A
- USB-2 output: DC 5V/3.0A, 9V/2A, 12V/1.5A

NEW



PD 45W USB-C power bank for MacBook

- Battery capacity: 14,400 mAh
- Micro USB input: DC 5V/2A, 9V/2A, 12V/1.5A
- USB-C input: DC 5V/3A, 9V/3A, 12V/3A, 15V/3A, 20V/3A
- USB-C output: DC 5V/3A, 9V/3A, 12V/3A, 15V/3A, 20V/2.25A
- USB-1 output: DC 5V/4.5A, 9V/2A, 12V/2A
- USB-2 output: DC 5V/3A, 9V/2A, 12V/1.5A

FOXSKY[®]

Shenzhen Fudeng Technology Co. Ltd

4/F, Unit C, Yourong Technology Park, 13 Shuitian 1st Rd, Baolong St, Tongle Community, Longgang, Shenzhen, Guangdong 518116, China
 Tel: (86-755) 6684 2198 • Fax: (86-755) 6684 1281

E-mail: foxsky@foxskychannel.com

www.globalsources.com/foxskychannel.co • www.foxskychannel.com

Global Sources  Verified Supplier ★★★★★



NEW

Customer-oriented PC accessory factory with 14 years' OEM experience

Focusing on private tooling production and development

- ODM and small orders accepted
- Providing professional pre-sales and after-sales services for 14 years
- 10 experienced R&D staff
- Releasing 10-15 private models per year
- HAMA, Walmart and Vodafone trust us
- Products with CE, RoHS, REACH, PAHs, SCCP, FCC and KC marks
- Factory has passed ISO 9001, BSCI, Sedex and Walmart certifications
- Delivery time of OEM orders: 30-35 days
- Daily output: 3,000-5,000 pcs
- MOQ: 1,000 pcs

Inquire now.

STAR
Technology



Star Technology Industrial Co. Ltd

Yindu Industrial District, Pengwu, Dongkeng, Dongguan, Guangdong 518100, China

Tel: (86-755) 8639 7260 • Fax: (86-755) 2660 9516

E-mail: sales@star-tec.cn

www.globalsources.com/startec.co

www.star-tec.com.cn

Global Sources  Verified Supplier ★★★★★



NEW



4-in-1 RGB light gaming combo



61 keys mini mechanical keyboard



RGB light mechanical keyboard



Private tooling RGB light gaming mice

RGB light gaming headphones

NEW

Professional manufacturer

4-port USB travel charger (isn5-A40550)

- Input: 100 - 240V AC and 50/60Hz
- Output: 5V, 5A
- Size: 71.7 x 66 x 28.4mm



- Exporting to Australia, Germany, Spain, the UK, Belgium and more
- Items come with CE, RoHS, FCC and SAA approvals
- Own R&D, mold workshop, QC and production departments
- Monthly capacity of 100,000 pieces; MOQ of 1,000 pieces
- Stringent QC inspection with 0.2% defect rate
- OEM and ODM services available
- Over 60 staff members

To begin sourcing, contact us today.

NEW

of USB chargers and cables for over 14 years



2-port USB charger (isn5-A20535)



2-port USB charger (isn5-A20520)



4-port USB charger (isn5-A40525)



USB charger (isn5-A10521)



Quick charging wall charger (isn5-A10530)



18W PD+QC charger



2.4A 2-port USB charger (isn5-A20524)



Wireless charging pad



USB-C cables (C3101)

YXISN5 ELECTRONIC CO., LTD.

Block B, 60 Maoxing Rd, Houmao, Fengze, Quanzhou, Fujian 362000, China

Tel: (86-595) 2827 2668 • Fax: (86-595) 2279 8063

E-mail: sales01@yxisn5.com

www.globalsources.com/yxisn5.co • www.yxisn5.com

Global Sources Verified Supplier

SAA CE FCC ETL



NEW**Gaming chair**

- Faux leather, soft and delicate texture
- Ergonomic and durable design with density of 75 kgs / M3 foam padding
- Super cool design makes the chair unique and outstanding
- Adjustable pro 4D armrests
- Multi-functional mechanism
- Aluminum base with ultra-high breakage resistance
- 65mm silent PU caster

- Independent metal frame production workshop
- Products certified to EN1335, CE, RoHS and TÜV standards
- BSCI- and ISO 9001-certified factory
- Small orders accepted

We don't just talk, we focus on action. Contact us now.

NEW

Providing 3-5 new designs monthly for clients worldwide

Main markets are Europe and the Americas



Gaming chairs

Gaming chair

- Gaming chair with RGB function
- Color controller, with single color and multicolor
- Cold molded foam for seat
- Class 4 gas lift
- 350mm nylon base, 60mm nylon caster

Ruibao

Anji Ruibao Furniture Co. Ltd

259 Ruizhu Rd, Zone 3 Sunshine Industrial Park,
Anji County, Zhejiang 313300, China
Tel: (86-572) 209 6897 • Fax: (86-572) 566 0537
E-mail: sales@rbchairs.com • tracy@rbchairs.com
www.globalsources.com/rbchairs.co
www.rbchairs.com

Global Sources  Verified Supplier ★★★★★



Analyst's Choice

Innovative and newly launched products from the entire Asian supply market

LED gaming chair tilts, rocks

[CONTACT SUPPLIER](#)

Anji Ruibao Furniture Co. Ltd (China)



Anji Ruibao Furniture Co. Ltd's model RGC-90042-1 LED gaming chair has tilting and rocking mechanisms. It can be adjusted up, down, and made to swivel and more.

The chair is made of PU leather with contrast stitching. It has an adjustable 2, 3 or 4D armrest and a class 4 gas lift.

Product details

Model:	RGC-90042-1
MOQ:	1 carton
Lead time:	20 to 25 days
FOB price:	\$65 to \$75

Supplier profile

Year established:	2010
Export markets:	Europe, South America, Middle East, Southeast Asia
Export products:	Gaming, office & racing chairs
Total staff:	150 to 200

www.globalsources.com/rbchairs.co

Self-balancing hovershoes run up to 12kph

[CONTACT SUPPLIER](#)

Freeman Intelligent Power Ltd (China)



From Freeman Intelligent Power Ltd, the D5-4885 model is a pair of self-balancing hovershoes that can run 10 to 12kph. The transporter covers 8 to 12km on a single charge of its 25.2V, 2Ah batteries with 50.4Wh capacity. Charging takes 2.5 to 3.5 hours.

The hovershoes handle up to 100kg and climb a 10-degree slope. They come with a user manual and a charger.

Guangdong province-based Freeman owns an ISO-compliant and BSCI-certified factory. It can make 2,000 products daily.

Product details

Model:	D5-4885
MOQ:	1 pair
Lead time:	30 to 35 days
FOB price:	\$90 to \$105 per pair

Supplier profile

Year established:	2014
Export markets:	Asia, Australasia, Central/South America, Europe, North America
Export products:	Unicycles, hoverboards, skateboards, electric scooters
Total staff:	100 to 150

www.globalsources.com/free-man.co

Charging dock for Nintendo Switch

[CONTACT SUPPLIER](#)

Shenzhen SZENXIN Technology Co. Ltd (China)



Shenzhen SZENXIN Technology Co. Ltd's SW-Charger 01-5809 is a fast-charging dock for Nintendo Switch Joy-Con controllers, with LED indicators. It has a built-in IC chip to prevent overcharging and overheating.

Mobile phone accessories specialist SZENXIN provides OEM and ODM services.

Product details

Model:	SW-Charger 01-5809
MOQ:	1,000 units
Lead time:	15 to 25 days
Certification:	CE
FOB price:	\$4.30

Supplier profile

Year established:	2013
Export markets:	Asia, Australasia, Central and South America
Export products:	Bluetooth headphones, Bluetooth stereo headsets, controller charging stations
Annual sales:	\$4 million to \$5 million
Total staff:	40 to 59

www.globalsources.com/szenxin.co

Modular Bluetooth gamepad

[CONTACT SUPPLIER](#)

Shenzhen Huachuangxing New Material Co. Ltd (China)



The S900 from Shenzhen Huachuangxing New Material Co. Ltd is a Bluetooth gamepad for the Nintendo Switch and PCs. It is modular. The rocker direction keys are interchangeable. The controller supports four-speed vibration adjustment.

Shenzhen Huachuangxing's products meet CE, FCC, RoHS and other standards.

Product details

Model:	S900
MOQ:	50 units
Lead time:	5 to 15 days
FOB price:	\$12 to \$13

Supplier profile

Year established:	2015
Export markets:	Asia, Central/South America, North America, Western Europe
Export products:	Joysticks, mobile phone accessories, health protection products, other

www.globalsources.com/szhcxgood.co

[continued on page 95 »](#)

NEW

Completing 50 ODM projects per year

- Specializing in the manufacture of UV sterilizer boxes and IP67 waterproof power banks
- Releasing 10 new IDs each month
- Products passing UL 2056 and Qi tests
- We do ID, tooling and PCB design for all products

Call us today to learn more.



10,000mAh power bank with waterproof flashlight

- Outdoor design
- IP67 waterproof level



Firstar Company Limited

Building A4, Fuzhong Industrial Park, Xiashiwei Rd, Fuyong St, Bao'an, Shenzhen, Guangdong 518103, China

Tel: (86-755) 3635 4917 • Fax: (86-755) 3311 6832

E-mail: peter@szfirstar.com

www.globalsources.com/sz-firstar.co

www.szfirstar.com

Global Sources  Verified Supplier ★★★★★



NEW



- Wireless chargers with sterilizing boxes
- 5 minutes of UVA + UVC disinfection
 - Kill 99.9% of germs
 - Suitable for 7-inch mobile phones, watches, headphones and jewelry

NEW

Over 17-year manufacturer



17"/19" combined LED KVM switch with 8/16 ports (MT-1708UL)

- Server room, modular design
- Easy to maintain: manually dismantle KVM module or operation screen
- Easy to upgrade: KVM module can be replaced at will
- 98-key keyboard and touch-pad touch/slide mouse
- Data can be transmitted only with standard (full 24+5 pin) DVI cable

- Providing OEM/ODM services for more than 160 customers
- Own R&D team and patents
- Over 50 engineers offer technical support
- ISO 9001-certified factory
- Our products meet CE, RoHS, EMC and FCC standards, and have been tested by SGS

You are welcome to contact us for more details.



Four-port HDMI video wall (MT-HD0104)

- One-way HDMI 1.4 signal input, four HDMI signal outputs
- Supports audio input and output
- Splicing mode can be changed at will, and four-way splicing can be 2 x 2 mode, with 2 x 1, 3 x 1, 4 x 1, 1 x 2, 1 x 3, 1 x 4 and other modes also available
- Cascading mode and multi-mode combination to form various shaped stitching
- 3D signal can be automatically recognized and switched using HDMI 1.4 input



1,000m HDMI extenders over optical cables (MT-ED07)

- One local output and two remote outputs
- Uncompressed video resolution up to 4K x 2K
- EDID copy function
- Support HDMI output with HDMI loop output on the transmitter
- Multi-mode optical fiber

NEW

of A/V converter systems



HDMI matrix and extender (MT-ED404)

- 4 x 4 HDMI matrix switches and extenders
- Four local and four remote outputs
- Switch by button, RS232, IR and TCP control
- 50m extended distance by UTP
- 4K x 2K resolution for local, 1080P for remote

MT-VIKI[®]
迈拓维矩

Guangdong MT-VIKI Electronics Technology Co. Ltd

19 Side St, Beiyong, Daojiao, Dongguan, Guangdong 523000, China

Mobile: (86) 158 8997 8827

Fax: (86-769) 8833 7108

E-mail: abyzhou@mt-viki.com

www.globalsources.com/mt-viki.co

www.mt-viki.net

Global Sources  Verified Supplier ★★★★★

ISO 9001:2015 REACH HDCP HDBaseT RoHS



100-300 m wireless HDMI extenders (MT-EDW100)

- Transfer HDMI signal by Wi-Fi, with range up to 300m
- Dedicated format for compressing and decompressing videos, effectively improving transmission efficiency and keeping smooth playback
- Support external remote infrared control for convenient manipulation of remote devices
- Can automatically identify and configure various display modes
- One transmitter to many receivers supported



4K @ 60Hz HDMI splitter (MT-SP142)

- 2/4/8 ports
- HDMI: 3D, color depth of 4K, compatible with HDCP2.2
- Supports HDR
- Resolution up to 4096 x 2160/3840 x 2160 @ 60Hz (4:4:4)
- Data transfer rate up to 18 Gbps (6 Gbps/channel)

NEW

We have more than 10 years' industry experience



Car dashboard for Jeep Wrangler JK2011-2018 (J PRO)

- Original data, stable and reliable
- Fast power-on
- More convenient interactive experience
- Independent R&D system: CAROBOTOR OS
- Full LCD display, ultimate visual experience
- Accurate data display during complex road conditions
- Switch between multiple themes at will



NEW



Car dashboard for Nissan Patrol Y62 (Y PRO)



Car dashboard for Toyota Land Cruiser LC200 (TL03)

- Linux-based product development ensures stable and fast system
- We can customize for different types of vehicle models
- More than 20 development engineers

Contact us now to learn more.



Shenzhen Carobotor Technology Co. Ltd

Rm 318, Bldg 1, Mingliang Technology Zone, Zhuguang N. Rd,
 Nanshan, Shenzhen, Guangdong 518100, China
 Mobile: (86) 138 2316 2253
 E-mail: tyliu268@gmail.com • sales@carobotor.com
www.globalsources.com/carobotor.co
www.carobotor.ca

Global Sources Verified Supplier ★★★★★

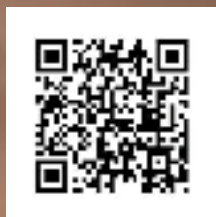

NEW

15 years' production experience in KVM switches

- Supplying OEM/ODM customers in more than 50 countries since 2005
- 20+ product patents
- 100% inspection before shipment
- Small orders accepted
- Factory is equipped with SMT machines

Source from us today.

OYEL[®]

Shenzhen Lianhongtai Electronic Co. Ltd

3/F, Gate 4, Bldg 5, Fluent Industrial Park, Huaxing Rd, Dalang St, Longhua, Shenzhen, Guangdong 518109, China
 Tel: (86-755) 2815 4462 • Fax: (86-755) 2815 3709
 E-mail: lhtoyel@163.com
www.globalsources.com/oyel.co
www.szoyel.com/index.php?l=en

Global Sources  Verified Supplier ★★★★★

CE



- 2-port HDMI cable KVM switch (EL-21HUB-C)
- Supports 4K x 2K @ 30Hz/60Hz high definition
 - Switching mode: Button switching
 - Supports keyboard mouse

- 30m HDMI extender (EL-HE30-1.0)
- 30m distance supports 1080p, 10m distance supports 4K
 - Supports plug and play

NEW

2 x 2 DP dual monitor KVM switch (EL-22DB)

- Supports 8K high definition
- Switching mode: IR controller/button
- Supports replication and extended features
- 4 x MTT USB 2.0 interface



8-port mini HDMI splitter (EL-148M)

- Supports 4K x 2K @ 30Hz high definition
- Supports plug and play

MFi 6.5.1-licensed, Sedex- and Walmart-audited manufacturer

- Our products are made in China and Vietnam
- Qi Wireless Charging Consortium (WPC) member
- USB-IF member (vendor ID: 11254)

OEM/ODM and logistics services available. Don't hesitate to contact us now.

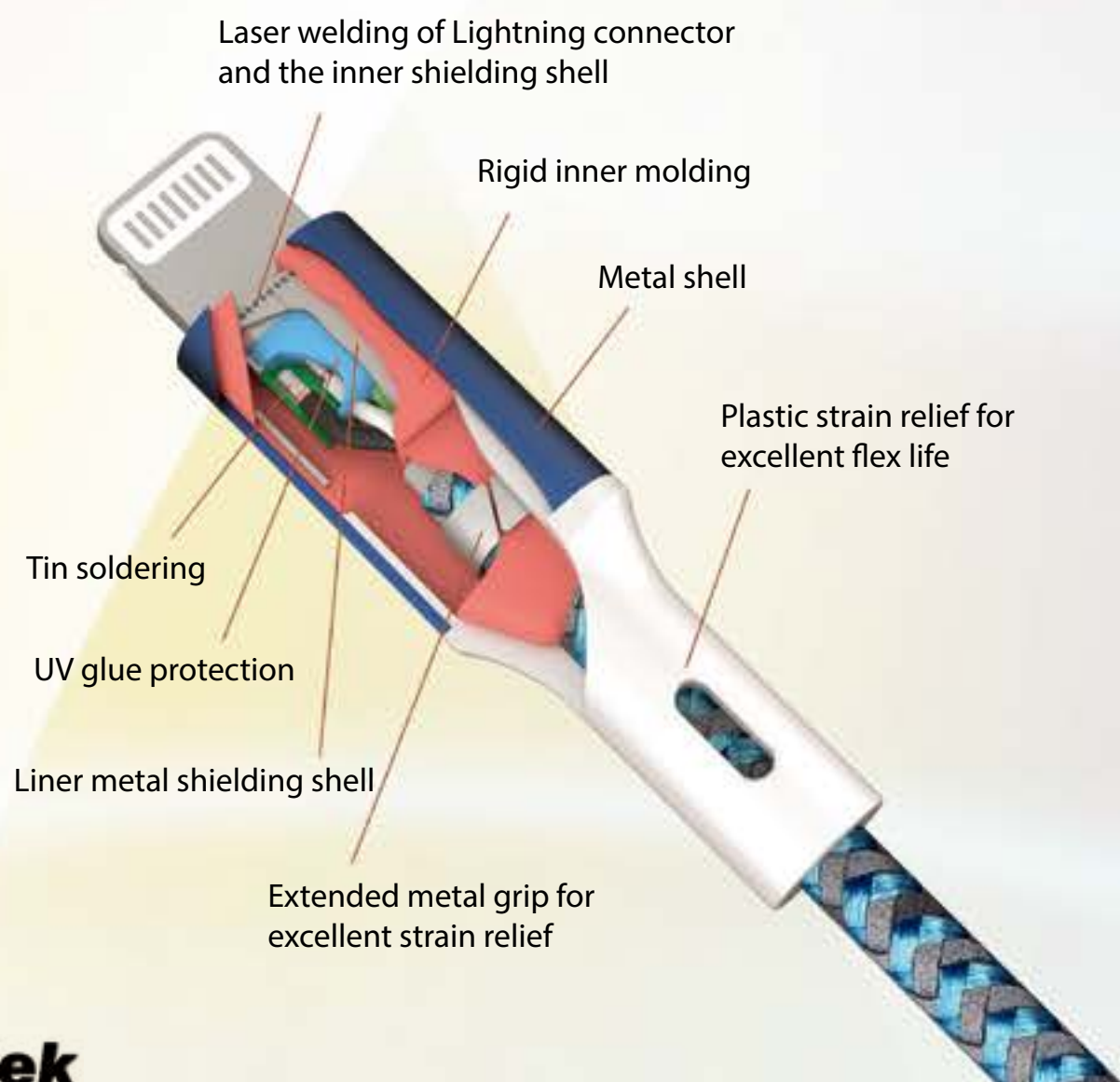

Sinotek

Shenzhen Sinotek Technology Co. Ltd

Bldg 5, Shi'ao 2nd Industry Zone, Dalang, Longhua, Shenzhen, Guangdong 518109, China

Tel: (86-755) 2823 3304

E-mail: marketing@sinotek.net

www.globalsources.com/sinotek.co • www.sinotek.net

Global Sources  Verified Supplier ★★★★★

ISO 9001:2000 ISO 14001:2004 ISO 9001:2015 Sedex Walmart



USB-C to Lightning cable



Made for
iPhone | iPad | iPod



NEW

Monthly production capacity of 150,000 units



- Bluetooth earbuds (TZ-EH303)
- Bluetooth version: 5.0
 - Quality super bass HD stereo sound
 - Ergonomic design, comfortable to wear



Shenzhen TIZE Technology Co. Ltd

3/F, Bldg 1, Tiankou Industrial Area, Huangtian, Xixiang, Bao'an, Shenzhen, Guangdong 518128, China
 Tel: (86-755) 8606 9065
 E-mail: sales1@tize.com.cn
www.globalsources.com/shenzhen-tize.co
www.cntize.com

Global Sources Verified Supplier ★★★★★



NEW

- Over 10-year OEM/ODM supplier of consumer electronics
- R&D team with nine years' experience
- 150 workers guarantee delivery time of 7-10 days
- SGS-/BV-/TÜV-/BSCI-verified Chinese factory
- Holding 30+ patented designs
- 24-hour online sales support
- 100% inspection before shipping; defect rate of less than 0.1%
- 5,000-square-meter factory with eight production lines and advanced machines

Contact us today to get a prompt quote.



Bluetooth earbuds (TZ-EH305)

Outdoor mini Bluetooth speakers (TZ-I503)



Front desk



Office



Workshop

NEW

Supplying Google-certified Android TV OS and GMS TV boxes

- Established in 2013
- 1,500-square-meter scale workshop and office area
- OEM/ODM services
- One-year warranty
- MOQ: one piece
- All products have passed CE and RoHS certifications

To source high-quality TV boxes, contact us now.

- Google-certified GMS TV box (Amlogic S905x2)
- Google Android 9.0 PEI ATV
 - RAM/ROM: 2GB/16GB
 - Bluetooth voice remote control
 - Supports YouTube 4K, Google Cast and Google Home



Android 9.0 TV box (A5X Play) (RK3318)

- 2+16 eMMC
- 2.4 Wi-Fi



LTE TV box with 4G/3G SIM card



Android 9.0 TV box (A5X MIX) (RK3318)

- 2+16/4+32/4+64GB eMMC
- 2.4/5G Wi-Fi
- Android TV OS system
- Voice remote

NEW



ANDROID 9.0
 2.4G WiFi

Hi3798M V130
 Quad core A53, GPU Mali 450, 64Bit

2GB LPDDR4
 + 16GB ANMMC

LPDDR4
 DDR3



Android TV box

TONIX

- Power
- USB3.0
- HD
- Ethernet
- Headphone microphone jack
- Power button
- SD Card Slot
- USB 0
- VGA

CPU: Intel Atom X5-DK119
Memory: 4GB
Storage: 64GB
WiFi + Bluetooth 4.0: 2.4G + 5.0G
Ethernet LAN: 1000Mbps

Mini PC



Syg Global Technology Co. Ltd

2/F, Bldg 8, Yujingtai Industrial Zone, 35 Huaxin Rd, Dalang St, Longhua, Shenzhen, Guangdong 518109, China

Mobile: (86) 133 1653 8047

E-mail: sales@beelinkbox.com

www.globalsources.com/sygglobal.co

Global Sources Verified Supplier ★★★★★



NEW

7-in-1 Type-C hub (UC-105)

- Port: Type C PD + HDMI + SD + MicroSD + 3 x USB3.0
- Housing: aluminum
- Multi-function: charging, card reader, HDMI 4K x 2K, USB data transfer

- Over 14 years' OEM/ODM experience
- BSCI- and ISO 9001-certified factory
- Supplying USB-C docking, USB hubs and card readers

Call or e-mail us today.

BOYYE

Dongguan Boyye Industrial Co. Ltd

38 Shengye Rd, Huangjiang, Dongguan, Guangdong 523749, China

Tel: (86-769) 8226 0891 • Fax: (86-769) 8226 0895

E-mail: sales@boyye.com

www.globalsources.com/dgboyye.co

www.boyye.com

Global Sources  Verified Supplier ★★★★★★

All items shown here with various trademarks, brand names and logos ('Marks') are for reference purposes only, and are not for sale. The Marks are the property of the respective owners, and we are not authorized to manufacture or sell any items bearing such Marks to any third party.



NEW



Manufacturing computer and mobile phone peripherals since 2006

Focusing on Type-C hubs



3-in-1 Type-C hub with 2 x USB 3.0 + LAN ports (UC-165)



5-in-1 Type-C hub with HDMI + LAN + 3 x USB 3.0 ports (UC-145)



7-in-1 Type-C docking station (UC-166)

- Port: HDMI + Type-C PD + USB 3.0 + SD + Micro SD + 3.5mm audio
- With stand function



7-in-1 Type-C docking station (UC-167)

- Port: HDMI + Type-C PD + USB 3.0 + SD + Micro SD + 3.5mm audio
- With stand function

NEW



ISO 9001-certified one-stop supplier of automated gate systems

Providing smarter gate automation

- 16 years' export experience
- 95% of output exported
- More than 10 years' R&D experience
- OEM/ODM orders accepted

We are looking forward to working with you. Inquire now to learn more about our products and services.



Swing gate openers



NEW



Universal multi-frequency remote control



Sliding gate openers



Giant Alarm System Co. Ltd

37 Yangguang Rd, Optoelectronic Information Base,
 Daxiamei, Nan'an, Fujian 362005, China
 Tel: (86-595) 2249 9516 • Fax: (86-595) 2249 2516
 E-mail: sales06@jujiang.net.cn • jujiang@jujiang.net
 www.globalsources.com/giant.co
 www.cngiant.net • www.giantautogate.com
 Global Sources Verified Supplier ★★★★★



CE SAA

NEW



TWS Bluetooth earphones



Power banks



USB cable



Wall chargers



Shenzhen Aidelong Intelligent Communication Co. Ltd

Bldg B8, Xiufeng Industrial Park, Buji, Longgang, Shenzhen, Guangdong 518112, China

Mobile: (86) 188 2467 1506 • Fax: (86-755) 2855 9389

E-mail: info2@szadl.com

www.globalsources.com/aidelong.co • www.smartsdl.com

Global Sources Verified Supplier ★★★★★



ISO 9001:2015



NEW

SGS-audited factory providing 200+ models of mobile phone accessories and intelligent hardware

- 15 years' OEM and ODM experience
- Developing 2-3 new molds each month
- 929m² warehouse; fast delivery: 3 days
- One-stop mobile accessory solutions
- ISO 9001:2015-certified factory
- Serving Global 500 companies like HSBC, Shell and China Mobile
- Power banks, chargers and cables with 11 utility and design patents
- MOQ: 100pcs

Inquire now.



360° rotatable car tracking holder

NEW

Powerful soundbar with mobile phone holder

- Crystal-clear stereo finished on cover
- Built-in 1,800mAh Lithium battery
- Playing time: 6-7 hours
- Supports TWS connection, hands free calling, USB drive and Aux input

- Exporting to 50 countries including the US, Canada, Mexico, Chile and Brazil
- Our factory has 6 Bluetooth speaker production lines, 2 TWS earphone production lines and 2 automatic tooling and painting lines
- Producing 500,000 pcs of speakers per month
- Products with CE, RoHS and FCC certifications
- ISO 9001-certified factory
- 15 large-scale injection machines in our model room

Call us now.

NEW

We develop 3 new models monthly and welcome OEM/ODM projects



TWS earbuds with built-in 40mAh battery

- Using Realtek solution
- Playing time: 25 hours
- With charging base
- 5.0 + EDR Bluetooth version
- Support binaural call function
- ABS material with high SPL



Wireless charging case



Shenzhen Hongyesheng Technology Co. Ltd

Letu Industrial Park, Xiakeng 1st Road, Changping,
Dongguan, Guangdong 518028, China
Tel: (86-769) 8399 1909
E-mail: admin@sz-hyskj.com
www.globalsources.com/szhyskj.co

Global Sources  Verified Supplier ★★★★★

RoHS CE FC



NEW

Professional R&D team with 21 experienced engineers

- Independent technology developing capabilities
- Launching new products every two years
- Online and offline shipping modes
- OEM/ODM services

Call us today to learn more.



Mini game consoles (HQ-M2)

- Dual boot system
- Function: supports emulator and game download



Wireless gamepad (HQ-G8721)

- Color: black
- Supports Android/iOS devices/PC



Ultra-thin concave two players game console (HQ-A1)

NEW



New horizontal mini game console
 • With L&R button
 • Colors: yellow/pink/blue



Shenzhen Moorechip Technologies Limited

Rm 606, Donglian Block, Bao'an, Shenzhen, Guangdong 518101, China
 Tel: (86-755) 2787 3253
 E-mail: daisy@nex-adas.com
 www.globalsources.com/nex-adas.co • www.goretroid.com

Global Sources Verified Supplier ★★★★★



NEW

A BSCI-audited manufacturer with a 4,000m² factory producing 2 million pieces monthly



PD 60W + QC 18W desktop charger

- Dimensions: (L x W x H) 103 x 70 x 28mm
- USB-C 1 output: 60W (5V/3A, 9V/3A, 12V/3A, 15V/3A, 20V/3A)
- USB-C 2 output: PD 18W (5V/3A, 9V/2A, 12/1.5A)
- USB-A 3 output: QC3.0 18W (3.6-6V/3A, 6.5-9V/2A, 9-12V/1.5A)
- USB-A 4 output: 5V/2.1A

NEW

- Expert manufacturer of USB travel chargers, car chargers and power adapters
- SMT workshop with testing, soldering, laser marking and ATE machines
- Providing OEM and ODM services for seven years
- R&D staff and engineers with 10 years' experience working in Astec
- ISO 9001:2015-certified
- Products are compliant with PSE, CB, GS, UL, FCC, KC, cUL, CE, RoHS, SAA and CCC standards

You are welcome to contact us.

PD 30W + QC 30W car charger

- Dimensions: (L x Dia.) 43 x 25mm
- Output 1: PD 30W
- Output 2: QC 30W
- 5V/3A (A+C ports)

USB PD travel charger

- PD 18W
- CE-, RoHS-, CE- and ErP-compliant

PD 18W +QC 18W wall charger

- Dimensions: (L x W x H) 43 x 43 x 23mm
- Output 1: PD 18W
- Output 2: QC 18W
- 5V/3A (A + C ports)



super eagle

Shenzhen Super Eagle Tech Co. Ltd

6-7/F, Building B, Jiabao Industrial Zone, Dawo, Longtian St, Pingshan, Shenzhen, Guangdong 518122, China

Tel: (86-755) 8524 3862 • Fax: (86-755) 2943 0157

E-mail: sales@super-eagle.cn

www.globalsources.com/supereagle.co • www.super-eagle.cn/en

Global Sources Verified Supplier ★★★★★



NEW

10-year OEM/ODM manufacturer with Apple MFi V7.0-certified factory

- 5,000m² factory audited by BSCI
- 100% testing before shipment
- Free design service
- Strong R&D team with 10 years' experience

Call us now for more details.



8-in-1 transparent hub with Type-C to HDMI + PD + 3 × USB 3.1 + TF + SD + RJ45 ports



Plug-and-play Type-C to audio adapter



Wireless charging pad with Qi certification



PD 18W & QC 3.0 car charger

NEW

Flashing USB-C cable



Charging/
flash light



100% full

MFi cable with fluorescent jacket

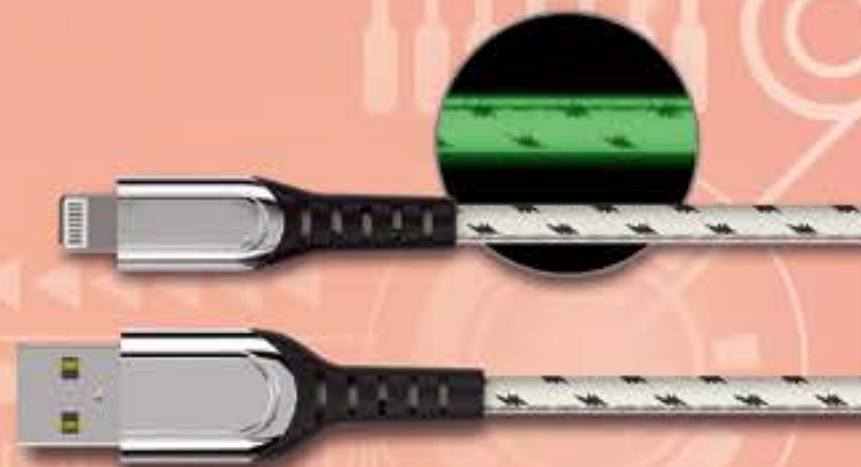

Super-strong jacket with
force bearing of 60kg

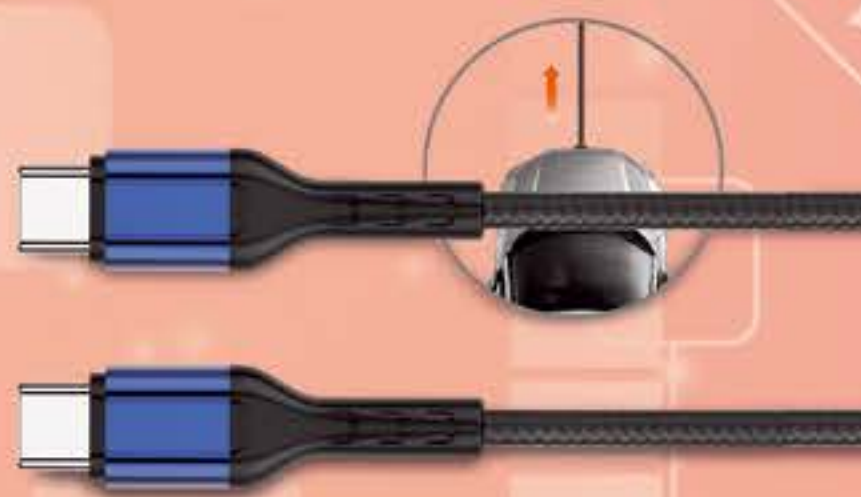

MFi USB-C to lightning cable
with zinc alloy plug



Sunlike Technology Co. Ltd

Bldg 3, Shi'ao 2nd Industrial Zone, Dalang St,
Longhua, Shenzhen, Guangdong 518109, China
Mobile: (86) 186 6581 3398
E-mail: christina@sunlikecable.com
www.globalsources.com/sunlike-technology.co
www.sunlikecable.com.cn



Global Sources Verified Supplier ★★★★★

NEW



We've exported electric scooters for over 15 years

- Experienced in design, production and sales
- Own brand: KUGOO
- Exporting to 15+ countries
- Certifications: eKFV (ABE), CE, UL, RoHS and MSDS

Contact us today to learn more.



Yongkang Kugooo Technology Co. Ltd

98 Mingyuan North Rd, Economic Zone, Yongkang,
 Jinhua, Zhejiang 321300, China
 Tel/Fax: (86-579) 8735 6100
 E-mail: max@kugooo.com
 www.globalsources.com/kugooo.co

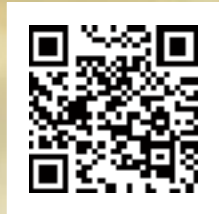

Global Sources Verified Supplier ★★★★★

Electric scooter (S1 PLUS)

- Motor power: 350W/36V
- Lithium battery: 36V, 6.0/7.5 Ah
- Charging time: 3-5 hours
- Tire size: 8" solid tire
- Max load: 120kg



Electric scooter (G-MAX)



Electric scooter (S1 PLUS)

NEW



- Electric scooter (G-MAX)
- Motor power: 500W/36V (peak value: 1,000W)
 - Lithium battery: 36V/10Ah
 - Charging time: 6-7 hours
 - Tire size: 10" inflatable tire
 - Max load: 200kg



Electric scooter (M2 PRO)



Electric scooter (G2 PRO)

NEW

We have been manufacturing products since 2009

- ISO 9001:2015-certified manufacturer
- Holding utility patents
- Small orders accepted
- 12 experienced engineers

Adequate stock for your orders.
Contact us today.

Type-C to RJ45 + HDMI + VGA + 2 x
USB3.0 + USB2.0 + SD/TF + PD

- HDMI: 4K x 30Hz
- VGA: 1080P
- USB3.0 x 2: 5G
- USB2.0: 480Mbps
- PD: PD3.0
- RJ45: gigabit
- SD/TF: 3.0



Hot sell ultra-thin Type-C 5-in-1 hub



Type-C dongle

ISO 9001:2015



NEW

electronic



Mini Type-C hub specially made for iPad Pro



Type-C cable



Worldpass Industrial Co. Ltd

40 Xingfa South Rd, Liwu, Chang'an, Dongguan, Guangdong 523857, China

Tel: (86-769) 3883 1766 • Fax: (86-769) 3886 1709

E-mail: wmsales06@worldtypec.com • kimtang@worldtypec.com

www.globalsources.com/worldpass.co • www.worldtypec.com

Global Sources  Verified Supplier ★★★★★

NEW

Specialist manufacturer of uniquely-designed consumer electronics since 2013

- 100% of our products are exported to overseas markets
- Passed ISO 9000, ISO 14000, BSCI and Sedex 4P certifications
- All products come with CE, RoHS and FCC marks
- Fast delivery: 2-3 days for samples and 18-20 days for complete orders
- Small orders accepted

We provide customization service and full technical support. Inquire now to learn more.



Bluetooth speaker (SUGAR series)

- Easy carrying
- Developed design makes the sound clearer and enhances user's auditory experience
- Can last for about 15 hours



Bluetooth speakers (LOLLY series)

- Rattle- and dandelion-inspired design
- LOLLY won the 2016 Golden Pin Concept Design Award
- Easy-to-operate button, anti-drop design, suitable for all kinds of outdoor environments

UEMade

Shenzhen UEMade Technology Co. Ltd

3/F, Bldg 3, Longfa Industry Park, Dakang Community, Yuanshan St, Longgang, Shenzhen, Guangdong 518115, China

Tel: (86-755) 2555 6885 • Mobile: (86) 185 2089 5246

E-mail: s2@uemade.com

www.globalsources.com/uemade.co • www.uemade.com

Global Sources Verified Supplier ★★★★★



NEW



- Bluetooth speakers (TANK BOX series)
- IPX waterproof, can be used in bathroom and on the seafont
 - Excellent outdoor sound experience
 - Can last for more than 12 hours
 - Support TF card

NEW

Over 12 years' experience in HDMI, USB, Type-C and DVI cables

- ISO 9001-certified manufacturer
- OEM and customization services provided
- Products pass TDR and EMI tests and have RoHS, CE, FCC, ATC and HDMI Premium certifications
- Small orders accepted
- Supplying ZTE, Huawei and Steren

Inquire now to learn more.



C to HDMI cable (TLD-CH01)
 • 4K/60Hz aluminum shell PVC jacket
 • Cypress + PS176 chipset



Data/charging cable (TLD-TC01)
 • USB3.0 to Type-C 3.1
 • With aluminum housing

High-speed Type-C to Type-C data/charging cable with aluminum housing and mesh jacket (TLD-TC02)



NEW



- Premium HDMI cable (TLD-H08)
- EMI passed 4K/60Hz, PVC jacket
 - Nickel-/gold-plated HDMI cable



- HDMI cable (TLD-H02)
- 4K/60Hz double-color PVC shell with mesh jacket
 - Gold-plated HDMI cable



Shenzhen Tailide Science and Technology Co. Ltd

Rm 508-509, Building B, Wisdom Valley Innovation Park, 8 Chang Fa Rd,
Bantian, Longgang, Shenzhen, Guangdong 518109, China

Tel: (86-755) 2935 7201 • Fax: (86-755) 2946 7882

Mobile: (86) 136 9184 2675

E-mail: sales06@tldcable.com

www.globalsources.com/tld.co • www.tldcable.com

Global Sources  Verified Supplier ★★★★★



ISO 9001:2015 **HDMI**[®]
HIGH DEFINITION MULTIMEDIA INTEAFACE

NEW

30+ R&D engineers provide one-stop charging solutions for end-user products from concept to production

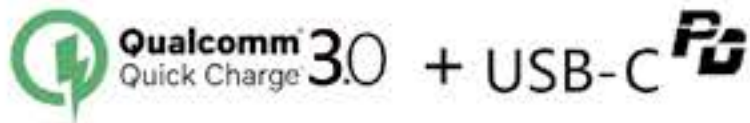

- 65W quick chargers
- USB-C PD and QC 3.0 fast charging
 - Customizable (with/without LED indicator)
 - Multiple output options
 - Universal plugs (detachable plug available)



Shenzhen Rewoda Electronics Co. Ltd

Office: Rm 908, Jia'anda Bldg, 110 Dalang Huafan Rd, Longhua, Shenzhen, Guangdong 518000, China

Factory: 38 Rd, Economy Zone, Ganzhou, Jiangxi 341000, China

Tel: (86-755) 3352 5517

Mobile: (86) 158 1854 2291

E-mail: marketing@rewoda.com

www.globalsources.com/rewoda.co • www.rewoda.com

Global Sources Verified Supplier ★★★★★

UL FCC CE SAA REACH RoHS KC ETL



NEW



65W GaN charger
 • 2 x USB-C + 1 x USB-A
 • GaN technology ultra-small fast charge
 • Universal plugs (detachable plug available)



100W desktop charger
 • 2 x USB-C + 2 x USB-A
 • 4-port ultra-slim with 100W output
 • Universal AC cable options

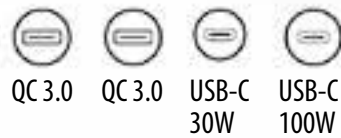

18-65W quick charger family
 • Glossy/half matt + half glossy finishing options
 • Universal plugs (detachable plug available)

- More than 600 employees
- Independent R&D capability
- Constant research in technological innovation to keep costs down and optimize solutions
- Over 50,000m² factory with modern SMT assembly lines and automated machines
- ISO 9001:2015- and ISO 14001:2015-certified; WPC member
- Monthly output: 3.5 million units

For more details, please contact us now.

NEW

SGS- and BV-audited factory

- Nine years' experience in battery quality control
- Nine design patents registered in Europe, the US and China
- Five production lines for e-scooters, e-bikes, hoverboards and sea scooters
- Walmart and Carrefour source from us
- Major markets: Italy, France, Brazil and Israel
- 100% QC before shipment

To learn more, contact us today.



Electric scooter (L9)

- 350W powerful motor
- Europe design patent

NEW



Electric bike (V1)

- EN15194 from TÜV
- Fashion design
- Pedal assistant system (PAS)



Water scooter (F2)

- 3,200W powerful motor
- US and Europe design patents



Shenzhen HTOMT Technology Co. Ltd

7/F, Bldg 3, Zhouteng Industrial Park, Nanwan, Longgang, Shenzhen, Guangdong 518129, China
 Tel: (86-755) 2803 9739 • Fax: (86-755) 2774 5899
 E-mail: assia@htomt.com
www.globalsources.com/htomt.co • www.htomt.com
 Global Sources Verified Supplier ★★★★★



NEW

Car holders and mounts with patents in the US, Germany and the Chinese mainland



Qi wireless charging phone holder

NEW



Windshield and dashboard suction mount holder



USB charger with mount holder



Air vent phone holder



Desk tablet mount with USB charger



Pen holder with USB charger



Magnetic headrest mount with USB charger



Shopping cart/baby stroller phone holder with cup holder



Portable stand for smart speaker/tablet/smartphone



PC monitor/TV display storage rack for cable box/remote controller

- Our holders for smartphones and 7-10" tablet PCs are adjustable
- Expert R&D team can develop new products in just 40 days
- Up to one million handsfree kits and car accessories monthly
- We can offer 3-week lead times for most volume orders
- Goods thoroughly checked at every stage of production
- Orders starting at 5,000 units or more are accepted

Contact us today.



Monoeric International Co. Ltd

2/F, No. 8, Alley 11, Lane 193, Jong Jeng N. Rd,
Sanchung Dist, New Taipei City, Taiwan Region

Tel: (886-2) 2982 1562 • Fax: (886-2) 2983 5061

E-mail: sales@monoeric.com.tw

www.globalsources.com/monoeric.co • www.monoeric.com.tw

Chinese Mainland Factory: Dongguan, Guangdong, China

Global Sources Verified Supplier ★★★★★



NEW**6.5" mini electric scooter (S8)**

- Two independent brake systems: electronic and rear fender physical brakes
- Decorative front LED tube
- LED headlight for safe riding at night
- Three-speed power adjustment
- Light and portable
- Anti-explosion solid tire



NEW

Holding over 100 patents for electric scooters, skateboards, hover boards and children's scooters

- One of the first electric mobility product manufacturers in the Chinese mainland; operating since 2014
- More than 15 experienced engineers in R&D team
- BSCI-certified factory
- All products carry CE, RoHS and REACH marks
- Provided OEM/ODM services to over 50 customers

Send us your OEM/ODM requirements today.



10" electric scooter (S6)

- Safe rear disc brake
- Powerful 350W motor with anti-explosion honeycomb tire
- Fashionable side LED strips
- Higher handle stem and wider anti-slip foot pedal
- Built-in rear physical suspension
- Bluetooth and app supported
- Upgraded folding mechanism
- Detachable seat provides max riding comfort

FREE-MAN

Freeman Intelligent Power Limited

Bldg 2, Gangbei Industrial Park, Ailian Area, Baohe Rd, Xinlian Community, Longcheng St, Longgang, Shenzhen, Guangdong 518172, China

Fax: (86-755) 8672 1060

E-mail: sales@free-man.cn

www.globalsources.com/free-man.co

www.free-man.cn

Global Sources  Verified Supplier ★★★★★



NEW

We passed ISO 9001, BSCI and Sedex audits

All products have CE and RoHS certifications and use KC-certified batteries

- Many famous brands such as Walmart and ELECOM trust us
- One million units produced by our 300 employees each month
- Engineers have over 10 years' experience in earphones
- Delivery time: 20-25 days
- 12-month product quality assurance
- 24-hour after-sales service

Our experienced ID and software engineers can design products based on your requests. Contact us now.



Comfortable earbuds with LCD display (TS06)



Large capacity earbuds with long working time (TS07)



TWS earbuds of superior quality (TS04)



High-quality TWS earbuds with LCD display (TS04S)

NEW



TWS earbuds with HiFi sound and nice design (TS08)

Dongguan Shinecon Industrial Co. Ltd

9 Shibe Rd, Tangli, Fenggang, Dongguan, Guangdong 523000, China

Mobile: (86) 158 7645 3392 • Fax: (86-769) 8906 8109

E-mail: sales2@shinecon.com

www.globalsources.com/ishinecon.co

www.shinecon.com

Global Sources  Verified Supplier ★★★★★

ISO 9001:2015 RoHS BSCI SEDEX CE



NEW

10,000m² BSCI-audited factory



Privately designed new urban e-scooter (Meteor HS8)

- 8.5 inch tires
- 350W
- 5.0/6.0/7.5Ah Chinese battery
- Speed: 25-30Km/h (max)
- 20-30km riding range

Privately designed new urban e-scooter (SWAN HR8)

- 8.5/10 inch tires
- 350W
- 5.0/6.0/7.5Ah Chinese battery
- Speed: 25-30Km/h (max)
- 20-30km riding range

Gyroor Technology (China) Co. Ltd
Shenzhen Chitado Technology Co. Ltd

Bldg 1, No. 1800112, Dafu Industrial Area, Guanlan St, Longhua, Shenzhen, Guangdong 518110, China
 Mobile: (86) 181 2369 2353 • E-mail: Lydia@gyroor.com
 www.globalsources.com/gyroor.co • www.gyroor.com

Global Sources Verified Supplier ★★★★★



NEW

GYROOR®



Hoverboard (Gyroor G5)

- 6.5/8.5 inches, off-road tires
- 36V/4.0Ah Chinese battery
- IPX4 approval



So Funny Gyroor S300

- Battery: 25.2V/2Ah per cell (7 cells in total)
- Max speed: 10km/h



- Holding over 70 patents
- OEM and ODM services
- Providing after-sales services

Gyroor would be a smart choice; contact us today.

NEW

20 years' experience in OEM/ODM digital A/V products

- Supplying customers from all walks of life including speaker retailers, distributors, event organizers, clubs, chain supermarkets and sports goods operators
- Annual sales of about four million units
- Our products are well-recognized by customers in Europe, the Americas and Southeast Asia
- Working with China Mobile, China Unicom, Samsung, Crazy English and Gionee
- Our own brand Music Angel has been registered in nearly 50 countries
- All products carry CCC, CE, RoHS and FCC marks

Contact us now to learn more about our patented products.



MUSIC ANGEL

Shenzhen Junjiahao Technology Co. Ltd

Bldg B, Block A, Phase 2, Tongfuyu Industrial Park, Dalang, Longhua,
Shenzhen, Guangdong 518109, China

Mobile: (86) 137 1438 1919 • Fax: (86-755) 3387 0798

E-mail: sophia@junjiahao.com

www.globalsources.com/junjiahao.co • www.musicangel.com

Global Sources  Verified Supplier ★★★★★



NEW



- Soccer TWS Bluetooth speaker
- 4W, 4ohms, 800mA
 - Anti-drop
 - With LED lights



- Football TWS Bluetooth speaker
- 4W, 4 ohms, 800mAh
 - Palm size
 - Hands-free calling



- Baseball TWS Bluetooth speaker
- 3W, 4 ohms, 600mAh
 - Palm size
 - Hands-free calling
 - Roly-poly



- Bluetooth speaker
- 3W, 4 ohms, 600mAh
 - Earphone interface
 - Built-in TF card
 - Supports MP3 format music



- Bluetooth mini soundbar
- TF card, DSP
 - RMS 10W x 2, 4 ohms



- Smart translator
- Supports 49 languages
 - Remote translation, multilingual chatting and group communication via 4G and Wi-Fi

NEW



Focusing on IoT intelligent hardware since 2005 covering home security, smart life and trip/child safety



- Robot vacuum cleaner (C50)
- 2,600Pa supreme suction
 - 360 smart navigation system
 - The large dust bin can hold up to 510ml of dust and debris
 - 2,600 mAh lithium battery
 - 300ml water tank



- Robot vacuum cleaner (S9)
- LDS lidar + ultrasonic anti-collision sensor + SLAM algorithm
 - 2,200Pa superior suction
 - Dual noise-reduction duct
 - 360 cleaning system 5.0
 - Intelligent water tank



- 360 robot vacuum cleaner (S7)
- 2,000Pa powerful suction with low noise
 - Maximum cleaning area: 180m²
 - Smart and easy app control
 - Anti-collision, anti-drop
 - Identifies carpets and increases suction power automatically



- Robot vacuum cleaner (S5)
- LDS lidar + SLAM algorithm
 - Set up off-limit areas, customized cleaning through app
 - Identifies carpets and increases suction power automatically
 - Anti-collision, anti-drop
 - Automatic recharging + resuming

NEW

- Industry-leading IoT producer in the Chinese mainland; shipped out 10 million pcs
- 1.2 billion users, 97% penetration in the PC market
- 500 million users, 66% penetration in the mobile phone market
- Listed on Shanghai Stock Exchange in 2018
- 12 R&D centers, four cyber research institutes, four cyber-tech labs
- Over 11,000 patents registered at home and abroad since 2018
- 8-10 kinds of new products released every quarter
- Monthly capacity: 500,000 to one million pcs
- Exporting to Europe and the US
- Small orders of 1,000 pcs accepted; delivery time: 45-60 days
- Product qualified rate: 99.99%; third-party inspection supported
- One-/two-year warranty and after-sales services provided
- 100% testing before delivery
- Certifications: CE, RoHS, REACH, WEEE, FCC, C-Tick, EAC, KC, PSE, TELEC, NCC, BSMI, WPC, BIS, RCM, SDPPI and ETL

Contact us today to begin sourcing.



- AC1C 360 smart camera
- Figure detection + audio alarm
 - 1080P HD image
 - Enhanced IR night vision
 - Low-light full-color shooting
 - Dual figure detection



- 360 children's watch (E2)
- 800 mAh battery
 - Waterproof level: IPX8
 - Real-time tracking
 - Dual HD cameras, 5 megapixels + 2 megapixels
 - Children can chat with family members or their friends in groups



- 360 dash camera (G300H)
- 1296P superior HD video quality
 - Clear night vision
 - 160° ultra-wide view angle
 - Built-in GPS and Google map
 - Driver fatigue reminder



Shenzhen Qihoo Jianan Intelligent Technology Co. Ltd

No. A2, Nanshan Intellectual Park, 1001 Xueyuan Rd, Nanshan, Shenzhen, Guangdong 518000, China
 E-mail: globalsales@360.cn
www.globalsources.com/qihujianan.co • smart.360.com

Global Sources  Verified Supplier ★★★★★

REACH WEEE CTICK EAC KC TELEC NCC BSMI WPC BIS RCM SDPPI



An over 8-year manufacturer working with

- Exporting more than 150,000 pcs to the US and over 100,000 pcs to Europe each year
- Product certifications: CE, RoHS, EMC, MD and UL 2272
- Factory certifications: ISO 9001 and BSCI
- Producing more than 1,000 pcs per day
- Small orders ready within one week and bulk orders within one month
- Customized logos, stickers, packaging cartons and manuals accepted

For more details, call or e-mail us today.



- 2019 newly-designed private electric scooter
- 8.5" solid tires, reinforced frame and new app
 - Superior performance: 350W motor, max speed of 18.6 mph, range of 17 miles
 - One-step folding design: 1-second foot-actuated folding for one-hand hold
 - Safety and comfort: smooth and secure braking with front shock absorber
 - Handy riding: simply connect Cxinwalk electric scooter via Bluetooth and use the app to check the scooter before use, activate cruise control and review other riding statistics; available for iOS and Android system
 - Unique and user-friendly: wider anti-slip pedal, dual headlights and clear LED display
 - Protection: short circuit, overcurrent, overcharge, over-discharge, low voltage, and temperature-anomaly protections

Walmart, Carrefour, Best Buy and Kugoo



New e-scooters



cxinwalk
Wuyi Chuangxin Metal Tools Co. Ltd

55 Qingyun Rd, Fenghuangshan Industrial Zone, Tongqin Industrial Park, Wuyi, Jinhua, Zhejiang 321200, China
 Mobile: (86) 152 5897 6965 • Fax: (86-579) 8772 0225
 E-mail: sale@chinachuangxin.net
www.globalsources.com/china-chuangxin.co
www.chinachuangxin.net

Global Sources  Verified Supplier ★★★★★



NEW

We own and operate four factories with over 4,000 employees



Surge protection



Overheating



Over-voltage



Over-current



ETL authentication

- 200+ R&D staff
- OEM/ODM services
- Specialized electronic product manufacturer with over 15 years of experience
- Main export markets: the US and Europe
- Highly advanced testing equipment and process ensures strict quality control
- 360-degree solutions including SMT, tooling, plastic injection, raw cable, metal stamping and connectors
- We invest about 4.5% of annual sales turnover into R&D every year

Contact us today to learn more.

NEW



57W(MAX)

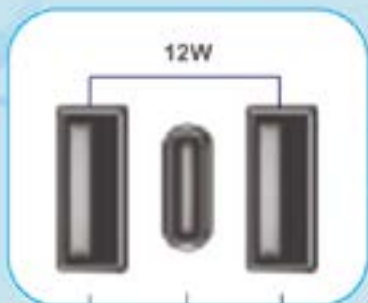

12W PD 45W 12W

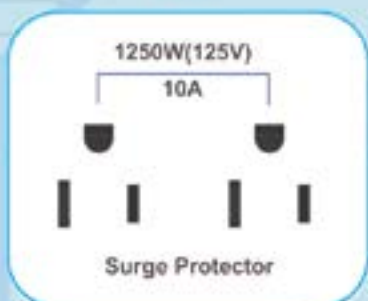

Surge Protector



Compatible devices

PD 57W power strip

- Charges 5 devices at the same time
- Diameter: 106mm
- Thickness: 30mm
- Line length: 1.5m
- Input: 10A/1250W, 60Hz
- Output: USB C: 5V/3A, 9V/3A, 15V/3A, 20V/2.25A
- USB A1-A2: 5V/2.4A
- 300 joules
- Certifications: ETL, CE and FCC



CE-LINK®

Hinen Electronics (Shenzhen) Co. Ltd

2/F, Building G, Licheng Tech Industrial Zone, Gonghe Shajing, Bao'an, Shenzhen, Guangdong 518104, China

Tel: (86-755) 2724 7356 • Fax: (86-755) 2724 7835

E-mail: market@ce-link.com

Facebook: CE-LINK-Electronics • LinkedIn: CE-LINK Electronics

www.globalsources.com/celink.co

www.ce-link.com

Global Sources Verified Supplier ★★★★★



NEW

Apple MFi- and USB-IF-licensed manufacturer

3-in-1 wireless charging pad

- Charges Apple AirPods, Watch and iPhone simultaneously
- Fast charge Apple (7.5W) or Android (10W) devices
- Supports Apple Watch nightstand mode
- Detachable watch module with male USB-A
- Dedicated AirPods charge pad
- Anti-slip surface material secures devices for optimal charging
- Compatible with cases, error < 5mm
- LED notification per charge pad
- Low profile stylish design
- Includes wall charger



PYS High-Tech Co. Ltd Shenzhen PYS Industrial Co. Ltd

Building 9, Lianhua Industrial Park, Longyuan Rd, Longhua,
Shenzhen, Guangdong 518000, China

Tel: (86-755) 2813 0218 • Fax: (86-755) 2813 1358

E-mail: sales@chinapysind.com

www.globalsources.com/pys.co • en.chinapysind.com

Global Sources  Verified Supplier ★★★★★



NEW



65W GaN multi-port wall chargers



36W PD 3.0 dual car chargers



Power bank for Apple Watch



6-in-1 USB-C Ethernet hub



10,000mAh PD 3.0 power bank



3-in-1 wireless charging pad



Premium charge and sync cables



Charging stand for Apple Watch



Power socket

- 20 years' experience in mobile accessories
- OEM/ODM services
- 170,000m² production base and more than 3,000 staff
- Product range includes Lightning/Type-C/micro cables, audio/LAN/video cables, smart car/wall chargers, wireless chargers, earphones, TWS and power bank sockets

Contact us now to learn more information.

Start your sourcing journey at **GlobalSources.com**



Analyst's Choice

[continued from page 35 »](#)

Bluetooth 5.0 DAB radio works as alarm clock

[CONTACT SUPPLIER](#)

Shenzhen Locitech Co. Ltd (China)



Shenzhen Locitech Co. Ltd's model IR D3 - Locitech DAB radio supports Bluetooth 5.0 and doubles as an alarm clock with sleep and snooze functions, and as an FM radio. It works with an app and connects to the internet. The device adopts a 5W hi-fi amplifier and measures 210x100x105mm.

Shenzhen Locitech owns a 50,000sqm factory and offers OEM and ODM services.

Product details

Model:	IR D3 - Locitech
MOQ:	1,000 sets
Lead time:	35 to 45 days

Supplier profile

Year established:	2004
Export markets:	North/South America, Europe, Asia, Australia, Middle East, Africa
Export products:	Portable Bluetooth, mini and Wi-Fi speakers, speakers for iPhone, and soundbars, multimedia audio and digital home theater systems

www.globalsources.com/locitech.co

Bluetooth 5.0 speaker emits 3D sound

[CONTACT SUPPLIER](#)

Shenzhen Meetime Electronic Technology Co. Ltd (China)



Shenzhen Meetime Electronic Technology Co. Ltd's W6-8098 model is a Bluetooth 5.0 neckband speaker for gaming. It yields 3D surround sound and can play music up to five hours.

The device has four 3W drivers with 4ohm impedance, and is made of ABS, TPU and metal. It can work with a PC or PS4.

Product details

Model:	W6-8098
MOQ:	1,000 units
Lead time:	25 to 35 days
FOB price:	\$17.50 to \$18.20

Supplier profile

Year established:	2010
Export markets:	Asia, Central/South America, North America, Western Europe
Export products:	Bluetooth speakers
Total staff:	100 to 150

www.globalsources.com/mgom.co

[continued on page 184 »](#)

NEW**K530**

- Bluetooth V5.0, low power consumption
- Can connect with PCs, tablets or cell phones
- 61-key portable compact design, RGB backlighting, built-in battery
- Type-C to USB charging cable
- Software compatible with games (for Windows system only)



Producing 1.5 million units every month

- 24 years' manufacturing experience
- Products ranked among the Best Sellers on Amazon
- Releasing six new models monthly

Feel free to contact us for more information.

NEW**K596**

- 2.4G+ wired dual-mode connection
- Built-in battery, easy charging with Type-C cable
- Backlighting can be controlled by button
- 10 Macro keys, RGB backlighting, side light effects, click lifecycle of 50 million times
- Full key conflict free for gaming

**M686**

- Professional-grade wireless gaming performance
- Up to 16,000 DPI, 40G acceleration, five DPI indicators, highly-precise optical sensor
- Wireless and wired dual-mode connection
- Optical switch button lifecycle: 20 million times, 16.8 million colors lighting
- Built-in 1,000mA Li-ion battery

**M988**

- High-speed gaming sensor (P3389), 16,000 DPI (max), 400 IPS, 50G ACC
- 125/250/500/1,000 Hz polling rate
- Long-life switches
- Five kinds of DPI adjustable, eight backlight modes, seven programmable buttons, five memory modes
- Professional software

Eastern Times Technology Co. Ltd

Bldg D, Nan'an Industrial Area, Youganpu, Fenggang, Guangdong 523079, China

Tel: (86-769) 8680 0666 ext. 862 • Fax: (86-792) 8680 0338

E-mail: sales09@easterntimes.cn

www.globalsources.com/easterntimes.co

www.easterntimes.cn/en

www.redragonzone.com

Global Sources  Verified Supplier ★★★★★



NEW**H320**

- Virtual 7.1 channel surround vocal cord driver software
- 24-bit HD digital decode, RGB backlighting
- High-quality reproduction of sound by 50mm dynamic stereo driver unit
- Precise positioning and high-resolution closed headphones
- Support Win 10/8/7/XP



Working with famous brands including Lenovo and Asus

- Manufacturing computer peripherals including wired and wireless mice and keyboards
- Lead time: 15-45 days
- Excellent R&D team; own brands

Contact us today to establish business relationships.

NEW**H350**

- Virtual 7.1 channel surround vocal cord driver software
- RGB backlighting
- Detachable noise-canceling mic
- High-quality reproduction of sound by dynamic stereo driver unit
- Support Win 10/8/7/XP

**K591**

- Low-profile gaming keyboard, slim and lightweight design
- Professional gaming software, removable mechanical switches
- RGB full-color LED backlit keys
- Fully metal case, n-key rollover, gold-plated USB port, spill-proof design

**M801P-RGB**

- Wired/2.4G dual modes, high-speed gaming sensor (P3327), 12,400 DPI (max), 220 IPS
- 125/250/500/1,000 Hz polling rate, long-life switches
- Five kinds of DPI adjustable: 500/1,000/2,000/3,000/6,200
- Eight backlight modes, nine programmable buttons, five memory modes
- Professional software

Eastern Times Technology Co. Ltd

Bldg D, Nan'an Industrial Area, Youganpu, Fenggang, Guangdong 523079, China

Tel: (86-769) 8680 0666 ext. 862 • Fax: (86-792) 8680 0338

E-mail: sales09@easterntimes.cn

www.globalsources.com/easterntimes.co

www.easterntimes.cn/en

www.redragonzone.com

Global Sources  Verified Supplier ★★★★★



NEW

11 years' OEM/ODM experience in wearable products



TWS earphones (A2)
• HiFi sound
• Bluetooth 5.0
• Long duration



NEW



- TWS earbuds (EVON PRO)
- Bluetooth 5.0
 - 800mAh battery
 - Dual-mic digital ANC
 - OLED display, dynamic interaction



- Bone conduction Bluetooth headset (GK)
- Bluetooth 5.0
 - IPX5 waterproof
 - Foldable and portable
 - True wireless stereo



- One-stop service
- 200+ staff
- 50+ design and software engineers
- Integrating design, software, app, algorithm, server and manufacture
- All products with BQB/FCC/CE/RoHS/KC/BIS certifications
- Five assembly lines and 3,000m² dust-free workshop
- Producing 200,000 units per month
- All our products have design patents

For more details, call us now.



Shenzhen Smart Care Technology Limited

3/F, Block B3, Junfeng Industrial Park, Chongqing Rd,
Fuhai St, Bao'an, Shenzhen, Guangdong 518100, China
Mobile/WhatsApp/WeChat: (86) 186 2030 6785
E-mail: Helen@smawatch.com
www.globalsources.com/smartcare.co
www.smawatch.com

Global Sources  Verified Supplier ★★★★★



NEW

11-year OEM/ODM manufacturer providing one-stop services for wearable technology



GPS sports watch (SMA-M4 GPS)

GPS sports watch (SMA-M5 GPS)

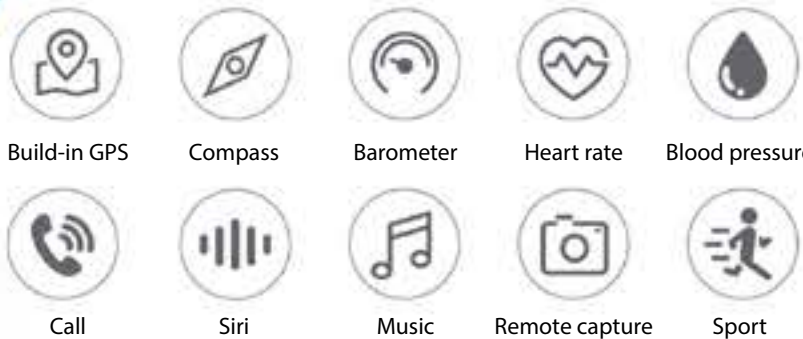

- 200+ skilled workers; 50+ in-house design and software engineers
- All products carry BQB/FCC/CE/RoHS/KC/BIS marks
- Five assembly lines with monthly output of 200,000 pcs; 3,000m² dust-free workshop
- Own design patent

To source fashionable watches, get in touch with us today.



GPS sports watch (SMA-M6 GPS)

GPS sports watch (SMA-M7 GPS)

NEW

Sports watches (SMA-R3/R4/R5)

- 1.3" full touch round screen
- Bluetooth 5.1 version, low battery MCU, big RAM and ROM
- 11 multi-sport modes for choice
- Dynamic heart rate monitoring
- Schedule reminder, menstrual reminder



Sports watches (SMA-F1/F2/F3)

- 1.3" IPS full touch screen
- Very low power consumption, 7-10 days working time
- 11 different sports modes
- Dynamic heart rate and blood pressure monitoring



GPS smart bracelets with fitness tracker and Nordic 52832 chipset



Shenzhen Smart Care Technology Co. Ltd

3/F, Block B3, Junfeng Industrial Park, Chongqing Rd, Fuhai St, Bao'an, Shenzhen, Guangdong 518000, China

Mobile: (86) 186 2030 6785

WhatsApp/WeChat: 186 2030 6785

E-mail: Helen@smawatch.com

www.globalsources.com/smartcare.co

www.smawatch.com

Global Sources  Verified Supplier ★★★★★



NEW

23 years' experience in the industry



IoT gateway with LTE

- Standard LoRa-WAN protocol
- Commercial-grade Qualcomm platform (GTW410L)
- Industrial-grade NXP platform (GTW370)
- Supports LoRa, Zwave, Zigbee, BLE, 4G/3G/2G and Wi-Fi
- Supports RS485/232 and Relay; customizable GPIO
- Customized hardware function accepted

NEW

- More than 60 engineers focusing on application, system and kernel development
- Overseas sales representatives in Taiwan, the US, Germany, Argentina and Brazil
- Manufacturing bases in Shenzhen and Hefei totaling 17,000m²
- Monthly capacity: 500,000 pcs
- Passed ISO 9001:2015, CE, FCC, CCC and RoHS standards
- Providing OEM/ODM and customization services
- Product line including: IoT gateway and sensor, set-top box, TV tuner, industrial PC, Dev board and tablet PC

Call us today to learn more.



Android TV box (ATV598MAX)

- OS Version: Android P or above
- Google-certified
- Supports Google Assistant and Googlecast
- Built-in digital TV tuner
- Complying with DVB-T2/C/ISDB-T/ATSC/DVB-S2



HDMI video capture (U800III)

- Supports 4K @ 60fps input and bypass for latest PS4 Pro/Xbox One X
- Capture resolution up to 1080p @ 60fps
- Compatible with UVC driver
- Supports mic input
- Supports Windows/Mac OS/Linux



Tablet PC (TPC2150K1)

- Different sizes available: 10.1"/15.6"/21.5"/27"/32"/55"
- 10-point touch screen
- Supports PIP function with HDMI output and input interfaces
- Video conferencing with cameras
- Supports LTE and GTIOT interfaces, and TV tuner

Geniatech

Shenzhen Geniatech Inc. Ltd

18/F, Building GDC, 9 Gaoxin Central 3rd Avenue,
Nanshan, Shenzhen, Guangdong 518000, China
Tel: (86-755) 8602 8588 • Fax: (86-755) 2671 0210
E-mail: sales@geniatech.com
www.globalsources.com/szgeniatech.co
www.geniatech.com

Global Sources  Verified Supplier ★★★★★

ISO 9001:2015    



NEW

20+ years' experience in sapphire production

- Monthly output: 1.5 million pieces of sapphire crystals
- Lead time: 25 days
- MOQ: 100 pcs
- Established in 1994
- More than 800 workers
- Factory of over 10,000 square meters

Inquire today.

Sun Yin Crystal Industry Company Limited

Flat A&B, 13/F, 88 Kwai Cheong Rd., Kwai Chung, N.T., Hong Kong SAR

Tel: (852) 3188 2976 • Fax: (852) 2780 7088

Mobile: (86) 147 1501 7088 • (852) 6280 8908

Contact Person: Dave Leung

Email: dave@sunyincrystal.com

www.globalsources.com/sunyincrystal.co

Global Sources  Verified Supplier ★★☆☆☆



Sapphire smart watch product



Sapphire smart watch product



Sapphire personal care equipment product

NEW



Sapphire lens product



Sapphire medical product



Sapphire lens product

NEW

12 years' experience in manufacturing smartphone batteries

Our workshop



Batteries for iPhone series

- Our own R&D team designs the PCB boards
- Seven fully-automatic assembly lines
- Daily output: 90,000 pieces
- 6,000m² factory
- 100% quality and safety testing
- Defect rate: <1‰, far below the industrial average
- One-year warranty

Source from us now.



NEW

Batteries for iPhone XS Max

Batteries for Samsung series

Batteries for Huawei

Tool battery

Battery for MacBook

Battery for iPad



Shenzhen Xinruiming Technology Co. Ltd

Office: A1, 4/F, Building A, Zhangkeng Industrial Zone, Minzhi St, Longhua, Shenzhen, Guangdong 518131, China

Factory: Canbo High-Tech Industrial Area, 38 Gongchang Rd, Huangjiang, Dongguan, Guangdong 523759, China

Mobile: (86) 138 2320 8950

E-mail: pinky@huarigor.com

www.globalsources.com/huarigor.co

www.huarigor.com

Global Sources Verified Supplier ★★★★★

ISO 9001:2015 CE IATA UN38.3 RoHS PSE IEC62133 CB



NEW

15 years of experience in manufacturing headphones



- Over-ear active noise canceling
Bluetooth headphone (ANC300)
- Bluetooth chipset: QCC3003
 - Noise canceling sensitivity: 18-20dB
 - 20-hour working time
 - 350mAh battery
 - 40mm driver

NEW

5.0 true wireless earphone with charging case (S1)

* Bluetooth version: 5.0

* Power on automatically when earbuds removed from charging case

* Touch control for power on/off, play/pause, volume up/volume down, next track/previous track

* The charging case can charge earphone 3 times

- Strong engineering team with 10+ years' experience
- BSCI-audited factory
- Products are compliant with CE, RoHS and REACH standards
- Delivery time: 25-30 days
- Monthly capacity of 200,000 pieces

We accept small orders and welcome your OEM/ODM orders.
Contact us now.

Shenzhen Unison Electronics Co. Ltd

Mapuao Industrial Zone, Zhutang, Fenggang,
Dongguan, Guangdong 523681, China

Mobile: (86) 137 9449 4366 • Fax: (86-769) 8190 8804

E-mail: roy.mao@szunison.cn

www.globalsources.com/unison.co • www.szunison.cn

Global Sources Verified Supplier ★★★★★



NEW

100% Taiwan-based manufacturer with 23 years of experience in two-way radio accessories

Headquarters and factory

- Patented earphones and speaker microphones with smart features and enhanced durability
- Trusted supplier to well-known OEM/ODM brands in Europe, the US, Japan and New Zealand
- An exporter since 1996
- Looking for wholesalers, distributors and importers worldwide

To find out more, visit our website today.



Plastic injection line



Assembly line

NEW



Commercial speaker microphone (JD-400X)



IP67-rated speaker microphone (JD-720X)



P54-rated earphone microphone (JD-230X) and detachable earpiece



Desktop microphone (JD-DM1)



JDI Jing Deng Industrial Co. Ltd

No. 2 Chonghua St, Sanchong Dist, New Taipei City 24158, Taiwan Region
 Tel: (886-2) 2999 7128 • Fax: (886-2) 2999 8326
www.globalsources.com/jdi.co • www.jdi-co.com

Global Sources Verified Supplier ★★★★★



RoHS

NEW

An MFi-licensed manufacturer of consumer electronics compatible with Apple devices

Annual sales volume of \$150 million



- Delivery time: 10 days
- Own brand: Reflying
- Walmart, Philips and Hama trust us
- 30-member R&D team, 40-member QC team
- Mainly exporting to North America (35%) and Europe (25%)
- 500-piece MOQ (for certain goods)
- Customization and OBM services

Get in touch with us now to find out more.

NEW



Smart plug



USB-Lightning cables



Wi-Fi smart sockets



GaN PD charger



Visual doorbells

REFLYING®

Shenzhen Reflying Electronic Co. Ltd

Bldg 6, Gaoxinjian Industrial Zone, Heping, Fuyong,
 Bao'an, Shenzhen, Guangdong 518103, China
 Mobile: (86) 137 3925 5179 • Fax: (86-755) 2671 8815
 E-mail: sales-f2@reflying.com
 www.globalsources.com/reflying.co • www.reflying.com



Global Sources  Verified Supplier ★★★★★

NEW

10 years' design experience in 3C digital products

- Established in 2010; factory covering 13,500m² with 500 staff
- Holding 50 design patents and 15 utility patents; developing 50 new designs each year
- R&D department with over 20 engineers; 96% of products are independently designed
- Nine product categories cover mobile and car-related products
- 35 quality testing laboratories; 3-stage 100% inspection of all goods
- All products bear CE, FCC and RoHS marks
- One-year warranty
- MOQ: 50 pieces
- On-time delivery rate: 95%
- Export markets: Europe, North America, Asia and other regions

Visit our website or contact us to learn more.

Stylus pen



Tablet holder



Car fragrance diffuser



Car charger



NEW



Waterproof noise-canceling wired earphones



Smart Devil Technology Co. Ltd

5-6/F, Bldg C, No. 10, East Area, Shangxue Technology Park,
 Bantian, Longgang, Shenzhen, Guangdong 518129, China
 Tel: (86-755) 8374 6007 • Mobile: (86) 151 1816 9926
 E-mail: smartdevil@smart-devil.com
www.globalsources.com/smart-devil.co
www.smart-devil.com

Global Sources  Verified Supplier ★★★★★

RoHS   



NEW

Supplying ZAGG, Elecom, Modecom and VTech for 10 years



Foldable Bluetooth keyboards (M1509)

- Keycap number: 65
- Dimension: 270 x 88.5 x 7.3mm
- Key travel: 1.6mm
- Key life: 10 million uses



Wireless keyboards with touch pads (M7605)

- Connection type: RF 2.4G
- Keycap number: 88
- Dimension: 439 x 114 x 16mm
- Key travel: 2.15mm
- Key life: 10 million uses
- Mouse is also available

- Designers and sample-makers have more than 5 years' experience
- New samples ready in 3-7 days
- 100% inspection for all products
- ISO 9001-certified
- Customization services available

Source from us today.



名盤科技
Mingpan Electronic Technology

Dongguan Mingpan Electronic Technology Co., Ltd

Yayao Industrial Estate, Huaide, Humen, Dongguan, Guangdong 523915, China

Mobile: (86) 159 8663 8578 • Fax: (86-769) 8538 0083

E-mail: Ken.Zheng@dgmingpan.com

www.globalsources.com/dgmingpan.co

www.dgmingpan.com/English/index.asp

Global Sources  Verified Supplier ★★★★★



NEW

We are a BSCI-certified factory

- Developing gaming products, especially high-quality gaming headphones since 2009
- All products use our own molds with attractive designs
- 20 QC staff ensure high product quality complies with ISO 9000 quality management system
- Providing OEM services
- Exporting to many European and American countries such as Spain, France, Germany, Poland, the US and Mexico
- Daily capacity: 8,000 pieces

Please contact us to discuss cooperation.



RGB and single color gaming headsets (G600)

- Perfect sound output
- Hand-made soft earpads
- Lightweight and comfortable wearing
- PC plug type: 1 x USB + 2 x 3.5mm or 7.1 plug type (single USB)
- Strong braided cables
- Flexible microphone

RGB gaming headset (G650)

- Single color gaming headset also available
- Detachable microphone
- Perfect sound output
- PC plug type: 1 x USB + 2 x 3.5mm or 7.1 plug type (single USB)
- Hand-made soft earpads
- Lightweight and comfortable wearing



Mechanical RGB gaming keyboard (K317)

- 18 different RGB lights
- Supports multi-language
- Switch rating: ≥ 60 million presses
- Operating force: $60 \pm 5g$
- Cable length: 1.75m
- 104 keys; 105 keys and 107 keys available
- Switch type: mechanical (ABT Blue)
- Key route: $3.8 \pm 0.2mm$
- Interface: USB 2.0
- OS: Windows 7 or newer

Dongguan Songman Technology Co. Ltd

Building E, Fulong 2nd Industrial Park, Fulong 2nd Rd, Shipai, Dongguan, Guangdong 523349, China

Tel: (86-769) 8278 0755 • Fax: (86-769) 8278 0756

E-mail: sales@songman-china.com

www.globalsources.com/songman.co

www.songman-china.com

Global Sources  Verified Supplier ★★★★★



NEW

Multi band digital wireless repeaters

- Supports any technologies and any frequencies of operators
- Used to extend the coverage of the mobile signal
- One cabinet can support 4 frequency bands, multi operators and technologies
- Each band can support more than 5 sub-bands of different operators
- Waterproof and dustproof grade: IP65
- Industrial-standard indicators
- Supports remote control by modem or TCP/IP

Focusing on the R&D and manufacture of wireless communication products for over 25 years

- 2G/3G/4G/5G wireless communication products are all available
- Independent R&D capability
- 30+ hardware engineers and 15 software engineers
- 10 production lines and more than 150 sets of instruments
- 50+ invention patents, utility model patents and software copyrights
- Customization services
- ODM/OEM orders accepted

E-mail us today to learn more.



Fujian Maiwei Communication Technology Co. Ltd

Maiwei Science Tech Park, Qingmeng, Quanzhou, Fujian 362000, China

Tel: (86-595) 2249 7868 • Fax: (86-595) 2249 7893

E-mail: Chenxing@maiwei.com.cn

www.globalsources.com/fjmaiwei.co • www.maiwei.com.cn/en/index.aspx

Global Sources  Verified Supplier ★★ ★

ISO 9001 ISO 14001



NEW

Products, software and manuals can be customized according to customer requirements



- Providing DMR radios, PTTtoC network radios and related accessories for walkie talkies
- OEM and ODM services
- Independent R&D capability
- No MOQ requirements
- Strict quality monitoring system, from material purchase to delivery, to ensure stable performance and high product quality

Inquire now.

PTTtoC radio (TID TD-G810)

- Android 5.1
- 4G/3G/2G network
- Dual SIM card
- Supports GPS and SOS
- Wi-Fi, Bluetooth
- IP66 waterproof
- Compatible with Zello, WalkieFleet, TeamSpeak, and customized PTT platform



Guangzhou Billion Leiden Electronic Technology Co. Ltd

A802, Kaixiang Business Center, 50 Juyuan St, Xicha Rd, Baiyun, Guangzhou, Guangdong 510400, China

Tel: (86-20) 3618 2009 • Fax: (86-20) 3618 1300

E-mail: sales@tid-china.com

www.globalsources.com/billion-leiden.co

www.tidradio.com

www.tid-china.com

Global Sources  Verified Supplier ★★★★★



PTTtoC radio (TID TD-G860)

- Android 8.0
- 4G/3G/2G network
- 2.8" touch screen
- Dual camera
- GPS, SOS, Wi-Fi and Bluetooth functions
- Supports cell phone call
- IP66 waterproof level
- Compatible with Zello, WalkieFleet, TeamSpeak, Real-PTT, PoCStars and customized PTT platform

NEW

Designing and manufacturing antennas in Taiwan since 1978

- Antennas available for 5G, IoT, WLAN, TPMS, UHF/VHF, wireless microphones and RFID/PCB
- Each item tested before shipment to ensure the defect rate is under 1%
- RoHS-compliant materials and components sourced from Japan and Taiwan
- Network analyzers for OEM/ODM projects; 100% quality control

Contact us today to work together.



2.4-2.5 GHz WLAN antenna with SMA male reverse connector (S-222)



850 MHz wireless microphone antenna with screw M3P0.5 connector (C-796-1)



148 MHz two-way radio antenna with SMA female connector (B-328-22)



465-468.9 MHz walkie-talkie antenna with SMA male connector (B-504)



433 MHz antenna with SMA male connector for IoT system (C-621-15)



2.4-2.5 GHz WLAN antenna with SMA male connector (S-001-1)



How Tsen Int'l Electronics Metal Co. Ltd

No. 12, Lane 130, Sec 2, Chung San East Rd, Shin Wu Dist., Tao Yuan 32741, Taiwan Region

Tel: (886-3) 477 7517/7518 • Fax: (886-3) 477 7520

Email: jukie@howtsen.com

www.globalsources.com/howtsen.co • www.howtsen.com

Global Sources  Verified Supplier ★★★★★



NEW

Over 20 years' R&D experience in the radio communication industry

- More than 20 R&D engineers releasing one new item each month
- Holding patents for utility models, designs and software
- Five production lines
- OEM/ODM services available
- 100-unit MOQ for OEM orders

Get in touch with us by phone or e-mail, or visit our website.



Dual band DMR with direct dual-slot technology (RS-569D)

- Dual standby
- Dual display and dual band switch
- Supports AMBE3000 vocoder
- Frequency can be manually input
- Supports 300-hour recording
- Voice encryption



VHF marine transceiver (RS-509MG)

- Dual receiver, independent DSC Dedicated receiver
- Built-in GPS and built-in Class B DSC
- Manually inputs GPS latitude and longitude and time
- IPX7 waterproof rating: 1 meter depth of water for 30 minutes
- Speaker vibration draining function



Digital mobile radio with direct dual-slot technology (RS-938D)

- Dual display and dual standby
- Frequency can be manually input
- 50W high power
- GPS positioning (optional)
- Voice recording (optional)



AIS net position meter (RS-107M)

- IPX7 waterproof rating
- High power transmission for long distance communication
- Fast receives GPS positioning
- Sends AIS positioning data in real time
- Used for search; anti-collision

Quanzhou Risen Electronics Co. Ltd

26 Zishan Rd, High-tech Industrial Zone, Licheng, Quanzhou, Fujian 362000, China

Tel: (86-595) 2810 6230 • Fax: (86-595) 2810 6231

E-mail: cs07@recentchina.com

www.globalsources.com/recent.co

Global Sources  Verified Supplier ★★★★★ ISO 9001:2015



NEW

Focusing on wireless signal jammers and cellphone signal boosters for more than 11 years

Full-band mobile signal booster

- AGC and MAC functions
- Customized band available
- Compact design: easy to install
- ALC ensures output level is stable and always adjustable
- Low power consumption; can avoid interference to BTS
- LED indicates uplink and downlink signal level
- Amplified linear power suppresses inter-modulation effectively



- Specializing in Wi-Fi/WLAN/4G/LTE/3G/2G antennas, mobile signal boosters, signal jammers, APs and CPEs
- Signal jammers trusted by state prisons, the police and military
- Supplying cellphone signal boosters to China Mobile, Rjio and Globel
- OEM/ODM orders accepted
- Factory covers a total area of 3,500m² with advanced equipment

Inquire now to join us.



18-antenna signal jammer

- Used for 3G/4G/Wi-Fi/GPS lojack
- Full bands; 18-channel design; customized for special frequency band
- High output power total: up to 42W, jamming: up to 40m
- External omni-directional antennas; all TX frequencies covered
- Car storage battery charger: 12V DC
- Built-in continuous cooling system
- Adjust/turn off single bands without influencing other bands



Runshine International Co. Ltd

Room 218A, Bldg D3, Yingzhan Industrial Zone, Longtian, Kengzi St, Pingshan, Shenzhen, Guangdong 518000, China

Tel: (86-755) 2836 9582 • Fax: (86-755) 2836 9592 • Mobile/WeChat/WhatsApp: (86) 134 1449 1512

Skype: hunterhe2

E-mail: hunter@runshine-link.com • hunter.520@hotmail.com

www.globalsources.com/runshine.co • www.runshine-link.com

Global Sources  Verified Supplier ★★★★★



NEW



ANC TWS earphones (T6)
 • IPX6 waterproof
 • With slide steel case

Trust an ISO 9001- and BSCI-certified OEM/ODM manufacturer

- Specializing in the manufacture of TWS earphones since 2015
- Independently developing 10 molds each year
- Three production lines and one packaging line
- Monthly output of 200,000 pieces
- 100% inspection (IPQC and IQC) before shipment
- Defect rate: less than 0.1%
- Two-year warranty

Source from us today.



Shenzhen Lambda Technology Co. Ltd

1/F East, Bldg 3, Hongye Industrial Zone, Lezhujiao Resident Group,
 Hangcheng St, Bao'an, Shenzhen, Guangdong 518000, China
 Mobile: (86) 136 8495 0281 • Fax: (86-755) 2321 2623
 E-mail: calerychoi@lambaogroup.com • 1683179808@QQ.com
 www.globalsources.com/lambao.co • www.lambaogroup.com

Global Sources Verified Supplier

FC CE RoHS TELEC KC BIS



PU leather TWS earphone cases (T5)

TWS earphones with handmade fabric case (T2)

TWS earphones with new slide-open metal case

NEW

15-year OEM/ODM manufacturer of 3G/4G/Wi-Fi IP cameras

- Expert in-house R&D team
- Products meet CE, FCC and RoHS standards
- GB/T 19001- and ISO 9001-certified
- Advanced production lines with a daily capacity of 5,000 units
- Our products are popular in the US and Europe

Inquire now.



Wi-Fi IP camera (SNO-PT250-20)



Wi-Fi IP camera (SNO-PT290-20)



Wi-Fi IP camera (SNO-PT080-20)



Wi-Fi IP camera (SNO-PT270-20)

- 2.0MP, cloud storage
- PTZ monitoring
- Intelligent humanoid detection
- Auto tracking

SNO
SNO ELECTRONICS CO. LTD

Sno Electronics Co. Ltd

3/F, Bldg 8, East Area, Shangxue Industrial Park, Bantian St, Longgang, Shenzhen, Guangdong 518100, China
WhatsApp: (86) 185 6568 6066
E-mail: marketing@cctvsno.com
www.globalsources.com/sno.co

Global Sources  Verified Supplier ★★★★★



NEW



15+ Years' OEM/ODM Experience In the Electronics Industry

- Specializing in the design, R&D, manufacturing and sale of high-tech intelligent electronics, sanitary, personal care and healthcare products
- Customized requirements on hardware appearance, tooling, function, printing and packaging accepted
- Quick responses to OEM/ODM projects

Contact us today to find out more.



Remote Controls



Disposable Masks



Infrared Forehead Thermometer



Disposable Protective Wear



Disposable Protective Gloves



Smarter Tech Co. Ltd

4/F, Bldg B3, Yintian Industrial Park, Xixiang St, Bao'an, Shenzhen, Guangdong 518102, China
 Tel/Fax: (86-755) 2708 7556 • Mobile: (86) 139 0302 2051
 E-mail: smarteertech@hotmail.com • sales@smarteertech.com
sales@nutunmedical.com
www.globalsources.com/nutunmedical.co



Global Sources Verified Supplier ★★★★★

NEW

LTE/L1.L2/GPS, GLONASS and LTE antennas made in Taiwan by 10-year R&D specialists

- ISO 9001:2015-, ISO 14001:2015- and D&B-certified
- Catering to the digital TV, satellite communication and other industries
- In-house production, QC and testing
- OEM/ODM orders accepted

Contact us today.



Mini coaxial cables



5G stubby rubber antennas



3G/4G/LTE patch antenna



IP67 combined antennas (GPS/GSM/GNSS/2.4G/5.8G/LTE)



FPC cable antennas

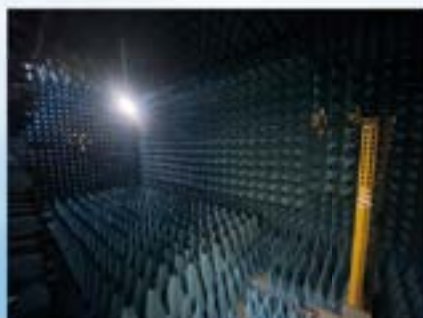

Antenna chamber for measuring gain value and efficiency of antennas



Magnetic mount antennas



GPS/VHF/4G omnidirectional antennas



Chinmore Industry Co. Ltd

No. 13, Lane 30, Guangwu Street, Shulin Dist, New Taipei City 238, Taiwan Region
 Tel: (886-2) 2689 5188 • Fax: (886-2) 8684 2881
 E-mail: service@chinmore.com.tw
www.globalsources.com/chinmore.co • www.chinmore.com
 Global Sources Verified Supplier ★★★★★

ISO 9001:2015
 ISO 14001:2015



NEW

More than 20 patented new items released each year

- 16 years of production and export experience
- Your OEM/ODM orders supported by our professional R&D team
- All our products are patented

Contact us now to experience one-stop purchasing.

4-in-1 Gaming combo

- 2.4G Wireless gaming headset
- RGB lighting headset stand with
- Virtual 7.1 surround sound card
- Gaming keyboard
- Pro gaming mouse



Dongguan Shanggui Electronics Co. Ltd Dongguan Biguan Electronics Co. Ltd

7 Yincheng Rd, Xiabian Village, Chang'an, Dongguan, Guangdong 523876, China

Tel: (86-769) 8285 5460 • Fax: (86-769) 8701 5991

Mobile/WeChat: (86) 137 1417 1734

E-mail: sales@aocean.com.cn

www.globalsources.com/aocean.co

www.aocean.com.cn

www.bg-audio.com.cn

Global Sources  Verified Supplier ★★★★★

ISO 9001:2015 RoHS REACH FC CE



NEW

Walmart trusts our products



Waterproof body Wi-Fi action camera



Dual-lens big screen children's camera



Private model dashcam with GPS and magnet connection



Solar power supply IP camera

- Producing action cams, dash cams and security cams since 2001
- Our main customers are in the UK, France, Germany and the US
- Lead time: 15-20 days; MOQ: 50 pcs
- OEM orders welcome
- Supplying National Geographic, Hyundai and Heineken

Call us today.

Eyesun Cam

Eyesun Technology Co. Ltd

Rm 201, Building B, Xinyongsheng Industrial Park,
Zhenan Industrial Zone, West Zhenan Rd, Xiagang,
Chang'an, Dongguan, Guangdong 523872, China
Mobile: (86) 138 2726 9697

Fax: (86-769) 8530 6716

E-mail: michaelzmp@dgeyesun.com

www.globalsources.com/eyesun.co

Global Sources  Verified Supplier ★★★★★



NEW

Benefit from our over 30 years' R&D experience in antennas



Outdoor helix antenna

4G rooftop antenna

- Two anechoic chambers with over 30 network analyzers
- One of the leading 2-way radio antenna manufacturers in the Chinese mainland
- VHF, UHF, CB, GSM, WiMAX, 4G and other antennas available

Call us today to begin sourcing.



Fujian Quanzhou Huahong Communication Co. Ltd

Jiangnan Hi-Tech Electronic Industry Zone,
Licheng, Quanzhou, Fujian 362000, China
Tel: (86-595) 2246 9067 • Fax: (86-595) 2246 9069
E-mail: hhsc05@fjhuahong.cn
www.globalsources.com/fjhuahong.co
www.huahongantenna.cn

Global Sources  Verified Supplier ★★★★★



Marine antenna mount

Handheld radio antennas

Mobile whip antennas

Omni fiberglass antennas

NEW

Turning out 200,000 pcs every month

- Engaged in the manufacturing of wired and wireless headsets since 2008
- Certifications: RoHS, CE and FCC
- OEM/ODM projects accepted
- 5,000-square-meter workshop with over 100 workers

For more details, don't hesitate to contact us today.



Wired headsets



EWAY

Guangzhou Eway Technology Co. Ltd

4/F, Block C, Tongzheng Industrial Park, Danidaxing Rd, Shatian, Dongguan, Guangdong 523000, China

Mobile: (86) 159 1585 0889

E-mail: terry@eway-gd.com

www.globalsources.com/eway.co

Global Sources  Verified Supplier ★★★★★



NEW

18 years in the R&D and production of special, hunting and bird-watching cameras

OEM/ODM orders accepted



App remote control

- 11 years' experience in product planning for famous brands
- Our current hunting camera solutions: 4G/3G/2G, Bluetooth, Wi-Fi, dual-lens, classic single lens and more
- Our products use industry-leading precise infrared induction auto technology
- Fast 100-piece OEM solution available
- One-piece drop shipping

4G hunting camera

- 30MP, 0.25s, easy to set
- Stand-by current: <75uA
- Timed period, timed scan
- 2.4" HD color display
- 12 x AA recommended (6 x AA can work); DC12V
- Supports apps and cloud service

Inquire now to begin sourcing our 2020 new models.



Keepway Industrial (Asia) Co. Ltd

4-5/F, Zhangge S & T P, Dafu Industrial Zone, Guanlan, Shenzhen, Guangdong 518110, China
 Tel: (852) 2768 9896 • Fax: (852) 2768 8706
 E-mail: sales@keepguard.com
 www.globalsources.com/keepway.co
 www.hdhuntingcameras.com

Global Sources Verified Supplier ★★★★★



GuardPoint iOS and Android



Low price hunting camera



Dual lens hunting camera



Mini Bluetooth hunting camera



NEW

Solar tracker (ST02)

- IP67, outdoor use
- Communication: 4G (customized)
- Motion sensing
- SOS function with one click

Engaged in the R&D and sale of GPS, BDS, GLONASS tracker products and IoT solutions since 2015

- Free standard version of app and customized development services available
- Providing hardware communication protocol for docking platform smoothly
- OEM orders are accepted
- R&D engineering team with over 10 years of experience
- Large and small orders are both accepted
- 24-hour pre-sales and post-sales support

Inquire now.



**Quwei (Xiamen) Intelligence
Technology Co. Ltd**

Rm 807, 1 Linhou West Rd, Huli, Xiamen, Fujian 361000, China

Tel: (86-592) 553 1699 • Fax: (86-592) 553 1696

Skype: susie_chen_3 • E-mail: susie_chen@hiquwei.com

www.globalsources.com/quwei.co

www.hiquwei.com

Global Sources  Verified Supplier ★★★★★



Solar tracker (ST01)

- IP67, outdoor use
- Communication: 2G (customized)



Solar tracker (ST05R)

- IP67, outdoor use
- Motion sensing
- Communication: BDS satellite channel (no SIM card)
- SOS function with one click
- Voice broadcast



GSM fixed wireless phone (Etross-6588)

- Frequency: GSM850/900/1,800/1,900MHz
- Supports 1 SIM card and 1 memory card
- Multiple languages: English, Spanish, French, Russian and more
- Back-up battery: 1,000mAh, 3.7V
- Supports hand-free function
- Samples: US\$13 per unit and US\$12 per unit (over 1,000 pcs)

11 years' production and export experience in GSM/CDMA/3G/4G LTE FWP's

- In-house R&D team to develop FWP/ FWT/Gateway
- Samples available
- CE and RoHS certifications
- Order delivery times: within 2 weeks (1,000 pcs), and 3 weeks (3,000-5,000 pcs)
- OEM/ODM service available
- ISO 9001-certified

Contact us now.



GSM fixed wireless phone (Etross-6688)

- Supports dual SIM card
- Brand: Etross or OEM

eTROSS

Shenzhen Etross Telecom Co. Ltd

3/F, Block B, Yuetong Complex Bldg, Minle Rd,
Longhua, Shenzhen, Guangdong 518109, China
Tel: (86-755) 2304 0460 • Fax: (86-755) 2304 1801
E-mail: sales@etross.com
www.globalsources.com/etross.co
Global Sources  Verified Supplier ★★★★★



NEW

A camera product manufacturer since 2009



- Product range includes action, dash, hunting and PC web cameras
- Supplying Walmart and other big customers
- Providing ODM services for global clients
- One-year warranty offered
- BSCI-, GSV- and RBA-audited factory
- Responses within two hours

For more product information, contact us today.

Naked 4K action camera

- Real 4K @ 30 fps video
- IP68-grade waterproof without housing
- Two screens, easy for selfie



Shenzhen Pano Technology Co. Ltd

3/F, Bldg 3, Yuanhu Science Park, Xinlian Community, Longcheng St, Longgang, Shenzhen, Guangdong 518172, China

Tel: (86-755) 2834 2052 • Fax: (86-755) 2899 3400

Mobile: (86) 136 3270 7322

E-mail: derek@sz-shx.net

www.globalsources.com/sportdv.co

Global Sources  Verified Supplier ★★★★★



NEW

We have more than 14 years' experience in manufacturing car electronic products

- 5,000m² factory; independent R&D team
- Products carry FCC and CE marks
- New samples finished within 2-4 days
- 12-month warranties for all products; free replacements provided in warranty period

We carry out 100% inspection before shipment. Discuss an OEM/ODM order today.



- 4-channel DVR system
- AHD 720p, 1080p cameras and monitor
- 256GB SD card capacity
- IPS 1024 x 600 monitor display
- Waterproof
- Loop recording
- Super night vision



- 4-channel mobile DVR system
- AHD 720p, 1080p cameras and monitor
- IPS 1024 x 600 resolution monitor
- DVR recording function
- GPS, 4G, Wi-Fi optional



- 11.88" full screen car DVR
- Exclusive design
- Dual 1080p video quality
- Loop recording, G-sensor
- IPS high resolution display



- 24V truck parking sensor
- Buzzer or LED display
- 5m distance detection
- Suitable for bus, truck, cement mixer, forklift and so on

STARSHINE.com

Shenzhen Starshine Industrial Limited

4/F, 34 Zhongbaotong Industrial Park, Guangjin Rd, Songgang, Bao'an, Shenzhen, Guangdong 518000, China

Tel/Fax: (86-755) 8926 3393 • Mobile: (86) 133 1659 2872

Skype: Oliver_zou527

E-mail: oliver@stars-shine.com

www.globalsources.com/stars-shine.co

www.stars-shine.com

Global Sources  Verified Supplier ★★★★★



NEW

Products with CE, FCC, RoHS and C-Tick marks



Car GPS navigation system

- CPU: Inter TS9@1A, 1.872GHz, octa-core
- GPU: dual GPU Mali 870
- IPS screen: 1024 x 600
- RAM: 4GB DDR3
- ROM: 64GB, supports 500G hard drive connection, through rear USB wires
- Radio station IC: 7786 IC (RDS)
- Power amplifier IC: TDA7850 IC
- Out power: 4 x 50W
- Android 8.1 system



Car GPS navigation system

- CPU: Allwinner T8, 1.8GHz, octa-core
- IPS screen: 1024 x 600
- RAM: 2GB DDR3
- ROM: 16GB/32GB, supports 500G hard drive connection, through rear USB wires
- Radio station IC: 7786 IC (RDS)
- Processor type: T8
- Power amplifier IC: TDA7850 IC
- Output power: 4 x 50W
- Android 9.0 system

- Over 10 years' export experience
- Developing over five new models each month
- Delivery time: within two weeks
- Warranty: 12 months
- Supplying after-sales and training services
- Technical support is also available
- More than 800 models to choose from

Inquire now.



Winneroid Technology & Development Co. Ltd

5/F, Block A, Jingan Mansion, Guangming Beihuan Avenue,
Guangming, Shenzhen, Guangdong 518000, China
Mobile/WeChat: (86) 188 2007 4455
E-mail: thomas@winneroid.com
www.globalsources.com/winneroid.co

Global Sources Verified Supplier ★★★★★



NEW

Manufacturing TWS Bluetooth headphones and earphones for 10 years



TWS earbuds with LCD display (AC077)

- Battery capacity of headset charging case is also displayed
- Support Qi standard wireless charging

- ISO 9001-certified; working with K-mart and Target
- Our halogen-free products come with CE, FCC, RCM, CCC, UL, UN38.3, RoHS, REACH, Prop65 and WEEE certifications
- Engineering teams: acoustic (AE), mechanical (ME), electronic (EE) and quality (QE)
- ID design team: CorelDRAW, Photoshop and 3Dmax for graphic and I.D. design; Pro/E and CAD for mechanical structural design
- Dust-free workshop with nine production lines and various headphone testing instruments; in-house lab
- 450-square-meter headphones showroom



Stereo Bluetooth over-ear headphones (AC072)

- Bluetooth version: V5.0
- Premium sound quality
- PU soft cushions, comfortable to wear
- Lightweight, portable
- Foldable and swivel design
- Patented design



ANC stereo Bluetooth over-ear headphones (AC063ANC)

- Active noise-canceling, premium sound quality
- Bass boost
- Metal ear cups and extended arms
- Super-soft ear cushions and headband
- Foldable and swivel design
- Patented design

Contact us now to get your order started.

Joy2Hear

Dongguan Joy2Hear Electronics Co. Ltd

38 Chuangyeheng Rd, Jiaolian Community, Wanjiang, Dongguan, Guangdong 523000, China

Tel: (86-769) 2366 7809

E-mail: jimzhan@joy2hear.com

www.globalsources.com/joy2hear.co

www.joy2hear.com/en/

Global Sources  Verified Supplier ★★★★★



We supply AKG, Maxell, Foster and Samsung



- MFi-licensed and CE-, RoHS- and REACH-certified manufacturer
- OEM/ODM services
- Monthly capacity: 4.8 million units
- One-stop service supplier since 2004
- Four factories covering an area of over 10,000 square meters

Call us today.

Touch control true wireless earphones (SMNC-10122)

- Sound insulation and noise reduction
- With unique backup battery case
- Ergonomic housing design



IPX4 true wireless earphones (SMBT-0619)

- With unique backup battery case
- Ergonomic housing design



Fast charging Bluetooth neckband earphones (SMBT-0623)

- With small control box
- Ergonomic housing design



Dongguan Siyoto Electronics Co. Ltd

Hecheng Industrial District, Dongjiang, Qiaotou, Dongguan, Guangdong 523539, China
 Tel: (86-769) 8102 2568 • Fax: (86-769) 8102 2567
 E-mail: jenny_do@siyoto.com
 www.globalsources.com/siyoto.co • www.siyoto.com
 Global Sources  Verified Supplier ★★★★★



NEW

Independent R&D team releases 5 new products each year



- 100% QC inspection
- R&D engineers averaging more than eight years' experience
- ISO 9001-certified; 70 product patents
- OEM/ODM orders accepted
- Main product range: network, analog, DMR digital and mobile radios
- Products with CE approvals
- Responses within 24 hours

Inquire now.

SenHaiX
森海克斯

Fujian Senhaix Electronic Technology Co. Ltd

7 Zihua Rd, Jiangnan Hi-tech Zone, Licheng,
Quanzhou, Fujian 362005, China
Tel/Fax: (86-595) 2222 2369
E-mail: sales@senhaixun.com
www.globalsources.com/senhaix.co
www.senhaixun.com

Global Sources  Verified Supplier **★★★**



In-vehicle IP radio (N60)

- 4G/Wi-Fi/Bluetooth
- Android 7.0
- Touchscreen



High output two-way radio (GT-10)

- 10W high output
- Hidden display
- Big battery capacity



Mini license-free two-way radio (1410)

- TX power 0.5W/2W
- Ultra slim design
- Dual PTT



Dual band two-way radio (8800)

- 5W UHF VHF dual band
- Bluetooth programmable
- Rainproof
- Optional big battery capacity

NEW

Trust a 52-year manufacturer



Power station

- Fits under cabinets, on desktops and in corners
- Modular design: power sockets, LED spot light, USB A and C fast charging (QC3.0 + PD) and Bluetooth speaker
- Available in different modular combination

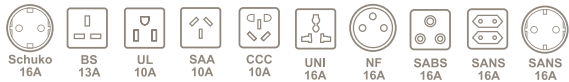

Desktop wireless charger with fast charging USB outlets (R60-PWACQ)

- Retractable design, fits 60mm or 80mm cutout
- Available with USB-A and -C fast charging outlets (QC 3.0 + PD)
- Suitable for all types of mobiles, tablets and the newer laptops (30W or below in power)
- External plug-in driver included



Stainless steel mini pop-up USB charger

- Retractable design fits 44mm cutout
- Dual USB-A outlet 2,400mA
- External plug-in driver included
- Available with dual fast charging USB-A and -C outlets



Pop-up socket

- Built-in TWS Bluetooth speaker
- Dual USB-A outlet 2,400mA
- 2 x power sockets
- Retractable design with IP54 water-resistant level

- 22,700-square-meter factory equipped with 30 production lines
- Conforming to CE, RoHS and ErP
- ISO 9001:2008- and BSI-audited factory



Luen Yick Electrical Mfg Co. Ltd

Hong Kong SAR Headquarters:

Flat F, 10/F, Blk. 2, Kingsford Industrial Building,
26-32 Kwai Hei St, Kwai Chung, N.T., Hong Kong SAR
Tel/Fax: (852) 2419 8200 • Email: sales@luenyick-elec.com
www.globalsources.com/luenyick.co • www.kengo.com

Global Sources Verified Supplier ★★★★★



Visit our website or contact us to learn more.



PRODUCT PATENTED



NEW

Leading GPS tracker manufacturer with 16 years' experience

- Professional R&D team focusing on both software and hardware
- Professional mechanical team in charge of providing designs for all OEM/ODM projects
- Excellent service team engaged in providing comprehensive business and technical support
- Strong production capability and adequate stock goods
- No MOQ; sample orders accepted

Call us now to get a quote.



GPS tracker

- Supports 4G LTE FDD/3G WCDMA/2G GSM
- Module inside supports PTCRB, GCF, FCC, IC, Anatel, AT&T, CCC
- GPS real-time tracking and history track playback
- ACC status detection
- Supports SOS, external battery, iButton and BLE (external battery, iButton and BLE hardware customized)
- Built-in battery, power disconnect alarm
- Built-in G-sensor, vibration, collision and falling alarm
- GEO-fence alarm, speed & shift alarm
- Relay to cut engine off, auto cut engine when over speed and recover when normal speed
- IP65 waterproof

**Shenzhen Eelink Communication
Technology Co. Ltd**

3/F, Yuyang Mansion, North Gaoxin 4th Rd, North Keji 2nd St,
Nanshan, Shenzhen, Guangdong 518000, China

Tel: (86-755) 8627 8376

Fax: (86-755) 8625 8387

E-mail: lindy@eelink.com.cn

www.globalsources.com/eelink.co

www.eelinktracker.com

Global Sources Verified Supplier ★★★★★

FC CE SGS CCC ISO 9001:2015



Custom orders ready in as fast as 15 days and samples ready in 5 days

- 3,000m² factory
- 30 engineers and 200 skilled workers
- Automated facilities for cost-efficient mass production
- Exporting 60 million pieces of products to the US and Europe every year

Call us today.



Smart power sockets

- Mobile remote control
- Timing function
- Intelligent sharing
- Smart configuration function for Android and iOS facilities

LED smart bulb

- Power: 8.5W
- Type of lamp holder: E26/E27/B22
- Rated voltage: AC100/220V 50Hz/60Hz
- Power factor: >0.6
- Color temperature: white 6,000K-7,000K + RGB
- Illumination intensity: 930lm
- Chromogenic index: ≥80
- Control mode: 2.4G Wi-Fi + APP + smart speaker (Amazon Alexa, Google Assistant)
- Working temperature: -20-40

Shenzhen SAPN Technology Co. Ltd

Fuda Building, 231 Xixiang Avenue, Bao'an, Shenzhen, Guangdong 518100, China

Tel/Fax: (86-755) 2708 0625

E-mail: 399516502@qq.com

www.globalsources.com/sapn.co

Global Sources  Verified Supplier ★★★★★



NEW

40-year manufacturer providing OEM/ODM services

Products with RoHS and CE marks

- In-house production lowers costs
- Our own plastic injection and mold-making machines
- Earphones, headsets, speakers and karaoke microphones are all available

Contact us today to start sourcing.

Shindar

Shin Cheng Technology Ltd

No. 731 Ta Tong Rd., Sec. 2, Tainan 70176, Taiwan Region

Tel: (886-6) 267 4716/268 4717 • Fax: (886-6) 268 4839

E-mail: shindar.sj@msa.hinet.net

www.globalsources.com/shinjang.co

www.go-shindar.com

Global Sources  Verified Supplier 

ISO 9001:2008 ISO 14001:2004



Antibacterial headset (SD-32M)

- 30mm driver unit
- Antibacterial plastic material and antibacterial leatherette
- Adjustable headband and mic boom
- Noise-canceling microphone element
- Silver decorative plate



Wired single ear headset (SD-37M)

- 27mm driver unit
- High-frequency imitation protein earmuffs
- Adjustable headband and mic boom
- Noise-canceling microphone element
- Decorative cap on arms (matt finish)
- 3.5mm plug/USB



Computer headset (SD-62M)

- 40mm driver unit
- Leatherette headband and leatherette pad
- Adjustable headband/mic boom
- Noise-canceling microphone element
- Over-ear design
- 3.5mm plug/USB



Wired headset (SD-1622M)

- 40mm driver unit
- Wrinkled leather ear pads
- Adjustable headband and mic boom
- Noise-canceling microphone element
- Matte green decorative ring
- 3.5mm plug/USB



Foldable wired headphone (SD-72)

- 40mm driver unit
- Leatherette headband and leatherette pad
- Adjustable headband
- 90-degree rotating ear cups
- Foldable design
- 3.5mm plug

NEW

We have more than 20 years' electronics manufacturing experience



Thermometer (AT-2002A)

Thermometer (AT-2006)

Non-contact wall-mounted digital thermometer

- Manufacturing and exporting household infrared forehead thermometers, wall-mounted thermometers and thermal imaging temperature detectors
- Annual export: 1-2 million pieces
- ISO 9001 and ISO 14001 certifications
- A fully-equipped reliability testing room
- In-house QA team
- Product manuals and e-mail installation guidance services available

Contact us today to begin sourcing.



Wall-mounted thermometer



Bluetooth voice remote control (160130)



Bluetooth voice remote control (190439)



Infrared thermal imaging temperature detector (AT-2005)



Shenzhen New Solution Electronics Co. Ltd

Rm 301, Jinbaolong Industrial Park, 3 Hongyan Rd, Yanchuan, Yanluo St, Bao'an, Shenzhen, Guangdong 518100, China
 Tel: (86-755) 2755 0466 • Fax: (86-532) 3323 0086
 E-mail: philip@remotechina.com
 www.globalsources.com/remotechina.co
 Global Sources  Verified Supplier ★★★★★



NEW

Piece-by-piece QC keeps our product defect rate below 0.1%

- 18-month warranties offered
- 25 years' R&D expertise
- 95% repeat order rate

Inquire about our radios today.



Radio repeater (STR-050)

- 16 channels
- Power output: 10W
- Built-in duplexer
- Working voltage: 12V DC
- PC software programmable

PoC mobile radio (SEM1000)

- Supports LTE(4G)/WCDMA(3G)/GSM(2G) network
- With GPS and SOS functions
- Supports dual SIM card
- Power input: DC 12V/24V
- With 2.8-inch colorful LCD display



DMR radio (SD850)

- 1,024 channels, 64 zones
- OLED display
- Digital DMR and analog modes
- 2 time slots
- AMBE + 2 vocoders
- Digital voice encryption
- DCDM (dual capacity direct mode)
- Individual calls and group calls



DMR + PoC

Multi-mode radio(SE800D)

- Supports LTE 4G/WCDMA 3G/GSM 2G and DMR/ analog network
- Dual antenna, mode and standby
- Output: 5W/1W
- Supports GPS and SOS
- Battery capacity 3,500mAh
- With crossband function
- Voice recording function (optional)
- Digital and analog carrier automatic recognition
- Wireless clone function available



Quanzhou SFE Electronic Technology Co. Ltd

35 Yangming Rd, Qianyang Industrial Zone,
Shuangyang, Luojiang, Quanzhou, Fujian 362000, China
Tel: (86-595) 2211 7363 • Fax: (86-595) 2220 1313

E-mail: sfe@sfecom.cn

www.globalsources.com/sfecom.co

Global Sources Verified Supplier ★★★★★



NEW

DMR portable (BF-TD511/BF-TD510)

- Supports mandown, lone worker and emergency alarm
- IP67 water-resistant
- RC4 encryption
- TDMA true 2-time slots
- Automatic roaming
- Integrated high-precision GPS

All exported products are CE- and FCC-certified

- Over 30 years of experience
- More than 600 skilled workers
- OEM/ODM orders accepted
- We have agents and distributors in different regions of the world

You are welcome to call or e-mail us for cooperation.



DMR SFR single-frequency repeater (BF-SFR600)

- Base station/repeater: dual modes
- Can extend DMO communication distance
- IP multi-site connectivity (with extra devices)
- Power-on password



Portable radio (BF-mini100)

- License-free
- CTCSS/CDCSS
- One-key recovery
- Multiple charging modes
- VOX/built-in timer

Belfone
Communications for Efficiency and Safety

Fujian Belfone Communications Technology Co. Ltd

Bldg A-15, Huaqiao Economic Development Zone,
Shuangyang, Luojiang, Quanzhou, Fujian 362000, China
Tel: (86-595) 2839 6717 • Fax: (86-595) 2277 1635
E-mail: overseas@belfone.com
www.globalsources.com/belfone.co
www.belfone.com

Global Sources  Verified Supplier ★★★★★



NEW

150,000 pcs of headphones output monthly

Most products made with our own molds



Wired/wireless two-version gaming headset (ZHAOCHEN-GL-577)



- OEM/ODM headphone factory
- Cooperative partners include Trust, Numskull, NOD, Impakt, Megasur and Electro Depot
- We are a 15-year headphone factory
- Exporting 95% of headphones
- ISO 9001-certified and BSCI-audited factory
- Compliant with CE, FCC, RoHS standards

Inquire now.



New gaming headset (ZHAOCHEN-GL-588)



New gaming headset (ZHAOCHEN-GL-550)



Shenzhen Zhaochen Electronics Co. Ltd

Building E, Zhongliantongtai Industrial Area, Liangbai Rd, Pinghu, Shenzhen, Guangdong 518111, China

Tel: (86-755) 8400 8688 • Fax: (86-755) 8476 3444

E-mail: Ann_Yuan@cnzhaochen.com

www.globalsources.com/zhaochen.co • www.cnzhaochen.com

Global Sources  Verified Supplier ★★★★★

RoHS    BSCI



NEW

29 years of production and R&D experience

POC radio

- 4G LTE global communication, unlimited talk range
- Visualization dispatch center: GPS tracking, trace replay, digital fence



- Supplying CB, UHF/VHF and PoC radios, and Bluetooth devices
- OEM/ODM services
- 40 R&D engineers including ID/MD/SW/HW testing engineers
- 10,000sqm production area, eight assembly lines, two SMT lines
- Monthly capacity of over 100,000 sets

Let us work with you on your next order.
Contact us today.

15W radio

- CB band: 25-30 MHz; UHF band: 400-480 MHz
- Bluetooth dongle and mic: can communicate wirelessly with CB
- Supports hands-free calls



Nanfone®

Xinwei Electronic Co. Ltd (Quanzhou)

Wan'an Tangxi Industrial Area, Luojiang, Quanzhou, Fujian 362011, China
Tel: (86-595) 2288 9201 • Fax: (86-595) 2288 5157 • E-mail: sales@nanfone.com
www.globalsources.com/utel.co • www.nanfone.com

Global Sources  Verified Supplier ★★★★★

ISO 9001:2015 BSCI RoHS CE FCC

NEW

We have over 500 long-term strategic partners



New

- ANC TWS earphones
- Effectively equal noise by 28dB
 - Touch control, customizable fit
 - Great sound with excellent Bluetooth connection



- Newest high-gloss true wireless stereo earphones
- Light-weight with high-gloss design
 - Tap control, easy to operate
 - Ultra-low power consumption
 - Support wireless charging



- TWS earphones
- Innovative semi in-ear design
 - BT5.0, patented design
 - Extremely comfortable to wear
 - Support wireless charging

- Seven R&D bases in the Chinese mainland and the US
- Exporting to more than 60 countries and regions worldwide
- Massive manufacturing facilities in India and the Chinese mainland

Inquire now to find out more.



FortuneShip

Guizhou FortuneShip Technology Co. Ltd

6-7/F, Kingson Building, New Energy and Innovation Industrial Park, 1st Chuangsheng Rd, Xili, Nanshan, Shenzhen, Guangdong 518000, China

Mobile: (86) 158 1854 2975

E-mail: lydia@waterworld.com.cn

www.globalsources.com/fortuneship.co

www.fortuneship.com/en/

Global Sources Verified Supplier ★★★★★

ISO 9001:2015 ISO 14001:2015



NEW

More than 15 years in manufacturing wireless 5G antennas in Taiwan

- Supplying UHF, GSM, 3G, 4G, 5G, GPS, WLAN, and DVB-T antennas
- We use network analyzers and anechoic chambers
- All processes done in-house to ensure high quality standards
- Products have an over 99.99% acceptance rate
- RoHS-compliant items with 1-year warranties
- No MOQ requirement for small-volume buyers
- Over 15-year OEM/ODM wireless product specialist

Inquire now.

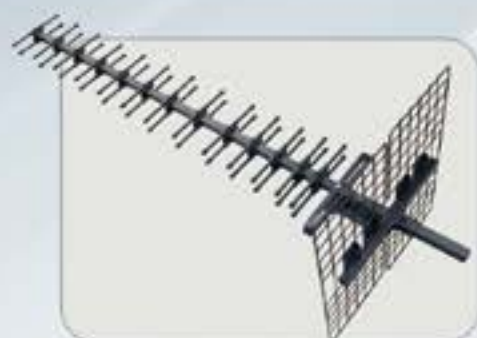

Directional antenna



Rubber duck swivel antennas



RF cable assemblies



RF coaxial connectors



Lightning protectors and signal splitter



GPS antennas



5G antennas



CHANGHONG
CHANG HONG TECHNOLOGY CO., LTD.

Chang Hong Technology Co. Ltd

No. 16, Lane 32, Kai-an Rd, An-nan Dist, Tainan 709, Taiwan Region

Tel: (886-6) 356 6103 • Fax: (886-6) 356 6104

E-mail: linda@changhong.com.tw

www.globalsources.com/changhong-tech.co

www.changhong.com.tw

Global Sources  Verified Supplier ★★★★★



We are an expert in portable wireless PA amplifiers with 20+ years' export experience



Portable wireless PA amplifiers



Movable wireless PA amplifiers



Specially produced tool kits

- Offering over 300 VHF/UHF wireless PA amplifiers
- Monthly output of 300,000 units
- OEM/ODM orders welcome

For more details, call us today.



Betterway Electronic Co. Ltd

V9-1, District 2, Enping Industrial Park, Jiangmen Industrial Transfer Zone, Enping, Guangdong 529400, China
 Tel: (86-750) 711 5544/7711 • Fax: (86-750) 711 0011
 E-mail: betterway@globalsources.com
 betterway01@betterwaychina.com.cn
 betterway03@betterwaychina.com.cn
 www.globalsources.com/betterway.co • www.bil.com.cn

Global Sources Verified Supplier ★★★★★



NEW

Providing low-latency wireless HD transmission solutions for homes, businesses, hospitals, schools and drones in 25+ countries



Wireless presentation and collaboration system

- Compatible with any devices
- Support up to 4K 60fps high resolution decode
- Undetectable latency, as low as 100ms
- High anti-interference protocol, transmission distance up to 50 meters
- Plug and play, one click to share, high-efficiency meeting room solution
- Up to 128 users' presentation at one time
- Auto pairing: support transmitter and receiver auto pairing, no configuration
- Support multicast function, up to 10 RX



Mini smart share devices

- Compatible with any devices
- Support up to 1080p 60fps high resolution decode
- Undetectable latency, as low as 100ms
- High anti-interference protocol, transmission distance up to 20 meters
- Plug and play, one click to share, high-efficiency meeting room solution
- Up to 32 users' presentation at one time



Real 4K game/video capture box with live streaming

- Stream and record Xbox, PlayStation, WiiU, Nintendo Switch, or other game consoles
- Capture in 4K 30fps with H.265 powerful hardware encoder, no latency and extremely low CPU usage
- Compatible with Windows XP, Windows 7, Windows 8.1, Windows 10, Mac OS X 10.7 or later
- Live stream or share directly to OBS, Xsplit, YouTube, Twitch, and other platforms
- Supports 4K 60fps HDMI pass-through function
- Supports recording to built-in SD card and USB disk, and support hard disc

- Focusing on audio and video streaming products
- Over 20 engineers specializing in wireless technology
- 30+ patents
- Holding CE, FCC, Teleg, IEC and SAA certifications
- Philips- and Sharp-certified factory

For a supplier you can trust, contact us today.

ViewPlay

Shenzhen Viewplay Co. Ltd

Rm 7703/5, Bldg 7, 1009 Baoyuan Rd, Bao'an Internet Industrial Base, Bao'an, Shenzhen, Guangdong 518102, China

Tel: (86-755) 8624 4095 • Mobile: (86) 158 1852 4663

WeChat: 15818524663

E-mail: inquiry@viewplay.com.cn

www.globalsources.com/viewplay.co

www.viewplay.com.cn

Global Sources  Verified Supplier ★★★★★



NEW

Manufacturer of Bluetooth speakers and radios since 2000



Bluetooth speaker with FM radio (NS-Q57BT)

- USB/TF slot
- 7.4V/2,400 mAh 18650 Li battery
- With USB charging line, mobile holder and torch



Bluetooth speaker with FM radio (NS-S26S)

- USB/TF slot
- 6V/1W solar panel
- 1,200 mAh 18650 Li battery
- With USB charging line and torch



Bluetooth speaker with FM radio (NS-S16)

- USB/TF slot
- 1,200 mAh 18650 Li battery
- With USB charging line, torch and flashing light



Bluetooth speaker with FM radio (NS-S25)

- USB/TF slot
- 3,000 mAh 18650 Li battery
- With USB charging line, torch and remote control

- Delivery time: 30 days
 - Over 10,000-square-meter plant
 - Design products based on customers' unique requests
 - 300 skilled production operators; more than 20 R&D staff
 - Releasing 30+ newly-designed speakers per year
 - 20 years' experience in exporting to the US, South America, Asia and South Africa
- Inquire today to begin sourcing.



INIS®

Dongguan Tangxi Electronics Technology Co. Ltd

Hengshan, Shipai, Dongguan, Guangdong 523330, China

Mobile: (86) 139 2292 1205 • Fax: (86-769) 8651 3778

E-mail: tingtang011@qq.com

www.globalsources.com/tangxi.co

Global Sources  Verified Supplier ★★★★★

NEW

Six inspection procedures throughout production process



Portable suitcase turntable player (HP-262D)

- MDF with PVC
- 3 speed selection: 33/45/78
- USB recording and playback
- Bluetooth playback
- 3.5mm aux in
- RCA line out

- 11+ years' experience in OEM/ODM for renowned international brands
- Exporting 500,000 to 800,000 pieces of turntable players to the US and Europe every year
- R&D cycle time set as per customers' requirements
- Custom samples ready in 7-10 working days
- Responses within 24 hours
- Excellent after-sales service

Give us a call to learn more product details.



Suitcase turntable player

Quán AUD

Huizhou Haiping Electronics Co. Ltd

No. 133, Xinwu Group, Panli, Lilin, Zhongkai
High-Tech Zone, Huizhou, Guangdong 516035, China
Tel: (86-752) 202 1299 • Fax: (86-752) 202 0199
E-mail: chinahaiping@vip.163.com
www.globalsources.com/haiping.co

Global Sources  Verified Supplier ★★★★★



NEW

Manufacturing wireless earphones for more than 12 years



TWS earphones (Q2)

- In-ear design
- Type-C port
- LED display

- 4,500m² workshop with six production lines and 10 engineers
- OEM supplier to Walmart
- Exporting to the US, Europe, India and other areas worldwide
- Free mold customization supported based on your designs or drawings
- Small orders accepted

We will reply to your e-mail within one hour.
Contact us today.

MAGIN[®]

Magin Industry Co., Ltd

5/F, Bldg D, Longda Industrial Area, Dalang, Longhua,
Shenzhen, Guangdong 518100, China

Tel: (86-135) 3961 9556

Fax: (86-755) 8465 4525

E-mail: sales@magingroup.cn

www.globalsources.com/magindustry.co

www.magingroup.com

Global Sources  Verified Supplier ★★★★ ☆☆☆☆



TWS earbuds (1101)

- In-ear design
- Type-C port
- Rubber finish soft texture
- Touch control

NEW

Providing ergonomic solutions for homes and offices for over 15 years

- 25 R&D staff releasing 30+ new models each year
- ISO 9001-, BSCI-, SGS-, BIFMA- and GS-certified
- More than 80 models are TÜV approved
- Delivery times: 3 days for samples, 35 days for general orders and 25 days for tooling development orders
- OEM and ODM services
- Responses in 24 hours

Send an inquiry now.



- Z-shaped PC gaming desk with LED lights (VM-ES02)
- Measures: 47.2" (L) x 23.6" (W) x 28.9" (H)
 - MDF desktop with waterproof carbon fiber cover
 - LED lighting for a better gaming experience
 - Z shape design can bear up to 176lbs weight
 - Adjustable desk leg pads
 - Fast installation: tools and manual included
 - 12-month warranty



Qidong Vision Mounts Manufacturing Co. Ltd

669 Huashi Rd, Qidong, Jiangsu 226200, China
 Tel: (86-513) 8325 9316 • Fax: (86-513) 6895 3154
 E-mail: info@v-mounts.com
www.globalsources.com/v-mounts.co
www.v-mounts.com

Global Sources Verified Supplier ★★★★★



ISO 9001:2000



- Gaming theme LED monitor gas spring arm (VM-GE22)
- Aluminum structure
 - Gas springs tested 50,000 times
 - Counter-balance height adjustment



- Sit to stand desktop (VM-SD10)
- Smooth and stable dual gas spring motion
 - Large work surface
 - Wide and angle tilt tray for keyboard and mouse



- Laptop rolling cart desk (VM-FDS106)
- Easy to operate: adjustable gas spring, lift up and down smoothly, stop at any position
 - Safety and stability: steel based
 - Four wheels are easy to move, two wheels can be locked, stable after fixing

NEW

Over 20 years' experience in the OEM/ODM and export of headsets

- Own R&D department with over 10 engineers
- Monthly production capacity: 300,000 pcs
- Own mold making, injection and inspection machines, and production lines

Contact us for more information and quotations.



Noise-canceling Bluetooth headset

- Great for drivers, call centers, Skype chat, conference calls, webinar presentations and more
- Mute function



Monaural call center headset

- Adjustable headband
- Flexible and strong microphone tube



Bluetooth headset

- Professional noise-canceling function with mute button
- Charging dock with Bluetooth adapter function
- 270-degree rotatable design
- Battery provides over 16-hour working time
- Connects two devices synchronously



Air tube two-way radio earpiece

- Transparent acoustic tube style surveillance earphones
- 360-degree revolving back clip
- Used for security; ideal for hotels and occasions



Shenzhen Kensing Electronic Co. Ltd

Area A, 3/F, Bldg 5, Hanhaida Industrial Park, Tianliao, Gongming, Shenzhen, Guangdong 518106, China

Tel/Fax: (86-755) 2716 2869

E-mail: nicole@kensing.net

www.globalsources.com/handsfree.co

www.kensing.net

Global Sources  Verified Supplier ★★★★★

NEW

Factory covering 9,000 square meters

- Leading manufacturer of dash and action cameras, and projectors
- 10 years' OEM/ODM experience
- 20 R&D engineers
- Annual shipping quantity: 500,000 pcs

Contact us to place an order.



- Children's projector (TY30)
- Supports recording, playback and photo-taking
 - Wireless/remote
 - Unique design
 - 24"-60" images



Special dual-lens dash camera with 1.66" round touch screen (M700)



Shenzhen Brosfuture Electronics Co. Ltd

4/F, Bldg H, Hejing Industrial Area, Heping, Fuyong, Bao'an, Shenzhen, Guangdong 518103, China
 Tel: (86-755) 2916 3260 ext. 828
 E-mail: ivy@brosfuture.com
www.globalsources.com/shenzhen-brosfuture.co
www.brosfuture.com



Global Sources Verified Supplier ★★★★★

NEW

Specializing in the car security market for 14 years

- Design services and gift box packaging available
- Software development services for products available
- All products are E-marked and certified to ATEX, SAE, DOT, CE, FCC and RoHS standards
- Delivery time for small orders: 5 days

For more information, contact us today.

ATEX flameproof, anti-explosion camera

- For use on ships, vehicles shipping dangerous goods and medical equipment; in the coal mining, chemical and military industries and the medical field
- Stainless steel 304 housing
- Designed to EN/IEC 60079-0:2017 and EN/IEC 60079-1:2014 standards
- IP69K water-resistant



LUVIEW
— in-car security —

Shenzhen Luvview Co. Ltd

3/F Building 1, Shunchen Ji Industrial Park, Longhua, Shenzhen, Guangdong 518109, China

Tel: (86-755) 2704 2170 • Fax: (86-755) 6111 0728

E-mail: sales@luvview.cn

www.globalsources.com/szbsxy.co • www.luvview.com

Global Sources  Verified Supplier ★★★★★



EMARK ATEX SAE DOT FCC CE CCC



NEW

Manufacturing projectors, voice translators, TV boxes, voice remote controllers, and screen cast devices since 2007



Portable mini DLP Android projector (S10)

- 150 ANSI lumens, auto focus and keystone
- 64-bit octa-core CPU, 2GB RAM/32GB ROM
- 2.4G/5G dual band
- Supports Wi-Fi and Bluetooth V4.0



Portable voice translator (T1)

- Online voice translation: supports 78 languages
- Offline voice translation: 14 languages for options
- Camera photo translation: supports 27 languages

- 200+ R&D staff
- 12 years' R&D experience
- OEM/ODM services

To get your order started, contact us today.

VSOONTECH

Shenzhen Qianhai Vsoontech Information Technology Co.,Ltd

3/F, 26 Qinglan St, Higher Education Mega Center, Guangzhou, Guangdong 510000, China
Mobile: (86) 1306 888 6057

E-mail: edwinli@vsoontech.com

www.globalsources.com/vsoontech.co • www.vsoontech.com

Global Sources  Verified Supplier ★★★★★

RoHS CE FC **HDMI**
HIGH DEFINITION MULTIMEDIA INTEAFACE



NEW

More than 15 years' experience in manufacturing BLE voice remote controls

Our remote controls efficiently
partner smart home products

- 10-member strong technical team dedicated to infrared to RF 2.4G, BLE and various other interactive protocols
- Professional R&D team and more than 120 operation workers handle the appearance design, sample test and whole-batch production
- High-end quality monitoring and environmentally-friendly materials have passed CE and RoHS certifications
- 1,000-piece MOQ
- Monthly production capacity of 600,000 pieces ensures fast delivery

We have many years of OEM / ODM experience.
Don't hesitate to contact us now.



BLE voice remote controls

- Used for TV, STB, IPTV and smart TV boxes
- Infrared / Bluetooth transmission and voice command, voice-search technology



BLE voice remote controls



Remote controls



AiFo Smart Technology Co. Limited

No. 699 Dongcheng Industrial Park, Tianchang, Anhui 239300, China

Tel: (86-550) 703 2600

E-mail: info@aifosmart.com

www.globalsources.com/aifo.co

Global Sources  Verified Supplier ★★★★★

One or more of the illustrations shown here is a drawing or other representation of a product, subject to the real product.

All items shown here with various trademarks, brand names and logos ("Marks") are for reference purposes only, and are not for sale. The Marks are the property of the respective owners, and we are not authorized to manufacture or sell any items bearing such Marks to any third party.

RoHS 



NEW

Engineers with 10+ years' experience develop your projects



Body temperature watch

- Body temperature
- HR/BP/SPO2 monitor
- Stopwatch
- Multi-sport mode
- Reject call

- Zero complaints from customers; repeat order rate of 85%
- Customized and small orders accepted
- Delivery time: 7-10 days

Inquire now.

Body temperature watches

- Body temperature, HR/BP/SPO2 monitoring, stopwatch, multi-sport mode, reject call

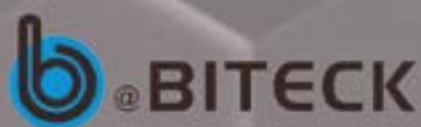

Shenzhen Bitech Co. Ltd

Rm 601, Bldg 1, Software Park, Keji Center 2nd Rd, Hi-Tech Park, Nanshan, Shenzhen, Guangdong 518000, China
 Tel/Fax: (86-755) 8616 8413
 E-mail: sales@szbitech.com
 www.globalsources.com/bitech.co

Global Sources Verified Supplier ★★★★★



NEW

Our daily capacity reaches 6,000 pieces



- More than four years' manufacturing experience
- Customers' inspection standard AQL major 1.0 - minor 2.5
- OEM orders of 20,000-30,000 pieces can be completed in 15 days
- Customers are mainly in Europe, the US, Australia and South America
- Customer logos can be applied to products and packaging
- Customers' e-mails replied to within 30 minutes

MOQ starts at just 500 pieces. Call now.

MAGIN[®]

Magin Technology Co., Ltd

5/F, Bldg D, Longda Ind. Area, Dalang, Longhua, Shenzhen, Guangdong 518109, China

Mobile: (86) 135 1050 5345

E-mail: Milo@magingroup.com

www.globalsources.com/magintech.co

www.magingroup.com

Global Sources  Verified Supplier ★★★★★



Rubberized TWS earbuds with charging case

- Private design
- Super bass quality
- Touch control
- Music up to 4 hours (volume 70%)
- Charging case supports up to 4 full charges
- Type-C charging port
- Rubber finish both on earbuds and charging case



TWS earbuds with metal slide-design charging case

NEW

3,000-square-meter factory with over 200 skilled workers



- Established in 2007
- OEM/ODM services
- Famous clients include Aldi, QFX, Ando, Technisat and Metronic
- ISO 9001, BSCI, CE, FCC, RoHS and BQB certifications

Portable heavy USB-charging FM worksite radios (MT-1606F)

- 18650 lithium-ion battery
- CE/RoHS/RED/QDID/TÜV certification
- Waterproof grade: IP65

For more details, feel free to contact us today.



Portable FM players with CD boombox and full-screen LED display (MT-850)

- CD compatible with CD-R/CD-RW
- FM receiver: PLL
- Support USB disk, storage device playback and MP3/WMA files
- Power output: 2 × 2W



14" aluminum moped electric bike (MT-14001)

- Max load: 120kg
- Motor power: 250W
- Material: aluminum alloy 6061



Electric scooter (MT-2013)

- Wheelbase: 1,510mm
- Net weight: 75kg
- Max speed: 32 km/h
- Three-speed regulation: level 1: 15 km/h, level 2: 20 km/h, level 3: 32 km/h
- Range: 30km
- Max load: 350kg



Automatic soap/sanitizer dispenser (MT-A201)

- Input voltage: 1.5-3.0V battery or power cord
- Bottle capacity: 500/1,000 ml

- Material: plastic
- Sensory technology: infrared ray
- Operation: automatic sensor
- Refilled with liquid/gel/foam

JOOJII A.O.ZMZ

Shenzhen Modeltime Electronics Co. Ltd

Rm 24B, Bldg E, Xianggemingyuan, Intersection of Qianhai Rd and Mianshan Rd, Nanshan, Shenzhen, Guangdong 518054, China

Mobile: (86) 136 0309 5797 • Fax: (86-755) 2161 7594

E-mail: modeltime@metdz.com

www.globalsources.com/modeltime.co

Global Sources  Verified Supplier 



NEW

Source digital key telephone systems from a 40-year industry veteran



Bluetooth hands-free function



Micro SD card record function

Digital key telephone system (A-724)

- 3 CO lines & 8 extensions, 5 CO lines & 16 extensions, 7 CO lines & 24 extensions available
- Bluetooth hands-free function (for A-724BT)
- Micro SD card record function: can store 36 hours per 1G of micro SD card
- Built-in answering machine, recording and answering 200 calls
- Built-in Caller ID with 50 sets of caller records

- Telewell has been operating since 1980
- Supplying wireless phones, auto-dialer emergency watches, call buttons and more
- IC design, mold making, assembly and production performed in-house
- R&D team has created over 100 internationally-patented products
- Complete OEM/ODM services to meet your specific requirements

Contact us today for more information.



Large-button SOS emergency phone system

Wired/wireless large-button phone with 5 emergency services presets (L-995) Wall mount wireless emergency autodialer with big button(WSD-1) Wireless emergency autodialer watch (WWD-01)



Caller ID block manager (D-820CB)

- 64 CID list, 30 invited list and 30 VIP list
- Standard, business and standby modes
- 80 blocked numbers list and 10 number B/I list

bertel
Since 1980

Telewell Electric Co. Ltd

5F, No. 196, Sec. 2, Chung Hsing Rd., Hsin Tien Dist., New Taipei City 231, Taiwan Region

Tel: (886-2) 2915 1521 (4 lines), 2915 0386 (4 lines)

Fax: (886-2) 2914 7461, 2913 5403, 2915 0385 • E-mail: telewell@ms12.hinet.net

www.telewell.com.tw • www.globalsources.com/telewell.co

Global Sources Verified Supplier ★★★★★

ISO 9001:2000 RoHS



Find your perfect supplier with a sample order



NEW

Professional manufacturer of projection screens with 15 years' experience

Experts in screens for 4K cinema and customized large events



SMX screen



- 16 years' OEM/ODM experience ensures stable quality
- Monthly capacity of 50,000 units enables the soonest delivery time
- No MOQ; custom large screens available
- New product: 3D holographic projection displays

We provide 24/7 service. Source from the best, call or e-mail us today.



Shenzhen SMX Display Technology Co. Ltd

Hangcheng Industrial Zone, Xixiang, Bao'an, Shenzhen, Guangdong 518126, China

Mobile: (86) 137 6025 6420

Fax: (86-755) 2946 0353

E-mail: info@smaxscreen.com

www.globalsources.com/smxdisplay.co

www.smaxscreen.com

Global Sources  Verified Supplier ★★★★★





80mm 3-inch thermal POS printers with auto cutters (TCK80)

- Low noise and high printing speed
- Compatible with different paper widths
- Supports wireless communication function (optional Wi-Fi and Bluetooth)
- Optional communication interfaces
- With cash drawer interface
- Supports mark paper and continuous paper printing



15 years' experience in POS printers

- Exporting to Europe, the Americas, Asia, Africa and other regions
- Working with Anas Garments and KASO Technologies S.R.O.
- Product maintenance rate: less than 3‰
- Strict quality inspection processes from raw materials and semi-finished products, to finished product assembly
- Independent R&D capability
- Monthly capacity: 200,000 units
- Delivery time: three days for 100 units, five days for 500 units

For more details, contact us now.



Xiamen Tncen Technology Co. Ltd

130 Tianan Rd, North Industrial Zone, Jimei, Xiamen, Fujian 361021, China

Tel: (86-592) 602 5990 • Fax: (86-592) 588 5816

E-mail: tc15@tncentech.com

www.globalsources.com/tncen.co • www.tncentech.com

Global Sources  Verified Supplier 



80mm 3-inch portable printer (TMP80A)

- Supports USB interface and Bluetooth connection
- Offers drivers for Windows, Android and LINUX operating systems
- Low noise and high printing speed
- Battery powered
- Supports continuous paper printing



Bluetooth speaker with wireless charging function

- Speaker: 5W x 2
- Battery capacity: 4,000mAh, AC power input optional
- Audio input: Bluetooth, USB, 3.5mm Aux, TF card, RCA or optical
- Built-in microphone for handsfree calling
- Supports TV/PC/phone/tablet/laptop/MP3/MP4/DVD player/TV box audio

At least 2 new items launched each month

- BSCI-audited factory
- Independent R&D capability
- 100% QC before shipment
- Professional pre-sales and after-sales services

Contact us today.



PD 3.0 + QC 3.0 power banks

- Capacity: 10,000mAh/20,000mAh
- Input: 5V/2A, 5V/3A
- Output: 5V 3A, 9V 2A, 12V 1.5A
- Material: ABS
- Colors: black, white, red, blue or customized



Stereo sound TWS earbuds with leather charging case

- Bluetooth solution: Realtek 5.0
- Effective distance: 15m
- Earphone battery: 50mAh
- Charging case capacity: 800mAh
- Waterproof level: IPX6
- Colors: black and red



Shenzhen T.Y. Industrial Co. Ltd

3/F, Block C, 41 Lixin Rd, Nanwan St, Longgang, Shenzhen, Guangdong 518000, China
 Mobile: (86) 198 0755 1587 • Fax: (86-755) 2850 1125
 E-mail: sales001@sztyindustrial.com
www.globalsources.com/sztyindustrial.co

Global Sources  Verified Supplier ★★★★★



NEW

Sit-stand desk with lockable gas spring (LXGL00S)

- One-touch sit-stand function
- Sturdy structure with flexibility when height adjusted
- Lockable gas spring provides smooth height adjustment
- Efficient space management above or under the desktop

Annual output of 100,000 pcs of office accessories

- MOQ: 1-100 units
- Delivery time: 10-15 days
- Exporting to the Americas, Europe, Southeast Asia, Africa and Australia
- Clients' custom logos on cartons accepted
- Certifications: ISO 9001, CE and RoHS

Send us inquiries today.



Wuxi Lexin AV Equipment Co. Ltd

Dongsheng Rd, Donggang, Wuxi,
Jiangsu 214000, China
Tel: (86-510) 8558 2788
Fax: (86-510) 8558 0105
E-mail: sales@wxlexin.com
www.globalsources.com/wuxilexin.co
www.wxlexin.com



Global Sources Verified Supplier ★★★★★



- Laptop trolley (LXGL01SM)
- Adjustable height: 700-1,100 mm
 - Gas spring lockable at any position
 - Force: 60-200 N
 - Material: aluminum tube with steel base
 - Table top made of MDF with PVC



- Aluminum laptop stand
- Comfortable visual angle with six-gear adjustment
 - Suitable for laptops, mobile phones, tablets or computer books
 - Weight bearing: 30kg



- Aluminum laptop stand with 10 gears
- Comfortable visual angle
 - Silicone anti-skid design
 - Double triangle design

NEW



- TWS Bluetooth earbuds (TS10)
- Stereo sound
 - Truly scientific ergonomic design
 - Support aptX™
 - Power digital display
 - Bluetooth chipset: QCC3020, BT 5.0
 - Profiles: HFP, HSP, A2DP, AVRCP
 - Wireless range: >10m
 - Frequency: 20Hz-20kHz
 - Play time: approx. 8 hours x 8
 - Battery: 50mAh x 2 (earbuds) + 800mAh li-battery (charging case)
 - Indicate battery status via smart phones

Our 6,000m² factory has over 300 workers

- A Bluetooth headphone manufacturer
- ISO 9001-certified
- Patented molds
- BSCI-approved
- Monthly output: 80,000 pcs
- 14 years' manufacturing experience

Inquire now.

Shenzhen Shengna Technology Co. Ltd

3/F, No. 17 Longbi Industrial Zone, Bantian St, Longgang, Shenzhen, Guangdong 518119, China
 Mobile: (86) 186 8208 7104
 Fax: (86-755) 8419 3939
 E-mail: sophia@sound-na.com
www.globalsources.com/sound-na.co
www.songnormi.com

Global Sources  Verified Supplier ★★★★★



TS30

- Bluetooth chipset: JL6936D/Bluetooth, BT 5.0
- Profiles: HFP, HSP, A2DP, AVRCP
- Wireless range: >10m
- Frequency: 20Hz-20kHz
- Play time: approx. 5 hours x 3
- Battery: 40mAh x 2 (earbuds) + 300mAh li-battery (charging case)
- Indicate battery status via smart phones



TS40

- Bluetooth chipset: JL6936D/Bluetooth, BT 5.0
- Profiles: HFP, HSP, A2DP, AVRCP
- Wireless range: >10m
- Frequency: 20Hz-20kHz
- Play time: approx. 6 hours x 3
- Battery: 40mAh x 2 (earbuds) + 300mAh li-battery (charging case)
- Indicate battery status via smart phones

NEW



23 years' production and R&D experience



Digital silicone microphones



Headphone speakers (NS50M-240001-100-01)



Speaker cabinets, grilles and material

Automotive microphone assembly

- Customization service
- Producing one million units per day
- 20 years' export experience
- Our plant occupies more than 100,000 square meters

Inquire now.



Huizhou N Acoustics Co. Ltd

Block A, Yonghua Industrial Park, Zhenlong, Huiyang, Huizhou, Guangdong 516227, China
 Tel: (86-752) 530 6530 • Fax: (86-752) 530 6537
 E-mail: sales@nacoustics.com
 www.globalsources.com/nacoustics.co
 Global Sources Verified Supplier ★★★★★



NEW

We have more than 15 years' manufacturing experience



2-in-1 camping lantern power bank (C5P)

- Up to 80 hours lighting time (low mode)
- 94-V0 fire-resistant material
- Can fully charge iPhone 6 up to 2 times

- Exporting to the US, UK, Turkey, France, Canada, Germany, Japan, Russia, India, Sri Lanka, Pakistan, Thailand and many other countries
- Providing complete solutions: good quality machine, installation, trial test running, operation training, formula technology support
- All models are made with our patented private molds

We reply to your e-mails within two hours.
Contact us now.



Shenzhen Gift Tree Technology Co. Ltd

Sales Office: B829 Tianhui Building, Donghuan 1st Rd, Longhua, Shenzhen, Guangdong 518000, China

Factory: 3/F, Yibang Industrial Building, No. 8, Lane 5, Shangnan Rd, Nance, District 5, Humen, Dongguan, Guangdong 523905, China

Tel/Fax: (86-755) 2373 2829

E-mail: judy@szgifttree.com

www.globalsources.com/gifttree.co

Global Sources  Verified Supplier ★★★★★



2-in-1 camping lantern power bank (LP7)

2-in-1 flood work light power bank (LP10)



3-in-1 speaker lantern power bank (SL10)

Car emergency light (E8)



Start your sourcing journey at **GlobalSources.com**



NEW



LCD screen

Our mobile phone and tablet spare parts are exported to the US, UK, Canada and Mexico



- All products come with one-year warranties
- Free samples provided; small orders accepted
- Customers' e-mail replied to within two hours
- Goods will be checked one by one before shipment

Contact us now to source from a one-stop supplier.



Shenzhen In-One Technology Co. Ltd

E10, 6/F, 27 Zhenhua Rd, Futian, Shenzhen, Guangdong 518000, China

Mobile: (86) 150 1853 2151

E-mail: ray@in-onetech.com • sherry@in-onetech.com

www.globalsources.com/sz-in-one.co

Global Sources Verified Supplier ★★★★★



Mobile phone back cover housing



3D full cover tempered glass

NEW

ISO 9001:2000-certified antenna manufacturer integrating design, molding, assembly and QC



Digital outdoor HDTV antenna (WA-2608B)



Digital indoor HDTV antenna (UHD-3925A)



Digital indoor HDTV antenna (AR-883C)



Digital indoor HDTV antenna (DA-400E)



Outdoor digital antenna with 4G/5G filter



Digital outdoor HDTV antenna (UHD-3942)



Digital outdoor HDTV antenna (WA-2608)

- Products undergo noise, mobile radio transmission, high-voltage, drop, salt spray and vibration tests
- 10 engineers with more than 10 years' experience
- Using RF network analyzers from Advantest
- 250,000 CE-marked antennas monthly from our factory
- Four partner factories allow us to ship orders in 25 days

Send us your requirements today.



Zhongshan Wanlitong Antenna Equipment Co. Ltd

Anle Industrial Area, Guangzhu Rd, Dongfeng, Zhongshan, Guangdong 528425, China
 Tel: (86-760) 2337 9888 • Fax: (86-760) 2263 3166, 2260 4086
 E-mail: sales@walito.com
 www.globalsources.com/wanlitong.co • www.walito.com
 Global Sources Verified Supplier ★★★★★

ISO 9001:2000



NEW

15 years' R&D experience in handheld and video game consoles

RG350 game console

- CPU: JZ4770 dual 1.0 GHz
- RAM: DDR2 512MB
- 3.5" IPS screen, 60Hz refresh rate
- Full dual shock button layout with L2 + R2 and dual analogs with L3 + R3
- Li-polymer 2,500mAh, lasting 6 hours



RG300 game console

- CPU: JZ4760B, dual-core 528MHz
- Screen display: 3" TFT, resolution: 960 x 480
- RAM: DDR2 128M
- L, R buttons of Omron
- Battery: 1,800mAh, lasting 6 hours



Super VIB TV game box

- Mini and portable
- Supports multiple TV display modes
- Supports 8 bit FC games, built-in 169 games (30 vibrating games)
- Two controllers with vibration (Type-C interface)



Retro arcade plus game console

- 4.3"/480 x 272 IPS full view TFT screen
- CPU: ATM7051-4 core A5-1G
- Supports 4K HDMI 1280 x 720p 60Hz game speed, FPS 1:1 output

- 12 years' export experience
- All products are made with our private molds and CE-certified
- One-piece MOQ; sufficient stock

Your OEM orders are welcome.
Send us an e-mail now.



Retro game plus game console

- 3" IPS screen
- A powerful dual-core 64-bit processor with 16GB of internal storage
- A Micro SD card slot for expansion and rechargeable battery



Shenzhen YangLiMing Electronic Technology Co., Ltd

4/F, Environmental Monitoring Center, 2nd Liuxian Rd, 71 Area,
Bao'an, Shenzhen, Guangdong 518101, China
Tel: (86-755) 2163 4681 • Fax: (86-755) 2163 4680
E-mail: sales04@yilmchina.com
www.globalsources.com/yilmchina.co
www.yilmchina.com/en/ • www.Anbernic.com
Global Sources  Verified Supplier ★★★★★



18 years of export experience

- Supplying thermal label, thermal transfer and receipt printers, barcode scanners and cash drawers
- A top choice for supermarkets, stores, restaurants, warehouses, and the e-commerce and logistics industries
- Small sample testing accepted

Inquire now for more information.



80mm thermal receipt printer



Thermal label printer



4-inch thermal transfer barcode printer



410 cash drawer



4-inch thermal barcode printer



Barcode scanner



Xiamen Liao Sheng Trading Co. Ltd

Unit 10A, Tongbao Building, Hubin North Rd, Xiamen, Fujian 361012, China

Tel: (86-592) 536 8802 • Fax: (86-592) 536 8805

E-mail: Andrew@liaosheng.com • www.globalsources.com/xmls.co

Global Sources Verified Supplier ★★★★★



NEW

11-year specialist in developing and manufacturing earphones and accessories

- Offering voice-activated microphones, two-way handheld radios and acoustic earphones
- ISO 9001:2008-certified factory
- Kenwood and Motorola source from us
- 80% of our output is exported to North America and Europe
- 18-member R&D team employed
- Monthly output of 600,000 earphones and microphones
- OEM and ODM services available

Contact us for more information.



- Noise-reduction foldable headset (NO-900)
- 25DB noise-reduction rating (SNR)
 - 4-hour auto shut-off
 - Working time: 100 hours



IP67 speaker
microphone
(JH-SM128)

NIER[®]

Best Talent Industrial Ltd
Shenzhen Best Talent Technology

3/F, Bldg 3, Jiayiyuan Industrial Region, Huaning Rd,
Dalang St, Longhua, Shenzhen, Guangdong 518109, China

Tel: (86-755) 8372 6299 • Fax: (86-755) 8372 6199

E-mail: besttalent@best-talent.com

www.globalsources.com/besttalent.co

Global Sources  Verified Supplier ★★★★★



NEW

A 12-year manufacturer releasing 5 new products each month



True wireless earphones

- 10 engineers averaging over 10 years' industry experience in our R&D team
- Custom service: we can provide different colors, earphone chips, battery capacities, earphone speakers and other solutions
- 98% on-time delivery rate and 99.5% product qualification rate in the last quarter
- Four inspection periods from raw materials to finished bulk goods
- 3,000m² factory with advanced production equipment and 200 employees
- Monthly capacity of one million pieces
- Products certified to CE, FCC, RoHS, FDA and UL standards

All products come with one-year warranties. Call now.



Shenzhen Youyuan Technology Co. Ltd Ainovo Industry Co. Ltd

201, 25 Liye Rd, Songtao Community, Songgang St,
Bao'an, Shenzhen, Guangdong 518105, China
Tel: (86-755) 2350 0125 • E-mail: shiny@szainovo.com
www.globalsources.com/szainovo.co
www.szainovo.com

Global Sources Verified Supplier ★★★★★

C-TICK RoHS



True wireless earphones



NEW

Trust our 18 years of product design experience

Providing scooters and scooter sharing solutions

- Independent R&D department handles your OEM/ODM projects
- ISO 9001-certified manufacturer
- Products meet UL2272, CE, RoHS, FCC and REACH standards
- Launched shared scooter projects successfully in Europe, the Americas and Southeast Asia

We're looking forward to cooperating with you. Call now.

Electric scooters for sharing

- 4G IoT module integrated, connect with your servers and apps
- Swappable battery, 3-step easy charging
- Durable modular design, saves your operation cost
- 10" bigger tire, better riding experience without suspension
- 486Wh battery, longer distance up to 50km
- 350W motor, achieve max. 15% gradeability and 25km/h
- Customizable



Scooters with swappable battery



Shenzhen MYWAY Technology Co. Ltd

Unit G, 9/F, Block B, Bldg 6, Baoneng S&R Park, Longhua, Shenzhen, Guangdong 518100, China

Tel: (86-755) 2949 3326

E-mail: mywaysales@launchdesign.com.cn

www.globalsources.com/mywayth.co

Global Sources  Verified Supplier ★★★★★

RoHS REACH ISO 9001 ISO 14001

UL2272 UL2271 CE FCC



Analyst's Choice

[continued from page 95 »](#)

Bluetooth 5.0-ready vertical mouse

[CONTACT SUPPLIER](#)

Dongguan Shanggui Electronics Co. Ltd (China)



Dongguan Shanggui Electronics Co. Ltd's model VM-600 vertical mouse can switch between Bluetooth 5.0 and 2.4G modes. It also features a self-setting screen.

The product has nine buttons and a built-in rechargeable 500mA lithium battery. Dimensions are 111x72x75.3mm.

Dongguan Shanggui's clients include Sanwa, ABKO, Speelink, Targus and Trust.

Product details

Model:	VM-600
MOQ:	500 units
Lead time:	30 to 35 days
FOB price:	\$9.50 to \$11

Supplier profile

Year established:	2004
Export markets:	Asia, Australasia, Central/South America, Europe, North America
Export products:	Mice, keyboards, headphones, presenters, cable holders, other computer peripherals
Total staff:	200 to 250

www.globalsources.com/aocean.co

Global Sources is an amazing show that I have been attending for many years. It is a great place to meet people, find new suppliers and build new relationships.

Ricardo Singer,
 Kickpower & broski, US

global sources

GlobalSources.com

NEW

Source UL2272-, CE- and LVD-certified electric scooters from a reliable supplier

- Wide product range: electric bicycles, electric scooters, ATVs, off-road vehicles, treadmills and more
- Maximum annual capacity of 300,000 sets
- BSCI- and ISO 9001-certified manufacturer
- Warehouses in Canada, Sweden, Israel and other countries
- Our products are sold to more than 50 countries

We provide convenient payment methods and guarantee fast delivery. Inquire now to begin sourcing.



350W electric scooters

- 6Ah-15Ah battery capacity is optional
- Front and rear 8.5" inflatable tires
- LED display



Electric balance bikes

- Lithium battery: 24V 2Ah/4Ah
- Material: aluminum frame + fork
- Tire size: 12" or 14"
- Designed for children



Zhejiang Lianmei Industrial Co. Ltd

99 West Jiuzhou Rd, Hardware Industrial Area, Yongkang, Zhejiang 321300, China

Tel: (86-579) 8748 1198, 8748 1098/1298, 8743 1888

Fax: (86-579) 8748 1627

E-mail: sales@cnlianmei.com

www.globalsources.com/lianmeizj.co

www.cnlianmei.com

Global Sources  Verified Supplier ★★★★★



NEW

Portable fabric Bluetooth speakers

- IPX5 waterproof
- Fabric design series
- Genuine leather hand belt
- Power bank function
- 3 types of speaker mode switch
- 360° stereo sound

Supplying Bluetooth speakers and TWS earphones made with our own molds and PCBAs



- Supplying famous brands such as Hama (Germany) and Pioneer (Japan)
- Control complete production processes from the interior main boards (PCBAs) to the exterior ID design
- All products carry CE, FCC and RoHS certifications
- Special function development supported

Earphones with charging case (MCT009)

- Master control IC QCC3020, low power consumption, good sound quality and antenna signal
- Strong bass, stereo surround, customized stereo generating unit
- Noise-reducing in-ear headphones
- Environmental noise cancellation (ENC)
- Four microphones, two in each side
- Automatic ear detection
- Mini magnetic suction charging chamber
- IPX5 waterproof and sweatproof

Contact us now to request a full product catalog.



Shenzhen Cheerstar Communication Technology Co. Ltd

3/F, Block B, Jiuwei 3rd Industrial Park, Hangcheng St, Bao'an, Shenzhen, Guangdong 518000, China

Mobile: (86) 134 1853 8097 • Fax: (86-755) 2950 9715

E-mail: nicole@cheerstar.net

www.globalsources.com/cheerstar.co

www.cheerstar.net

Global Sources  Verified Supplier ★★★★★

RoHS CE FCC



Earphones with charging case (MCT011)

- UV & IPX7 waterproof
- Qualcomm® chip provides a stable connection
- Qualcomm aptX™ technology delivers Hi-Fi experience
- Support tactile switches and voice assistance
- Up to 35 hours playtime
- Tactile switches for more comfortable operation
- Dual modes with independent earpiece support

NEW

Operating a 1,400m² dust-free plant with four production lines

- We specialize in universal remote controls and receivers
- In-house R&D department with six engineers
- Constantly updating our product lines
- SMT machine, laser machine and high-accuracy QC test machine
- Orders shipped within 15-20 working days
- OEM/ODM and small orders accepted

Call now to become one of our valued customers today.



Wi-Fi smart camera
 • Indoor and outdoor uses
 • Controls garage door via app



Universal 280-870MHz rolling code access control keypad



Wireless roller shutter and door wall switch



280-900MHz multi-frequency multi-copy remote control



433.92/315MHz Wi-Fi receiver



Universal 280-870MHz Wi-Fi and Bluetooth remote control



Universal 230V AC tubular motor receiver for sliding and garage doors



Quanzhou Juhui Electronics Co. Ltd

288 Changxing Rd, Huoju Industrial District, Licheng, Quanzhou, Fujian 362000, China
 Mobile: (86) 188 7653 7189
 Fax: (86-595) 2262 2065
 Email: alee@juhuico.com
www.globalsources.com/juhui.co
www.juhuitech.net

Global Sources Verified Supplier



NEW

Workshop is equipped with 4 SMT lines and 10 production lines



Dual screen touch POS terminal (ZQ-T8550)

- 19 years' manufacturing experience
- OEM/ODM services
- A listed company on the stock market
- ISO 9001-certified
- CE-, RoHS-, FCC- and UL-marked
- Over 13,000m² factory and office building area
- More than 300 employees

Contact us, our staff will reply to you within 24 hours.



Automatic sanitizer dispenser (ZQ-SD10)



Guangzhou Zonerich Business Machine Co. Ltd

North Gate, 17 Yunjun Rd, Huangpu,
Guangzhou, Guangdong 510530, China
Tel: (86-20) 6667 1666
Fax: (86-20) 6660 0577
E-mail: trade@zonerich.com
www.globalsources.com/zonerich.co
www.zonerich.com/index-en.html



Global Sources  Verified Supplier ★★★★★

ISO 9001:2008 RoHS   



Advertising machine with automatic sanitizer dispenser and infrared thermometer (ZQ-SK20)

NEW

More than 100 types of cable terminals and connectors in complete specifications for selection

- 11 years of production and R&D experience
- Customization service: opened two sets of new molds for customers in 2018
- Daily capacity of terminals: 5,000 units; sufficient stock goods
- Our products are mainly exported to Europe and the Americas
- Our own R&D team

Inquire now to place an order with no MOQ and a short lead time.



100W home mobile Bluetooth speaker



LED indoor and outdoor IPX4 waterproof Bluetooth speaker



Mobile phone game bone conduction strap



Hong Kong Taosheng Electronics Company Limited

Guanlan Office, Jintongsheng Building, Longhua, Shenzhen, Guangdong 518110, China

Tel/Fax: (86-755) 2370 2486

E-mail: lina@hktaosheng.com

www.globalsources.com/hktaosheng.co

Global Sources  Verified Supplier ★★★★★



NEW

Supported by 7 R&D bases in China and the US

- One-stop supplier of robotic vacuum cleaners
- Trusted by over 500 long-term strategic partners
- Full range of products including random-, gyroscope-, visual- and laser-type robotic vacuum cleaners

For more detailed information, contact us today.



FD
Free dynamics



Robotic vacuum cleaner (RVC)

**Guizhou FortuneShip
Technology Co. Ltd
Shenzhen Free Dynamics
Development Co. Ltd**

Rm 402, 4/F, Kingson Building, New Energy and Innovation Industrial Park, 1st Chuangsheng Rd, Xili, Nanshan, Shenzhen, Guangdong 518000, China
Mobile: (86) 152 7911 5917

E-mail: penghua@freedynamics.com
www.globalsources.com/fortuneship.co
www.fortuneship.com/en/
www.freedynamics.com/portal/index/index/l/en

Global Sources  Verified Supplier ★★★★★

NEW



9"/10.1"Android MTK car multimedia player with GPS/Wi-Fi

11-year OEM/ODM manufacturer of car multimedia players

- Advanced production lines with a daily capacity of 3,000 units
- In-house R&D center
- Factory equipped with advanced SMT machines
- Products meet CE and RoHS standards
- ISO 9001:2015- and ISO/TS 16949-certified

Inquire now to see how we can help with your orders.



- 9" double-DIN special car multimedia player
- Android system with CANBus
 - More than 200 models for selection



- 7" double-DIN universal car MP5 player
- USB/TF/Aux-in/Bluetooth/steer wheel control
 - Mirror link/amplifier control
 - Panel size: 172 x 97mm



- 7" double-DIN car multimedia player
- Android system
 - Full-touch design



Shenzhen Elecsource Technology Co. Ltd

5/F, Bldg 1, Chengdexuan Technology District, Gongming, Shenzhen, Guangdong 518106, China
 Tel: (86-755) 8173 8979 • Fax: (86-755) 2958 8206
 E-mail: info@elecsource.com
 www.globalsources.com/elecsource.co



Global Sources Verified Supplier ★★★★★

NEW



- Massage gun
- Patented design
 - 10-level adjustment, LCD display
 - Four different massage heads

Source health massager and beauty products from a 12-year OEM/ODM manufacturer

- 2+ new models released each month
- We hold 20+ patents
- Small orders accepted
- MOQ: 100pcs
- SGS- and TÜV-audited factory
- CE, RoHS, FCC and EPA approvals
- One-year warranty

Inquire now.



LOVEKA

Shenzhen Loveka Technology Co. Ltd

5/F, Building 6, Tianfu'an Industrial Park, Hangcheng Rd, Bao'an, Shenzhen, Guangdong 518102, China

Tel: (86-755) 3630 4759 • Mobile: (86) 137 2349 9601

E-mail: sales@loveka.vip • sales@loveka.com.cn

www.globalsources.com/loveka.co

Global Sources Verified Supplier ★★★★★

RoHS EPA TÜV CE FC (SGS)

Illustrations shown here are drawings or other representations of products. They are not actual photographs of the products.



Patented mini massager with heated pad



Foot massagers

- Rechargeable
- With remote control



Children's electric toothbrush

- Patented design
- Wireless charging

NEW

13-year POS system solution supplier and manufacturer

1519D set

- 12"-17" touch POS terminal
- 12"-19" touch screen monitor
- 1D/2D/wireless/barcode scanner
- 58mm/80mm receipt thermal printer
- Cash drawer and VFD customer display



- Daily output: 500 POS machines, 2,000 displays and 3,000 scanners
- Exporting to Europe, Africa, the Middle East, Australia, the US, Canada and South America
- Accepting OEM and ODM orders
- 40% of total sales were to Europe and Africa last year
- CE, FCC and RoHS certifications
- Supplying KFC in the Chinese mainland
- Customized logos

Inquire today to find out more.



SZ Expo Hong Compos Tech Co. Ltd

1 Chongchong Rd, Huangjunshan Building, Bantian St,
Longgang, Shenzhen, Guangdong 518100, China
Tel: (86-755) 8315 3765 • Fax: (86) 133 1682 7231
E-mail: 0326dan@163.com
www.globalsources.com/szexpo.co • compostech.net

Global Sources Verified Supplier



1520 VFD



Color-1

NEW

42 years' experience helped launch our new BEH air purifiers

ODM/OEM services available



BEH Portable air purifiers

Serving world-famous enterprises

What makes us the preferred supplier of Honeywell, Panasonic, Trimble Navigation and other world-renowned companies? Since 1978, we've been efficiently manufacturing a wide range of electronic device components and assembling components to final working products. This includes plastic and rubber parts for consumer electronics and next-generation industrial electronics.

Utilizing a mold-flow system

At our 65,000m² factory with ISO 14001:2015, ISO 9001:2015, IATF 16949:2016 and D-U-N-S registered certifications in the Chinese mainland, we provide in-mold decoration, silk-screening, label-making and other services. We use a mold-flow software system to make our production process more efficient. And we have 1,000 employees on hand to process your orders – including 30 skilled engineers and 60 plastic and rubber mold-making specialists.

Providing R&D from Taiwan

To further enhance the quality of our goods and our production efficiency, we provide R&D services from Taiwan and logistics from Hong Kong. To view our full product line, log on to our Global Sources website today.



Manufacturer and Exporter

Win Industry Company

Flat B, 18/F Southeast Industrial Building, 611-619 Castle Peak Rd, Tsuen Wan, Hong Kong SAR

Tel: (852) 2755 6233/6485 • Fax: (852) 2756 6465

E-mail: marketing@winindustry.com • win.tp@winindustry.com
sales.win@seed.net.tw

Taiwan region headquarters: PO Box 87-142, Taipei 105, Taiwan Region

Tel: (886-2) 2763 1284 • Fax: (886-2) 2763 1287, 2762 0964

www.globalsources.com/win.co • www.winindustry.com • www.win-industry.com

Chinese mainland factory: 1 Kehui Rd, Science and Industry

Park, Nantou, Shenzhen, Guangdong 518057, China

Tel: (86-755) 2650 0951, 2663 6821 • Fax: (86-755) 2663 9400

USA branch office: Tel: (1-248) 921 1565, 344 7956 • Fax: (1-248) 344 7935

Global Sources  Verified Supplier ★★★★★

ISO/TS 16949:2009 ISO 14001:2015 ISO 9001:2015 IATF 16949:2016 D-U-N-S Registered



Air purifier series:



Home use purifier

Portable purifiers

Purifier for vehicles

Desktop purifiers

Negative ion rubber products:

Silicone eye mask

Magnetic parts



NEW

Our brilliant industrial designs have won the Red Dot and IF Design Awards



True wireless Bluetooth earbuds (T50)

- 2.17 x 1.46 x 1.1 inches
- Microphone, sports and exercise modes
- Noise-canceling and lightweight



Family design power banks



- 10+ years' OEM and ODM experience
- BSCI-certified factory manufactures 600,000 pcs of power banks per month
- More than 50 appearance patents
- 30 experienced QC staff
- Certifications: UL, GS, CB, and CE
- Fast delivery: within 25 days

To find more details, please call us today.

18W portable wireless power bank



Double wireless charging pad



ASPIRER

Fab-Chain Service Co. Ltd

Hong Kong Aspirer Industrial Limited

5/F, Bldg A, 2028 Song Bai Rd, Shiyao, Bao'an, Shenzhen, Guangdong 518000, China

Tel/Fax: (86-755) 2640 9987 • E-mail: ben.zhao@aspirer.hk

www.globalsources.com/fab-chainservice.co • www.aspirer.hk

Global Sources  Verified Supplier ★★★★★



NEW

Developing 5-10 different kinds of new products every quarter



3-in-1 15W QC3.0 collapsible wireless charger with Type-C port (S)

- Manufacturing power adapters since 2011
- Exporting to Europe and the US
- Working with Kswkingdo, Kabcon, KJ-KayJI, Colcon, Nozza and Weeten
- Monthly capacity: 150,000-300,000 pcs; four production lines and more than 150 manufacturing staff
- MOQ: 50 pcs; delivery time: 7-15 days
- 5,000m² factory with over 30 senior management and R&D technical personnel
- Holding 10 national and overseas patents, and UL, RoHS, CE, FCC, CB and ETL certifications
- OEM/ODM services provided

Send inquiries today.



61W smart multi-function GaN charger with Type-C port (GA)



75W power adapter with special holder (TU)

- Close charging
- Multiple ports: 2 × USB-A + 2 × USB-C

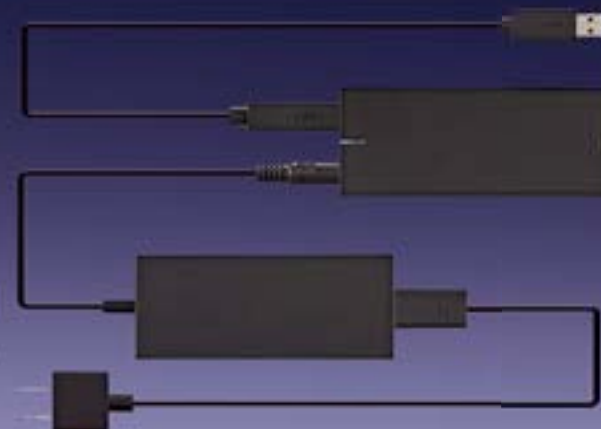

32W portable adapter for Xbox Kinect (XB-M)



Dongguan AnJu Electronic Technology Co. Ltd

3/F, 1 Hexie Rd, Danwu, Shijie, Dongguan, Guangdong 523290, China

Mobile: (86) 157 6887 4130 • 137 2435 5261

Fax: (86-769) 8638 0366

E-mail: mary@anju-ltd.com

www.globalsources.com/anju.co

www.anju-ltd.com/index_en.html

Global Sources  Verified Supplier ★★★★★



NEW

Over 20-year specialized manufacturer of high-efficiency UPSs and inverters



UPS + inverter (HT-8000)

- Pure sine wave output
- Microprocessor based design with true line-interactive structure, DC/AC isolation
- Remaining Estimated Backup Time indication (EBT system on LCD version)
- Wide input range: 140V-310V for 230V regions and 70V-155V for 115V regions
- Adjustable charging voltage and voltage-transfer points
- Smart battery management with intelligent 2 (or 3) stages of charging control
- Adjustable charging current by DIP switch for different batteries
- Real-time auto detection for battery condition
- Automatic restart of load after inverter shutdown
- Smart AVR function (two buck/boost modes)
- Dual-input design for city power and generators/solar power (optional)
- 'Green power' design with auto on/off function and adjustable level
- Network manageable (SNMP/AS400/ModBus card, optional)
- Optional RS-232/USB interface for communication, compatible with all major OS including Windows, Linux, SCO UNIX, and DOS
- Protection for overload, short circuit and over heat; also with thermal control cooling fan
- Supports solar panel input for charging (with MPPT, optional)



- A quality-conscious supplier to reputable OEMs for 25 years
- ISO 9001:2015-certified factory produces uniform-quality goods
- Systems calculate and display the remaining power in real time
- Adjustable voltage, voltage-transfer points and charging voltages
- Units can be monitored through built-in LCDs or a connected PC
- Items checked using PCB in-circuit testers and auto optical testing equipment

Contact us today.



BEAM TECH

Beam Tech Electronics Co. Ltd

4F, 756 Chung Cheng Rd, Chung Ho Dist,
New Taipei City 235, Taiwan Region
Tel: (886-2) 2225 9928 • Fax: (886-2) 2225 6675
E-mail: info@beamtech.com.tw
www.globalsources.com/beam.co • www.beam-tech.com

Global Sources Verified Supplier ★★★★★



UPS for heavy inductive loads

- Capacity: 1KVA-3KVA/0.5HP-2HP, or more
- Compatible with refrigerators, elevators, overhead motor doors and generators
- Pure sine wave output
- Smart backup time estimation (EBT)
- Adjustable voltage sensitivity, voltage-transfer points and charging voltage
- Automatic restart of load after UPS shutdown
- Smart AVR function (two buck/boost modes)
- Cold-start capable
- Audible alarm
- Supports various communication interfaces, including dry contact (DB9), and USB/RS232
- Supports communication extension card, optional for SNMP, AS400 and ModBus
- LED display (full function of LCD display optional)
- Smart battery management with intelligent double stages of charging control



Double conversion topology sine wave UPS

- Using universal input and single output for special applications
- Common neutral design
- Wide range input window and input power factor correction
- 0.8 - 0.9 output power factor
- Smart low-noise cooling fan
- High efficiency with new full-bridge inverter design
- Smart backup time estimation LCD
- Adjustable floating charging voltage



DC uninterruptible power supply AD/BD series

- Used as power and charging device
- Soft start characteristic
- Zero interruption
- Total discharge protection
- Smart battery condition monitoring

NEW

Choose our MFi-licensed products for your retail brands

Providing OEM/ODM services since 2003



Made for
 iPhone | iPad | iPod

USB-C to Lightning cables (WK-MFI01F)

- Walmart, K-mart and Big Lots source from us
- Products with CE, CB, FCC, UL, ETL, MFi, Qi and RoHS marks
- 15 engineers release 10 new models monthly
- Monthly capacity: 400,000-450,000 pcs for chargers and 500,000 pcs for cables

Send us inquiries today.



Lightning to USB cables (WK-MFI01P)



30W mini USB-C/USB-A car chargers (WK-129)



18W dual USB-C/USB-A wall charger (WK-QC51)



Shenzhen Winkeen Electronics Co. Ltd

Rm B1208, WDL Biz Bldg, Meilong Rd, Longhua, Shenzhen, Guangdong 518100, China
 Tel: (86-755) 2314 9652 • Fax: (86-755) 2945 9344
 E-mail: sales@winkeen.com
www.globalsources.com/winkeenelectronics.com
www.winkeen.com

Global Sources Verified Supplier ★★★★★



NEW

12 years' experience in POS terminals



Android 7.x smart POS terminal with fingerprint ID, adhering to FBI and STQC standards (FP8900)

- Holding PCI, EMV and payWave certifications
- OEM/ODM orders and customized sample orders accepted
- 24-hour services provided

Send us inquiries today.

SZFP
Make it easier for you

SZFP (Shenzhen) Technology Limited

Rm 506-507, Huatong Business Building, Xingao Rd,
Xili, Nanshan, Shenzhen, Guangdong 518000, China

Tel: (86-755) 8627 6295

E-mail: sales@szfpotech.com

www.globalsources.com/szfp.co

www.szfpotech.com

Global Sources  Verified Supplier ★★★★★

PCI EMV payWave certification



Mini POS terminal (FP9310)

- Can secure payments anytime and anywhere with smartphones and tablets
- Can be easily integrated with apps running on iOS, Android, Windows and Linux

Your sourcing partner



Get the **GlobalSources.com** app



Simple to use, easy to create supplier lists



Send inquiries, order samples



Connect with more suppliers today



HA_AAU_660

[GlobalSources.com/app](https://www.globalsources.com/app)

NEW

AiTouch - a Bluetooth intercom solution provider since 2006



Bluetooth headset (R1A)

- CE-, FCC- and NCC-certified
- Bluetooth version: 5.0
- Type-C interface
- Waterproof grade: IP66
- Connect with intercom
- Answering calls, talking back and forth, and listening to music/navigation are all supported



Dongle/wireless PTT (R1BKA)



Wireless walkie (AI-5118A)



Finger PTT (R2A)



Working distance of wireless device up to 10 meters



- 1,200m² facility equipped with three production lines
- Our products include helmet headsets, antenna communication devices and Bluetooth intercoms
- OEM/ODM services provided

Don't hesitate to contact us today.



Taiwan Protect LTD

No. 337-1, Sec.1, Zhongyang Rd., Wuchi Dist., Taichung City 43546, Taiwan Region
 Tel: (886-4) 2630 8708 • E-mail: rose@zs-radio.com • jessica@zs-radio.com
 www.globalsources.com/aitouch.co • www.twaitouch.com/index-en.html

Global Sources Verified Supplier ★★★★★





- Karaoke mixer with HDMI in and out
- Echo and tone knob control
 - TV HDMI (ARC) sound in
 - Two wireless microphones support phones and PCs

Supplying wireless microphones and karaoke mixers for over 10 years



Optical coaxial in karaoke mixer with echo and tone control



Optical coaxial in karaoke mixer with echo and tone control



Bluetooth speaker with two handheld microphones (echo and tone on microphone)



Portable Bluetooth microphone

- Exporting to more than 30 countries worldwide
- Engineers averaging over 10 years' experience
- Six years of export experience
- OEM/ODM services

Contact us now to benefit from our VHF/UHF devices.

Highmic

Hiaudio Electronics Co. Limited

3/F, 22 Dayangtian Industrial Area of Wanfeng, Shajing, Bao'an, Shenzhen, Guangdong 518104, China

Tel/Fax: (86-755) 2708 4970

E-mail: sales1@hiaudio-cn.com

www.globalsources.com/hiaudio-cn.co

www.hiaudio-cn.com

Global Sources Verified Supplier ★★★★★



NEW



- Car air purifier (YMT-700H)
- Can remove 0.1µm particles, absorb peculiar smells, and decompose organic matter
 - UVC ultraviolet ray sterilization
 - Constantly monitors air quality
 - Product parameters use space: <math><10\text{m}^3</math>
 - Air volume: 70m³/h
 - Anion production: 3,000 million/cm³
 - Ozone production: 8mg/h
 - Rated voltage: DC 12V
 - Net weight of fuselage: 0.7kg
 - Product size: 170mm x 170mm x 72mm

Supplying Haier, TCL, WinCloud and ROEL

- Product export rate: 99.99%
- Specializing in the R&D and production of air purifier products for six years
- Three years' exporting experience
- OEM and ODM orders accepted
- MOQ: 200 sets
- Daily capacity: 5,000 units
- Lead time: 25-30 days



Car air purifier (YMT-151)



Car air purifier (YMT-161)



Car air purifier (YMT-700)



Car air purifier (YMT-800)

Place an order now.



Xiamen Yometec Technology Co. Ltd

5/F, 421 South Tongji Rd, Jimei, Xiamen, Fujian 361026, China
 Tel/Fax: (86-592) 731 9886 • E-mail: info@yometec.com
www.globalsources.com/yometec.co

Global Sources Verified Supplier ★★★★★

Illustrations shown here are drawings or other representations of products. They are not actual photographs of the products.

NEW

Specialized Bluetooth speaker manufacturer and exporter since 2010



Wooden Bluetooth speaker (NH-BT-W)

- Bluetooth/FM/clock/alarm/wireless charging/USB/AUX
- Remote control
- Decorative LED light
- Touch button

- Own R&D team and three production lines; one or two new products released every month
- BSCI- and ISO 9001:2015-certified factory
- MOQ: 1,000 pcs
- Samples ready in 5-7 working days
- Production time: 25-35 working days
- Supplying Tesco, Target and Walmart
- OEM/ODM services provided
- Our infrared thermometers have passed CE certification issued by Eurofins

Contact us now to place an OEM/ODM order.



Medical infrared forehead thermometer

- Non-contact measurement (1-3 cm)
- High accuracy: +/- 0.2 °C (32 °F)
- Celsius °C/Fahrenheit °F switch
- Body and surface temperature measurement
- Fast reading: less than two seconds
- Sound on/off switch
- 32 memory recalls



Portable Bluetooth speaker with LED screen (DAB LIVE)

- FM/DAB radio
- Clock, alarm, earphone
- 20-preset station
- Frontier silicone DAB solution
- FOB: \$9.9 per piece



Bluetooth soundbar (LSB-01)

- Original ultra-thin 360-degree surround wooden soundbar
- BT V5.0, imported DSP chip
- HDMI, ARC and coaxial connectors
- Output power: RMS 120W
- 2"2 x 3 horn configuration can match any other horn systems in the market

AIERSON

Shenzhen Aierson Technology Co. Ltd

3/F, Block B4, Gangshen High-tech Park, 73 Youmagang Rd, Gongming St, Guangming, Shenzhen, Guangdong 518000, China

Tel: (86) 186 6501 4520 • Fax: (86-755) 8255 9600

E-mail: Owen@aierson.com

www.globalsources.com/aierson.co • www.aierson.com/?_l=en

Global Sources  Verified Supplier ★★★★★

ISO 9001:2015 BSCI



Source products that are bestsellers for Amazon, Aldi, Target, Ross, Woolworths, Kmart, Radioshack and Rakuten



49-/54-/61-key electronic keyboard



88-key digital piano (DP881)



61-key keyboard kit with stand, bench and headphone

- Items carry CE, UL, RoHS, ErP, SAA and MEPS marks
- Goods are checked piece-by-piece prior to shipment
- 38 categories in our catalog
- 10 designers expand our selection with several new models yearly
- 60,000 units every month from our four production lines
- Orders ready for shipment in 30 days
- Get started on your first order with as few as 200 units

Join top retailers in stocking up on our musical instruments. Inquire today.

Joy

Fuzhou Paide Technology Co. Ltd

99 Hudong Rd, Fuzhou, Fujian 350001, China

Tel: (86-591) 8760 0018/1818

Fax: (86-591) 8760 0618

E-mail: elecj@globalsources.com

Global Sales: China Joy Keyboards Co. Ltd

E-mail: jk@chinakeyboards.com

www.globalsources.com/keyboards.co

www.chinakeyboards.com

Global Sources  Verified Supplier ★★★★★

CE FC WEEE    BSCI



Supplier Capability Assessment Report Online

NEW

More than 20 years' OEM experience

- Designers with 25 years' experience
- 24-hour, 365-day online services
- Delivery time: 7-30 days
- 0% quality complaints
- Free technical guidance
- Supporting wholesale and retail; exporting worldwide

Call us today.



Compression drive unit (JNCT-4441)



Compression drive unit (DE880)



Compression drive unit (N3801)



Polymer diaphragm (PEI 0.125 F)



Polymer diaphragm (PEI 0.125 NB)



Polymer diaphragm (PEN 0.125 Q51)



Cixi Luckytone Electronic Co. Ltd

24 Huancheng West Rd, Zhangqi Industrial Park, Cixi, Zhejiang 315315, China

Tel/Fax: (86-574) 2367 8828

E-mail: l.t.ele.william88@hotmail.com

www.globalsources.com/cixijiyin.co

Global Sources  Verified Supplier ★★★★★



NEW



HDMI extender

- Compact size
- 4K @ 30Hz transmission
- Supports 3D and HDCP
- Max transmission rate with no latency: 340 MHz
- Max bandwidth transmission rate with no quality compressed: 340 MHz
- Long-distance transmission: 4K @ 30Hz, up to 80m; 1080p @ 60Hz, up to 120m

Backed by 10 production lines

- Patented design and technology
- OEM/ODM and customized services available
- Small orders accepted

Contact us today to get your order started.



Hub (mate8)



Hub (JD.79)



Brocade-ai Smart Space Co. Ltd

18/F, Bldg 6-2, Xinchuan Innovation and Technology Park,
High-tech Zone, Chengdu, Sichuan 610000, China

Mobile: (86) 186 9600 7112

E-mail: smart-space@brocadeai.com

www.globalsources.com/brocadeai.co

Global Sources  Verified Supplier 



NEW



USB charger for Toyota
 • Innovative double-sided insertion USB
 • With waterproof cover

ISO 9001-certified factory with 10 years' OEM/ODM experience

- All products designed and produced ourselves
- Small orders accepted
- Delivery time: within one week
- 100% inspection before shipment

Any questions or inquiries will be answered within 12 hours. Call now.



Dongguan Ideal Charge Electronic Technology Co. Ltd

2/F, 15 Fengxing Rd, Lingtou, Qiaotou, Dongguan, Guangdong 523530, China
 Tel: (86-769) 8345 2199 • Fax: (86-769) 8102 1393 • E-mail: helsin@c-ideal.com
www.globalsources.com/c-ideal.co • www.c-ideal.com

Global Sources Verified Supplier ★★★★★



USB chargers for car/bus
 • Screw hole concealment
 • Various colors are available

NEW

ISO 9001-certified manufacturer of Bluetooth speakers

Multi-function Bluetooth speaker for outdoor adventures

- Output power: 5W
- 5,000 mAh power bank
- SOS alarm/LED torch/compass
- Solar panel/hand crank/USB charging
- AM/FM radio
- IPX6-grade waterproof

- R&D team with rich OEM/ODM experience
- Own mold making, double-shot molding, oil injection and SMT machines
- Supplying famous customers such as Altec Lansing, Portronics, Belkin and EA

To source quality speakers, contact us now.



KAYINOW

Shenzhen Jiayin Nuoxin E-commerce Co. Ltd

Factory: Bldg B, Chanjing Industrial Park, Xinxu, Huizhou, Guangdong 516226, China

Office: 142-5 Botanical Garden Rd, Baolong St, Longgang, Shenzhen, Guangdong 518116, China

Mobile: (86) 135 3760 2663

E-mail: jynxdzsw1001@gmail.com

www.globalsources.com/jiayinnuoxin.co

Global Sources  Verified Supplier ★★★★★



Portable outdoor Bluetooth speaker with handle

- Low-frequency amplification and contraction design
- Double power protection
- Five types of light effect modes



TWS speaker

- IPX7-grade waterproof
- Patented product
- Portable, ideal for outdoor use
- Dual power protection
- Hands-free communication
- Low-frequency compression design

NEW



Diameter = 3.8mm

Leading manufacturer of data cables and power supplies since 1995

- ISO 9001-, ISO 14001- and BSCI-certified
 - Our products meet CE, GS, UL, FCC, RoHS 2.0, REACH, Prop 65 and SAA standards
 - Complete technical after-sales support
 - OEM/ODM services; small orders accepted
- Inquire now to learn more about our patented products.

Armored ultra-thin HDMI AOC cables

- Super-slim metal armor
- Support 4K/60Hz, 18Gbps bandwidth and YUV 4:4:4

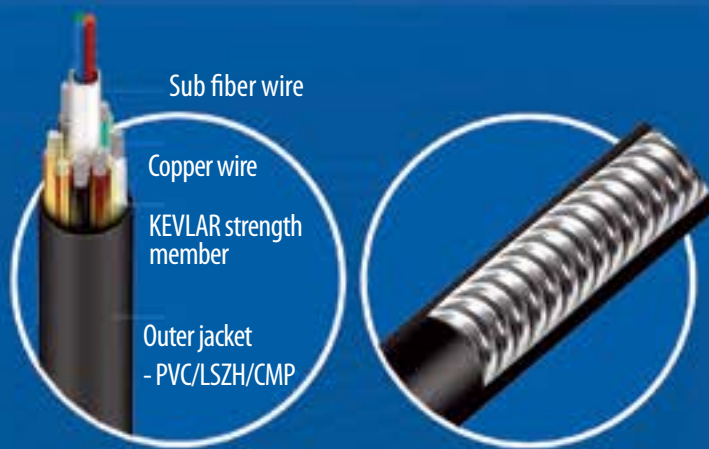

Ultra-thin armored AOC



Tianning Technological Electronics Co. Ltd

Bldg 2, No. 8-12 Oriental Business Center, Ningbo, Zhejiang 315041, China
 Tel: (86-574) 8730 2708, 8729 5271
 Fax: (86-574) 8730 3208 • E-mail: flora@tteelectronics.com
www.globalsources.com/tte.co
www.tteelectronics.com

Global Sources Verified Supplier ★★★★★



HDMI, the HDMI Logo, and High-Definition Multimedia Interface are trademarks or registered trademarks of HDMI Licensing LLC

NEW

Massage gun (MINI-M1)

- High speed motor
- Strong power hits the depths of the muscle
- Upgraded motor, strong vibration
- Enhanced penetration; drive away soreness and fatigue, bring users super comfort
- Space-level aluminum alloy
- Hard, corrosion-resisting, sound-proof, heat-radiative and only weighs 0.5kg, small body to carry easily
- 4-level adjustable frequency; one key to adjust
- Multi-frequency vibration design meets diversified muscle relax needs



Our massage apparatus have received EU appearance patent (007428081-0001)

- Products with SGS and TÜV certifications
- 10,000m² production base with 150 workers
- 35-staff R&D team
- Monthly capacity: 50,000 massage guns and 30,000 electric scooters

Products in various prices ranging from \$19 to \$30 available. Place an order now.



Massage gun (H2)

- Metal heat sink
- Shell metal cooling net effectively reduces internal noise echo and improves heat dissipation efficiency
- 45db silent massage
- Adopts the new generation of noise reduction technology; no need to endure high decibel noise, enjoy quiet comfort
- 6-speed vibration design, two massage modes
- Press the switch twice continuously to switch the massage mode; can meet different massage needs
- High-power brushless motor, with 16V power lithium battery, no-load speed up to 3,500r/min, 12mm amplitude

Shenzhen Rui Sixiang Technology Co. Ltd

4/F, Block E, Guancheng Hi-Tech Park, 37 Zhenxing Rd, Lou Village, Guangming, Shenzhen, Guangdong 518106, China
 Mobile: (86) 135 3765 1319 • E-mail: lee@szcido.com
www.globalsources.com/ruisixiang.co

Global Sources Verified Supplier ★★★★★



NEW**Banknote Counter (HAAN-G2)**

- With cool black LCD display
- Single-denomination value counting
- UV + MG counterfeit detections
- Openable back cover for easy jamming troubleshooting
- Half/chain/double note and DD detection
- Basic, Add and Batch counting modes
- Auto/manual start with adjustable sensitivity levels
- Real frontloading mechanism suitable for most currencies

**Multi-currency Value Counter (MVC-150)**

- Double CIS solution
- Value counting function for mixed denomination counting for most currencies in the world
- Serial number reading for several currencies
- Detailed report directly on the TFT LCD display
- Able to connect receipt printers with serial port for counting result and printing purposes
- UV, MG, MT and IR image detections

**Banknote Counter (BC-2800)**

- DC power system
- Longer continuous operation time
- Black LCD display with detail report and 10-digit total amount display
- Single-denomination value counting function (manual value counting)
- UV, MG and IR detections with self-adjusting function

20-year expert providing you with strong technical support

- 50+ types of products
- OEM/ODM projects accepted
- Items delivered in 20-40 days

For more details, visit our website or call us today.



Bcash Electronics Co. Ltd

Wenzhou Vanmac Trading Co. Ltd

Unit 1501, Tower 2, Chanhe Mansions, Lianhua Rd,
Lucheng, Wenzhou, Zhejiang 325000, China



Tel: (86-577) 8829 5838

Fax: (86-577) 8973 3375

E-mail: sales@bcash.cn

www.globalsources.com/vanmac.co

www.bcash.cn

Global Sources  Verified Supplier 



NEW

15 years of experience in tire pressure monitoring systems (TPMS)



- OEM and ODM services available
- 3,000sqm factory and 20 R&D engineers
- Products with FCC and CE marks
- IATF 16949 certification

TPMS (tire pressure monitoring system)

- Monitoring tire pressure and temperature in real time
- External DIY sensors can support up to 22 tires

Source from us now.



Shenzhen Jetson Auto-Elec Co. Ltd

4/F, 3-1 Tongfuyu Industrial Park, Kukeng, Guanlan St,
Longhua, Shenzhen, Guangdong 518110, China
Tel: (86-755) 8171 6422 • Fax: (86-755) 2947 2905
E-mail: Cathy.Qi@tesee.com.cn
www.globalsources.com/jetson.co
www.tesee.com.cn/home.html

Global Sources  Verified Supplier ★★★★★

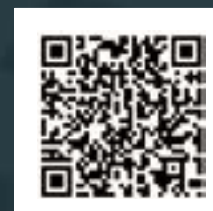

NEW

Over 200 TV wall mounts to choose from



Tilt/swivel TV bracket (DWD1278)

- Wall-mounted
- Suitable for 37" to 70" TVs



Tilt/swivel TV bracket

- Wall-mounted
- Suitable for 17" to 55" TVs



Tilt/swivel TV bracket (DWD1290)



Folding laptop stand (DWD108)



Gas spring monitor mount (DWD1468)



Monitor riser stand (DWD132)

- Over 150 staff including four R&D engineers can handle your OEM/ODM orders
- Manufacturer since 2006
- Releasing three new items monthly
- 90% repeated orders

Contact us today.



Ningbo Yinzhou Dowell Electronics Co. Ltd

Factory: Qihang North Rd, Binhai Industrial Park, Zhanqi, Yinzhou, Ningbo, Zhejiang 315040, China

Tel: (86-574) 8785 2729 • Fax: (86-574) 8739 1730

E-mail: sales@nbmounts.com

www.globalsources.com/nbmounts.co

www.nbmounts.com

Global Sources  Verified Supplier ★★★★★



NEW

Wired/wireless 2D Bluetooth handheld barcode scanner

- ARM 32-bit cortex high-speed processor: up to 200 scans/sec
- Supports Windows/Vista/Android/iOS/MacOS/Linux
- Supports more than 20 languages, including English, German, French, Italian and Russian
- Large memory storage: 33,000 2D barcodes
- Reads barcodes on mobile devices, such as smartphones, tablets and PC

11 years' experience in manufacturing and export

- R&D team develops products according to customer requirements
- Quick delivery for samples; MOQ is one unit
- 15 utility and design patents
- Compliance with CE, RoHS, FCC, BIS, FDA and IP54 standards
- OEM/ODM services
- Lifetime technical support and 24-month warranties

Call us today for the best deals.



2D image handheld barcode scanner



Mini Bluetooth mobile thermal receipt printer



Windows/Android all-in-one touch-screen POS terminal

MINJCODE

Huizhou Minjie Technology Co. Ltd

Yongjun Rd, Qianjin Industrial Park, Chenjiang,
Zhongkai High-Tech Zone, Huizhou, Guangdong 516229, China
Tel/Fax: (86-752) 325 1993 • E-mail: jessicaluo@minj.cn
www.globalsources.com/mjbarcodescanner.co • www.minj.cn

Global Sources  Verified Supplier ★★★★★



NEW

15 years of experience in phone cases and consumer electronic products



Crystal cover

- Most of our regular customers are in the US, Europe, and the Middle East
- OEM/ODM orders accepted
- Providing a one-stop service for cases such as TPU, PC and hybrid cases, and other consumer electronic products

Get in contact with us today.



Hands-free fans



Shockproof cover



Shenzhen Greatpine Technology Co. Ltd
 3/F, Baofeng Rd, Hengtang, Tangxia, Dongguan,
 Guangdong 523710, China
 Tel: (86-769) 8200 1716 • Mobile: (86) 136 8665 6083
 E-mail: Dylan@greatpine.com.cn
 www.globalsources.com/greatpine.co

Global Sources Verified Supplier ★★★★★

SGS FCC CE RoHS



iPhone is a trademark of Apple Inc.

Smart home sales to grow amidst global pandemic

The global COVID-19 pandemic has caused an upsurge of work from home arrangements and has made home quarantine the new normal. With the majority of the population staying at home, interest and value in voice-controlled smart home devices has grown since they help minimize possible transmission on commonly touched surfaces like light switches, remotes, door handles and more. ABI Research estimates a 30 percent sales growth on voice-enabled units, with about 180 million units to be sold at the end of 2020. Buyers looking to source what's hot in the electronics market despite the pandemic can start sourcing smart home devices like voice-activated speakers, lights & controls and smart doorbells, which are readily available on Global Sources.

Smart speakers – These devices are popular with the Gen-Z youth and the millennials, the largest spending generation. The latest models now have added features like voice recognition in regional languages, music playback, and streaming and podcast support – which, in turn, attract more consumers. Some smart speakers can be used for online shopping. This convenience helps reduce face-to-face interactions in public, further decreasing any possible virus transmission.

Smart lighting – With smart lighting and home automation products, users won't have to constantly

touch switches at home. House lights can all be controlled via smartphone apps, voice-control and motion. These energy-efficient smart lights can be operated remotely and can produce different variations of colored lights, which can make smart homes even more attractive.



Security – Home security products like smart doorbells and video cameras help avoid face-to-face interaction of homeowners and people outside. Conversations can be carried out via video doorbells and smart intercom systems. Deliveries being sent at home can be dropped directly at the doorstep. ABI Research Director Jonathan Collins states that these “delivery capabilities are especially valuable for those already in-home quarantine or for those receiving home testing kits.”

Collins adds that “a smarter home can be a safer home.” As the world adjusts by assimilating stronger safety measures against viruses, homes are getting smarter and safer as well.

COVID-19 increases demand for smart, personal transporters

According to Market Research Future (MRF), the global personal transporter market will accelerate at a robust pace of 8.5% from 2019 to 2025. It is expected to be valued at around 150 million units by 2025.

The coronavirus pandemic will likely impact this growth in the market as more people prefer personal transporters or electric-powered, short-distance and low-velocity vehicles for one to two people over public modes of transportation due to sanitation and social distancing measures.

As a result, personal mobility solutions have become a trend in the automotive industry. Among the top demands in the market are eco-friendly smart personal transporters, personal mobility transporters and personal e-transporters: e-bikes, e-scooters, hoverboards, and e-skateboards are also included in this product category.



Photo from Unsplash.com

Based on the MRF report, major brands such as Inmotion Technologies, Segway, and Honda are focused on developing products with reduced mass, advanced DSP processors, and better battery technology. In term of geography, Asia-Pacific is projected to have the majority of growth market share as people in countries like China, India, Japan and Vietnam have been keen to adopt the use of self-balancing scooters and two-wheelers.

World's leading electronics sourcing solution

Electronics.GlobalSources.com

The screenshot displays the website's navigation bar with links for ONLINE MARKETPLACE, TRADE SHOWS, MAGAZINES, OTHER SERVICES, LOGIN, REGISTER, and MESSAGES. The main content area features a search bar, category tabs (Consumer Electronics, Mobile Electronics, Smart Living, Electronic Components), and a featured banner for 'Innovation' with a woman wearing headphones. Below this is an 'O2O Showcase' section with four product cards: a smart watch, USB cables, a camera, and wireless headphones. A 'Meet Suppliers at our Trade Shows' section highlights two trade shows: Consumer Electronics and Mobile Electronics, both held from October 11-14, 2018. The bottom of the page includes a 'Hot Product Videos' section with video thumbnails for a smartphone, a robot, and a pink device.

global sources
Electronics

Products from our ►
exhibitors, selected
by analysts

Also featuring:

- Top Brands
- Next-Gen Components
- Analyst's Choice
- And more!

HA_AAU_652

NEW

Holding patents in the Chinese mainland, the US, Japan and Europe



Sleep box

- Convenient timer function
- White noise

- More than 10 years' export experience
- Certified to BSCI, CE and RoHS standards
- Trusted by Walmart, Swarovski, PNY, Pearl and Coppel
- No MOQ

To source quality products for your market, contact us today.



Shenzhen City Italian Energy Equipment Limited Company

Rm 1206, No. 20, Shipaiyixiang, Dafapu, Bantian, Longgang, Shenzhen, Guangdong 518000, China

Mobile: (86) 135 5689 8279 • Fax: (86-755) 8215 3377

E-mail: sales@oldshark.com

www.globalsources.com/daiierlee.co • www.oldshark.com

Global Sources  Verified Supplier ★★★★★



Sleep box with wireless charger

- Zuck light, USB charger
- 10 soothing sleep soundtracks

NEW

Export markets cover more than 60 countries and regions worldwide

Clinical-level e-health watches monitor lifestyle health from the wrist

**New**

Smart bracelet

- FDA-/CFDA-certified blood pressure sensor module
- Meet AAMI and ESH standards
- Clinical-level blood pressure and blood oxygen monitoring
- 24-hour dynamic heart rate monitoring
- Real time heart-rate measurement
- Auto-monitoring records user's sleep quality, time and status
- Pressure checking helps users know pressure level, providing best guidance to relieve physical and mental anxiety
- IP67 waterproof and lightweight design give a better life
- Smart reminders enhance lifestyle convenience

- Seven R&D bases located in the Chinese mainland and the US
- Four manufacturing bases in the Chinese mainland and India
- Backed by three large factories

Call us now to get your order started.

**FortuneShip**

Guizhou FortuneShip Technology Co. Ltd

6-7/F, Kingson Building, New Energy and Innovation Industrial Park, 1st Chuangsheng Rd, Xili, Nanshan, Shenzhen, Guangdong 518000, China

Mobile: (86) 135 1059 1706

E-mail: zxinglin@waterworld.com.cn

www.globalsources.com/fortuneship.co

www.fortuneship.com/en/

Global Sources  Verified Supplier ★★★★★

ISO 9001:2015 ISO 14001:2015



NEW

Supplying global brands with PC and gaming accessories since 1989



Wireless gamepad (NSJ-411 BT)

- Bluetooth wireless technology
- Multifunction for Switch, PS3, PC, X-input, Xbox 360 and Android devices



6 extra PRO buttons



Programmable game controller (Nr. XIJ-2377)

- 21 buttons
- With customized function for e-sports gamers



Interchangeable D-Pads



Dual wireless multi-gamepad (Nr. NSJ-2402B)

- BT and 2.4GHz dual wireless
- For NSW, Android, P3, PC, PC360



Pro gamepad for PS4 (Nr. P4J-387B)

- Illuminated buttons
- Four remap function buttons



- Source our newly-designed gaming controllers
- We use CAD/CAM software to design new items every season
- Cost-efficient advanced production facilities
- Conducting rigorous in-house multistage QC tests
- OEM and ODM services offered

Contact us today.

Fortune Power Electronic Technology Co. Ltd

11F-4, No. 163 Nanking E. Rd, Sec. 5,
Taipei 105, Taiwan Region
Tel: (886-2) 2764 7318 • Fax: (886-2) 8787 8206
E-mail: fortunepower@fortunepower.com.tw
www.globalsources.com/fortunepower.co
www.fortunepower.com.tw

Global Sources Verified Supplier ★★★★★



NEW

Supplying Amazon, Argos and Gewa Music



Thinline acoustic-electric guitar

- Established in 2002
- 10,000m² factory
- OEM/ODM services available
- Own brand: Joy

For more details, feel free to contact us today.



Acoustic guitar for beginners

Classical guitar

Ukulele

Joy

China Joy Guitar Co.Ltd

99 Hudong Rd, Fuzhou, Fujian 350001, China
 Tel: (86-591) 8760 0568/0018 • Fax: (86-591) 8760 0618
 E-mail: jg@joyguitar.com • marketing@joyguitar.com
www.globalsources.com/guitar.co • www.joyguitar.com
 Global Sources  Verified Supplier ★★★★★

21st year
with Global Sources



Supplier Capability
Assessment Report Online

NEW

Focusing on wire-free solar power home security cameras for 12 years



- New products developed semi-annually
- Products certified to CE, RoHS and FCC standards
- Small orders accepted
- Experienced engineers in our R&D team can customize products to your requirements
- OEM/ODM services provided

Get in touch with us for more information.

FUVISION®

Shenzhen Etong Electronics Co. Ltd
Shenzhen Fuvision Electronics Co. Ltd

Rm 3A28, 4/F, Block C, Huafeng Headquarters Economic Building,
 288 Xixiang Ave, Bao'an, Shenzhen, Guangdong 518102, China

Tel: (86-755) 2792 6912/2912 8513 • Fax: (86-755) 2357 8735

E-mail: sales@china-etong.com

www.globalsources.com/e-tong.co

www.china-etong.com

Global Sources  Verified Supplier ★★★★★

RoHS ISO 9001:2019 CE FCC



Wireless rechargeable battery security camera with spotlight

- 100% wire-free solar battery powered wireless security camera
- Easy install in minutes, and view video directly from phone
- Activate spotlight manually or automatically with motion
- Built to withstand the heat, cold, rain or sun
- Hear and speak to visitors clearly with superior audio quality



Wire-free battery-powered floodlight wireless home security camera



Wire-free solar power rechargeable battery floodlight wireless security camera

NEW

Dynamic sirens

Piezo sirens

An over 23-year electronic component manufacturer and exporter

- Small and OEM orders are accepted
- R&D team releases 50 new products each year
- Prompt delivery: 30 days

Send us an inquiry today.



Micro speakers



Mylar speakers



Speaker



Transducer



Microphones

Wealthland (Audio) Ltd

Rm 10, 8/F, Block B, Tonic Industrial Centre, 19 Lam Hing St, Kowloon Bay, Hong Kong SAR
 Tel: (852) 2793 0820 • E-mail: wealthla@wealthland.com.hk
www.globalsources.com/wealthla.co

Global Sources  Verified Supplier ★★☆☆☆



NEW

A projector manufacturer since 2006 with BSCI, Amazon, FQA and ISO 9001:2015 certifications



- Home theater projector
- Get 300" super full HD picture
 - Enjoy comfortable images, stereo sound
 - Wi-Fi screen mirroring, Bluetooth
 - Full connectivity for streaming content

- Products carry CCC, FCC, CE, PSE and HDMI marks
- 200 staff; 30 R&D engineers
- Eight production lines

For more details, contact us today.



Portable lifestyle projector series



Shenzhen Powerful Photoelectron Co. Ltd

4/F, Bldg E, Hongfa Science Park, Tangtou St, Bao'an, Shenzhen, Guangdong 518000, China

Tel/Fax: (86-755) 2679 2525

Mobile: (86) 151 1639 4653 (Stanley Shan) • 158 1370 7134 (Johnny Chan)

WeChat/WhatsApp: (86) 151 1639 4653

E-mail: sales4@szqiangpu.com • johnny.chan@szqiangpu.com

www.globalsources.com/szqiangpu.co

www.szqiangpu.com

Global Sources  Verified Supplier ★★★★★



NEW

We have more than 10 years' experience in producing set-top boxes

Products cover DVB-T/T2, DVB-S/S2, ISDBT, ATSC-T and more



- Operating under ISO 9001 quality management system and implementing 5S site management rules
- We are equipped with Rohde & Schwarz SFC broadcast signal analyzer and other instruments for exact parameter measurement
- 26 experienced engineers in our R&D team
- Monthly capacity of five million units; qualification rate of 99%
- Exporting to Europe, North and South America, the Middle East and Southeast Asia

Digital full HD DVB T2 set-top box

- Operating system: Android 4.2
- Certification: CE, RoHS
- Features: heat sinking
- Processor core: quad core
- Processor: Amlogic S905
- Support resolution: 1920 x 1080
- Ethernet: 1 x 10/100/1000Mbps
- Wi-Fi: 802.11n 2.4GHz, 802.11ac
- Chipset: Mstar 7T01 Ali3821
- AV/SCART: optional
- Wi-Fi dongle: optional
- PVR: support
- 7-day EPG: support
- 1080p HD: support
- Brand name: OEM

One-stop customized designs, quick working prototypes and mass production can meet customers' expectations. Call now.

Hengli Digital Industrial Co. Ltd

17C/F, Qianyihuayuan, Tian'an S. Rd, Fengze, Quanzhou, Fujian 362000, China
Tel: (86-595) 2266 9290 • Fax: (86-595) 2270 0706
E-mail: Lina@hengli-dig.com
www.globalsources.com/hengli-dig.co
www.hengli-dig.com

Global Sources  Verified Supplier ★★★★★



NEW

More than 10 years' manufacturing experience in printer ribbons



- Compatible ribbon (R5F008EAA)
- Color: YMCKO
 - Print images: 300 images
 - Suitable printers: Primacy, Zenius

- A specialized manufacturer of card printer-compatible ribbons
- Delivery time: 3-7 working days
- Producing more than 5,000 rolls per day
- Strictly test every batch of materials
- Professional in-house R&D team

Call us today to learn more.



- Compatible ribbon (CBGR0100C)
- Color: YMCKO
 - Print images: 100 images
 - Suitable printers: Badgy100/200



Guangdong Kede Tech Co. Limited

2043 Dongmen North Rd, Luohu, Shenzhen, Guangdong 518000, China
Tel: (86-755) 2320 4816 • E-mail: sales@kedetech.com
www.globalsources.com/kedetech.co

Global Sources  Verified Supplier ★★★★★



NEW

Manufacturing earphones for 20 years



TWS earphones

- ENC noise reduction technology
- No risk of sound interference
- Smart voice control, tap control, dual mic ENC

- Daily output: 3,000 pcs of Bluetooth earphones
- OEM/ODM orders accepted
- More than 50 professional engineers
- 1,500 skilled workers
- BSCI-, CE-, FCC- and RoHS-certified

Call us today for more support.



BINSHI

Dongguan Binshi Electronic Technology Co. Ltd

Qi Langwei Industrial District, Tangjiao, Chashan,
Dongguan, Guangdong 510700, China

Mobile: (86) 139 0261 3971/133 4264 8671

Fax: (86-769) 8221 0476

E-mail: Lucy@binshi.net.cn

www.globalsources.com/dgbinshi.co

www.bs-group.com.cn/plus/list.php?tid=68

Global Sources  Verified Supplier ★★★★★



Bluetooth earbuds

- BT V5.0
- High quality MEMS microphone
- Touch adjustment button
- 5-hour talking time

NEW

Source our new premium breath alcohol testers and ketone meters

IGNITION LOCKING DEVICE

ALCOSCAN
ALX3000

Suracell™ technology

Breath alcohol ignition locking device

Certified to:

- EN 50436-1:2014 (offender programs)
- EN 50436-2:2014 (general preventive use)
- E-mark
- IATF 16949



ibLOW 10

Suracell™ technology

Breathalyzer

- 2 types of results display: passive and numerical
- Replaceable blow cap for hygiene purposes
- Several LED lighting modes
- Built-in magnet
- Calibration and calibration grace period reminder
- Calibration controlled by PC software
- Convenient device settings for users



- For law enforcement and industrial safety use
- New advanced SURACELL™ sensor technology
- 22 years' industry experience

For more information, contact us today.

SENTECH

Sentech Korea Corp.

21-6 Jimok-Ro, 75 Beon-Gil, Paju-Si, Gyeonggido 10880, South Korea

Tel: (82-31) 8071 4400 • Fax: (82-31) 8071 4411

E-mail: sentech@sentechkorea.com • hsoh@sentechkorea.com

www.globalsources.com/sentech.co

www.sentechkorea.com

Global Sources  Verified Supplier ★★★★★



KETOSCAN^{MINI}

Real-time fat burning monitor

KETOSCAN mini breath ketone meter

- Portable breath acetone analyzer
- Measures ketone level and calculates body fat burning rate by exhaling
- Results can be checked on both the device and mobile app



NEW

Producing 3 million modular plugs per day

- Manufacturing communication products since 2006
- Working with Schneider, Nexans, Belden, Belkin, Datwyler, Molex, Legrand and LG
- R&D staff with 35 years' experience
- MOQ: 5,000 pieces
- One-stop service: from product stamping to injection molding and assembly
- Customization service available
- OEM orders accepted

For more details, please call us today.



FTP Cat 7 plug (TC6G6G1)

- 4-up and 4-down
- 2-pc V2 phosphor copper
- 3 prongs copper shield with tail
- Suitable for inner wire of OD 1.45mm, 1.30mm, 1.20mm

Cat 5e/Cat 6 RJ45 8P8C pass through connector



Cobtel Precision Electronics Co. Ltd

38 Baxin Rd, Wanjiang St, Dongguan, Guangdong 523063, China

Tel: (86-769) 8076 5658, ext. 168 • Fax: (86-769) 8707 6565

E-mail: sales01@cn-cob.com

www.globalsources.com/cobtel.co • www.cn-cob.com

Global Sources  Verified Supplier ★★★★★



NEW

More than 30 years of professional production experience



Mini PD 20W adapters
 • Dimensions: L: 39.5 × W: 39.5 × H: 28 mm
 • Power: 5V/3A, 9V/2.2A, 12V/1.5A
 • Charge 50% battery within half an hour



Super mini GaN Type-C PD 100W adapter
 • Saves 50% charging time
 • Universal chargeable plug design



Double Type-C PD adapters
 • Single Type-C PD 60W quick charging for laptops; save 50% charging time
 • Double 30W fast charging for two notebooks
 • ETL/CE/FCC/DOE/ERP approvals

- Exporting to the US, Europe, Australia, South America and Southeast Asia
- Product certifications: UL, cUL, GS, BS, CE, SAA, PSE, CCC and KCC
- ISO 9001:2015-/ISO 14001:2015-/BSCI-/MFi-certified factory
- 100+ highly-specialized management and R&D technical personnel
- Own automatic production line

Visit our website or contact us to learn more.



Golden Profit Electronics Ltd.

Jinsha Rd, Shayao Village, Shijie, Dongguan, Guangdong 523000, China
 Mobile: (86) 159 1485 2460
 Fax: (86-769) 8663 3512
 E-mail: hyz@gpepower.com
www.globalsources.com/golden-profit.co

Global Sources Verified Supplier ★★★★★



Universal travel adapters
 • PD 60W quick charging for laptops
 • Save 50% charging time
 • ETL/CE/FCC/DOE/ERP/CCC approvals

NEW

10 years' export experience and 7 years' private mold production and R&D experience



USB-C hub

- Adequate goods in stock
- Daily capacity of 1,000 pieces
- More than 15 injection molding machines
- No MOQ request; short lead time

We provide high-quality products and excellent after-sales service. Get in touch with us today.



iRonsen Technology (Shenzhen) Co. Ltd

No. 306, Bldg 4, Xialingpai Industrial Zone, Dalang St,
Longhua, Shenzhen, Guangdong 518109, China
Mobile: (86) 138 5999 7320
E-mail: ironsen@hotmail.com
www.globalsources.com/ironsen.co
www.ironsen.com

Global Sources  Verified Supplier ★★★★★



USB-C hubs

NEW

11 years' experience in the security industry

Smart household Wi-Fi cameras

- 24-hour, 7-day guarding
- AI true human tracking
- IP66-grade waterproof
- Talkback and alarm functions
- HiSilicon chipset
- Full HD, 1080p resolution
- 360° panoramic and night vision



- Our products are exported to more than 40 countries and regions
- ISO 9001:2015-certified
- One-piece MOQ for non-custom products
- More than 100 workers in our factory
- Monthly capacity of 50,000 sets

Inquire now to see how we can help with your custom requirements.



GRANDSECU

Shenzhen Grandsecu Technology Co. Ltd

5 Xiantian Rd, Longgang, Shenzhen, Guangdong 518116, China

Tel / Fax: (86-755) 8404 5996

E-mail: jane@grandsecu.cn

www.globalsources.com/grandsecu.co

www.grandsecu.cn

Global Sources  Verified Supplier ★★★★★

World's leading electronics sourcing solution

Electronics.GlobalSources.com

The screenshot displays the website's navigation bar with links for ONLINE MARKETPLACE, TRADE SHOWS, MAGAZINES, OTHER SERVICES, LOGIN, REGISTER, and MESSAGES. The main content area features a search bar, category tabs (Consumer Electronics, Mobile Electronics, Smart Living, Electronic Components), and a featured banner for 'Innovation' with a woman wearing headphones. Below this is an 'O2O Showcase' section with four product cards: a smart watch, USB cables, a camera, and wireless headphones. A 'Meet Suppliers at our Trade Shows' section highlights two trade shows: Consumer Electronics and Mobile Electronics, both held from October 11-14, 2018. The bottom of the page includes a 'Hot Product Videos' section with video thumbnails for a smartphone, a robot, and a pink device.

global sources
Electronics

Products from our ►
exhibitors, selected
by analysts

Also featuring:

- Top Brands
- Next-Gen Components
- Analyst's Choice
- And more!

HA_AAU_652

NEW

Leading global supplier of vehicle vision solutions since 2013

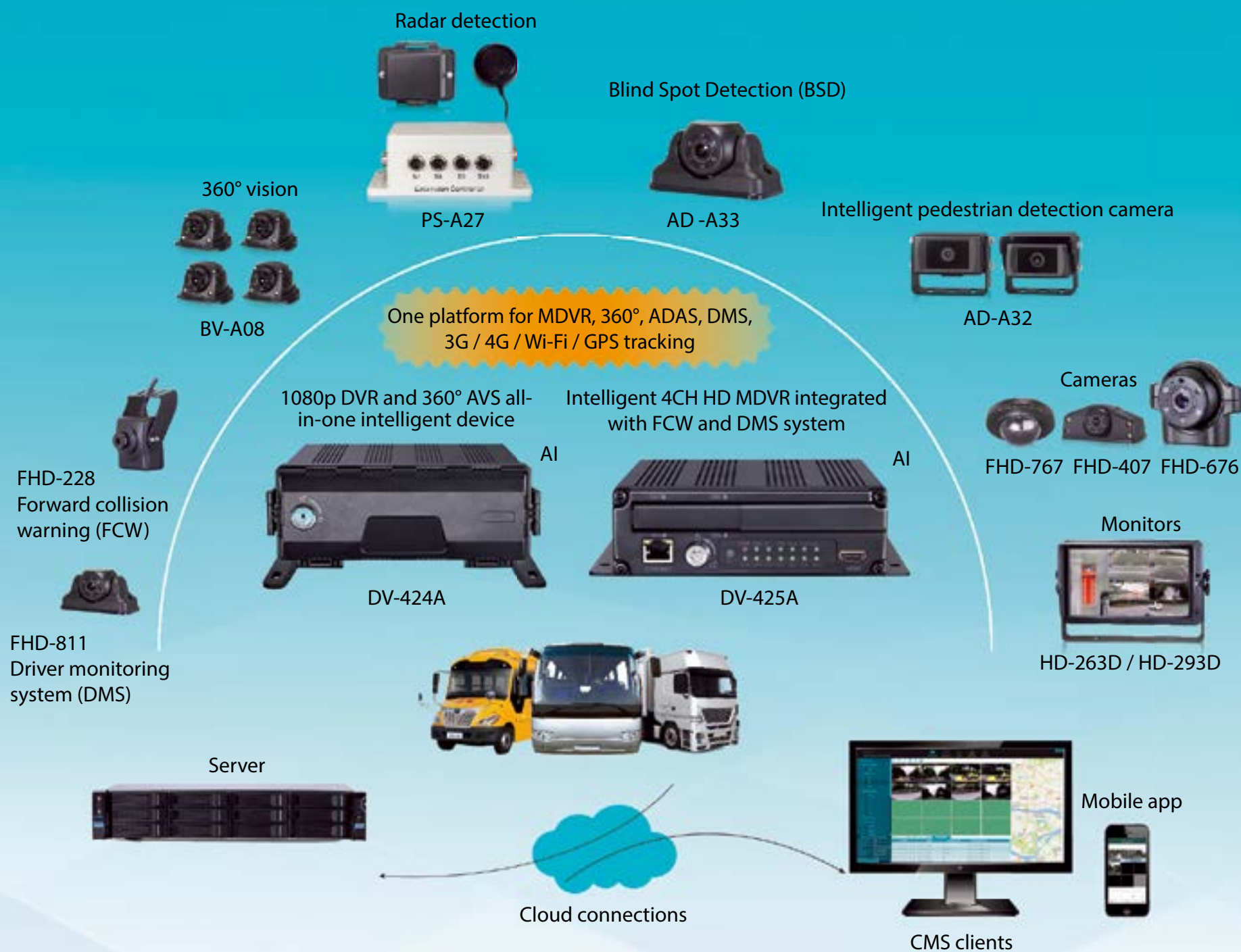

- Strong R&D support with 80+ senior engineers
- Awarded title of "High-tech enterprise" in 2008
- OEM/ODM with free design service
- IATF 16949:2016-certified since 2010
- Exporting 98% of output

Start benefiting from our one-stop OEM/ODM services by getting in touch today.

STONKAM[®]
make a better vision world

STONKAM Co. Ltd

1/F Bldg 6, Huangzhou Industrial Park, Chebei Rd, Tianhe, Guangzhou, Guangdong 510660, China
Tel: (86-20) 6667 0988 • Fax: (86-20) 6667 0977

E-mail: sales@stonkam.com
www.globalsources.com/sharpvision.co
www.stonkam.com

Global Sources Verified Supplier ★★★★★

IATF 16949:2016 e-Mark

SAE RED **CE** **FC**





RL-1504
Suitcase turntable player



RL-204
Portable suitcase turntable player



RL-705
Turntable player:
MDF with real wood



RL-801
Portable Hi-Fi music Bluetooth speaker
with USB/TF/Aux-in



RL-68U
Solid wood lacquer
turntable players

Eight years' experience in turntable players, retro radios and turntable accessories

- BSCI- and ISO 9001-certified
- Small orders accepted
- Producing turntable players, retro radios and turntable accessories
- Shipping 10,000 pieces of needle vinyl mats, clean kits and cartridges to each of our large customers per month

For more details, please call us today.

Retroline *Skywin*

Shenzhen Retroline Electronic Co. Ltd

Unit 13-9, Yuanhuhenerxiang, Zhangbei Industry Zone,
Longgang, Shenzhen, Guangdong 518172, China

Tel: (86-755) 8956 2499 • Fax: (86-755) 2899 5331

E-mail: skywin@skywinsz.com.cn • warsun@warsun.com.cn

www.globalsources.com/retroline.co

Global Sources  Verified Supplier ★★★★★



NEW

More than 12 years' manufacturing history



LED monitor

- Backlight: LED
- Interface: VGA/HDMI/DP/USB
- Suitable for homes, offices and playing games

- 90% of our products are customized
- Technicians with over 20 years' industry experience
- Lead time: under 28 days for standard orders
- Product defect rate: less than 0.5%
- MOQ: 300 pcs
- Customers from Asia, Africa, Europe and South America

To get your order started, contact us now.



Dongguan Kaidi Technology Co. Ltd

Kaidi Industrial Park, Taoci St, Xianchong Community, Wanjiang, Dongguan, Guangdong 523000, China
 Tel: (86-769) 2271 6468 • Fax: (86-769) 2271 6478
 E-mail: sales@kdledtv.com
www.globalsources.com/ctslcd.co
www.kdledtv.com/en



Global Sources  Verified Supplier ★★★★★

LED monitor

NEW

CE-, FCC-, UL-certified touch memory iButton readers



- Our featured touch memory iButton reader reads the registration numbers of Dallas Semiconductor iButtons
- This device is used for identification, automated password entry and more
- Its compact size makes it ideal for POS system integration
- For 28 years, we've served everyone from multinationals to small startups
- Our catalog includes RFID items, POS peripherals, mobile data-collection terminals, access control systems, networking devices and more
- Production takes place in our advanced ISO 9001:2008-certified facilities
- We offer custom manufacturing and programming services based on your OEM/ODM specifications

For more information, contact us now.

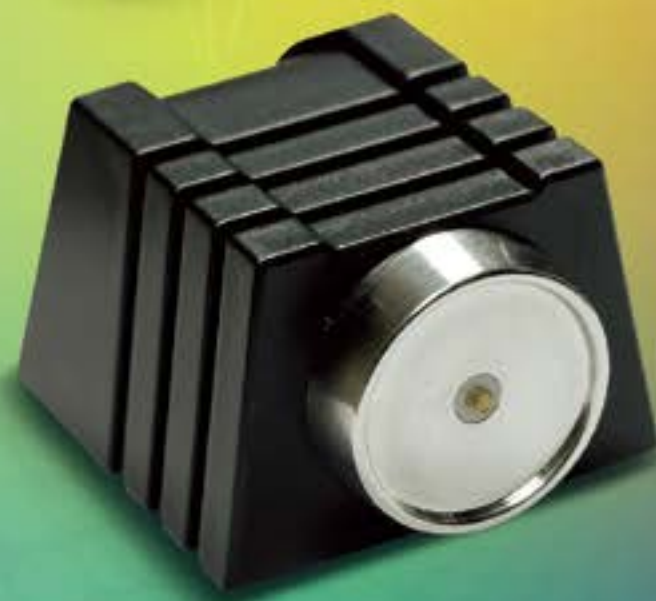

GIGA-TMS Inc.

8F, No. 31, Lane 169, Kang-Ning St., Hsi-Chih District, New Taipei City, Taiwan Region

Tel: (886-2) 2695 4214 • Fax: (886-2) 2695 4213

E-mail: promag@gigatms.com.tw

www.globalsources.com/giga.co • www.gigatms.com.tw

Global Sources  Verified Supplier ★★★★★

ISO 9001:2008 RoHS   



TMR901

Touch memory iButton reader

- USB HID keyboard or RS-232 interface
- Reads all Dallas Semiconductor touch memory iButtons
- 3-color LED indicator shows operation status
- Audible beeper indicates reading status
- Compact size
- Applications: access, security, personal ID and POS systems, and automatic data logging

NEW

Novelty TWS earphone manufacturer producing 30,000 pieces each week



- Newest TWS earbuds with built-in mic
- Deep bass
 - Stereo Hi-Fi output ensures an extremely accurate listening experience
 - Advanced chips support dual-channel audio outputs
 - Lightweight and ergonomic designs

- Leading factory in China supplying a full range of wireless earbuds
- All products are made with our private molds and quality chipsets
- Strict QC processes: IQC, QC and QA
- Three production lines

Providing stellar service and quality earbuds to customers worldwide. Call now.

MAGIN

IMG Electronics Co. Limited

5/F, Bldg D, Longda Industrial Zone, Dalang, Longhua, Shenzhen, Guangdong 518110, China
 Mobile: (86) 135 3961 9519
 E-mail: bill@magingroup.com
 www.globalsources.com/szimg.co
 www.magingroup.com

Global Sources Verified Supplier ★★★★★



ISO 9001:2015



One or more of the illustrations shown here is a drawing or other representation of a product and not an actual photograph of the product.



TWS earbuds



NEW

One-stop solution provider and manufacturer of electronic products with over 10 years' experience

Focusing on high-tech consumer electronics and digital medical and health products



Massage gun

- LED segment display, touch key operation
 - 16.8V brushless motor
 - 6-speed with six professional heads
 - Two vibration modes, support variable frequency vibration
 - 50 low decibel noise reduction
 - 2,500mAh battery (removeable), working time: 5-6 hours
 - Unit weight: 860g
- 30,000m² factory with 16 dust-free assembly lines
 - Over 300 workers and more than 40 R&D engineers
 - Releasing 3-4 new products every month
 - Monthly capacity of 900,000 pieces

Inquire now to learn more.



Shenzhen JoyHong Technology Co. Ltd

5/F, Bldg 1, Zhongtai Rd, No. 18 Loucun 2nd Industrial Park, Xihu St, Guangming, Shenzhen, Guangdong 518107, China
 Tel: (86-755) 3688 7957 • Fax: (86-755) 2999 9987
 E-mail: Betty@joyhong.com • info@joyhong.com
 www.globalsources.com/joyhong.co
 www.joyhong.com

Global Sources Verified Supplier ★★★★★

RoHS REACH ISO 13485:2016 ISO 9001:2015

One or more of the illustrations shown here is a drawing or other representation of a product and not an actual photograph of the product.



Smart phone



Infrared thermometer



Automatic soap dispenser



Digital signage



10.1" digital photo frame



NEW

Gaming monitor

- 23.8-inch slim design, IPS panel 144Hz, 1ms in-game response time
- HDR, FreeSync, G-Sync, low Blu-ray and Flicker Free are our standard configuration
- Exclusive gaming style base design, swift/lifting base optional

An LED monitor supplier since 2006

- Launching new products quarterly
- Working with AUO, CMI, BOE, Samsung and other brands
- Exporting to 100+ countries including the US, the Middle East, Southeast Asia and Europe
- OEM and ODM services and CKD/SKD technical support available
- EMC, CE, LVDS, ERP, RoHS and ENERGY STAR certifications

For more details, please contact us today.

MAXPAC

Maxpac Electronics Co. Ltd

3/F, Building A, Jinxiongda High-Tech Industrial Park, Xinyuan Rd, Dalingshan, Dongguan, Guangdong 523800, China

Tel: (86-769) 8305 2388 • Fax: (86-769) 8305 2828

E-mail: sales@maxpac.com.cn • anne@maxpac.com.cn

www.globalsources.com/maxpacelectronics.co

www.maxpac.com.cn

Global Sources  Verified Supplier ★★★★★

RoHS EMC LVDS ERP ENERGY STAR CE



Gaming monitors

NEW



- GaN quick chargers (C-504)
- 65W PD quick charging
 - Lightweight, foldable and portable
 - Size: 30.8 x 30.8 x 62.8mm

Over 15 years' OEM and ODM experience

- Product qualification rate: up to 99.99%; third-party inspection supported
- BSCI-, ISO 9001:2015- and RBA/VAP-certified
- QA staff with 13 years' working experience; \$1 million R&D budget per year
- Professional pre-sales and after-sales services
- Products with one-year warranty
- Supplying ONN, Hama and iHome
- Accepted payment terms: T/T, OA, L/C

Place your order now.



Dongguan Tyjin Electronics Co. Ltd

7 Keyan Rd, Wulian, Fenggang, Dongguan, Guangdong 523000, China
 Tel: (86-769) 8252 7266 • Fax: (86-769) 8252 7200
 E-mail: info@tyjin.com
 www.globalsources.com/tyjin.co • www.tyjin.com
 Global Sources  Verified Supplier ★★★★★



RBA VAP qi FCC ID PAH SCCP ISO 9001:2015 
 CE-RED LVD ERP RoHS    



- USB-C Qi hubs (HC-001)
- Two USB-A (USB 3.0) ports + one HDMI port + one RJ45 (1,000M) port + one USB-C (PD) port
 - Double coil stand charger: 10W wireless charging



- Multi-port chargers (C-017)
- Total power: 50W
 - 4-port USB-A output: 5V/6.4A
 - 1-port USB-C output: PD 18W



- Five-coil wireless charger (C-078)
- Power: 5W/7.5W/10W
 - Multidirectional charging
 - Supports two smartphones charging synchronously

NEW

Over 100 major distribution channels in over 50 countries



Wireless charger
with USB ports

- Three industrial units covering one million sqm
- ISO 9001-, QC 080000- and UL-certified factories
- Over 270 innovative R&D engineers and over 8,000 employees
- A leading power strip manufacturer and well-known brand in the Chinese mainland
- Products have ETL, GS, CB, GCC, TÜV and SASO marks

Call us today.



Adapter



Lightning cable



SmartC USB
charging station



USB Type-C charger



Multifunctional
LED desk lamp



Surge protector



Monitor

Huntkey
航嘉

Shenzhen Huntkey Electric Co. Ltd
Huntkey Enterprise Group

Huntkey Industrial Park, Banlan Rd, Bantian, Shenzhen, Guangdong 518129, China

Tel: (86-755) 8960 6670 • Fax: (86-755) 8960 6333

E-mail: huntkey@huntkeydiy.com

www.globalsources.com/huntkey.co

www.huntkey.com • www.en.huntkey.com

Global Sources  Verified Supplier ★★★★★

QC 080000 ISO 9001:2015 GCC **CB**   



NEW

10-year professional manufacturer of Bluetooth earphones

TWS earbuds

- LED display
- Bluetooth 5.0
- Type-C charging port
- Fast pairing, stereo sound quality with deep bass
- Profile: A2DP, HFP, HSP and AVRCP
- Frequency: 2.4-2.48GHz
- Distance range: 10-15m
- Working time: 5 hours
- Charging time: 1.5 hour
- Battery (earphone): 45mAh
- Charging box: 500mAh



- Exporting to more than 20 countries
- Professional private mold R&D and production
- Monthly capacity of 200,000 pieces
- OEM/ODM and small orders accepted

TWS earbuds with charging case

We promise fast lead time, good service, reasonable price and one-year warranty. Call now.

Mission®

Shenzhen Mission Electronic Ltd

3/F, Yusheng Industrial Area, Liaokeng, Shiyan, Bao'an, Shenzhen, Guangdong 518108, China

Tel/Fax: (86-755) 2908 9177

Mobile/WeChat: (86) 137 1418 2864 (Licy)

Mobile/WeChat: (86) 159 9960 9911 (Launa)

E-mail: sales3@ms-elec.com • sales1@ms-elec.com

www.globalsources.com/ms-elec.co

www.ms-elec.com

Global Sources  Verified Supplier ★★★★★

RoHS KC NCC FC CE



Illustrations shown here are drawings or other representations of products. They are not actual photographs of the products.



TWS earbuds with APTX lossless sound quality



Easy-to-ride helmet headphones

NEW

Over 10 years' experience manufacturing thermal printers

58mm thermal label printer for scales (LP201)

- Printer directly connected to the scales, serial RS232 connection
- Supports thermal label/receipt printing
- Compatible with multiple kinds of electronic scales
- Easy paper loading, support big paper roll, max. diameter of 85mm
- Supports adjusted printing paper width, compatible with multiple paper widths, such as 1" and 2"
- Special software provided for free, with which users can edit the labels themselves



- New products released monthly
- OEM/ODM and custom programming services
- Strict QC system covers whole processes from design, purchase, production and packaging, to shipping
- 2,500sqm factory
- Products come with one-year warranties
- Complete and responsible after-sales service
- 60-member R&D team providing solutions to meet different customer needs



4" thermal label printer (CC435)

Send us an inquiry today.



Caysn®

Xiamen Apt Electronic Tech. Co. Ltd

No. 202, 46 Hening Li, Huli, Xiamen, Fujian 361012, China

Mobile: (86) 180 5985 8250 • Fax: (86-592) 591 6062

E-mail: amy@a-printer.com

www.globalsources.com/airprint.co

www.a-printer.com

Global Sources  Verified Supplier ★★★★★



58mm thermal portable Bluetooth printer (P58E)

NEW

Specializing in the development and production of earphones since 2011

TWS earbuds

- Bluetooth 5.0
- Solution: Realtek 8763
- Charging time: approximately 1 hour
- Talk/music time: 3 hours
- Standby time: 50 hours
- Power bank case: 400mAh
- Up to 10 meters working distance
- Handmade driver: 6mm
- Sensitivity: max. 110dB
- Impedance: 16ohm
- Micro USB charging cable included

- Own large-scale molds and painting, spray painting, injection and assembly workshops
- 200 employees
- R&D team with over 10 years' experience in the industry
- Factory covers over 10,000 square meters
- Strict QC system to ensure every item shipped is of high quality
- Can finish new samples in 3-7 days

For more information, contact us today.



Bluetooth earbuds

Wireless earbuds



Shenzhen Xuan Yue Digital Technology Co. Ltd

Building 20, Lihao Industrial Park, 80 Ainan Rd, Longgang, Shenzhen, Guangdong 518116, China

Tel: (86-755) 8488 3238 • E-mail: kelvin@chinaxuanyue.com

www.globalsources.com/xuanyue.co • www.chinaxuanyue.com

Global Sources  Verified Supplier ★★★★★

Bluetooth and the Bluetooth logo are registered trademarks of the Bluetooth SIG.



NEW

Exporting 500,000 Qi wireless chargers to the US and Europe every year

- Holding design patents; private molds
- WPC member; BSCI-audited factory
- 3-5 new molds developed each year
- 12-month warranties
- Working with famous chain retailers in the US and EU markets

We provide 24/7 service and fast delivery.
Call us now.

Wireless mobile phone charger with UV sterilizing function

- UV sterilizing, eliminates 99.9% of bacteria
- Supports fast wireless charging
- 12h/24h time; snooze function
- RGB LED nightlight
- Dimmer function for time display
- USB output charging for additional devices
- Magnetic suction power supply
- EPP Qi-certified



Wireless mobile phone charging alarm clock

- Multiple functions: FM radio; temperature and humidity; perpetual calendar
- Supports fast wireless charging
- 12h/24h time; snooze function
- RGB LED nightlight
- Dimmer function for time display
- USB output charging for additional devices
- Magnetic suction function, can be used separately
- EPP Qi-certified
- Can also be used as a frame

Shenzhen Shuo Yu Technology Co. Ltd

30/F, East Block, Weihua Bldg, 1027 Shennan E. Rd, Luohu, Shenzhen, Guangdong 518105, China

Tel: (86-755) 2821 3096 • Mobile: (86) 138 2748 6068

E-mail: shuoyu1688@shuoyutec.com

www.globalsources.com/shuoyu.co

www.shuoyutec.com

Global Sources  Verified Supplier ★★★★★

Qi RoHS REACH CP65 BSCI ISO 9001:2015 ISO 14001:2015 CE FCC



Pointuch

300,000+ products manufactured in our 3,000m² factory every year



360-degree panoramic dash cam

- 1563 x 1563 front camera
- 170-degree 1080p rear camera (VGA, 720P optional)

- Patented and private appearance
- WDR and night version
- Parking monitor and time lapse, 24-hour protection

- 10-year OEM/ODM factory with over 100 employees
- Own mold-making department
- Exporting mainly to Japan and 50 other countries
- Less than 1% defect rate verified by customers

Inquire now to find out more.



Shenzhen Lutu Technology Co. Ltd

5/F, Bldg C, Xiangshanwan Industrial Park, Shenzhen, Guangdong 518105, China
 Mobile: (86) 158 1871 9158
 Fax: (86-755) 3697 2407
 E-mail: info@lutaradar.com
www.globalsources.com/szlutu.co
www.lutaradar.com

Global Sources  Verified Supplier ★★★★★



360-degree panoramic dash cam



NEW

Covering 50,000m² with over 400 patents since 1995

- 4 own brands: GOLDENSEA UV, TERBLY, GSARC and WTC
- 1,000+ employees, 100+ R&D engineers, 140+ after-sales staff
- Headquarters in Guangzhou, China, with subsidiaries in HK SAR, France and Germany
- Production capacity: 200,000+ pcs/month
- Product safety: radar sensor, alarm, delayed start, time setting and wireless control
- UV lamps are ozone-free with 99.9% disinfection rate
- Wide application: from 0.6m² households to 960m² public places

Contact us today.



Guangzhou Haoyang Electronic Co. Ltd

109 Haiyong Rd, Shiqi, Panyu, Guangzhou, Guangdong 511450, China
 Tel/Fax: (86-20) 3996 6399
 E-mail: gsuv@goldensea.com
www.globalsources.com/gsuv.co
www.goldenseauv.com



Global Sources Verified Supplier ★★★★★



Our facility

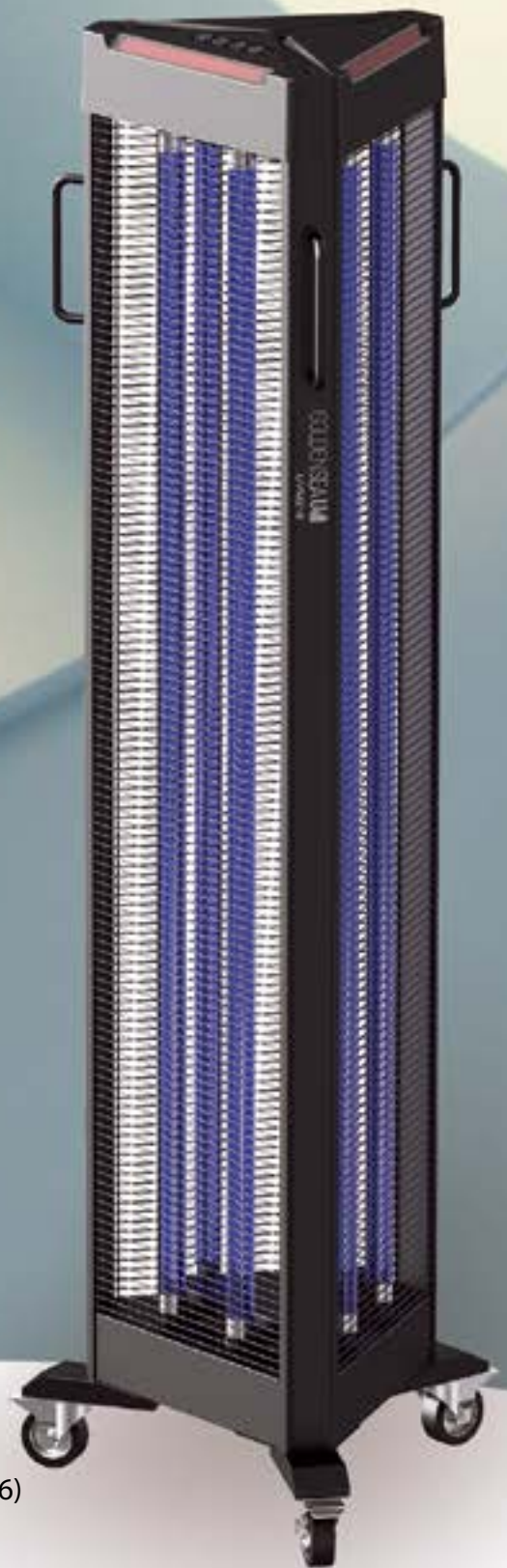

Moveable industrial UVC disinfection lamp (UVM216)

- 216W, 9,000-hour lifetime
- Fall protection, lightweight



2.65kg industrial UVC disinfection lamp (UVL72)

- 72W, 9,000-hour lifetime
- Flexible mounting



0.8kg portable UVC disinfection lamp (UVP36)

- 36W, 9,000-hour lifetime
- Fall protection, child lock
- Patent No.: 202030193981.2

NEW

Exporting power tools for 19 years

- OEM/ODM services
- CE-, UL-, SGS- and CCC-certified
- Passed ISO 9001:2015 certification
- 100% inspection before shipment
- Providing after-sales service
- Own brand: Kingsdun E-Durable

Get started sourcing the best tools, call today.



- Precision electric screwdriver set**
- Comes with 10-piece different driver S2 bits
 - Powerful max. torque of automatic mode is 2Nm/180rpm; 3 stage push-type structure switch
 - 1,500mAh lithium-ion battery for long-lasting power
 - The charging cable is suitable for any USB sockets



- 31-in-1 double-sided screwdriver set**
- Built-in strong magnet, easy to plug
 - Two-sided bits installation design
 - 30 high-precision bits



- 130-in-1 precision screwdriver set**
- 360° rotation extension
 - Precision magnetic screwdriver head
 - Suitable for smart phones, computers, home appliances, cameras, drones, game consoles and other daily product repair

- 115-in-1 screwdriver set**
- Suitable for smart phones, tablets, laptops, watches, glasses, cameras, PS4/Xbox controllers, home and digital items
 - Lightweight and compact size



Shenzhen Youfu Tools Co. Ltd

4/F, Bldg 4, Dongwu Industry Area, Donghuan 1st Rd, Longhua, Shenzhen, Guangdong 518109, China
 Tel: (86-755) 8325 8692 • Fax: (86-755) 8325 3695
 E-mail: sophie@youfutools.com
 www.globalsources.com/youfu.co • www.youfutools.com

Global Sources Verified Supplier ★★★★★



NEW

Products with CE, FCC, RoHS and E-mark certifications



- Solar-powered wireless backup camera
- 5-min DIY, plug and play
 - Real-time monitor, only touch the monitor for activation
 - No interference wireless transmission
 - Universal mounting bracket to fit different license plate sizes
 - IP67 waterproof level
 - Low power consumption design

- BSCI- and ISO 9001-certified factory
- Independent R&D capability
- OEM/ODM orders accepted
- 300 employees to support mass production
- Main products include dash cameras, parking sensors, car cameras and monitors, car entertainment systems and TPMS

Source from us today.



Shenzhen Sunway Industry Co. Ltd

Building 17, Guanlida Industrial Zone, LuoZu, Shiyan, Bao'an, Shenzhen, Guangdong 518108, China

Tel: (86-755) 2905 8679 • Fax: (86-755) 2763 3890

E-mail: sun@sunwayi.com

www.globalsources.com/sunwayindustry.co • www.sunwayi.com

Global Sources Verified Supplier ★★★★★



Wireless backup cameras

- Solar-powered
- Embedded antennas
- Real-time monitor, only touch the monitor for activation
- No interference wireless transmission
- Low power consumption design

Video parking sensors for US driving license plates

- Highly integrated (3 sensors + 1 camera)
- No external box/less cable connection
- Parking aid via voice warning and color display
- Works as dash camera, rear camera or video parking sensor

5.0" HD IPS touchscreen dual-record dash camera

- 360° panorama record, outstanding parking monitoring
- GPS tracking playback
- Super capacitance (no battery, no exposure)
- Super night vision, WDR, rearview reversing

NEW

Over 27 years of production experience



ECOM gigabit management switch (P2632GF)

- 24 PoE ports + 4 copper/SFP fiber combo ports
- Bandwidth: 56/192 Gbps
- Power: 400W max, 350W in nominal
- High-power PoE, VLAN, SNMP

- Head office established in 1993
- Working with Overteck, ProLink, TOTO-LINK, and clients from the Russian and South Korean telecom industry
- 3-year warranty and 3/1,000 spare parts provided
- 10 R&D staff; OEM/ODM services available
- Average daily capacity: 10,000 pcs
- Delivery time: 22-24 days

Don't hesitate to contact us for more details.

ECOM[®]
Networking & Communication Products

Shenzhen YILIANWANG Technology Co. Ltd

6/F, Unit A, Bldg 11, Makan North Industrial Park, Xili, Nanshan, Shenzhen, Guangdong 518055, China

Tel: (86-755) 8600 0058 • Fax: (86-755) 8600 0057

E-mail: sales16@longway.com • sales15@longway.com

www.globalsources.com/yilianwang.co

www.ecomswitch.com

www.longway.com



Global Sources  Verified Supplier ★★☆☆☆

One-stop sourcing agent with more than 12 years of experience

Robot vacuum cleaner

- Panoramic navigation, with 360 degree vision camera
- Intelligent planning path
- 2050PA large suction
- 600ml dust box, double filter system
- 2,500mAh long-life Li-battery
- 75mm slim design
- 400ml electronically controlled water tank
- Automatic recharge function



- With over 200,000 SKUs from more than 10,000 leading manufacturers
 - Agents of Haier and Huami
 - Exporting to more than 60 countries
 - Inquiries replied to within 24 hours
 - MOQ: 50 pieces
 - Lead times: 3-5 days
- Contact us now to find out more.



Shenzhen Star A e-Commerce Co. Ltd

Rm 703, Bldg 4, Tongtai Mansion, 6259 Bao'an Rd, Bao'an, Shenzhen, Guangdong 518103, China
 Tel: (86-755) 2322 9519 • Mobile: (86) 135 1076 8009
 E-mail: eric.hsu@starasources.com
www.globalsources.com/starasources.co
www.starasources.com



Global Sources Verified Supplier ★★★★★

TÜV FC CE RoHS

NEW

Producing 5,000 pieces of high-quality monitors per month

- More than 10 R&D staff
- 100% inspection and testing
- CE and FCC certifications
- Receiving good comments in the last 10 years from both end customers and wholesalers

Call us today.



Hanshi Jingxian Innovation Technology (Huizhou) Co. Ltd

2/F, Building 4, Derong Industrial Zone, Jimadi, Luoyang, Boluo, Huizhou, Guangdong 516000, China

Tel: (86-752) 665 5092

E-mail: sunrise@intehill.com

www.globalsources.com/intehill.co

Global Sources Verified Supplier ★★★★★

All trademarks shown are for reference purposes only. We are not authorized to sell any items bearing such trademarks.



Monitors for gaming



Portable monitors



We have been visiting the Global Sources exhibitions in Hong Kong for many years to source mobile electronics products.

We are very much looking forward to coming back this October.



Michal Manowiecki,
SUNEN , Poland

HA_GSTJ_1.2H_b_200608

global sources

GlobalSources.com

NEW

16 years of industry experience

- Providing one-stop services from product development to delivery
- Supplying home gym equipment, weight benches, steppers, free weights, dumbbells, barbell sets, yoga and Pilates supplies, and exercise accessories
- Exporting to Europe, the US, South Korea, Japan, Central and South America, and Mediterranean areas

Send inquiries today.

EQFIT
英桥运动

Nantong Enjoy Sports and Homefitness Co. Ltd

Rm 402, Bldg 17, Zhongnan Century City,
8 Taoyuan Rd, Nantong, Jiangsu 226000, China
Tel: (86-513) 8110 5258 • Fax: (86-513) 6819 9258
Mobile: (86) 139 0148 8329 • E-mail: sales@enjoyfit.com.cn
www.globalsources.com/enjoyfit.co
Global Sources  Verified Supplier 

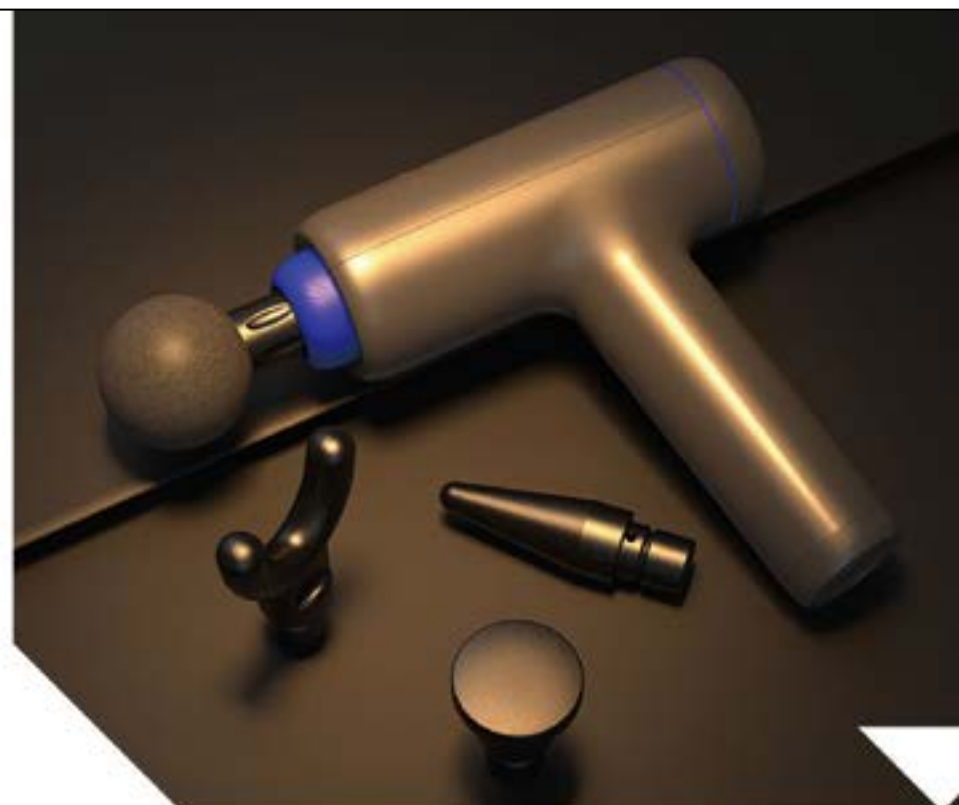

Fascia gun

- Six-speed deep massage, six types of massage heads
- Massages gun: only takes 30s to aid condition
- Battery life: eight hours
- LCD; silent motor without brush



Fascia gun

NEW

More than 10 years' production and R&D experience

- Over 100 kinds of cable assemblies, converters, adapters, connectors and splitters
- Lead time: less than seven days
- Small MOQ accepted
- 60% of our customers are from Europe and the US

Contact us today to begin sourcing.



USB cables



8K HDMI 2.1 cable



HDMI to VGA



Fiber optic HDMI cable

IKOTEKSUN

Shenzhen Koteksun Technology Co. Ltd.

Bldg C501, Jingyefang Industrial Park, 210 Wanfeng Central Rd,
Shajing, Bao'an, Shenzhen, Guangdong 518104, China
Mobile: (86) 136 3292 1737 • Fax: (86-577) 3665 3875
E-mail: chrishwong@ikoteksun.com
www.globalsources.com/koteksun.co
www.koteksun-cable.com
www.ikoteksun-cable.com • www.lls-cable.com
Global Sources  Verified Supplier 



NEW

11 years' export experience



- Holding CE, RoHS and FCC certifications
- MOQ: one piece
- OEM/ODM services available

Contact us today.

21.5" advertising display

- With hand sanitizer and automatic sensor
- Both wall-mounted and standing types available

Shenzhen Yoshingy Technology Co. Ltd

Xuyuan Building, Longgang St, Longgang, Shenzhen, Guangdong 518116, China
 Mobile: (86) 135 1096 3537
 E-mail: Sales1@yoshingy.com
www.globalsources.com/yoshingy.co

Global Sources Verified Supplier ★★★★★



New display



New 21.5" standing display

NEW

We have more than 400 kinds of cables and connectors

- 5,000-square-meter workshop; over 200 skilled workers
- OEM/ODM services provided
- Providing inspection report and loading picture for each delivery

Inquire with us now.



USB 3.1 Gen-2 cable (10-1002)

- Connector: 2 x USB 3.1 Type-C male with E-Marker
- Data transfer rate: up to 10 Gbps
- PD charging: max 100W (20V/5A)
- Resolution: up to 4K x 2K @ 60Hz



Fiber optic HDMI 2.0 cable (40-5001)

- Connector: 2 x HDMI male
- Data transfer rate: up to 18 Gbps
- Resolution: 4K x 2K @ 60Hz (4:4:4, 8 bit)
- Head: metal
- Cable length: 1-150m
- Supports LOGO print; no MOQ



Ningbo Uplofit Intelligent Technology Co. Ltd

Rm 1004-5, Haoru Building, 468 Taikang Rd, Yinzhou, Ningbo, Zhejiang 315199, China
 Tel: (86-574) 8830 2180 • Fax: (86-574) 8830 3760
 E-mail: sales@uplofit.com
www.globalsources.com/uplofit.co

Global Sources Verified Supplier ★★★★★

NEW



Bluetooth bone conduction headphones (ES-768)

- Sound anti-leak technology
- All DIY modules can be replaced by the user
- QCC3024 BT V5.0, dual-mic noise reduction
- Made of hypothermia titanium alloy materials; usage not affected in all seasons
- Waterproof grade: IPX7

13-year consumer electronics manufacturer with 7 years' experience in bone conduction products

- 12 years' export experience
- Own patented models; offering OEM/ODM services
- Six production lines; monthly output of 100,000 to 150,000 units
- Our own brand MoreinTech is recruiting agents worldwide

Inquire now to learn more.



MoreinTech

Ovtech Industrial Co. Ltd

3/F, Bldg 3, Dongwangyang Industrial Park, Huangtian, Xixiang, Bao'an, Shenzhen, Guangdong 518128, China

Mobile/WeChat: (86) 134 1848 2535

Tel: (86-755) 2923 1798

E-mail: sales@ovtech.cn

www.globalsources.com/ovtech.co

www.ovtech.cn • www.moreintech.com.cn

Global Sources Verified Supplier ★★★★★



ES-668



NEW

10+ years' manufacturing EMS stimulators

- Main products: abs stimulators, EMS abdominal muscle toners, EMS feet/neck/shoulder massagers, TENS units and more
- All products compliant with CE, FCC, RoHS and REACH certifications
- Professional R&D team with 100+ staff

Call us now to learn more.



Electronic muscle stimulator



Electric leg and foot massagers

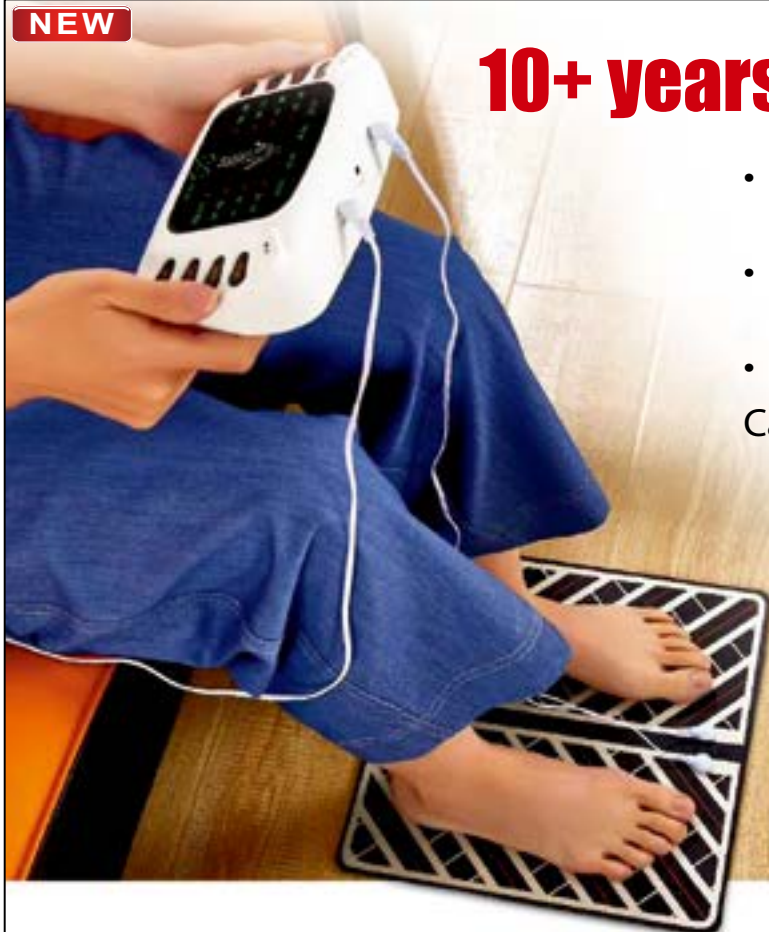

Li-battery operated foot massager

- Muscle strengthening
- Reduction and prevention of muscle atrophy
- Increasing local blood circulation
- Relaxation of muscles
- Relief from minor pain (joint pains, muscle aches and others)



Shenzhen Ol-sky Technology Ltd

3/F, 138 Wan'an Rd, Wangfeng, Shajing, Bao'an, Shenzhen, Guangdong 518100, China

Mobile: (86) 185 6623 9427 • Fax: (86-755) 6114 9229

E-mail: sales@ol-sky.com

www.globalsources.com/olsky.co

Global Sources Verified Supplier ★★★★★



NEW

All our products are private molds with patents

- Nine years' experience in gaming headsets
- Working with Cooler Master, HP and Marvel
- MOQ: 500 pcs; lead time: 25-30 days
- ISO 9001:2015-certified factory
- OEM/ODM services offered
- Monthly capacity of 1.3 million pieces

Feel free to contact us today.

Gaming headset (G2000)

- 3.5+ USB RGB light
- Driver unit: 50mm
- Cable length: 2.4m
- Impedance: $16\Omega \pm 15\%$
- Mic sensitivity: $-38 \pm 3\text{dB}$
- Mic size: $6.0 \times 2.7\text{mm}$

Gaming headset (M12)

- 7.1 virtual surround sound, RGB lighting, with USB connector and inline controller
- Driver unit: 50mm
- Cable length: 2.4m
- Impedance: $16\Omega \pm 15\%$
- Mic sensitivity: $-38 \pm 3\text{dB}$
- Mic size: $6.0 \times 2.7\text{mm}$



Dongguan Huayanda Electronics Technology Co. Ltd

5 Heshi Rd, Hekeng, Qiaotou, Dongguan, Guangdong 523527, China

Mobile: (86) 138 7503 0568 • Fax: (86-769) 8339 8799

E-mail: sales01@dghuayanda.com

www.globalsources.com/dghuayanda.co

Global Sources Verified Supplier ★★★★★

RoHS



NEW

Engaged in the R&D and production of antennas and microwave devices for 16 years

- Holding ISO 9001: 2015, RoHS, REACH and 3C certifications
- Supplying GPS/Wi-Fi/car/DVB-T/MIMO/GSM/4G LTE/5G antennas, etc.
- A leader in designing antennas and microwave devices ranging from 2MHz to 30GHz

To source high-quality antennas and communication parts, send inquiries today.



High-quality antennas and communication parts



Ktech

Shenzhen Ktech Telecom Tech. Co. Ltd

Building B, Pingtaichang Science Park, Tangxiayong, Bao'an, Shenzhen, Guangdong 518108, China

Tel: (86-755) 2983 5105 • Fax: (86-755) 2983 5007

E-mail: cheryl@ktech.net.cn

www.globalsources.com/ktech.co • www.ktech.net.cn

Global Sources Verified Supplier ★★★★★

SGS



High-quality antennas and communication parts

NEW

Strategic partner of Samsung, AUO and other famous brands



49" curved 32:9 ultra-wide QLED HDR gaming monitor



- 43.8" 32:9 ultra-wide E-LED HDR600 screen gaming monitors
- Flat, DFHD 3840 x 1080, 120Hz
 - Local dimming HDR600 high brightness
 - PIP/PBP, 7-color RGB backlight
 - Interface: HDMI1.4 + HDMI2.0 + DP1.2 + Type-C + audio out + USB3.0 + speaker
 - Height-adjustable stand
 - AMD free sync, flicker-free

- Focusing on ultra-wide office and gaming monitors (23.6-49 inches)
- New samples finished in 3-7 days
- Repeat purchase rate of 94%
- Zero delivery complaints in the past year
- Quick responses to your inquiries within 24 hours

Inquire now.

Inno&cn

Shenzhen Century Joint Innovation Technology Co. Ltd

12/F, Bldg 2, COFCO Business Park, Liuxian 2nd Rd, Bao'an, Shenzhen, Guangdong 518129, China
Tel/Fax: (86-755) 2300 5327 • Mobile: (86) 186 6682 1758

E-mail: Betty@inno-cn.cn

www.globalsources.com/inno-cn.co • inno-cn.cn/english/

Global Sources Verified Supplier ★★★★★



NEW

10 years' OEM and ODM experience



Business Bluetooth V5.0 headset (TSM890)

- Supports HF, HSP, A2DP, AVRCP and AAC
- Noise-canceling microphone, crystal clear sound
- One button on mic boom for easy mute
- Applicable for call centers, offices and remote work

- Supplying accessories for iOS and Android smartphones and tablet PCs
- RoHS-, REACH- and CE-compliant
- Exporting to more than 20 countries
- Small orders can be shipped within 48 hours
- 24-hour online service

Contact us today to find out more.



Xiamen Topperstar Elec-Tech Co. Ltd

7/F, Xindu Int'l Bldg, Huli Innovation Park, Xiamen, Fujian 361006, China
Tel: (86-592) 603 7689 • WeChat/QQ: 8163 3365

Skype: sunny_huang1688 • WhatsApp: (86) 159 808 11887

E-mail: topperstar@gmail.com

www.globalsources.com/topperstar.co

Global Sources Verified Supplier ★★★★★



- Memory foam tips for AirPods Pro
- Secure fit, no more falling out
 - All-day comfort, ultra-soft memory foam
 - Block outside noise, keep focused on audio



- Universal stylus pen (SNY6768)
- Soft fiber tip
 - Precision CD panel
 - With ballpoint pen

NEW

GSEO has passed ISO 9001:2015 certification and BSCI audit



LED work light (G804B)

- LED lighting system provider
- We have a professional LED lighting product design team
- CE, ETL, FCC, PSE and UL certifications
- Independent R&D capability

We look forward to establishing successful business relationships with customers worldwide in the future. Call now.



LED flashlight (G603B)



200W UFO high bay light (G060C)



LED fishing light (G817A)

GSEO
GIANT ELECTRONIC OPTICAL

Genius Electronic Optical Co. Ltd

Headquarters: Central Taiwan Science Park, 1 Keya East Rd, Daya, Taichung 42882, Taiwan Region
Tel: (886-4) 2566 7115 ext. 1111
Fax: (886-4) 2566 7117
Mobile (886) 936 822 689
E-mail: carrie.chan@gseo.com
www.globalsources.com/gseo.co
giant.gseo.com

Global Sources  Verified Supplier ★★★★★



Underwater panoramic camera set (D301)

Analyst's Choice

Innovative and newly launched products from the entire Asian supply market

Portable LED work light with power bank

[CONTACT SUPPLIER](#)

Umex (Ningbo) Import & Export Co. Ltd (Dept.4) (China)



The model HL70709BK 10W rechargeable LED work light from Umex (Ningbo) Import & Export Co. Ltd (Dept.4) doubles as a 3.7V, 3,000 or 4,400mAh power bank. Each of the four lamps has a 2,200gs magnetic force. The IPX5-rated unit adopts a 180-degree handle, magnet handle and tripod hole. It is made of nylon, TPR and aluminum. Dimensions are 171.7x126.8x41.5mm.

Umex (Ningbo) has more than 15 years of manufacturing experience and has 200 molds in its selection. The company can output up to 200,000 units monthly.

Product details

Model:	HL70709BK
MOQ:	200 units
Lead time:	20 to 25 days
FOB Price:	\$8.95 to \$9.50

Supplier profile

Year established:	2001
Export markets:	Asia-Pacific, North & South America, Europe, Middle East
Export products:	Car accessories, LED lamps
Annual sales:	\$100,000 to \$200,000
Total staff:	60 to 80

www.globalsources.com/ningbbestparts.co

200W solar panel

[CONTACT SUPPLIER](#)

Seasun New Energy Co. Ltd (China)



The HY200P-6659 model from Seasun New Energy Co. Ltd is a 200W solar panel with a maximum system voltage of 1,000VDC. With a maximum operation of 36.8V, 5.3A the panel has a 19.2 percent cell efficiency and can operate from -40 to 85 C. Open circuit voltage is 44.8V and short circuit current is 5.72A. Each panel weighs 15kgs and measures 1330x992x35mm.

Seasun offers 25 years warranty for its products.

Product details

Model:	HY200P-6659
MOQ:	10 units
Lead time:	5 to 15 days
Certification:	CE, IEC
FOB Price:	\$42 to \$54.605

Supplier profile

Year established:	2008
Export markets:	Asia-Pacific, North & South America, Europe, Middle East
Export products:	Solar power systems
Annual sales:	\$25 million to \$30 million
Total staff:	150 to 200

www.globalsources.com/seasunpower.co

[continued on page 267 »](#)

NEW

20 years' experience



UV disinfection lamp + G9 LED light

- Walmart's LED strip light supplier
- More than 20 engineers
- OEM/ODM and customization services available
- Monthly output: over one million units

You are welcome to contact us for more details.

NEW

in LED lights



COB/FOB strip light + smart LED strip light



Wi-Fi smart home lighting solution



Shenzhen Pyramid Lighting Co. Ltd

Rm 1310, Jinrun Building, Chegongmiao, Futian, Shenzhen, Guangdong 518000, China

Mobile: (86) 150 7317 3688, 139 2650 7875

Fax: (86-755) 2697 8625

E-mail: lawrence@pyramidledlight.com

www.globalsources.com/pyramidlighting.co

www.pyramidledlight.com

Global Sources  Verified Supplier ★★★★★



Start your sourcing journey at **GlobalSources.com**



NEW

Products compliant with ETL, TÜV, CE and INMETRO standards



400W PERC mono half-cell solar PV module



Solar panel

- Production capacity of more than 300MW
- Cooperating with GameChange Solar Racking
- Guarantee: 10-year warranties; 30 years' 80% power output
- Support EPC, solar plant technical design and training

Inquire now to learn more.

Futuresolar Energy and Manufacturing (Putian) Co. Ltd

1089 Wanhao Rd, Huangshi, Licheng, Putian, Fujian 351100, China

Tel/Fax: (86-594) 299 1536

E-mail: Nicholas@futuresolarpv.com

www.globalsources.com/futuresolartech.co

www.Futuresolarpv.com

Global Sources Verified Supplier ★★★★★

Illustrations shown here are drawings or other representations of products.
They are not actual photographs of the products.

4th year

CE TÜV



NEW



We provide a 3-year warranty for all products

- All-in-one solar LED street light
- Aluminum alloy lamp body with built-in lithium battery
 - MPPT control

- 10 years' manufacturing experience
- Main customers in Europe and North America
- Integrating R&D, production and sales
- Quick delivery: 10-20 days for normal quantity orders
- Small orders accepted; MOQ: 10 pcs for most models
- OEM and ODM services
- Customized packaging accepted

Contact us today to get your order started.



Solar flood light



Solar wall light

YISHENG

Ningbo Yisheng Electronic Technology Co. Ltd

Rm 9-3, 348 Meidi Fourth Rd, Wuxiang, Ningbo, Zhejiang 315111, China

Mobile: (86) 135 6660 3880

Fax: (86-574) 8300 1519

E-mail: eric@zj-shengtai.com

www.globalsources.com/shengtailed.co

www.zj-shengtai.com

Global Sources  Verified Supplier ★★★★★



Analyst's Choice

[continued from page 261](#) »

Water-resistant 100W LED floodlight

CONTACT SUPPLIER

Zhongshan Huadengxing Lighting Co. Ltd (China)



The model HDX-TG-J200W 100W LED floodlight from Zhongshan Huadengxing Lighting Co. Ltd is IP65-rated. The unit has 100 to 110 lm/W luminous flux, 85 to 265V power and 2,700 to 6,500K CCT. Running on an SMP chip, the aluminum-made floodlight adopts a 4 or 6KV driver and a PMMA optical lens with up to 94 percent transmittance. The effectivity of its LED3030 chip is up to 140 lm/W. Shelf life is 50,000 hours and warranty is up to five years.

Zhongshan Huadengxing has eight years of manufacturing experience. OEM and ODM services are provided.

Product details

Model:	HDX-TG-J200W
MOQ:	1 unit
Lead time:	3 to 15 days
Certification:	RoHS, CE
FOB Price:	\$20.40 to \$20.80

Supplier profile

Year established:	2012
Export markets:	Asia-Pacific, North & South America, Europe, Middle East
Export products:	LED lights
Annual sales:	\$15 million to \$20 million
Total staff:	100 to 150

www.globalsources.com/led-hdx.co

150W red, blue portable solar warning lights

CONTACT SUPPLIER

H.Z.M Electronics Co. Ltd (China)

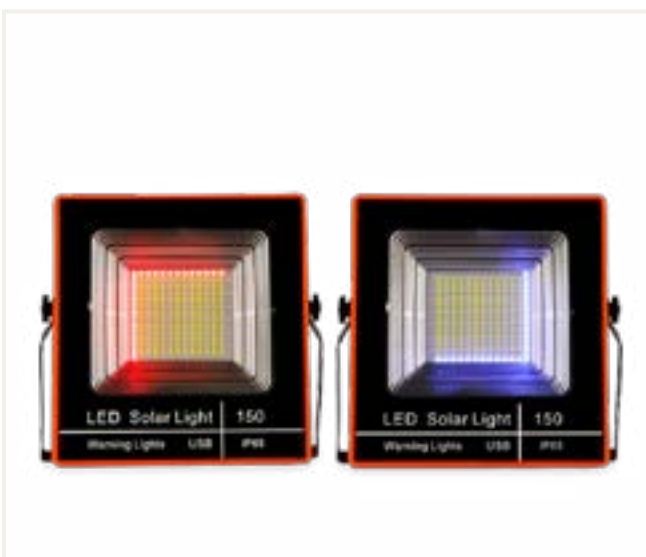

Made of alloy and ABS, the model HZM 150W blue and red portable solar warning lights from H.Z.M Electronics Co. Ltd adopts 280 superbright LEDs. Solar panel, battery and cable power are 5V, 10W, 3.7V, 12Ah and 5V, respectively. The unit has four gears, which are low, half and high brightness, and red and blue light. Product dimensions are 32x32x6cm.

Product details

Model:	HZM 150W
MOQ:	100 units
Lead time:	2 to 7 days
Certification:	CE, UL
FOB Price:	\$19 to \$19.9

Supplier profile

Year established:	2008
Export markets:	Asia-Pacific, North & South America, Europe, Middle East
Export products:	Lithium batteries, chargers, solar LED lights
Annual sales:	\$70 million to \$75 million
Total staff:	800 to 850

www.globalsources.com/hzmpower.co

Find your perfect supplier with a sample order





48 LEDs solar motion sensor wall lights

- Waterproof
- Remote controlled
- With 3 lighting modes
- Energy saving

10+ years' experience in solar lawn lights, string lights and motion sensor wall lights

- Serving customers in the US, Europe, Australasia and Asia
- Free samples available
- Accepting small and OEM orders
- Six strict QC processes to ensure product quality
- Nine sets of production equipment to ensure stable output

Contact us today.



Remote-controlled solar wall lights



LONG BAI XIANG

Nanjing Long Bai Xiang Electronic Technology Co. Ltd

Rm 1706, Building 2, Shoujing Rd, Qixia, Nanjing, Jiangsu 210046, China

Tel/Fax: (86-25) 5705 6887 • E-mail: jackson_zhao@126.com

www.globalsources.com/longbaixiang.co

Global Sources  Verified Supplier ★★★★★



Your sourcing partner



Get the **GlobalSources.com** app



Simple to use, easy to create supplier lists



Send inquiries, order samples



Connect with more suppliers today



HA_AAU_660

[GlobalSources.com/app](https://www.globalsources.com/app)

NEW

5,000m² factory equipped with 11 production lines

Professional manufacturer since 2010



P2.5 LED rental display

- Our no-screw LED tiles/panels with double duplicated design support tool-free installation
- Working with customers in more than 45 countries
- European and American customers account for a large proportion of our sales
- We have strong structure and electrical R&D teams

Inquire now to contact one of our 24-hour online sales representatives.



FE series double duplicated design display



Shenzhen Fjcreate Co. Ltd

Block 3, Jinxiongda Industrial Park, Bao'an, Shenzhen, Guangdong 518000, China

Tel/Fax: (86-755) 2587 3458 • E-mail: julia@fjcreate.net

www.globalsources.com/led-display.co • www.fjcreate.net

Global Sources  Verified Supplier ★★☆☆☆



World's leading electronics sourcing solution

Electronics.GlobalSources.com

The screenshot displays the website's navigation bar with links for ONLINE MARKETPLACE, TRADE SHOWS, MAGAZINES, OTHER SERVICES, LOGIN, REGISTER, and MESSAGES. The main content area features a search bar, category tabs (Consumer Electronics, Mobile Electronics, Smart Living, Electronic Components), and a featured banner for 'Innovation' with a woman wearing headphones. Below this is an 'O2O Showcase' section with four product cards: a smart watch, USB cables, a camera, and wireless headphones. A 'Meet Suppliers at our Trade Shows' section highlights two trade shows: Consumer Electronics and Mobile Electronics, both held from October 11-14, 2018. The bottom of the page includes a 'Hot Product Videos' section with video thumbnails for a smartphone, a robot, and a pink device.

global sources
Electronics

Products from our ►
exhibitors, selected
by analysts

Also featuring:

- Top Brands
- Next-Gen Components
- Analyst's Choice
- And more!

HA_AAU_652

NEW

Supplier to Home Depot and Tesco



- BSCI, ISO 9001 and ISO 14001 certifications
 - Exporting to over 50 countries
 - 35 R&D and 30 QC staff
 - One-stop service offered
- Inquire now to find the right products for your market.



Smart bulb



Smart LED ceiling light



Smart LED downlight



Zhejiang Twinsel Electronic Technology Co. Ltd

Tashan Industrial Zone, Melin St, Ninghai, Ningbo 315609, China

Tel: (86-574) 5995 3561 • Fax: (86-574) 5995 3105

E-mail: dean@twinsel.com

www.globalsources.com/twinsel.co

www.twinsel.com

Global Sources Verified Supplier ★★★★★

ISO 9001:2015 ISO 14001:2015



NEW

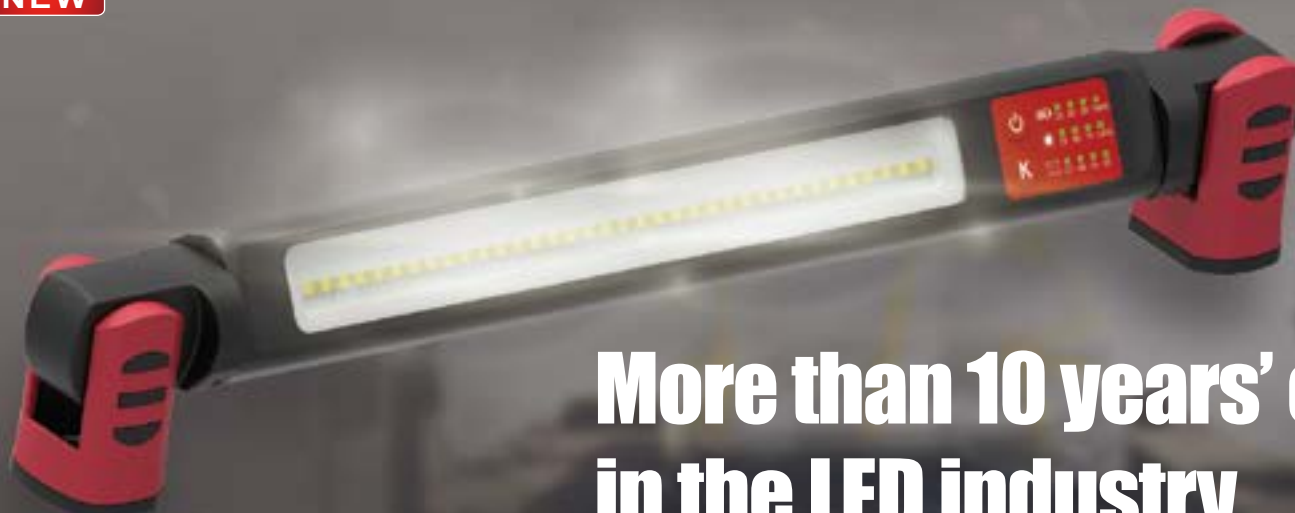

C0321 work light with under bonnet

- Two flexible magnetic bases can be mounted under bonnet easily, no extra big grips needed
- Four lighting modes optional, bright output up to 1,200lm, 360° rotatable for multi-angle usage
- Suitable for industrial lighting, vehicle inspection and repair, machine and equipment maintenance, and any other work lighting

More than 10 years' experience in the LED industry

- Main markets: North America and Europe
- 1,500-square-meter factory with testing laboratory
- Own R&D team
- OEM/ODM services available
- One-year warranty against manufacturing defects

Visit our website or contact us for more information.



Inductive chargeable work lights

- Work light: up to 700lm, flashlight: up to 250lm
- Latest inductive wireless charging technology
- IP67-grade waterproof, IK07-level anti-impact

DLIGHT STAR



Xiamen Dlight Star Technology Co. Ltd

358 Jiqun Rd, Tong'an Industrial District, Xiamen, Fujian 361100, China

Mobile: (86) 137 7997 1206 • Fax: (86-592) 710 7075 • E-mail: a.lee@dlightstar.com

www.globalsources.com/dlightstar.co • www.dlightstar.com

Global Sources Verified Supplier ★★★★★

RoHS PROP65

I love Global Sources because of the **unique curated products** that they have on display there. They have all these cool little niches where they showcase the trends, the trending colors, what's going on. And they also have a unique supplier matching service – they find you the perfect supplier for exactly what you are looking for from their massive directory.



Amy Wees,

Amazing at Home/USA

global sources

GlobalSources.com

Product Index

This index will help you quickly find the products you are looking for. On the PDF version of this magazine, enter a page number in the top bar of your PDF Reader to go directly to that ad page. Return to this page anytime by clicking on Product Index at the top of each page.

Source smarter with Star Ranking

- Global Sources' six-star ranking system helps you find the suppliers that match your needs
- Companies with more stars are generally larger and more experienced exporters
- Companies with more stars have paid more to get more exposure, and to provide you with more information to evaluate their capabilities
- Looking for large, well-established suppliers? Contact 4, 5 and 6-star suppliers

For more details, please visit www.globalsources.com/SITE/QUALITY.HTM

Product / Advertiser	Page	E-mail	Website	Star Ranking
CONSUMER ELECTRONICS				
2.0-CH COMPUTER SPEAKERS				
Cixi Luckytone Electronic Co. Ltd	206	l.t.ele.william88@hotmail.com	www.globalsources.com/cixijiyin.co	★★★★☆☆
4-PORT USB HUBS				
Worldpass Industrial Co. Ltd	66-67	kimtang@allpasselec.com	www.globalsources.com/worldpass.co	★★★★★☆☆
4G ANTENNAS				
Fujian Quanzhou Huahong Communication Co. Ltd	131	hhsc05@fjhuahong.cn	www.globalsources.com/fjhuahong.co	★★★★★☆☆
A/V CLEANING & SCRATCH REMOVERS				
Yuh Yih Industrial Co. Ltd	6	yuhyihco@ms24.hinet.net	www.globalsources.com/yuhyih.co	★★★★★☆☆
ACTION CAMERAS				
Eyesun Technology Co. Ltd	130	michaelzmp@dgeyesun.com	www.globalsources.com/eyesun.co	★★★★★☆☆
Shenzhen Pano Technology Co. Ltd	136	cheng@sz-shx.net	www.globalsources.com/sportdv.co	★★★★★☆☆
AIR PURIFIERS				
Win Industry Company	194	marketing@winindustry.com	www.globalsources.com/win.co	★★★★★☆☆
Xiamen Yometec Technology Co.Ltd	203	info@yometec.com	www.globalsources.com/yometec.co	★★★★★☆☆
AUDIO MIXERS				
Shenzhen Shunxingsheng Electronic Co. Ltd	202	sales1@hiaudio-cn.com	www.globalsources.com/hiaudio-cn.co	★★★★★☆☆
BILL COUNTERS				
Wenzhou Vanmac Trading Co. Ltd	212	sales@vanmac.net	www.globalsources.com/vanmac.co	★★★★★☆☆
BLUETOOTH HEADPHONES				
Dongguan Joy2Hear Electronics Co.Ltd	139	jimzhan@joy2hear.com	www.globalsources.com/joy2hear.co	★★★★★☆☆
Dongguan Siyoto Electronics Co. Ltd	140	jenny_do@siyoto.com	www.globalsources.com/siyoto.co	★★★★★☆☆
Shenzhen Unison Electronics Co. Ltd	110-111	roy.mao@szunison.cn	www.globalsources.com/unison.co	★★★★★☆☆
BLUETOOTH HEADSETS				
Taiwan Protect Ltd	201	rose@zs-radio.com	www.globalsources.com/aitouch.co	★★★★★☆☆
Xiamen Topperstar Elec-Tech Co. Ltd	259	topperstar@globalsources.com	www.globalsources.com/topperstar.co	★★★★★☆☆
BLUETOOTH SPEAKERS				
Dongguan CitySING-E Electronics Technology Co.Ltd	C-3	info@szinfocore.com	www.globalsources.com/dgshengyi.co	★★★★★☆☆
Dongguan Tangxi Electronics Technology Co. Ltd	155	sawado@vip.163.com	www.globalsources.com/tangxi.co	★★★★★☆☆
Shenzhen Aierson Technology Co. Ltd	204	owen@aierson.com	www.globalsources.com/aierson.co	★★★★★☆☆
Shenzhen Jiayin Nuoxin E-Commerce Co.Ltd	209	zhufenglin@cnjynx.com	www.globalsources.com/jiayinnuoxin.co	★★★★★☆☆
Shenzhen Junjiahao Technology Co.Ltd	84-85	stone@junjiahao.com	www.globalsources.com/junjiahao.co	★★★★★☆☆
Shenzhen Retroline Electronic Co. Ltd	236	skywin@skywinsz.com.cn	www.globalsources.com/retroline.co	★★★★★☆☆
Shenzhen T.Y. Industrial Co.Ltd	171	sales001@sztyindustrial.com	www.globalsources.com/sztyindustrial.co	★★★★★☆☆
Shenzhen UEMade Technology Co. Ltd	68-69	s2@uemade.com	www.globalsources.com/uemade.co	★★★★★☆☆
BONE CONDUCTION HEADSETS				
Ovtech Industrial Co. Ltd	257	fayne@ovtech.cn	www.globalsources.com/ovtech.co	★★★★★☆☆
CABLE SUPPLIES FOR IPHONE				
Shenzhen Winkeen Electronics Co. Ltd	198	elaine@winkeen.com	www.globalsources.com/winkeenelectronics.co	★★★★★☆☆

@ For more information, visit this supplier's website.

Product / Advertiser	Page	E-mail	Website	Star Ranking
CAMERA LENSES				
Sun Yin Crystal Industry Co. Ltd	106-107	dave@sunyincrystal.com	www.globalsources.com/sunyincrystal.co	★★★★☆☆
CAR ANTENNAS				
Chinmore Industry Co. Ltd	128	service@chinmore.com.tw	www.globalsources.com/chinmore.co	★★★★★☆☆
Tekfun Co. Ltd	8	info@tekfun.com.tw	www.globalsources.com/tekfun.co	★★★★★☆☆
CAR CHARGER HOLDERS				
Monoeric International Co. Ltd	76-77	sales@monoeric.com.tw	www.globalsources.com/monoeric.co	★★★★★☆☆
CAR GPS NAVIGATION SYSTEMS				
Shenzhen Starshine Industrial Co. Ltd	137	oliver@stars-shine.com	www.globalsources.com/stars-shine.co	★★★★★☆☆
Winneroid Technology&Development Co.Ltd	138	admin@winneroid.com	www.globalsources.com/winneroid.co	★★★★★☆☆
CAR GPS TRACKERS				
Quwei (Xiamen) Intelligence Technology Co.Ltd	134	jason_zeng@hiquwei.com	www.globalsources.com/quwei.co	★★★★★☆☆
Shenzhen Elink Communication Technology Co.Ltd	143	wangyuebin@eelink.com.cn	www.globalsources.com/eelink.co	★★★★★☆☆
CAR HOLDERS				
Monoeric International Co. Ltd	76-77	sales@monoeric.com.tw	www.globalsources.com/monoeric.co	★★★★★☆☆
CAR MOUNTS FOR IPHONE				
Monoeric International Co. Ltd	76-77	sales@monoeric.com.tw	www.globalsources.com/monoeric.co	★★★★★☆☆
CAR MULTIMEDIA PLAYERS				
Shenzhen Carobotor Technology Co.Ltd	40-41	sales@carobotor.com	www.globalsources.com/carobotor.co	★★★★☆☆☆☆
Shenzhen Elecsource Technology Co. Ltd	191	sales2@elecsource.com	www.globalsources.com/elecsource.co	★★★★★☆☆
CAR REARVIEW SYSTEMS				
Shenzhen Sunway Industry Co. Ltd	251	sun@sunwayi.com	www.globalsources.com/sunwayindustry.co	★★★★★☆☆
Stonkam Co. Ltd	235	market@stonevision.cn	www.globalsources.com/sharpvision.co	★★★★★☆☆
CHARGERS FOR IPHONE				
Dongguan Anju Electronic Technology Co.Ltd	196	53633096@qq.com	www.globalsources.com/anju.co	★★★★★☆☆
CHILDREN'S DIGITAL CAMERAS				
Shenzhen Aobaisen Electronic Technology Co. Ltd	10-11	lin@aobaisen.com	www.globalsources.com/aobaisen.co	★★★★★☆☆
COMPUTER BLUETOOTH KEYBOARDS				
Dongguan Mingpan Electronic Technology Co. . Ltd	118	ken.zheng@dgmingpan.com	www.globalsources.com/dgmingpan.co	★★★★☆☆☆☆
DAB RADIOS				
Shenzhen Modeltime Electronics Co. Ltd	166	modeltime@metdz.com	www.globalsources.com/modeltime.co	★★★★☆☆☆☆
DASH CAMERAS				
Shenzhen Lutu Technology Co.Ltd	248	540056377@qq.com	www.globalsources.com/szlutu.co	★★★★★☆☆
DIGITAL CAMERAS				
Huarui Technology (Shenzhen) Co. Ltd	133	sales@keepguard.com	www.globalsources.com/keepway.co	★★★★☆☆☆☆
DIGITAL SIGNAGE SYSTEMS				
Shenzhen Yoshingy Technology Co.Ltd	256	sales1@yoshingy.com	www.globalsources.com/yoshingy.co	★★★★★☆☆
DLP PROJECTORS				
Shenzhen Powerful Potoelectron Co. Ltd	225	sales4@szqiangpu.com	www.globalsources.com/szqiangpu.co	★★★★★☆☆
DUAL-BAND HANDHELD TWO-WAY RADIOS				
Taiwan Protect Ltd	201	rose@zs-radio.com	www.globalsources.com/aitouch.co	★★★★☆☆☆☆
ELECTRIC HANDHELD MASSAGERS				
Shenzhen Joyhong Technology Co. Ltd	240	betty@joyhong.com	www.globalsources.com/joyhong.co	★★★★★☆☆
Shenzhen Loveka Technology Co.Ltd	192	sales@loveka.vip	www.globalsources.com/loveka.co	★★★★★☆☆
Shenzhen Rui Sixiang Technology Co.Ltd	211	april@e-foxttech.com	www.globalsources.com/ruisixiang.co	★★★★☆☆☆☆
ELECTRIC LEG & FOOT MASSAGERS				
Nantong Enjoy Sports and Homefitness Co.Ltd	255	mega163@vip.163.com	www.globalsources.com/enjoyfit.co	★★★★☆☆☆☆
Shenzhen Ol-sky Technology Ltd	257	sales@ol-sky.com	www.globalsources.com/olsky.co	★★★★★☆☆
ELECTRIC SCOOTERS				
Freeman Intelligent Power Ltd	78-79	support@free-man.cn	www.globalsources.com/free-man.co	★★★★★☆☆

@ For more information, visit this supplier's website.

Product / Advertiser	Page	E-mail	Website	Star Ranking
Gyroor Technology (China) Co. Ltd	82-83	lydia@gyroor.com	www.globalsources.com/gyroor.co	★★★★☆
Shenzhen HTOMT Technology Co. Ltd	74-75	assia@htomt.com	www.globalsources.com/htomt.co	★★★★☆
Shenzhen MYWAY Technology Co. Ltd	183	li_zhijing@launchdesign.com.cn	www.globalsources.com/mywayth.co	★★★★☆
Shenzhen Rui Sixiang Technology Co. Ltd	211	april@e-foxtech.com	www.globalsources.com/ruisixiang.co	★★★★☆
Shenzhen Uni-Sun Electronics Ltd	2	candice@hkunisun.com	www.globalsources.com/uni-sun.co	★★★★☆
Wuyi Chuang Xin Metal Tools Co. Ltd	88-89	sale03@chinachuangxin.net	www.globalsources.com/china-chuangxin.co	★★★★☆
Yongkang Kugooo Technology Co. Ltd	64-65	max@kugooo.com	www.globalsources.com/kugooo.co	★★★★☆
Zhejiang Lianmei Industrial Co. Ltd	185	sales@cnlianmei.com	www.globalsources.com/lianmeizj.co	★★★★☆
ELECTRONIC HANDHELD GAMES				
Shenzhen Yangliming Electronics Technology Co.Ltd	179	sales04@ylmchina.com	www.globalsources.com/ylmchina.co	★★★★☆
ELECTRONIC ORAL THERMOMETERS				
Shenzhen New Solution Electronics Co. Ltd	146	philip@remotechina.com	www.globalsources.com/remotechina.co	★★★★☆
ELECTRONIC TRANSLATORS/DICTIONARIES				
Shenzhen Qianhai Vsoontech Information Technology Co.Ltd	162	edwinli@vsoontech.com	www.globalsources.com/vsoontech.co	★★★★☆
EMERGENCY PHONES				
Telewell Electric Co. Ltd	167	eric@telewell.com.tw	www.globalsources.com/telewell.co	★★★★☆
ETHERNET SWITCHES				
Shenzhen Yilianwang Technology Co. Ltd	252	sales16@longway.com	www.globalsources.com/yilianwang.co	★★★★☆
FIXED WIRELESS PHONES				
Shenzhen Etross Telecom Co. Ltd	135	sales@etross.com	www.globalsources.com/etross.co	★★★★☆
GAMING CHAIRS				
Anji Ruibao Furniture Co. Ltd	32-33	tracy@rbchairs.com	www.globalsources.com/rbchairs.co	★★★★☆
Shenzhen Meetion Tech Co. Ltd	22	info@meetion.com	www.globalsources.com/meetion.co	★★★★☆
Shenzhen Meetion Tech Co. Ltd	20-21	info@meetion.com	www.globalsources.com/meetion.co	★★★★☆
Shenzhen Meetion Tech Co. Ltd	18-19	info@meetion.com	www.globalsources.com/meetion.co	★★★★☆
GAMING HEADSETS				
Dongguan Huayanda Electronics Technology Co. Ltd	258	sales01@dghuayanda.com	www.globalsources.com/dghuayanda.co	★★★★☆
Dongguan Shanggui Electronics Co.Ltd	129	sales@aocean.com.cn	www.globalsources.com/aocean.co	★★★★☆
Dongguan SongMan Technology Co.Ltd	119	sales@songman-china.com	www.globalsources.com/songman.co	★★★★☆
Eastern Times Technology Co. Ltd	98-99	et_lh@vip.163.com	www.globalsources.com/easterntimes.co	★★★★☆
Shenzhen Zhaochen Electronics Co. Ltd	149	ann_yuan@cnzhaochen.com	www.globalsources.com/zhaochen.co	★★★★☆
GAMING KEYBOARDS				
Eastern Times Technology Co. Ltd	98-99	et_lh@vip.163.com	www.globalsources.com/easterntimes.co	★★★★☆
Eastern Times Technology Co. Ltd	96-97	et_lh@vip.163.com	www.globalsources.com/easterntimes.co	★★★★☆
Shenzhen Meetion Tech Co. Ltd	18-19	info@meetion.com	www.globalsources.com/meetion.co	★★★★☆
Shenzhen Meetion Tech Co. Ltd	20-21	info@meetion.com	www.globalsources.com/meetion.co	★★★★☆
Shenzhen Meetion Tech Co. Ltd	22	info@meetion.com	www.globalsources.com/meetion.co	★★★★☆
GAMING MICE				
Eastern Times Technology Co. Ltd	98-99	et_lh@vip.163.com	www.globalsources.com/easterntimes.co	★★★★☆
Eastern Times Technology Co. Ltd	96-97	et_lh@vip.163.com	www.globalsources.com/easterntimes.co	★★★★☆
GAMING MONITORS				
Maxpac Electronics Co. Ltd	241	anne@maxpac.com.cn	www.globalsources.com/maxpacelectronics.co	★★★★☆
Shenzhen Century Joint Innovation Technology Co. Ltd	259	racheal@inno-cn.cn	www.globalsources.com/inno-cn.co	★★★★☆
GNSS & GPS ANTENNAS				
Shenzhen City Kangjie Communication Technology Co. Ltd	258	lxj@ktech.net.cn	www.globalsources.com/ktech.co	★★★★☆
GPS PERSONAL TRACKERS				
Shenzhen Smart Care Technology Limited	102-103	sales03@smawatch.com	www.globalsources.com/smartcare.co	★★★★☆
GRAPHICS CARDS				
Shenzhen Yoshingy Technology Co. Ltd	256	sales1@yoshingy.com	www.globalsources.com/yoshingy.co	★★★★☆
GSM/CDMA WIRELESS ANTENNAS				
Chang Hong Technology Co. Ltd	152	linda@changhong.com.tw	www.globalsources.com/changhong-tech.co	★★★★☆

@ For more information, visit this supplier's website.

Product / Advertiser	Page	E-mail	Website	Star Ranking
Chinmore Industry Co. Ltd	128	service@chinmore.com.tw	www.globalsources.com/chinmore.co	★★★★★☆
GSM/CDMA WIRELESS TERMINALS				
Chinmore Industry Co. Ltd	128	service@chinmore.com.tw	www.globalsources.com/chinmore.co	★★★★★☆
HANDHELD POS TERMINALS				
SZFP (Shenzhen) Technology Limited	199	sales@szfpotech.com	www.globalsources.com/szfp.co	★★★☆☆☆
HANDHELD TWO-WAY RADIOS				
Fujian Belfone Communications Technology Co.Ltd	148	petrel@belfone.com	www.globalsources.com/belfone.co	★★★★★☆
Fujian New Century Communications Co. Ltd	C-2,1	info@kydera.com	www.globalsources.com/fjnewcentury.co	★★★★★
Fujian Senhaix Electronic Technology Co. Ltd	141	sales2@senhaixun.com	www.globalsources.com/senhaix-elec.co	★★★☆☆☆
Guangzhou Billion Leiden Electronic Technology Co. Ltd	121	tina@tid-china.com	www.globalsources.com/billion-leiden.co	★★★☆☆☆
Quanzhou Risen Electronics Co. Ltd	123	cs07@recentchina.com	www.globalsources.com/recent.co	★★★★★☆
Quanzhou SFE Electronic Technology Co. Ltd	147	sfe@sfecom.cn	www.globalsources.com/sfecom.co	★★★★☆☆
Xiamen Puxing Electronics Science and Technology Co. Ltd	C-4	sales@pxdz.com	www.globalsources.com/pxdz.co	★★★★★
Xinwei Electronic Co. Ltd (Quanzhou)	150	sales@nanfone.com	www.globalsources.com/utel.co	★★★★☆☆
HD SET-TOP BOXES				
Hengli Digital Industrial Co.Ltd	226	kevin.kang@hengli-dig.com	www.globalsources.com/hengli-dig.co	★★★★☆☆
HDMI CABLES				
Shenzhen Tailide Science and Technology Co. Ltd	70-71	sales06@tldcable.com	www.globalsources.com/tld.co	★★★★★☆
Tianning Technological Electronics Co. Ltd	210	flora@ttelectronics.com	www.globalsources.com/tte.co	★★★★☆☆
HDMI EXTENDERS				
Brocade Smart Space Technology Co. Ltd	207	smart-space@brocadeai.com	www.globalsources.com/brocadeai.co	★★★☆☆☆
HDMI MATRIXES				
Guangzhou Mt-Viki Electronics Co. Ltd	38-39	abyzhou@mt-viki.com	www.globalsources.com/mt-viki.co	★★★★★
HEADPHONE STANDS				
Dongguan Shanggui Electronics Co.Ltd	129	sales@aocean.com.cn	www.globalsources.com/aocean.co	★★★★★☆
HOME THEATER PROJECTORS				
Shenzhen Powerful Potoelectron Co. Ltd	225	sales4@szqiangpu.com	www.globalsources.com/szqiangpu.co	★★★★☆☆
HORN/SIREN SPEAKERS				
Huizhou N Acoustics Co.Ltd	174	sales@nacoustics.com	www.globalsources.com/nacoustics.co	★★★☆☆☆
HYBRID MOBILE PHONE CASES				
Shenzhen Greatpine Technology Co. Ltd	216	dylan@greatpine.com.cn	www.globalsources.com/greatpine.co	★★★★☆☆
IN-VEHICLE TWO-WAY RADIO ACCESSORIES				
JDI Jing Deng Industrial Co. Ltd	112-113	jdi-sales@jdi-co.com	www.globalsources.com/jdi.co	★★★☆☆☆
Tekfun Co. Ltd	8	info@tekfun.com.tw	www.globalsources.com/tekfun.co	★★★★☆☆
IN-VEHICLE TWO-WAY RADIOS				
Taiwan Protect Ltd	201	rose@zs-radio.com	www.globalsources.com/aitouch.co	★★★☆☆☆
IP RADIOS				
Fujian Senhaix Electronic Technology Co. Ltd	141	sales2@senhaixun.com	www.globalsources.com/senhaix-elec.co	★★★☆☆☆
JOYPADS				
Fortune Power Electronic Technology Co. Ltd	221	fortunepower@fortunepower.com.tw	www.globalsources.com/fortunepower.co	★★★★★☆
KEYBOARD & MOUSE COMBOS				
Shenzhen Star Sources Electronic Technology Co. Ltd	28-29	sales@star-tec.cn	www.globalsources.com/startec.co	★★★★★
KVM SWITCHES				
Guangzhou Mt-Viki Electronics Co. Ltd	38-39	abyzhou@mt-viki.com	www.globalsources.com/mt-viki.co	★★★★★
Shenzhen Lianhongtai Electronics Co. Ltd	42-43	lhtoyel@163.com	www.globalsources.com/oyel.co	★★★★☆☆
LCD PC MONITORS (14-INCH TO 15-INCH)				
Dongguan Kaidi Technology Co. Ltd	237	sales@kdledtv.com	www.globalsources.com/ctslcd.co	★★★★☆☆
LCD PC MONITORS (17-INCH TO 18-INCH)				
Dongguan Kaidi Technology Co. Ltd	237	sales@kdledtv.com	www.globalsources.com/ctslcd.co	★★★★☆☆

@ For more information, visit this supplier's website.

Product / Advertiser	Page	E-mail	Website	Star Ranking
LCD PC MONITORS (19-INCH & ABOVE)				
Dongguan Kaidi Technology Co. Ltd	237	sales@kdledtv.com	www.globalsources.com/ctslcd.co	★★★★☆
LCD PC MONITORS (BELOW 14-INCH)				
Hanshi Jingxian Innovative Technology (Huizhou) Co. Ltd	254	susanna@intehill.com	www.globalsources.com/intehill.co	★★★★☆
LINE INTERACTIVE UPS				
Beam Tech Electronics Co. Ltd	197	info@beamtech.com.tw	www.globalsources.com/beam.co	★★★★☆
MAGNETIC CARD READERS				
GIGA-TMS Inc.	238	promag@gigatms.com.tw	www.globalsources.com/giga.co	★★★★☆
MECHANICAL KEYBOARDS				
Eastern Times Technology Co. Ltd	96-97	et_lh@vip.163.com	www.globalsources.com/easterntimes.co	★★★★☆
Eastern Times Technology Co. Ltd	98-99	et_lh@vip.163.com	www.globalsources.com/easterntimes.co	★★★★☆
MICROPHONE ACCESSORIES				
How Tsen Intl Electronics Metal Co. Ltd	122	jukie@howtsen.com	www.globalsources.com/howtsen.co	★★★★☆
MOBILE PHONE BATTERIES				
Shenzhen Xinruiming Technology Co. Ltd	108-109	pinky@huarigor.com	www.globalsources.com/huarigor.co	★★★★☆
MOBILE PHONE CHARGERS				
Dongguan Golden Profit Electronics Co. Ltd	231	suky-023@163.com	www.globalsources.com/golden-profit.co	★★★★☆
Dongguan Tyjin Electronics Co. Ltd	242	sales8@tyjin.com	www.globalsources.com/tyjin.co	★★★★☆
Firststar Company Limited	36-37	sheryl@szfirststar.com	www.globalsources.com/sz-firststar.co	★★★★☆
Shenzhen Huntkey Electric Co.Ltd	243	sales@huntkey.net	www.globalsources.com/huntkey.co	★★★★☆
Shenzhen Shenchuang Hi-Tech Electronics Co.Ltd	4-5	tina.tian@schitech.com	www.globalsources.com/schitech.co	★★★★☆
Shenzhen Shuo Yu Technology Co. Ltd	247	shuoyu1688@shuoyutec.com	www.globalsources.com/shuoyu.co	★★★★☆
YXISN5 Electronic Co. Ltd	30-31	ellie@yxisn5.com	www.globalsources.com/yxisn5.co	★★★★☆
MOBILE PHONE CHARGING STATIONS				
Luen Yick Electrical Mfg Co. Ltd	142	sales@luenyick-elec.com	www.globalsources.com/luenyick.co	★★★★☆
MOBILE PHONE HOLDERS				
Shenzhen Aidelong Intelligent Communication Co.Ltd	54-55	info2@szadl.com	www.globalsources.com/aidelong.co	★★★★☆
MOBILE PHONE LCDS				
Shenzhen In-One Technology Co.Ltd	177	ray@in-onetech.com	www.globalsources.com/sz-in-one.co	★★★★☆
MOBILE PHONE TOOLBOXES				
Shenzhen Youfu Tools Co. Ltd	250	sophie@youfutools.com	www.globalsources.com/youfu.co	★★★★☆
MOBILE SIGNAL BOOSTERS				
Runshine International Co.Ltd	124	hunter@runshine-link.com	www.globalsources.com/runshine.co	★★★★☆
MODIFIED SINE WAVE HOME INVERTERS				
Drow Enterprise Co. Ltd	12-13	geniusc.com@msa.hinet.net	www.globalsources.com/drow.co	★★★★☆
MULTI-PORT USB CHARGERS				
YXISN5 Electronic Co. Ltd	30-31	ellie@yxisn5.com	www.globalsources.com/yxisn5.co	★★★★☆
NETWORK GATEWAYS				
Shenzhen Geniatech Inc. Ltd	104-105	abbey@geniatech.com	www.globalsources.com/szgeniatech.co	★★★★☆
Shenzhen Reflying Electronic Co. Ltd	114-115	alice@reflying.com	www.globalsources.com/reflying.co	★★★★☆
NETWORKING CABLES				
Cobtel Precision Electronics Co. Ltd	230	sales@cn-cob.com	www.globalsources.com/cobtel.co	★★★★☆
Shenzhen PYS High-Tech Co. Ltd	92	emily@chinapysind.com	www.globalsources.com/pys.co	★★★★☆
Shenzhen PYS Industrial Co. Ltd	93	gs@chinapysind.com	www.globalsources.com/pys.co	★★★★☆
NOISE-CANCELING HEADSETS				
Shenzhen Kensing Electronic Co. Ltd	159	nicole@kensing.net	www.globalsources.com/handsfree.co	★★★★☆
Shenzhen Best Talent Technology	181	besttalent@best-talent.com	www.globalsources.com/besttalent.co	★★★★☆
OMNI ANTENNAS				
Chang Hong Technology Co. Ltd	152	linda@changhong.com.tw	www.globalsources.com/changhong-tech.co	★★★★☆

@ For more information, visit this supplier's website.

Product / Advertiser	Page	E-mail	Website	Star Ranking
ONLINE UPS				
Beam Tech Electronics Co. Ltd	197	info@beamtech.com.tw	www.globalsources.com/beam.co	★★★★★☆
OUTDOOR TV ANTENNAS				
Zhongshan Wanlitong Antenna Equipment Co. Ltd	178	sales@walito.com	www.globalsources.com/wanlitong.co	★★★★★☆
PA AMPLIFIERS				
Betterway Electronic Co. Ltd	153	pennypeng@betterwaychina.com.cn	www.globalsources.com/betterway.co	★★★☆☆☆
PERSONAL & PROFESSIONAL BREATHALYZERS				
Sentech Korea Corp.	229	sentech@sentechkorea.com	www.globalsources.com/sentech.co	★★★★☆☆
PORTABLE SPEAKERS				
China Joy Guitar Co. Ltd	222	jg@joyguitar.com	www.globalsources.com/guitar.co	★★★★★★
Fuzhou Paide Technology Co Ltd	205	elecj@globalsources.com	www.globalsources.com/keyboards.co	★★★★★★
Shenzhen Cheerstar Communication Technology Co. Ltd	186	nicole@cheerstar.net	www.globalsources.com/cheerstar.co	★★★★☆☆
POS KEYBOARDS				
GIGA-TMS Inc.	238	promag@gigatms.com.tw	www.globalsources.com/giga.co	★★★★☆☆
POS TERMINALS				
Guangzhou Zonerich Business Machine Co. Ltd	188	yaocaibin@zonerich.com	www.globalsources.com/zonerich.co	★★★★☆☆
SZ Expo Hong Compos Tech Co.Ltd	193	admin@compostech.net	www.globalsources.com/szexpo.co	★★★☆☆☆
POWER BANKS				
Shenzhen Fudeng Technology Co. Ltd	26-27	cage_chen@foxskychannel.com	www.globalsources.com/foxskychannel.co	★★★★★★
Shenzhen Fudeng Technology Co. Ltd	24-25	cage_chen@foxskychannel.com	www.globalsources.com/foxskychannel.co	★★★★★★
Shenzhen Gift Tree Technology Co. Ltd	175	tim@szgifttree.com	www.globalsources.com/gifttree.co	★★★★☆☆
PRINTER RIBBONS				
Guangdong Kede Tech Co. Ltd	227	sales@kedetech.com	www.globalsources.com/kedetech.co	★★★☆☆☆
PROJECTION SCREENS				
Shenzhen SMX Display Technology Co. Ltd	169	sales@smaxscreen.com	www.globalsources.com/smxdisplay.co	★★★★☆☆
Wuxi Lexin Audio-Visual Equipment Co.Ltd	172	ivy@wxlexin.com	www.globalsources.com/wuxilexin.co	★★★★☆☆
PROJECTORS				
Shenzhen Brosfuture Electronics Technology Co. Ltd	160	ivy@brosfuture.com	www.globalsources.com/shenzhen-brosfuture.co	★★★★☆☆
Shenzhen Qianhai Vsoontech Information Technology Co.Ltd	162	edwinli@vsoontech.com	www.globalsources.com/vsoontech.co	★★★★☆☆
Ultmost Technology Group	3	ut@ultmost.com.cn	www.globalsources.com/ultmost-sz.co	★★★★★★
PURE SINE WAVE HOME INVERTERS				
Drow Enterprise Co. Ltd	12-13	geniusc.com@msa.hinet.net	www.globalsources.com/drow.co	★★★★★★
REARVIEW CAMERAS				
Shenzhen Luview Co. Ltd	161	1250286124@qq.com	www.globalsources.com/szbsxy.co	★★★★☆☆
REARVIEW MIRROR MONITORS				
Shenzhen Lutu Technology Co.Ltd	248	540056377@qq.com	www.globalsources.com/szlutu.co	★★★★☆☆
RECEIPT PRINTERS				
Xiamen Apt Electronic Tech. Co.Ltd	245	15123911269@163.com	www.globalsources.com/airprint.co	★★★★☆☆
REMOTE CONTROLS				
Giant Alarm System Co. Ltd	52-53	sales06@jujiang.net	www.globalsources.com/giantalarm.co	☆☆☆☆☆☆
Quanzhou Juhui Electronics Co. Ltd	187	alee@juhuico.com	www.globalsources.com/juhui.co	★★★★☆☆
RETRACTABLE USB CABLES				
Shenzhen Koteksun Technology Co. Ltd	255	chrishwong@ikoteksun.com	www.globalsources.com/koteksun.co	★★★☆☆☆
ROBOTIC VACUUM CLEANERS				
Guizhou FortuneShip Technology Co. Ltd	190	xshizhe@freedynamics.com	www.globalsources.com/fortuneship.co	★★★★☆☆
Shenzhen Qihoo Jian An Intelligent Technology Co Ltd	86-87	globalsales@360.cn	www.globalsources.com/qihujianan.co	★★★★★★
Shenzhen Star A E-Commerce Co. Ltd	253	eric.hsu@starasources.com	www.globalsources.com/starasources.co	★★★★★★
SELF-BALANCE HOVERBOARDS				
Wuyi Chuang Xin Metal Tools Co. Ltd	88-89	sale03@chinachuangxin.net	www.globalsources.com/china-chuangxin.co	★★★★☆☆

@ For more information, visit this supplier's website.

Product / Advertiser	Page	E-mail	Website	Star Ranking
SELF-BALANCING E-SKATES				
Freeman Intelligent Power Ltd	78-79	support@free-man.cn	www.globalsources.com/free-man.co	★★★★☆☆
SIT-STAND COMPUTER RISERS & DESKS				
Qidong Vision Mounts Manufacturing Co. Ltd	158	info@v-mounts.com	www.globalsources.com/v-mounts.co	★★★★★★
Wuxi Lexin Audio-Visual Equipment Co.Ltd	172	ivy@wxlexin.com	www.globalsources.com/wuxilexin.co	★★★★☆☆
SMART BRACELETS				
Guizhou Fortuneship Technology Co. Ltd	220	xshizhe@freedynamics.com	www.globalsources.com/fortuneship.co	★★★★☆☆
Shenzhen Bitech Technology Co. Ltd	164	sales@szbitech.com	www.globalsources.com/bitech.co	★★★★☆☆
SMART HOME & SUPPORT INTEGRATED SERVICES				
Beam Tech Electronics Co. Ltd	197	info@beamtech.com.tw	www.globalsources.com/beam.co	★★★★☆☆
GIGA-TMS Inc.	238	promag@gigatms.com.tw	www.globalsources.com/giga.co	★★★★☆☆
SMART REMOTE CONTROLS				
Aifo Smart Technology Co.Ltd	163	info@aifosmart.com	www.globalsources.com/aifo.co	★★★★☆☆
SMART TVS				
Ultmost Technology Group	3	ut@ultmost.com.cn	www.globalsources.com/ultmost-sz.co	★★★★★★
SOUND BARS				
Shenzhen Hongyesheng Technology Co.Ltd	56-57	admin@sz-hyskj.com	www.globalsources.com/szhyskj.co	★★★★☆☆
STAGE EFFECT MACHINES				
China Joy Guitar Co. Ltd	222	jj@joyguitar.com	www.globalsources.com/guitar.co	★★★★★★
Fuzhou Paide Technology Co Ltd	205	elecj@globalsources.com	www.globalsources.com/keyboards.co	★★★★★★
STEREO MINI SPEAKERS				
Hong Kong Taosheng Electronics Company Limited	189	lina@hktaosheng.com	www.globalsources.com/hktaosheng.co	★★★★☆☆
THERMAL PRINTERS				
Xiamen Liao Sheng Trading Co. Ltd	180	andrew@liaosheng.com	www.globalsources.com/xmlsel.co	★★★★☆☆
Xiamen Tncen Technology Co.Ltd	170	tc12@tncentech.com	www.globalsources.com/tncen.co	★★★★☆☆
TIRE PRESSURE MONITORING SYSTEMS				
Shenzhen Jetson Auto-Elec Co.Ltd	213	zx@tesee.com.cn	www.globalsources.com/jetson.co	★★★★☆☆
TOUCHPAD GAME CONTROLLERS				
Fortune Power Electronic Technology Co. Ltd	221	fortunepower@fortunepower.com.tw	www.globalsources.com/fortunepower.co	★★★★☆☆
TURNTABLE PLAYERS				
Huizhou Haiping Electronics Co. Ltd	156	chinahaiping@vip.163.com	www.globalsources.com/haiping.co	★★★★☆☆
TV REMOTE CONTROLS				
Smarter Tech Co. Ltd	127	sales@smarteertech.com	www.globalsources.com/nutunmedical.co	★★★★☆☆
TV TUNER BOXES				
Syg Global Technology Co. Ltd	48-49	sales@beelinkbox.com	www.globalsources.com/syglobal.co	★★★★☆☆
TV WALL MOUNTS				
Ningbo Yinzhou Dowell Electronics Co. Ltd	214	sales@nbmounts.com	www.globalsources.com/nbaudio.co	★★★★☆☆
TWO-WAY RADIO ACCESSORIES				
JDI Jing Deng Industrial Co. Ltd	112-113	jdi-sales@jdi-co.com	www.globalsources.com/jdi.co	★★★★☆☆
Shenzhen Best Talent Technology	181	besttalent@best-talent.com	www.globalsources.com/besttalent.co	★★★★☆☆
TWO-WAY RADIO ANTENNAS				
How Tsen Intl Electronics Metal Co. Ltd	122	jukie@howtsen.com	www.globalsources.com/howtsen.co	★★★★☆☆
TWO-WAY RADIO HEADSETS				
JDI Jing Deng Industrial Co. Ltd	112-113	jdi-sales@jdi-co.com	www.globalsources.com/jdi.co	★★★★☆☆
TWS EARBUDS				
Fab-Chain Service Co. Ltd	195	ben.zhao@aspirer.hk	www.globalsources.com/fab-chainservice.co	★★★★☆☆
IMG Electronics Co. Ltd	239	gs@inmygoal.com	www.globalsources.com/szimg.co	★★★★☆☆
Shenzhen Mission Electronic Ltd	244	sales1@ms-elec.com	www.globalsources.com/ms-elec.co	★★★★☆☆
Shenzhen Shengna Technology Co. Ltd	173	sophia@sound-na.com	www.globalsources.com/sound-na.co	★★★★☆☆

@ For more information, visit this supplier's website.

Product / Advertiser	Page	E-mail	Website	Star Ranking
Shenzhen TIZE Technology Co. Ltd	46-47	sales1@tize.com.cn	www.globalsources.com/shenzhen-tize.co	★★★★★
Shenzhen Xuan Yue Digital Technology Co. Ltd	246	kelvin@chinaxuanyue.com	www.globalsources.com/xuanyue.co	★★★★☆
Shenzhen Youyuan Technology Co. Ltd	182	hedy@szainovo.com	www.globalsources.com/szainovo.co	★★★★☆
TWS EARBUDS WITH CHARGING CASES				
Dongguan Binshi Electronic Technology Co. Ltd	228	lucy@binshi.net.cn	www.globalsources.com/dgbinshi.co	★★★★☆
Dongguan Shinecon Industrial Co. Ltd	80-81	mandy@shinecon.com	www.globalsources.com/ishinecon.co	★★★★☆
Magin Industry Co. Ltd	157	sales@magingroup.cn	www.globalsources.com/maginindustry.co	★★★☆☆
Magin Technology Co. Ltd	165	magintech@magingroup.com	www.globalsources.com/magintech.co	★★★☆☆
USB 2.0 DATA CABLES (A TO A)				
Shenzhen De Qin Sheng Technology Co. Ltd	14-15	sales003@jellicohk.com	www.globalsources.com/deqinsheng.co	★★★★☆
Shenzhen De Qin Sheng Technology Co. Ltd	16-17	sales003@jellicohk.com	www.globalsources.com/deqinsheng.co	★★★★☆
USB 2.0 DATA CABLES (A TO C)				
Sunlike Technology Co. Ltd	62-63	sales09@sunlikecable.com	www.globalsources.com/sunlike-technology.co	★★★★☆
USB 2.0 EXTENSION CABLES				
Shenzhen Sinotek Technology Co. Ltd	44-45	marketing@sinotek.net	www.globalsources.com/sinotek.co	★★★★★
USB 2.0 IN-CAR CHARGERS				
Dongguan Ideal Charge Electronic Technology Co. Ltd	208	sandra@c-ideal.com	www.globalsources.com/c-ideal.co	★★★★☆
Drow Enterprise Co. Ltd	12-13	geniusc.com@msa.hinet.net	www.globalsources.com/drow.co	★★★★★
USB ADAPTERS				
Ningbo Eprofe Intelligent Technology Co. Ltd	256	sales@uplofit.com	www.globalsources.com/uplofit.co	★★★☆☆
USB CUP STERILIZERS				
Guangzhou Haoyang Electronic Co. Ltd	249	corrine.wu@terbly.com	www.globalsources.com/gsuvc.co	★★★★☆
USB POWER ADAPTERS				
Dongguan Anju Electronic Technology Co.Ltd	196	53633096@qq.com	www.globalsources.com/anju.co	★★★★☆
Hinen Electronics (Shenzhen) Co. Ltd	91	market@ce-link.com	www.globalsources.com/celink.co	★★★★★
Hinen Electronics (Shenzhen) Co. Ltd	90	market@ce-link.com	www.globalsources.com/celink.co	★★★★★
Shenzhen Rewoda Electronics Co. Ltd	72-73	marketing@rewoda.com	www.globalsources.com/rewoda.co	★★★★☆
USB-C CABLES				
Dongguan Boyye Industrial Co. Ltd	50-51	sales@boyye.com	www.globalsources.com/dgboyye.co	★★★★☆
USB-C HUBS				
Dongguan Boyye Industrial Co. Ltd	50-51	sales@boyye.com	www.globalsources.com/dgboyye.co	★★★★☆
iRonsen Technology (Shenzhen) Co. Ltd	232	ironsen@hotmail.com	www.globalsources.com/ironsen.co	★★★★☆
Sunlike Technology Co. Ltd	62-63	sales09@sunlikecable.com	www.globalsources.com/sunlike-technology.co	★★★★☆
Worldpass Industrial Co. Ltd	66-67	kimtang@allpasselec.com	www.globalsources.com/worldpass.co	★★★★☆
USB-C IN-CAR CHARGERS				
Dongguan Boyye Industrial Co. Ltd	50-51	sales@boyye.com	www.globalsources.com/dgboyye.co	★★★★☆
USB-C LAPTOP ADAPTERS				
Shenzhen Super Eagle Technology Co. Ltd	60-61	15017948218@163.com	www.globalsources.com/super-eagle.co	★★★★☆
VIDEO GAME CONSOLES				
Shenzhen Moorechip Technologies Limited	58-59	andrew.liu@nex-adas.com	www.globalsources.com/nex-adas.co	★★★★☆
VOIP PHONES				
Telewell Electric Co. Ltd	167	eric@telewell.com.tw	www.globalsources.com/telewell.co	★★★★☆
WATER-RESISTANT SPEAKERS				
Wealthland (Audio) Ltd	224	wealthla@globalsources.com	www.globalsources.com/wealthla.co	★★★☆☆
WI-FI CAMERAS				
Quanzhou Juhui Electronics Co. Ltd	187	alee@juhuico.com	www.globalsources.com/juhui.co	★★★★☆
Shenzhen Etong Electronics Co. Ltd	223	sales@china-etong.com	www.globalsources.com/e-tong.co	★★★★☆
Shenzhen Grandsecu Technology Co.Ltd	233	jane@grandsecu.cn	www.globalsources.com/grandsecu.co	★★★★☆
WI-FI SOCKETS				
Shenzhen SAPN Technology Co.Ltd	144	399516502@qq.com	www.globalsources.com/sapn.co	★★★☆☆

@ For more information, visit this supplier's website.

Product / Advertiser	Page	E-mail	Website	Star Ranking
WIRED COMPUTER HEADSETS				
Shin Cheng Technology Ltd	145	shindar.sj@msa.hinet.net	www.globalsources.com/shinjang.co	★★★★☆☆
WIRED EARPHONES				
Smart Devil Technology Co. Ltd	116-117	globalsources@smart-devil.com	www.globalsources.com/smart-devil.co	★★★★☆☆
Wealthland (Audio) Ltd	224	wealthla@globalsources.com	www.globalsources.com/wealthla.co	★★★★☆☆
WIRED HEADPHONES				
Dongguan Siyoto Electronics Co. Ltd	140	jenny_do@siyoto.com	www.globalsources.com/siyoto.com	★★★★★★
Guangzhou Eway Technology Co. Ltd	132	terry@eway-gd.com	www.globalsources.com/eway.co	★★★★☆☆
Shin Cheng Technology Ltd	145	shindar.sj@msa.hinet.net	www.globalsources.com/shinjang.co	★★★★☆☆
Wealthland (Audio) Ltd	224	wealthla@globalsources.com	www.globalsources.com/wealthla.co	★★★★☆☆
WIRED IP CAMERAS				
Shenzhen Sno Electronic Co. Ltd	126	marketing@cctvsno.com	www.globalsources.com/sno.com	★★★★☆☆
WIRELESS EARPHONES				
Dongguan Joy2Hear Electronics Co. Ltd	139	jimzhan@joy2hear.com	www.globalsources.com/joy2hear.co	★★★★☆☆
Guizhou Fortuneship Technology Co. Ltd	151	xshizhe@freedynamics.com	www.globalsources.com/fortuneship.co	★★★★☆☆
Shenzhen Lambda Technology Co. Ltd	125	calerychoi@lambaogroup.com	www.globalsources.com/lambao.co	★★★★☆☆
Shenzhen Smart Care Technology Limited	100-101	sales03@smawatch.com	www.globalsources.com/smartcare.co	★★★★☆☆
WIRELESS HANDHELD BARCODE SCANNERS				
Huizhou Minjie Technology Co. Ltd	215	admin@minj.cn	www.globalsources.com/mjbarcodescanner.co	★★★★★★
WIRELESS HDMI TRANSMITTERS				
Shenzhen Viewplay Co. Ltd	154	inquiry@viewplay.com.cn	www.globalsources.com/viewplay.co	★★★★☆☆
WIRELESS MICROPHONE SYSTEMS				
Shenzhen Jiuyi Electronic Co. Ltd	7	Jiuyi0211@vip.163.com	www.globalsources.com/jiuyi.co	★★★★☆☆
WIRELESS REPEATERS				
Fujian Maiwei Communication Technology Co. Ltd	120	chenxing@maiwei.com.cn	www.globalsources.com/fjmaiwei.co	★★★★☆☆
WIRELESS SPEAKERS				
Shenzhen City Italian Energy Equipment Limited Company	219	kevin@oldshark.com	www.globalsources.com/italian.co	★★★★☆☆
WIRELESS USB ADAPTERS				
Dongguan Anju Electronic Technology Co.Ltd	196	53633096@qq.com	www.globalsources.com/anju.co	★★★★☆☆
WLAN ANTENNAS				
Chang Hong Technology Co. Ltd	152	linda@changhong.com.tw	www.globalsources.com/changhong-tech.co	★★★★★★
Tekfun Co. Ltd	8	info@tekfun.com.tw	www.globalsources.com/tekfun.co	★★★★☆☆
LED & SOLAR PRODUCTS				
G9 LED BULBS				
Shenzhen Pyramid Lighting Co.Ltd	262-263	pyramidlighting@qq.com	www.globalsources.com/pyramidlighting.co	★★★★☆☆
LED WORK LIGHTS				
Genius Electronic Optical Co.Ltd	260	carrie.chan@gseo.com	www.globalsources.com/gseo.co	★★★★☆☆
Xiamen Dlight Star Technology Co.Ltd	274	r.lin@dlightstar.com	www.globalsources.com/dlightstar.co	★★★★☆☆
OUTDOOR LED DISPLAYS				
Shenzhen Fjcreate Co. Ltd	271	julia@fjcreate.net	www.globalsources.com/co-led-display.co	★★★★☆☆
SOLAR PANELS				
Futuresolar Energy And Manufacturing(Putian)Co.Ltd	265	Nicholas@futuresolarpv.com	www.globalsources.com/futuresolartech.co	★★★★☆☆
SOLAR STREET LIGHTS				
Ningbo Yisheng Electronic Technology Co. Ltd	266	eric@zj-shengtai.com	www.globalsources.com/shengtailed.co	★★★★☆☆
SOLAR WALL LIGHTS				
Nanjing Long Bai Xiang Electronic Technology Co.Ltd	269	njlbxeelectronic@163.com	www.globalsources.com/longbaixiang.co	★★★★☆☆
WI-FI LED BULBS				
Zhejiang Twinsel Electronic Technology Co. Ltd	273	will@twinsel.com	www.globalsources.com/twinsel.co	★★★★★★

@ For more information, visit this supplier's website.

Advertiser Index

Advertisers	Page
Aifo Smart Technology Co.Ltd	163
Anji Ruibao Furniture Co. Ltd	32-33
Beam Tech Electronics Co. Ltd	197
Betterway Electronic Co. Ltd	153
Brocade Smart Space Technology Co. Ltd	207
Chang Hong Technology Co. Ltd	152
China Joy Guitar Co. Ltd	222
Chinmore Industry Co. Ltd	128
Cixi Luckytone Electronic Co. Ltd	206
Cobtel Precision Electronics Co. Ltd	230
Dongguan Anju Electronic Technology Co.Ltd	196
Dongguan Binshi Electronic Technology Co. Ltd	228
Dongguan Boyye Industrial Co. Ltd	50-51
Dongguan CitySING-E Electronics Technology Co. Ltd	C-3
Dongguan Golden Profit Electronics Co. Ltd	231
Dongguan Huayanda Electronics Technology Co. Ltd	258
Dongguan Ideal Charge Electronic Technology Co. Ltd	208
Dongguan Joy2Hear Electronics Co. Ltd	139
Dongguan Kaidi Technology Co. Ltd	237
Dongguan Mingpan Electronic Technology Co.Ltd	118
Dongguan Shanggui Electronics Co.Ltd	129
Dongguan Shinecon Industrial Co.Ltd	80-81
Dongguan Siyoto Electronics Co. Ltd	140
Dongguan Songman Technology Co.Ltd	119
Dongguan Tangxi Electronics Technology Co. Ltd	155
Dongguan Tyjin Electronics Co. Ltd	242
Drow Enterprise Co. Ltd	12-13
Eastern Times Technology Co. Ltd	96-97
Eastern Times Technology Co. Ltd	98-99
Eyesun Technology Co. Ltd	130
Fab-Chain Service Co. Ltd	195
Firstar Co. Ltd	36-37
Fortune Power Electronic Technology Co. Ltd	221
Freeman Intelligent Power Ltd	78-79

Advertisers	Page
Fujian BelFone Communications Technology Co.Ltd	148
Fujian Maiwei Communication Technology Co. Ltd	120
Fujian New Century Communications Co. Ltd	C-2,1
Fujian Quanzhou Huahong Communication Co. Ltd	131
Fujian Senhaix Electronic Technology Co. Ltd	141
Futuresolar Energy And Manufacturing(Putian)Co.Ltd	265
Fuzhou Paide Technology Co Ltd	205
Genius Electronic Optical Co.Ltd	260
Giant Alarm System Co. Ltd	52-53
GIGA-TMS Inc.	238
Guangdong Kede Tech Co. Ltd	227
Guangzhou Billion Leiden Electronic Technology Co. Ltd	121
Guangzhou Eway Technology Co. Ltd	132
Guangzhou Haoyang Electronic Co. Ltd	249
Guangzhou MT-VIKI Electronics Co. Ltd	38-39
Guangzhou Zonerich Business Machine Co. Ltd	188
Guizhou Fortuneship Technology Co. Ltd	151
Guizhou Fortuneship Technology Co. Ltd	190
Guizhou Fortuneship Technology Co. Ltd	220
Gyror Technology (China) Co. Ltd	82-83
Hanshi Jingxian Innovative Technology (Huizhou) Co. Ltd	254
Hengli Digital Industrial Co.Ltd	226
Hinen Electronics (Shenzhen) Co. Ltd	90
Hinen Electronics (Shenzhen) Co. Ltd	91
Hongkong Taosheng Electronics Co. Ltd	189
How Tsen Intl Electronics Metal Co. Ltd	122
Huarui Technology (Shenzhen) Co. Ltd	133
Huizhou Haiping Electronics Co. Ltd	156
Huizhou Minjie Technology Co. Ltd	215
Huizhou N Acoustics Co.Ltd	174
Img Electronics Co. Ltd	239
iRonsen Technology (ShenZhen) Co.Ltd	232
JDI Jing Deng Industrial Co. Ltd	112-113
Luen Yick Electrical Mfg Co. Ltd	142

Advertisers	Page
Magin Industry Co. Ltd	157
Magin Technology Co. Ltd	165
Maxpac Electronics Co. Ltd	241
Monoeric International Co. Ltd	76-77
Nanjing Long Bai Xiang Electronic Technology Co.Ltd	269
Nantong Enjoy Sports and Homefitness Co.Ltd	255
Ningbo Eprofe Intelligent Technology Co. Ltd	256
Ningbo Yinzhou Dowell Electronics Co. Ltd	214
Ningbo Yisheng Electronic Technology Co. Ltd	266
Ovtech Industrial Co. Ltd	257
Qidong Vision Mounts Manufacturing Co. Ltd	158
Quanzhou Juhui Electronics Co. Ltd	187
Quanzhou Risen Electronics Co. Ltd	123
Quanzhou SFE Electronic Technology Co. Ltd	147
Quwei (Xiamen) Intelligence Technology Co. Ltd	134
Runshine International Co.Ltd	124
Sentech Korea Corp.	229
Shenzhen Aidelong Intelligent Communication Co.Ltd	54-55
Shenzhen Aierson Technology Co. Ltd	204
Shenzhen Aobaisen Electronic Technology Co. Ltd	10-11
Shenzhen Best Talent Technology	181
Shenzhen Bitech Technology Co. Ltd	164
Shenzhen Brosfuture Electronics Technology Co. Ltd	160
Shenzhen Carobotor Technology Co.Ltd	40-41
Shenzhen Century Joint Innovation Technology Co. Ltd	259
Shenzhen Cheerstar Communication Technology Co. Ltd	186
Shenzhen City Italian Energy Equipment Limited Company	219
Shenzhen City Kangjie Communication Technology Co. Ltd	258
Shenzhen De Qin Sheng Technology Co. Ltd	14-15
Shenzhen De Qin Sheng Technology Co. Ltd	16-17
Shenzhen Elecsource Technology Co. Ltd	191
Shenzhen Elink Communication Technology Co.Ltd	143
Shenzhen Etong Electronics Co. Ltd	223
Shenzhen Etross Telecom Co. Ltd	135
Shenzhen Fjcreate Co. Ltd	271
Shenzhen Fudeng Technology Co. Ltd	24-25

Advertisers	Page
Shenzhen Fudeng Technology Co. Ltd	26-27
Shenzhen Geniatech Inc. Ltd	104-105
Shenzhen Gift Tree Technology Co. Ltd	175
Shenzhen Grandsecu Technology Co.Ltd	233
Shenzhen Greatpine Technology Co. Ltd	216
Shenzhen Hongyesheng Technology Co.Ltd	56-57
Shenzhen HTOMT Technology Co. Ltd	74-75
Shenzhen Huntkey Electric Co.Ltd	243
Shenzhen In-One Technology Co.Ltd	177
Shenzhen Jetson Auto-Elec Co.Ltd	213
Shenzhen Jiayin Nuoxin E-Commerce Co.Ltd	209
Shenzhen Jiuyi Electronic Co.Ltd	7
Shenzhen Joyhong Technology Co. Ltd	240
Shenzhen Junjiahao Technology Co. Ltd	84-85
Shenzhen Kensing Electronic Co.Ltd	159
Shenzhen Koteksun Technology Co. Ltd	255
Shenzhen Lambda Technology Co. Ltd	125
Shenzhen Lianhongtai Electronics Co. Ltd	42-43
Shenzhen Loveka Technology Co.Ltd	192
Shenzhen Lutu Technology Co.Ltd	248
Shenzhen Luvview Co. Ltd	161
Shenzhen Meetion Tech Co. Ltd	22
Shenzhen Meetion Tech Co. Ltd	18-19
Shenzhen Meetion Tech Co. Ltd	20-21
Shenzhen Mission Electronic Ltd	244
Shenzhen Modeltime Electronics Co. Ltd	166
Shenzhen Moorechip Technologies Limited	58-59
Shenzhen MYWAY Technology Co. Ltd	183
Shenzhen New Solution Electronics Co. Ltd	146
Shenzhen Ol-Sky Technology Ltd	257
Shenzhen Pano Technology Co. Ltd	136
Shenzhen Powerful Potoelectron Co. Ltd	225
Shenzhen Pyramid Lighting Co.Ltd	262-263
Shenzhen PYS High-Tech Co.Ltd	92
Shenzhen PYS Industrial Co. Ltd	93
Shenzhen Qianhai Vsoontech Information Technology Co.Ltd	162

Advertisers	Page
Shenzhen Qihoo Jian An Intelligent Technology Co Ltd	86-87
Shenzhen Reflying Electronic Co. Ltd	114-115
Shenzhen Retroline Electronic Co. Ltd	236
Shenzhen Rewoda Electronics Co. Ltd	72-73
Shenzhen Rui Sixiang Technology Co. Ltd	211
Shenzhen SAPN Technology Co.Ltd	144
Shenzhen Shenchuang Hi-Tech Electronics Co.Ltd	4-5
Shenzhen Shengna Technology Co. Ltd	173
Shenzhen Shunxingsheng Electronic Co. Ltd	202
Shenzhen Shuo Yu Technology Co. Ltd	247
Shenzhen Sinotek Technology Co. Ltd	44-45
Shenzhen Smart Care Technology Limited	100-101
Shenzhen Smart Care Technology Limited	102-103
Shenzhen SMX Display Technology Co. Ltd	169
Shenzhen SNO Electronic Co. Ltd	126
Shenzhen Star A E-Commerce Co.Ltd	253
Shenzhen Star Sources Electronic Technology Co. Ltd	28-29
Shenzhen Starshine Industrial Co. Ltd	137
Shenzhen Sunway Industry Co. Ltd	251
Shenzhen Super Eagle Technology Co.Ltd	60-61
Shenzhen T.Y. Industrial Co.Ltd	171
Shenzhen Tailide Science and Technology Co. Ltd	70-71
Shenzhen TIZE Technology Co. Ltd	46-47
Shenzhen UEMade Technology Co. Ltd	68-69
Shenzhen Unison Electronics Co. Ltd	110-111
Shenzhen Uni-Sun Electronics Ltd	2
Shenzhen Viewplay Co. Ltd	154
Shenzhen Winkeen Electronics Co. Ltd	198
Shenzhen Xinruiming Technology Co. Ltd	108-109
Shenzhen Xuan Yue Digital Technology Co. Ltd	246
Shenzhen Yangliming Electronics Technology Co.Ltd	179
Shenzhen Yilianwang Technology Co. Ltd	252
Shenzhen Yoshingy Technology Co. Ltd	256
Shenzhen Youfu Tools Co. Ltd	250
Shenzhen Youyuan Technology Co. Ltd	182
Shenzhen Zhaochen Electronics Co. Ltd	149

Advertisers	Page
Shin Cheng Technology Ltd	145
Smart Devil Technology Co. Ltd	116-117
Smarteer Tech Co. Ltd	127
Stonkam Co. Ltd	235
Sun Yin Crystal Industry Co. Ltd	106-107
Sunlike Technology Co. Ltd	62-63
Syg Global Technology Co. Ltd	48-49
SZ Expo Hong Compos Tech Co. Ltd	193
SZFP(Shenzhen) Technology Limited	199
Taiwan Protect Ltd	201
Tekfun Co. Ltd	8
Telewell Electric Co. Ltd	167
Tianning Technological Electronics Co. Ltd	210
Ultmost Technology Group	3
Wealthland (Audio) Ltd	224
Wenzhou Vanmac Trading Co. Ltd	212
Win Industry Company	194
Winneroid Technology&Development Co. Ltd	138
Worldpass Industrial Co. Ltd	66-67
Wuxi Lexin Audio-Visual Equipment Co.Ltd	172
Wuyi Chuang Xin Metal Tools Co. Ltd	88-89
Xiamen Apt Electronic Tech. Co.Ltd	245
Xiamen Dlight Star Technology Co.Ltd	274
Xiamen Liao Sheng Trading Co. Ltd	180
Xiamen Puxing Electronics Science and Technology Co. Ltd	C-4
Xiamen Tncen Technology Co.Ltd	170
Xiamen Topperstar Elec-Tech Co. Ltd	259
Xiamen Yometec Technology Co.Ltd	203
Xinwei Electronic Co. Ltd (Quanzhou)	150
Yongkang Kugoo Technology Co. Ltd	64-65
Yuh Yih Industrial Co. Ltd	6
YXISN5 Electronic Co. Ltd	30-31
Zhejiang Lianmei Industrial Co. Ltd	185
Zhejiang Twinsel Electronic Technology Co.Ltd	273
Zhongshan Wanlitong Antenna Equipment Co. Ltd	178

NEW

Professional Bluetooth speaker manufacturer with more than 200 private models

Super-bass Bluetooth speakers
with app control

- Support BT/Aux/USB/TF/FM/Mic/App/TWS
- Loudspeaker: 2 x 6.5"
- Output: 25W, 7-8V (Boost IC)
- Bluetooth 5.0+EDR
- LED display and flashlight
- 3,600mAh Li-battery inside
- Size: 225 x 215 x 570mm
- Weight: 3,560g



- Certifications: CE, RoHS, FCC and ISO 9001:2015
- Over 10 years' experience in Bluetooth speakers
- Supplying Disney, IQ Sound and QFX
- Exporting to 20+ countries
- ODM service available
- Monthly production capacity: 500,000 pieces
- Factory area: 10,000 square meters

Inquire now.



Super-bass Bluetooth speakers

Sing-e

Dongguan CitySING-E Electronics Technology Co. Ltd

5 Jinsheng Rd, Qiaotou, Dongguan, Guangdong 523520, China

Tel: (86-755) 8948 9689 • Fax: (86-531) 8948 9859

E-mail: info@szinfocore.com

www.globalsources.com/dgshengyi.co

Global Sources  Verified Supplier ★★★★★

NEW

Over 20 years' OEM and ODM experience

- Products are exported to over 30 countries
- Self-owned SMT factory
- 2,000m² factory with six automated production lines
- Self-developed two-way radios using our own molds
- 200m² self-owned ALT laboratory
- Holding over 30 patents

You are welcome to call or e-mail us for cooperation.



DMR dual-band radio (PD-560L)



3W DMR radio (PD250)



IP67 DMR radio (PD826)



4G POC radio (G25)

Xiamen Puxing Electronics Science & Technology Co. Ltd

11 Xianghong Rd, Torch Hi-tech Zone, Xiang'an, Xiamen, Fujian 361101, China

Tel: (86-592) 776 9996 ext. 857 • Fax: (86-592) 776 9958

Mobile/WhatsApp/WeChat: (86) 135 9952 0473

Skype: puxingwendy • QQ: 1733981962 • E-mail: meilan@puxingradio.com

www.globalsources.com/pxdz.co • www.globalsources.com/puxingradio.co

www.puxingradio.com/en/index.aspx

Global Sources  Verified Supplier ★★★★★

