



Pro Display XDR

Recycler Guide

2021 年 3 月

內容

- 3 關於本指南
- 4 辨識方法
- 5 需要特別處理的組件
- 6 安全考慮
- 7 建議工具
- 8 拆卸指引
- 19 處理散件

關於本指南

Apple Recycler Guide 會為電子回收商提供指引，說明如何安全拆卸產品並盡可能回收最多資源。這些指南會提供逐步拆卸說明，以及與材料成份有關的資料，幫助回收商將散件交給適當的材料回收商。

為了節省重要的資源，我們致力減少所用的材料，希望有朝一日可以 100% 使用在產品中回收或可再生的材料。要達成這個目標的主要方法，就是從報廢電子產品中回收資源。

拆卸程序只可由經過培訓的專業電子產品回收人員執行。回收商須負責獨立評估，並確保有遵守與工作相關的所有適用環境、健康和安全法例。當中包括但不限於與管理、處理、運輸和處置製造過程中所產生的廢物之相關法例，以及為確保所有負責相關工作的員工健康和 safety 之相關法例。

如果對本指南有任何疑問或意見，請發送電郵至 contactesci@apple.com。

辨識方法



型號號碼

A1999

需要特別處理的組件

根據 2012/19/EU 指令附件 VII 所連，應去除以下物質和成份來進行特別處理。

物質/元素	地點	去除指引
表面大於 10 平方厘米的已印刷電路板	主機板、顯示器底板、LED 陣列底板	按照步驟 1 - 7 操作
如果表面大於 100 平方厘米，請遮蓋玻璃和 LCD 單元	遮蓋玻璃和 LCD 單元	按照步驟 1 - 3 操作
外置接線	Thunderbolt 3 Pro 接線、AC 電源線	按照步驟 1 操作
沒有其他附件 VII 中所列的物質或成份		

安全考慮

回收商有責任獨立評估其員工為執行或支援相關工作而進行的所有活動，並確保有遵守與工作相關的所有適用健康和安全法例。當中包括但不限於與所有負責相關工作的員工健康和 safety 相關之法例。回收商亦有責任評估工作環境，確保有按照人體工學的最好做法來設計工作區域，並滿足所有人體工學要求，以確保能保護員工的健康。

危險警告



玻璃碎片的危險



對雙手造成傷害的危險



吸入化學品的危險



鋒利的元素

個人防護設備

在整個回收過程中，均應穿戴個人防護設備。



穿戴手部防護設備



佩戴口罩



穿戴眼部防護設備



穿戴腳部防護設備



穿著保護衣物

建議工具

一字螺絲批

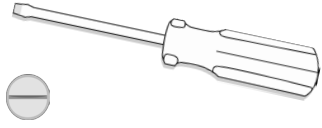

平面刮板



錘子

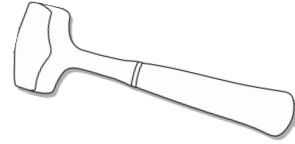

尖鑿



起釘器

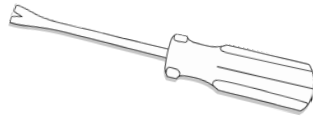

拆卸指引

1. 從裝置上拔出顯示器電源線和 Thunderbolt 3 Pro 接線。

- » 關閉顯示器。



- » 拔出接線。

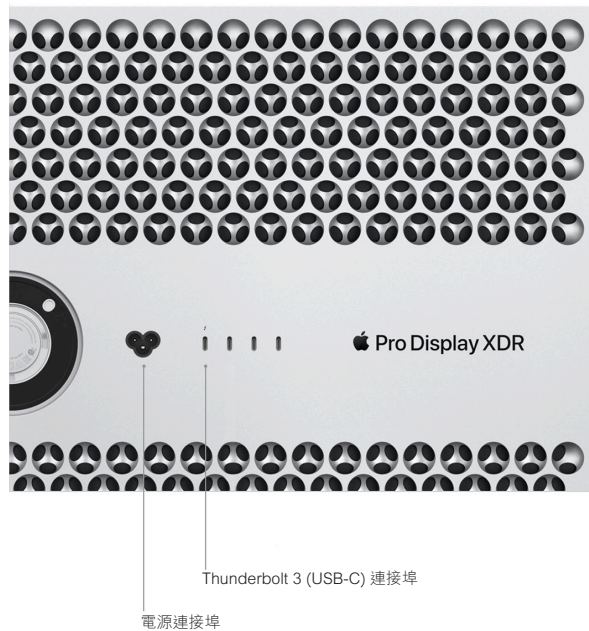
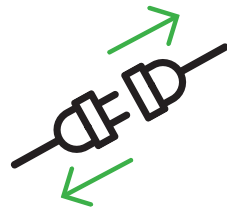

2. 移除支架。如果使用 Pro Stand，請按照第一組指引操作。如果使用 VESA 安裝轉換器，請按照第二組指引操作。

» 從 Pro Stand 卸下 Pro Display XDR。

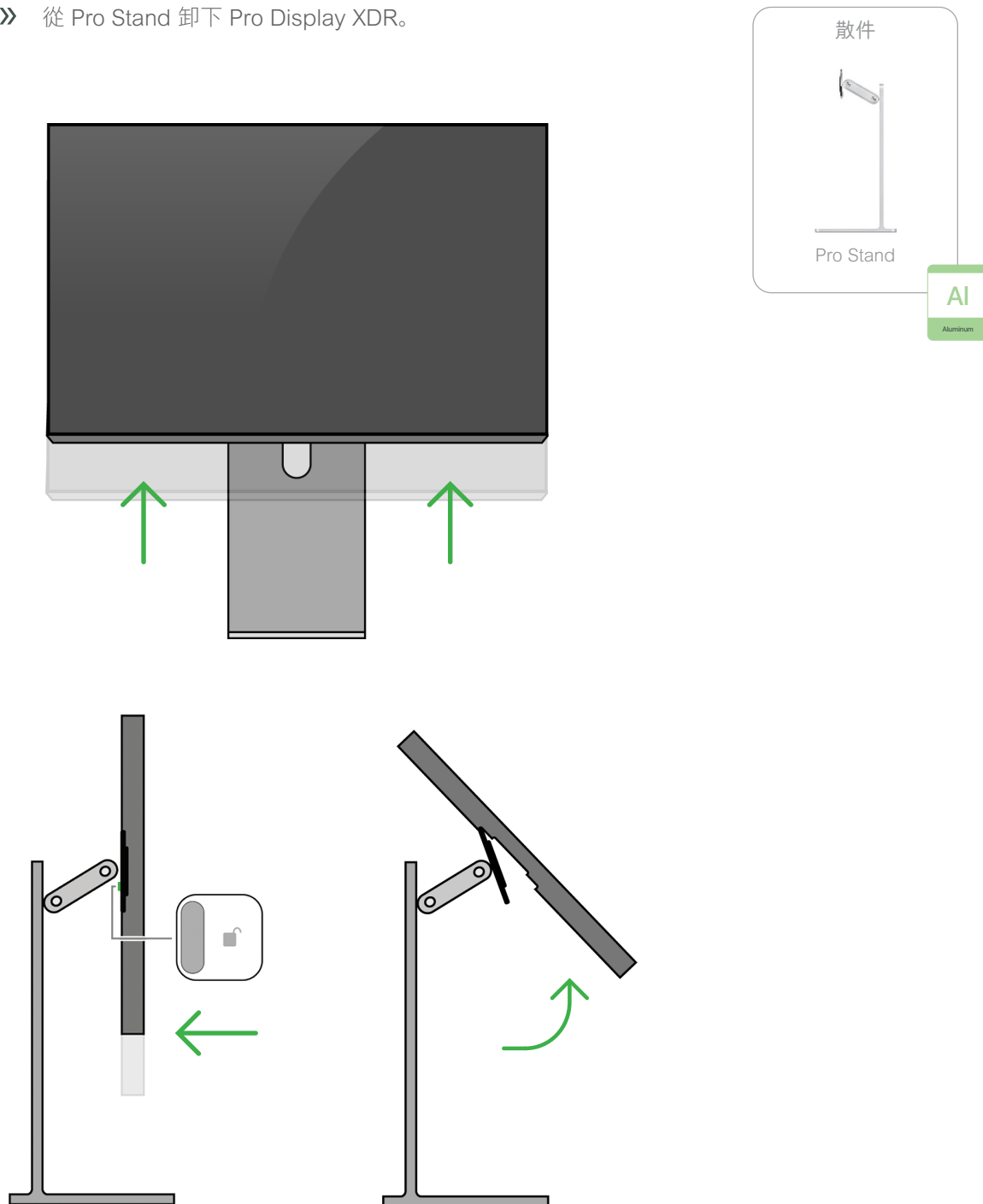

» 從 VESA 安裝轉換器卸下 Pro Display XDR。

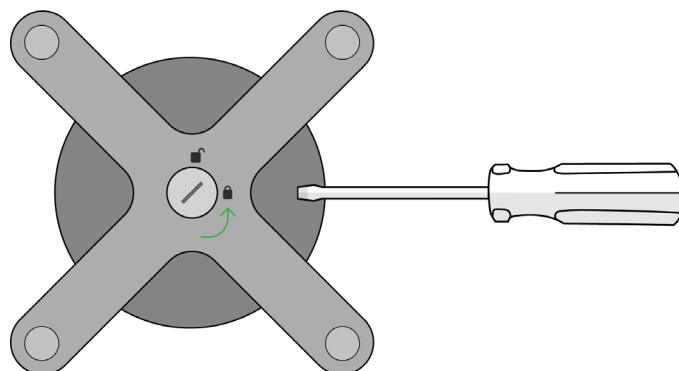

所需工具



散件

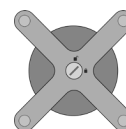

VESA 安裝
轉換器

AI

Aluminum



3. 移除遮蓋玻璃和 LCD 單元。



玻璃碎片的危險

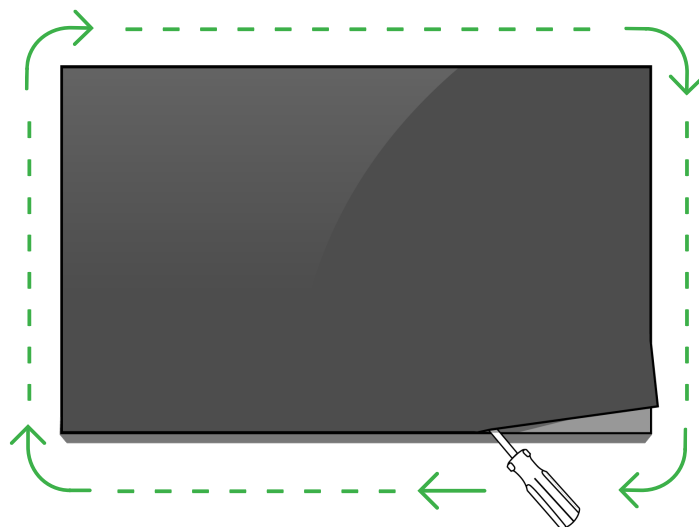

所需工具

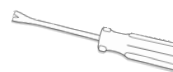

散件



遮蓋玻璃
和 LCD 單元

GL

Glass

散件



薄膜

PL

Plastics

4. 移除連接至顯示器的兩塊底板。



鋒利的元素



散件



顯示器
底板 (x2)

PMs

Precious
Metals

5. 移除 LED 陣列

所需工具

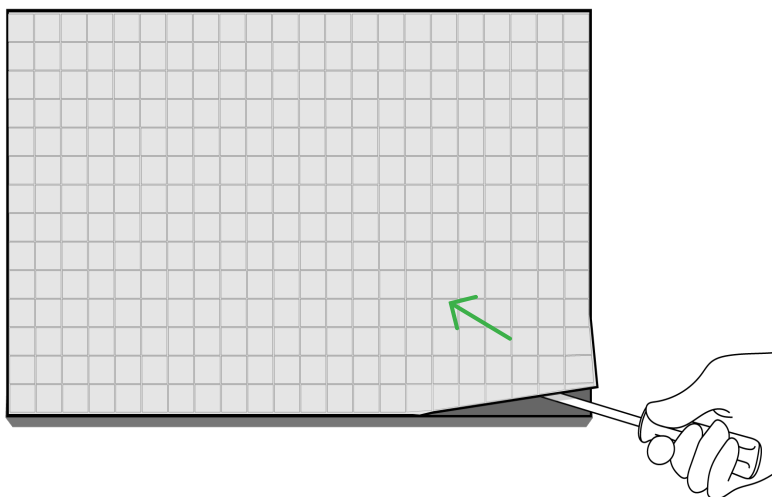

» 從底座拉出 LED 陣列。留起底座在下一步時使用。

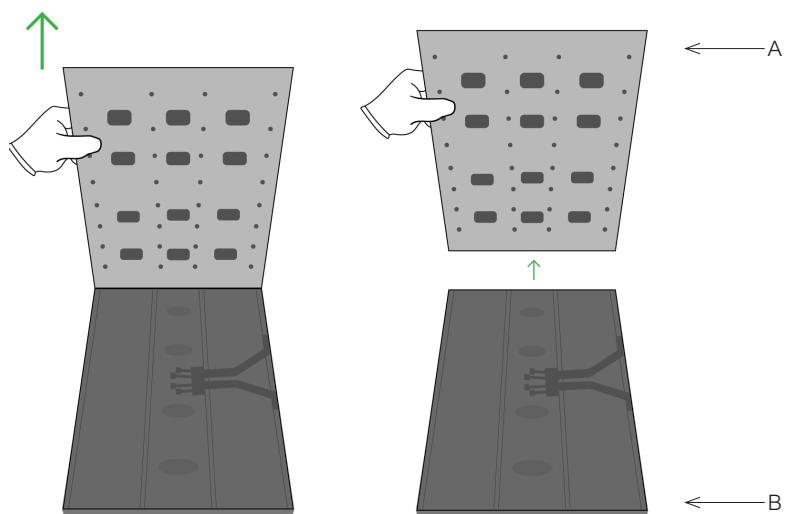

» 移除反光板

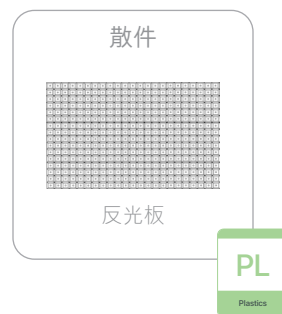
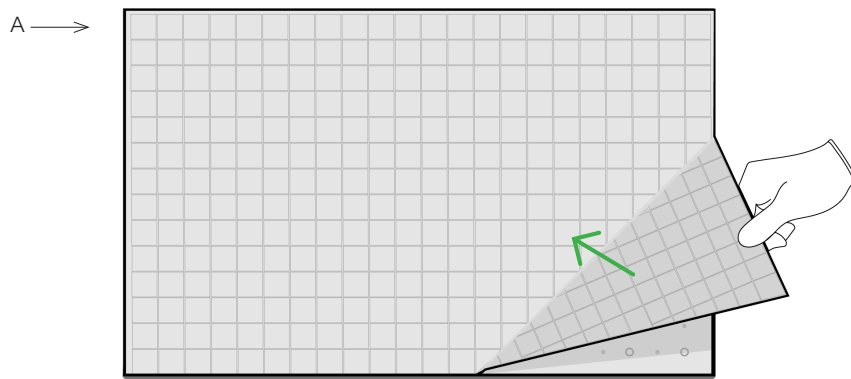

» 移除兩塊 LED 陣列底板

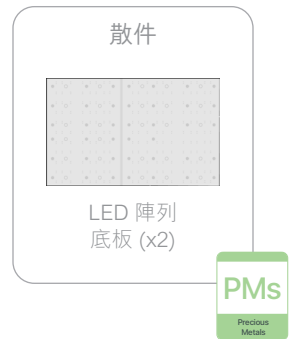
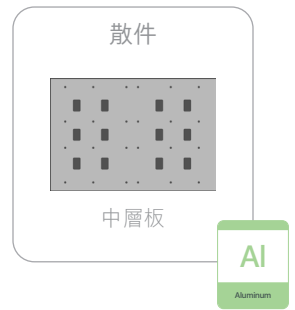
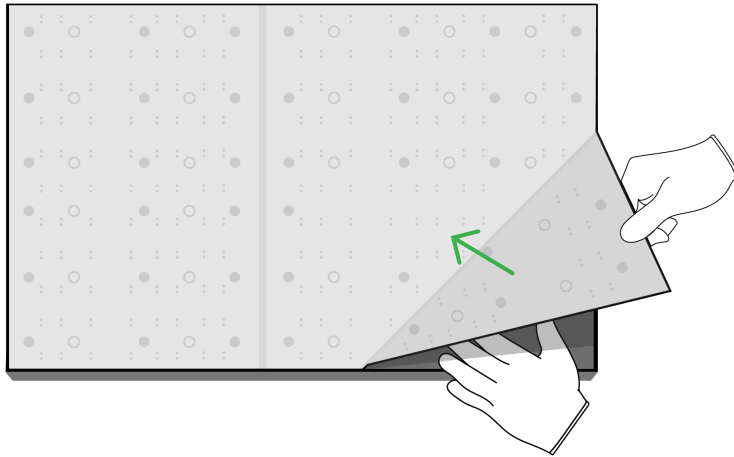

6. 移除防塵板。

» 移除帶狀電線。

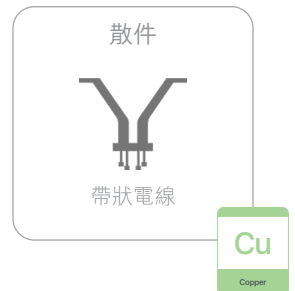
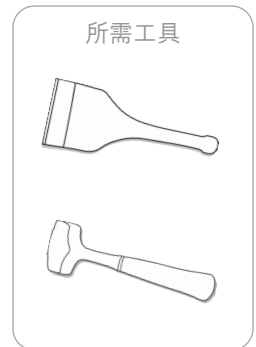
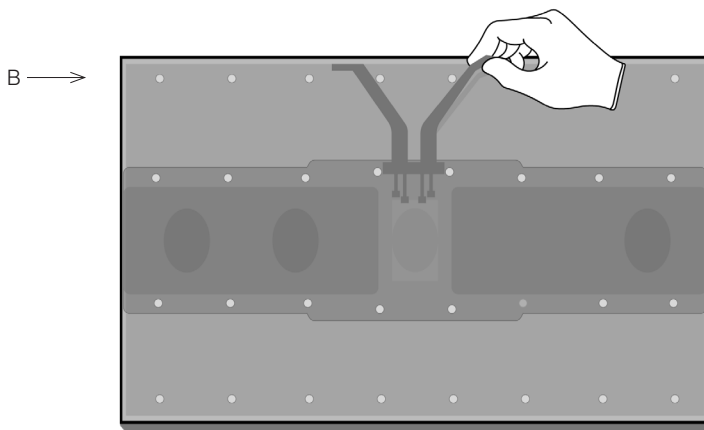

» 使用尖鑿移除螺絲。



對雙手造成傷害的危險

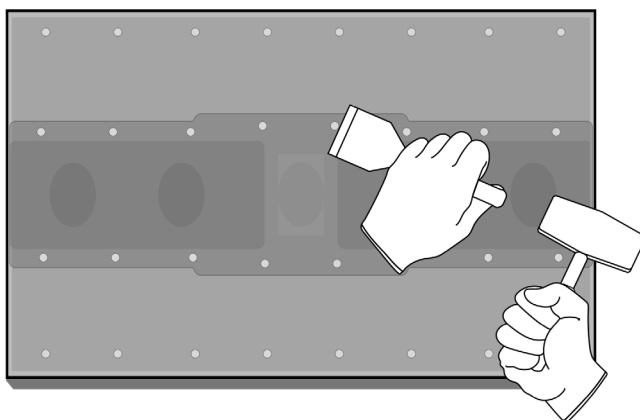

散件



中間的防塵板

Al

Aluminum

散件

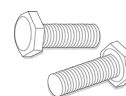

螺絲 (x35)

Fe

Ferrous

» 移除兩邊的防塵板。

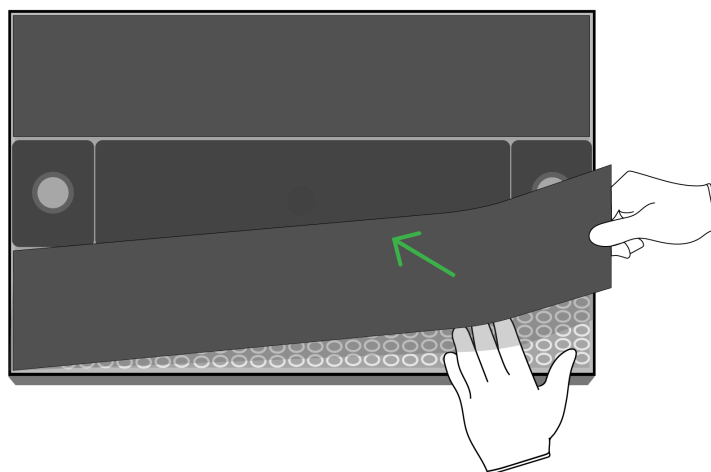

散件



兩邊的
防塵板

Fe

Ferrous

7. 移除四塊主機板。

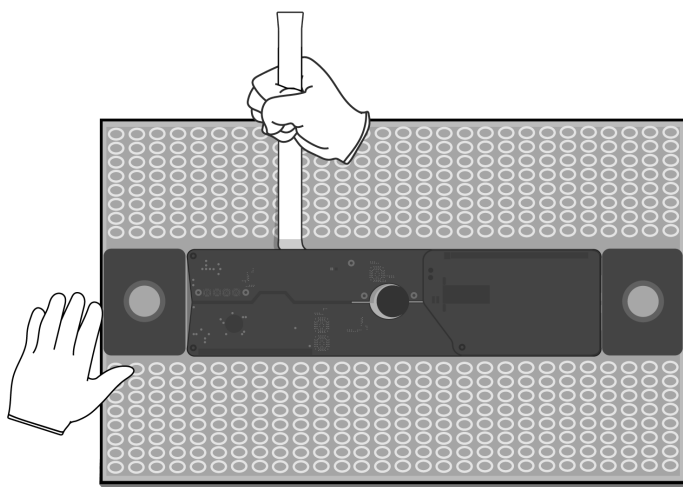

所需工具



散件

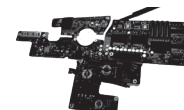

主機板 (x4)

PMs
Precious
Metals

8. 移除磁石。

» 移除中間的磁石。

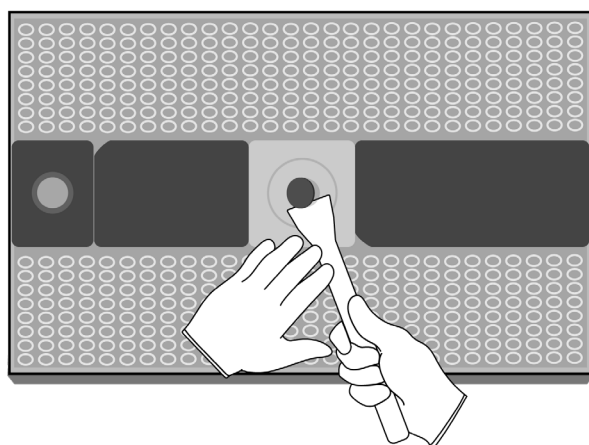

所需工具



散件

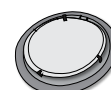

磁石

REE
Rare Earth
Elements

» 移除側邊的磁石。

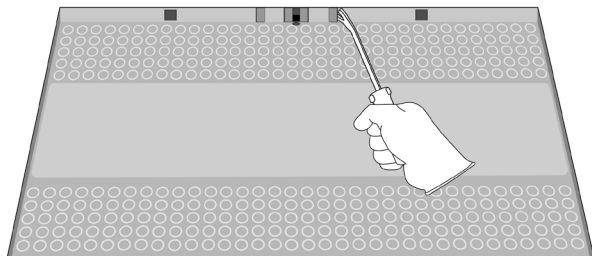

散件



磁石

REE

Rare Earth
Elements

9. 移除風扇和 AC 電源模組。

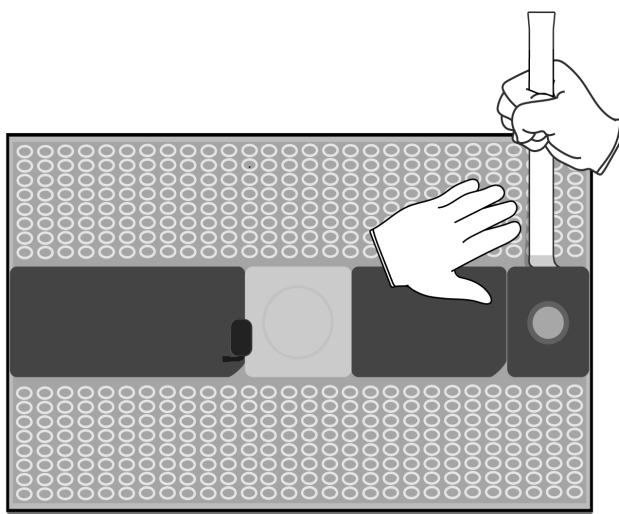

所需工具



散件



風扇

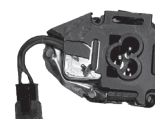

AC 電源模組

Cu

Copper

10. 移除最後的帶狀電線和接線。

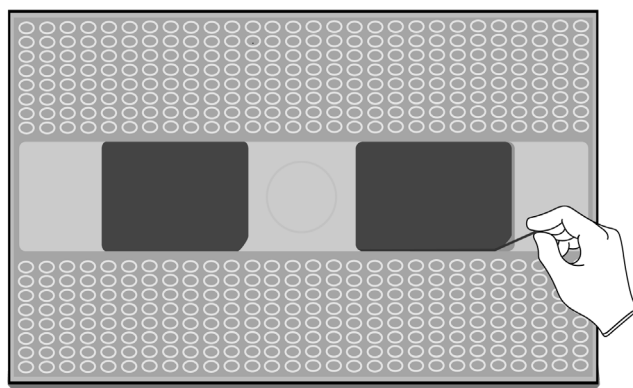
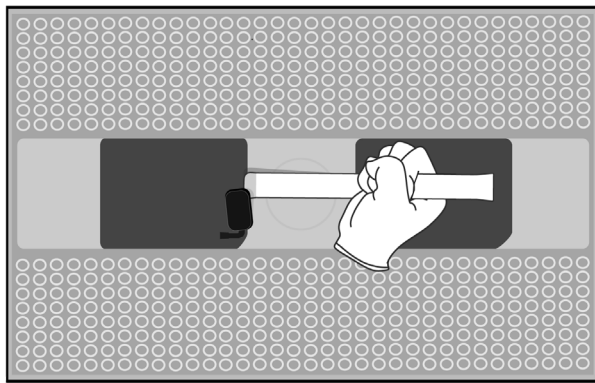

所需工具



散件



帶狀電線
和接線

Cu

Copper

散件









鋁金屬外殼

Al

Aluminum

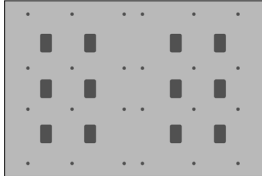
處理散件

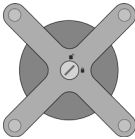
此過程中所產生的所有物件，都必須根據適用的廢物法例和法規進行管理、處理和棄置，相關法規包括但不限於廢棄物架構指令及歐洲國家/地區的相關法規。

散件	下游處理
<p data-bbox="461 550 542 579">鋁金屬</p>  <p data-bbox="435 722 565 751">中間的防塵板</p>	<p data-bbox="1039 550 1198 579">主要目標材料</p> 
 <p data-bbox="467 987 532 1016">中層板</p>	<p data-bbox="1039 764 1198 793">其他潛在材料</p> 
 <p data-bbox="451 1205 552 1255">VESA 安裝 轉換器</p>	
 <p data-bbox="451 1499 548 1528">Pro Stand</p>	
 <p data-bbox="451 1726 555 1755">鋁金屬外殼</p>	

散件

下游處理

底板

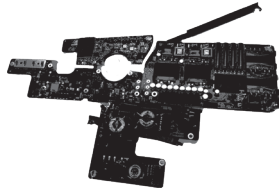

主機板

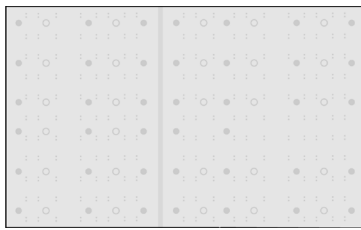

LED 陣列底板



顯示器底板

主要目標材料



其他潛在材料



亞鐵

主要目標材料



兩邊的防塵板

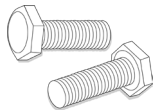

螺絲



散件

下游處理

遮蓋玻璃 和 LCD 單元



遮蓋玻璃和 LCD 單元

主要目標材料



其他潛在材料



混合電子零件



風扇和 AC 電源模組

主要目標材料



其他潛在材料

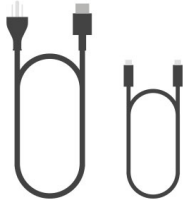

接線

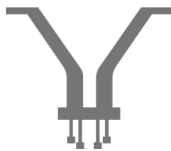

帶狀電線

散件

下游處理

混合塑膠

主要目標材料

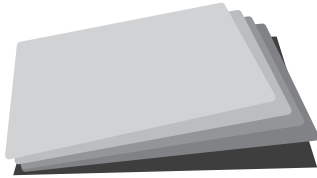

薄膜

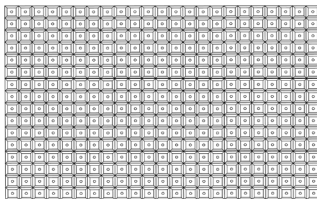

反光板

稀土磁鐵

主要目標材料

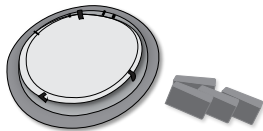

磁石

