

TESLA™ C2050
COMPUTING PROCESSOR

INSTALLATION GUIDE



NVIDIA Tesla C2050

TABLE OF CONTENTS

Introduction	1
About This Guide	1
Minimum System Requirements	2
Unpacking	3
Equipment	3
Hardware Installation	5
Before You Begin	5
Tesla C2050 Installation	5
Driver Installation	9
Windows Installation	9
Control Panel Set Up	14
Linux Installation	16
Verifying Linux Installation	19
References and Resources	21
Getting Driver Updates	21
Registration, Support and Warranty	23
Registering Your Tesla C2050 Computing Board	23
Warranty and Support	23
Compliance and Certifications	25

01 INTRODUCTION

The NVIDIA® Tesla™ C2050 Computing Processor transforms your workstation to a personal supercomputer by offering unprecedented computing capabilities at 1/10th the cost of a conventional CPU-only workstation. The NVIDIA Tesla C2050 Computing Processor supports “must have” features for technical and enterprise computing, including C++ support, ECC memory for uncompromised accuracy and scalability, and 7X the double precision performance compared to Tesla 10-series GPU computing products.

About This Guide

This installation guide discusses the installation and configuration of the Tesla C2050 Computing Processor.

01

Minimum System Requirements

Prior to unpacking your new Tesla C2050, confirm that your system meets all the system requirements for a smooth installation.

> Operating System

- Microsoft Windows XP, Vista, Windows 7 (32-bit or 64-bit)
- Linux 32-bit and 64-bit on:
 - Redhat Enterprise Linux 3.x, 4.x, 5.x
 - SUSE Linux Enterprise Desktop 11 and 10
 - OpenSUSE 11.1, 11.0, 10.3, 10.2, 10.1
 - Fedora 10, 9, 8, 7
 - Ubuntu 9.04, 8.10, 8.04, 7.10, 7.04

> Processor

- Intel Pentium 4 or Xeon processor or higher
- AMD Athlon processor or higher

> RAM

- 1 GB minimum, 4 GB recommended per Tesla C2050

> Graphics

- Single DVI-I Dual Link

> PCI Express Slot

- PCI Express x16 slot, Gen2 recommended but not required

> Power Consumption

- 247 W maximum power consumption
- Power supply in the workstation typically need to have one 8-pin power connector and one 6-pin power connector. Certain power supplies may only need to have one 8-pin power connector. (Please check with your system vendor for the power supply specifications)

02 UNPACKING

Be sure to inspect each piece of equipment. If anything is missing or damaged, contact your supplier.

Equipment

The following equipment is included in the Tesla C2050 box.

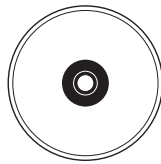

Installation CD

Contains this file (installation guide) and all the necessary drivers to enable the Tesla C2050. To keep your drivers current, visit www.nvidia.com to download the latest drivers.

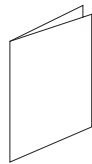

Quick Start Guide

Contains basic hardware and software installation instructions. Read carefully, and refer to the Installation Guide on the CD for full installation instructions and troubleshooting.



Registration Card

Register to gain priority access to online and phone support. Take time to follow the instructions on this card to register your product to take advantage of customer support and warranty.

Tesla C2050 GPU Computing Processor

Installs into the PCI Express x16 slot in your computer.

02

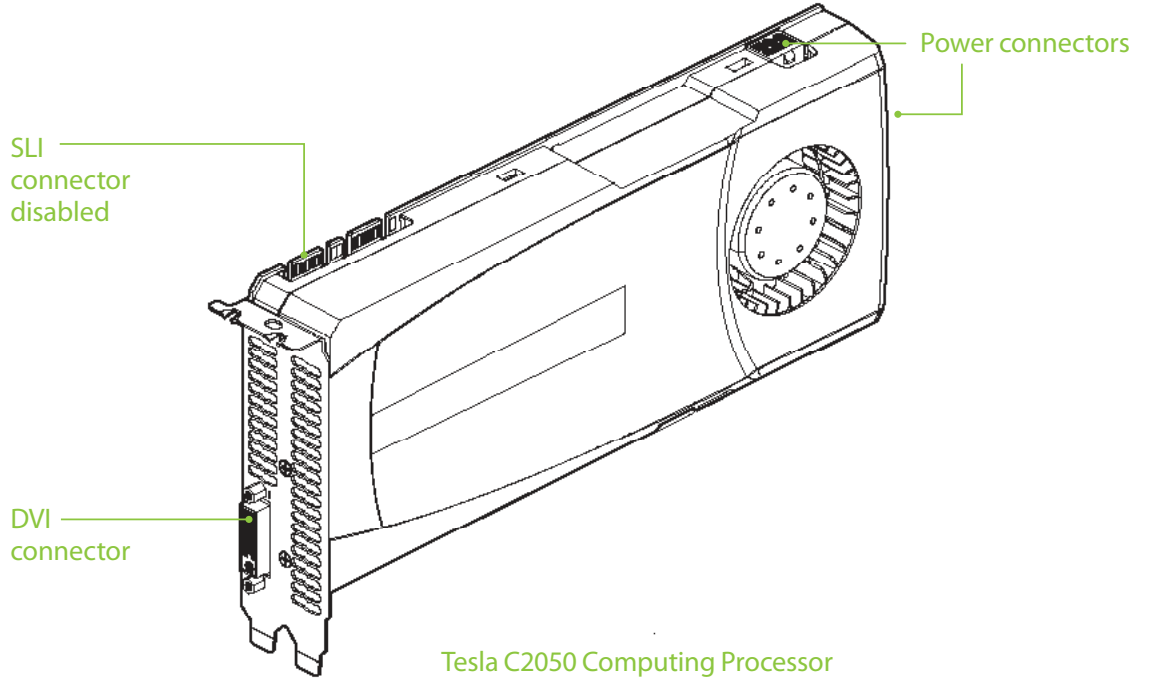

03

HARDWARE INSTALLATIONS

Installing the Tesla C2050 hardware involves opening up your computer.



Note: All hardware must be installed prior to installation of the drivers.

Before You Begin

If you have an NVIDIA graphics solution, either as a discrete card or as on-board graphics on your motherboard, you will need to uninstall the NVIDIA graphics software driver before installing your Tesla card.



Note: This does not apply to Linux based systems. It only applies to Windows based systems.

Tesla C2050 Installation

A computer system with an available PCI Express ×16 slot is required for the Tesla C2050. For the best system bandwidth between the host processor and the Tesla C2050, it is recommended (but not required) that the Tesla C2050 be installed in a PCI Express ×16 Gen2 slot.

Because there are so many different computer systems on the market, the installation procedure for the Tesla C2050 can vary from system to system. Use the following instructions as a guideline and consult the documentation for clarification of computer specific procedures.

03

 Note: It is important that all power to the computer be removed (unplugged) before you install the computing board. You must also discharge your body's static electricity before handling sensitive components. Simply touch a grounded surface before beginning.

 Note: To simplify reconnections, label cables as they are disconnected.

- 1 Turn off your computer and monitor and disconnect the power cord at the outlet or at the back of your system (depending on the system).
- 2 Open your computer chassis (refer to your system documentation for details).
- 3 Remove the slot bracket for the two adjacent slots, if they are still covered. The Tesla C2050 computing board is a dual-slot board and will take up two (2) slots. Save any hardware (such as screws) to use to anchor the Tesla C2050 computing board after it is seated properly. rail installation.

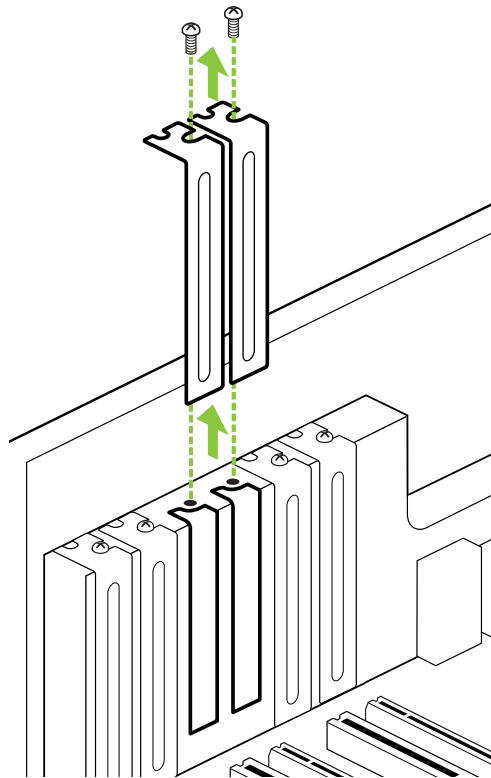

The Tesla C2050 requires two PCI Express x16 slots.

- 4 Connect the 8-pin power connector and the 6-pin power connector from the power supply to the 8-pin and 6-pin power connectors on the board. If the power supply is capable, one 8-pin power connector may be sufficient. (Please check with your power supply vendor).
- 5 Reinstall the computer cover and any cables that were removed earlier.

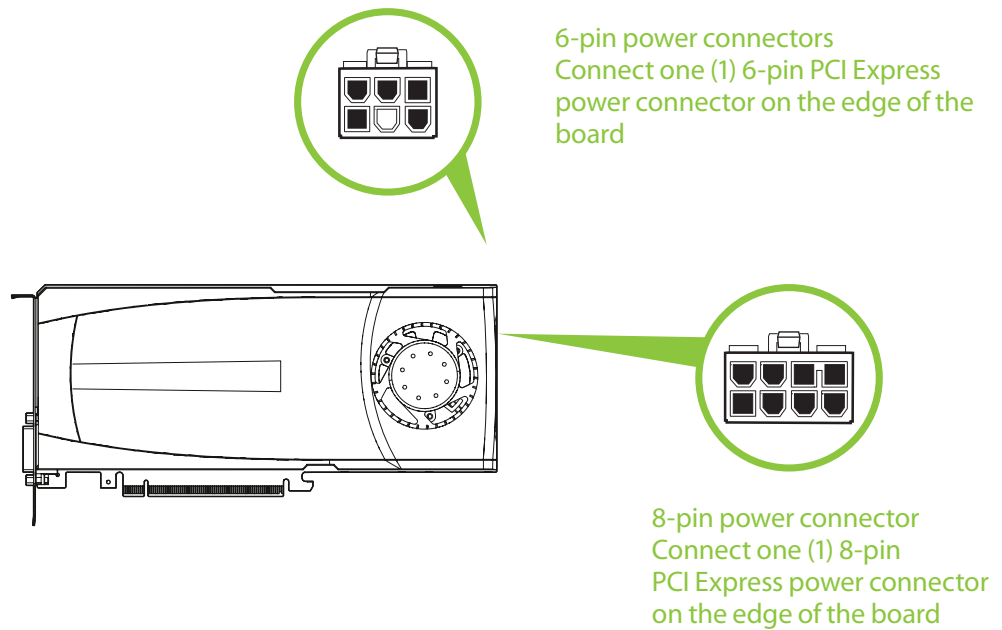

Note: If you are using one 8-pin power connector, you must ensure that the power supply can drive enough power through the 8-pins to the power connector.

03

04

DRIVER INSTALLATION

This section contains the instructions to install the software drivers within a Windows environment or within a Linux environment.

Windows Installation

The required software for the Tesla C2050 includes the CUDA drivers, which should also serve as the driver for the NVIDIA discrete or on-board graphics processor. While driver installation may be carried out using the enclosed installation CD, it is recommended that the customer download the most recent drivers available at www.nvidia.com.



Note: Use only drivers that are designated to support Tesla C2050. Not all NVIDIA graphics drivers support the Tesla C2050.

04

- 1 Power up your computer
- 2 Click Cancel each time the Windows Found New Hardware Wizard window displays. It will display one or more times.



- 3 Insert the installation CD for the drivers included in the Tesla C2050 package. Follow instructions in the installer package.
- 4 Right-click on the CD driver and select AutoPlay or explore the files on the CD and double click Launch.exe if it does not begin to auto play.

- 5 Click Install Latest Driver from the Tesla C2050 Software screen.



- 6 On the NVIDIA driver download site, select Tesla C2050 product and the appropriate OS for your system.
- 7 Click Run and follow directions.
- 8 Select I accept the terms of the license agreement.
- 9 Click Next.



04

- 10 Click Next when the Welcome to the InstallShield Wizard window displays.

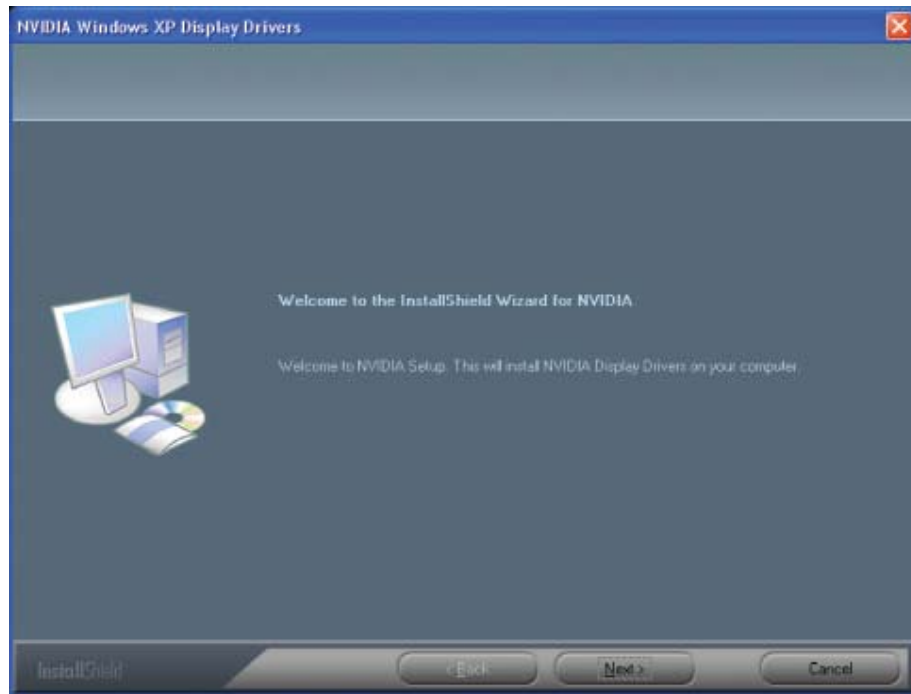

- 11 Click Continue Anyway when the Hardware Installation warning window displays.



This warning tells you that the drivers you are about to install have not passed the windows logo testing (WHQL). WHQL is a Microsoft testing procedure that is required before Microsoft approves the software. Clicking Continue Anyway will not harm your system.

- 12 Select Yes, I want to restart my computer now.
- 13 Click Finish to complete the installation and restart your system.

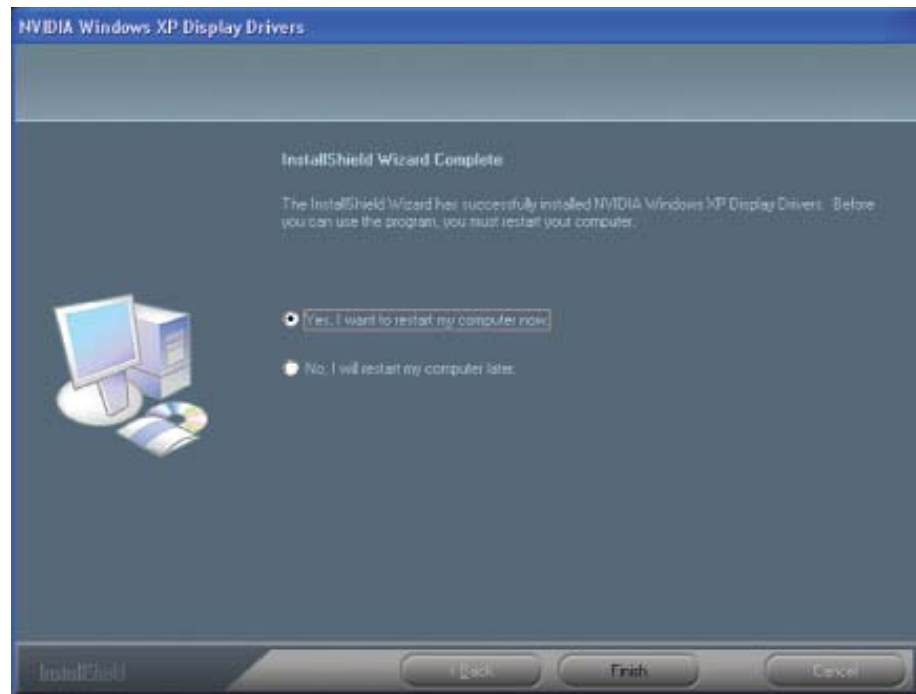

04

Control Panel Setup

- 1 Select Standard or Advanced views depending on your preference for the Control Panel view selection. The Advanced view allows the user to select and modify application profiles through the control panel.

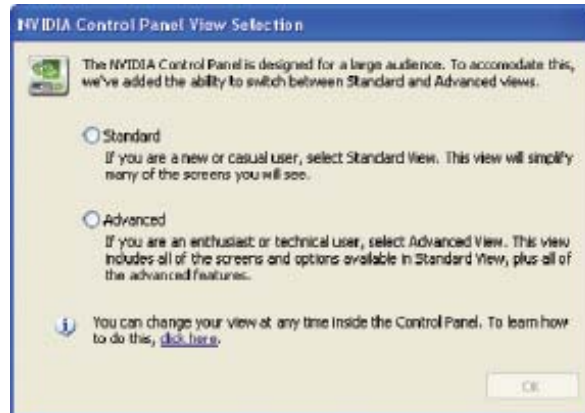

- 2 Select Do not enable SLI technology Configuration settings are application-dependent so you will need to configure SLI after the Tesla C2050 software has been installed and you have verified proper operation. Visit www.nvidia.com for application configuration information.

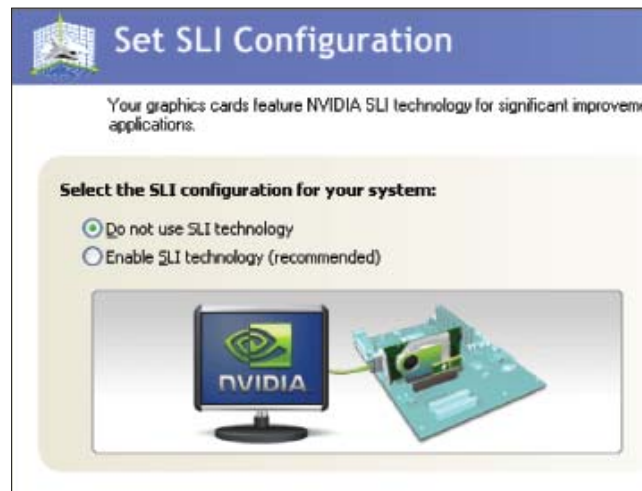

Once you have the computing board installed and verify it is functioning, you can customize setting for your particular application. Visit www.nvidia.com for information particular to your application.

Verifying Windows Installation

It is recommended that you verify your installation by going to the NVIDIA Control Panel and verifying that the boards have been installed correctly and are recognized by the drivers.

Use the following procedure to verify the installation of the boards:

- 1 Go to Start > Control Panel.
- 2 Select NVIDIA Control Panel.
- 3 Go to Help > System Info in the menu bar
- 4 Select Display tab.
- 5 Highlight the Tesla C2050 in the list of components.

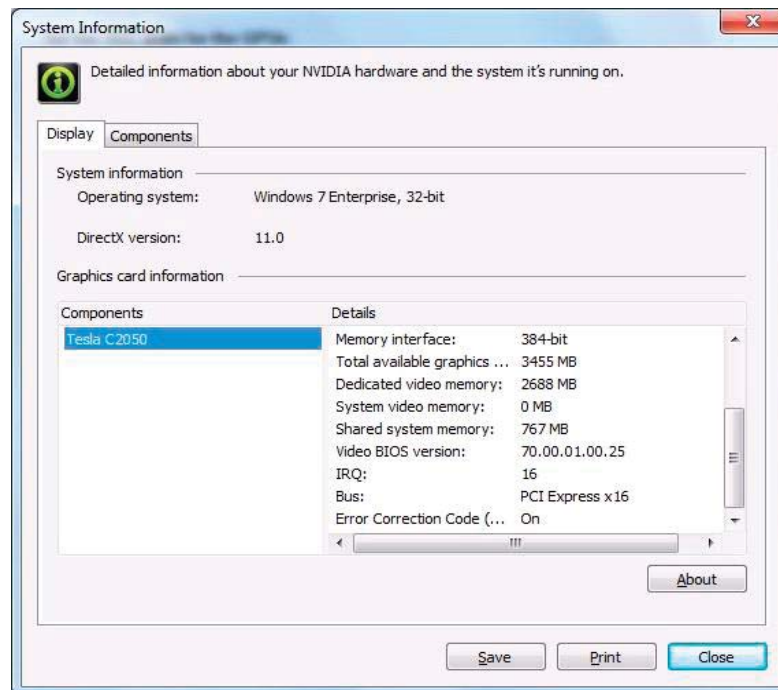

04

Linux Installation

While driver installation may be carried out using the enclosed installation CD, it is recommended that the customer download the most recent drivers available at www.nvidia.com

Before you begin the installation, you should exit the X server and close all OpenGL applications (it is possible that some OpenGL applications persist even after the X server has stopped). You should also set the default run level on your system such that it will boot to a VGA console and not directly to X. Doing so will make it easier to recover if there is a problem during the installation process.

- 1 Download the 32-bit or 64-bit Linux driver (the driver will have a similar naming convention as NVIDIA-Linux-x86-100.14.11-pkg1.run or NVIDIA-Linux-x86_64-100.14.11-pkg2.run).
- 2 Change to the directory containing the downloaded file.
- 3 Run as root the NVIDIA-Linux*.run file downloaded in Step 1.
As the root user you can run the following executables:
`cd download_directory`
NVIDIA-Linux-x86-xxx-xx-xx.run or NVIDIA-Linux-x86_64-xxx-xx-xx.run
The NVIDIA-Linux*.run file is a self-extracting archive. When executed, it extracts the content of the archive and runs the contained nvidia-installer utility, which provides an interactive interface to walk you through the installation.
nvidia-installer will also install itself to /usr/bin/nvidia-installer which may be used at some later time to uninstall drivers, auto download updated drivers, etc.

4 Select Accept to accept the License Agreement.

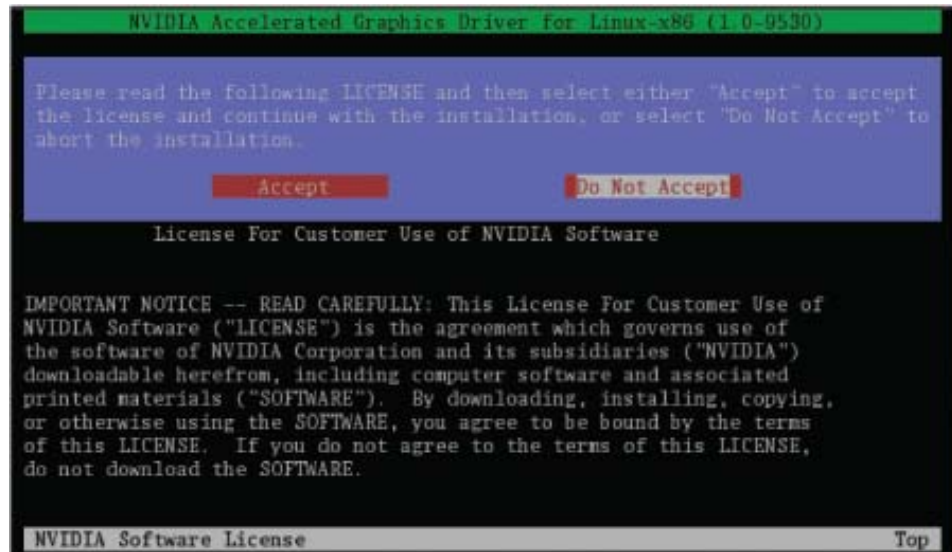

5 Select Yes if a warning window displays indicating that there are drivers already installed. Selecting Yes tells the installation process to overwrite the previously installed drivers.

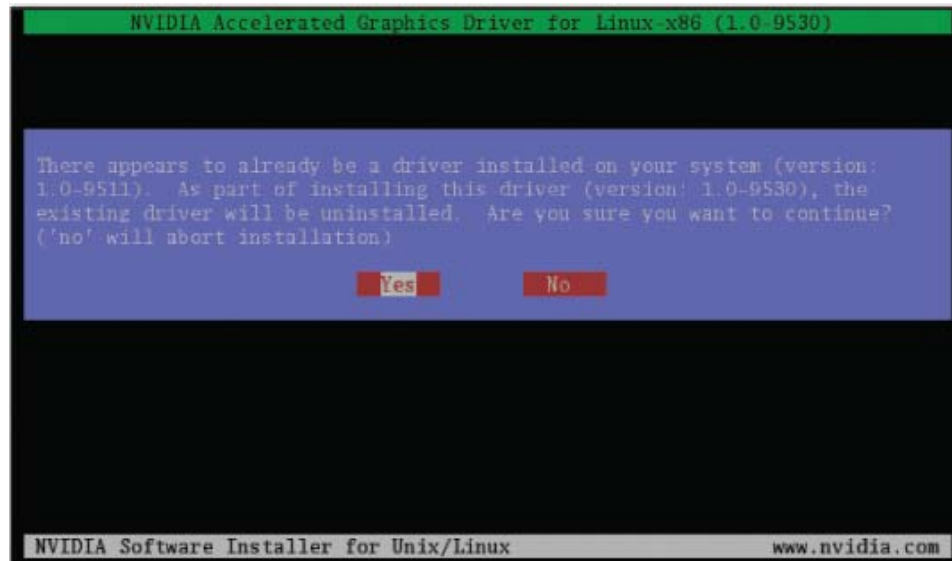

04

- 6 Select Yes when the Kernel Interface window displays.
When the installer is run, it will determine if it has a precompiled kernel interface for the kernel you are running. If it does not have one, it will check if there is one on the NVIDIA FTP site and download it.

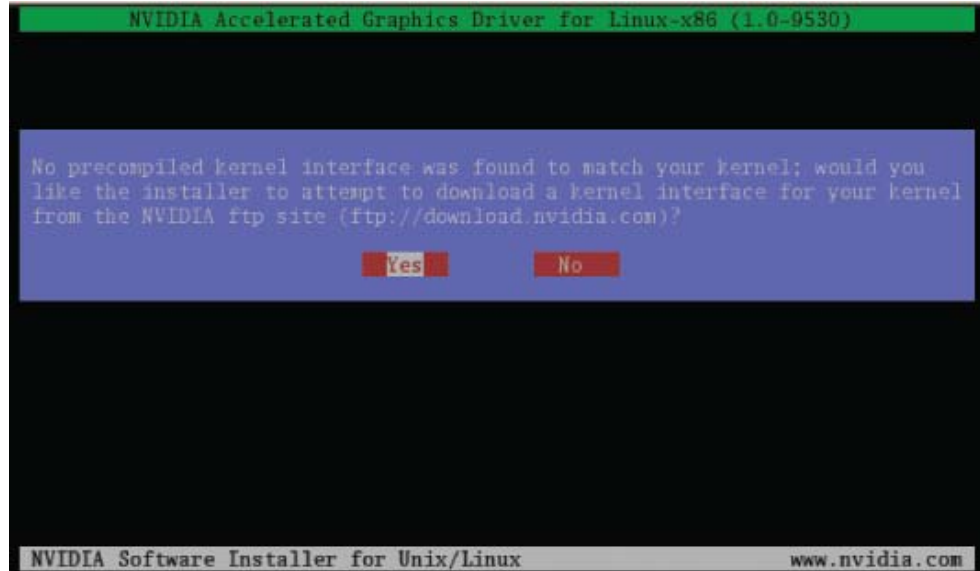

- 7 Select OK to compile a kernel interface.
If a kernel interface cannot be downloaded, either because the FTP site cannot be reached or because one is not provided, the installer will check your system for the required kernel sources and compile the interface for you. You must have the source code for your kernel installed for compilation to work. On most systems this means that you will need to locate and install the correct kernel source, kernel headers or kernel development package.

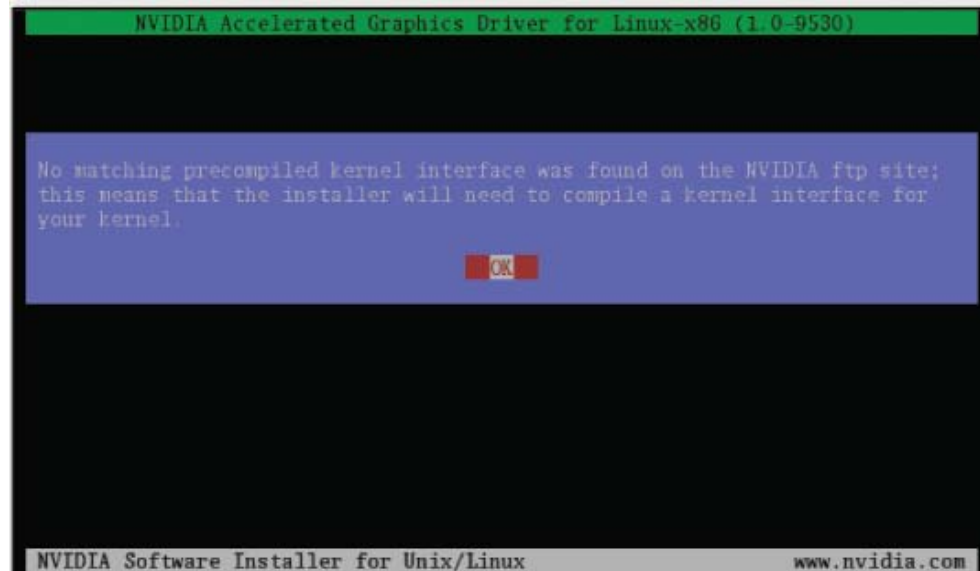

Linking of the kernel interface (in the case that the interface downloaded or compiled at installation) required you to have a linker installed on your system. The linker, usually `/usr/bin/ld`, is part of the `binutils` package. If a precompiled kernel interface is not found, you must install a linker prior to installing the NVIDIA driver.

- 8 Run `nvidia-xconfig` utility.
`nvidia-xconfig` will find the X configuration file and modify it to use the NVIDIA X driver. In most cases, you can answer Yes when the installer asks if it should run it. If you need to reconfigure your X server later, you can run `nvidia-xconfig` again from a terminal. `nvidia-xconfig` will make a backup copy of your configuration file before modifying it.
- 9 Installation is complete.



Note: The X server must be restarted for any changes to its configuration file to take effect.

More information about `nvidia-xconfig` can be found in the `nvidia-xconfig` manual page by running:

```
% man nvidia-xconfig
```

Verifying Linux Installation

- 1 Run `nvidia-settings` to displays the Server Settings window.
- 2 Verify here that the installation is correct and working.

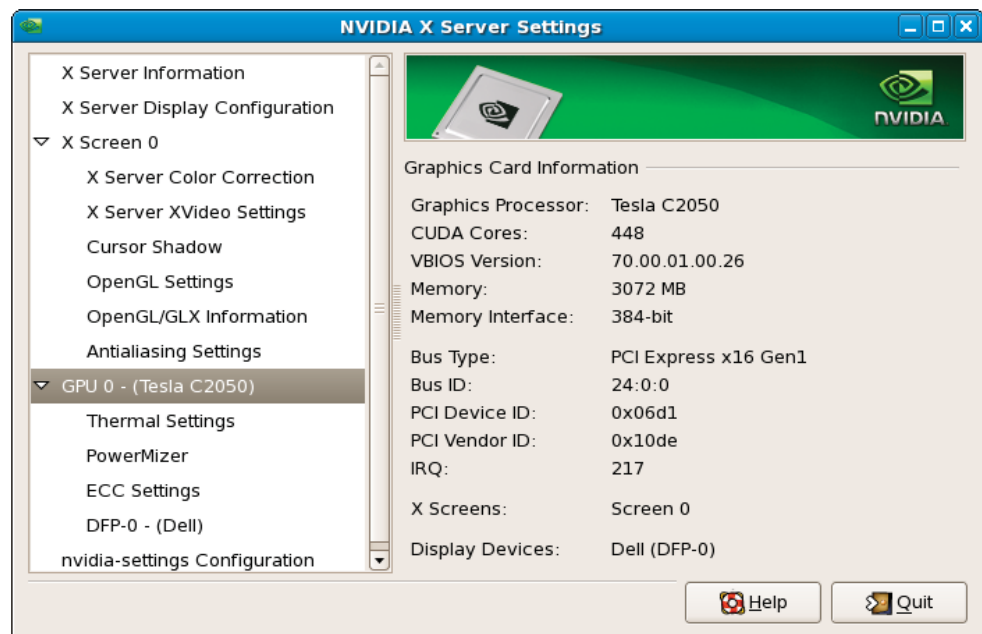

04

REFERENCES AND RESOURCES

Getting Driver Updates

During NVIDIA software installation, the installation wizard provides an option to check for updated software online. You can also download software updates by visiting: www.nvidia.com.

05

REGISTRATION, WARRANTY, AND SUPPORT

Registering Your Tesla C2050 Computing Board

Registering your Tesla C2050 computing board, gives you priority access to the NVIDIA Customer Care support center. Once you have completed registration, you will be given a user ID and password for online customer care. You can also elect to receive automatic notification of special promotions and software updates through email to ensure that your Tesla C2050 computing board continues to operate optimally.



Warranty and Support

The Tesla C2050 is covered by a 36 month warranty.

For support, visit the Customer Care Center at www.nvidia.com/support. The Web site offers access to a broad range of product information.



COMPLIANCE AND CERTIFICATIONS

- > Bureau of Standards, Metrology, and Inspection (BSMI)
- > C-Tick
- > China Compulsory Certification (CCC)
- > Conformité Européenne (CE) 
- > Federal Communications Commission (FCC) - Class B 
- > Interference-Causing Equipment Standard (ICES)
- > Ministry of Information and Communication (MIC)
- > Underwriters Laboratories (UL, CUL) 
- > Voluntary Control Council for Interference (VCCI)

Notice

ALL NVIDIA DESIGN SPECIFICATIONS, REFERENCE BOARDS, FILES, DRAWINGS, DIAGNOSTICS, LISTS, AND OTHER DOCUMENTS (TOGETHER AND SEPARATELY, "MATERIALS") ARE BEING PROVIDED "AS IS." NVIDIA MAKES NO WARRANTIES, EXPRESSED, IMPLIED, STATUTORY, OR OTHERWISE WITH RESPECT TO THE MATERIALS, AND EXPRESSLY DISCLAIMS ALL IMPLIED WARRANTIES OF NONINFRINGEMENT, MERCHANTABILITY, AND FITNESS FOR A PARTICULAR PURPOSE.

Information furnished is believed to be accurate and reliable. However, NVIDIA Corporation assumes no responsibility for the consequences of use of such information or for any infringement of patents or other rights of third parties that may result from its use. No license is granted by implication or otherwise under any patent or patent rights of NVIDIA Corporation. Specifications mentioned in this publication are subject to change without notice. This publication supersedes and replaces all information previously supplied. NVIDIA Corporation products are not authorized for use as critical components in life support devices or systems without express written approval of NVIDIA Corporation.

Trademarks

NVIDIA and the NVIDIA logo are trademarks or registered trademarks of NVIDIA Corporation in the United States and other countries. Other company and product names may be trademarks of the respective companies with which they are associated.

Copyright

© 2010 NVIDIA Corporation. All rights reserved.

