

RF23A9675AP

SAMSUNG

BESPOKE 4-Door Flex Counter-Depth Refrigerator 22.8 cu. ft.



Signature Features

Customizable Door Panels

Customize the design of your refrigerator with changeable colour door panels. Choose from 8 colours and 2 finishes to create a space that fits your style – the options are endless.

Beverage Center

Quick access to refreshingly cool, filtered water two ways. Choose from an internal dispenser or a built-in pitcher that automatically refills, with the option to infuse with a flavour.

Dual Ice Maker with Ice Bites

Be prepared for any occasion with two different types of ice. The Dual auto ice maker makes both cubed ice and ice bites.

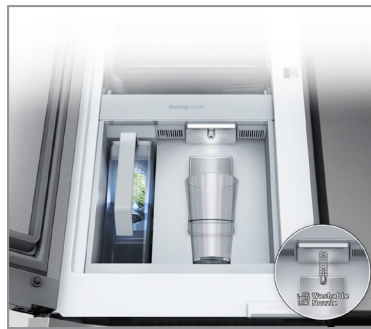

Beverage Center™ with
AutoFill™ Water Pitcher



Dual Ice Maker with Cubed Ice
and IceBites™

BESPOKE Panel Colour Selection



Design

- Customizable Door Colours
- Beverage Center
- Modern Design
- LED Lighting

Technology

- Dual Ice Maker with Ice Bites and Cubed Ice
- UV Deodorizing Filter
- Wi-Fi Enabled

Performance

- FlexZone™
- FlexCrisper
- Triple Cooling

Rating



- ENERGY STAR® - Rated
- Energy Consumption (annual) = 634 kWh/yr

RF23A9675AP

SAMSUNG

BESPOKE 4-Door Flex Counter-Depth Refrigerator 22.8 cu. ft.

Installation Specifications

1. Measure the height, width and depth of the opening, making sure to include baseboards, molding tile, countertop overhang, etc. Check to be sure there is enough room to open the door (consider walls, islands or other obstacles when measuring).
2. Refer to illustration below to determine dimensions.
3. Allow $1\frac{1}{8}$ " of clearance on hinge side of refrigerator when installing next to a wall where door may make contact.
4. Allow 2" minimum clearance at rear for proper air circulation and water/electrical connections. Allow a $\frac{3}{8}$ " minimum clearance at sides and top for ease of installation.
5. Ensure each door and entryway in the home is wide enough for the refrigerator to be moved through easily.

For optimal usage and to be able to open refrigerator doors completely, do not install next to a wall.

Please note: The following dimension and cutout information is for planning purposes only. For complete installation details, consult manual packed with product, or download manual online at samsung.com.

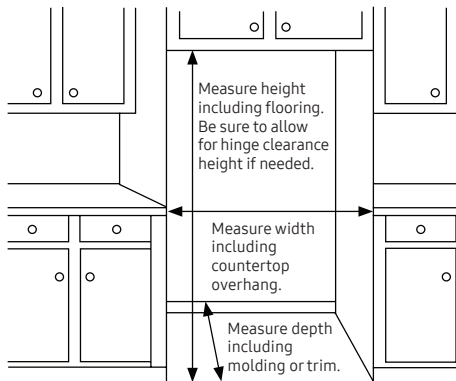

Dimensions

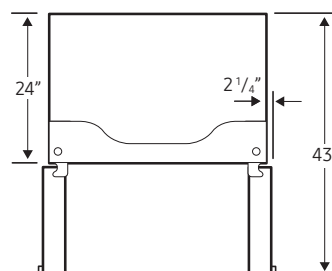
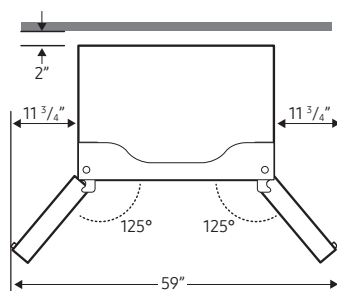
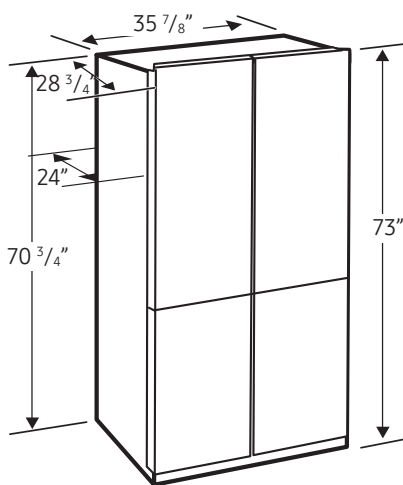

Total Capacity: 22.8 cu. ft.

Refrigerator: 14.0 cu. ft.

- 4 Tempered Glass Spill-Proof Shelves
- 2 Clear Drawers: FlexCrisper and Crisper+
- 6 Door Bins
 - Right: 1 Gallon Bin, 2 Regular Bins
 - Left: 1 Gallon Bin, 2 Regular Bins
- LED Lighting

Freezer: 8.8 cu. ft.

- Dual Ice Maker in Freezer (Cubed Ice or Ice Bites)
 - 2 Ice Buckets with Cover and 1 Scoop
- 3 Slide-Out Shelves
- 2 Clear Drawers
- 6 Door Bins
- LED Lighting

Accessories

Water Filter: HAF-QIN

Volt/Amps	115V / 60Hz / 3.5A
Power Cord Length	2 meters

Warranty

One (1) Year Parts and Labour on Refrigerator
Ten (10) Years Parts on Digital Inverter Compressor

Product Dimensions & Weight (WxHxD)

Dimensions (WxHxD with hinges, handles and doors):

$35\frac{7}{8}$ " x 73 " x $28\frac{3}{4}$ "

Dimensions (WxHxD without hinges and door):

$35\frac{7}{8}$ " x $70\frac{3}{4}$ " x 24 "

Dimensions (WxHxD with hinge and door, no handle):

$35\frac{7}{8}$ " x 73 " x $28\frac{3}{4}$ "

Weight: 317.5 lbs (144 kg)

Shipping Dimensions & Weight (WxHxD)

Dimensions: $38\frac{1}{4}$ " x $78\frac{5}{8}$ " x $31\frac{1}{4}$ "

Weight: 339.5 lbs (154 kg)

Style

Counter-Depth
Standard-Depth

Model

RF23A9675AP/AC
RF29A9675AP/AC

UPC

887276593159
887276593203