

TINY AUDIO C10

Digital Audio Adapter

User Guide

Table of Content

INTRODUCTION.....	1
CONTENTS OF PACKAGE	2
OVERVIEW OF THE CONTROLS AND CONNECTORS.....	3
INSTALLATION.....	4
Securing TINY AUDIO C10, Step by Step.....	7
Antenna Installation.....	8
Installation, Do and Don't	13
Main microphone Installation	14
OPERATION CONTROLS.....	15
STARTING UP THE SYSTEM.....	18
USING DAB ADAPTER.....	19
To Turn On or Off TINY AUDIO C10	19
To Scan for the DAB Stations	19
To Listen to the DAB Stations.....	19
To Change DLS/DL+ Information Display	20
To Save a Memory Preset	20
To Recall a Memory Preset	21
To Recall the Last Listened DAB Station.....	21
USING AUDIO STREAMING	23
To Set the Bluetooth Audio Input mode.....	23
USING HANDS FREE FUNCTION	24
To Receive Incoming Call.....	24
To Make Outgoing Call.....	24
FM TRANSMITTING FREQUENCY SETTINGS	25
To Display the current FM Transmitting Frequency	26
To Set FM Transmitting Frequency in AFC Mode.....	26
To Set FM Transmitting Frequency Manually	26
To Save a Desired FM Transmitting Frequency in Memory.....	26
To Recall FM Transmitting Frequency Saved in Memory	27
To Force Immediate FM Transmitting Frequency Change.....	28
To Set FM Transmitting Frequency Setting to Preset F1	28
To Reset FM Transmitting Frequency Setting	28
MENU SETTINGS	30
To Enable DLS/DL+ Display.....	30
To Set DAB Sorting Order	30
To Enable Bluetooth.....	31
To Setup Bluetooth Pairing.....	31
To Display Bluetooth Information.....	32
To Reset Bluetooth Pairing.....	32
To Enable AFC (Automatic Frequency Change)	32
To Enable AutoScan.....	34
To Enable RC Beep Tone.....	35
To Set Antenna Power	35
To Perform DAB List Reset	36

To Restore to Factory Settings	36
To Upgrade Module Software	36
To Display Software Version	37
TROUBLESHOOTING	38
TECHNICAL SPECIFICATIONS.....	40
INFORMATION ON WASTE DISPOSAL	41



INTRODUCTION

The TINY AUDIO C10 is an in-car digital audio adapter that offers a flexible and cost effective way to apply modern digital audio technology to your existing analogue in-car audio system.

The existing analogue system can be easily upgraded to receive digital signal without replacement of any component of the car audio system. TINY AUDIO C10 support the Hands free function and caller ID display for the incoming call to the Bluetooth connected mobile device, and receive the digital signal from the audio streaming from a mobile device using the Bluetooth technology and the DAB digital radio service output from the DAB antenna, and convert the digital signal to an FM signal. The FM signal is then transmitted on a FM frequency and listen through the in-car audio system.

The TINY AUDIO C10 is operated using a remote controller, while all messages related to the system's operations, such as service name, memory preset, etc., are converted to RDS text and displayed on the LCD screen of your in-car audio system; also, TINY AUDIO C10 uses FM-RDS micro-transmitter and no complex cabling to your car audio system. These flexible configuration options of the TINY AUDIO C10 make it easy to install in different car makes and models.

Furthermore, TINY AUDIO C10 has an AFC (Automatic Frequency Change) function that allows you to continuously listen to your favorite DAB programs thru your car radio system without the need to change the FM frequency manually when you drive into a metropolitan area where FM stations are highly crowded. Consult your car radio manual or the car dealer if your car radio is RDS compatible, has the AF (alternative frequency) function, and how to enable AF function before using this AFC function. If AF function is not built in your car radio, you can use TINY AUDIO C10's AutoScan function instead.

Note:

TINY AUDIO C10 needs to operate with an RDS car radio in order to properly display the relevant system message of TINY AUDIO C10 via the in-car radio display.

CONTENTS OF PACKAGE

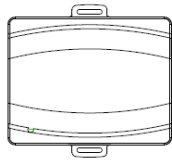

TINY AUDIO C10 unit



Remote Control
with CR2032 Battery



Power cable
with cigarette lighter

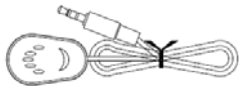

Microphone with
Cable

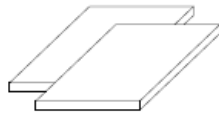

Dual Lock Tapes x3



Screw x2

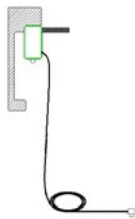

DAB Antenna

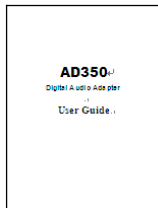

User Guide

OVERVIEW OF THE CONTROLS AND CONNECTORS

Front Panel

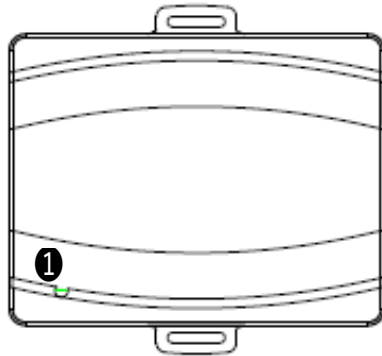

- ① LED

Left Side Panel

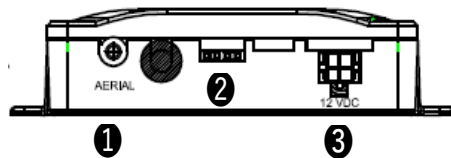

- ① SMB Connector, for DAB antenna
- ② SW update cable connector
- ③ Power Jack, for power cable with Cigarette Lighter plug

Right Side Panel

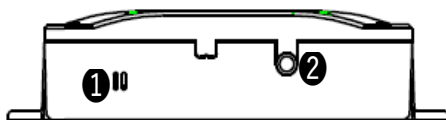

- ① Auxiliary microphone
- ② Main microphone cable connector

INSTALLATION

Please read the installation procedure carefully prior to the actual installation. Consult a professional installer if you have any issues or concerns with the installation.

ATTENTION

1. We recommend that if you are going to use the cigarette lighter as the power source for TINY AUDIO C10, the lighter socket needs to connect to the ignition.
 2. Otherwise, you may have the following condition, after the car engine is turned off:
 - TINY AUDIO C10 will continue to draw minimal power from the battery.
 - For many intelligent new cars, TINY AUDIO C10 may be detected as device not disconnected.
 3. Car radio and TINY AUDIO C10 may become out of sync when you resume to listening to TINY AUDIO C10. In this case, please read the troubleshooting section for the solution.
-
1. Select a location to store TINY AUDIO C10. For the best performance, please store it in the middle and under the car's glove compartment. For other locations, please store it away from metal objects and in an open area.
 2. Store TINY AUDIO C10 with the bottom cover up, and with the antenna cable, power cable, and connectors point to the back.

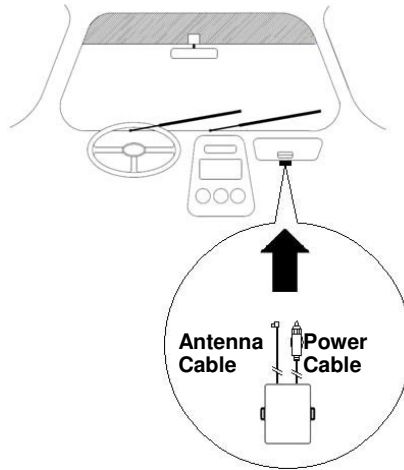

3. Secure TINY AUDIO C10 with the supplied dual lock tapes and screws. Please refer to the installation section on *Securing TINY AUDIO C10, Step by Step*.
4. Install the DAB antenna; please refer to the installation section on *Antenna Installation*.

ATTENTION

1. We have fully tested DAB Antenna, if supplied, to work with TINY AUDIO C10. If you use a third party's DAB antenna, the performance may suffer.
2. For TINY AUDIO C10 to work with the active antenna, the antenna power must be set to ON; for TINY AUDIO C10 to work with a passive antenna, the antenna power must be set to OFF.
3. Anytime you need to disconnect/connect the antenna from TINY AUDIO C10, please unplug TINY AUDIO C10 from the cigarette lighter first to avoid possible damage to the antenna.
4. Damage resulted from incorrect installation of the antenna is not covered by the warranty.

5. Minimize coiling loops of excessive power cable and antenna cable, and do not secure them on TINY AUDIO C10. Please refer to the installation section on *Installation do and don't*.
6. Install the main microphone cable; please refer to the installation section on *Main microphone installation*.

7. Plug one end of the power cable into TINY AUDIO C10's SMB connector, and the cigarette-lighter plug into car's cigarette lighter.
8. Start using TINY AUDIO C10 with the remote control; please refer to the sections on *OPERATION CONTROLS* and *STARTING UP THE SYSTEM*.

Securing TINY AUDIO C10, Step by Step

To secure TINY AUDIO C10 on a chosen store location using the supplied dual lock tapes and/or screws, do the following:

1. Locate the positions on the back of TINY AUDIO C10 and the chosen store location (e.g. in the middle and under the car's glove compartment) where you want to apply the dual lock tapes.

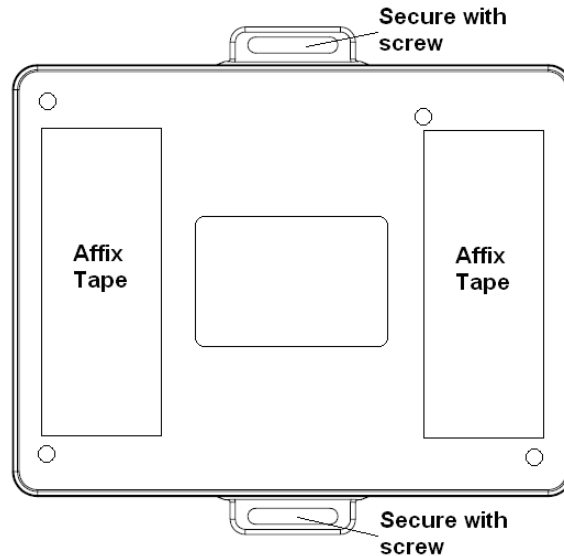

2. Clean both surfaces, the affix tape positions on TINY AUDIO C10 and the chosen store location, with alcohol if available and wipe dry before you start.
3. Remove one side of the backing from each of the two pieces of dual lock tapes, and adhere the tapes onto the back of TINY AUDIO C10 on the marked positions in 1.
4. Remove the other side of the backing and adhere TINY AUDIO C10 to the chosen store location with TINY AUDIO C10's cables and connectors to the back.
5. Carefully, remove TINY AUDIO C10 from the store location with dual lock tapes separated, so that TINY AUDIO C10 and store location each has 2 half pieces of the tapes.
6. Apply the pressure evenly to all 4 half pieces on TINY AUDIO C10 and the store location, so that the tapes adhere to both surfaces securely.
7. Wait 8 hours, and then adhere TINY AUDIO C10 to the store location by joining the 4 half pieces of the tape together.
8. Alternatively, or in addition, secure TINY AUDIO C10 with the supplied screws.

Antenna Installation

Overview

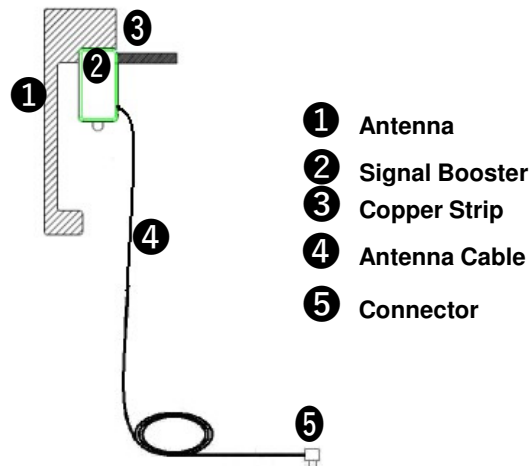

Warning:

1. Please read the Antenna Installation section carefully prior to the actual installation.
2. This glass-mount DAB antenna is exclusively for use inside the vehicle.
3. It is not suitable for use on reflective-coated glass.
4. Do not bend or damage the Antenna.
5. This DAB antenna is to be installed on either side of the front windshield only.
6. The vehicle's DAB receiver must provide a phantom power to the connector for the DAB antenna.
7. Once the DAB antenna is adhered to the windshield it can not be relocated. Please test and fit the antenna in its location before removing the adhesive separator and permanently fixing it to the windshield. The antennas that have been adhered in location are not valid for return and warranty claims.

Procedure

1. Pre-Installation

The glass-mount antenna must be placed on the top corner and on the either side of the front windshield. Before installing, consider the following important reception and installation factors when you choose the location.

1.1 UV protection layer

If there is a UV protection layer across the top of the windshield then you must place the DAB antenna with the Antenna at least 5cm below the layer.

1.2 Windshield wiper

For the best performance in the digital reception, the glass-mount antenna must be placed outside of the swept area of the windshield wiper.

Right Mount

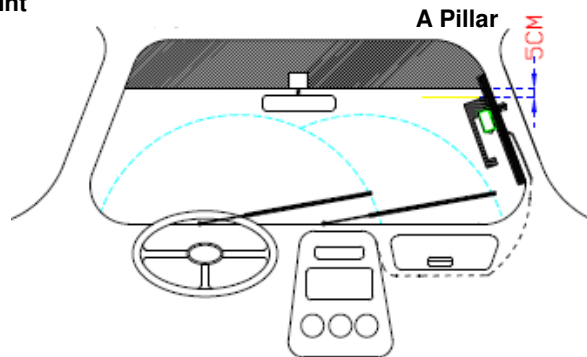

Left Mount

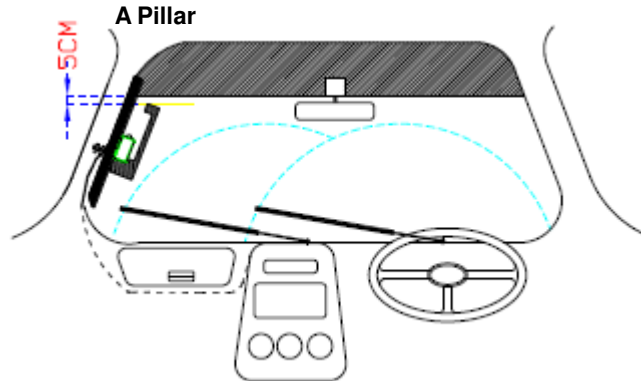

1.3 A Pillar and Windshield

The windshield usually has a black enamel band along the edges that contains a border of dots and a black-shade area, the Signal Booster is to be installed next to the dotted area along the side of the windshield. Open the A Pillar cover; the remaining parts of the DAB antenna are to be installed on the metal frame and inside the A Pillar cover.

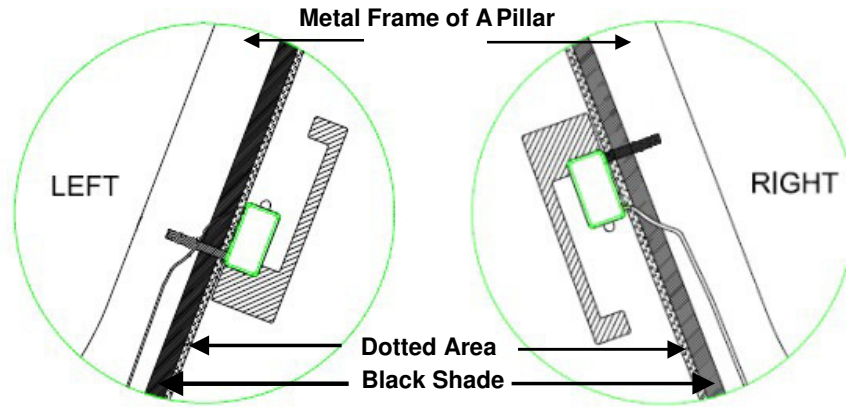

1.4 Fit the DAB antenna

As the DAB antenna is designed to be attached once only, if the DAB antenna is removed, it will not adhere again; therefore, it is recommended that you try fitting the DAB antenna on the chosen location first before attaching the antenna permanently.

- a. Fit the Antenna for a location according to 1.1 to 1.3 above.
- b. Mark the position of Signal Booster on the windshield for the

2. Permanent Installation

You should complete reviewing the pre-installation section and fit the antenna before you begin the permanent installation of this DAB antenna.

2.1 Clean the windshield

Ensure the chosen antenna location on the windshield is clean and free of dirt, water, and other substance which will help the antenna adhere to your car windshield properly. Clean the glass with alcohol prep pad, and wait until the surface is completely dry before attaching the glass-mount DAB antenna.

Note:

-  Do not use a cleaner with surfactant to clean the windshield because Antenna and the Signal Booster may not stick to the glass.

2.2 Installation Procedure

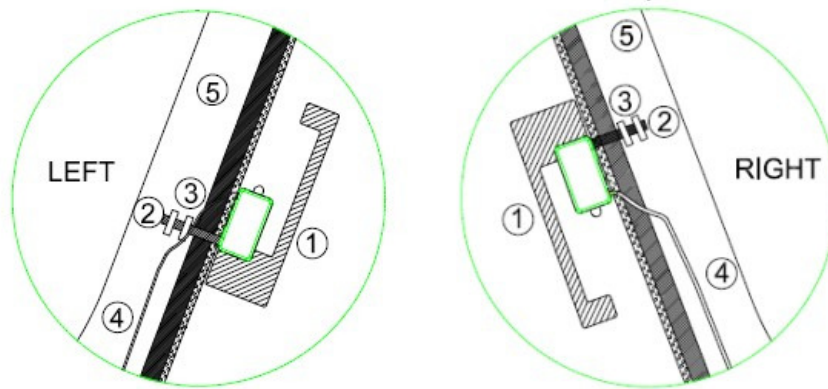

Steps:

- ✂ Open and remove APillar plastic cover.
- ✂ Mount the DAB antenna on the left or right side of the windshield.

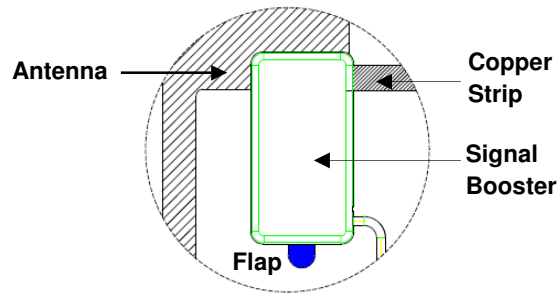

- ① **Attach the Signal Booster and Antenna**
Gently peel off the adhesive separator of the Signal Booster and Antenna; use the Flap to help peeling off a small portion of the adhesive separator on antenna fiber; also peel off a small portion of the adhesive separator on the Copper Strip. Then, press and bond the Signal Booster and Antenna to the marked location from pre-installation and on the inside of the front windshield. Ensure that the Signal Booster, Copper Strip, and Antenna are not distorted.
- ② **Attach the Copper Stripe**
Gently peel off the rest of adhesive separator of the Copper Stripe and paste it across the windshield to the metal frame of the A Pillar, press and smooth out the Copper Strip.

- ③ Secure the Copper Stripe
Secure the Copper Strip with sticky tapes on the metal frame.
- ④ Secure the Antenna Cable
Secure the antenna cable tightly down on the metal frame of the A-Pillar with sticky tapes.
- ⑤ Re-attach A Pillar cover
Re-attach the A Pillar cover with the antenna cable runs out of bottom of the cover.

- ✧ Route the antenna cable
Route the antenna cable from the bottom of the A-Pillar cover within the car interior to the DAB receiver, make sure the antenna cable does not interfere with the safe operation of steering wheel, air bags, and seatbelts or other equipment.
- ✧ Connect to the DAB receiver
 - a. Power off the DAB receiver.
 - b. Plug the Antenna Connector at the end of the antenna cable into DAB receiver's antenna input connector.
 - c. Power on the DAB receiver and start using your DAB receiver with the DAB antenna.

Note:

-  To achieve the best performance, Antenna must not be placed over a UV protection layer.

Installation, Do and Don't

As TINY AUDIO C10 has internal antenna and FM Transmitter, it is important to avoid signal interference from excessive cable coiling. Below are the do and don't when you coil and store TINY AUDIO C10's excessive antenna cable and power cable.

1. Do not tangle the antenna and power cables together.



2. Minimize coiling loops of excessive power cable or antenna cable, and do not secure them on or besides TINY AUDIO C10. The coiling loops of excessive power or antenna cables should start at about 10 cm away from the TINY AUDIO C10.

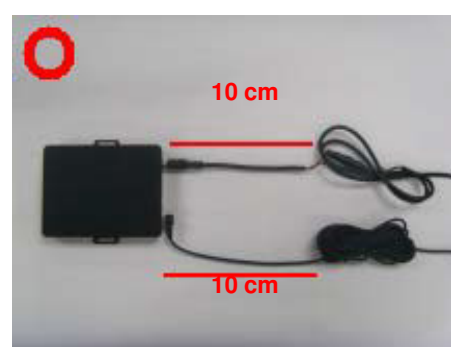

Main microphone Installation

TINY AUDIO C10 comes with an external microphone to be used for the Hands free function. To install the microphone, follow the diagram and procedure below. Once the microphone is installed and TINY AUDIO C10 is started, refer to the section on *USING THE HANDS FREE FUNCTION* to use the function.

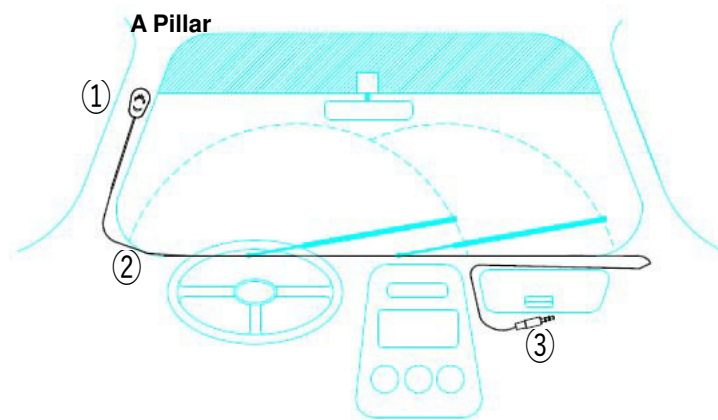

Steps:

- ① **Attach the microphone**
Gently peel off the adhesive separator on the backside of the microphone, then, press and bond the microphone onto the A-Pillar on the driver side as shown.
- ② **Route the microphone cable**
Route the microphone cable on top of the dashboard to the passenger side, then route the microphone cable to where TINY AUDIO C10 is installed – e.g. in the middle and under the car's glove compartment. Make sure the microphone cable does not interfere with the safe operation of steering wheel, air bags, and seatbelts or other equipment.
- ③ **Plug into TINY AUDIO C10**
Plug the end of the microphone cable into TINY AUDIO C10's main microphone cable connector.

OPERATION CONTROLS

In-Car Audio System LCD Display

The TINY AUDIO C10 unit is operated by using a remote controller; the system messages from the remote control operation are converted to RDS text and displayed as 8 characters display on the LCD screen of your in-car audio system.

Below is a list of TINY AUDIO C10 system messages displayed on the in-car audio system LCD display, while operating with the remote control:



Messages	Description
DABRADIO	■ Display after TINY AUDIO C10 is powered on.
<i>station name</i>	■ Display the 8-character short service name of the DAB station.
TUNING	■ Indicate tuning a DAB station is in progress.
RESETTING	■ Indicate performing a DAB reset or factory reset is in progress.
DONE	■ Confirm completion for certain system operation,
RETUNING	■ Indicate FM transmitting frequency is being tuned to a new frequency.
<i>TO frequency</i>	■ Indicate TINY AUDIO C10 is changing FM transmitting frequency to a new frequency from a manual setting.
<i>AF frequency</i>	■ Indicate TINY AUDIO C10 is changing FM transmitting frequency to a new frequency from the AFC function. Other than press and hold the BACK key, any remote control keys pressed is ignored before the change is completed.
POWEROFF	■ Display after TINY AUDIO C10 is turned off (into the standby mode).
RC LOW	■ Indicate remote control's battery is low, battery change is due.

Basic Remote Operation

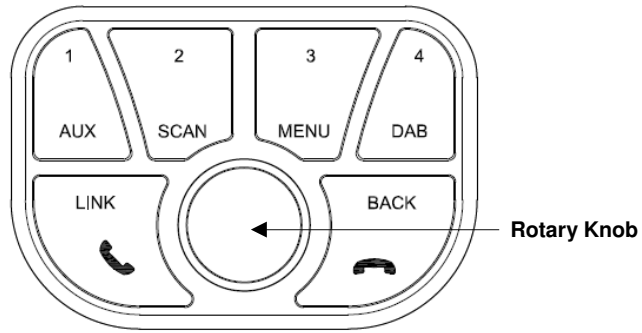
There are 6 control keys and a rotary knob on the remote control, press **Rotary Knob** and one of the four number keys to invoke the labeled function.



Control key	General operation
<p>Rotary Knob</p>	<p>Press</p> <ul style="list-style-type: none"> ■ Turn on TINYAUDIO C10 while it is off. ■ Confirm a selection. ■ Change DLS/DL+ information while listening to a DAB station. ■ Press and followed by DAB, AUX, SCAN or MENU to enter the selected function. ■ Toggle the control of play/pause while in the Bluetooth audio streaming mode. ■ Toggle to mute or un-mute the active phone call. <p>Rotate [◀] [▶]</p> <ul style="list-style-type: none"> ■ Step tune to select a DAB station. ■ Navigate to items, sub items, and settings in the menu function. ■ Adjust FM transmitting frequency by 100 KHz in the link function. ■ Control of previous/next song while in the Bluetooth audio streaming mode. ■ Switch between two active phone calls. <p>Accelerate Rotation [◀] [▶]</p> <ul style="list-style-type: none"> ■ Quick tune to select a DAB station. ■ Adjust FM transmitting frequency by 2MHz in the link function. <p>Press and Hold</p> <ul style="list-style-type: none"> ■ Turn off TINYAUDIO C10 while it is on.
<p>1 AUX</p>	<p>Press</p> <ul style="list-style-type: none"> ■ Recall memory preset in group 1. <p>Press and Hold</p> <ul style="list-style-type: none"> ■ Program memory preset in group 1 with the listening DAB station. <p>Function AUX</p> <ul style="list-style-type: none"> ■ Switch TINY AUDIO C10 audio input to AUX mode to listen to audio streaming

<p style="text-align: center;">2 SCAN</p>	<p>Press</p> <ul style="list-style-type: none"> ■ Recall memory preset in group 2. <p>Press and Hold</p> <ul style="list-style-type: none"> ■ Program memory preset in group 2 with the listening DAB station. <p>Function SCAN</p> <ul style="list-style-type: none"> ■ Perform a full scan for DAB stations.
<p style="text-align: center;">3 MENU</p>	<p>Press</p> <ul style="list-style-type: none"> ■ Recall memory preset in group 3. <p>Press and Hold</p> <ul style="list-style-type: none"> ■ Program memory preset in group 3 with the listening DAB station. <p>Function MENU</p> <ul style="list-style-type: none"> ■ RADIOTXT – enable/disable display of DLS/DL+ information from the station ■ DABORDER – DAB station list order sequence; order by alphabet or by ensemble. ■ DABRESET – erase the DAB station list but keep the DAB memory presets and then perform a full scan of DAB stations automatically. ■ BT POWER – enable/disable Bluetooth function. ■ BT PAIR – enter Bluetooth device pairing mode. ■ BT INFO – display the connected device information. ■ BT RESET – erase all existing paired devices setup. ■ LINKMODE – select operating mode (AFC_H/AFC_L/AutoScan). ■ ANTENNA – set ON for active DAB antenna, set OFF for passive antenna. ■ FACTORY – return all system settings to defaults. ■ UPGRADE – upgrade the module software to a new version. ■ VERSION – display the current software version.
<p style="text-align: center;">4 DAB</p>	<p>Press</p> <ul style="list-style-type: none"> ■ Recall memory preset in group 4. <p>Press and Hold</p> <ul style="list-style-type: none"> ■ Program memory preset in group 4 with the listening DAB station. <p>Function DAB</p> <ul style="list-style-type: none"> ■ Switch TINY AUDIO C10 audio input to DAB mode to listen to DAB programming.
<p style="text-align: center;"> LINK</p>	<p>Press</p> <ul style="list-style-type: none"> ■ Display adaptor's current FM transmitting frequency. ■ Select and set the FM transmitting frequency from a manual setting or from one of the four memory presets. ■ Save the FM transmitting frequency setting to one of the four memory presets. ■ Answer the incoming phone call. <p>Press and Hold</p> <ul style="list-style-type: none"> ■ Perform an immediate FM transmitting frequency change.
<p style="text-align: center;"> BACK</p>	<p>Press</p> <ul style="list-style-type: none"> ■ Recall the last listened DAB station. ■ Cancel an operation, or return to home screen display from the menu selection. ■ Reject the incoming phone call or hang up the active call. <p>Press and Hold</p> <ul style="list-style-type: none"> ■ Reset FM transmitting frequency to the frequency saved in FM preset 1. Within 30 seconds, press and hold again to return the frequency to 88.1MHz.

STARTING UP THE SYSTEM

1. Turn on your in-car audio system.
2. Enable the AF function on your car radio if it is equipped (Consult your car radio manual or the car dealer if your car radio has AF feature, and how to enable AF feature).
3. Tune the car radio's FM frequency to FM 88.1MHz, which is the same as TINY AUDIO C10 default FM TX frequency.
4. Start TINY AUDIO C10 by plugging the cigarette-lighter power plug into the cigarette lighter, the audio system display will show 《 DABRADIO 》.
5. TINY AUDIO C10 will perform a Scan of DAB stations automatically.
6. If FM 88.1MHz is already used by a FM broadcaster or the station is noisy, change the initial FM TX frequency as below:

Operating on TINY AUDIO C10

- Press and hold **LINK** for 3 seconds, TINY AUDIO C10 will set a new and clear frequency to transmit the FM signal.

Operating on Car Radio

- Tune the car radio's FM frequency to match to TINY AUDIO C10 FM TX frequency shown on the LCD display screen; the TINY AUDIO C10 and the car radio are now synchronized.
7. If your car radio does not have AF feature, do the following to change TINY AUDIO C10's LINKMODE to AutoScan instead of the default AFC.
 - 7.1 Press **Rotary Knob** and then **MENU** to enter the menu function.
 - 7.2 Rotate the **Rotary Knob [◀] [▶]** until the screen shows 《 LINKMODE 》.
 - 7.3 Press **Rotary Knob**, and then rotate the **Rotary Knob [◀] [▶]** until the screen shows 《 AUTOSCAN 》.
 - 7.4 Press **Rotary Knob**, the function of AutoScan is now enabled and the TINY AUDIO C10 is operating in the AutoScan mode.
 8. Now you can listen to the DAB stations. For the system operation, please refer to *USING DAB ADAPTER* section.
 9. While you are using AutoScan function and you are experiencing noise on the listening DAB station, please refer to *To Force Immediate FM Frequency Change* or *To Set FM Transmitting Frequency Manually* to manually switch to another FM frequency.
 10. To avoid unnecessary draining of the car battery when TINY AUDIO C10 is idle, after 4 hours of idling from the user's last action, TINY AUDIO C10 will be automatically turned off. While in the standby mode, press **Rotary Knob** to return TINY AUDIO C10 back to the operating mode.

USING DAB ADAPTER

To Turn On or Off TINY AUDIO C10

The TINY AUDIO C10 operating mode can be turned off or turned on by the following:





1. Press and hold **Rotary Knob** to turn it off, while TINY AUDIO C10 is in the operating mode.
2. Press **Rotary Knob** to return it to the operating mode, while TINY AUDIO C10 is off.

To Scan for the DAB Stations

This function searches for all DAB stations in Band III from channel frequency 5A to channel frequency 13F that are available in the area where your car is presently located. Stations found as a result of the search are added to the station list. To scan for the DAB stations, do the following:

1. Press **Rotary Knob** and then **SCAN** to do a full scan of DAB stations, the screen will show《 SCANNING 》.

Note:

-  While the Scan operation is in process, you can press **BACK** at any time to stop Scan function and revert to listening to the currently selected station.
-  Each time you start TINY AUDIO C10, if the station list is empty, it will perform a Full Scan of DAB stations automatically.
-  You may also need to perform a Scan function if you drive your car to a new area where the broadcasting DAB stations are not on the current station list.
-  If there are no stations found after the DAB Scan, the screen will show《 EMPTY 》as there are no DAB stations available in the area where you performed DAB Scan function.

To Listen to the DAB Stations

There are two options available for you to select and listen to a DAB station: **Quick Tune** and **Step Tune**. **Step Tune** is used when you want to step through the list of stations one by one. **Quick Tune** allows you to move more quickly through the list of stations according to the sorting method, either by alphabetical order or by ensemble sequence. Once you have reached the desired initial alphabet or the ensemble number by **Quick Tune**, you can then use **Step Tune** to refine and move to the desired station one by one within the selected initial alphabet or within the selected ensemble.

Step Tune

1. Rotate the **Rotary Knob** [◀] [▶] to step through the stations, one by one, until the screen shows the desired station: 《 *station name* 》.

Quick Tune

1. Accelerate Rotating the **Rotary Knob** [◀] [▶] to move through the first letters in the alphabet if the station list is sorted alphabetically, or move through the ensemble sequence if the station is sorted by ensemble. Repeat the action, one alphabet at a time, or one ensemble at a time, until the screen shows the DAB station with desired initial alphabet or the desired ensemble.
2. Do the Step Tune to step thru the stations, one by one, until the screen shows the desired station:《 *station name* 》.
3. The system will tune to the station immediately.

Note:



The DAB sorting method for the station list, either by alphabetical order or by ensemble, is set thru the menu setting.

To Change DLS/DL+ Information Display

The TINY AUDIO C10 provides a number of information about the current listening station; this information can be displayed thru repeatedly pressing the **Rotary Knob** key.

1. Each time you press **Rotary Knob** while listening to a DAB station, the screen will cycle through station's information below:

《 *station name* 》 where *station name* is name of the DAB station.

《 *DLS/DL+ info* 》 when DLS/DL+ is enabled thru menu settings, it displays real time Dynamic Label Segment (DLS) station information such as song titles, music type and news or traffic updates, or Dynamic Label Plus (DL+) extended information for song track and song artist.

《 SIG *xx*% 》 where *xx* is the signal quality value.

Note:



If the display setting is set to off, the screen will show 《 TEXT OFF 》while displaying the DLS/DL+ information.

To Save a Memory Preset

You can save your favorite stations in the memory preset List. There are 4 groups (1 to 4) of memory presets, and each group has 4 sets of memory location to store 4 DAB stations. Therefore, a total of 16 DAB stations can be saved in the memory preset List in DAB mode.

1. Select a station or while listening to the desired DAB station, you can that save this station (e.g. station Z) into a memory preset location of a presetgroup.
2. Press a number control key **X** (**X** from 1 to 4) that corresponds to the preset group you would like to save to. The screen will display the first of 4 memory preset of the preset group **X** as « * station name » if there is a station already saved, or « * EMPTY » if there is no station saved. If there is a station already saved, TINY AUDIO C10 will tune to the preset station immediately.
3. If you would like to save the DAB station Z into the first memory preset location of the preset group **X**, then press and hold the same control key **X**. The screen will display a short message of « **XA** SAVED ».
4. Otherwise, keep pressing the same control key **X** until a desired memory preset location is displayed, then press and hold the same control key **X** to save the DAB station Z into the memory preset location of the preset group **X**. The screen will show « **XY** SAVED » where Y is from A to D.

Note:



This new setting will overwrite a previous setting in memory preset location of the preset group **X**.

To Recall a Memory Preset

This function allows you to recall a preset favorite DAB station from the memory preset groups **1** to **4**.

1. Press a number control key **X** (**X** from 1 to 4) that corresponds to the preset group. The screen will display the first of 4 memory preset of the preset group **X** as « * station name » if there is a station already saved, or « * EMPTY » if there is no station saved. If there is station already saved, TINY AUDIO C10 will tune to the preset station immediately.
2. Keep pressing the same control key **X** until the desired memory preset is being displayed and tuned to, or press a different control key for memory preset in another preset group.

Note:



While recalling a memory preset, if there is no DAB station saved in the memory preset location of the preset group **X**. the system will tune to the last played station.

To Recall the Last Listened DAB Station

The TINY AUDIO C10 automatically remembers the station that is last listened to. This allows you to go back to last listened DAB station quickly; even it is not in the memory Preset List.

1. Press **BACK** to recall the station that was most recently listened to. The screen will show 《 LS EMPTY 》 if the last listened station has not memorized a station name yet or 《 *station name* 》if it has.

USING AUDIO STREAMING

The TINY AUDIO C10 is capable of receiving audio streaming through your car radio when it is switched to AUX mode. While in the audio streaming, you can return to the DAB mode and listen to the DAB station by the following:

- To listen to the last listened DAB station, you must press **Rotary Knob** and then **DAB** to return to DAB mode and then TINY AUDIO C10 will tune to the last listened DAB station.
- To recall a preset DAB station, you must press a number control key **X** directly (where **X** is from 1 to 4) to return to the DAB mode and tune to the last listened memory preset location in preset group **X**. If the memory preset is empty then TINY AUDIO C10 will tune to the last listened DAB station instead.

To Set the Bluetooth Audio Input mode

The Bluetooth audio input mode is setup to play audio from your mobile device (Smartphone or Tablets) using the Bluetooth technology, you must switch TINY AUDIO C10 to AUX mode, enable TINY AUDIO C10's Bluetooth function, and then perform the Bluetooth device pairing between TINY AUDIO C10 and your mobile device, if they are not already paired, before the connection can be made. For detail, please refer to the menu setting sections for *To Enable Bluetooth*, *To Setup Bluetooth Pairing*, and *To Reset Bluetooth Pairing*.

1. Press **Rotary Knob** then **AUX** to switch to AUX mode, and start listening to the audio streaming if a mobile device is connected to TINY AUDIO C10 using Bluetooth.
2. Rotate the **Rotary Knob [▶]** to advance the play to the next song in the list.
3. Rotate the **Rotary Knob [◀]** to return the play to the previous song in the list.
4. Press **Rotary Knob** to toggle the play/pause control.
5. The play control can also be operated from your mobile device.

USING HANDS FREE FUNCTION

The TINY AUDIO C10 is capable of providing the Hands Free function for incoming and outgoing phone calls from your mobile device using Bluetooth technology and listen to the audio through your car radio. To use this function, you must enable Bluetooth, do the Bluetooth pairing first. For detail, please refer to the menu setting sections for *To Enable Bluetooth, To Setup Bluetooth Pairing*. TINY AUDIO C10 can support up to two phone calls at the same time to a Bluetooth connected phone while the system is operating in either DAB mode or Audio Streaming mode.

To Receive Incoming Call

TINY AUDIO C10 provides the incoming call indication and allows you to operate on the TINY AUDIO C10 to answer, reject, hang up, and switch between the two active calls. The current audio from the DAB mode or the Audio Streaming mode is stopped until the call is hung up.

1. Incoming call indication

While a call, either the first or the second call, is ringing, there will be a warning tone from the car radio, and the screen will show the scrolling text of *« device code: caller ID »* where *device code* is the code for corresponding connected Bluetooth device, either A or B, and the *caller ID* is the phone number.



2. Answer an incoming call

Press  (LINK) key to answer the first or the second incoming call, the screen will show *« LINE X »* where *X* = 1 or 2 of the call sequence. When you answer the second call, the first call is put on hold automatically.

3. Reject an incoming call

Press the  (BACK) key to reject the first or the second incoming call.

4. Switch between two active calls

Rotate the **Rotary Knob** [] [] to switch between the two active calls.

5. Hang up a call

Press the  (BACK) key to hang up the active call.

Note:



While you are active on a call, you can press **Rotary Knob** to mute/un-mute the active call with a warning tone from the car radio every 3 seconds when the call is muted.

To Make Outgoing Call

You must make outgoing calls from your Smartphone and while the destination is

ringing, the car radio screen will display 《 OUTGOING CALL 》and the current audio from the DAB mode or the Audio Streaming mode is interrupted. Once the call destination answers the call, the screen will show 《 LINE X 》as for the incoming call. Then, you can hang up, answer another call, and switch between two active calls.

ATTENTION

While using your Smartphone on a Hands Free call via TINY AUDIO C10, the far end party may experience echo. When this happens, please try the following steps, in sequence, to lessen the echo effect:

1. Adjust your car radio's volume

As car radio's volume range varies among different models, adjust the volume to clear, comfortable, but not a loud level while listening to the far end on a call.

2. Adjust your Smartphone's volume

Use your phone's volume button and lower the Bluetooth connection's volume setting to decrease the echo effect. As there are many different made of Smartphone, the setting can differ. For example, the suggested setting for iPhone users is 5 notches below the maximum setting.

FM TRANSMITTING FREQUENCY SETTINGS

The FM transmitting frequency is used by TINY AUDIO C10 to transmit the audio and for car radio to receive the audio. The FM transmitting frequency can be changed by the following:

1. Set FM transmitting frequency in AFC mode
2. Set FM transmitting frequency manually
3. Recall FM transmitting frequency saved in the memory
4. Force immediate FM transmitting frequency change
5. Set FM transmitting frequency to memory preset F1
6. Reset FM transmitting frequency to default 88.1 MHz

To Display the current FM Transmitting Frequency

1. Press **LINK**, and the screen will show 《 *Frequency* 》 where *Frequency* is the current FM Transmitting Frequency.

To Set FM Transmitting Frequency in AFC Mode

When your TINY AUDIO C10 identifies a need to switch FM transmission frequency this will usually force the car radio to change FM frequency automatically in most cases and the car radio display will show《 *AF Frequency* 》where *Frequency* is the new frequency TINY AUDIO C10 is transmitting. Refer to *To Enable AFC* in the *MENU SETTINGS* section to enable AFC mode.

To Set FM Transmitting Frequency Manually

If you wish to change the setting and use your own selected FM transmitting frequency manually, do the following:

1. Press **LINK**, and the screen will show the current FM Transmitting Frequency 《 *Frequency* 》.
2. You can accelerate rotating the **Rotary Knob [◀] [▶]** to step up or down FM frequency by 2MHz, or rotate the **Rotary Knob [◀] [▶]** to step up or down FM frequency by 100KHz, to choose a frequency until the desired FM frequency is displayed (e.g. 106.7MHz).
3. Then press **Rotary Knob** or after 5 seconds timeout, the TINY AUDIO C10 will set and transmit FM signal at this new frequency. The screen will display the new frequency as the current frequency.
4. Press FM preset of your car radio corresponding to the same frequency from step 2 if you have previously saved for DAB reception. Otherwise, tune the car radio to the same FM frequency.
5. Now you can listen to DAB stations via this new FM Frequency.

Note:





It is recommended to set the selected FM frequency as one of the memory presets of your car radio, selecting this particular preset FM frequency and together with setting the TINY AUDIO C10's FM transmitting frequency will quickly enable you to start listening to DAB stations.

To Save a Desired FM Transmitting Frequency in Memory

As unused FM frequency may vary from one area to another, it is suggested to save a few frequencies (up to 4 frequencies) in TINY AUDIO C10 so that you can switch to a new FM transmitting frequency instantly when you drive into an area where the original FM frequency for DAB is no longer available.

1. Press **LINK**, and the screen will show the current FM Transmitting Frequency 《 *Frequency* 》.
2. You can accelerate rotating the **Rotary Knob** [**◀**] [**▶**] to step up or down FM frequency by 2MHz, or rotate the **Rotary Knob** [**◀**] [**▶**] to step up or down FM frequency by 100KHz, to choose a frequency, until the desired FM frequency is displayed (e.g. 106.7MHz).
3. Then press and hold a **X** control key (where **X** is from 1 to 4) to save the current selected FM frequency into the corresponding preset memory **FX**.
4. The screen will display a short message of 《 **FXSAVED** 》.

Note:

-  The default FM frequencies saved in presets **F1** to **F4** are 88.1MHz, 92.5MHz, 102.5MHz and 107.9MHz, respectively.
-  It is suggested to set those FM frequencies saved in TINY AUDIO C10 into FM preset of your car radio. Selecting the FM preset of your car radio and the matching FM preset of TINY AUDIO C10 will switch the FM transmission frequency instantly for a clear reception of the DAB station.
-  Saving the frequency in memory does not affect the current FM transmitting frequency; it remains the same as before saving the frequency.

To Recall FM Transmitting Frequency Saved in Memory

You may drive into an area where the FM frequency transmitted by TINY AUDIO C10 is used by an FM broadcaster. When this happens, your reception of DAB station will be getting worse with increasing interference from another FM program. Switch to a free FM frequency will ensure continuous and clear reception of the DAB station to which you are currently listening.

1. Press **LINK**, and the screen will show the current FM Transmitting Frequency.
2. Press a **X** control key (where **X** is from 1 to 4) to select a corresponding FM memory preset **FX** and the screen will show 《 **FX Frequency** 》 where frequency is the frequency saved in FM preset memory **FX**.
3. Press **Rotary Knob** or after 5 seconds timeout, the TINY AUDIO C10 will set and transmit FM signal at this new frequency. The screen will display the new frequency as the current frequency.
4. Press FM preset of your car radio corresponds to the same frequency from step 2 if you have previously saved for DAB reception. Otherwise, tune the car radio to the same FM frequency.
5. Now you can listen to DAB stations via this new FM Frequency.

To Force Immediate FM Transmitting Frequency Change

This function can be used in either AFC or AutoScan mode to force a FM transmission frequency change immediately.

In AFC_H or AFC_L Mode

While listening to a DAB station, if you hear static noise or a FM program and before AFC tunes to a clear frequency you can force an immediate frequency change by:

1. Press and hold **LINK**, the screen will show 《 *AF Frequency* 》 where *Frequency* is the new frequency that TINY AUDIO C10 will set and use to transmit FM signal and force radio to tune to the same frequency automatically.
2. Now you can listen to DAB stations via this new FM Frequency.

In AutoScan Mode

If you notice your current listening DAB program is being interfered with, you can force an immediate frequency change. TINY AUDIO C10 will automatically choose and set a new frequency but you must tune the car radio to match TINY AUDIO C10 new frequency manually. Do the following:

Operating on TINY AUDIO C10

1. Press and hold **LINK**, the screen will show 《 *TO Frequency* 》 where *Frequency* is the new frequency that TINY AUDIO C10 will set and use to transmit FM signal.

Operating on Car Radio

1. Manually change your car radio's FM frequency to match the new TINY AUDIO C10 transmitting frequency setup.

To Set FM Transmitting Frequency Setting to Preset F1

This function allows you to set the FM transmitting frequency to the frequency saved in FM frequency preset F1. TINY AUDIO C10 will change the transmitting frequency immediately.

1. Press and hold **BACK** to set FM transmitting frequency to the frequency saved in FM preset F1.

Note:



After setting the FM frequency to preset F1, You have the option to return to the default FM transmitting frequency 88.1MHz by, within 30 seconds after step 1, press and hold **BACK** again.

To Reset FM Transmitting Frequency Setting

This function allows you to reset the FM transmitting frequency to the default setting FM 88.1MHz.

1. Press and hold **BACK** twice in succession to reset FM transmitting frequency to 88.1MHz.

MENU SETTINGS

You must press **Rotary Knob** then **MENU** button to enter the menu function, rotate **Rotary Knob** [◀] [▶] to select a menu setting, and then press **Rotary Knob** to confirm the selection to return to the menu selection screen. Then, you must press the **Back** key or after 5 seconds timeout, to return to the DAB or Audio Streaming display mode.

To Enable DLS/DL+ Display

When you enable DLS/DL+ Display, the screen will show DLS information such as song titles, music types and news or traffic updates from the station if DLS is being received, or DL+ information, song track, song artist if DL+ is being received. The DLS/DL+ information are either displayed in one line or three lines as enabled below:

1. In the menu function, rotate **Rotary Knob** [◀] [▶] until the selection is « RADIOTXT ».
2. Press **Rotary Knob** to enter radio text selection operation.
3. Then you can rotate **Rotary Knob** [◀] [▶] until the screen shows « ON » to enable the DLS/DL+ display on radio.
4. Or you can rotate **Rotary Knob** [◀] [▶] until the screen shows « OFF » to disable the DLS/DL+ display on screen.
5. Finally, press **Rotary Knob** to set the DLS/DL+ display.

Note:



The default DLS/DL+ setting is ON.

To Set DAB Sorting Order

There are two ways that TINY AUDIO C10 can sort the stations in the station list, it can be either sorted by alphabetical order of the station name, or by DAB ensemble (channel) ID. In each DAB ensemble, the stations are ordered according to the station ID and not necessary by alphabetical order of the station name.

1. In the menu function, rotate **Rotary Knob** [◀] [▶] until the screen shows « DABORDER ».
2. Press **Rotary Knob** to enter DAB sorting selection operation.
3. If you do want to sort the DAB station list by ensemble, rotate **Rotary Knob** [◀][▶] to find « ENSEMBLE ».
4. Otherwise, if you want to sort the DAB station list by alphabetical order, rotate **Rotary Knob** [◀] [▶] to find « ALPHABET ».

5. Finally, press **Rotary Knob** for confirmation.

Note:

 The default DAB List Order setting is by alphabetical order.

To Enable Bluetooth

When you enable Bluetooth, you will be able to pair and connect TINY AUDIO C10 to your mobile device (Smartphone or Tablet) for audio streaming.

1. In the menu function, rotate **Rotary Knob [◀] [▶]** until the screen shows « BT POWER ».
2. Press **Rotary Knob** to enter Bluetooth selection operation.
3. Then you can rotate **Rotary Knob [◀] [▶]** until the screen shows « BT ON » to enable Bluetooth function.
4. Or you can rotate **Rotary Knob [◀] [▶]** until the screen shows « BT OFF » to disable Bluetooth function.
5. Finally, press **Rotary Knob** to set the Bluetooth option

Note:

 The default Bluetooth setting is ON.

 TINY AUDIO C10 will attempt to connect to the mobile device that is already paired automatically, after you have enabled the Bluetooth function in TINY AUDIO C10 and your mobile device.

To Setup Bluetooth Pairing

Once you have enabled the Bluetooth function, if your mobile device has not already been paired to TINY AUDIO C10, you must do the pairing first before TINY AUDIO C10 can connect to your mobile device. Once the pairing is done, it is saved and you do not have to the pairing again for the same mobile device. To do the pairing, do the following:



1. In the menu function, rotate **Rotary Knob [◀] [▶]** until the screen shows « BT PAIR ».
2. Press **Rotary Knob** to enter the pairing mode, TINY AUDIO C10 is now waiting for you to pair your mobile device to TINY AUDIO C10.
3. Operate your mobile device to enable the Bluetooth function, enter the search mode for Bluetooth devices, and then select **TINY AUDIO C10** device name to complete the pairing.

To Display Bluetooth Information

You can check the Bluetooth device connection information on the system; TINY AUDIO C10 allows a maximum of 2 Bluetooth devices connected to the system at the same time.

1. In the menu function, rotate **Rotary Knob** [◀] [▶] until the screen shows « BT INFO ».
2. Press **Rotary Knob** to display Bluetooth information, the screen will show the scrolling text of « *device code: device name* » where *device code* is the code for the corresponding connected Bluetooth device, either A or B, and *device name* is the name of the connected Bluetooth device.
3. Rotate **Rotary Knob** [◀] [▶] to switch between device code A and B.

Note:

-  If there are no Bluetooth devices connected to TINY AUDIO C10, the display will only show « N/A ».
-  If there is only one Bluetooth device connected to TINY AUDIO C10, the unconnected device (e.g. device code B) will show « B: N/A ».

To Reset Bluetooth Pairing

The Reset Bluetooth Pairing, when invoked, will remove all known pairing in the TINY AUDIO C10, and thus allow TINY AUDIO C10 to pair with additional mobile devices.

1. In the menu function, rotate **Rotary Knob** [◀] [▶] until the screen shows « BT RESET ».
2. Press **Rotary Knob** to enter Bluetooth reset operation.
3. If you do want to reset, rotate **Rotary Knob** [◀] [▶] to find « YES » and then press **Rotary Knob** for confirmation. Otherwise, you can press **Rotary Knob** to cancel while the screen shows « NO ».

To Enable AFC (Automatic Frequency Change)

If your car radio does not have AF feature then please refer to *To Enable AutoScan*.

It may become necessary to change the FM transmitting frequency as you drive into an area where the FM frequency transmitted by TINY AUDIO C10 is used by an FM broadcaster. TINY AUDIO C10 has an AFC function that allows you to continuously listen to DAB programs through your car radio system without the need to change the FM frequency manually. (Subject to car radio compatibility)

To perform this AFC function, your car radio must have AF (Alternative Frequency)

feature and the AF feature of your car radio must be activated. When the AFC function of TINY AUDIO C10 is enabled and the AF feature of your car radio is activated, your car radio will tune to an unused FM frequency automatically when you drive into an area where the original FM frequency for DAB is no longer available.

Furthermore, there are two AFC modes, AFC_H (High Sensitive) & AFC_L (Low Sensitive). While in AFC mode, TINY AUDIO C10 will detect and determine if a frequency change is necessary constantly. Set AFC_L mode, if you experience the FM frequency is being changed too often, and set AFC_H mode, if you often hear static noise and the FM frequency is not changed.

By default TINY AUDIO C10 is already set to use AFC_H mode; however, if you want to change or return to AFC mode, do the following:





Setting on TINY AUDIO C10

1. In the menu function, rotate **Rotary Knob** [◀] [▶] until the screen shows 《 LINKMODE 》.
2. Press **Rotary Knob**, and then rotate **Rotary Knob** [◀] [▶] until the screen shows 《 AFC_H 》 or 《 AFC_L 》.
3. Press **Rotary Knob**, the AFC function is now enabled and the TINY AUDIO C10 is operating in the AFC mode.
4. When TINY AUDIO C10 performs this AFC function, the screen will show 《 AF *Frequency* 》 where *Frequency* is the new frequency that TINY AUDIO C10 will set and use to transmit FM signal and force radio to tune to the same frequency automatically.

Setting on Car Radio

1. Enable the Alternative Frequency feature of your car radio (consult your car radio manual or the car dealer if your car radio has the AF feature, and how to enable AF feature).

Note:

-  If your car radio does not have AF feature, the AFC function must not be enabled, and refer to *To Enable AutoScan*.
-  If the AF feature of your car radio and TINY AUDIO C10's AFC function are not compatible, the AFC function must not be enabled; instead, refer to *To Enable AutoScan*.
-  If you hear static noise or a FM program and before AFC tunes to a clear frequency you can force an immediate frequency change manually, refer to the *To Force Immediate FM Transmitting Frequency Change* section for detail.
-  While in AFC mode, if the FM transmitting frequency for TINY AUDIO C10 and the car radio listening frequency are out of sync, and you wish to reset

them, refer to the procedure outlined in the *TROUBLESHOOTING* section for detail.

ATTENTION

The TINY AUDIO C10 comes equipped with the AFC function. In order to use this function, your car radio must have AF (alternative frequency) feature, and AF must be enabled. Please consult your car radio manual or the car dealer for these requirements before using this function.

While working with the AFC function, the possible factors that could affect its normal operation are:

1. The FM sensitivity varies among car radios and the sensitivity can affect AFC's performance.
2. The algorithm implemented in each car radio's AF feature varies and this can affect radio's FM frequency tuning when triggered by AFC.
3. While the system is in Aux mode and listening to an audio device, if the device's volume is turned up too high, it can affect AFC's performance.



If AFC function is unable to function normally, please disable AFC and use AutoScan mode instead. Refer to the next section *To enable AutoScan*.

To Enable AutoScan

If your car radio does not have AF feature, then you must disable AFC and enable AutoScan instead.

1. In the menu function, rotate **Rotary Knob** [◀] [▶] until the screen shows ◀ LINKMODE ▶.
2. Press **Rotary Knob**, and then rotate **Rotary Knob** [◀] [▶] until screen shows ◀ AUTOSCAN ▶.
3. Press **Rotary Knob**, the function of AutoScan is now enabled. The TINY AUDIO C10 is operating in the AutoScan mode,

Note:

-  Switching to the AutoScan mode does not change the current FM transmitting frequency as it remains the same as before the switch.
-  Switching to the AutoScan mode, it disables the AFC function.
-  TINY AUDIO C10 will keep searching automatically for unused FM frequency.

Then, when necessary, you can press and hold the **LINK** control key to force the immediate FM transmitting frequency change to use this searched frequency as the new transmitting frequency. You must also tune your car radio to this new FM frequency to receive DAB services.

To Enable RC Beep Tone

When you enable RC beep tone, TINY AUDIO C10 will respond with a beep tone, each time an operation is performed on the remote control.

1. In the menu function, rotate **Rotary Knob** [◀] [▶] until the screen shows « RC BEEP ».
2. Press **Rotary Knob** to enter RC beep tone selection operation.
3. Then you can rotate **Rotary Knob** [◀] [▶] until the screen shows « BEEP ON » to enable the RC beep tone.
4. Or you can rotate **Rotary Knob** [◀] [▶] until the screen shows « BEEP OFF » to disable the RC beep tone.
5. Finally, press **Rotary Knob** to set the RC beep tone, screen will then show « DONE ».

Note:

 The default setting is OFF.

To Set Antenna Power

For TINY AUDIO C10 to work with the active antenna, the antenna power must be set to ON. TINY AUDIO C10 can also work with a passive antenna, you must set the antenna power to OFF.

1. In the menu function, rotate **Rotary Knob** [◀] [▶] until the selection is « ANTENNA ».
2. Press **Rotary Knob** to enter Antenna Power selection operation.
3. Then you can rotate **Rotary Knob** [◀] [▶] until the screen shows « ANT ON » to set the Antenna Power On.
4. Or you can rotate **Rotary Knob** [◀] [▶] until the screen shows « ANT OFF » to set the Antenna Power Off.
5. Finally, press **Rotary Knob** to set the Antenna Power.

Note:

 The default Antenna Power setting is ON.

To Perform DAB List Reset

1. In the menu function, rotate **Rotary Knob** [◀] [▶] until the selection is « DABRESET ».
2. Press **Rotary Knob** to perform a reset operation for DAB station list.
3. If you do want to reset, rotate **Rotary Knob** [◀] [▶] to find « YES » and then press **Rotary Knob** for confirmation. Otherwise, you can press **Rotary Knob** to cancel while the screen shows « NO ». The screen will then show « RESETTING » to indicate that DAB list reset is in progress.

Note:



DAB list reset will erase the station list but keep the memory presets for all DAB Presets, and then perform a full scan of DAB stations automatically after the DAB list has reset. It does not change the current FM transmitting frequency or return all FM transmitting frequency presets to default.

To Restore to Factory Settings

1. In the menu function, rotate **Rotary Knob** [◀] [▶] until the screen shows « FACTORY ».
2. Press **Rotary Knob** to perform a factory reset operation.
3. If you do want to reset, rotate **Rotary Knob** [◀] [▶] to find « YES » and then press **Rotary Knob** for confirmation. Otherwise, you can press **Rotary Knob** to cancel while the screen shows « NO ».
 - 3.1 The screen will show « RESETTING » to indicate that factory reset is in progress.
 - 3.2 The system will perform a scan of DAB stations automatically after the factory reset is completed. You must switch the car radio to FM 88.1MHz to continue DAB listening.

Note:



Factory reset will erase all previous system's settings and set them to default.

To Upgrade Module Software

This function is used by the maintenance personnel only, to upgrade the existing TINY AUDIO C10 module software to a new version.

To Display Software Version

This function allows you to display the current software version of your TINY AUDIO C10.

1. In the menu function, rotate **Rotary Knob** [◀] [▶] until the screen shows « VERSION ».
2. Press **Rotary Knob** to display the software version, the screen will show the current software version number « x.x.x.x ».

TROUBLESHOOTING

Please read this user manual carefully before using the TINY AUDIO C10 In-Car DAB Adapter. If you still have difficulties to use this unit, this section gives some of the most likely solutions to the problems you might have.

◆ **I cannot find any DAB stations.**

Ensure that DAB coverage exists in your area. Please visit www.worlddab.org or www.digitalradionow.com to check for DAB coverage.

◆ **I forget the FM transmitting frequency setting of TINY AUDIO C10.**

Press **LINK** key the screen will show the current FM Transmitting frequency.

◆ **I cannot hear DAB program when I start up my car and turn on the car radio.**

Check the following:

1. Follow the instruction on the section *STARTING UP THE SYSTEM* to initialize the FM transmitting frequency on TINY AUDIO C10 and the car radio.
2. Make sure that the car radio is not in mute and check the volume settings of the car radio.
3. Make sure TINY AUDIO C10 is not in the Audio Streaming mode, if so, press **Rotary Knob** then **DAB** to return to DAB mode.

◆ **While listening to a DAB station, I lost reception suddenly and hear static noise or a FM program**

1. Check if TINY AUDIO C10 station information shows 《 POOR SIG 》 or 《 UNAVAIL 》, if so, you may be leaving the signal coverage area, please refer to *To Listen to the DAB stations* to select another station. Also, the station may be unavailable temporarily as you drive into a tunnel.
2. If TINY AUDIO C10 is in AFC mode, the FM Transmitting Frequency for TINY AUDIO C10 and the car radio listening Frequency maybe out of sync. To reset them, do the following:
 - a) Reset to 88.1MHz

Operating on Car Radio

- Press FM preset of your car radio to the frequency 88.1MHz if you have previously saved for DAB reception. Otherwise, tune the car radio to FM frequency 88.1MHz manually.

Operating on TINY AUDIO C10

- Press and hold **BACK** twice in succession to reset FM transmitting frequency to 88.1MHz.

b) Reset to frequency that has been saved in FM frequency preset 1

Operating on Car Radio

- Press FM preset of your car radio corresponds to the same frequency as in TINY AUDIO C10's FM frequency preset 1, if you have previously saved for DAB reception. Otherwise, tune the car radio to that FM frequency manually.

Operating on TINY AUDIO C10

- Press and hold **BACK** to reset FM transmitting frequency to FM frequency preset 1.

3. If TINY AUDIO C10 is in AutoScan mode, the FM channel you selected for DAB mode may be occupied by an existing radio station. You need to change the frequency settings of FM Transmitter. Please refer *To enable AutoScan* to set a suitable new frequency.

◆ **If you hear static noise or a FM program and before AFC tunes to a clear frequency, you can force an immediate frequency change manually by one of the following:**

Refer to *FM Transmitting Frequency Settings* section:

1. Set FM transmitting frequency manually
2. Recall FM transmitting frequency saved in the memory
3. Force immediate FM transmitting frequency change
4. Set FM transmitting frequency to memory preset F1
5. Reset FM transmitting frequency to default 88.1MHz

◆ **I cannot hear audio from the Bluetooth Audio Streaming**

Check the setup and ensure the following:

1. Enable Bluetooth from your mobile device.
2. Enable Bluetooth from TINY AUDIO C10's menu setting.
3. Start Bluetooth pairing from TINY AUDIO C10's menu setting
4. Search and connect to TINY AUDIO C10 from your mobile device
5. Once connected, ensure TINY AUDIO C10 Bluetooth device's Media Audio setting is checked on your mobile device.
6. Start playing the audio from your mobile device.
7. Switch TINY AUDIO C10 to Audio Streaming by pressing **Rotary Knob** then **AUX** to listen to the audio from your car radio.

◆ **I cannot re-connect to the held phone call automatically while in Hands Free mode**

As there are different made of Smartphone, you might not be re-connected back to the held call automatically on the following condition.

1. There are two calls in progress, one is active and one is on hold.
2. If the active call is hung up (by you or the destination); although TINY AUDIO C10 displays the held call becomes active, but the actual call might be still on hold.
3. When this happens, try rotate **Rotary Knob [◀] [▶]** to return the held call to active. If this does not work, please hang up and redial the held party.

◆ **I hear echo or call volume is too low while in Hands Free mode**

While the Hands Free call is in progress, if you experience the following conditions:

1. If the destination party hears echo, try turning down the volume of your Smartphone or the car radio.
2. If you hear the call volume is too low, try turning up the volume of your Smartphone or the car radio.
3. If the destination party indicates the call volume is too low, advise the destination party to turn up the volume of his Smartphone or try turning up the volume of your Smartphone.

TECHNICAL SPECIFICATIONS

- Digital Audio Services: DAB/DAB+.
- RF Frequency Range: DAB Band III (174 MHz ~ 240 MHz).
- RF Sensitivity for DAB Band III: -98dBm ~ -100dBm.
- FM Transmit Range: 88.1 MHz ~ 107.9 MHz.
- Bluetooth: Version 4.1, backward compatible with BT3.0, 2.0, and 1.2
- Mains Power: 12V DC
- Presets: 4x4 DAB station presets and 4 FM transmit presets.
- Operating Temperature Range: -10D ~ +70D.
- Storage Temperature Range: -30D ~ +80D.
- DAB Antenna Connector:
 - Connector Type: SMB
 - Output Voltage: 12V

INFORMATION ON WASTE DISPOSAL

This mark on a product and/or accompanying documents indicates that when it is to be disposed of, it must be treated as Waste Electrical & Electronic Equipment (WEEE).

Any WEEE marked waste products must not be mixed with general household waste, but kept separate for the treatment, recovery and recycling of the materials used.

For proper treatment, recovery and recycling; please take all WEEE marked waste to your Local Authority Civic waste site, where it will be accepted free of charge.

If all consumers dispose of Waste Electrical & Electronic Equipment correctly, they will be helping to save valuable resources and preventing any potential negative effects upon human health and the environment, of any hazardous materials that the waste may contain.



Note about Remote control battery:

There is a risk of explosion if battery is replaced by an incorrect type. Dispose of used batteries according to the instructions.

Tiny Audio is distributed by TT Micro AS – Salg@ttmicro.no – www.ttmicro.no