

# SAMSUNG

## Product Guide

# Bespoke 3-Door French Door Refrigerator (30 cu. ft.) with Beverage Center™

**RF30BB6600**

Available in:

Bespoke 3-Door French Door Refrigerator (30 cu. ft.) with Beverage Center™  
in Customizable Door Panel Colors

Bespoke 3-Door French Door Refrigerator (30 cu. ft.) with Beverage Center™  
in Stainless Steel - All Panels

Bespoke 3-Door French Door Refrigerator (30 cu. ft.) with Beverage Center™  
in White Glass - All Panels

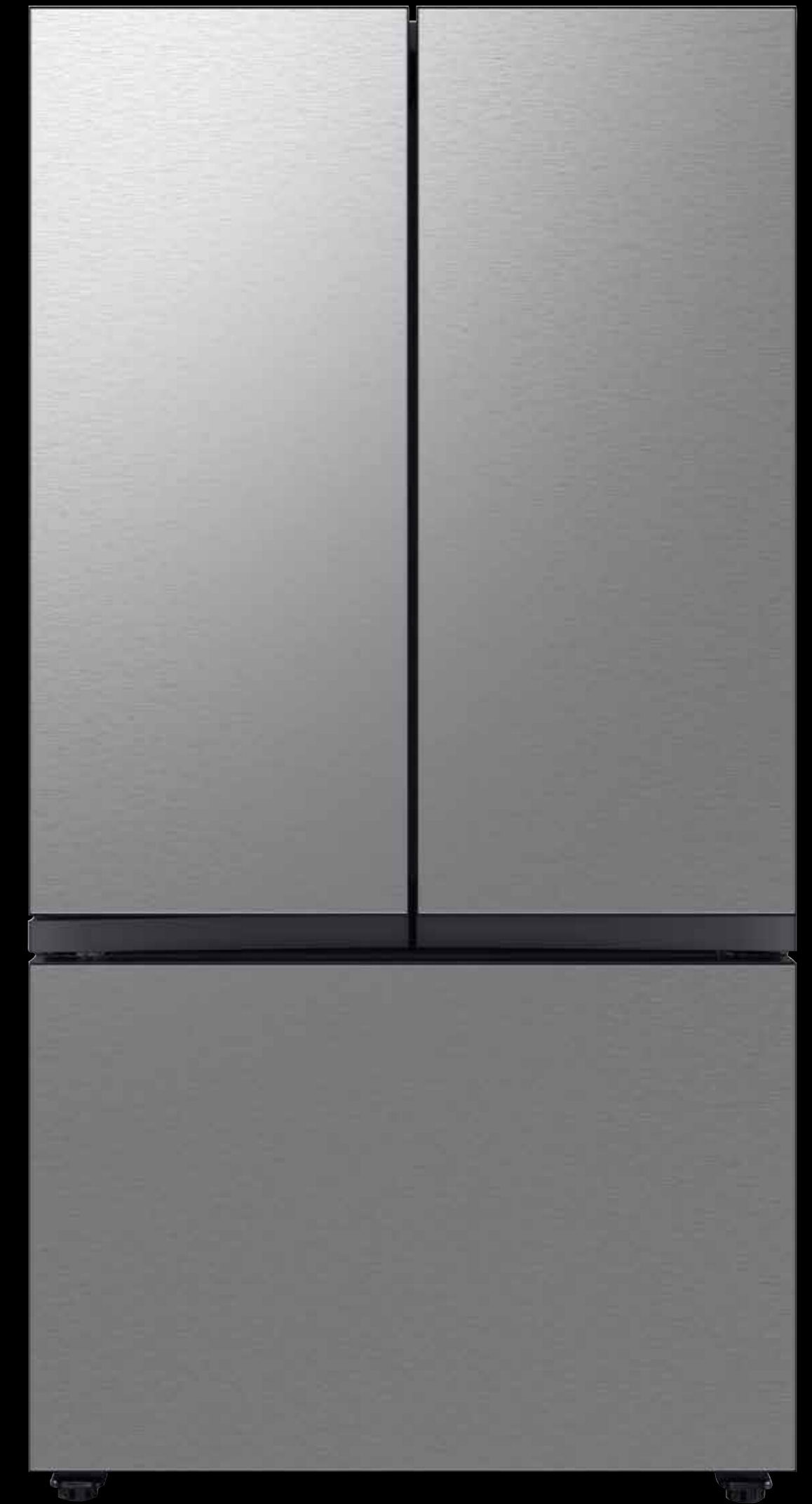

# Table of Contents

## Product Overview

Product Overview	4
Carousel Image Order	5

## Product Messaging

Features and Benefits	9
Lifestyle Images	14
Videos	16

## Product Specs

Review Mapping and Related Product	18
Spec Sheet	19
Will It Fit Guide	20
Energy Guide and User Manual	21
Bespoke Panel Installation Guide	22
Warranty	23

<b>Feature Icons</b>	<b>25</b>
----------------------	-----------

# Product Overview

---

**RF30BB6600 – Bespoke 3-Door French Door Refrigerator (30 cu. ft.) with Beverage Center™**

# Product Overview

## Product Title

Bespoke 3-Door French Door Refrigerator (30 cu. ft.) with Beverage Center™

## Product Description

Extra-large capacity 3-Door French Door Refrigerator with customizable and changeable door panels available in a variety of colors and finishes. A revolution in convenience and design, the concealed Beverage Center™ features both a water dispenser and AutoFill Water Pitcher. Plus a Dual Ice Maker with cubed ice and Ice Bites™.

## Available Colors



**Bespoke 3-Door French Door Refrigerator (30 cu. ft.) with Beverage Center™ in Customizable Door Panel Colors**

RF30BB6600AP



**Bespoke 3-Door French Door Refrigerator (30 cu. ft.) with Beverage Center™ in Stainless Steel – All Panels**

RF30BB6600QL



**Bespoke 3-Door French Door Refrigerator (30 cu. ft.) with Beverage Center™ in White Glass – All Panels**

RF30BB660012





# RF30BB6600AP Carousel Image Order

Easy Ad Links:

R.COM <https://dam.gettyimages.com/p/z0c3461/external?q=RF30BB6600AP%20Carousel%20Images%20RCOM>

S.COM <https://dam.gettyimages.com/p/z0c3461/external?q=RF30BB6600AP%20Carousel%20Images%20SCOM>

360 Spins <https://dam.gettyimages.com/p/z0c3461/external?q=RF30BB6600AP%20360%20Spins>





# RF30BB6600QL Carousel Image Order

Easy Ad Links:

R.COM <https://dam.gettyimages.com/p/z0c3461/external?q=RF30BB6600QL%20Carousel%20Images%20RCOM>

S.COM <https://dam.gettyimages.com/p/z0c3461/external?q=RF30BB6600QL%20Carousel%20Images%20SCOM>

360 Spins: See RF30BB6600AP Carousel for available assets.





# RF30BB660012 Carousel Image Order

Easy Ad Links:

R.COM <https://dam.gettyimages.com/p/z0c3461/external?q=RF30BB660012%20Carousel%20Images%20RCOM>

S.COM <https://dam.gettyimages.com/p/z0c3461/external?q=RF30BB660012%20Carousel%20Images%20SCOM>

360 Spins: See RF30BB6600AP Carousel for available assets.





# Product Messaging

---



**RF30BB6600 – Bespoke 3-Door French Door Refrigerator (30 cu. ft.) with Beverage Center™**



## Features and Benefits – RF30BB6600



Overall Product Headline	Feature Name	Long Body Copy	Short Body Copy	Associated Image
<p><b>Customizable Door Colors</b></p>	<p><b>Color Customization</b></p>	<p>Customize the design of your refrigerator with changeable door panels. Choose from a variety of colors and two finishes to create a space that fits your style.</p>	<p>With customizable door panels, choose from twelve colors and two finishes to create a space that fits your style.</p>	
<p><b>Press or Pour – Water Two Ways</b></p>	<p><b>Beverage Center™</b></p>	<p>Quick access to refreshingly cool, filtered water two ways. Choose from an internal dispenser or a built-in pitcher that automatically refills, with the option to infuse with a flavor.</p>	<p>Choose from an internal dispenser or a built-in AutoFill Water Pitcher.</p>	
<p><b>More space, more ways to stay organized</b></p>	<p><b>Extra-large Capacity</b></p>	<p>With 30 cu. ft. of capacity, this spacious refrigerator is designed for convenience, offering flexibility and organization to store and access all your favorite foods with ease.</p>	<p>30 cu. ft. of flexible storage space to fit all the food you love, with room for more.</p>	

## Features and Benefits – RF30BB6600 (Continued)

Overall Product Headline	Feature Name	Long Body Copy	Short Body Copy	Associated Image
<b>Ice your way</b>	<b>Dual Ice Maker with Ice Bites™</b>	Enjoy your favorite beverage with your choice of ice. Select from cubed ice or Ice Bites™ that chill your drink faster.	Select from cubed ice or Ice Bites™ that chill your drink faster.	
<b>Designed for a modern look</b>	<b>Modern Design</b>	Flat Panel door design with easy-to-open recessed handles blends into your kitchen to give you a modern look.	Modern look that blends into your kitchen.	
<b>Separate pantry drawers for more storage</b>	<b>Pantry Drawers</b>	Two separate drawers that let you store more deli items, meat, poultry, and fish, including larger-sized items.	Store more meat, poultry and fish.	



## Features and Benefits – RF30BB6600 (Continued)

Overall Product Headline	Feature Name	Long Body Copy	Short Body Copy	Associated Image
Keep your fruits and vegetables fresh	Large Crisper Drawers	Two large drawers that are perfect for storing fruits and vegetables.	Two large drawers perfect for storing fruits and vegetables.	
N/A	Twin Cooling Plus™	Independent fridge and freezer controls keep food fresher longer.	Independent controls keep food fresher longer.	
Stay connected anywhere, anytime	Wi-Fi Connectivity	Use the Samsung SmartThings App* to get notified when the door's open or when you need a new water filter. <small>*Available on Android and iOS devices. A Wi-Fi connection and a Samsung account are required.</small>	Use Samsung SmartThings to get notified when the door's open or when you need a new water filter.* <small>*Available on Android and iOS devices. A Wi-Fi connection and a Samsung account are required.</small>	



## Features and Benefits – RF30BB6600 (Continued)

Overall Product Headline	Feature Name	Long Body Copy	Short Body Copy	Associated Image
N/A	<b>ADA-Compliant Display</b>	ADA-Compliant Display Easy-to-reach controls for everyone.	Easy-to-reach controls.	

# Lifestyle Images

---

**RF30BB6600 – Bespoke 3-Door French Door Refrigerator (30 cu. ft.) with Beverage Center™**

# Lifestyle Images

Easy Ads link

<https://dam.gettyimages.com/p/z0c3461/external?o=AND&q=RF30BB6600%20Lifestyle%20Image>





# Videos

---

**RF30BB6600 – Bespoke 3-Door French Door Refrigerator (30 cu. ft.) with Beverage Center™**

# Videos

## Easy Ads link

<https://dam.gettyimages.com/p/z0c3461/external?o=AND&q=RF30BB6600%20Videos>



Overview Bespoke 3-Door



Color Customization



Beverage Center™



Large Capacity 3-Door



Wi-Fi Connectivity



Twin Cooling Plus™

# Product Specs

---

**RF30BB6600 – Bespoke 3-Door French Door Refrigerator (30 cu. ft.) with Beverage Center™**



# Review Mapping

SKU	Type	Color
RF30BB6600AP	3-Door French Door	Bespoke 3-Door French Door Refrigerator (30 cu. ft.) with Beverage Center™ in Customizable Door Panel Colors
RF30BB6600QL	3-Door French Door	Bespoke 3-Door French Door Refrigerator (30 cu. ft.) with Beverage Center™ in Stainless Steel – All Panels
RF30BB660012	3-Door French Door	Bespoke 3-Door French Door Refrigerator (30 cu. ft.) with Beverage Center™ in White Glass – All Panels

## Related Product

Water Filter
HAF-QIN

# Spec Sheet

## Easy Ads link

<https://dam.gettyimages.com/p/z0c3461/external?o=AND&q=RF30BB6600%20Spec%20Sheet>

## RF30BB6600

Bespoke 3-Door French Door Refrigerator  
(30 cu. ft.) with Beverage Center™

SAMSUNG





### Signature Features

**Customizable Door Colors**  
Customize the design of your refrigerator with changeable door panels. Choose from a variety of colors and two finishes to create a space that fits your style.

**Beverage Center™**  
Quick access to refreshingly cool, filtered water two ways. Choose from an internal dispenser or a built-in pitcher that automatically refills, with the option to infuse with a flavor.

**Extra-large Capacity**  
With 30 cu. ft. of capacity, this spacious refrigerator is designed for convenience, offering flexibility and organization to store and access all your favorite foods with ease.

Bespoke 3-Door French Door Standard Color Models

Design

- Customizable Door Colors
- Modern Design
- Recessed Handle

Technology

- Beverage Center™
- Wi-Fi Enabled

Performance

- Dual Ice Maker with Ice Bites
- 30 cu. ft. Capacity
- Twin Cooling Plus

Rating

ENERGY STAR® rated:  
695 kWh/yr





Spec Sheet - front

## RF30BB6600

Bespoke 3-Door French Door Refrigerator  
(30 cu. ft.) with Beverage Center™

SAMSUNG

### Installation Specifications

1. Measure the height, width and depth of the opening, making sure to include baseboards, molding, tile, countertop overhang, etc. Check to be sure there is enough room to open the door (consider walls, islands or other obstacles when measuring).
2. Refer to illustration below to determine dimensions.
3. Allow 2.5" of clearance on hinge side of refrigerator when installing next to a wall where handle may make contact.
4. Allow 1" minimum clearance at rear for proper air circulation and water/electrical connections. Allow a 3/8" minimum clearance at sides and top for ease of installation.
5. Ensure each door and entryway in the home is wide enough for the refrigerator to be moved through easily.

For optimal usage and ability to open refrigerator doors completely, do not install next to a wall.

Please note: The following dimension and cutout information is for planning purposes only. For complete installation details, consult manual packed with product, or download manual online at [samsung.com](http://samsung.com).

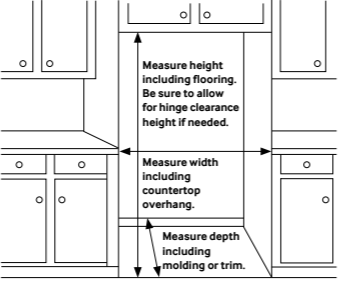

Total Capacity: 30.1 cu. ft.

Refrigerator: 21.1 cu. ft.

- 4 Tempered Glass Spill-Proof Shelves
- 2 Clear Drawers, Including Crisper+
- 2 Large Pantry Drawers
- 8 Door Bins
- Right: 1 Gallon Bin, 3 Regular Bins
- Left: 4 Regular Bins
- Surface Lighting

Freezer: 9.0 cu. ft.

- Dual Ice Maker in Freezer (Cubed Ice AND Ice Bites)
- Ice Bucket with Cover and 1 Scoop
- Produces up to 5.3 lbs ice/day, stores up to 9.9 lbs
- High Efficiency LED Lighting

Accessories

Water Filter: HAF-QIN

Warranty

One (1) Year Parts and Labor on Refrigerator  
Two (2) Years Parts and Labor on Ice Maker  
Five (5) Years Parts and Labor on Sealed Refrigeration System Only\*  
Ten (10) Years Parts and Five (5) Years Labor on Digital Inverter Compressor

\*Compressor, evaporator, condenser, drier and connecting tubing.

Product Dimensions

Dimensions (WxHxD with hinges and doors):  
35 3/4" x 70" x 34 1/4"

Dimensions (WxHxD without hinges and door):  
35 3/4" x 68 7/8" x 29 3/8"

Shipping Dimensions (WxHxD)

Dimensions: 38 1/4" x 75 1/4" x 36 1/4"

Color	Model #	UPC Code	Product & Shipping Weight (lbs)
Stainless Steel - All Panels	RF30BB6600QL	887276624419	332.9 357.1
White Glass - All Panels	RF30BB660012	887276639918	343.9 368.2
Custom Panel-Ready	RF30BB6600AP	887276624402	315.3 339.5

### Dimensions

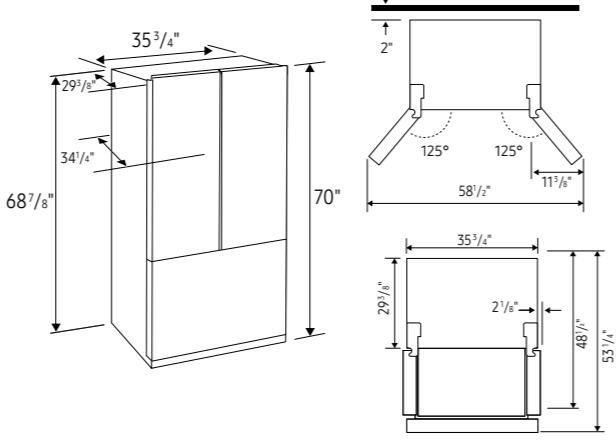

Actual color may vary. Design, specifications, and color availability are subject to change without notice. Non-metric weights and measurements are approximate.  
©2022 Samsung Electronics America, Inc., 85 Challenger Road, Ridgefield Park, NJ 07660. Tel: 800-SAMSUNG. [samsung.com](http://samsung.com). Samsung is a registered trademark of Samsung Electronics Co., Ltd.

Spec Sheet - back

# Will It Fit Guide

## Easy Ads link

<https://dam.gettyimages.com/p/z0c3461/external?o=AND&q=RF30BB6600%20Spec%20Sheet>

30 cu. ft. 3-Door French Door Refrigerator
SAMSUNG

MODEL RF30BB6600 DIMENSIONS

**Be sure your new fridge will fit**  
Don't wait until delivery to be sure your new refrigerator will fit – both in your kitchen and through all doorways. This guide includes all pertinent measurements and clearances so you can buy with confidence.

**Standard-Depth Refrigerator**  
Standard-depth refrigerators typically measure 30 to 35 inches in depth, as opposed to counter-depth refrigerators that sit flush with cabinetry.

**Installation clearances**

- ✓ Allow 3 3/4" of clearance when installing along a wall. This will allow for the door to open 90 degrees without the handle contacting the wall.
- ✓ Allow 2" minimum clearance at rear for proper air circulation and water/electrical connections.
- ✓ Allow a 3/8" minimum clearance at sides and top for ease of installation.

**For optimal usage and ability to open refrigerator doors completely, do not install next to a wall.**

Please note: The above dimension and cutout information is for planning purposes only. For complete installation details, consult manual packed with product or download manual online at [samsung.com](http://samsung.com).

**Walk the delivery route**

- ✓ Identify the narrowest opening that the appliance will travel through, from outside the home to the location where it will be installed.
- ✓ Appliance depth or width must be smaller than the width of the narrowest opening.

Will It Fit Guide



# Energy Guide and User Manual

## Easy Ads link

<https://dam.gettyimages.com/p/z0c3461/external?o=AND&q=RF30BB6600%20Energy%20Label>

U.S. Government Federal law prohibits removal of this label before consumer purchase.

# ENERGYGUIDE

Refrigerator-Freezer Samsung  
 • Automatic Defrost Model RF30BB6600\*\*  
 • Bottom-Mounted Freezer Capacity: 30.1 Cubic Feet  
 • No Through-the-Door Ice Service

**Compare ONLY to other labels with yellow numbers.**  
 Labels with yellow numbers are based on the same test procedures.

**Estimated Yearly Energy Cost**  
**\$83**

Cost Ranges	Models with similar features	\$78	\$86
	All models	\$78	\$107

**695 kWh**  
 Estimated Yearly Electricity Use



- Your cost will depend on your utility rates and use.
- Both cost ranges based on models of similar size capacity.
- Models with similar features have automatic defrost, bottom-mounted freezer, and no through-the-door ice.
- Estimated energy cost based on a national average electricity cost of 12 cents per kWh.

[ftc.gov/energy](http://ftc.gov/energy)

Energy Guide

## Easy Ads link

<https://dam.gettyimages.com/p/z0c3461/external?o=AND&q=RF30BB6600%20User%20Manual>

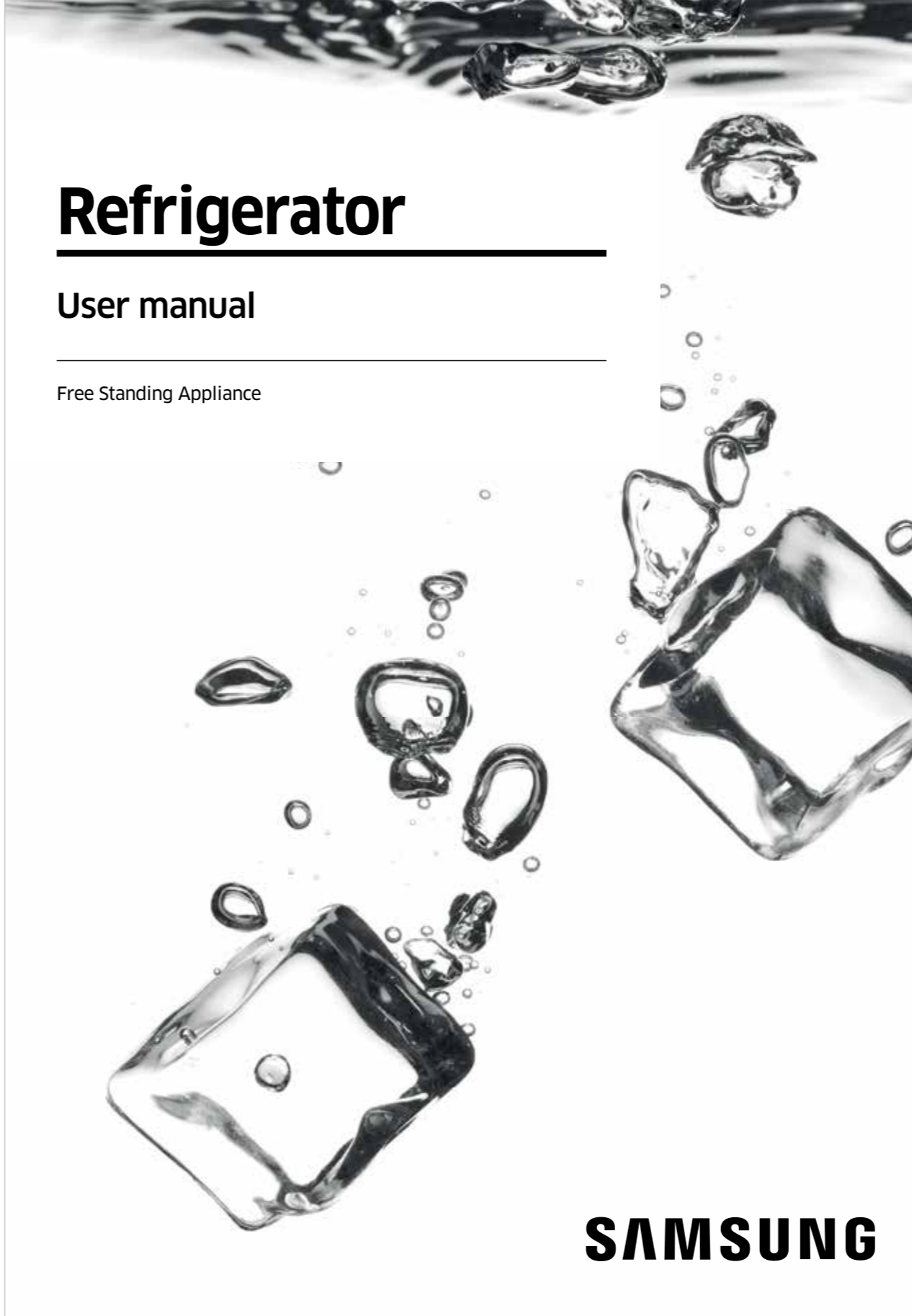

# Refrigerator

## User manual

Free Standing Appliance

**SAMSUNG**

User Manual

# Bespoke Panel Installation Guide

## Easy Ads link

<https://dam.gettyimages.com/p/z0c3461/external?o=AND&q=RF30BB6600%20Installation%20Guide>

## Installation Instruction

DA68-02659F-01

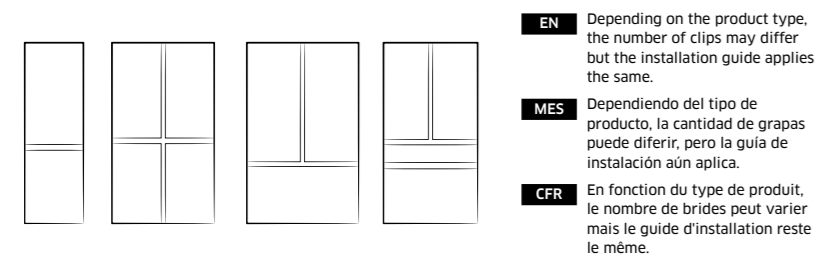

**EN** Depending on the product type, the number of clips may differ but the installation guide applies the same.

**MES** Dependiendo del tipo de producto, la cantidad de grapas puede diferir, pero la guía de instalación aún aplica.

**CFR** En fonction du type de produit, le nombre de brides peut varier mais le guide d'installation reste le même.

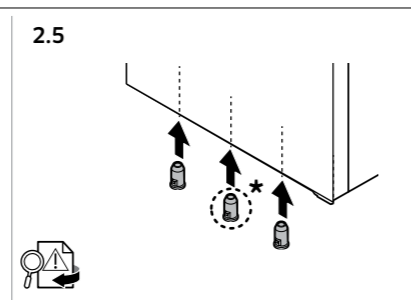
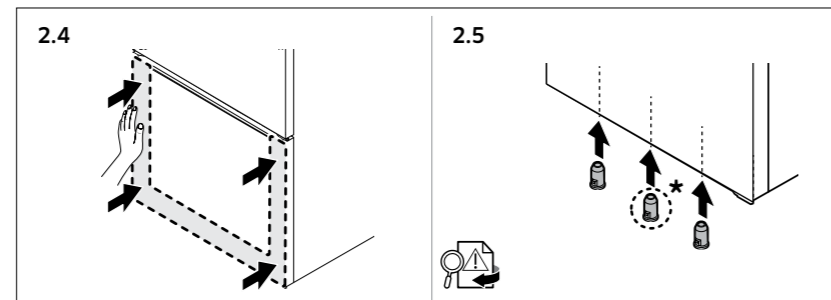
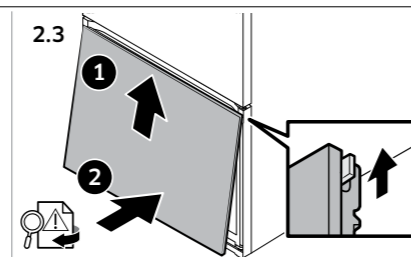
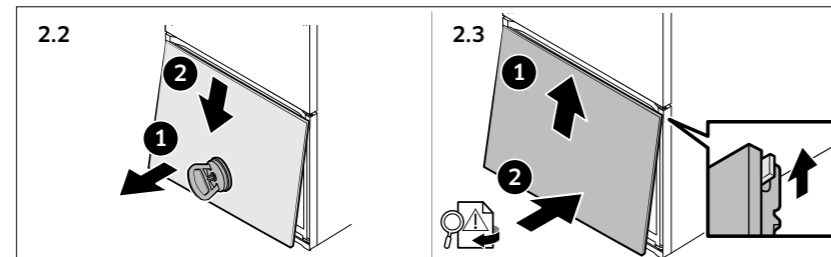
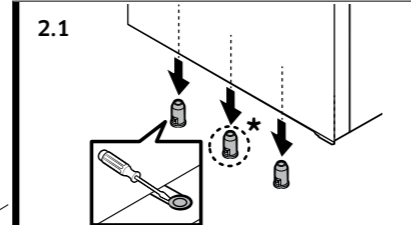
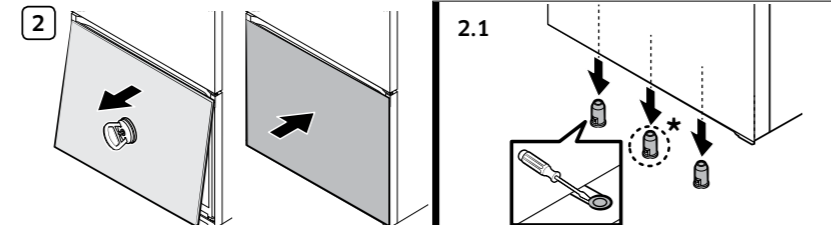
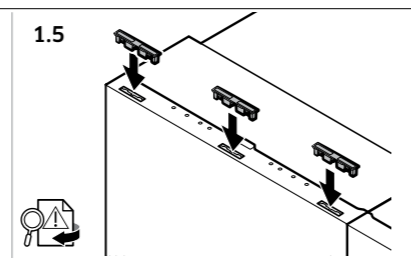
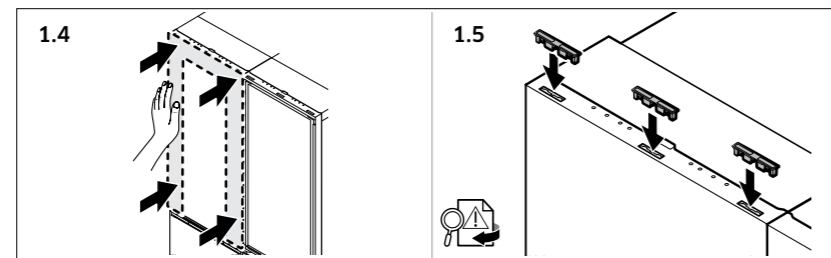
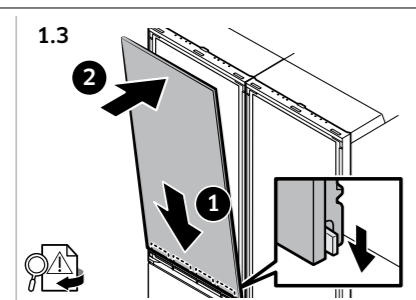
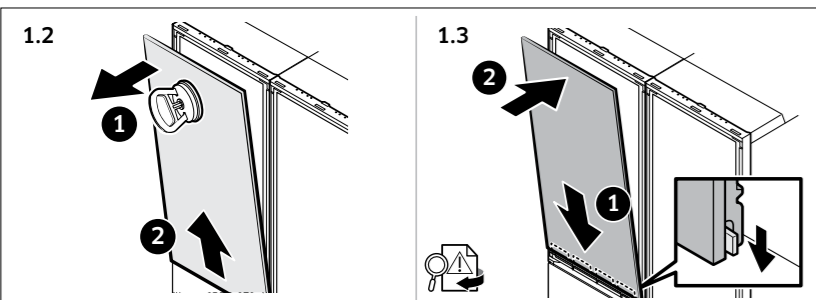
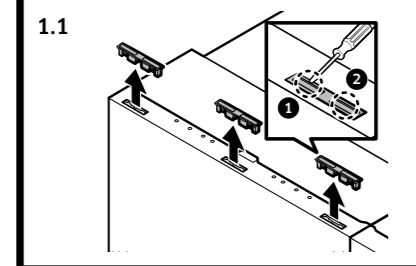
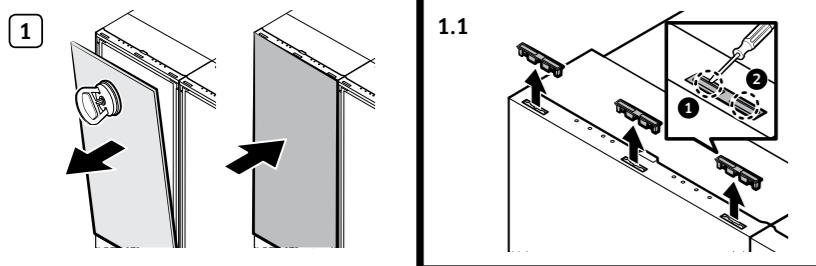
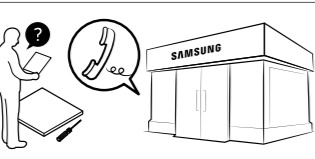
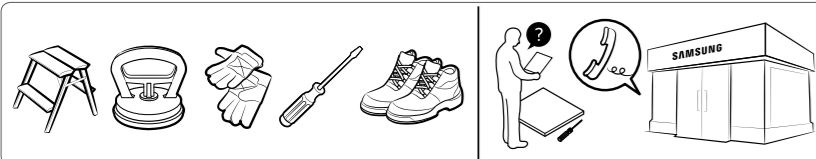

## Installation Instruction

### CAUTION

EN

- Place the top panel into the groove along the bottom of the top door and press the edges of the panel in to secure it as shown in figure 1.3. Make sure that there is no gap between the panel and the door. Once the panel is securely installed, insert the retaining clips as shown in figure 1.5.
- Place the middle or bottom panel into the groove along the top of the bottom door and press the edges of the panel in to secure it as shown in figure 2.3. Make sure that there is no gap between the panel and the door. Once the panel is securely installed, insert the retaining clips as shown in figure 2.5. (The number of clips differs with the product type.)
- After inserting the panel properly, make sure it is firmly secured by pressing its edges tightly.
- Ensure there is no gap between the panel and the door and the retaining clips are fully inserted to prevent the panel from falling off due to external forces.

- Wear gloves without ornaments such as rings before working on the installation.
- It is recommended to use a chair or ladder when working on a higher portion of the product. Be careful not to fall.
- For safety reasons, two or more persons are recommended to handle the product.
- When removing the bottom clips, take caution not to drop them under the bottom of the product.

### PRECAUCIÓN

MES

- Inserte el panel superior en el canal de abajo de la puerta superior y presione los bordes del panel para ensamblarlo como se muestra en la figura 1.3. Verifique que no haya espacio entre el panel y la puerta en ningún punto alrededor del marco y después fíjelo insertando los clips como se muestra en la figura 1.5.
- Coloque el panel central o inferior en la ranura a lo largo de la parte superior de la puerta inferior y presione los bordes del panel para asegurarlo como se muestra en la figura 2.3. Asegúrese de que no quede espacio entre el panel y la puerta. Una vez que el panel quede instalado en forma segura, inserte las grapas de retención como se muestra en la figura 2.5. (La cantidad de grapas varía según el tipo de producto).
- Luego de colocar el panel adecuadamente, asegúrese de que quede bien agarrado presionando sus bordes con firmeza.
- Si los clips no se insertan completamente o hay un espacio entre el panel y la puerta, el panel puede caerse con cualquier impacto externo, como golpes o cerrando fuerte la puerta.

- Use guantes sin accesorios tales como anillos antes de trabajar en la instalación.
- Se recomienda el uso de una silla o una escalera al trabajar en la parte superior del producto. Tenga cuidado de no caerse.
- Por razones de seguridad, se recomienda que el producto sea manipulado por dos o más personas.
- Al quitar las grapas de la parte inferior, tenga cuidado de que no se caigan debajo del producto.

### ATTENTION

CFR

- Insérez le panneau supérieur dans la rainure de fixation de la partie inférieure de la porte supérieure, puis appuyez sur le bord du panneau pour le fixer comme indiqué à la figure 1.3, et vérifiez qu'il n'y a pas d'espace entre le panneau et la porte, puis fixez-le en insérant les clips comme illustré à la figure 1.5.
- Placez le panneau central ou inférieur dans la rainure le long de la partie supérieure de la porte inférieure et appuyez sur les bords du panneau pour le fixer comme indiqué sur la figure 2.3. Vérifiez l'absence d'espace entre le panneau et la porte. Une fois le panneau correctement installé, insérez les brides de retenue comme indiqué sur la figure 2.5. (Le nombre de brides varie en fonction du type de produit.)
- Une fois le panneau inséré correctement, appuyez fermement sur ses bords pour vous assurer de sa fixation adéquate.
- Si les clips ne sont pas complètement insérés ou s'il y a un espace entre le panneau et la porte, le panneau peut tomber à la suite d'un choc externe.

- Portez des gants sans bijoux, telles que des bagues, lorsque vous procédez à l'installation.
- Il est recommandé d'utiliser une chaise ou une échelle lorsque vous intervenez sur une partie en hauteur de l'appareil. Faites attention à ne pas tomber.
- Pour des raisons de sécurité, deux personnes ou plus sont recommandées pour manipuler l'appareil.
- Lors du retrait des brides inférieures, veillez à ne pas les faire tomber sous l'appareil.

# Warranty

## Easy Ads link

<https://dam.gettyimages.com/p/z0c3461/external?o=AND&q=RF30BB6600%20Warranty>

### LIMITED WARRANTY (U.S.A.)

RF24BB6200  
RF30BB6200  
RF24BB6600  
RF30BB6600

#### SAMSUNG REFRIGERATOR

##### LIMITED WARRANTY TO ORIGINAL CONSUMER PURCHASER WITH PROOF OF PURCHASE

This SAMSUNG brand product, as supplied and distributed by Samsung Electronics America, Inc. (SAMSUNG) and delivered new, in the original carton to the original consumer purchaser, is warranted by SAMSUNG against manufacturing defects in materials or workmanship for the limited warranty period of:

One (1) Year Parts and Labor on Refrigerator

Two (2) Years Parts and Labor on Ice Maker

Five (5) Years Parts and Labor on Sealed Refrigeration System Only (Compressor, Evaporator, Condenser, Drier, and Connecting Tubing)

Ten (10) Years Parts and Five (5) Years Labor on Digital Inverter Compressor

This limited warranty is valid only on products purchased and used in the United States that have been installed, operated, and maintained according to the instructions attached to or furnished with the product. To receive warranty service, the purchaser must contact SAMSUNG at the address or phone number provided below for problem determination and service procedures. Warranty service can only be performed by a SAMSUNG authorized service center. The original dated bill of sale must be presented upon request as proof of purchase to SAMSUNG or SAMSUNG's authorized service center to receive warranty service.

SAMSUNG will provide in-home service within the contiguous United States during the warranty period at no charge, subject to availability of SAMSUNG authorized servicers within the customer's geographic area. If in-home service is not available, SAMSUNG may elect, at its option, to provide transportation of the product to and from an authorized service center. If the product is located in an area where service by a SAMSUNG authorized servicer is not available, you may be responsible for a trip charge or required to bring the product to a SAMSUNG authorized service center for service.

To receive in-home service, product must be unobstructed and accessible to the service agent.

During the applicable warranty period, a product will be repaired, replaced, or the purchase price refunded, at the sole option of SAMSUNG. SAMSUNG may use new or reconditioned parts in repairing a product, or replace the product with a new or reconditioned product. Replacement parts and products are warranted for the remaining portion of the original product's warranty or ninety (90) days, whichever is longer. All replaced parts and products are the property of SAMSUNG and you must return them to SAMSUNG.

This limited warranty covers manufacturing defects in materials or workmanship encountered in normal household, noncommercial use of this product and shall not cover the following: damage that occurs in shipment, delivery, installation, and uses for which this product was not intended; damage caused by unauthorized modification or alteration of the product; product where the original factory serial numbers have been removed, defaced, changed in any way, or cannot be readily determined; cosmetic damage including scratches, dents, chips, and other damage to the product's finishes; damage caused by abuse, misuse, pest infestations, accident, fire, floods, or other acts of nature or God; damage caused by use of equipment, utilities, services, parts, supplies, accessories, applications, installations, repairs, external wiring or connectors not supplied or authorized by SAMSUNG; damage caused by incorrect electrical line current, voltage, fluctuations and surges; damage caused by failure to operate and maintain the product according to instructions; in-home instruction on how to use your product; and service to correct installation not in accordance with electrical or plumbing codes or correction of household electrical or plumbing (i.e., house wiring, fuses, or water inlet hoses). The cost of repair or replacement under these excluded circumstances shall be the customer's responsibility.

Visits by an authorized servicer to explain product functions, maintenance or installation are not covered by this limited warranty. Please contact SAMSUNG at the number below for assistance with any of these issues.

#### EXCLUSION OF IMPLIED WARRANTIES

IMPLIED WARRANTIES, INCLUDING THE IMPLIED WARRANTIES OF MERCHANTABILITY OR FITNESS FOR A PARTICULAR PURPOSE, ARE LIMITED TO ONE YEAR OR THE SHORTEST PERIOD ALLOWED BY LAW. Some states do not allow limitations on how long an implied warranty lasts, so the above limitations or exclusions may not apply to you. This warranty gives you specific rights, and you may also have other rights, which vary from state to state.

#### LIMITATION OF REMEDIES

YOUR SOLE AND EXCLUSIVE REMEDY IS PRODUCT REPAIR, PRODUCT REPLACEMENT, OR REFUND OF THE PURCHASE PRICE AT SAMSUNG'S OPTION, AS PROVIDED IN THIS LIMITED WARRANTY. SAMSUNG SHALL NOT BE LIABLE FOR SPECIAL, INCIDENTAL OR CONSEQUENTIAL DAMAGES, INCLUDING BUT NOT LIMITED TO TIME AWAY FROM WORK, HOTELS AND/OR RESTAURANT MEALS, REMODELING EXPENSES, LOSS OF REVENUE OR PROFITS, FAILURE TO REALIZE SAVINGS OR OTHER BENEFITS REGARDLESS OF THE LEGAL THEORY ON WHICH THE CLAIM IS BASED, AND EVEN IF SAMSUNG HAS BEEN ADVISED OF THE POSSIBILITY OF SUCH DAMAGES. Some states do not allow exclusion or limitation of incidental or consequential damages, so the above limitations or exclusions may not apply to you. This warranty gives you specific rights, and you may also have other rights, which vary from state to state.

SAMSUNG does not warrant uninterrupted or error-free operation of the product. No warranty or guarantee given by any other person, firm, or corporation with respect to this product shall be binding on SAMSUNG.

To obtain warranty service, please contact SAMSUNG at:

Samsung Electronics America, Inc.  
85 Challenger Road  
Ridgefield Park, NJ 07660  
1-800-SAMSUNG (726-7864)  
[www.samsung.com/us/support](http://www.samsung.com/us/support)



# Feature Icons

---

**RF30BB6600 – Bespoke 3-Door French Door Refrigerator (30 cu. ft.) with Beverage Center™**

# Feature Icons

## Easy Ads link

<https://dam.gettyimages.com/p/z0c3461/external?o=AND&q=RF30BB6600%20Icons>

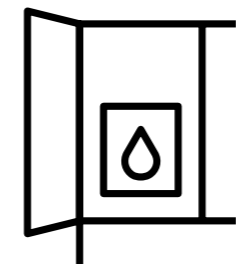

Beverage Center

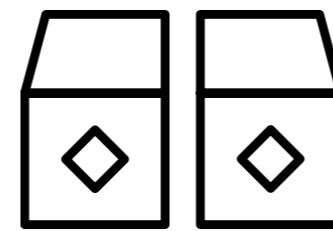

Dual Ice Maker

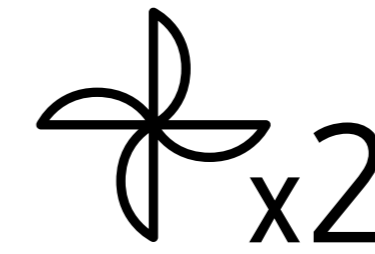

Twin Cooling Plus™

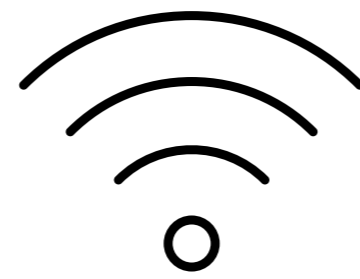

Wi-Fi Connectivity



ADA Compliant

**SAMSUNG**