

MNS-300EM

Embedded Manual



Copyright© 2019 silex technology, Inc. All rights reserved.

WA105830XX

Index

1. Introduction	1
1-1. Introduction	2
MNS-300EM User's Manuals	2
Disclaimers.....	2
Trademarks	2
1-2. Safety Instructions	3
1-3. Product Information and Customer Services.....	6
Product Information	6
Customer Support Center	6
2. Product Specifications	7
2-1. MNS-300EM Embedding Methods	8
2-1-1. Parts and Functions.....	9
2-1-2. Dimensions.....	10
2-2. Interface Connector	11
2-2-1. Interface Connector	11
2-2-2. Pin Allocation for Interface Connector.....	12
2-3. Antenna Specifications	13
2-3-1. Antenna Connector.....	13
2-3-2. List of Recommended Antennas	14
3. How to Embed MNS-300EM	15

3-1. Necessary Items	16
3-2. Installation	18
3-3. Initial Configuration	20
3-3-1. Configuration Using Console Commands.....	20
Configuration from UART1.....	20
Configuration from UART3.....	22
3-3-2. Configuration Using AMC Manager®	23
Connecting Target Product to PC	23
Configuring MNS-300EM Setting	25
A. Appendix	27
A-1. MNS-300EM-EVK Circuit Schematic.....	28

1. Introduction

Thank you for purchasing the Intelligent Module MNS-300EM.

1-1. Introduction

MNS-300EM User's Manuals

MNS-300EM has the following user's manuals:

MNS-300EM Embedded Manual (this document)

This document describes the specifications and procedures for embedding MNS-300EM into the customer's device (hereinafter "target device").

MNS-300EM Setting Manual

This document explains the functions and configuration methods of MNS-300EM.

MNS-300EM Command Manual

This document describes the console commands that can be used on MNS-300EM.

Before using MNS-300EM, please read **1-2. Safety Instructions** in this manual.

Disclaimers

- The unauthorized transfer or copying of the content of this manual, in whole or in part, without prior written consent is expressly prohibited by law.
- The content of this manual is subject to change without notice.
- Although every effort was made to prepare this manual with the utmost accuracy, Silex Technology will not be held liable for any damages as a result of errors, setting examples, or other content.

Trademarks



- AMC Manager® is a registered trademark of Silex Technology.
- Microsoft and Windows are either registered trademarks or trademarks of Microsoft Corporation in the United States and/or other countries.
- Other brand or product names are registered trademarks or trademarks of their respective owners.

1-2. Safety Instructions







This page provides the safety instructions for safe use of MNS-300EM.

To ensure safe and proper use, please read the following information carefully before using MNS-300EM. The safety instructions include important information on safe handling of MNS-300EM and on general safety issues.



<Indication of the warning>

	Warning	<ul style="list-style-type: none"> "Warning" indicates the existence of a hazard that could result in death or serious injury if the safety instruction is not observed.
	Caution	<ul style="list-style-type: none"> "Caution" indicates the existence of a hazard that could result in serious injury or material damage if the safety instruction is not observed.

<Meaning of the symbols>



	<ul style="list-style-type: none"> This symbol indicates the warning and caution. (Example:  "Danger of the electric shock")
	<ul style="list-style-type: none"> This symbol indicates the prohibited actions. (Example:  "Disassembly is prohibited")
	<ul style="list-style-type: none"> This symbol indicates the actions users are required to observe. (Example:  "Remove the AC plug from an outlet")

 **Warning**

	<ul style="list-style-type: none">• Do not disassemble or modify MNS-300EM. It may cause fire, electrical shock or malfunction.• Do not disassemble or modify the AC adapter that comes with the evaluation board of MNS-300EM. It may cause fire, electrical shock or malfunction.
	<ul style="list-style-type: none">• Do not allow physical impact. When damaged, turn off the connected devices, unplug the AC plug of MNS-300EM from a power outlet and contact your point of purchase. Failure to take this action could cause fire or an electrical shock.• In the following cases, turn off the connected devices and unplug the AC plug of MNS-300EM from a power outlet and contact your point of purchase. Failure to take this action could cause fire or an electrical shock.<ul style="list-style-type: none">- When MNS-300EM emits a strange smell, smoke or sound or becomes too hot to touch.- When foreign objects (metal, liquid, etc.) gets into MNS-300EM.
	<ul style="list-style-type: none">• Keep the cords and cables away from children. It may cause an electrical shock or serious injury.• If a ground wire is supplied with your device to use with, connect it to the ground terminal in order to prevent an electrical shock. Do not connect the ground wire to gas pipe, water pipe, lighting rod or telephone ground wire. It may cause malfunction.



Caution

	<ul style="list-style-type: none">• Do not place any objects on the cable or bend, twist, or pull it excessively.• Do not use or store MNS-300EM under the following conditions. It may cause malfunction.<ul style="list-style-type: none">- Locations subject to vibration or shock- Shaky, uneven or tilted surfaces- Locations exposed to direct sunlight- Humid or dusty places- Wet places (kitchen, bathroom, etc.)- Near a heater or stove- Locations subject to extreme changes in temperature- Near strong electromagnetic sources (magnet, radio, wireless device, etc.)
	<ul style="list-style-type: none">• When removing MNS-300EM, disconnect the AC plugs of both MNS-300EM and the other devices you are using with.• Verify all codes or cables are plugged correctly before using MNS-300EM.• When MNS-300EM will not be used for a long time, unplug the power cables of MNS-300EM and the other devices you are using with.
	<ul style="list-style-type: none">• When unplugging the power plug of the evaluation board, do not pull the cord. The cord may be damaged and it may result in fire or electrical shock. Be sure to hold the plug when disconnecting it.

1-3. Product Information and Customer Services

Product Information

The services below are available from the Silex Technology website. For details, please visit the Silex Technology website.

Silex Technology website
(URL) <https://www.silextechnology.com/>

- Latest firmware download
- Latest software download
- Latest manual download
- Support information (FAQ)

Customer Support Center

Customer Support is available by e-mail or telephone for any problems that you may encounter. If you cannot find the relevant problem in this manual or on our website, or if the corrective procedure does not resolve the problem, please contact Silex Technology Customer Support.

Contact Information		
USA	+1-657-218-5199	support@silexamerica.com
Europe	+49-2154-88967-0	support@silexeurope.com



Note

- Refer to the Silex Technology website (<https://www.silextechnology.com/>) for the latest FAQ and product information.

2. Product Specifications

This chapter describes the specifications of interfaces and antennas.

2-1. MNS-300EM Embedding Methods

There are following methods to embed MNS-300EM in the target device.

Directly connect MNS-300EM to the target PCB

When a PCB of the target device is equipped with a connector or a spacer, MNS-300EM can directly be connected to it without a special daughter card or a cable.

Use a special daughter card to embed

Create a special daughter card, connect MNS-300EM to it and then embed it to the target device. As a sample of creating the daughter card, MNS-300EM's evaluation board, **MNS-300EM-EVK** can be used. (For more details, refer to **2-2. Evaluation Board** in **MNS-300EM Setting Manual**.) As a supporting document for the daughter card design, the circuit schematics of the evaluation board can be found at **A. Appendix**.

Use a dedicated cable

When MNS-300EM cannot be directly connected to a daughter card or PCB, create a special cable. One end requires a 50-pin female connector to connect MNS-300EM, while the other end requires an appropriate connector for the target device.

MNS-300EM is equipped with the following connectors:

- 50-pin connector

The 50-pin connector is a main component to connect the target device or the special daughter card and MNS-300EM. The pin allocation of the connector and the notes on the structure will be explained in this chapter.

- Wireless LAN antenna connector

MNS-300EM is equipped with two U.FL connectors.

2-1-1. Parts and Functions

The parts and functions are as follows:

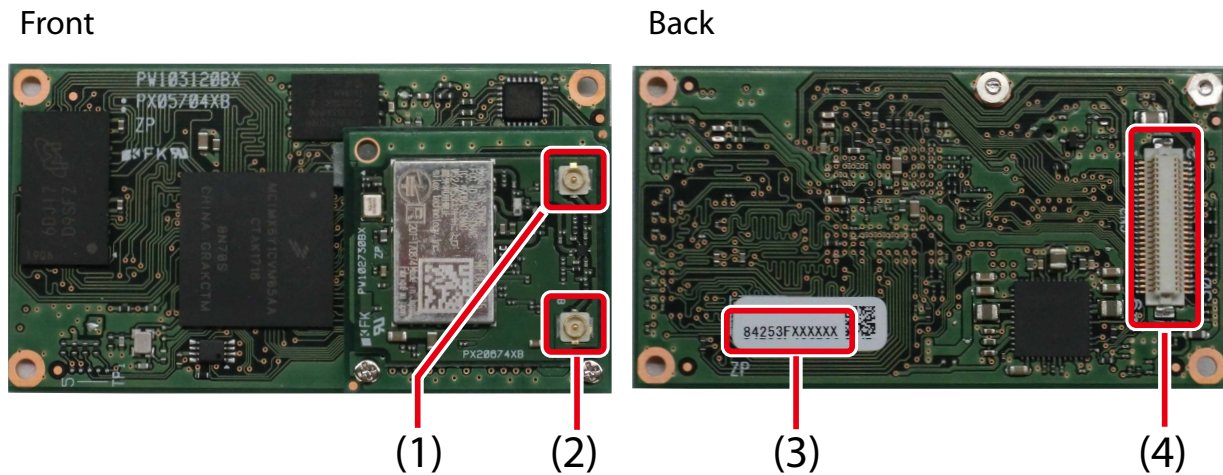

#	Name	Description
(1)	Secondary antenna connector	Connect to a wireless LAN antenna.
(2)	Primary antenna connector	For how to connect a wireless LAN antennas, refer to 2-3-1 Antenna Connector .
(3)	MAC address	MAC address of MNS-300EM. The last 6 digits are the serial number. Example) When the MAC address is 84:25:3F:00:11:22, it is noted on the label as "84253F001122" and then the serial number is "001122".
(4)	Interface connector	A 50-pin male connector that connects MNS-300EM and the target device or the special daughter card. For the connector specification, refer to 2-2-1. Interface Connector .

2-1-2. Dimensions

The dimensions are described below.

Use this information for your reference to design a special daughter board.

(Unit : mm)

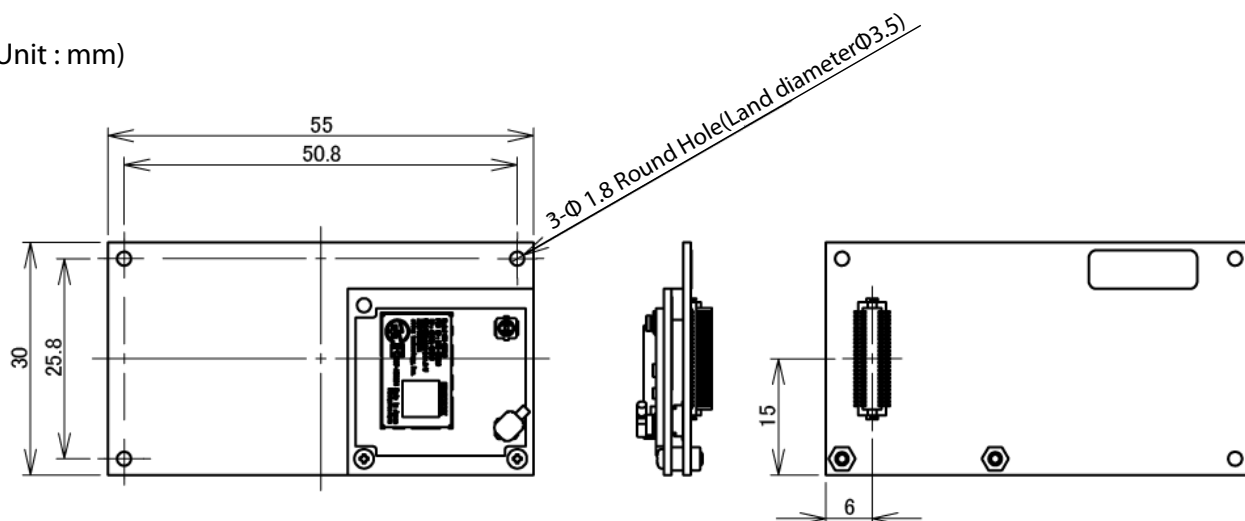

The height of MNS-300EM varies with a female connector to use.

For details, see **2-2-1. Interface Connector**.

2-2. Interface Connector

2-2-1. Interface Connector

For the interface connector, Hirose's 50-pin male connector is used. The following table shows the connector model number and compatible female connector models.

MNS-300EM's connector	DF12-50DS-0.5V (86) (HIROSE)
Compatible connectors	DF12(3.5)-50DP-0.5V (86) (HIROSE)
	DF12(4.0)-50DP-0.5V (86) (HIROSE)
	DF12(5.0)-50DP-0.5V (86) (HIROSE)

The distance between MNS-300EM and the target device or special daughter card ('A' in the image below) changes depending on the connectors.

The following shows the clearance after the target device or daughter card is connected.

(Unit : mm)

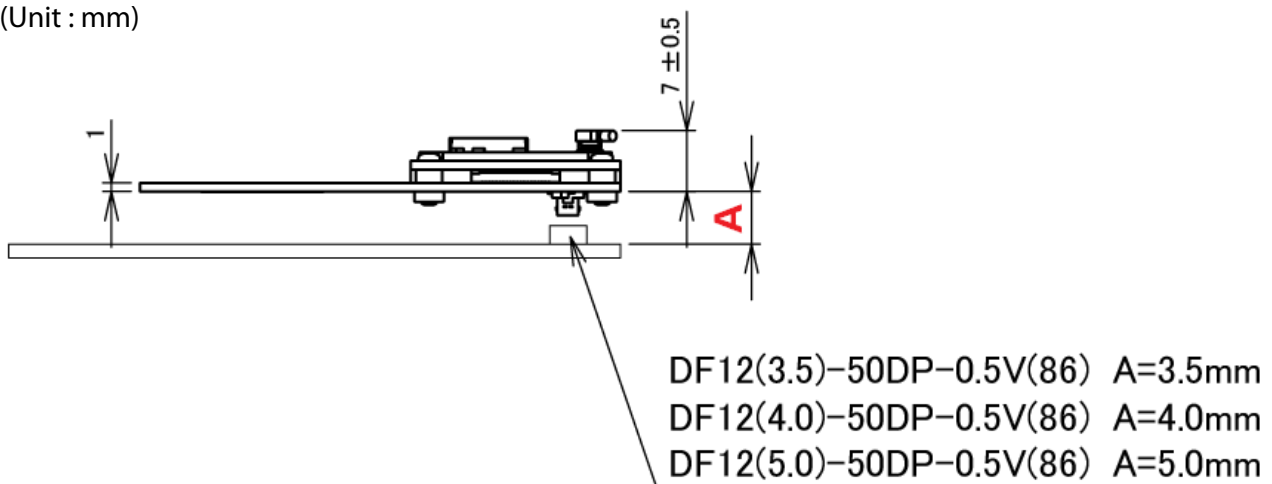

- To connect MNS-300EM, three spacers are required. Prepare spacers of appropriate height.

TIP

2-2-2. Pin Allocation for Interface Connector

The interface connector is a component that connects MNS-300EM to the target device. The connector consists of 50 pins and includes important signal lines such as serial data I/O, GPIO and power. The following table shows the pin allocation of the interface connector.

PIN	SIGNAL	ATTRIBUTE	BUFFER	PIN	SIGNAL	ATTRIBUTE	BUFFER
1	+5.0V	+5.0V	Power	2	+5.0V	+5.0V	Power
3	+5.0V	+5.0V	Power	4	GPIO0/Switch	I/O(PU)	LVTTTL
5	RESET	I(PU)	LVTTTL	6	RESETOUT	O(PD)	LVTTTL
7	GND	GND	Power	8	GND	GND	Power
9	USB1-DP	I/O	USB	10	USB2-DN	I/O	USB
11	USB1-DN	I/O	USB	12	USB2-DP	I/O	USB
13	GND	GND	Power	14	GND	GND	Power
15	PCM_IN	I	LVTTTL	16	PCM_OUT	O	LVTTTL
17	PCM_BCK	I/O	LVTTTL	18	GPIO1	I/O(PU)	LVTTTL
19	PCM_SYNC	I/O	LVTTTL	20	GPIO3	I/O(PU)	LVTTTL
21	GPIO2	I/O(PU)	LVTTTL	22	GPIO5	I/O(PU)	LVTTTL
23	GPIO4	I/O(PU)	LVTTTL	24	GPIO7	I/O(PU)	LVTTTL
25	GPIO6	I/O(PU)	LVTTTL	26	GND	GND	Power
27	GPIO8	I/O(PU)	LVTTTL	28	UART2 TX	O	LVTTTL
29	GPIO9	I/O(PU)	LVTTTL	30	UART2_CTS	I(PU)	LVTTTL
31	UART3 TX	O	LVTTTL	32	UART2_RTS	O	LVTTTL
33	UART3 RX	I(PU)	LVTTTL	34	UART2_RX	I(PU)	LVTTTL
35	GPIO11	I/O	LVTTTL	36	UART1_TX	O	LVTTTL
37	GPIO12	I/O(PU)	LVTTTL	38	UART1_RX	I(PU)	LVTTTL
39	GPIO13	I/O	LVTTTL	40	I2C_SCL	I/O(PU)	I2C
41	GPIO14	I/O	LVTTTL	42	I2C_SDA	I/O(PU)	I2C
43	GND	GND	Power	44	GND	GND	Power
45	LAN_TX_P	O	LAN	46	LAN_RX_P	I	LAN
47	LAN_TX_M	O	LAN	48	LAN_RX_M	I	LAN
49	LAN_CT	O	LVTTTL	50	GPIO10	I/O(PU)	LVTTTL

I (PU), O (PU), I/O (PU) : 3.3V 10 kΩ pull-up

O (PD) : 10 kΩ pull-down

2-3. Antenna Specifications

2-3-1. Antenna Connector

MNS-300EM is equipped with two SMT Ultra-miniature coaxial connectors (U.FL/I-PEX). Connect a wireless LAN antenna as follows.

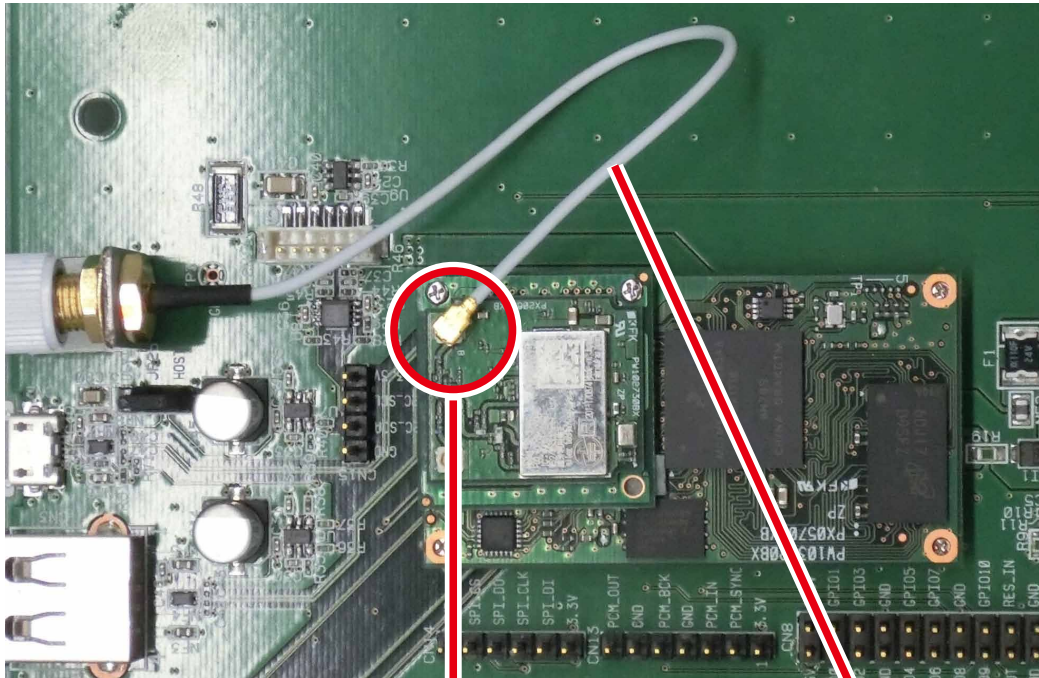

Primary Antenna Connector

Antenna Cable



- MNS-300EM does not support a diversity function.

2-3-2. List of Recommended Antennas

The following antennas are recommended:

Antenna	Vendor	Gain (2.4GHz)	Gain (5GHz)
H2B1PC1A1C (AA258) (Exclude cable loss)	Unictron URL: https://www.unictron.com/index/	+2.9dBi	+4.4dBi
H2B1PD1A1C (AA222) (Exclude cable loss)	Unictron URL: https://www.unictron.com/index/	+2.8dBi	+4.2dBi
H2U84W1H1S (AA077) (On-board antenna)	Unictron URL: https://www.unictron.com/index/	+1.4dBi	+2.3dBi
1461530100 (Exclude cable loss)	Molex URL: http://www.molex.com/molex/home	+3.25dBi	+5.0dBi
1000418 (Exclude cable loss)	Etheronics URL: https://www.ethertronics.com/	+2.5dBi	+3.5dBi
ANTDC-081A0/B0 (Exclude cable loss)	SANSEI ELECTRIC URL: http://www.sansei-e.co.jp/	+2.0dBi	+2.0dBi
ANTDP-027A0 (Exclude cable loss)	SANSEI ELECTRIC URL: http://www.sansei-e.co.jp/	+1.5dBi	+2.1dBi



- To use with Bluetooth, antennas with a gain +5.0dBi (2400MHz-2500MHz) or less will need to be used taking account of the cable loss.

3. How to Embed MNS-300EM

This chapter describes how to embed MNS-300EM to the target device.

The following shows the example to attach MNS-300EM to a PCB of the target device or to the special daughter card.

3-1. Necessary Items

The following components are needed for the installation on the target PCB or the daughter card. Since they do not come with MNS-300EM or EVK, prepare them on your own.

Screws x 3

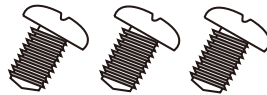

Spacers x 3

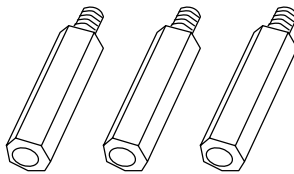

Screw nuts x 3

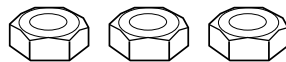

Recommended screws, spacers, and screw nuts vary with the interface connector (female) on the target PCB or the daughter card.

The following table shows the recommended components:

Interface connector (female)	Spacer (manufacturer)	Screw nut (manufacturer)	Screws	Spacer specifications
DF12(3.5)-50DP-0.5V(86)	CF-2003.5ZE (HIROSUGI-KEIKI)	BNT-17 (HIROSUGI-KEIKI)	Nickel-iron pan M1.7x7mm	
DF12(4.0)-50DP-0.5V(86)	BSB-1704E (HIROSUGI-KEIKI)	BNT-17 (HIROSUGI-KEIKI)	Nickel-iron pan M1.7x3mm	
DF12(5.0)-50DP-0.5V(86)	BSB-1705E (HIROSUGI-KEIKI)	BNT-17 (HIROSUGI-KEIKI)	Nickel-iron pan M1.7x3mm	



- For dimensions and connector specifications of MNS-300EM, see **2. Product Specifications**.

Note

3-2. Installation

1. Fix spacers on the target PCB or the daughter card with screw nuts.

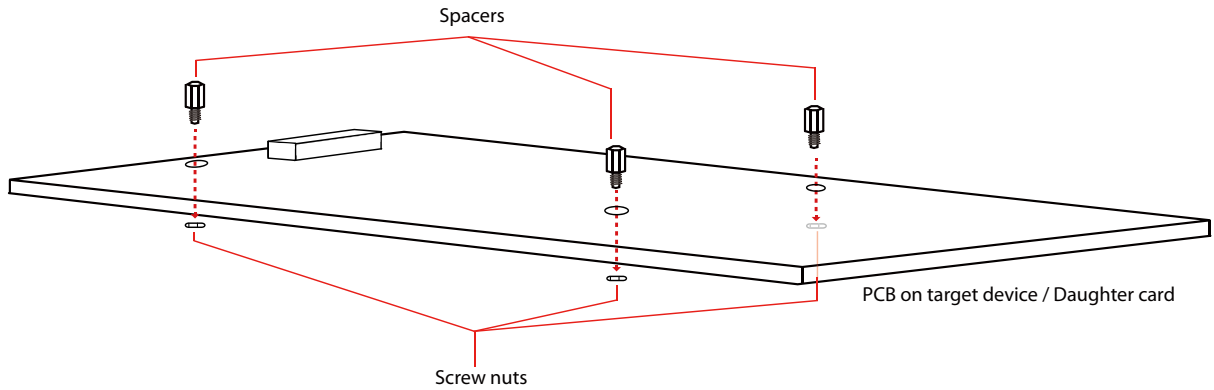

- Be sure to use spacers to prevent MNS-300EM from warping.

2. Insert MNS-300EM's 50-pin connector into the 50-pin connector of the target PCB or the daughter card.

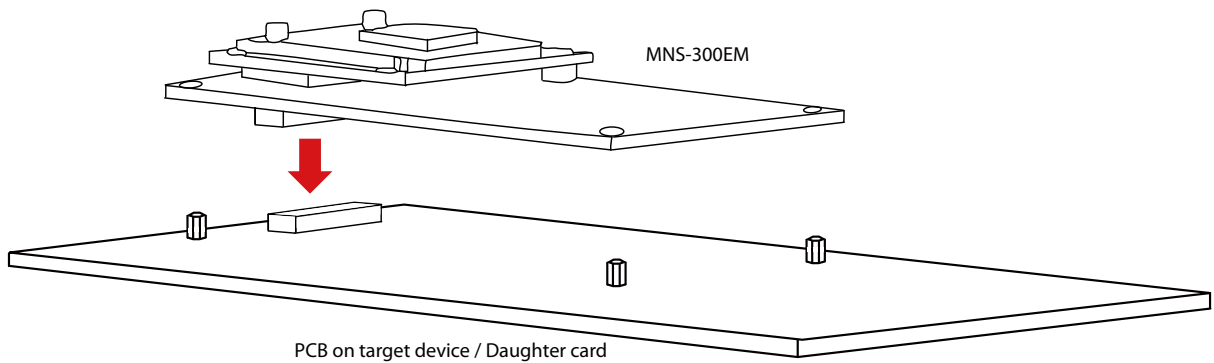

3. Fix MNS-300EM with screws.

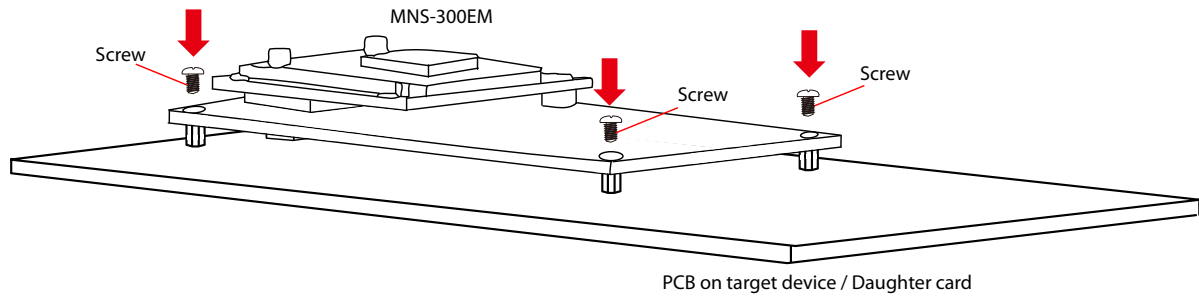

- Be careful NOT to over-tighten the screws. Spacers have a function to prevent the PCB from warping, however, overtightened screws may damage spacers as it gives a high pressure.
- Silex Technology does not guarantee MNS-300EM if it is soldered.

4. Connect a wireless LAN antenna to MNS-300EM.

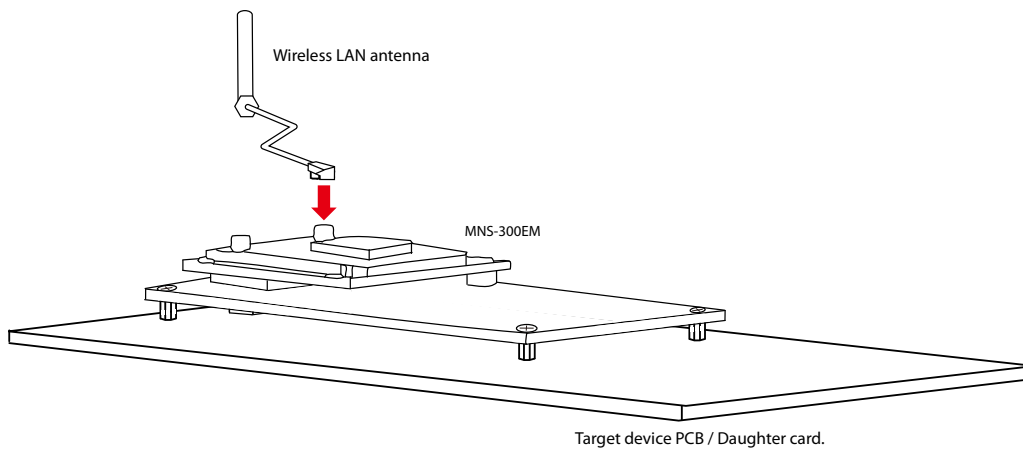

- To use a single wireless LAN antenna, connect the antenna to the primary antenna connector.

MNS-300EM has been fixed.

3-3. Initial Configuration

This chapter describes the method of initial configuration that will need to be done after MNS-300EM is embedded to the target device. There are two ways of configuration below.

- Use the command-input console of MNS-300EM (command console) or Linux console to issue the console commands.
- Use AMC Manager® (Silex Technology's unified management software) to configure MNS-300EM over a wired/wireless LAN.

3-3-1. Configuration Using Console Commands

Use UART to access the Linux console/command console and issue the console commands to configure the settings.

Ground pins and UART pins on the interface connector have to be connected to the terminal device.

Configuration from UART1

- 1.** By connecting Pin 36, 38 and GND of the interface connector to the terminal device, the Linux console can be accessed from UART1.

To do so, change the serial port setting of the terminal device as follows.

- Speed: 115200 bps
- Parity: None
- Flow control: None
- Data bit: 8 bits

2. When they are connected properly, the product name and system name of MNS-300EM are displayed on the terminal device. When **login:** is shown, enter the user name and the password.

- User name: admin
- Password: none

3. When **Local>** prompt is shown, input the command to change the MNS-300EM setting.



- The supported console commands are described in **MNS-300EM Command Manual**.

Note

Configuration from UART3

1. By connecting Pin 31, 33 and GND of the interface connector to the terminal device, the command console can be accessed from UART3.

To do so, change the serial port setting of the terminal device as follows.

- Speed: 115200 bps
- Parity: None
- Flow control: None
- Data bit: 8 bits

2. Press any key to show the **Local>** prompt on the terminal device.
When **Local>** prompt is shown, enter the command to change the MNS-300EM setting.



- The supported console commands are described in **MNS-300EM Command Manual**.

Note

3-3-2. Configuration Using AMC Manager®

This chapter describes how to use AMC Manager® to configure the setting of MNS-300EM embedded to the target product. Download AMC Manager® from the Silex Technology's website (<https://www.silextechnology.com/>).

Connecting Target Product to PC

The connection method will differ depending on if the target product has a wired LAN port that can communicate to MNS-300EM. The following shows how to connect the target product and PC.



- For the IP address configuration, enable **Obtain an IP address automatically** in the PC.

TIP

When the target product has a LAN port:

Connect the target product and PC using a network cable.

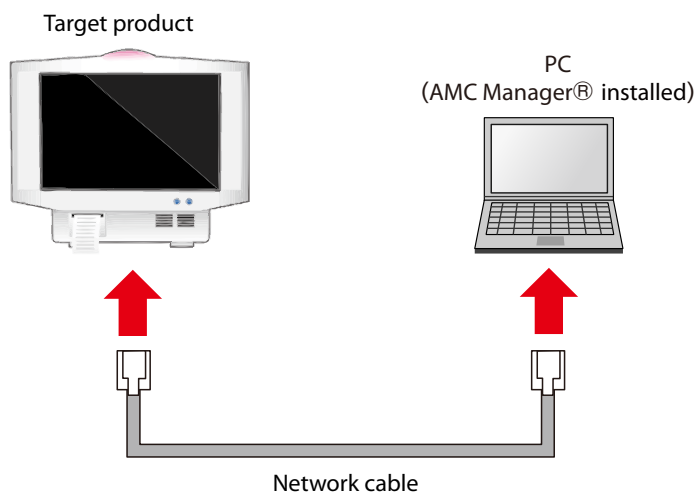

When the target product does not have a wired LAN port:

Configure MNS-300EM over the wireless LAN.

By defaults, MNS-300EM is set to start in Mesh mode and is unable to connect to Access Point. Create the Mesh network where the PC and MNS-300EM can communicate by using one of Silex products as follows.

- BR-400AN
- MNS-300EM-EVK

The following connection method uses MNS-300EM-EVK.

Restore MNS-300EM-EVK to the factory default setting in advance.

Start the target device and MNS-300EM-EVK, and connect MNS-300EM-EVK and PC using a network cable.

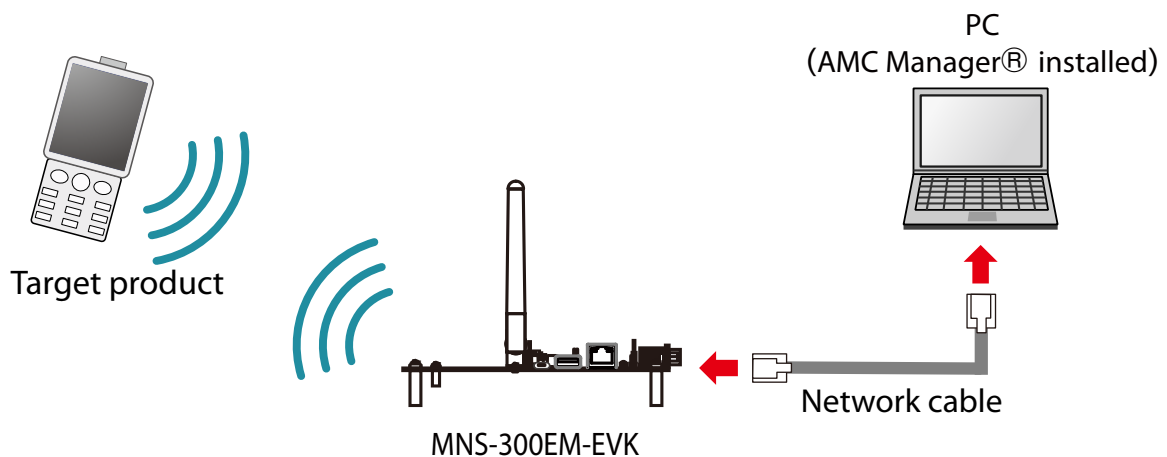
**Note**

- BR-400AN can be connected in the same way.
- You do not have to make any changes to the default setting of MNS-300EM, MNS-300EM-EVK and BR-400AN in order to establish the Mesh network.

For either wired or wireless connection method, turn on all the target devices.

Once the embedded MNS-300EM units join the Mesh network, all of them can be configured from the PC.

**TIP**

- For the initial configuration, place all the target devices in a close distance to configure the Mesh network.
- Up to 10 devices can be connected to a single MNS-300EM unit at once.

Configuring MNS-300EM Setting

Configure the MNS-300EM setting after the target device is connected to the PC (to which AMC Manager® is installed). For detailed configuration methods, refer to **MNS-300EM Setting Manual**.

- To configure a single MNS-300EM unit using AMC Manager®:

See **3-3-2. Individual Configuration Using AMC Manager® of MNS-300EM Setting Manual**.

- To configure multiple MNS-300EM units using AMC Manager®:

See **3-3-3. Bulk Configuration Using AMC Manager® of MNS-300EM Setting Manual**.

(Blank page)

A. Appendix

A-1. MNS-300EM-EVK Circuit Schematic

As a supporting document for creating a special daughter card to connect to MNS-300EM, the circuit schematics of the evaluation board "MNS-300EM-EVK" are shown in the following pages.

Please note that these are for reference only.

For more circuit schematics, contact Silex Technology, Inc.



Note

- The schematics of MNS-300EM-EVK are same as the schematics of the evaluation board for Silex Technology's intelligent modules, SX-570/SX-580/SX-582/SX-590.

<MNS-300EM I/F>

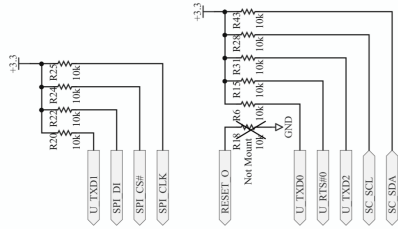
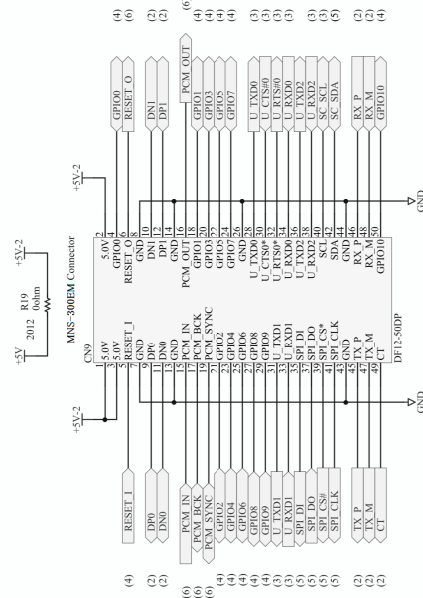

<Power Input >

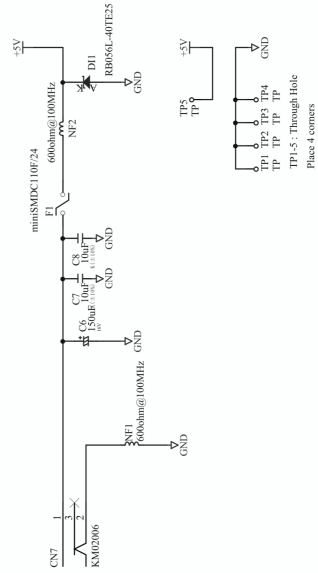

<.3.3V Power >

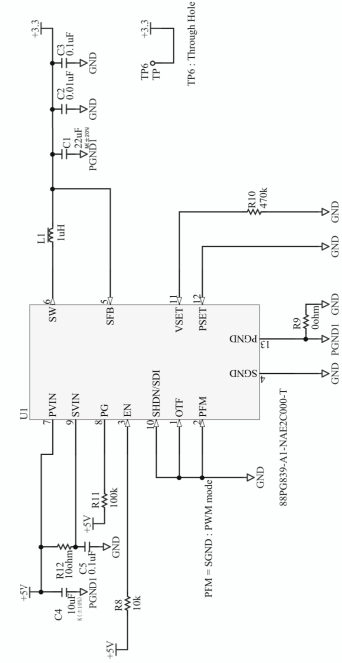

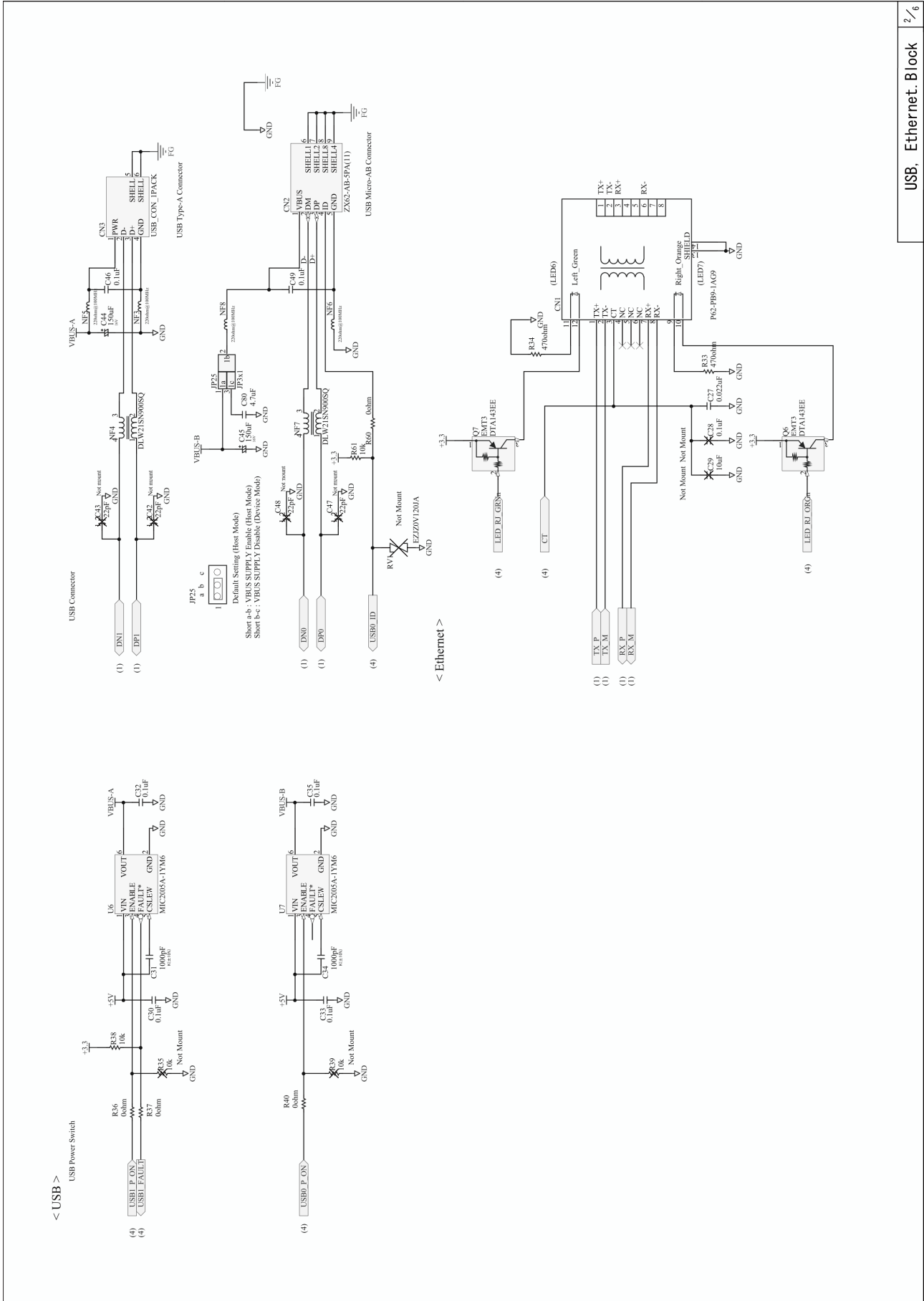

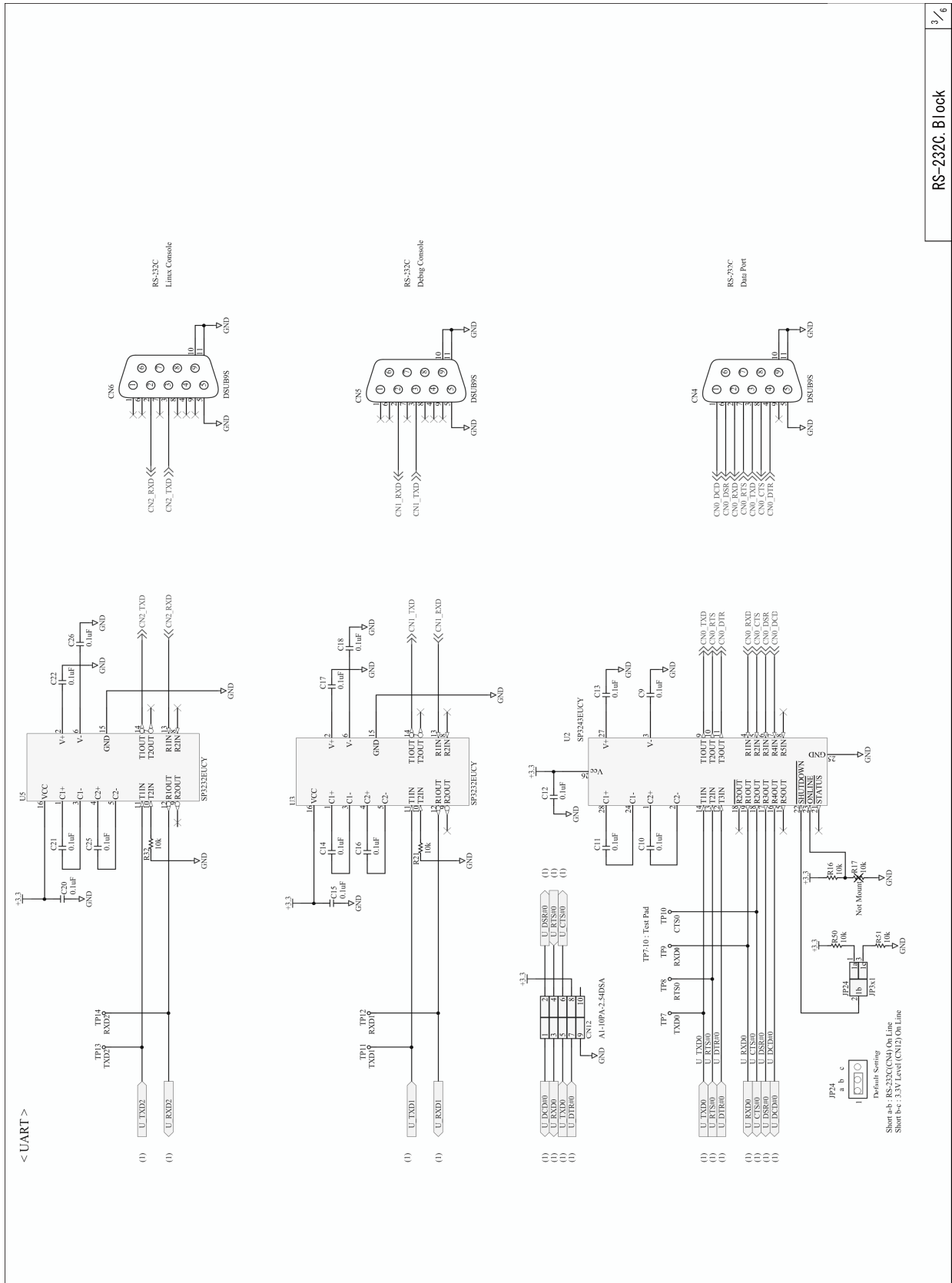

<Bit Selecter >

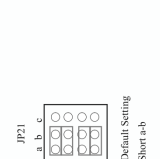
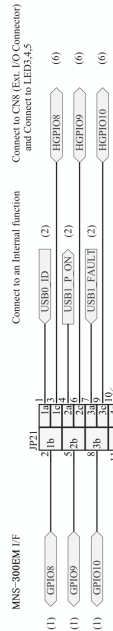
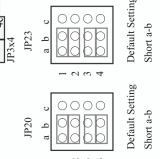
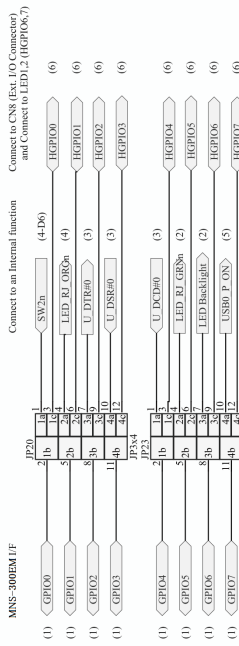

< Switch >

