

RB12A3006**

Refrigerator user manual

English

imagine the possibilities

Thank you for purchasing a Samsung product.

Free Standing Appliance

SAMSUNG

safety information

SAFETY INFORMATION

- Before operating the appliance, please read this manual thoroughly and retain it for your reference.
- Use this appliance only for its intended purpose as described in this instruction manual. This appliance is not intended for use by persons (including children) with reduced physical, sensory or mental capabilities, or lack of experience and knowledge, unless they have been given supervision or instruction concerning use of the appliance by a person responsible for their safety.
- This appliance can be used by children aged from 8 years and above and persons with reduced physical, sensory or mental capabilities or lack of experience and knowledge if they have been given supervision or instruction concerning use of the appliance in a safe way and understand the hazards involved.
Children shall not play with the appliance. Cleaning and

user maintenance shall not be made by children without supervision.

- Warnings and Important Safety Instructions in this manual do not cover all possible conditions and situations that may occur. It is your responsibility to use common sense, caution, and care when installing, maintaining, and operating your appliance.
- Because these following operating instructions cover various models, the characteristics of your refrigerator may differ slightly from those described in this manual. R-600a or R-134a is used as a refrigerant. Check the compressor label on the rear of the appliance or the rating label inside the fridge to see which refrigerant is used for your refrigerator. When this product contains flammable gas (Refrigerant R-600a), contact your local authority in regard to safe disposal of this product.
- In order to avoid the creation of a flammable gas-air mixture

if a leak in the refrigerating circuit occurs, the size of the room in which the appliance may be sited depends on the amount of refrigerant used.

- Never start up an appliance showing any signs of damage. If in doubt, consult your dealer. The room must be 1 m³ in size for every 8 g of R-600a refrigerant inside the appliance. The amount of refrigerant in your particular appliance is shown on the identification plate inside the appliance.
- Refrigerant squirting out of the pipes could ignite or cause an eye injury. When refrigerant leaks from the pipe, avoid any naked flames and move anything flammable away from the product and ventilate the room immediately.
- Failing to do so may result in fire or explosion.
- Do not store explosive substances such as aerosol cans with a flammable propellant in this appliance.



Warning; Risk of fire / flammable materials

Important safety symbols and precautions:

	<p>Hazards or unsafe practices that may result in severe personal injury or death.</p>
	<p>Hazards or unsafe practices that may result in minor personal injury or property damage.</p>
	<p>Do NOT attempt.</p>
	<p>Do NOT disassemble.</p>
	<p>Do NOT touch.</p>
	<p>Follow directions carefully.</p>
	<p>Unplug the power plug from the wall socket.</p>
	<p>Make sure the machine is grounded to prevent electric shock.</p>
	<p>Call the contact center for help.</p>
	<p>Note.</p>

These warning signs are here to prevent injury to you and others. Please follow them carefully. After reading this section, keep it in a safe place for future reference.

STATE OF CALIFORNIA PROPOSITION 65 WARNING

 **WARNING : Cancer and Reproductive Harm - www.P65Warnings.ca.gov.**

SEVERE WARNING SIGNS FOR TRANSPORTATION AND SITE

-  • When transporting and installing the appliance, care should be taken to ensure that no parts of the refrigerating circuit are damaged.
- Refrigerant leaking from the pipe work could ignite or cause an eye injury. If a leak is detected, avoid any naked flames or potential sources of ignition and air the room in which the appliance is standing for several minutes.
- This appliance contains a small amount of isobutane refrigerant (R-600a), a natural gas with high environmental

compatibility that is, however, also combustible.

When transporting and installing the appliance, care should be taken to ensure that no parts of the refrigerating circuit are damaged.

SEVERE WARNING SIGNS FOR INSTALLATION

-  • Deteriorated insulation of electrical parts may cause an electric shock or fire.
- Do not place this refrigerator in direct sunlight or expose to the heat from stoves, room heaters or other appliance.
- Do not plug several appliances into the same multiple power board. The refrigerator should always be plugged into its own individual electrical outlet which has a voltage rating that matched the rating plate.
- This provides the best performance and also prevents overloading house wiring circuits, which could cause a fire hazard from overheated wires.
- If the wall socket is loose, do not insert the power plug.
- There is a risk of electric shock or fire.

- Do not use a cord that shows cracks or abrasion damage along its length or at either end.
 - Do not pull or excessively bend the power cord.
 - Do not twist or tie the power cord.
 - Do not hook the power cord over a metal object, place a heavy object on the power cord, insert the power cord between objects, or push the power cord into the space behind the appliance.
 - When moving the refrigerator, be careful not to roll over or damage the power cord.
 - This may result in an electric shock or fire.
 - Do not use aerosols near the refrigerator.
 - Aerosols used near the refrigerator may cause an explosion or fire.
 - Do not bend the power cord excessively or place heavy articles on it.
-
- ★ • This refrigerator must be properly installed and located in accordance with the manual before it is used.
- Do not install the refrigerator in a damp place or place where it may come in contact with water.
 - Deteriorated insulation of electrical parts may cause an electric shock or fire.
 - Connect the power plug in proper position with the cord hanging down.
 - If you connect the power plug upside down, wire can get cut off and cause a fire or an electric shock.
 - Make sure that the power plug is not squashed or damaged by the back of the refrigerator.
 - When moving the refrigerator, be careful not to roll over or damage the power cord.
 - This constitutes a fire hazard.
 - Keep the packing materials out of reach of children.
 - There is a risk of death from suffocation if children put them on their head.
 - This appliance should be positioned in such a way that it is accessible to the power plug.
 - Failing to do so may result in an electric shock or fire due to electric leakage.

- Do not install this appliance near a heater, inflammable material.
- Do not install this appliance in a humid, oily or dusty location, in a location exposed to direct sunlight and water (rain drops).
- Do not install this appliance in a location where gas may leak.
 - This may result in an electric shock or fire.
- If any dust or water is in the refrigerator, pull out power plug and contact your Samsung Electronics service center.
 - Otherwise there is a risk of fire.
- Do not stand on top of the appliance or place objects (such as laundry, lighted candles, lighted cigarettes, dishes, chemicals, metal objects, etc.) on the appliance.
 - This may result in an electric shock, fire, problems with the product, or injury.



- This appliance must be properly grounded.
- Do not ground the appliance

- to a gas pipe, plastic water pipe, or telephone line.
- You must ground the refrigerator to prevent any power leakages or electric shocks caused by current leakage from the refrigerator.
- This may result in an electric shock, fire, explosion, or problems with the product.
- Never plug the power cord into a socket that is not grounded correctly and make sure that it is in accordance with local and national codes.



- If the supply cord is damaged, it must be replaced by the manufacturer, its service agent or similarly qualified persons in order to avoid a hazard.
- The fuse on the refrigerator must be changed by a qualified technician or service company.
 - Failing to do so may result in an electric shock or personal injury.
- When positioning the appliance, ensure the supply cord is not trapped or damaged.
- Do not locate multiple

portable socket-outlets or portable power supplies at the rear of the appliance.



CAUTION SIGNS FOR INSTALLATION

-  • Keep ventilation opening in the appliance enclosure or mounting structure clear of obstruction.
- Allow the appliance to stand for 2 hours after installation.
- The installation or any service of this appliance is recommended by a qualified technician or service company.
- Failing to do so may result in an electric shock, fire, explosion, problems with the product, or injury.



SEVERE WARNING SIGNS FOR USING

-  • Do not touch the power plug with wet hands.
- This may result in an electric shock.
- Do not store articles on the top of the appliance.
- When you open or close the door, the articles may fall and cause a personal injury and/or material damage.
- Do not put items filled with

water on the refrigerator.

- If spilled, there is a risk of fire or electric shock.
- Do not touch the inside walls of the freezer or products stored in the freezer with wet hands.
- This may cause frostbite.
- Do not use or place any substances sensitive to temperature such as inflammable sprays, inflammable objects, dry ice, medicine, or chemicals near the refrigerator.
Do not keep volatile or inflammable objects or substances (benzene, thinner, propane gas, alcohol, ether, LP gas and other such products etc.) in the refrigerator.
- This refrigerator is for storing food only.
- This may result in a fire or an explosion.
- Do not store pharmaceuticals products, scientific materials or temperature-sensitive products in the refrigerator.
- Products that require strict temperature controls must not be stored in the refrigerator.
- Do not place or use

- electrical appliance inside the refrigerator/freezer, unless they are of a type recommended by the manufacturer.
- If you smell pharmaceutical or smoke, pull out power plug immediately and contact your Samsung Electronics service center.
 - If any dust or water is in Refrigerator, pull out power plug and contact your Samsung Electronics service center.
 - Otherwise there is a risk of fire.
 - If gas leak is detected, avoid any naked flames or potential sources of ignition and air the room in which the appliance is standing for several minutes.
 - Do not use mechanical devices or any other means to accelerate the defrosting process, other than those recommended by the manufacturer.
 - Do not damage the refrigerant circuit.
 - Do not spray volatile material such as insecticide onto the surface of the appliance.
 - As well as being harmful to humans, it may also result in an electric shock, fire or problems with the product.
- Do not use a hair dryer to dry the inside of the refrigerator. Do not place a lighted candle in the refrigerator for removing bad odours.
 - This may result in an electric shock or fire.
 - Fill the water tank, ice tray and water cubes only with potable water (mineral water or purified water).
 - Do not fill the tank with tea, juice or sports drink, this may damage the refrigerator.
 - Do not let children hang on the door. If not, a serious injury may occur.
 - Risk of children entrapment. Do not let children enter inside the refrigerator.
 - Do not leave the doors of the refrigerator open while the refrigerator is unattended and do not let children enter inside the refrigerator.
 - Do not allow babies or children go inside the drawer.
 - It can cause death from suffocation by entrapment or personal injury.
 - Do not sit on the Freezer door.

- The door may be broken and cause a personal injury.
- Do not use mechanical devices or any other means to accelerate the defrosting process, other than those recommended by the manufacturer.
- Do not damage the refrigerant circuit.
- Do not put fridge shelf in upside down.
Shelf stopper could not work.
- It may cause a personal injury because of glass shelf drop.



- In the event of a gas leak (such as propane gas, LP gas, etc.), ventilate immediately without touching the power plug. Do not touch the appliance or power cord.
- Do not use a ventilating fan.
- A spark may result in an explosion or fire.
- Use only the LED Lamps provided by manufacturer or service agent.
- Children should be supervised to ensure that they do not play with the appliance.
- Keep fingers out of “pinch point” areas; clearances

between the doors and cabinet are necessarily small.

- Do not let children hang on the door. If not, a serious injury may occur.
- There is a Risk of children entrapment.
Do not let children enter inside the refrigerator.
- Bottles should be stored tightly together so that they do not fall out.
- This product is intended only for the storage of food in a domestic environment.
- Never put fingers or other objects into the dispenser hole, ice chute and ice maker bucket.
- It may cause a personal injury or material damage.
- Do not insert hands, feet or metal objects (such as chopsticks, etc.) into the bottom or the back of the refrigerator.
- This may result in an electric shock or injury.
- Any sharp edges may cause a personal injury.



- Do not attempt to repair, disassemble, or modify the appliance yourself.

- Do not use any fuse (such as cooper, steel wire, etc.) other than the standard fuse.
- When repairing or reinstalling the appliance is required, contact your nearest service center.
- Failing to do so may result in an electric shock, fire, problems with the product, or injury.



- If the appliance generates a strange noise, a burning or smell or smoke, unplug the power plug immediately and contact your nearest service center.
- Failing to do so may result in an electric or fire hazards.
- Pull the power plug out of the socket before changing the interior lamps of the refrigerator.
- Otherwise, there is a risk of electric shock.
- If you experience difficulty when changing the light, contact service agent.
- If the products is equipped with the LED Lamp, do not disassemble the Lamp Cover and LED Lamp by yourself.
- Please contact your service

agent.

- Plug the power plug into the wall socket firmly.
Do not use a damaged power plug, damaged power cord or loose wall socket.
- This may result in an electric shock or fire.
- Do not put a container filled with water on the appliance.
- If spilled, there is a risk of fire or electric shock.
- Never stare directly at the UV LED lamp for long periods of time.
- This may result in eye strain due to the ultraviolet rays.



CAUTION SIGNS FOR USING



- To get best performance from the product,
- Do not place foods too closely in front of the vents at the rear of the appliance as it can obstruct free air circulation in the refrigerator compartment.
- Wrap the food up properly or place it in airtight containers before putting it into the refrigerator.
- Do not put any newly introduced food for freezing near to already existing food.

- Do not place glass or bottles or carbonated beverages into the freezer.
- The container may freeze and break, and this may result in injury.
- Please observe maximum storage times and expiry dates of frozen goods.
- There is no need to disconnect the refrigerator from the power supply if you will be away for less than three weeks.
But, remove all the food if you are going away for the three weeks or more.
Unplug the refrigerator and clean it, rinse and dry.
- Do not place carbonated or fizzy drinks in the freezer compartment.
Do not put bottles or glass containers in the freezer.
- When the contents freeze, the glass may break and cause personal injury and property damage.
- Do not change or modify the functionality of the refrigerator.
- Changes or modifications may result in a personal injury and/or property damage.
Any changes or modifications

performed by a 3rd party on this completed appliance are neither covered under Samsung warranty service, nor is Samsung responsible for safety issues and damages that result from 3rd party modifications.

- Do not block air holes.
- If the air holes are blocked, especially with a plastic bag, the refrigerator can be over cooled.
- Use only the ice-maker provided with the refrigerator.
- Wipe excess moisture from the inside and leave the doors open.
- Otherwise, odor and mold may develop.
- When the refrigerator got wet by water, pull out the power plug and contact your Samsung Electronics service center.
- Do not keep vegetable oil in your refrigerator's door bins. The oil can solidify, making it foul-tasting and difficult to use. In addition, the open container can leak and the leaked oil can cause the door bin to crack. After opening an oil container, it is best to

keep the container in a cool and shaded place such as a cupboard or pantry.

- Examples of vegetable oil: olive oil, corn oil, grape-seed oil, etc.



CAUTION SIGNS FOR CLEANING AND MAINTENANCE



- Do not spray cleaning products directly on the display.
- Printed letters on the display may come off.
- If any foreign substance such as water has entered the appliance, unplug the power plug and contact your nearest service center.
- Failing to do so may result in an electric shock or fire.
- Remove all foreign substances such as dust or water from the power plug terminals and contact points using a dry cloth on a regular basis.
- Unplug the power plug and clean it with a dry cloth.
- Failing to do so may result in an electric shock or fire.
- Do not clean the appliance by spraying water directly onto it.

- Do not use benzene, thinner, or Clorox, Chloride for cleaning.
 - They may damage the surface of the appliance and may cause a fire.
 - Never put fingers or other objects into the dispenser hole.
 - It may cause a personal injury or material damage.
-



- Before cleaning or performing maintenance, unplug the appliance from the wall socket.
- Failing to do so may result in an electric shock or fire.
- Use a clean sponge or soft cloth and a mild detergent in warm water to clean the refrigerator.
- Do not use abrasive or harsh cleansers such as window sprays, scouring cleansers, flammable fluids, muriatic acid, cleaning waxes, concentrated detergents, bleaches, or cleansers containing petroleum products on exterior surfaces (doors and cabinet), plastic parts, door and interior liners, and gaskets.
- These can scratch or damage

the material.

- Do not clean glass shelves or covers with warm water when they are cold. Glass shelves and covers may break if exposed to sudden temperature changes or impacts such as bumping or dropping.



SEVERE WARNING SIGNS FOR DISPOSAL

- ★ • Leave the shelves in place so that children may not easily climb inside.
- Ensure that none of the pipes on the back of the appliance are damaged prior to disposal.
- R-600a or R-134a is used as a refrigerant.
Check the compressor label on the rear of the appliance or the rating label inside the refrigerator to see which refrigerant is used for your refrigerator.
When this product contains flammable gas (Refrigerant R-600a), contact your local authority in regard to safe disposal of this product.
Cyclopentane is used as an insulation blowing gas.
The gases in insulation

material require special disposal procedure.

Please contact your local authorities in regard to the environmentally safe disposal of this product.

Ensure that none of the pipes on the back of the appliances are damaged prior to disposal.

The pipes shall be broken in the open space.

- When disposing of this or other refrigerator/s, remove the door/door seals, door latch so that children or animals cannot become trapped inside.
Children should be supervised to ensure that they do not enter and play with the appliance.
- If trapped inside, the child may become injury and suffocate to death.
- Please dispose of the packaging material for this product in an environmentally friendly manner.
- Keep all packaging materials well out of the reach of children, as packaging materials can be dangerous to children.
- If a child places a bag over

its head, it may result in suffocation.

ADDITIONAL TIPS FOR PROPER USAGE

- In the event of a power failure, call the local office of your Electricity Company and ask how long it is going to last.
- Most power failures that are corrected within an hour or two will not affect your refrigerator temperatures. However, you should minimize the number of door openings while the power is off.
- But should the power failure last more than 24 hours, remove all frozen food.
- If keys are provided with the refrigerator, the keys should be kept out of the reach of children and not be in the vicinity of the appliance.
- The appliance might not operate consistently (possibility of defrosting of contents or temperature becoming too warm in the frozen food compartment) when sited for an extended period of time below the cold end of the range of temperature for which the

refrigerating appliance is designed.

- Do not store food which goes bad easily at low temperature, such as bananas, melons.
- Your appliance is frost free, which means there is no need to manually defrost your appliance, as this will be carried out automatically.
- Temperature rise during defrosting can comply with ISO requirements. But if you want to prevent an undue rise in the temperature of the frozen food while defrosting the appliance, please wrap the frozen food up in several layers of newspaper.
- Any increase in temperature of frozen food during defrosting can shorten its storage life.
- Do not re-freeze frozen foods that have thawed completely.
- The temperature of two star section (sections) or compartment (compartments) which have two star symbol () is slightly higher than other freezer compartment (compartments). The two star section (sections) or compartment

(compartments) is (are) based on the instruction and/or the condition as delivered.

Saving Energy Tips

- Install the appliance in a cool, dry room with adequate ventilation.

Ensure that it is not exposed to direct sunlight and never put it near a direct source of heat (radiator, for example).

- Never block any vents or grilles on the appliance.
- Allow warm food to cool down before placing it in the appliance.

- Put frozen food in the refrigerator to thaw.

You can then use the low temperatures of the frozen products to cool food in the refrigerator.

- Do not keep the door of the appliance open for too long when putting food in or taking food out.

The shorter time for which the door is open, the less ice will form in the freezer.

- Allow clearance to the right, left, back and top when installing.

This will help reduce power consumption and keep your

energy bills lower.

- We recommend the value of clearance to be :
 - Right, left, and back side: more than 50 mm
 - Top side: more than 100 mm
- For the most efficient use of energy, please keep the all inner fittings such as baskets, drawers, shelves on the position supplied by manufacturer.

This appliance is intended to be used in household and similar applications such as

- staff kitchen areas in shops, offices and other working environments;
- farm houses and by clients in hotels, motels and other residential type environments;
- bed and breakfast type environments;
- catering and similar non-retail applications.

contents

SETTING UP YOUR REFRIGERATOR	16
OPERATING YOUR REFRIGERATOR	18
REVERSING THE DOOR	23
TROUBLESHOOTING	28

setting up your refrigerator

GETTING READY TO INSTALL THE REFRIGERATOR

Congratulations on the purchase of your Samsung Refrigerator.

We hope you will enjoy the many state-of-the-art features and efficiencies that this new appliance has to offer.

- This refrigerator must be properly installed and located in accordance with the manual before it is used.
- Use this appliance only for its intended purpose as described in this instruction manual.
- We strongly recommend that any servicing be performed by a qualified individual.
- Please dispose of the packaging material for this product in an environmentally friendly manner.

 **WARNING** • Pull the power plug out of the socket before changing the interior light of the refrigerator.

- Otherwise, there is a risk of electric shock.
- For the models that require door panel installation, plug in the power cord and make sure the refrigerator works properly before assembling the door panel.

Selecting the best location for the refrigerator

- Select a location without direct exposure to sunlight.
- Select a location with level (or nearly level) flooring.
- Select a location with enough space for the

refrigerator doors to open easily.

- Allow sufficient space to install the refrigerator on a flat surface.
- If your refrigerator is not level, the internal cooling system may not work correctly.
- Overall space required in use. Refer to drawing and dimension as below.
- The length of the power cord is two meters.

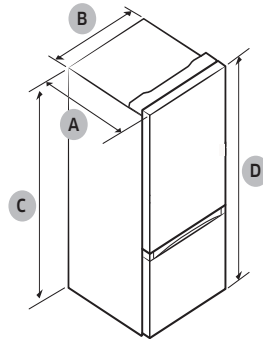

Model	RB12*
Depth "A"	26 3/8" (669mm)
Width "B"	23 3/8" (595mm)
Height "C"	71 6/8" (1824mm)
Overall Height "D"	73" (1853mm)

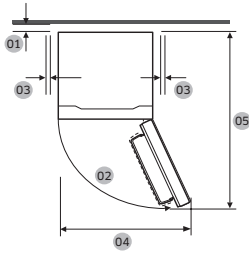

Model	RB12*
01	more than 2" (50 mm) recommended
02	105°
03	at least 2" (50 mm)
04	29 2/8" (744 mm)
05	47 4/8" (1208 mm)



- Allow sufficient space to the right, left, back and top for air circulation. This will help reduce power consumption and keep your energy bills lower.
- Do not install the refrigerator where the temperature will go below 10 °C (50 °F).
- Please ensure that appliance can be moved freely in the event of maintenance & service.



When installing, servicing, or cleaning behind the refrigerator, be sure to pull the unit straight out and push back in straight after finishing. Also, make sure your floor supports the full-load refrigerator. Otherwise, it may cause floor damage.



Please tie up the extra length of the power cord at the back of the refrigerator so as not to be touched on the floor preventing the power cord from being crushed by the rollers upon relocation.

FLOORING

For proper installation, this refrigerator must be placed on a level surface of hard material that has the same height as the rest of the flooring. This surface should be strong enough to support a fully loaded refrigerator (or approximately 65 kg). To protect the floor finish, cut a large section of the cardboard carton and place it under the refrigerator where you are working.



- Pulling or pushing the refrigerator may damage the floor. Moving the refrigerator after installation may damage the floor.

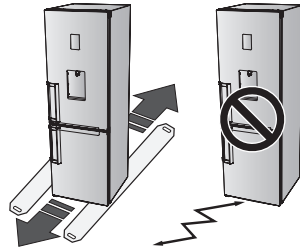

operating your refrigerator

LEVELLING THE REFRIGERATOR

If the front of the appliance is slightly higher than the rear, the door can be opened and closed more easily.

Case 1) The appliance tilts down to the left.
Turn the left adjusting leg in the direction of the arrow until the appliance is level.

Case 2) The appliance tilts down to the right.
Turn the right adjusting leg in the direction of the arrow until the appliance is level.

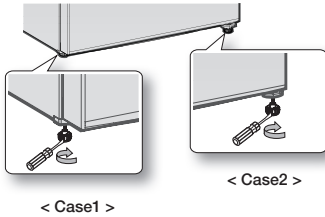

SETTING UP THE REFRIGERATOR

Now that you have your new refrigerator installed and in place, you are ready to set up and enjoy the full features and functions of the appliance. By completing the following steps, your refrigerator should be fully operational.

If not, first check the power supply and electricity source or try the troubleshooting section at the back of this user guide.

If you have any further questions, contact your Samsung Electronics service center.

1. Place the refrigerator in an appropriate location with reasonable clearance between the wall and the refrigerator.
Refer to installation instructions in this manual.
2. Before using the refrigerator please remove the shelf corner covers shown on below figure. (The covers are used to secure your refrigerator during transportation).



3. Once the refrigerator is plugged in, make sure the interior light comes on when you open the doors.
4. Set the temperature control to the coldest temperature and wait for an hour.
The freezer should get slightly chilled and the motor should run smoothly.
5. After powering the refrigerator, it will take a few hours to reach the appropriate temperature. Once the refrigerator temperature is sufficiently cool, you can store food and drink in the refrigerator.

USING THE CONTROL PANEL

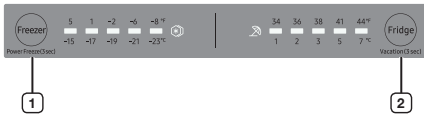

 Each time you press a button on the control panel, you will hear a short beep.

 Depending on the model, the LED indicators of the freezer may not turn on when you open the freezer door.

① Freezer

Press the Freezer button to set the freezer to desired temperature from range between -15 °C(5 °F) and -23 °C (-8 °F). Default set temperature is set on -19 °C(-2 °F) and each time you press the Freeze button, temperature will be changed in the following order and temperature indicator will display the desired temperature.



Press this button for 3 seconds to activate the Power Freeze function.

Power Freeze indicator () will light up and the refrigerator will speed up the time to needed to freeze products in the freezer.

This function will be activated for 50 hours and freezer indicator will not change display.

This function switches off automatically.

When the Power Freeze process is completed, the Power freeze indicator switches off and the freezer switches back to the previous temperature setting.

When you use this function, the energy consumption will increase.

Remember to turn it off when you do not need it and return the freezer to your original temperature setting. To deactivate this function, press the Freezer button for 3 seconds.

If you need to freeze large amount of food stuff, activate Power Freeze function 20 hours before.

② Fridge

Press the Fridge button to set the fridge to desired temperature between 1 °C (34 °F) and 7 °C (44 °F). Default set temperature is set on 3 °C (38 °F) and each time to you press the Fridge button, temperature will be changed in the following order and temperature indicator will display the desired temperature.



Press this button for 3 seconds to activate the Vacation function. Vacation indicator () will light up and the refrigerator will set the temperature to under 17 °C(63 °F) to minimize you are going on a long vacation or business trip or you do not need to use the refrigerator. While Vacation function is activated, freezer compartment remains on. Vacation function will be automatically deactivated if you adjust fridge temperature while Vacation function is on.

Make sure to remove foods in the fridge compartment before using Vacation function.

operating your refrigerator

Components

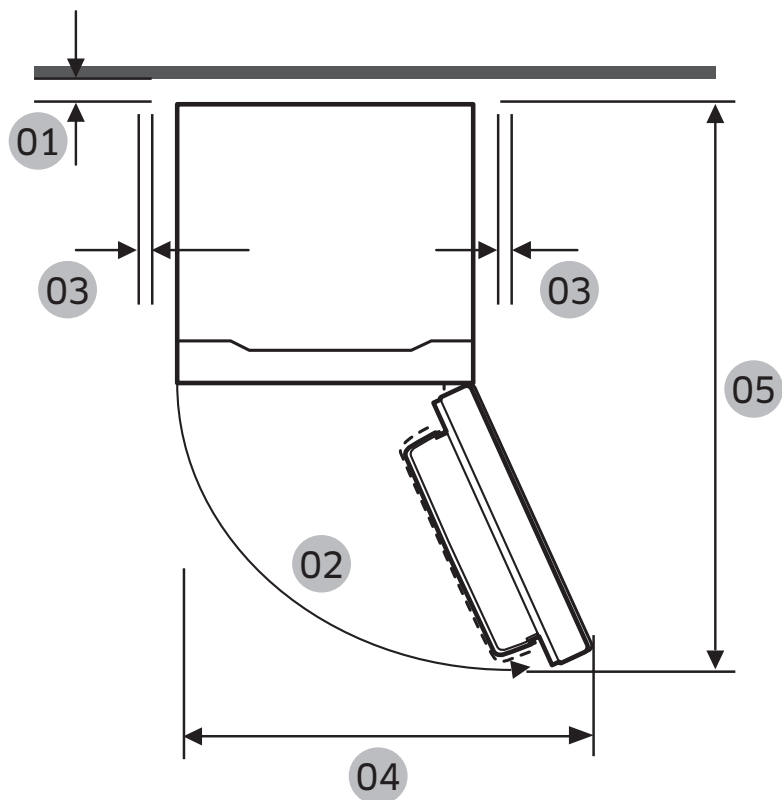

FEATURES OF THE FREEZER COMPARTMENT

Frozen-food mark on the Door panel

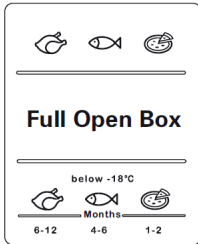

The figures above to the symbols indicate the permitted storage period of the produce in months. When purchasing frozen produce, observe the date of manufacture or sell-by date.

Freezing food

Freeze fresh, undamaged food only. Keep food which is to be frozen away from food which is already frozen. To prevent food from losing its flavour or drying out, place in airtight containers.

Packing food correctly:

1. Place the food in the packaging.
2. Press out all the air.
3. Seal the wrapping.
4. Label the wrapping with the contents and date.

The following products are not suitable for wrapping food:

Wrapping paper, greaseproof paper, cellophane, refuse bags and used shopping bags.

The following products are suitable for wrapping food:

Plastic film, polyethylene blown film, aluminium foil and freezer tins. These products can be purchased from your dealer.

The following products are suitable for sealing the wrapped food:

Rubber bands, plastic clips, string, cold-resistant adhesive tape or similar. Bags and polyethylene blown film can be sealed with a film sealer.

Shelf life of frozen food

Storage duration depends on the type of food. At a temperature setting of $-18\text{ }^{\circ}\text{C}$ ($-0.4\text{ }^{\circ}\text{F}$):

- Fresh Poultry(whole chicken), Fresh meat (steaks, Roasts) : up to 12 months
- Fish(Lean fish, Cooked fish), Fresh shrimp, scallops, squid: up to 6 months
- Pizza, Sausage: up to 2 months

Storage duration is referred to FDA web site (<http://www.fda.gov/>).



- If you do not follow this period, you will have food poisoning sounds a bit extreme.

Purchasing and storing deep-frozen food

When purchasing frozen food, observe the following:

- Check that the packaging is not damaged.
- Check the sell-by date.
- The temperature of the supermarket freezer should be below $-18\text{ }^{\circ}\text{C}$ ($-0.4\text{ }^{\circ}\text{F}$) or lower. If not, the shelf life of the frozen food is reduced.
- Purchase deep-frozen food last. Wrap food in newspaper or place in a cool bag and take home.
- At home immediately place deep-frozen food in the freezer compartment. Consume the frozen food before the use-by date expires.

Thawing frozen food

Depending on the type and application, select one of the following options:

- At room temperature.
- In the refrigerator.
- In an electric oven, with/without fan assisted hot-air.
- In a microwave oven.



Do not refreeze food which is beginning to thaw or which has already thawed.

The food cannot be refrozen until it has been prepared (boiled or fried).

Do not store the frozen products longer than the max storage period.

operating your refrigerator

REMOVING THE INTERIOR PARTS

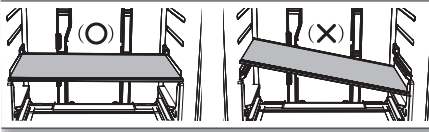

CAUTION When assembling, put fridge shelves in the correct position and do not put them upside down. It may cause a personal injury or material damage.

 When you put the shelves back, make sure the side with the label "Front" on it face the front of the refrigerator.

Shelves

Gently lift up the shelves with both hands and pull it toward you. (Glass shelf)

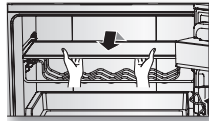

CAUTION Do not put the shelves upside down or backwards. There is a risk of falling.

Door guards

Firmly grab the door guards with both hands and lift it up gently to remove the door guards.

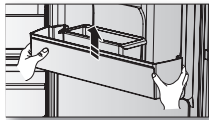

Drawers

Pull the drawers out fully then slightly lift it up to remove the drawers.



- If the drawers get stuck to door, remove drawer by lifting up after remove shelves.

CLEANING THE REFRIGERATOR

WARNING Do not use Benzene, Thinner or Clorox™ for cleaning.

They may damage the surface of the appliance and can create a risk of fire.

CAUTION Do not spray the refrigerator with water while it is plugged in, as it may cause an electric shock. Do not clean the refrigerator with benzene, thinner or car detergent for risk of fire.

1. Unplug the power cord of the refrigerator.
2. Slightly dampen a soft lint-free cloth or paper towel with water.

 Do not use any kind of detergent to clean the refrigerator because that can discolor or damage the refrigerator.

3. Wipe the inside and outside of refrigerator until it is clean and dry.
4. Plug the power cord of the refrigerator.

REPLACING THE LED LAMP

When the interior or exterior LED lamp has gone out, do not disassemble the lamp cover and LED lamp by yourself.

 Please contact your service agents.

reversing the door

REVERSING THE DOOR

Before you reverse the refrigerator door, make sure to unplug the refrigerator. Samsung recommends that reversing of the door opening is only completed by Samsung approved Service providers. This will be on a chargeable basis and at the customers expense.



Any damage caused while attempting to reverse the door opening is not covered under the appliance manufactures warranty.

Any repairs requested due to this circumstance will be completed on a chargeable basis at the customers expense.

1. Before attempting to reverse the refrigerator doors ensure that the refrigerator is disconnected from the main electricity supply and all food stuffs are emptied from inside the appliance.
2. If the customer does not feel confident to follow instruction in the user manual, a Samsung qualified service engineer must be contacted to carry out this change.
3. Do not plug in Refrigerator just after door reverse finished process and wait for at least one hour.

Required Tools

Not provided		
Phillips Head Driver (+)	Flat Head Driver (-)	11 mm Wrench (for hinge shaft)

Not provided	Additional part	
8 mm Socket Wrench (for bolts)	Hinge Cover / Cap Space Door	

Additional part
Hinge-Up Left

Disassembly of the refrigerator door

1. Remove the Cover Hinge to push a hook like below Pictures.
 - Insert a flat-head screwdriver and lever up the cover as shown in Figure #1.(Take care not to damage the Cover Hinge)

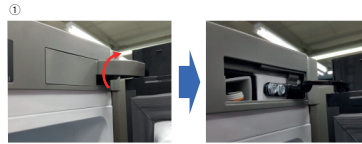

2. Remove the screws and disassemble the upper hinge. (Be careful not to drop the door when you disassemble it.)

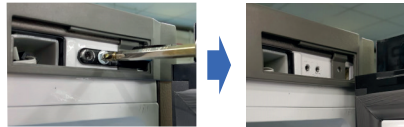

3. Remove the fridge door from the middle hinge by carefully lifting the door straight up.

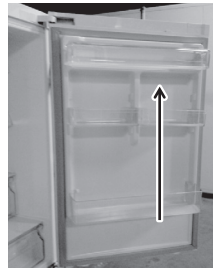

The door is heavy, be careful not to injure yourself when removing the door.

reversing the door

4. Disassemble the middle hinge by removing the screws using a Phillips Head (+) screwdriver.

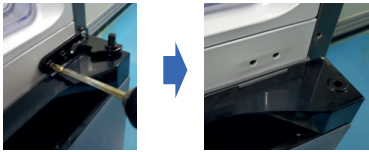

 The freezer door may fall forward so please support the door.

5. Remove the freezer door from the bottom hinge by carefully lifting the door straight up.



 **CAUTION** The door is heavy, be careful not to injure yourself when removing the door.

6. Remove the screw on the bottom right side of the Fridge and Freezer Door Switch Lever Auto Closer from the right to the left.

Basic position

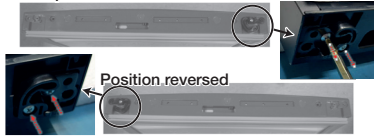



7. Switch the position of cap screw and cap. Pull out using a thin flat screwdriver.

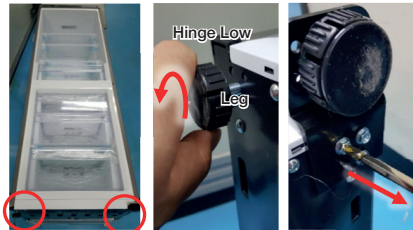

 **CAUTION** Be careful not to injure yourself during operation.

8. Lay the refrigerator carefully on it's back. Remove the leg (unscrew in an anti-clockwise direction) and the Hinge Low.



 To protect the refrigerator damage, cut a large section of the cardboard carton and place it under the refrigerator.

9. Assemble the Middle hinge using the Phillips Head (+) screwdriver. (Assemble Washer upwardly before assembling Middle hinge.)



10. Switch the position of Bottom hinge and Leg. (Right -> Left)
 Assemble the Hinge Low after putting the Freezer Door in the middle hinge.
- Disassemble the Guide auto close and the Shaft-hinge.
 - Assemble the Shaft-hinge and the Guide auto close like this on picture.

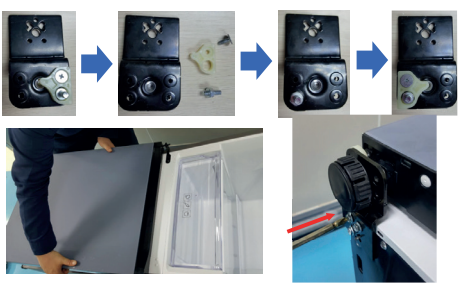

11. Put the fridge up. Make sure the door is working properly.

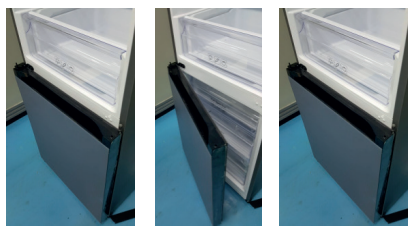

12. After removing the Cap Control from the upper left corner of the Fridge, reassemble on the right side.



13. Remove the Cap Space Door at the top of the door before reinstalling it. (press the sides before lifting up)

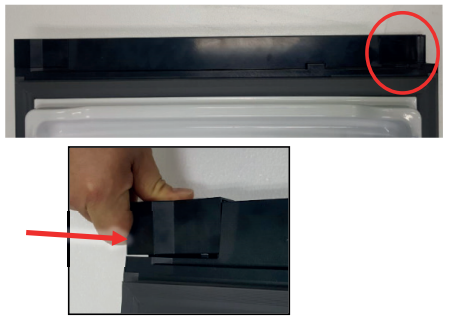

14. Assemble Hinge-upp Left, Cover Hinge Left, Cap Space Door provided when purchasing the refrigerator.

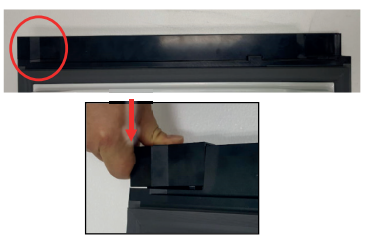

15. Make sure the doors are working properly.



16. Detach the Fridge and Freezer gaskets and attach them after rotating 180°. Make sure the door gaskets are properly arranged. If not, there can be a noise or dew can be formed which affects performance of the unit.



 When you reverse the Freezer Door, detach the Freezer Door gasket and the inside left gasket (A). And then attach the inside gasket to the right (B). Attach the Freezer door gasket after rotating it 180°.

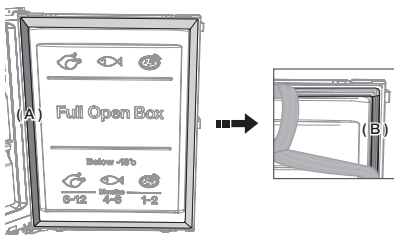

troubleshooting

Before calling for service, review the checkpoints below. Any service calls regarding normal situations (No Defect Cases) will be charged to users.

General

Temperature

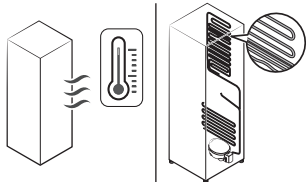
Symptom	Possible causes	Solution
Fridge/freezer does not operate. Fridge/freezer temperature is warm.	<ul style="list-style-type: none"> Power cord is not plugged in properly. 	<ul style="list-style-type: none"> Properly plug in the power cord.
	<ul style="list-style-type: none"> Temperature control is not set correctly. 	<ul style="list-style-type: none"> Set the temperature lower.
	<ul style="list-style-type: none"> Refrigerator is located near a heat source or direct sunlight. 	<ul style="list-style-type: none"> Keep the refrigerator away from direct sunlight or a heat source.
	<ul style="list-style-type: none"> Not enough clearance between refrigerator and sides/rear. 	<ul style="list-style-type: none"> Make sure there are at least 5 cm from the rear and sides.
	<ul style="list-style-type: none"> Vacation mode is activated. 	<ul style="list-style-type: none"> Deactivate vacation mode.
	<ul style="list-style-type: none"> The refrigerator is overloaded. Food is blocking the refrigerator vents. 	<ul style="list-style-type: none"> Do not overload the refrigerator. Do not allow food to block ventilation.
Fridge/freezer is over-cooling.	<ul style="list-style-type: none"> Temperature control is not set correctly. 	<ul style="list-style-type: none"> Set the temperature higher.
Interior wall is hot.	<ul style="list-style-type: none"> Refrigerator has heat-proof piping in the interior wall. 	<ul style="list-style-type: none"> To prevent condensation from forming, the refrigerator has heat-proof piping in the front corners. If the ambient temperature rises, this equipment may not work effectively. This is not a system failure.
		

Odors

Symptom	Possible causes	Solution
Refrigerator has odors.	<ul style="list-style-type: none"> Spoiled food. 	<ul style="list-style-type: none"> Clean the refrigerator and remove any spoiled food.
	<ul style="list-style-type: none"> Food with strong odors. 	<ul style="list-style-type: none"> Make sure strong smelling food is wrapped airtight.

Frost

Symptom	Possible causes	Solution
Frost around the vents.	<ul style="list-style-type: none"> Food is blocking the vents. 	<ul style="list-style-type: none"> Make sure no food blocks the refrigerator vents.
Frost on interior walls.	<ul style="list-style-type: none"> Door is not closed properly. 	<ul style="list-style-type: none"> Make sure food does not block the door. Clean the door gasket.
Fruits or vegetables are frozen.	<ul style="list-style-type: none"> Fruits or vegetables are stored in the Fresh/Chef Zone. 	<ul style="list-style-type: none"> The Fresh/Chef Zone is only for meat/fish.

Condensation

Symptom	Possible causes	Solution
Condensation forms on the interior walls.	<ul style="list-style-type: none"> If door is left open, moisture enters the refrigerator. 	<ul style="list-style-type: none"> Remove the moisture and do not open the door for a long time.
	<ul style="list-style-type: none"> Food with high moisture content. 	<ul style="list-style-type: none"> Make sure food is wrapped airtight.

Do you hear abnormal sounds from the refrigerator?

Before calling for service, review the checkpoints below. Any service calls related to normal sounds will be charged to the user.

These sounds are normal.

- When starting or ending an operation, the refrigerator may make sounds similar to a car engine igniting. As the operation stabilizes, the sounds will decrease.

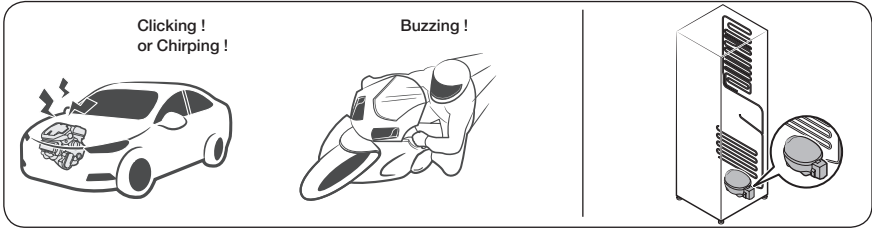

- While the fan is operating, these sounds may occur. When the refrigerator reaches the set temperature, no fan sound will occur.



- During a defrost cycle, water may drip on the defrost heater, causing sizzling sounds.

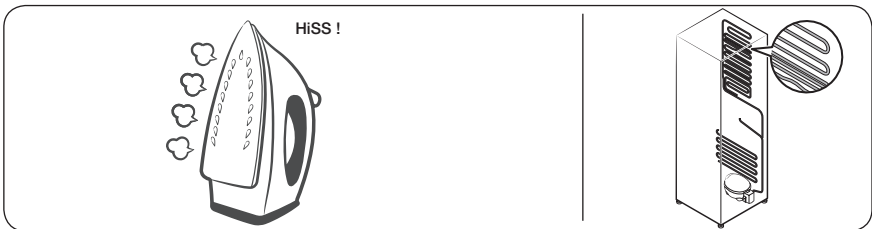

- As the refrigerator cools or freezes, refrigerant gas moves through sealed pipes, causing bubbling sounds.

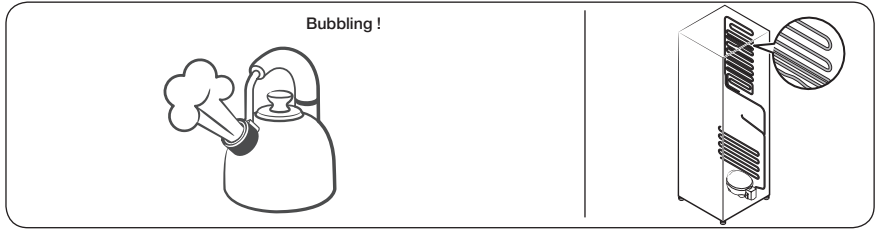

- As the refrigerator temperature increases or decreases, plastic parts contract and expand, creating knocking noises. These noises occur during the defrosting cycle or when electronic parts are working.

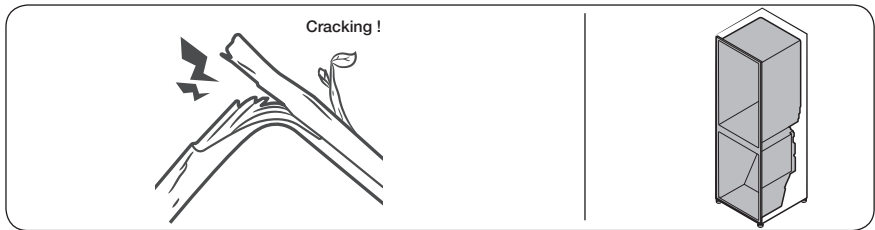

- For ice maker models: When the water valve opens to fill the ice maker, buzzing sounds may occur.
- Due to pressure equalizing when opening and closing the refrigerator door, whooshing sounds may occur.

LIMITED WARRANTY (U.S.A.)

SAMSUNG REFRIGERATOR

LIMITED WARRANTY TO ORIGINAL CONSUMER PURCHASER WITH PROOF OF PURCHASE

This SAMSUNG brand product, as supplied and distributed by Samsung Electronics America, Inc. (SAMSUNG) and delivered new, in the original carton to the original consumer purchaser, is warranted by SAMSUNG against manufacturing defects in materials or workmanship for the limited warranty period of:

One (1) year parts and labor

Five (5) years parts and labor on Sealed Refrigeration System Only (Compressor, Evaporator, Condenser, Drier, and Connecting Tubing)

Ten (10) years part and Five (5) years labor on Digital Inverter Compressor Only

This limited warranty is valid only on products purchased and used in the United States that have been installed, operated, and maintained according to the instructions attached to or furnished with the product. To receive warranty service, the purchaser must contact SAMSUNG at the address or phone number provided below for problem determination and service procedures. Warranty service can only be performed by a SAMSUNG authorized service center. The original dated bill of sale must be presented upon request as proof of purchase to SAMSUNG or SAMSUNG's authorized service center to receive warranty service.

SAMSUNG will provide in-home service within the contiguous United States during the warranty period at no charge, subject to availability of SAMSUNG authorized servicers within the customer's geographic area. If in-home service is not available, SAMSUNG may elect, at its option, to provide transportation of the product to and from an authorized service center. If the product is located in an area where service by a SAMSUNG authorized servicer is not available, you may be responsible for a trip charge or required to bring the product to a SAMSUNG authorized service center for service.

To receive in-home service, product must be unobstructed and accessible to the service agent.

During the applicable warranty period, a product will be repaired, replaced, or the purchase price refunded, at the sole option of SAMSUNG. SAMSUNG may use new or reconditioned parts in repairing a product, or replace the product with a new or reconditioned product. Replacement parts and products are warranted for the remaining portion of the original product's warranty or ninety (90) days, whichever is longer. All replaced parts and products are the property of SAMSUNG and you must return them to SAMSUNG.

This limited warranty covers manufacturing defects in materials or workmanship encountered in normal household, noncommercial use of this product and shall not cover the following: damage that occurs in shipment, delivery, installation, and uses for which this product was not intended; damage caused by unauthorized modification or alteration of the product; product where the original factory serial numbers have been removed, defaced, changed in any way, or cannot be readily determined; cosmetic damage including scratches, dents, chips, and other damage to the product's finishes; damage caused by abuse, misuse, pest infestations, accident, fire, floods, or other acts of nature or God; damage caused by use of equipment, utilities, services, parts, supplies, accessories, applications, installations, repairs, external wiring or connectors not supplied or authorized by SAMSUNG; damage caused by incorrect electrical line current, voltage, fluctuations and surges; damage caused by failure to operate and maintain the product according to instructions; in-home instruction on how to use your product; and service to correct installation not in accordance with electrical or plumbing codes or correction of household electrical or plumbing (i.e., house wiring, fuses, or water inlet hoses). The cost of repair or replacement under these excluded circumstances shall be the customer's responsibility.

LIMITED WARRANTY (U.S.A.)

Visits by an authorized servicer to explain product functions, maintenance or installation are not covered by this limited warranty. Please contact SAMSUNG at the number below for assistance with any of these issues.

EXCLUSION OF IMPLIED WARRANTIES

IMPLIED WARRANTIES, INCLUDING THE IMPLIED WARRANTIES OF MERCHANTABILITY OR FITNESS FOR A PARTICULAR PURPOSE, ARE LIMITED TO ONE YEAR OR THE SHORTEST PERIOD ALLOWED BY LAW. Some states do not allow limitations on how long an implied warranty lasts, so the above limitations or exclusions may not apply to you. This warranty gives you specific rights, and you may also have other rights, which vary from state to state.

LIMITATION OF REMEDIES

YOUR SOLE AND EXCLUSIVE REMEDY IS PRODUCT REPAIR, PRODUCT REPLACEMENT, OR REFUND OF THE PURCHASE PRICE AT SAMSUNG'S OPTION, AS PROVIDED IN THIS LIMITED WARRANTY. SAMSUNG SHALL NOT BE LIABLE FOR SPECIAL, INCIDENTAL OR CONSEQUENTIAL DAMAGES, INCLUDING BUT NOT LIMITED TO TIME AWAY FROM WORK, HOTELS AND/OR RESTAURANT MEALS, REMODELING EXPENSES, LOSS OF REVENUE OR PROFITS, FAILURE TO REALIZE SAVINGS OR OTHER BENEFITS REGARDLESS OF THE LEGAL THEORY ON WHICH THE CLAIM IS BASED, AND EVEN IF SAMSUNG HAS BEEN ADVISED OF THE POSSIBILITY OF SUCH DAMAGES. Some states do not allow exclusion or limitation of incidental or consequential damages, so the above limitations or exclusions may not apply to you. This warranty gives you specific rights, and you may also have other rights, which vary from state to state.

SAMSUNG does not warrant uninterrupted or error-free operation of the product. No warranty or guarantee given by any other person, firm, or corporation with respect to this product shall be binding on SAMSUNG.

To obtain warranty service, please contact SAMSUNG at:

Samsung Electronics America, Inc.

85 Challenger Road

Ridgefield Park, NJ 07660

1-800-SAMSUNG (726-7864)

1-844-SAM-PAYS (726-7297)

www.samsung.com/us/support

Warranty Information (CANADA)

If your refrigerator needs service

Do not hesitate to call any Samsung Authorized Service Center nearby giving them your name, address and telephone number when your product is not functioning properly.

Limited Warranty for Original Purchaser

This Samsung product is warranted by Samsung Electronics Canada, Inc. (hereafter referred to as SECA) against manufacturing defects in material or workmanship for the following periods:

Labor : 1 year (in-home)

Parts : 1 year

Inverter Compressor : 10 years(part only)

SECA further warrants that if this product fails to operate properly within the specified warranty period and the failure is due to improper workmanship or defective material, SECA will repair or replace the product at its option.

All warranty repairs or part replacements must be performed by a SECA Authorized Service Center. (To find the nearest SECA Service Center, call 1-800-SAMSUNG (7267864) or visit our web site at www.samsung.com/ca)

Obligation to the Original Owner

The original dated sales receipt must be retained by the customer and is the only acceptable proof of purchase. It must be presented to a SECA Authorized Service Center at the time service is requested before warranty services are rendered. On all carry-in models, transportation to and from the Authorized Service Center is the responsibility of the customer.

Exclusions of the Warranty

This warranty does not cover damage due to accident, fire, flood, and/or other Acts of God, misuse, incorrect line voltage, improper installation, improper or unauthorized repairs, commercial use, or damage that occurs during shipping. Customer adjustments which are explained in this owner's manual are not covered under the terms of this warranty. This warranty will automatically be voided for any unit found with a missing or altered serial number. This warranty is valid only on products purchased and used in the Canada.

SAMSUNG CUSTOMER CARE CENTER

Samsung Electronics Canada Inc. 2050 Derry Road West, Mississauga,

Ontario L5N 0B9 Canada

1-800-SAMSUNG(726-7864)

1-844-SAM-PAYS (726-7297)

www.samsung.com/ca/support (English)

www.samsung.com/ca_fr/support (French)

Contact SAMSUNG WORLD WIDE

If you have any questions or comments relating to Samsung products, please contact the SAMSUNG customer care center.

COUNTRY	Custom Care Center	WEBSITE
U.S.A	1-800-SAMSUNG (726-7864) 1-844-SAM-PAYS (726-7297)	www.samsung.com/us/support
CANADA	1-800-SAMSUNG(726-7864) 1-844-SAM-PAYS (726-7297)	www.samsung.com/ca/support (English) www.samsung.com/ca_fr/support (French)

