

Report on the Testing of the

Itron, Inc.
OW1

In accordance with:
FCC 47 CFR part 15.247
ISED RSS-247 Issue 2, February 2017

Prepared for: Itron, Inc.
313 N Highway 11
West Union, South Carolina 29696 USA



America

Add value.
Inspire trust.

COMMERCIAL-IN-CONFIDENCE

Document Number: AT72187413.1P0

SIGNATURE

NAME	JOB TITLE	RESPONSIBLE FOR	ISSUE DATE
Kirby Munroe	Wireless / EMC Technical and Certification Manager, NA TUV SUD America Inc.	Authorized Signatory	3/31/2023

Signatures in this approval box have checked this document in line with the requirements of TÜV SÜD America, Inc. document control rules.

FCC Accreditation Designation Number US1233
FCC Test Site Registration Number 967699
Innovation, Science, and Economic Development Canada Lab Code 23932

EXECUTIVE SUMMARY

A sample of this product was tested and found to be compliant with the standards listed above.



A2LA Cert. No. 2955.09

DISCLAIMER AND COPYRIGHT

This non-binding report has been prepared by TÜV SÜD America with all reasonable skill and care. The document is confidential to the potential Client and TÜV SÜD America. No part of this document may be reproduced without the prior written approval of TÜV SÜD America. © TÜV SÜD.

ACCREDITATION

Our A2LA Accreditation does not cover opinions and interpretations and any expressed are outside the scope of our A2LA Accreditation.

TÜV SÜD America
5945 Cabot Parkway, Suite 100
Alpharetta, GA 3005

Phone: 678-341-5900
www.tuv-sud-america.com

TÜV SÜD

TÜV®



Contents

1	Report Summary	3
1.1	Report Modification Record.....	3
1.2	Introduction.....	3
1.3	Brief Summary of Results	5
1.4	Product Information	6
1.5	Deviations from the Standard.....	9
1.6	EUT Modification Record	9
1.7	Test Location	9
2	Test Details	10
2.1	Antenna Requirement	10
2.2	Power Line Conducted Emissions	11
2.3	Radiated Spurious Emissions into Restricted Frequency Bands.....	14
2.4	Test Equipment Used.....	28
3	Diagram of Test Set-ups.....	29
4	Accreditation, Disclaimers and Copyright.....	31



1 Report Summary

1.1 Report Modification Record

Alterations and additions to this report will be issued to the holders of each copy in the form of a complete document.

Table 1.1-1 – Modification Record

Issue	Description of Change	Date of Issue
0	First Issue	3/31/2023

1.2 Introduction

The purpose of this report is to demonstrate compliance with Part 15 Subpart C of the FCC's Code of Federal Regulations Section 15.247 and Innovation Science and Economic Development Canada's Radio Standards Specification RSS-247 for the tests documented herein to certify the module with the new antenna and antenna connector under a Class II permissive change on the existing module having FCC ID: SK9OW1 / IC ID:864G-OW1

Applicant	Christopher O'Steen
Manufacturer	Itron, Inc
Applicant's Email Address	Christopher.O'steen@itron.com
Model Name	OW1
Serial Number(s)	102600000066-009 102600000077-009
FCC ID	SK9OW1
ISED Certification Number	864G-OW1
Hardware Version(s)	NA
Software Version	NA
Number of Samples Tested	2
Test Specification/Issue/Date	US Code of Federal Regulation (CFR): Title 47, Part 15, Subpart C: Radio Frequency Devices, Intentional Radiators, 2022 ISED Canada Radio Standards Specification: RSS-247 – Digital Transmission Systems (DTSS), Frequency Hopping Systems (FHSs) and License-Exempt Local Area Network (LE-LAN) Devices, Issue 2, February 2017.
Order Number	72186194
Date of Receipt of EUT	2/14/2023
Start of Test	2/14/2023
Finish of Test	2/16/2023



Related Document(s)

ANSI C63.10-2013: American National Standard of Procedures for Compliance Testing of Unlicensed Wireless Device.

FCC OET KDB 558074 D01 15.247 Meas Guidance v05r02: Guidance for Compliance Measurements on Digital Transmission System, Frequency Hopping Spread Spectrum System, and Hybrid System Devices Operating under Section 15.247 of the FCC Rules, April 2, 2019

US Code of Federal Regulations (CFR): Title 47, Part 2, Subpart J: Equipment Authorization Procedures, 2022.

ISED Canada Radio Standards Specification: RSS-GEN – General Requirements for Compliance of Radio Apparatus, Issue 5, Amendment 1 (March 2019), Amendment 2 (February 2021)



1.3 Brief Summary of Results

A brief summary of the tests carried out in accordance with FCC Part 15.247 and ISED Canada's RSS-247 is shown below.

Table 1.3-1: Test Result Summary

Test Parameter	Test Plan (Yes/No)	Test Result	FCC 47 CFR Rule Part	ISED Canada's RSS	Test Report Page No
Antenna Requirement	Yes	Pass	15.203, 15.204	-----	10
Carrier Frequency Separation	No	Not Tested	15.247(a)(1)	RSS-247 5.1(b)	-----
Number of Hopping Channels	No	Not Tested	15.247(a)(1)(i)	RSS-247 5.1(c)	-----
Channel Dwell Time	No	Not Tested	15.247(a)(1)(i)	RSS-247 5.1(c)	-----
20 dB Bandwidth	No	Not Tested	15.247(a)(1)(i)	RSS-247 5.1(c)	-----
99% Bandwidth	No	Not Tested	-----	RSS-GEN 6.7	-----
Peak Output Power	No	Not Tested	15.247(b)(2)	RSS-247 5.4(a)	-----
Band-Edge Compliance of RF Conducted Emissions	No	Not Tested	15.247(d)	RSS-247 5.5	-----
RF Conducted Spurious Emissions	No	Not Tested	15.247(d)	RSS-247 5.5	-----
Radiated Spurious Emissions into Restricted Frequency Bands	Yes	Pass	15.205, 15.209	RSS-GEN 8.9, 8.10	14
Power Spectral Density	No	Not Tested	15.247(e)	RSS-247 5.2(b)	-----
Power Line Conducted Emissions	Yes	Pass	15.207	RSS-GEN 8.8	11
Duty Cycle	No	-----			-----



1.4 Product Information

1.4.1 Technical Description

The Itron OW1 is a communication module which includes a 902.4 -927.6 MHz transmitter. The module operates on DC Voltage which is supplied by a host device.

This test report documents the compliance of additional technical parameters identified below:

Table 1.4.1-1 – General Information

Detail	Description
FCC ID	SK9OW1
ISED Certification Number	864G-OW1
Model(s) / HVIN(s)	OW1
PMN(s)	CAM1 Star Module
Operating Voltage	12Vdc
Antenna Type / Description:	Monopole Cisco Antenna ANT-5G-MP-OUT-N / 2 dBi

Table 1.4.1-2 – Technical Parameters

Frequency Range (MHz)	Number of Channels	Channel Separation (kHz)	Modulation Format	Data Rates Supported (kbps)
902.4 – 927.6	64	400	FSK	50, 150
902.4 – 927.6	64	400	OFDM	200, 600
902.4 – 927.6	64	400	DSSS	6.25, 12.5

Note: Only the technical parameters listed above, from the original certification, were evaluated for the additional antenna. The device is capable of additional modes / frequency bands, as defined in subsequent permissive change applications, which are not valid for use with the antenna detailed in table 1.4-1.

A full description and detailed product specification details are available from the manufacturer.

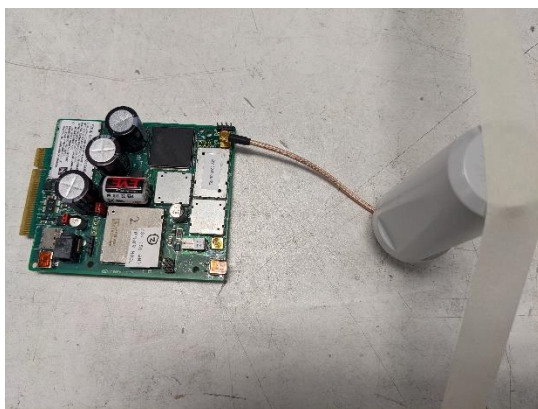

Figure 1.4.1-1: Front Side of the EUT

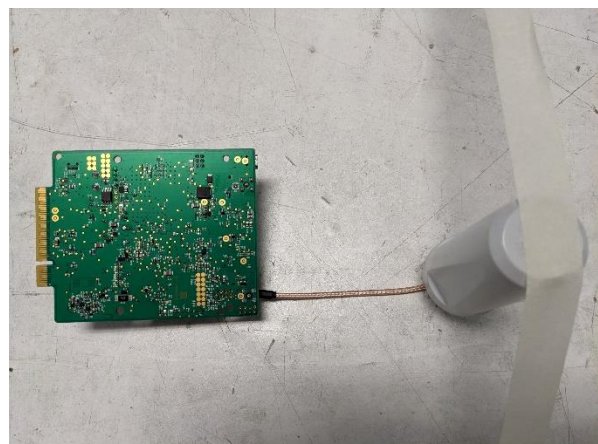

Figure 1.4.1-2: Back Side of the EUT

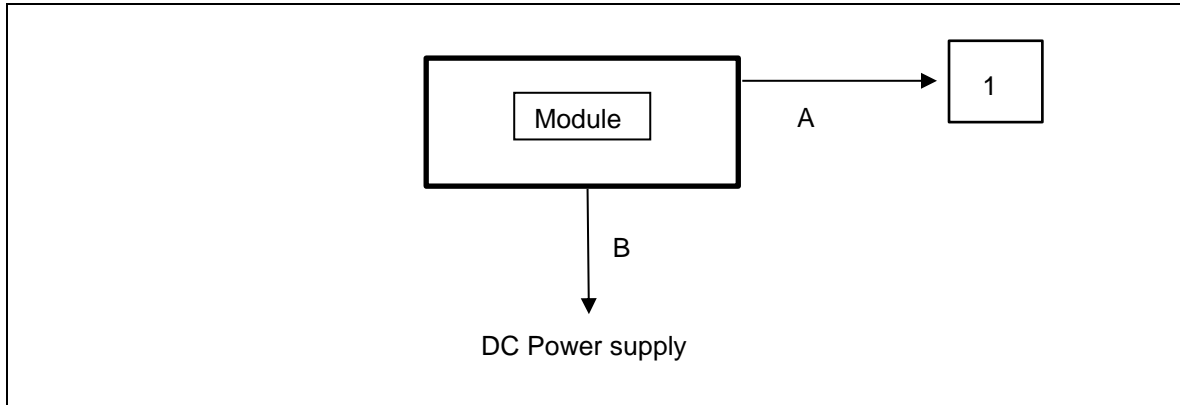

Figure 1.4.1-3 –Test Setup Block Diagram

Table 1.4.1-3 – Cable Descriptions

Item	Cable/Port	Description
A	USB Serial cable	Programming cable connected to laptop
B	DC Power Supply Cable	DC power supply

Table 1.4.1-4 – Support Equipment Descriptions

Item	Make/Model	Description
1	DELL	Laptop used for configuring module



1.4.2 Modes of Operation

The Itron OW1 is a communication module which includes a 902.4 - 927.6 MHz transmitter. This test report documents the compliance of the 902.4 – 927.6 MHz transceiver modes of operation as defined below. The worst-case data rate for each mode (modulation) was chosen for evaluation. See section 1.4.1 for additional detail.

Mode of Operation	Frequency Range (MHz)	Number of Channels	Channel Separation (kHz)	Modulation Format	Data Rates Supported (kbps)
1	902.4 – 927.6	64	400	FSK	50
2	902.4 – 927.6	64	400	OFDM	600
3	902.4 – 927.6	64	400	DSSS	12.5

1.4.3 Monitoring of Performance

For radiated emissions, the EUT was evaluated in three orthogonal orientations. The worst-case orientation was X-position. See test setup photos for more information. The EUT was programmed to generate a continuously modulated signal on each channel evaluated.

For power line conducted emissions, the EUT was powered by a representative wall wart power supply.

Software power setting during test: FSK: 4
 OFDM: 2
 DSSS: 4



1.5 Deviations from the Standard

No deviations from the applicable test standard were made during testing.

1.6 EUT Modification Record

The table below details modifications made to the EUT during the test program. The modifications incorporated during each test are recorded on the appropriate test pages.

Modification State	Description of Modification still fitted to EUT	Modification Fitted By	Date Modification Fitted
0	Initial State		

The equipment was tested as provided without any modifications.

1.7 Test Location

TÜV SÜD conducted the following tests at our Alpharetta, GA test laboratory.

Test Name	Name of Engineer(s)	Accreditation
Antenna Requirement	Divya Adusumilli	A2LA
Power Line Conducted Emissions	Divya Adusumilli	A2LA
Radiated Spurious Emissions into Restricted Frequency Bands	Divya Adusumilli	A2LA

Office address:
 TÜV SÜD America
 5945 Cabot Parkway, Suite 100
 Alpharetta, GA 30005, USA



2 Test Details

2.1 Antenna Requirement

2.1.1 Specification Reference

FCC Section: 15.203, 15.204

2.1.2 Equipment Under Test and Modification State

As shown in §1.4 with modification state "0", as noted in §1.6.

2.1.3 Date of Observation

2/14/2023

2.1.4 Test Method

N/A

2.1.5 Environmental Conditions

N/A

2.1.6 Observation

The EUT utilizes monopole antenna connected to the module via vertical MCX Connector with peak gain 2 dBi, therefore satisfying the requirements of Section 15.203.



2.2 Power Line Conducted Emissions

2.2.1 Specification Reference

FCC Section: 15.207
ISED Canada: RSS-Gen 8.8

2.2.2 Equipment Under Test and Modification State

As shown in §1.4 with modification state "0", as noted in §1.6.

2.2.3 Date of Test

2/15/2023

2.2.4 Test Method

ANSI C63.10 section 6 was the guiding documents for this evaluation. Conducted emissions were performed from 150kHz to 30MHz with the spectrum analyzer's resolution bandwidth set to 9kHz and the video bandwidth set to 30kHz. The calculation for the conducted emissions is as follows:

Corrected Reading = Analyzer Reading + LISN Loss + Cable Loss
Margin = Corrected Reading - Applicable Limit

2.2.5 Environmental Conditions

The EUT was evaluated within the temperature, humidity and pressure range of the EUT as specified by the standard. The laboratory shall have an ambient temperature range of 15°C to 35°C, relative humidity range of 30% to 60% and atmospheric pressure range of 86 kPa to 106 kPa.

Ambient Temperature	22.3 °C
Relative Humidity	53.8 %
Atmospheric Pressure	972.2 mbar



2.2.6 Test Results

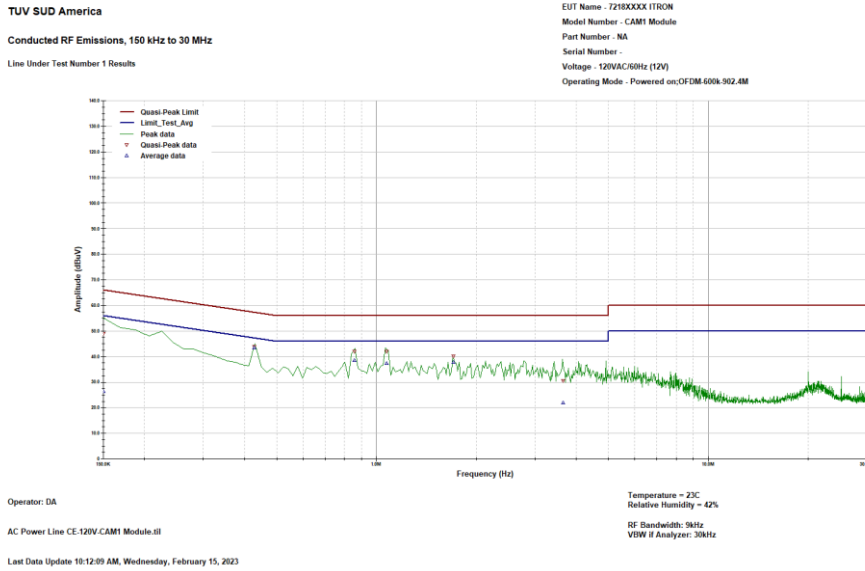

Figure 2.2.6-1: Conducted Emission Plot – Line 1

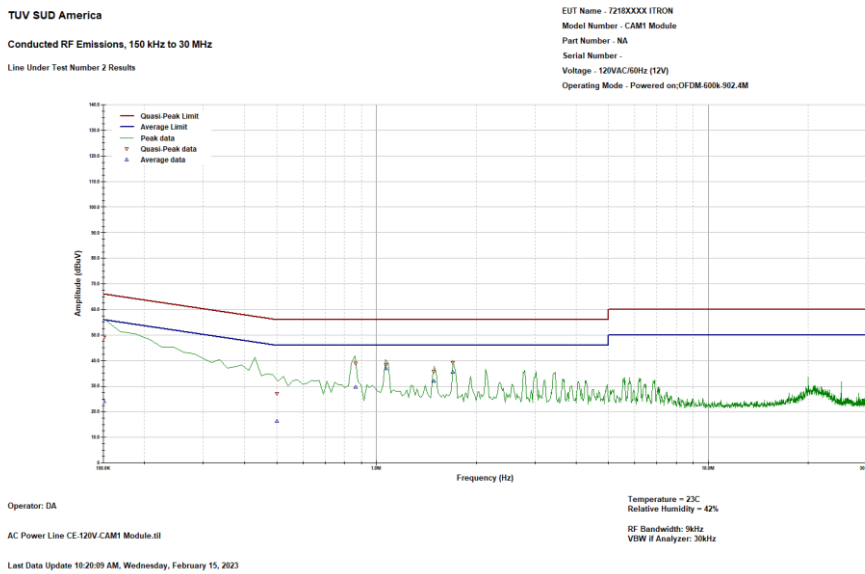

Figure 2.2.6-2: Conducted Emission Plot – Neutral



Table 2.2.6-1: Conducted EMI Results-Avg – Line 1

Frequency	Avg Limit	Avg Level Corr	Avg Level	CF	Avg Margin	Result
MHz	dBuV	dBuV	dBuV	dB	dB	
0.15	56	26.4	16.7	9.682	-29.6	PASS
0.43	48.1	43.5	33.8	9.654	-4.6	PASS
0.86	46	38.5	28.8	9.672	-7.5	PASS
1.07	46	37.2	27.5	9.684	-8.8	PASS
1.71	46	37.9	28.2	9.735	-8.1	PASS
3.65	46	21.9	12.2	9.78	-24.1	PASS

Table 2.2.6-2: Conducted EMI Results-QP – Line 1

Frequency	QP Limit	QP Level Corr	QP Level	CF	QP Margin	Result
MHz	dBuV	dBuV	dBuV	dB	dB	
0.15	66	49	39.3	9.682	-17	PASS
0.43	58.1	43.8	34.1	9.654	-14.3	PASS
0.86	56	42	32.3	9.672	-14	PASS
1.07	56	42	32.3	9.684	-14	PASS
1.71	56	40.1	30.4	9.735	-15.9	PASS
3.65	56	30.6	20.9	9.78	-25.4	PASS

Table 2.2.6-3: Conducted EMI Results-Avg – Neutral

Frequency	Avg Limit	Avg Level Corr	Avg Level	CF	Avg Margin	Result
MHz	dBuV	dBuV	dBuV	dB	dB	
0.15	56	24.1	14.4	9.675	-31.9	PASS
0.5	46	16.4	6.7	9.63	-29.6	PASS
0.86	46	29.7	20.1	9.652	-16.3	PASS
1.07	46	36.8	27.1	9.668	-9.2	PASS
1.49	46	31.9	22.1	9.718	-14.1	PASS
1.7	46	35.4	25.7	9.736	-10.6	PASS

Table 2.2.6-4: Conducted EMI Results-QP – Neutral

Frequency	QP Limit	QP Level Corr	QP Level	CF	QP Margin	Result
MHz	dBuV	dBuV	dBuV	dB	dB	
0.15	66	49	39.3	9.675	-17	PASS
0.5	56	27	17.4	9.63	-29	PASS
0.86	56	38.9	29.2	9.652	-17.1	PASS
1.07	56	38.5	28.9	9.668	-17.5	PASS
1.49	56	35.6	25.9	9.718	-20.4	PASS
1.7	56	39.1	29.4	9.736	-16.9	PASS



2.3 Radiated Spurious Emissions into Restricted Frequency Bands

2.3.1 Specification Reference

FCC Sections: 15.205, 15.209.
ISED Canada: RSS – Gen 8.9/8.10

2.3.2 Equipment Under Test and Modification State

As shown in §1.4 with modification state “0”, as noted in §1.6.

2.3.3 Date of Test

02/14/2023 to 02/16/2023

2.3.4 Test Method

Radiated emissions tests were made over the frequency range of 9 kHz to 10 GHz, 10 times the highest fundamental frequency of 900 MHz. Each emission found to be in a restricted band as defined by section 15.205, including any emission at the operational band-edge, was compared to the radiated emission limits as defined in Section 15.209.

The EUT was rotated through 360° and the receive antenna height was varied from 1m to 4m so that the maximum radiated emissions level would be detected. For frequencies below 150 kHz, quasi-peak measurements were made using a resolution bandwidth RBW of 300 Hz and a video bandwidth VBW of 1 kHz and frequencies between 150 kHz and 30MHz, quasi-peak measurements were made using a resolution bandwidth RBW of 10 kHz and a video bandwidth VBW of 30 kHz. For frequencies between 30 MHz and 1000 MHz, quasi-peak measurements were made using a resolution bandwidth RBW of 100 kHz and a video bandwidth VBW of 300 kHz. For frequencies above 1000 MHz, peak and average measurements were made with RBW of 1 MHz and VBW of 3 MHz.

2.3.5 Environmental Conditions

The EUT was evaluated within the temperature, humidity and pressure range of the EUT as specified by the standard. The laboratory shall have an ambient temperature range of 15°C to 35°C, relative humidity range of 30% to 60% and atmospheric pressure range of 86 kPa to 106 kPa.

Ambient Temperature	22.3 °C
Relative Humidity	53.8 %
Atmospheric Pressure	972.2 mbar



2.3.6 Test Results

Test Summary: EUT was set to the transmit modes as per sections 1.4.2 / 1.4.3.

Test Results: Pass

See data below for detailed results.

Table 2.3.6-1: Radiated Spurious Emissions Tabulated Data – Mode 1 – FSK - 50 kbps

Frequency	Peak Value	QP/Avg Value	Peak Limit	QP/Avg Limit	Peak Margin	QP/Avg Margin	Polarity	Peak Limit Results	QP/Avg Limit Results
MHz	dBµV/m	dBµV/m	dBµV/m	dBµV/m	dB	dB	H/V	Pass/Fail	Pass/Fail
LCH – 902.4 MHz									
2707.25	46.34	32.257	74	54	-27.66	-21.74	H	PASS	PASS
3609.6	47.578	32.863	74	54	-26.42	-21.14	H	PASS	PASS
4512.125	48.567	33.401	74	54	-25.43	-20.6	H	PASS	PASS
2707.125	47.407	35.445	74	54	-26.59	-18.55	V	PASS	PASS
3609.6	47.142	32.993	74	54	-26.86	-21.01	V	PASS	PASS
4511.9	48.873	33.45	74	54	-25.13	-20.55	V	PASS	PASS
MCH – 915.2 MHz									
328.714	-----	32.296	-----	46	-----	-13.7	H	-----	PASS
38.073	-----	11.93	-----	40	-----	-28.07	V	-----	PASS
328.812	-----	33.904	-----	46	-----	-12.1	V	-----	PASS
2745.65	46.444	33.199	74	54	-27.56	-20.8	H	PASS	PASS
3660.575	47.907	33.117	74	54	-26.09	-20.88	H	PASS	PASS
4576.025	47.294	33.028	74	54	-26.71	-20.97	H	PASS	PASS
2745.675	48.241	37.996	74	54	-25.76	-16	V	PASS	PASS
3661.025	47.449	33.163	74	54	-26.55	-20.84	V	PASS	PASS
4576.225	48.171	33.083	74	54	-25.83	-20.92	V	PASS	PASS
HCH – 927.6 MHz									
2782.95	45.362	31.173	74	54	-28.64	-22.83	H	PASS	PASS
3710.325	47.244	32.737	74	54	-26.76	-21.26	H	PASS	PASS
4637.8	47.164	32.738	74	54	-26.84	-21.26	H	PASS	PASS
2782.925	47.081	32.22	74	54	-26.92	-21.78	V	PASS	PASS
3710.325	48.376	34.108	74	54	-25.62	-19.89	V	PASS	PASS
4637.825	47.705	33.229	74	54	-26.29	-20.77	V	PASS	PASS



Table 2.3.6-2: Radiated Spurious Emissions Tabulated Data – Mode 2 – OFDM - 600 kbps

Frequency	Peak Value	QP/Avg Value	Peak Limit	QP/Avg Limit	Peak Margin	QP/Avg Margin	Polarity	Peak Limit Results	QP/Avg Limit Results
MHz	dBµV/m	dBµV/m	dBµV/m	dBµV/m	dB	dB	H/V	Pass/Fail	Pass/Fail
LCH – 902.4 MHz									
2707	45.969	31.217	74	54	-28.03	-22.78	H	PASS	PASS
3609.7	48.211	32.928	74	54	-25.79	-21.07	H	PASS	PASS
2707.275	45.683	31.329	74	54	-28.32	-22.67	V	PASS	PASS
3609.7	47.035	32.951	74	54	-26.97	-21.05	V	PASS	PASS
MCH – 915.2 MHz									
2745.675	46.588	31.565	74	54	-27.41	-22.43	H	PASS	PASS
3660.8	48.431	33.39	74	54	-25.57	-20.61	H	PASS	PASS
2745.5	46.647	31.837	74	54	-27.35	-22.16	V	PASS	PASS
3660.95	48.266	33.473	74	54	-25.73	-20.53	V	PASS	PASS
HCH – 927.6 MHz									
2782.625	45.437	31.177	74	54	-28.56	-22.82	H	PASS	PASS
3710.45	47.041	32.896	74	54	-26.96	-21.1	H	PASS	PASS
2782.625	48.087	31.442	74	54	-25.91	-22.56	V	PASS	PASS
3710.525	47.465	32.918	74	54	-26.53	-21.08	V	PASS	PASS



Table 2.3.6-3: Radiated Spurious Emissions Tabulated Data – Mode 3 – DSSS – 12.5 kbps

Frequency	Peak Value	QP/Avg Value	Peak Limit	QP/Avg Limit	Peak Margin	QP/Avg Margin	Polarity	Peak Limit Results	QP/Avg Limit Results
MHz	dBµV/m	dBµV/m	dBµV/m	dBµV/m	dB	dB	H/V	Pass/Fail	Pass/Fail
LCH – 902.4 MHz									
2706.975	46.214	31.555	74	54	-27.79	-22.45	H	PASS	PASS
3609.55	47.496	32.99	74	54	-26.5	-21.01	H	PASS	PASS
8121.35	53.37	39.36	74	54	-20.63	-14.64	H	PASS	PASS
2707.25	47.989	37.05	74	54	-26.01	-16.95	V	PASS	PASS
3609.425	47.531	32.912	74	54	-26.47	-21.09	V	PASS	PASS
8121.75	54.15	39.462	74	54	-19.85	-14.54	V	PASS	PASS
MCH – 915.2 MHz									
2745.55	48.337	37.257	74	54	-25.66	-16.74	H	PASS	PASS
3660.75	47.704	33.298	74	54	-26.3	-20.7	H	PASS	PASS
2745.675	49.56	40.174	74	54	-24.44	-13.83	V	PASS	PASS
3660.675	48.317	34.076	74	54	-25.68	-19.92	V	PASS	PASS
HCH – 927.6 MHz									
2782.725	48.33	36.913	74	54	-25.67	-17.09	H	PASS	PASS
3710.225	47.781	32.708	74	54	-26.22	-21.29	H	PASS	PASS
2782.725	48.903	39.271	74	54	-25.1	-14.73	V	PASS	PASS
3710.4	48.575	33.545	74	54	-25.42	-20.46	V	PASS	PASS

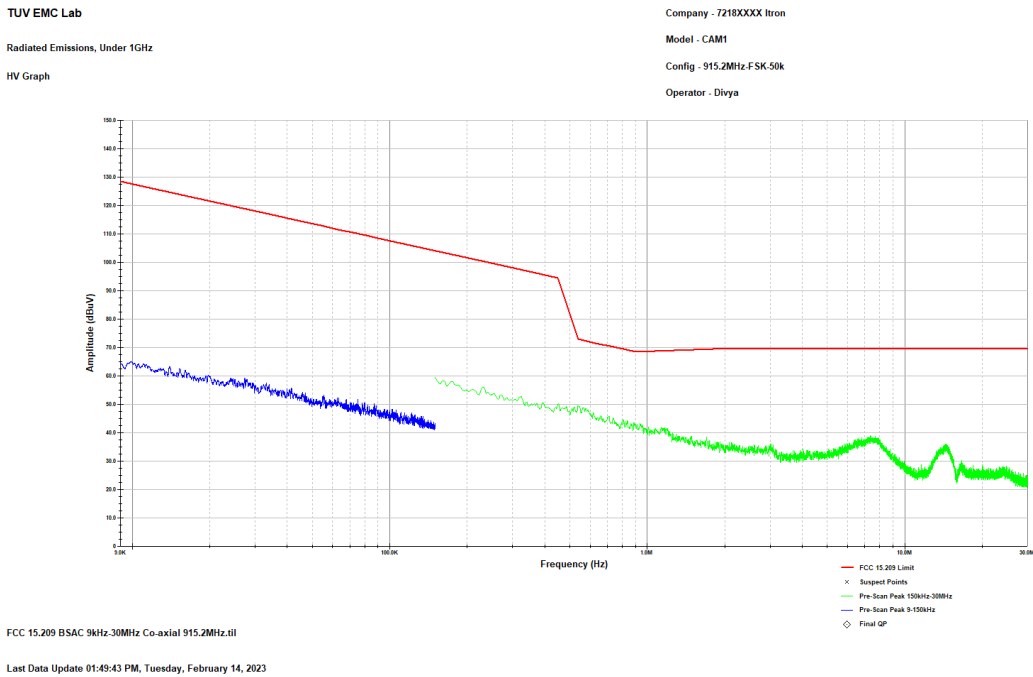

Figure 2.3.6-1: Reference plot for Radiated Spurious Emissions – 9 kHz – 30 MHz – Mode 1 – 50 kbps – Coaxial

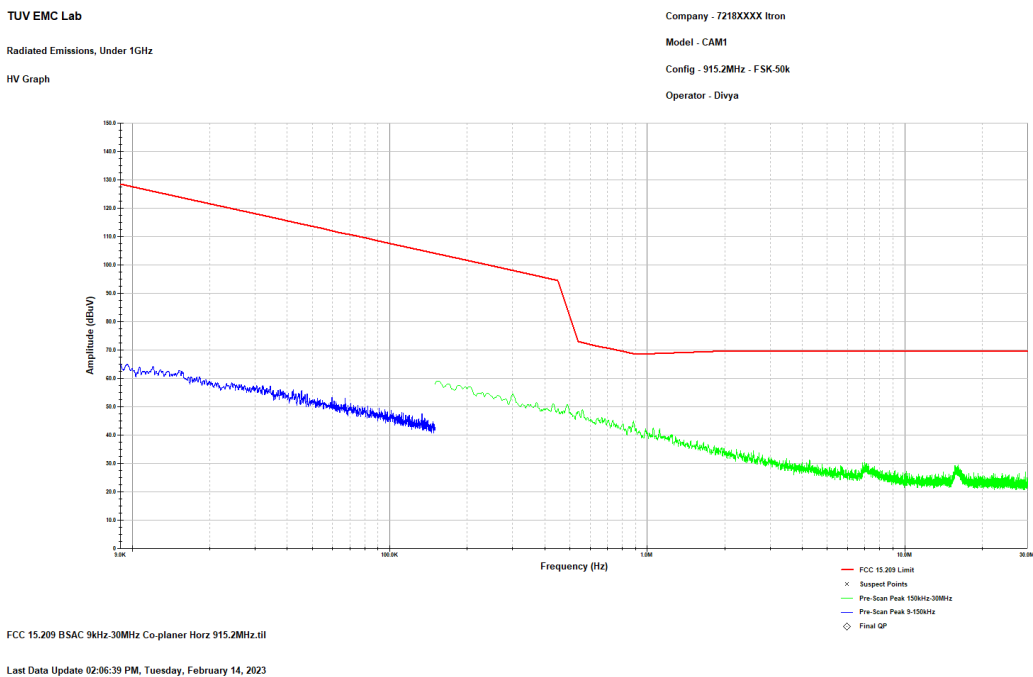

Figure 2.3.6-2: Reference plot for Radiated Spurious Emissions – 9 kHz – 30 MHz – Mode 1 – 50 kbps – Co-planar Horizontal

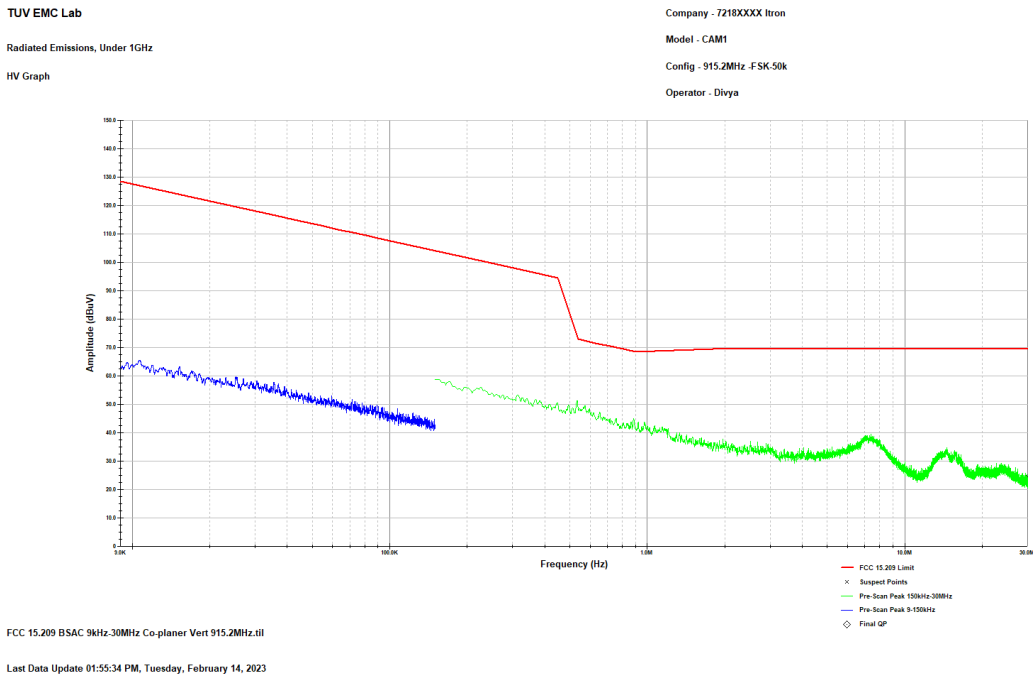

Figure 2.3.6-3: Reference plot for Radiated Spurious Emissions – 9 kHz – 30 MHz – Mode 1 – 50 kbps – Co-planar Vertical

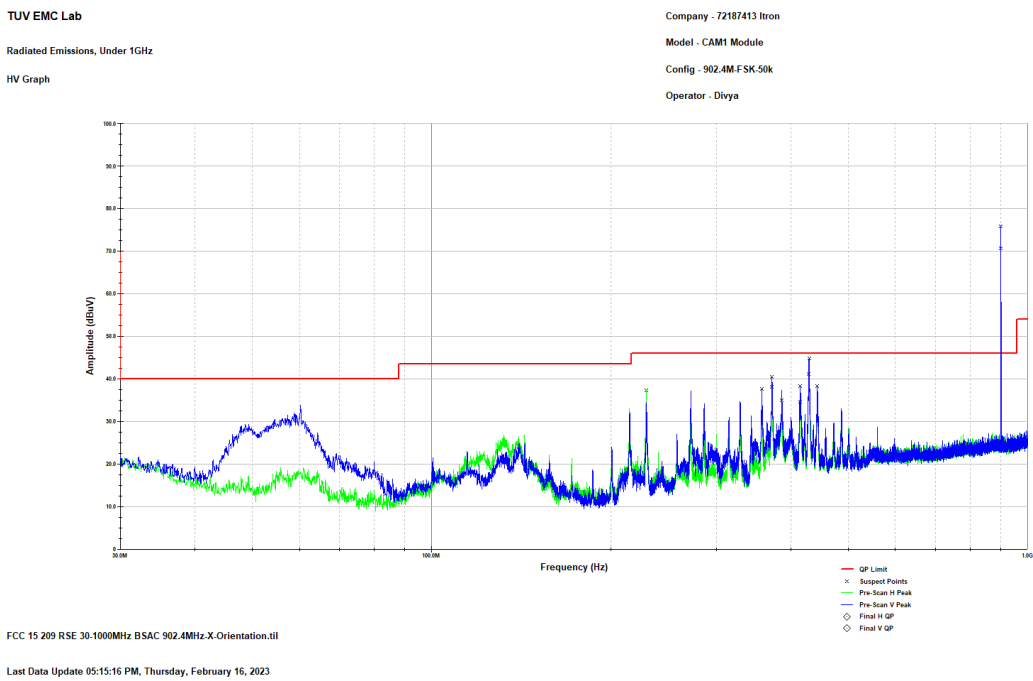

Figure 2.3.6-4: Reference plot for Radiated Spurious Emissions – 30 MHz – 1 GHz – Mode 1 – 50 kbps
Note: Emissions within restricted bands only were evaluated and emission above the limit is the Fundamental.

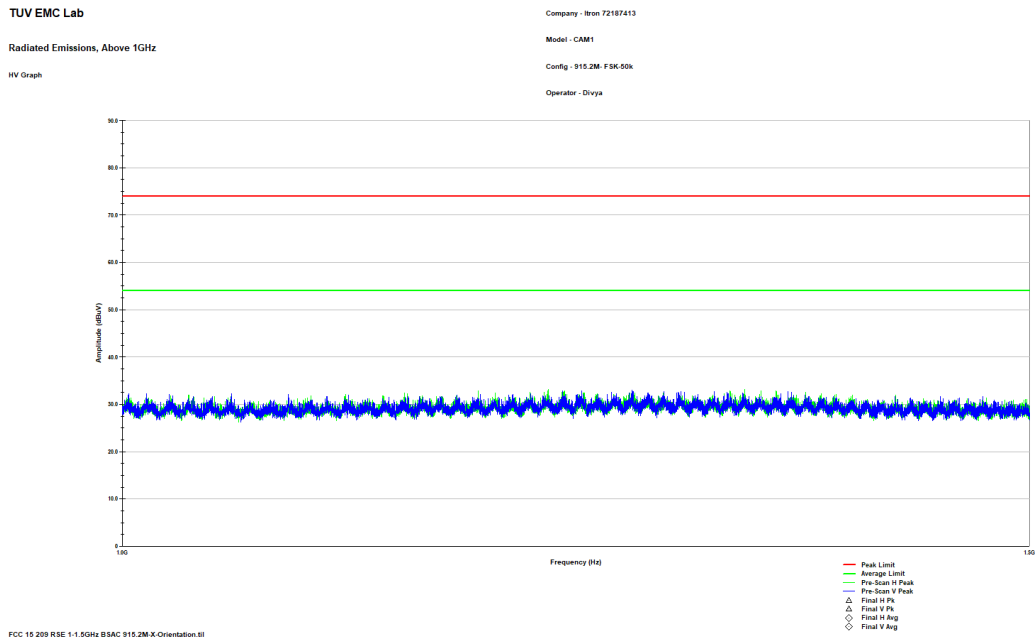

Figure 2.3.6-5: Reference plot for Radiated Spurious Emissions – 1 GHz – 1.5 GHz – Mode 1 – 50 kbps

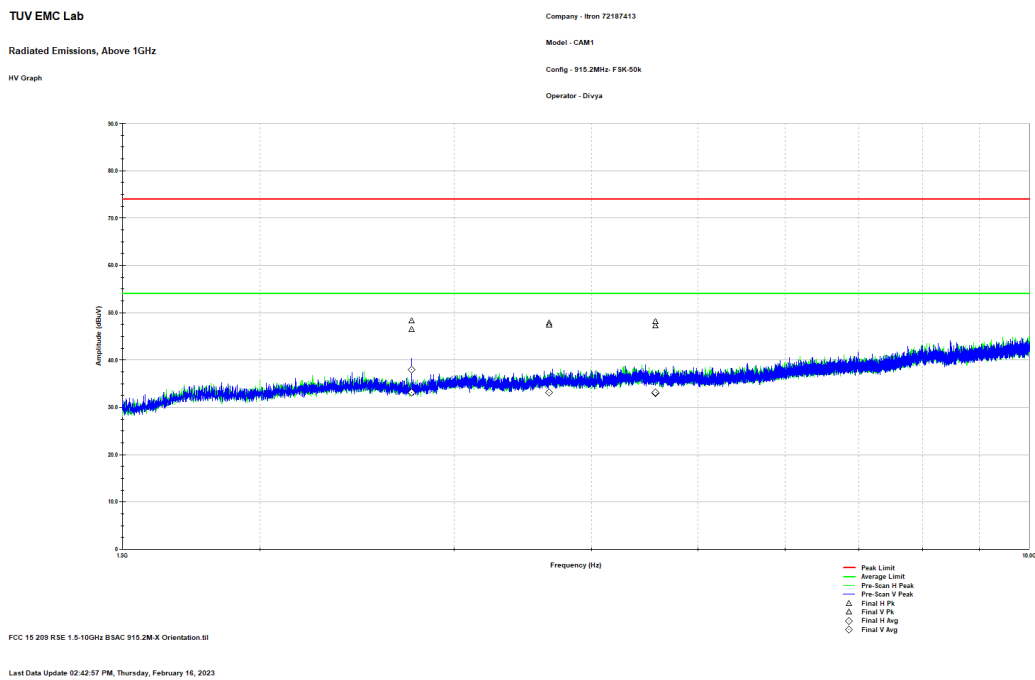

Figure 2.3.6-6: Reference plot for Radiated Spurious Emissions – 1.5 GHz – 10 GHz – Mode 1 – 50 kbps

Note: Emissions within restricted bands only were evaluated.

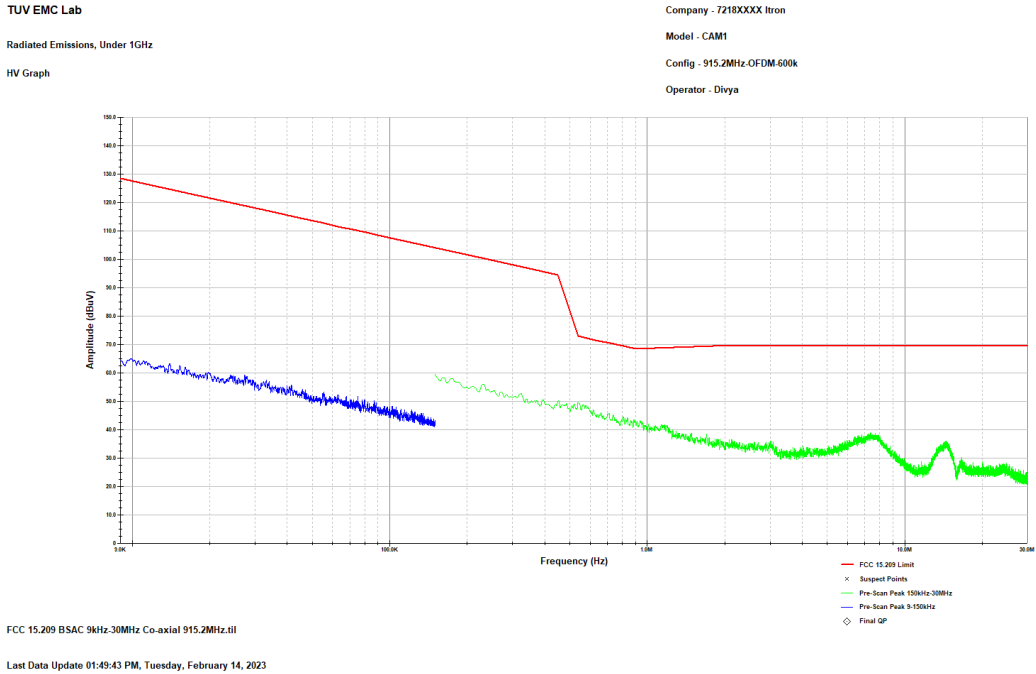

Figure 2.3.6-7: Reference plot for Radiated Spurious Emissions – 9 kHz – 30 MHz – Mode 2 – 600 kbps – Coaxial

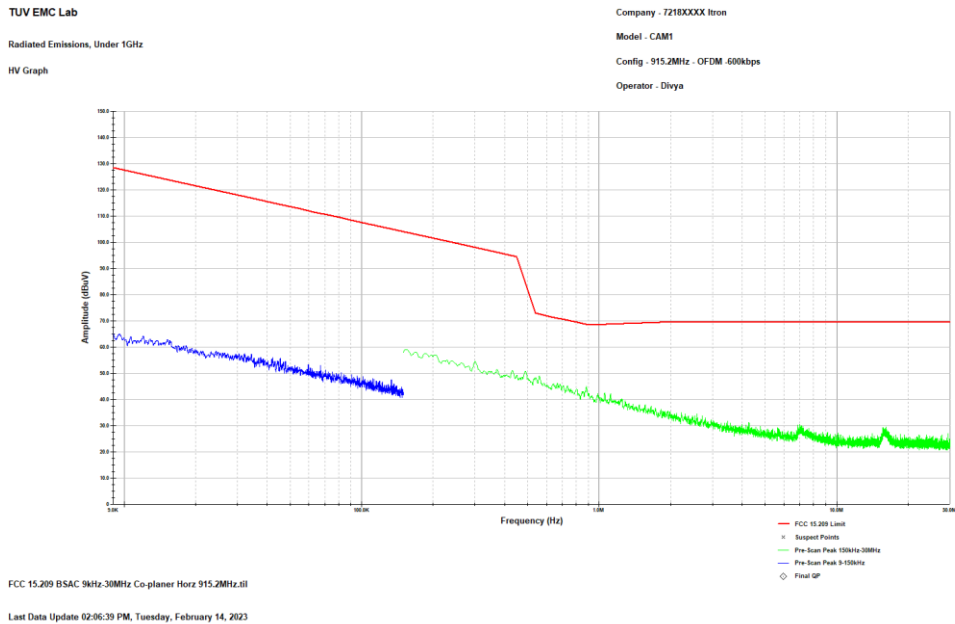

Figure 2.3.6-8: Reference plot for Radiated Spurious Emissions – 9 kHz – 30 MHz – Mode 2 – 600 kbps – Co-planar Horizontal

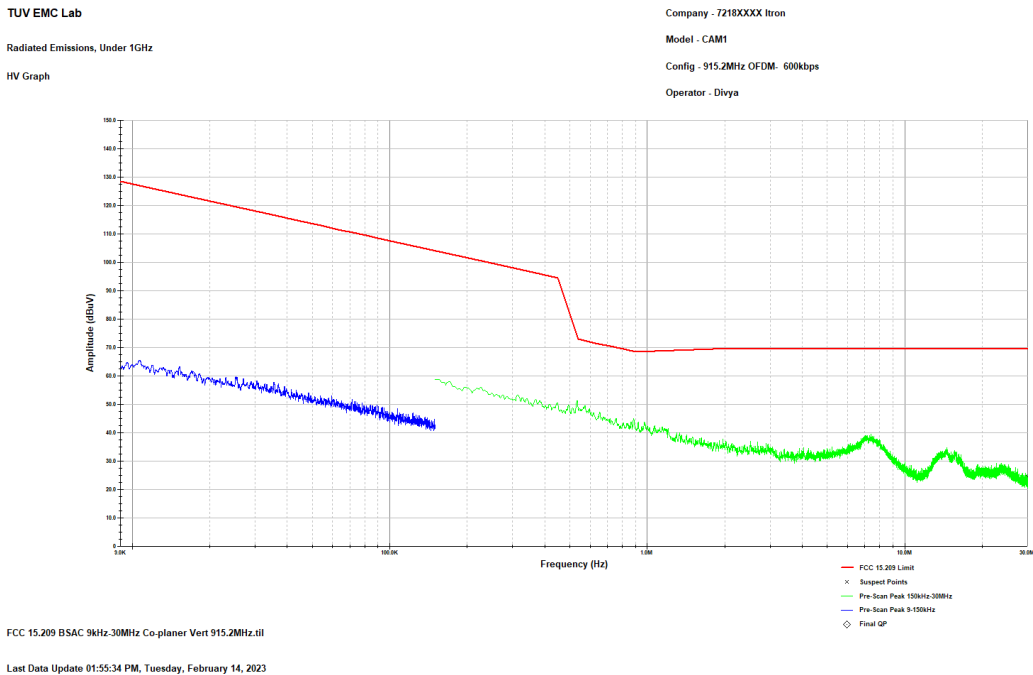

Figure 2.3.6-9: Reference plot for Radiated Spurious Emissions – 9 kHz – 30 MHz – Mode 2 – 600 kbps – Co-planar Vertical

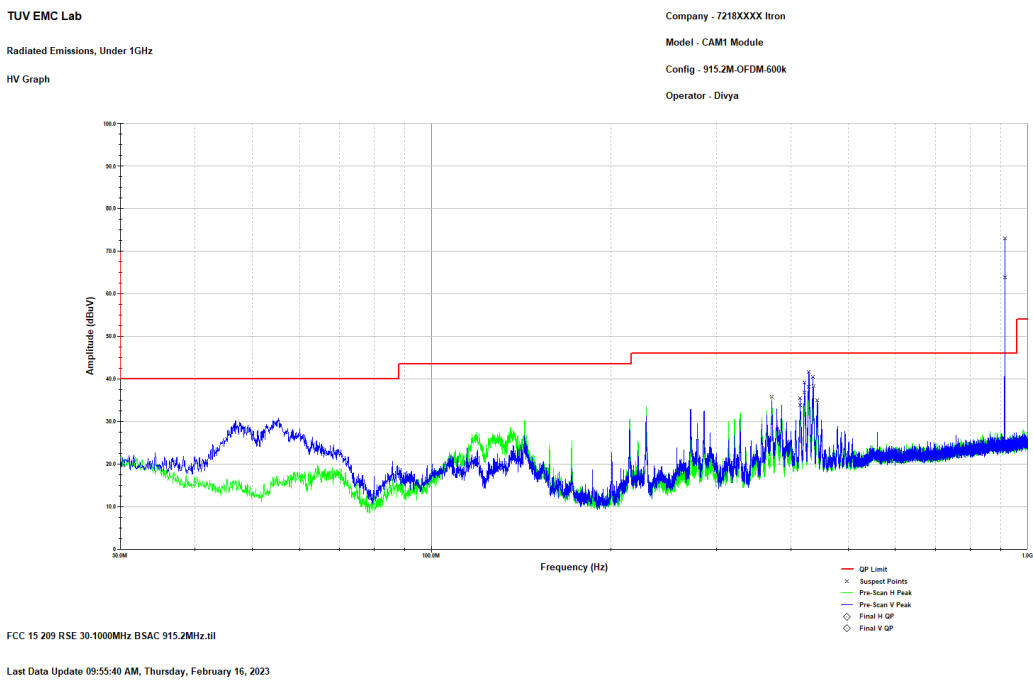

Figure 2.3.6-10: Reference plot for Radiated Spurious Emissions – 30 MHz – 1 GHz – Mode 2 – 600 kbps

Note: Emissions within restricted bands only were evaluated and emission above the limit is the Fundamental.

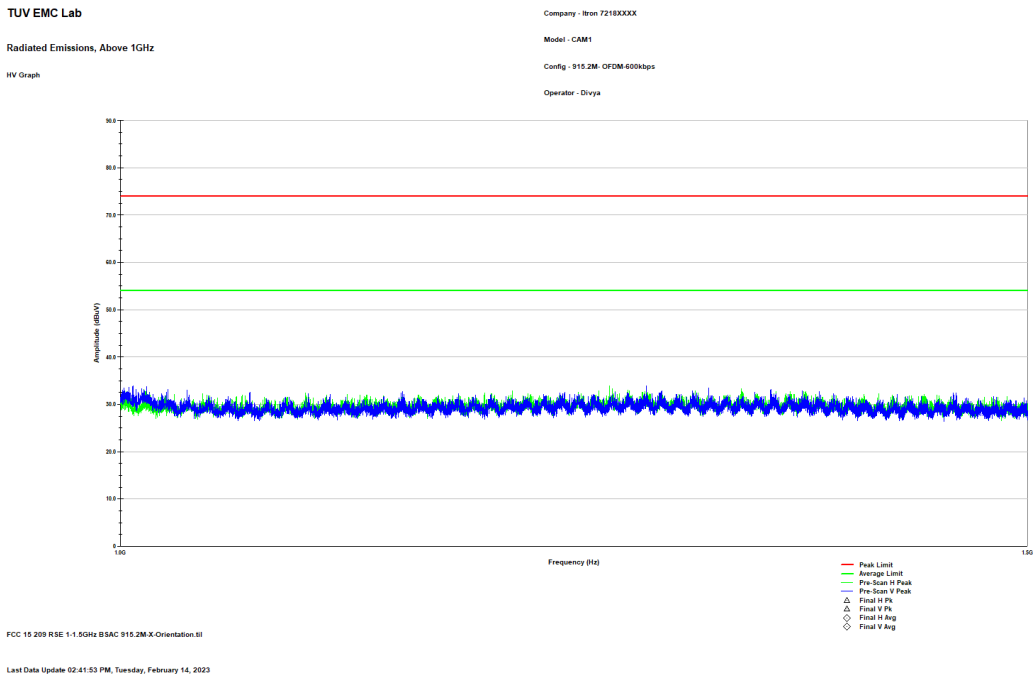

Figure 2.3.6-11: Reference plot for Radiated Spurious Emissions – 1 GHz – 1.5 GHz – Mode 2 – 600 kbps

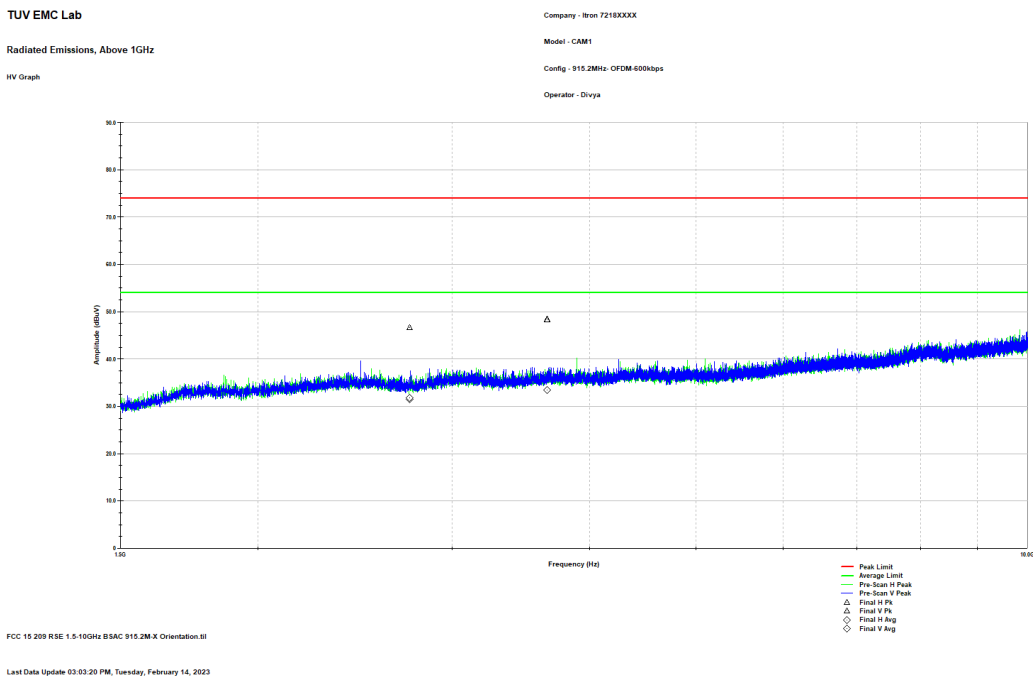

Figure 2.3.6-12: Reference plot for Radiated Spurious Emissions – 1.5 GHz – 10 GHz – Mode 2 – 600 kbps

Note: Emissions within restricted bands only were evaluated.



TUV EMC Lab

Radiated Emissions, Under 1GHz

HV Graph

Company - 7218XXXX Iron

Model - CAM1

Config - 915.2MHz-DSSS-12.5k

Operator - Divya

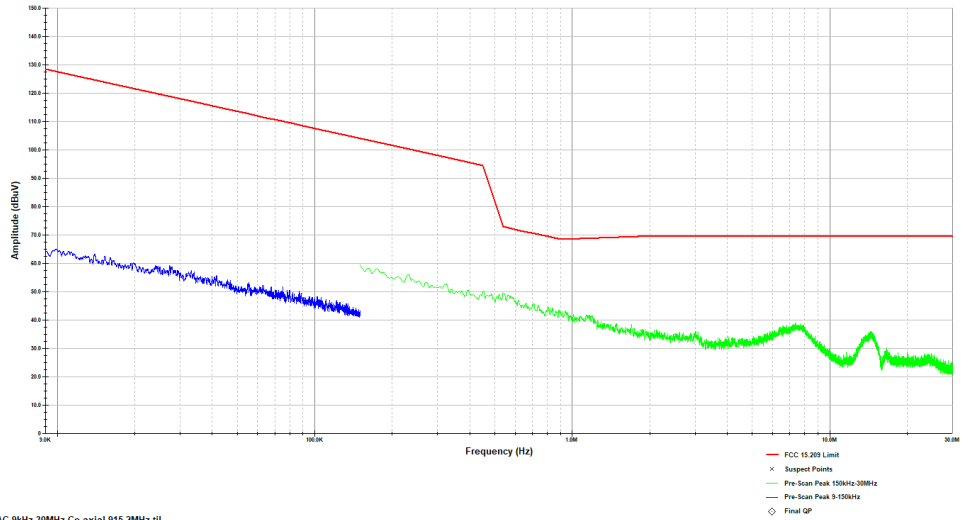

FCC 15.209 BSAC 9kHz-30MHz Co-axial 915.2MHz.ttl

Last Data Update 01:49:43 PM, Tuesday, February 14, 2023

Figure 2.3.6-13: Reference plot for Radiated Spurious Emissions – 9 kHz – 30 MHz – Mode 3 – 12.5 kbps – Coaxial

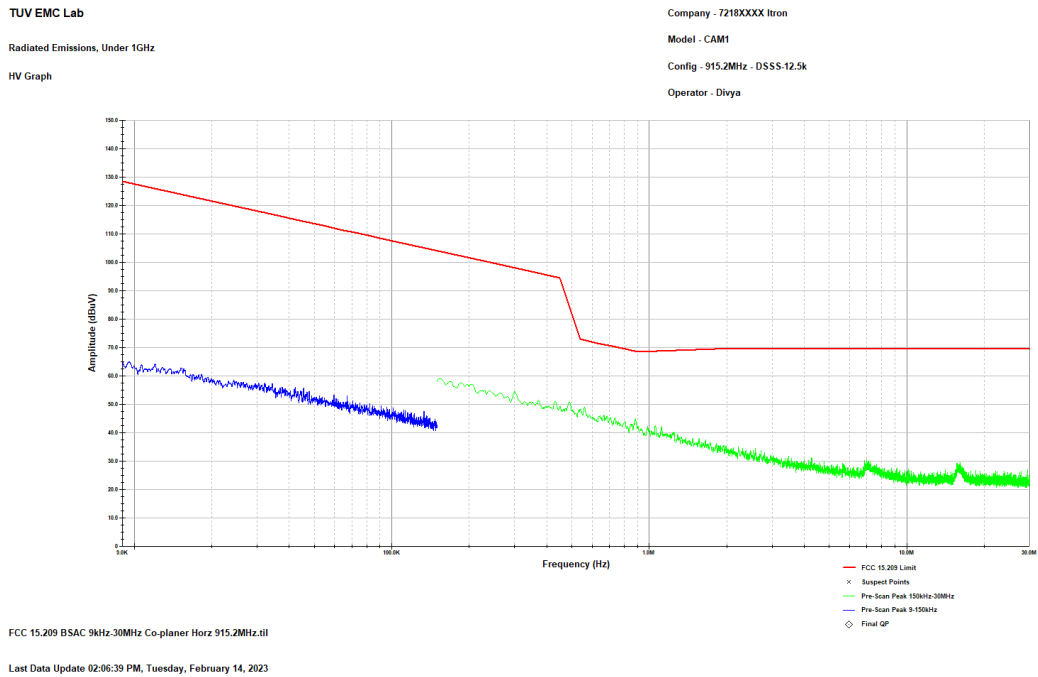

Figure 2.3.6-14: Reference plot for Radiated Spurious Emissions – 9 kHz – 30 MHz – Mode 3 – 12.5 kbps – Co-planar Horizontal

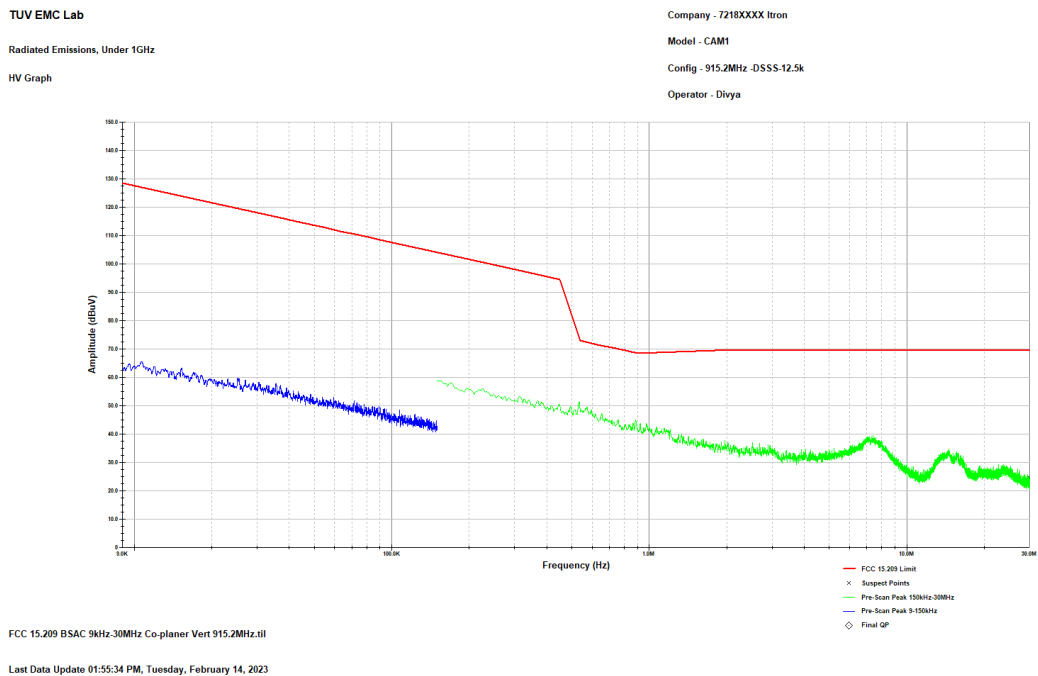

Figure 2.3.6-15: Reference plot for Radiated Spurious Emissions – 9 kHz – 30 MHz – Mode 3 – 12.5 kbps – Co-planar Vertical

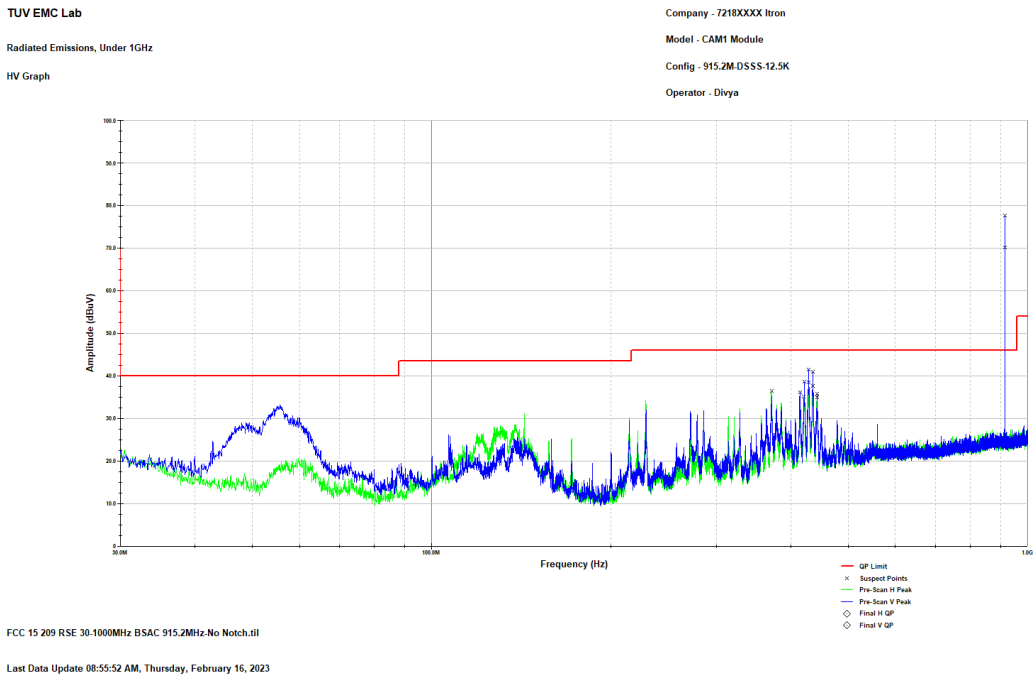

Figure 2.3.6-16: Reference plot for Radiated Spurious Emissions – 30 MHz – 1 GHz – Mode 3 – 12.5 kbps

Note: Emissions within restricted bands only were evaluated and emission above the limit is the Fundamental.

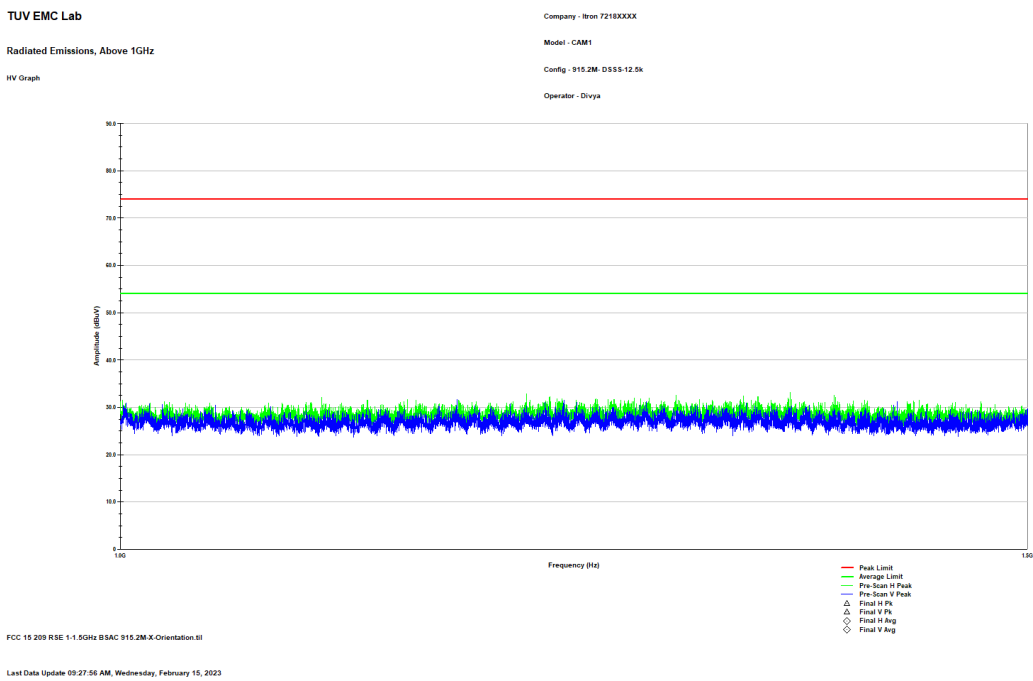

Figure 2.3.6-17: Reference plot for Radiated Spurious Emissions – 1 GHz – 1.5 GHz – Mode 3 – 12.5 kbps

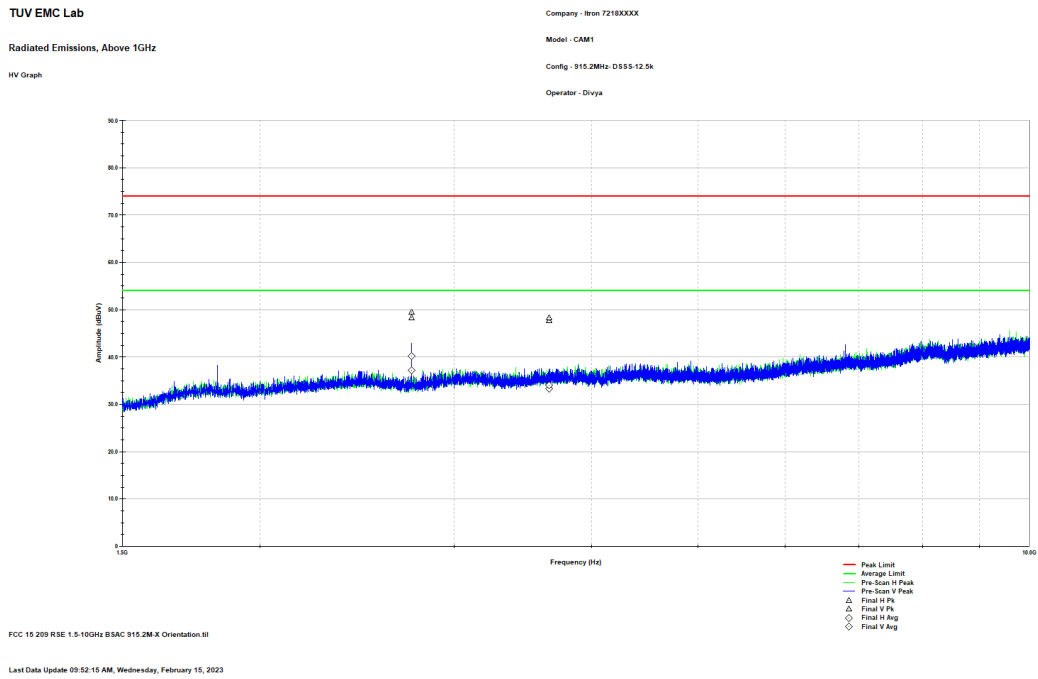

Figure 2.3.6-18: Reference plot for Radiated Spurious Emissions – 1.5 GHz – 10 GHz – Mode 3 – 12.5 kbps

Note: Emissions within restricted bands only were evaluated.



2.4 Test Equipment Used

Table 2.4-1 –Equipment List

Asset ID	Manufacturer	Model	Equipment Type	Serial Number	Last Calibration Date	Calibration Due Date
628	EMCO	6502	Active Loop Antenna 10kHz-30MHz	9407-2877	06/08/2021	06/08/2023
853	Teseq	CBL6112D	BiLog Antenna	51616	7/15/2021	7/15/2023
884	ETS Lindgren (EMCO)	3117	DOUBLE-RIDGED GUIDE ANTENNA	240106	5/6/2021	5/6/2023
889	Com Power	PAM 103	Pre-amplifier	18020215	9/27/2022	9/27/2023
338	Hewlett Packard	8449B	High Frequency Pre-Amp	3008A01111	6/22/2021	6/22/2023
882	Rohde & Schwarz	ESW44	ESW44 EMI TEST RECEIVER	101961	7/14/2022	7/14/2023
22	Teledyne Storm Microwave	90-195-456	BSAC Cable	N/A	10/7/2022	10/7/2023
20	Teledyne Storm Microwave	R-90-195-036	BSAC Cable	N/A	7/12/2022	7/12/2023
21	Teledyne Storm Microwave	R-90-195-072	BSAC Cable	N/A	7/12/2022	7/12/2023
337	Microwave Circuits	H1G513G1	Microwave filter	282706	5/31/2022	5/31/2023
872	HP	E7402A	EMI Receiver	US40240258	6/21/2022	6/21/2023
871	ACS	n/a	Conducted EMI Cable	871	4/1/2022	4/1/2023
3010	Rohde & Schwarz	ENV216	Two-Line V-Network	3010	6/22/2022	6/22/2023

N/A – Not Applicable

3 Diagram of Test Set-ups

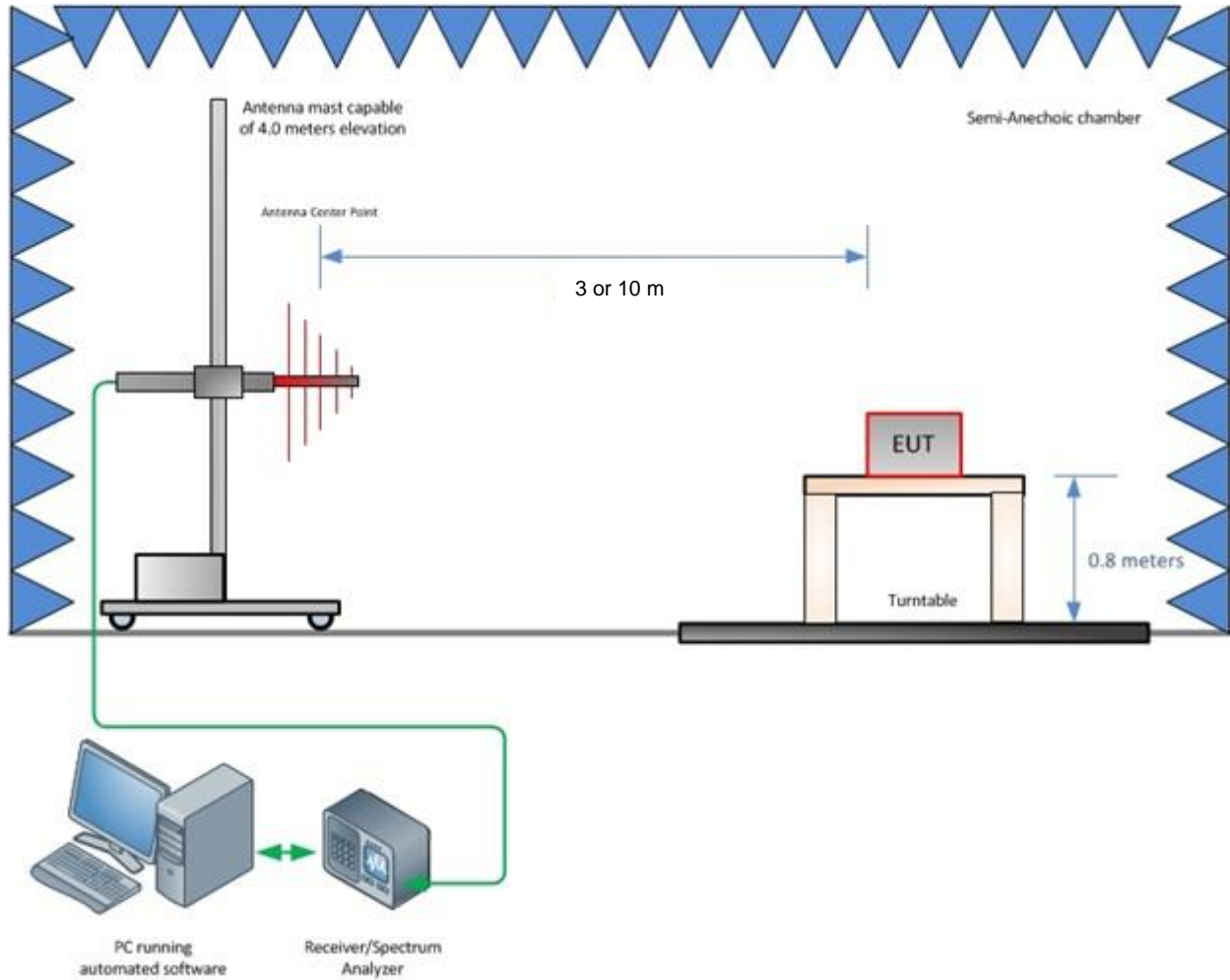

Figure 3-1 – Radiated Emissions Test Setup up to 1 GHz

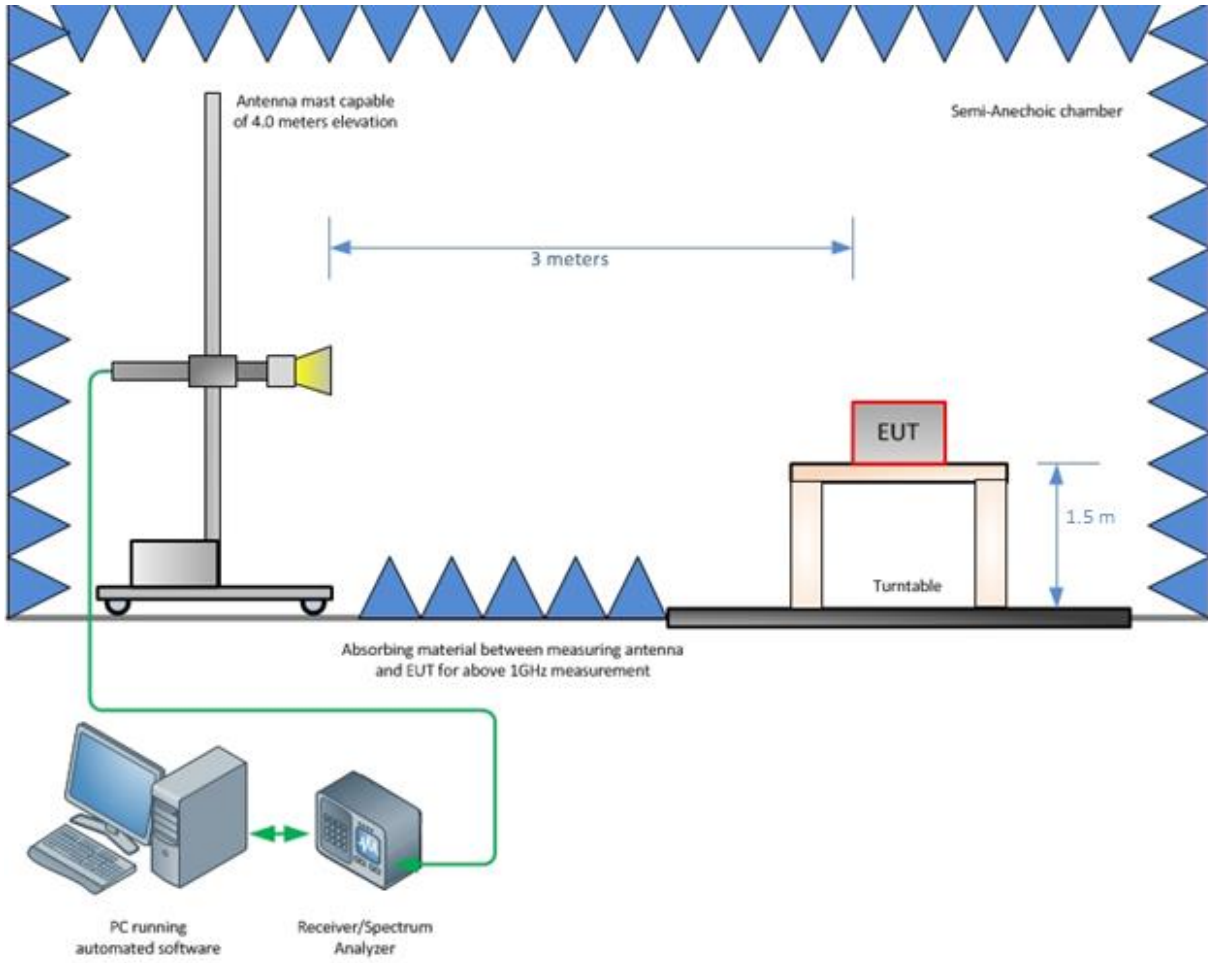

Figure 3-2 – Radiated Emissions Test Setup above 1 GHz



4 Accreditation, Disclaimers and Copyright

TÜV SÜD America Inc.'s reports apply only to the specific sample tested under stated test conditions. It is the manufacturer's responsibility to assure the continued compliance of production units of this model. TÜV SÜD America, Inc. shall have no liability for any deductions, inferences or generalizations drawn by the client or others from TÜV SÜD America, Inc.'s issued reports.

This report is the confidential property of the client. As a mutual protection to our clients, the public and TÜV SÜD America, Inc., extracts from the test report shall not be reproduced, except in full without TÜV SÜD America, Inc.'s written approval.

This report must not be used to claim product certification, approval, or endorsement by A2LA, NIST, or any agency of the federal government.

STATEMENT OF MEASUREMENT UNCERTAINTY

The expanded laboratory measurement uncertainty figures (U_{Lab}) provided below correspond to an expansion factor (coverage factor) $k = 1.96$ which provide confidence levels of 95%.

Table 4-1: Estimation of Measurement Uncertainty

Parameter	U_{lab}
Occupied Channel Bandwidth	$\pm 0.009 \%$
RF Conducted Output Power	$\pm 0.349 \text{ dB}$
Power Spectral Density	$\pm 0.372 \text{ dB}$
Antenna Port Conducted Emissions	$\pm 1.264 \text{ dB}$
Radiated Emissions $\leq 1 \text{ GHz}$	$\pm 5.814 \text{ dB}$
Radiated Emissions $> 1 \text{ GHz}$	$\pm 4.318 \text{ dB}$
Temperature	$\pm 0.860 \text{ }^\circ\text{C}$
Radio Frequency	$\pm 2.832 \times 10^{-8}$
AC Power Line Conducted Emissions	$\pm 3.360 \text{ dB}$

TEST EQUIPMENT

All measurement instrumentation is traceable to the National Institute of Standards and Technology and is calibrated to meet test method standard requirements and/or manufacturer's specifications.