

USER MANUAL



CONTENTS

1. SAFETY INFORMATION.....	2
2. SAFETY INSTRUCTIONS.....	5
3. INSTALLATION.....	7
4. PRODUCT DESCRIPTION.....	8
5. DAILY USE.....	10
6. ADDITIONAL FUNCTIONS.....	14
7. CARE AND CLEANING.....	17
8. HINTS AND TIPS.....	18
9. TROUBLESHOOTING.....	21
10. TECHNICAL DATA.....	23
11. ENERGY EFFICIENCY.....	24
12. ENVIRONMENTAL CONCERNS.....	25

FOR PERFECT RESULTS

Thank you for choosing this AEG product. We have created it to give you impeccable performance for many years, with innovative technologies that help make life simpler – features you might not find on ordinary appliances. Please spend a few minutes reading to get the very best from it.

Visit our website to:



Get usage advice, brochures, trouble shooter, service and repair information:
www.aeg.com/support



Register your product for better service:
www.registeraeg.com



Buy Accessories, Consumables and Original spare parts for your appliance:
www.aeg.com/shop

CUSTOMER CARE AND SERVICE

Always use original spare parts.

When contacting our Authorised Service Centre, ensure that you have the following data available: Model, PNC, Serial Number.

The information can be found on the rating plate.

 Warning / Caution-Safety information

 General information and tips

 Environmental information

Subject to change without notice.

1. SAFETY INFORMATION

Before the installation and use of the appliance, carefully read the supplied instructions. The manufacturer is not responsible for any injuries or damage that are the result

of incorrect installation or usage. Always keep the instructions in a safe and accessible location for future reference.

1.1 Children and vulnerable people safety

- This appliance can be used by children aged from 8 years and above and persons with reduced physical, sensory or mental capabilities or lack of experience and knowledge if they have been given supervision or instruction concerning the use of the appliance in a safe way and understand the hazards involved. Children of less than 8 years of age and persons with very extensive and complex disabilities shall be kept away from the appliance unless continuously supervised.
- Children should be supervised to ensure that they do not play with the appliance.
- Keep all packaging away from children and dispose of it appropriately.
- **WARNING:** The appliance and its accessible parts become hot during use. Keep children and pets away from the appliance when in use and when cooling down.
- If the appliance has a child safety device, it should be activated.
- Children shall not carry out cleaning and user maintenance of the appliance without supervision.

1.2 General Safety

- This appliance is for cooking purposes only.
- This appliance is designed for single household domestic use in an indoor environment.
- This appliance may be used in, offices, hotel guest rooms, bed & breakfast guest rooms, farm guest houses and other similar accommodation where such use does not exceed (average) domestic usage levels.

- **WARNING:** The appliance and its accessible parts become hot during use. Care should be taken to avoid touching heating elements.
- **WARNING:** Unattended cooking on a hob with fat or oil can be dangerous and may result in fire.
- Never use water to extinguish the cooking fire. Switch off the appliance and cover flames with e.g. a fire blanket or lid.
- **WARNING:** The appliance must not be supplied through an external switching device, such as a timer, or connected to a circuit that is regularly switched on and off by a utility.
- **CAUTION:** The cooking process has to be supervised. A short term cooking process has to be supervised continuously.
- **WARNING:** Danger of fire: Do not store items on the cooking surfaces.
- Metallic objects such as knives, forks, spoons and lids should not be placed on the hob surface since they can get hot.
- Do not use the appliance before installing it in the built-in structure.
- Do not use a steam cleaner to clean the appliance.
- After use, switch off the hob element by its control and do not rely on the pan detector.
- If the glass ceramic surface / glass surface is cracked, switch off the appliance and unplug it from the mains. In case the appliance is connected to the mains directly using junction box, remove the fuse to disconnect the appliance from power supply. In either case contact the Authorised Service Centre.
- If the supply cord is damaged, it must be replaced by the manufacturer, an authorized Service or similarly qualified persons in order to avoid a hazard.
- **WARNING:** Use only hob guards designed by the manufacturer of the cooking appliance or indicated by the manufacturer of the appliance in the instructions for use as suitable or hob guards incorporated in the

appliance. The use of inappropriate guards can cause accidents.

2. SAFETY INSTRUCTIONS

2.1 Installation



WARNING!

Only a qualified person must install this appliance.



WARNING!

Risk of injury or damage to the appliance.

- Remove all the packaging.
- Do not install or use a damaged appliance.
- Follow the installation instructions supplied with the appliance.
- Keep the minimum distance from other appliances and units.
- Always take care when moving the appliance as it is heavy. Always use safety gloves and enclosed footwear.
- Seal the cut surfaces with a sealant to prevent moisture from causing swelling.
- Protect the bottom of the appliance from steam and moisture.
- Do not install the appliance next to a door or under a window. This prevents hot cookware from falling from the appliance when the door or the window is opened.
- Each appliance has cooling fans on the bottom.
- If the appliance is installed above a drawer:
 - Do not store any small pieces or sheets of paper that could be pulled in, as they can damage the cooling fans or impair the cooling system.
 - Keep a distance of minimum 2 cm between the bottom of the appliance and parts stored in the drawer.
- Remove any separator panels installed in the cabinet below the appliance.

2.2 Electrical Connection



WARNING!

Risk of fire and electric shock.

- All electrical connections should be made by a qualified electrician.
- The appliance must be earthed.
- Before carrying out any operation make sure that the appliance is disconnected from the power supply.
- Make sure that the parameters on the rating plate are compatible with the electrical ratings of the mains power supply.
- Make sure the appliance is installed correctly. Loose and incorrect electricity mains cable or plug (if applicable) can make the terminal become too hot.
- Use the correct electricity mains cable.
- Do not let the electricity mains cable tangle.
- Make sure that a shock protection is installed.
- Use the strain relief clamp on the cable.
- Make sure the mains cable or plug (if applicable) does not touch the hot appliance or hot cookware, when you connect the appliance to a socket.
- Do not use multi-plug adapters and extension cables.
- Make sure not to cause damage to the mains plug (if applicable) or to the mains cable. Contact our Authorised Service Centre or an electrician to change a damaged mains cable.
- The shock protection of live and insulated parts must be fastened in such a way that it cannot be removed without tools.
- Connect the mains plug to the mains socket only at the end of the installation. Make sure that there is access to the mains plug after the installation.

- If the mains socket is loose, do not connect the mains plug.
- Do not pull the mains cable to disconnect the appliance. Always pull the mains plug.
- Use only correct isolation devices: line protecting cut-outs, fuses (screw type fuses removed from the holder), earth leakage trips and contactors.
- The electrical installation must have an isolation device which lets you disconnect the appliance from the mains at all poles. The isolation device must have a contact opening width of minimum 3 mm.

2.3 Use



WARNING!

Risk of injury, burns and electric shock.

- Do not change the specification of this appliance.
- Remove all the packaging, labelling and protective film (if applicable) before first use.
- Make sure that the ventilation openings are not blocked.
- Do not let the appliance stay unattended during operation.
- Set the cooking zone to “off” after each use.
- Do not put cutlery or saucepan lids on the cooking zones. They can become hot.
- Do not operate the appliance with wet hands or when it has contact with water.
- Do not use the appliance as a work surface or as a storage surface.
- If the surface of the appliance is cracked, disconnect immediately the appliance from the power supply. This to prevent an electrical shock.
- Users with a pacemaker must keep a distance of minimum 30 cm from the induction cooking zones when the appliance is in operation.
- When you place food into hot oil, it may splash.



WARNING!

Risk of fire and explosion

- Fats and oil when heated can release flammable vapours. Keep flames or

heated objects away from fats and oils when you cook with them.

- The vapours that very hot oil releases can cause spontaneous combustion.
- Used oil, that can contain food remnants, can cause fire at a lower temperature than oil used for the first time.
- Do not put flammable products or items that are wet with flammable products in, near or on the appliance.



WARNING!

Risk of damage to the appliance.

- Do not keep hot cookware on the control panel.
- Do not put a hot pan cover on the glass surface of the hob.
- Do not let cookware boil dry.
- Be careful not to let objects or cookware fall on the appliance. The surface can be damaged.
- Do not activate the cooking zones with empty cookware or without cookware.
- Do not put aluminium foil on the appliance.
- Cookware made of cast iron or with a damaged bottom can cause scratches on the glass / glass ceramic. Always lift these objects up when you have to move them on the cooking surface.

2.4 Care and cleaning

- Clean the appliance regularly to prevent the deterioration of the surface material.
- Switch off the appliance and let it cool down before cleaning.
- Do not use water spray and steam to clean the appliance.
- Clean the appliance with a moist soft cloth. Use only neutral detergents. Do not use abrasive products, abrasive cleaning pads, solvents or metal objects.

2.5 Service

- To repair the appliance contact the Authorised Service Centre. Use original spare parts only.
- Concerning the lamp(s) inside this product and spare part lamps sold

separately: These lamps are intended to withstand extreme physical conditions in household appliances, such as temperature, vibration, humidity, or are intended to signal information about the operational status of the appliance. They are not intended to be used in other applications and are not suitable for household room illumination.

- Contact your municipal authority for information on how to dispose of the appliance.
- Disconnect the appliance from the mains supply.
- Cut off the mains electrical cable close to the appliance and dispose of it.

2.6 Disposal



WARNING!

Risk of injury or suffocation.

3. INSTALLATION



WARNING!

Refer to Safety chapters.

3.1 Before the installation

Before you install the hob, write down the information below from the rating plate. The rating plate is on the bottom of the hob.

Serial number

3.2 Built-in hobs

Only use the built-in hobs after you assemble the hob into correct built-in units and work surfaces that align to the standards.

3.3 Connection cable

- For a single phase or two phase connection, use the cable type: H05BB-F or H03V2V2-F which withstands a temperature of 90 °C or higher.
- To replace the damaged mains cable, use the cable: H05BB-F or H03V2V2-F which withstands a temperature of 90 °C or higher. Contact an Authorised Service Centre. The connection cable may only be replaced by a qualified electrician.

3.4 Assembly

If you install the hob under a hood, please see the installation instructions of

the hood for the minimum distance between the appliances.

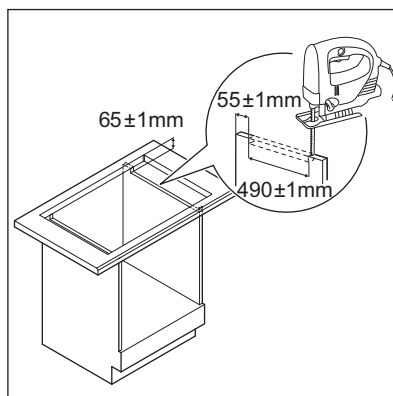
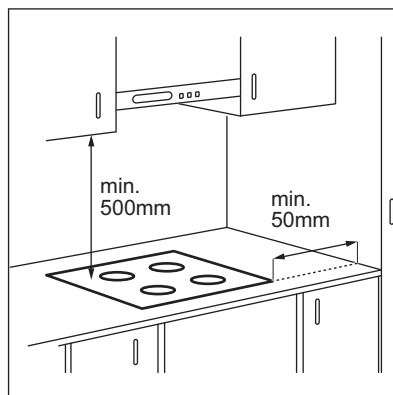

If the appliance is installed above a drawer, the hob ventilation can warm up

the items stored in the drawer during the cooking process.

Combination with standard oven

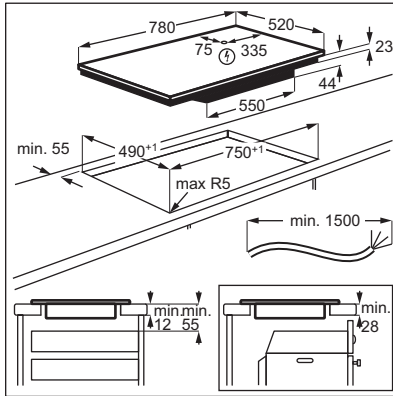

Combination with double oven

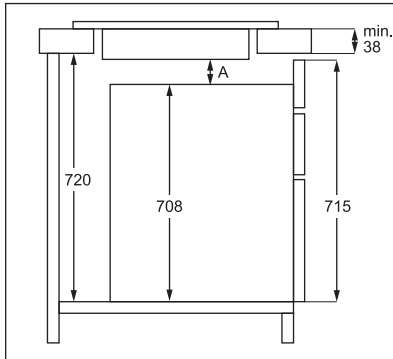

A = min. 6 mm, for double ovens from AEG, Electrolux and Zanussi.

A = min. 12 mm, for double ovens from other brands.

Find the video tutorial "How to install your AEG Induction Hob - Worktop installation" by typing out the full name indicated in the graphic below.



4. PRODUCT DESCRIPTION

4.1 Cooking surface layout

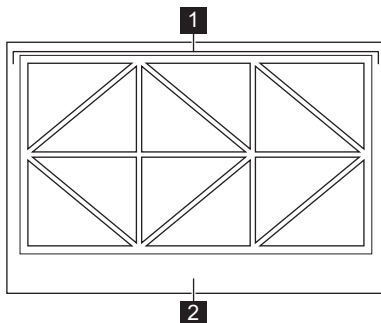

- 1** Induction cooking surface
- 2** Control panel

4.2 Control panel layout

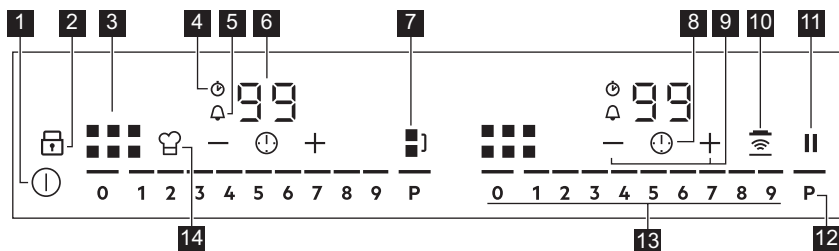

Use the sensor fields to operate the appliance. The displays, indicators and sounds tell which functions operate.

Sensor field	Comment
1	To activate and deactivate the hob.
2	To activate and deactivate Lock or Child Safety Device.
3	To show the active zone.
4	CountUp Timer indicator.
5	Count Down Timer indicator.
6	- Timer display: 00 - 99 minutes.
7	To activate and deactivate Bridge and to switch between the modes.
8	To select Timer functions.
9	To increase and decrease the time.
10	To activate and deactivate Hob²Hood.
11	To activate and deactivate Pause.
12	To activate PowerBoost.
13	- To set a heat setting: 0 - 9.
14	To activate and deactivate PowerSlide.

4.3 OptiHeat Control (3 step Residual heat indicator)



WARNING!

As long as the indicator is on, there is a risk of burns from residual heat.

The induction cooking zones produce the heat necessary for the cooking process directly in the bottom of the cookware. The glass ceramic is heated by the heat of the cookware.

The indicators appear when a cooking zone is hot. They show the level

of the residual heat for the cooking zones you are currently using.

The indicator may also appear:

- for the neighbouring cooking zones even if you are not using them,
- when hot cookware is placed on cold cooking zone,

- when the hob is deactivated but the cooking zone is still hot.

The indicator disappears when the cooking zone has cooled down.

5. DAILY USE



WARNING!
Refer to Safety chapters.

5.1 Activating and deactivating

Press and hold  to activate or deactivate the hob.

Control bars come on after you activate the hob and go off after you deactivate the hob. When the hob is deactivated you can see only .

When you activate the hob and place the cookware in the correct position, the hob recognizes it and the appropriate control panel lights up. The red cooking zone indicator appears above the control bar and indicates the position of the pot.

5.2 Automatic Switch Off

The function deactivates the hob automatically if:

- you do not place any cookware on the hob for 50 seconds,
- you do not set the heat setting for 50 seconds after you place the cookware,
- you spill something or put something on the control panel for more than 10 seconds (a pan, a cloth). When you hear the acoustic signal, the hob deactivates. Remove the object or clean the control panel.
- the hob gets too hot (e.g. when a saucepan boils dry). Let the cooking zone cool down before you use the hob again.
- you do not deactivate a cooking zone or change the heat setting. After some time, the hob deactivates.

The relation between the heat setting and the time after which the hob deactivates:

Heat setting	The hob deactivates after
1 - 2	6 hours
3 - 4	5 hours
5	4 hours
6 - 9	1.5 hours

5.3 Heat setting

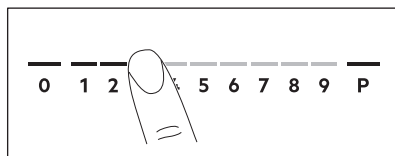

Press the desired heat setting on the control bar. You can also move your finger along the control bar to set or change the heat setting for a cooking zone.

To deactivate a cooking zone, press 0.

5.4 Using the hob

The induction cooking surface consists of 12 single triangular zones in total. The triangular zones may be activated separately or can be combined in pairs to create 6 standard cooking zones. The pairs of triangular zones can be further combined together in various ways.

Each pair of triangles is controlled by the appropriate control bar. Each square on the control panel represents one standard cooking zone on the induction cooking surface.

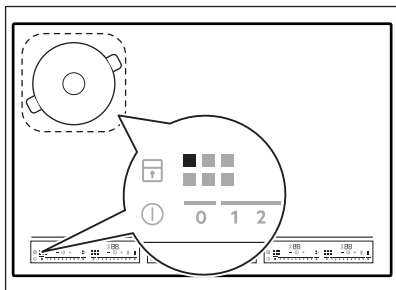

- i** One pair of triangles works as a standard cooking zone.

Cookware

You may use various sizes of cookware: small, medium, large. To learn how the hob determines the cooking mode based on the cookware refer to "Induction cooking surface" below. For more information on cookware, refer to "Hints and tips".

5.5 Induction cooking surface

The hob automatically determines the mode applicable to the size and the shape of the cookware.

Place the cookware centrally on the selected area. The cookware should cover the selected area as much as possible.

- Smaller cookware with the bottom diameter between 100 mm and 160 mm should be placed centrally on a single triangle.

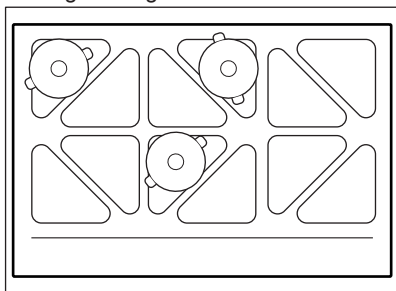

- Medium-sized cookware with the bottom diameter between 160 mm and 210 mm should be placed on a pair of triangles.

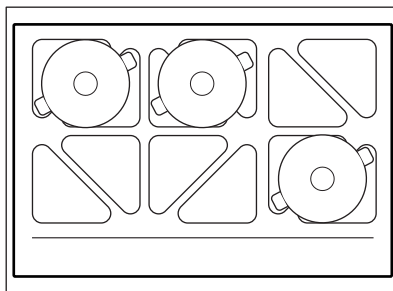

- Cookware with the bottom diameter between 240 mm and 350 mm should be placed on four triangles.

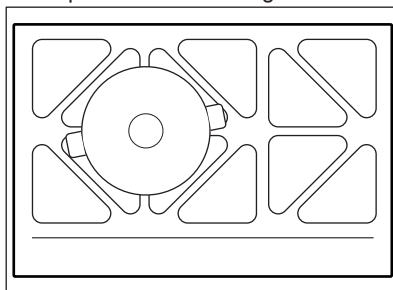

- Oval-shaped cookware (e.g. roasting tins) should be placed on vertical or horizontal Bridge combinations.

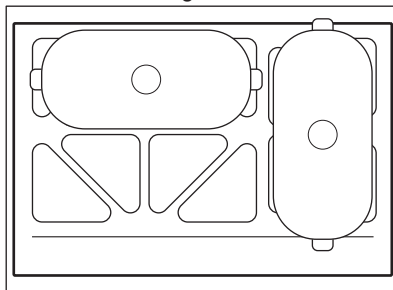

- i** The cookware must cover 3 or 4 triangles.

5.6 Using the control panel and zone indicators

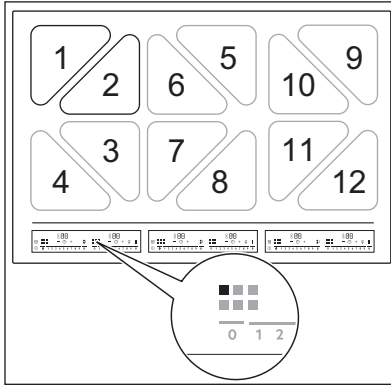

Two single triangles combined create a standard cooking zone and are indicated by the A B C D E F indicators.

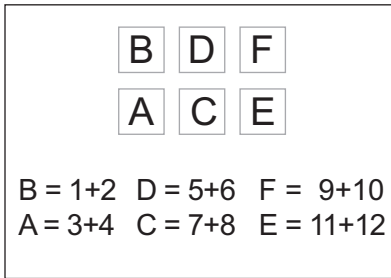

Zone indicators indicate which standard cooking zone is controlled by the appropriate control bar. The hob has 6 control bars.

Cookware positions and zone indicators

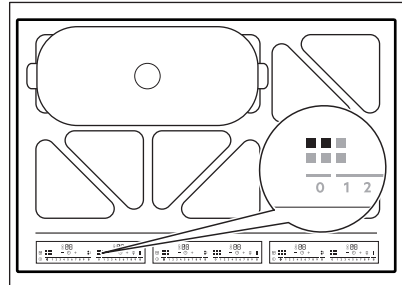
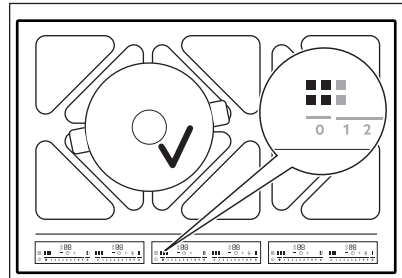
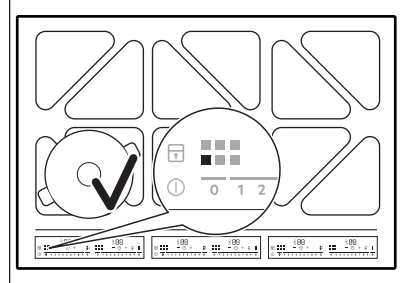
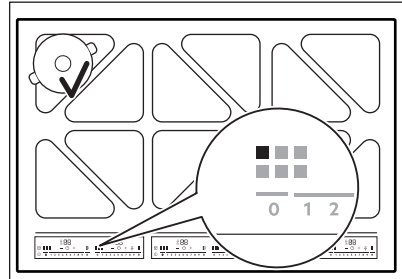

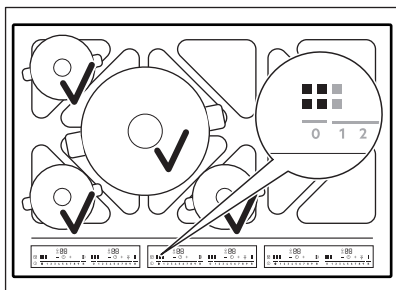
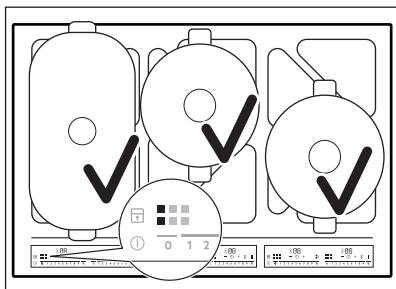



For the combination indicated above, there are four active control bars. The left front pot is indicated by A indicator visible on the first control bar. The left rear pot is indicated by B indicator on the second control bar. The middle pot is indicated by indicators A B C D visible on the third control bar. The right front pot is indicated by C indicator visible on the fourth bar.

i It is not possible to use more than 4 pots in this combination.

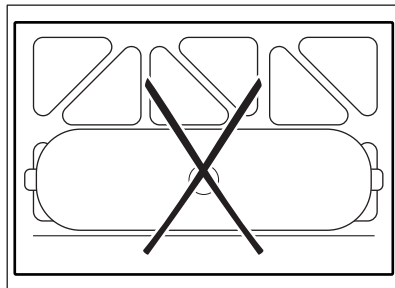
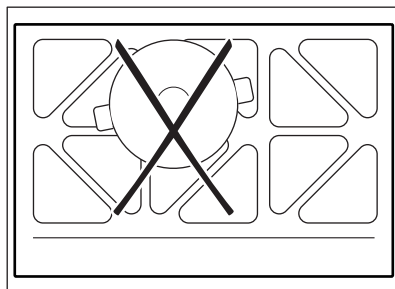
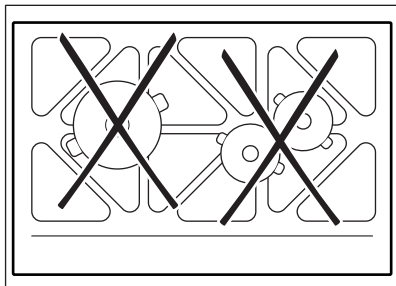
5.7 Incorrect cookware positions



5.8 Bridge

If you place cookware on two or more standard cooking zones and the heat setting level is set to 0,  appears.



If the default configuration is not appropriate for your cookware, press  repeatedly to choose the desired configuration manually.

The following modes are available:

- Centre
- Vertical
- Horizontal
- Standard cooking zone

The cooking zone indicators change automatically to show the possible combination.

All single triangles of one mode are controlled by one control bar which lights up.

When you change the heat setting,  disappears. When the heat setting is set to 0,  comes on again.

5.9 PowerBoost

This function activates more power for the appropriate induction cooking zone,

depending on the cookware size. The function can be activated only for a limited period of time.

It is not possible to use the function when Bridge is activated in the Centre, Vertical or Horizontal mode.

To activate the function for the cooking zone: touch . The symbol turns red.

The function deactivates automatically.





 For maximum duration values, refer to "Technical data".

5.10 Timer







• **Count Down Timer**

You can use this function to set the length of a single cooking session.

First set the heat setting for the cooking zone, then set the function.

To activate the function or change the time: touch . The timer digits **00** and the indicators  and  light up on the display.  turns red, and  turns white.



 If the timer is not set, all indicators disappear after 3 seconds.

Touch  or  to set the time (00 - 99 minutes). After 3 seconds, the timer starts to count down automatically. The indicators , , and  disappear.  stays red.

When the timer finishes counting down, a signal sounds and **00** flashes. To stop the signal, touch .



To deactivate the function: touch .



The indicators  and  light up. Use

 or  to set **00** on the display. Alternatively, set the heat level to **0**. As a result, a signal sounds and the timer is cancelled.

• **CountUp Timer**









You can use this function to monitor how long a cooking zone operates.

To activate the function: touch  twice. The indicator  turns red, the timer starts automatically.

To deactivate the function: touch . When the indicators light up, touch .

• **Minute Minder**





You can use this function as a Minute Minder when the hob is activated but the cooking zones do not operate. To see the Timer symbols, place a pot on a cooking zone.

To activate the function: touch  until the indicator  turns red. Touch  or  to set the time. The function starts automatically after 4 seconds. The indicators , , and  disappear.  stays red.

When you set the function, you can remove the pot.

When the time comes to an end, a signal sounds and **00** flashes. Touch  to stop the signal.

To deactivate the function: touch .

The indicators  and  light up. Use  or  to set **00** on the display.





 The function has no effect on the operation of the cooking zones.

6. ADDITIONAL FUNCTIONS

6.1 Pause

This function sets all cooking zones that operate to the lowest heat setting.

When the function operates, all other symbols on the control panels are locked.

 When the function is active,  and  symbols can be used. The function does not stop the timer functions:  and .

To activate the function: touch . The symbol turns red. The heat setting is lowered to 1.

To deactivate the function: touch . The symbol turns white. The previous heat setting comes on.

6.2 Lock

You can lock the control panel while the hob operates. It prevents an accidental change of the heat setting.

Set the heat setting first.

To activate the function: touch . The symbol turns red and blinks.

To deactivate the function: touch . The symbol turns white.

 When you deactivate the hob, you also deactivate this function.

6.3 Child Safety Device

This function prevents an accidental operation of the hob.

To activate the function: activate the hob. Do not set the heat setting. Touch  until it turns red and the control bar disappears.

To deactivate the function: activate the hob. Do not set the heat setting. Touch  until it turns white and the control bar appears. Deactivate the hob.

6.4 PowerSlide

This function allows you to adjust the temperature by moving the cookware to a different position on the induction cooking surface.

The function divides the cooking area into three vertical cooking zones that have different heat settings. The hob



detects the position of the cookware and adjusts the pre-set power level accordingly. You can place the cookware on the left, centre, or right vertical bridge.

General information:

- For this function, use cookware with the minimum bottom diameter of 160 mm.
- The zone indicator indicates both zones in a bridge even if only one of the zones is used.
- You may adjust the heat setting manually only if at least one of the zones is activated automatically.
- You can change the heat settings for each position separately. When you deactivate the hob, it remembers your heat settings and applies it next time you activate the function.
- If you want to change the heat setting, lift up the cookware and place it on a different zone. Sliding the cookware can cause scratches and discolouration of the surface.

Activating the function

To activate the function, press . When the function is activated, the symbol turns red and the control bar displays the pre-set power level.

 If there is no cookware detected on the cooking zones, after 9 minutes an acoustic signal sounds and the cooking zones deactivate automatically. Press  to resume this function.

Adjusting power level





To adjust the power level, choose the heat setting on the control bar.



Deactivating the function

To deactivate the function, press .

6.5 OffSound Control (Deactivating and activating the sounds)

Deactivate the hob. Press  for 3 seconds. The display comes on and

goes out. Press  for 3 seconds.  or  appears. Press  of the timer to choose one of the following:

-  - the sounds are off
-  - the sounds are on

To confirm your selection wait until the hob deactivates automatically.

When the function is set to  you can hear the sounds only when:

- you touch 
- Minute Minder comes down
- Count Down Timer comes down
- you put something on the control panel.

6.6 Power management

If multiple zones are active and the consumed power exceeds the limitation of the power supply, this function divides the available power between all cooking zones. The hob controls heat settings to protect the fuses of the house installation.

- Cooking zones are grouped according to the location and number of the phases in the hob. Each phase has a maximum electricity loading of 3680 W. If the hob reaches the limit of maximum available power within one phase, the power of the cooking zones will be automatically reduced.
- For cooking zones that have a reduced power, the control panel shows the maximum possible heat settings. The heat setting may be 0 when the other pots consume the maximum available power. As a result, you cannot activate any other zone.
- If a higher heat setting is not available reduce it for the other cooking zones first.
- The activation of the function depends on the number and size of pots.

Refer to the illustration for possible combinations in which power can be distributed among the cooking zones.

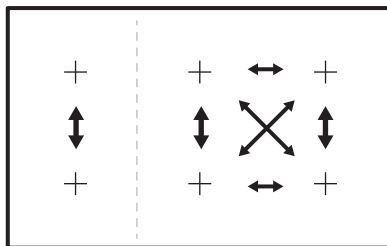

6.7 Hob²Hood

It is an advanced automatic function which connects the hob to a special hood. Both the hob and the hood have an infrared signal communicator. The speed of the fan is defined automatically on the basis of the mode setting and the temperature of the hottest cookware on the hob. You can also operate the fan manually.



For most of the hoods, the remote system is originally deactivated. Activate it before you use the function. For more information refer to the hood user manual.

Operating the function automatically

To operate the function automatically set the automatic mode to H1 – H6. The hob is originally set to H5. The hood reacts whenever you operate the hob. The hob recognizes the temperature of the cookware and adjusts the speed of the fan automatically.

Automatic modes

	Auto- matic light	Boiling ¹⁾	Frying ²⁾
Mode H0	Off	Off	Off
Mode H1	On	Off	Off
Mode H2 ³⁾	On	Fan speed 1	Fan speed 1
Mode H3	On	Off	Fan speed 1





	Auto- matic light	Boiling ¹⁾	Frying ²⁾
Mode H4	On	Fan speed 1	Fan speed 1
Mode H5	On	Fan speed 1	Fan speed 2
Mode H6	On	Fan speed 2	Fan speed 3

¹⁾ The hob detects the boiling process and activates fan speed in accordance with automatic mode.

²⁾ The hob detects the frying process and activates fan speed in accordance with automatic mode.

³⁾ This mode activates the fan and the light and does not rely on the temperature.





Changing the automatic mode

1. Deactivate the appliance.
2. Touch  for 3 seconds. The display comes on and goes off.
3. Touch  for 3 seconds.
4. Touch  repeatedly until  comes on.
5. Touch  to select an automatic mode.



 To operate the hood directly on the hood panel deactivate the automatic mode of the function.

 When you finish cooking and deactivate the hob, the hood fan may still operate for a certain period of time. After that time the system deactivates the fan automatically and prevents you from accidental activation of the fan for the next 30 seconds.

Operating the fan speed manually

You can also operate the function manually. To do that, touch  when the hob is active. The symbol turns white. This deactivates automatic operation of the function and allows you to change the fan speed manually. When you press , you raise the fan speed by one. When you reach an intensive level and press  again, you set the fan speed to 0, which deactivates the hood fan. The symbol turns red. To start the fan again at the fan speed 1 touch .

 To activate the automatic operation of the function, deactivate the hob and activate it again.

 If the function is not active,  deactivates after 10 seconds. When the hob is restarted,  lights up again.

Activating the light

You can set the hob to activate the light automatically whenever you activate the hob. To do so, set the automatic mode to H1 – H6.

 The light on the hood deactivates 2 minutes after deactivating the hob.

7. CARE AND CLEANING



WARNING!
Refer to Safety chapters.

7.1 General information

- Clean the hob after each use.

- Always use cookware with a clean base.
- Scratches or dark stains on the surface have no effect on how the hob operates.
- Use a special cleaner suitable for the surface of the hob.
- Use a special scraper for the glass.

7.2 Cleaning the hob

- **Remove immediately:** melted plastic, plastic foil, sugar and food with sugar, otherwise, the dirt can cause damage to the hob. Take care to avoid burns.

Use a special hob scraper on the glass surface at an acute angle and move the blade on the surface.

- **Remove when the hob is sufficiently cool:** limescale rings, water rings, fat stains, shiny metallic discoloration. Clean the hob with a moist cloth and a non-abrasive detergent. After cleaning, wipe the hob dry with a soft cloth.
- **Remove shiny metallic discoloration:** use a solution of water with vinegar and clean the glass surface with a cloth.

8. HINTS AND TIPS



WARNING!

Refer to Safety chapters.

8.1 Cookware



For induction cooking zones a strong electro-magnetic field creates the heat in the cookware very quickly.

Use the induction cooking zones with suitable cookware.

- The bottom of the cookware must be as thick and flat as possible.
- Ensure pan bases are clean and dry before placing on the hob surface.
- In order to avoid scratches, do not slide or rub the pot across the ceramic glass.

Cookware material

- **correct:** cast iron, steel, enamelled steel, stainless steel, multi-layer bottom (with a correct marking from a manufacturer).
- **not correct:** aluminium, copper, brass, glass, ceramic, porcelain.

Cookware is suitable for an induction hob if:

- water boils very quickly on a zone set to the highest heat setting.
- a magnet pulls on to the bottom of the cookware.

Cookware dimensions



Refer to "Induction cooking surface" in "Daily use".

- Induction cooking zones adapt to the dimension of the bottom of the cookware automatically.
- The cooking zone efficiency is related to the diameter of the cookware. The cookware with a diameter smaller than the minimum receives only a part of the power generated by the cooking zone.
- For both safety reasons and optimal cooking results, do not use cookware larger than indicated in "Cooking zones specification". Avoid keeping cookware close to the control panel during the cooking session. This might impact the functioning of the control panel or accidentally activate hob functions.



Refer to "Technical data".

Cookware types

Depending on the cookware type you use, the hob determines the appropriate bridge mode. For example:

Single triangles, standard cooking zones, centre mode

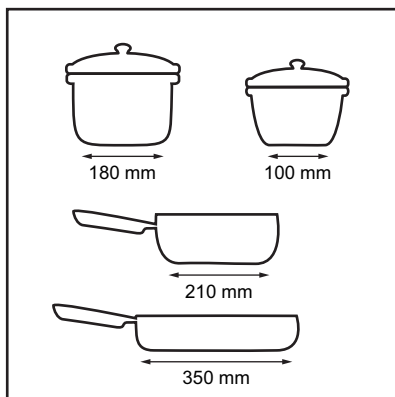

Vertical mode, horizontal modes

- i** The cookware must cover 3 or 4 single triangles.

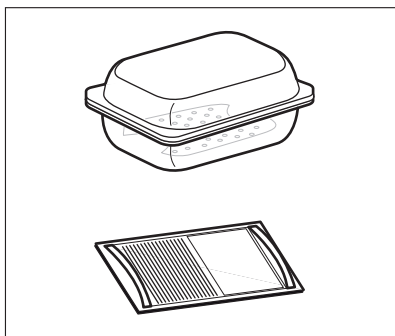

- !** **WARNING!**
Do not use baking tray.

8.2 The noises during operation

If you can hear:

- crack noise: cookware is made of different materials (a sandwich construction).
 - whistle sound: you use a cooking zone with a high power level and the cookware is made of different materials (a sandwich construction).
 - humming: you use a high power level.
 - clicking: electric switching occurs.
 - hissing, buzzing: the fan operates.
- The noises are normal and do not indicate any malfunction.**

8.3 Öko Timer (Eco Timer)

To save energy, the heater of the cooking zone deactivates before the count down timer sounds. The difference in the operation time depends on the heat setting level and the length of the cooking operation.

8.4 Examples of cooking applications

The correlation between the heat setting of a zone and its consumption of power is not linear. When you increase the heat setting, it is not proportional to the increase of the consumption of power. It means that a cooking zone with the medium heat setting uses less than a half of its power.

- i** The data in the table is for guidance only.

Heat setting	Use to:	Time (min)	Hints
1	Keep cooked food warm.	as necessary	Put a lid on the cookware.
1 - 2	Hollandaise sauce, melt: butter, chocolate, gelatine.	5 - 25	Mix from time to time.
1 - 2	Solidify: fluffy omelettes, baked eggs.	10 - 40	Cook with a lid on.

Heat setting	Use to:	Time (min)	Hints
2 - 3	Simmer rice and milkbased dishes, heat up ready-cooked meals.	25 - 50	Add at least twice as much liquid as rice, mix milk dishes halfway through the procedure.
3 - 4	Steam vegetables, fish, meat.	20 - 45	Add a couple of tablespoons of liquid.
4 - 5	Steam potatoes.	20 - 60	Use max. ¼ l of water for 750 g of potatoes.
4 - 5	Cook larger quantities of food, stews and soups.	60 - 150	Up to 3 l of liquid plus ingredients.
6 - 7	Gentle fry: escalope, veal cordon bleu, cutlets, rissoles, sausages, liver, roux, eggs, pancakes, doughnuts.	as necessary	Turn halfway through.
7 - 8	Heavy fry, hash browns, loin steaks, steaks.	5 - 15	Turn halfway through.
9	Boil water, cook pasta, sear meat (goulash, pot roast), deep-fry chips.		
P	Boil large quantities of water. PowerBoost is activated.		

8.5 Hints and Tips for Hob²Hood

When you operate the hob with the function:

- Protect the hood panel from direct sunlight.
- Do not spot halogen light on the hood panel.
- Do not cover the hob control panel.
- Do not interrupt the signal between the hob and the hood (e.g. with the hand, a cookware handle or a tall pot). See the picture.

The hood in the picture is only exemplary.

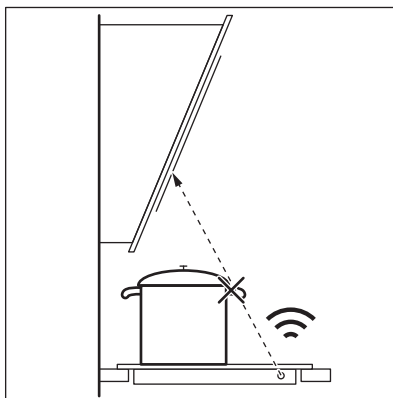

Other remotely controlled appliances may block the signal. Do not use any such appliances near to the hob while Hob²Hood is on.

Cooker hoods with the Hob²Hood function

To find the full range of cooker hoods which work with this function refer to our

consumer website. The AEG cooker hoods that work with this function must have the symbol .



9. TROUBLESHOOTING



WARNING!
Refer to Safety chapters.

9.1 What to do if...

Problem	Possible cause	Remedy
You cannot activate or operate the hob.	The hob is not connected to an electrical supply or it is connected incorrectly.	Check if the hob is correctly connected to the electrical supply.
	The fuse is blown.	Make sure that the fuse is the cause of the malfunction. If the fuse is blown again and again, contact a qualified electrician.
	You do not set the heat setting for 10 seconds.	Activate the hob again and set the heat setting in less than 10 seconds.
	You touched 2 or more sensor fields at the same time.	Touch only one sensor field.
	Pause operates.	Refer to "Additional functions".
You cannot select the maximum heat setting for one of the cooking zones. You cannot activate one of the cooking zones.	The other zones consume the maximum available power.	Reduce the heat setting of the other cooking zones connected to the same phase. Refer to "Power management".
	Your hob works properly.	
An acoustic signal sounds and the hob deactivates. An acoustic signal sounds when the hob is deactivated.	You put something on one or more sensor fields.	Remove the object from the sensor fields.
The hob deactivates.	You put something on the control panel.	Remove the object from the control panel.
Residual heat indicator does not come on.	The zone is not hot because it operated only for a short time or the sensor is damaged.	If the zone operated sufficiently long to be hot, speak to an Authorised Service Centre.

Problem	Possible cause	Remedy
Hob ² Hood does not work.	You covered the control panel.	Remove the object from the control panel.
	You use a very tall pot which blocks the signal.	Use a smaller pot, change the cooking zone or operate the hood manually.
The sensor fields become hot.	The cookware is too large or you put it too near to the controls.	Put large cookware on the rear zones, if possible.
There is no sound when you touch the panel sensor fields.	The sounds are deactivated.	Activate the sounds. Refer to "Additional functions".
 comes on.	Child Safety Device or Lock operates.	Refer to "Additional functions".
The control bar blinks.	There is no cookware on the zone or the zone is not fully covered.	Put cookware on the zone so that it fully covers the cooking zone.
	The cookware is unsuitable.	Use suitable cookware. Refer to "Hints and tips".
	The diameter of the bottom of the cookware is too small for the zone.	Use cookware with correct dimensions. Refer to "Technical data".
	PowerSlide operates. Two pots are placed on the flexible induction cooking area.	Use only one pot. Refer to "Daily use".
 and a number come on.	There is an error in the hob.	Deactivate the hob and activate it again after 30 seconds. If  comes on again, disconnect the hob from the electrical supply. After 30 seconds, connect the hob again. If the problem continues, speak to an Authorised Service Centre.
You can hear a constant beep noise.	The electrical connection is incorrect.	Disconnect the hob from the electrical supply. Ask a qualified electrician to check the installation.

9.2 If you cannot find a solution...

If you cannot find a solution to the problem yourself, contact your dealer or an Authorised Service Centre. Give the

data from the rating plate. Make sure, you operated the hob correctly. If not the servicing by a service technician or dealer will not be free of charge, also during the warranty period. The information about guarantee period and

Authorised Service Centres are in the guarantee booklet.

10. TECHNICAL DATA

10.1 Rating plate

Model IKK86681FB
 Typ 62 D6A 06 AA
 Induction 7.35 kW
 Ser.Nr.
 AEG

PNC 949 597 873 00
 220 - 240 V / 400 V 2N 50 - 60 Hz
 Made in: Germany
 7.35 kW

10.2 Cooking zones specification

Induction cooking surface	Nominal power (maximum heat setting) [W]	PowerBoost [W]	PowerBoost maximum duration [min]
Single triangle	1150	1600	10
Standard cooking zone	2000	3000	10
Centre zone	4200	-	-
Vertical zone	3200	-	-
Horizontal left zone	4100	-	-
Horizontal right zone	3200	-	-

The power of the cooking zones can be different from the data in the table. It changes with the material and dimensions of the cookware.

Cookware sizes

Bridge mode	Cookware dimension (minimum)	Cookware dimension (maximum)
Single triangle	100 mm	160 mm
Standard cooking zone	160 mm	210 mm
Centre zone	240 mm	350 mm
Vertical zone	The area of 3 single triangles	The area of 4 single triangles
Horizontal zone	The area of 3 single triangles	The area of 4 single triangles

For more information on the recommended cookware dimensions, refer to "Induction cooking surface" in "Daily use".

11. ENERGY EFFICIENCY

11.1 Product Information Sheet according to UK Ecodesign Regulation

Model identification	IKK86681FB	
Type of hob	Built-In Hob	
Number of cooking zones	2	
Number of cooking areas	1	
Heating technology	Induction	
Length (L) and width (W) of the cooking zone	Right front	L 22.8 cm W 17.9 cm
	Right rear	L 22.8 cm W 18.5 cm
Length (L) and width (W) of the cooking area	Left	L 46.5 cm W 37.2 cm
Energy consumption per cooking zone (EC electric cooking)	Right front	201.5 Wh / kg
	Right rear	201.5 Wh / kg
Energy consumption of the cooking area (EC electric cooking)	Left	188.7 Wh / kg
Energy consumption of the hob (EC electric hob)	192.3 Wh / kg	

BS EN 60350-2 - Household electric cooking appliances - Part 2: Hobs - Methods for measuring performance.

The energy measurements referring to the cooking area are identified by the markings of the respective cooking zones.

Energy consumption measured according to the illustration:

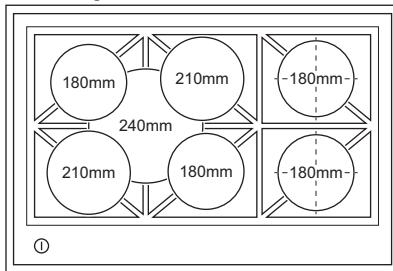



11.2 Energy saving

You can save energy during everyday cooking if you follow below hints.

- When you heat up water, use only the amount you need.
- If it is possible, always put the lids on the cookware.
- Before you activate the cooking zone put the cookware on it.
- Put the smaller cookware on the smaller cooking zones.
- Put the cookware directly in the centre of the cooking zone.
- Use the residual heat to keep the food warm or to melt it.

12. ENVIRONMENTAL CONCERNS

Recycle materials with the symbol .
Put the packaging in relevant containers to recycle it. Help protect the environment and human health by recycling waste of electrical and electronic appliances. Do not dispose of

appliances marked with the symbol  with the household waste. Return the product to your local recycling facility or contact your municipal office.

www.aeg.com/shop



OK

867366862-C-022022

AEG