



Test report No.: 2320640R-RFNAV03S-1

## Test Result

Product Name	Mesa Pro
Trademark	Juniper Systems
Model and /or type reference	ST1
Contains FCC ID	VSF29579, N7NEM74B
Contains IC	7980A-29579, 2417C-EM74B
Applicant's name / address	Juniper Systems, Inc. FCC: 1132 W 1700 N, Logan, Utah, 84321 United States IC:1132 W 1700 N, Logan UT 84321, United States
Manufacturer's name	Juniper Systems, Inc.
Test method requested, standard	Simultaneous Transmit (co-location)
Verdict Summary	IN COMPLIANCE
Documented By (Project Specialist / Ida Tung)	<i>Ida Tung</i>
Tested By (Senior Engineer / Ivan Chuang)	<i>Ivan Chuang</i>
Approved By (Senior Engineer / Alan Chen)	<i>Alan Chen</i>
Date of Receipt	2023 / 02 / 01
Date of Issue	2023 / 03 / 14
Report Version	V1.0

## INDEX

---

	Page
<b>1. General Information .....</b>	<b>5</b>
1.1. Eut Description .....	5
1.2. Test Summary .....	7
1.3. Tested System Details .....	8
1.4. Configuration Of Tested System .....	9
1.5. Eut Exercise Software .....	9
1.6. Test Facility .....	10
1.7. List Of Test Item And Equipment .....	11
1.8. Uncertainty .....	12
<b>2. Radiated Emission.....</b>	<b>13</b>
2.1. Test Setup .....	13
2.2. Limits.....	15
2.3. Test Procedure .....	16
2.4. Test Result Of Radiated Emission .....	17
<b>3. Emi Reduction Method During Compliance Testing .....</b>	<b>22</b>

Appendix 1: EUT Test Photographs

Appendix 2: Product Photos-Please refer to the file: 2320640R-Product Photos

## Competences and Guarantees

---

DEKRA is a testing laboratory competent to carry out the tests described in this report.

In order to assure the traceability to other national and international laboratories, DEKRA has a calibration and maintenance program for its measurement equipment.

DEKRA guarantees the reliability of the data presented in this report, which is the result of the measurements and the tests performed to the item under test on the date and under the conditions stated in the report and it is based on the knowledge and technical facilities available at DEKRA at the time of performance of the test.

DEKRA is liable to the client for the maintenance of the confidentiality of all information related to the item under test and the results of the test.

The results presented in this Test Report apply only to the particular item under test established in this document.

**IMPORTANT:** No parts of this report may be reproduced or quoted out of context, in any form or by any means, except in full, without the previous written permission of DEKRA.

## General conditions

---

1. The test results relate only to the samples tested.
2. The test results shown in the test report are traceable to the national/international standard through the calibration report of the equipment and evaluated measurement uncertainty herein.
3. This report must not be used to claim product endorsement by TAF or any agency of the government.
4. The test report shall not be reproduced without the written approval of DEKRA Testing and Certification Co., Ltd.
5. Measurement uncertainties evaluated for each testing system and associated connections are given here to provide the system information for reference. Compliance determinations do not take into account measurement uncertainties for each testing system, but are based on the results of the compliance measurement.

## Revision History

---

Report No.	Version	Description	Issued Date
2320640R-RFNAV03S-1	V1.0	Initial issue of report.	2023 / 03 / 14

## 1. General Information

### 1.1. EUT Description

Product Name	Mesa Pro
Trademark	Juniper Systems
Model and /or type reference	ST1
EUT Rated Voltage	AC 100-240V, 50-60Hz
EUT Test Voltage	AC 120V/60Hz
Contains FCC ID	VSF29579, N7NEM74B
Contains IC	7980A-29579, 2417C-EM74B
Power Adapter	MFR: CWT, M/N: 2AEC060KC Input: AC 100-240V~50/60Hz, 1.7A Output: 19.0V=3.16A, 60.0W Power Cord: Non-shielded, 1.8m

Note: The RF specifications of EUT refer to Intel 9260NGW and Sierra EM7411, follow above FCC ID and IC.

## Antenna List

No.	Manufacturer	Part No.	Antenna Type	Peak Gain
1	Juniper Systems	29552 (WLAN Main)	PIFA	3.1 dBi for 2400 MHz 3.0 dBi for 5150-5250 MHz 3.4 dBi for 5250-5350 MHz 1.5 dBi for 5470-5725 MHz 1.1 dBi for 5725-5850 MHz
		29554 (WLAN Aux)	PIFA	2.8 dBi for 2400 MHz 2.4 dBi for 5150-5250 MHz 2.7 dBi for 5250-5350 MHz 1.1 dBi for 5470-5725 MHz 0.0 dBi for 5725-5850 MHz
2	Juniper Systems	29552 (Cellular main TX)	Monopole	3.3 dBi for WCDMA Band 2 2.0 dBi for WCDMA Band 4 0.3 dBi for WCDMA Band 5 3.3 dBi for LTE Band 2 2.0 dBi for LTE Band 4 0.3 dBi for LTE Band 5 0.5 dBi for LTE Band 7 2.3 dBi for LTE Band 12 1.9 dBi for LTE Band 13 1.6 dBi for LTE Band 14 3.1 dBi for LTE Band 25 1.1 dBi for LTE Band 26 1.0 dBi for LTE Band 41 3.6 dBi for LTE Band 42 3.9 dBi for LTE Band 43 1.9 dBi for LTE Band 48 2.0 dBi for LTE Band 66 2.5 dBi for LTE Band 71
		29554 (Cellular diversity RX)	Monopole	3.3 dBi for WCDMA Band 2 3.8 dBi for WCDMA Band 4 0.7 dBi for WCDMA Band 5 3.3 dBi for LTE Band 2 3.8 dBi for LTE Band 4 0.7 dBi for LTE Band 5 3.6 dBi for LTE Band 7 1.4 dBi for LTE Band 12 1.5 dBi for LTE Band 13 2.1 dBi for LTE Band 14 3.3 dBi for LTE Band 25 0.7 dBi for LTE Band 26 3.8 dBi for LTE Band 41 4.3 dBi for LTE Band 42 3.9 dBi for LTE Band 43 3.3 dBi for LTE Band 48 4.4 dBi for LTE Band 66 1.6 dBi for LTE Band 71

Note: The WLAN antenna of EUT is conform to FCC 15.203.

1.2. Test Summary

Simultaneous Transmit (co-location) Requirement

Requirement – Test Item	Result
Radiated Emissions	Pass

Note:

1. The EUT is a Mesa Pro, which contains functions on WWAN and 2.4 GHz/5 GHz band WIFI with Bluetooth card module transceiver.
2. These tests were conducted on a sample for the purpose of demonstrating compliance of transmitter with simultaneous transmit (co-location).
3. There consider simultaneous transmit (co-location) based on KDB 996369 D02 Question 1 and KDB 996369 D04 for Radiated Emission.
4. The antenna gain and output power are both comply with the original certification, the final product complies with the ERP/EIRP rules.
5. The final test results meets all the applicable FCC/ISED rules.
6. Change the battery back cover (from plastic to metal).

Test Mode	Mode 1	Transmit LTE B13-10M-CH23230 (1RB#0) + BLE-2440MHz Transmit LTE B14-10M-CH23330 (1RB#0) + BLE-2440MHz Transmit WCDMA B2-CH9538 + BLE-2440MHz Transmit WCDMA B5-CH4233 + BLE-2440MHz Transmit LTE B13-10M-CH23230 (1RB#0) + 11n20-2442MHz Transmit LTE B14-10M-CH23330 (1RB#0) + 11n20-2442MHz Transmit WCDMA B2-CH9538 + 11n20-2442MHz Transmit WCDMA B5-CH4233 + 11n20-2442MHz
-----------	--------	------------------------------------------------------------------------------------------------------------------------------------------------------------------------------------------------------------------------------------------------------------------------------------------------------------------------------------------------------------------------------------------------------

### 1.3. Tested System Details

The types for all equipment, plus descriptions of all cables used in the tested system (including inserted cards) are:

Product	Manufacturer	Model No.	Serial No.	Power Cord
1 Power Adapter	CWT	2AEC060KC	N/A	Non-shielded, 1.8m
2 Loopback	N/A	N/A	N/A	N/A
3 External HDD	Transcend	TS1TSJ25H3B	F21786-0125	N/A
4 External HDD	Transcend	TS1TSJ25H3B	F21786-0103	N/A
5 External HDD	Transcend	TS1TSJ25MC	F30467-0011	N/A
6 Microphone & Earphone	Verbatim	C09024VB	N/A	N/A

Cable Type	Cable Description
A Power Cable	Non-shielded, 1.8m
B USB Cable	Shielded, 0.5m
C USB Cable	Shielded, 0.5m
D Microphone & Earphone	Non-shielded, 1.2m



#### 1.4. Configuration of Tested System

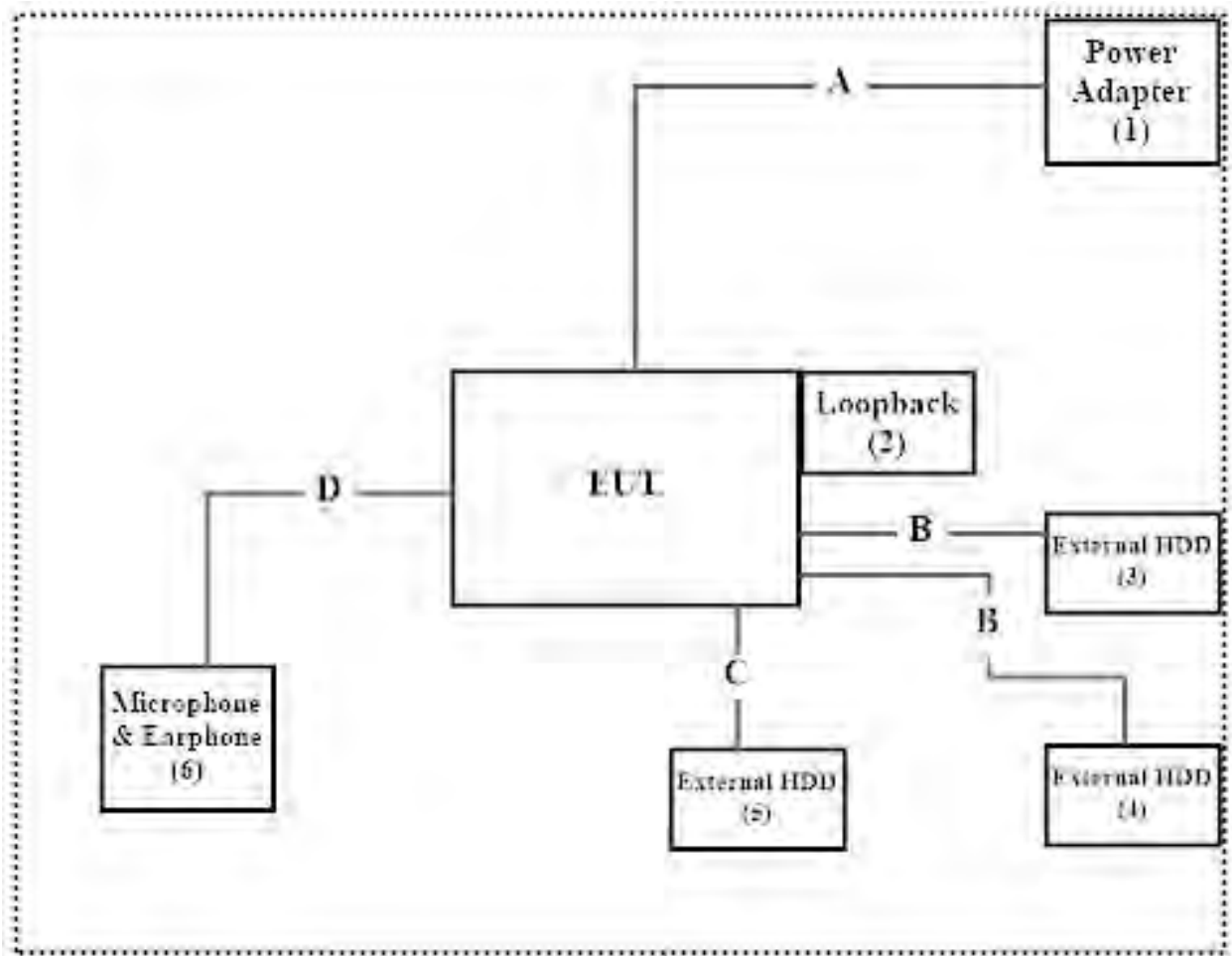

#### 1.5. EUT Exercise Software

- (1) Setup the EUT as shown on 1.5.
- (2) Execute software “DRTU Version 22.21050.0.0-OEM.DRTUU.12004” on the EUT.
- (3) The Communication Analyzer (MT8820C) uses in controlling EUT to transmit continuously.
- (4) Configure the test mode, the test channel, and the data rate.
- (5) Start the continuous transmission.
- (6) Verify that the EUT works properly.

## 1.6. Test Facility

Ambient conditions in the laboratory:

Performed Item	Items	Required	Actual
Radiated Emission	Temperature (°C)	10~40 °C	21 °C
	Humidity (%RH)	10~90 %	60 %

USA	FCC Registration Number: TW0033
Canada	CAB Identifier Number: TW3023 / Company Number: 26930

Site Description	Accredited by TAF
	Accredited Number: 3023

Test Laboratory	DEKRA Testing and Certification Co., Ltd.
	Linkou Laboratory
Address	No.5-22, Ruishukeng Linkou District, New Taipei City, 24451, Taiwan, R.O.C
Performed Location	No. 26, Huaya 1st Rd., Guishan Dist., Taoyuan City 333411, Taiwan, R.O.C.
Phone Number	+886-3-275-7255
Fax Number	+886-3-327-8031

## 1.7. List of Test Item and Equipment

**For Radiated measurements / HY-CB01**

Equipment	Manufacturer	Model No.	Serial No.	Cal. Date	Due. Date
Loop Antenna	AMETEK	HLA6121	56736	2022/05/14	2023/05/13
Bi-Log Antenna	SCHWARZBECK	VULB9168	9168-0675	2021/08/11	2023/08/10
Horn Antenna	RF SPIN	DRH18-E	210802A18ES	2022/06/08	2023/06/07
Horn Antenna	Com-Power	AH-840	101101	2021/11/30	2023/11/29
Pre-Asmplifier	SGH	0301	20211007-7	2023/01/10	2024/01/09
Pre-Amplifier	EMCI	EMC051845SE	980632	2023/01/10	2024/01/09
Pre-Amplifier	EMCI	EMC184045SE	980369	2023/01/10	2024/01/09
Coaxial Cable	EMCI	EMC102-KM-KM-600	1160314		
Coaxial Cable	EMCI	EMC102-KM-KM-7000	170242		
Filter	MICRO TRONICS	BRM50702	G251	2023/01/05	2024/01/04
EMI Test Receiver	R&S	ESR3	102792	2022/12/29	2023/12/28
Spectrum Analyzer	R&S	FSV3044	101115	2023/01/06	2024/01/05
Radio Communication Tester	Anritsu	MT8820C	6201465467	2022/08/10	2023/08/09
Coaxial Cable	SUHNER	SUCOFLEX 106	25450/6	2023/01/10	2024/01/09
Coaxial Cable	SGH	HA800	GD20110222-8		
Coaxial Cable	SGH	SGH18	2021003-8		
Coaxial Cable	EMCI	EMC106	151113		

Note: Test Software version: AUDIX e3 V9.

### 1.8. Uncertainty

Uncertainties have been calculated according to the DEKRA internal document.

The reported expanded uncertainties are based on a standard uncertainty multiplied by a coverage factor of  $k=2$ , providing a level of confidence of approximately 95 %.

Measurement uncertainties evaluated for each testing system and associated connections are given here to provide the system information for reference. Compliance determinations do not take into account measurement uncertainties for each testing system, but are based on the results of the compliance measurement.

<b>Test item</b>	<b>Uncertainty</b>	
Radiated Emission	Under 1 GHz $\pm 4.06$ dB	Above 1 GHz $\pm 3.73$ dB

## 2. Radiated Emission

### 2.1. Test Setup

Under 30 MHz

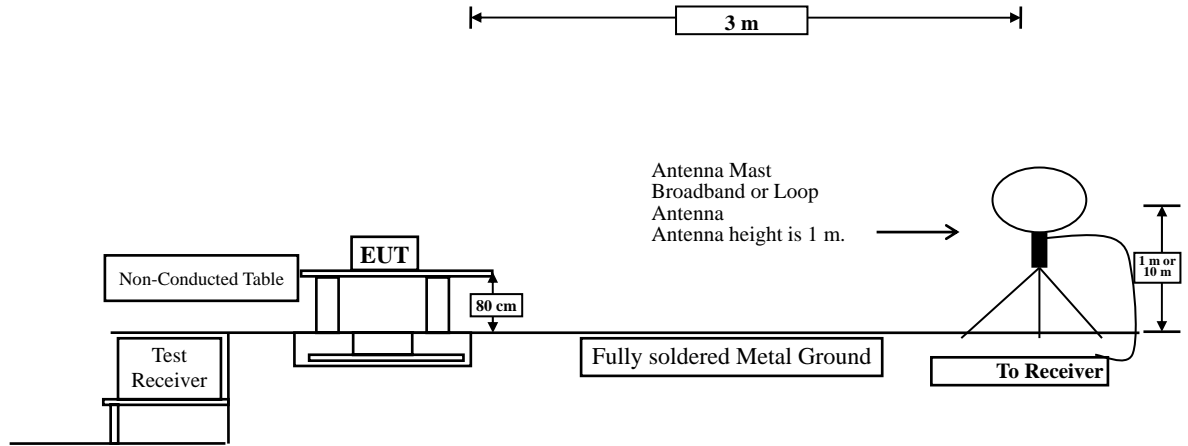

Below 1 GHz

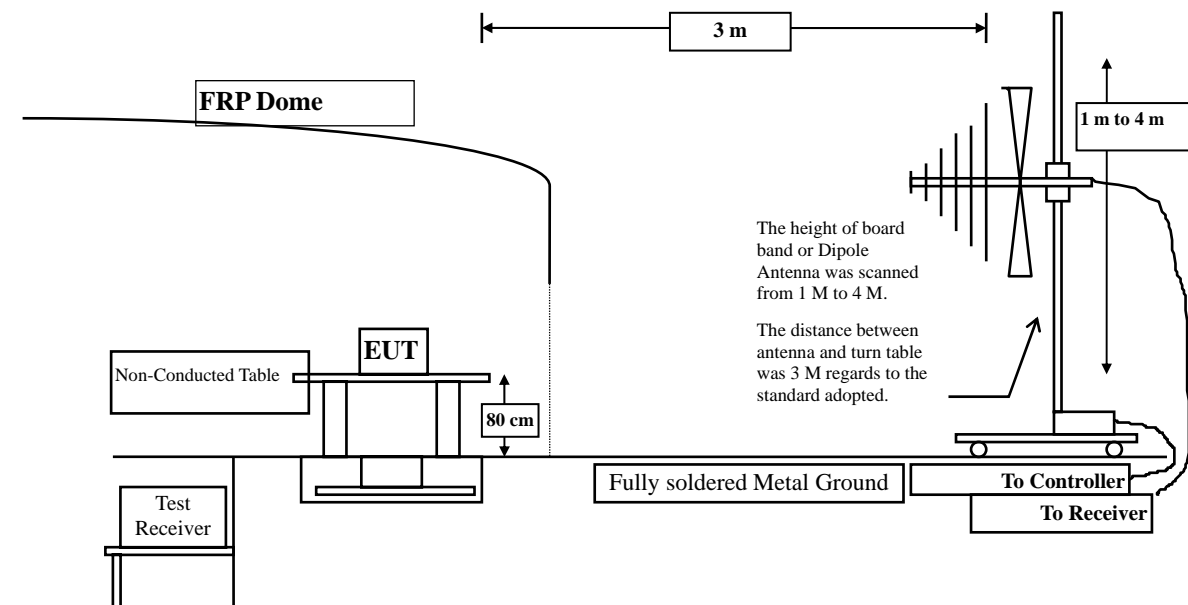

Above 1GHz

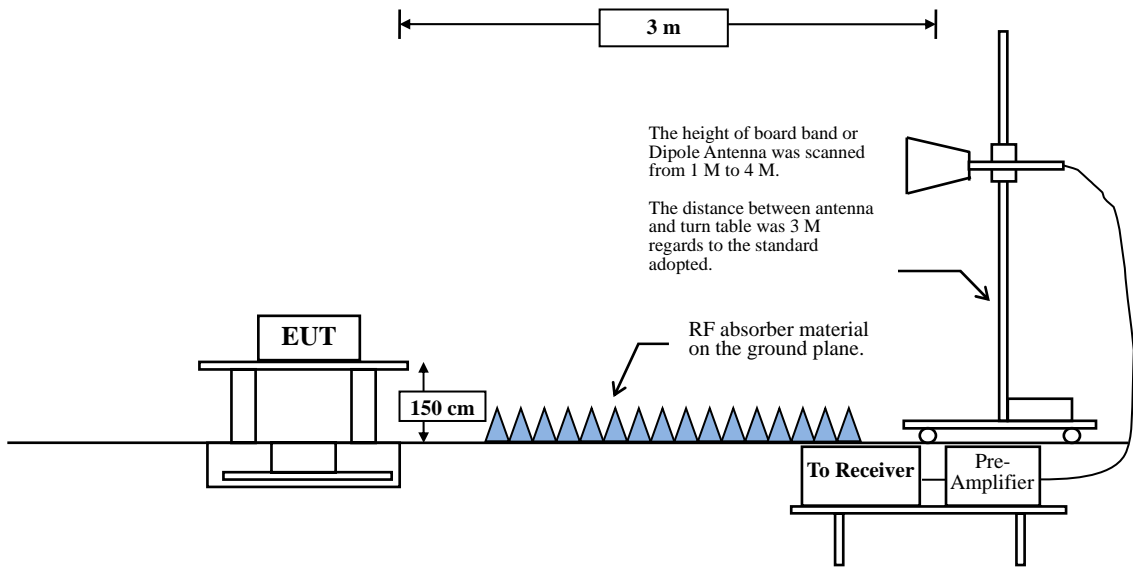

## 2.2. Limits

### ➤ General Radiated Emission Limits

Emissions radiated outside of the specified frequency bands, except for harmonics, shall be attenuated by at least 20 dB below the level of the fundamental or to the general radiated emission limits in paragraph 15.209, whichever is the lesser attenuation.

FCC Part 15 Subpart C Paragraph 15.209 Limits		
Frequency MHz	Field strength (microvolts/meter)	Measurement distance (meter)
0.009-0.490	2400/F(kHz)	300
0.490-1.705	24000/F(kHz)	30
1.705-30	30	30
30-88	100	3
88-216	150	3
216-960	200	3
Above 960	500	3

- Remarks:
1. RF Voltage (dBuV) = 20 log RF Voltage (uV)
  2. In the Above Table, the tighter limit applies at the band edges.
  3. Distance refers to the distance in meters between the measuring instrument antenna and the closed point of any part of the device or system.

### 2.3. Test Procedure

The EUT was setup according to ANSI C63.10: 2013 and tested according to DTS test procedure of KDB558074 for compliance to FCC 47CFR 15.247 requirements.

Measuring the frequency range below 1 GHz, the EUT is placed on a turn table which is 0.8 meter above ground, when measuring the frequency range above 1 GHz, the EUT is placed on a turn table which is 1.5 meter above ground.

The turn table is rotated 360 degrees to determine the position of the maximum emission level.

The EUT was positioned such that the distance from antenna to the EUT was 3 meters.

The antenna is scanned between 1 meter and 4 meters to find out the maximum emission level. This is repeated for both horizontal and vertical polarization of the antenna. In order to find the maximum emission, all of the interface cables were manipulated according to ANSI C63.10: 2013 on radiated measurement.

The resolution bandwidth below 30 MHz setting on the field strength meter is 9 kHz and 30 MHz~1 GHz is 120 kHz and above 1 GHz is 1 MHz.

Radiated emission measurements below 30 MHz are made using Loop Antenna and 30 MHz~1 GHz are made using broadband Bilog antenna and above 1 GHz are made using Horn Antennas.

The measurement is divided into the Preliminary Measurement and the Final Measurement.

The suspected frequencies are searched for in Preliminary Measurement with the measurement antenna kept pointed at the source of the emission both in azimuth and elevation, with the polarization of the antenna oriented for maximum response. The antenna is pointed at an angle towards the source of the emission, and the EUT is rotated in both height and polarization to maximize the measured emission. The emission is kept within the illumination area of the 3 dB bandwidth of the antenna.

The worst radiated emission is measured in the Open Area Test Site on the Final Measurement.

The measurement frequency range from 9 kHz - 10th Harmonic of fundamental was investigated.



## 2.4. Test Result of Radiated Emission

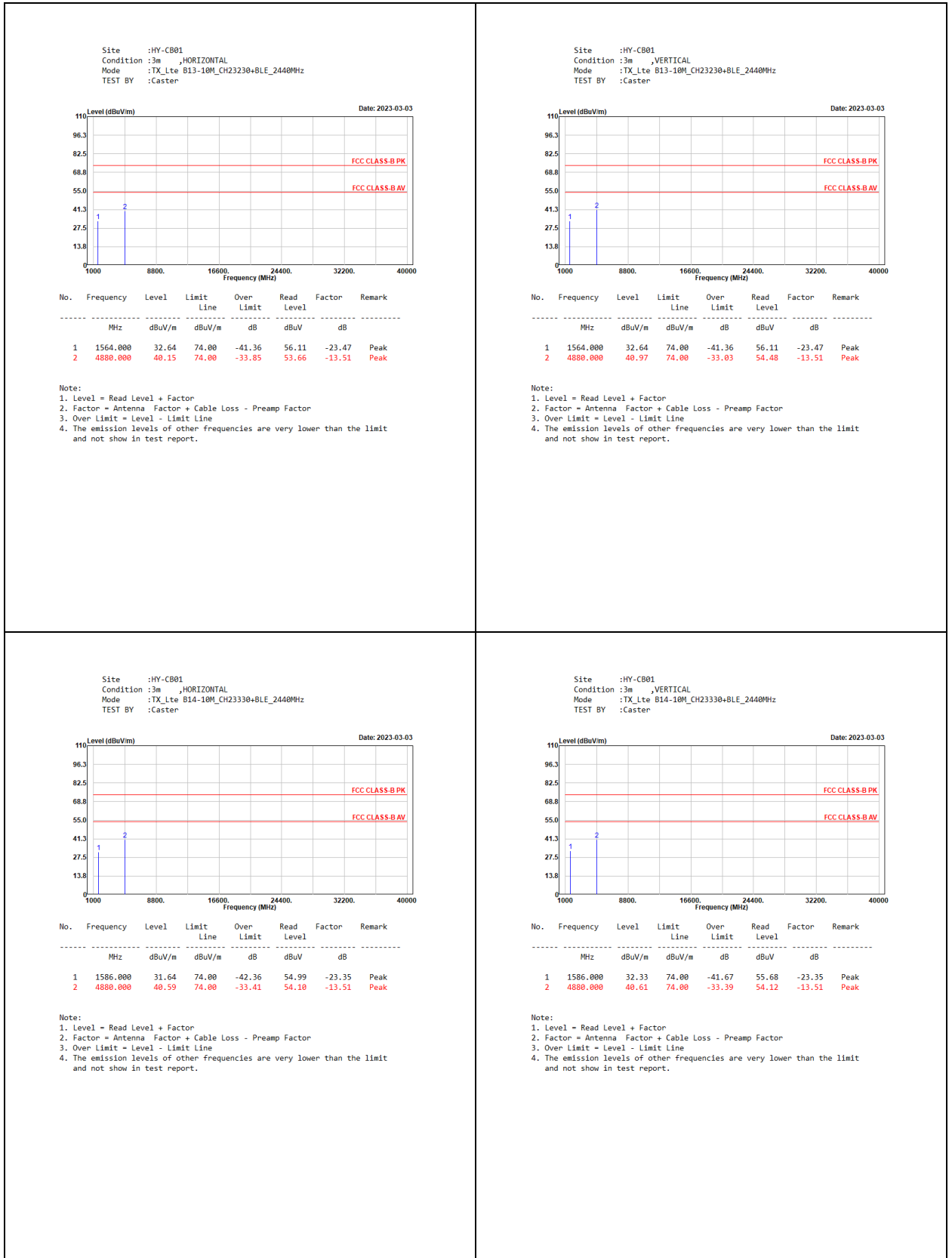

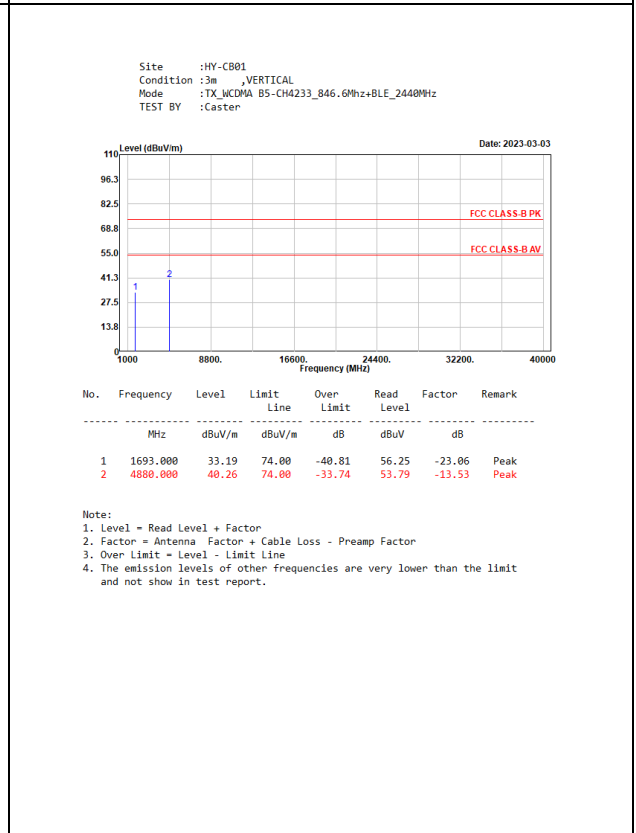
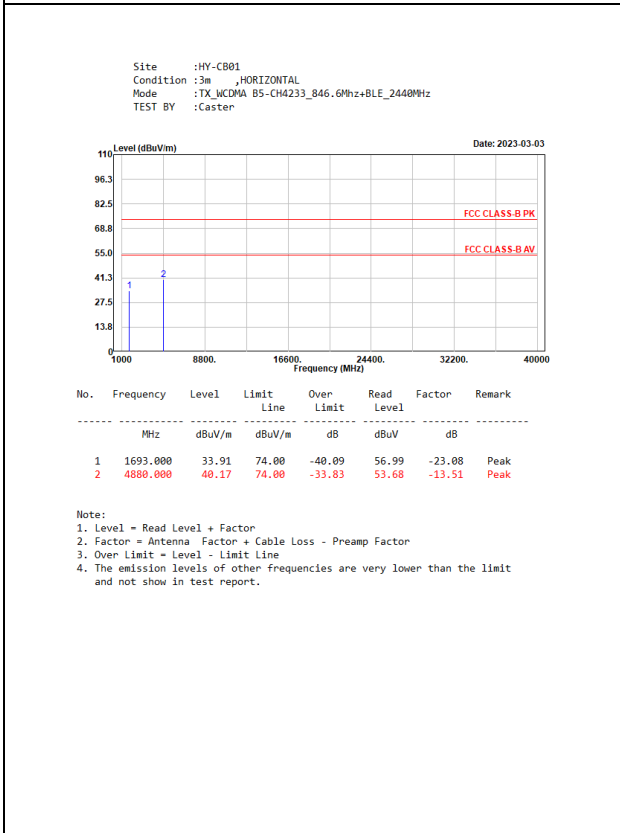
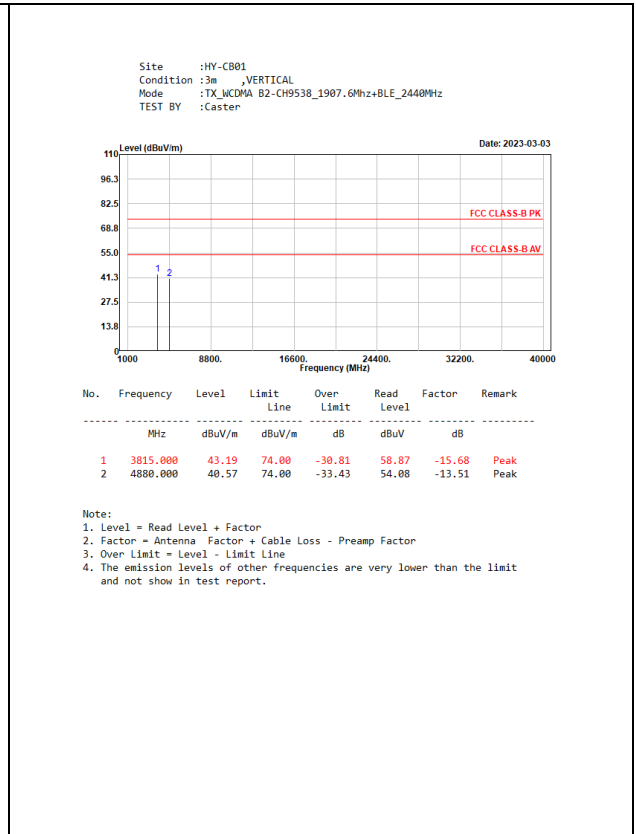
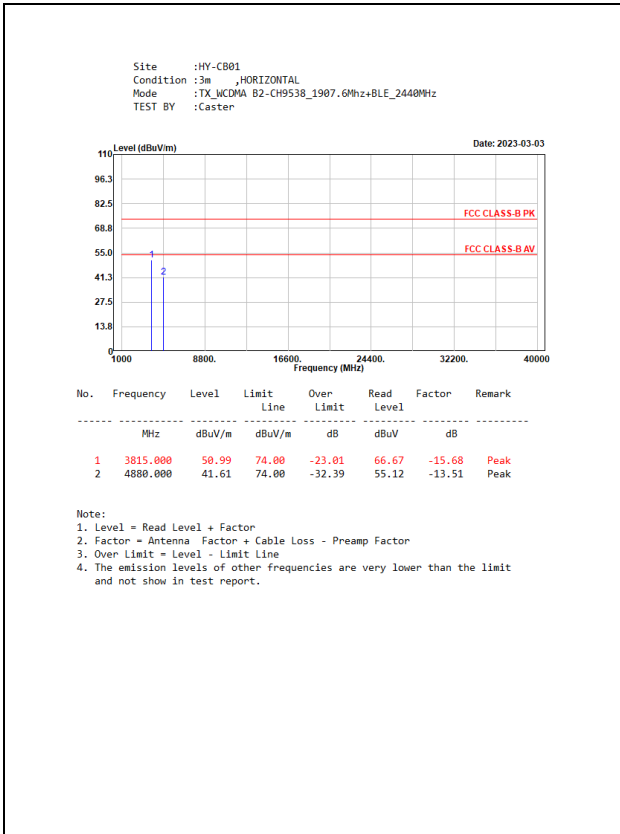

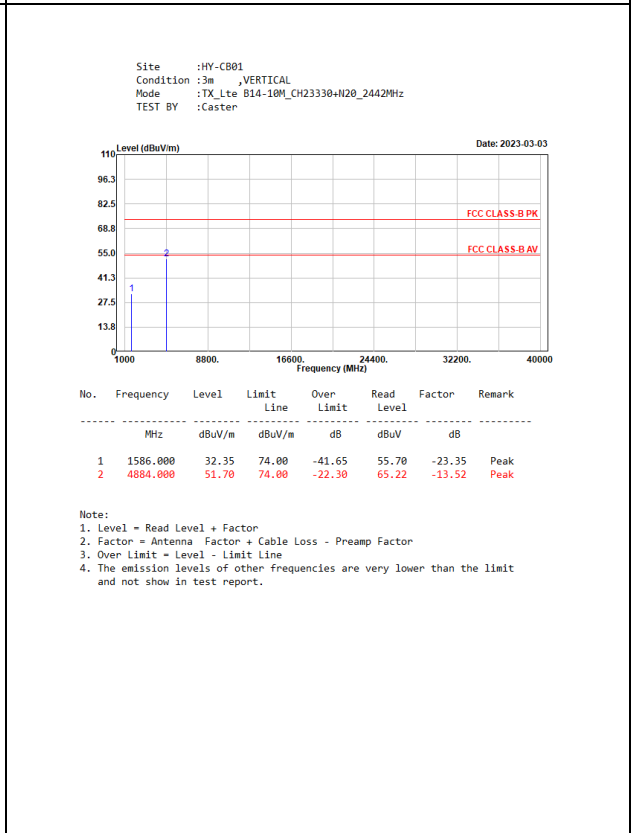
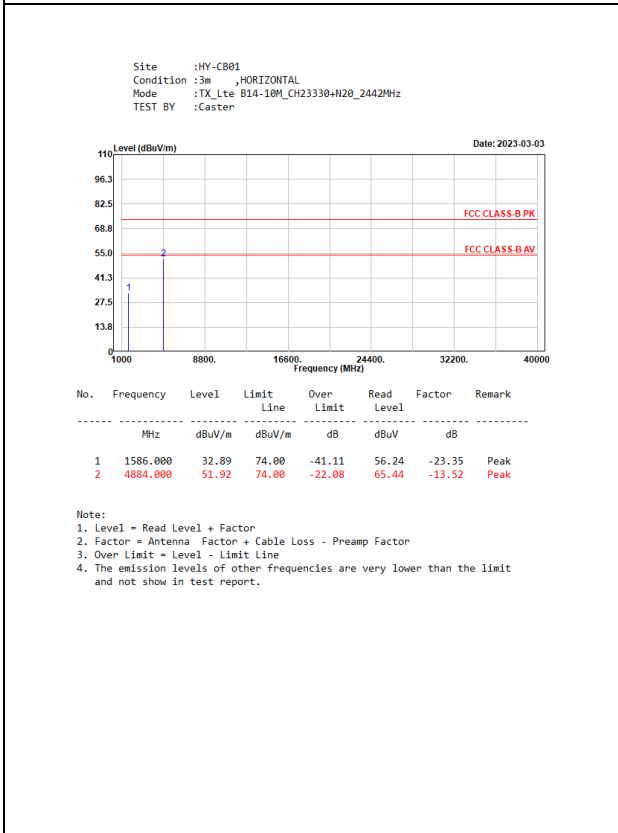
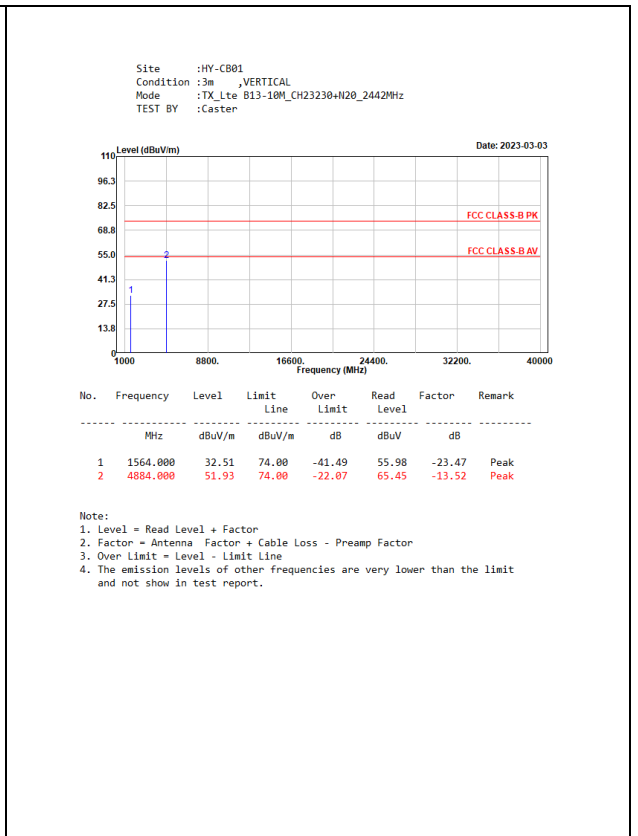
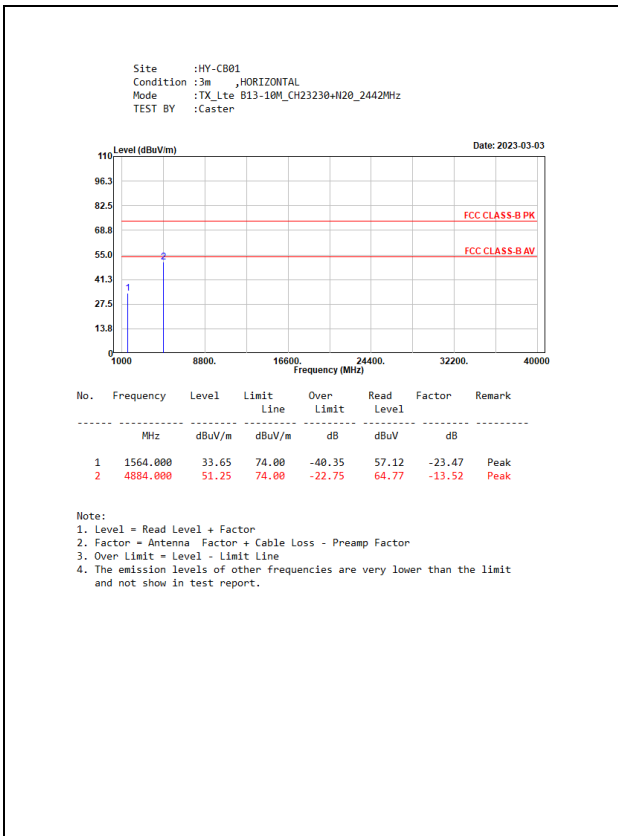

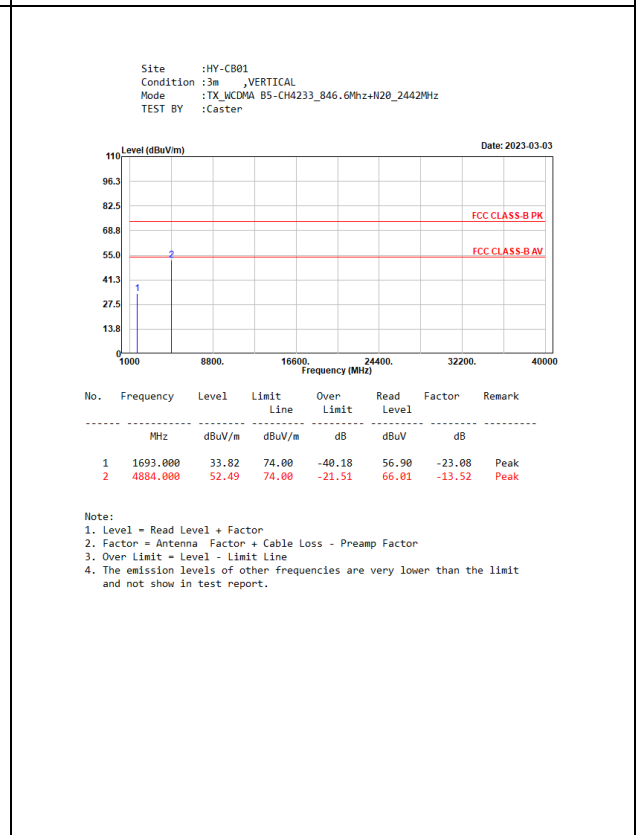
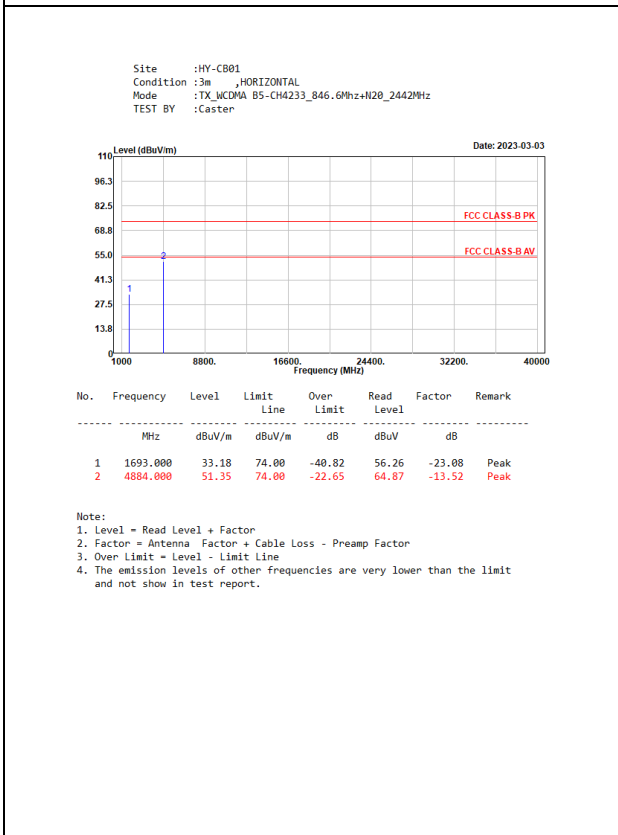
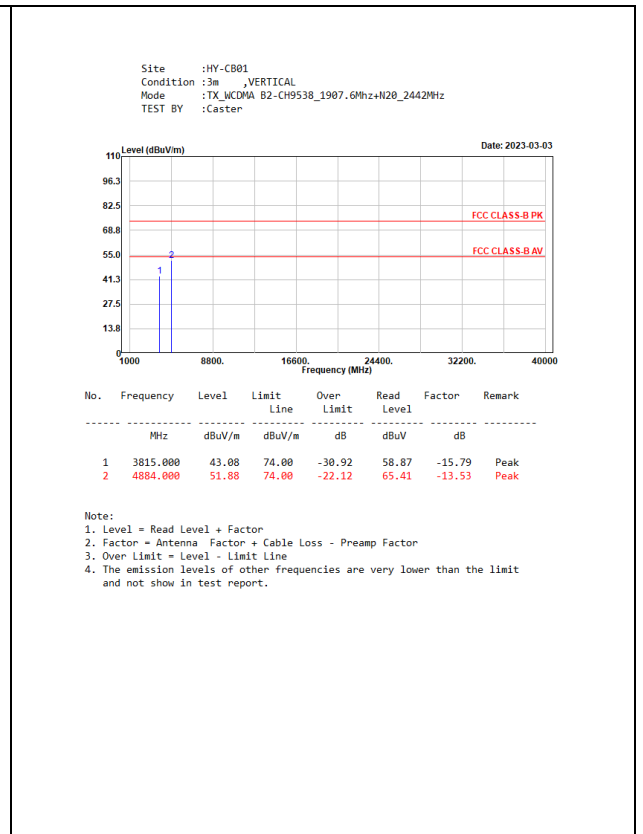
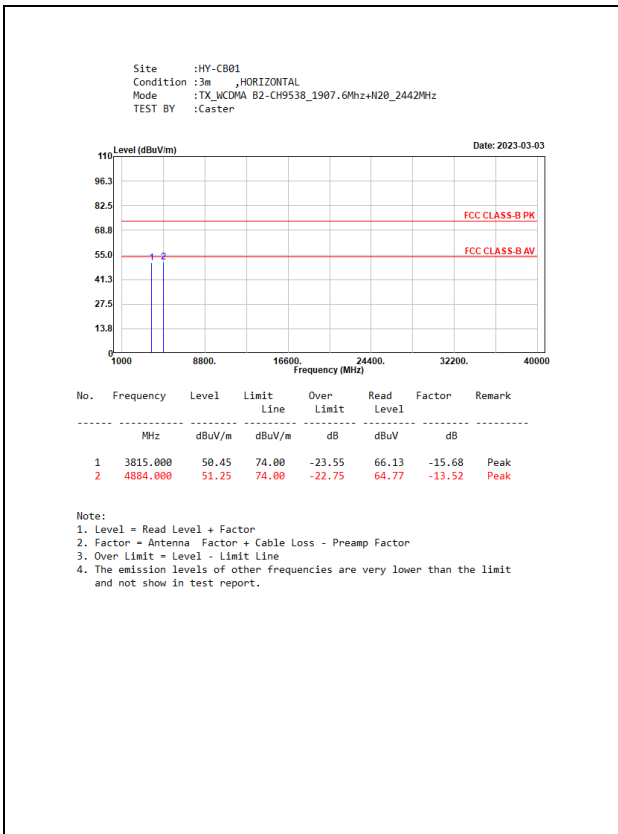

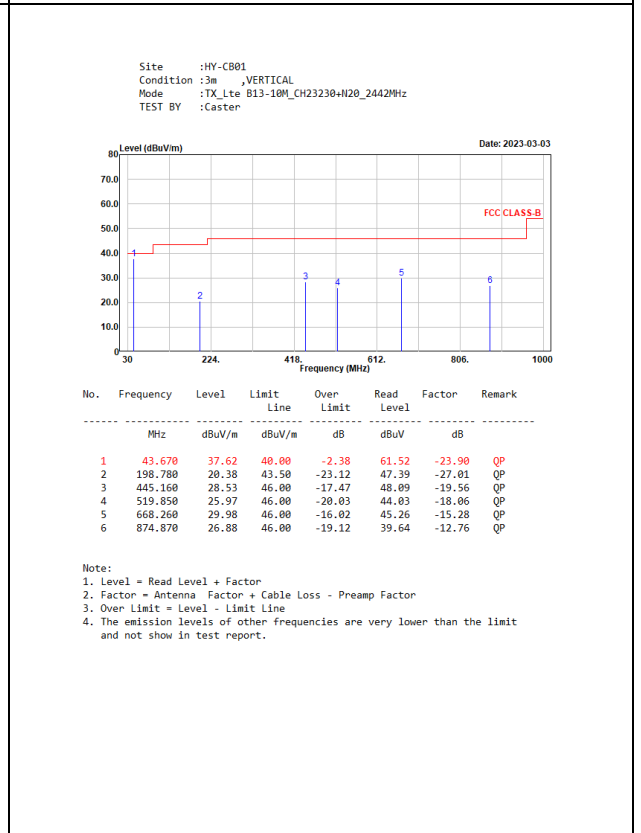
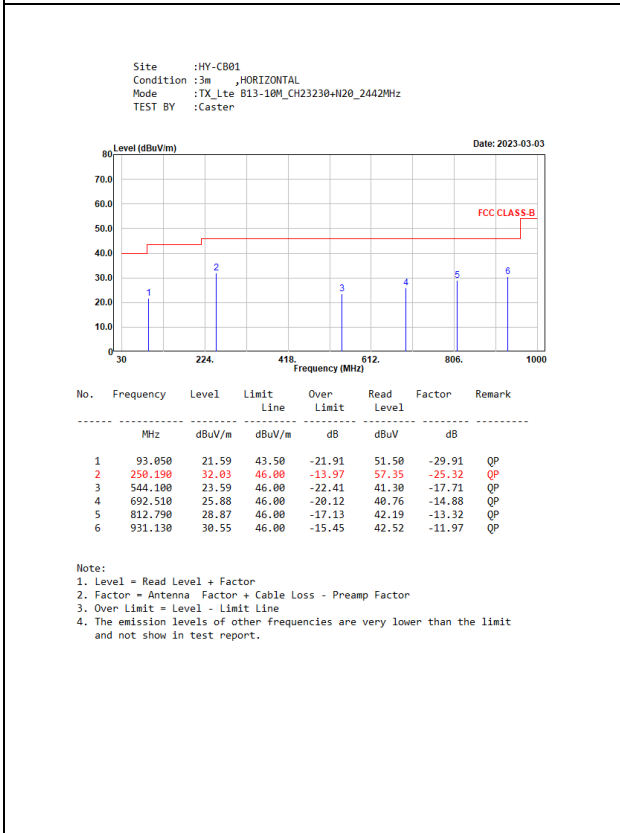
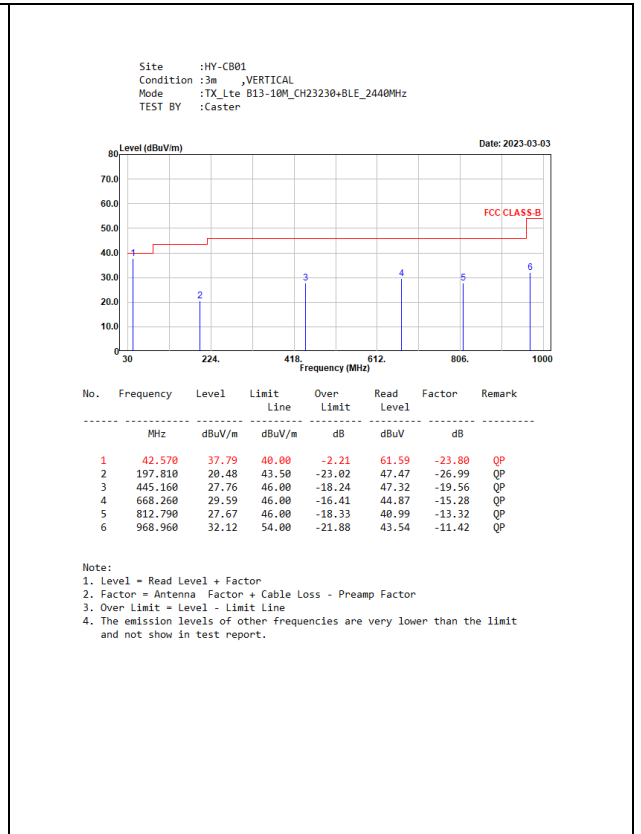
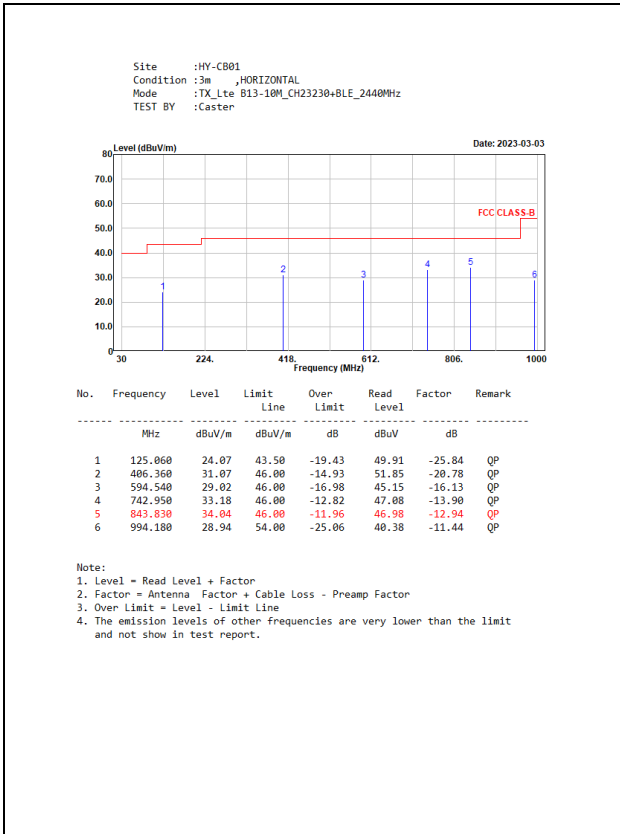

### **3. EMI Reduction Method During Compliance Testing**

No modification was made during testing.