

mITX-DNV

Doc. User Guide, Rev. 1.5

Doc. ID: 1065-7139

This page has been intentionally left blank

 MITX-DNV - USER GUIDE

Disclaimer

Kontron would like to point out that the information contained in this user guide may be subject to alteration, particularly as a result of the constant upgrading of Kontron products. This document does not entail any guarantee on the part of Kontron with respect to technical processes described in the user guide or any product characteristics set out in the user guide. Kontron assumes no responsibility or liability for the use of the described product(s), conveys no license or title under any patent, copyright or mask work rights to these products and makes no representations or warranties that these products are free from patent, copyright or mask work right infringement unless otherwise specified. Applications that are described in this user guide are for illustration purposes only. Kontron makes no representation or warranty that such application will be suitable for the specified use without further testing or modification. Kontron expressly informs the user that this user guide only contains a general description of processes and instructions which may not be applicable in every individual case. In cases of doubt, please contact Kontron.

This user guide is protected by copyright. All rights are reserved by Kontron. No part of this document may be reproduced, transmitted, transcribed, stored in a retrieval system, or translated into any language or computer language, in any form or by any means (electronic, mechanical, photocopying, recording, or otherwise), without the express written permission of Kontron. Kontron points out that the information contained in this user guide is constantly being updated in line with the technical alterations and improvements made by Kontron to the products and thus this user guide only reflects the technical status of the products by Kontron at the time of publishing.

Brand and product names are trademarks or registered trademarks of their respective owners.

©2020 by Kontron AG

Kontron AG

Lise-Meitner-Str. 3-5
86156 Augsburg
Germany
www.kontron.com

High Risk Applications Hazard Notice

THIS DEVICE AND ASSOCIATED SOFTWARE ARE NOT DESIGNED, MANUFACTURED OR INTENDED FOR USE OR RESALE FOR THE OPERATION OF NUCLEAR FACILITIES, THE NAVIGATION, CONTROL OR COMMUNICATION SYSTEMS FOR AIRCRAFT OR OTHER TRANSPORTATION, AIR TRAFFIC CONTROL, LIFE SUPPORT OR LIFE SUSTAINING APPLICATIONS, WEAPONS SYSTEMS, OR ANY OTHER APPLICATION IN A HAZARDOUS ENVIRONMENT, OR REQUIRING FAIL-SAFE PERFORMANCE, OR IN WHICH THE FAILURE OF PRODUCTS COULD LEAD DIRECTLY TO DEATH, PERSONAL INJURY, OR SEVERE PHYSICAL OR ENVIRONMENTAL DAMAGE (COLLECTIVELY, "HIGH RISK APPLICATIONS").

You understand and agree that your use of Kontron devices as a component in High Risk Applications is entirely at your risk. To minimize the risks associated with your products and applications, you should provide adequate design and operating safeguards. You are solely responsible for compliance with all legal, regulatory, safety, and security related requirements concerning your products. You are responsible to ensure that your systems (and any Kontron hardware or software components incorporated in your systems) meet all applicable requirements. Unless otherwise stated in the product documentation, the Kontron device is not provided with error-tolerance capabilities and cannot therefore be deemed as being engineered, manufactured or setup to be compliant for implementation or for resale as device in High Risk Applications. All application and safety related information in this document (including application descriptions, suggested safety measures, suggested Kontron products, and other materials) is provided for reference only.

Revision History

Revision	Brief Description of Changes	Date of Issue
1.0	Initial Issue	2018-Mar-16
1.1	Add extended temperature spec	2018-Oct-31
1.2	Modify M.2 Key B type	2018-Nov-15
1.3	Update OS support	2019-Mar-26
1.4	Add a power notice	2019-July-25
1.5	Add C3750 & C3950 CPU	2020-Apr-07

Terms and Conditions

Kontron warrants products in accordance with defined regional warranty periods. For more information about warranty compliance and conformity, and the warranty period in your region, visit <http://www.kontron.com/terms-and-conditions>.

Kontron sells products worldwide and declares regional General Terms & Conditions of Sale, and Purchase Order Terms & Conditions. Visit <http://www.kontron.com/terms-and-conditions>.

For contact information, refer to the corporate offices contact information on the last page of this user guide or visit our website [CONTACT US](#).

Customer Support

Find Kontron contacts by visiting: <http://www.kontron.com/support>.

Customer Service

As a trusted technology innovator and global solutions provider, Kontron extends its embedded market strengths into a services portfolio allowing companies to break the barriers of traditional product lifecycles. Proven product expertise coupled with collaborative and highly-experienced support enables Kontron to provide exceptional peace of mind to build and maintain successful products.

For more details on Kontron's service offerings such as: enhanced repair services, extended warranty, Kontron training academy, and more visit <http://www.kontron.com/support-and-services/services>.

Customer Comments

If you have any difficulties using this user guide, discover an error, or just want to provide some feedback, contact [Kontron support](#). Detail any errors you find. We will correct the errors or problems as soon as possible and post the revised user guide on our website.

Symbols

The following symbols may be used in this user guide

⚠ DANGER

DANGER indicates a hazardous situation which, if not avoided, will result in death or serious injury.

⚠ WARNING

WARNING indicates a hazardous situation which, if not avoided, could result in death or serious injury.

NOTICE

NOTICE indicates a property damage message.

⚠ CAUTION

CAUTION indicates a hazardous situation which, if not avoided, may result in minor or moderate injury.



Electric Shock!

This symbol and title warn of hazards due to electrical shocks (> 60 V) when touching products or parts of products. Failure to observe the precautions indicated and/or prescribed by the law may endanger your life/health and/or result in damage to your material.



ESD Sensitive Device!

This symbol and title inform that the electronic boards and their components are sensitive to static electricity. Care must therefore be taken during all handling operations and inspections of this product in order to ensure product integrity at all times.



HOT Surface!

Do NOT touch! Allow to cool before servicing.



Laser!

This symbol inform of the risk of exposure to laser beam and light emitting devices (LEDs) from an electrical device. Eye protection per manufacturer notice shall review before servicing.



This symbol indicates general information about the product and the user guide.

This symbol also indicates detail information about the specific product configuration.



This symbol precedes helpful hints and tips for daily use.

For Your Safety

Your new Kontron product was developed and tested carefully to provide all features necessary to ensure its compliance with electrical safety requirements. It was also designed for a long fault-free life. However, the life expectancy of your product can be drastically reduced by improper treatment during unpacking and installation. Therefore, in the interest of your own safety and of the correct operation of your new Kontron product, you are requested to conform with the following guidelines.

High Voltage Safety Instructions

As a precaution and in case of danger, the power connector must be easily accessible. The power connector is the product's main disconnect device.

CAUTION

Warning

All operations on this product must be carried out by sufficiently skilled personnel only.

CAUTION



Electric Shock!

Before installing a non hot-swappable Kontron product into a system always ensure that your mains power is switched off. This also applies to the installation of piggybacks. Serious electrical shock hazards can exist during all installation, repair, and maintenance operations on this product. Therefore, always unplug the power cable and any other cables which provide external voltages before performing any work on this product.

Earth ground connection to vehicle's chassis or a central grounding point shall remain connected. The earth ground cable shall be the last cable to be disconnected or the first cable to be connected when performing installation or removal procedures on this product.

Special Handling and Unpacking Instruction

NOTICE



ESD Sensitive Device!

Electronic boards and their components are sensitive to static electricity. Therefore, care must be taken during all handling operations and inspections of this product, in order to ensure product integrity at all times.

Do not handle this product out of its protective enclosure while it is not used for operational purposes unless it is otherwise protected.

Whenever possible, unpack or pack this product only at EOS/ESD safe work stations. Where a safe work station is not guaranteed, it is important for the user to be electrically discharged before touching the product with his/her hands or tools. This is most easily done by touching a metal part of your system housing.

It is particularly important to observe standard anti-static precautions when changing piggybacks, ROM devices, jumper settings etc. If the product contains batteries for RTC or memory backup, ensure that the product is not placed on conductive surfaces, including anti-static plastics or sponges. They can cause short circuits and damage the batteries or conductive circuits on the product.

Lithium Battery Precautions

If your product is equipped with a lithium battery, take the following precautions when replacing the battery.

CAUTION

Danger of explosion if the battery is replaced incorrectly.

- ▶ Replace only with same or equivalent battery type recommended by the manufacturer.
- ▶ Dispose of used batteries according to the manufacturer's instructions.

General Instructions on Usage

In order to maintain Kontron's product warranty, this product must not be altered or modified in any way. Changes or modifications to the product, that are not explicitly approved by Kontron and described in this user guide or received from Kontron Support as a special handling instruction, will void your warranty.

This product should only be installed in or connected to systems that fulfill all necessary technical and specific environmental requirements. This also applies to the operational temperature range of the specific board version that must not be exceeded. If batteries are present, their temperature restrictions must be taken into account.

In performing all necessary installation and application operations, only follow the instructions supplied by the present user guide.

Keep all the original packaging material for future storage or warranty shipments. If it is necessary to store or ship the product then re-pack it in the same manner as it was delivered.

Special care is necessary when handling or unpacking the product. See Special Handling and Unpacking Instruction.

Quality and Environmental Management

Kontron aims to deliver reliable high-end products designed and built for quality, and aims to complying with environmental laws, regulations, and other environmentally oriented requirements. For more information regarding Kontron's quality and environmental responsibilities, visit <http://www.kontron.com/about-kontron/corporate-responsibility/quality-management>.

Disposal and Recycling

Kontron's products are manufactured to satisfy environmental protection requirements where possible. Many of the components used are capable of being recycled. Final disposal of this product after its service life must be accomplished in accordance with applicable country, state, or local laws or regulations.

WEEE Compliance

The Waste Electrical and Electronic Equipment (WEEE) Directive aims to:

- ▶ Reduce waste arising from electrical and electronic equipment (EEE)
- ▶ Make producers of EEE responsible for the environmental impact of their products, especially when the product become waste
- ▶ Encourage separate collection and subsequent treatment, reuse, recovery, recycling and sound environmental disposal of EEE
- ▶ Improve the environmental performance of all those involved during the lifecycle of EEE



Environmental protection is a high priority with Kontron.

Kontron follows the WEEE directive

You are encouraged to return our products for proper disposal.

Table of Contents

Symbols.....	6
For Your Safety	7
High Voltage Safety Instructions	7
Special Handling and Unpacking Instruction	7
Lithium Battery Precautions.....	8
General Instructions on Usage	8
Quality and Environmental Management	8
Disposal and Recycling.....	8
WEEE Compliance.....	8
Table of Contents	9
List of Tables	10
List of Figures	11
1/ Introduction	13
2/ Installation Procedures	14
2.1. Installing the Board	14
2.2. Chassis Safety Standards.....	15
2.3. Lithium Battery Replacement	15
3/ System Specifications	17
3.1. System Block Diagram.....	17
3.2. Component Main Data	18
3.3. Environmental Conditions	19
3.4. Standards and Certifications.....	19
3.5. Processor Support.....	20
3.6. System Memory Support.....	20
3.6.1. Memory Operating Frequencies	20
3.7. On-board Graphics Subsystem.....	21
3.8. Power Supply.....	21
4/ Connector Locations	23
4.1. Top Side.....	23
4.2. Connector Panel Side.....	25
5/ Connector Definitions	26
6/ I/O-Area Connectors	27
6.1. VGA Connector (CN24).....	27
6.2. Ethernet Connectors (CN18, CN19 & CN20)	28
6.3. USB Connectors (I/O Area).....	29
6.4. RS232/422/485 COM1 Connector (CN26)	31
7/ Internal Connectors	32
7.1. Power Input Wafer (ATX1).....	32
7.2. CPU / System Fan Wafer (FAN1 & FAN2).....	34
7.3. SATA (Serial ATA) Port 1 ~ Port 6 Connector (SATA1 ~ SATA6)	35
7.4. USB Connectors (Internal) (CN17).....	36
7.5. Front Panel Pin Header (FP1 & FP2).....	37
7.6. Serial COM2 Ports (CN16).....	39
7.7. Digital Input / Output Wafer (CN15).....	40
7.8. PS/2 Keyboard and Mouse Wafer (CN21).....	41
7.9. M.2 Key-B SSD Slot (M2B1).....	42

7.10. mPCIe / mSATA Socket (MPCIE1).....	45
7.11. SIM Interface Wafer for MPCIE1 (CN4)	47
7.12. PCIe x8 Socket (PCIE1)	48
7.13. GbE LAN LED Header (CN2).....	50
7.14. Wireless Activity LED Header for MPCIE1 (CN5)	51
7.15. General Purpose LED Wafer (CN25).....	51
7.16. Switches and Jumpers.....	53
7.16.1. mPCIe / mSATA Selection for MPCIE1 (JP1).....	53
7.16.2. USB Power Selection (JP2)	53
7.16.3. AT / ATX Power Mode Selection (JP3).....	54
7.16.4. MFG Mode Selection (JP5).....	54
7.16.5. Clear CMOS Selection (JP10).....	54
7.16.6. Flash Security Override Selection (JP11)	55
7.16.7. Power Output Selection for COM1 Pin-9 (JP15).....	55
8/ On-Board Connectors & Mating Connector Types	56
9/ BIOS.....	57
9.1. Starting the uEFI BIOS.....	57
9.2. Setup Menus	58
9.2.1. Main Setup Menu	58
9.2.2. Advanced Setup Menu.....	60
9.2.3. Power Setup Menu	76
9.2.4. Boot Setup Menu.....	78
9.2.5. Security Setup Menu	79
9.2.5.1. Remember the password	80
9.2.6. Save & Exit Setup Menu.....	81
Appendix A: List of Acronyms.....	82
About Kontron	83

List of Tables

Table 1: Component Main Data	18
Table 2: Environmental Conditions	19
Table 3: Standards and Certifications	19
Table 4: Processor Support.....	20
Table 5: Memory Operating Frequencies	20
Table 6: Display Configuration.....	21
Table 7: Supply Voltage.....	21
Table 8: Jumper List.....	23
Table 9: Top Side Internal Connector Pin Assignment.....	23
Table 10: Connector Panel Side Connector List	25
Table 11: Pin Assignment VGA Connector CN24.....	27
Table 12: Pin Assignment Ethernet Connectors CN18, CN19, CN20	28
Table 13: Signal Description	28
Table 14: Pin Assignment USB3.0 / USB2.0 Connector CN22, CN23	29
Table 15: Signal Description	30
Table 16: Pin Assignment RS232/422/485 COM1 Connector CN26.....	31
Table 17: Signal Description	31
Table 18: Pin Assignment ATX1	32
Table 19: Signal Description	33
Table 20: 4-Pin Mode FAN1, FAN2	34
Table 21: 3-Pin Mode FAN1, FAN2.....	34
Table 22: Signal Description	34

Table 23: Pin Assignment SATA1 ~ SATA6	35
Table 24: Signal Description	35
Table 25: Pin Assignment CN5.....	36
Table 26: Signal Description	36
Table 27: Pin Assignment FP1.....	37
Table 28: Signal Description	37
Table 29: Pin Assignment FP2.....	38
Table 30: Signal Description	38
Table 31: Pin Assignment CN16	39
Table 32: Signal Description	39
Table 33: Pin Assignment CN15.....	40
Table 34: Pin Assignment CN21	41
Table 35: Signal Description	41
Table 36: Pin Assignment CON1	42
Table 37: Pin Assignment MPCIE1	45
Table 38: Pin Assignment CN4.....	47
Table 39: Pin Assignment PCIE1.....	48
Table 40: Pin Assignment CN2.....	50
Table 41: Pin Assignment CN5.....	51
Table 42: Pin Assignment CN25.....	51
Table 43: Pin Assignment JP1	53
Table 44: Pin Assignment JP2	53
Table 45: Pin Assignment JP3.....	54
Table 46: Pin Assignment JP5.....	54
Table 47: Pin Assignment JP10	54
Table 48: Pin Assignment JP11	55
Table 49: Pin Assignment JP15.....	55
Table 50: On-Board Connectors & Mating Connector Types	56
Table 51: Font Size Table.....	57
Table 52: Main Setup Menu Sub-Screens and Functions.....	58
Table 53: List of Acronyms.....	82

List of Figures

Figure 1: System Block Diagram miTX-DNV.....	17
Figure 2: Top Side	23
Figure 3: Connector Panel Side	25
Figure 4: VGA Connector CN24.....	27
Figure 5: Ethernet Connectors CN18, CN19, CN20	28
Figure 6: USB 3.0 Connector CN22, CN23.....	29
Figure 7: USB 2.0 High Speed Cable	30
Figure 8: USB 3.0 High Speed Cable.....	30
Figure 9: RS232/422/485 COM1 Connector CN26	31
Figure 10: Power Input Wafer ATX1	32
Figure 11: CPU / System Fan Wafer FAN1, FAN2	34
Figure 12: SATA Port 1 ~ Port 6 Connector SATA1 ~ SATA6.....	35
Figure 13: USB 2.0 Port 1, 2 Pin Header CN17.....	36
Figure 14: Front Panel 1 Pin Header FP1.....	37
Figure 15: Front Panel 2 Pin Header FP2	37
Figure 16: Serial COM CN16	39
Figure 17: Digital Input / Output Wafer CN15.....	40
Figure 18: PS/2 Keyboard / Mouse Wafer CN21.....	41
Figure 19: M.2 Key-B SSD Slot M2B1.....	42
Figure 20: mPCIe Socket MPCIE1.....	45
Figure 21: SIM Interface Wafer CN4.....	47
Figure 22: PCIE x8 Socket PCIE1.....	48

Figure 23: GbE LAN LED Header CN2	50
Figure 24: Wireless Activity LED Header CN5.....	51
Figure 25: General Purpose LED Wafer CN25.....	51
Figure 26: Programming example 1.....	52
Figure 27: Programming example 2	52
Figure 28: Jumper Connector.....	53
Figure 29: mPCIe / mSATA Selection JP1.....	53
Figure 30: USB Power Selection JP2.....	53
Figure 31: AT / ATX Power Mode Selection JP3	54
Figure 32: MFG Mode Selection JP5.....	54
Figure 33: Clear CMOS Selection JP10	54
Figure 34: Flash Security Override Selection JP11.....	55
Figure 35: Power Output Selection JP15.....	55
Figure 36: BIOS Main Menu Screen System Data and Time	59
Figure 37: BIOS Advanced Menu	61
Figure 38: BIOS Advanced Menu - FIA HSI012 Configuration.....	62
Figure 39: BIOS Advanced Menu - CPU Chipset Configuration.....	63
Figure 40: BIOS Advanced Menu - SATA Configuration.....	64
Figure 41: BIOS Advanced Menu - USB Configuration	65
Figure 42: BIOS Advanced Menu - Trsted Computing.....	66
Figure 43: BIOS Advanced Menu - Network Stack Configuration.....	67
Figure 44: BIOS Advanced Menu - DIO Configuration	68
Figure 45: BIOS Advanced Menu - Super IO Configuration.....	69
Figure 46: BIOS Advanced Menu - Super IO Configuration - Serial Port 1 Configuration	69
Figure 47: BIOS Advanced Menu - Super IO Configuration - Serial Port 2 Configuration.....	70
Figure 48: BIOS Advanced Menu - Serial Port Console Redirection	71
Figure 49: BIOS Advanced Menu - Serial Port Console Redirection - COM1 / COM2 Console Redirection Settings.....	72
Figure 50: BIOS Advanced Menu - Serial Port Console Redirection - Legacy Console Redirection Settings.....	73
Figure 51: BIOS Advanced Menu - Serial Port Console Redirection - Out-of-Band Mgmt Port Console Redirection Settings.....	74
Figure 52: BIOS Advanced Menu - H/W Monitor	75
Figure 53: BIOS Power Setup Menu	76
Figure 54: BIOS Power Setup Menu - WatchDog Timer Configuration.....	77
Figure 55: BIOS Boot Setup Menu.....	78
Figure 56: BIOS Boot Setup Menu.....	79
Figure 57: BIOS Boot Setup Menu.....	81

1/ Introduction

This user guide describes the mITX-DNV board made by Kontron. This board will also be denoted mITX-DNV within this user guide.

Use of this user guide implies a basic knowledge of PC-AT hardware and software. This user guide focuses on describing the mITX-DNV board's special features and is not intended to be a standard PC-AT textbook.

New users are recommended to study the short installation procedure stated in the following chapter before switching on the power.

All configuration and setup of the CPU board is either carried out automatically or manually by the user via the BIOS setup menus.

Latest revision of this user guide, datasheet, thermal simulations, BIOS, drivers, BSP's (Board Support Packages), mechanical drawings (2D and 3D) can be downloaded from Kontron's Web Page.

2/ Installation Procedures

2.1. Installing the Board

NOTICE



ESD Sensitive Device

Electrostatic discharge (ESD) can damage equipment and impair electrical circuitry.

- ▶ Wear ESD-protective clothing and shoes
- ▶ Wear an ESD-preventive wrist strap attached to a good earth ground
- ▶ Check the resistance value of the wrist strap periodically (1 MΩ to 10 MΩ)
- ▶ Transport and store the board in its antistatic bag
- ▶ Handle the board at an approved ESD workstation
- ▶ Handle the board only by the edges

To get the board running follow these steps. If the board shipped from KONTRON already has components like RAM and CPU cooler mounted, then skip the relevant steps below.

1. Turn off the PSU (Power Supply Unit)

NOTICE

Turn off PSU (Power Supply Unit) completely (no mains power connected to the PSU) or leave the Power Connectors unconnected while configuring the board. Otherwise, components (RAM, LAN cards etc.) might get damaged. Make sure PSU has 3.3V monitoring watchdog (standard ATX PSU feature). Running the board without 3.3V will damage the board within minutes.

NOTICE

The power supply unit shall comply with the requirements as defined in IEC 62368-1 according Clause 6.2.2 to power source category PS2 "Limited Power Source".

2. Insert the DDR4 1866 / 2133 / 2400 module(s)

Be careful to push the memory module(s) in the slot(s) before locking the tabs.

3. Cooler Installation

You can connect the cooler fan electrically to the CPU Fan connector.

4. Connecting interfaces

Insert all external cables for hard disk, keyboard etc. A monitor must be connected in order to change BIOS settings.

5. Connect and turn on PSU

Connect PSU to the board by the 24-pin ATX power connector (Figure 2, pos. 8).

6. BIOS setup

Enter the BIOS setup by pressing the key during boot up.

Enter "Exit Menu" and Load Setup Defaults.



To clear all BIOS setting, including Password protection, activate "Clear CMOS Jumper" for 10 sec (without power connected).

7. Mounting the board in chassis

NOTICE

When mounting the board to chassis etc. please note that the board contains components on both sides of the PCB that can easily be damaged if board is handled without reasonable care. A damaged component can result in malfunction or no function at all.

When fixing the board on a chassis, it is recommended to use screws with an integrated washer and a diameter of > 7 mm. Do not use washers with teeth, as they can damage the PCB and cause short circuits.

2.2. Chassis Safety Standards

Before installing the miTX-DNV in the chassis, users must evaluate the end product to ensure compliance with the requirements of the IEC60950-1 safety standard:

- ▶ The board must be installed in a suitable mechanical, electrical and fire enclosure.
- ▶ The system, in its enclosure, must be evaluated for temperature and airflow considerations.
- ▶ The board must be powered by a CSA or UL approved power supply that limits the maximum input current.
- ▶ For interfaces having a power pin such as external power or fan, ensure that the connectors and wires are suitably rated. All connections from and to the product shall be with SELV circuits only.
- ▶ Wires have suitable rating to withstand the maximum available power.
- ▶ The peripheral device enclosure fulfils the IEC60950-1 fire protecting requirements.

2.3. Lithium Battery Replacement

If replacing the lithium battery follow the replacement precautions stated in the notification below:

⚠ CAUTION

Danger of explosion if the lithium battery is incorrectly replaced.

- ▶ Replace only with the same or equivalent type recommended by the manufacturer
- ▶ Dispose of used batteries according to the manufacturer's instructions

VORSICHT! Explosionsgefahr bei unsachgemäßem Austausch der Batterie.

- ▶ Ersatz nur durch denselben oder einen vom Hersteller empfohlenen gleichwertigen Typ
- ▶ Entsorgung gebrauchter Batterien nach Angaben des Herstellers

ATTENTION! Risque d'explosion avec l'échange inadéquat de la batterie.

- ▶ Remplacement seulement par le même ou un type équivalent recommandé par le producteur
- ▶ L'évacuation des batteries usagées conformément à des indications du fabricant

PRECAUCION! Peligro de explosión si la batería se sustituye incorrectamente.

- ▶ Sustituya solamente por el mismo o tipo equivalente recomendado por el fabricante
- ▶ Disponga las baterías usadas según las instrucciones del fabricante

ADVARSEL! Lithiumbatteri – Eksplosjonsfare ved feilagtig håndtering.

- ▶ Udsiftning må kun ske med batteri af samme fabrikat og type
- ▶ Levér det brugte batteri tilbage til leverandøren

ADVARSEL! Eksplosjonsfare ved feilaktig skifte av batteri.

- ▶ Benytt samme batteritype eller en tilsvarende type anbefalt av apparatfabrikanten
- ▶ Brukte batterier kasseres i henhold til fabrikantens instruksjoner

VARNING! Explosionsfara vid felaktigt batteribyte.

- ▶ Använd samma batterityp eller en ekvivalent typ som rekommenderas av apparattillverkaren
 - ▶ Kassera använt batteri enligt fabrikantens instruktion
-

VAROITUS! Paristo voi räjähtää, jos se on virheellisesti asennettu.

- ▶ Vaihda paristo ainoastaan lalteval- mistajan suosittelemaan tyyppiln
 - ▶ Hävitä käytetty paristo valmistajan ohjeiden mukaisesti
-

3/ System Specifications

3.1. System Block Diagram

Figure 1: System Block Diagram mITX-DNV

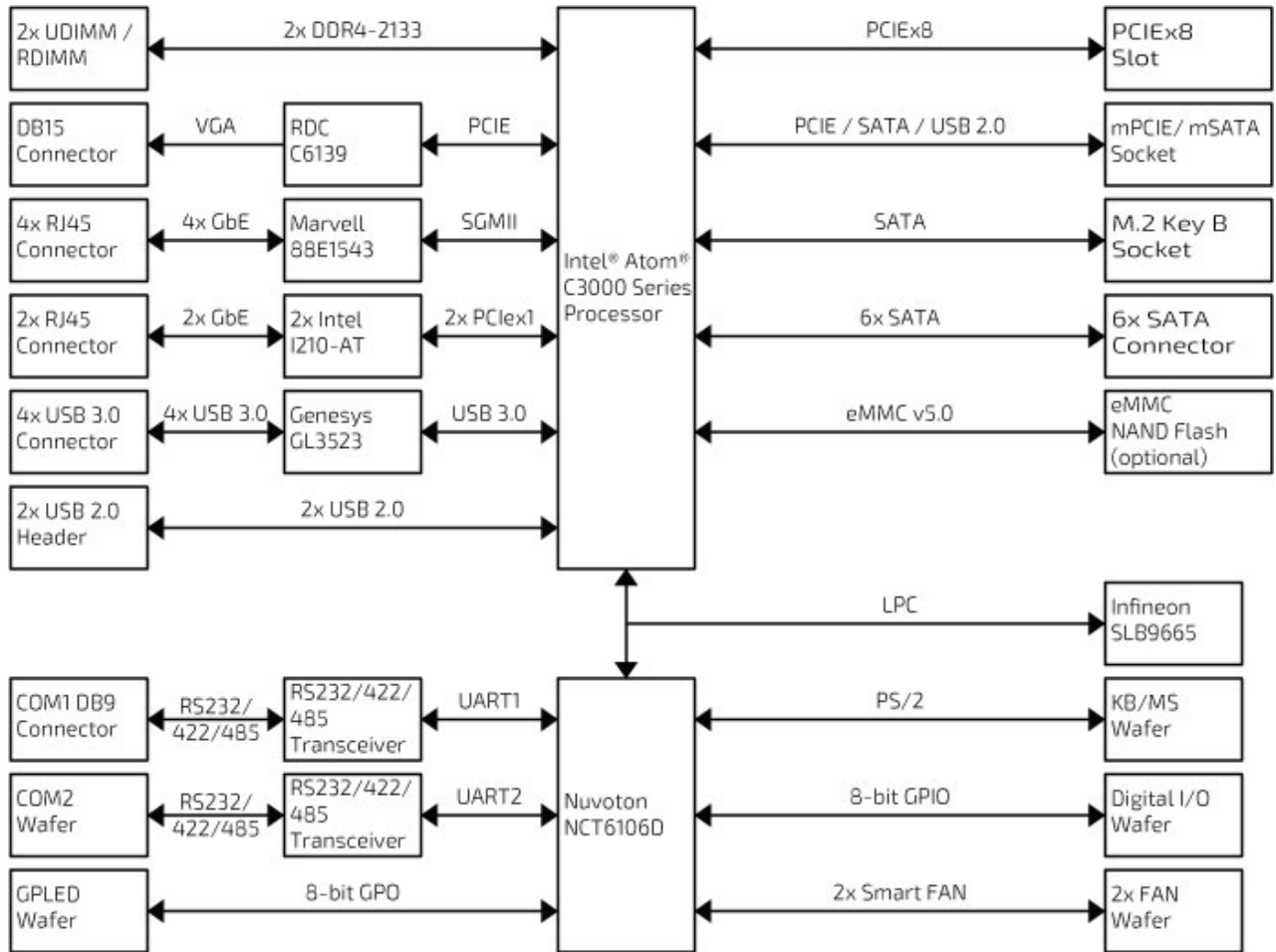

3.2. Component Main Data

The table below summarizes the features of the miTX-DNV motherboard.

Table 1: Component Main Data

System	
Processor	Intel® Atom® C3000 Series Processor
Memory	Up to 2x DDR4 UDIMM memory socket
Video	
Display Interface	1x VGA (on rear)
Network Connection	
Ethernet	6x GbE LAN (RJ45 on rear, 2x Intel® I210-AT, 4x Marvell® 88E1543)
Peripheral Connection	
USB	<ul style="list-style-type: none"> ▶ 4x USB 3.0 (Type A on rear from HUB) ▶ 2x USB 2.0 (by wafer from SoC)
Serial Port	▶ 2x RS232/422/485 (1x DB9 on rear with 5 V / 12 V power output support, 1x by wafer)
Other I/Os	<ul style="list-style-type: none"> ▶ 1x PS/2 Keyboard/Mouse (by wafer) ▶ 1x 8-bit DIO (by wafer)
Storage & Expansion	
Storage & Expansion	<ul style="list-style-type: none"> ▶ 6x SATA 3.0 ▶ eMMC support (optional) ▶ 1x M.2 Key-B (type 2280, for SSD only) ▶ 1x mSATA / mPCIe (full size, mixed with SATA, USB 2.0) ▶ 1x PCIe x8 (supporting PCIe x1 / x4 / x8 depending on HSIO selection) ▶ 1x SIM Card Cage (by wafer)
Power	
Input Voltage	DC +5V / -5V / +12V / -12V / +3.3V / 5VSB
Connector	2x12-pin ATX connector
Firmware	
BIOS	AMI uEFI BIOS w/ 128 Mb SPI Flash
Watchdog	Programmable WDT to generate system reset event
H/W Monitor	Voltages, Temperatures
Real Time Clock	SoC integrated RTC
TPM	TPM 2.0 support (Infineon SLB9665)
System Control & Monitoring	
FP Header	<ul style="list-style-type: none"> ▶ 1x Header for Reset button, HDD LED & External Speaker ▶ 1x Header for Power button, Power LED & SM bus ▶ 1x Header for 6x LAN LED ▶ 1x Header for mPCIe LED ▶ 1x Wafer for 8x General Purpose LED
Cooling	
FAN	<ul style="list-style-type: none"> ▶ 1x Wafer for CPU Smart Fan ▶ 1x Wafer for System Smart Fan

Software	
OS Support	Windows Server
Mechanical	
Dimension (L x W)	Mini-ITX (170 mm x 170 mm / 6.70" x 6.70")

3.3. Environmental Conditions

The mITX-DNV is compliant with the following environmental conditions. It is the customer's responsibility to provide sufficient airflow around each of the components to keep them within the allowed temperature range.

Table 2: Environmental Conditions

Operating Temperature	0 °C ~ 60 °C / 32 °F ~ 140 °F (Standard) -20 °C ~ 70 °C / -4 °F ~ 158 °F (Extended)
Storage Temperature	-20 °C ~ 80 °C / -4 °F ~ 176 °F (Standard) -40 °C ~ 85 °C / -40 °F ~ 185 °F (Extended)
Humidity	0 % ~ 95 %

3.4. Standards and Certifications

The mITX-DNV meets the following standards and certification tests.

Table 3: Standards and Certifications

CE	<ul style="list-style-type: none"> ▶ EN 55022: 2010 + AC: 2011 Class A ▶ EN 55024: 2010 ▶ EN 61000-3-2: 2006 + A1: 2009 + A2: 2009 Class D ▶ EN 61000-3-3: 2013 ▶ EN 60950-1: 2006 + A11: 2009 + A1: 2010 + A12: 2011 + A2: 2013 ▶ IEC 60950-1: 2005 (Second Edition) + Am 1: 2009 + Am 2: 2013
FCC	<ul style="list-style-type: none"> ▶ FCC CFR Title 47 Part 15 Subpart B: 2014 ▶ ANSI C63.4-2009 ▶ ICES-003 Issue 5: 2012 ▶ CISPR 22: 2008 ▶ CAN/CSA-CISPR 22-10

3.5. Processor Support

The miTX-DNV is designed to support Intel® Denverton Processors, Atom™ C3000 Series. The BGA CPU is remounted from factory. Kontron has defined the board versions as listed in the following table. Other versions are expected at a later date.

Table 4: Processor Support

Name	Core #	Speed	Turbo	Embedded	Cache	Socket	TDP	Tj
Atom® C3338	2	1.50 GHz	2.20 GHz	Yes	4M	FCBGA1310	9 W	100 °C
Atom® C3538	4	2.10 GHz	2.10 GHz	Yes	8M	FCBGA1310	15 W	100 °C
Atom® C3750	8	2.20 GHz	2.40 GHz	No	16M	FCBGA1310	21 W	100 °C
Atom® C3950	16	1.70 GHz	2.20 GHz	No	16M	FCBGA1310	24 W	100 °C

Sufficient cooling must be applied to the CPU in order to remove the effect as listed as TDP (Thermal Design Power) in above table. The sufficient cooling is also depending on the worst case maximum ambient operating temperature and the actual worst case load of processor.

3.6. System Memory Support

The miTX-DNV has two DDR4 UDIMM socket. The socket supports the following memory features:

- ▶ 1x DDR4 UDIMM 288-pin (Atom® C3338)
- ▶ 2x DDR4 UDIMM 288-pin (Atom® C3538 / C3750 / C3950)
- ▶ 1866 MHz memory speed (Atom® C3338)
- ▶ 2133 MHz memory speed (Atom® C3538)
- ▶ 2400 MHz memory speed (Atom® C3750 / C3950)
- ▶ SPD timing supported
- ▶ ECC supported

The installed DDR4 UDIMM should support the Serial Presence Detect (SPD) data structure. This allows the BIOS to read and configure the memory controller for optimal performance. If non-SPD memory is used, the BIOS will attempt to configure the memory settings, but performance and reliability may be impacted, or the board may not be able to boot totally.

3.6.1. Memory Operating Frequencies

In all modes, the frequency of system memory is the lowest frequency of all the memory modules placed in the system. Each memory module's frequency can be determined through the SPD registers on the memory modules.

The table below lists the resulting operating memory frequencies based on the combination of UDIMMs and processor.

Table 5: Memory Operating Frequencies

SO-DIMM Type	Module Name	Memory Data Transfer (MT/s)	Processor System Bus Frequency (MHz)	Resulting Memory Clock Frequency (MHz)	Peak Transfer Rate (MB/s)
DDR4 1866	PC4-14900	1866.67	933.33	233.33	14933.33
DDR4 2133	PC4-17000	2133.33	1066.67	266.67	17066.67
DDR4 2400	PC4-19200	2400	1200	300	19200

Memory modules have in general a much lower longevity than embedded motherboards, and therefore EOL of modules can be expected several times during lifetime of the motherboard.

As a minimum it is recommend using Kontron memory modules for prototype system(s) in order to prove stability of the system and as for reference.

For volume production you might request to test and qualify other types of RAM. In order to qualify RAM it is recommend configuring 3 systems running RAM Stress Test program in heat chamber at 60° C for a minimum of 24 hours.

3.7. On-board Graphics Subsystem

The miTX-DNV integrates a VGA GPU based on the PCIe high-speed interface for small screen display applications.

Table 6: Display Configuration

Display	Max. Resolution (Px) at 60 Hz
VGA	1024 x 768

3.8. Power Supply

In order to ensure safe operation of the board, the input power supply must monitor the supply voltage and shut down if the supply is out of range – refer to the actual power supply specification. Please note, in order to keep the power consumption to a minimal level, boards do not implement a guaranteed minimum load. In some cases, this can lead to compatibility problems with ATX power supplies that require a minimum load to stay in regulation. The miTX-DNV board must be powered through the 24-pin ATX (24-pole) connector using a standard ATX power supply.

ATX supply: ATX-24p connector must be used in according to the ATX PSU standard.

NOTICE

Hot Plugging power supply is not supported. Hot plugging might damage the board.

The requirements to the supply voltages are as follows:

Table 7: Supply Voltage

Supply	Min.	Max.	Note
VCC3.3	3.135 V	3.265 V	Should be $\pm 5\%$ for compliance with the ATX specification
Vcc	4.75 V	5.25 V	Should be $\pm 5\%$ for compliance with the ATX specification. Should be minimum 5.00 V measured at USB connectors in order to meet the requirements of USB standard.
+12 V	11.4 V	12.6 V	Should be $\pm 5\%$ for compliance with the ATX specification
-12 V	-13.2 V	-10.8 V	Should be $\pm 10\%$ for compliance with the ATX specification
-5 V	-5.50 V	-4.5 V	Not required for the miTX-DNV boards
5VSB	4.75 V	5.25 V	Should be $\pm 5\%$ for compliance with the ATX specification

NOTICE

If any of the supply voltages drops below the allowed operating level longer than the specified hold-up time, all the supply voltages should be shut down and left OFF for a time long enough to allow the internal board voltages to discharge sufficiently.

If the OFF time is not observed, parts of the board or attached peripherals may work incorrectly or even suffer a reduction of MTBF.

The minimum OFF time depends on the implemented PSU model and other electrical factors

and needs to be measured individually for each case.

4/ Connector Locations

4.1. Top Side

Figure 2: Top Side

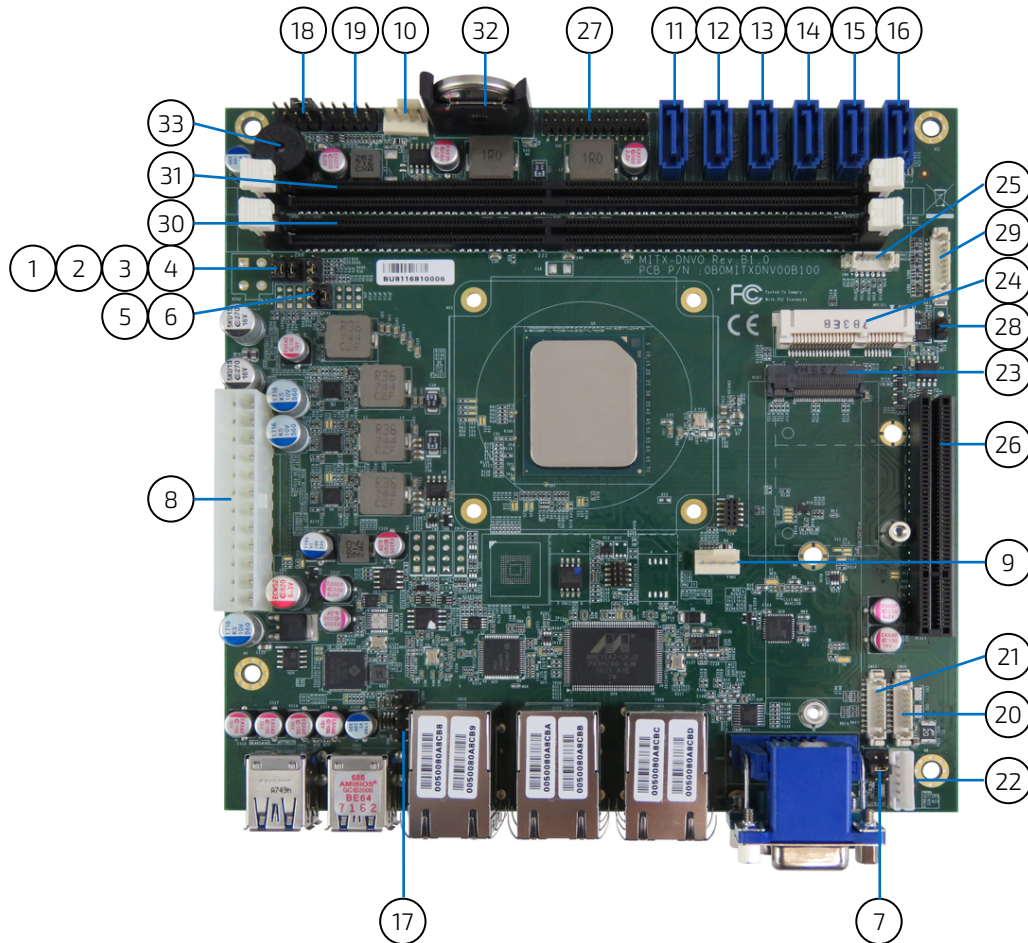

Table 8: Jumper List

Item	Designation	Description	See Chapter
1	JP1	mPCIE / mSATA Selection for MPCIE1	7.16.1
2	JP2	USB Power Selection	7.16.2
3	JP3	AT / ATX Power Mode Selection	7.16.3
4	JP5	MFG Mode Selection	7.16.4
5	JP10	Clear CMOS Selection	7.16.5
6	JP11	Flash Security Override Selection	7.16.6
7	JP15	Power Output Selection for COM1 Pin-9	7.16.7

Table 9: Top Side Internal Connector Pin Assignment

Item	Designation	Description	See Chapter
8	ATX1	2x12-Pin ATX Power Input Wafer	7.1
9	FAN1	CPU FAN Wafer	7.2

Item	Designation	Description	See Chapter
10	FAN2	System FAN Wafer	7.2
11	SATA1	SATA Port-1 Connector	7.3
12	SATA2	SATA Port-2 Connector	7.3
13	SATA3	SATA Port-3 Connector	7.3
14	SATA4	SATA Port-4 Connector	7.3
15	SATA5	SATA Port-5 Connector	7.3
16	SATA6	SATA Port-6 Connector	7.3
17	CN17	USB2.0 Port-1, 2 Header	7.4
18	FP1	Front Panel Header 1	7.5
19	FP2	Front Panel Header 2	7.5
20	CN16	RS-232/422/485 COM2 Wafer	7.6
21	CN15	8-bit Digital Input / Output Wafer	7.7
22	CN21	PS/2 KB/MS Wafer	7.8
23	M2B1	M.2 Key-B SSD Slot	7.9
24	MPCIE1	mPCIE / mSATA Port-1 Slot	7.10
25	CN4	SIM Interface Wafer for MPCIE1	7.11
26	PCIE1	PCIE x8 Slot	7.12
27	CN2	GbE LAN LED Header	7.13
28	CN5	Wireless Activity LED Header for MPCIE1	7.14
29	CN25	General Purpose LED Wafer	7.15
30	DIMM1	Channel-0 DDR4 DIMM Slot	3.6
31	DIMM2	Channel-1 DDR4 DIMM Slot	3.6
32	CN1	CR2032 Battery Holder	
33	BZ1	Onboard Buzzer	

4.2. Connector Panel Side

Figure 3: Connector Panel Side

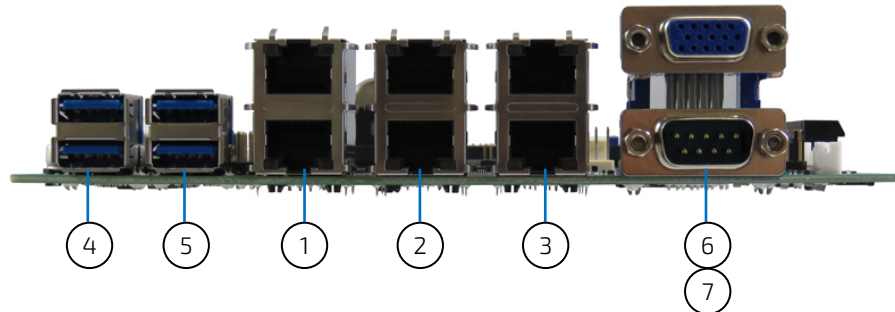

Table 10: Connector Panel Side Connector List

Item	Designation	Description	See Chapter
1	CN18	GbE LAN1, 2 RJ45 Connector	6.2
2	CN19	GbE LAN3, 4 RJ45 Connector	6.2
3	CN20	GbE LAN5, 6 RJ45 Connector	6.2
4	CN22	USB 3.0 Port 3, 4 Connector	6.3
5	CN23	USB 3.0 Port 1, 2 Connector	6.3
6	CN24	VGA Connector	6.1
7	CN26	RS232/422/485 COM1 Connector	6.4

5/ Connector Definitions

The following defined terms are used within this user guide to give more information concerning the pin assignment and to describe the connector's signals.

Defined Term	Description
Pin	Shows the pin numbers in the connector
Signal	The abbreviated name of the signal at the current pin The notation "XX#" states that the signal "XX" is active low
Note	Special remarks concerning the signal
Designation	Type and number of item described
See Chapter	Number of the chapter within this user guide containing a detailed description

The abbreviation TBD is used for specifications that are not available yet or which are not sufficiently specified by the component vendors.

6/ I/O-Area Connectors

6.1. VGA Connector (CN24)

The external I/O connector panel supports one DB-15 VGA female port.

Figure 4: VGA Connector CN24

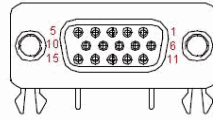

Table 11: Pin Assignment VGA Connector CN24

Pin	Signal	Description
1	Red	Analogue output carrying the red colour values. (75 Ohm cable impedance).
2	Green	Analogue output carrying the green colour values. (75 Ohm cable impedance).
3	Blue	Analogue output carrying the blue colour values. (75 Ohm cable impedance).
4	NC	No Connection
5	GND	Ground
6	GND	Ground
7	GND	Ground
8	GND	Ground
9	VCC	5V supply input
10	GND	Ground
11	NC	No Connection
12	DDC data	Display Data Channel Data. Used as data signal to/from monitors with DDC interface.
13	HSYNC	CRT horizontal synchronization output.
14	VSYNC	CRT vertical synchronization output.
15	DDC clock	Display Data Channel Clock. Used as clock signal to/from monitors with DDC interface.

6.2. Ethernet Connectors (CN18, CN19 & CN20)

The miTX-DNV supports six channels of 10/100/1000 Mbit Ethernet, which are based Intel® I210-AT (LAN1 & LAN2 (CN18)) and Marvell® 88E1543 (LAN3 & LAN4 (CN19), LAN5 & LAN6 (CN20)) controllers respectively.

In order to achieve the specified performance of the Ethernet port, Category 5 twisted pair cables must be used with 10/100 MByte and Category 5E, 6 or 6E with 1 Gbit LAN networks.

The signals for the Ethernet ports are as follows:

Figure 5: Ethernet Connectors CN18, CN19, CN20

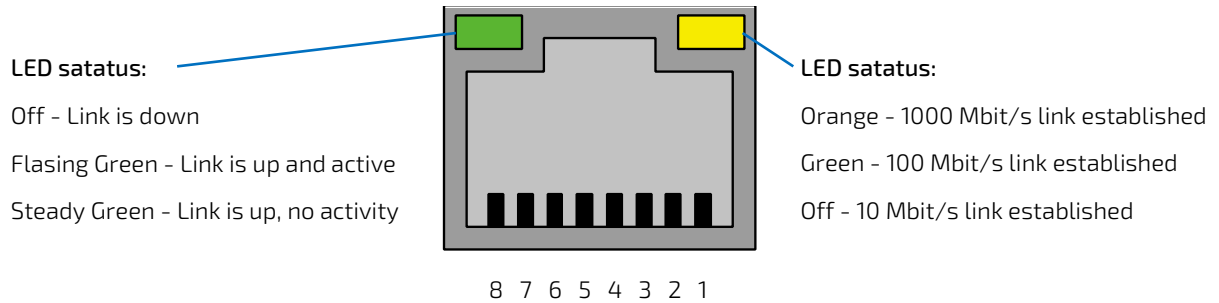

Table 12: Pin Assignment Ethernet Connectors CN18, CN19, CN20

Pin	Signal	Note
1	MDI[0]+	
2	MDI[0]-	
3	MDI[1]+	
4	MDI[1]-	
5	MDI[2]+	
6	MDI[2]-	
7	MDI[3]+	
8	MDI[3]-	

Table 13: Signal Description

Signal	Description
MDI[0]+ / MDI[0]-	In MDI mode, this is the first pair in 1000Base-T, i.e. the BI_DA+/- pair, and is the transmit pair in 10Base-T and 100Base-TX. In MDI crossover mode, this pair acts as the BI_DB+/- pair, and is the receive pair in 10Base-T and 100Base-TX.
MDI[1]+ / MDI[1]-	In MDI mode, this is the second pair in 1000Base-T, i.e. the BI_DB+/- pair, and is the receive pair in 10Base-T and 100Base-TX. In MDI crossover mode, this pair acts as the BI_DA+/- pair, and is the transmit pair in 10Base-T and 100Base-TX.
MDI[2]+ / MDI[2]-	In MDI mode, this is the third pair in 1000Base-T, i.e. the BI_DC+/- pair. In MDI crossover mode, this pair acts as the BI_DD+/- pair.
MDI[3]+ / MDI[3]-	In MDI mode, this is the fourth pair in 1000Base-T, i.e. the BI_DD+/- pair. In MDI crossover mode, this pair acts as the BI_DC+/- pair.

'MDI' – media dependent Interface

6.3. USB Connectors (I/O Area)

The external I/O connector panel supports two dual USB 3.0 connectors.



USB3.0 ports are backward compatible with USB2.0.

Figure 6: USB 3.0 Connector CN22, CN23

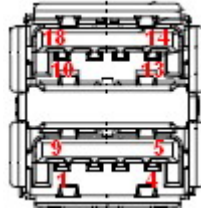

Table 14: Pin Assignment USB3.0 / USB2.0 Connector CN22, CN23

Pin	Signal	Note
Top		
18	USBB_TX+	USB 3.0 Tx. Differential Pair (+)
17	USBB_TX-	USB 3.0 Tx. Differential Pair (-)
16	GND	
15	USBB_RX+	USB 3.0 Tx. Differential Pair (+)
14	USBB_RX-	USB 3.0 Tx. Differential Pair (-)
13	GND	
12	USBB_D-	USB 2.0 Differential Pair (+)
11	USBB_D-	USB 2.0 Differential Pair (-)
10	+USBB_VCC*	+5 V Supply for USB device
Bottom		
9	USBA_TX+	USB 3.0 Tx. Differential Pair (+)
8	USBA_TX-	USB 3.0 Tx. Differential Pair (-)
7	GND	
6	USBA_RX+	USB 3.0 Tx. Differential Pair (+)
5	USBA_RX-	USB 3.0 Tx. Differential Pair (-)
4	GND	
3	USBA_D-	USB 2.0 Differential Pair (+)
2	USBA_D-	USB 2.0 Differential Pair (-)
1	+USBA_VCC*	+5 V Supply for USB device



* The power source of +USBVCC can be selected by JP2.

Table 15: Signal Description

Signal	Description
USBn_TX+, USBn_TX-, USBn_RX+, USBn_RX-, USBn_D-, USBn_D-	Differential pair works as serial differential receive/transmit data lines. (n= A, B)
+USBn_VCC	5 V supply for external devices. VCC is supplied during power-down to allow wakeup on USB device activity. Protected by a 1A current limiting IC covering each of the USB port. (n= A, B)

For HiSpeed rates it is required to use a USB cable, which is specified in USB 2.0 standard:

Figure 7: USB 2.0 High Speed Cable

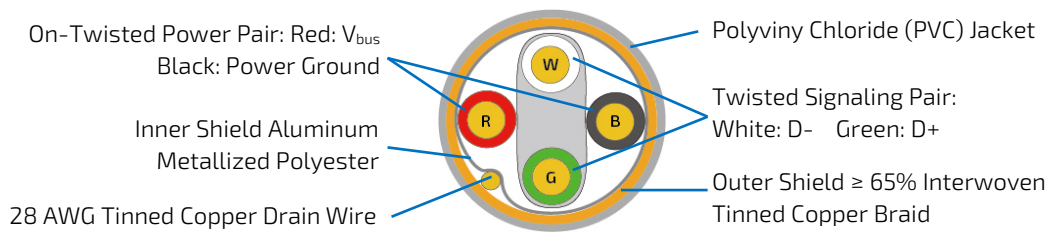

For USB 3.0 cabling it is required to use only HiSpeed USB cable, specified in USB3.0 standard:

Figure 8: USB 3.0 High Speed Cable

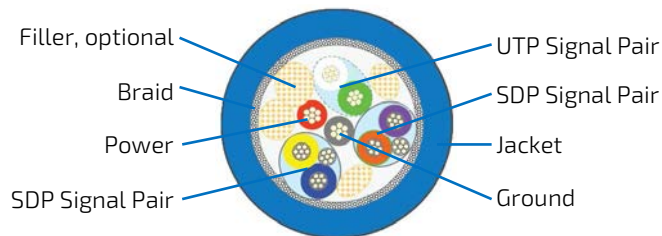

6.4. RS232/422/485 COM1 Connector (CN26)

The external I/O connector panel supports one DB9 RS232/422/485 port.

Figure 9: RS232/422/485 COM1 Connector CN26

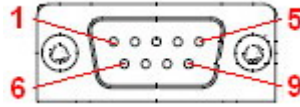

Table 16: Pin Assignment RS232/422/485 COM1 Connector CN26

Pin	RS232 Signal	RS422 Signal	RS485 Signal	Note
1	DCD	TX-	DATA-	
2	RXD	TX+	DATA+	
3	TXD	RX+	-	
4	DTR	RX-	-	
5	GND	GND	GND	
6	DSR	-	-	
7	RTS	-	-	
8	CTS	-	-	
9	RI	-	-	

Table 17: Signal Description

Signal	Description
DCD	Data Carrier Detect, indicates that the modem or data set has detected the data carrier.
RXD	Received Data, receives data from the communications link.
TXD	Transmitted Data, sends data to the communications link. The signal is set to the marking state (-12 V) on hardware reset when the transmitter is empty or when loop mode operation is initiated.
DTR	Data Terminal Ready, indicates to the modem etc. that the on-board UART is ready to establish communication link.
GND	Power Supply GND signal
DSR	Data Set Ready, indicates that the modem etc. is ready to establish a communications link.
RTS	Request To Send, indicates to the modem etc. that the on-board UART is ready to exchange data.
CTS	Clear To Send, indicates that the modem or data set is ready to exchange data.
RI	Ring Indicator, indicates that the modem has received a ringing signal from the telephone line.
TX+/-	Transmitted Data differential pair sends data to the communications link.
RX+/-	Received Data differential pair receives data from the communications link.

7/ Internal Connectors

7.1. Power Input Wafer (ATX1)

The mITX-DNV boards are designed to be supplied from a standard ATX power supply.

NOTICE

Hot plugging any of the power connector is not allowed.

Hot plugging might damage the board. In other words, turn off main supply etc. to make sure all the power lines are turned off when connecting to the motherboard.

Figure 10: Power Input Wafer ATX1

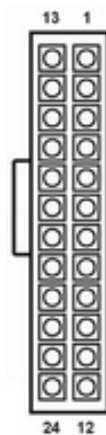

Table 18: Pin Assignment ATX1

Pin	Signal	Description
1	+3.3V	
2	+3.3V	
3	GND	Ground
4	+5V	
5	GND	Ground
6	+5V	
7	GND	Ground
8	POWER OK	
9	+5VSB	
10	+12V	
11	+12V	
12	+3.3V	
13	+3.3V	
14	-12V	
15	GND	Ground
16	PS_ON	
17	GND	
18	GND	Ground

Pin	Signal	Description
19	GND	Ground
20	-5V	
21	+5V	
22	+5V	
23	+5V	
24	GND	Ground

Table 19: Signal Description

Signal	Description
POWER_OK	<p>POWER_OK is a power good signal and should be asserted high by the power supply to indicate that the +5VDC and +3.3VDC outputs are above the undervoltage thresholds of the power supply. When this signal is asserted high, there should be sufficient energy stored by the converter to guarantee continuous power operation within specification. Conversely, when the output voltages fall below the undervoltage threshold, or when mains power has been removed for a time sufficiently long so that power supply operation is no longer guaranteed, POWER_OK should be de-asserted to a low state. The recommended electrical and timing characteristics of the POWER_OK signal are provided in the ATX12V Power Supply Design Guide.</p> <p>It is strongly recommended to use an ATX supply, in order to implement the supervision of the 5V and 3V3 supplies. These supplies are not supervised on-board.</p>
PS_ON	Active low open drain signal from the board to the power supply to turn on the power supply outputs. Signal must be pulled high by the power supply.

7.2. CPU / System Fan Wafer (FAN1 & FAN2)

The CPU Fan Wafer (FAN1) is used for the connection of the Fan for the CPU. The System Fan Wafer (FAN2) can be used to power, control and monitor a fan for chassis ventilation etc.

The 4-pin wafer is recommended to be used for driving 4-wire type FAN in order to implement FAN speed control. 3-wire Fan support is also possible, but no fan speed control is integrated.

Figure 11: CPU / System Fan Wafer FAN1, FAN2

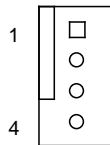

Table 20: 4-Pin Mode FAN1, FAN2

Pin	Signal	Description
1	GND	Ground
2	+12V	Power +12V
3	SENSE	Sense signal
4	PWM	PWM output

Table 21: 3-Pin Mode FAN1, FAN2

Pin	Signal	Description
1	GND	Ground
2	+12V	Power +12V
3	SENSE	Sense signal
4	-	Not used

Table 22: Signal Description

Signal	Description
GND	Power Supply GND signal
+12V	+12 V supply for fan
SENSE	Sense input signal from the fan, for rotation speed supervision RPM (Rotations Per Minute). The signal shall be generated by an open collector transistor or similar.
PWM	PWM output signal for FAN speed control

7.3. SATA (Serial ATA) Port 1 ~ Port 6 Connector (SATA1 ~ SATA6)

The SATA connectors supply the data connection for the SATA hard disk and are SATA 3.0 compatible.

Figure 12: SATA Port 1 ~ Port 6 Connector SATA1 ~ SATA6

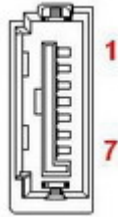

Table 23: Pin Assignment SATA1 ~ SATA6

Pin	Signal	Note
1	GND	
2	TX+	
3	TX-	
4	GND	
5	RX-	
6	RX+	
7	GND	

Table 24: Signal Description

Signal	Description
RX+ / RX-	Host transmitter differential signal pair
TX+ / TX-	Host receiver differential signal pair

7.4. USB Connectors (Internal) (CN17)

The USB port pin header CN17 supports two USB 2.0 ports.

Figure 13: USB 2.0 Port 1, 2 Pin Header CN17

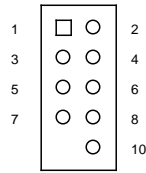

Table 25: Pin Assignment CN5

Pin	Signal	Note
1	+USBVCC	
2	+USBVCC	
3	USB_A-	
4	USB_B-	
5	USB_A+	
6	USB_B+	
7	GND	
8	GND	
9	KEY	
10	GND	



The power source of +USBVCC can be selected by JP2.

Table 26: Signal Description

Signal	Description
+USBVCC	5 V supply for external devices. SB5V is supplied during power down to allow wakeup on USB device activity. Protected by active power switch 1 A fuse for each USB port.
USB_A-/+ USB_B-/+	Universal Serial Bus Differentials: Bus Data / Address / Command Bus.

7.5. Front Panel Pin Header (FP1 & FP2)

Figure 14: Front Panel 1 Pin Header FP1

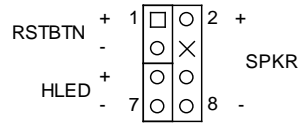

Table 27: Pin Assignment FP1

Pin	Signal	Note
1	Reset Button +	
2	Speaker +	
3	Reset Button -	
4	NC	
5	HDD LED +	
6	Internal Speaker -	
7	HDD LED -	
8	Speaker -	



Internal Buzzer is enabled when Pin6-8 is shorted.

Table 28: Signal Description

Signal	Description
Reset Button -/+	Reset Button. This 2-pin connector is for chassis mounted reset button for system reboot without turning off the system power.
HDD LED -/+	Hard Disk Drive Activity LED. This 2-pin connector is for HDD Activity LED. Connect the HDD Activity LED cable to this connector. The HDD LED lights up or flashes when data is read from or written to the HDD.
Internal Speaker - Speaker -/+	System warning speaker. The speaker allows user to hear beeps and warnings.

Figure 15: Front Panel 2 Pin Header FP2

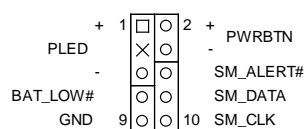

Table 29: Pin Assignment FP2

Pin	Signal	Note
1	Power LED +	
2	Power Button +	
3	NC	
4	Power Button -	
5	Power LED -	
6	SM_ALERT#	
7	BAT_LOW#	
8	SMBus Data	
9	GND	
10	SMBus Clock	

Table 30: Signal Description

Signal	Description
Power LED - /+	System Power LED. The power LED lights up when users turn on the system power, and blinks when the system is in sleep mode.
Power Button -/+	The 2-pin connector is for the system power button. Pressing the power button turns the system on or puts the system in sleep or soft-off mode depending on the operating system settings. Pressing the power switch for more than four seconds while the system turns from ON to OFF.
SM_ALERT#	System Management Bus Alert
SMBus Data	System Management Bus bidirectional data line
SMBus Clock	System Management Bus bidirectional clock line
BAT_LOW#	Battery low input. This signal may be driven low by external circuitry to signal that the system battery is low. It also can be used to signal some other external power management event.

7.6. Serial COM2 Ports (CN16)

Figure 16: Serial COM CN16

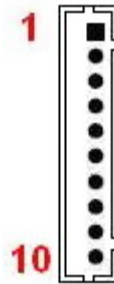

Table 31: Pin Assignment CN16

Pin	RS232 Signal	RS422 Signal	Half Duplex RS485 Signal	Full Duplex RS485 Signal	Note
1	DCD	TX-	DATA-	TX-	
2	DSR	-	-	-	
3	RXD	TX+	DATA+	TX+	
4	RTS	-	-	-	
5	TXD	RX+	-	RX+	
6	CTS	-	-	-	
7	DTR	RX-	-	RX-	
8	RI	-	-	-	
9	GND	GND	GND	GND	
10	+5V	+5V	+5V	+5V	



The COM ports need to install an OS patch from ITE. The patch is only available for Windows and is not available Linux.

Table 32: Signal Description

Signal	Description
TXD	Transmitted Data, sends data to the communications link. The signal is set to the marking state (-12 V) on hardware reset when the transmitter is empty or when loop mode operation is initiated.
RXD	Received Data, receives data from the communications link.
DTR	Data Terminal Ready, indicates to the modem etc. that the on-board UART is ready to establish communication link.
DSR	Data Set Ready, indicates that the modem etc. is ready to establish a communications link.
RTS	Request To Send, indicates to the modem etc. that the on-board UART is ready to exchange data.
CTS	Clear To Send, indicates that the modem or data set is ready to exchange data.
DCD	Data Carrier Detect, indicates that the modem or data set has detected the data carrier.
RI	Ring Indicator, indicates that the modem has received a ringing signal from the telephone line.
TX+/-	Transmitted Data differential pair sends data to the communications link.
RX+/-	Received Data differential pair receives data from the communications link.
GND	Power Supply GND signal

7.7. Digital Input / Output Wafer (CN15)

Figure 17: Digital Input / Output Wafer CN15

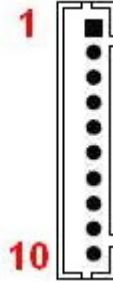

Table 33: Pin Assignment CN15

Pin	Signal	Note
1	+5V	
2	DIO_0	
3	DIO_1	
4	DIO_2	
5	DIO_3	
6	DIO_4	
7	DIO_5	
8	DIO_6	
9	DIO_7	
10	GND	

7.8. PS/2 Keyboard and Mouse Wafer (CN21)

Attachment of a PS/2 keyboard / mouse can be done through the pinrow connector CN21. Both interfaces utilize open-drain signalling with on-board pull-up.

Figure 18: PS/2 Keyboard / Mouse Wafer CN21

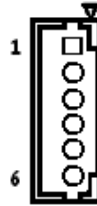

Table 34: Pin Assignment CN21

Pin	Signal	Note
1	MSCLK	
2	VCC	
3	MSDAT	
4	KBDAT	
5	GND	
6	KBCLK	

Table 35: Signal Description

Signal	Description
MSCLK	Bi-directional clock signal used to strobe data/commands from/to the PS/2 mouse.
MSDAT	Bi-directional serial data line used to transfer data from or commands to the PS/2 mouse.
KBCLK	Bi-directional clock signal used to strobe data/commands from/to the PC-AT keyboard.
KBDAT	Bi-directional serial data line used to transfer data from or commands to the PC-AT keyboard.

7.9. M.2 Key-B SSD Slot (M2B1)

The miTX-DNV supports M.2 modules in format 2280 with Key B. The M.2 specification enables one SATA3.0 (6 Gb/s) SSD socket to be exposed.

Figure 19: M.2 Key-B SSD Slot M2B1

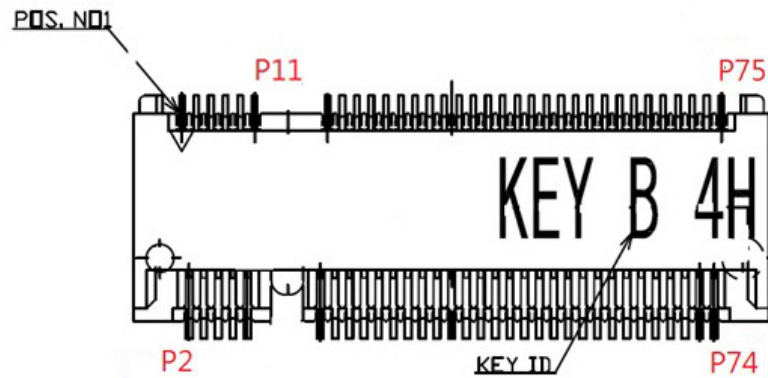

SATA M.2 requires the following BIOS depending on the class code options below.

M.2 SSD	Boot	Storage
SATA M.2 SSD	Supported	Supported

Table 36: Pin Assignment CON1

Pin	Signal	Note
1	-	
2	+3.3V	
3	GND	
4	+3.3V	
5	GND	
6	-	
7	-	
8	-	
9	-	
10	-	
11	GND	
12	KEY B	
13	KEY B	
14	KEY B	
15	KEY B	
16	KEY B	
17	KEY B	
18	KEY B	
19	KEY B	

Pin	Signal	Note
20	-	
21	-	
22	-	
23	-	
24	-	
25	-	
26	-	
27	GND	
28	-	
29	-	
30	-	
31	-	
32	-	
33	GND	
34	-	
35	-	
36	-	
37	-	
38	-	
39	GND	
40	-	
41	SATA_RX+	
42	-	
43	SATA_RX-	
44	-	
45	GND	
46	-	
47	SATA_TX-	
48	-	
49	SATA_TX+	
50	-	
51	GND	
52	-	
53	-	
54	-	
55	-	
56	-	
57	GND	
58	-	
59	-	
60	-	
61	-	

Pin	Signal	Note
62	-	
63	-	
64	-	
65	-	
66	-	
67	-	
68	-	
69	-	
70	+3.3V	
71	GND	
72	+3.3V	
73	GND	
74	+3.3V	
75	-	

7.10. mPCIe / mSATA Socket (MPCIE1)

Full-sized Mini-PCI Express V1.2 socket (MPCIE1). Socket MPCIE1 supports mPCIe, mSATA, USB2.0 and SIM-card socket. The SIM-card socket makes it possible to use a 3G/4G-wireless modem in this mPCIe slot. The USB does support WAKE function.

Figure 20: mPCIe Socket MPCIE1

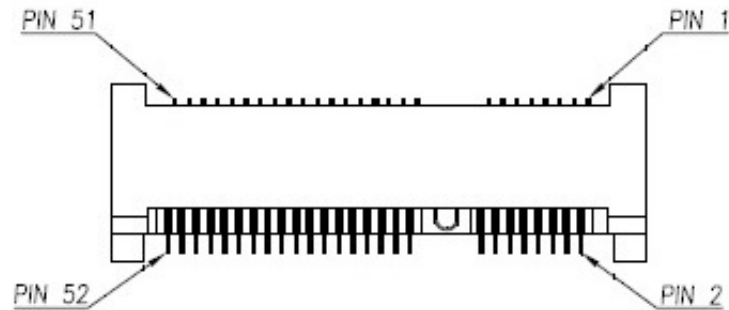

Table 37: Pin Assignment MPCIE1

Pin	Signal	Note
1	WAKE#	
2	+3.3VSB / +3.3V*	
3	Reserved	
4	Ground	
5	Reserved	
6	+1.5V	
7	CLKREQ#	
8	UIM_PWR**	
9	Ground	
10	UIM_DATA**	
11	REFCLK-	
12	UIM_CLK**	
13	REFCLK+	
14	UIM_RESET**	
15	Ground	
16	UIM_VPP**	
17	Reserved	
18	Ground	
19	Reserved	
20	W_Disable#	
21	Ground	
22	PERST#	
23	PERn0 / SATA_RX+*	
24	+3.3VSB / +3.3V*	

Pin	Signal	Note
25	PERp0 / SATA_RX-*	
26	Ground	
27	Ground	
28	+1.5V	
29	Ground	
30	SMB_CLK	
31	PETn0 / SATA_TX-*	
32	SMB_DATA	
33	PETp0 / SATA_TX+*	
34	Ground	
35	Ground	
36	USB_D-	
37	Ground	
38	USB_D+	
39	+3.3VSB / +3.3V*	
40	Ground	
41	+3.3VSB / +3.3V*	
42	LED_WWAN#	
43	Ground / NC*	
44	LED_WLAN#	
45	Reserved	
46	LED_WPAN#	
47	Reserved	
48	+1.5V	
49	Reserved	
50	Ground	
51	Reserved	
52	+3.3VSB / +3.3V*	



* These pins are switchable to mSATA or mPCIe mode via the jumper JP1.



** These pins are connected to CN4 SIM Interface directly.

7.11. SIM Interface Wafer for MPCIE1 (CN4)

Figure 21: SIM Interface Wafer CN4



Table 38: Pin Assignment CN4

Pin	Signal	Description	Note
1	UIM_PWR	Power +5V or +3.3V	
2	UIM_DATA	Input or Output for serial data	
3	UIM_RESET	Reset signal	
4	UIM_VPP	Programming voltage input	
5	UIM_CLK	Clock signal	
6	GND	Ground	

7.12. PCIe x8 Socket (PCIe1)

The 8-lane (x8) PCI Express slot connector can be used for external PCI Express cards inclusive graphics card and dedicated TMD5 passive card. The slot is located nearest the edge of the board. Maximum theoretical bandwidth using 8 lanes is 8 GB/s.

Figure 22: PCIe x8 Socket PCIe1

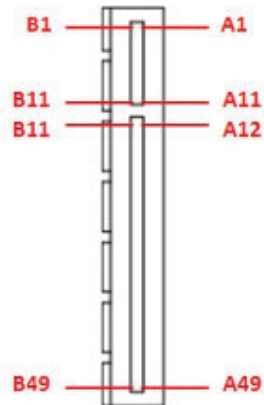

Table 39: Pin Assignment PCIe1

Pin	Side B Connector		Side A Connector	
	Signal	Description	Signal	Description
1	+12V	+12 V power	PRSNT1#	Hot plug presence detect
2	+12V	+12 V power	+12V	+12 V power
3	RSVD	Reserved	+12V	+12 V power
4	GND	Ground	GND	Ground
5	SMCLK	SMBus clock	JTAG2	TCK
6	SMDAT	SMBus data	JTAG3	TDI
7	GND	Ground	JTAG4	TDO
8	+3.3V	+3.3 V power	JTAG5	TMS
9	JTAG1	+TRST#	+3.3V	+3.3 V power
10	3.3VAUX	3.3 V power	+3.3V	+3.3 V power
11	PCIE_WAKE#	Link Reactivation	PERST#	Reset
Mechanical Key				
12	RSVD	Reserved	GND	Ground
13	GND	Ground	REFCLK+	Reference clock differential pair
14	PETp0	Transmitter Lane 0, differential pair	REFCLK-	
15	PETn0		GND	Ground
16	GND	Ground	PERp0	Receiver Lane 0, differential pair
17	PRSNT2#	Hot plug presence detect	PERn0	
18	GND	Ground	GND	Ground
19	PETp1	Transmitter Lane 1, differential pair	RSVD	Reserved
20	PETn1		GND	Ground

Pin	Side B Connector		Side A Connector	
	Signal	Description	Signal	Description
21	GND	Ground	PERp1	Receiver Lane 1, differential pair
22	GND	Ground	PERn1	
23	PETp2	Transmitter Lane 2, differential pair	GND	Ground
24	PETn2		GND	Ground
25	GND	Ground	PERp2	Receiver Lane 2, differential pair
26	GND	Ground	PERn2	
27	PETp3	Transmitter Lane 3, differential pair	GND	Ground
28	PETn3		GND	Ground
29	GND	Ground	PERp3	Receiver Lane 3, differential pair
30	RSVD	Reserved	PERn3	
31	PRSNT2#	Hot plug presence detect	GND	Ground
32	GND	Ground	RSVD	Reserved
33	PETp4	Transmitter Lane 4, differential pair	RSVD	Reserved
34	PETn4		GND	Ground
35	GND	Ground	PERp4	Receiver Lane 4, differential pair
36	GND	Ground	PERn4	
37	PETp5	Transmitter Lane 5, differential pair	GND	Ground
38	PETn5		GND	Ground
39	GND	Ground	PERp5	Receiver Lane 5, differential pair
40	GND	Ground	PERn5	
41	PETp6	Transmitter Lane 6, differential pair	GND	Ground
42	PETn6		GND	Ground
43	GND	Ground	PERp6	Receiver Lane 6, differential pair
44	GND	Ground	PERn6	
45	PETp7	Transmitter Lane 7, differential pair	GND	Ground
46	PETn7		GND	Ground
47	GND	Ground	PERp7	Receiver Lane 7, differential pair
48	PRSNT2#	Hot plug presence detect	PERn7	
49	GND	Ground	GND	Ground

7.13. GbE LAN LED Header (CN2)

Figure 23: GbE LAN LED Header CN2

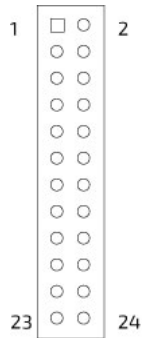

Table 40: Pin Assignment CN2

Pin	Signal	Description	Note
1	LAN1_LINK+		
2	LAN1_LINK-		
3	LAN1_100#		
4	LAN1_1000#		
5	LAN2_LINK+		
6	LAN2_LINK-		
7	LAN2_100#		
8	LAN2_1000#		
9	LAN3_LINK+		
10	LAN3_LINK-		
11	LAN3_100#		
12	LAN3_1000#		
13	LAN4_LINK+		
14	LAN4_LINK-		
15	LAN4_100#		
16	LAN4_1000#		
17	LAN5_LINK+		
18	LAN5_LINK-		
19	LAN5_100#		
20	LAN5_1000#		
21	LAN6_LINK+		
22	LAN6_LINK-		
23	LAN6_100#		
24	LAN6_1000#		

7.14. Wireless Activity LED Header for MPCIE1 (CN5)

Figure 24: Wireless Activity LED Header CN5

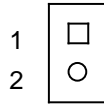

Table 41: Pin Assignment CN5

Pin	Signal	Description	Note
1	LED+		
2	LED-		

7.15. General Purpose LED Wafer (CN25)

Figure 25: General Purpose LED Wafer CN25

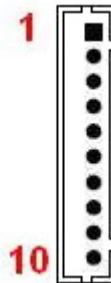

Table 42: Pin Assignment CN25

Pin	Signal	Description	Note
1	+5VSB_VCC		
2	GPLLED#_1		
3	GPLLED#_2		
4	GPLLED#_3		
5	GPLLED#_4		
6	GPLLED#_5		
7	GPLLED#_6		
8	GPLLED#_7		
9	GPLLED#_8		
10	GND		

For programming choose one of the following two examples.

Figure 26: Programming example 1

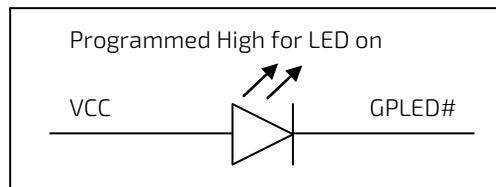
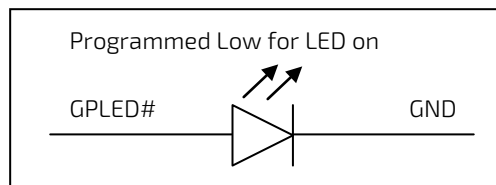

Figure 27: Programming example 2



7.16. Switches and Jumpers

The product has several jumpers that must be properly configured to ensure correct operation.

Figure 28: Jumper Connector

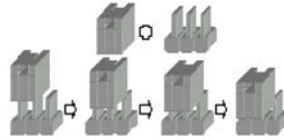

For a three-pin jumper (see Figure 25), the jumper setting is designated "1-2" when the jumper connects pins 1 and 2. The jumper setting is designated "2-3" when pins 2 and 3 are connected and so on. You will see that one of the lines surrounding a jumper pin is thick, which indicates pin No.1.

To move a jumper from one position to another, use needle-nose pliers or tweezers to pull the pin cap off the pins and move it to the desired position.

7.16.1. mPCIe / mSATA Selection for MPCIE1 (JP1)

Figure 29: mPCIe / mSATA Selection JP1

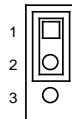

Table 43: Pin Assignment JP1

Jumper Position		Description
Pin 1-2	Pin 2-3	
X	-	mPCIe
-	X	mSATA

"X" = Jumper set (short) and "-" = jumper not set (open)

7.16.2. USB Power Selection (JP2)

Figure 30: USB Power Selection JP2

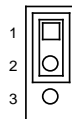

Table 44: Pin Assignment JP2

Jumper Position		Description
Pin 1-2	Pin 2-3	
X	-	+5V
-	X	+5VSB

"X" = Jumper set (short) and "-" = jumper not set (open)

7.16.3. AT / ATX Power Mode Selection (JP3)

Figure 31: AT / ATX Power Mode Selection JP3

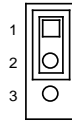

Table 45: Pin Assignment JP3

Jumper Position		Description
Pin 1-2	Pin 2-3	
X	-	ATX Power Mode
-	X	AT Power Mode

"X" = Jumper set (short) and "-" = jumper not set (open)

7.16.4. MFG Mode Selection (JP5)

Figure 32: MFG Mode Selection JP5

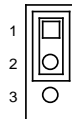

Table 46: Pin Assignment JP5

Jumper Position		Description
Pin 1-2	Pin 2-3	
X	-	Normal
-	X	Enable MFG Mode

"X" = Jumper set (short) and "-" = jumper not set (open)

7.16.5. Clear CMOS Selection (JP10)

Figure 33: Clear CMOS Selection JP10

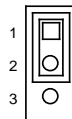

Table 47: Pin Assignment JP10

Jumper Position		Description
Pin 1-2	Pin 2-3	
X	-	Normal
-	X	Clear CMOS

"X" = Jumper set (short) and "-" = jumper not set (open)

7.16.6. Flash Security Override Selection (JP11)

Figure 34: Flash Security Override Selection JP11

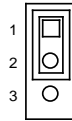

Table 48: Pin Assignment JP11

Jumper Position		Description
Pin 1-2	Pin 2-3	
X	-	Normal
-	X	Flash Security Override

"X" = Jumper set (short) and "-" = jumper not set (open)

7.16.7. Power Output Selection for COM1 Pin-9 (JP15)

Figure 35: Power Output Selection JP15

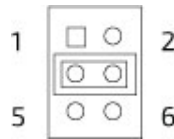

Table 49: Pin Assignment JP15

Jumper Position			Description
Pin 1-2	Pin 3-4	Pin 5-6	
X	-	-	+5V
-	X	-	RI#
-	-	X	+12V

"X" = Jumper set (short) and "-" = jumper not set (open)

8/ On-Board Connectors & Mating Connector Types

The Mating connectors / Cables are connectors or cable kits that are fitting the On-board connector.

The cable kits marked with "*" are included in the "miTX-DNV Cable & Driver Kit".

Table 50: On-Board Connectors & Mating Connector Types

Connector	On-Board Connectors		Mating Connectors / Cables	
	Manufact.	Type No.	Manufact.	Type No.
Power Input (ATX1)				
FAN (FAN1, FAN2)				
SATA (SATA1 ~ SATA6)				
USB 2.0 (CN17)				
Front Panel (FP1)				
Front Panel (FP2)				
COM (CN16)				
DIO (CN15)				
Keyboard / Mouse (CN21)				
M.2 Key-B (M2B1)				
mPCIe / mSATA (MPCIE1)				
SIM (CN4)				
PCIE x8 (PCIE1)				
LAN LED (CN2)				
MPCIE1 Activity LED (CN5)				



Please note that standard connectors like DP, mPCIe, Audio Jack, Ethernet and USB are not included in the list.

9/ BIOS

9.1. Starting the uEFI BIOS

The miTX-DNV is provided with a Kontron-customized, pre-installed and configured version of AMI Aptio® V uEFI BIOS. AMI BIOS firmware is based on the Unified Extensible Firmware Interface (UEFI) specification and the Intel® Platform Innovation Framework for EFI. This uEFI BIOS provides a variety of new and enhanced functions specifically tailored to the hardware features of the miTX-DNV.

The uEFI BIOS comes with a setup program that provides quick and easy access to the individual function settings for control or modification of the uEFI BIOS configuration. The setup program allows the accessing of various menus that provide functions or access to sub-menus with more specific functions of their own.

To start the uEFI BIOS setup program, follow the steps below:

1. Power on the board.
2. Wait until the first characters appear on the screen (POST messages or splash screen).
3. Press the key.
4. If the uEFI BIOS is password-protected, a request for password will appear. Enter either the User Password or the Supervisor Password (see Security menu), press <RETURN>, and proceed with step 5.
5. A setup menu will appear.

The miTX-DNV uEFI BIOS setup program uses a hot key-based navigation system. A hot key legend bar is located on the bottom of the setup screens.

The following table provides information concerning the usage of these hot keys.

Table 51: Font Size Table

Hotkeys	Description
<F1>	The <F1> key invokes the General Help window.
<->	The <Minus> key selects the next lower value within a field.
<+>	The <Plus> key selects the next higher value within a field.
<F2>	The <F2> key loads the previous values.
<F3>	The <F3> key loads the standard default values.
<F4>	The <F4> key saves the current settings and exit the uEFI BIOS setup.
<→> or <←>	The <Left/Right> arrows selects major setup menus on the menu bar. For example: Main, Advanced, Security, etc.
<↑> or <↓>	The <Up/Down> arrows selects fields in the current menu. For example: A setup function or a sub-screen.
<ESC>	The <ESC> key exits a major setup menu and enter the Exit setup menu. Pressing the <ESC> key in a sub-menu displays the next higher menu level.
<RERURN>	The <RETURN> key executes a command or select a submenu.

9.2. Setup Menus

The Setup utility features shows six menus in the selection bar at the top of the screen:

- ▶ Main
- ▶ Advanced
- ▶ Power
- ▶ Boot
- ▶ Security
- ▶ Save & Exit

The Setup menus are selected via the left and right arrow keys. The currently active menu and the currently active uEFI BIOS Setup item are highlighted in white. Each Setup menu provides two main frames. The left frame displays all available functions. Functions that can be configured are displayed in blue. Functions displayed in gray provide information about the status or the operational configuration. The right frame displays an Item Specific Help window providing an explanation of the respective function.

9.2.1. Main Setup Menu

Upon entering the uEFI BIOS Setup program, the Main Setup menu is displayed. This screen lists the Main Setup menu sub-screens and provides basic system information. Additionally functions for setting the system time and date are offered.

Table 52: Main Setup Menu Sub-Screens and Functions

Function	Description
BIOS Information	Read only field. Displays information about the system BIOS
Memory Information	Read only field. Displays information about total memory
ME Information	Read only field. Displays information about Intel Management Engine (ME) version
TXE Information	Read only field. Displays information about TXE information
Firmware Information	Code version and firmware information
System Date	Set System Date
System Time	Set System Time

Figure 36: BIOS Main Menu Screen System Data and Time

BIOS SETUP UTILITY					
Main	Advanced	Power	Boot	Security	Save & Exit
Product Information					
Product Name		mITX-DNV-C3538			
BIOS Version		R0.09 (x64)			
BIOS Build Date		03/12/2018			
ME FW Version		0B:4.0.0.143			
CPU Information					
Intel® Atom™ CPU C3538 @ 2.10GHz					
Microcode Revision		20h			
Processor Cores		4/ 4			
Memory Information					
Total Size		8192 MB (DDR4)			
Frequency		2133 MHz			
System Date		[Wed 03/14/2018]			
System Time		[15:50:43]			
Access Level		Administrator			
				→ ←: Select Screen ↑ ↓: Select Item Enter: Select +/-: Change Opt. F1: General Help F2: Previous Values F3: Optimized Defaults F4: Save & Exit ESC: Exit	
Version 2.19.1266. Copyright (C) 2018, American Megatrends, Inc.					

Feature	Option	Description
System Date	[dd/mm/yyyy]	Set the Date. Use Tab to switch between Data elements.
System Time	[hh:mm:ss]	Set the Time. Use Tab to switch between Time elements.

9.2.2. Advanced Setup Menu

The Advanced setup menu provides sub-screens and functions for advanced configurations. The following sub-screen functions are included in the menu:

- ▶ LAN Configuration
- ▶ FIA HSI012 Configuration
- ▶ CPU Chipset Configuration
- ▶ SATA Configuration
- ▶ USB Configuration
- ▶ Trusted Computing
- ▶ Network Stack Configuration
- ▶ DIO Configuration
- ▶ Super IO Configuration
- ▶ Serial Port Console Redirection
- ▶ H/W Monitor

NOTICE

Setting items on this screen to incorrect values may cause the system to malfunction.

Figure 37: BIOS Advanced Menu

BIOS SETUP UTILITY					
Main	Advanced	Power	Boot	Security	Save & Exit
Load Intel I210 UNDI		[Disabled]			
Load X553 1GbE UNDI		[Disabled]			
> FIA HSI012 Configuration					
> CPU Chipset Configuration					
> SATA Configuration					
> USB Configuration					
> Trusted Computing					
> Network Stack Configuration					
> DIO Configuration					
> Super IO Configuration					
> Serial Port Console Redirection					
> H/W Monitor					
				→ ←: Select Screen	
				↑ ↓: Select Item	
				Enter: Select	
				+/-: Change Opt.	
				F1: General Help	
				F2: Previous Values	
				F3: Optimized Defaults	
				F4: Save & Exit	
				ESC: Exit	
Version 2.19.1266. Copyright (C) 2018, American Megatrends, Inc.					

Feature	Option	Description
Load Intel I210 UNDI	[Disabled], [Enabled]	Select whether or not to load onboard UNDI (Universal Network Driver Interface) for Intel I210.
Load X553 1GbE UNDI	[Disabled], [Enabled]	Select whether or not to load onboard UNDI (Universal Network Driver Interface) for X553 1GbE.

Figure 38: BIOS Advanced Menu - FIA HSI012 Configuration

BIOS SETUP UTILITY							
Main	Advanced	Power	Boot	Security	Save & Exit		
Flexible I/O Adapter HSI012 Configuration							
HSI012 I/O amount		Full Active					
Lane 8:PCIE-C6139(VGA)		[PCIE Enabled]					
Lane18:XHCI		[XHCI Enabled]					
Lane 0:PCIE-Soltx1		[Lane Disabled]					
Lane12:I210-AT-1		[PCIE Enabled]					
Lane14:I210-AT-2		[PCIE Enabled]					
Lane10:mPCIE1/mSATA1		[JP1 with mPCIE]					
Lane19:M.2 Key-B		[SATA Enabled]		→ ←: Select Screen ↑ ↓: Select Item Enter: Select +/-: Change Opt. F1: General Help F2: Previous Values F3: Optimized Defaults F4: Save & Exit ESC: Exit			
Lane 9:SATA1		[SATA Enabled]					
Lane11:SATA2		[SATA Enabled]					
Lane13:SATA3		[SATA Enabled]					
Lane15:SATA4		[SATA Enabled]					
Lane16:SATA5		[SATA Enabled]					
Lane17:SATA6		[SATA Enabled]					
mPCIE1 W-DISABLE# Pin		[Enabled (Driven High)]					
Version 2.19.1266. Copyright (C) 2018, American Megatrends, Inc.							

Feature	Option	Description
Lane 8:PCIE-C6139(VGA)	[Lane Disabled], [PCIE Enable]	Select Lane 8 to work as Disabled or PCIE-C6139(VGA).
Lane18:XHCI	[Lane Disabled], [XHCI Enabled]	Select Lane18 to work as Disabled or XHCI.
Lane 0:PCIE-Soltx1	[Lane Disabled], [PCIE Enabled]	Select Lane 0 to work as Disabled or PCIE-Solt.
Lane12:I210-AT-1 Lane14:I210-AT-2	[Lane Disabled], [PCIE Enabled]	Select Lane12 / Lane14 to work as Disabled or I210-AT-1 / I210-AT-2 respectively.
Lane10:mPCIE1/ mSATA1	[Lane Disabled], [PCIE Enable], [SATA Enable], [JP1 with mPCIE]	Select Lane10 to work as Disabled, mPCIE1 or mSATA1.
Lane19:M.2 Key-B	[Lane Disabled], [SATA Enabled]	Select Lane19 to work as Disabled or M.2 Key-B.
Lane 9:SATA1 Lane11:SATA2 Lane13:SATA3 Lane15:SATA4 Lane16:SATA5 Lane17:SATA6	[Lane Disabled], [SATA Enabled]	Select Lane 9 / Lane11 / Lane13 / Lane15 / Lane16 / Lane17 to work as Disabled or SATA1 / SATA2 / SATA3 / SATA4 / SATA5 / SATA6 respectively.
mPCIE1 W-DISABLE# Pin	[Disabled (Driven Low)], [Enabled (Driven High)]	Select to control mPCIE1 W-DISABLE# signal Pin status. This signal is used by the system to control radio operation on add-in cards that implement radio frequency applications.

Figure 39: BIOS Advanced Menu - CPU Chipset Configuration

BIOS SETUP UTILITY					
Main	Advanced	Power	Boot	Security	Save & Exit
CPU Chipset Configuration					
EIST		[Enabled]			
Turbo Mode		[Enabled]			
CPU C State		[Enabled]		→ ←: Select Screen	
Active Processor Core		0		↑ ↓: Select Item	
VMX		[Enabled]		Enter: Select	
VT-d		[Enabled]		+/-: Change Opt.	
VT-d Interrupt remapping		[Enabled]		F1: General Help	
Max CPUID Value Limit		[Disabled]		F2: Previous Values	
Execute Disable Bit		[Enabled]		F3: Optimized Defaults	
IQAT		[Enabled]		F4: Save & Exit	
Fast Boot		[Enabled]		ESC: Exit	
Version 2.19.1266. Copyright (C) 2018, American Megatrends, Inc.					

Feature	Option	Description
EIST	[Disabled], [Enabled]	Select whether to enable or disable Enhanced Intel SpeedStep Technology.
Turbo Mode	[Disabled], [Enabled]	Select whether to enable or disable CPU Turbo capability.
CPU C State	[Disabled], [Enabled]	Select whether to enable or disable the Enhanced Cx state of the CPU.
VMX	[Disabled], [Enabled]	Select whether to enable or disable the Vanderpool Technology.
VT-d	[Disabled], [Enabled]	Select whether to enable or disable VT-d capability.
VT-d Interrupt remapping	[Disabled], [Enabled]	Select whether to enable or disable VT-d Interrupt remapping. If Interrupt Remapping is disabled, the XAPIC mode will be disabled.
Max CPUID Value Limit	[Disabled], [Enabled]	Select whether to limit CPUID maximum value.
Execute Disable Bit	[Disabled], [Enabled]	Select whether to enable or disable Execute Disable Bit functionality, which prevents malicious buffer overflow attacks.
IQAT	[Disabled], [Enabled]	Select whether or not to hide Intel QuickAssist Technology device from an OS.
Fast Boot	[Disabled], [Enabled]	Select whether to enable or disable fast boot which skips memory training and attempts to boot using last known good configuration.

Figure 40: BIOS Advanced Menu - SATA Configuration

BIOS SETUP UTILITY					
Main	Advanced	Power	Boot	Security	Save & Exit
SATA Configuration					
SATA Controller 0		[Enabled]			
SATA-0 Port Multiplier		[Disabled]			
SATA Controller 1		[Enabled]			
SATA-1 Port Multiplier		[Disabled]			
Serial ATA Port 1		Empty			
SATA1		[Enabled]			
Serial ATA Port 2		Empty			
SATA2		[Enabled]			
Serial ATA Port 3		Empty			
SATA3		[Enabled]			
Serial ATA Port 4		Empty		→ ←: Select Screen ↑ ↓: Select Item Enter: Select +/-: Change Opt. F1: General Help F2: Previous Values F3: Optimized Defaults F4: Save & Exit ESC: Exit	
SATA4		[Enabled]			
Serial ATA Port 5		Empty			
SATA5		[Enabled]			
Serial ATA Port 6		Empty			
SATA6		[Enabled]			
M.2 Key-B		Empty			
M.2 SATA		[Enabled]			
Version 2.19.1266. Copyright (C) 2018, American Megatrends, Inc.					

Feature	Option	Description
SATA Controller 0 SATA Controller 1	[Enabled], [Disabled]	Select whether to enable or disable SATA Controller0 / 1.
SATA-0 Port Multiplier SATA-1 Port Multiplier	[Enabled], [Disabled]	Select whether to enable or disable SATA Controller 0 / 1 port multiplier support in CAP register of the controller.
SATA1 SATA2 SATA3 SATA4 SATA5 SATA6 M.2 SATA	[Disabled], [Enabled]	Select whether to enable or disable SATA1 / SATA2 / SATA3 / SATA4 / SATA5 / SATA6 / M.2 SATA respectively.

Figure 41: BIOS Advanced Menu - USB Configuration

BIOS SETUP UTILITY					
Main	Advanced	Power	Boot	Security	Save & Exit
USB Configuration					
USB Devices: 1 Keyboard, 2 Mice, 2 Hubs				→ ←: Select Screen ↑ ↓: Select Item Enter: Select +/-: Change Opt. F1: General Help F2: Previous Values F3: Optimized Defaults F4: Save & Exit ESC: Exit	
Legacy USB Support		[Enabled]			
xHCI Hand-off		[Enabled]			
USB Mass Storage Driver Support		[Enabled]			
Version 2.19.1266. Copyright (C) 2018, American Megatrends, Inc.					

Feature	Option	Description
Legacy USB Support	[Enabled], [Disabled], [Auto]	Select whether to enable or disable Legacy USB support. AUTO option disables legacy support if no USB devices are connected.
XHCI Hand-off	[Enabled], [Disabled]	Select whether to enable or disable XHCI Hand-off function. This is a workaround for OSes without XHCI hand-off support. The XHCI ownership change should be claimed by XHCI driver.
USB Mass Storage Driver Support	[Disabled], [Enabled]	Select whether to enable or disable USB Mass Storage Driver Support.

Figure 42: BIOS Advanced Menu - Trusted Computing

BIOS SETUP UTILITY					
Main	Advanced	Power	Boot	Security	Save & Exit
Configuration					
Security Device Support		[Disabled]			
NO Security Device				→ ←: Select Screen ↑ ↓: Select Item Enter: Select +/-: Change Opt. F1: General Help F2: Previous Values F3: Optimized Defaults F4: Save & Exit ESC: Exit	
Version 2.19.1266. Copyright (C) 2018, American Megatrends, Inc.					

Feature	Option	Description
Security Device Support	[Disabled], [Enabled]	Select whether to enable or disable BIOS support for security device. O.S. will no show Security Device. TCG EFI protocol and INT1A interface will not be available.

Figure 43: BIOS Advanced Menu - Network Stack Configuration

BIOS SETUP UTILITY					
Main	Advanced	Power	Boot	Security	Save & Exit
Network Stack Configuration					
LAN Boot I210-AT-1		[Disabled]		→ ←: Select Screen	
LAN Boot I210-AT-2		[Disabled]		↑ ↓: Select Item	
LAN Boot X553 1GbE-1		[Disabled]		Enter: Select	
LAN Boot X553 1GbE-2		[Disabled]		+/-: Change Opt.	
LAN Boot X553 1GbE-3		[Disabled]		F1: General Help	
LAN Boot X553 1GbE-4		[Disabled]		F2: Previous Values	
				F3: Optimized Defaults	
Ipv4 PXE Support		[Enabled]		F4: Save & Exit	
Ipv6 PXE Support		[Disabled]		ESC: Exit	
Version 2.19.1266. Copyright (C) 2018, American Megatrends, Inc.					

Feature	Option	Description
LAN Boot I210-AT-1 LAN Boot I210-AT-2 LAN Boot X553 1GbE-1 LAN Boot X553 1GbE-2 LAN Boot X553 1GbE-3 LAN Boot X553 1GbE-4	[Disabled], [Load PXE]	Select whether to enable or disable load onboard PXE (Preboot Execution Environment) or uEFI-SNP (Simple Network Protocol).
Ipv4 PXE Support	[Disabled], [Enabled]	Select whether to enable or disable Ipv4 PXE boot support. If disabled, Ipv4 PXE boot support will not be available.
Ipv6 PXE Support	[Disabled], [Enabled]	Select whether to enable or disable Ipv6 PXE boot support. If disabled, Ipv6 PXE boot support will not be available.

Figure 44: BIOS Advanced Menu - DIO Configuration

BIOS SETUP UTILITY					
Main	Advanced	Power	Boot	Security	Save & Exit
DIO Configuration					
User Configuration		[Disabled]			
DIO_0*		[Output High]			
DIO_1*		[Output High]			
DIO_2*		[Output High]			
DIO_3*		[Output High]			
DIO_4*		[Output High]			
DIO_5*		[Output High]			
DIO_6*		[Output High]			
DIO_7*		[Output High]			
DIO_0 Value		1		→ ←: Select Screen ↑ ↓: Select Item Enter: Select +/-: Change Opt. F1: General Help F2: Previous Values F3: Optimized Defaults F4: Save & Exit ESC: Exit	
DIO_1 Value		1			
DIO_2 Value		1			
DIO_3 Value		1			
DIO_4 Value		1			
DIO_5 Value		1			
DIO_6 Value		1			
DIO_7 Value		1			
Version 2.19.1266. Copyright (C) 2018, American Megatrends, Inc.					

* These items appear only when enabling User Configuration.

Feature	Option	Description
User Configuration	[Enabled], [Disabled]	Select whether or not to allow user to set the DIO pin value.
DIO_0..7	[Output Low], [Output High], [Input]	Set up the DIO pin value.

Figure 45: BIOS Advanced Menu - Super IO Configuration

BIOS SETUP UTILITY					
Main	Advanced	Power	Boot	Security	Save & Exit
Super IO Configuration					
> Serial Port 1 Configuration > Serial Port 2 Configuration				→ ←: Select Screen ↑ ↓: Select Item Enter: Select +/-: Change Opt. F1: General Help F2: Previous Values F3: Optimized Defaults F4: Save & Exit ESC: Exit	
Version 2.19.1266. Copyright (C) 2018, American Megatrends, Inc.					

Figure 46: BIOS Advanced Menu - Super IO Configuration - Serial Port 1 Configuration

BIOS SETUP UTILITY					
Main	Advanced	Power	Boot	Security	Save & Exit
Serial Port 1 Configuration					
Serial Port		[Enabled]		→ ←: Select Screen ↑ ↓: Select Item Enter: Select +/-: Change Opt. F1: General Help F2: Previous Values F3: Optimized Defaults F4: Save & Exit ESC: Exit	
Device Settings		IO=3F8h; IRQ=4;			
Change Setting		[Auto]			
Serial Port 1 Type		[RS232]			
RS485 Deplx Mode*		[Half Duplex]			
RS485 Auto Flow Control		[Disabled]			
Version 2.19.1266. Copyright (C) 2018, American Megatrends, Inc.					

* These items appear only when selecting RS485 for the Serial Port 1 Type.

Feature	Option	Description
Serial Port	[Disabled], [Enabled]	Select whether to enable or disable Serial Port (COM).
Change Settings	[Auto], [IO=3F8h; IRQ=4;], [IO=3F8h; IRQ=3, 4, 5, 6, 7, 9, 10, 11, 12;], [IO=2F8h; IRQ=3, 4, 5, 6, 7, 9, 10, 11, 12;], [IO=3E8h; IRQ=3, 4, 5, 6, 7, 9, 10, 11, 12;], [IO=2E8h; IRQ=3, 4, 5, 6, 7, 9, 10,	Select an optional setting for Super IO device.

Feature	Option	Description
	11, 12;]	
Serial Port 1 Type	[RS232], [RS422], [RS485]	Select an appropriate type for Serial Port 1.
RS485 Duplex Mode	[Half Duplex], [Full Duplex]	Select an appropriate RS485 Duplex Mode.
RS485 Auto Flow Control	[Disabled], [Enabled]	Select whether to enable or disable RS485 Auto Flow Control.

Figure 47: BIOS Advanced Menu - Super IO Configuration - Serial Port 2 Configuration

BIOS SETUP UTILITY					
Main	Advanced	Power	Boot	Security	Save & Exit
Serial Port 2 Configuration					
Serial Port		[Enabled]		→ ←: Select Screen	
Device Settings		IO=2F8h; IRQ=3;		↑ ↓: Select Item	
Change Setting		[Auto]		Enter: Select	
Serial Port 2 Type		[RS232]		+/-: Change Opt.	
RS485 Deplx Mode*		[Half Duplex]		F1: General Help	
RS485 Auto Flow Control		[Disabled]		F2: Previous Values	
				F3: Optimized Defaults	
				F4: Save & Exit	
				ESC: Exit	
Version 2.19.1266. Copyright (C) 2018, American Megatrends, Inc.					

* These items appear only when selecting RS485 for the Serial Port 2 Type.

Feature	Option	Description
Serial Port	[Disabled], [Enabled]	Select whether to enable or disable Serial Port (COM).
Change Settings	[Auto], [IO=2F8h; IRQ=3;], [IO=3F8h; IRQ=3, 4, 5, 6, 7, 9, 10, 11, 12;], [IO=2F8h; IRQ=3, 4, 5, 6, 7, 9, 10, 11, 12;], [IO=3E8h; IRQ=3, 4, 5, 6, 7, 9, 10, 11, 12;], [IO=2E8h; IRQ=3, 4, 5, 6, 7, 9, 10, 11, 12;]	Select an optional setting for Super IO device.
Serial Port 2 Type	[RS232], [RS422], [RS485]	Select an appropriate type for Serial Port 2.
RS485 Duplex Mode	[Half Duplex], [Full Duplex]	Select an appropriate RS485 Duplex Mode.
RS485 Auto Flow Control	[Disabled], [Enabled]	Select whether to enable or disable RS485 Auto Flow Control.

Figure 48: BIOS Advanced Menu - Serial Port Console Redirection

BIOS SETUP UTILITY					
Main	Advanced	Power	Boot	Security	Save & Exit
COM1					
Console Redirection		[Disabled]			
> Console Redirection Settings					
COM2					
Console Redirection		[Disabled]			
> Console Redirection Settings					
Legacy Console Redirection					
> Legacy Console Redirection Settings					
Serial Port for Out-of-Band Management / Windows Emergency Management Services (EMS)					
Console Redirection		[Disabled]			
> Console Redirection Settings					
				→ ←: Select Screen	
				↑ ↓: Select Item	
				Enter: Select	
				+/-: Change Opt.	
				F1: General Help	
				F2: Previous Values	
				F3: Optimized Defaults	
				F4: Save & Exit	
				ESC: Exit	
Version 2.19.1266. Copyright (C) 2018, American Megatrends, Inc.					

Feature	Option	Description
Console Redirection	[Disabled], [Enabled]	Select whether to enable or disable console redirection.

Figure 49: BIOS Advanced Menu - Serial Port Console Redirection - COM1 / COM2 Console Redirection Settings

BIOS SETUP UTILITY					
Main	Advanced	Power	Boot	Security	Save & Exit
COM1 Console Redirection Settings					
Terminal Type		[ANSI]			
Bits per second		[115200]		→ ←: Select Screen	
Data Bits		[8]		↑ ↓: Select Item	
Parity		[None]		Enter: Select	
Stop Bits		[1]		+/-: Change Opt.	
Flow Control		[None]		F1: General Help	
VT-UTF8 Combo Key Support		[Enabled]		F2: Previous Values	
Recorder Mode		[Disabled]		F3: Optimized Defaults	
Resolution 100x31		[Disabled]		F4: Save & Exit	
Putty KeyPad		[VT100]		ESC: Exit	
Version 2.19.1266. Copyright (C) 2018, American Megatrends, Inc.					

Feature	Option	Description
Terminal Type	[VT100], [VT100+], [VT-UTF8], [ANSI]	Determine the terminal type.
Bits per second	[9600], [19200], [38400], [57600], [115200]	Select serial port transmission speed. The speed must be matched on the other side. Long or noisy lines may require lower speeds.
Data Bits	[7], [8]	Determine the data bits.
Parity	[None], [Even], [Odd], [Mark], [Space]	A parity bit can be sent with the data bits to detect some transmission errors.
Stop Bits	[1], [2]	Stop bits indicate the end of a serial data packet (A start bit indicates the beginning.). The standard setting is 1 stop bit. Communication with slow devices may require more than 1 stop bit.
Flow Control	[None], [Hardware RTS/CTS]	Flow control can prevent data loss from buffer overflow. When sending data, if the receiving buffers are full, a 'stop' signal can be sent to stop the data flow. You may select "None" or "Hardware RTS/CTS" depending on the circumstances.
VT-UTF8 Combo Key Support	[Disabled], [Enabled]	Select whether to enable or disable VT-UTF8 Combination Key Support for ANSI/VT100 terminals.
Recorder Mode	[Disabled], [Enabled]	Select whether to enable or disable recorder mode. With this mode enabled, only text will be sent. This is to capture terminal data.
Resolution 100x31	[Disabled], [Enabled]	Select whether to enable or disable extended terminal resolution.
Putty KeyPad	[VT100], [LINUX], [XTERMR6], [SCO], [ESCN], [VT400]	Select FunctionKey and KeyPad on Putty.

Figure 50: BIOS Advanced Menu - Serial Port Console Redirection - Legacy Console Redirection Settings

BIOS SETUP UTILITY					
Main	Advanced	Power	Boot	Security	Save & Exit
Legacy Console Redirection Settings					
Redirection COM Port		[COM1]		→ ←: Select Screen	
Resolution		[80x24]		↑ ↓: Select Item	
Redirect After POST		[BootLoader]		Enter: Select	
				+/-: Change Opt.	
				F1: General Help	
				F2: Previous Values	
				F3: Optimized Defaults	
				F4: Save & Exit	
				ESC: Exit	
Version 2.19.1266. Copyright (C) 2018, American Megatrends, Inc.					

Feature	Option	Description
Redirection COM Port	[COM1], [COM2]	Select a COM port to display redirection of Legacy OS and Legacy OPRM Messages.
Resolution	[80x24], [80x25]	Select the number of rows and columns supported redirection on legacy OS.
Redirect After POST	[Always Enabled], [BootLoader]	When BootLoader is selected, legacy console redirection is disabled before booting to legacy OS. When Always Enabled is selected, legacy console redirection is enabled for legacy OS.

Figure 51: BIOS Advanced Menu - Serial Port Console Redirection - Out-of-Band Mgmt Port Console Redirection Settings

BIOS SETUP UTILITY					
Main	Advanced	Power	Boot	Security	Save & Exit
Out-of-Band Mgmt Port		[COM1]			
Terminal Type		[VT-UTF8]			
Bits per second		[115200]			
Flow Control		[None]			
Data Bits		8			
Parity		None			
Stop Bits		1			
				→ ←: Select Screen ↑ ↓: Select Item Enter: Select +/-: Change Opt. F1: General Help F2: Previous Values F3: Optimized Defaults F4: Save & Exit ESC: Exit	
Version 2.19.1266. Copyright (C) 2018, American Megatrends, Inc.					

Feature	Option	Description
Out-of-Band Mgmt Port	[COM1], [COM2]	Select a COM port for Out-of-Band Management Port. Microsoft Windows Emergency Management Services (EMS) allows remote management of a Windows Server OS through a serial port.
Terminal Type	[VT100], [VT100+], [VT-UTF8], [ANSI]	Determine the terminal type. VT-UTF8 is the preferred terminal type for out-of-band management. The next best choice is VT100+ and then VT100.
Bits per second	[9600], [19200], [57600], [115200]	Select serial port transmission speed. The speed must be matched on the other side. Long or noisy lines may require lower speeds.
Flow Control	[None], [Hardware RTS/CTS], [Software Xon/Xoff]	Flow control can prevent data loss from buffer overflow. When sending data, if the receiving buffers are full, a 'stop' signal can be sent to stop the data flow. You may select "None", "Hardware RTS/CTS" or "Software Xon/Xoff" depending on the circumstances.

Figure 52: BIOS Advanced Menu - H/W Monitor

BIOS SETUP UTILITY							
Main	Advanced	Power	Boot	Security	Save & Exit		
PC Health Status							
> Smart FAN Configuration							
CPU Temperature-DTS		: +31 C					
CPU Temperature-Diode		: +31 C					
System Temperature		: +34 C					
CPU Fan Speed		: 5818 RPM		→ ←: Select Screen ↑ ↓: Select Item Enter: Select +/-: Change Opt. F1: General Help F2: Previous Values F3: Optimized Defaults F4: Save & Exit ESC: Exit			
SYS Fan Speed		: N/A					
+V CORE		: +1.021 V					
+12V		: +11.956 V					
+5V		: +5.146 V					
+V MEM		: +1.221 V					
+3.3V		: +3.392 V					
+V RTC		: +3.184 V					
Version 2.19.1266. Copyright (C) 2018, American Megatrends, Inc.							

BIOS SETUP UTILITY							
Main	Advanced	Power	Boot	Security	Save & Exit		
Smart FAN Configuration							
CPU FAN Setting		[Manual]		→ ←: Select Screen ↑ ↓: Select Item Enter: Select +/-: Change Opt. F1: General Help F2: Previous Values F3: Optimized Defaults F4: Save & Exit ESC: Exit			
Manual Duty		255					
System FAN Setting		[Manual]					
Manual Duty		255					
Version 2.19.1266. Copyright (C) 2018, American Megatrends, Inc.							

Feature	Option	Description
CPU FAN Setting	[Manual], [Smart]	Switch the CPU FAN control mode.
System FAN Setting		

9.2.3. Power Setup Menu

The Power setup menu provides functions and a sub-screen for power configurations. The following sub-screen function is included in the menu:

- ▶ WatchDog Timer Configuration

Figure 53: BIOS Power Setup Menu

BIOS SETUP UTILITY					
Main	Advanced	Power	Boot	Security	Save & Exit
Power Configuration					
Restore AC Power Loss		[Power Off]			
Power Saving Mode		[Disabled]			
Resume Event Control				→ ←: Select Screen	
Resume By X553 1GbE-1		[Disabled]	↑ ↓: Select Item		
Resume By X553 1GbE-2		[Disabled]	Enter: Select		
Resume By X553 1GbE-3		[Disabled]	+/-: Change Opt.		
Resume By X553 1GbE-4		[Disabled]	F1: General Help		
Resume By LAN I210-AT-1		[Disabled]	F2: Previous Values		
Resume By LAN I210-AT-2		[Disabled]	F3: Optimized Defaults		
Resume By RTC Alarm		[Disabled]	F4: Save & Exit		
> WatchDog Timer Configuration				ESC: Exit	
Version 2.19.1266. Copyright (C) 2018, American Megatrends, Inc.					

Feature	Option	Description
Restore AC Power Loss	[Power Off], [Power On], [Last State]	Control whether the system will stay on after AC power is removed and then restored. Select [Power Off] if you want the system to remain off after power restored. Select [Power On] if you use a power strip to turn the system on.
Power Saving Mode	[Disabled], [EUP AUX Power], [EUP SOC Power]	Select whether to enable Power Saving Mode.
Resume By X553 1GbE-1/2/3/4 Resume By I210-AT-1/2	[Disabled], [OS-Driver], [FW-MagicPacket]	Select whether to enable or disable Wake from LAN Device X553 NIC with Marvell 88E1543 Port 1/2/3/4 or Intel I210-AT Port 1/2 respectively.
Resume By RTC Alarm	[Disabled], [Enabled]	Select whether to enable or disable Wake Up on Alarm, to turn on your system on a special day of the month.

Figure 54: BIOS Power Setup Menu - WatchDog Timer Configuration

BIOS SETUP UTILITY					
Main	Advanced	Power	Boot	Security	Save & Exit
WatchDog Timer Configuration					
WDT Function		[Disabled]		→ ←: Select Screen ↑ ↓: Select Item Enter: Select +/-: Change Opt. F1: General Help F2: Previous Values F3: Optimized Defaults F4: Save & Exit ESC: Exit	
Version 2.19.1266. Copyright (C) 2018, American Megatrends, Inc.					

Feature	Option	Description
WDT Function	[Disabled], [Enabled]	Select whether to enable or disable WatchDog Timer function.

9.2.4. Boot Setup Menu

The boot setup menu lists the for boot device priority order, that is generated dynamically.

Figure 55: BIOS Boot Setup Menu

BIOS SETUP UTILITY					
Main	Advanced	Power	Boot	Security	Save & Exit
Boot Configuration					
Full Screen LOGO Display		[Disabled]			
Setup Prompt Timeout		1		→ ←: Select Screen	
Bootup NumLock State		[On]		↑ ↓: Select Item	
CSM Support		[Enabled]		Enter: Select	
Boot Option Filter		[UEFI and Legacy]		+/-: Change Opt.	
Load build-in Shell		[Enabled]		F1: General Help	
File System Drivers		[Enabled]		F2: Previous Values	
Boot Option Priorities				F3: Optimized Defaults	
				F4: Save & Exit	
				ESC: Exit	
Version 2.19.1266. Copyright (C) 2018, American Megatrends, Inc.					

Feature	Option	Description
Full Screen LOGO Display	[Disabled], [Enabled]	Select whether to enable or disable to display logo screen.
Bootup NumLock State	[On], [Off]	Select the state of the NumLock feature of the keyboard after Startup. [On]: The keys on the keypad will act as numeric keys. [Off]: The keys on the keypad will act as cursor keys.
CSM Support	[Enabled]	Select whether to enable or disable CSM support.
Boot Option Filter	[UEFI and Legacy], [Legacy only], [UEFI only]	Control Legacy / UEFI ROMs priority.
Load build-in Shell	[Enabled], [Disabled]	It controls installation of the boot option for a built-in shell.
File System Drivers	[Enabled], [Disabled]	Free Software UEFI File System Drivers, such as a read-only NTFS or exFAT EFI drivers, courtesy of the GRUB project.

9.2.5. Security Setup Menu

The Security setup menu provides information about the passwords and functions for specifying the security settings. The passwords are case-sensitive. The miTX-DNV provides no factory-set passwords.

NOTICE	<p>If there is already a password installed, the system asks for this first. To clear a password, simply enter nothing and acknowledge by pressing <RETURN>. To set a password, enter it twice and acknowledge by pressing <RETURN>.</p>
---------------	--

Figure 56: BIOS Boot Setup Menu

BIOS SETUP UTILITY					
Main	Advanced	Power	Boot	Security	Save & Exit
Password Description					
If ONLY the Administrator's password is set, then this only limits access to Setup and is only asked for when entering Setup					
If ONLY the User's password is set, then this is a power on password and must be entered to boot or enter Setup. In Setup the User will have Administrator rights					
The password length must be in the following range:				→ ←: Select Screen	
Minimum Length		3		↑ ↓: Select Item	
Maximum length		20		Enter: Select	
Administrator Password				+/-: Change Opt.	
User Password				F1: General Help	
Secure Boot menu				F2: Previous Values	
				F3: Optimized Defaults	
				F4: Save & Exit	
				ESC: Exit	
Version 2.19.1266. Copyright (C) 2018, American Megatrends, Inc.					

Feature	Description
Administrator Password	Set administrator password
User Password	Set user password



If only the administrator's password is set, then only access to setup is limited. The password is only entered when entering setup.

If only the user's password is set, then the password is a power on password and must be entered to boot or enter setup. Within the setup menu the user has administrator rights.

Password length requirements are maximum 20 characters and minimum 3 characters.

9.2.5.1. Remember the password

It is highly recommended to keep a record of all passwords in a safe place. Forgotten passwords results in being locked out of the system.

If the system cannot be booted because the User Password or the Supervisor Password are not know, contact Kontron Support for further assistance.



HDD security passwords cannot be cleared using the above method.

9.2.6. Save & Exit Setup Menu

The exit setup menu provides functions for handling changes made to the UEFI BIOS settings and the exiting of the setup program.

Figure 57: BIOS Boot Setup Menu

BIOS SETUP UTILITY					
Main	Advanced	Power	Boot	Security	Save & Exit
Save Changes and Reset					
Discard Changes and Reset					
Save Options				→ ←: Select Screen	
Save Changes				↑ ↓: Select Item	
Discard Changes				Enter: Select	
Restore Defaults				+/-: Change Opt.	
				F1: General Help	
				F2: Previous Values	
				F3: Optimized Defaults	
				F4: Save & Exit	
				ESC: Exit	
Version 2.19.1266. Copyright (C) 2018, American Megatrends, Inc.					

Feature	Description
Save Changes and Exit	Exit system setup after saving the changes. Once you are finished making your selections, choose this option from the Exit menu to ensure the values you selected are saved to the CMOS RAM. The CMOS RAM is sustained by an onboard backup battery and stays on even when the PC is turned off. When you select this option, a confirmation window appears. Select [Yes] to save changes and exit.
Discard Changes and Exit	Exit system setup without saving any changes. Select this option only if you do not want to save the changes that you made to the Setup program. If you made changes to fields other than system date, system time, and password, the BIOS asks for a confirmation before exiting.
Save Changes	Save changes done so far to any of the setup values. This option allows you to save the selections you made. After selecting this option, a confirmation appears. Select [Yes] to save any changes.
Discard Changes	Discards changes done so far to any of the setup values. This option allows you to discard the selections you made and restore the previously saved values. After selecting this option, a confirmation appears. Select [Yes] to discard any changes and load the previously saved values.
Restore Defaults	Restore Default values for all the setup values. This option allows you to load optimal default values for each of the parameters on the Setup menus, which will provide the best performance settings for your system. The F9 key can be used for this operation.

Appendix A: List of Acronyms



The following table does not contain the complete acronyms used in signal names, signal type definitions or similar. A description of the signals is included in the I/O Connector and Internal connector chapters within this user guide.

Table 53: List of Acronyms

2D	Two-Dimensional
3D	Three-Dimensional
AHCI	Advanced Host Controller Interface
AMT	Active Management Technology
AT	Advanced Technology
ATX	Advanced Technology eXtended
BGA	Ball Grid Array
BIOS	Basic Input / Output System
BSP	Board Support Package
CMOS	Complementary Metal Oxide Semiconductor
CPU	Central Processing Unit
DC	Direct Current
DDC	Display Data Channel
DIO	Digital Input / Output
DP	DisplayPort
ECC	Error-Correcting Code
ECX	Embedded Compact eXtended
EEE	Electrical and Electronic Equipment
EIST	Enhanced Intel SpeedStep Technology
EOS	Electrical OverStress
ESD	ElectroStatic Discharge
GbE	Gigabit Ethernet
HDD	Hard Disk Drive
HDMI	High Definition Multimedia Interface
LAN	Local Area Network
LED	Light Emitting Device
LVDS	Low-Voltage Differential Signaling
ME F/W	Management Engine Firmware
mPCIe	mini Peripheral Component Interconnect express
NGFF	Next Generation Form Factor
PC-AT	Personal Computer - Advanced Technology
PCB	Printed Circuit Board
PSU	Power Supply Unit
PVC	PolyViny Chloride
PWM	Pulse Width Modulation
RAM	Random Access Memory
ROM	Read-Only Memory
RTC	Real-Time Clock
SATA	Serial Advanced Technology Attachment
SD	Secure Digital memory card
SDP	Serial Download Protocol
SELV	Safety Extra-Low Voltage
SIM	Subscriber Identity Module
SMBus	System Management Bus
SoC	System on Chip
SO-DIMM	Small Outline Dual In-line Memory Module
SPD	Serial Presence Detect
SPI	Serial Peripheral Interface
TDP	Thermal Design Power
TPM	Trusted Platform Module
UEFI	Unified Extensible Firmware Interface
USB	Universal Serial Bus
UTP	Update Transfer Protocol
VGA	Video Graphics Array
WDT	WatchDog Timer
WEEE	Waste Electrical and Electronic Equipment



About Kontron

Kontron is a global leader in Embedded Computing Technology (ECT). As a part of technology group S&T, Kontron offers a combined portfolio of secure hardware, middleware and services for Internet of Things (IoT) and Industry 4.0 applications. With its standard products and tailor-made solutions based on highly reliable state-of-the-art embedded technologies, Kontron provides secure and innovative applications for a variety of industries. As a result, customers benefit from accelerated time-to-market, reduced total cost of ownership, product longevity and the best fully integrated applications overall. For more information, please visit: www.kontron.com



Global Headquarters

Kontron S&T AG

Lise-Meitner-Str. 3-5
86156 Augsburg
Germany
Tel.: +49 821 4086-0
Fax: +49 821 4086-111
info@kontron.com