



Cisco Nexus 9336PQ ACI-Mode Switch Hardware Installation Guide

First Published: 2014-08-13

Last Modified: 2019-03-28

Americas Headquarters

Cisco Systems, Inc.
170 West Tasman Drive
San Jose, CA 95134-1706
USA
<http://www.cisco.com>
Tel: 408 526-4000
800 553-NETS (6387)
Fax: 408 527-0883

THE SPECIFICATIONS AND INFORMATION REGARDING THE PRODUCTS IN THIS MANUAL ARE SUBJECT TO CHANGE WITHOUT NOTICE. ALL STATEMENTS, INFORMATION, AND RECOMMENDATIONS IN THIS MANUAL ARE BELIEVED TO BE ACCURATE BUT ARE PRESENTED WITHOUT WARRANTY OF ANY KIND, EXPRESS OR IMPLIED. USERS MUST TAKE FULL RESPONSIBILITY FOR THEIR APPLICATION OF ANY PRODUCTS.

THE SOFTWARE LICENSE AND LIMITED WARRANTY FOR THE ACCOMPANYING PRODUCT ARE SET FORTH IN THE INFORMATION PACKET THAT SHIPPED WITH THE PRODUCT AND ARE INCORPORATED HEREIN BY THIS REFERENCE. IF YOU ARE UNABLE TO LOCATE THE SOFTWARE LICENSE OR LIMITED WARRANTY, CONTACT YOUR CISCO REPRESENTATIVE FOR A COPY.

The following information is for FCC compliance of Class A devices: This equipment has been tested and found to comply with the limits for a Class A digital device, pursuant to part 15 of the FCC rules. These limits are designed to provide reasonable protection against harmful interference when the equipment is operated in a commercial environment. This equipment generates, uses, and can radiate radio-frequency energy and, if not installed and used in accordance with the instruction manual, may cause harmful interference to radio communications. Operation of this equipment in a residential area is likely to cause harmful interference, in which case users will be required to correct the interference at their own expense.

The following information is for FCC compliance of Class B devices: This equipment has been tested and found to comply with the limits for a Class B digital device, pursuant to part 15 of the FCC rules. These limits are designed to provide reasonable protection against harmful interference in a residential installation. This equipment generates, uses and can radiate radio frequency energy and, if not installed and used in accordance with the instructions, may cause harmful interference to radio communications. However, there is no guarantee that interference will not occur in a particular installation. If the equipment causes interference to radio or television reception, which can be determined by turning the equipment off and on, users are encouraged to try to correct the interference by using one or more of the following measures:

- Reorient or relocate the receiving antenna.
- Increase the separation between the equipment and receiver.
- Connect the equipment into an outlet on a circuit different from that to which the receiver is connected.
- Consult the dealer or an experienced radio/TV technician for help.

Modifications to this product not authorized by Cisco could void the FCC approval and negate your authority to operate the product

The Cisco implementation of TCP header compression is an adaptation of a program developed by the University of California, Berkeley (UCB) as part of UCB's public domain version of the UNIX operating system. All rights reserved. Copyright © 1981, Regents of the University of California.

NOTWITHSTANDING ANY OTHER WARRANTY HEREIN, ALL DOCUMENT FILES AND SOFTWARE OF THESE SUPPLIERS ARE PROVIDED "AS IS" WITH ALL FAULTS. CISCO AND THE ABOVE-NAMED SUPPLIERS DISCLAIM ALL WARRANTIES, EXPRESSED OR IMPLIED, INCLUDING, WITHOUT LIMITATION, THOSE OF MERCHANTABILITY, FITNESS FOR A PARTICULAR PURPOSE AND NONINFRINGEMENT OR ARISING FROM A COURSE OF DEALING, USAGE, OR TRADE PRACTICE.

IN NO EVENT SHALL CISCO OR ITS SUPPLIERS BE LIABLE FOR ANY INDIRECT, SPECIAL, CONSEQUENTIAL, OR INCIDENTAL DAMAGES, INCLUDING, WITHOUT LIMITATION, LOST PROFITS OR LOSS OR DAMAGE TO DATA ARISING OUT OF THE USE OR INABILITY TO USE THIS MANUAL, EVEN IF CISCO OR ITS SUPPLIERS HAVE BEEN ADVISED OF THE POSSIBILITY OF SUCH DAMAGES.

Any Internet Protocol (IP) addresses and phone numbers used in this document are not intended to be actual addresses and phone numbers. Any examples, command display output, network topology diagrams, and other figures included in the document are shown for illustrative purposes only. Any use of actual IP addresses or phone numbers in illustrative content is unintentional and coincidental.

Cisco and the Cisco logo are trademarks or registered trademarks of Cisco and/or its affiliates in the U.S. and other countries. To view a list of Cisco trademarks, go to this URL: <https://www.cisco.com/go/trademarks>. Third-party trademarks mentioned are the property of their respective owners. The use of the word partner does not imply a partnership relationship between Cisco and any other company. (1721R)

© 2014–2017 Cisco Systems, Inc. All rights reserved.



CONTENTS

Trademarks ?

PREFACE

Preface vii

Audience vii

Documentation Conventions vii

Related Documentation viii

Documentation Feedback x

Obtaining Documentation and Submitting a Service Request x

CHAPTER 1

Overview 1

Overview 1

Ports 2

Fan Modules 3

Power Supply Modules 3

CHAPTER 2

Preparing the Site 5

Temperature Requirements 5

Humidity Requirements 5

Altitude Requirements 6

Dust and Particulate Requirements 6

Minimizing Electromagnetic and Radio Frequency Interference 6

Shock and Vibration Requirements 7

Grounding Requirements 7

Planning for Power Requirements 7

Airflow Requirements 9

Airflow Requirements 10

Rack and Cabinet Requirements 10

Clearance Requirements 11

CHAPTER 3**Installing the Chassis 13**

Installation Options with Rack-Mount Kits, Racks, and Cabinets 13

Install a Rack 13

Unpacking and Inspecting a New Switch 14

Planning How to Position the Chassis in the Rack 15

Installing the Chassis in a Four-Post Rack 16

 Installing the Switch using the N9K-C9300-RMK Rack-mount Kit 16

 Attaching the Bottom-Support Rails to the Rack 16

 Attaching Front-Mount Brackets to the Chassis 18

 Installing the Chassis in a Four-Post Rack 19

Grounding the Chassis 21

Starting the Switch 23

CHAPTER 4**Connecting the Switch to the ACI Fabric 25**

ACI Fabric Topology 25

Preparing to Connect to Other Devices 26

Connecting Leaf Switches to APICs 27

Connecting Leaf Switches to Spine Switches 28

Installing a Gigabit Ethernet module (GEM) 30

Virtual Port Channel Migration - Migration of Nodes from a First-Generation Switch to a
 Second-Generation Switch 30

Setting Up an Optional Console Interface 31

Setting Up an Optional Management Connection 32

Optic Transceiver Removal Using the Optics Extraction Tool 32

Maintaining Transceivers and Optical Cables 33

CHAPTER 5**Replacing Modules 35**

Replacing a Fan Module During Operations 35

Replacing a Power Supply Module 37

 Removing an AC Power Supply 37

 Removing a DC Power Supply 38

| | |
|---|----|
| Installing an AC Power Supply | 39 |
| Installing a DC Power Supply | 40 |
| Wiring a 48 V DC Electrical Connector Block | 41 |

| | | |
|-------------------|--|-----------|
| APPENDIX A | Rack Specifications | 43 |
| | Overview of Racks | 43 |
| | General Requirements for Cabinets and Racks | 43 |
| | Requirements Specific to Standard Open Racks | 44 |
| | Requirements Specific to Perforated Cabinets | 44 |
| | Cable Management Guidelines | 44 |

| | | |
|-------------------|---|-----------|
| APPENDIX B | System Specifications | 45 |
| | Environmental Specifications | 45 |
| | Switch Dimensions | 45 |
| | Switch and Module Weights and Quantities | 45 |
| | Switch Power Input Requirements | 46 |
| | Power Cable Specifications | 46 |
| | 3-kW AC Power Cable Specifications | 47 |
| | 3-kW Universal AC/DC Power Cable Specifications | 50 |
| | 3-kW DC Power Supply Power Cord Specifications | 54 |

| | | |
|-------------------|---------------------|-----------|
| APPENDIX C | LEDs | 55 |
| | Switch Chassis LEDs | 55 |
| | Fan Module LEDs | 56 |
| | Power Supply LEDs | 56 |

| | | |
|-------------------|------------------------------|-----------|
| APPENDIX D | Additional Kits | 59 |
| | Rack Mount Kit N9K-C9300-RMK | 59 |

| | | |
|-------------------|---|-----------|
| APPENDIX E | Site Preparation and Maintenance Records | 61 |
| | Site Preparation Checklist | 61 |
| | Contact and Site Information | 62 |
| | Chassis and Module Information | 63 |



Preface

- [Audience, on page vii](#)
- [Documentation Conventions, on page vii](#)
- [Related Documentation, on page viii](#)
- [Documentation Feedback, on page x](#)
- [Obtaining Documentation and Submitting a Service Request, on page x](#)

Audience

This publication is for hardware installers and network administrators who install, configure, and maintain Cisco Nexus switches.

Documentation Conventions

Command descriptions use the following conventions:

| Convention | Description |
|---------------|---|
| bold | Bold text indicates the commands and keywords that you enter literally as shown. |
| <i>Italic</i> | Italic text indicates arguments for which the user supplies the values. |
| [x] | Square brackets enclose an optional element (keyword or argument). |
| [x y] | Square brackets enclosing keywords or arguments separated by a vertical bar indicate an optional choice. |
| {x y} | Braces enclosing keywords or arguments separated by a vertical bar indicate a required choice. |
| [x {y z}] | Nested set of square brackets or braces indicate optional or required choices within optional or required elements. Braces and a vertical bar within square brackets indicate a required choice within an optional element. |
| variable | Indicates a variable for which you supply values, in context where italics cannot be used. |

| Convention | Description |
|------------|---|
| string | A nonquoted set of characters. Do not use quotation marks around the string or the string will include the quotation marks. |

Examples use the following conventions:

| Convention | Description |
|-----------------------------|---|
| screen font | Terminal sessions and information the switch displays are in screen font. |
| boldface screen font | Information you must enter is in boldface screen font. |
| <i>italic screen font</i> | Arguments for which you supply values are in italic screen font. |
| <> | Nonprinting characters, such as passwords, are in angle brackets. |
| [] | Default responses to system prompts are in square brackets. |
| !, # | An exclamation point (!) or a pound sign (#) at the beginning of a line of code indicates a comment line. |

Related Documentation

The Application Centric Infrastructure documentation set includes the following documents that are available on Cisco.com at the following URL:

<https://www.cisco.com/c/en/us/support/cloud-systems-management/application-policy-infrastructure-controller-apic/sd-products-support-series-home.html>

Web-Based Documentation

- *Cisco APIC Management Information Mode Reference*
- *Cisco APIC Online Help Reference*
- *Cisco APIC Python SDK Reference*
- *Cisco ACI Compatibility Tool*
- *Cisco ACI MIB Support List*

Downloadable Documentation

- *Knowledge Base Articles (KB Articles)* are available at the following URL:
<https://www.cisco.com/c/en/us/support/cloud-systems-management/application-policy-infrastructure-controller-apic/products-configuration-examples-list.html>
- *Cisco Application Centric Infrastructure Controller Release Notes*
- *Cisco Application Centric Infrastructure Fundamentals Guide*
- *Cisco APIC Getting Started Guide*
- *Cisco ACI Virtualization Guide*
- *Cisco APIC REST API User Guide*
- *Cisco APIC Command Line Interface User Guide*

- *Cisco APIC Faults, Events, and System Messages Management Guide*
- *Cisco ACI System Messages Reference Guide*
- *Cisco APIC Layer 4 to Layer 7 Services Deployment Guide*
- *Cisco APIC Layer 4 to Layer 7 Device Package Development Guide*
- *Cisco APIC Layer 4 to Layer 7 Device Package Test Guide*
- *Cisco ACI Firmware Management Guide*
- *Cisco ACI Troubleshooting Guide*
- *Cisco ACI Switch Command Reference, NX-OS Release 11.0*
- *Cisco Verified Scalability Guide for Cisco ACI*
- *Cisco ACI MIB Quick Reference*
- *Cisco Nexus CLI to Cisco APIC Mapping Guide*
- *Application Centric Infrastructure Fabric Hardware Installation Guide*
- *Cisco NX-OS Release Notes for Cisco Nexus 9000 Series ACI-Mode Switches*
- *Cisco Nexus 9000 Series ACI Mode Licensing Guide*
- *Cisco Nexus 93108TX-EX ACI-Mode Switch Hardware Installation Guide*
- *Cisco Nexus 93108TX-FX ACI-Mode Switch Hardware Installation Guide*
- *Cisco Nexus 93120TX ACI-Mode Switch Hardware Installation Guide*
- *Cisco Nexus 93128TX ACI-Mode Switch Hardware Installation Guide*
- *Cisco Nexus 93180LC-EX ACI-Mode Switch Hardware Installation Guide*
- *Cisco Nexus 93180YC-EX ACI-Mode Switch Hardware Installation Guide*
- *Cisco Nexus 93180YC-FX ACI-Mode Switch Hardware Installation Guide*
- *Cisco Nexus 9332PQ ACI-Mode Switch Hardware Installation Guide*
- *Cisco Nexus 9336PQ ACI-Mode Switch Hardware Installation Guide*
- *Cisco Nexus 9372PX and 9372PX-E ACI-Mode Switches Hardware Installation Guide*
- *Cisco Nexus 9372TX and 9372TX-E ACI-Mode Switches Hardware Installation Guide*
- *Cisco Nexus 9396PX ACI-Mode Switch Hardware Installation Guide*
- *Cisco Nexus 9396TX ACI-Mode Switch Hardware Installation Guide*
- *Cisco Nexus 9504 ACI-Mode Switch Hardware Installation Guide*
- *Cisco Nexus 9508 ACI-Mode Switch Hardware Installation Guide*
- *Cisco Nexus 9516 ACI-Mode Switch Hardware Installation Guide*

Cisco Application Centric Infrastructure (ACI) Simulator Documentation

The following Cisco ACI Simulator documentation is available at

<https://www.cisco.com/c/en/us/support/cloud-systems-management/application-centric-infrastructure-simulator/tsd-products-support-series-home.html>

- *Cisco ACI Simulator Release Notes*
- *Cisco ACI Simulator Installation Guide*
- *Cisco ACI Simulator Getting Started Guide*

Cisco Nexus 9000 Series Switches Documentation

The Cisco Nexus 9000 Series Switches documentation is available at

<https://www.cisco.com/c/en/us/support/switches/nexus-9000-series-switches/tsd-products-support-series-home.html>

Cisco Application Virtual Switch Documentation

The Cisco Application Virtual Switch (AVS) documentation is available at

<https://www.cisco.com/c/en/us/support/switches/application-virtual-switch/tsd-products-support-series-home.html>

Documentation Feedback

To provide technical feedback on this document, or to report an error or omission, please send your comments to apic-docfeedback@cisco.com. We appreciate your feedback.

Obtaining Documentation and Submitting a Service Request

For information on obtaining documentation, using the Cisco Bug Search Tool (BST), submitting a service request, and gathering additional information, see *What's New in Cisco Product Documentation*, at: <https://www.cisco.com/warp/public/687/Directory/DirTAC.shtml>.

Subscribe to *What's New in Cisco Product Documentation*, which lists all new and revised Cisco technical documentation as an RSS feed and delivers content directly to your desktop using a reader application. The RSS feeds are a free service.



CHAPTER 1

Overview

- [Overview, on page 1](#)

Overview

The Cisco Nexus 9336PQ ACI Spine Switch (N9K-C9336PQ) is a 2-rack-unit (RU) switch for the Cisco Application-Centric Infrastructure (ACI). This switch includes the following components:

- 36 fixed 40-Gigabit Quad Small Form-factor Pluggable (QSFP+) ports
- Console and out-of-band-management ports (one each)
- Fan modules (two)
 - Port-side intake version with burgundy coloring (N9K-C9300-FAN3)
 - Port-side exhaust version with blue coloring (N9K-C9300-FAN3-B)
- Power supplies (two—one required for operations and an optional one for redundancy)
 - 1200-W AC power supply with port-side intake airflow (burgundy coloring) (N9K-PAC-1200W)
 - 1200-W AC power supply with port-side exhaust airflow (blue coloring) (N9K-PAC-1200W-B)
 - 1200-W HVAC/HVDC power supply with dual-direction airflow (white coloring) (N9K-PUV-1200W)
 - 930-W DC power supply with port-side intake airflow (green coloring) (UCSC-PSU-930WDC)
 - 930-W DC power supply with port-side exhaust airflow (gray coloring) (UCS-PSU-6332-DC)

The following figure shows the hardware features seen on the power supply side of the chassis.

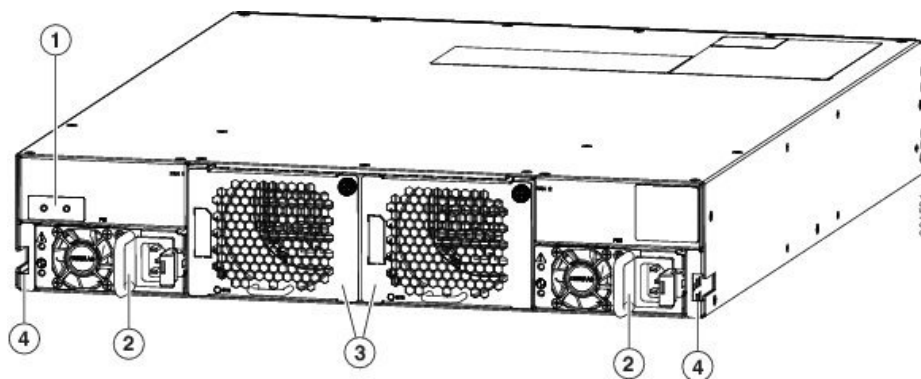

| | | | |
|---|--|---|-----------------|
| 1 | Grounding Pad | 3 | Fan modules (2) |
| 2 | Power supplies (2) (AC power supply shown) | | |

The following figure shows the hardware features seen from the port side of the chassis.

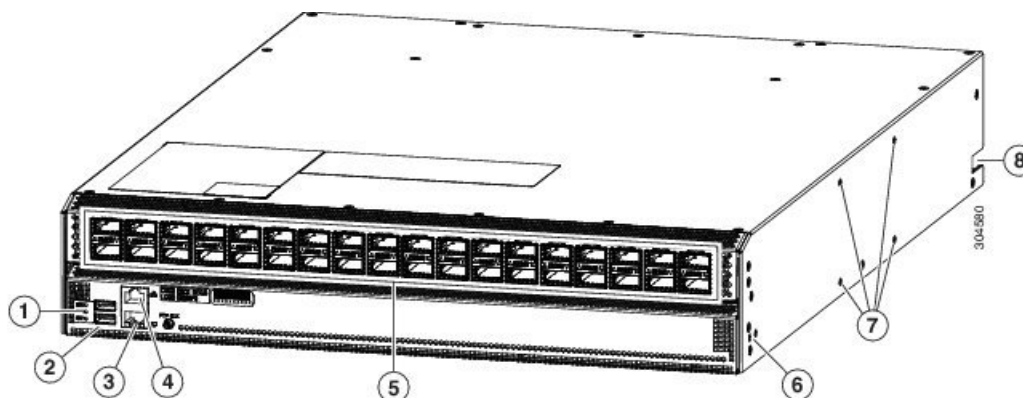

| | | | |
|---|--|---|---|
| 1 | Chassis LEDs | 5 | 36 40-Gigabit QSFP+ ports |
| 2 | USB ports | 6 | Screw holes (2) for attaching a front-mount bracket for 4-post racks (1 bracket on each of 2 sides) |
| 3 | Out-of-band management port (RJ-45 port) | 7 | Notch in both sides of the chassis for locking the power supply end of the chassis to the bottom support brackets |
| 4 | Console port (RJ232 port) | | |

Ports

The switch chassis includes the following types of ports:

- 40-Gigabit QSFP+ interface ports (36)
- Console port (1)
- Out-of-band management port (1)
- USB flash-memory ports (2)

The interface ports support QSFP+ transceivers. You use these ports to connect the switch to leaf switches in the ACI network that this switch belongs to. These ports are numbered 1 to 36 from left to right.



Note To see which transceivers are supported by this switch, see <http://www.cisco.com/c/en/us/support/interfaces-modules/transceiver-modules/products-device-support-tables-list.html>.

The console port enables you to perform the initial setup of the switch.

The out-of-band management port enables you to manage switch operations after you set up the switch.

If you need to download or upload switch configurations on a flash drive, you can use the flash drive in one of the two USB ports.

Fan Modules

The switch supports two fan modules, which provide port-side intake or port-side exhaust airflow for cooling. You can hot swap one of the fan modules during operations but must replace it within one minute. If you cannot replace the fan module within one minute, then it is best to leave the failed fan module in the chassis until you are ready to replace it.

The fan modules are labeled FAN 1 on the left and FAN 2 on the right.



Note The switch must run with all of its power supply and fan modules taking in cooling air from a cold aisle and exhausting to a hot aisle. If they take in air from the hot aisle, the switch can overheat and shut down. All fan and power supply modules must use the same direction of airflow.

Power Supply Modules

The switch has two power supply slots labeled PS1 on the left and PS2 on the right. You can mix any of the following power supplies in those slots:

- 1200-W port-side intake AC power supply with burgundy coloring (N9K-PAC-1200W)
- 1200-W port-side exhaust AC power supply with blue coloring (N9K-PAC-1200W-B)
- 930-W DC power supplies with green coloring for port-side intake airflow (UCSC-PSU-930WDC)
- 930-W DC power supplies with gray coloring for port-side exhaust airflow (UCS-PSU-6332-DC)

The switch requires one power supply for its operations and a second power supply for power redundancy. You can hot swap one of the power supplies during operations but otherwise must always have two power supplies (or one power supply and one blank faceplate) installed in the chassis to maintain the designed airflow.

**Caution**

The switch must run with all of its power supply and fan modules taking in cooling air from a cold aisle and exhausting to a hot aisle. If they take in air from the hot aisle, the switch can overheat and shut down. All power supply and fan modules must use the same direction of airflow.



CHAPTER 2

Preparing the Site

- [Temperature Requirements, on page 5](#)
- [Humidity Requirements, on page 5](#)
- [Altitude Requirements, on page 6](#)
- [Dust and Particulate Requirements, on page 6](#)
- [Minimizing Electromagnetic and Radio Frequency Interference, on page 6](#)
- [Shock and Vibration Requirements, on page 7](#)
- [Grounding Requirements, on page 7](#)
- [Planning for Power Requirements, on page 7](#)
- [Airflow Requirements, on page 9](#)
- [Airflow Requirements, on page 10](#)
- [Rack and Cabinet Requirements, on page 10](#)
- [Clearance Requirements, on page 11](#)

Temperature Requirements

The switch requires an operating temperature of 32 to 104 degrees Fahrenheit (0 to 40 degrees Celsius). If the switch is not operating, the temperature must be between –40 to 158 degrees Fahrenheit (–40 to 70 degrees Celsius).

Humidity Requirements

High humidity can cause moisture to enter the switch. Moisture can cause corrosion of internal components and degradation of properties such as electrical resistance, thermal conductivity, physical strength, and size. The switch is rated to withstand from 5- to 95-percent (noncondensing) relative humidity.

Buildings in which the climate is controlled by air-conditioning in the warmer months and by heat during the colder months usually maintain an acceptable level of humidity for the switch equipment. However, if the switch is located in an unusually humid location, use a dehumidifier to maintain the humidity within an acceptable range.

Altitude Requirements

Altitude rating is based on power supply installed; see critical components list in the system CB report for altitude rating.

Dust and Particulate Requirements

Exhaust fans cool power supplies and system fans cool switches by drawing in air and exhausting air out through various openings in the chassis. However, fans also ingest dust and other particles, causing contaminant buildup in the switch and increased internal chassis temperature. Dust and particles can act as insulators and interfere with the mechanical components in the switch. A clean operating environment can greatly reduce the negative effects of dust and other particles.

In addition to keeping your environment free of dust and particles, follow these precautions to avoid contamination of your switch:

- Do not permit smoking near the switch.
- Do not permit food or drink near the switch.

Minimizing Electromagnetic and Radio Frequency Interference

Electromagnetic interference (EMI) and radio frequency interference (RFI) from the switch can adversely affect other devices, such as radio and television (TV) receivers. Radio frequencies that emanate from the switch can also interfere with cordless and low-power telephones. Conversely, RFI from high-power telephones can cause spurious characters to appear on the switch monitor.

RFI is defined as any EMI with a frequency above 10 kHz. This type of interference can travel from the switch to other devices through the power cable and power source or through the air as transmitted radio waves. The Federal Communications Commission (FCC) publishes specific regulations to limit the amount of EMI and RFI that are emitted by computing equipment. Each switch meets these FCC regulations.

To reduce the possibility of EMI and RFI, follow these guidelines:

- Cover all open expansion slots with a blank filler plate.
- Always use shielded cables with metal connector shells for attaching peripherals to the switch.

When wires are run for any significant distance in an electromagnetic field, interference can occur to the signals on the wires with the following implications:

- Bad wiring can result in radio interference emanating from the plant wiring.
- Strong EMI, especially when it is caused by lightning or radio transmitters, can destroy the signal drivers and receivers in the chassis and even create an electrical hazard by conducting power surges through lines into equipment.



Note To predict and prevent strong EMI, you need to consult experts in radio frequency interference (RFI).

The wiring is unlikely to emit radio interference if you use a twisted-pair cable with a good distribution of grounding conductors. If you exceed the recommended distances, use a high-quality twisted-pair cable with one ground conductor for each data signal when applicable.

**Caution**

If the wires exceed the recommended distances, or if wires pass between buildings, give special consideration to the effect of a lightning strike in your vicinity. The electromagnetic pulse that is caused by lightning or other high-energy phenomena can easily couple enough energy into unshielded conductors to destroy electronic switches. You will want to consult experts in electrical surge suppression and shielding if you had similar problems in the past.

Shock and Vibration Requirements

The switch has been shock- and vibration-tested for operating ranges, handling, and earthquake standards.

Grounding Requirements

The switch is sensitive to variations in voltage that is supplied by the power sources. Overvoltage, undervoltage, and transients (or spikes) can erase data from memory or cause components to fail. To protect against these types of problems, ensure that there is an earth-ground connection for the switch. You can connect the grounding pad on the switch either directly to the earth-ground connection or to a fully bonded and grounded rack.

When you properly install the chassis in a grounded rack, the switch is grounded because it has a metal-to-metal connection to the rack. Alternatively, you can ground the chassis by using a customer-supplied grounding cable that meets your local and national installation requirements. For U.S. installations, we recommend 6-AWG wire. Connect your grounding cable to the chassis with a grounding lug (provided in the switch accessory kit) and to the facility ground.

**Note**

You automatically ground AC power supplies when you connect them to AC power sources. For DC power supplies, you must connect a grounding wire when wiring the power supply to the DC power source.

Planning for Power Requirements

The switch includes two power supplies (1-to-1 redundancy with current sharing) in one of the following combinations:

- Two 1200-W AC power supplies
- Two 1200-W HVAC/HVDC power supplies
- Two 930-W DC power supplies



Note Both power supplies must be the same type. Do not mix AC, DC, and HVAC/HVDC power supplies in the same chassis.



Note For $n+1$ redundancy, you can use one or two power sources for the two power supplies. For $n+n$ redundancy, you must use two power sources and connect each power supply to a separate power source.

The power supplies are rated to output up to 1200 W (AC power supplies) or up to 930 W (DC power supplies), but the switch requires less than those amounts of power from the power supply. To operate the switch, you must provision enough power from the power source to cover the requirements of both the switch and a power supply. Typically, this switch and a power supply require about 400 W of power input from the power source, but you must provision as much as 660 W power input from the power source to cover peak demand.



Note Some of the power supply modules have rating capabilities that exceed the switch requirements. When calculating your power requirements, use the switch requirements to determine the amount of power that is required for the power supplies.

To minimize the possibility of circuit failure, make sure that each power-source circuit that is used by the switch is dedicated to the switch.



Note For AC input application, please refer to the following statement:



Warning **Statement 1005**—Circuit Breaker

This product relies on the building's installation for short-circuit (overcurrent) protection. Ensure that the protective devices are rated not greater than 20A (North America), 16A (Europe), and 13A (UK).



Note For DC input application, please refer to the following statement:



Warning **Statement 1005**—Circuit Breaker

This product relies on the building's installation for short-circuit (overcurrent) protection.

- Ensure that the protective devices are rated not greater than 30A when the switch is powered with regular DC power supplies (rated 48-60VDC).
 - Ensure that the protective devices are rated not greater than 10A when the switch is powered with HVDC power supplies (rated 240-350VDC).
-

**Warning Statement 1033**

Connect the unit only to DC power source that complies with the Safety Extra-Low Voltage (SELV) requirements in IEC 60950 based safety standards.



Note We recommend 8-AWG wire for DC installations in the U.S.



Note For the power cables to use with the power supplies, see [Power Cable Specifications, on page 46](#).

Airflow Requirements

The switch is positioned with its ports in either the front or the rear of the rack depending on your cabling and maintenance requirements. You must have fan and power supply modules that move the coolant air from the cold aisle to the hot aisle in one of the following ways:

- Port-side exhaust airflow—Cool air enters the chassis through the fan and power supply modules in the cold aisle and exhausts through the port end of the chassis in the hot aisle.
- Port-side intake airflow—Cool air enters the chassis through the port end in the cold aisle and exhausts through the fan and power supply modules in the hot aisle.
- Dual-direction airflow—The direction of the installed fan modules determines the airflow.

You can identify the airflow direction of each fan and power supply module by its coloring as follows:

- Blue coloring indicates port-side exhaust airflow.
- Burgundy coloring indicates port-side intake airflow.
- White coloring on HVAC/HVDC power supplies indicates dual-direction airflow.
- Gray coloring on DC power supplies indicates port-side exhaust airflow.
- Green coloring on DC power supplies indicates port-side intake airflow.



Note To prevent the switch from overheating and shutting down, you must position the air intake for the switch in a cold aisle. The fan and power supply modules must have the same direction of airflow (even if their coloring is different). If you must change the airflow direction for the switch, you must shutdown the switch before changing the modules.

Airflow Requirements

The switch is positioned with its ports in either the front or the rear of the rack depending on your cabling and maintenance requirements. You must have fan and power supply modules that move the coolant air from the cold aisle to the hot aisle in one of the following ways:

- Port-side exhaust airflow—Coolant air enters the chassis through the fan and power supply modules in the cold aisle and exhausts through the port end of the chassis in the hot aisle.
- Port-side intake airflow—Coolant air enters the chassis through the port end in the cold aisle and exhausts through the fan and power supply modules in the hot aisle.
- Dual-direction airflow—The direction of the installed fan modules determines the airflow.

You can identify the airflow direction of each fan and power supply module by its coloring as follows:

- Blue coloring indicates port-side exhaust airflow.
- Burgundy coloring indicates port-side intake airflow.
- White coloring on HVAC/HVDC power supplies indicates dual direction airflow.
- Gray coloring on DC power supplies indicates port-side exhaust airflow.
- Green coloring on DC power supplies indicates port-side intake airflow.

**Note**

To prevent the switch from overheating and shutting down, you must position the air intake for the switch in a cold aisle. The fan and power supply modules must have the same direction of airflow (even if their coloring is different). If you must change the airflow direction for the switch, you must shutdown the switch before changing the modules.

Rack and Cabinet Requirements

You can install the following types of racks or cabinets for your switch:

- Standard perforated cabinets
- Solid-walled cabinets with a roof fan tray (bottom-to-top cooling)
- Standard open four-post Telco racks

Work with your cabinet vendors to determine which of their cabinets meet the following requirements or see the Cisco Technical Assistance Center (TAC) for recommendations:

- Use a standard 19-inch (48.3-cm), four-post Electronic Industries Alliance (EIA) cabinet or rack with mounting rails that conform to English universal hole spacing per section 1 of the ANSI/EIA-310-D-1992 standard.
- The depth of a four-post rack must be 24 to 32 inches (61.0 to 81.3 cm) between the front and rear mounting rails (for proper mounting of the bottom-support brackets or other mounting hardware).

- Required clearances between the chassis and the edges of its rack or the interior of its cabinet are as follows:
 - 4.5 inches (11.4 cm) between the front of the chassis and the interior of the cabinet (required for cabling).
 - 3.0 inches (7.6 cm) between the rear of the chassis and the interior of the cabinet (required for airflow in the cabinet if used).
 - No clearance is required between the chassis and the sides of the rack or cabinet (no side airflow).

Also, you must have power receptacles that are located within reach of the power cords that are used with the switch.



Warning Statement 1048—Rack Stabilization

The rack stabilizing mechanism must be in place, or the rack must be bolted to the floor before installation or servicing. Failure to stabilize the rack can cause bodily injury.

Clearance Requirements

Provide the chassis with adequate clearance between the chassis and any other rack, device, or structure so that you can properly install the chassis. Provide the chassis with adequate clearance to route cables, provide airflow, and maintain the switch. For the clearances required for an installation of this chassis in a four-post rack, see the following figure.

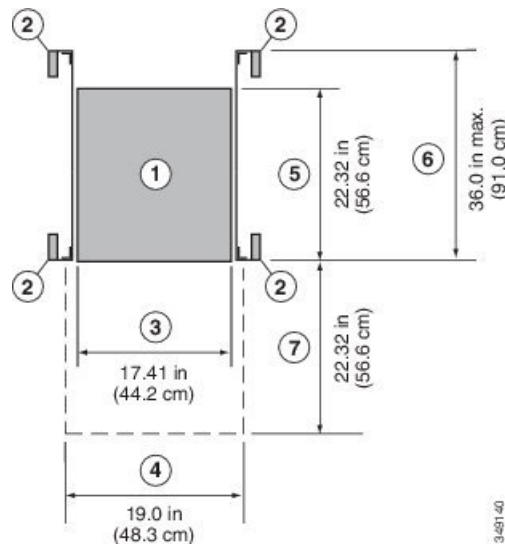

| | | | |
|---|-------------------------------------|---|--|
| 1 | Chassis | 5 | Depth of the chassis |
| 2 | Vertical rack-mount posts and rails | 6 | Maximum extension of the bottom-support rails |
| 3 | Chassis width | 7 | Depth of the front clearance area (equal to the depth of the chassis). |

| | | | |
|---|---|--|--|
| 4 | Width of the front clearance area (equal to the width of the chassis with two rack-mount brackets that are attached to it). | | |
|---|---|--|--|



Note Both the front and rear of the chassis must be open to both aisles for airflow.



CHAPTER 3

Installing the Chassis

- [Installation Options with Rack-Mount Kits, Racks, and Cabinets, on page 13](#)
- [Install a Rack, on page 13](#)
- [Unpacking and Inspecting a New Switch, on page 14](#)
- [Planning How to Position the Chassis in the Rack, on page 15](#)
- [Installing the Chassis in a Four-Post Rack, on page 16](#)
- [Grounding the Chassis, on page 21](#)
- [Starting the Switch, on page 23](#)

Installation Options with Rack-Mount Kits, Racks, and Cabinets

The rack-mount kit enables you to install the switch into racks of varying depths. You can position the switch with easy access to either the port connections or the fan and power supply modules.

You can install the switch using the following rack-mount options:

- Rack-mount kit (N9K-C9300-RMK) which you can order from Cisco.

You can install the switch in the following types of racks:

- Open EIA rack
- Perforated EIA cabinet

The rack or cabinet that you use must meet the requirements listed the in [General Requirements for Cabinets and Racks, on page 43](#) section.



Note You are responsible for verifying that your rack and rack-mount hardware comply with the guidelines that are described in this doc.

Install a Rack

Before you install the switch, you must install a standard four-post, 19-inch EIA data center rack (or a cabinet that contains such a rack) that meets the requirements listed in [Overview of Racks, on page 43](#).

Step 1 Bolt the rack to the concrete subfloor before moving the chassis onto it.

Warning Statement 1048—Rack Stabilization

The rack stabilizing mechanism must be in place, or the rack must be bolted to the floor before installation or servicing. Failure to stabilize the rack can cause bodily injury.

Step 2 If the rack has bonded construction, connect it to the earth ground. This action enables you to easily ground the switch and its components and to ground your electrostatic discharge (ESD) wrist strap to prevent damaging discharges when you handle ungrounded components before installing them.

Step 3 Include one or two power sources at the rack. For AC power, provide a power receptacle. For DC power, provide a circuit breaker with terminals for connecting power cables.

Warning Statement 1018—Supply Circuit

To reduce risk of electric shock and fire, take care when connecting units to the supply circuit so that wiring is not overloaded.

Note If you are not using power redundancy or are using $n+1$ redundancy, you need only one power source. If you are using $n+n$ redundancy, you need two power sources.

Unpacking and Inspecting a New Switch

Before you install a new chassis, you need to unpack and inspect it to be sure that you have all the items that you ordered and verify that the switch was not damaged during shipment. If anything is damaged or missing, contact your customer representative immediately.



Caution

When you handle the chassis or its components, you must follow ESD protocol at all times to prevent ESD damage. This protocol includes but is not limited to wearing an ESD wrist strap that you connect to the earth ground.



Tip

Do not discard the shipping container when you unpack the switch. Flatten the shipping cartons and store them. If you need to move or ship the system in the future, you will need this container.

Step 1 Compare the shipment to the equipment list that is provided by your customer service representative and verify that you have received all of the ordered items.

The shipment should include the following:

- Switch chassis, which includes the following installed components:
 - Two power supplies (any combination of the following with the airflow direction being the same as for the fan modules):

- 1200-W AC power supply
 - Port-side exhaust airflow with blue coloring (N9K-PAC-1200W-B)
 - Port-side intake airflow with burgundy coloring (N9K-PAC-1200W)
- 930-W DC power supply
 - Port-side exhaust airflow with gray coloring (UCS-PSU-6332-DC)
 - Port-side intake airflow with green coloring (UCSC-PDU-930WDC)
- Two fan modules (all fan and power supply modules must have the same airflow direction)
 - Port-side exhaust airflow with blue coloring (N9K-C9300-FAN3-B)
 - Port-side intake airflow with burgundy coloring (N9K-C9300-FAN3)
- Switch accessory kit

Step 2 Check the contents of the box for damage.

Step 3 If you notice any discrepancies or damage, send the following information to your customer service representative by email:

- Invoice number of the shipper (see the packing slip)
- Model and serial number of the missing or damaged unit
- Description of the problem and how it affects the installation

Planning How to Position the Chassis in the Rack

The switch is designed so that you can have coolant air flow through the switch in one of the two following directions:

- Enter the port side and exhaust out the power supply side (port-side intake airflow)
- Enter the power supply side and exhaust out the port side (port-side exhaust airflow)

For port-side intake airflow, the switch must have port-side intake fan and AC power supply modules with one or more of the following colorings:

- Burgundy coloring on fan modules and AC power supplies
- Green coloring on DC power supplies

For port-side exhaust airflow, the switch must have port-side exhaust fan and AC power supply modules with one or more of the following colorings:

- Blue coloring on fan modules and AC power supplies
- Gray coloring on DC power supplies

You can plan the positioning of the switch so that its ports are located close to ports on connected devices or so that the fan and power supply modules are conveniently located in a maintenance aisle, and then order the modules that move coolant air in the appropriate direction from the cold aisle to the hot aisle.



Note All fan and power supply modules in the same switch must operate with the same direction of airflow and the air intake portion of the switch must be located in a cold aisle.

Installing the Chassis in a Four-Post Rack

Before you install the chassis, be sure that the rack is fully secured to the data center floor.

Installing the Switch using the N9K-C9300-RMK Rack-mount Kit

Attaching the Bottom-Support Rails to the Rack

The switch chassis that you are installing ships with two adjustable bottom-support rails that you can attach to a four-post rack to hold the chassis. Each of these bottom-support rails has two pieces—one that slides into the other so that you can adjust them to fit racks with front and rear mounting posts that are spaced less than 36 inches (91 cm). On each bottom-support rail, the rail half that slides into the other rail includes a chassis stop that fits into the module end of the chassis. Depending on direction of the chassis airflow, you need to position the rail half with the chassis stop so that the fan and power supply modules end up in the appropriate aisle as follows:

- Port-side intake (burgundy coloring for fan modules) airflow requires that the bottom-support rail with the chassis stop be located on the hot aisle side of the rack.
- Port-side exhaust (blue coloring for fan modules) airflow requires that the bottom-support rail with the chassis stop be located on the cold aisle side of the rack.



Warning **Statement 1074**—Comply with Local and National Electrical Codes

To reduce risk of electric shock or fire, installation of the equipment must comply with local and national electrical codes.

Before you begin

Before you can install the bottom support rails for the chassis, you must do the following:

- Verify that a four-post rack or cabinet is installed.
- If any other devices are stored in the rack or cabinet, verify that the heavier switches are installed below lighter switches.
- Verify that the bottom-support rails kit is included in the switch accessory kit.
- Verify that you have 8 screws for attaching the bottom support brackets to the racks (typically M6 x 10 mm screws or the screw appropriate for the vertical mounting rails on the rack).

**Warning Statement 1006**—Chassis Warning for Rack-Mounting and Servicing

To prevent bodily injury when mounting or servicing this unit in a rack, you must take special precautions to ensure that the system remains stable. The following guidelines are provided to ensure your safety:

- This unit should be mounted at the bottom of the rack if it is the only unit in the rack.
- When mounting this unit in a partially filled rack, load the rack from the bottom to the top with the heaviest component at the bottom of the rack.
- If the rack is provided with stabilizing devices, install the stabilizers before mounting or servicing the unit in the rack.

-
- Step 1** Look at the fan and power supply modules installed in the chassis to determine how you must position the bottom-support rails on the rack.
- If the fan modules have blue coloring (port-side exhaust modules), you must position the bottom support rails so that the chassis stop is positioned by the cold aisle.
 - If the fan modules have burgundy (port-side intake modules), you must position the bottom support rails so that the chassis stop is positioned by the hot aisle.
- Step 2** Separate the two sliders that make up one bottom-support rail and position the half with the chassis stop by the appropriate aisle for the fan and power supply modules. Also make sure that there is at least 1 rack unit open above the bottom-support rails so that you can easily install the chassis.
- Step 3** Use two customer-supplied screws (typically M6 x 10 mm screws) to attach the bottom-support rail half to the vertical mounting rails on the rack post. Tighten each screw to the appropriate torque setting for the screws (for M6 x 10 mm screws, use 40 in. lbs [4.5 N·m] of torque).
- Step 4** Slide the other half of the bottom-support rail onto the attached half of the rail set and use two customer supplied screws (typically M6 x 10 mm screws) to secure that portion to the vertical mounting rails on the rack. Tighten each screw to the appropriate torque setting for the screws (for M6 x 10 mm screws, use 40 in. lbs [4.5 N·m] of torque).

Figure 1: Positioning an Expanding Bottom-Support Rail Set

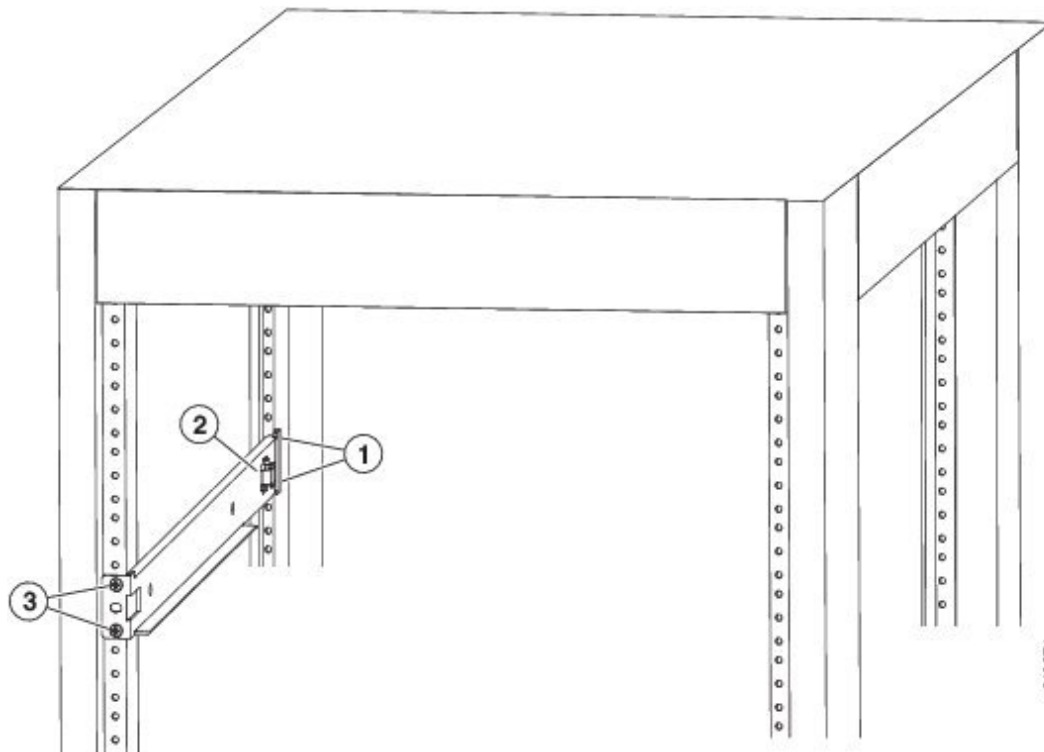

| | | | |
|---|--|---|--|
| 1 | 2 screws holding one end of the bottom-support bracket to the rear of the rack | 3 | 2 screws holding the front end of the bottom-support bracket to the front side of the rack |
| 2 | Chassis stop on the expanding bottom-support bracket | | |

Step 5 Repeat Steps 2 and 3 to attach the other expanding bottom-support rails to the other side of the rack.

Note Check the two installed bottom support rails to be sure that both have their chassis stops by the same aisle (either both by the hot aisle or both by the cold aisle) and that both rails are level and level with each other. If they are not level, adjust the higher rail down to the level of the lower rail.

What to do next

You are ready to install two front-mount brackets on the chassis.

Attaching Front-Mount Brackets to the Chassis

You need to attach a right-angled bracket to each side of the chassis. This bracket holds the chassis in place on a four-post rack.

Before you begin

- You must have the following tools and equipment:
 - Manual Phillips-head torque screwdriver
 - Front-mount brackets (2) and screws (4) (found inside the switch accessory kit)

Step 1

Align the two holes in one side of one of two front-mount brackets to two holes on the left or right side of the chassis (see the following figure).

Be sure that the other side of the bracket is facing toward the front (port end) of the chassis.

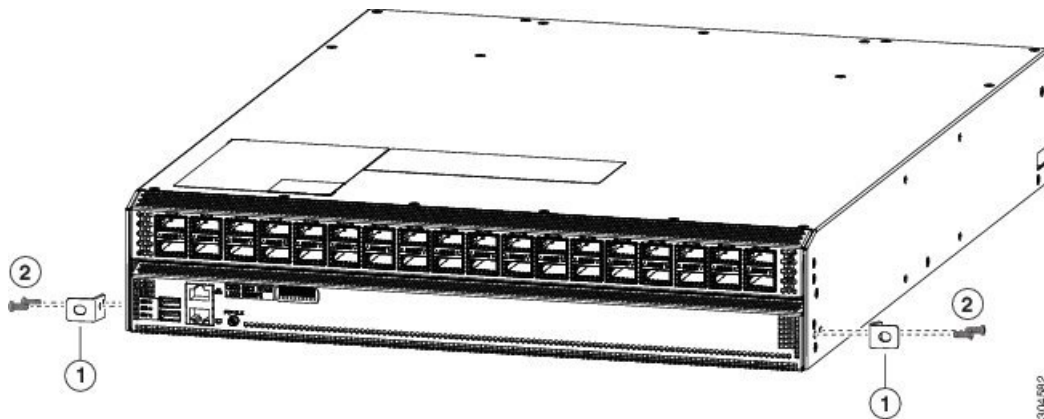

| | | | |
|---|--|---|---|
| 1 | Front-mount bracket with two screw holes aligned to two screw holes in the chassis and one screw hole facing the front (port side) of the chassis. | 2 | Two M4 x 6 mm screws used to fasten the bracket to the chassis. |
|---|--|---|---|

Step 2

Use two M4 x 6 mm screws to attach the bracket to the chassis. Tighten each screw to 11 to 15 in-lb (1.2 to 1.7 N·m).

Step 3

Repeat Steps 1 and 2 to attach the second center-mount bracket to the other side of the chassis.

What to do next

You are ready to mount the chassis to the four-post rack.

Installing the Chassis in a Four-Post Rack

You need to slide the chassis onto the bottom-support rails so that the power supply end locks onto the chassis stops at the end of the rails and so that the front-mount brackets on the chassis come into contact with the front-mount rails on the rack.

**Warning**

Statement 1074—Comply with Local and National Electrical Codes

To reduce risk of electric shock or fire, installation of the equipment must comply with local and national electrical codes.

**Warning Statement 1032**—Lifting the Chassis

To prevent personal injury or damage to the chassis, never attempt to lift or tilt the chassis using the handles on modules (such as power supplies, fans, or cards); these types of handles are not designed to support the weight of the unit.

Before you begin

- Make sure that the four-post rack is properly installed and secured to the concrete subfloor.
- Make sure that the bottom-support rails are installed so that the fan modules will be in the appropriate aisle as follows:
 - Burgundy (port-side intake airflow) fan modules are positioned in a hot aisle (the chassis stop on the bottom-support rails is positioned by the hot aisle).
 - Blue colored (port-side exhaust airflow) fan modules are positioned in a cold aisle (the chassis stop on the bottom-support rails is positioned by the cold aisle).
- Make sure that two front-mount brackets are securely fastened to the sides of the chassis at the port end.
- Make sure that you have two customer-supplied rack-mount screws (M6 x 10 mm or appropriate screw for the vertical mounting rails on the rack).

**Warning Statement 1006**—Chassis Warning for Rack-Mounting and Servicing

To prevent bodily injury when mounting or servicing this unit in a rack, you must take special precautions to ensure that the system remains stable. The following guidelines are provided to ensure your safety:

- This unit should be mounted at the bottom of the rack if it is the only unit in the rack.
- When mounting this unit in a partially filled rack, load the rack from the bottom to the top with the heaviest component at the bottom of the rack.
- If the rack is provided with stabilizing devices, install the stabilizers before mounting or servicing the unit in the rack.

Step 1 Slide the power supply end of the chassis onto the bottom-support rails that are installed on the rack.

Be sure that the sides of the chassis by the power supplies clips into the chassis stops on the bottom-support rails and the front-mount brackets come in contact with the rack (see the following figure).

Note If the bottom-support rails are extended a long distance, they can bend outwards slightly when you install the chassis and the chassis stops at the far end of the rails might not fit into the end of the chassis. If this happens, press the side rails toward the sides of the chassis so that the chassis stops can go inside the chassis and hold it in place on the rack.

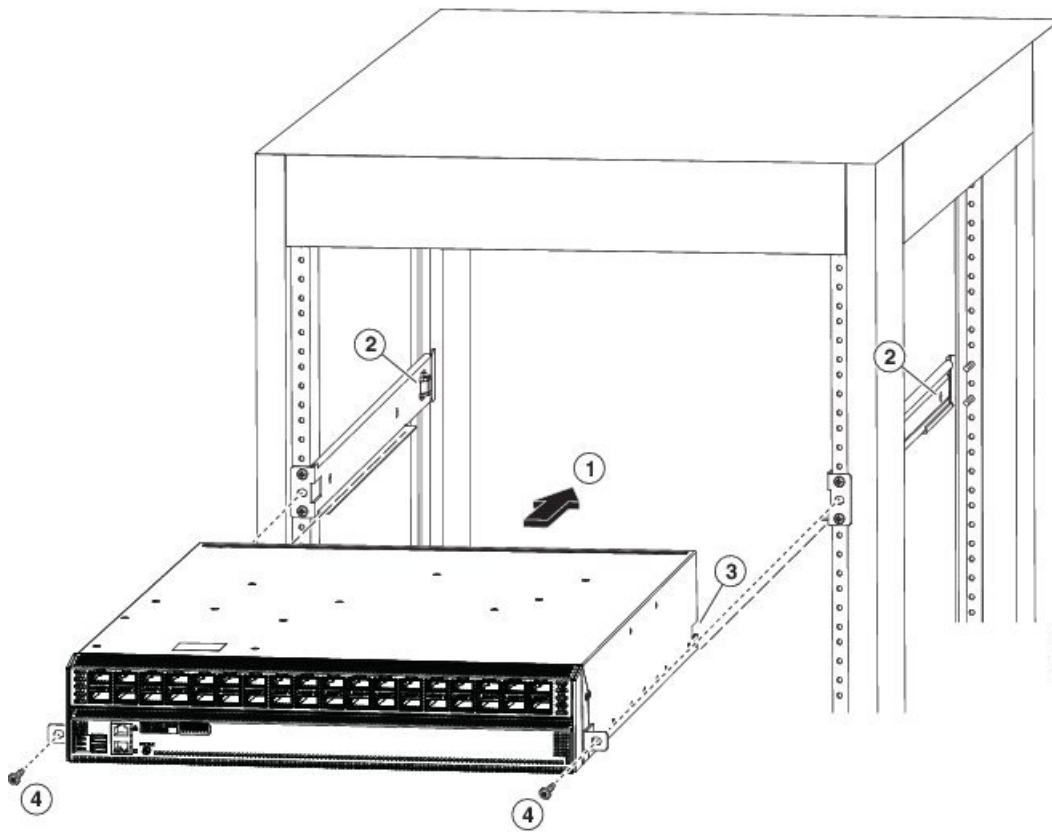

| | | | |
|---|---|---|--|
| 1 | Slide the power-supply end of the chassis onto the bottom-support rails so that the chassis locks onto the chassis stops at the end of the rails. | 3 | Receiving hole on each side of the chassis for the chassis stops on the bottom-support rails. |
| 2 | Chassis stops for holding the chassis (positioned by the aisle required for the fan and power supply modules). | 4 | Customer-supplied rack-mount screw (M6 x 10 mm screw or other screw appropriate for the rack) used to secure each side of the chassis to the rack. |

Step 2

Use a customer-supplied rack-mount screw (an M6 x 10 mm screw or other appropriate screw for the rack) to attach each of the two mounting brackets on the chassis to the rack and tighten each screw to the appropriate torque setting for the screw (for M6 x 10 mm screws, use 40 in-lbs [4.5 N·m] of torque).

Grounding the Chassis

The switch chassis is automatically grounded when you properly install the switch in a grounded rack with metal-to-metal connections between the switch and rack.

You can also ground the chassis, which is required if the rack is not grounded, by attaching a customer-supplied grounding cable. Attach the cable to the chassis grounding pad and the facility ground.



Warning Statement 1024—Ground Conductor

This equipment must be grounded. To reduce the risk of electric shock, never defeat the ground conductor or operate the equipment in the absence of a suitably installed ground conductor. Contact the appropriate electrical inspection authority or an electrician if you are uncertain that suitable grounding is available.



Warning Statement 1046—Installing or Replacing the Unit

To reduce risk of electric shock, when installing or replacing the unit, the ground connection must always be made first and disconnected last.

Before you begin

Before you can ground the chassis, you must have a connection to the earth ground for the data center building.

Step 1 Use a wire-stripping tool to remove approximately 0.75 inch (19 mm) of the covering from the end of the grounding wire. We recommend 6-AWG wire for the U.S. installations.

Step 2 Insert the stripped end of the grounding wire into the open end of the grounding lug. Use a crimping tool to crimp the lug to the wire, see the following figure. Verify that the ground wire is securely attached to the grounding lug by attempting to pull the wire out of the crimped lug.

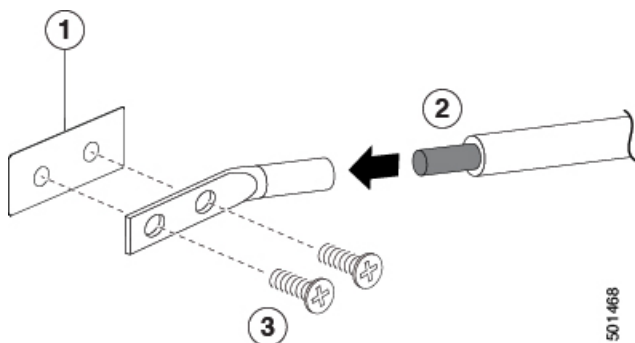

| | | | |
|---|---|---|---|
| 1 | Chassis grounding pad | 3 | 2 M4 screws are used to secure the grounding lug to the chassis |
| 2 | Grounding cable, with 0.75 in. (19 mm) of insulation that is stripped from one end, which is inserted into the grounding lug and crimped in place | | |

Step 3 Secure the grounding lug to the chassis grounding pad with two M4 screws, see the previous figure. Tighten the screws to 11 to 15 in-lb (1.24 to 1.69 N·m) of torque.

Step 4 Prepare the other end of the grounding wire and connect it to the facility ground.

Starting the Switch

You start the switch by connecting it to its dedicated power source. If you need $n+1$ redundancy, you must connect each of the power supplies to one or two power sources. If you need $n+n$ redundancy, you must connect each power supply in a switch to a different power source.

Before you begin

- The switch must be installed and secured to a rack or cabinet.
- The switch must be adequately grounded.
- The rack must be close enough to the dedicated power source so that you can connect the switch to the power source by using a designated power cables.
- You have the designated power cables for the power supplies that you are connecting to the dedicated power sources.



Note Depending on the outlet receptacle on your AC power distribution unit, you might need an optional jumper power cord to connect the switch to your outlet receptacle.

- The switch is not connected to the network (this includes any management or interface connections).
- The fan and power supply modules are fully secured in their chassis slots.

Step 1 For each AC power supply, do the following:

- a) Using the recommended AC power cable for your country or region, connect one end to the AC power supply.
- b) Connect the other end of the power cable to the AC power source.

Step 2 For each HVAC/HVDC power supply, connect it to a power source as follows:

- a) Using the recommended high voltage power cable for your country or region, connect the Anderson Power Saf-D-Grid connector on the power cable to the power receptacle on the power supply. Make sure that the connector clicks when fully pushed into the receptacle.
- b) Connect the other end of the power cable to a power source.
 - When connecting to an HVAC power source, insert the C14 or LS-25 plug in a receptacle for the HVAC power source.
 - When connecting to an HVDC power source, do the following:
 1. Verify that the power is turned off at a circuit breaker for the power source terminals.
 2. Remove the nuts from each of the terminal posts for the power supply.
 3. Place the power cable negative-wire terminal ring on the negative terminal for the power source and secure them with a terminal nut.

4. Place the power cable positive-wire terminal ring on the positive terminal for the power source and secure them with a terminal nut.
5. Place the power cable ground-wire terminal ring on the ground terminal for the power source and secure them with a terminal nut.
6. If there is a safety cover for the power source terminals, place and secure it over the terminals to avoid an electrical shock hazard.
7. Turn on the power at the power source circuit breaker.

Step 3 For each DC power supply, do the following:

- a) Turn off the circuit breaker for the power source to avoid an electrical shock hazard.
- b) Verify that the power cable wires from the power source are connected to a connector block.
- c) Insert the connector block into the receptacle on the power supply. Make sure that the connector block clicks when fully inserted in the receptacle and does not pull out.
- d) If there is a safety cover for the terminals, place and secure it over the terminals to avoid an electrical shock hazard.
- e) Turn on the power at the circuit breaker for the DC power source.

Step 4 Verify that the power supply  LED is on and green.

Step 5 Listen for the fans; they should begin operating when the power supply is powered.

Step 6 After the switch boots, verify that the following LEDs are lit:

- On the fan modules, the Status (STA or STS) LED is green.
If a fan module Status LED is not green, try reinstalling the fan module.
- After initialization, the switch chassis Status (labeled as STA or STS) LED is green.

Step 7 Verify that the system software has booted and the switch has initialized without error messages.

A setup utility automatically launches the first time that you access the switch and guides you through the basic configuration. For instructions on how to configure the switch and check module connectivity, see the appropriate Cisco Nexus 9000 Series configuration guide.



CHAPTER 4

Connecting the Switch to the ACI Fabric

- [ACI Fabric Topology, on page 25](#)
- [Preparing to Connect to Other Devices, on page 26](#)
- [Connecting Leaf Switches to APICs, on page 27](#)
- [Connecting Leaf Switches to Spine Switches, on page 28](#)
- [Installing a Gigabit Ethernet module \(GEM\), on page 30](#)
- [Virtual Port Channel Migration - Migration of Nodes from a First-Generation Switch to a Second-Generation Switch, on page 30](#)
- [Setting Up an Optional Console Interface, on page 31](#)
- [Setting Up an Optional Management Connection, on page 32](#)
- [Optic Transceiver Removal Using the Optics Extraction Tool , on page 32](#)
- [Maintaining Transceivers and Optical Cables, on page 33](#)

ACI Fabric Topology

The ACI fabric topology includes the following major components:

- Application Centric Infrastructure Controller (APIC) appliance (cluster of APICs)
- Leaf switches (for switch compatibility, please see the data sheets here: <https://www.cisco.com/c/en/us/products/switches/nexus-9000-series-switches/datasheet-listing.html>)
- Spine switches (for switch compatibility, please see the data sheets here: <https://www.cisco.com/c/en/us/products/switches/nexus-9000-series-switches/datasheet-listing.html>)

As shown in the following figure, each APIC is connected to one or two leaf switches and each leaf switch should be connected to every spine switch in the same fabric.



Note To prevent sub-optimal forwarding between endpoints, connect every leaf switch in the fabric to every spine switch in the same fabric.

Figure 2: Connections Between APIC Clusters, Leaf Nodes, and Spine Nodes

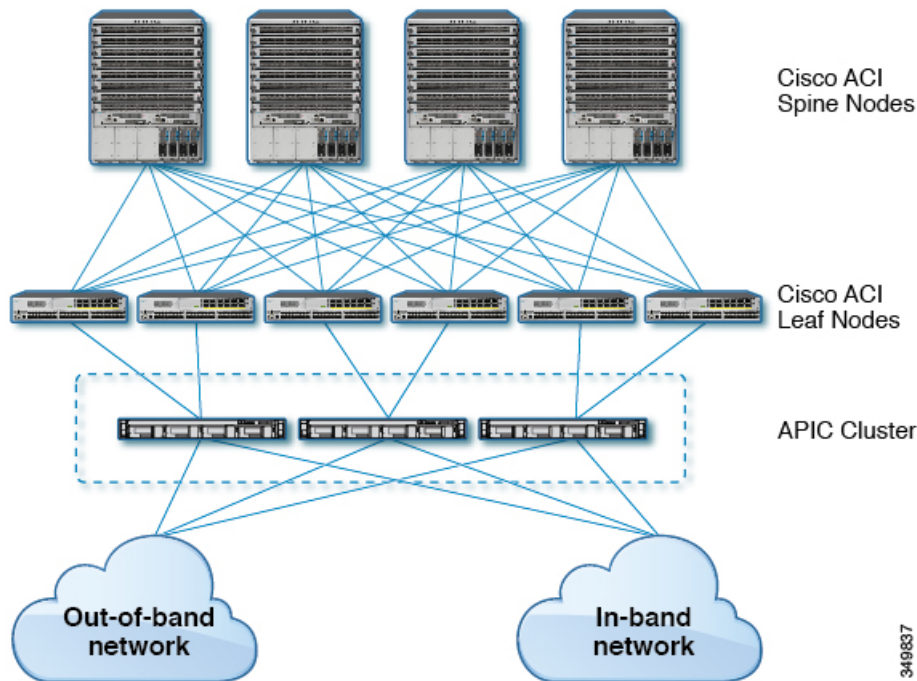

Preparing to Connect to Other Devices

When preparing to connect the fabric devices, consider the following for each type of interface, and gather all of the required equipment before making the connections:

- Cabling type required for each interface type
- Distance limitations for each signal type
- Additional interface equipment required



Note When running power and data cables in overhead or subfloor cable trays, we strongly recommend that you locate power cables and other potential noise sources as far away as practical from network cabling that terminates on Cisco equipment. In situations where long parallel cable runs cannot be separated by at least 3.3 feet (1 meter), we recommend that you shield any potential noise sources by housing them in a grounded metallic conduit.

The optical transceivers that are not already assembled to their cables come separate from their cables. To prevent these transceivers and their cables from being damaged, we recommend that you keep the transceivers disconnected from their cables when installing them in ports and then insert the optical cable into the transceiver. When removing transceivers from ports, remove their cables before removing the transceivers.

To maximize the effectiveness and life of your transceivers and optical cables, do the following:

- Wear an ESD-preventative wrist strap that is connected to an earth ground whenever handling transceivers. The switch is typically grounded when you install transceivers and provides an ESD port to which you

can connect your wrist strap. If you cannot find an ESD port, connect the wrist strap to an earth ground (such as the grounding connection for the chassis).

- Do not remove or insert a transceiver more often than necessary. Repeated removals and insertions can shorten its useful life.
- Keep the transceivers and fiber-optic cables clean and dust free to maintain high signal accuracy and to prevent damage to the connectors. Attenuation (loss of light) increases with contamination and should be kept below 0.35 dB.
 - Clean these parts before installing them to prevent dust from scratching the fiber-optic cable ends.
 - Clean the connectors regularly; the required frequency of cleaning depends upon the environment. In addition, clean connectors if they are exposed to dust or accidentally touched. Both wet and dry cleaning techniques can be effective; refer to your site's fiber-optic connection cleaning procedures.
 - Do not touch the ends of connectors. Touching the ends can leave fingerprints and cause other contamination.
- Inspect routinely for dust and damage. If you suspect damage, clean and then inspect fiber ends under a microscope to determine if damage has occurred.

Connecting Leaf Switches to APICs

You must downlink one or two (recommended for redundancy) Cisco Nexus 9300 platform ACI-mode leaf switches to each Application Policy Infrastructure Controller (APIC) in your ACI fabric. The type of virtual interface card (VIC) installed on the APIC determines the types of interface cables that you can use to connect the leaf switches to the APICs.

- The **VIC 1225T** module supports copper connectors, copper cables, and switches with copper downlink ports (such as: Cisco Nexus 93108TC-EX, 93108TC-FX, 93120TX, 93128TX, 9372TX, 9372TX-E, and 9396TX switches).
- The **VIC 1225** module supports optical transceivers, optical cables, and switches with optical downlink ports (such as: Cisco Nexus 93180LC-EX, 93180YC-EX, 93180YC-FX, 9332PQ, 9336C-FX2, 9348GC-FXP, 9372PX, 9372PX-E, 9396PX, and 93600CD-GC switches).
- The **VIC 1455** module supports optical transceivers, optical cables, and switches with optical downlink ports (such as: Cisco Nexus 9336C-FX2, 93180LC-EX, 93180YC-EX, 93180YC-FX, 93240YC=FX2, and 93600CD-GC switches).

Before you begin

The APIC and leaf switches in the fabric must be fully installed in their racks and grounded.

Step 1

Connect an interface cable to one of the two to four ports on the virtual interface card (VIC) installed on the APIC. If the cable is not already assembled to its transceivers, insert the transceiver into the VIC port and then connect the optical interface cable to the transceiver.

- For a **VIC 1225T** 10GBASE-T copper module, use 10GBASE-T cables with RJ-45 connectors.
- For a **VIC 1225** optical module, use one of the following sets of transceivers and cables:

- For a **VIC 1455** SFP28 module, 10-Gigabit only, use one of the following sets of transceivers and cables:
 - Cisco 10GBASE-LR transceivers (SFP-10G-LR) supporting a link length of up to 6.1 miles (10 km)
 - Cisco 10GBASE-SR transceivers (SFP-10G-SR) supporting the following link lengths:
 - Using 2000 MHz MMF (OM3) for up to 984 feet (300 m)
 - Using 4700 MHz MMF (OM4) for up to 1312 feet (400 m)
 - Cisco SFP+ Active Optical Cables (SFP-10G-AOCxM [where x=1, 2, 3, 5, 7, or 10 for lengths in meters])
 - Cisco SFP+ Twinax Cables (SFP-H10GB-CUxM [where x=1, 2, 3, 5, 7, or 10 for lengths in meters])

Note The VIC 1455 has 4 ports, port-1, port-2, port-3, and port-4 from left to right.

- All ports must have the same speed, either 10-Gigabit or 25-Gigabit.
- Port-1 and port-2 is one pair, corresponding to eth2-1 on APIC and port-3 and port-4 is another pair, corresponding to eth2-2 on APIC. Only one connection is allowed for each pair. For example, you can connect one cable to either port-1 or port-2, and connect another cable to either port-3 or port-4 (**please do not connect two cables on any pair**).

To determine which transceivers, adapters, and cables are supported by this switch, see

<http://www.cisco.com/c/en/us/support/interfaces-modules/transceiver-modules/products-device-support-tables-list.html>.

To see the transceiver specifications and installation information, see

<http://www.cisco.com/c/en/us/support/interfaces-modules/transceiver-modules/products-installation-guides-list.html>.

Step 2 Connect the other end of the interface cable to a downlink port on a leaf switch.

- For a Cisco 10GBASE-LR or -SR transceiver and cable, insert the transceiver into a downlink optical port on a leaf switch before connecting the cable to the transceiver.
- For Cisco SFP+ Active Optical Cables, insert the transceiver on the cable into a downlink optical port on a leaf switch.
- For a 10GBASE-T copper cable, insert the RJ-45 connector on the cable into a downlink BASE-T port on a leaf switch.

Note To determine which transceivers and cables are supported by this switch, see <http://www.cisco.com/c/en/us/support/interfaces-modules/transceiver-modules/products-device-support-tables-list.html>.

Connecting Leaf Switches to Spine Switches

For optimal forwarding between endpoints, you must connect each leaf switch to every spine switch in the same ACI fabric.

To determine which transceivers, adapters, and cables are supported by this switch, see

<http://www.cisco.com/c/en/us/support/interfaces-modules/transceiver-modules/products-device-support-tables-list.html>.

To see the transceiver specifications and installation information, see

<http://www.cisco.com/c/en/us/support/interfaces-modules/transceiver-modules/products-installation-guides-list.html>.

**Warning Statement 1055**—Class 1/1M Laser

Warning – Invisible Laser Radiation. Do not expose users of telescopic optics. Class 1/1M Laser Products.

**Warning Statement 1056**—Unterminated Fiber Cable

Invisible laser radiation may be emitted from the end of the unterminated fiber cable or connector. Do not view directly with optical instruments. Viewing the laser output with certain optical instruments (for example, eye loupes, magnifiers, and microscopes) within a distance of 100 mm may pose an eye hazard.

Before you begin

- The leaf and spine switches in the fabric (such as: N9K-C9364C, N9K-C9332C, and N9K-C9316D-GX) must be fully installed in their racks and grounded.
- If there are modular switches in the fabric, their ACI-mode line cards must already be installed. The line cards can be of the following types:
 - 36-port 40-Gigabit (such as: N9K-X9736PQ)
 - 32-port 100-Gigabit (such as: N9K-X9732C-EX) (supported by Cisco Nexus 9504 and 9508 modular switches)
 - 36-port 100-Gigabit (such as: N9K-X9736C-FX)



Note You cannot include NX-OS line cards in the same chassis when running in ACI mode.



Note Multiple uplinks from a leaf switch to a spine switch is supported. A symmetrical topology is recommended so that all devices have equal access to resources.

- Step 1** For the transceivers with removable cables, make sure that the transceivers are separated from their interface cables.
- Step 2** Insert the appropriate transceiver into an active uplink port on the leaf switch.
- Step 3** Insert the same type of transceiver in the spine switch port on the line card.
- Step 4** For transceivers with removable cables, insert the interface cable into the open end of each of those transceivers.
- Step 5** Repeat Steps 1 through 4 for each spine switch in the ACI fabric.

The leaf switch is connected to each spine switch in the ACI fabric.

- Step 6** Repeat Steps 1 through 5 for each leaf switch in the ACI fabric.
Each leaf switch in the ACI fabric is connected to each spine switch in the network,

The fabric automatically implements Equal Cost Multi-Pathing (ECMP) and enables all links. You do not need to configure the links.

Installing a Gigabit Ethernet module (GEM)

- Step 1** Clear the switch's current configuration by using the `setup-clean-config` command.
- Step 2** Power off the switch by disconnecting the power.
- Step 3** Replace the current GEM card with the new GEM card.
- Step 4** Power on the switch.
-

Virtual Port Channel Migration - Migration of Nodes from a First-Generation Switch to a Second-Generation Switch

Initially the fabric is configured with vPCs between two first-generation switches. Traffic flows are designed so that only these vPCs are used for data traffic. Now that you want to migrate both of the first-generation switches to second-generation switches, the following steps are required.

For this procedure, vPC primary and vPC secondary are first generation switches in vPC pair, sending traffic as described above.

To determine which transceivers, adapters, and cables that this switch supports, see <http://www.cisco.com/c/en/us/support/interfaces-modules/transceiver-modules/products-device-support-tables-list.html>. To see the transceiver specifications and installation information, see <http://www.cisco.com/c/en/us/support/interfaces-modules/transceiver-modules/products-installation-guides-list.html>.

Before you begin

You have two first-generation Cisco Nexus 9000 Series switches comprising a virtual port channel (vPC). You are migrating to two second-generation Cisco Nexus 9000 Series switches using the same cables.

First-generation Cisco Nexus 9000 Series switches include those switches that do not contain an EX or an FX in the PID (product identification).

Second-generation Cisco Nexus 9000 Series switches include those switches that have an EX or an FX in the PID.

Move any APIC controllers that are connected to the migrating vPC first-generation switches to any other switches in the fabric and wait for the APIC cluster to become "Fully Fit".

-
- Step 1** From the APIC GUI, perform the **Remove From Controller** operation for vPC secondary. The switch is clean rebooted by the APIC. Wait for about 10 minutes for this operation to finish. This action prompts all traffic to use the other first-generation switch for data traffic. Disconnect the cabling from vPC secondary.
- Step 2** Uninstall the first-generation switch by reversing the order of the steps in the Installing the Switch Chassis section, of the switch specific Hardware Installation Guide.
- Step 3** Install the second-generation switch by following the steps in the Installing the Switch Chassis section, of the switch specific Hardware Installation Guide.
- Step 4** Connect the loose cabling that you removed from the first-generation switch, to the same ports on the second-generation switch.
- Step 5** Now you register the new second-generation switch with the APIC. Register the new node with the same node name and node ID. This switch becomes part of the fabric. Policies are pushed to the new switch and the vPC legs are kept down since there is a mismatch of generation switches. At this point, vPC primary continues to send the data traffic.
- Step 6** From the APIC GUI, perform the **Remove From Controller** operation for vPC primary. This switch is clean rebooted by the APIC.
- Wait for about 10 minutes for this operation to finish. The vPC leg on the second-generation switch, which was kept down earlier comes up. This action prompts all traffic to move to the new second-generation switch. Please note the vPC ports on the new second-generation switch will come up in about 10 to 22 seconds when STP is disabled for the deployed VLANs on the remote devices, and there will be traffic drops in the range of 10 to 40 seconds, depending upon the flows in the fabric. When STP is enabled on the VLANs on the remote devices, the traffic loss will be in the range of 40 to 75 seconds, depending upon the flows in the fabric.
- Step 7** Disconnect the cabling from the other first-generation switch.
- Step 8** Uninstall the first-generation switch, like you did in step 2.
- Step 9** Install the second-generation switch, like you did in step 3.
- Step 10** Connect the loose cabling, like you did in step 4.
- Step 11** Register the new second-generation switch with the APIC. Register the new node with the same node name and node ID. This switch becomes part of the fabric. Policies are pushed to the new switch and the vPC legs comes up and starts passing traffic.
-

Setting Up an Optional Console Interface

You can optionally set up a console interface for performing the initial configuration of the switch. To do this, use the interface cable provided in the accessory kit to connect the switch to your console device. You can connect the console port on the switch to a modem. If you do not connect it to a modem, make the connection either before powering up the switch or after completing the boot process for the switch.

Before you begin

The console device must support VT100 terminal emulations and asynchronous transmissions.

-
- Step 1** Configure the terminal emulator program to match each of the following default port characteristics:
- 9600 baud

- 8 data bits
- 1 stop bit
- No parity

Step 2 Insert the RJ-45 connector on the interface cable found in the accessory kit into the RS-232 port on the switch and insert the DB-9 connector on the other end of the cable to the serial port on the console device.

What to do next

You can now perform the initial configuration for the switch (see the *Cisco ACI Getting Started Guide*).

Setting Up an Optional Management Connection

You can optionally set up an out-of-band management connection for monitoring and troubleshooting purposes. To do this, depending on your switch, you connect either the RJ-45 management port or the SFP management port on the switch to an external hub, switch, or router.

Before you begin

To prevent an IP address conflict, you must complete the initial configuration for the switch and establish an IP address before you create the management connection.

Step 1 Connect the interface cable to a management port on the switch.

Step 2 Connect the other end of the cable to an external hub, switch, or router.

Optic Transceiver Removal Using the Optics Extraction Tool

You use both ends of the optics extraction tool in this procedure. You use the wide end for releasing the bale latch, and the narrow end for removing the transceiver module.

Before you begin

Ensure that before you handle any switch components, you are wearing a grounded electrostatic discharge (ESD) strap. To ground the strap, attach it directly to earth ground or to a grounded rack or chassis. There must be a metal-to-metal connection to earth ground.

Step 1 Remove the fiber-optic cables from the transceiver module before removing the transceiver module.

Step 2 Use the wide side of the optics extraction tool to release the bale latch (see the following image).

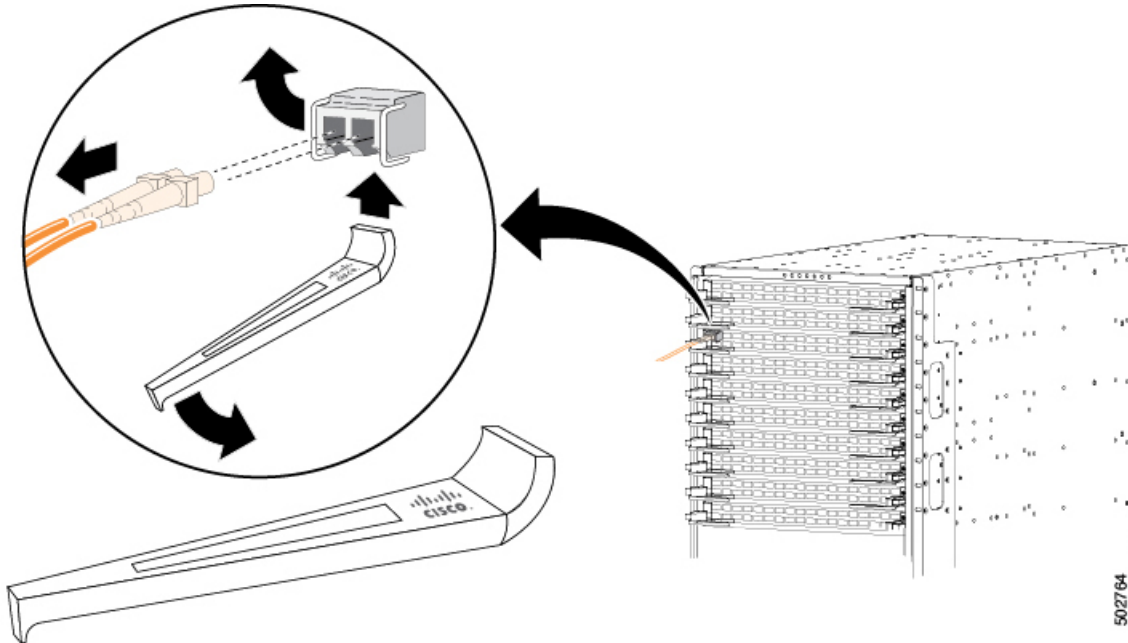

Step 3 Use the narrow end of the optics extraction tool to carefully remove the transceiver module (see the following

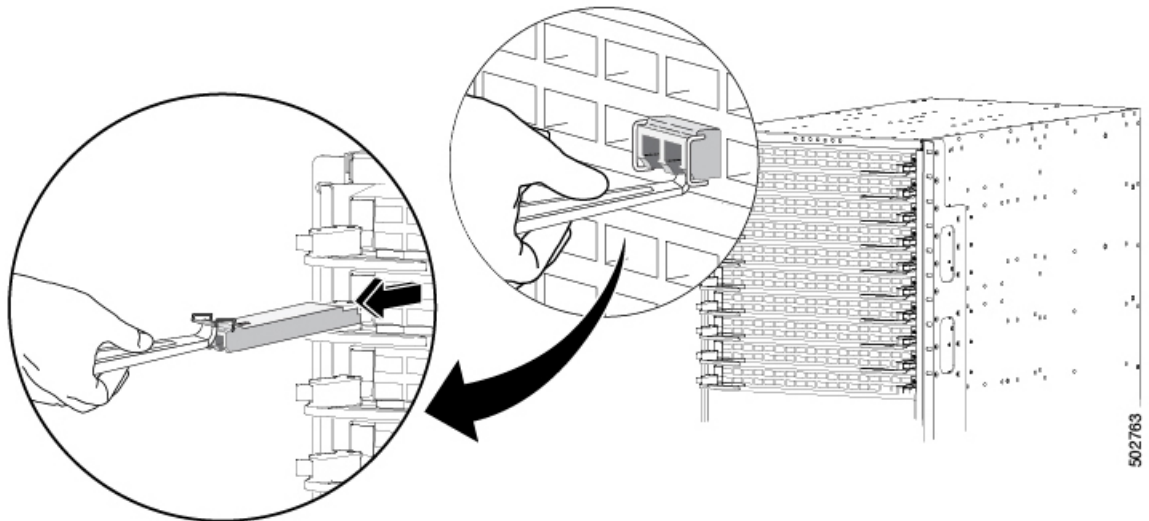

image).

Step 4 Place the transceiver module in an antistatic bag or other protective environment.

Maintaining Transceivers and Optical Cables

Transceivers and fiber-optic cables must be kept clean and dust free to maintain high signal accuracy and prevent damage to the connectors. Contamination increases attenuation (loss of light) and should be below 0.35 dB.

Consider the following maintenance guidelines:

- Transceivers are static sensitive. To prevent ESD damage, wear an ESD-preventative wrist strap that is connected to the grounded chassis.
- Do not remove and insert a transceiver more often than is necessary. Repeated removals and insertions can shorten its useful life.
- Keep all optical connections covered when not in use. Clean them before using to prevent dust from scratching the fiber-optic cable ends.
- Do not touch the ends of connectors. Touching the ends can leave fingerprints and cause other contamination.
- Clean the connectors regularly; the required frequency of cleaning depends upon the environment. In addition, clean connectors if they are exposed to dust or accidentally touched. Both wet and dry cleaning techniques can be effective; refer to the fiber-optic connection cleaning procedures for your site.
- Inspect routinely for dust and damage. If you suspect damage, clean and then inspect fiber ends under a microscope to determine if damage has occurred.



CHAPTER 5

Replacing Modules

- [Replacing a Fan Module During Operations, on page 35](#)
- [Replacing a Power Supply Module, on page 37](#)

Replacing a Fan Module During Operations

There must always be at least two fan modules installed in the chassis to maintain the designed airflow. You can remove one fan module temporarily to replace it with another fan module but if the replacement fan module is not available, leave the original fan module in the chassis.

All fan and power supply modules must have the same airflow direction or else an error can occur with the switch overheating and shutting down. You can determine the airflow direction of a fan module by the color of the stripe on the front of the module. If the fan module has a blue stripe for port-side exhaust airflow, the power supplies must have blue or gray coloring for the same airflow direction. If the fan module has a burgundy stripe for port-side intake airflow, the power supplies must have burgundy or green coloring for the same airflow direction. To avoid over heating the switch, make sure that the fan modules are positioned in one of the following ways:

- For port-side exhaust airflow with blue coloring, position the fan modules in a cold aisle.
- For port-side intake airflow with burgundy coloring, position the ports in a cold aisle.

Before you begin

Before you can replace a fan module, ensure that both of the following conditions exist:

- There is another functioning fan module in the chassis. In order to replace a fan module during operations, there must be another fan module circulating air in the chassis at all times.
- The replacement fan module must have the same airflow direction as the other modules in the chassis.

If you must replace the fan module during operations and both of the above conditions are not met, leave the fan module that you need to replace in the chassis to preserve the designed airflow until you have the required module.

Step 1 Remove the fan module that you need to replace as follows:

- a) Unscrew the captive screw that secures the fan module to the chassis (see the following figure).

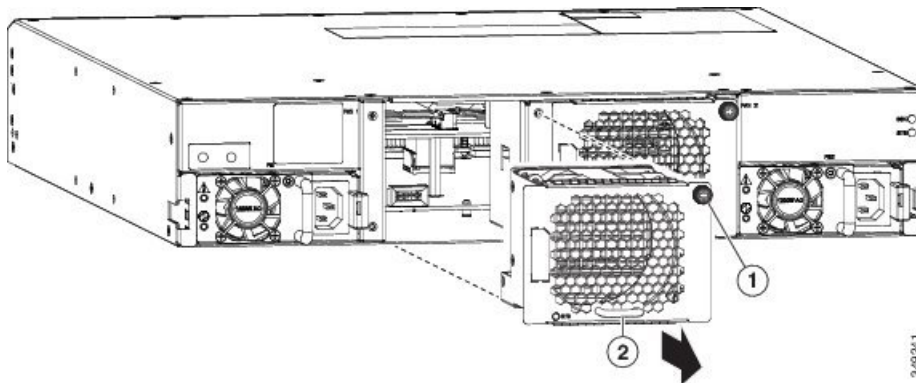

| | | | |
|---|---|---|--|
| 1 | Loosen the captive screw so that it is no longer in contact with the chassis. | 2 | Holding the handle on the fan module, slide it out of the chassis. |
|---|---|---|--|

- b) Pull the fan module handle to slide the module out of the chassis.

Caution To prevent electrostatic discharge (ESD) damage to the module electronics, do not touch the electrical connectors on the back side of the module. Also, to prevent any damage to the electrical connectors, prevent them touching anything that can bend or break them.

- c) Place the removed module on an antistatic surface or in an antistatic bag. If possible, repack the module in its packing materials for safe shipping or storage.

Step 2

Follow these steps to replace the missing fan module within two minutes to avoid a shutdown.

- a) Remove the replacement fan module from its packing materials and place it on an antistatic surface.

Hold the module by its handle and do not touch the electrical connectors on its backside. Also, to protect the electrical connectors, avoid letting them come in contact with anything other than the electrical connectors inside the chassis.

- b) Verify that you have the right fan module for the chassis. The correct fan module has one of the following part numbers:

- N9K-C9300-FAN3-B (port-side exhaust airflow direction and a blue stripe)
- N9K-C9300-FAN3 (port-side intake airflow direction and a burgundy stripe)

Note Be sure that the airflow direction of the new fan module matches the airflow direction of the other fan and AC power supply modules already installed in the chassis. Port-side intake airflow is indicated with burgundy or green coloring, and port-side exhaust airflow is indicated with blue or gray coloring. Power supplies with dual-direction airflow (airflow direction is set by the fan modules) have white coloring.

- c) Position the fan module in front of the open fan slot (be sure that the backside of the module with the electrical connectors is positioned to enter the slot first) and slide the module all the way into the chassis until its front side comes in contact with the chassis. For the last 0.2 inches (0.5 cm), carefully mount the module onto the chassis connectors by pushing more firmly, but do not force the module if it does not move further (excessive force can damage the connectors).

Note If you are not able to push the module all the way into the slot, carefully slide the module out of the slot and check its electrical connectors for damage. If damaged, contact Cisco Technical Assistance for help. If undamaged, repeat this step to reinstall the module.

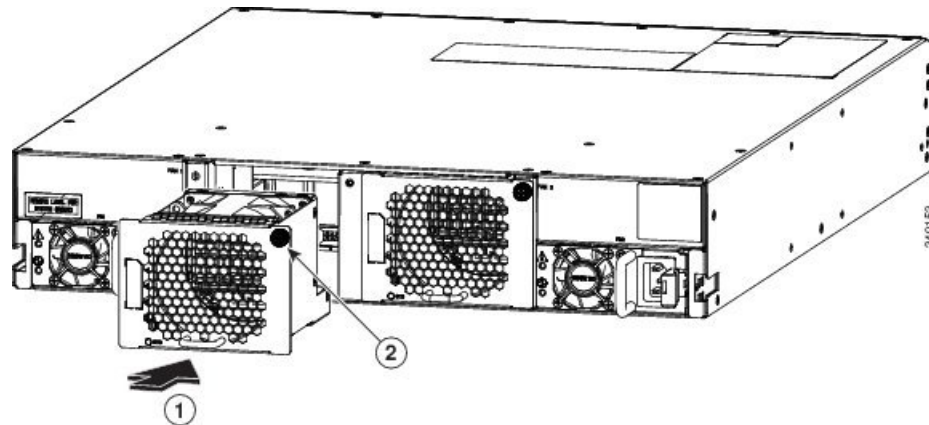

| | | | |
|---|--|---|---|
| 1 | Holding the handle on the fan module, slide its connector end into the fan slot until the front of the fan module is touching the chassis. | 2 | Screw in the captive screw to attach the module to the chassis. |
|---|--|---|---|

- d) Verify that the STS LED turns on and becomes green.

If the STS LED does not turn on, slide the module out of the chassis, and visually check the electrical connectors on the back side of the chassis for damage. If damaged, contact Cisco Technical Assistance for help. If undamaged, repeat the previous step to reinstall the module.

- e) Secure the fan module to the chassis by screwing in the captive screw to the chassis. Tighten the screw to 5 to 7 in-lb (0.56 to 0.79 N·m).

Replacing a Power Supply Module

The switch requires two power supplies for redundancy. With one power supply providing the necessary power for operations, you can replace the other power supply during operations so long as the new power supply has the same airflow direction as the other modules in the chassis.

You can replace a power supply with another supported power supply that has the same power source type and the same wattage rating as the other installed power supply. Additionally, the airflow direction of the power supply must match or conform to the airflow direction of the installed fan modules. For the airflow direction used by the switch, see the coloring of the fan modules.

Removing an AC Power Supply

To remove an AC power supply, you must first disconnect the power cable and then remove the module from the chassis.

Before you begin

- To replace a power supply during operations, you must have a functioning power supply providing power to the switch while you replace the other power supply. If there is only one power supply installed in the switch and you need to replace it, install the new power supply in the open slot and power it up before removing the original power supply.

- Ensure that the chassis is grounded. For grounding instructions, see [Grounding the Chassis, on page 21](#).

Step 1 Pull the power cord out from the power receptacle on the power supply to be removed and verify that the  LED turns off.

Note The  LED might be on and amber colored to indicate that the input power has been disconnected.

Step 2 Remove the power supply from the chassis by pushing and holding its thumb latch to the left and pulling the power supply part way out of the chassis (see the following figure).

Figure 3: Replacing a Power Supply from the Chassis

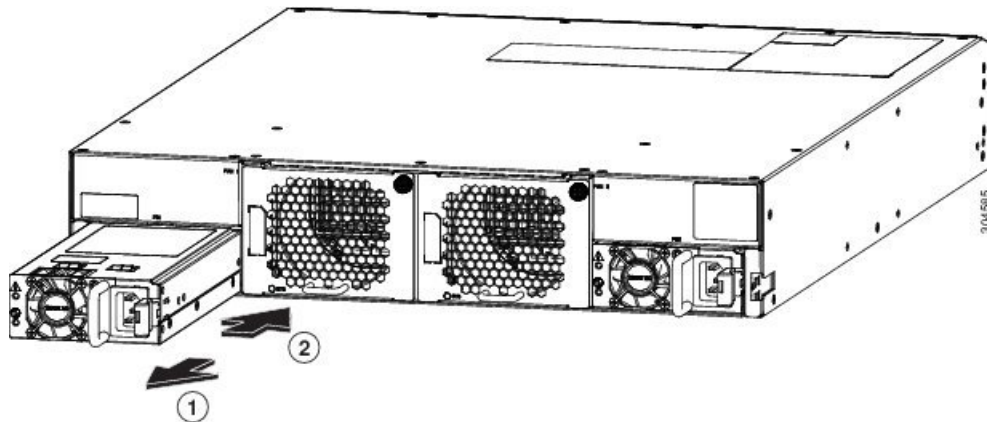

| | | | |
|---|---|---|--|
| 1 | Push thumb latch to the left and slide out to remove. | 2 | Slide in until the latch clicks to install |
|---|---|---|--|

Step 3 Place your other hand under the power supply to support it while you slide it out of the chassis.

Either place the power supply on an antistatic surface or pack it in its packing materials.

Step 4 If the power supply slot is to remain empty, install a blank power supply filler panel (part number N2200-P-BLNK).

What to do next

You are ready to install the replacement power supply.

Removing a DC Power Supply

You can remove one power supply while the other one provides power to the switch.

To disconnect the power supply from its power cables, you must shut off the power from the power source and then either disconnect a connector for the power cables or release each of three cables from the power supply (requires a standard screw driver).

Step 1 Turn off the circuit breaker for the power feed to the power supply that you are replacing.

Be sure that the LEDs turn off on the power supply that you are removing.

- Step 2** Remove the power cable from the power supply by doing the following:
- To remove an orange power cable connector from a 48-V DC power supply, do the following:
 - a. Push the orange plastic button on the top of the connector block inward toward the power supply.
 - b. Pull the connector block out of the power supply.
 - To remove an Anderson Power Products Saf-D-Grid power cable connector from a high-voltage power supply, press on the tab at the top of the Saf-D-Grid connector and pull the connector out of the power supply.
- Step 3** Grasp the power supply handle while pressing the release latch towards the power supply handle.
- Step 4** Pull the power supply out of the bay.

What to do next

You are ready to install a DC power supply in the open slot.

Installing an AC Power Supply

You can replace one power supply while the other one provides power to the switch.

Before you begin

- The power supply that you are installing must be capable of using the same airflow direction as the fan trays installed in the same switch and it must use the same type of power source as the other power supply installed in the same switch (do not mix AC and DC power supplies in the same switch).



Note DC power supplies with green coloring have the same port-side intake airflow direction as the power supplies with red coloring, and DC power supplies with gray coloring have the same port-side exhaust airflow direction as the power supplies with blue coloring. If the power supply that you are replacing has a different color handle than the replacement power supply, verify that it has or will have the same airflow direction as the other modules in the switch.

- An AC power source must be within reach of the power cable that will be used with the replacement power supply. If you are using $n+n$ power redundancy, there must be a separate power source for each power supply installed in the chassis. Otherwise, only one power source is required.
- There must be an earth ground connection to the chassis that you are installing the replacement module. Typically, the chassis is grounded by its metal-to-metal connection with a grounded rack. If you need to ground the chassis, see [Grounding the Chassis, on page 21](#).

-
- Step 1** Holding the replacement power supply with one hand underneath the module and the other hand holding the handle, turn the power supply so that its release latch is on the right side and align the back end of the power supply (the end with the electrical connections) to the open power supply slot before carefully sliding the power supply all the way into the slot until it clicks into place.

Note If the power supply does not fit into the open slot, turn the module over before sliding it carefully into the open slot.

Step 2 Test the installation by trying to pull the power supply out of the slot without using the release latch.

If the power supply does not move out of place, it is secured in the slot. If the power supply moves, carefully press it all the way into the slot until it clicks in place.

Step 3 Attach the power cable to the electrical outlet on the front of the power supply.

Step 4 Make sure that the other end of the power cable is attached to the appropriate power source for the power supply.

Note Depending on the outlet receptacle on your power distribution unit, you might need the optional jumper cable to connect the switch to your outlet receptacle.

Step 5 Verify that the power supply is operational by making sure that the power supply  LED is green. For information on what the power supply LEDs indicate, see [Power Supply LEDs, on page 56](#).

Installing a DC Power Supply

This topic is for installing the 48-V DC power supply into switch chassis.

You can replace one power supply while the other one provides power to the switch.

Before you begin

- The circuit breaker for the DC power source for the power supply must be turned off.
- The power supply that you are installing must be capable of using the same airflow direction as the fan trays installed in the same switch
- A DC power source must be within reach of the power cable that will be used with the replacement power supply. If you are using $n+n$ power redundancy, there must be a separate power source for each power supply installed in the chassis (do not mix AC and DC power sources for the same switch). Otherwise, only one power source is required.
- There must be an earth ground connection to the chassis that you are installing the replacement module. Typically, the chassis is grounded by its metal-to-metal connection to a grounded rack. If you need to ground this chassis by another means, see [Grounding the Chassis, on page 21](#).
- We recommend 8-AWG wire for DC installation in the U.S.
- All DC power supplies have reverse polarity protection. When you inadvertently connect the input power (+) to the DC PSU's – terminal and the input power – to the DC PSU's (+) terminal, the PSU will not be damaged and will operate fine after the input power feeds are correctly wired.

Step 1 Holding the replacement power supply with one hand underneath the module and the other hand holding the handle, turn the power supply so that its release latch is on the right side and align the back end of the power supply (the end with the electrical connections) to the open power supply slot before carefully sliding the power supply all the way into the slot until it clicks into place.

Note If the power supply does not fit into the open slot, turn the module over before carefully sliding it into the open slot.

Step 2 If the DC power cables and a grounding cable are already connected to an electrical connector block, insert the block into the power receptacle on the power supply.

If the electrical cables have not been connected to the electrical connector block, wire them as described in [Wiring a 48 V DC Electrical Connector Block, on page 41](#).

Step 3 Turn on the circuit breaker for the DC power source connected to the power supply.

Step 4 Verify that the power supply is operational by making sure that the power supply  LED is green. For information on what the power supply LEDs indicate, see [Power Supply LEDs, on page 56](#).

Wiring a 48 V DC Electrical Connector Block

You must connect the ground, negative, and positive DC power cables to a connector block in order to connect the power cables to a 48 V DC power supply.



Note The recommended wire gauge is 8 AWG. The minimum wire gauge is 10 AWG.



Warning [Statement 342](#)—Before Connecting to System Power Supply

High touch/leakage current – Permanently connected protective earth ground is essential before connecting to system power supply.



Warning [Statement 1024](#)—Ground Conductor

This equipment must be grounded. To reduce the risk of electric shock, never defeat the ground conductor or operate the equipment in the absence of a suitably installed ground conductor. Contact the appropriate electrical inspection authority or an electrician if you are uncertain that suitable grounding is available.

Before you begin

You must turn off the circuit breaker for the DC power cables that you are connecting to prevent electrocution.

Step 1 Verify that the circuit breaker for the power feed to the replacement power supply is turned off.

Step 2 Remove the DC power connector block from the power supply by doing the following:

- Push the orange plastic button on the top of the connector block inward toward the power supply.
- Pull the connector block out of the power supply.

Step 3 Strip 0.6 inches (15 mm) of insulation off the DC wires that you are using.

Step 4 Orient the connector as shown in the following figure with the orange plastic button on top.

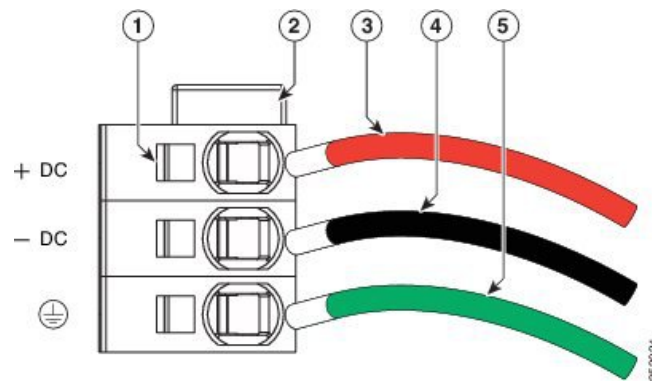

| | | | |
|---|---|---|-------------------------------------|
| 1 | Wire retainer lever | 4 | -48V (-DC) cable |
| 2 | Orange plastic button on top of the connector | 5 | Grounding cable (8 AWG recommended) |
| 3 | -48V Return (+DC) cable | | |

- Step 5** Use a small screwdriver to depress the spring-loaded wire retainer lever on the lower spring-cage wire connector. Insert your green (ground) wire into the aperture and then release the lever.
- Step 6** Use a small screwdriver to depress the spring-loaded wire retainer lever on the middle spring-cage wire connector. Insert your black (DC negative) wire into the aperture and then release the lever.
- Step 7** Use a small screwdriver to depress the spring-loaded wire retainer lever on the upper spring-cage wire connector. Insert your red (DC positive) wire into the aperture and then release the lever.
- Step 8** Insert the connector block back into the power supply. Make sure that your red (DC positive) wire aligns with the power supply label, "+ DC".
- Step 9** Verify that the other ends of the cables are attached to the DC power source and ground. You are then ready to turn on the DC power source.



APPENDIX **A**

Rack Specifications

- [Overview of Racks, on page 43](#)
- [General Requirements for Cabinets and Racks, on page 43](#)
- [Requirements Specific to Standard Open Racks, on page 44](#)
- [Requirements Specific to Perforated Cabinets, on page 44](#)
- [Cable Management Guidelines, on page 44](#)

Overview of Racks

You can install the switch in the following types of cabinets and racks, assuming an external ambient air temperature range of 0 to 104°F (0 to 40°C):

- Standard perforated cabinets
- Solid-walled cabinets with a roof fan tray (bottom to top cooling)
- Standard open racks



Note If you are selecting an enclosed cabinet, we recommend one of the thermally validated types, either standard perforated or solid-walled with a fan tray.



Note We do not recommend that you use racks that have obstructions (such as power strips), because the obstructions could impair access to field-replaceable units (FRUs).

General Requirements for Cabinets and Racks

The cabinet or rack must also meet the following requirements:

- Standard 19-inch (48.3 cm) (two- or four-post EIA cabinet or rack, with mounting rails that conform to English universal hole spacing per section 1 of ANSI/EIA-310-D-1992). For more information, see [Requirements Specific to Perforated Cabinets, on page 44](#).

- The minimum vertical rack space requirement per chassis is:
 - For a one RU (rack unit) switch, 1.75 inches (4.4 cm)
 - For a one and a half RU (rack unit) switch, 2.63 (6.68 cm)
 - For a two RU (rack unit) switch, 3.5 inches (8.8 cm)
 - For a three RU (rack unit) switch, 5.25 inches (13.3 cm)
- The width between the rack-mounting rails must be at least 17.75 inches (45.0 cm) if the rear of the device is not attached to the rack. For four-post EIA racks, this measurement is the distance between the two front rails.

Four-post EIA cabinets (perforated or solid-walled) must meet the following requirements:

- The minimum spacing for the bend radius for fiber-optic cables should have the front-mounting rails of the cabinet offset from the front door by a minimum of 3 inches (7.6 cm).
- The distance between the outside face of the front mounting rail and the outside face of the back mounting rail should be 23.0 to 30.0 inches (58.4 to 76.2 cm) to allow for rear-bracket installation.

Requirements Specific to Standard Open Racks

If you are mounting the chassis in an open rack (no side panels or doors), ensure that the rack meets the following requirements:

- The minimum vertical rack space per chassis must be one rack unit (RU), equal to 1.75 inches (4.4 cm).
- The distance between the chassis air vents and any walls should be 2.5 inches (6.4 cm).

Requirements Specific to Perforated Cabinets

A perforated cabinet has perforations in its front and rear doors and side walls. Perforated cabinets must meet the following requirements:

- The front and rear doors must have at least a 60 percent open area perforation pattern, with at least 15 square inches (96.8 square cm) of open area per rack unit of door height.
- The roof should be perforated with at least a 20 percent open area.
- The cabinet floor should be open or perforated to enhance cooling.

The Cisco R Series rack conforms to these requirements.

Cable Management Guidelines

To help with cable management, you might want to allow additional space in the rack above and below the chassis to make it easier to route all of the fiber optic or copper cables through the rack.



APPENDIX **B**

System Specifications

- [Environmental Specifications, on page 45](#)
- [Switch Dimensions, on page 45](#)
- [Switch and Module Weights and Quantities, on page 45](#)
- [Switch Power Input Requirements, on page 46](#)
- [Power Cable Specifications, on page 46](#)

Environmental Specifications

| Environment | | Specification |
|-------------------|-------------------------------|--------------------------------------|
| Temperature | Ambient operating temperature | 32 to 104°F (0 to 40°C) |
| | Ambient nonoperating | −40 to 158°F (−40 to 70°C) |
| Relative humidity | Nonoperating | 5 to 85% |
| Altitude | Operating | 0 to 13,123 feet (0 to 4,000 meters) |

Switch Dimensions

| Switch | Width | Depth | Height |
|--------------------|-----------------------|-----------------------|----------------------------|
| Cisco Nexus 9336PQ | 17.5 inches (44.5 cm) | 22.5 inches (57.1 cm) | 3.5 inches (8.9 cm) (2 RU) |

Switch and Module Weights and Quantities

| Component | Weight per Unit | Quantity |
|--|-------------------|----------|
| Cisco Nexus 9336PQ Chassis (N9K-C9336PQ) | 24.3 lb (11.0 kg) | 1 |

| Component | Weight per Unit | Quantity |
|---|------------------|---|
| Fan Module | — | 2 |
| – Port-side exhaust (blue) (N9K-C9300-FAN3-B) | 2.4 lb (1.1 kg) | |
| – Port-side intake (burgundy) (N9K-C9300-FAN3) | 2.4 lb (1.1 kg) | |
| Power Supply module | — | 2 (1 for operations and 1 for redundancy) |
| – 1200-W AC port-side exhaust (blue) (N9K-PAC-1200W-B) | 2.64 lb (1.2 kg) | |
| – 1200-W AC port-side intake (burgundy) (N9K-PAC-1200W) | 2.64 lb (1.2 kg) | |
| – 1200-W AC port-side intake (burgundy) (N9K-PAC-1200W) | 2.42 lb (1.1 kg) | |
| – 1200-W HVAC/HVDC dual-direction (white) (N9K-PUV-1200W) | 2.42 lb (1.1 kg) | |
| – 930-W DC port-side exhaust (gray) (UCS-PSU-6332-DC) | 2.42 lb (1.1 kg) | |
| – 930-W DC port-side intake (green) (UCSC-PSU-930WDC) | 2.42 lb (1.1 kg) | |

Switch Power Input Requirements

The following table lists the typical amount of power that the switch consumes. It also lists the maximum amount of power that you must provision for the switch and power supply for peak conditions.



Note Some power supplies have capabilities that are greater than the maximum power requirements for a switch. To determine the power consumption characteristics for the switch, use the typical and maximum requirements that are listed in the following table.

| Switch | Typical Power Consumption (AC or DC) | Maximum Power Consumption (AC or DC) | Heat Dissipation Requirement |
|--------------------|--------------------------------------|--------------------------------------|------------------------------|
| Cisco Nexus 9336PQ | 400 W | 660 W | 2252.013 BTUs per hour |

Power Cable Specifications

The following sections specify the power cables that you can order and use with this switch.

3-kW AC Power Cable Specifications

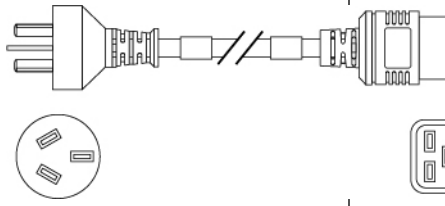
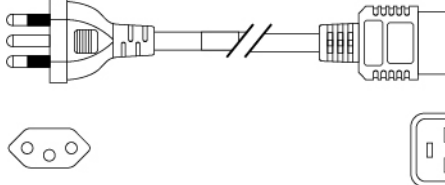
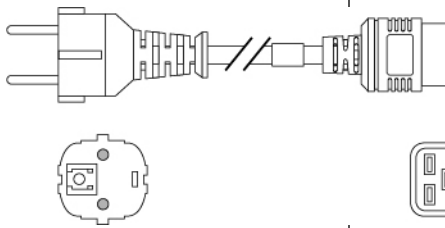
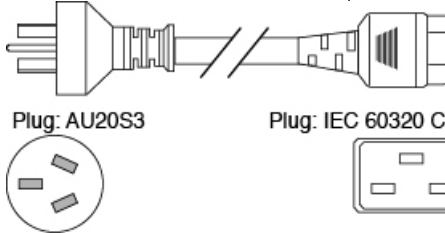
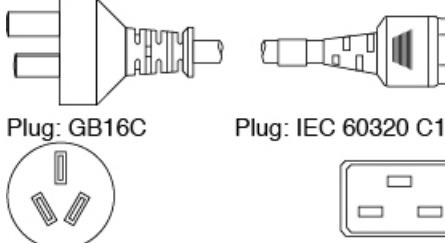

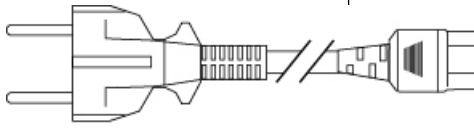
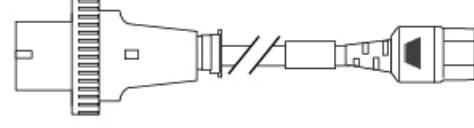
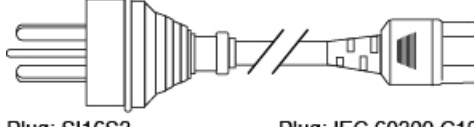
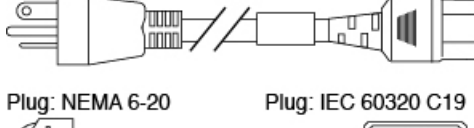
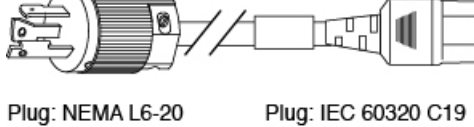
| Locale | Power Cord Part Number | Cord Set Rating | Power Cord Illustration |
|---------------------------|------------------------|-----------------|--|
| Argentina | CAB-9K16A-ARG | 16 A, 250 VAC |  |
| Brazil | CAB-9K16A-BRZ | 16 A, 250 VAC |  |
| Korea | CAB-9K16A-KOR | 16 A, 250 VAC |  |
| South Africa | CAB-9K16A-SA | 16 A, 250 VAC | TBD |
| Australia and New Zealand | CAB-AC-16A-AUS | 16 A, 250 VAC |  <p>Plug: AU20S3 Plug: IEC 60320 C13</p> |
| Peoples Republic of China | CAB-AC-16A-CH | 16 A, 250 VAC |  <p>Plug: GB16C Plug: IEC 60320 C13</p> |

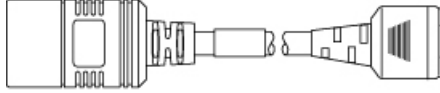
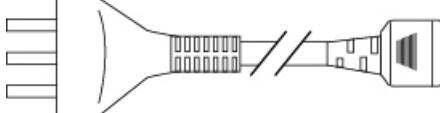
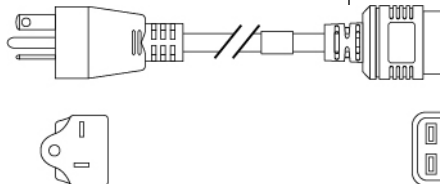
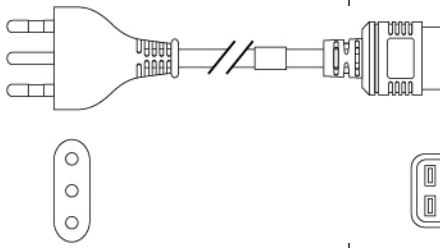
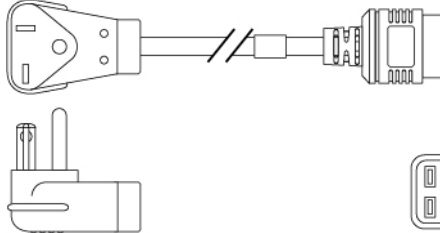



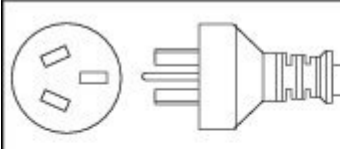
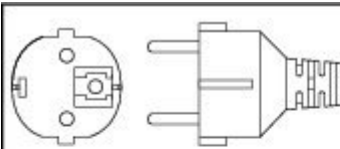
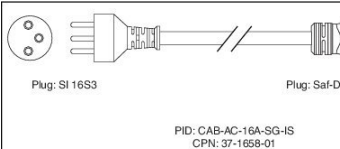

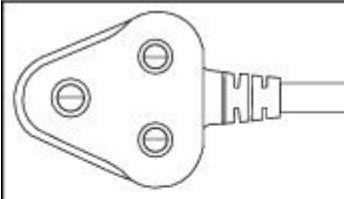

| Locale | Power Cord Part Number | Cord Set Rating | Power Cord Illustration |
|--|------------------------|-----------------|--|
| Continental Europe | CAB-AC-2500W-EU | 16 A, 250 VAC |  <p>Plug: CEE 7/7</p> <p>Plug: IEC 60320 C19</p> |
| International | CAB-AC-2500W-INT | 16 A, 250 VAC |  <p>Plug: IEC 309</p> <p>Plug: IEC 60320 C19</p> |
| Israel | CAB-AC-2500W-ISRL | 16 A, 250 VAC |  <p>Plug: SI16S3</p> <p>Plug: IEC 60320 C19</p> |
| Japan and North America (nonlocking) 200-240 VAC operation | CAB-AC-2500W-US1 | 16 A, 250 VAC |  <p>Plug: NEMA 6-20</p> <p>Plug: IEC 60320 C19</p> |
| Japan and North America (locking) 200-240 VAC operation | CAB-AC-C6K-TWLK | 16 A, 250 VAC |  <p>Plug: NEMA L6-20</p> <p>Plug: IEC 60320 C19</p> |

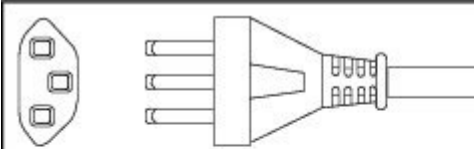
| Locale | Power Cord Part Number | Cord Set Rating | Power Cord Illustration |
|---|------------------------|---|--|
| Power distribution unit (PDU) | CAB-C19-CBN | 16 A, 250 VAC |  Plug: IEC 60320 C20 Plug: IEC 60320 C |
| Switzerland | CAB-ACS-16 | 16 A, 250 VAC |  Plug: SEV 5934-2 Type 23 Plug: IEC 60320 C |
| US | CAB-AC-STRT-C19US | 16 A, 250 VAC (straight blade NEMA 6-20 plug) |  |
| Italy | CAB-C2316-C19-IT | 16 A, 250 VAC (IEC 60320 C19 to CEI 23-16) |  |
| Taiwan | CAB-AC-C19-TW | 16 A, 250 VAC (IEC 60320 C19 to EL 218) |  |
| All except Argentina, Brazil, and Japan | NO-POWER-CORD | No power cord is included with order. | N.A. |

3-kW Universal AC/DC Power Cable Specifications

| Locale | Power Cord Part Number | Cord Set Rating | Power Cord Illustration |
|---------------------------|------------------------|---------------------------------------|--|
| Australia and New Zealand | CAB-AC-16A-SG-AZ | 16 A, 250 VAC (AU20LS3/Saf-D-Grid) |  <p>Plug: AU20LS3</p> <p>PID: CAB- CPN:</p> |
| | CAB-AC-16A-SG-EU | 16A, 250 VAC |  <p>Plug: CEE 7-7</p> <p>PID: CA CPN:</p> |
| Israel | CAB-AC-16A-SG-IS | 16 A, 250 VAC |  <p>Plug: SI 16S3</p> <p>Plug: Saf-D-Grid "T" Latch 3-5958P4</p> <p>PID: CAB-AC-16A-SG-IS CPN: 37-1658-01</p> |

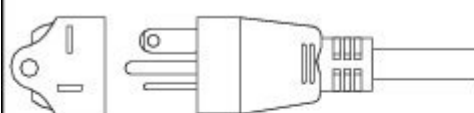
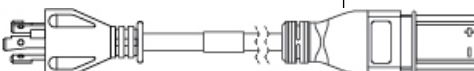
| Locale | Power Cord Part Number | Cord Set Rating | Power Cord Illustration |
|------------------|------------------------|-----------------|--|
| International/UK | CAB-AC-16A-SG-IN | 16 A, 250 VAC |  <p data-bbox="1252 472 1421 506">Plug: IEC60309</p> |
| Italy | CAB-AC-16A-SG-IT | 16 A, 250 VAC |  <p data-bbox="1187 892 1528 926">Plug: CEI 23-50 Saf-D-Grid "T" Latch 3-595</p> |
| South Africa | CAB-AC-16A-SG-SA | 16 A, 250 VAC |  <p data-bbox="1252 1249 1356 1283">Plug: EL</p> <p data-bbox="1502 1346 1615 1400">PID: CAB-A CPN: 3</p> |

| Locale | Power Cord Part Number | Cord Set Rating | Power Cord Illustration |
|--|------------------------|-----------------|---|
| Switzerland | CAB-AC-16A-SG-SW | 16 A, 250 VAC |  <p>Plug: SEV 5934-2</p> <p>PID: CAB CP</p> |
| North America | CAB-AC-20A-SG-C20 | 250 VAC 20 A |  <p>Plug: IEC C20 Plug: Saf-D-Grid "T" Latch 3-5958P4</p>   |
| North America | CAB-AC-20A-SG-US | 16 A, 250 VAC |  <p>Plug: NEMA 5-20P Saf-D-Grid "T" Latch 3-5958P4</p>   |
| North America (non locking) 200-240 VAC operation | CAB-AC-20A-SG-US2 | 250 VAC 20 A |  <p>Plug: NEMA 6-20</p> <p>PID: CAB CPN</p> |
| North America | CAB-AC-20A-SG-US3 | 250 VAC 20 A |  <p>250 VAC 20A, twist lock, NEMA L6-20/Saf-D-Grid</p>   |

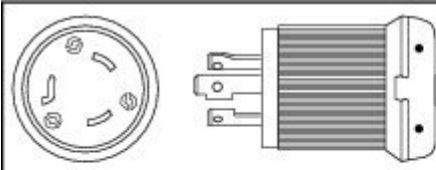
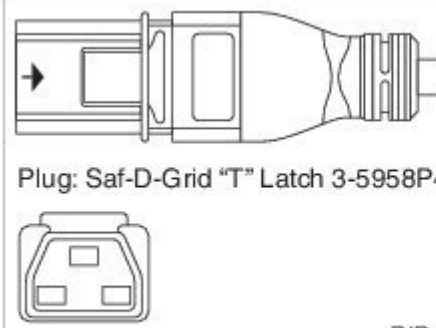
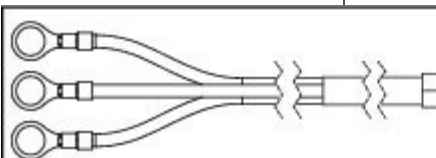
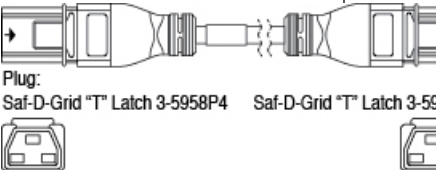
| Locale | Power Cord Part Number | Cord Set Rating | Power Cord Illustration |
|--|------------------------|-----------------------------------|--|
| North America 277 VAC operation | CAB-AC-20A-SG-US4 | 277 VAC 20 A |  <p data-bbox="1235 485 1451 512">Plug: NEMA L7-20P</p> <p data-bbox="1593 575 1620 602">PI</p> |
| International, Saf-D-Grid/Saf-D-Grid | CAB-HV-25A-SG-IN1 | 400 VAC 20 A |  <p data-bbox="1198 877 1620 905">Plug: Saf-D-Grid "T" Latch 3-5958P4</p> <p data-bbox="1572 1037 1620 1094">PID: CPN</p> |
| International, Ring Terminal source plug, Ring Terminal/Saf-D-Grid | CAB-HV-25A-SG-IN2 | 20A, 300 VAC/500 VDC |  <p data-bbox="1198 1325 1620 1352">Plug: 3/8-inch Ring Terminals PI</p> <p data-bbox="1463 1415 1620 1472">PID: CAB-HV- CPN: 37-1640</p> |
| North America | CAB-HV-25A-SG-US1 | 277 VAC/ 240 VDC/ 380 VDC 25 A |  <p data-bbox="1187 1591 1620 1640">Plug: Saf-D-Grid "T" Latch 3-5958P4 Saf-D-Grid "T" Latch 3-5958P4</p> |

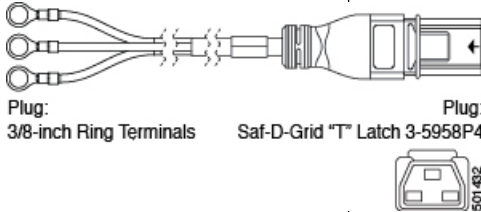
| Locale | Power Cord Part Number | Cord Set Rating | Power Cord Illustration |
|---|------------------------|-----------------------------------|--|
| North America | CAB-HV-25A-SG-US2 | 277 VAC/ 240 VDC/ 380 VDC 25 A |  Plug: 3/8-inch Ring Terminals Saf-D-Grid "T" Latch 3-5958P4 |
| All except Argentina, Brazil, and Japan | NO-POWER-CORD | No power cord included with order | N.A. |

3-kW DC Power Supply Power Cord Specifications

Each 3-kW DC power supply requires four customer-supplied power cables (two negative cables and two positive cables). We recommend using six gauge cables. Cisco supplies 6-gauge lugs for connections to the power supply. You supply the connectors that are required to connect the cables to the DC power source.



APPENDIX C

LEDs

- [Switch Chassis LEDs, on page 55](#)
- [Fan Module LEDs, on page 56](#)
- [Power Supply LEDs, on page 56](#)

Switch Chassis LEDs

The BCN, STS, and ENV, LEDs are located on the left side of the front of the switch. The port LEDs appear as triangles pointing up or down to the nearest port.

| LED | Color | Status |
|-----|----------------|---|
| BCN | Flashing blue | The operator has activated this LED to identify this switch in the chassis. |
| | Off | This switch is not being identified. |
| STS | Green | The switch is operational. |
| | Flashing amber | The switch is booting up. |
| | Amber | Temperature exceeds the minor alarm threshold. |
| | Red | Temperature exceeds the minor alarm threshold. |
| | Off | The switch is not receiving power. |
| ENV | Green | Fans and power supply modules are operational. |
| | Amber | At least one fan or power supply module is not operating. |

| LED | Color | Status |
|--------|-------|---|
| (port) | Green | Port admin state is 'Enabled', SFP is present and the interface is connected (that is, cabled, and the link is up). |
| | Amber | Port admin state is 'Disabled', or the SFP is absent, or both. |
| | Off | Port admin state is 'Enabled' and SFP is present, but interface is not connected. |

Fan Module LEDs



The fan module LED is located below the air holes on the front of the module.

| LED | Color | Status |
|-----|-------|---|
| STS | Green | The fan module is operational. |
| | Red | The fan module is not operational (fan is probably not functional). |
| | Off | Fan module is not receiving power. |

Power Supply LEDs

The power supply LEDs are located on the left front portion of the power supply. Combinations of states indicated by the Okay (🟢) and Fault (⚠️) LEDs indicate the status for the module as shown in the following table.

| 🟢 LED | ⚠️ LED | Status |
|----------------|--------|--|
| Green | Off | Power supply is on and outputting power to the switch. |
| Flashing green | Off | Power supply is connected to a power source but not outputting power to the switch—power supply might not be installed in the chassis. |
| Off | Off | Power supply is not receiving power. |

|  LED |  LED | Status |
|---|---|--|
| Green | Flashing amber | Power supply warning—possibly one of the following conditions: <ul style="list-style-type: none">• High voltage• High power• Low voltage• Power supply installed in chassis but not connected to a power source• Slow power supply fan |



APPENDIX **D**

Additional Kits

- [Rack Mount Kit N9K-C9300-RMK, on page 59](#)

Rack Mount Kit N9K-C9300-RMK

The following table lists and illustrates the contents for the 2-RU rack-mount kit (N9K-C9300-RMK).

| Illustration | Description | Quantity |
|--------------|---|----------|
| | Rack-mount kit <ul style="list-style-type: none"> • Bottom support rails (2) • Front-mount brackets (2) | 1 |



APPENDIX **E**

Site Preparation and Maintenance Records

- [Site Preparation Checklist, on page 61](#)
- [Contact and Site Information, on page 62](#)
- [Chassis and Module Information, on page 63](#)

Site Preparation Checklist

Planning the location and layout of your equipment rack or cabinet is essential for successful switch operation, ventilation, and accessibility.

The following table lists the site planning tasks that we recommend that you complete before you install the switch. Your completion of each task ensures a successful switch installation.

| Planning Activity | Verification Time and Date |
|---------------------------|----------------------------|
| Space evaluation: | |
| Space and layout | |
| Floor covering | |
| Impact and vibration | |
| Lighting | |
| Physical access | |
| Maintenance access | |
| Environmental evaluation: | |
| Ambient temperature | |
| Humidity | |
| Altitude | |
| Atmospheric contamination | |
| Airflow | |

| Planning Activity | Verification Time and Date |
|--|----------------------------|
| Power evaluation: | |
| Input power type | |
| Power receptacles | |
| Receptacle proximity to the equipment | |
| Dedicated (separate) circuits for power redundancy | |
| UPS for power failures | |
| Grounding: proper wire gauge and lugs | |
| Circuit breaker size | |
| Grounding evaluation: | |
| Data center ground | |
| Cable and interface equipment evaluation: | |
| Cable type | |
| Connector type | |
| Cable distance limitations | |
| Interface equipment (transceivers) | |
| EMI evaluation: | |
| Distance limitations for signaling | |
| Site wiring | |
| RFI levels | |

Contact and Site Information

Use the following worksheet to record contact and site information for the installation.

| | |
|----------------|--|
| Contact person | |
| Contact phone | |

| | |
|----------------------|--|
| Contact e-mail | |
| Building/site name | |
| Data center location | |
| Floor location | |
| Address (line 1) | |
| Address (line 2) | |
| City | |
| State/Provence | |
| Contact person | |
| ZIP/postal code | |
| Country | |

Chassis and Module Information

Use the following worksheet to record information about the switch.

| | |
|-----------------------|--|
| Contract number | |
| Chassis serial number | |
| Product number | |

Use the following worksheet to record network-related information.

| | |
|------------------------|--|
| Switch IP address | |
| Switch IP netmask | |
| Hostname | |
| Domain name | |
| IP broadcast address | |
| Gateway/router address | |
| DNS address | |

Use the following worksheet to record information about the modules in the switch.

| Module Slot | Module Type | Module Serial Number | Notes |
|--------------|-------------|----------------------|-------|
| Fan module 1 | | | |

| Module Slot | Module Type | Module Serial Number | Notes |
|--------------------|--------------------|-----------------------------|--------------|
| Fan module 2 | | | |
| Fan module 4 | | | |
| Power Supply 1 | | | |
| Power Supply 2 | | | |