



**Halmac** Services (Qld) Pty Ltd

ACN 098 852 923 ABN 40 741 712 113 ECL 53064

30 Palmer Place Murarrie, Qld 4172

Telephone (07) 3249 9500 Fax (07) 3249 9599

A QUALITY COMPANY TO AS/ISO9001

# SP148 DONALDSON ROAD SEWAGE PUMP STATION SWITCHBOARD

## OPERATION & MAINTENANCE MANUAL

JOB No A4230

HALMAC SERVICES IS A QUALITY COMPANY SERVING QUEENSLAND SINCE 1960

ELECTRICAL ENGINEERS & CONTRACTORS, DATA & COMMUNICATIONS, SERVICE AND MAINTENANCE, SWITCHBOARD MANUFACTURE, PLC, SCADA, TELEMETRY DESIGN & INSTALLATION

Email [info@halmac.net.au](mailto:info@halmac.net.au)

Web Site [www.halmac.net.au](http://www.halmac.net.au)

**Halmac** Services(Qld)Pty.Ltd.

30 Palmer Place Murarrie, Qld. 4172  
Telephone : (07) 3249 9500 Fax : (07) 3249 9599

A QUALITY COMPANY TO AS/ISO9001



SP148 DONALDSON  
ROAD SEWAGE  
PUMP STATION

OPERATION &  
MAINTENANCE  
MANUAL

JOB NO: A4230

1	<i>MOULDED CASE CIRCUIT BREAKER</i>
2	<i>MINIATURE CIRCUIT BREAKER</i>
3	<i>CONTACTOR</i>
4	<i>CONTROL RELAY &amp; PHASE FAILURE RELAY</i>
5	<i>CHASSIS</i>
6	<i>FUSE &amp; FUSE HOLDER</i>
7	<i>GSM MODEM</i>
8	<i>HUMAN MACHINE INTERFACE</i>
9	<i>LEVEL TRANSMITTER</i>
10	<i>MULTITRODE LEVEL RELAY</i>
11	<i>POWER SUPPLY &amp; BATTERY</i>
12	<i>PROXIMITY SWITCH</i>
13	<i>PUSHBUTTON &amp; INDICATOR</i>
14	<i>PRESSURE TRANSMITTER &amp; ADJUSTMENT UNIT</i>
15	<i>RADIO MODEM</i>
16	<i>SOFT STARTERS</i>
17	<i>SOCKET OUTLET &amp; INLET PLUG</i>
18	<i>SURGE DIVERTER &amp; SURGE REDUCTION FILTER</i>
19	<i>TIMER</i>
20	<i>TEST SHEETS</i>
21	<i>SECTION NOT USED</i>
22	<i>SECTION NOT USED</i>
23	<i>SECTION NOT USED</i>
24	<i>SECTION NOT USED</i>









**Halmac** Services (Qld) Pty. Ltd.  
A.C.N. 098 852 923  
A.B.N. 40 741 712 113

# MOULDED CASE CIRCUIT BREAKER

1. S250PE MCCB TECHNICAL DETAILS
2. S125GJ & E125NJ MCCB TECHNICAL DETAILS
3. MCCB ACCESSORIES



### Electronic type

## S250PE

### 70kA

Current rating: 50 – 250A

Approvals and Tests:  
Standards AS/NZS 3947-2, and IEC60947-2

Interrupting capacity:

	Voltage	I <sub>cu</sub>	I <sub>cs</sub>
AC use	380/415	70	70

Over Current Relay:

- Electronic, for general & selectivity applications
- 7-dial selectable characteristic curves suited for a variety of applications
- Base current *I<sub>R</sub>* is adjustable from 40% - 100% of the nominal rated current *I<sub>n</sub>*.
- STD setting 2.5 – 10 (*x I<sub>R</sub>*)<sup>2</sup>
- INST setting 13 – 14 (*x I<sub>R</sub>*)<sup>2</sup>

OCR Options:

- Neutral Pole protection for 4 pole MCCBs only (AN)
- Pre-Trip Alarm (AP)

Dimensions (mm)

Poles	3	4
H	165	165
W	105	140
D (less toggle)	103	103
Toggle cut-out	Standard DIN	

Ampere

Rating

*I<sub>R</sub>* Adjustment

NRC

Min - Max.

Cat. No. 1)

125

50 - 125

S250 PE \_ 125

250

100 - 250

S250 PE \_ 250

Price Adder - if OCR options are required, add the selected OCR option price below to the above MCCB price to calculate the total MCCB cost.

3 P OCR options: PTA 3)

S250 PE 3 AP #

4 P OCR options: PTA 3)

S250 PE 4 AP #

AP 3)

S250 PE 4 AN #

PTA + NP 3)

S250 PE 4 APN #

- 1) Add poles to complete MCCB catalogue number. Eg: 3 pole 250A: S250PE 3 250. \*#\* add OCR trip unit rating where shown.
- 2) The STD and Instantaneous pickup currents (*I<sub>std</sub>* & *I<sub>i</sub>*) settings are not individually adjustable, however by selecting different curve types and different *I<sub>R</sub>* settings the values will vary. Curve 1 & 2 *I<sub>std</sub>* = 2.5 x *I<sub>R</sub>*, curve 3 *I<sub>std</sub>* = 5 x *I<sub>R</sub>*, curve 4 - 7 *I<sub>std</sub>* = 10 x *I<sub>R</sub>*. *I<sub>R</sub>* dial setting 0.4 – 0.9 *I<sub>i</sub>* = 14 x *I<sub>R</sub>* and *I<sub>R</sub>* dial setting 0.95 – 1.0 *I<sub>i</sub>* = 13 x *I<sub>R</sub>*. Refer curve examples & setting data on pages 18 to 30.  
  
*NRC* = Nominal rated current, *I<sub>R</sub>* = Current adjustment dial setting, *STD* = Short Time Delay, *INST* = instantaneous
- 3) To order a MCCB with the above options insert the required option after the pole to make up the cat. number. Eg: S250PE 4 APN 250 is a S250PE 4 Pole 250A MCCB c/w Pre-trip Alarm and Neutral Protection.

Price Schedule T2

## ACCESSORIES

### ACCESSORIES FOR DUAL SUPPLY CHANGEOVER SYSTEMS

#### Wire Interlock (MW)

Wire interlocks consist of two mechanisms connected by a cable. The mechanisms are mounted on two MCCBs located at a distance from each other which is limited by the length and bend radius of the cable. The mechanisms and cable inhibit the closure of one MCCB unless the other is in the OFF position. Each mechanism is ordered separately. Cables of 1.0m or 1.5m length are also ordered as separate items.

Wire interlocks can be used on a mixture of 3 and 4 pole MCCBs of different frame sizes. This allows potential cost savings by using lower rated MCCBs for the alternative power supply. MCCBs can be mounted in different switchboard compartment or on different planes.

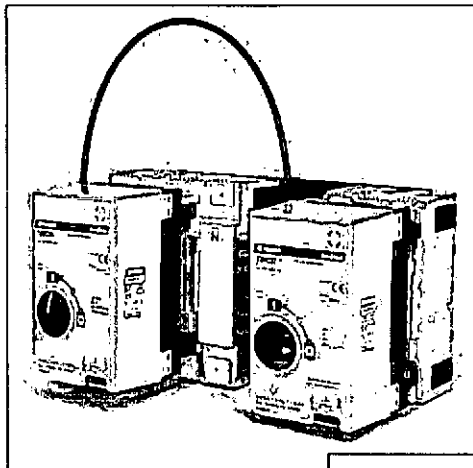

*Changeover Pair with Wire Interlock and Motor Operators*

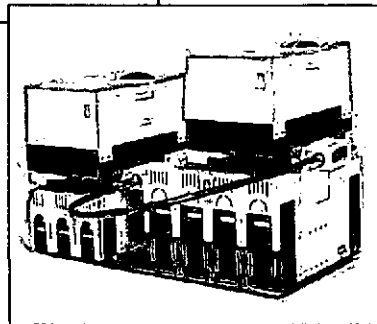

*View from above*

The TemBreak 2 wire interlock is an innovative design breakthrough which will save space, time and money for switchboard builders in that:

- Installation is extremely simple. Wire interlocks are field-installable.
- Wire interlocks replace the accessory cover on the front of the breaker
- Motor operators and operating handles are compatible with wire interlocks
- Interlocking of MCCBs mounted in different compartments is possible
- No need to buy factory-built backplates with MCCBs and interlocks pre-fitted
- An automatic changeover pair consisting of an interlocked pair of MCCBs with internal control accessories and motor operators can be assembled in a few minutes!

#### Slide Interlock (MS)

Slide interlocks are manually operated toggle locking devices which can be installed between two adjacent MCCBs. Depending on the position of the slide, one or other of the MCCBs on either side of a slide interlock is inhibited from being in the ON position.

Slide interlocks can be used between MCCBs of the same number of poles and of the same frame size.

Slide interlocks can be installed in the field and are padlockable in both positions.

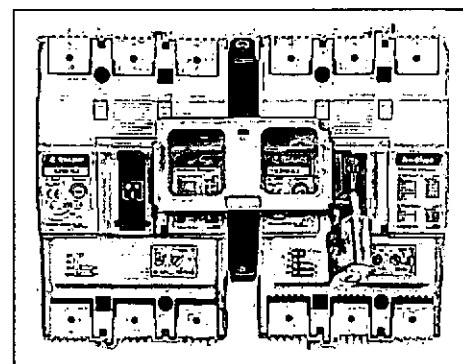

*Slide Interlock Installed Between two MCCBs*





TEMBREAK 2 MCCBs

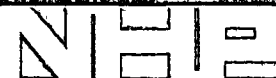

# INSTALLATION

## CONNECTION AND MOUNTING OPTIONS AND ACCESSORIES

### Connection of Busbars and Terminated Cables

This connection method is standard for all front connected (FC) MCCB models. Solid conductors or cables terminated with crimp lug terminals can be used.

#### Serrated Terminal Surface

Each terminal on 160A and 250A models has a serrated surface. This provides excellent grip for heavy cables terminated with crimp lug terminals, thereby preventing sideways rotation of the lug.

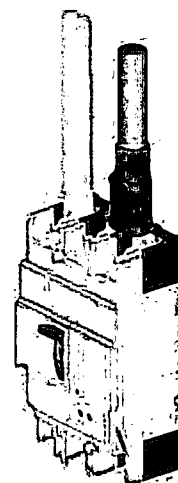
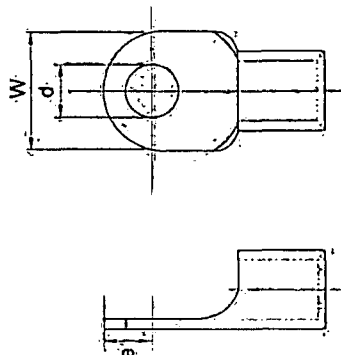

Maximum Dimensions of Compression Terminals			
Frame Size (A)	125*	160 & 250	400 & 630
Width, W (mm)	17	25	25
Diameter, d (mm)	9	9	11
Maximum from centre to tip, e(mm)	8.5	10	12

#### Connection of Large Conductors and Multiple Conductors

Flat bars (FB) are terminal extensions which can be fitted to line or load side terminals and are used to connect large conductors and multiple conductors. Available for field fitting in sets of 3 or 4 bars.

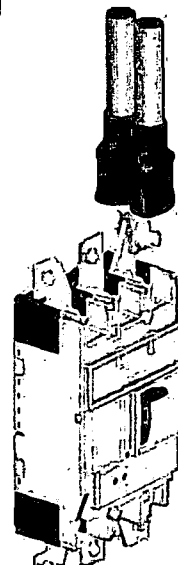

SECTION 6

\*H125 and L125 are 250A frame size



TEMBREAK 2 MCCBs



# INSTALLATION

## CONNECTION AND MOUNTING OPTIONS AND ACCESSORIES

Direct Entry of Stranded Cable

Solderless clamp terminals (FW) can be used to secure stranded cable directly to the MCCB. Available for field fitting in sets of 3 or 4.

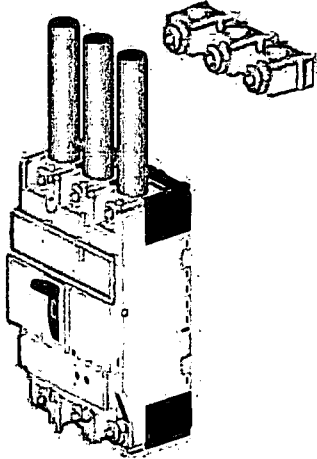

MCCB Model	Cable Capacity (mm <sup>2</sup> )
E125, S125, S125-NF	1.5 to 50 (1 cable)
H125, L125, S160-NF	1.5 to 70 (1 cable)
S160, E250, S250, H250, L250	35 to 120 (1 cable)
E400, S400, H400, L400	80 to 240 (1 cable)
	60 to 120 (2 cables)

**SECTION 6**

Termination in Separate Compartment

Rear connections (RC) allow termination of conductors in a different switchboard compartment to the MCCB body.

The terminal bar can be rotated in steps of 45 degrees in the field.

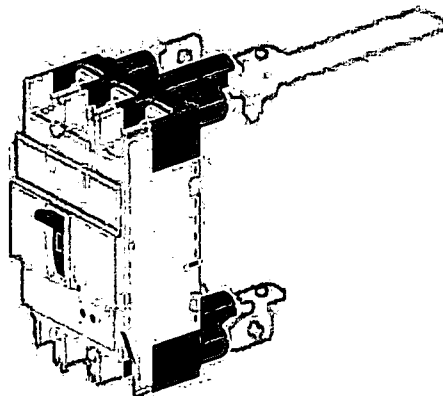



TEMBREAK 2 MCCBs

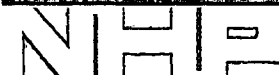

# INSTALLATION

## CONNECTION AND MOUNTING OPTIONS AND ACCESSORIES

### Plug-in Mounting

The plug in mounting system allows fast replacement of the MCCB body without the need to disturb the terminations. Solid conductors or cables terminated with compression terminals can be used.

### Plug-In Safety Lock



The plug-in MCCB body is **automatically locked to the base** when the contacts are closed (toggle ON). It cannot be removed unless the contacts are in the isolated position (toggle OFF or TRIPPED). This system ensures safe removal of the MCCB from the base.

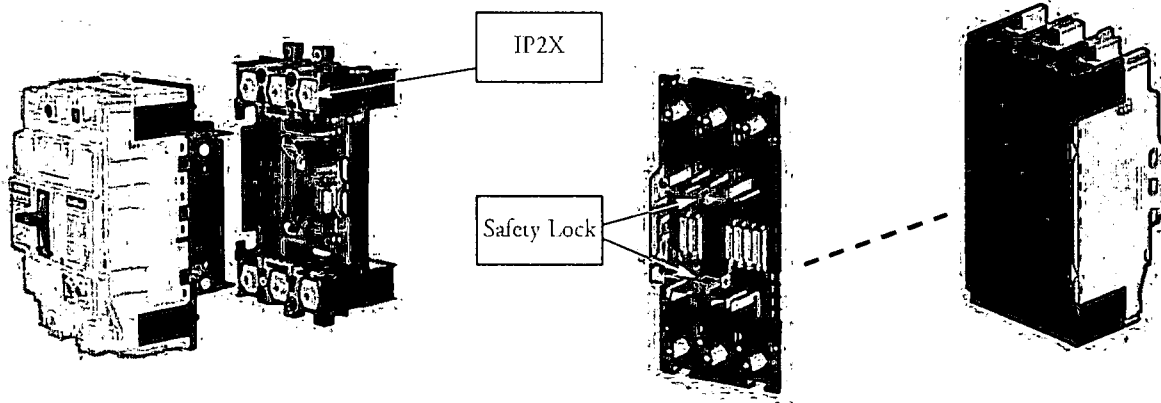

*Plug-in MCCB and base*

*Plug-in connections and safety lock are fitted to the back of the MCCB*

SECTION 6

The connection bars for plug-in bases are optional and can be configured in the field either for front or rear access. The illustrations below show possible mounting and connection options for plug in bases.

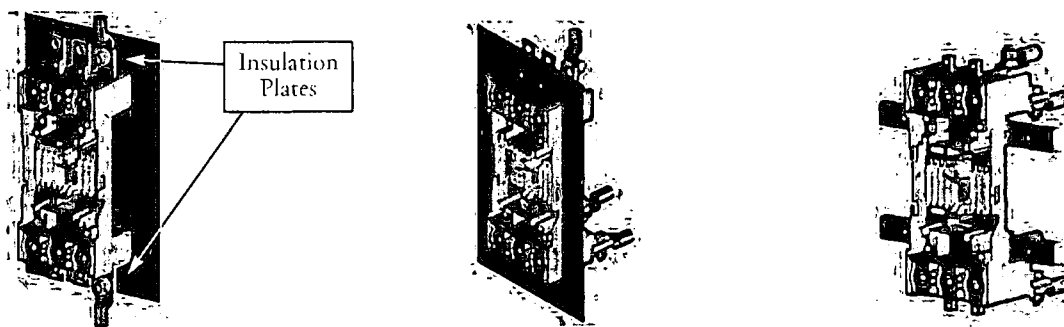

1. Mounted on base plate with connection bars mounted for front access. Insulation plates are supplied as standard and must be fitted.
2. Terminations in separate compartment. Connection bars are mounted for top access at the top and rear access at the bottom.
3. Mounted on angle bars. Connection bars are mounted for rear access.



TEMBREAK 2 MCCBs



# OPERATING CHARACTERISTICS

## LET-THROUGH PEAK CURRENT CHARACTERISTICS

H160-NJ, L160-NJ, S250-PE, H250-NJ, H250-NE, L250-NJ. 440V AC.

H160-NJ, L160-NJ, S250-PE, H250-NJ, H250-NE, L250-NJ. 690V AC.

SECTION 3

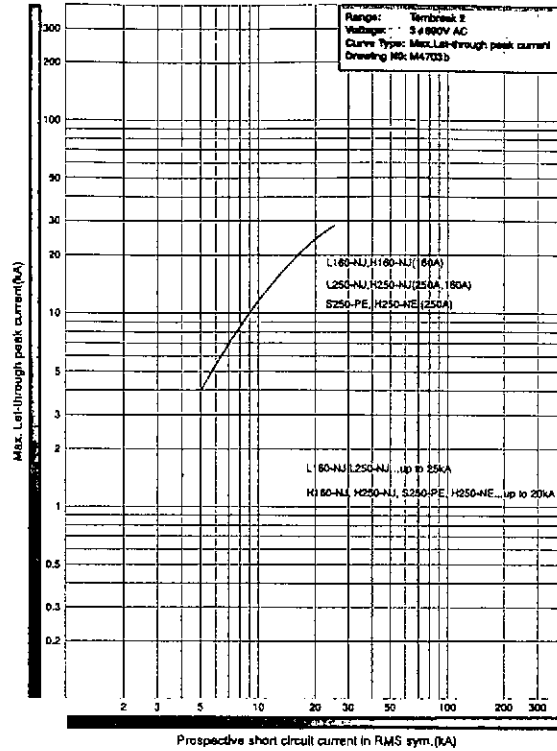
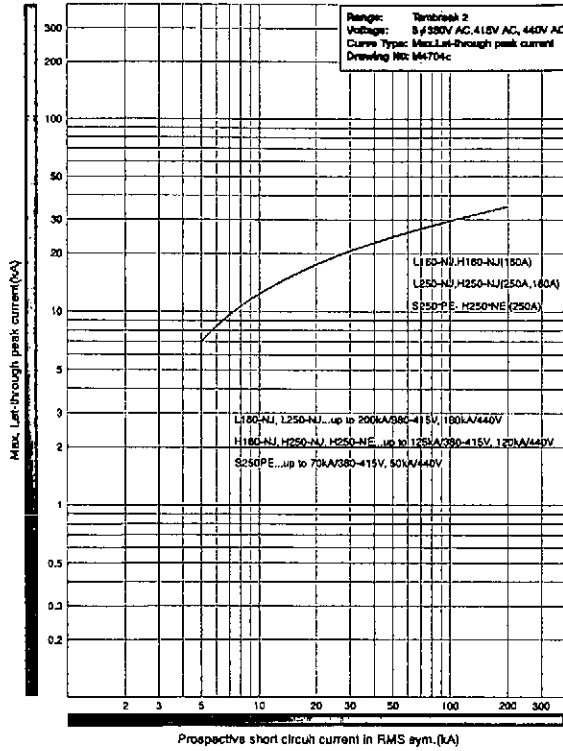

E400-NJ, S400-CJ, S400-NJ, S400-NE, S400-GJ, S400-GE, 415V AC.

S400-CJ, S400-NJ, S400-NE, S400-GJ, S400-GE, 690V AC.

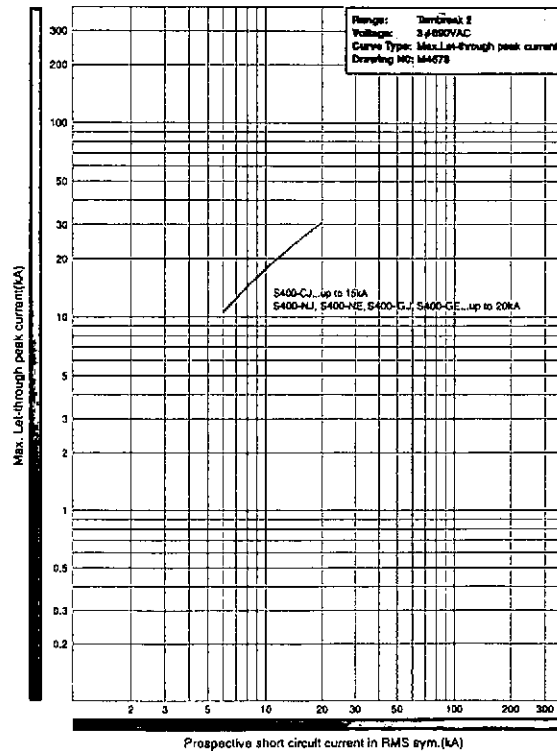
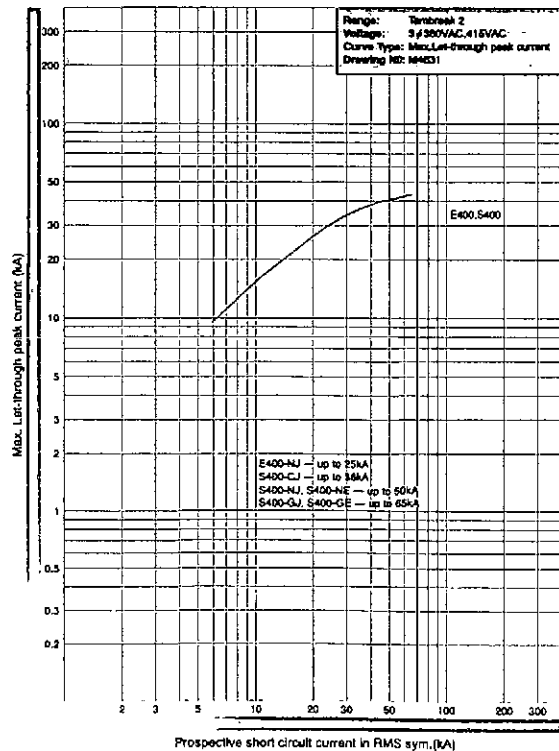



TEMBREAK 2 MCCBs

NHP

## APPLICATION DATA

### SELECTIVITY (DISCRIMINATION) AND CASCADE

#### Selectivity

The principle of Selectivity (Discrimination) is based upon an analysis of several circuit breaker characteristics. These include time-current (tripping) curves, peak-let-through current ( $I_{peak}$ ) and energy let-through ( $I^2t$ ).

The figures stated give the maximum selectivity level with the two nominated breakers in series under short-circuit conditions. For an indication on selectivity under overloads refer to the circuit breaker tripping/characteristic curves, or use the NHP TemCurve selectivity analysis software package.

Selectivity can be enhanced beyond the breaking capacity of the downstream breaker provided it is backed up by an appropriately selected upstream breaker, which should not trip (unlatch) under the stated short circuit current.

#### Cascade

Cascading is achieved by using an upstream device to assist (back-up) a downstream device in clearing a fault current. This principle is necessary should the downstream device be required to clear a prospective short circuit current greater than the devices' breaking capacity.

In most cascading applications it is generally necessary for the upstream breaker to trip (unlatch), as well as the downstream breaker to give adequate back-up protection. As such, cascade is commonly used in feeding and protecting non-essential loads, such as basic lighting.

For more information on selectivity and cascading please refer to the latest NHP Part C catalogue.

**Selectivity & Cascade Tables**  
@ 400 / 415 V

Downstream MCCBs	Upstream MCCBs	kA (RMS)	S250PE	H250NE	S400NE	S400GE	H400NE	L400NE	E630NE	S630CE
			70	125	50	70	125	200	36	50
E125NJ	25	25/25	25/65	25/36	25/60	25/65	25/85	25/36	25/25	
S125NJ	36	36/36	36/85	36/50	36/65	36/85	36/125	36/36	36/36	
S125GJ	65	65/65	65/125	50/50	65/70	65/125	65/150	36/36	50/50	
H125NJ	125	70/70	125/125	50/50	70/70	125/125	125/200	36/36	50/50	
S160NJ	36			36/50	36/65	36/85	36/125	36/36	36/50	
S180GJ	65			50/50	65/70	65/125	65/150	36/36	50/50	
H160NJ	125					125/125	125/200	36/36	50/50	
E250NJ	25					25/65	25/85	25/36	25/25	
S250NJ	36					36/85	36/125	36/36	36/36	
S250GJ	65					65/125	65/150	36/36	50/50	
S250PE	70					40/125	70/150	36/36	50/50	
H250NJ	125					125/125	125/200	36/36	50/50	
H250PE	125					125/125	125/200	36/36	50/50	
E400NJ	25							10/25	10/25	
S400CJ	36							10/36	10/36	
S400NE	50							10/36	10/50	
S400NJ	50							10/36	10/36	
S400GJ	70							10/36	10/50	
H400NJ	125							10/36	10/50	
H400NE	125							10/36	10/50	
E630NE	36									
E630CE	50									
S630GE	70									
XS630CJ	45									
XS630NJ	65									
XS630PJ	85									
XS630SE	50									
XH630SE	65									
XH630PE	65									
XS800NJ	65									
XS800SE	50									
XJ800PJ	85									
XH800SE	65									
XH800PE	65									
XS1250SE	65									
XS1600SE	85									

Beyond the Standard™ **TemBreak** page 45

**XX/YY**  
Selectivity/Cascade

S630GE	TL630NE	XS600SE	XH800SE	TL800NE	XS1250SE	TL1250NE	XS1600SE	XS2000NE	XS2500NE
70	125	50	65	125	85	125	100	85	85
25/50	25/25	25/36	25/36	25/65	25/25	25/25	25/25	25/25	25/25
36/85	36/36	36/50	36/36	36/36	36/36	36/36	36/36	36/36	36/36
65/70	65/65	65/50	65/65	65/65	65/65	65/65	65/65	65/65	65/65
70/70	70/70	50/50	65/85	65/65	65/50	65/50	100/100	65/85	65/85
36/50	36/36	36/36	36/85	36/65	36/36	36/36	36/36	36/36	36/36
65/70	65/65	50/50	50/65	50/65	65/65	65/65	65/65	65/65	65/65
70/70	70/70	50/50	50/65	50/65	65/65	65/65	100/100	65/85	65/85
25/50	25/25	25/25	25/50	25/50	25/25	25/25	25/25	25/25	25/25
36/85	36/36	36/36	36/36	36/36	36/36	36/36	36/36	36/36	36/36
65/70	65/65	50/50	50/65	50/65	65/65	65/65	65/65	65/65	65/65
70/70	70/70	50/50	50/65	50/65	70/70	70/70	70/70	70/70	70/70
70/70	70/70	50/50	50/65	50/65	85/85	85/85	100/100	85/85	85/85
70/70	70/70	50/50	50/65	50/65	85/85	85/85	100/100	85/85	85/85
10/50	10/36	25/25	25/25	25/36	25/25	25/25	25/36	25/25	25/25
10/65	10/50	25/36	25/36	25/50	36/36	36/36	36/50	36/36	36/36
10/50	10/50	25/50	25/50	25/50	50/50	50/50	50/50	50/50	50/50
10/70	10/65	25/50	25/50	25/65	50/50	50/50	50/65	50/50	50/50
10/70	10/70	25/50	25/50	25/65	70/36	70/36	70/85	70/70	70/70
10/70	10/70	25/50	25/65	25/65	125/85	125/85	125/100	125/85	125/85
10/70	10/70	25/50	25/65	25/65	125/85	125/85	125/100	125/85	125/85
		25/36	25/36	25/36	36/36	36/36	36/36	36/36	36/36
		25/50	25/50	25/50	50/50	50/50	50/50	50/50	50/50
					70/70	70/70	70/70	70/70	70/70
					30/45	30/45	30/45	35/45	35/45
					30/65	30/65	30/65	35/65	36/65
					30/85	30/85	30/85	35/85	35/85
					30/65	30/65	30/85	30/85	30/85
					30/65	30/65	30/85	30/85	30/85
					15/65	15/65	20/65	35/65	35/65
					15/50	15/50	20/50	35/50	35/50
					15/85	15/85	20/85	35/85	35/85
					15/65	15/65	20/85	35/65	35/65
					15/65	15/65	20/65	35/65	35/65
							20/65	35/65	35/65
								35/85	35/85

SECTION 4

**APPLICATION DATA**  
**SELECTIVITY TABLES**

TEMBREAK 2 MCCBS



NEPA



TEMBREAK 2 MCCBs

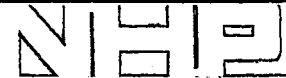

# INSTALLATION

## INSULATION DISTANCE IN mm (AT 440V AC MAXIMUM)

Model	Type	A	B1	B2	C	D	E
E125	NJ	50	10	10	0	25	*(1)
S125	NF	50	10	10	0	25	*(1)
S125	NJ	50	10	10	0	25	*(1)
S125	GJ	75	45	25	0	25	*(1)
H125	NJ	100	80	60	0	50	*(1)
L125	NJ	100	80	60	0	50	*(1)
S160	NF	50	40	30	0	25	*(1)
S160	NJ	50	40	30	0	25	*(1)
S160	GJ	100	80	60	0	50	*(1)
H160	NJ	100	80	60	0	50	*(1)
L160	NJ	100	80	60	0	50	*(1)
E250	NJ	50	40	30	0	25	*(1)
S250	NJ	50	40	30	0	25	*(1)
S250	GJ	100	80	30	0	25	*(1)
S250	PE	100	80	60	0	50	*(1)
H250	NJ	100	80	60	0	50	*(1)
H250	NE	100	80	60	0	50	*(1)
L250	NJ	100	80	60	0	50	*(1)
E400	NJ	100	80	40	0	30	*(1)
S400	CJ	100	80	40	0	30	*(1)
S400	NJ	100	80	40	0	30	*(1)
S400	GJ	100	80	40	0	30	*(1)
S400	GE	100	80	40	0	30	*(1)
H400	NJ	120	120	80	0	80	*(1)
H400	NE	120	120	80	0	80	*(1)
L400	NJ	120	120	80	0	80	*(1)
L400	NE	120	120	80	0	80	*(1)
E630	NE	120	100	80	0	80	*(1)
S630	CE	120	100	80	0	80	*(1)
S630	GE	120	100	80	0	80	*(1)

\*Note: (1) Insulate the exposed conductor until it overlaps the moulded case at the terminal, or the terminal cover.



TEMBREAK 2 MCCBs

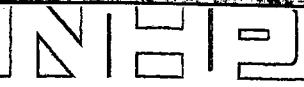

# DIMENSIONS

## H125-NJ, L125-NJ, H160-NJ, L160-NJ, S250-PE, H250-NJ, H250-NE, L250-NJ. Plug-in Versions

ASL: Arrangement Standard Line  
 H: Handle Frame Centre Line

Outline Dimensions

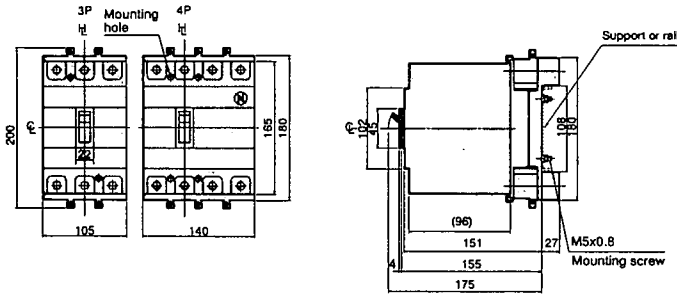

Termination of Busbar

Preparation of conductor

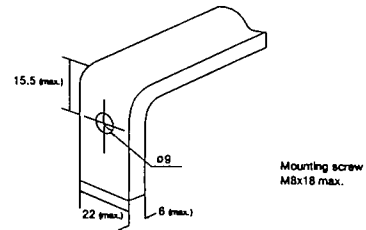

Mounting on a support or rails (shown with optional connection bars oriented for rear access)

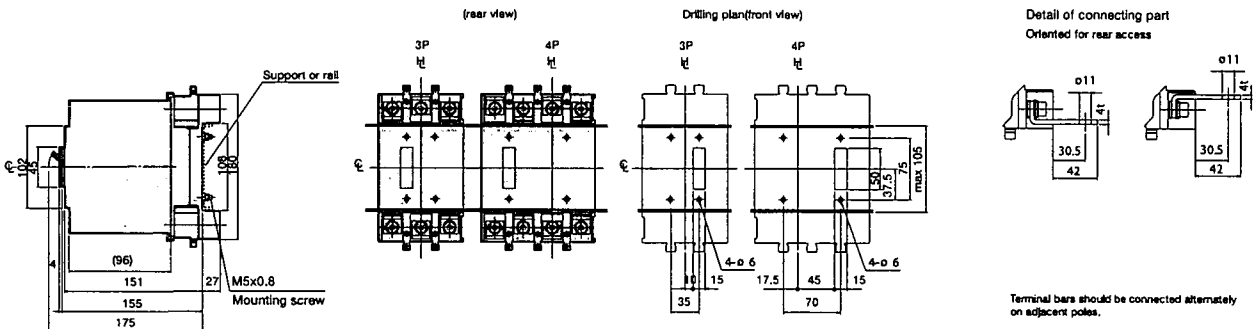

Terminal bars should be connected alternately on adjacent poles.

Mounting through the backplate (shown with optional connection bars oriented for rear access)

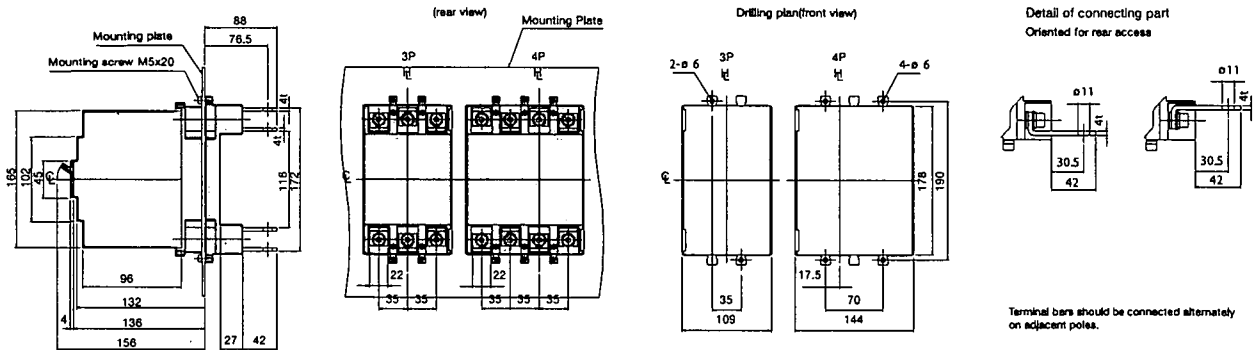

Terminal bars should be connected alternately on adjacent poles.

Mounting on the backplate (optional connection bars must be oriented for front access)

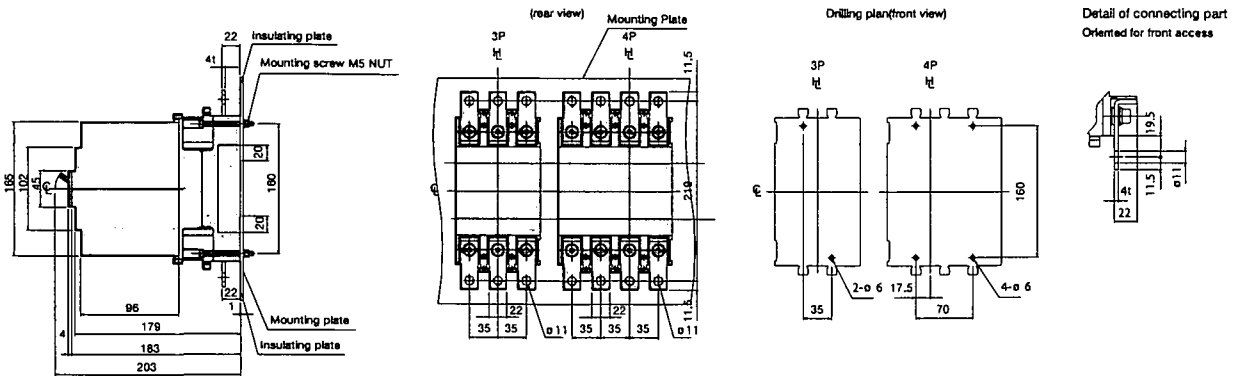

SECTION 7





TEMBREAK 2 MCCBs

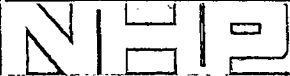

# OPERATING CHARACTERISTICS

## ELECTRONIC CHARACTERISTICS

S250-PE, H250-NE

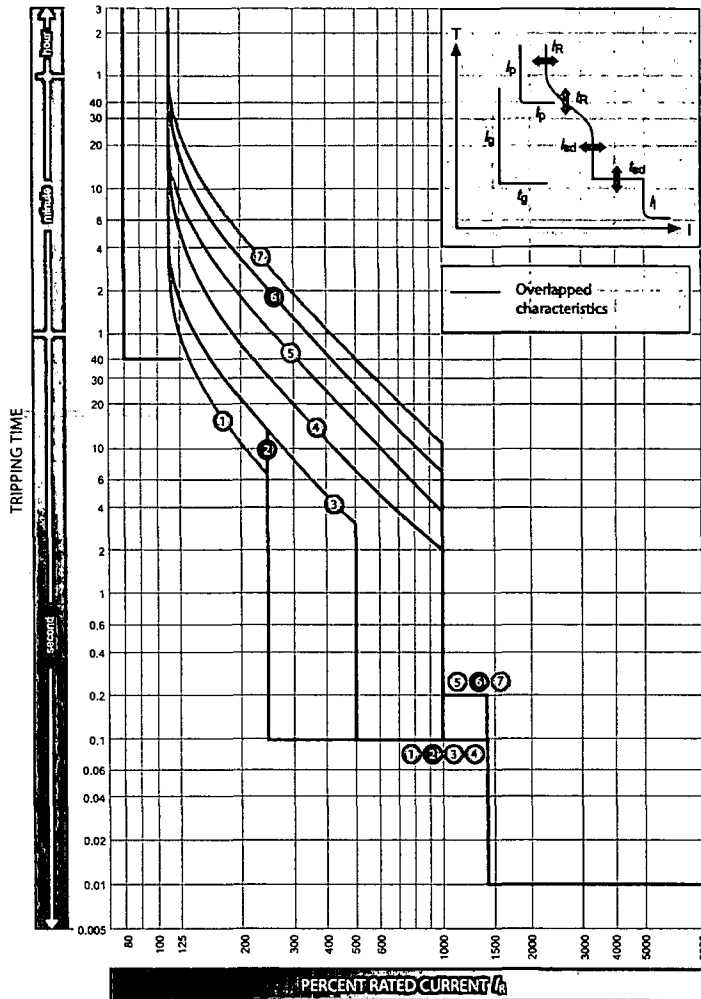

SECTION 3

$I_n = 250A; 160A; 125A; 40A$

		$I_n(A)$									
		LTD Pick-up current	$I_R$	$x/I_n$	0.4	0.5	0.63	0.8	0.9	0.95	1.0
Standard	LTD	$t_R$	(s)		11	21	21	5	10	19	29
	STD	$I_{sd}$	$x/I_R$	at 200% $x I_R$		2.5		5		10	
		$t_{sd}$	(s)			0.1		0.2			
	INST	$I_i$	$x/I_R$	14(Max: 13 $x I_n$ ) Note (1)							
Option	PTA	$I_p$	$x/I_R$	0.8							
		$t_p$	(s)	40							
	N	$I_N$	$x/I_n$	1.0							
		$t_N$	(s)	$t_N = t_R$ Note(2)							

Note

(1)  $I_i$  max. = 13  $x I_n$ . (2) Standard setting of  $t_N$  is 100% of  $t_R$ . For any other setting please specify when ordering.



TEMBREAK 2 MCCBs

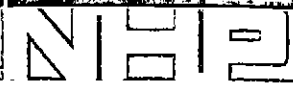

# INSTALLATION

## TEMPERATURE RATINGS & DERATINGS

Calibration Temperature: 45°C

MCCB Type	Connection Type	Rating at calibration temperature (50°C)	Rated Current (A)			
			50°C	55°C	60°C	65°C
E125-NJ S125-NJ S125-GJ	Front	20A	19	18.5	18	17.5
	Rear	32A	31	30.5	30	29
	Plug-in	50A	48	45	43	41
		63A	60	57	55	52
		100A	97	94	90	87
		125A	121	117	113	109
H125-NJ L125-NJ	Front	20A	19	18.5	18	17.5
	Rear	32A	31	30	29	28
	Plug-in	50A	48	47	45	44
		63A	61	59	57	55
		100A	97	95	92	89
		125A	121	118	114	111
S160-NJ S160-GJ	Front	20A	19	18.5	18	17.5
	Rear	32A	31	30	29	28
	Plug-in	50A	48	46	44	42
		63A	61	59	57	55
		100A	97	94	91	88
		125A	121	117	113	109
H160-NJ L160-NJ	Front	160A	156	151	146	141
	Rear		156	151	146	141
E250-NJ	Front	20A	19	18.5	18	17.5
	Rear	32A	31	30	29	28
	Plug-in	50A	48	46	44	42
		63A	61	59	57	55
		100A	97	94	91	88
		125A	121	117	113	109
E250-NJ S250-NJ S250-GJ	Front	160A	156	151	146	141
	Rear	250A	243	235	227	219
	Plug-in	250A	243	235	227	219
H250-NJ L250-NJ	Front	160A	156	151	147	143
	Rear					
	Plug-in	250A	244	237	230	223
		250A	244	237	230	223
E400-NJ S400-CJ S400-NJ S400-GJ	Front	250A	244	237	230	223
	Rear	400A	390	380	369	358
	Plug-in	250A	243	237	230	223
		400A	392	384	376	368
H400-NJ L400-NJ	Front	250A	243	237	230	223
	Rear	400A	390	381	371	361
	Plug-in	250A	243	237	231	224
		400A	392	384	376	368

Calibration Temperature: 30°C

MCCB Type	Connection Type	Rating at calibration temperature (30°C)	35°C	40°C	45°C	50°C	55°C	60°C	65°C
H250-NJ L250-NJ	Plug-in Conn.	250A	244	236	225	219	209	200	190

MCCB Type	Connection Type	Rating	Rated Current (A)							
			30°C	35°C	40°C	45°C	50°C	55°C	60°C	65°C
S250-PE H250-NE	Front	250A	250	250	250	250	237.5	225	200	200
	Rear		250	250	250	250	237.5	225	200	200
S400-NE S400-GE	Front	250A	250	250	250	250	250	250	225	200
	Rear	400A	400	400	400	400	400	380	360	320
	Plug-in	250A	250	237.5	225	225	200	200	157.5	157.5
H400-NE L400-NE	Front	250A	250	250	250	250	250	250	225	200
	Rear	400A	400	400	400	400	400	380	360	320
	Plug-in	250A	250	250	250	250	250	250	225	200
		400A	400	400	400	400	400	380	360	320
E630-NE S630-CE S630-GE	Front	630A	630	630	630	630	598.5	598.5	567	504
	Rear		630	630	630	630	598.5	598.5	567	504

SECTION 6



TEMBREAK 2 MCCBs

# OPERATING CHARACTERISTICS

## LET-THROUGH ENERGY CHARACTERISTICS

H160-NJ, L160-NJ, S250-PE, H250-NE, H250-NJ,  
L250-NJ. 440V AC.

H160-NJ, L160-NJ, S250-PE, H250-NE, H250-NJ, L250-  
NJ. 690V AC.

SECTION 3

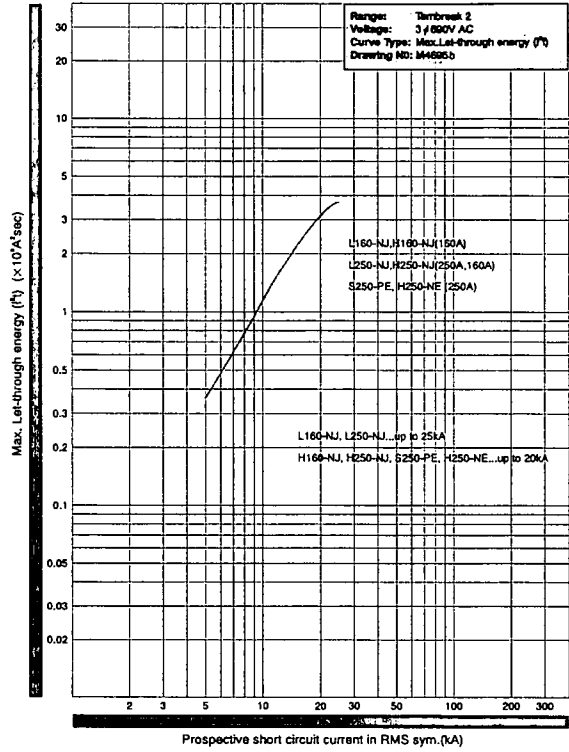
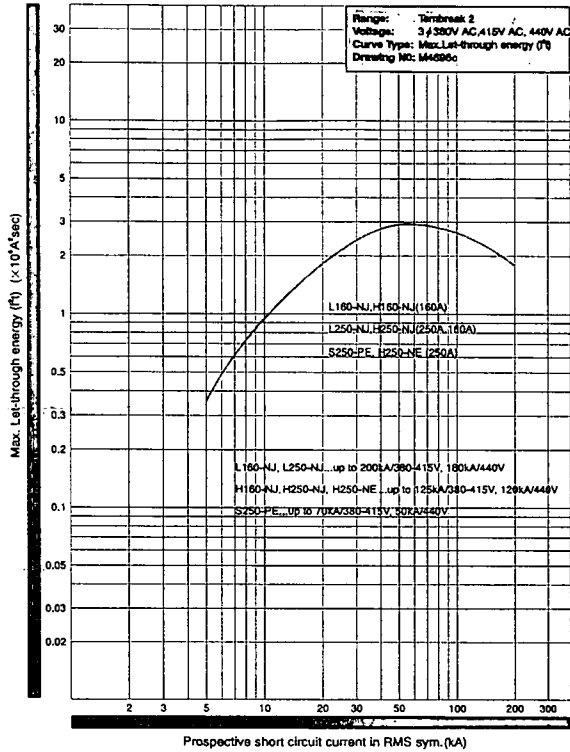

E400-NJ, S400-CJ, S400-NJ, S400-NE, S400-GJ,  
S400-GE. 415V AC.

S400-CJ, S400-NJ, S400-NE, S400-GJ, S400-GE. 690V AC.

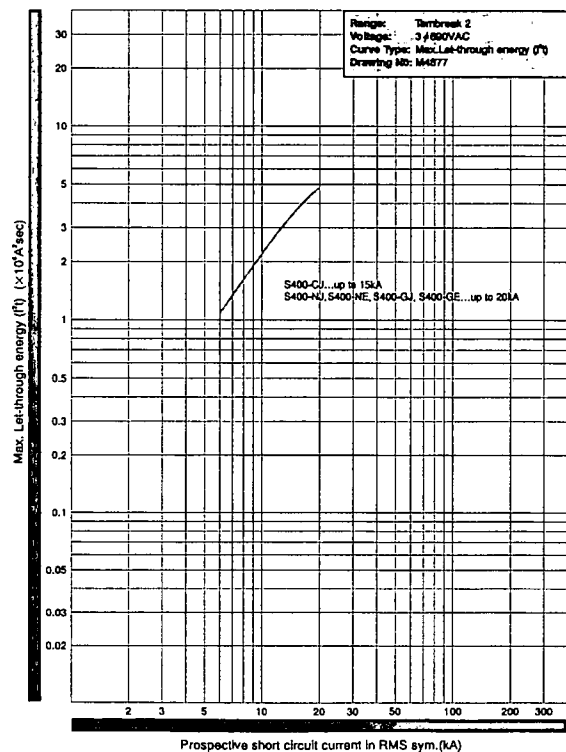
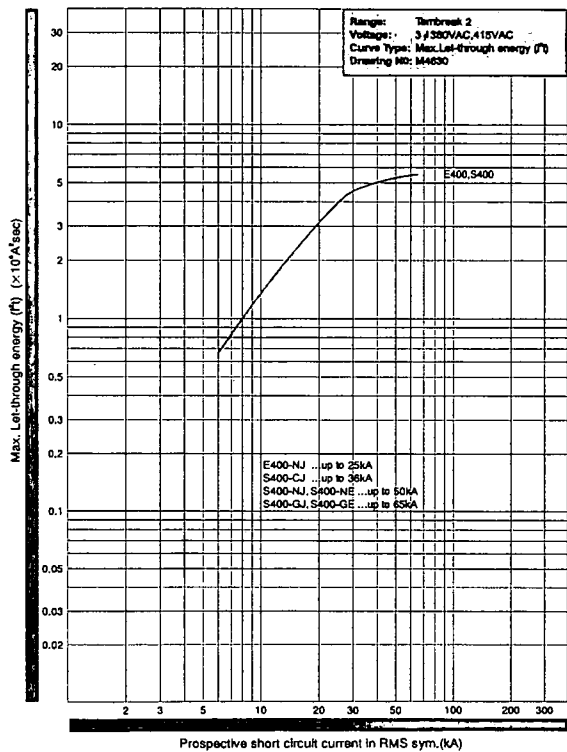

# NHP

## Thermal magnetic type S125GJ

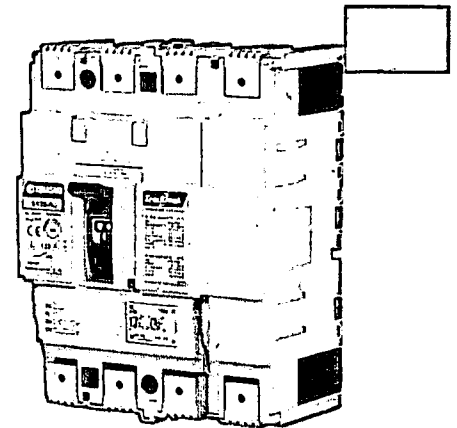

### 65kA

Current rating: 12.5 – 125A

Approvals and Tests:  
Standards AS/NZS 3947-2, and IEC60947-2

Interrupting capacity:

	Voltage	Icu	Ics
AC use	380/400	65	36
DC use	250V	40	40

Trip unit:  
Adjustable thermal (0.63 *I<sub>r</sub>* to 100% *I<sub>r</sub>*) and adjustable magnetic (6 *I<sub>m</sub>* to 12 *I<sub>m</sub>*)

#### Dimensions (mm)

Poles	3	4
H	155	155
W	90	120
D (less toggle)	68	68
Toggle cut-out	Standard DIN	

Ampere Rating NRC	Adj. <i>I<sub>r</sub></i> <sup>1)</sup> Min - Max.	Adj. <i>I<sub>m</sub></i> <sup>1)</sup> Min - Max.	Cat. No.
20	12.5 - 20	120 - 240	S125 GJ 3 20 S125 GJ 4 20
32	20 - 32	192 - 384	S125 GJ 3 32 S125 GJ 4 32
50	32 - 50	300 - 600	S125 GJ 3 50 S125 GJ 4 50
63	40 - 63	378 - 756	S125 GJ 3 63 S125 GJ 4 63
100	63 - 100	600 - 1200	S125 GJ 3 100 S125 GJ 4 100
125	80 - 125	750 - 1500	S125 GJ 3 125 S125 GJ 4 125

1) NRC: Nominal rated current  
Adj. *I<sub>r</sub>*: Adjustable thermal setting  
Adj. *I<sub>m</sub>*: Adjustable magnetic setting

Replaces: XH125NJ, TL100NJ, Note: check exact ratings or dimensions to suit your application requirement

Price Schedule T2

**NHP**



**Thermal magnetic type  
E125NJ**

**25kA**

**Current rating: 12.5 – 125A**

**Approvals and Tests:**  
Standards AS/NZS 3947-2, and IEC60947-2

**Interrupting capacity:**

	Voltage	Icu	Ics
AC use	380/415	25	19
DC use	250V	25	19

**Trip unit:**

Adjustable thermal (0.63 *I<sub>r</sub>* to 100% *I<sub>r</sub>*) and adjustable magnetic (6 *I<sub>m</sub>* to 12 *I<sub>m</sub>*)

**Dimensions (mm)**

Poles	3
H	155
W	90
D (less toggle)	68
Toggle cut-out	Standard DIN

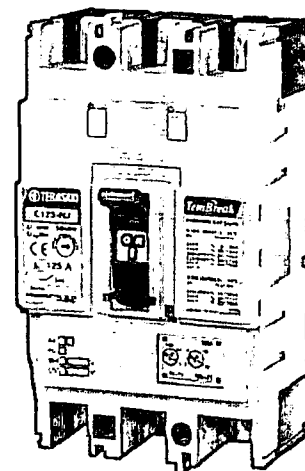

**Ampere**

Rating NRC	Adj. <i>I<sub>r</sub></i> <sup>1)</sup> Min - Max.	Adj. <i>I<sub>m</sub></i> <sup>1)</sup> Min - Max.	Cat. No.
20	12.5 - 20	120 - 240	E125 NJ 3 20
32	20 - 32	192 - 384	E125 NJ 3 32
50	32 - 50	300 - 600	E125 NJ 3 50
63	40 - 63	378 - 756	E125 NJ 3 63
100	63 - 100	600 - 1200	E125 NJ 3 100
125	80 - 125	750 - 1500	E125 NJ 3 125

1) NRC: Nominal rated current  
Adj. *I<sub>r</sub>*: Adjustable thermal setting  
Adj. *I<sub>m</sub>*: Adjustable magnetic setting

Replaces: XS125CJ, Note: check exact ratings or dimensions to suit your application requirement

Price Schedule T2



TEMBREAK 2 MCCBs



# DIMENSIONS

## E125-NJ, S125-NJ, S125-GJ

ASL: Arrangement Standard Line  
H<sub>L</sub>: Handle Frame Centre Line

Front connected

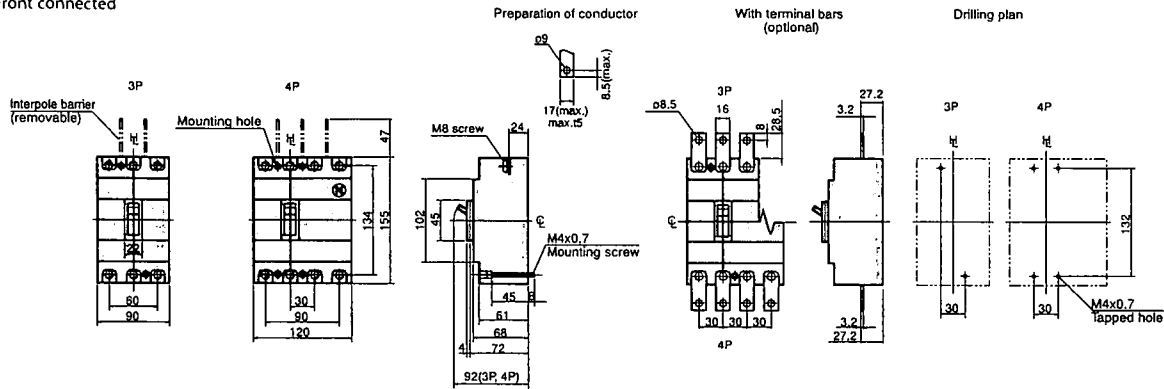

Rear connected

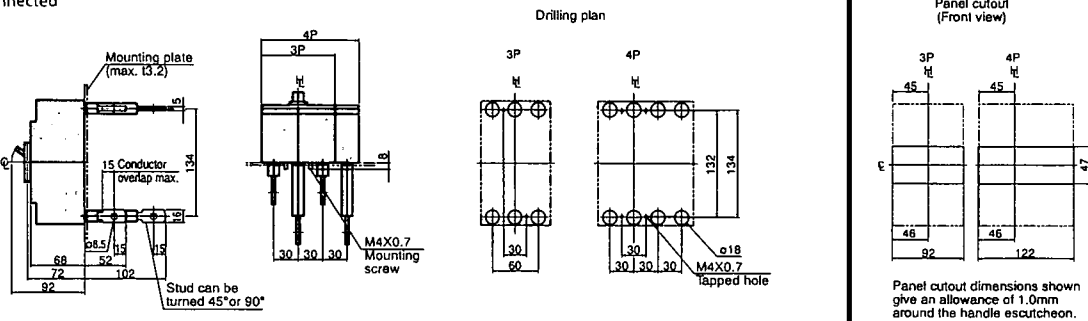

Front connected with Motor Operator

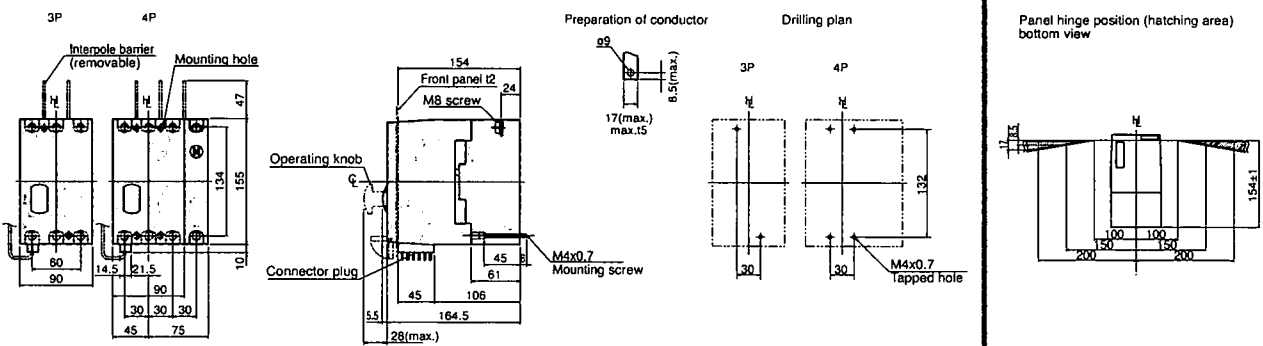

Rear connected with Motor Operator

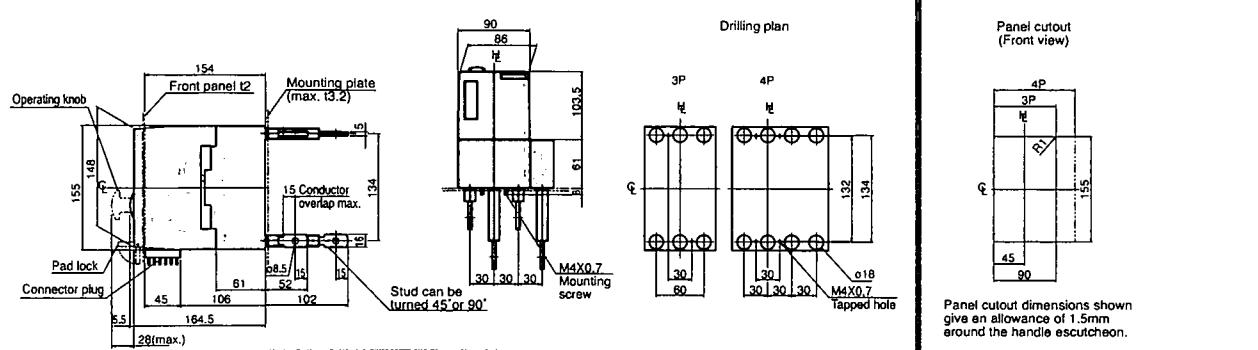

SECTION 7



TEMBREAK 2 MCCBs



# INSTALLATION

## INSULATION DISTANCE IN mm (AT 440V AC MAXIMUM)

Model	Type	A	B1	B2	C	D	E
E125	NJ	50	10	10	0	25	*(1)
S125	NF	50	10	10	0	25	*(1)
S125	NJ	50	10	10	0	25	*(1)
S125	GJ	75	45	25	0	25	*(1)
H125	NJ	100	80	60	0	50	*(1)
L125	NJ	100	80	60	0	50	*(1)
S160	NF	50	40	30	0	25	*(1)
S160	NJ	50	40	30	0	25	*(1)
S160	GJ	100	80	60	0	50	*(1)
H160	NJ	100	80	60	0	50	*(1)
L160	NJ	100	80	60	0	50	*(1)
E250	NJ	50	40	30	0	25	*(1)
S250	NJ	50	40	30	0	25	*(1)
S250	GJ	100	80	30	0	25	*(1)
S250	PE	100	80	60	0	50	*(1)
H250	NJ	100	80	60	0	50	*(1)
H250	NE	100	80	60	0	50	*(1)
L250	NJ	100	80	60	0	50	*(1)
E400	NJ	100	80	40	0	30	*(1)
S400	CJ	100	80	40	0	30	*(1)
S400	NJ	100	80	40	0	30	*(1)
S400	GJ	100	80	40	0	30	*(1)
S400	GE	100	80	40	0	30	*(1)
H400	NJ	120	120	80	0	80	*(1)
H400	NE	120	120	80	0	80	*(1)
L400	NJ	120	120	80	0	80	*(1)
L400	NE	120	120	80	0	80	*(1)
E630	NE	120	100	80	0	80	*(1)
S630	CE	120	100	80	0	80	*(1)
S630	GE	120	100	80	0	80	*(1)

\*Note: (1) Insulate the exposed conductor until it overlaps the moulded case at the terminal, or the terminal cover.



TEMBREAK 2 MCCBs



## APPLICATION DATA

### SELECTIVITY (DISCRIMINATION) AND CASCADE

#### Selectivity

The principle of Selectivity (Discrimination) is based upon an analysis of several circuit breaker characteristics. These include time-current (tripping) curves, peak-let-through current ( $I_{peak}$ ) and energy let-through ( $I^2t$ ).

The figures stated give the maximum selectivity level with the two nominated breakers in series under short-circuit conditions. For an indication on selectivity under overloads refer to the circuit breaker tripping/characteristic curves, or use the NHP TemCurve selectivity analysis software package.

Selectivity can be enhanced beyond the breaking capacity of the downstream breaker provided it is backed up by an appropriately selected upstream breaker, which should not trip (unlatch) under the stated short circuit current.

#### Cascade

Cascading is achieved by using an upstream device to assist (back-up) a downstream device in clearing a fault current. This principal is necessary should the downstream device be required to clear a prospective short circuit current greater than the devices' breaking capacity.

In most cascading applications it is generally necessary for the upstream breaker to trip (unlatch), as well as the downstream breaker to give adequate back-up protection. As such, cascade is commonly used in feeding and protecting non-essential loads, such as basic lighting.

For more information on selectivity and cascading please refer to the latest NHP Part C catalogue.



**Selectivity & Cascade Tables**  
@ 400 / 415 V

Downstream MCCBs	Upstream MCCBs	kA (RMS)	S250PE	H250NE	S400NE	S400GE	H400NE	L400NE	E630NE	S630CE
			70	125	50	70	125	200	36	50
E125NJ	25	25/25	25/65	25/36	25/50	25/65	25/85	25/36	25/25	
S125NJ	36	36/36	36/85	36/50	36/65	36/85	36/125	36/36	36/36	
S125GJ	65	65/65	65/125	50/50	65/70	65/125	65/150	36/36	50/50	
H125NJ	125	70/70	125/125	50/50	70/70	125/125	125/200	36/36	50/50	
S180NJ	36			36/50	36/65	36/85	36/125	36/36	36/50	
S180GJ	65			50/50	65/70	65/125	65/150	36/36	50/50	
H180NJ	125					125/125	125/200	36/36	50/50	
E250NJ	25					25/65	25/85	25/36	25/25	
S250NJ	36					36/85	36/125	36/36	36/36	
S250GJ	65					65/125	65/150	36/36	50/50	
S250PE	70					40/125	70/150	36/36	50/50	
H250NJ	125					125/125	125/200	36/36	50/50	
H250PE	125					125/125	125/200	36/36	50/50	
E400NJ	25							10/25	10/25	
S400CJ	36							10/36	10/36	
S400NE	50							10/36	10/50	
S400NJ	50							10/36	10/36	
S400GJ	70							10/36	10/50	
H400NJ	125							10/36	10/50	
H400NE	125							10/36	10/50	
E630NE	36									
E630CE	50									
S630GE	70									
XS830CJ	45									
XS830NJ	65									
XS830PJ	85									
XS630SE	50									
XH630SE	65									
XH630PE	65									
XS800NJ	65									
XS800SE	50									
XJ800PJ	85									
XH800SE	65									
XH800PE	65									
XS1250SE	65									
XS1600SE	85									

XX / YY		Selectivity/Cascade									
S630GE	TL630NE	XS800SE	SE800HX	TL800NE	XS1250SE	TL1250NE	SE1600SX	XS2000NE	XS2500NE	XS2500NE	XS2500NE
70	125	50	65	125	85	125	100	85	85	85	85
25/50	25/25	25/36	25/36	25/65	25/25	25/25	25/25	25/25	25/25	25/25	25/25
36/65	36/36	36/50	36/36	36/36	36/36	36/36	36/36	36/36	36/36	36/36	36/36
65/70	65/65	65/50	65/65	65/65	65/65	65/65	65/65	65/65	65/65	65/65	65/65
70/70	70/70	50/50	65/65	65/65	85/50	85/50	100/100	85/85	85/85	85/85	85/85
36/50	36/36	36/36	36/65	36/65	36/36	36/36	36/36	36/36	36/36	36/36	36/36
65/70	65/65	50/50	50/65	50/65	65/65	65/65	65/65	65/65	65/65	65/65	65/65
70/70	70/70	50/50	50/65	50/65	85/65	85/65	100/100	85/85	85/85	85/85	85/85
25/50	25/25	25/25	25/50	25/50	25/25	25/25	25/25	25/25	25/25	25/25	25/25
36/65	36/36	36/36	36/36	36/36	36/36	36/36	36/36	36/36	36/36	36/36	36/36
65/70	65/65	50/50	50/65	50/65	65/65	65/65	65/65	65/65	65/65	65/65	65/65
70/70	70/70	50/50	50/65	50/65	70/70	70/70	70/70	70/70	70/70	70/70	70/70
70/70	70/70	50/50	50/65	50/65	85/85	85/85	100/100	85/85	85/85	85/85	85/85
70/70	70/70	50/50	50/65	50/65	85/85	85/85	100/100	85/85	85/85	85/85	85/85
10/50	10/36	25/25	25/25	25/36	25/25	25/25	25/36	25/25	25/25	25/25	25/25
10/65	10/50	25/36	25/36	25/50	36/36	36/36	36/50	36/36	36/36	36/36	36/36
10/50	10/50	25/50	25/50	25/50	50/50	50/50	50/50	50/50	50/50	50/50	50/50
10/70	10/65	25/50	25/50	25/65	50/50	50/50	50/65	50/50	50/50	50/50	50/50
10/70	10/70	25/50	25/50	25/65	70/36	70/36	70/85	70/70	70/70	70/70	70/70
10/70	10/70	25/50	25/65	25/65	125/85	125/85	125/100	125/85	125/85	125/85	125/85
10/70	10/70	25/50	25/65	25/65	125/85	125/85	125/100	125/85	125/85	125/85	125/85
		25/36	25/36	25/36	36/36	36/36	36/36	36/36	36/36	36/36	36/36
		25/50	25/50	25/50	50/50	50/50	50/50	50/50	50/50	50/50	50/50
					70/70	70/70	70/70	70/70	70/70	70/70	70/70
					30/45	30/45	30/45	35/45	35/45	35/45	35/45
					30/65	30/65	30/65	35/65	36/65	36/65	36/65
					30/85	30/85	30/85	35/85	35/85	35/85	35/85
					30/65	30/65	30/85	30/85	30/85	30/85	30/85
					30/65	30/65	30/85	30/85	30/85	30/85	30/85
					30/65	30/65	30/85	30/85	30/85	30/85	30/85
					15/65	15/65	20/65	35/65	35/65	35/65	35/65
					15/50	15/50	20/50	35/50	35/50	35/50	35/50
					15/85	15/85	20/85	35/85	35/85	35/85	35/85
					15/65	15/65	20/65	35/65	35/65	35/65	35/65
					15/65	15/65	20/65	35/65	35/65	35/65	35/65
							20/65	35/65	35/65	35/65	35/65
								35/85	35/85	35/85	35/85

Beyond the Standard™ TemBreak page 45

TEMBREAK 2 MCCBS



APPLICATION DATA  
SELECTIVITY TABLES

NEPA





TEMBREAK 2 MCCBs



# APPLICATION DATA

## CASCADE TABLES

SECTION 4

CASCADE @ 380 - 415 V AC <sup>1)</sup>	Downstream MCCBs	kA (RMS)	E125NJ	S125NJ	S125GJ	H125NJ	L125NJ	S160NJ	S160GJ	H160NJ	L160NJ	E250NJ	S250NJ	S250GJ	S250PE	H250NJ	H250NE	L250NJ
			25	36	65	125	200	36	65	125	200	25	36	65	70	125	125	200
E125NJ	25	25	36	36	65	85	36	36	65	85	-	36	36	-	65	65	85	
S125NJ	36	-	-	50	85	125	-	50	85	125	-	-	-	-	85	85	125	
S125GJ	65	-	-	-	125	150	-	-	125	150	-	-	-	65	-	125	125	150
H125NJ	125	-	-	-	-	200	-	-	-	200	-	-	-	65	-	-	-	200
S160NJ	36	-	-	65	-	-	-	65	85	125	-	-	-	65	65	85	85	125
S160GJ	85	-	-	-	-	-	-	-	125	150	-	-	-	-	70	125	125	150
H160NJ	125	-	-	-	-	-	-	-	-	200	-	-	-	-	-	-	-	200
S250NJ	36	-	-	-	-	-	-	65	-	-	-	-	-	-	65	85	85	125
S250GJ	65	-	-	-	-	-	-	-	-	-	-	-	-	-	70	125	125	150
S250PE	70	-	-	-	-	-	-	-	-	-	-	-	-	-	-	125	125	150
H250NJ	125	-	-	-	-	-	-	-	-	-	-	-	-	-	-	-	-	200
E400NJ	25	-	-	-	-	-	-	-	-	-	-	-	-	-	36	65	65	-
S400CJ	36	-	-	-	-	-	-	-	-	-	-	-	-	-	50	70	70	-
S400NJ	50	-	-	-	-	-	-	-	-	-	-	-	-	-	50	65	85	85
S400GJ	70	-	-	-	-	-	-	-	-	-	-	-	-	-	50	-	125	125
H400NJ	125	-	-	-	-	-	-	-	-	-	-	-	-	-	-	-	-	-

Note: <sup>1)</sup> Ratings have not been verified where a dash "-" is shown.

All pick-up and time delay settings are to be set at a maximum for upstream MCCB's

CASCADE @ 380 - 415 V AC <sup>1)</sup>	Downstream MCCBs	kA (RMS)	Upstream MCCBs															
			S400CJ	S400NE	S400GJ	H400NE	L400NJ	L400NE	E630NE	S630CE	S630GE	TL630NE	XS800SE	XS800NJ	XH800SE	TL800NE	XS1250SE	XS1600SE
E125NJ	25	25	36	36	50	65	85	85	36	-	50	-	36	36	36	-	-	-
S125NJ	36	-	50	65	85	125	125	-	-	65	-	50	50	-	-	-	-	-
S125GJ	65	-	-	70	125	150	150	-	50	70	-	-	-	65	-	-	-	-
H125NJ	125	-	-	-	-	200	200	-	-	-	-	-	-	65	-	50	-	-
S160NJ	36	-	50	65	85	125	125	-	50	50	-	-	65	65	-	-	-	-
S160GJ	85	-	-	70	125	150	150	-	-	70	-	-	-	-	-	-	-	-
H160NJ	125	-	-	-	-	200	200	-	-	-	-	-	-	65	-	65	-	-
E250NJ	25	36	36	50	65	85	85	36	-	50	-	-	36	50	-	-	-	-
S250NJ	36	-	50	65	85	125	125	-	-	65	-	-	65	-	-	-	-	-
S250GJ	65	-	-	70	125	150	150	-	-	70	-	-	-	-	-	-	-	-
S250PE	70	-	-	-	125	150	150	-	-	-	-	-	-	-	-	-	-	-
H250NJ	125	-	-	-	-	200	200	-	-	-	-	-	-	-	-	-	-	-
E400NJ	25	36	36	50	65	85	85	36	-	50	36	-	-	-	36	-	-	36
S400CJ	36	-	50	65	70	100	100	-	-	65	50	-	-	-	50	-	-	50
S400NJ	50	-	-	70	85	125	125	-	36	70	65	-	-	50	65	-	-	65
S400GJ	70	-	-	-	125	150	150	-	36	-	-	-	-	50	-	36	-	85
H400NJ	125	-	-	-	-	200	200	-	-	-	-	-	-	-	-	-	-	-

Note: <sup>1)</sup> Ratings have not been verified where a dash "-" is shown.

All pick-up and time delay settings are to be set at a maximum for upstream MCCBs



TEMBREAK 2 MCCBs



# APPLICATION DATA

## SELECTIVITY AND CASCADE TEMBREAK 2 MCCBs AND DIN-T / SAFE-T MCBs

Downstream MCB	Amp rating	kA (RMS)	Upstream MCCB							
			E125NJ	S125NJ	H125NJ S125GJ	S250NJ	S250GJ	S400CJ	S400GE S400GJ	H400NJ
			25	36	65	36	65	36	70	125
<b>DTCB6</b>	2 – 20	6	18/18	25/25	35/35	35/35	35/35	-	-	-
	25 – 63	6	18/18	20/25	20/25	30/30	30/30	-	-	-
<b>DTCB10</b>	0.5 – 32	10	18/18	30/30	30/50	35/35	40/50	35/35	40/50	40/50
	40 – 63	10	18/18	20/25	25/25	30/30	30/30	30/30	30/30	30/30
<b>DSRCBH / DSRCD</b>	0.5 – 32	10	18/18	30/30	30/50	35/35	40/50	35/35	40/50	40/50
	40	10	18/18	20/25	25/25	30/30	30/30	30/30	30/30	30/30
<b>DIn-T10H</b>	80 – 125	10	4/18	4/25	4/25	15/15	15/15	10/10	10/10	-
<b>DTCH15</b>	0.5 – 32	15	18/18	30	30/50	35/35	40/50	35/35	40/50	40/50
	40 – 63	15	18/18	20	25/25	30/30	30/30	30/30	30/30	30/30
<b>Safe-T</b>	16 – 20	6	3/10	3/10	3/10	-	-	-	-	-
<b>SRCB</b>	16 – 20	6	3/10	3/10	3/10	-	-	-	-	-

SECTION 4

### Guide

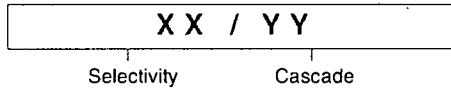

Notes: All figures stated are at 400/415 V AC.



TEMBREAK 2 MCCBs

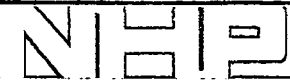

# APPLICATION DATA

## MOTOR STARTING TYPE 1 CO-ORDINATION TABLES

### Short-Circuit Co-Ordination Motor Starting Table

Type '1'  
Terasaki MCCB's & Sprecher + Schuh KT7's  
DOL starting 50/65 kA @ 400/415 V to AS/NZS 60947.4.1



SECTION 4

Motor Size (kW)	Approx. amps @ 400/415 V (A)	Terasaki Combinations	
		MCCB	Contactors
0.37	1.1	XM30PB/1.4	CA7-8
0.55	1.5	XM30PB/2	CA7-8
0.75	1.8	XM30PB/2.8	CA7-8
1.1	2.6	XM30PB/4.0	CA7-8
1.5	3.4	XM30PB/5	CA7-8
2.2	4.8	XM30PB/8	CA7-8
3	6.5	XM30PB/10	CA7-8
4	8.2	XM30PB/12	CA7-8
5.5	11	S125GJ/20	CA7-12
7.5	14	S125GJ/20	CA7-16
11	21	S125GJ/32	CA7-23
15	28	S125GJ/50	CA7-30
18.5	34	S125GJ/50	CA7-37
22	40	S125GJ/85	CA7-43
30	55	S125GJ/100	CA7-60
37	66	S125GJ/100	CA7-72
45	80	S125GJ/125	CA7-85
55	100	S125GJ/125	CA6-110
5	130	S250PE/250	CA6-140
0	155	S250PE/250	CA6-180
10	200	S250PE/250	CA6-210
32	225	S400GE/400	CA6-210
60	270	S400GE/400	CA6-300
00	361	S400GE/400	CA6-420

Terasaki Combinations		Sprecher + Schuh Combinations	
Overload Relay	Thermal Setting (A)	KT7 Circuit Breaker	Contactors
CT 7-24	1.0 - 1.8	KTA7-25S-1.0A	CA7-9
CT 7-24	1.0 - 1.8	KTA7-25S-1.6A	CA7-9
CT 7-24	1.8 - 2.4	KTA7-25S-2.5A	CA7-9
CT 7-24	2.4 - 4.0	KTA7-25S-2.5A	CA7-9
CT 7-24	2.4 - 4.0	KTA7-25S-4.0A	CA7-9
CT 7-24	4.0 - 6.0	KTA7-25S-6.3A	CA7-9
CT 7-24	6.0 - 10	KTA7-25S-6.3A	CA7-9
CT 7-24	6.0 - 10	KTA7-25S-10A	CA7-9
CT 7-24	10 - 18	KTA7-25H-16A	CA7-12
CT 7-24	10 - 18	KTA7-25H-16A	CA7-16
CT 7-24	18 - 24	KTA7-45H-20A	CA7-23
CT 7-45	18 - 30	KTA7-45H-32A	CA7-30
CT 7-45	30 - 45	KTA7-45H-45A	CA7-37
CT 7-45	30 - 45	KTA7-45H-45A	CA7-43
CT 7-75	45 - 60	KTA3-100-63A	CA7-60
CT 7-75	60 - 75	KTA3-100-90A	CA7-72
CT 7-100	70 - 80	KTA3-100-90A	CA7-85
CEF 1-11/12	20 - 180	KTA3-160S-100A	CA6-110
CEF 1-11/12	20 - 180	KTA3-160S-160A	CA6-140
CEF 1-11/12	20 - 180	KTA3-160S-160A	CA6-180
CEF 1-41/42	180 - 400	KTA3-250S-200A	CA6-210
CEF 1-41/42	160 - 400	KTA3-250S-250A	CA6-250
CEF 1-41/42	180 - 400	KTA3-400S-320A	CA6-300
CEF 1-41/42	180 - 400	KTA3-400S-400A	CA6-420

- Notes:
- Thermal or electronic overload relays may be used.
  - XM30PB MCCB's can be replaced with S125GJ/20 if required.
  - Combinations based on the thermal overload relay tripping before the circuit breaker at overload currents up to the motor locked rotor current.



TEMBREAK 2 MCCBs



# APPLICATION DATA

## MOTOR STARTING TYPE 2 CO-ORDINATION TABLES

### Short-Circuit Co-Ordination DOL Motor Starting Table

Type '2'  
Terasaki MCCB's & Sprecher + Schuh KT7's  
DOL starting 50/65 kA @ 400/415 V to AS/NZS 60947.4.1

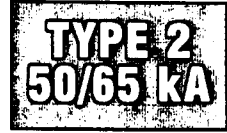

Motor Size (kW)	Approx. amps @ 400/415 V (A)	Terasaki Combinations	
		MCCB	Contactors
0.37	1.1	XM30PB/1.4	CA7-9
0.55	1.5	XM30PB/2	CA7-9
0.75	1.8	XM30PB/2.6	CA7-9
1.1	2.6	XM30PB/4.0	CA7-16
1.5	3.4	XM30PB/5	CA7-16
2.2	4.8	XM30PB/8	CA7-16
3	6.5	XM30PB/10	CA7-30
4	8.2	XM30PB/12	CA7-30
5.5	11	S125GJ/20	CA7-30
7.5	14	S125GJ/20	CA7-30
11	21	S125GJ/32	CA7-30
15	28	S125GJ/50	CA7-43
18.5	34	S125GJ/50	CA7-43
22	40	S125GJ/83	CA7-43
30	55	S125GJ/100	CA7-72
37	66	S125GJ/100	CA7-72
45	80	S125GJ/125	CA8-105
55	100	S250PE/160	CA8-105
75	130	S250PE/250	CA8-140
90	155	S250PE/250	CA8-170
110	200	S250PE/250	CA8-210
132	225	S400PE/400	CA8-210
160	270	S400PE/400	CA8-300
200	361	S400PE/400	CA8-420

Overload Relay	Thermal Setting (A)	Sprecher + Schuh Combinations	
		KT7 Circuit Breaker	Contactors
CT 7-24	1.0 - 1.6	KTA7-25S-1A	CA7-9
CT 7-24	1.0 - 1.6	KTA7-25S-1.6A	CA7-9
CT 7-24	1.6 - 2.4	KTA7-25S-2.5A	CA7-9
CT 7-24	2.4 - 4.0	KTA7-25S-2.5A	CA7-9
CT 7-24	2.4 - 4.0	KTA7-25S-4A	CA7-9
CT 7-24	4.0 - 8.0	KTA7-25S-6.3A	CA7-9
CT 7-24	8.0 - 10	KTA7-25S-6.3A	CA7-9
CT 7-24	8.0 - 10	KTA7-25S-10A	CA7-9
CT 7-24	10 - 18	KTA7-25H-16A	CA7-12
CT 7-24	10 - 18	KTA7-25H-16A	CA7-16
CT 7-24	18 - 24	KTA7-45H-20A	CA7-23
CT 7-45	18 - 30	KTA7-45H-32A	CA7-30
CT 7-45	30 - 45	KTA7-45H-45A	CA7-37
CT 7-45	30 - 45	KTA7-45H-45A	CA7-43
CT 7-75	45 - 60	KTA3-100-63A	CA7-60
CT 7-75	80 - 75	KTA3-100-90A	CA7-72
CT 7-100	70 - 90	KTA3-100-90A	CA7-85
CEF 1-11/12	20 - 180	KTA3-160S-100A	CA6-110
CEF 1-11/12	20 - 180	KTA3-160S-160A	CA6-140
CEF 1-11/12	20 - 180	KTA3-160S-160A	CA6-180
CEF 1-41/42	180 - 400	KTA3-250S-200A	CA6-210
CEF 1-41/42	180 - 400	KTA3-250S-250A	CA6-250
CEF 1-41/42	180 - 400	KTA3-400S-320A	CA6-300
CEF 1-41/42	180 - 400	KTA3-400S-400A	CA6-420

- Notes:
- Thermal or electronic overload relays may be used.
  - XM30PB combinations can be replaced with S125GJ/20 and CA7-30 if required.
  - Combinations based on the thermal overload relay tripping before the circuit breaker at overload currents up to the motor locked rotor current.

SECTION 4



TEMBREAK 2 MCCBs



# APPLICATION DATA

## MOTOR STARTING TYPE 2 CO-ORDINATION

### Short-Circuit Co-Ordination DOL Motor Starting Table

Type '2'  
Terasaki MCCB's & Sprecher + Schuh KT7's  
DOL starting 85 kA @ 400/415 V to AS/NZS 60947.4.1

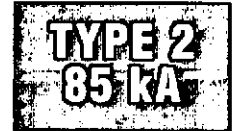

SECTION 4

Motor Size (kW)	Approx. amps @ 400/415 V (A)	Terasaki Combinations	
		MCCB	Contactors
0.37	1.1	XM30PB/1.4	CA 7-8
0.55	1.5	XM30PB/2	CA 7-8
0.75	1.8	XM30PB/2.8	CA 7-8
1.1	2.6	XM30PB/4.0	CA 7-18
1.5	3.4	XM30PB/5	CA 7-18
2.2	4.8	XM30PB/8	CA 7-30
3	6.5	XM30PB/10	CA 7-30
4	8.2	XM30PB/12	CA 7-30
5.5	11	H125NJ/20	CA 7-30
7.5	14	H125NJ/20	CA 7-30
11	21	H125NJ/32	CA 7-30
15	28	H125NJ/50	CA 7-43
18.5	34	H125NJ/50	CA 7-43
22	40	H125NJ/83	CA 7-43
30	55	H125NJ/100	CA 7-72
37	66	H125NJ/100	CA 7-72
45	80	H125NJ/160	CA 8-105
55	100	H180NJ/160	CA 8-105
75	130	H250PE/250	CA 8-210
90	155	H250PE/250	CA 8-210
110	200	H250PE/250	CA 8-210
132	225	H400NE/400	CA 8-210
160	270	H400NE/400	CA 8-300
200	361	H400NE/400	CA 8-420

Terasaki Combinations		Sprecher + Schuh Combinations	
Overload Relay	Thermal Setting (A)	KT7 Circuit Breaker	Contactors
CT 7-24	1.0 - 1.8	KTA7-25S-1A	CA 7-9
CT 7-24	1.0 - 1.8	KTA7-25S-1.6A	CA 7-9
CT 7-24	1.8 - 2.4	KTA7-25S-2.5A	CA 7-9
CT 7-24	2.4 - 4.0	KTA7-25H-2.5A	CA 7-9
CT 7-24	2.4 - 4.0	KTA7-25H-4A	CA 7-9
CT 7-24	4.0 - 8.0	KTA7-25H-6.3A	CA 7-9
CT 7-24	8.0 - 10	KTA7-25H-6.3A	CA 7-9
CT 7-24	6.0 - 10	KTA7-25H-10A	CA 7-9
CT 7-24	10 - 16	KTA7-45H-16A	CA 7-12
CT 7-24	10 - 16	KTA7-45H-16A	CA 7-16
CT 7-24	18 - 24	KTA7-45H-20A	CA 7-23
CT 7-45	18 - 30	KTA7-45H-32A	CA 7-30
CT 7-45	30 - 45	KTA7-45H-45A	CA 7-37
CT 7-45	30 - 45	KTA7-45H-45A	CA 7-43
CT 7-75	45 - 80	KTA3-100-63A	CA7-60
CT 7-75	60 - 75	KTA3-100-90A	CA7-72
CT 7-100	70 - 80	KTA3-100-90A	CA7-85
CEF 1-11/12	20 - 180	-	-
CEF 1-11/12	20 - 180	-	-
CEF 1-11/12	20 - 180	-	-
CEF 1-41/42	160 - 400	-	-
CEF 1-41/42	160 - 400	-	-
CEF 1-41/42	160 - 400	-	-
CEF 1-41/42	160 - 400	-	-

- Notes:
- Thermal or electronic overload relays may be used.
  - XM30PB combinations can be replaced with H125GJ/20 and CA7-30 if required.
  - Combinations based on the thermal overload relay tripping before the circuit breaker at overload currents up to the motor locked rotor current.



TEMBREAK 2 MCCBs



# APPLICATION DATA

## MOTOR STARTING TYPE 2 CO-ORDINATION

### Short-Circuit Co-Ordination DOL Motor Starting Table

Type '2'  
Terasaki MCCB's & Sprecher + Schuh KT7's  
DOL starting 100 kA @ 400/415 V to AS/NZS 60947.4.1



Motor Size (kW)	Approx. amps @ 400/415 V (A)	Terasaki Combinations	
		MCCB	Contactors
0.37	1.1	H125NJ/20	CA 7-30
0.55	1.5	H125NJ/20	CA 7-30
0.75	1.8	H125NJ/20	CA 7-30
1.1	2.6	H125NJ/20	CA 7-30
1.5	3.4	H125NJ/20	CA 7-30
2.2	4.8	H125NJ/20	CA 7-30
3	6.5	H125NJ/20	CA 7-30
4	8.2	H125NJ/20	CA 7-30
5.5	11	H125NJ/20	CA 7-30
7.5	14	H125NJ/20	CA 7-30
11	21	H125NJ/32	CA 7-30
15	28	H125NJ/50	CA 7-43
18.5	34	H125NJ/50	CA 7-43
22	40	H125NJ/83	CA 7-43
30	55	H125-NJ/100	CA 7-60
37	66	H125-NJ/100	CA 7-72
45	80	H125-NJ/125	CA 7-85
55	100	H250-NE/180	CA 8-85
75	130	H250-NE/250	CA 8-140
90	155	H250-NE/250	CA 8-140
110	200	H250-NE/250	CA 8-180
132	225	H400-NE/400	CA 8-420
160	270	H400-NE/400	CA 8-420
200	381	H400-NE/400	CA 8-420

Terasaki Combinations		Sprecher + Schuh Combinations	
Overload Relay	Thermal Setting (A)	KT7 Circuit Breaker	Contactors
CT 7-24	1.0 - 1.8	KTA7-25S-1A	CA 7-9
CT 7-24	1.0 - 1.8	KTA7-25S-1.6A	CA 7-9
CT 7-24	1.8 - 2.4	KTA7-25S-2.5A	CA 7-9
CT 7-24	2.4 - 4.0	KTA7-25H-2.5A	CA 7-9
CT 7-24	2.4 - 4.0	KTA7-25H-4A	CA 7-9
CT 7-24	4.0 - 8.0	KTA7-25H-6.3A	CA 7-9
CT 7-24	8.0 - 10	KTA7-25H-8.3A	CA 7-9
CT 7-24	8.0 - 10	KTA7-25H-10A	CA 7-9
CT 7-24	10 - 18	KTA7-45H-16A	CA 7-12
CT 7-24	10 - 18	KTA7-45H-16A	CA 7-16
CT 7-24	18 - 24	KTA7-45H-20A	CA 7-23
CT 7-46	18 - 30	KTA7-45H-32A	CA 7-30
CT 7-46	30 - 45	KTA7-45H-45A	CA 7-37
CT 7-46	30 - 45	KTA7-45H-45A	CA 7-43
CT 7-75	45 - 60	-	-
CT 7-75	60 - 75	-	-
CT 7-100	70 - 90	-	-
GEF 1-11/12	20 - 180	-	-
GEF 1-11/12	20 - 180	-	-
GEF 1-11/12	20 - 180	-	-
GEF 1-41/42	180 - 400	-	-
GEF 1-41/42	180 - 400	-	-
GEF 1-41/42	180 - 400	-	-
GEF 1-41/42	180 - 400	-	-

- Notes:
- Thermal or electronic overload relays may be used.
  - Combinations based on the thermal overload relay tripping before the circuit breaker at overload currents up to the motor locked rotor current.

SECTION 4



TEMBREAK 2 MCCBs

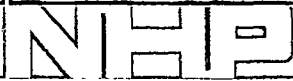

# OPERATING CHARACTERISTICS

## THERMAL MAGNETIC CHARACTERISTICS

125A Frame MCCBs

Time/current characteristic curves  
E125-NJ, S125-NJ, S125-GJ

Time/current characteristic curves  
H125-NJ, L125-NJ

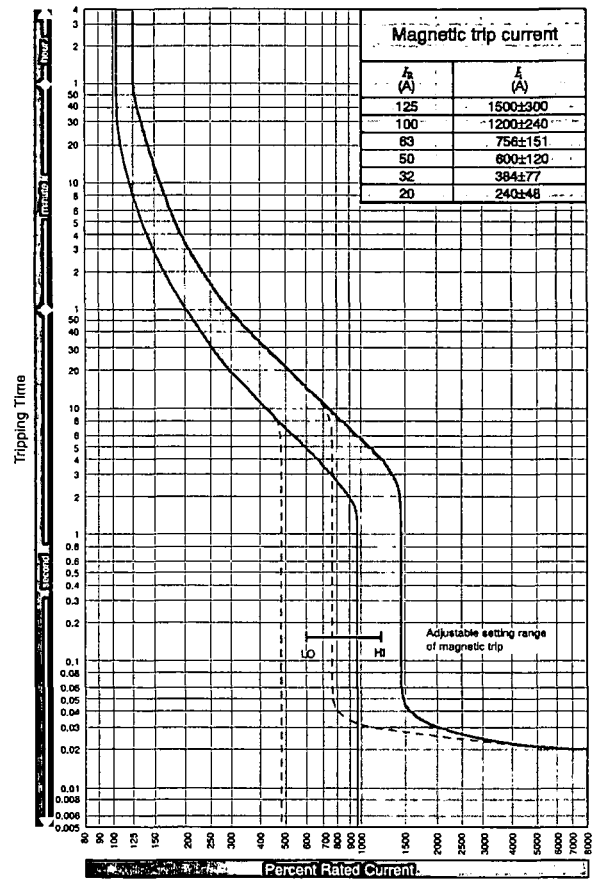
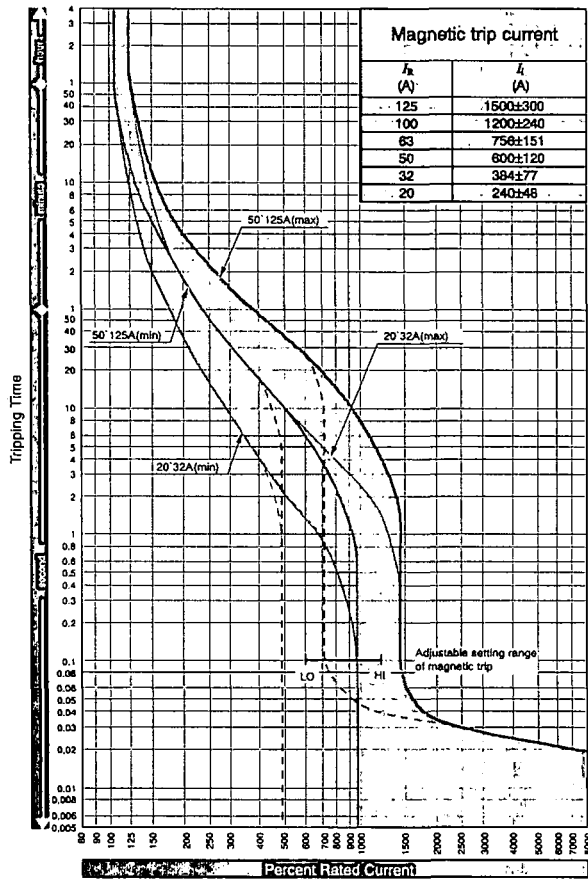

SECTION 3



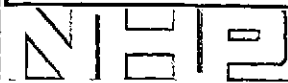

# OPERATING CHARACTERISTICS

## THERMAL MAGNETIC PROTECTION

### Adjustment Dials

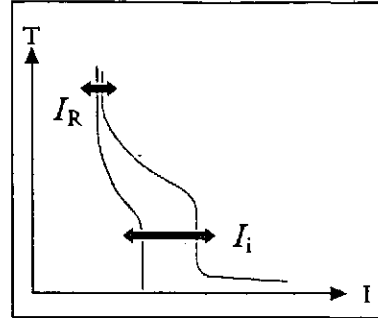
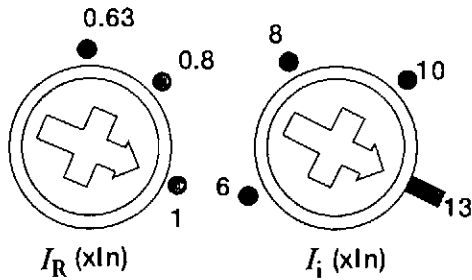

SECTION 3

1.  $I_R$  is the thermal element adjustment dial and is used to set the rated current to match the conductor rating.

$I_R$  can be set between 0.63 and 1.0 times  $I_n$ .

2.  $I_i$  is the magnetic element adjustment dial and is used to set the short circuit tripping threshold to suit the application.

$I_i$  can be set between 6 and 12 times  $I_n$  on 125A and 400A frame models.

$I_i$  can be set between 6 and 13 times  $I_n$  on 250A frame models with ratings of 160A, 200A and 250A.

$I_i$  can be set between 6 and 12 times  $I_n$  on 250A frame models with ratings of 125A and less.

### Models, Types and Rated Currents of Thermal Elements

Model	Type	Current Rating (In (A))
S125	-NF	16, 20, 25, 32, 40, 50, 63, 80, 100, 125
E125	-NJ	20, 32, 50, 63, 100, 125
S125	-NJ	20, 32, 50, 63, 100, 125
S125	-GJ	20, 32, 50, 63, 100, 125
H125	-NJ	20, 32, 50, 63, 100, 125
L125	-NJ	20, 32, 50, 63, 100, 125
S160	-NF	16, 20, 25, 32, 40, 50, 63, 80, 100, 125, 160
S160	-NJ	20, 32, 50, 63, 100, 125, 160
S160	-GJ	50, 63, 100, 125, 160
H160	-NJ	160
L160	-NJ	160
E250	-NJ	20, 32, 50, 63, 100, 125, 160, 200, 250
S250	-NJ	160, 200, 250
S250	-GJ	160, 200, 250
H250	-NJ	160, 250
L250	-NJ	160, 250
E400	-NJ	250, 400
S400	-CJ	250, 400
S400	-NJ	250, 400
S400	-GJ	250, 400
H400	-NJ	250, 400
L400	-NJ	250, 400



TEMBREAK 2 MCCBs

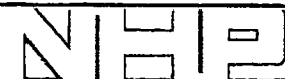

# OPERATING CHARACTERISTICS

## LET-THROUGH PEAK CURRENT CHARACTERISTICS

S125-NF, 240V AC

S160-NF, 240V AC.

SECTION 3

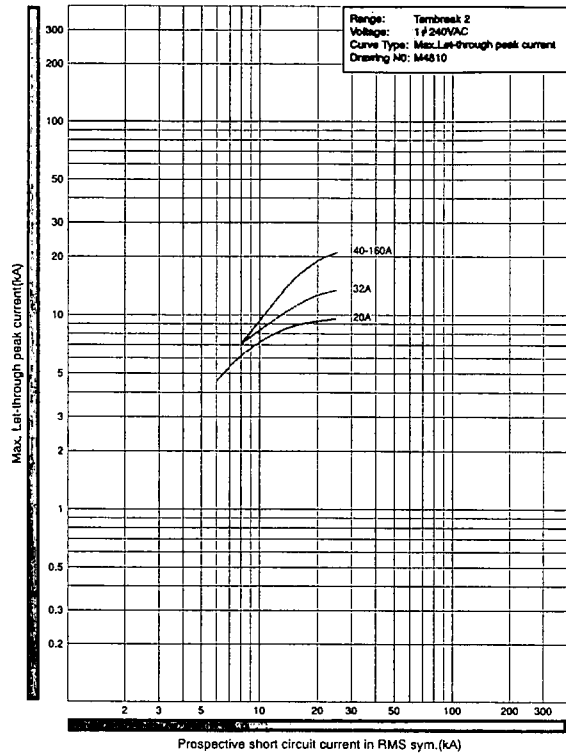
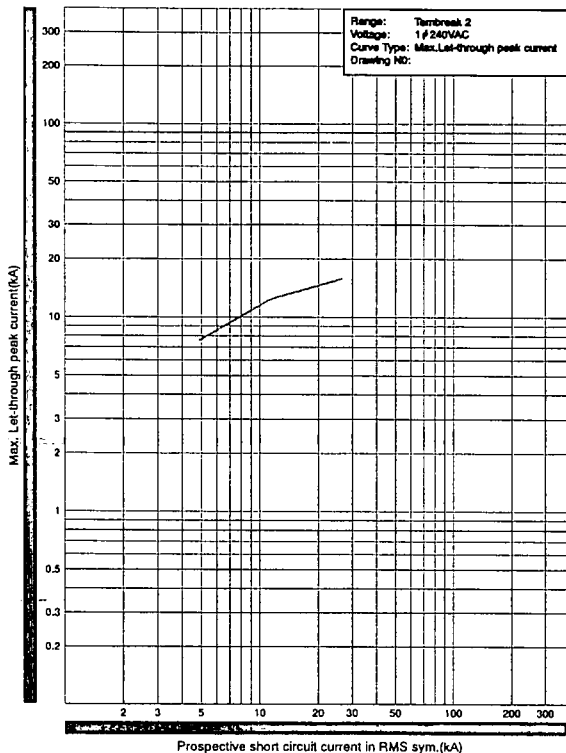

E125-NJ, S125-NJ, S125-GJ. 440V AC.

S125-NJ, S125-GJ. 690V AC.

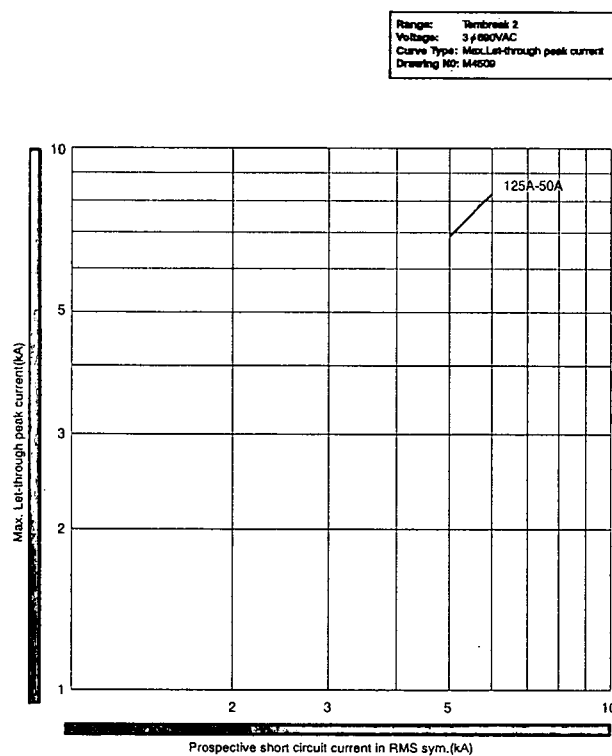
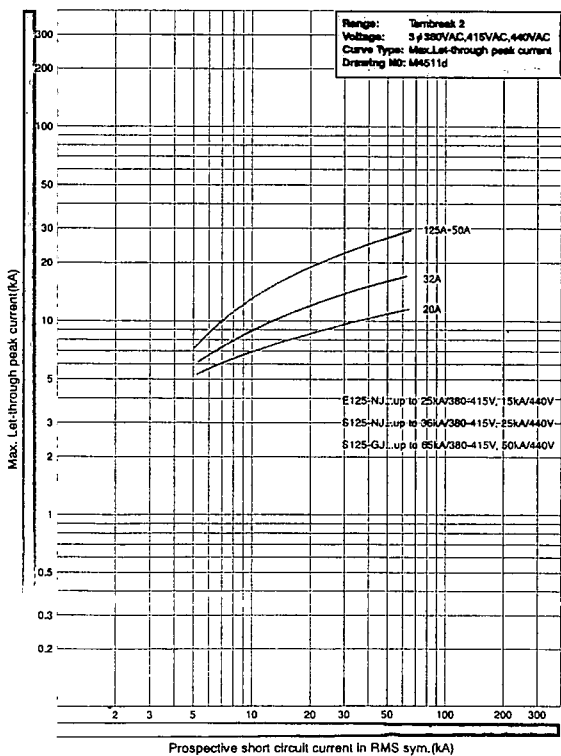



TEMBREAK 2 MCCBs



# OPERATING CHARACTERISTICS

## LET-THROUGH ENERGY CHARACTERISTICS

S125-NF, 240V AC

S160-NF, 240V AC

SECTION 3

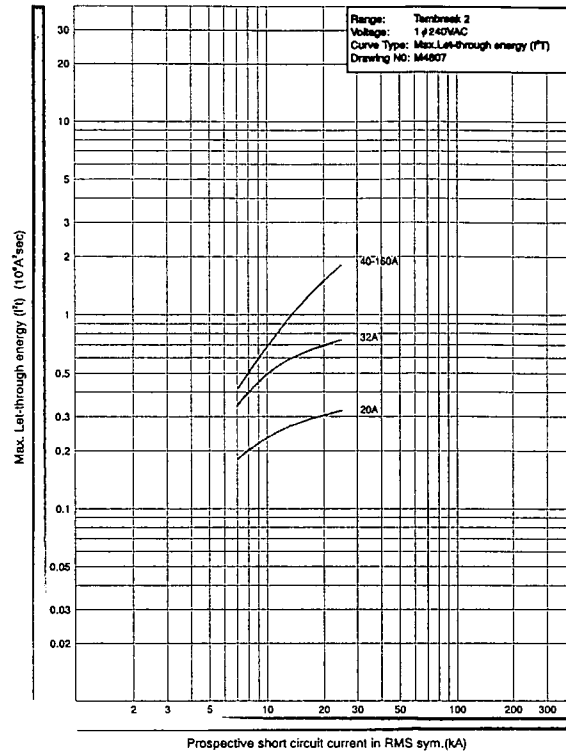
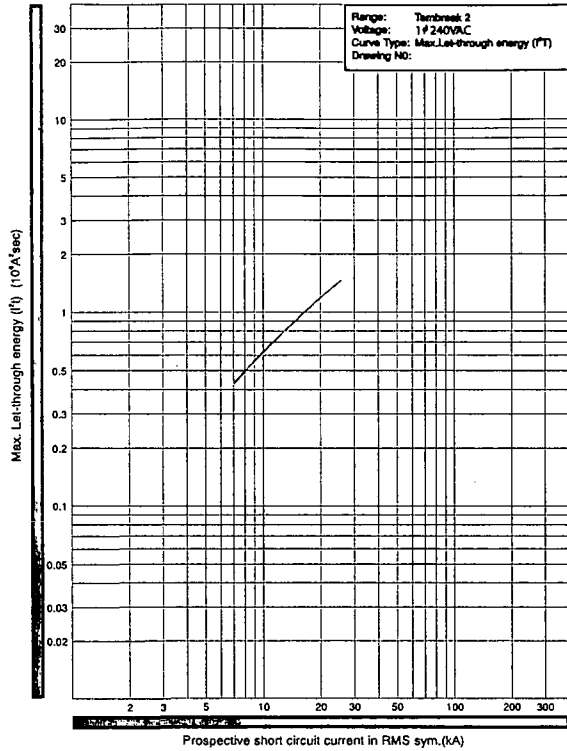

E125-NJ, S125-NJ, S125-GJ, 440V AC.

S125-NJ, S125-GJ, 690V AC.

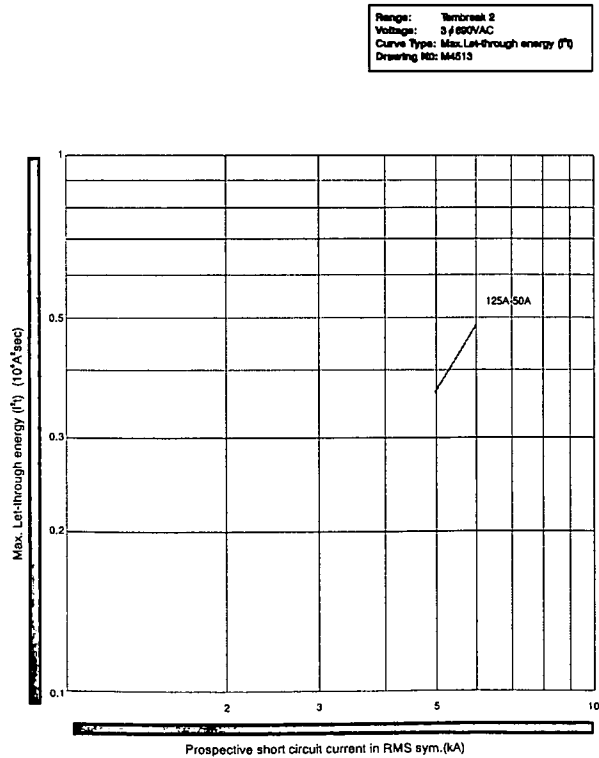
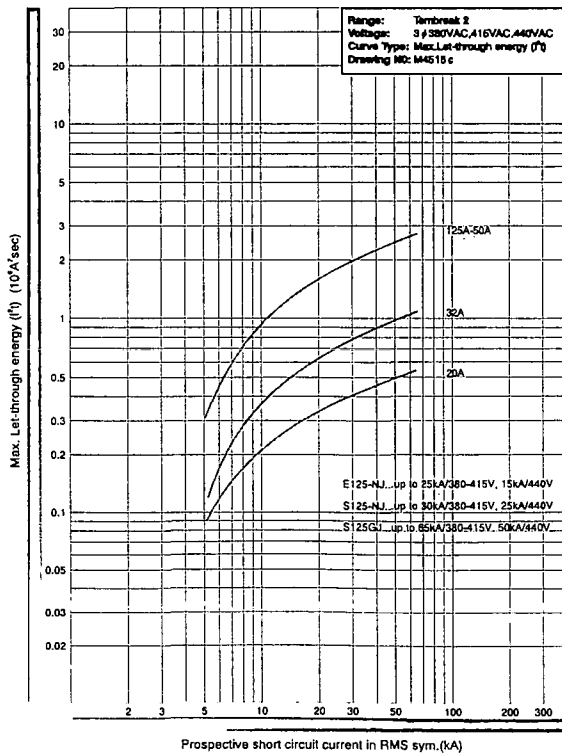

**NHP**

**Accessories to suit 125 - 630AF MCCBs**

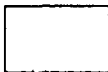

**External accessories**

**Cat. No.**

Door interlocking, variable depth    Suits MCCB types

**E125, S125**

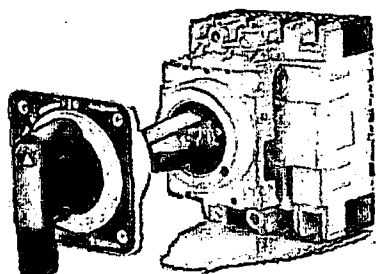

**IP54 rated**

Grey/black  
Grey/black c/w key lock  
Red/yellow  
Red/yellow c/w key lock

T2HP12R5BNA4  
T2HP12R5BKA4  
T2HP12R5RNA4  
T2HP12R5RKA4

**IP65 rated**

Grey/black  
Grey/black c/w key lock  
Red/yellow  
Red/yellow c/w key lock

T2HP12R6BNA4  
T2HP12R6BKA4  
T2HP12R6RNA4  
T2HP12R6RKA4

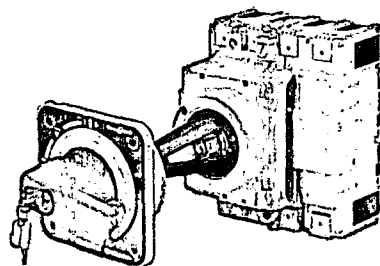

**H125, L125, S160, H160, L160, E250, S250, H250, L250**

**IP54 rated**

Grey/black  
Grey/black c/w key lock  
Red/yellow  
Red/yellow c/w key lock

T2HP25R5BNA4  
T2HP25R5BKA4  
T2HP25R5RNA4  
T2HP25R5RKA4

**IP65 rated**

Grey/black  
Grey/black c/w key lock  
Red/yellow  
Red/yellow c/w key lock

T2HP25R6BNA4  
T2HP25R6BKA4  
T2HP25R6RNA4  
T2HP25R6RKA4

**Note:** Handles supplied with shaft

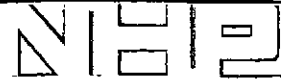

# ACCESSORIES

## OPERATING HANDLES & LOCKING DEVICES

TemBreak 2 handles are extremely reliable, having been designed to endure the same switching duty as the host MCCB.

It is easy to fit the operating unit to the MCCB. Fitting involves three easy steps:

1. Align breaker toggle with operating mechanism
2. Push handle into position (the handle's round pegs locate securely in the breaker's round holes and the handle's\* square pegs in the breaker's square holes).
3. Twist locking screws through 45 degrees.\*

### Safety Features

- Door interlock mechanism with override facility included as standard
- IP54 (door mounted version), IP 54 as standard (breaker mounted version)
- IP65 (door mounted version), IP 65 optional (breaker mounted version)
- Locks OFF with up to 3 padlocks (8mm hasps)
- Optional keylock in OFF position
- Available in black or red and yellow
- A trip test can be performed with the handle fitted to the MCCB

SECTION 5

### Orientation

To switch the breaker from OFF to ON the handle is rotated through 90 degrees in a clockwise direction.

The ON (I) and OFF (O) indication of the handle can be re-oriented in steps of 90 degrees with respect to the operating mechanism. This allows the indication position to remain the same whether the breaker is mounted vertically (right side up or upside down) or horizontally (on its left side or on its right side). The hole cut-out dimensions for a panel or door will remain unchanged if the handle is re-oriented. The handle's axis of rotation is on the intersection of the centre lines of a 3P MCCB.

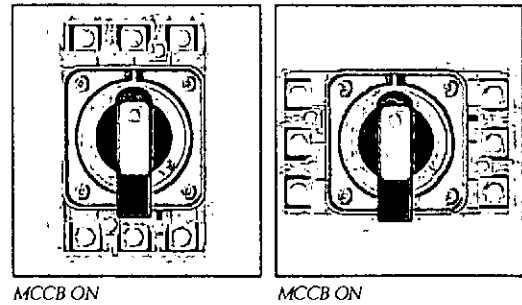

MCCB ON

MCCB ON

This means that the positioning of the door cutouts is symmetrical for breakers mounted horizontally on either side of a vertical busbar system.

### Cubicle Door Cutouts

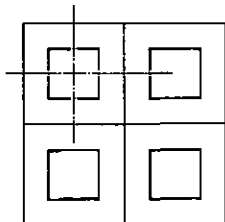

Using TemBreak 2 Operating Handles

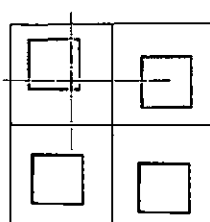

Using other MCCB Operating Handles

\*handles for 400A and 630A Frame models are secured with four screws.

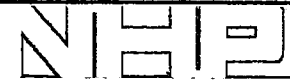

# ACCESSORIES

## OPERATING HANDLES & LOCKING DEVICES

### Door Mounted Handle (HP)

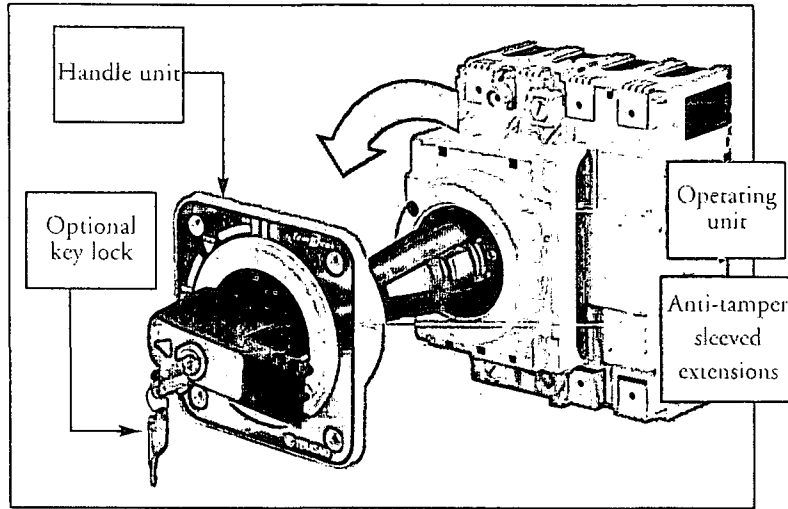

Door Mounted Handle with Optional Keylock

The door mounted operating handle is used to operate a circuit breaker mounted inside a cubicle from outside the door. It consists of an operating mechanism that is mounted on the breaker, an operating handle that is mounted on the door, and a shaft that transmits the turning force from the handle to the operating unit. The shaft can be cut to the required length.

SECTION 6

### Breaker Mounted Handle (HB)

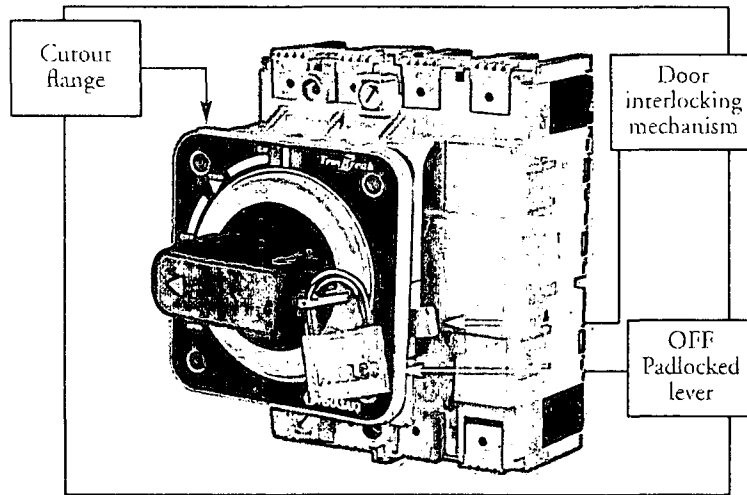

Breaker Mounted Handle Padlocked in the OFF Position

This handle is used to operate a circuit breaker mounted just behind a compartment door with the door closed. The operating unit and the handle itself are mounted directly onto the circuit breaker. The handle protrudes through a cutout in the door. A moulded door flange is supplied with the handle which covers the cutout from the front.

Padlocking and keylocking is possible in the OFF position or both the ON and OFF position depending on the mounting direction.

### Locking Devices

Toggle locking devices allow MCCBs to be locked ON or OFF using up to three padlocks. Locking devices for 125A, 160A and 250A frame models accept padlocks with 5mm hasp diameter. Locking devices for 400A and 630A frame models accept padlocks with 8mm hasp diameter.

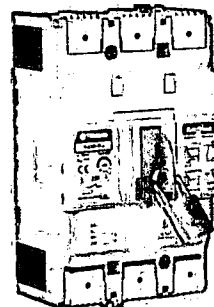

S250 Locked OFF

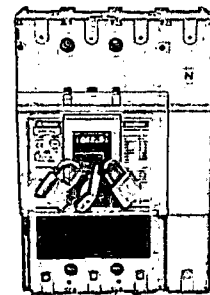

S400 Locked OFF

Fittings for Castell and Fortress locks are available. They are suitable for use on toggle-operated MCCBs, or on door mounted handles (HP) for MCCBs.



TEMBREAK 2 MCCBs



# DIMENSIONS

## Door Mounted Handle

Applicable MCCB	A *1	B	C	Shaft support
E125 S125	540 max.	370	421	With +

\*1: Max. means the maximum length for A without cutting the shaft.

+ The shaft can be cut to the required length. If it is necessary to cut the shaft so short that it does not protrude beyond the shaft support, the shaft support may be removed.

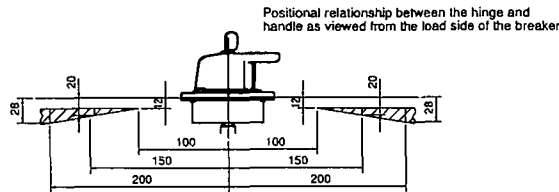
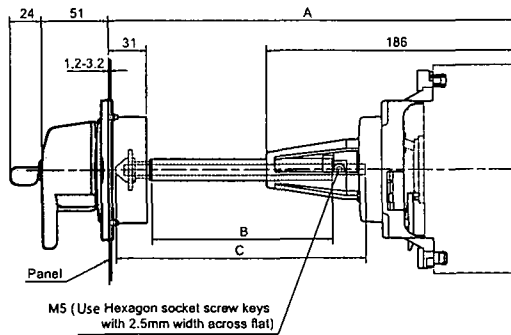
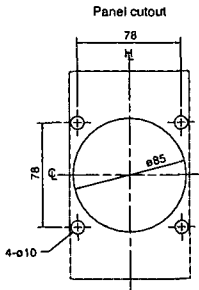
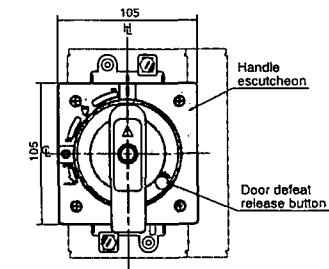

ASL: Arrangement Standard Line  
 H: Handle Frame Centre Line  
 C: Handle Centre Line

Padlock dimensions (mm)

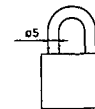

SECTION 2



TEMBREAK 2 MCCBs

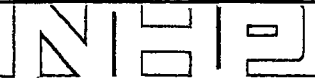

# DIMENSIONS

## Door Mounted Handle

Applicable MCCB	A *1	B	C	D	Shaft support
E250 S250 (except S250-PE)	540 max.	370	421	186	With +
S250-PE H125 L125 H160 L160 H250 L250	575 max.	370	421	221	With +

\*1: Max. means the maximum length for A without cutting the shaft.

+ The shaft can be cut to the required length. If it is necessary to cut the shaft so short that it does not protrude beyond the shaft support, the shaft support may be removed.

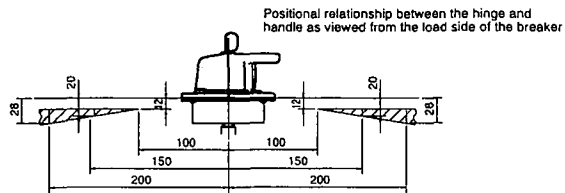
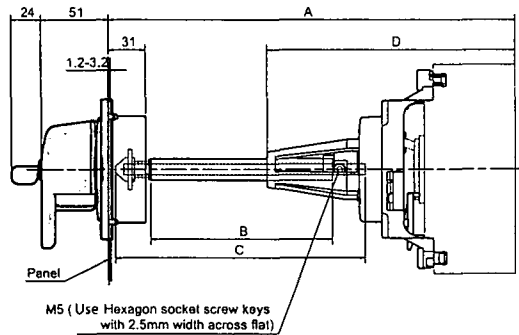
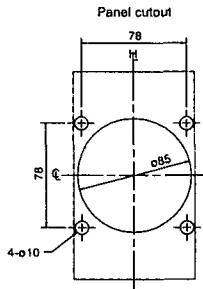
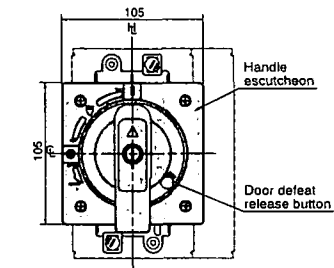

ASL: Arrangement Standard Line  
 HL: Handle Frame Centre Line  
 CL: Handle Centre Line

Padlock dimensions (mm)

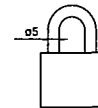

SECTION 7





TEMBREAK 2 MCCBs



# DIMENSIONS

## Door Mounted Handle

Applicable MCCB	A *1	B	C	D	Shaft support
E400 E630	270 min.	12	107.5	—	Without
S400 S630	610 max.	280	447.5	261	With +
H400	307 min.	12	107.5	—	Without
L400	647 max.	280	447.5	298	With +

\*1: Min. means the minimum length for A by cutting the shaft.

Max. means the maximum length for A without cutting the shaft.

+ The shaft can be cut to the required length. If it is necessary to cut the shaft so short that it does not protrude beyond the shaft support, the shaft support may be removed.

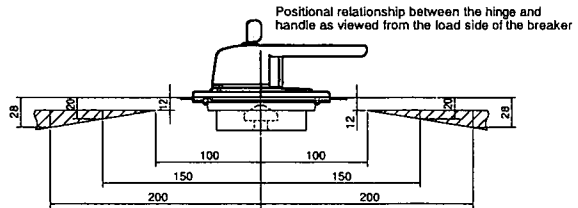
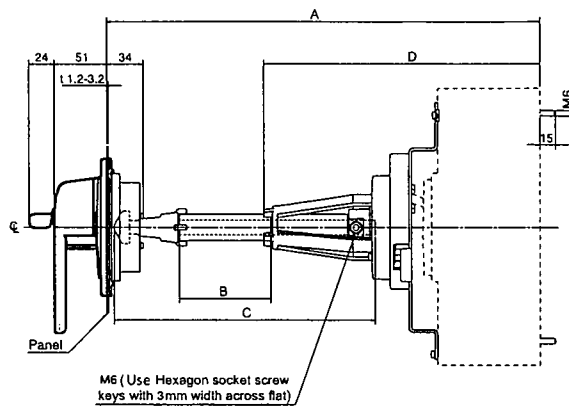
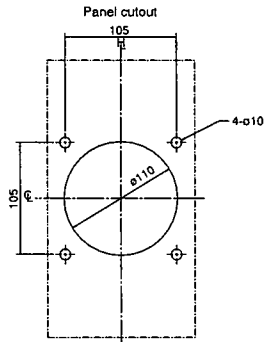
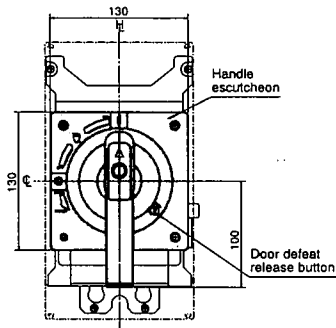

ASL: Arrangement Standard Line  
 H<sub>L</sub>: Handle Frame Centre Line  
 C<sub>L</sub>: Handle Centre Line

Padlock dimensions (mm)

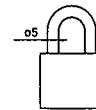



*TempBreak* MCCB's

**NHP**

**Accessories to suit 125 - 630AF MCCBs**



**External accessories**

**Cat. No.**

Door interlocking, variable depth Suits MCCB types

**E400, S400, H400, L400, E630, S630**

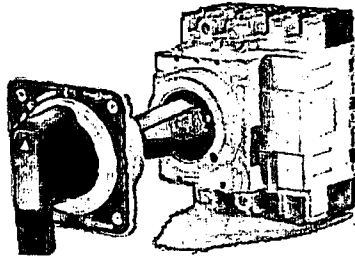

**IP54 rated**

Grey/black  
 Grey/black c/w key lock  
 Red/yellow  
 Red/yellow c/w key lock

T2HP40R5BNA4  
 T2HP40R5BKA4  
 T2HP40R5RNA4  
 T2HP40R5RKA4

**IP65 rated**

Grey/black  
 Grey/black c/w key lock  
 Red/yellow  
 Red/yellow c/w key lock

T2HP40R6BNA4  
 T2HP40R6BKA4  
 T2HP40R6RNA4  
 T2HP40R6RKA4

Note: Handles supplied with shaft

**Mechanical Interlocks**

Link Interlock – suitable for manual or motorised operation. Will accept handles. Suitable for front or rear connection

**E125, S125**

**With trip interlock function**

3 or 4 pole right side section  
 3 pole left side section  
 4 pole left side section

T2ML12RA  
 T2ML12L3A  
 T2ML12L4A

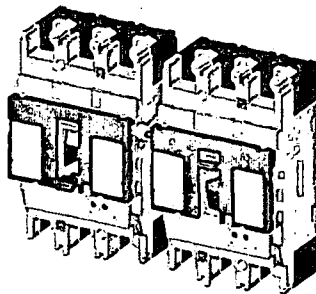

**H125, L125, S160, H160, L160, E250, S250, H250, L250**

**With trip interlock function**

3 or 4 pole right side section  
 3 pole left side section  
 4 pole left side section

T2ML25RA  
 T2ML25L3A  
 T2ML25L4A

**E400, S400, H400, L400, E630, S630**

**With trip interlock function**

3 or 4 pole right side section  
 3 pole left side section  
 4 pole left side section

T2ML40RA  
 T2ML40L3A  
 T2ML40L4A

Refer page 53 if MCCB labels are required or refer to NHP.

Price Schedule T2



TEMBREAK 2 MCCBs



## ACCESSORIES

### OPERATING HANDLES & LOCKING DEVICES

TemBreak 2 handles are extremely reliable, having been designed to endure the same switching duty as the host MCCB.

It is easy to fit the operating unit to the MCCB. Fitting involves three easy steps:

1. Align breaker toggle with operating mechanism
2. Push handle into position (the handle's round pegs locate securely in the breaker's round holes and the handle's\* square pegs in the breaker's square holes).
3. Twist locking screws through 45 degrees.\*

#### Safety Features

- Door interlock mechanism with override facility included as standard
- IP54 (door mounted version), IP 54 as standard (breaker mounted version)
- IP65 (door mounted version), IP 65 optional (breaker mounted version)
- Locks OFF with up to 3 padlocks (8mm hasps)
- Optional keylock in OFF position
- Available in black or red and yellow
- A trip test can be performed with the handle fitted to the MCCB

#### Orientation

To switch the breaker from OFF to ON the handle is rotated through 90 degrees in a clockwise direction.

The ON (I) and OFF (O) indication of the handle can be re-oriented in steps of 90 degrees with respect to the operating mechanism. This allows the indication position to remain the same whether the breaker is mounted vertically (right side up or upside down) or horizontally (on its left side or on its right side). The hole cut-out dimensions for a panel or door will remain unchanged if the handle is re-oriented. The handle's axis of rotation is on the intersection of the centre lines of a 3P MCCB.

This means that the positioning of the door cutouts is symmetrical for breakers mounted horizontally on either side of a vertical busbar system.

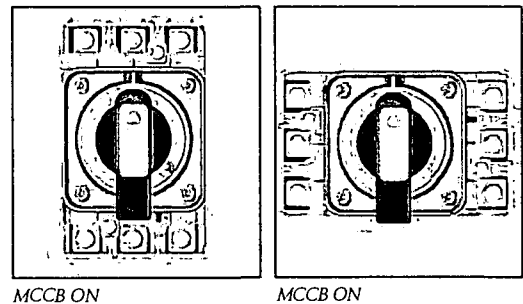

#### Cubicle Door Cutouts

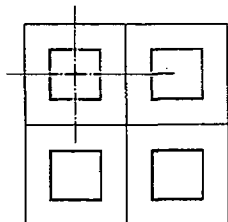

Using TemBreak 2 Operating Handles

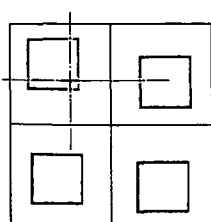

Using other MCCB Operating Handles

\*handles for 400A and 630A Frame models are secured with four screws.

SECTIONS



TEMBREAK 2 MCCBs



# ACCESSORIES

## OPERATING HANDLES & LOCKING DEVICES

### Door Mounted Handle (HP)

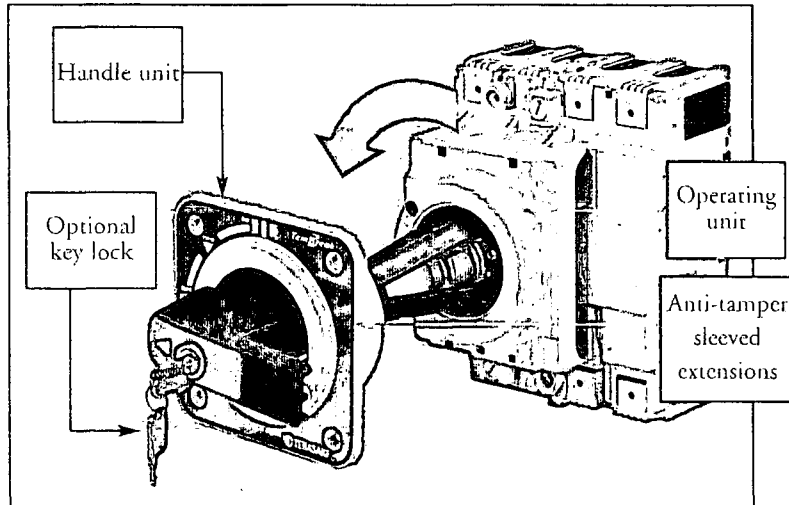

The door mounted operating handle is used to operate a circuit breaker mounted inside a cubicle from outside the door. It consists of an operating mechanism that is mounted on the breaker, an operating handle that is mounted on the door, and a shaft that transmits the turning force from the handle to the operating unit. The shaft can be cut to the required length.

*Door Mounted Handle with Optional Keylock*

### Breaker Mounted Handle (HB)

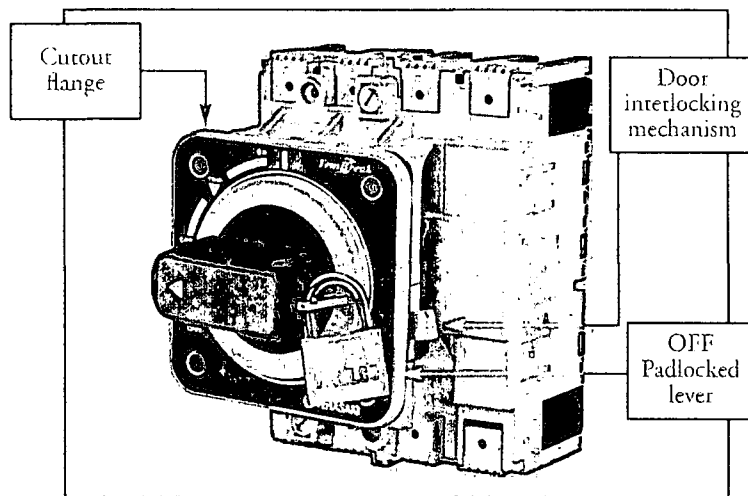

This handle is used to operate a circuit breaker mounted just behind a compartment door with the door closed. The operating unit and the handle itself are mounted directly onto the circuit breaker. The handle protrudes through a cutout in the door. A moulded door flange is supplied with the handle which covers the cutout from the front. Padlocking and keylocking is possible in the OFF position or both the ON and OFF position depending on the mounting direction.

*Breaker Mounted Handle Padlocked in the OFF Position*

### Locking Devices

Toggle locking devices allow MCCBs to be locked ON or OFF using up to three padlocks. Locking devices for 125A, 160A and 250A frame models accept padlocks with 5mm hasp diameter. Locking devices for 400A and 630A frame models accept padlocks with 8mm hasp diameter.

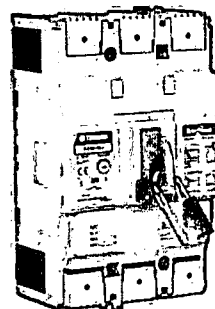

*S250 Locked OFF*

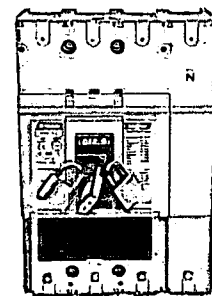

*S400 Locked OFF*

Fittings for Castell and Fortress locks are available. They are suitable for use on toggle-operated MCCBs, or on door mounted handles (HP) for MCCBs.

SECTION 6



TEMBREAK 2 MCCBs



# DIMENSIONS

## Door Mounted Handle

Applicable MCCB	A *1	B	C	Shaft support
E125 S125	540 max.	370	421	With +

\*1: Max. means the maximum length for A without cutting the shaft.  
 + The shaft can be cut to the required length. If it is necessary to cut the shaft so short that it does not protrude beyond the shaft support, the shaft support may be removed.

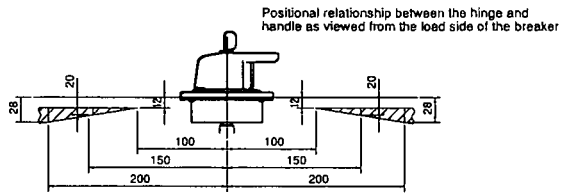
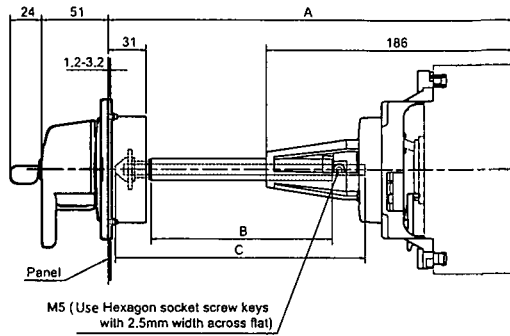
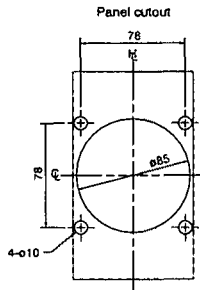
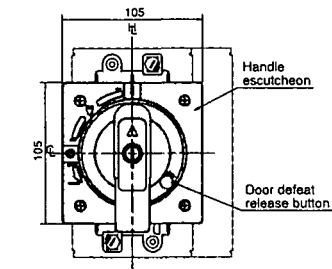

ASL: Arrangement Standard Line  
 H: Handle Frame Centre Line  
 C: Handle Centre Line

Padlock dimensions (mm)

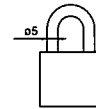



TEMBREAK 2 MCCBs



# DIMENSIONS

## Door Mounted Handle

Applicable MCCB	A *1	B	C	D	Shaft support
E250 S250 (except S250-PE)	540 max.	370	421	186	With +
S250-PE H125 L125 H160 L160 H250 L250	575 max.	370	421	221	With +

\*1: Max. means the maximum length for A without cutting the shaft.

+ The shaft can be cut to the required length. If it is necessary to cut the shaft so short that it does not protrude beyond the shaft support, the shaft support may be removed.

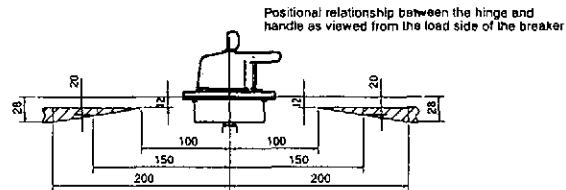
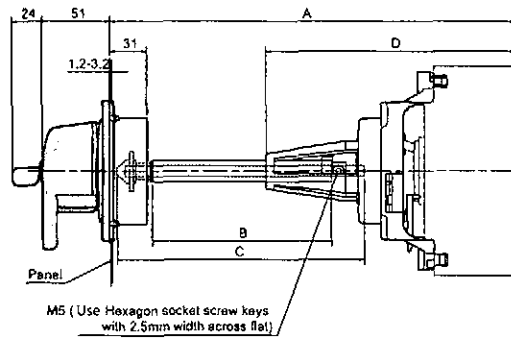
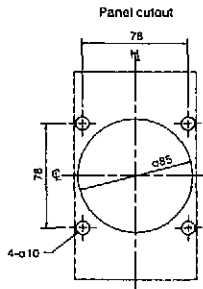
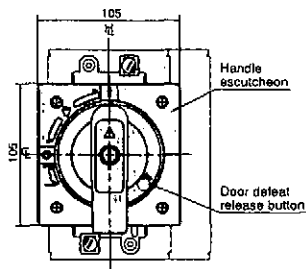

ASL: Arrangement Standard Line  
 H: Handle Frame Centre Line  
 C: Handle Centre Line

Padlock dimensions (mm)

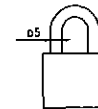

SECTION 7



TEMBREAK 2 MCCBs



# DIMENSIONS

## Door Mounted Handle

Applicable MCCB	A *1	B	C	D	Shaft support
E400 E630	270 min.	12	107.5	—	Without
S400 S630	610 max.	280	447.5	261	With +
H400	307 min.	12	107.5	—	Without
L400	647 max.	280	447.5	298	With +

\*1: Min. means the minimum length for A by cutting the shaft.  
 Max. means the maximum length for A without cutting the shaft.  
 + The shaft can be cut to the required length. If it is necessary to cut the shaft so short that it does not protrude beyond the shaft support, the shaft support may be removed.

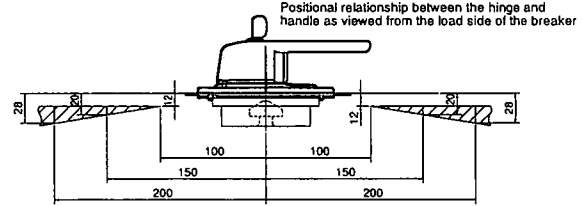
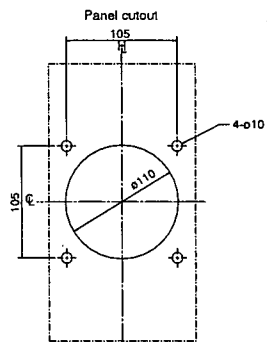
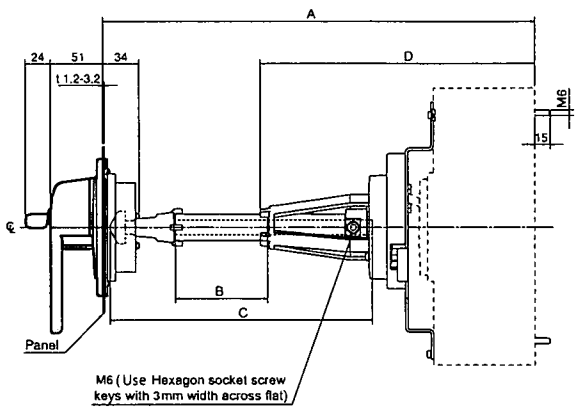
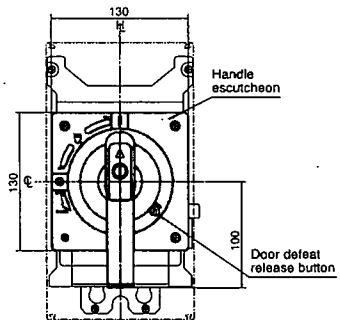

ASL: Arrangement Standard Line  
 H: Handle Frame Centre Line  
 Q: Handle Centre Line

Padlock dimensions (mm)

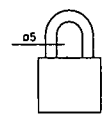









**Halmac** Services (Qld) Pty. Ltd.  
A.C.N. 098 852 923  
A.B.N. 40 741 712 113

# MINIATURE CIRCUIT BREAKER

1. MCB TECHNICAL DETAILS
2. MCB/RCD TECHNICAL DETAILS



## Miniature circuit breakers

### Din-T6 series 6 kA MCB

DTCB6  
1 pole

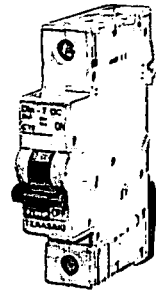

- Standards AS/NZS 4898
- Approval No. N17481
- Current range 2-63 Amps 1, 2 and 3 pole
- Sealable and lockable handle
- Available in curve type C and D
- Mounts on CD chassis (250 A and 355 A)

#### 1 pole 1 module

In (A)	C - Curve 5-10 In
2	DTCB6102C
4	DTCB6104C
6	DTCB6106C
10	DTCB6110C
13	DTCB6113C
16	DTCB6116C
20	DTCB6120C
25	DTCB6125C
32	DTCB6132C
40	DTCB6140C
50	DTCB6150C
63	DTCB6163C

#### 2 pole 2 modules

2	DTCB6202C
4	DTCB6204C
6	DTCB6206C
10	DTCB6210C
13	<sup>1</sup> DTCB6213C
16	DTCB6216C
20	DTCB6220C
25	DTCB6225C
32	DTCB6232C
40	DTCB6240C
50	DTCB6250C
63	DTCB6263C

#### 3 pole 3 modules

2	DTCB6302C
4	DTCB6304C
6	DTCB6306C
10	DTCB6310C
13	<sup>1</sup> DTCB6313C
16	DTCB6316C
20	DTCB6320C
25	DTCB6325C
32	DTCB6332C
40	DTCB6340C
50	DTCB6350C
63	DTCB6363C

#### Short circuit capacity 6 kA

In (A)	2 - 63	
1 P	240 V AC	
2 P	240 - 415 V AC	
3 P	240 - 415 V AC	
DC use	1 P	2 P <sup>1)</sup>
Short circuit	20 kA	25 kA
Max.voltage (DC)	48 V	110 V

#### Use at DC

When using Din-T6 in a DC application the magnetic tripping current is approximately 40 % higher than in AC 50/60 Hz.

#### Shock resistance (In X, Y, Z directions).

20 g with shock duration 10 ms (minimum 18 shocks).  
40 g with shock duration 5 ms (minimum 18 shocks).

#### Vibration resistance (In X, Y, Z directions).

3 g in frequency range 10 to 55 Hz  
(operating time at least 30 min).  
According to IEC 60068-2-6.

#### Storage temperature

From -55 °C to +55 °C, according to IEC 88 part 2 - 1  
(duration 96 hours).

#### Operating temperature

From -25 °C to +55 °C, according to  
VDE 0664 parts 1 and 2.

#### Use at 400 Hz

At 400 Hz the magnetic trip current is approximately  
50 % higher than in AC 50/60 Hz.

Notes: <sup>1)</sup> 2 pole MCB connected in series.

The line side is the "OFF" (bottom) side of  
the MCB, and connects to CD chassis tee-offs.

<sup>1</sup> Available on indent only.

## Din-T MCBs Technical data

### Characteristics according to BS EN 60898

Miniature Circuit Breakers are intended for the protection of wiring installations against both overloads and short-circuits in **domestic** or **commercial** wiring installations where operation is possible by **uninstructed** people

3

#### Tripping characteristic curves

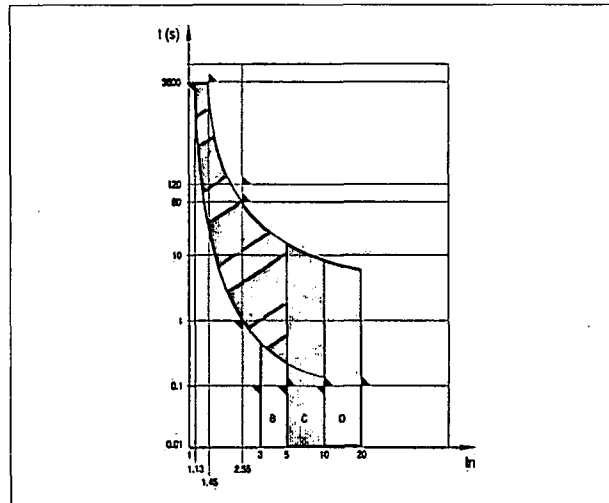

#### Magnetic release

An electromagnet with plunger ensures instantaneous tripping in the event of short-circuit. The NHP Din-T range has 3 different types, following the current for instantaneous release: types B, C and D curve.

Icn (A)	Test current	Tripping time	Applications
B	3 x In	0.1 < t < 45 s (In ≤ 32 A)	Only for resistive loads eg: • electrical heating • water heater • stoves.
	5 x In	0.1 < t < 90 s (In > 32 A) t < 0.1 s	
C	5 x In	0.1 < t < 15 s (In ≤ 32 A)	Usual loads such as: • lighting • socket outlets • small motors
	10 x In	0.1 < t < 30 s (In > 32 A) t < 0.1 s	
D	10 x In	0.1 < t < 4 s (**) (In ≤ 32 A)	Control and protection of circuits having important transient inrush currents (large motors)
	20 x In	0.1 < t < 8 s (In > 32 A) t < 0.1 s	

#### Thermal release

The release is initiated by a bimetal strip in the event of overload. The standard defines the range of releases for specific overload values. Reference ambient temperature is 30 °C.

Test current	Tripping time
1.13 x In	t ≥ 1 h (In ≤ 63 A) t ≥ 2 h (In > 63 A)
1.45 x In	t < 1 h (In ≤ 63 A) t < 2 h (In > 63 A)
2.55 x In	1 s < t < 60 s (In ≤ 32 A) 1 s < t < 120 s (In > 32 A)

#### Rated short-circuit breaking capacity (Icn)

Is the value of the short-circuit that the MCB is capable of withstanding in the following test of sequence of operations: O-t-CO.

After the test the MCB is capable, without maintenance, to withstand a dielectric strength test at a test voltage of 900 V. Moreover, the MCB shall be capable of tripping when loaded with 2.8 In within the time corresponding to 2.55 In but greater than 0.1s.

#### Service short-circuit breaking capacity (Ics)

Is the value of the short-circuit that the MCB is capable of withstanding in the following test of sequence of operations: O-t-CO-t-CO.

After the test the MCB is capable, without maintenance, to withstand a dielectric strength test at a test voltage of 1500 V. Moreover, the MCB shall not trip at a current of 0.96 In. The MCB shall trip within 1h when current is 1.6 In.

- O - Represents an opening operation
- C - Represents a closing operation followed by an automatic opening.
- t - Represents the time interval between two successive short-circuit operations: 3 minutes.

The relation between the rated short-circuit capacity (Icn) and the rated service short-circuit breaking capacity (Ics) shall be as follows:

Icn (A)	Ics (A)
≤ 6000	6000
> 6000 ≤ 10000	0.75 Icn min. 6000
> 10000	0.75 Icn min. 7500

In both sequences all MCBs are tested for emission of ionized gases during short-circuit (grid distance), in a safety distance between two MCBs of 35 mm when devices are installed in two different rows in the enclosure. This performance allows the use of any NHP/Terasaki enclosure.

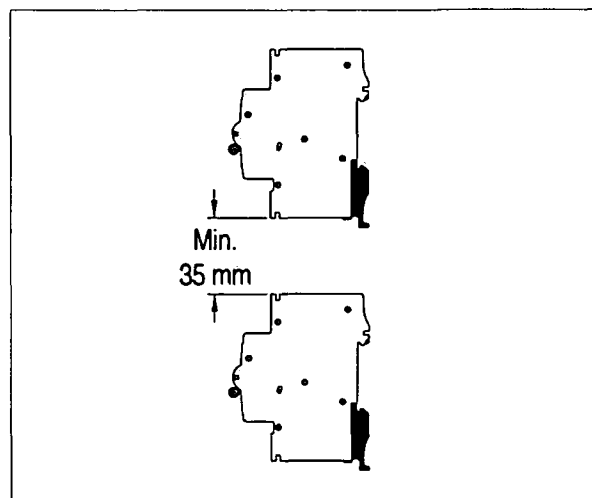



## Din-T MCBs Technical data

### Tripping curves according to EN 60898

The following tables show the average tripping curves of the Terasaki Din-T MCBs based on the thermal and magnetic characteristics.

Curve C

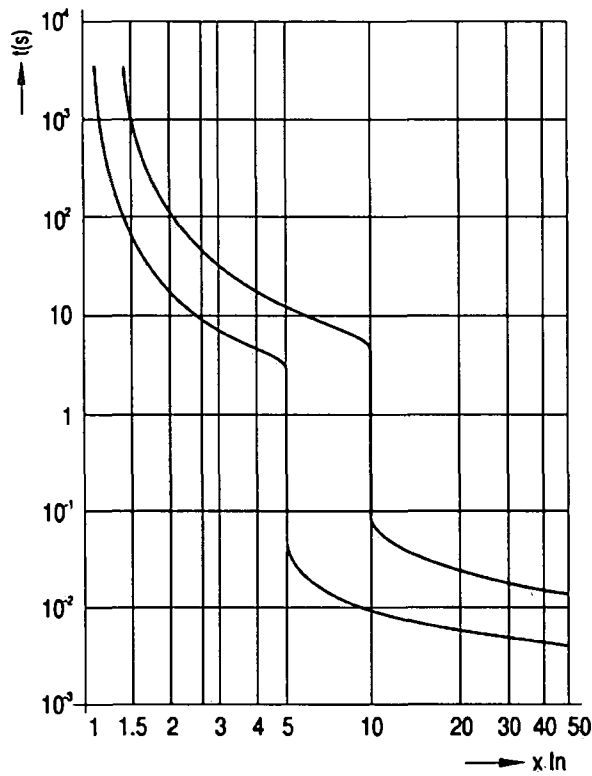

3



## Din-T MCBs Technical data

### Influence of ambient air temperature on the rated current

The maximum value of the current which can flow through an MCB depends on the nominal current of the MCB, the conductor cross-section and the ambient air temperature.

The values shown in the table below are for devices in free air. For devices installed with other modular devices in the same switchboard, a correction factor (K) shall be applied relative to the mounting situation of the MCB, the ambient temperature and the number of main circuits in the installation.

No of devices	K <sup>1)</sup>
2 or 3	0.9
4 or 5	0.8
6 or 9	0.7
> 10	0.6

#### Calculation example

Within a distribution board consisting of eight 2-Pole, 16 A, 'C' curve type MCBs, with an operating ambient temperature of 45 °C, which is the highest temperature the MCB can operate at without unwanted tripping?

#### Calculation

The correction factor  $K = 0.7$ , for use in an eight circuit installation:  $16 \text{ A} \times 0.7 = 11.2 \text{ A}$

As the MCB is working at 45 °C it shall be given another factor (90 % = 0.9):

$\text{In at } 45 \text{ °C} = \text{In at } 30 \text{ °C} \times 0.9 = 11.2 \text{ A} \times 0.9 = 10.1 \text{ A}$ .

**Note:** <sup>1)</sup> Applicable for MCBs working at maximum rated currents.

The thermal calibration of the MCBs was carried out at an ambient temperature of 30 °C. Ambient temperatures different from 30 °C influence the bimetal and this results in earlier or later thermal tripping.

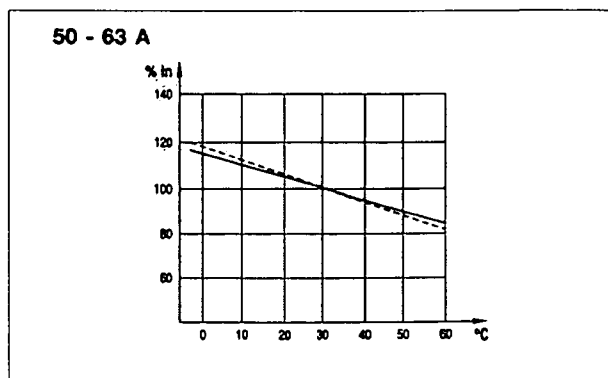
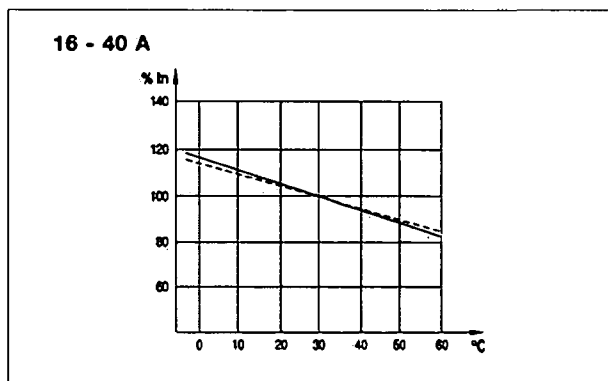
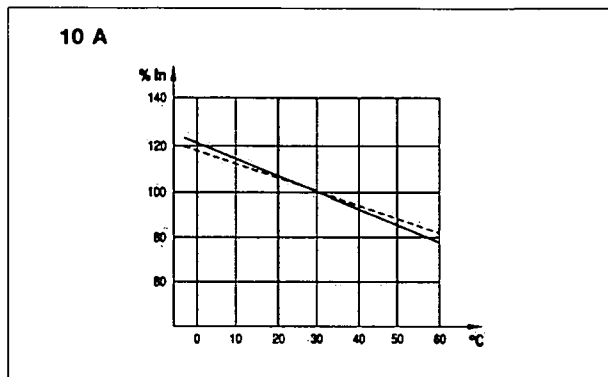
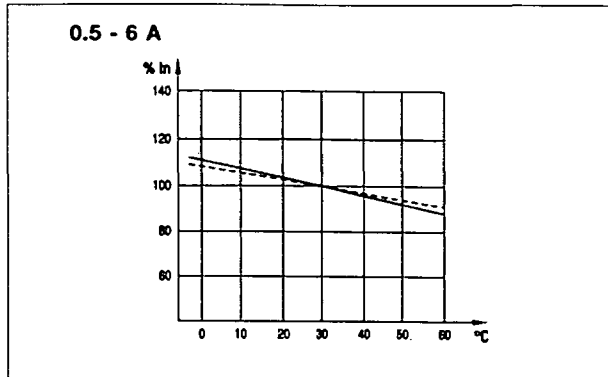

————— : 1P (single pole)

----- : mP (multi-pole)

3

## Din-T MCBs Technical data

### Effects of frequency on the tripping characteristic

All the MCBs are designed to work at frequencies of 50-60 Hz, therefore to work at different values, consideration must be given to the variation of the tripping characteristics. The thermal tripping does not change with variation of the frequency but the magnetic tripping values can be up to 50 % higher than the ones at 50-60 Hz.

#### Tripping current variation

60 Hz	100 Hz	200 Hz	300 Hz	400 Hz
1	1.1	1.2	1.4	1.5

### Power losses

The power losses are calculated by measuring the voltage drop between the incoming and the outgoing terminals of the device at rated current.

#### Power loss per pole

In (A)	Voltage drop (V)	Energy loss (W)	Resistance (mOhm)
0.5	2.230	1.115	4458.00
1	1.270	1.272	1272.00
2	0.620	1.240	310.00
3	0.520	1.557	173.00
4	0.370	1.488	93.00
6	0.260	1.570	43.60
8	0.160	1.242	19.40
10	0.160	1.560	15.60
13	0.155	2.011	11.90
16	0.162	2.586	10.10
20	0.138	2.760	6.90
25	0.128	3.188	5.10
32	0.096	3.072	3.00
40	0.100	4.000	2.50
50	0.090	4.500	1.80
63	0.082	5.160	1.30
80	0.075	6.000	0.90
100	0.075	7.500	0.75
125	0.076	9.500	0.60

### Limitation curves

#### Let-through energy $I^2t$

The limitation capacity of an MCB in short-circuit conditions, is its capacity to reduce the value of the let-through energy that the short-circuit would be generating.

#### Peak current $I_p$

Is the value of the maximum peak of the short-circuit current limited by the MCB.

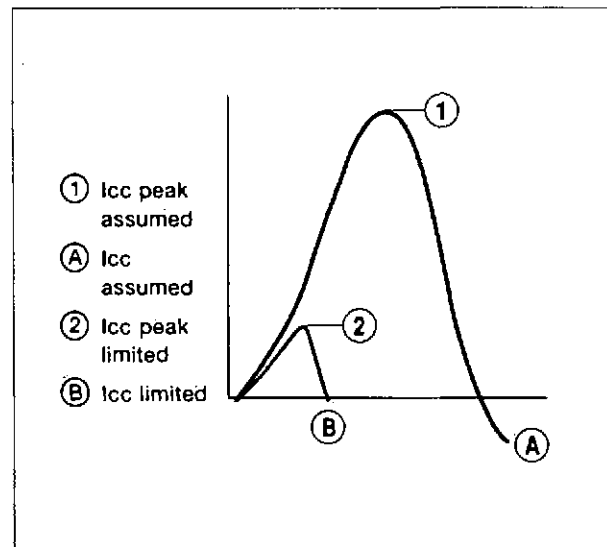

See following pages



## Din-T MCBs Technical data

Din-T 6

6 kA

C curve

3

**$I^2t$  Let-through energy at 240/415 V**

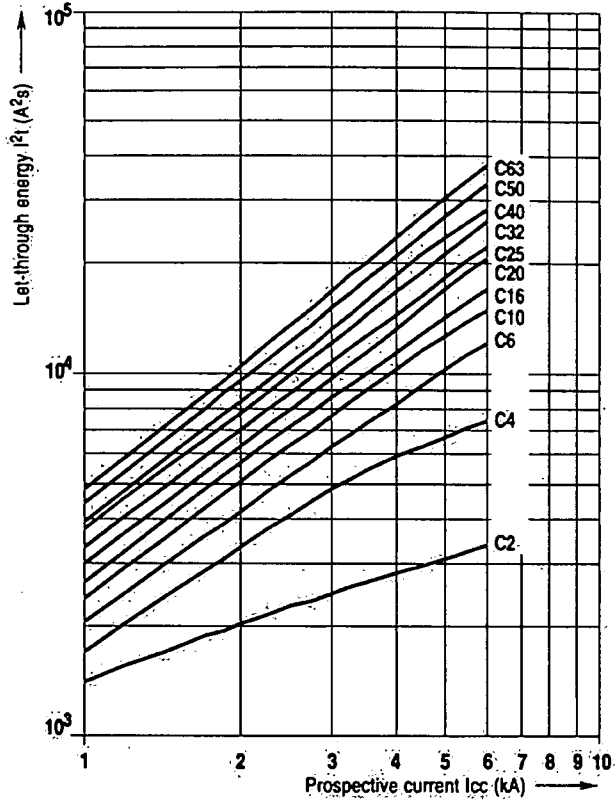

**$I_d$  Limited peak current at 230/400 V**

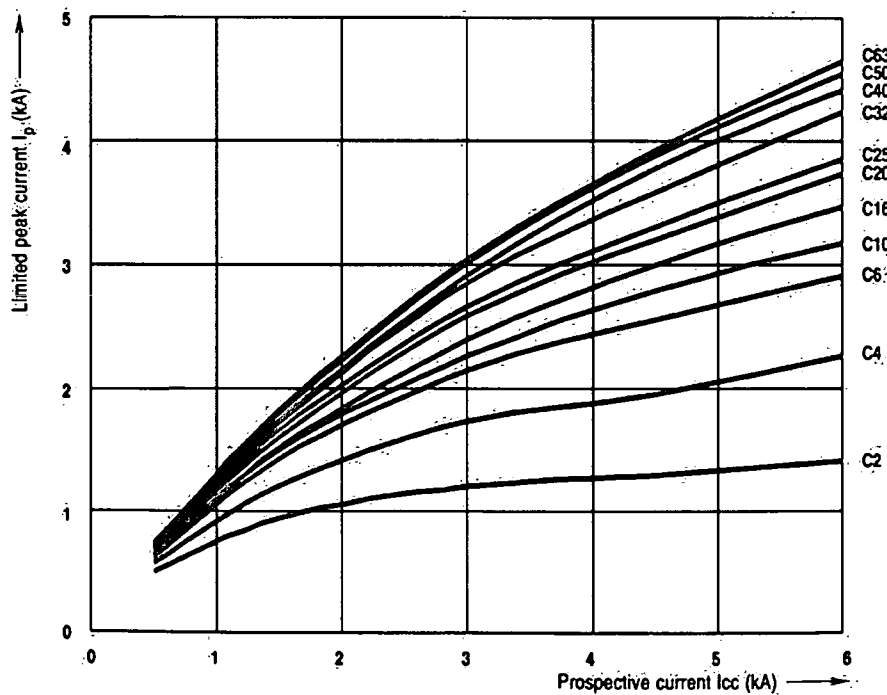



## Din-T MCBs Technical data

### Use of standard MCB for DC use

For MCBs designed to be used in alternating current but used in installations in direct current, the following should be taken into consideration:

- For protection against overloads it is necessary to connect the two poles to the MCB. In these conditions the tripping characteristic of the MCB in direct current is similar to alternating current.

- For protection against short-circuits it is necessary to connect the two poles to the MCB. In these conditions the tripping characteristic of the MCB in direct current is 40% higher than the one in alternating current.

**3**

### Use in DC selection table

Series	Rated current (A)	48 V 1 pole Icu (kA)	110 V 2 poles in series Icu (kA)	250 V 1 pole Icu (kA)	440 V 2 poles in series Icu (kA)
Din-T 6	0.5...63 A	20	25	-	-

## Din-T MCBs Technical data

### Text for specifiers

#### MCB Series Din-T 6

- According to EN 60898 standard
- For DIN rail mounting according to DIN EN 50022; EN 50022; future EN 60715; IEC 60715 (top hat rail 35 mm)
- Grid distance 35 mm
- Working ambient temperature from -25 °C up to +50 °C
- Approved by CEBC, VDE, KEMA, IMQ.
- 1 pole is a module of 18 mm wide
- Nominal rated currents are:  
0.5/1/2/3/4/6/10/13/16/20/25/32/40/50/63 A
- Tripping characteristics: B,C,D (B curve Din-T 10 only).
- Number of poles: 1 P, 1 P+N, 2 P, 3 P, 3 P+N, 4 P
- The short-circuit breaking capacity is: 6/10k A, energy limiting class 3
- Terminal capacity from 1 up to 35 mm<sup>2</sup> rigid wire or 1.5 up to 25 mm<sup>2</sup> flexible wire.
- Screw head suitable for flat or Pozidrive screwdriver
- Can be connected by means of both pin or fork busbars
- The toggle can be sealed in the ON or OFF position
- Rapid closing
- Both incoming and outgoing terminals have a protection degree of IP 20 and they are sealable
- Isolator function thanks to Red/Green printing on the toggle.
- Maximum voltage between two phases; 440 V~
- Maximum voltage for utilisation in DC current: 48 V 1 P and 110 V 2 P
- Two position rail clip
- Mechanical shock resistance 40 g (direction x, y, z) minimum 18 shocks 5 ms half-sinusoidal acc. to IEC 60068-2-27
- Vibration resistance: 3 g (direction x, y, z) minimum 30 min. according to IEC 60068-2-6
- Extensions can be added on both left or right hand side
  - ☛ Auxiliary contact
  - ☛ Shunt trip
  - ☛ Undervoltage release
  - ☛ Motor operator
  - ☛ Panelboard switch
- Add-on RCD can be coupled.

## Din-T MCBs Technical data

Series		Din-T6 AS/NZS 4898		
Standards (Aust / NZ / International)		IEC 60898		
Tripping characteristics		C, D		
Nominal current		A C/D(0.5-63)		
Calibration temperature		°C 30		
Number of poles (# mod)		1/2/3/4		
Neutral pole protected		yes		
Nominal voltage Un	AC 1 P	V	240/415	
	3 P/4 P	V	415	
	DC 1 P <sup>1)</sup>	V DC	48	
	2 P (in series) <sup>1)</sup>	V DC	110	
Frequency		Hz	50/60	
		Hz	DC: magn.trip +40%	
		Hz	400: magn.trip +50%	
Maximum service voltage U <sub>bm</sub> between two wires		V	250/440; 53/120	
Minimum service voltage U <sub>bm</sub> in		V	12; 12	
Selectivity class (IEC 60898)		3		
Isolator application IEC 60947-2		yes		
Rated insulation voltage	Pollution degree 2	V	500	
	Pollution degree 3	V	440	
Impulse withstand test voltage		kV	6	
Insulation resistance		mOhm	10,000	
Dielectric rigidity		kV	2.5	
Vibration resistance (in x, y, z direction) (IEC 77/16.3)		3 g		
Endurance	Electrical at Un, In	10,000		
	mechanical	20,000		
Utilisation category (IEC 60947-2)		A		
Protection degree (outside / inside, in enclosure with door)		IP 20/IP 40		
Self-extinguish degree (according to UL94)		V2		
Tropicalisation (according to IEC 60068-2 / DIN 40046) °C/RH		+55 °C/95 % RH		
Operating temperature		°C	-25/+55	
Storage temperature		°C	-55/+55	
Terminal capacity	Rigid cable min/max (top)	mm <sup>2</sup>	1/35	
	Flexible cable min*/max (top)	mm <sup>2</sup>	0.75/25	
	Rigid cable min/max (bottom)	mm <sup>2</sup>	1/35	
	Flexible cable min*/max (bottom)	mm <sup>2</sup>	0.75/25	
	(* Flexible cable 0.75/1/1.5 mm <sup>2</sup> with cable lug)			
	Torque	Nm	4.5	
Add-on devices (side add-on)	Auxiliary contacts	yes		
	LVT	yes		
	Shunt trip	yes		
	Motor operator	yes		
	Panelboard switch	yes		
Busbar systems	Pin (top/bottom)	yes/yes		
	Fork (top/bottom)	-/yes		
Accessories		yes		
Dimensions, weights, packaging				
(HxDxW) 86x68xW		mm/mod.	18	
Weight/mod.		g	120	
Package		mod.	12	
Short-circuit capacity AC (kA)		AS/NZS 4898		
IEC 60898	I <sub>cn</sub>	1 P	230/400 V	6
		2 P	230/400 V	6
		3 P/4 P	230/400 V	6
I <sub>cs</sub> (service)		100 % I <sub>cn</sub>		
IEC 60947-2	I <sub>cu</sub> (ultimate)	1 P	127 V	20
			240 V	10
		415 V	3	
		2 P	127 V	-
	240 V		15	
	3 P, 4 P	415 V	10	
		240 V	15	
	415 V	10		
440 V		6		
I <sub>cs</sub> (service)		75 % I <sub>cu</sub>		
NEMA AB1 (120/240V)		20		
Short-circuit capacity DC (kA)				
IEC 60947-2	I <sub>cu</sub> (ultimate)	1 P	≤60 V	20
			≤220 V	-
	2 P	≤125 V	25	
		≤440 V	-	
I <sub>cs</sub> (service)		100 % I <sub>cu</sub>		

Notes Refer pages 3 - 23, 24 for information on SAFE-T MCBs.

<sup>1)</sup> Preferred values of rated control supply voltage (IEC 60947 - 2): 24 V, 48 V, 110 V, 125 V, 250 V

<sup>1)</sup> 0.5-4 A/6-25 A/32-40 A/50-63 A

<sup>1)</sup> 10 (125 V DC)

<sup>1)</sup> 10 (250 V DC)

<sup>1)</sup> On request.

3

## Din-T MCBs Technical data

### Miniature circuit breakers - Din-T 6

Dimensions in mm.

3

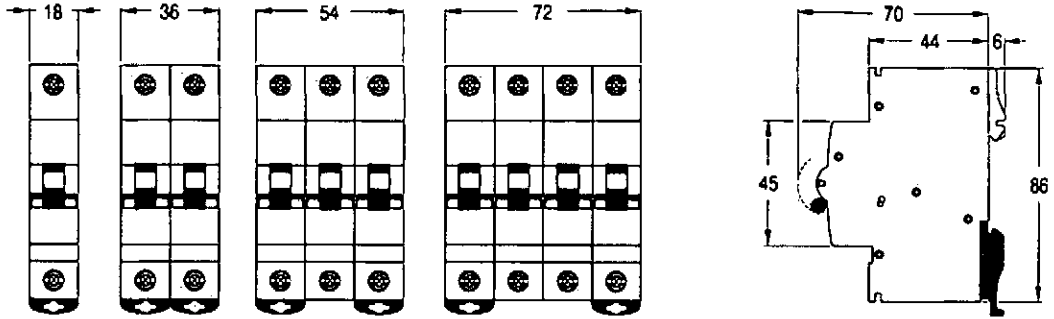



## Miniature circuit breakers

### Din-T15 series 15 kA, 20 kA, 25 kA MCBs

- Standards AS/NZS 3947-2
- Current range 6-63 Amp 1, 2, 3 and 4 pole
- Sealable and lockable handle
- Modular design
- Mounts on CD chassis (250 A and 355 A)
- Industrial applications

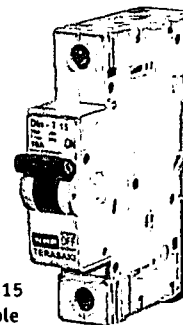

DTCB15  
1 pole

#### 1 pole 1 module <sup>3)</sup>

In (A)	Icu (kA)	C - Curve 5 - 10 In
6	25	DTCB15106C
10	25	DTCB15110C
13	25	<input type="checkbox"/> DTCB15113C
16	25	DTCB15116C
20	25	DTCB15120C
25	25	DTCB15125C
32	20	DTCB15132C
40	20	DTCB15140C
50	15	DTCB15150C
63	15	DTCB15163C

#### 2 pole 2 modules <sup>3)</sup>

In (A)	Icu (kA)	C - Curve 5 - 10 In
6	25	<input type="checkbox"/> DTCB15206C
10	25	<input type="checkbox"/> DTCB15210C
13	25	<input type="checkbox"/> DTCB15213C
16	25	<input type="checkbox"/> DTCB15216C
20	25	<input type="checkbox"/> DTCB15220C
25	25	<input type="checkbox"/> DTCB15225C
32	20	<input type="checkbox"/> DTCB15232C
40	20	<input type="checkbox"/> DTCB15240C
50	15	<input type="checkbox"/> DTCB15250C
63	15	<input type="checkbox"/> DTCB15263C

In (A)	6 - 63
1 P	240 V AC
2 P	240/415 V AC
3 P	240/415 V AC
4 P	240/415 V AC

Shock resistance (in x, y, z direction)  
20 g with shock duration of 10 ms  
(minimum 18 shocks)  
40 g with shock duration of 5 ms  
(minimum 18 shocks)

Vibration resistance (in x, y, z direction)  
3 g in frequency range 10 to 55 Hz  
(operating time at least 30 mins)  
according to IEC 60068-2-6

#### 3 pole 3 modules <sup>3)</sup>

6	25	DTCB15306C
10	25	DTCB15310C
13	25	<input type="checkbox"/> DTCB15313C
16	25	DTCB15316C
20	25	DTCB15320C
25	25	DTCB15325C
32	20	DTCB15332C
40	20	DTCB15340C
50	15	DTCB15350C
63	15	DTCB15363C

#### 4 pole 4 modules <sup>3)</sup>

6	25	<input type="checkbox"/> DTCB15406C
10	25	<input type="checkbox"/> DTCB15410C
13	25	<input type="checkbox"/> DTCB15413C
16	25	<input type="checkbox"/> DTCB15416C
20	25	<input type="checkbox"/> DTCB15420C
25	25	<input type="checkbox"/> DTCB15425C
32	20	<input type="checkbox"/> DTCB15432C
40	20	<input type="checkbox"/> DTCB15440C
50	15	<input type="checkbox"/> DTCB15450C
63	15	<input type="checkbox"/> DTCB15463C

Storage temperature  
from -55 °C to +55 °C according to  
VDE 0664 parts 1 and 2

Operating temperature  
from -25 °C to +55 °C according to  
VDE 0664 Parts 1 and 2.

Use at 400 Hz  
At 400 Hz the magnetic tripping current  
is approximately 50 % higher than at AC  
50/60 Hz

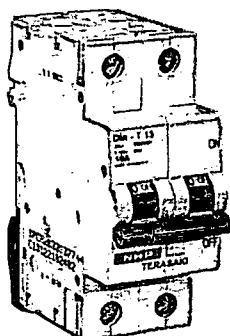

DTCB15  
2 pole

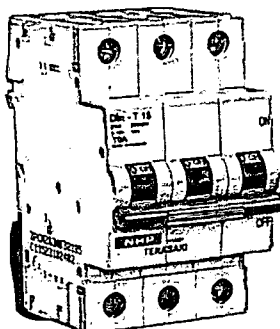

DTCB15  
3 pole

Notes: <sup>1)</sup> 2 P MCB connected in series.  
The LINE-side is the OFF or bottom of the MCB and connects to CD chassis  
tee-offs.

<sup>2)</sup> All poles include overcurrent and short circuit protection.

<sup>3)</sup> Refer Section 3 for kA ratings at 240/415 V. The above ratings are at 415 V AC.

Available on indent only.

# Din-T MCBs Technical data

## Characteristics according to EN 60947-2

Miniature Circuit Breakers are intended for the protection of the lines against both overloads and short-circuits in industrial wiring installations where normal operation is done by instructed people

### Tripping characteristic curves

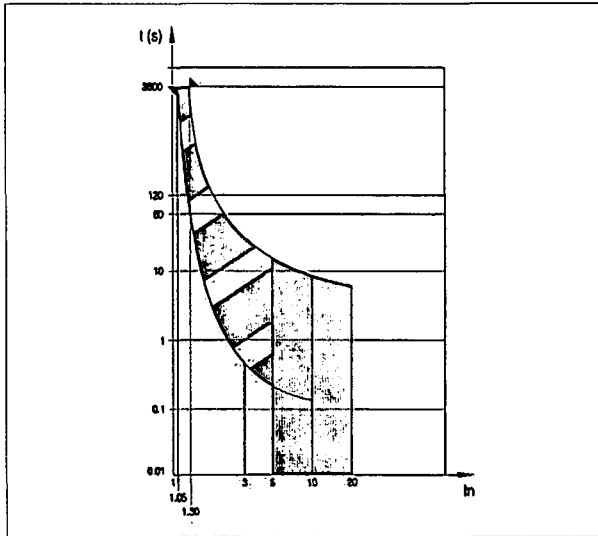

### Magnetic release

An electromagnet with plunger ensures instantaneous tripping in the event of short-circuit. The standard leaves the calibration of magnetic release to the manufacturers discretion.

NHP offers instantaneous tripping ranges:

- release between 5 and 10 In
- release between 10 and 20 In

### Thermal release

The release is initiated by a bimetal strip in the event of overload. The standard defines the range of release for two special overload values. Reference ambient temperature is 40 °C.

Test current	Tripping time
1.05 x In	t ≥ 1 h (In ≤ 63 A) t ≥ 2 h (In > 63 A)
1.30 x In	t < 1 h (In ≤ 63 A) t < 2 h (In > 63 A)

### Rated ultimate short-circuit breaking capacity (Icu)

Is the value of the short-circuit that the MCB is capable of withstanding in the following test of sequence of operations: O-t-CO.

After the test the MCB is capable, without maintenance, to withstand a dielectric strength test at a test voltage of 1000 V. Moreover the MCB shall be capable of tripping when loaded with 2.5 In within the time corresponding to 2 In but greater than 0.1 s.

### Rated service short-circuit breaking capacity (Ics)

Is the value of the short-circuit that the MCB is capable of withstanding in the following test of sequence of operations: O-t-CO-t-CO.

After the test the MCB is capable, without maintenance, to withstand a dielectric strength test at a test voltage of twice its rated insulation voltage with a minimum of 1000 V. A verification of the overload releases on In and moreover the MCB shall trip within 1 h when current is 1.45 In (for In < 63 A) and 2 h (for In > 63 A).

- O - Represents an opening operation
- C - Represents a closing operation followed by an automatic opening.
- t - Represents the time interval between two successive short-circuit operations: 3 minutes.

Category A: Without a short-time withstand current rating.

### Utilization

category	Application with respect to selectivity
A	Circuit breakers not specifically intended for selectivity under short-circuit conditions with respect to other short-circuit protective devices in series on the load side, i.e. without an intentional short-time delay provided for selectivity under short-circuit conditions, and therefore without a short-time withstand current rating according to 4.3.5.4
B	Circuit breakers specifically intended for selectivity under short-circuit conditions with respect to other short-circuit protective devices in series on the load side, i.e. without an intentional short-time delay (which may be adjustable), provided for selectivity under short-circuit conditions. Such circuit-breakers have a short-time withstand current rating according to 4.3.5.4



## Din-T MCBs Technical data

### Tripping curves according to EN 60898

The following tables show the average tripping curves of the Terasaki Din-T MCBs based on the thermal and magnetic characteristics.

Curve C

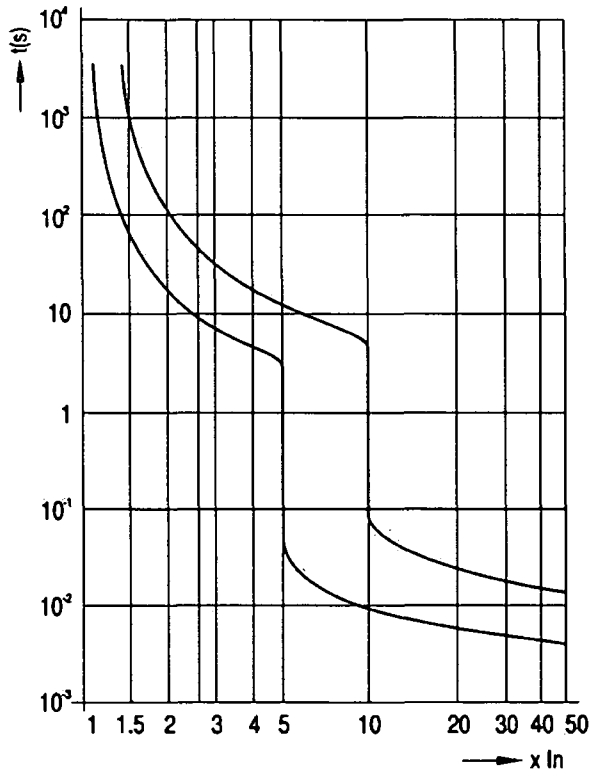

3

## Din-T MCBs Technical data

### Definitions related to circuit breakers

MCB = Miniature Circuit Breaker

#### Short-circuit (making and breaking) capacity

Alternating component of the prospective current, expressed by its RMS value, which the circuit breaker is designed to make, to carry for its opening time and to break under specified conditions.

#### Ultimate or rated short-circuit breaking capacity ( $I_{cn}$ - EN 60898)

A breaking capacity for which the prescribed conditions, according to a specified test sequence, do not include the capability of the MCB to carry 0.96 times its rated current for the conventional time.

#### Ultimate short-circuit breaking capacity ( $I_{cu}$ - EN 60947-2)

A breaking capacity for which the prescribed conditions, according to a specified test sequence, do not include the capability of the MCB to carry its rated current for the conventional time.

#### Service short-circuit breaking capacity ( $I_{cs}$ - EN 60898)

A breaking capacity for which the prescribed conditions, according to a specified test sequence, include the capability of the MCB to carry 0.96 times its rated current for the conventional time.

#### Prospective current

The current that would flow in the circuit, if each main current path of the MCB were replaced by a conductor of negligible impedance.

#### Conventional non-tripping current ( $I_{nt}$ )

A specified value of current which the circuit breaker is capable of carrying for a specified time without tripping.

#### Open position

The position in which the predetermined clearance between open contacts in the main circuit of the MCB is secured.

#### Closed position

The position in which the predetermined continuity of the main circuit of the MCB is secured.

#### Maximum prospective peak current ( $I_p$ )

The prospective peak current when the initiation of the current takes place at the instant which leads to the highest possible value.

**3**





## Din-T MCBs Technical data

### Influence of ambient air temperature on the rated current

The maximum value of the current which can flow through an MCB depends on the nominal current of the MCB, the conductor cross-section and the ambient air temperature.

The values shown in the table below are for devices in free air. For devices installed with other modular devices in the same switchboard, a correction factor (K) shall be applied relative to the mounting situation of the MCB, the ambient temperature and the number of main circuits in the installation.

No of devices	K <sup>1)</sup>
2 or 3	0.9
4 or 5	0.8
6 or 9	0.7
> 10	0.6

#### Calculation example

Within a distribution board consisting of eight 2 Pole, 16 A, 'C' curve type MCBs, with an operating ambient temperature of 45 °C, which is the highest temperature the MCB can operate at without unwanted tripping?

#### Calculation

The correction factor K = 0.7, for use in an eight circuit installation: 16 A x 0.7 = 11.2 A

As the MCB is working at 45 °C it shall be given another factor (90 % = 0.9):

In at 45 °C = In at 30 °C x 0.9 = 11.2 A x 0.9 = 10.1 A.

**Note:** <sup>1)</sup> Applicable for MCBs working at maximum rated currents.

The thermal calibration of the MCBs was carried out at an ambient temperature of 30 °C. Ambient temperatures different from 30 °C influence the bimetal and this results in earlier or later thermal tripping.

0.5 - 6 A

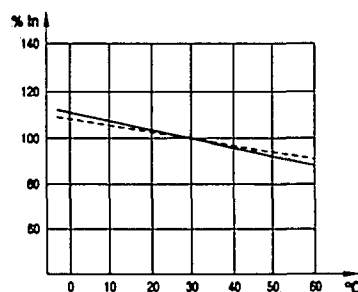

10 A

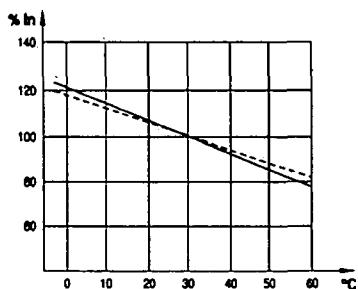

16 - 40 A

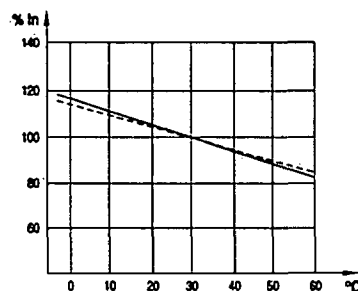

50 - 63 A

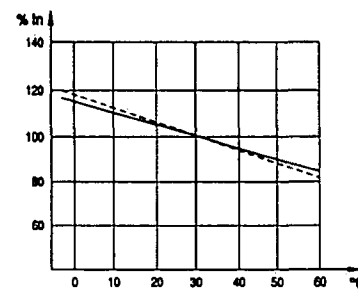

———— : 1P (single pole)

----- : mP (multi-pole)

3

## Din-T MCBs Technical data

### Effects of frequency on the tripping characteristic

All the MCBs are designed to work at frequencies of 50-60 Hz, therefore to work at different values, consideration must be given to the variation of the tripping characteristics. The thermal tripping does not change with variation of the frequency but the magnetic tripping values can be up to 50 % higher than the ones at 50-60 Hz.

#### Tripping current variation

60 Hz	100 Hz	200 Hz	300 Hz	400 Hz
1	1.1	1.2	1.4	1.5

### Power losses

The power losses are calculated by measuring the voltage drop between the incoming and the outgoing terminals of the device at rated current.

#### Power loss per pole

In (A)	Voltage drop (V)	Energy loss (W)	Resistance (mOhm)
0.5	2.230	1.115	4458.00
1	1.270	1.272	1272.00
2	0.620	1.240	310.00
3	0.520	1.557	173.00
4	0.370	1.488	93.00
6	0.260	1.570	43.60
8	0.160	1.242	19.40
10	0.160	1.560	15.60
13	0.155	2.011	11.90
16	0.162	2.586	10.10
20	0.138	2.760	6.90
25	0.128	3.188	5.10
32	0.096	3.072	3.00
40	0.100	4.000	2.50
50	0.090	4.500	1.80
63	0.082	5.160	1.30

### Limitation curves

#### Let-through energy $I^2t$

The limitation capacity of an MCB in short-circuit conditions, is its capacity to reduce the value of the let-through energy that the short-circuit would be generating.

#### Peak current $I_p$

Is the value of the maximum peak of the short-circuit current limited by the MCB.

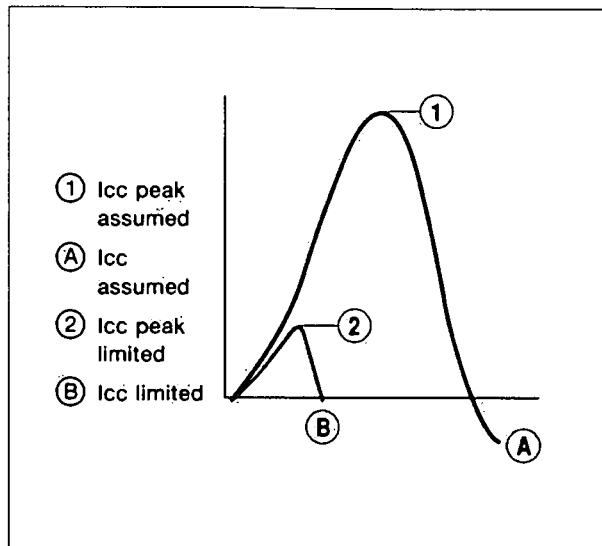

See following pages

## Din-T MCBs Technical data

Din-T 15

15 kA

C curve

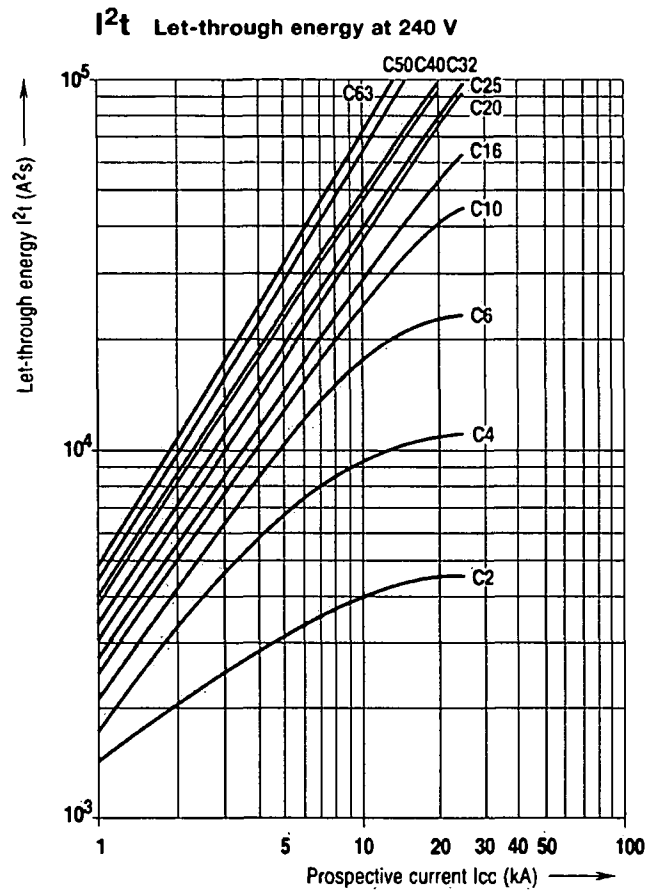

## Din-T MCBs Technical data

### Use of standard MCB for DC use

For MCBs designed to be used in alternating current but used in installations in direct current, the following should be taken into consideration:

- For protection against overloads it is necessary to connect the two poles to the MCB. In these conditions the tripping characteristic of the MCB in direct current is similar to alternating current.

- For protection against short-circuits it is necessary to connect the two poles to the MCB. In these conditions the tripping characteristic of the MCB in direct current is 40% higher than the one in alternating current.

**3**

### Use in DC selection table

Series	Rated current (A)	48 V 1 pole Icu (kA)	110 V 2 poles in series Icu (kA)	250 V 1 pole Icu (kA)	440 V 2 poles in series Icu (kA)
Din-T 15	6...25 A	10	10	-	-

Installation of Din-T DC MCBs in direct current

## Din-T MCBs + RCDs Technical data

### Text for specifiers

#### MCB Series Din-T 15

- According to EN 60947.2 standard
- For DIN rail mounting according to DIN EN 50022; EN 50022; future EN 60715; IEC 60715 (top hat rail 35 mm)
- Working ambient temperature from -25 °C up to +50 °C
- 1 pole is a module of 18 mm wide
- Nominal rated currents are:  
6/10/13/16/20/25/32/40/50/63 A
- Tripping characteristic: C
- Number of poles: 1 P, 2 P, 3 P, 4 P
- Short-circuit capacity is: 15 kA
- Terminal capacity from 1 up to 35 mm<sup>2</sup> rigid wire or 1.5 up to 25 mm<sup>2</sup> flexible wire
- Screw head suitable for flat or Pozidrive screwdriver
- Can be connected by means of both pin or fork busbars
- The toggle can be sealed in the ON or OFF position
- Rapid closing
- Both incoming and outgoing terminals have a protection degree of IP 20 and they are sealable
- Isolator function thanks to Red/Green printing on the toggle.
- Maximum voltage between two phases; 440 V~
- Maximum voltage for utilisation in DC current: 48 V 1 P and 110 V 2 P
- Two position rail clip
- Mechanical shock resistance 40 g (direction x, y, z) minimum 18 shocks 5 ms half-sinusoidal acc. to IEC 60068-2-27
- Vibration resistance: 3 g (direction x, y, z) minimum 30 min. according to IEC 60068-2-6
- Extensions can be added on both left or right hand side
  - ☛ Auxiliary contact
  - ☛ Shunt trip
  - ☛ Undervoltage release
  - ☛ Motor operator
  - ☛ Panelboard switch
- Add-on RCD can be coupled.

## Din-T MCBs Technical data

Series		Din-T15 AS/NZS 3947-2		
Standards (Aust / NZ / International)		IEC 60947-2		
Tripping characteristics		C		
Nominal current		A	0.5-63	
Calibration temperature		°C	40	
Number of poles (# mod)		1/2/3/4		
Neutral pole protected		-		
Nominal voltage Un	AC 1 P	V	240/415	
	3 P/4 P	V	415	
	DC 1 P <sup>1)</sup>	V DC	48	
	2 P (in series) <sup>1)</sup>	V DC	110	
Frequency		Hz	50/60	
		Hz	DC: magn.trip +40%	
		Hz	400: magn.trip +50%	
Maximum service voltage U <sub>max</sub> between two wires		V	250/440; 53/120	
Minimum service voltage U <sub>min</sub>		V	12; 12	
Selectivity class (IEC 60898)		3		
Isolator application IEC 60947-2		yes		
Rated insulation voltage	Pollution degree 2	V	500	
	Pollution degree 3	V	440	
Impulse withstand test voltage		kV	6	
Insulation resistance		mOhm	10,000	
Dielectric rigidity		kV	2.5	
Vibration resistance (in x, y, z direction) (IEC 77/16.3)		3 g		
Endurance	Electrical at Un, In	4000		
	mechanical	20,000		
Utilisation category (IEC 60947-2)		A		
Protection degree (outside / inside, in enclosure with door)		IP 20/IP 40		
Self-extinguish degree (according to UL94)		V2		
Tropicalisation (according to IEC 60068-2 / DIN 40046) °C/RH		+55 °C/95 % RH		
Operating temperature		°C	-25/+55	
Storage temperature		°C	-55/+55	
Terminal capacity	Rigid cable min/max (top)	mm <sup>2</sup>	1/35	
	Flexible cable min*/max (top)	mm <sup>2</sup>	0.75/25	
	Rigid cable min/max (bottom)	mm <sup>2</sup>	1/35	
	Flexible cable min*/max (bottom)	mm <sup>2</sup>	0.75/25	
	(* Flexible cable 0.75/1/1.5 mm <sup>2</sup> with cable lug)			
	Torque	Nm	4.5	
Add-on devices (side add-on)	Auxiliary contacts	yes		
	LVT	yes		
	Shunt trip	yes		
	Motor operator	yes		
	Panelboard switch	yes		
Busbar systems	Pin (top/bottom)	yes/yes		
	Fork (top/bottom)	-/yes		
Accessories		yes		
Dimensions, weights, packaging				
(HxDxW) 86x68xW		mm/mod.	18	
Weight/mod.		g	120	
Package		mod.	12	
Short-circuit capacity AC (kA)		AS/NZS 3947-2		
IEC 60898	Icn	1 P	230/400 V	-
		2 P	230/400 V	-
		3 P/4 P	230/400 V	-
Ics (service)		-		
IEC 60947-2	Icu (ultimate)	1 P	127 V	50
			240 V	50/25/20/15 <sup>1)</sup>
			415 V	-
	2 P	127 V	-	
		240 V	50/50/40/30 <sup>1)</sup>	
		415 V	50/25/20/15 <sup>1)</sup>	
		240 V	50/50/40/30 <sup>1)</sup>	
		415 V	50/25/20/15 <sup>1)</sup>	
		440 V	50/20/15/10 <sup>1)</sup>	
	Ics (service)		75 % Icu	
NEMA AB1 (120/240V)				
Short-circuit capacity DC (kA)				
IEC 60947-2	Icu (ultimate)	1 P	≤60 V	25
			≤220 V	-
		2 P	≤125 V	30
			≤440 V	-
Ics (service)		100 % Icu		

Notes Refer pages 3 - 23, 24 for information on SAFE-T MCBs.

<sup>1)</sup> Preferred values of rated control supply voltage (IEC 60947 - 2): 24 V, 48 V, 110 V, 125 V, 250 V

<sup>2)</sup> 0.5-4 A/6-25 A/32-40 A/50-63 A  
<sup>3)</sup> 10 (125 V DC)

<sup>4)</sup> 10 (250 V DC)  
<sup>5)</sup> On request.

3

## Din-T MCBs + RCDs Technical data

### Miniature circuit breakers - Din-T 15

Dimensions in mm.

**3**

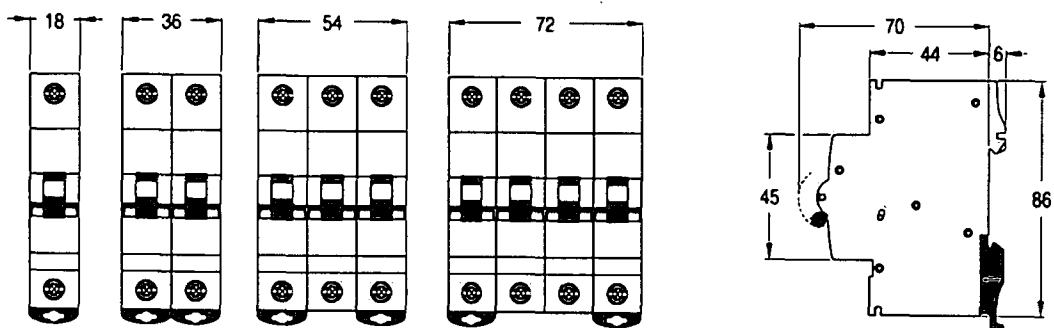



## Miniature circuit breakers

### Din-Safe single pole width residual current circuit breaker (RCBO)

- Standards AS/NZS 61009
- Approval N17482
- One module wide (18 mm)
- Short circuit, overcurrent and earth leakage protection
- Short circuit protection 10 kA
- Sensitivity 10 and 30 mA
- Din rail mount
- Suits CD chassis
- Type "A" residual current device (AC/DC)

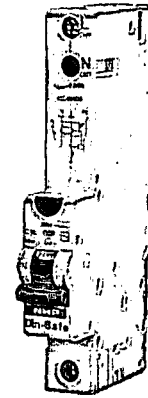

Amp rating (A)	Modules (18mm)	Voltage (AC)	Short circuit (kA)	Trip Sensitivity (mA)	Cat. No <sup>1)</sup> <sup>2)</sup>
6	1	240	10	30	DSRCBH0630A
10	1	240	10	30	DSRCBH1030A
16	1	240	10	30	DSRCBH1630A
20	1	240	10	30	DSRCBH2030A
25	1	240	10	30	DSRCBH2530A
32	1	240	10	30	DSRCBH3230A
40	1	240	10	30	DSRCBH4030A
6	1	240	10	10	<sup>3)</sup> DSRCBH0610A
10	1	240	10	10	DSRCBH1010A
16	1	240	10	10	DSRCBH1610A
20	1	240	10	10	DSRCBH2010A
25	1	240	10	10	<sup>3)</sup> DSRCBH2510A
32	1	240	10	10	<sup>3)</sup> DSRCBH3210A
40	1	240	10	10	<sup>3)</sup> DSRCBH4010A

**Note:** <sup>1)</sup> Neutral not switched.  
<sup>2)</sup> Will not accept side mounting accessories.  
<sup>3)</sup> Available on indent only.

#### Operation

This unit combines the overload and short circuit protection of an MCB with earth leakage protection of an RCD. The unit occupies one, sub-circuit (one pole) of the distribution board and provides single phase protection against overload, short circuit and earth leakage current.

- The MCB element provides thermal and magnetic tripping protection which is rated to 10 kA prospective fault current.
- The RCD element of the device provides core-balance detection of the difference between the active and neutral currents and amplification to provide high sensitivity. The rated residual operating current ( $I_{\Delta n}$ ) is 10 mA or 30 mA.
- The green/yellow earth reference cable, in case of loss of supply neutral, ensures the device will continue to provide earth leakage protection and will operate normally upon detection of an earth leakage current.

#### Dimensions (mm)

**Note:** A 1.2 m long pigtail lead is included as standard.

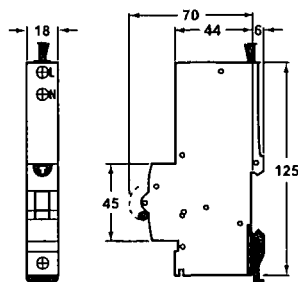

#### Application

The Din-Safe single pole width residual current circuit breaker will fit the standard Din-T chassis for use in NHP panelboards. The design makes it possible to provide an MCB complete with earth leakage protection in an 18 mm wide module, which allows a greater number of devices to be fitted into a distribution board.

#### Connection diagram

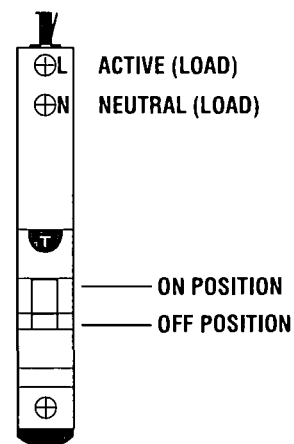

**Note:** Nuisance tripping may be experienced in VFD and motor starting applications refer NHP.



## Din-T MCBs + RCDs Technical data

### Tripping curves according to EN 60898

The following tables show the average tripping curves of the Terasaki Din-T MCBs based on the thermal and magnetic characteristics.

Curve C

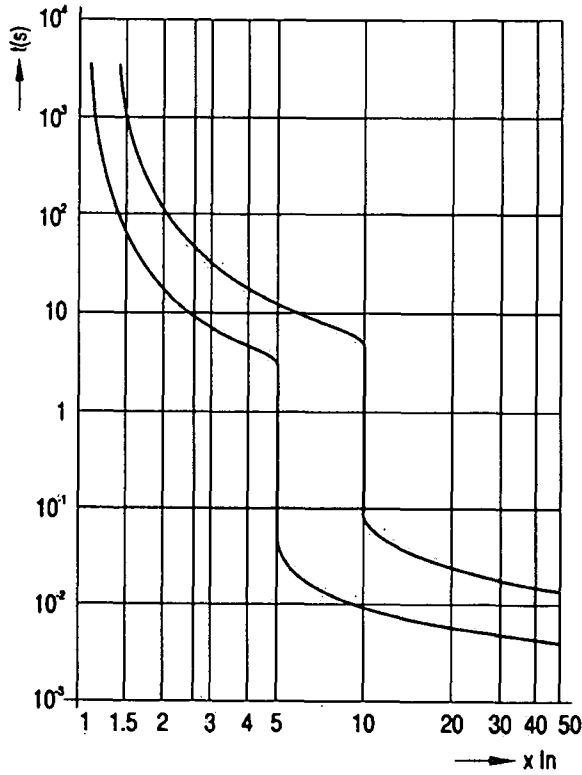

3

## Din-T MCBs + RCDs Technical data

### What is an RCD?

3

The RCD (Residual Current Device) is a device intended to protect people against indirect contact, the exposed conductive parts of the installation being connected to an appropriate earth electrode. It may be used to provide protection against fire hazards due to a persistent earth fault current, without operation of the overcurrent protective device.

RCDs having a rated residual operating current not exceeding 30 mA are also used as a means for additional protection in case of failure of the protective means against electric shock (direct contact).

#### Working Principle

The main components of an RCD are the following:

- The core transformer: which detects the earth fault current.
- The relay: when an earth fault current is detected, the relay reacts by tripping and opening the contacts.
- The mechanism: element to open and close the contacts either manually or automatically.
- The contacts: to open or close the main circuit.

The RCD constantly monitors the vectorial sum of the current passing through all the conductors. In normal conditions the vectorial sum is zero ( $I_1+I_2=0$ ) but in case of an earth fault, the vectorial sum differs from zero ( $I_1+I_2=I_d$ ), this causes the actuation of the relay and therefore the release of the main contacts.

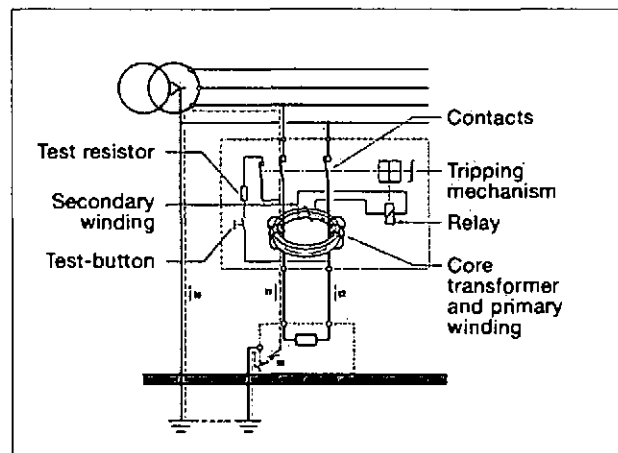

#### Definitions related to RCDs

**RCCB = Residual Current Circuit Breaker without overcurrent protection.**

**RCBO = Residual Current Circuit Breaker with overcurrent protection.**

#### Breaking capacity

A value of AC component of a prospective current that an RCCB is capable of breaking at a stated voltage under prescribed conditions of use and behaviour.

#### Residual making and breaking capacity ( $I_{\Delta m}$ )

A value of the AC component of a residual prospective current which an RCCB can make, carry for its opening time and break under specified conditions of use and behaviour.

#### Conditional residual short-circuit current ( $I_{\Delta c}$ )

A value of the AC component of a prospective current which an RCCB protected by a suitable SCPD (short-circuit protective device) in series, can withstand, under specific conditions of use and behaviour.

#### Conditional short-circuit current ( $I_{nc}$ )

A value of the AC component of a residual prospective current which an RCCB protected by a suitable SCPD in series, can withstand, under specific conditions of use and behaviour.

#### Residual short-circuit withstand current

Maximum value of the residual current for which the operation of the RCCB is ensured under specified conditions, and above which the device can undergo irreversible alterations.

#### Prospective current

The current that would flow in the circuit, if each main current path of the RCCB and the overcurrent protective device (if any) were replaced by a conductor of negligible impedance.

#### Making capacity

A value of AC component of a prospective current that an RCCB is capable to make at a stated voltage under prescribed conditions of use and behaviour.

#### Open position

The position in which the predetermined clearance between open contacts in the main circuit of the RCCB is secured.

#### Closed position

The position in which the predetermined continuity of the main circuit of the RCCB is secured.

#### Tripping time

The time which elapses between the instant when the residual operating current is suddenly attained and the instant of arc extinction in all poles.

#### Residual current ( $I_{\Delta n}$ )

Vector sum of the instantaneous values of the current flowing in the main circuit of the RCCB.

#### Residual operating current

Value of residual current which causes the RCCB to operate under specified conditions.

#### Rated short-circuit capacity ( $I_{cn}$ )

Is the value of the ultimate short-circuit breaking capacity assigned to the circuit breaker. (Only applicable to RCBO)

#### Conventional non-tripping current ( $I_{nt}$ )

A specified value of current which the circuit breaker is capable of carrying for a specified time without tripping. (Only applicable to RCBO)

#### Conventional tripping current ( $I_t$ )

A specified value of current which causes the circuit breaker to trip within a specified time. (Only applicable to RCBO)

# Din-T MCBs + RCDs Technical data

## RCDs classification according to EN 61008/61009

RCDs may be classified according to:

The behaviour in the presence of DC current

(types for general use).

■ Type AC

■ Type A

The time-delay (in the presence of residual current)

■ RCDs without time delay: type for general use

■ RCDs with time delay: type S for selectivity

Type AC '1) '2)

The type AC RCDs are designed to release with sinusoidal residual currents which occur suddenly or slowly rise in magnitude.

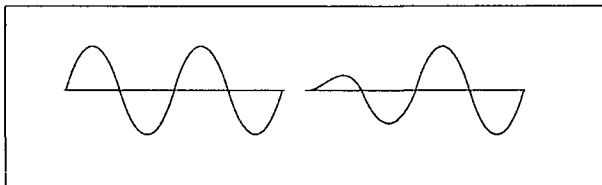

Residual current	Tripping time
0.5 x I $\Delta$ n	t = $\infty$
1 x I $\Delta$ n	t = <300 ms
2 x I $\Delta$ n	t = <150 ms
5 x I $\Delta$ n	t = $\leq$ 40 ms

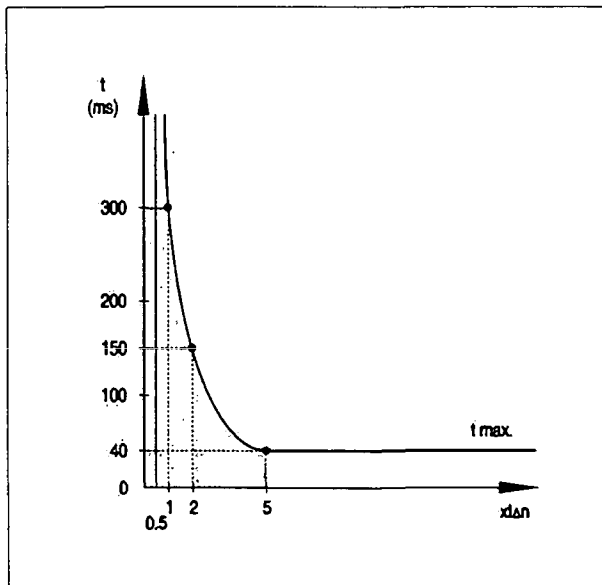

Tripping curve type AC

'1) Standard in Australia

'2) Type A acceptable in Australia

Tripping curve type A

'3) Standard in New Zealand

'4) DSRCBH is type A.

Type A '3) '4)

Certain devices during faults can be the source of non-sinusoidal earth leakage currents (DC components) due to the electronic components e.g. diodes, thyristors etc.

Type A RCDs are designed to ensure that under these conditions the residual current devices operate on sinusoidal residual current and also with pulsating direct current(\*) which occur suddenly or slowly rise in magnitude.

(\*) Pulsating direct current: current of pulsating wave form which assumes, in each period of the rated power frequency, the value 0 or a value not exceeding 0.006 A DC during one single interval of time, expressed in angular measure of at least 150°.

Residual current	Tripping time
1. For sinusoidal residual current	
0.5 x I $\Delta$ n	t = $\infty$
1 x I $\Delta$ n	t = <300 ms
2 x I $\Delta$ n	t = <150 ms
5 x I $\Delta$ n	t = $\leq$ 40 ms

2. For residual pulsating direct current

Residual current	Tripping time
At point of wave 0°	
0.35 x I $\Delta$ n	t = $\infty$
1.4 x I $\Delta$ n	t = <300 ms
2.8 x I $\Delta$ n	t = <150 ms
7 x I $\Delta$ n	t = $\leq$ 40 ms

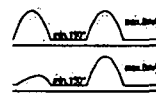

Residual current	Tripping time
At point of wave 90°	
0.25 x I $\Delta$ n	t = $\infty$
1.4 x I $\Delta$ n	t = <300 ms
2.8 x I $\Delta$ n	t = <150 ms
7 x I $\Delta$ n	t = $\leq$ 40 ms



Residual current	Tripping time
At point of wave 135°	
0.11 x I $\Delta$ n	t = $\infty$
1.4 x I $\Delta$ n	t = <300 ms
2.8 x I $\Delta$ n	t = <150 ms
7 x I $\Delta$ n	t = $\leq$ 40 ms

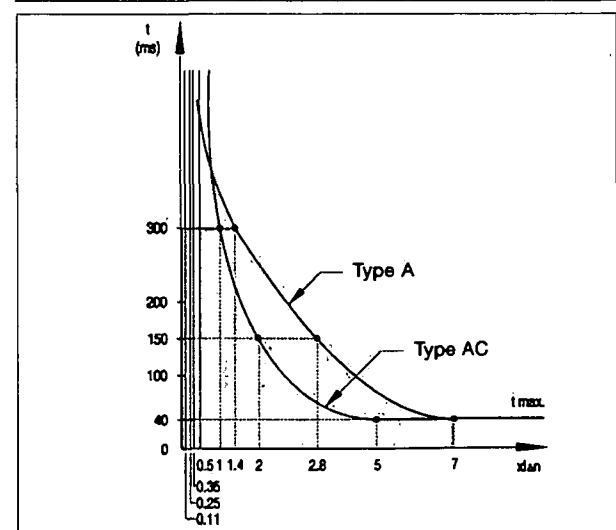

## Din-T MCBs + RCDs Technical data

### Nuisance tripping

All DinSafe RCDs have a high level of immunity to transient currents, against current impulses of 8/20  $\mu$ s according to EN 61008/61009 and VDE 0664.T1.

Type A, AC.....250 A 8/20  $\mu$ s

Type S.....3000 A 8/20  $\mu$ s

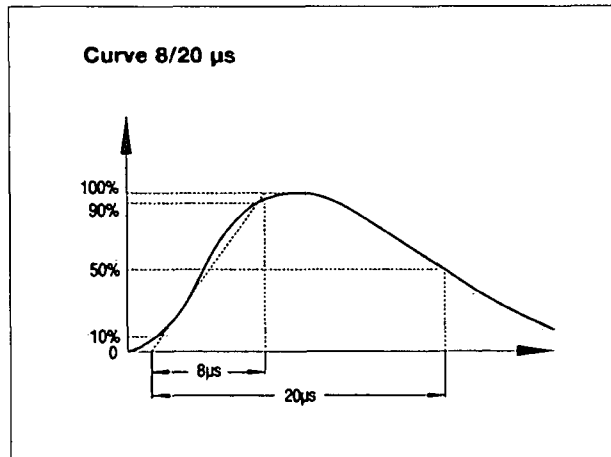

RCDs have a high level of immunity against alternating currents of high frequency according to EN 61008/61009.

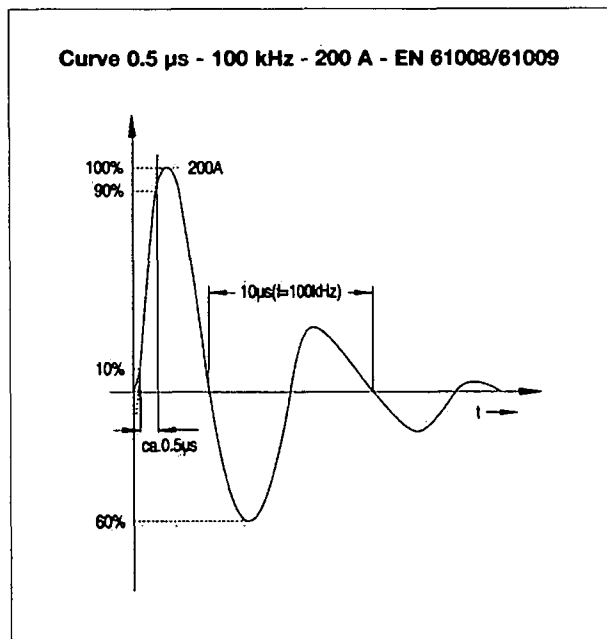

## Din-T MCBs + RCDs Technical data

### Use of an RCBO (DSRCBH)

**3**

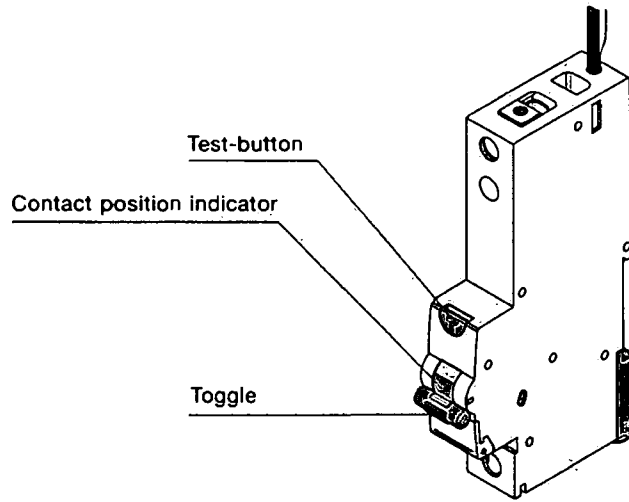

#### TEST-BUTTON

To ensure the correct functioning of the RCBO, the test-button T shall be pressed frequently. The device must trip when the test-button is pressed.

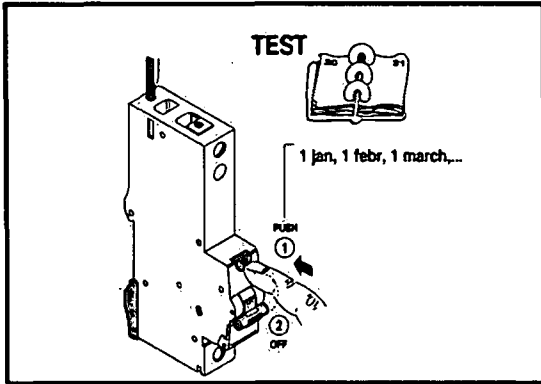

#### CONTACT POSITION INDICATOR

Printing on the toggle to provide information of the real contact position.

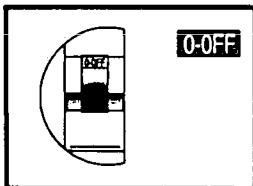

**O-OFF**  
Contacts in open position. Ensure a distance between contacts > 4 mm.

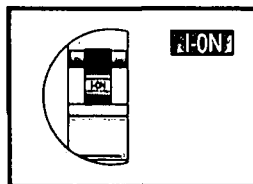

**I-ON**  
Contacts in closed position. Ensure continuity in the main circuit.

#### TOGGLE

To manually switch the RCBO ON or OFF

#### CABLE CONNECTION

The power supply (L) must be done at the bottom terminal, and the supply neutral flying cable (black) shall be connected to the neutral bar.

Load connection shall be done in both terminals at the top side (L out / N out).

The earth reference cable (FE white) ensures protection against earth leakage in case of loss of supply neutral.

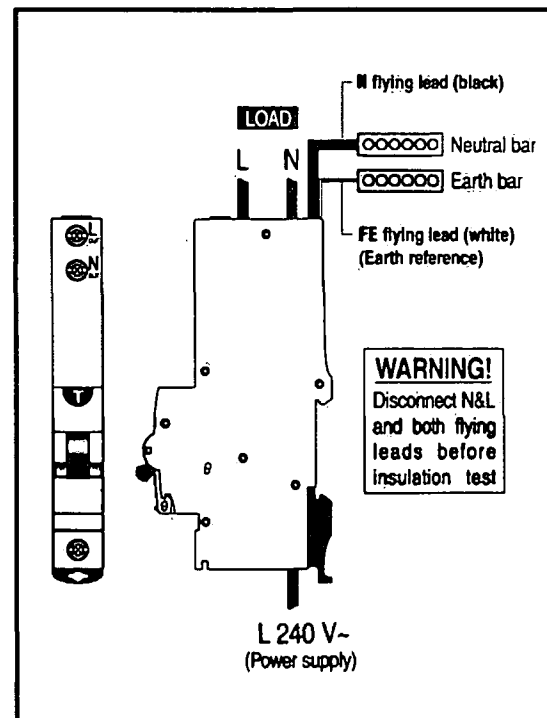



## Din-T MCBs + RCDs Technical data

### Product related information

#### Influence of temperature on RCBOs (DinSafe DSRCB)

The thermal calibration of the RCBO was carried out at an ambient temperature of 30 °C. Ambient temperatures different from 30 °C influence the bimetal and this results in earlier or later thermal tripping.

3

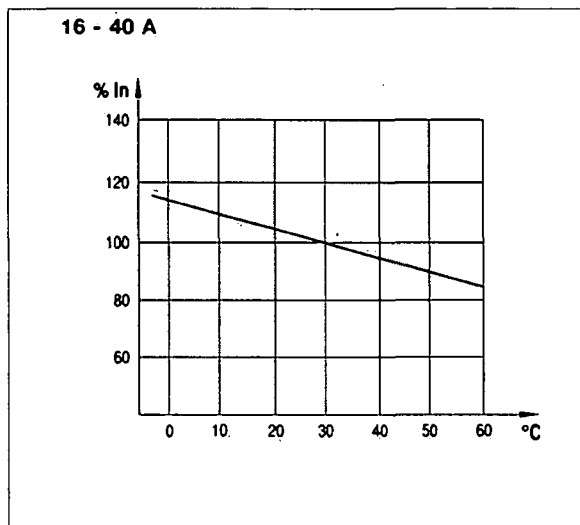
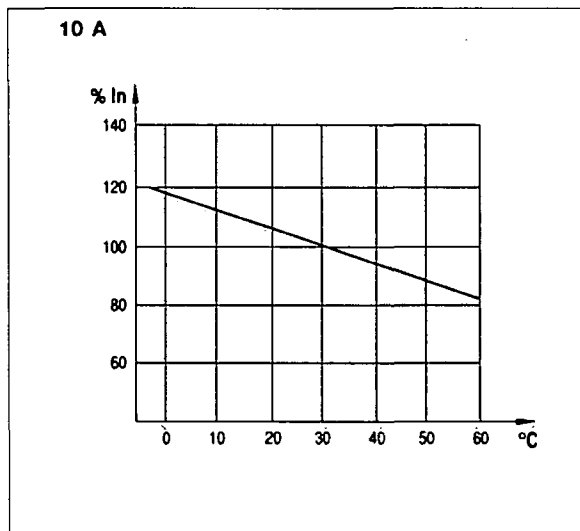
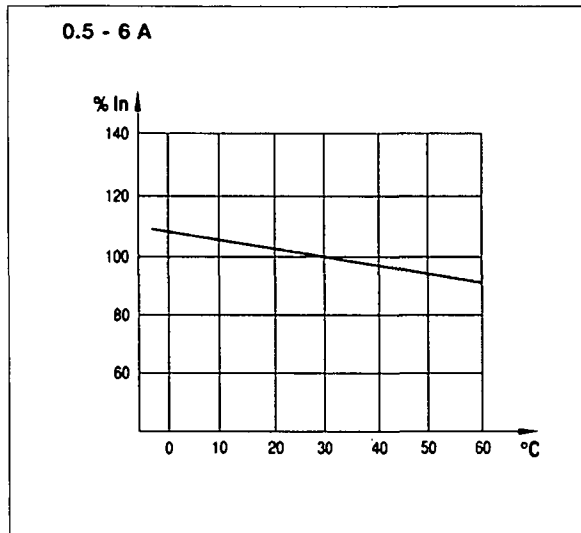

## Din-T MCBs + RCDs Technical data

### Tripping current as a function of the frequency

All RCDs are designed to work at frequencies of 50-60 Hz, therefore to work at different values, we must consider the variation of the tripping sensitivity according to the tables below. It should be taken into consideration that there is a no tripping risk when pushing the test-button, due to the fact that such action is made by means of an internal resistor with a fixed value.

#### RCBO DSRCBH <sup>1)</sup>

Type AC <sup>1)</sup>	10 Hz	30 Hz	50 Hz	100 Hz	200 Hz	300 Hz	400 Hz
30 mA	0.62	0.65	0.80	0.91	1.24	1.55	1.88
100 mA	0.74	0.71	0.80	0.95	1.16	1.38	1.59
300 mA	0.80	0.74	0.80	0.97	1.19	1.44	1.64
500 mA	1.10	0.81	0.80	0.89	1.18	1.38	1.68

#### Type A <sup>2)</sup>

30 mA	8.17	3.13	0.75	1.70	3.10	3.52	3.67
100 mA	6.81	2.71	0.75	1.43	2.35	2.58	2.71
300 mA	6.20	2.16	0.75	0.49	0.87	0.74	0.95
500 mA	4.34	1.53	0.75	0.39	0.59	0.62	0.64

Notes: <sup>1)</sup> The standard NHP/Terasaki type is the "type AC" in Australia, Type "A" in New Zealand.

<sup>2)</sup> The standard NHP/Terasaki DSRCBH single pole RCBO is "type A" in Australia and New Zealand.

<sup>3)</sup> The numbers in the table above are multipliers, e.g. A "DSRCD" at 50 hz has an 0.8 multiplier.  
Therefore a 30 mA, "type AC" RCD will trip at (0.8 x 30 mA) 24 mA.

### Power losses

The power losses are calculated by means of measuring the voltage drop between the incoming and the outgoing terminal of the device at rated current. Power loss per pole:

#### RCBO-Single pole DSRCBH

In (A)	6	10	13	16	20	25	32	40	50	63
Z (mOhm)	45.8	16.4	12.5	10.6	7.3	5.4	3.2	2.6	1.9	1.4
Pw. (W)	1.65	1.7	2.1	2.7	2.9	3.3	3.4	4.2	4.8	5.6

3

## Din-T MCBs + RCDs Technical data

### RCBO (DSRCB) let-through energy $I^2t$

The benefit of an RCBO in short-circuit conditions, is its ability to reduce the value of the let-through energy that the short-circuit would be generating.

#### Din-T single pole width RCD (DSRCBH)

Curve C

Let-through energy at 230 V

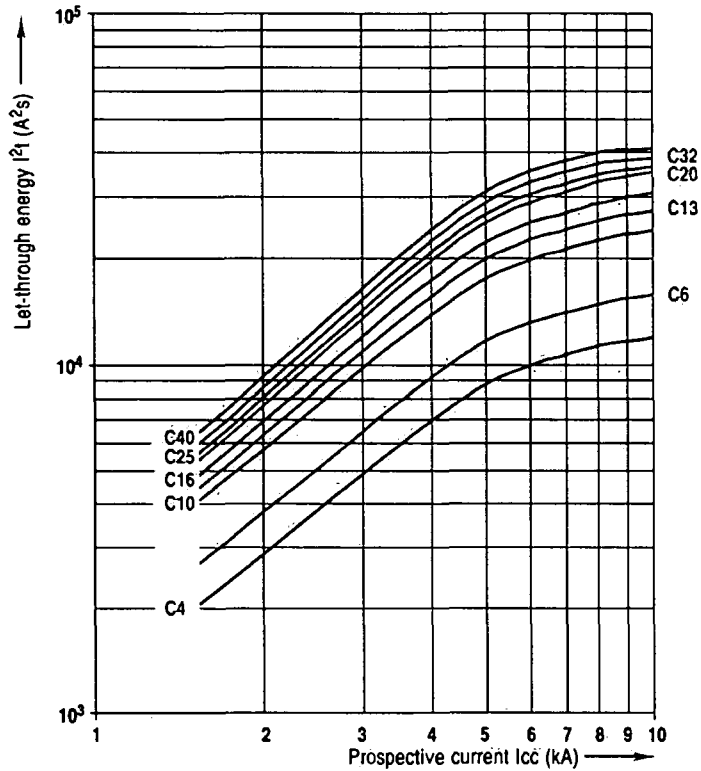

#### RCCB - Din-Safe safety switch (DSRCD)

#### RCBO - Din-Safe (DSRCBH)

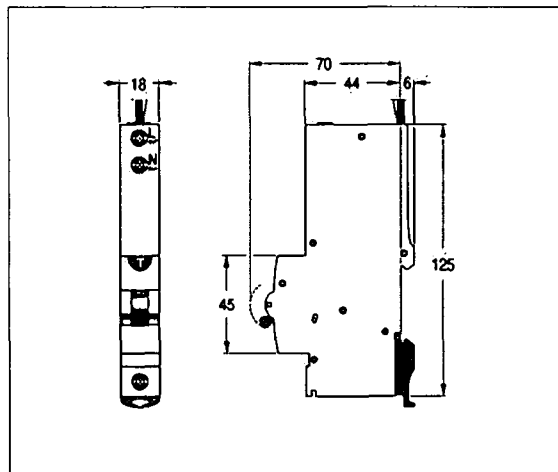

Dimensions in mm



## Din-T MCBs + RCDs Technical data

### Overview Din-Safe RCDs

RCBO



#### Device type definition

Rating/description	Cat. No.	DSRCBH
Standards		IEC 61009-1
Magnetic tripping characteristics		C
Residual tripping characteristic <sup>1)</sup>		A
Tripping time at I <sub>Δn</sub>		
Instantaneous	ms	<300
Selective	ms	-
Rated current	A	6, 10, 16, 20, 25, 32, 40
Rated residual current I <sub>Δn</sub>	mA	10, 30
Calibration temperature	°C	30
Number of poles versus modules		1
Rated voltage U <sub>n</sub>		
2 P AC	V	240 (1 P+N)
3 P AC	V	-
4 P AC	V	-
Frequency	Hz	50/60
Maximum service voltage U <sub>bmax</sub>	V	255
Minimum service voltage U <sub>bmin</sub>	V	100
Power supply		Bottom
Selectivity class		3
Rated making and breaking capacity (I <sub>m</sub> )	A	10xI <sub>n</sub>
Residual making and breaking capacity (I <sub>Δm</sub> )	A	10000
Conditional short-circuit capacity (I <sub>nc</sub> )	A	-
Conditional residual short-circuit capacity (I <sub>Δc</sub> )	A	-
Short-circuit capacity (I <sub>cn</sub> )	A	10000
Grid distance (safety distance between two devices)	mm	-
Isolator application		yes
Insulation degree		
Insulation voltage	V (DC)	500 <sup>2)</sup>
Shock voltage (1.2/50 ms)	kV	6 <sup>2)</sup>
Insulation resistance	(mΩm)	1000 <sup>2)</sup>
Dielectric strength	V	2500 <sup>2)</sup>
Shock resistance (in x, y, z direction)[IEC 60077/16.3]		40 g, 18 shocks 5 ms
Vibration resistance (in x, y, z direction; IEC 60068-2-6)		2 g, 30 min, 0...80 Hz
Endurance		
electrical at U <sub>n</sub> , I <sub>n</sub>		10000
mechanical at U <sub>n</sub> , I <sub>n</sub>		20000
Protection degree (outside/inside electrical enclosure)		IP 20 / IP 40
Self extinguish degree (according to UL 94)		V2
Tropicalisation (according to IEC 60068-2, DIN 40046)	*C/RH	+55/95 %
Pollution degree (acc. IEC 60947-1)		3
Operating temperature	°C	-5...+60
Storage temperature	°C	-25...+70
Terminals capacity		
Rigid cable min/max (Top)	mm <sup>2</sup>	1/25
Flexible cable min*/max (Top)	mm <sup>2</sup>	1/16
Rigid cable min/max (bottom)	mm <sup>2</sup>	1/35
Flexible cable min*/max (bottom)	mm <sup>2</sup>	1/25
	(*Flexible cable 0.75/1.5 mm <sup>2</sup> with cable lug)	
Torque	Top/Bottom	Nm
		3
Add-on devices (side add-on)		
Auxiliary contacts		-
LVT		-
Shunt trip		-
Motor operator		-
Panelboard switch		Bottom
Busbars systems		
Pin		Bottom
Fork		yes
Accessories		
Dimensions, weights, packaging		
# Poles		1+N
(HxOxW) 86x68xW	mm	38
Weight/unit	g	350
Package/unit		1

Note: <sup>1)</sup> Refer catalogue section for types.

<sup>2)</sup> Making sure that N-L and both flying leads are disconnected.

3







**Halmac** Services (Qld) Pty. Ltd.  
A.C.N. 098 852 923  
A.B.N. 40 741 712 113

# CONTACTOR

## 1. CA7 CONTACTOR TECHNICAL DETAILS



# AC contactors

## 3 pole open type with AC coil



Refer catalogue CA 6, 2212, SACS

AC 3 rating at 60°C

### Ratings to IEC 947 and AS 3497 400/415 V

- For CA 7 contactors with coil terminals on line side, add ...V AC to Catalogue No. Eg - CA 7-9-10-240 V AC<sup>1)</sup>
- For CA 7 contactors with coil terminals on load side, add ...V AC-U to Catalogue No. Eg - CA 7-9-10-240 V AC-U

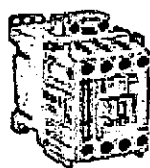

Contactor CA 7-9

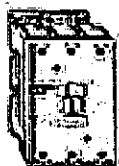

Contactor CA 7-72

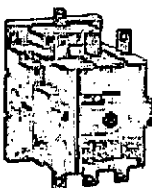

Contactor CA 6-105-EI

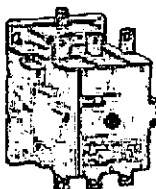

Contactor CA 6-170-EI

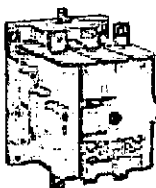

Contactor CA 6-250-EI

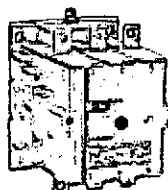

Contactor CA 6-420-EI

AC 3 400/415 V kW <sup>1)</sup>	AC 3 400/415 V Amps <sup>1)</sup>	AC 1 <sup>1)</sup> AC 1 <sup>1)</sup>		Auxiliary contacts standard			Cat. No. <sup>2)</sup>
		Amps 40 °C	Amps 60 °C	N/O	N/C	Max.	
4	9	32	32	1	0	9	CA 7-9-10...V AC CA 7-9-01...V AC
5.5	12	32	32	1	0	9	CA 7-12-10...V AC CA 7-12-01...V AC
7.5	16	32	32	1	0	9	CA 7-16-10...V AC CA 7-16-01...V AC
11	23	32	32	1	0	9	CA 7-23-10...V AC CA 7-23-01...V AC
15	30	50	45	0	0	8	CA 7-30-00...V AC
18.5	37	50	45	0	0	8	CA 7-37-00...V AC
22	43	85	63	0	0	8	CA 7-43-00...V AC
30	60	100	100	0	0	8	CA 7-60-00...V AC
37	72	100	100	0	0	8	CA 7-72-00...V AC
45	85	100	100	0	0	8	CA 7-85-00...V AC
55 (45)	95 (33)	160	135	1	1	8	CA 6-85-11...V AC
75 (55)	130 (40)	160	135	1	1	8	CA 6-105-11...V AC
90 (75)	155 (55)	250	210	1	1	8	CA 6-140-11...V AC
75 (55)	130 (40)	160	135	1	1	8	CA 6-105-EI-11...V AC <sup>3)</sup>
90 (75)	155 (55)	250	210	1	1	8	CA 6-140-EI-11...V AC <sup>3)</sup>
100 (90)	170 (65)	250	210	1	1	8	CA 6-170-EI-11...V AC <sup>3)</sup>
132 (111)	225 (80)	350	300	1	1	8	CA 6-210-EI-11...V AC <sup>3)</sup>
150 (133)	258 (95)	350	300	1	1	8	CA 6-250-EI-11...V AC <sup>3)</sup>
185 (163)	320 (115)	450	380	1	1	8	CA 6-300-EI-11...V AC <sup>3)</sup>
250 (225)	425 (160)	500	425	1	1	8	CA 6-420-EI-11...V AC <sup>3)</sup>
220 (220)	370 (155)	500	420	2	2	8	CA 5-370...V AC <sup>3)</sup>
265 (280)	450 (200)	600	510	2	2	8	CA 5-450...V AC <sup>3)</sup>
325 (355)	550 (250)	780	645	2	2	8	CA 5-550...V AC <sup>3)</sup>
430 (500)	700 (340)	1000	850	2	2	8	CA 5-700...V AC <sup>3)</sup>
520 (550)	860 (380)	1100	930	2	2	8	CA 5-860...V AC <sup>3)</sup>
600	1000	1200	1020	1	1	8	CA 5-1000...V AC <sup>3)</sup>
700	1150	1350	1150	1	1	8	CA 5-1200...V AC <sup>3)</sup>

- Notes:
- <sup>1)</sup> 1000 volt ratings ( )
  - <sup>2)</sup> Add control voltage to Cat. No. when ordering: 24, 32, 110, 240, 415, 440V 50 Hz. Standard voltages for CA 6-105-EI...250-EI are 24, 48, 110, 240 and 415 V AC. Standard voltages for CA 6-300-EI...420-EI 48, 110, 240 and 415 V AC. Standard voltages for CA 5-370...1200, 110, 240 and 415 V AC.
  - <sup>3)</sup> All CA 7 coils can be reversed for line or load side coil terminals as required. Both versions are held in NHP stock for convenience.
  - <sup>4)</sup> Electronically controlled mechanism (ECM) with interface suffix (EI).
  - <sup>5)</sup> 55 °C enclosed.
  - <sup>6)</sup> Contact NHP for recommended cable size.

240/415 V rated coils are suitable for use on 230/400 V in accordance with AS 60038 : 2000.



# ACS contactors CA 7

## 4 - 45kW



Refer catalogue SACS

### The highest switching capacity in the smallest space

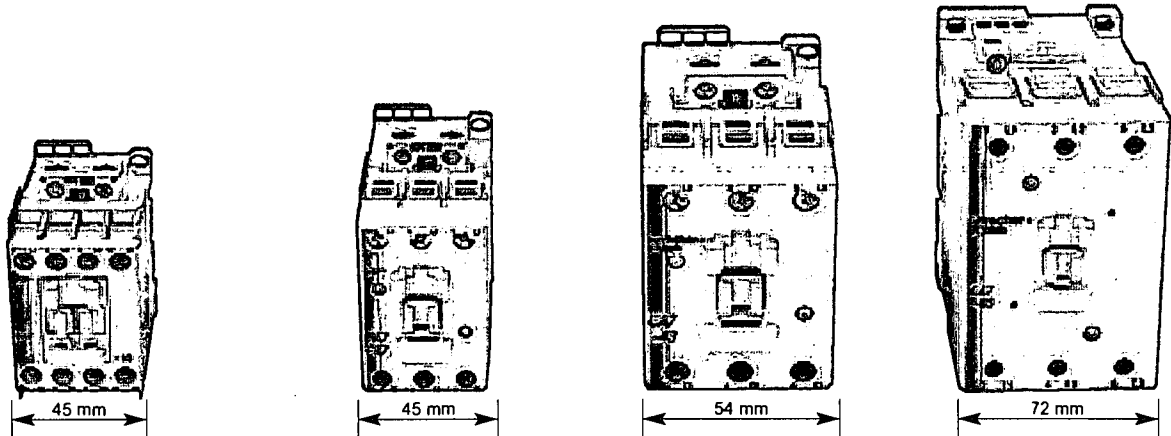

### Compact without compromise

Compact without compromise is the best way to describe the CA 7 range of contactors and motor protection relays from Sprecher + Schuh. In spite of the new compact dimensions, the CA 7 range features high breaking capacity and extraordinary flexibility. Up to 18.5 kW the contactors are only 45 mm wide and even the largest 45 kW frame is only 72 mm wide. The CA 7 contactors are the main component in the new Advanced Control System (ACS).

### With CA 7 you have flexibility with auxiliary contacts

Common auxiliaries from 9 to 85 amps

Three fitting positions

- Front mounting
- Side mounting left
- Side mounting right

Alternatively you can choose to combine left, right and front mounting auxiliary contacts to fulfil your requirements.

Instead of the top mounted auxiliary contacts, on or off delay timing modules or mechanical latches can be fitted.

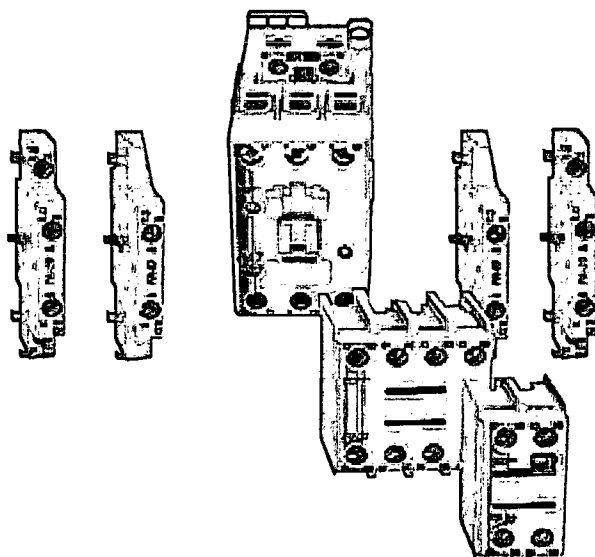

### Motor switching rating AC 3 @ 400/415 V

CA 7-9	4 kW	45 mm		9 A
CA 7-12	5.5 kW			12 A
CA 7-16	7.5 kW			16 A
CA 7-23	11 kW			23 A
CA 7-30	15 kW	45 mm		30 A
CA 7-37	18.5 kW			37 A
CA 7-43	22 kW	54 mm		43 A
CA 7-60	30 kW	72 mm		60 A
CA 7-72	37 kW			72 A
CA 7-85	45 kW			85 A

### With CA 7 you have more clip on accessories

Common accessories from 9 to 85 amps

- On and off delay pneumatic timers
- Coil mounted electronic timers on delay, off delay, star delta
- Coil mounted 24 V DC interface
- Coil mounted RC and varistor suppressor modules
- Mechanical latch
- Mechanical interlock
- Mechanical interlock with integrated N/C interlock contacts
- Moulded wire link sets for DOL, reversing and star delta starters
- Large choice of front and side mounting auxiliary contacts

Sprecher + Schuh



# ACS contactors CA 7

4-45kW



Refer catalogue SACS

## Innovation and ease of use provide solutions for your control systems

### Coil terminals are always in the correct position

The coil terminations on the CA 7 contactors can be supplied optionally at the top or the bottom of the contactor. It is also a simple task to change this on site should the requirements change.

When CA 7 contactors are used in combination with KTA 7 circuit motor circuit breakers the bottom coil terminations are used. For use with standard CT 7 thermal or CEP 7 electronic overloads the top coil termination should be selected.

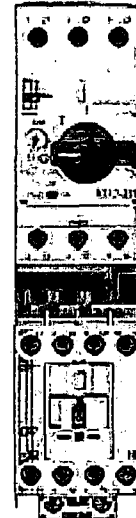
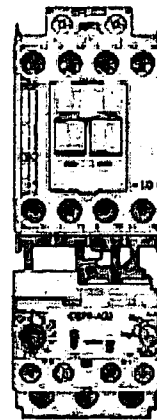

### Mechanical interlocks save space

Only 9mm wide, the CM 7 mechanical interlock snaps into place between any of the CA 7 contactors. It is allowed also to interlock different sizes of the CA 7 range with the same interlock.

The basic mechanical interlock is supplemented by a variation with built in N/C auxiliary contacts for electrical interlocking. This version is also only 9mm wide and further minimises space requirements.

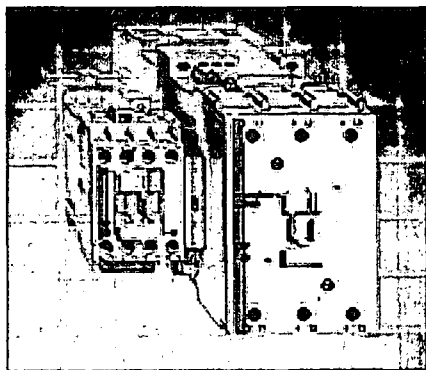

### CA 7 contactors provide improved wiring terminals

The main terminals of all CA 7 contactors are designed to accept at least two cables. At the same time they comply with safety standards regarding touch protection.

The larger contactors CA 7-30 and upwards employ a special cage terminal which allows the connection of two cables in separate chambers.

The ease of wiring with CA 7 contactors saves both time and money.

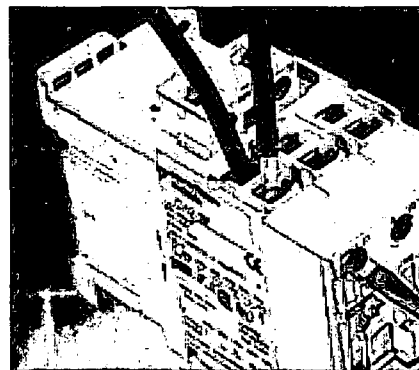

With Sprecher + Schuh you can choose the best protection for your motors.

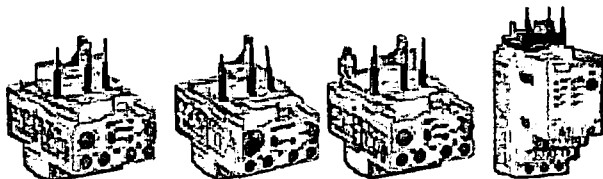

High tech electronic protection type CEP 7 in trip class 10 or 20.

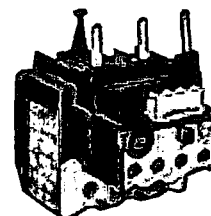

Standard thermal overloads type CT 7

# ACS Short circuit co-ordination

## Type '2' with KT 7 circuit breakers

Refer Catalogue C-CO

Automatic Type '2' co-ordination <sup>1)</sup> with  
no-oversizing of contactors

DOL starting  
50/65 kA @ 400/415 V

**NEW**  
Automatic  
Type '2'

Motor size kW	Approx. amps @ 400/415 V	Sprecher + Schuh circuit breaker	Setting range amps	Magnetic amps	Sprecher + Schuh contactor	AC-3 amps
0.18	0.60	KT 7-25S	0.40 - 0.63	8.2	CA 7-9	9
0.25	0.80	KT 7-25S	0.63 - 1.00	13	CA 7-9	9
0.37	1.10	KT 7-25S	1.00 - 1.60	21	CA 7-9	9
0.55	1.50	KT 7-25S	1.00 - 1.60	21	CA 7-9	9
0.75	1.80	KT 7-25S	1.60 - 2.50	33	CA 7-9	9
1.10	2.60	KT 7-25S	2.50 - 4.00	52	CA 7-9	9
1.15	3.40	KT 7-25S	2.50 - 4.00	52	CA 7-9	9
2.20	4.80	KT 7-25S	4.00 - 6.30	80	CA 7-9	9
3.00	6.50	KT 7-25S	6.30 - 10.0	130	CA 7-9	9
4.00	8.20	KT 7-25S	6.30 - 10.0	130	CA 7-9	9
5.50	11.00	KT 7-25S	10.0 - 16.0	208	CA 7-12	12
7.50	14.00	KT 7-25S	10.0 - 16.0	208	CA 7-16	16
9.00	17.00	KT 7-25H	14.5 - 20.0	260	CA 7-23	23
11.00	21.00	KT 7-25H	18.0 - 25.0	325	CA 7-23	23
15.00	28.00	KT 7-45H	23.0 - 32.0	416	CA 7-30	30
18.50	34.00	KT 7-45H	32.0 - 45.0	585	CA 7-37	37
22.00	40.00	KT 7-45H	32.0 - 45.0	585	CA 7-43	43
30.00	55.00	KT 3-100	40.0 - 63.0	882	CA 7-60	60
37.00	66.00	KT 3-100	63.0 - 90.0	1260	CA 7-72	72
45.00	80.00	KT 3-100	63.0 - 90.0	1260	CA 7-85	85

Definition Type '2' co-ordination according to IEC 947-4-1:

- The contactor or the starter must not endanger persons or systems in the event of a short circuit
- The contactor or the starter must be suitable for further use
- No damage to the overload relay or other parts may occur with the exception of welding of the contactor or starter contacts provided that these can be easily separated without significant deformation (such as with a screwdriver)
- In the event of a short circuit, fast opening current limiting circuit breakers KT 7 make it possible to build economical, fully short circuit co-ordinated starter combinations in accordance with IEC 947-4-1, Type '2' co-ordination
- Type '2' co-ordination without oversizing of contactors means: Type '1' = Type '2'

**Note:** <sup>1)</sup> What is meant by Automatic Type '2' co-ordination?  
The high speed operation of the new KT 7 motor protection circuit breakers means that contactors need not be oversized to achieve type '2' co-ordination. Simply select the normal AC 3 rated contactor and the corresponding KT 7 circuit breaker and type '2' co-ordination is assured.

240/415 V rating suitable for use on 230/400 V in accordance with AS 60038 : 2000

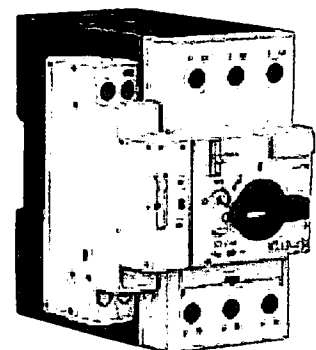



sprecher  
schuh

**TERASAKI**  
Creating Service Maximizing Quality

# Short circuit co-ordination

## Type '1' with circuit breakers or fuses



Refer Catalogue C-CO

MCCB or fuse DOL starting  
50/65 kA @ 400/415 V to AS 3947.4.1

### TemBreak Moulded Case Circuit Breaker or fuse

Motor size kW	Approx. amps	Terasaki circuit breaker	or	NHP HRC fuse to BS88	Sprecher + Schuh contactor type	Sprecher + Schuh thermal O/L relay type	Setting range amps
0.37	1.1	XM30PB/1.4		NTIA-6	CA 7-9	CT 7-24	1 - 1.6
0.55	1.5	XM30PB/2		NTIA-6	CA 7-9	CT 7-24	1 - 1.6
0.75	1.8	XM30PB/2.6		NTIA-10	CA 7-9	CT 7-24	1.6 - 2.4
1.1	2.6	XM30PB/4.0		NTIA-10	CA 7-9	CT 7-24	2.4 - 4
1.5	3.4	XM30PB/5		NTIA-10	CA 7-9	CT 7-24	2.4 - 4
2.2	4.8	XM30PB/8		NTIA-16	CA 7-9	CT 7-24	4 - 6
3.0	6.5	XM30PB/10		NTIA-16	CA 7-9	CT 7-24	6 - 10
4.0	8.2	XM30PB/12		NTIA-25	CA 7-9	CT 7-24	6 - 10
5.5	11	XH125NJ/20		NTIA-32	CA 7-12	CT 7-24	10 - 16
7.5	14	XH125NJ/20		NTIS-40	CA 7-16	CT 7-24	10 - 16
11	21	XH125NJ/32		NTIS-50	CA 7-23	CT 7-24	16 - 24
15	28	XH125NJ/50		NTIS-63	CA 7-30	CT 7-45	18 - 30
18.5	34	XH125NJ/50		NTCP-80	CA 7-37	CT 7-45	30 - 45
22	40	XH125NJ/63		NTCP-80	CA 7-43	CT 7-45	30 - 45
30	55	XH125NJ/100		NTCP-100	CA 7-60	CT 7-75	45 - 60
37	66	XH125NJ/100		NTF-160	CA 7-72	CT 7-75	60 - 75
45	80	XH125NJ/125 ')		NTF-160	CA 6-85	CT 7-100	70 - 90
55	100	XH125NJ/125 ')		NTF-200	CA 6-105-EI	CT 6-110	85 - 110
75	130	XH250NJ/250		NTKF-250	CA 6-140-EI	CT 6-150	105 - 150
90	155	XH250NJ/250 ')		NTKF-250	CA 6-170-EI	CT 6-200	140 - 200
110	200	XH250NJ/250 ')		NTKF-315	CA 6-210-EI	CEF 1-41/42	160 - 400
132	225	XH400NE/400		NTMF-355	CA 6-210-EI	CEF 1-41/42	160 - 400
150	250	XH400NE/400		NTMF-355	CA 6-250-EI	CEF 1-41/42	160 - 400
160	270	XH400NE/400		NTMF-400	CA 6-300-EI	CEF 1-41/42	160 - 400
185	310	XH400NE/400		NTTF-450	CA 6-300-EI	CEF 1-41/42	160 - 400
200	361	XH400NE/400		NTTM-500	CA 6-420-EI/CA 5-450	CEF 1-41/42	160 - 400
250	425	XH630NE/630		NTTM-630	CA 6-420-EI/CA 5-450	CEF 1-52	160 - 630
315	530	XH630NE/630		NNTLM-710	CA 5-550	CEF 1-52	160 - 630

**Notes:** Fuses 65 kA. XH125NJ circuit breaker combinations limited to 50 kA, others 65 kA.

Overloads may be changed to different types eg. thermal style to electronic.

Some combinations also gives Type '2' performance.

' ) Use 'magnetic only' breaker - Refer NHP.

240/415 V rating suitable for use on 230/400 V in accordance with AS 60038 : 2000

sprecher +  
schuh

# Short circuit co-ordination

## Type '2' with NHP fuses

NHP

Refer Catalogue C-CO

Fuse protection DOL starting <sup>1)</sup>  
50/65 kA @ 400/415 V to AS 3947.4.1

### Fuse

Motor size kW	Approx. amps @ 400/415 V	NHP HRC fuse to BS88	Sprecher + Schuh contactor	Sprecher + Schuh overload relay <sup>2)</sup> <sup>3)</sup>	Setting range amps
0.37	1.1	NTIA-4	CA 7-9	CEP 7	1.0 - 2.9
0.75	1.8	NTIA-6	CA 7-9	CEP 7	1.0 - 2.9
1.5	3.4	NTIA-10	CA 7-9	CEP 7	1.6 - 5
2.2	4.8	NTIA-16	CA 7-9	CEP 7	3.7 - 12
4.0	8.2	NTIA-20	CA 7-9	CEP 7	3.7 - 12
5.5	11	NTIA-25	CA 7-12	CEP 7	3.7 - 12
7.5	14	NTIA-32	CA 7-16	CEP 7	12 - 32
11	21	NTIS-50	CA 7-30	CEP 7	12 - 32
15	28	NTIS-63	CA 7-30	CEP 7	12 - 37
18.5	34	NTCP-80	CA 7-37	CEP 7	12 - 37
22	40	NTCP-80	CA 7-43	CEP 7	14 - 45
30	55	NTCP-100	CA 7-60	CEP 7	26 - 85
37	66	NTF-125	CA 7-72	CEP 7	26 - 85
45	80	NTF-160	CA 7-85	CEP 7	26 - 85
55	100	NTF-200	CA 6-105-EI	CT 6-110	85 - 110
75	130	NTKF-250	CA 6-140-EI	CT 6-150	105 - 150
90	155	NTKF-250	CA 6-170-EI	CT 6-200	140 - 200
110	200	NTKF-315	CA 6-210-EI	CEF 1-41/42 <sup>4)</sup>	160 - 400
132	225	NTMF-355	CA 6-210-EI	CEF 1-41/42 <sup>4)</sup>	160 - 400
150	250	NTMF-355	CA 6-250-EI	CEF 1-41/42 <sup>4)</sup>	160 - 400
185	320	NTTM-450	CA 6-300-EI	CEF 1-41/42 <sup>4)</sup>	160 - 400
250	425	NTTM-560	CA 6-420-EI	CEF 1-52 <sup>4)</sup>	160 - 630
320	538	NTLM-710	CA 5-550	CEF 1-52 <sup>4)</sup>	160 - 630
380	650	NTLM-800	CA 5-700	CEF 1-11/12P <sup>4)</sup>	300 - 1200

- Notes: <sup>1)</sup> Fuses with equal or lower let through energy may also be used.  
<sup>2)</sup> Thermal overloads may be used instead of electronic CEP 7.  
<sup>3)</sup> Above 37 kW overloads may also be electronic or thermal.  
<sup>4)</sup> CET 4 may be used instead of CEF 1.

240/415 V rating suitable for use on 230/400 V in accordance with AS 60038 : 2000

Sprecher +  
Schuh

**TERASAKI**  
Ensuring Service Maintaining Quality

# Short circuit co-ordination

## Type '2' using Terasaki circuit breakers



Refer Catalogue C-CO

**TemBreak circuit breakers DOL starting  
50 kA @ 400/415 V to AS 3947.4.1**

### TemBreak MCCBs

Motor size kW	Approx. amps	Terasaki circuit breaker	Sprecher + Schuh contactor	Sprecher + Schuh overload relay	Setting range amps
0.37	1.1	XM30PB/1.4	CA 7-9	CT 7-24-1.6	1 - 1.6
0.55	1.5	XM30PB/2	CA 7-9	CT 7-24-1.6	1 - 1.6
0.75	1.8	XM30PB/2.6	CA 7-9	CT 7-24-2.4	1.6 - 2.4
1.1	2.6	XM30PB/4.0	CA 7-16	CT 7-24-4	2.4 - 4
1.5	3.4	XM30PB/5	CA 7-16	CT 7-24-4	2.4 - 4
2.2	4.8	XM30PB/8	CA 7-16	CT 7-24-6	4 - 6
3	6.5	XM30PB/10	CA 7-30	CT 7-24-10	6 - 10
4	8.2	XM30PB/12	CA 7-30	CT 7-24-10	6 - 10
5.5	11	XH125NJ/20	CA 7-30	CT 7-24-16	10 - 16
7.5	14	XH125NJ/20	CA 7-30	CT 7-24-16	10 - 16
11	21	XH125NJ/32	CA 7-30	CT 7-24-24	16 - 24
15	28	XH125NJ/50	CA 7-43	CT 7-45-30	18 - 30
18.5	34	XH125NJ/50	CA 7-43	CT 7-45-45	30 - 45
22	40	XH125NJ/63	CA 7-43	CT 7-45-45	30 - 45
30	55	XH125NJ/100	CA 6-85	CT 7-75 <sup>2)</sup>	45 - 60
37	66	XH125NJ/100	CA 6-85	CT 7-75 <sup>2)</sup>	60 - 75
45	80	XH125NJ/125	CA 6-105-EI	CT 6-90	70 - 90
55	100	XH125NJ/125 <sup>1)</sup>	CA 6-105-EI	CT 6-110	85 - 110
75	130	XH250NJ/250	CA 6-140-EI	CT 6-150	105 - 150
90	155	XH250NJ/250	CA 6-170-EI	CT 6-200	140 - 200
110	200	XH250NJ/250 <sup>1)</sup>	CA 6-210-EI	CEF 1-41/42	160 - 400
132	225	XS400SE/400	CA 6-210-EI	CEF 1-41/42	160 - 400
150	250	XS400SE/400	CA 6-250-EI	CEF 1-41/42	160 - 400
160	270	XS400SE/400	CA 6-300-EI	CEF 1-41/42	160 - 400
200	361	XS400SE/400	CA 6-420-EI	CEF 1-41/42	160 - 400
200	361	XS400SE/400	CA 5-450	CEF 1-22 <sup>2)</sup>	160 - 400
250	425	XS630SE/630	CA 5-700	CEF 1-52 <sup>2)</sup>	160 - 630
320	538	XS630SE/630	CA 5-700	CEF 1-52 <sup>2)</sup>	160 - 630

**Notes:** Overloads may be thermal or electronic.  
 Combinations based on the overload tripping before the circuit breaker at overload currents up to the motor locked rotor current.  
<sup>1)</sup> Use 'magnetic only' breaker or next higher circuit breaker / contactor combination.  
<sup>2)</sup> Use with separate mounting bracket.  
 Data for 65 kA co-ordination available refer Cat. C-CO.

**240/415 V rating suitable for use on 230/400 V in accordance with AS 60038 : 2000**

sprecher +  
schuh

**TERASAKI**  
Ensuring Service, Maintaining Quality

# Short circuit co-ordination

## Type '2' using Terasaki circuit breakers



Refer Catalogue C-CO

TemBreak circuit breakers DOL starting. 85 kA @ 400/415 V to AS 3947.4.1

**MCCBs**

Motor size kW	Approx. FLC @ 400/415 V (A)	Terasaki circuit breaker	Sprecher + Schuh contactor	Sprecher + Schuh thermal O/L type	Setting range (A)
0.37	1.1	XM30PB/1.4	CA 7-9	CEP 7-M32-2.9-10	1.0 - 2.9
0.55	1.5	XM30PB/2.0	CA 7-9	CEP 7-M32-2.9-10	1.0 - 2.9
0.75	1.8	XM30PB/2.6	CA 7-9	CEP 7-M32-2.9-10	1.0 - 2.9
1.1	2.6	XM30PB/4	CA 7-16	CEP 7-M32-2.9-10	1.0 - 2.9
1.5	3.4	XM30PB/5	CA 7-16	CEP 7-M32-5-10	1.6 - 5
2.2	4.8	XM30PB/8	CA 7-30	CEP 7-M32-12-10	3.7 - 12
3	6.5	XM30PB/8	CA 7-30	CEP 7-M32-12-10	3.7 - 12
4	8.2	XM30PB/10	CA 7-30	CEP 7-M32-12-10	3.7 - 12
5.5	11	TL100NJ/20	CA 7-30	CEP 7-M32-12-10	3.7 - 12
7.5	14	TL100NJ/20	CA 7-30	CEP 7-M32-32-10	12 - 32
9	17	TL100NJ/32	CA 7-30	CEP 7-M32-32-10	12 - 32
10	19	TL100NJ/32	CA 7-30	CEP 7-M32-32-10	12 - 32
11	21	TL100NJ/32	CA 7-30	CEP 7-M32-32-10	12 - 32
15	28	TL100NJ/50	CA 7-43	CEP 7-M32-32-10	12 - 32
18.5	34	TL100NJ/50	CA 7-43	CEP 7-M37-37-10	12 - 37
22	40	TL100NJ/63	CA 7-43	CEP 7-M45-45-10	14 - 45
30	55	TL100NJ/100	CA 7-72	CEP 7-M85-85-10	26 - 85
37	66	TL100NJ/100	CA 7-72	CEP 7-M85-85-10	26 - 85
45	80	TL250NJ/160	CA 6-105	CEP 7-M85-85-10	26 - 85
55	100	TL250NJ/160	CA 6-105	CEF 1-11/12	0.5 - 180
75	135	TL250NJ/250	CA 6-210-EI	CEF 1-11/12	0.5 - 180
90	160	TL250NJ/250	CA 6-210-EI	CEF 1-11/12	0.5 - 180
110	200	TL250NJ/250	CA 6-210-EI	CEF 1-41/42/52	160 - 630
132	230	TL400NE/400	CA 6-210-EI	CEF 1-41/42/52	160 - 630
160	270	TL400NE/400	CA 6-300-EI	CEF 1-41/42/52	160 - 630
200	361	TL400NE/400	CA 6-420-EI	CEF 1-41/42/52	160 - 630

Din-T circuit breakers with rotary isolator. DOL starting.  
50 kA @ 400/415 V to AS 3947.4.1

**Din-T MCBs**

Motor size kW	Approx. amps @ 400/415 V	Sprecher + Schuh isolator	Terasaki circuit breaker	Sprecher + Schuh current limiter	Sprecher + Schuh contactor	Sprecher + Schuh thermal O/L relay	Thermal overload range
0.37	1.1	LA 7-80	Din-T 10 / 4	-	CA 7-9	CT 7-24	0.6 - 1.6
0.55	1.5	LA 7-80	Din-T 10 / 4	-	CA 7-9	CT 7-24	1 - 1.6
0.75	1.8	LA 7-80	Din-T 10 / 4	-	CA 7-9	CT 7-24	1.6 - 2.4
1.1	2.6	LA 7-80	Din-T 10 / 6	-	CA 7-23	CT 7-24	2.4 - 4
1.5	3.4	LA 7-80	Din-T 10 / 6	-	CA 7-23	CT 7-24	2.4 - 4
2.2	4.8	LA 7-80	Din-T 10 / 10	KTL 3-65	CA 7-23	CT 7-24	4 - 6
3	6.5	LA 7-80	Din-T 10 / 16	KTL 3-65	CA 7-23	CT 7-24	6 - 10
4	8.2	LA 7-80	Din-T 10 / 16	KTL 3-65	CA 7-23	CT 7-24	6 - 10
5.5	11	LA 7-80	Din-T 10 / 20	KTL 3-65	CA 7-23	CT 7-24	10 - 16
7.5	14	LA 7-80	Din-T 10 / 32	KTL 3-65	CA 7-30	CT 7-45	10 - 16
11	21	LA 7-80	Din-T 10 / 40	KTL 3-65	CA 7-30	CT 7-24	16 - 24
15	28	LA 7-100	Din-T 10 / 63	KTL 3-65	CA 7-37	CT 7-45	18 - 30
18.5	34	LA 7-100	Din-T 10 / 63	KTL 3-65	CA 7-37	CT 7-45	30 - 45

Note: 240/415 V rating suitable for use on 230/400 V in accordance with AS 60038 : 2000



# ACS contactors CA 7

## Technical data



Refer Catalogue C-CO

TemBreak circuit breakers DOL starting. 85 kA @ 400/415 V to AS 3947.4.1

### MCCBs

Motor size kW	Approx. FLC @ 400/415 V (A)	Terasaki circuit breaker	Sprecher + Schuh contactor	Sprecher + Schuh thermal O/L type	Setting range (A)
0.37	1.1	XM30PB/1.4	CA 7-9	CEP 7-M32-2.9-10	1.0 - 2.9
0.55	1.5	XM30PB/2.0	CA 7-9	CEP 7-M32-2.9-10	1.0 - 2.9
0.75	1.8	XM30PB/2.6	CA 7-9	CEP 7-M32-2.9-10	1.0 - 2.9
1.1	2.6	XM30PB/4	CA 7-16	CEP 7-M32-2.9-10	1.0 - 2.9
1.5	3.4	XM30PB/5	CA 7-16	CEP 7-M32-5-10	1.6 - 5
2.2	4.8	XM30PB/8	CA 7-30	CEP 7-M32-12-10	3.7 - 12
3	6.5	XM30PB/8	CA 7-30	CEP 7-M32-12-10	3.7 - 12
4	8.2	XM30PB/10	CA 7-30	CEP 7-M32-12-10	3.7 - 12
5.5	11	TL100NJ/20	CA 7-30	CEP 7-M32-12-10	3.7 - 12
7.5	14	TL100NJ/20	CA 7-30	CEP 7-M32-32-10	12 - 32
9	17	TL100NJ/32	CA 7-30	CEP 7-M32-32-10	12 - 32
10	19	TL100NJ/32	CA 7-30	CEP 7-M32-32-10	12 - 32
11	21	TL100NJ/32	CA 7-30	CEP 7-M32-32-10	12 - 32
15	28	TL100NJ/50	CA 7-43	CEP 7-M32-32-10	12 - 32
18.5	34	TL100NJ/50	CA 7-43	CEP 7-M37-37-10	12 - 37
22	40	TL100NJ/63	CA 7-43	CEP 7-M45-45-10	14 - 45
30	55	TL100NJ/100	CA 7-72	CEP 7-M85-85-10	26 - 85
37	66	TL100NJ/100	CA 7-72	CEP 7-M85-85-10	26 - 85
45	80	TL250NJ/160	CA 6-105	CEP 7-M85-85-10	26 - 85
55	100	TL250NJ/160	CA 6-105	CEF 1-11/12	0.5 - 180
75	135	TL250NJ/250	CA 6-210-EI	CEF 1-11/12	0.5 - 180
90	160	TL250NJ/250	CA 6-210-EI	CEF 1-11/12	0.5 - 180
110	200	TL250NJ/250	CA 6-210-EI	CEF 1-41/42/52	160 - 630
132	230	TL400NE/400	CA 6-210-EI	CEF 1-41/42/52	160 - 630
160	270	TL400NE/400	CA 6-300-EI	CEF 1-41/42/52	160 - 630
200	361	TL400NE/400	CA 6-420-EI	CEF 1-41/42/52	160 - 630

Din-T circuit breakers with rotary isolator. DOL starting.  
50 kA @ 400/415 V to AS 3947.4.1

### Din-T MCBs

Motor size kW	Approx. amps @ 400/415 V	Sprecher + Schuh isolator	Terasaki circuit breaker	Sprecher + Schuh current limiter	Sprecher + Schuh contactor	Sprecher + Schuh thermal O/L relay	Thermal overload range
0.37	1.1	LA 7-80	Din-T 10 / 4	-	CA 7-9	CT 7-24	0.6 - 1.6
0.55	1.5	LA 7-80	Din-T 10 / 4	-	CA 7-9	CT 7-24	1 - 1.6
0.75	1.8	LA 7-80	Din-T 10 / 4	-	CA 7-9	CT 7-24	1.6 - 2.4
1.1	2.6	LA 7-80	Din-T 10 / 6	-	CA 7-23	CT 7-24	2.4 - 4
1.5	3.4	LA 7-80	Din-T 10 / 6	-	CA 7-23	CT 7-24	2.4 - 4
2.2	4.8	LA 7-80	Din-T 10 / 10	KTL 3-65	CA 7-23	CT 7-24	4 - 6
3	6.5	LA 7-80	Din-T 10 / 16	KTL 3-65	CA 7-23	CT 7-24	6 - 10
4	8.2	LA 7-80	Din-T 10 / 16	KTL 3-65	CA 7-23	CT 7-24	6 - 10
5.5	11	LA 7-80	Din-T 10 / 20	KTL 3-65	CA 7-23	CT 7-24	10 - 16
7.5	14	LA 7-80	Din-T 10 / 32	KTL 3-65	CA 7-30	CT 7-45	10 - 16
11	21	LA 7-80	Din-T 10 / 40	KTL 3-65	CA 7-30	CT 7-24	16 - 24
15	28	LA 7-100	Din-T 10 / 63	KTL 3-65	CA 7-37	CT 7-45	18 - 30
18.5	34	LA 7-100	Din-T 10 / 63	KTL 3-65	CA 7-37	CT 7-45	30 - 45

Note: 240/415 V rating suitable for use on 230/400 V in accordance with AS 60038 : 2000



# ACS contactors CA 7

## Technical data



General data		CA 7-9...CA 7-85									
Rated insulation voltage $U_i$											
IEC	690 V										
UL, CSA	600 V										
Rated impulse voltage withstand $U_{imp}$											
8k V											
Test voltage											
1 minute (to IEC 947-4)	2500 V										
Rated voltage $U_e$											
AC	110, 240, 400/415, 500, 690 V										
DC	24, 48, 110, 220, 440 V										
Rated frequency of coil											
50/60 Hz											
Ambient temperature											
Storage	-55...+80 °C (-67...176 °F)										
Operation at nominal current	-25...+60 °C (-13...140 °F)										
Maximum with 15 % AC 1 current reduction > 60 °C	-25...+70 °C (-13...158 °F)										
Climatic withstand											
Cyclicly changing humid atmosphere to IEC 68-2-30 and DIN 50 016, 56											
Maximum altitude											
2000 m NN, to IEC 947-4											
Protection class											
IP 2LX (IEC 529 and DIN 40050)	In connected condition										
Protection against contact											
Touch protection to VDE 0106, Part 100											
Standards											
IEC 947-1/4; VDE 0660, Part 100/104; UL 508; CSA 22.2. Part 14											
Compliance											
CE; UL; CSA											
Short time withstand											
$I_{cw}$ , 60°	CA7-9	CA7-12	CA7-16	CA7-23	CA7-30	CA7-37	CA7-43	CA7-60	CA7-72	CA7-85	
1 s (A)	210	210	290	380	480	525	650	1100	1150	1250	
4 s (A)	140	150	220	280	360	390	480	820	860	910	
10 s (A)	100	120	175	220	290	310	375	640	680	710	
15 s (A)	90	100	150	200	250	270	325	560	600	620	
60 s (A)	60	60	90	125	170	175	200	350	370	380	
240 s (A)	40	40	50	60	100	100	120	190	190	200	
900 s (A)	30	30	38	38	54	60	76	108	108	120	
Minimum cooling time at zero current [Min]											
20											



# ACS contactors CA 7

## Technical data



Auxiliary contact data		Built-in auxiliary contacts CA 7-9...23							Clip-on auxiliary contacts and accessories									
Switching of AC current																		
AC 1I <sub>th</sub>	at 40 °C	[A]	25							10								
	at 60 °C	[A]	20							6								
AC 15 at rated voltage		[V]	24	48	120	240	400	500	600	690	24	48	120	240	400	500	600	690
		[A]	16	16	14	10	5	2.5	1.8	1	6	6	6	3	2	1.5	1.2	0.7
Short circuit protection	Fuse gG																	
Co-ordination type '2'	[A]		10							10								
Rated impulse voltage																		
withstand U <sub>imp</sub>	[kV]		8							6								
Isolation between control and load																		
circuits to DIN, VDE 0106, parts	[V]		400							Between auxiliary circuit 250 V, between load & auxiliary circuit 690 V								
Contact reliability to DIN 19240																		
without soiling, normal industry atmosphere			17 V, 5 mA, >10 <sup>8</sup> switchings per failure							17 V, 5 mA, >10 <sup>8</sup> switchings per failure								
Terminals for auxiliary contacts																		
Terminal size to IEC 947-1																		
			2 x A4							2 x A4								
Flexible wire with sleeve																		
	1 wire [mm <sup>2</sup> ]		1...4							0.5...2.5								
	2 wire [mm <sup>2</sup> ]		1...4							0.75...2.5								
Stranded/solid core																		
	1 wire [mm <sup>2</sup> ]		1.5...6							0.5...2.5								
	2 wire [mm <sup>2</sup> ]		1.5...6							0.75...2.5								
Tightening torque																		
	[Nm]		1...2.5							1...1.5								

		Built-in auxiliary contacts CA 7-9...85					Clip-on auxiliary contacts Front mount					Clip-on auxiliary contacts Side mount				
Switching DC loads																
L/R < 1 ms, resistive loads at:	[V]	24	48	110	220	440	24	48	110	220	440	24	48	110	220	440
	[A]	12	9	3.5	0.55	0.2	12	9	3.5	0.55	0.2	6	3.2	0.45	0.18	0.1
L/R < 15 ms, inductive loads with economy resistor in series at:																
	[V]	24	48	110	220	440	24	48	110	220	440	24	48	110	220	440
	[A]	9	5	2	0.4	0.16	9	5	2	0.4	0.16	2	1.6	0.3	0.12	0.05
DC-13, switching electro magnets at:																
	[V]	24	48	110	220	440	24	48	110	220	440	24	48	110	220	440
	[A]	5	2	0.7	0.25	0.12	5	2	0.7	0.25	0.12	3	1.5	0.6	0.3	0.2



# ACS contactors CA 7

## Technical data



### Additional rating data - contactors to IEC 947

Contactor		CA 7-9	CA 7-12	CA 7-16	CA 7-23	CA 7-30	CA 7-37	CA 7-43	CA 7-60	CA 7-72	CA 7-85
AC 1 resistive load											
switching 3~											
Ambient temperature 40 °C											
$I_e$ <sup>1)</sup>	[A]	32	32	32	32	50	50	85	100	100	100
230/240 V	[kW]	10	10	13	13	18	20	25	36	36	40
400/415 V	[kW]	18	18	23	23	32	36	45	64	64	71
690 V	[kW]	30	30	38	38	54	60	75	108	108	120
Ambient temperature 60 °C											
$I_e$ <sup>1)</sup>	[A]	32	32	32	32	45	45	63	100	100	100
230/240 V	[kW]	8	8	10	10	14	16	20	29	29	34
400/415 V	[kW]	14	14	17	17	26	28	36	51	51	61
690 V	[kW]	24	24	29	29	44	48	60	86	86	102
AC motor switching											
AC 2, AC 3, AC 4											
230/240 V	[A]	11.5	14.5	20	26.5	34	37	42	62	70	85
400/415 V	[A]	9	12	16	23	30	37	43	60	72	85
690 V	[A]	5	7	9.3	12	17	20	25	34	42	49
230/240 V	[kW]	3	4	5.5	7.5	10	11	13	18.5	22	25
400/415 V	[kW]	4	5.5	7.5	11	15	18.5	22	30	37	45
690 V	[kW]	4	5.5	7.5	10	15	18.5	22	30	37	45
Rated making capacity											
$I_e$ AC 4, 50 Hz	max. 690 V [A]	135	180	240	345	450	555	645	900	1080	1275
Rated breaking capacity											
$I_e$ AC 4	max. 460 V [A]	135	180	240	345	450	555	645	900	1080	1275
	max. 690 V [A]	75	105	140	140	255	300	375	510	630	735
Short circuit protection											
without protection relay											
fuse gG to IEC 947-4-1											
co-ordination type '1'	[A]	50	50	50	63	100	125	160	200	250	250
co-ordination type '2'	[A]	20	25	25	35	50	80	100	100	125	160
Main current circuit											
resistance	[mΩ]	2.7	2.7	2.7	2	2	2	1.5	0.9	0.9	0.9
Power dissipated by all											
circuits at le AC 3	[w]	0.7	1.2	2.1	3.2	5.4	8.2	8.3	9.7	14	19.5
Total power dissipation											
at le AC 3	AC control [w]	3.3	3.8	4.7	6.2	8.4	11.2	11.5	14.2	18.5	–
	DC control [w]	6.7	7.2	8.1	12.4	14.6	17.4	18.4	14.6	18.9	–
Life span in millions of operations											
Mechanical	AC control	13	13	13	13	13	13	12	10	10	10
	DC control	13	13	13	13	13	13	13	10	10	10
Operating times (DC)											
	Make (mS)	40...70	40...70	40...70	40...70	50...80	50...80	50...80	20...40	20...40	20...40
	Break (mS)	7...15	7...15	7...15	7...15	7...15	7...15	–	–	–	–

Note: <sup>1)</sup> Contact NHP for recommended cable size.





# ACS contactors CA 7

## Dimensions



### Dimensions in (mm)

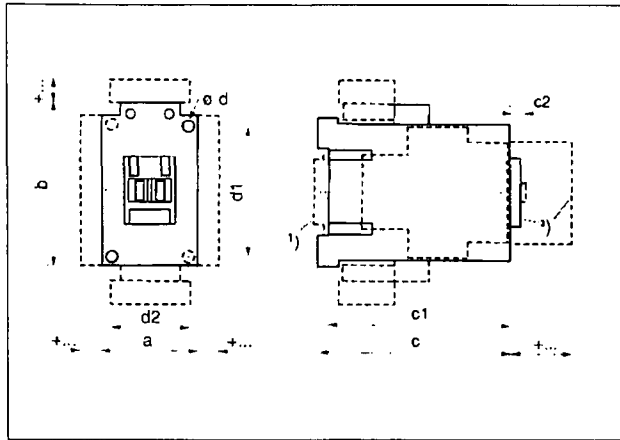

### Mounting position

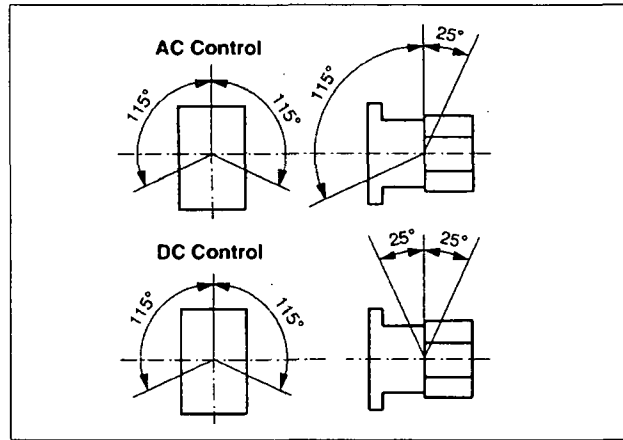

### Contactor (AC control)

Type	a	b	c	c1	c2	ød	d1	d2')
CA 7-9...CA 7-23 <sup>2)</sup>	45	81	80.5	75.5	6	4.5	60	35
CA 7-30...CA 7-37	45	81	97.5	92.6	6.5	4.5	60	35
CA 7-43	54	81	100.5	95.6	6.5	4.5	60	45
CA 7-60...CA 7-85	72	122	117	111.5	8.5	5.4	100	55

### (DC control)

Type	a	b	c	c1	c2	ød	d1	d2')
CA 7-9C...CA 7-16C	45	81	106.5	101.5	6	4.5	60	35
CA 7-23C	45	81	123.5	119	6	4.5	60	35
CA 7-30C...CA 7-37C	45	81	141.5	136.5	6.5	4.5	60	35
CA 7-43C	54	81	144.5	140	6.5	4.5	60	45
CA 7-60C...CA 7-85C	72	122	117	111.5	8.5	5.4	100	55

### Accessories

Contactor with		(AC control) (mm)	(DC control) (mm)
Front mounting auxiliary contact	2 or 4 pole	c/c1 + 39	c/c1 + 39
Side mounting auxiliary contact	1 or 2 pole	a + 9	a + 9
Pneumatic timing module		c/c1 + 58	-
Electronic timing module	coil mounting	b + 24	b + 24
Mechanical interlock	mounts between contactors	a + 9	a + 9
Mechanical latch		c/c1 + 61	-
Interface	coil mounting	b + 9	-
Suppressor	coil mounting	b + 3	b + 3
With inscriptions <sup>3)</sup>	labels	+0	+0
	label support system V4/V5	+5.5	+5.5

Notes: <sup>1)</sup> DIN Rail mounting 35 mm to EN 50 022.  
<sup>2)</sup> Dimensions for 4 pole contactors same as 3 pole with auxiliary.  
<sup>3)</sup> Dimensions with inscriptions.



# ACS electronic overloads CEP 7

## Dimensions with and without contactors



Dimensions in (mm)  
 CEP 7, CEP 7s and CEP 7-B mounted on CA 7 contactors

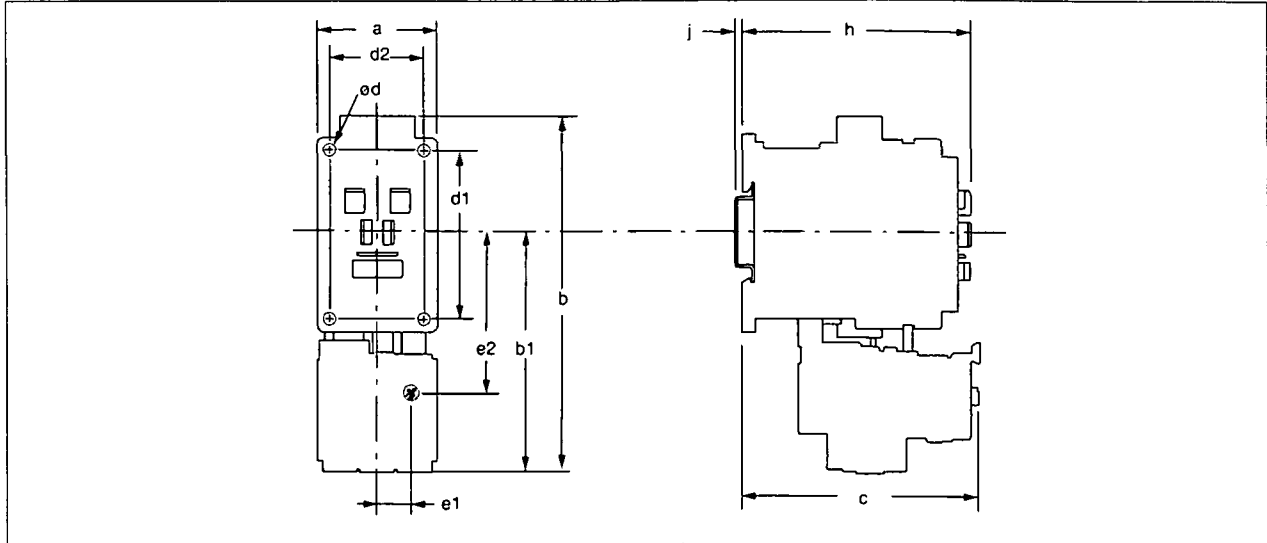

Cat. No.	a	b	b1	c	e1	e2	d1	d2	h	j	ød
CA 7-9/12/16/23 with CEP 7 or CEP 7S	45	131	86	88.5	16.5	69	60	35	86.5	2	4.2
CA 7-9/12/16/23 with CEP 7-B	54	137	97	90.7	5.1	59	60	35	85.1	2	4.2
CA 7-30/37 with CEP 7 or CEP 7S	45	136.5	91.5	92	16.5	69	60	35	104	2	4.2
CA 7-30/37 with CEP 7-B	54	137	97	92.1	5.2	59	60	35	104.7	2	4.2
CA 7-43 with CEP 7, CEP 7S or CEP 7-B	54	136.5	91.5	93	22	69	60	45	107	2	4.2
CA 7-60/72/85 with CEP 7, CEP 7S or CEP 7-B	72	188.5	120	120	18	84.5	100	55	125.5	2	5.5

### CEP 7 with separate mounting bracket

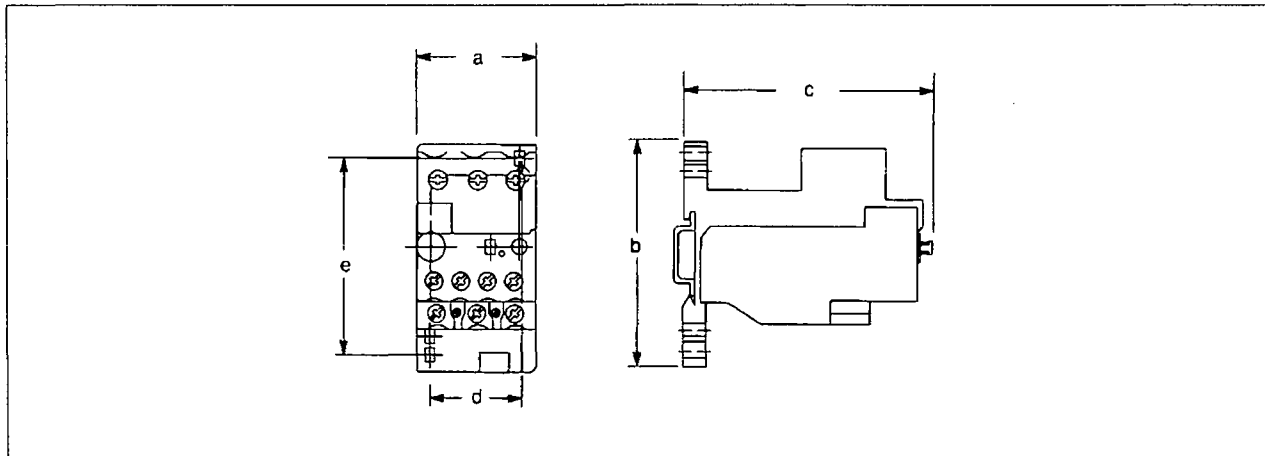

Type	a	b	c	d	e
CEP 7-37-P-A	45	90	75	30	75
CEP 7-45-P-A	55	90	96.5	40	75
CEP 7-85-P-A	70	115	110	55	105

sprecher+  
schuh

# ACS thermal overloads CT 7

## Technical data

NHP

General	CT 7-24	CT 7-45	CT 7-75	CT 7-100
Weight	[kg] 0.13	0.21	0.21	1.3
Standards	IEC 947, EN 60 947, DIN VDE 0660, UL, LRS, GUS, CSA			
Climatic	damp/heat, constant, to DIN, IEC 68, Part 2 - 3 damp/heat, cyclic, to DIN, IEC 68, Part 2 - 30			
Ambient temperature	open	-25...+60 °C		
	enclosed	-25...+50 °C		
Temperature compensation	continuous temperature range -5...+40 °C to IEC 947, EN 60947; PTB: -5...+50 °C			
Shock resistance (sinusoidal 10 ms) [G]	10			
Protection	IP 00 IP 2LX			
Protection	touch proof (VDE 0106, Part 100)			

### Contactor, timer and overload selection chart for auto transformer starters

ATS kW	Line contactor	Trans contactor	Star contactor	Timer	Overload
11	CA 7-23-10	CA 7-16-10	CA 7-9-10	RZ7 FSY2D	CEP 7-M32-32-10
15	CA 7-30-00	CA 7-23-10	CA 7-12-10	RZ7 FSY2D	CEP 7-M37-37-10
18.5	CA 7-37-00	CA 7-30-00	CA 7-16-10	RZ7 FSY2D	CEP 7-M37-37-10
22	CA 7-43-00	CA 7-30-00	CA 7-23-10	RZ7 FSY2D	CEP 7-M45-45-10
30	CA 7-60-00	CA 7-37-00	CA 7-30-00	RZ7 FSY2D	CEP 7-M85-85-10
37	CA 7-72-00	CA 7-43-00	CA 7-30-00	RZ7 FSY2D	CEP 7-M85-85-10
45	CA 7-85-00	CA 7-60-00	CA 7-37-00	RZ7 FSY2D	CEP 7-M85-85-10
55	CA 6-85-11	CA 7-60-00	CA 7-43-00	RZ7 FSY2D	CT 6-110
75	CA 6-105-11	CA 7-85-00	CA 7-60-00	RZ7 FSY2D	CT 6-150
90	CA 6-140EI-11	CA 6-85-11	CA 7-72-00	RZ7 FSY2D	CT 6-200
110	CA 6-170EI-11	CA 6-105-11	CA 7-85-00	RZ7 FSY2D	CEF 1-41
132	CA 6-210EI-11	CA 6-140EI-11	CA 6-105-11	RZ7 FSY2D	CEF 1-41
150	CA 6-250EI-11	CA 6-140EI-11	CA 6-105-11	RZ7 FSY2D	CEF 1-41
185	CA 6-300EI-11	CA 6-210EI-11	CA 6-140EI-11	RZ7 FSY2D	CEF 1-41
220	CA 6-420EI-11	CA 6-210EI-11	CA 6-140EI-11	RZ7 FSY2D	CEF 1-41

### Contactor, timer and overload selection chart for star delta starters

SDS kW	Line contactor	Delta contactor	Star contactor	Timer	Overload
7.5	CA 7-9-10	CA 7-9-01	CA 7-9-01	RZ7 FSY2D	CEP 7-M32-12-10
11	CA 7-12-10	CA 7-12-01	CA 7-9-01	RZ7 FSY2D	CEP 7-M32-32-10
15	CA 7-16-10	CA 7-16-01	CA 7-9-01	RZ7 FSY2D	CEP 7-M32-32-10
18.5	CA 7-23-10	CA 7-23-01	CA 7-12-01	RZ7 FSY2D	CEP 7-M32-32-10
22	CA 7-23-10	CA 7-23-01	CA 7-16-01	RZ7 FSY2D	CEP 7-M32-32-10
30-37	CA 7-37-00	CA 7-37-00	CA 7-23-01	RZ7 FSY2D	CEP 7-M45-45-10
45	CA 7-60-11	CA 7-60-11	CA 7-30-00	RZ7 FSY2D	CEP 7-M85-85-10
55	CA 7-60-11	CA 7-60-11	CA 7-37-00	RZ7 FSY2D	CEP 7-M85-85-10
75	CA 7-85-00	CA 7-85-00	CA 7-43-00	RZ7 FSY2D	CEP 7-M85-85-10
90	CA 6-85-11	CA 6-85-11	CA 7-60-00	RZ7 FSY2D	CT 6-90
110	CA 6-105-11	CA 6-105-11	CA 7-72-00	RZ7 FSY2D	CT 6-110
132	CA 6-140EI-11	CA 6-140EI-11	CA 7-85-00	RZ7 FSY2D	CT 6-150
150	CA 6-170EI-11	CA 6-170EI-11	CA 6-85-00	RZ7 FSY2D	CTA 6-200
185	CA 6-210EI-11	CA 6-210EI-11	CA 6-105-11	RZ7 FSY2D	CEF 1-41
220	CA 6-210EI-11	CA 6-210EI-11	CA 6-140EI-11	RZ7 FSY2D	CEF 1-41



# ACS thermal overloads CT 7

## Dimensions with and without contactors



### Mounted on CA 7 contactors

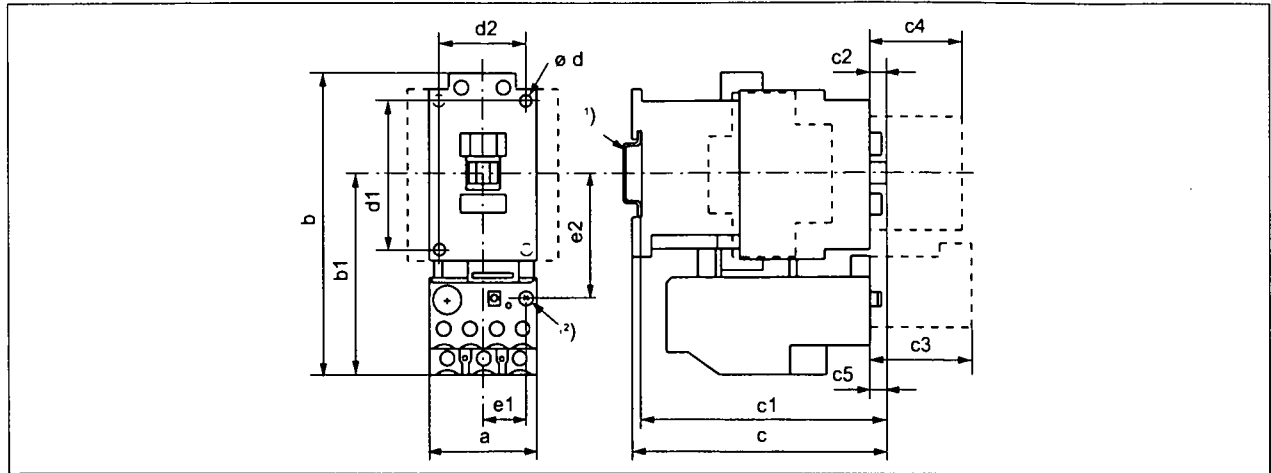

CT 7-24, CT 7-45, CT 7-75

Type	For contactor	a	b	b1	c	c1	c2	c3	c4	c5	ød	d1	d2	e1	e2
CT 7-24	CA 7-9...23	45	127	83	96	91	15	51	39	5	4.5	60	35 <sup>1)</sup>	16.5	51
	CA 7-30...37	45	127	83	105	99	6.5	51	39	9.5	4.5	60	35 <sup>1)</sup>	16.5	51
CT 7-45	CA 7-30...37	60	140	97	105	99	6.5	51	39	6.5	4.5	60	35 <sup>1)</sup>	16.5	57
	CA 7-43	60	140	97	107	103	6.5	51	39	8.5	4.5	60	45 <sup>1)</sup>	16.5	57
CT 7-75	CA 7-60...85	72	185	120	125	120	8.5	51	39	28.5	5.4	100	55 <sup>1)</sup>	16.5	82

### Separate mounting with bracket

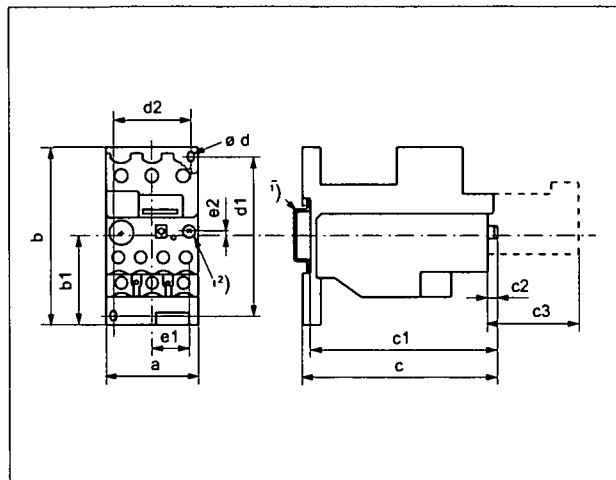

### Separate mounting

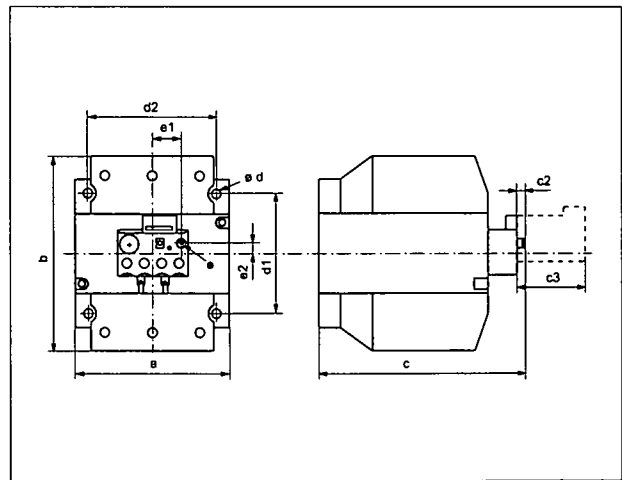

Type	a	b	b1	c	c1	c2	c3	ød	d1	d2	e1	e2
CT 7-24	45	85	44	95	70.5	5	51	4.5	60...74	35 <sup>1)</sup>	16	3
CT 7-75	60	90	44	117	112	15	51	5.4	74	50 <sup>1)</sup>	16	0
CT 7-90	100	120	-	135	-	5	51	6.2	74	80 <sup>1)</sup>	16	7

- Notes: <sup>1)</sup> Standard DIN rail to EN 50 022-35.  
<sup>2)</sup> With reset rod, maintain 9 mm maximum operating radius from centre of reset button.  
 c3 Reset magnet.  
 c4 Auxiliary contact block.







**Halmac** Services (Qld) Pty. Ltd.  
A.C.N. 098 852 923  
A.B.N. 40 741 712 113

# CONTROL RELAY & PHASE FAILURE RELAY

1. IDEC CONTROL RELAY TECHNICAL DETAILS
2. PHASE FAILURE RELAY TECHNICAL DETAILS



**RH Series Compact Power Relays**

**SPDT through 4PDT, 10A contacts**  
**Compact power type relays**

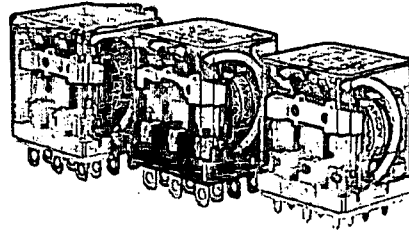
The RH series are miniature power relays with a large capacity. The RH relays feature 10A contact capacity as large as the RR series but in a miniature package. The compact size saves space.

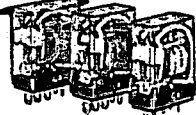
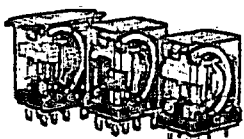
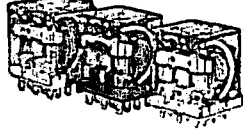

**Part Number Selection**

Contact	Model	Part Number		Coil Voltage Code (Standard Stock in bold)
		Blade Terminal	PCB Terminal	
SPDT 	Basic	RH1B-U	RH1V2-U	
	With Indicator	RH1B-UL	—	AC6V, AC12V, AC24V, AC110V, AC120V,
	With Check Button	RH1B-UC	—	AC220V, AC240V DC6V, DC12V, DC24V,
	With Indicator and Check Button	RH1B-ULC	—	DC48V, DC110V
	Top Bracket Mounting	RH1B-UT	—	
	With Diode (DC coil only)	RH1B-UD	RH1V2-JD	DC6V, DC12V, DC24V, DC48V, DC110V
	With Indicator and Diode (DC coil only)	RH1B-ULD	—	DC12V, DC24V, DC48V, DC110V
DPDT 	Basic	RH2B-U	RH2V2-U	
	With Indicator	RH2B-UL	RH2V2-UL	AC6V, AC12V, AC24V, AC110-120V,
	With Check Button	RH2B-UC	—	AC220-240V
	With Indicator and Check Button	RH2B-ULC	—	DC6V, DC12V, DC24V, DC48V, DC100-110V
	Top Bracket Mounting	RH2B-UT	—	
	With Diode (DC coil only)	RH2B-JD	RH2V2-JD	DC6V, DC12V, DC24V, DC48V, DC100-110V
	With Indicator and Diode (DC coil only)	RH2B-JLD	—	
3PDT 	Basic	RH3B-U	RH3V2-U	
	With Indicator	RH3B-UL	RH3V2-UL	AC6V, AC12V, AC24V, AC110V, AC120V,
	With Check Button	RH3B-UC	—	AC220V, AC240V DC6V, DC12V, DC24V,
	With Indicator and Check Button	RH3B-ULC	—	DC48V, DC110V
	Top Bracket Mounting	RH3B-UT	—	
	With Diode (DC coil only)	RH3B-D*	RH3V2-D*	DC6V, DC12V, DC24V, DC48V, DC110V
	With Indicator and Diode (DC coil only)	RH3B-LD*	—	
4PDT 	Basic	RH4B-U	RH4V2-U	
	With Indicator	RH4B-UL	RH4V2-UL	AC6V, AC12V, AC24V, AC110V, AC120V,
	With Check Button	RH4B-UC	—	AC220V, AC240V DC6V, DC12V, DC24V, DC48V,
	With Indicator and Check Button	RH4B-ULC	—	DC110V
	Top Bracket Mounting	RH4B-UT	—	
	With Diode (DC coil only)	RH4B-JD	RH4V2-JD	DC6V, DC12V, DC24V, DC48V, DC110V
	With Indicator and Diode (DC coil only)	RH4B-LD*	—	



- \*Carries no UL recognition mark.
- PCB terminal relays are designed to mount directly to a circuit board without any socket.

**Ordering Information**

When ordering, specify the Part No. and coil voltage code:

(example) **RH3B-U** **AC120V**  
 Part No.                      Coil Voltage Code

Switches & Pilot Lights

Display Lights

Relays & Sockets

Timers

Terminal Blocks

Circuit Breakers







# Relays & Sockets

RH Series





## Sockets (for Blade Terminal Models)

Relays	Standard DIN Rail Mount <sup>1</sup>	Finger-safe DIN Rail Mount <sup>1</sup>	Through Panel Mount	PCB Mount
RH1B	SH1B-05	SH1B-05C	SH1B-51	SH1B-62
RH2B	SH2B-05	SH2B-05C	SH2B-51	SH2B-62
RH3B	SH3B-05	SH3B-05C	SH3B-51	SH3B-62
RH4B	SH4B-05	SH4B-05C	SH4B-51	SH4B-62

 1. DIN Rail mount socket comes with two horseshoe clips. Do not use unless you plan to insert pullover wire spring. Replacement horseshoe clip part number is Y778-011.

## Hold Down Springs & Clips

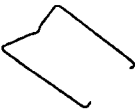
Appearance	Description	Relay	For DIN Mount Socket	For Through Panel & PCB Mount Socket	Min Order Qty
	Pullover Wire Spring	RH1B	SY2S-02F1 <sup>2</sup>	SY4S-51F1	10
		RH2B	SY4S-02F1 <sup>2</sup>		
		RH3B	SH3B-05F1 <sup>2</sup>		
		RH4B	SH4B-02F1 <sup>2</sup>		
	Leaf Spring (side latch)	RH1B, RH2B, RH3B, RH4B	SFA-202 <sup>3</sup>	SFA-302 <sup>3</sup>	20
		RH1B, RH2B, RH3B, RH4B	SFA-101 <sup>3</sup>	SFA-301 <sup>3</sup>	
	Leaf Spring (top latch)	RH1B, RH2B, RH3B, RH4B	SFA-101 <sup>3</sup>	SFA-301 <sup>3</sup>	

 2. Must use horseshoe clip when mounting in DIN mount socket. Replacement horseshoe clip part number is Y778-011.  
3. Two required per relay.

## AC Coil Ratings

Voltage (V)	Rated Current (mA) ±15% at 20°C								Coil Resistance (Ω) ±10% at 20°C				Operation Characteristics (against rated values at 20°C)		
	AC 50Hz				AC 60Hz				SPDT	DPDT	3PDT	4PDT	Max. Continuous Applied Voltage	Pickup Voltage	Dropout Voltage
	SPDT	DPDT	3PDT	4PDT	SPDT	DPDT	3PDT	4PDT							
6	170	240	330	387	150	200	280	330	330	9.4	6.4	5.4			
12	86	121	165	196	75	100	140	165	165	39.3	25.3	21.2			
24	42	60.5	81	98	37	50	70	83	83	153	103	84.5			
110	9.6	—	18.1	21.6	8.4	—	15.5	18.2	18.2	—	2,200	1,800			
110-120	—	9.4-10.8	—	—	—	8.0-9.2	—	—	—	—	—	—			
120	8.6	—	16.4	19.5	7.5	—	14.2	16.5	16.5	—	10,800	7,360			
220	4.7	—	8.8	10.7	4.1	—	7.7	9.1	9.1	—	10,800	7,360			
220-240	—	4.7-5.4	—	—	—	4.0-4.6	—	—	—	18,820	—	—			
240	4.9	—	8.2	9.8	4.3	—	7.1	8.3	8.3	—	12,100	9,120			

## DC Coil Ratings

Voltage (V)	Rated Current (mA) ±15% at 20°C				Coil Resistance (Ω) ±10% at 20°C				Operation Characteristics (against rated values at 20°C)		
	SPDT	DPDT	3PDT	4PDT	SPDT	DPDT	3PDT	4PDT	Max. Continuous Applied Voltage	Pickup Voltage	Dropout Voltage
6	128	150	240	250	47	40	25	24	110%	80% maximum	10% minimum
12	64	75	120	125	188	160	100	96			
24	32	36.9	60	62	750	650	400	388			
48	18	18.5	30	31	2,660	2,600	1,600	1,550			
100-110	—	8.2-9.0	—	—	—	12,250	—	—			
110	8	—	12.8	15	13,800	—	8,600	7,340			

 Standard coil voltages are in BOLD.

Switches & Pilot Lights

Display Lights

Relays & Sockets

Timers

Terminal Blocks

Circuit Breakers



**RH Series**

**Relays & Sockets**

Switches & Pilot Lights

Display Lights

Relays & Sockets

Timers

Terminal Blocks

Circuit Breakers

**Contact Ratings**

Maximum Contact Capacity						
Model	Continuous Current	Allowable Contact Power		Rated Load		
		Resistive Load	Inductive Load	Voltage (V)	Res. Load	Ind. Load
SPDT	10A	1540VA 300W	990VA 210W	110 AC	10A	7A
				220 AC	7A	4.5A
				30 DC	10A	7A
DPDT 3PDT 4PDT	10A	1650VA 300W	1100VA 225W	110 AC	10A	7.5A
				220 AC	7.5A	5A
				30 DC	10A	7.5A

Note: Inductive load for the rated load — cos φ = 0.3, L/R = 7 ms



**TUV Ratings**

Voltage	RH1	RH2	RH3	RH4
240V AC	10A	10A	7.5A	7.5A
30V DC	10A	10A	10A	10A

AC: cos φ = 1.0, DC: L/R = 0 ms



**UL Ratings**

Voltage	Resistive			General Use			Horse Power Rating		
	RH1 RH2	RH3	RH4	RH1 RH2	RH3	RH4	RH1 RH2	RH3	RH4
240V AC	10A	7.5A	7.5A	7A	6.5A	5A	1/3 HP	1/3 HP	—
120V AC	—	10A	10A	—	7.5A	7.5A	1/6 HP	1/6 HP	—
30V DC	10A	10A	—	7A	—	—	—	—	—
28V DC	—	—	10A	—	—	—	—	—	—

**CSA Ratings**

Voltage	Resistive				General Use				Horse Power Rating
	RH1	RH2	RH3	RH4	RH1	RH2	RH3	RH4	RH1, 2, 3
240V AC	10A	10A	—	7.5A	7A	7A	7A	5A	1/3 HP
120V AC	10A	10A	10A	10A	7.5A	7.5A	—	7.5A	1/6 HP
30V DC	10A	10A	10A	10A	7A	7.5A	—	—	—

**Socket Specifications**

	Sockets	Terminal	Electrical Rating	Wire Size	Torque	
<b>DIN Rail Mount Sockets</b>	SH1B-05	(Coil) M3 screws (contact) M3.5 screws with captive wire clamp	250V, 10A	Maximum up to 2-#12AWG	5.5 - 9 in•lbs 9 - 11.5 in•lbs	
	SH2B-05 SH3B-05 SH4B-05	M3.5 screws with captive wire clamp	300V, 10A	Maximum up to 2-#12AWG	9 - 11.5 in•lbs	
	<b>Finger-safe DIN Rail Mount</b>	SH1B-05C	(coil) M3 screws (contact) M3.5 screws with captive wire clamp, fingersafe	250V, 10A	Maximum up to 2-#12AWG	5.5 - 9 in•lbs 9 - 11.5 in•lbs
		SH2B-05C SH3B-05C SH4B-05C	M3.5 screws with captive wire clamp, fingersafe	300V, 10A	Maximum up to 2-#12AWG	9 - 11.5 in•lbs
<b>Through Panel Mount Socket</b>		SH1B-51 SH2B-51 SH3B-51 SH4B-51	Solder	300V, 10A	—	—
		<b>PCB Mount Socket</b>	SH1B-62	PCB mount	250V, 10A	—
	SH2B-62 SH3B-62 SH4B-62		PCB mount	300V, 10A	—	—

**Accessories**

Description	Appearance	Use with	Part No.	Remarks
Aluminum DIN Rail (1 meter length)		All DIN rail sockets	BNDN1000	IDEC offers a low-profile DIN rail (BNDN1000). The BNDN1000 is designed to accommodate DIN mount sockets. Made of durable extruded aluminum, the BNDN1000 measures 0.413 (10.5mm) in height and 1.37 (35mm) in width (DIN standard). Standard length is 39" (1,000mm).
DIN Rail End Stop		DIN rail	BNL5	9.1 mm wide.
Replacement Hold-Down Spring Anchor		DIN mount sockets and hold down springs.	Y778-011	For use on DIN rail mount socket when using pullover wire hold down spring. 2 pieces included with each socket.

# Relays & Sockets

RH Series



## Specifications

<b>Contact Material</b>	Silver cadmium oxide	
<b>Contact Resistance <sup>1</sup></b>	50mΩ maximum	
<b>Minimum Applicable Load</b>	24V DC, 30 mA; 5V DC, 100 mA (reference value)	
<b>Operate Time <sup>2</sup></b>	SPDT DPDT	20ms maximum
	3PDT 4PDT	25ms maximum
<b>Release Time <sup>2</sup></b>	SPDT DPDT	20ms maximum
	3PDT 4PDT	25ms maximum
<b>Power Consumption (approx.)</b>	SPDT	AC: 1.1VA (50Hz), 1VA (60Hz)      DC: 0.8W
	DPDT	AC: 1.4VA (50Hz), 1.2VA (60Hz)      DC: 0.9W
	3PDT	AC: 2VA (50Hz), 1.7VA (60Hz)      DC: 1.5W
	4PDT	AC: 2.5VA (50Hz), 2VA (60Hz)      DC: 1.5W
<b>Insulation Resistance</b>	100MΩ minimum (500V DC megger)	
<b>Dielectric Strength <sup>3</sup></b>	SPDT	Between live and dead parts: 2,000V AC, 1 minute
		Between contact and coil: 2,000V AC, 1 minute
		Between contacts of the same pole: 1,000V AC, 1 minute
	DPDT 3PDT 4PDT	Between live and dead parts: 2,000V AC, 1 minute
		Between contact and coil: 2,000V AC, 1 minute
		Between contacts of different poles: 2,000V AC, 1 minute
		Between contacts of the same pole: 1,000V AC, 1 minute
<b>Operating Frequency</b>	Electrical:	1,800 operations/hour maximum
	Mechanical:	18,000 operations/hour maximum
<b>Vibration Resistance</b>	Damage limits:	10 to 55Hz, amplitude 0.5 mm
	Operating extremes:	10 to 55Hz, amplitude 0.5 mm
<b>Shock Resistance</b>	Damage limits:	1,000m/s <sup>2</sup> (100G)
	Operating extremes:	200m/s <sup>2</sup> (20G - SPDT, DPDT) 100m/s <sup>2</sup> (10G - 3PDT, 4PDT)
<b>Mechanical Life</b>	50,000,000 operations minimum	
<b>Electrical Life</b>	DPDT	500,000 operations minimum (120V AC, 10A)
	SPDT 3PDT 4PDT	200,000 operations minimum (120V AC, 10A)
<b>Operating Temperature <sup>4</sup></b>	SPDT	-25 to +50°C (no freezing)
	DPDT 3PDT 4PDT	-25 to +40°C (no freezing)
<b>Operating Humidity</b>	45 to 85% RH (no condensation)	
<b>Weight (approx.)</b>	SPDT: 24g, DPDT: 37g, 3PDT: 50g, 4PDT: 74g	



Note: Above values are initial values.

1. Measured using 5V DC, 1A voltage drop method
2. Measured at the rated voltage (at 20°C), excluding contact bouncing  
Release time of relays with diode: 40 ms maximum
3. Relays with indicator or diode: 1000V AC, 1 minute
4. For use under different temperature conditions, refer to Continuous Load Current vs. Operating Temperature Curve. The operating temperature range of relays with indicator or diode is -25 to +40°C.

Switches & Pilot Lights

Display Lights

Relays & Sockets

Timers

Terminal Blocks

Circuit Breakers

**Characteristics (Reference Data)**

Switches & Pilot Lights

Display Lights

Relays & Sockets

Timers

Terminal Blocks

Circuit Breakers

**Electrical Life Curves**

**AC Load**

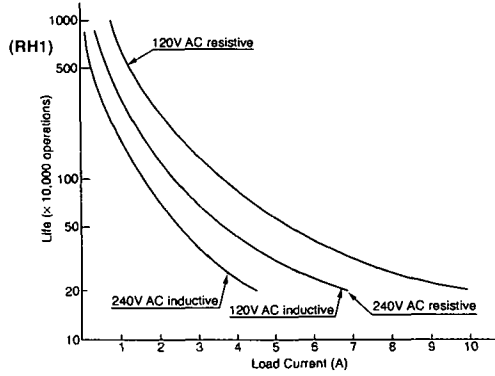

**DC Load**

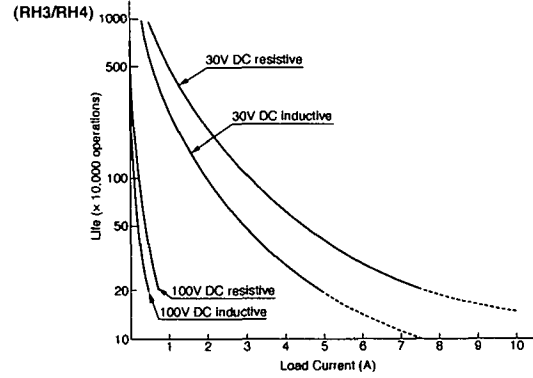
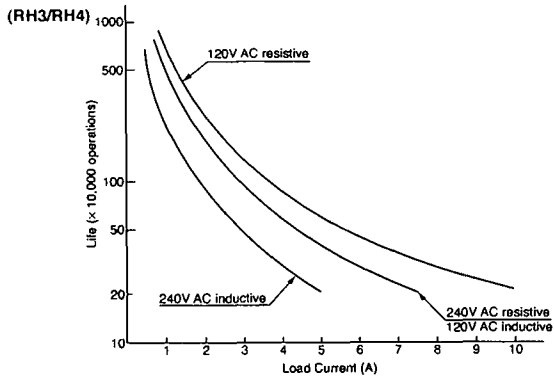
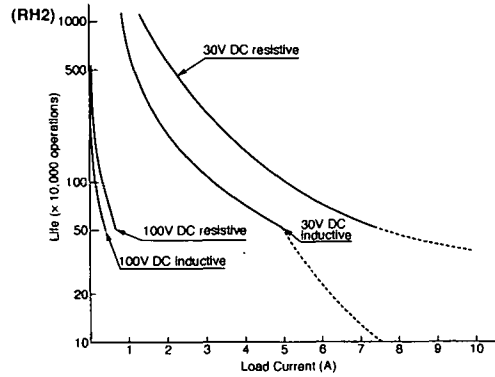
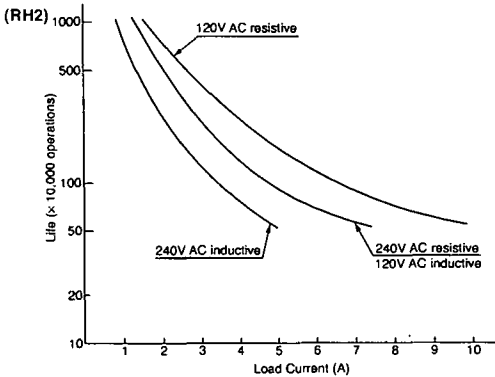
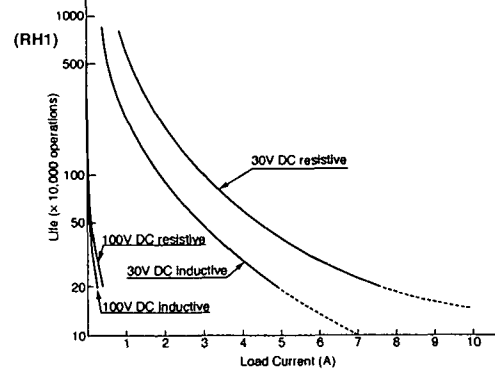

**Maximum Switching Capacity**

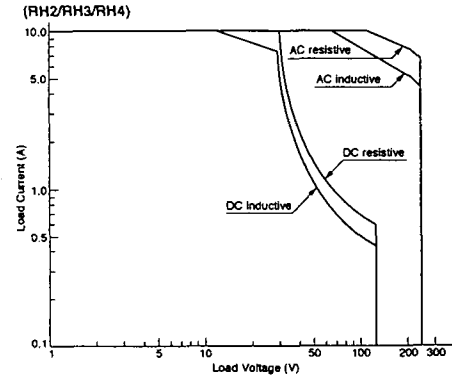
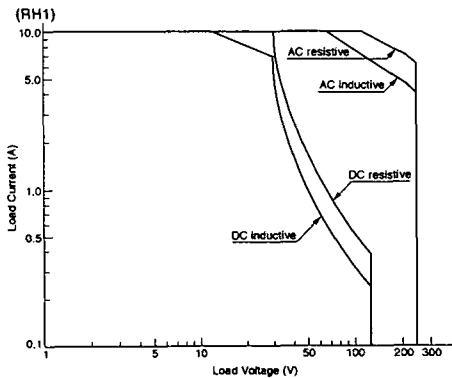

# Relays & Sockets

RH Series



## Continuous Load Current vs. Operating Temperature Curve (Basic Type, With Check Button, and Top Bracket Mounting Type)

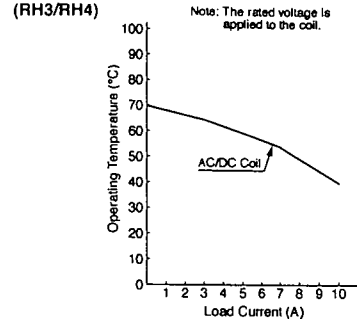
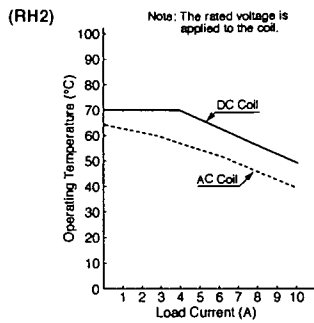
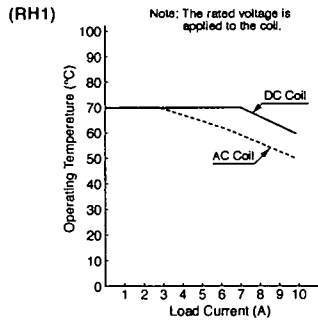

### Internal Connection (View from Bottom) Basic Type

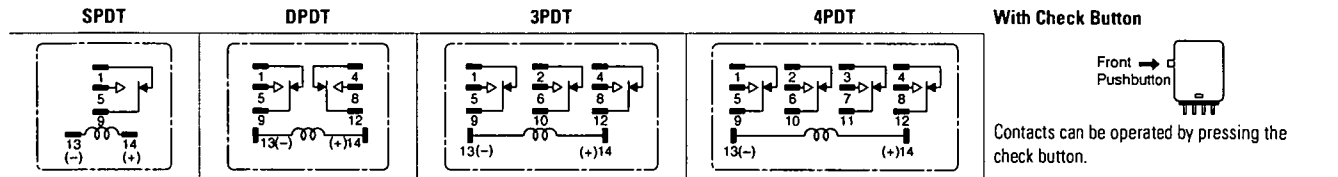

### With Indicator (-L type)

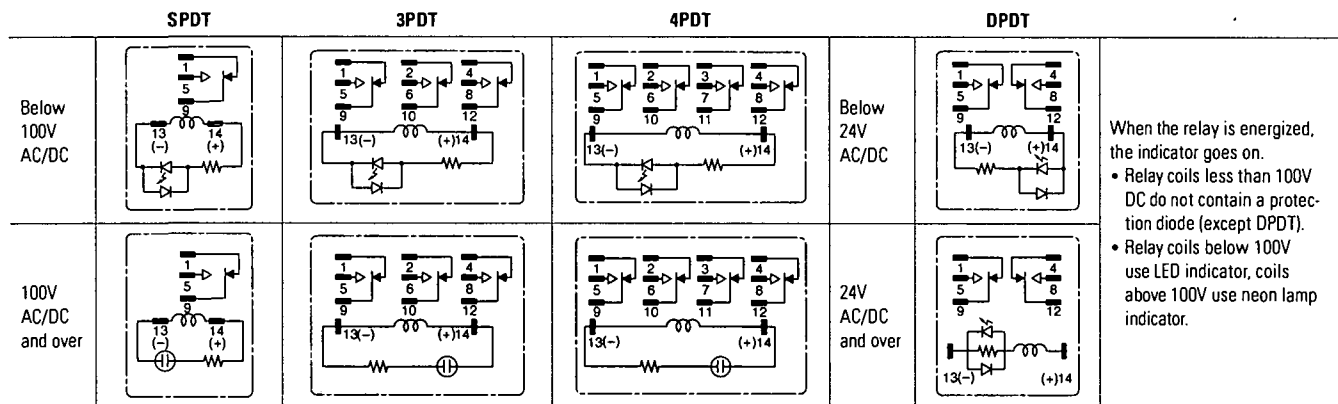

### With Diode (-D type)

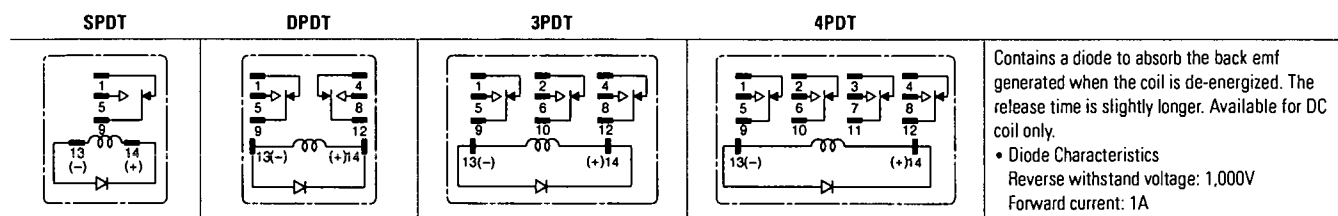

Switches & Pilot Lights

Display Lights

Relays & Sockets

Timers

Terminal Blocks

Circuit Breakers



**RH Series**

**Relays & Sockets**

**With Indicator LED & Diode (-LD type)**

Switches & Pilot Lights

Display Lights

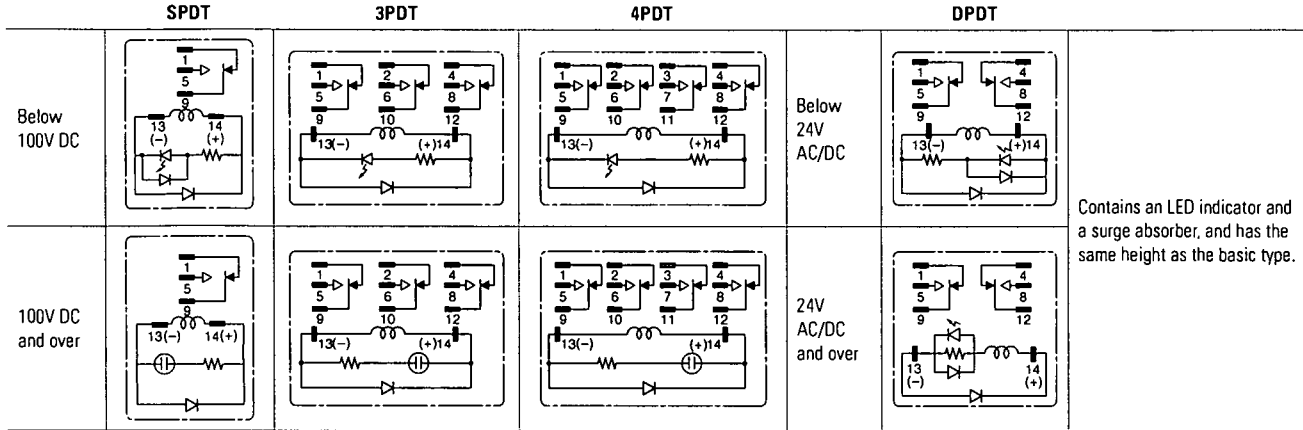

**Dimensions (mm)**

Relays & Sockets

**RH1B-U/RH1B-UL/RH1B-UD/RH1B-ULD**

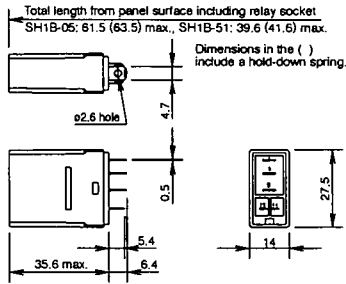

**RH2B-U/RH2B-UL/RH2B-UD/RH2B-ULD**

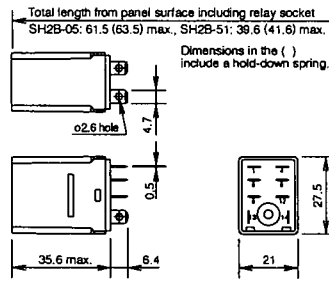

**RH3B-U/RH3B-UL/RH3B-D/RH3B-LD**

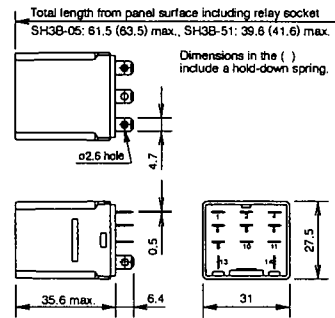

Timers

**RH4B-U/RH4B-UL/RH4B-UD/RH4B-LD**

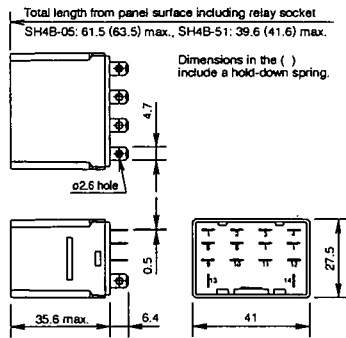

**RH1B-UT**

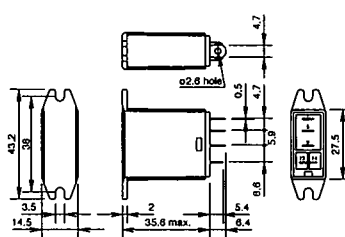

**RH2B-UT**

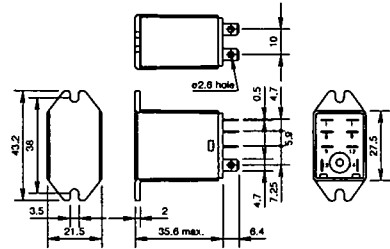

Terminal Blocks

**RH3B-UT**

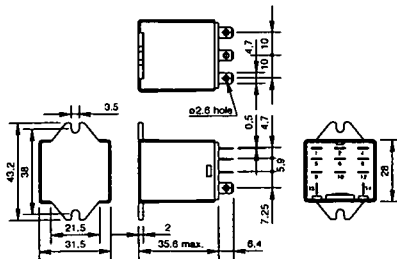

**RH4B-UT**

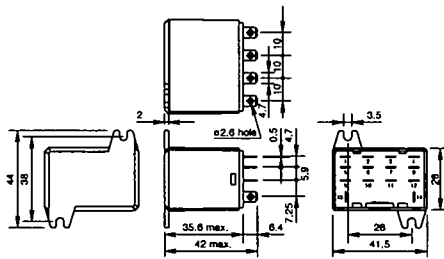

Circuit Breakers



Dimensions con't (mm)

RH1V2-U/RH1V2-UD

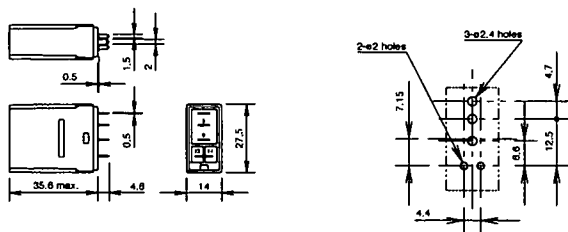

RH2V2-U/RH2V2-UL/RH2V2-UD

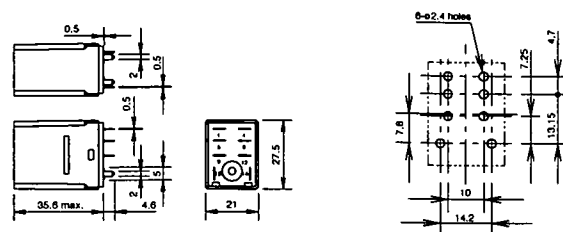

RH3V2-U/RH3V2-UL/RH3V2-D

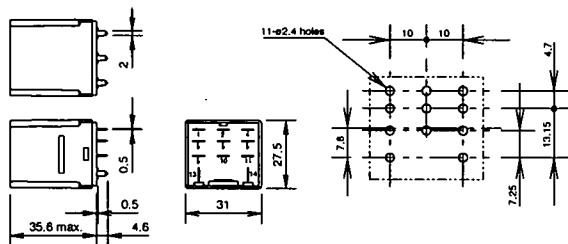

RH4V2-U/RH4V2-UL/RH4V2-UD

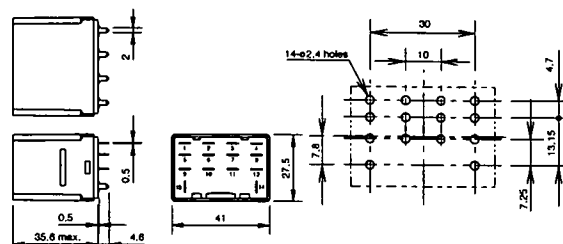

Standard DIN Rail Mount Sockets

SH1B-05

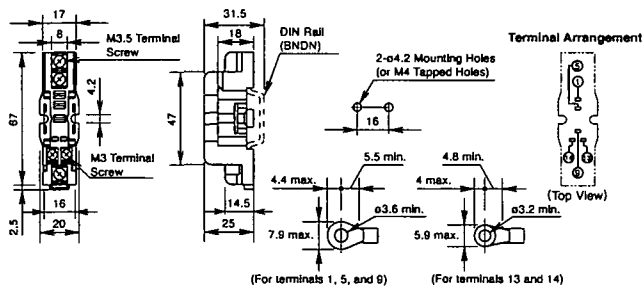

SH2B-05

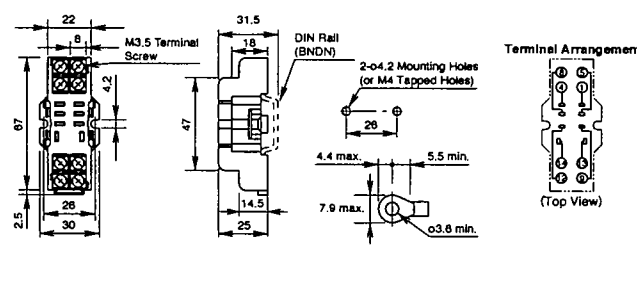

SH3B-05

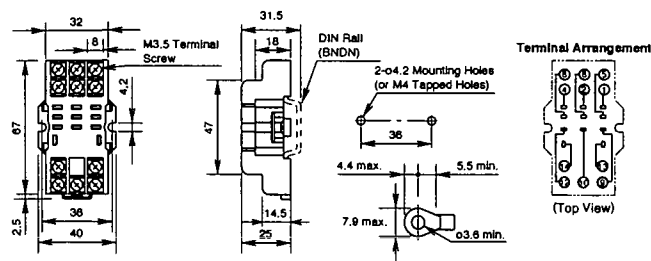

SH4B-05

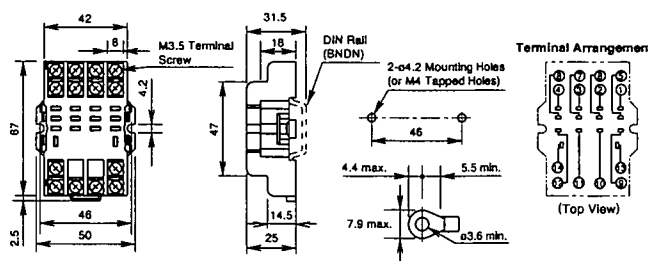

Switches & Pilot Lights

Display Lights

Relays & Sockets

Timers

Terminal Blocks

Circuit Breakers



Dimensions con't (mm)

Finger-safe DIN Rail Mount Sockets

SH1B-05C

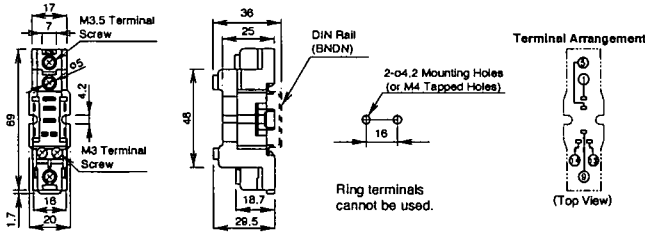

SH2B-05C

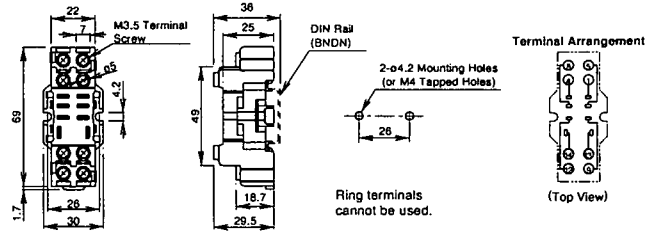

SH3B-05C

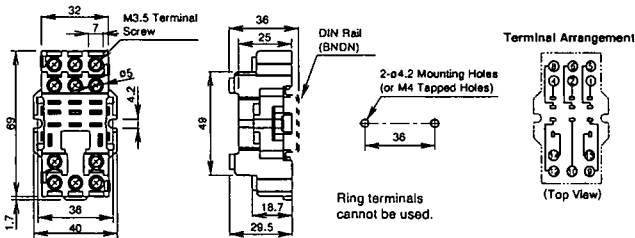

SH4B-05C

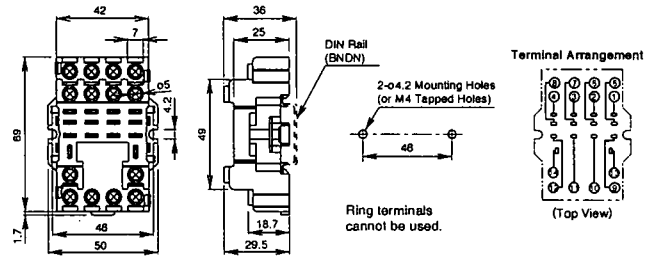

Through Panel Mount Socket

SH1B-51

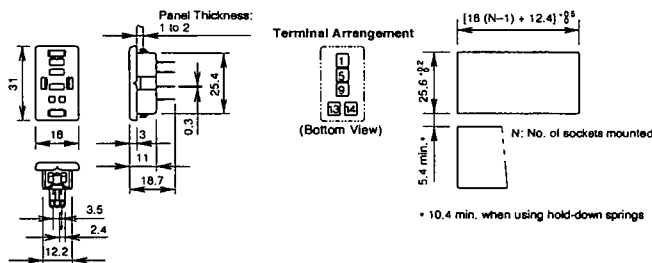

SH2B-51

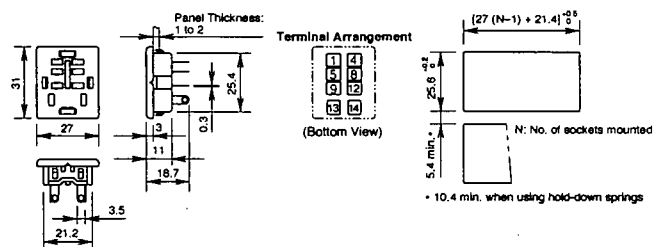

SH3B-51

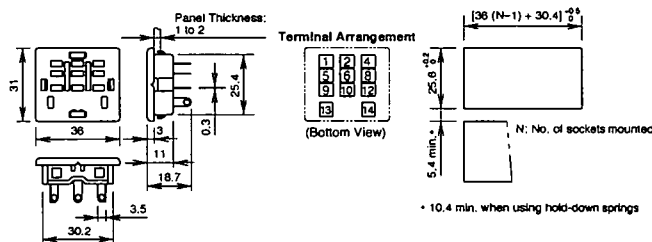

SH4B-51

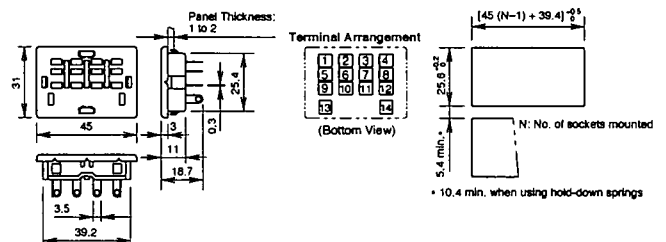

Switches & Pilot Lights

Display Lights

Relays & Sockets

Timers

Terminal Blocks

Circuit Breakers



Relays & Sockets

RH Series



Dimensions con't (mm)

PCB Mount Sockets

SH1B-62

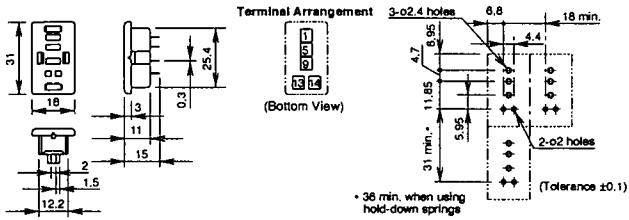

SH2B-62

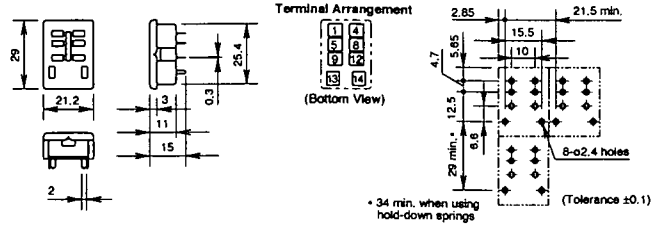

SH3B-62

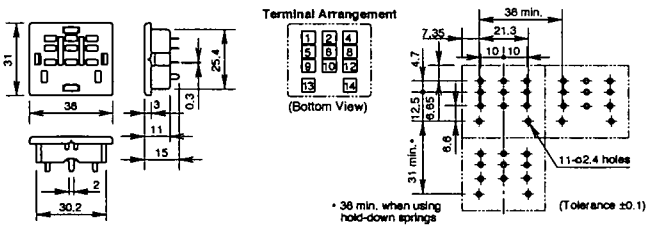

SH4B-62

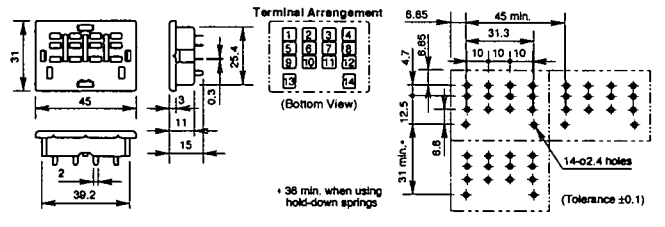

Switches & Pilot Lights

Display Lights

Relays & Sockets

Timers

Terminal Blocks

Circuit Breakers

Operating Instructions

Switches & Pilot Lights

Display Lights

Relays & Sockets

Timers

Terminal Blocks

Circuit Breakers

**Driving Circuit for Relays**

- To ensure correct relay operation, apply rated voltage to the relay coil.
- Input voltage for the DC coil:  
A complete DC voltage is best for the coil power to make sure of stable relay operation. When using a power supply containing a ripple voltage, suppress the ripple factor within 5%. When power is supplied through a rectification circuit, the relay operating characteristics, such as pickup voltage and dropout voltage, depend on the ripple factor. Connect a smoothing capacitor for better operating characteristics as shown below.

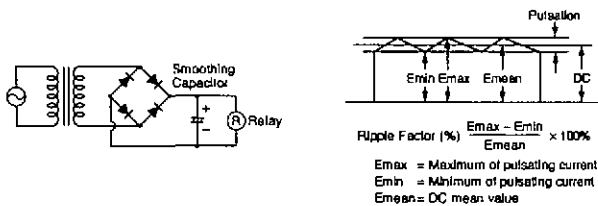

- Leakage current while relay is off:  
When driving an element at the same time as the relay operation, special consideration is needed for the circuit design. As shown in the incorrect circuit below, leakage current (I<sub>0</sub>) flows through the relay coil while the relay is off. Leakage current causes coil release failure or adversely affects the vibration resistance and shock resistance. Design a circuit as shown in the correct example.

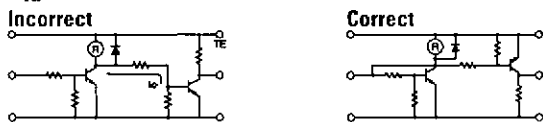

- Surge suppression for transistor driving circuits:  
When the relay coil is turned off, a high-voltage pulse is generated, causing a transistor to deteriorate and sometimes to break. Be sure to connect a diode to suppress the back electromotive force. Then, the coil release time becomes slightly longer. To shorten the coil release time, connect a Zener diode between the collector and emitter of the transistor. Select a Zener diode with a Zener voltage slightly higher than the power voltage.

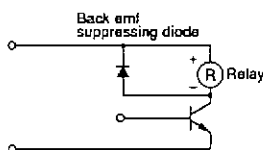

**Protection for Relay Contacts**

- The contact ratings show maximum values. Make sure that these values are not exceeded. When an inrush current flows through the load, the contact may become welded. If this is the case, connect a contact protection circuit, such as a current limiting resistor.
- Contact protection circuit:  
When switching an inductive load, arcing causes carbides to form on the contacts, resulting in increased contact resistance. In consideration of contact reliability, contact life, and noise suppression, use of a surge absorbing circuit is recommended. Note that the release time of the load becomes slightly longer. Check the operation using the actual load. Incorrect use of a contact protection circuit will adversely affect switching characteristics. Four typical examples of contact protection circuits are shown in the following table:

RC		This protection circuit can be used when the load impedance is smaller than the RC impedance in an AC load power circuit. • R: Resistor of approximately the same resistance value as the load • C: 0.1 to 1 μF
		This protection circuit can be used for both AC and DC load power circuits. R: Resistor of approximately the same resistance value as the load C: 0.1 to 1 μF
Diode		This protection circuit can be used for DC load power circuits. Use a diode with the following ratings. Reverse withstand voltage: Power voltage of the load circuit x 10 Forward current: More than the load current
Varistor		This protection circuit can be used for both AC and DC load power circuits. For a best result, when using a power voltage of 24 to 48V AC/DC, connect a varistor across the load. When using a power voltage of 100 to 240V AC/DC, connect a varistor across the contacts.

- Do not use a contact protection circuit as shown below:

	This protection circuit is very effective in arc suppression when opening the contacts. But, the capacitor is charged while the contacts are opened. When the contacts are closed, the capacitor is discharged through the contacts, increasing the possibility of contact welding.
	This protection circuit is very effective in arc suppression when opening the contacts. But, when the contacts are closed, a current flows to charge the capacitor, causing contact welding.

Generally, switching a DC inductive load is more difficult than switching a DC resistive load. Using an appropriate arc suppressor, however, will improve the switching characteristics of a DC inductive load.

**Soldering**

- When soldering the relay terminals, use a soldering iron of 30 to 60W, and quickly complete soldering (within approximately 3 seconds).
- Use a non-corrosive rosin flux.



## Operating Instructions con't

### Other Precautions

#### 1. General notice:

To maintain the initial characteristics, do not drop or shock the relay.

The relay cover cannot be removed from the base during normal operation. To maintain the initial characteristics, do not remove the relay cover.

Use the relay in environments free from condensation, dust, sulfur dioxide (SO<sub>2</sub>), and hydrogen sulfide (H<sub>2</sub>S).

Make sure that the coil voltage does not exceed applicable coil voltage range.

2. UL and CSA ratings may differ from product rated values determined by IDEC.

3. Do not use relays in the vicinity of strong magnetic field, as this may affect relay operation.

### Safety Precautions

- Turn off the power to the relay before starting installation, removal, wiring, maintenance, and inspection of the relays. Failure to turn power off may cause electrical shock or fire hazard.
- Observe specifications and rated values, otherwise electrical shock or fire hazard may be caused.
- Use wires of the proper size to meet voltage and current requirements. Tighten the terminal screws on the relay socket to the proper tightening torque.
- Surge absorbing elements on AC relays with RC or DC relays with diode are provided to absorb the back electromotive force generated by the coil. When the relay is subject to an excessive external surge voltage, the surge absorbing element may be damaged. Add another surge absorbing provision to the relay to prevent damage.

### Precautions for the RU Relays

- Before operating the latching lever of the RU relay, turn off the power to the RU relay. After checking the circuit, return the latching lever to the original position.
- Do not use the latching lever as a switch. The durability of the latching lever is a minimum of 100 operations.
- When using DC loads on 4PDT relays, apply a positive voltage to terminals of neighboring poles and a negative voltage to the other terminals of neighboring poles to prevent the possibility of short circuits.
- DC relays with a diode have a polarity in the coil terminals. Apply the DC voltage to the correct terminals.

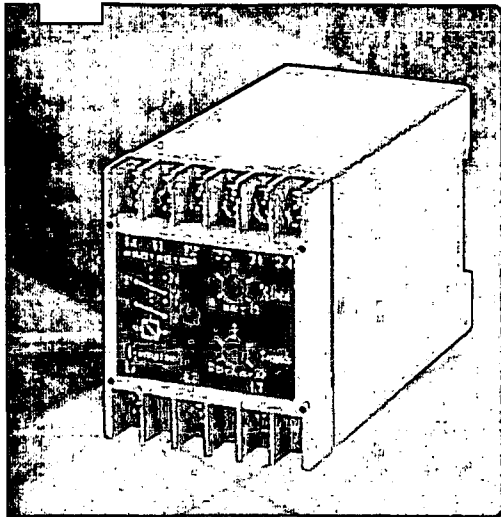

## 250 Series DIN-rail and Wall Mounted Relays

### Phase Balance

The 250 series phase balance protector module provides continuous surveillance of a three-phase, three- or four-wire system and monitors the correct phase rotation or sequence of three-phase supply systems. The module protects against phase loss, reversal or sequence, phase unbalance and system under-voltage.

### Operation

Rotating machines are particularly vulnerable to incorrect phase sequence. Three-phase motors can rotate in the wrong direction, potentially leading to physical damage or the risk of injury to personnel, yet voltage and current readings may appear normal. If one phase is lost because of a blown fuse, electric motors can continue to operate (single-phasing) which can result in severe electrical or mechanical damage. This relay has the added advantage that it will detect the phantom or regenerated phase that can be caused by a single-phase failure on some equipment or when running motors at low load levels.

An unbalanced supply voltage can lead to temperature rises in motors. An unbalanced voltage as little as 10% can increase operating temperature to 150% of normal. For permanent installations, this relay should be used to monitor the incoming supply, protecting all equipment against incorrect connection at initial installation or after maintenance work. Rotating machines that cannot tolerate reverse rotation or pose significant risk to personnel under this condition should be individually protected with this relay. The possibility of incorrect supply connection is much more likely in portable equipment or marine applications.

The protector continuously monitors the three-phase supply. With the correct phase sequence applied and all three voltages balanced within the required limits, the front panel LED will illuminate and the output relay will be energised. An incorrect sequence, missing phase, out of balance or under-voltage condition will de-energise the relay and the LED will be extinguished.

The set point control allows adjustment of the voltage matching between 5% and 15%. The time delay function operates only for the voltage unbalance condition. The delay can be used to prevent nuisance tripping due to short term unbalance situations. Incorrect phase rotation, a missing phase or an under-voltage condition trip the relay immediately.

### Features

- Three-phase, three or four-wire
- Adjustable set point
- Adjustable time delay
- Internal differential
- LED trip indication
- Double-pole relay contacts
- Automatic reset

### Benefits

- Monitoring of correct phase rotation
- Protects against phantom or regenerated phase voltage
- Protection against phase loss, reversal or sequence
- Under-voltage and unbalanced voltage monitoring
- Prevents reverse rotation of motor driven equipment
- Ensures correct engine rotation
- Protects portable electrical equipment
- Nuisance tripping avoidance

### Applications

- Marine panels
- Switchgear
- Distribution systems
- Generator sets
- Control panels
- Process control
- Motor protection
- Transformers
- Overload protection

### Product Codes

Relay	Protection	ANSI no.	Cat. no.
3-phase 3- or 4-wire	Phase loss and unbalance 5-15%	47	252-PSF
3-phase 3- or 4-wire	Phase loss, unbalance and under-voltage 5-15%	47/27	252-PSG

Please specify system voltage, frequency and required options at time of ordering.

**Specification - Phase Balance**

Nominal voltage	110V, 120V, 208V, 220V, 230V, 240V, 277V, 380V, 400V, 415V, 440V or 480V
System frequency	50 or 60Hz
Voltage burden	3VA approx.
Overload	1.2 x rating continuously, 1.5 x rating for 10 x seconds
Set point repeatability	>0.5% of full span
Under-voltage set point	Pre-set at 15% of nominal voltage. Other values 10 to 30% to order (model 252-PSG only)
Trip level adjustment	Phase unbalance adjustable 5 to 15%
Time delay	10 seconds as standard. Up to 30 seconds available
Auxiliary voltage burden	4VA (max)
Output relay	2-pole change over
Relay contact rating	AC: 240V 5A, non inductive DC: 24V 5A resistive
Relay mechanical life	0.2 million operations at rated loads
Relay reset	Automatic
Operating temperature	0°C to +60°C (0°C to +40°C for UL models)
Storage temperature	-20°C to +70°C
Temperature co-efficient	0.05% per °C
Interference immunity	Electrical stress surge withstand and non-function to ANSI/IEEE C37 90a
Enclosure style	DIN-rail with wall mounting facility
Material	Flame retardant polycarbonate/ABS
Enclosure integrity	IP50
Model 252 dimensions	55mm (2.2") wide x 70mm (2.8") high x 112mm (4.4") deep
Weight	0.4Kg approx.

**Connections**

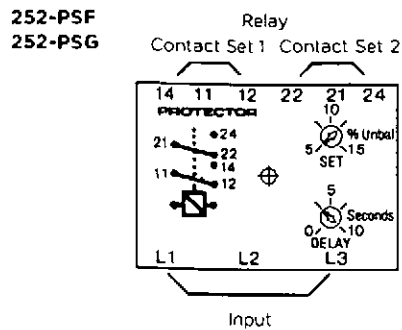

**Note:** Neutral connection not required.

**Dimensions**

**Model 252**

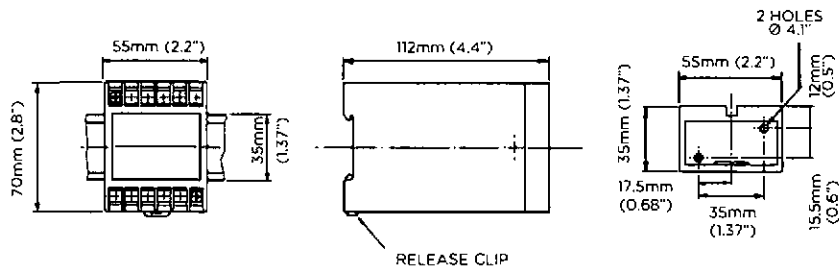







**Halmac** Services (Qld) Pty. Ltd.  
A.C.N. 098 852 923  
A.B.N. 40 741 712 113

# CHASSIS

---

## 1. CD-2 CHASSIS TECHNICAL DETAILS





## Panelboards, loadcentres and accessories

2

### CONCEPT•PLUS and Premier busbar chassis – Din-T

- Standards AS/NZS 3439
- Current rating 250 A
- Withstand rating 250 A/20 kA for 0.2 sec
- Splayed busbar to suit 160 A & 250 A switch
- Top and bottom feed – splayed top & bottom
- Tee-offs stripped and 50% capped
- Top power feed stripped and capped
- Full 35 mm DIN rail, improved MCB mounting security
- Improved insulation coating

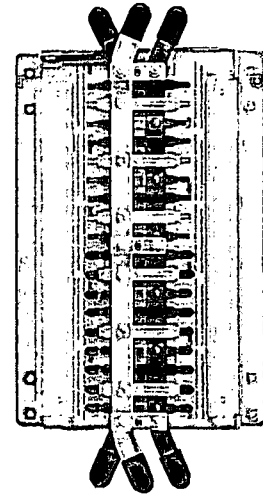

3 pole CD chassis to suit Din-T MCBs

Concept Din-T – 250 to suit Din-T MCBs (18 mm pole pitch)<sup>3)</sup>

Pole capacity	250 A Cat. No. <sup>1)</sup>
12	CD-2-12/18-3U
18	CD-2-18/18-3U
24	CD-2-24/18-3U
30	CD-2-30/18-3U
36	CD-2-36/18-3U
42	CD-2-42/18-3U
48	CD-2-48/18-3U
54	CD-2-54/18-3U
60	CD-2-60/18-3U
72	CD-2-72/18-3U
78	CD-2-78/18-3U
84	CD-2-84/18-3U
96	CD-2-96/18-3U

- Notes: <sup>1)</sup> 4 pole and other special configurations available to special order refer NHP.  
<sup>2)</sup> 'OFF' (line) side of MCB connects to chassis tee-off.  
 MCB DIN clips may be disengaged or removed when mounting onto "CD" chassis.  
 If applicable use insulated tool provided to disengage DIN clip when removing MCB from chassis.  
<sup>3)</sup> Not suitable for CONCEPT economy Panelboards. Contact NHP for availability.  
 Available on indent only.

#### Accessories

Description	Cat. No.
Split tariff kit 250/355 A (supplied loose)	STKCD
Split tariff kit (fitted)	REFER NHP
Plastic tee-off cap 250 / 355 A	CD250TOPC

#### Technical data – CD/CT busbar chassis

Description	CD-250 A
Busbar rating (Amp)	250
Voltage rating (V)	415
Short circuit rating (kA)	20
Short circuit time (sec)	0.2
Insulation material	Polyolefin PPA-441

#### Catalogue number structure – CD/CT busbar chassis

XX	X	XX	XX	X
Type	Current rating	No. of ways	Pole pitch (mm)	No. of phases
CD Din-T	2 250 A	12	18 Din-T	2 1 P + N (red, black)
CDH Din-T10H	3 355 A	18	27 Din-T10H	3 3 P (red, white, blue)
CT Safe-T	Etc.	24	27/18 Hybrid	4 3 P + N (red, white, blue, black)
		30	Din-T10H/Din-T	
		36 etc.	25 Safe-T	
		27 mm/18 mm		
		6/24		
		12/60		





## Panelboards, loadcentres and accessories

### Dimensions (mm)

2

CD chassis 250 to suit Din-T6, 10 and 15

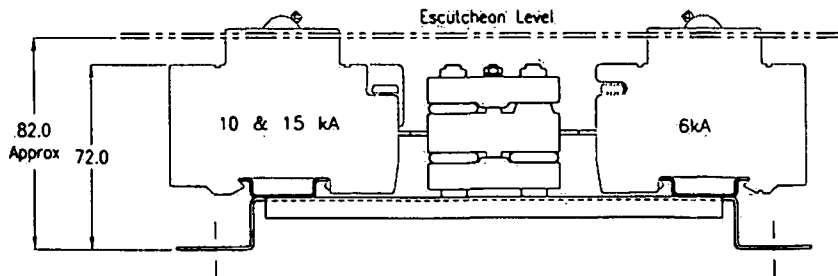
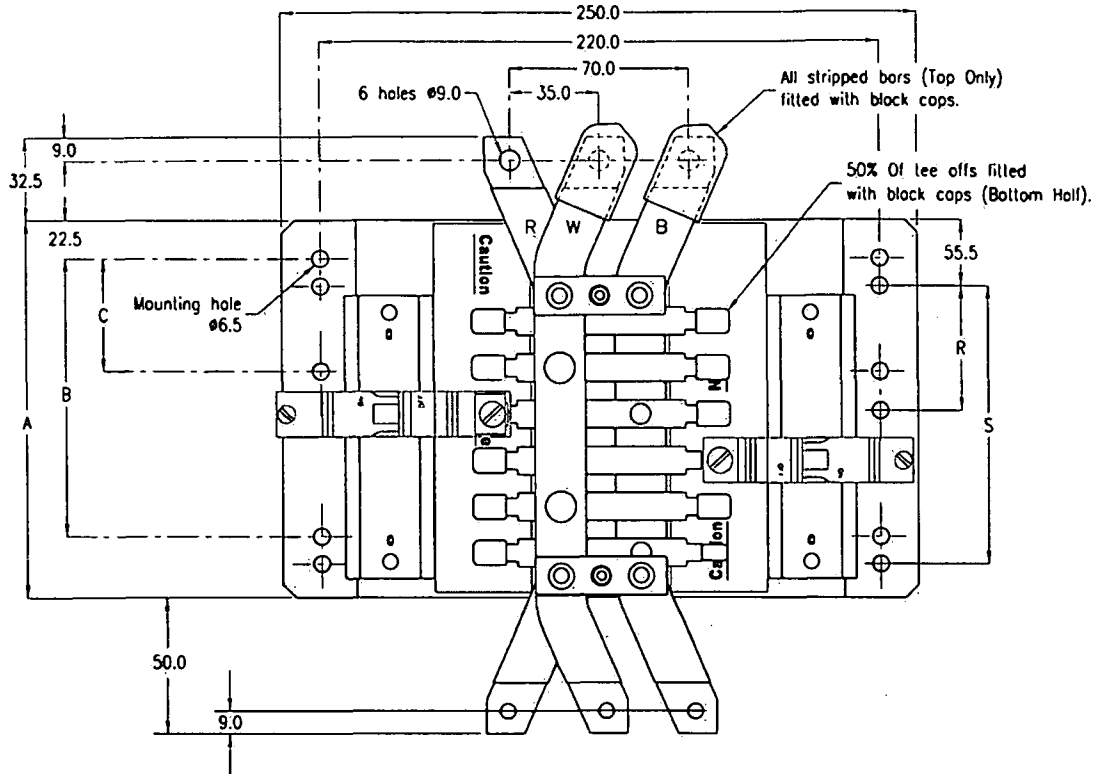

Escutcheon cut-out details

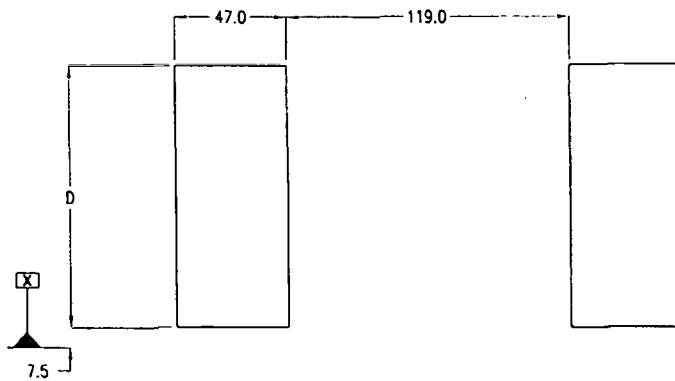

Dimensions (mm)

Chassis size <sup>1)</sup>	A	B	C	D	R	S
CD-X-12/18-3U	152	100	-	110	-	100
CD-X-18/18-3U	206	100	-	164	-	100
CD-X-24/18-3U	260	100	-	218	-	100
CD-X-30/18-3U	314	200	-	272	-	200
CD-X-36/18-3U	368	300	-	326	-	300
CD-X-42/18-3U	422	300	-	280	-	300
CD-X-48/18-3U	476	400	-	434	-	400
CD-X-54/18-3U	530	400	-	488	-	400
CD-X-60/18-3U	584	500	-	542	-	500
CD-X-72/18-3U	692	600	-	650	-	600
CD-X-78/18-3U	745	700	300	704	300	700
CD-X-84/18-3U	800	700	300	758	300	700
CD-X-96/18-3U	908	800	400	866	400	800

**Notes:** <sup>1)</sup> "X" insert 2 = 250 A or 3 = 355 A, current rating does not effect above dims.  
 Maximum current rating of tee-off = 100 A.  
 'OFF' (line) side of MCB connects to chassis tee-off.  
 MCB DIN clips may be disengaged or removed when mounting onto "CD" chassis.  
 Use insulated tool provided to disengage DIN clip when removing MCB from chassis.







**Halmac** Services (Qld) Pty. Ltd.  
A.C.N. 098 852 923  
A.B.N. 40 741 712 113

# FUSE & FUSE HOLDER

1. FUSE LINKS & FUSE HOLDER TECHNICAL DETAILS

**NHP** COMPACT FUSES

# BS fuse holders



Refer Catalogue NF

## Compact fuse holders (Bolt-in)

- New compact size
- Front (FW) or stud/front (SFW) versions
- Smaller dimensions
- Saves panel space

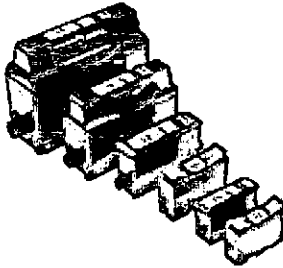

**UP TO 30% SMALLER**

	Dimensions (mm)			Suggested Max. cable size
	H	W	D	
<b>NC32_</b>	87	27	50	10 mm <sup>2</sup>
<b>NC63_</b>	109	31	62	25 mm <sup>2</sup>
<b>NC100_</b>	118	35	72	50 mm <sup>2</sup>
<b>NC200_</b>	154	54	108	95 mm <sup>2</sup>

Rating (A)	Fuse link to suit		Cat. No.
Front wired – bolt in			
32		NNIT	<b>NC32FW</b>
63		NTIA NTIS	<b>NC63FW</b>
100	NOS	NTIA NTIS	<b>NC100FW</b>
200		NTIA ') NTIS ') NTFP NOS ') NTCP	<b>NC200FW</b>

Back stud/front wired – bolt in			
32		NNIT	<b>NC32SFW</b>
63		NTIA NTIS	<b>NC63SFW</b>
100	NOS	NTIA NTIS	<b>NC100SFW</b>
200		NTIA ') NTIS ') NTFP NOS ') NTCP	<b>NC200SFW</b>

Note: ') Fuses can be fitted using adaptor 100M FLK.

## Standard fuse holders (Bolt-in)

- Ratings from 20 to 200 A
- Front (FW) or stud/front (SFW) versions
- Complies with BS88



N20FW

	Dimensions (mm)			Suggested Max. cable size
	H	W	D	
<b>N20_</b>	87	27	50	10 mm <sup>2</sup>
<b>N32_</b>	109	31	62	10 mm <sup>2</sup>
<b>N63_</b>	118	35	72	50 mm <sup>2</sup>
<b>N100_</b>	154	54	108	70 mm <sup>2</sup>
<b>N200_</b>	193	70	149	150 mm <sup>2</sup>

Rating (A)	Fuse link to suit		Cat. No.
Front wired – bolt in			
20		NNIT	<b>N20FW</b>
32		NTIA	<b>N32FW</b>
63		NTIA NTIS	<b>N63FW</b>
100		NTIA ') NTIS ') NOS ') NTCP	<b>N100FW</b>
200		NTBC NTC NTF	<b>N200FW</b>

Back stud/front wired – bolt in			
20		NNIT	<b>N20SFW</b>
32		NTIA	<b>N32SFW</b>
63		NTIA NTIS	<b>N63SFW</b>
100		NTIA ') NTIS ') NOS ') NTCP	<b>N100SFW</b>
200		NTBC NTC NTF	<b>N200SFW</b>

## Clip-in fuse holders - DIN rail mount

Fast, reliable fitting and removal of fuse links



NV20FW

NV32FW

NV63FW

Rating (A)	Fuse link to suit		Cat. No.
Front wired – clip-in – Black			
20		NSS	<b>NV20FW</b>
32		NSS	<b>NV32FW</b>
63		NES	<b>NV63FW</b>
Front wired – Clip-in – White			
32		NNS	<b>NV32FWW</b>
63		NES	<b>NV63FWW</b>

**NHP** COMPACT FUSES

# BS compact fuse links

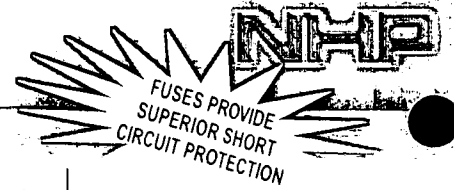

NTF 200



NTKM 250



NTM 400



NTLT 710



NTXU 1250

Rating (A)	BS 88 Ref.	Fixing centres (mm)	Cat. No.
<b>Bolted pattern centre tags (cont.)</b>			
80	B1	111	NTC 80
100			NTC 100
100M125			NTC 100M125
100M160			NTC 100M160
100M 200			NTC 100M200
125	B2	111	NTF 125
160			NTF 160
200			NTF 200
200M 250			NTF 200M250
200M 315			NTF 200M315
250	B3	111	NTKF 250
315			NTKF 315
315M 400			NTKF 315M400
250	B4	133	NTKM 250
315			NTKM 315
355		111	NTMF 355
400			NTMF 400
355	C1	133/184	NTM 355
400			NTM 400
450	C2	133/184	NTTM 450
500			NTTM 500
560			NTTM 560
630			NTTM 630
450	C3	133/184	NTT 450
500			NTT 500
560			NTT 560
630	165/229	165/229	NTT 630
710			NTLM 710
800			NTLM 800
710	165/229	165/229	NTLT 710
800			NTLT 800
1000	D1	149	NTXU 1000
1250			NTXU 1250



# BS compact fuse links

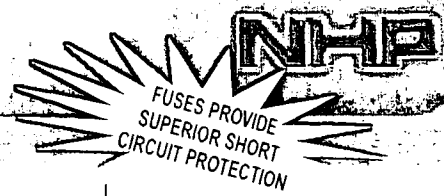

Refer Catalogue NF

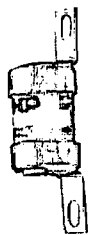

NOS100M125



NTFP100

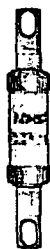

NTB 16



NTBC 16

Rating (A)	BS 88 Ref	Fixing centres (mm)	Cat. No.
<b>Bolted pattern offset tags (cont.)</b>			
35	A3	73	NTIS 35
40			NTIS 40
50			NTIS 50
63			NTIS 63
63M80			NTIS 63M80
63M100			NTIS 63M100
80	HYBRID A3	73	NOS 80
100			NOS 100
100M125			NOS 100M125
100M160			NOS 100M160
80	A4	94	NTCP 80
100			NTCP 100
100M125			NTCP 100M125
100M160			NTCP 100M160
125	HYBRID A4	94	NTFP 125
160			NTFP 160
200			NTFP 200
200M250			NTFP 200M250

Note: <sup>1)</sup> Fuses can be fitted using adaptor 100MFLK.

**Bolted pattern centre tags**

2	-	97	NTB 2
4			NTB 4
6			NTB 6
10			NTB 10
16			NTB 16
20			NTB 20
25			NTB 25
32			NTB 32
40			NTB 40
50			NTB 50
63			NTB 63
63M80			NTB 63M80
63M100			NTB 63M100
2			B1
4	NTBC 4		
6	NTBC 6		
10	NTBC 10		
16	NTBC 16		
20	NTBC 20		
25	NTBC 25		
32	NTBC 32		
40	NTBC 40		
50	NTBC 50		
63	NTBC 63		
63M80	NTBC 63M80		
63M100	NTBC 63M100		



Refer Catalogue NF

This chart is designed to help choose the correct fuse to fit a particular Strömberg switch fuse (or vice versa) and to help choose the correct replacement fuse. Some data is from other manufacturers publications and as such cannot be guaranteed by NHP. Beware that some motor start fuses are in a larger body size than a normal fuse. It is wise to consult the fuse manufacturers data to determine their particular fuse sizes (ie. A2-C3).

## Fuse manufacturers part numbers - Australian/British standard

BS Ref.	Amps	NHP COMPACT FUSES	MEM	Holec	Alstrom GEC	Bussmann	PDL	Siemens
F1	2...32	NNS	SN2	NS	NS	F06	N20C	3NW NS
F2	20...63	NES	SP	MES	ES	ESD	N63	3NW ES
A1	2...32	NNIT	SA	NIT	NIT	F21	N20B	3NW NIT
A2	2...32	NTIA	SB3	TIA	TIA	H07	N32B	3NW TIA
A3	35...63	NTIS	SB4	TIS	TIS	K07	N63	3NW TIS
Hybrid (A3)	80...100	NOS	SO	-	OS	K07R	NOSD	3NW OS
A4	80...100	NTCP	SD5	TCP	TCP	L14	N100	3NW TCP
Hybrid (A4)	125...200	NTFP <sup>1)</sup>	SD6	TFP	TFP	M14	N200B	3NW TFP
-	2...32	NTB	SE3	TB	TB	K08	-	3NW TB
B1	2...32	NTBC	SF3	TBC	TBC	K09	-	3NW TBC
-	40...63	NTB	SE4	TB	TB	K08	N_TB	3NW TB
B1	40...63	NTBC	SF4	TBC	TBC	K09	N63B	3NW TBC
B1	80...100	NTC	SF5	TC	TC	L09	N100B	3NW TC
B2	125...200	NTF	SF6	TF	TF	M09	N200B	3NW TF
B3	250...315	NTKF	SF7	TKF	TKF	P09	N315B	3NW TKF
-	250...315	NTKM	SG7	TKM	TKM	N11	N315B	3NW TKM
B4	355...400	NTMF	SF8	TMF	TMF	P09	N400B	3NW TMF
C1	355...400	NTM	SH8	TM	TM	P11	N404B	3NW TM
C2	450...630	NTTM	SH9	TTM	TTM	R11	N504B	3NW TTM
-	450...630	NTT	SY9	TT	TT	R12	N630B	3NW TT
C3	710...800	NTLM	SH10	TLM	TLM	S11	N804B	3NW TLM
-	710...800	NTLT	SY10	TLT	TLT	800S	B804B	3NW TLT
D1	1000...1250	NTXU	SJ11	TXU	TXU	U44	-	3NW TXU
<b>Din pattern</b>								
00	6...160	N00	NH00	-	NHG-00	-	-	3NA5
1	25...250	N1	NH01	-	NHG-1	-	-	3NA4 144
2	80...400	N2	NH02	-	NHG-2	-	-	3NA4 260
3	315...630	N3	NH03	-	NHG-3	-	-	3NA1
<b>Fuse holders</b>								
Clip in	20A	NV20FW	V20FF	-	SC20H	-	FC20FW	-
	32A	NV32FW	V32FF	-	SC32H	-	NC32FW	3NW 32NNSF
Front wired	20A	N20FW	20MFB	-	RS20H	-	FB20FW	3NWC20FC
	32A	N32FW	32MFB	200846	RS32H	-	FB32FW	3NW CM32F
	63A	N63FW	63MFB	LCF63FCFC	RS63H	-	FB63FW	3NW CM63F
	100A	N100FW	100MFB	-	RS100H	-	FB100FW	3NW CM100F
	200A	N200FW	200MFB	-	RS200H	-	FB200FW	3NW 200DF
Stud/ front wired	20A	N20SFW	20MFD	-	RS20PH	-	FB20SF	-
	32A	N32SFW	32MFD	LCF32FCBC	RS32PH	-	FB32SF	-
	63A	N63SFW	63MFD	LCF63FCBC	RS63PH	-	FB63SF	-
	100A	N100SFW	100MFD	-	RS100PH	-	FB100SF	-
	200A	N200SFW	200MFD	-	RS200PH	-	FB200SF	-

**Note:** <sup>1)</sup> This hybrid type fuse is actually an A4 size fuse, but as it is over 100 amps it cannot be called an A4 fuse to AS 2005.

**NHP** COMPACT FUSES**BS compact fuse links**  
**Bolted pattern - Centre tag****NHP****Motor rated fuse links**

BS88 aligns with the international fuse specification IEC 269. Special motor rated fuse links are listed and are available in various barrel sizes, in each case fitted with special fuse elements. Their selection frequently permits the use of lower rated switch and/or fusegear than would be the case if using Class gG fuse links. This range of fuse-links has been ASTA certified for a breaking capacity of 80 kA at 415 V AC.

NHP Compact industrial bolted pattern fuse links conform with BS88: Part 2: 1998 and have been ASTA certified for a breaking capacity of 80 kA at 415 V AC or 550 V AC and have utilisation categories gG.

NHP Compact fuse-links are suitable for back-up protection in motor circuits, having excellent time delay characteristics with low fusing factor and high rupturing capacity.

Fuses for use in motor circuits should be selected in accordance with the requirements for the protection of motor control gear as specified by the control gear manufacturer.

As a guide, the following table shows the minimum fuse sizes that may be associated with motors based on the assumption that the starting conditions for typical 3 phase 4 pole 415 V motors are; 8 x F.L.C. for 6 secs [D.O.L] and 4 x F.L.C. for 12 secs [Star Delta].

**Fuse link selection for motor circuit protection**

kW	Motor rating		Approx. F.L.C. (A)	D.O.L. starting fuse link (A)	Motor rated fuse-link (A)	Start assisted Standard fuse link (A)
	hp					
0.19	0.25		0.7	4		2
0.37	0.5		1.3	6		4
0.55	0.75		1.6	6		4
0.75	1.0		1.8	10		4
1.1	1.5		2.6	10		6
1.5	2.0		3.4	10		10
2.2	3.0		5.0	16		10
3.0	4.0		6.5	16		10
4.0	5.5		8.0	20	20M25	16
5.5	7.5		11.0	25	20M32	16
7.5	10		15	40	32M40	25
11.0	15		22	50	32M50	32
15.0	20		28	63	32M63	40
18.5	25		36	80	63M80	50
22	30		39	80	63M80	63
30	40		52	100	63M100	63
37	50		69	160	100M160	80
45	60		79	160	100M160	100
55	75		96	200		160
75	100		125	200	200M250	160
90	125		156	250	200M250	160
110	150		189	315		200
132	175		224	355		250
150	200		255	355		250
160	220		275	400		315
185	250		318	450		315
200	270		339	500		355
220	300		374	560		400
257	350		450	630		450
295	400		500	710		500
315	430		535	710		560
355	483		580	800		630
400	545		646	800		710
450	612		725	1000		800



# BS fuse link selection chart



Strömberg switch fuses, NHP fuse holders & SlimLine fuse cassettes

SlimLine cassettes			Strömberg PowerLine switch fuses											Fuse type Cat. No. Prefix	
SFM_BS			OESA						OS						
400	250	100	800	630	400	315	250	200	160	100	63	32	32 mini		
													✓	NNS_	
														✓	NES_
														✓	NNIT_
		✓							✓	✓	✓	✓		NTIA_	
		✓							✓	✓	✓	✓		NTIS_	
		✓												NOS_	
									✓					NTCP_	
									✓					NTFP_	
✓	✓					✓	✓	✓	✓					NTB_	
✓	✓					✓	✓	✓	✓					NTBC_	
✓	✓					✓	✓	✓	✓					NTC_	
✓	✓					✓	✓	✓	✓					NTF_	
														NTKM_	
✓						✓								NTMF_	
			✓	✓										NTM_	
			✓	✓										NTTM_	
														NTT_	
			✓											NTLM_	

NHP HRC fuse holders												Fuse type Cat. No. Prefix	
NC (Compact - Bolt-in)				N (Bolt-in)					NV (Clip-in)				
200	100	63	32	200	100	63	32	20	63	32	20		
										✓	✓		NNS_
									✓				NES_
			✓					✓					NNIT_
✓ A	✓	✓			✓ A	✓	✓						NTIA_
✓ A	✓	✓			✓ A	✓							NTIS_
✓ A	✓				✓ A								NOS_
✓					✓								NTCP_
✓													NTFP_
													NTB_
				✓									NTBC_
				✓									NTC_
				✓									NTF_

Legend: ✓ Fuse links fit direct.  
 ✓ A Fuses require 100MFLK adaptor.

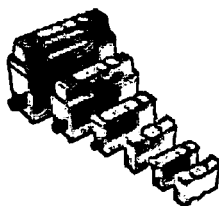

N - series  
(Standard fuse holders)



N20FW



NV32FW  
(Clip-in)

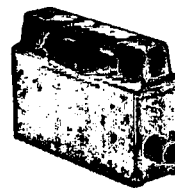

NC100FW

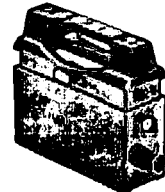

NC200FW

(New compact fuse holders)







**Halmac** Services (Qld) Pty. Ltd.  
A.C.N. 098 852 923  
A.B.N. 40 741 712 113

## GSM MODEM

1. **FASTRACK SUPREME GSM MODEM  
TECHNICAL DETAILS**
2. **FASTRACK SUPREME GSM MODEM USER  
GUIDE**

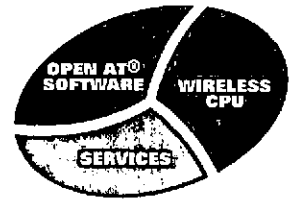

**Fastrack Supreme**

**GSM/GPRS/EDGE  
with unlimited expandability**

Fastrack Supreme is a versatile Plug & Play Wireless CPU\* that will carry your applications well into the future. It has been designed to accommodate any additional features you can imagine, thanks to a revolutionary, open standard Internal Expansion Socket which you can populate with an expansion card from Wavecom – or one of your own.

**SECURE CELLULAR INTERNET**

Prevent hacker attacks by using our Security software Plug-In to connect your sales terminal, meter, vehicle, asset tracking or monitoring product via GSM, GPRS or high speed EDGE to the cellular Internet highway.

**POWERFUL CORE  
APPLICATION PROCESSING**

Every Fastrack Supreme features a Wavecom Q26-family Wireless CPU\*: a powerful central processing unit with an ARM9 32 bit, 26-104MHz core, programmable via any combination of AT commands, C and Lua.

**FASTRACK = YOUR PRODUCT**

By designing your product value as an expansion card you save time and money in cellular learning curve, certification, mechanical design and time to market. Fastrack can now become *your* product.

**UNHEARD-OF EXPANDABILITY**

Add additional IO connectivity or features like GPS, WiFi, Bluetooth, Zigbee and more. The open interface means you can develop your own expansion modules for your specific needs.

**INTELLIGENT DEVICE SERVICES**

Our Intelligent Device Services enable you to remotely monitor and securely upgrade the software of your product, in order to reduce post-deployment field maintenance costs.

**PROFESSIONAL SERVICES**

Accelerate your product design and ensure you capitalize on market opportunities!

**wavecom**<sup>®</sup>  
*Smart wireless. Smart business.*

Operating Systems | Plug-Ins | Integrated Development Environments | Wireless CPUs | Services

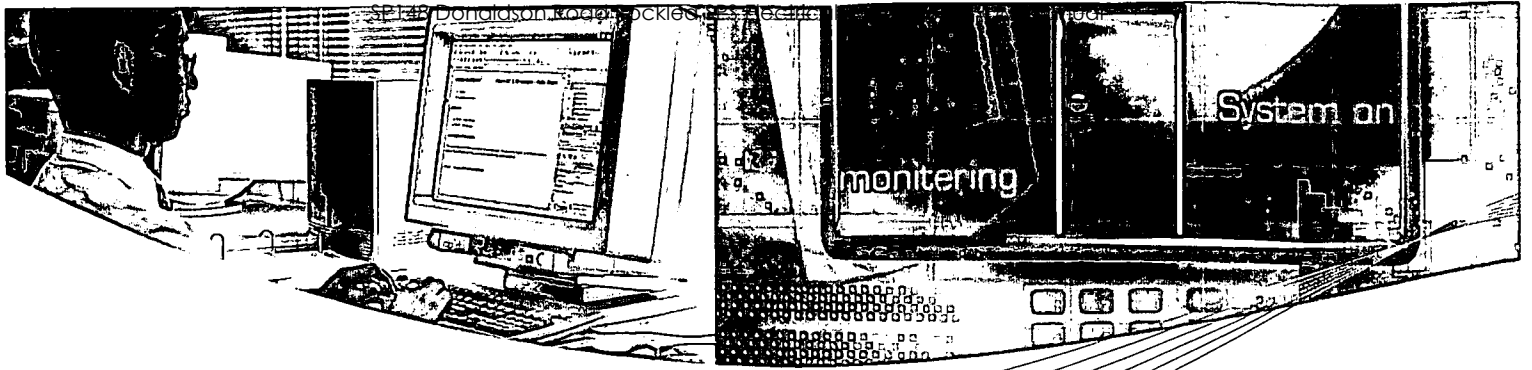

## Fastrack Supreme

# Plug and play with unlimited expandability

Evolve to the latest cellular technology and add functionality without sacrificing the form factor you have come to rely on. The Fastrack Supreme is the same size, has the same interfaces and is completely backward compatible with previous Fastrack products, and is packed with a host of new features.

Wavecom has developed an exciting new, open-standard Internal Expansion Socket (IESM) interface for you to add additional IO connectivity or features like GPS, WiFi, Bluetooth, Zigbee and more. The open interface means you can develop your own expansion modules and customize the product for your specific requirements, or you can look to Wavecom for new expansion modules designed to address your most-pressing needs.

## Features

	Wireless CPU		IESM			
	FASTRACK Supreme 10	FASTRACK Supreme 20	IESM GPS+USB	IESM IO+USB	IESM IO+USB+GPS	IESM Ethernet
Core CPU	ARM9, 32 bit with cache	ARM9, 32 bit with cache				MAC ethernet
Open AT <sup>®</sup> Software Suite	FW6.63/OS4.20	FW6.63/OS4.20				
VariSpeed	26/104MHz	26/104MHz				
MIPS	87 max.	87 max.				
DOTA	Type I & II	Type I & II				
External Interruption	<1ms	<1ms				
RTC Interruption	<1ms	<1ms				
GPIO	2	2		3+2	2	
Analogue Audio	2	2				
ADC/DAC/SPI/I2C				1/1/1/1	1/1/1/1	
RS232	1	1		1		
USB			1	1	1	1
SIM/RUIM	3V/1.8V SIM	3V/1.8V SIM				
Voltage/VDC (nom)	5.5 to 32	5.5 to 32	4		4	4
Current/A (max)	0.48 @ 5.5V	0.48 @ 5.5V	0.12 @ 5.5V		0.12 @ 5.5V	
MMCx			•		•	
SMA	•	•				
RJ45						•
Size/mm	73x54.5x25.5	73x54.5x25.5	58x35.7x10.01	58x35.7x10.01	58x35.7x10.01	58x35.7x10.01
Weight/g	89	89	<10	<10	<10	<10
SIM holder	•	•				
Operating t° range	-30°C+75°C	-30°C+75°C	-30°C+65°C	-30°C+65°C	-30°C+65°C	-30°C+65°C
GSM	•	•				
GPRS class	10	10				
EDGE class		10				
850/900/1800/1900	•	•				
Max Sensitivity (dBm)	-109 @ 900	-109 @ 900				
Codecs	FR/EFR/HR	FR/EFR/HR				
RIL	•	•				
TCP/IP & Internet	Plug-In	Plug-In				
Ethernet						Companion
Bluetooth	Plug-In	Plug-In				
Security	Plug-In	Plug-In				
GPS	Plug-In	Plug-In	Companion		Companion	





## Open AT® Software Suite 2.0

# Industrial software for industrial design demands

The Open AT® Software Suite allows you to develop, compile, test, debug, download and natively execute your applications written in standard ANSI C directly on the Fastrack Supreme, or indeed any other Wavecom Wireless CPU®. It is royalty free and comprises operating system, compiler and integrated development environments. There are no hidden costs - maintenance and qualification are provided for free by Wavecom.

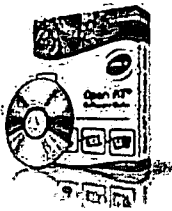

- Multitasked Pre-Emptive Event-Based Real-Time Operating System
- Integrated Development Environment built on Eclipse™
- Extensive Set of Plug-Ins (Internet Suite, C-GPS and more)
- GSM Release 99 compliant modem firmware
- Secure Intelligent Device Services (IDS) compatible

### REAL TIME OPERATING SYSTEM

#### Real-Time

Guaranteed response time to interruption (even during GSM/GPRS/EDGE activities, calls and transfer).

#### Wireless CPU® Resources Direct Access and IT Management

- Hardware and Software Timers
- DSP
- SPI
- ADC
- External Interrupt Pins
- GPIOs
- UARTS (coming in 2008)

#### Multitasking

#### Auto shut-down feature

Feature improving the overall consumption of the application by deactivating the RS232 interface.

#### Application dedicated Hardware Watchdog

- application dedicated for close monitoring
- tunable depending on the complexity of the processing (ex: Pulse count Vs RSA signature calculation...)

### CROSS-PLATFORM INTEGRATED DEVELOPMENT ENVIRONMENT

For eased application debug it can be performed on PC: for very fast and convenient application debugging through Remote Task Environment.

#### On target for final Integration and time-critical behavior management:

- Live through Traces
- Post mortem through BackTraces

#### On field:

- for difficult error causing operating scenarios through IDS device monitoring services and BackTraces over the air retrieval.

### SEAMLESSLY PLUG-IN ADDITIONAL FEATURES

Plug-Ins are an optional range of software feature packages that are selected when your order your Wireless CPU®. The standard range provides access to Internet clients & protocols, controller-less companion wireless peripherals such as Bluetooth & GPS. Of course, the powerful flexibility of Open AT® Software Suite means that you can also develop your own Plug-Ins and own custom AT commands.



Lua  
Easy Scripting



Internet  
Clients & Protocols



C-GPS  
Companion



C-Bluetooth™  
Companion



aqLink®  
in-band modem

### WAVECOM BSP-BASED EMBEDDED SOFTWARE ARCHITECTURE



## Wavecom Services

The wireless products you are developing are most probably very complex, and they will stay in the field for many years. With this in mind, Wavecom has created a range of professional and operated services to make the development process easier and to help you protect your investment, enrich your products and services, and reduce the lifetime cost of your device network.

## Professional services: Less pain, more gain

Wavecom Professional Services help you be faster, sleeker and more adaptable to the ever changing needs of your market, all along the typical product lifecycle timeline:

<p><b>WAVECOM UNIVERSITY</b></p> <ul style="list-style-type: none"> <li>→ Open AT® Developer course</li> <li>→ Open AT® Expert course</li> </ul>	<p><b>PRODUCT BUILD</b></p> <ul style="list-style-type: none"> <li>→ IMEI implementation</li> <li>→ Tailored Delivery (Express &amp; Fast)</li> <li>→ Tailored Product Configuration</li> </ul>
<p><b>PRODUCT DESIGN</b></p> <ul style="list-style-type: none"> <li>→ Customer Design Review</li> <li>→ Customer Product Certification</li> <li>→ Open AT® Application Code Review</li> </ul>	<p><b>AFTER SALES</b></p> <ul style="list-style-type: none"> <li>→ Reconfiguration for Wireless CPU®</li> <li>→ Out Of Warranty repair for Wireless CPU®</li> <li>→ Repair Equipment Wireless CPU®</li> </ul>

## Intelligent Device Services: Investment protection

Wavecom has created the world's first cellular operated service portfolio to benefit from easy to use end-to-end Intelligent Device Services that enable to remotely monitor and securely upgrade the application software of your product in addition to the entire Wavecom embedded Open AT® Software:

<p><b>WIRELESS DEVICE MANAGEMENT</b></p> <ul style="list-style-type: none"> <li>→ Simplify your device installation and protect your wireless investment while reducing your field service costs</li> </ul>
<p><b>COMMUNICATION MANAGEMENT</b></p> <ul style="list-style-type: none"> <li>→ Analyze your traffic load and roaming usage, and adjust your tariff plans to your real usage</li> </ul>
<p><b>APPLICATION MANAGEMENT</b></p> <ul style="list-style-type: none"> <li>→ Benefit from proactive maintenance services to diagnose issues and take action before a significant problem occurs.</li> </ul>

See the Fastrack Supreme online:  
[www.wavecom.com/fastracksupreme](http://www.wavecom.com/fastracksupreme)

Join the Wavecom Developer community:  
[www.wavecom.com/forum](http://www.wavecom.com/forum)



Wavecom®, Open AT®, and certain other trademarks and logos appearing on this document, are filed or registered trademarks of Wavecom S.A. in France or in other countries. The Bluetooth® word mark and logos are owned by the Bluetooth SIG, Inc. and any use of such marks by Wavecom is under licence. Eclipse™ and Built on Eclipse are trademarks of Eclipse foundation, Inc. IBM® and WebSphere® are trademarks of International Business Machines Corporation in the United States, other countries, or both. Java™ is a registered trademark of Sun Microsystems, Inc. in the United States and other countries. All other company and/or product names mentioned may be filed or registered trademarks of their respective owners. 06/08

**wavecom**<sup>®</sup>  
 Smart wireless. Smart business.



WAVECOM S.A. - 3, esplanade du Foncet - 92442 Issy-les-Moulineaux Cedex - France - Tel: +33 (0)1 46 29 08 00 - Fax: +33 (0)1 46 29 08 08  
 Wavecom, Inc. - 4810 Eastgate Mall - Second Floor - San Diego, CA 92121 - USA - Tel: +1 858 362 0101 - Fax: +1 858 558 5485  
 WAVECOM Asia Pacific Ltd. - Unit 201-207, 2nd Floor - Bio-Informatics Centre - No. 2 Science Park West Avenue - Hong Kong  
 Science Park, Shatin - New Territories, Hong Kong - Tel: +852 2824 0254 - Fax: +852 2824 0255

[www.wavecom.com](http://www.wavecom.com)

Wavecom S.A. may, at any time and without notice, make changes or improvements to the product and services offered and/or cease producing or commercializing them.

anklin Partners - Makheia group  
 Desig

Fastrack Supreme User Guide  
WA\_DEV\_Fastrk\_UGD\_001

## Plug and Play Wireless CPU<sup>®</sup>

# FASTRACK Supreme User Guide

Reference: WA\_DEV\_Fastrk\_UGD\_001

Revision: 001e

Date: 5 June, 2007

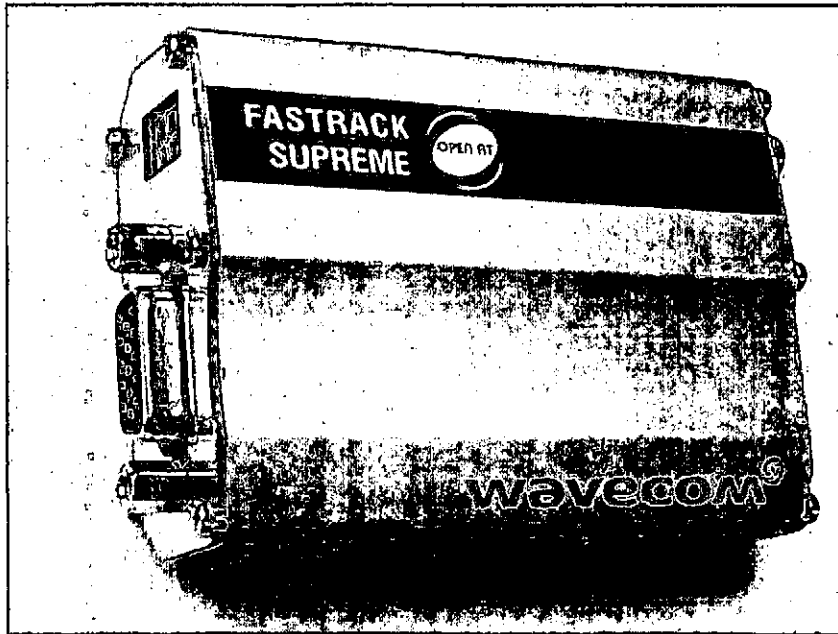

Supports Open AT<sup>®</sup> embedded ANSI C applications

## Document History

Revision	Date	List of revisions	
001	9 February, 07	First Issue	
001a	23 February, 2007	Update DC cable GPIO mapping, add AutoShutDown	
001b	21 May, 07	Add detail of IES, RTC and serial port autoshutdown	
001c	1 Jun, 07	Change to Quad Band	
001d	4 Jun, 07	Update label/packaging photo	
001e	5 Jun, 07	Comment	

## Overview

The FASTRACK Supreme 10 and FASTRACK Supreme 20 are discrete, rugged cellular Plug & Play Wireless CPU<sup>®</sup> offering state-of-the-art GSM/GPRS (and EGPRS for FASTRACK Supreme 20) connectivity for machine to machine applications.

Proven for reliable, stable performance on wireless networks worldwide, Wavecom's latest generation of FASTRACK Supreme continues to deliver rapid time to market and painless integration.

Having comparable size with the previous M1306B generation, and updated with new features, the FASTRACK Supreme offers an Internal Expansion Socket (IES) interface accessible for customer use. Expanding application features is easy without voiding the warranty of the FASTRACK Supreme by simply plugging in of an Internal Expansion Socket Module (IESM) board.

Fully certified, the quad band 850/900/1800/1900 MHz FASTRACK Supreme 10 offers GPRS Class 10 capability and FASTRACK Supreme 20 offers GPRS/EGPRS Class 10 capability. Both support a powerful open software platform (Open AT<sup>®</sup>). Open AT<sup>®</sup> is the world's most comprehensive cellular development environment, which allows embedded standard ANSI C applications to be natively executed directly on the Wireless CPU<sup>®</sup>.

FASTRACK Supreme is controlled by firmware through a set of AT commands.

This document describes the FASTRACK Supreme and gives information on the following topics:

- general presentation,
- functional description,
- basic services available,
- technical characteristics,
- installing and using the FASTRACK Supreme,
- user-level troubleshooting.
- recommended accessories to be used with the product.

### **Note:**

This document covers the FASTRACK Supreme Plug & Play alone and does not include

- The programmable capabilities provided via the use of Open AT<sup>®</sup> Software Suites.
- The development guide for IESM for expanding the application feature through the IES interface.

For detailed, please refer to the documents shown in the "Reference documents" section.

**Fastrack Supreme User Guide**  
**WA\_DEV\_Fastrk\_UGD\_001**
**RoHS Directive**

The FASTRACK Supreme is now compliant with RoHS Directive 2002/95/EC, which sets limits for the use of certain restricted hazardous substances. This directive states that "from 1st July 2006, new electrical and electronic equipment put on the market does not contain lead, mercury, cadmium, hexavalent chromium, polybrominated biphenyls (PBB), and polybrominated diphenyl ethers (PBDE)".

Plug & Plays which are compliant with this directive are identified by the RoHS logo on their label.

**Disposing of the product**

This electronic product is subject to the EU Directive 2002/96/EC for Waste Electrical and Electronic Equipment (WEEE). As such, this product must not be disposed off at a municipal waste collection point. Please refer to local regulations for directions on how to dispose off this product in an environmental friendly manner.



## Cautions

Information furnished herein by WAVECOM is accurate and reliable. However, no responsibility is assumed for its use. Please read carefully the safety recommendations given in Section 9 for an application based on FASTRACK Supreme Plug & Play.

## Trademarks

®, WAVECOM®, Wireless CPU®, Open AT® and certain other trademarks and logos appearing on this document, are filed or registered trademarks of Wavecom S.A. in France or in other countries. All other company and/or product names mentioned may be filed or registered trademarks of their respective owners.

## Copyright

This manual is copyrighted by WAVECOM with all rights reserved. No part of this manual may be reproduced in any form without the prior written permission of WAVECOM. No patent liability is assumed with respect to the use of their respective owners.



## Fastrack Supreme User Guide

WA\_DEV\_Fastrk\_UGD\_001

## Web Site Support

General information about Wavecom and its range of products:	<a href="http://www.wavecom.com">www.wavecom.com</a>
Specific support is available for the FASTRACK Supreme Plug & Play Wireless CPU®:	TBD
Open AT® Introduction:	<a href="http://www.wavecom.com/OpenAT">www.wavecom.com/OpenAT</a>
Developer community for software and hardware:	<a href="http://www.wavecom.com/forum">www.wavecom.com/forum</a>

---

 wavecom<sup>®</sup> confidential ©

Page: 6 / 77

This document is the sole and exclusive property of WAVECOM. Not to be distributed or divulged without prior written agreement.

WA\_DEV\_Fastrk\_UGD\_001

5 June, 2007





# Contents

**DOCUMENT HISTORY .....2**

**OVERVIEW .....3**

**CAUTIONS .....5**

**TRADEMARKS .....5**

**COPYRIGHT .....5**

**WEB SITE SUPPORT .....6**

**CONTENTS .....7**

**LIST OF FIGURES .....11**

**LIST OF TABLES.....12**

**1 REFERENCES .....13**

1.1 Reference Documents .....13

1.1.1 Open AT® Software Documentation.....13

1.1.2 AT Software Documentation.....13

1.1.3 Firmware Upgrade Documents.....13

1.1.4 Delta between M1306B Documents.....13

1.1.5 IESM Related Documents .....13

1.2 Abbreviations .....14

**2 PACKAGING .....17**

2.1 Contents .....17

2.2 Packaging Box.....18

2.3 Production Labelling .....19

**3 GENERAL PRESENTATION .....20**

3.1 Description.....20

3.2 External Connections .....22

3.2.1 Connectors .....22

3.2.1.1 Antenna Connector.....22

3.2.1.2 Power Supply Connector .....22

3.2.1.3 Sub HD 15-pin Connector.....23



**Fastrack Supreme User Guide**

**WA\_DEV\_Fastrk\_UGD\_001**

3.2.1.4 IES Connector.....25

3.2.2 Power supply cable .....29

**4 FEATURES AND SERVICES.....31**

4.1 Basic Features and Services .....31

4.2 Additional NEW Features .....34

4.2.1 Support Additional GSM850/PCS1900 Bands .....34

4.2.2 IES Interface for Easy Expansion of Application Features.....34

4.2.3 Serial Port Auto Shut Down or Improving Power Consumption .....34

4.2.4 Real Time Clock (RTC) for Saving Date and Time .....34

4.2.5 SIM Card Lock Feature .....35

**5 USING THE FASTRACK SUPREME PLUG & PLAY .....36**

5.1 Getting Started.....36

5.1.1 Mount the FASTRACK Supreme.....36

5.1.2 Set up the FASTRACK Supreme .....36

5.1.3 Check the communication with the FASTRACK Supreme.....37

5.1.4 Reset the FASTRACK Supreme .....37

5.2 Specific Recommendations when Using the FASTRACK Supreme on Trucks .....38

5.2.1 Recommended Power Supply Connection on Trucks.....38

5.2.2 Technical Constraints on Trucks .....38

5.3 FASTRACK Supreme Operational Status.....39

5.4 Echo Function Disabled.....40

5.5 Verify the Received Signal Strength.....41

5.6 Check the Pin Code Status .....41

5.7 Switch between EU/US Band(s).....41

5.8 Check the Band(s) Selection .....42

5.9 Verify the FASTRACK Supreme Network Registration .....43

5.10 Main AT Commands for the Plug & Play .....44

5.11 Firmware Upgrade Procedure .....45

**6 TROUBLESHOOTING .....46**

6.1 No Communication with the FASTRACK Supreme through the Serial Link .....46

6.2 Receiving "ERROR" Message.....46

6.3 Receiving "NO CARRIER" Message .....47

**7 FUNCTIONAL DESCRIPTION.....50**

7.1 Architecture.....50

7.2 EU and US Bands.....51

7.2.1 General Presentation.....51

7.2.2 AT COMMAND for Bands Switch .....51

7.3 Power Supply.....51

## Fastrack Supreme User Guide

WA\_DEV\_Fastrk\_UGD\_001

7.3.1	General Presentation.....	51
7.3.2	Protections.....	51
7.4	RS232 Serial Link.....	51
7.4.1	General Presentation.....	51
7.4.2	Autobauding Mode.....	52
7.4.3	Pin Description.....	53
7.4.4	Serial Port Auto shut down Feature.....	53
7.5	General Purpose Input/Output (GPIO).....	54
7.6	BOOT.....	54
7.7	RESET.....	54
7.7.1	General presentation.....	54
7.7.2	Reset Sequence.....	55
7.8	Audio.....	56
7.8.1	Microphone Inputs.....	56
7.8.2	Speaker Outputs.....	57
7.9	Real Time Clock (RTC).....	58
7.10	FLASH LED 58	
<b>8</b>	<b>TECHNICAL CHARACTERISTICS.....</b>	<b>59</b>
8.1	Mechanical Characteristics.....	59
8.2	Electrical Characteristics.....	61
8.2.1	Power Supply.....	61
8.2.2	Power Consumption.....	62
8.2.3	Audio Interface.....	65
8.2.4	General Purpose Input/Output.....	66
8.2.5	SIM Interface.....	66
8.2.6	RESET Signal.....	66
8.2.7	RF Characteristics.....	67
8.2.7.1	Frequency Ranges.....	67
8.2.7.2	RF Performances.....	68
8.2.7.3	External Antenna.....	69
8.3	Environmental Characteristics.....	69
8.4	Conformity.....	72
8.5	Protections.....	72
8.5.1	Power Supply.....	72
8.5.2	Overvoltage.....	73
8.5.3	Electrostatic Discharge.....	73
8.5.4	Miscellaneous.....	73
<b>9</b>	<b>SAFETY RECOMMENDATIONS.....</b>	<b>74</b>
9.1	General Safety.....	74
9.2	Vehicle Safety.....	74
9.3	Care and Maintenance.....	75
9.4	Your Responsibility.....	75



**Fastrack Supreme User Guide**

**WA\_DEV\_Fastrk\_UGD\_001**

**10 RECOMMENDED ACCESSORIES.....76**

**11 ONLINE SUPPORT .....77**

## List of Figures

Figure 1: Complete package contents.....	17
Figure 2: Packaging box.....	18
Figure 3: Production Label .....	19
Figure 4: FASTRACK Supreme general description .....	20
Figure 5: FASTRACK Supreme holding bridles .....	21
Figure 6: SMA connector for antenna connection .....	22
Figure 7: Power supply connector .....	23
Figure 8: Sub HD 15-pin connector .....	24
Figure 9: IES connector for feature expansion.....	26
Figure 10: Power supply cable .....	29
Figure 11: SIM card lock feature .....	35
Figure 12: FASTRACK Supreme mounting.....	36
Figure 13: Recommended power supply connection on trucks.....	38
Figure 14: Example of electrical connection which may dramatically damage the FASTRACK Supreme.....	39
Figure 15: Functional architecture .....	50
Figure 16: RS232 Serial Link signals .....	52
Figure 17: Reset sequence diagram .....	56
Figure 18: Dimensioning diagram.....	60



## List of Tables

Table 1: Power supply connector pin description.....	23
Table 2: Sub HD 15-pin connector description.....	24
Table 3: IES Connector Description .....	27
Table 4: Basic features of the FASTRACK Supreme.....	31
Table 5: FASTRACK Supreme operational status .....	40
Table 6: Values of received signal strength .....	41
Table 7: AT+CPIN Responses .....	41
Table 8: AT+WMBS Band Selection .....	42
Table 9: AT+WMBS Responses.....	42
Table 10: Values of network registration.....	43
Table 11: Main usual AT commands for the Plug & Play.....	44
Table 12: Solutions for no connection with FASTRACK Supreme through serial link .....	46
Table 13: Solutions for "NO CARRIER" message.....	48
Table 14: Interpretation of extended error code.....	49
Table 15: Mechanical characteristics .....	59
Table 16: Electrical characteristics .....	61
Table 17: Effects of power supply defect.....	61
Table 18: Power consumption (1*) .....	62
Table 19: Audio parameters characteristics .....	65
Table 20: Microphone inputs internal audio filter characteristics .....	65
Table 21: Recommended characteristics for the microphone:.....	65
Table 22: Recommended characteristics for the speaker:.....	66
Table 23: Operating conditions.....	66
Table 24: SIM card characteristics .....	66
Table 25: Electrical characteristics .....	66
Table 26: Operating conditions.....	67
Table 27: Frequency ranges.....	67
Table 28: Receiver and transmitter RF performances .....	68
Table 29: External antenna characteristics .....	69
Table 30: Ranges of temperature.....	69
Table 31: Environmental standard constraints .....	70
Table 32: List of recommended accessories .....	76

## 1 References

### 1.1 Reference Documents

For more details, several reference documents may be consulted. The Wavecom reference documents are provided in the Wavecom documents package contrary to the general reference documents, which are not Wavecom owned.

#### 1.1.1 Open AT<sup>®</sup> Software Documentation

- [1] Getting started with Open AT<sup>®</sup> (Ref. WM\_ASW\_OAT\_CTI\_001)
- [2] Open AT<sup>®</sup> Tutorial (Ref. WM\_ASW\_OAT\_UGD\_001)
- [3] Tools Manual (Ref. WM\_ASW\_OAT\_UGD\_003)
- [4] Open AT<sup>®</sup> Programming Guide (Ref. TBD)
- [5] Open AT<sup>®</sup> Customer Release Note (Ref. WM\_ASW\_OAT\_DVD\_00062)

Remark: The document above is for Open AT3.12 and FASTRACK Supreme will use new release of Open AT4.21. Reference document not yet available and TBC.

#### 1.1.2 AT Software Documentation

- [6] AT commands interface Guide for X51 (Ref. WM\_ASW\_OAT\_UGD\_00016)
- [7] Customer Release Note X51 (Ref. WM\_ASW\_OAT\_DVD\_00120)

Remark: The document above is for X51 and FASTRACK Supreme will use new release of FW6.63. Reference document not yet available and TBC.

#### 1.1.3 Firmware Upgrade Documents

- [8] Firmware upgrade procedure (Ref. WM\_SW\_GEN\_UGD\_001)

#### 1.1.4 Delta between M1306B Documents

- [9] Delta between M1306B and FASTRACK Supreme (Ref. WA\_DEV\_Fastrk\_UGD\_004)

#### 1.1.5 IESM Related Documents

- [10] IESM Product Technical Specification (Ref. WA\_DEV\_Fastrk\_PTS\_001)
- [11] IESM-GPS+USB User Guide (Ref. WA\_DEV\_Fastrk\_UGD\_002)
- [12] IESM-GPS+USB Installation Guide (Ref. WA\_DEV\_Fastrk\_UGD\_003)
- [13] IESM-IO+USB Installation Guide (Ref. WA\_DEV\_Fastrk\_UGD\_005)
- [14] IESM-IO+USB User Guide (Ref. WA\_DEV\_Fastrk\_UGD\_006)

## Fastrack Supreme User Guide

### References

#### Note:

New versions of software may be available. Wavecom recommends customers to check the web site for the latest documentation.

### 1.2 Abbreviations

Abbreviation	Definition
AC	Alternating Current
ACM	Accumulated Call Meter
AMR	Adaptive Multi-Rate
AT	ATtention (prefix for Wireless CPU <sup>®</sup> commands)
CLK	CLock
CMOS	Complementary Metal Oxide Semiconductor
CS	Coding Scheme
CTS	Clear To Send
dB	Decibel
dBc	Decibel relative to the Carrier power
dBi	Decibel relative to an Isotropic radiator
dBm	Decibel relative to one milliwatt
DC	Direct Current
DCD	Data Carrier Detect
DCE	Data Communication Equipment
DCS	Digital Cellular System
DSR	Data Set Ready
DTE	Data Terminal Equipment
DTMF	Dual Tone Multi-Frequency
DTR	Data Terminal Ready
EEPROM	Electrically Erasable Programmable Read-Only Memory
EFR	Enhanced Full Rate
E-GSM	Extended GSM
EMC	ElectroMagnetic Compatibility
EMI	ElectroMagnetic Interference
ESD	ElectroStatic Discharges
ETSI	European Telecommunications Standards Institute
FIT	Series of connectors (micro-FIT)
FR	Full Rate



## Fastrack Supreme User Guide

### References

Abbreviation	Definition
FTA	Full Type Approval
GCF	Global Certification Forum
GND	GrouND
GPIO	General Purpose Input Output
GPRS	General Packet Radio Service
GSM	Global System for Mobile communications
HR	Half Rate
I	Input
IEC	International Electrotechnical Commission
IES	Internal Expansion Socket
IESM	Internal Expansion Socket Module
IMEI	International Mobile Equipment Identification
I/O	Input / Output
LED	Light Emitting Diode
MAX	MAXimum
ME	Mobile Equipment
MIC	MICrophone
Micro-Fit	Family of connectors from Molex
MIN	MINimum
MNP	Microcom Networking Protocol
MO	Mobile Originated
MS	Mobile Station
MT	Mobile Terminated
NOM	NOMinal
O	Output
Pa	Pascal (for speaker sound pressure measurements)
PBCCH	Packet Broadcast Control CHannel
PC	Personal Computer
PCL	Power Control Level
PDP	Packet Data Protocol
PIN	Personal Identity Number
PLMN	Public Land Mobile Network
PUK	Personal Unblocking Key
RF	Radio Frequency

## Fastrack Supreme User Guide

### References

Abbreviation	Definition
RFI	Radio Frequency Interference
RI	Ring Indicator
RMS	Root Mean Square
RTS	Request To Send
RX	Receive
SIM	Subscriber Identification Module
SMA	SubMiniature version A RF connector
SMS	Short Message Service
SNR	Signal-to-Noise Ratio
SPL	Sound Pressure Level
SPK	SpeaKer
SRAM	Static RAM
TCP/IP	Transmission Control Protocol / Internet Protocol
TDMA	Time Division Multiple Access
TU	Typical Urban fading profile
TUHigh	Typical Urban, High speed fading profile
TX	Transmit
TYP	TYPical
VSWR	Voltage Stationary Wave Ratio

## 2 Packaging

### 2.1 Contents

The complete package content of the FASTRACK Supreme consists of (see):

- one packaging box (A),
- one FASTRACK Supreme (B),
- two holding bridles (C),
- one power supply cable with fuse integrated (D)
- a mini notice (E) with:
  - a summary of the main technical features,
  - safety recommendations,
  - EC declaration of conformity.

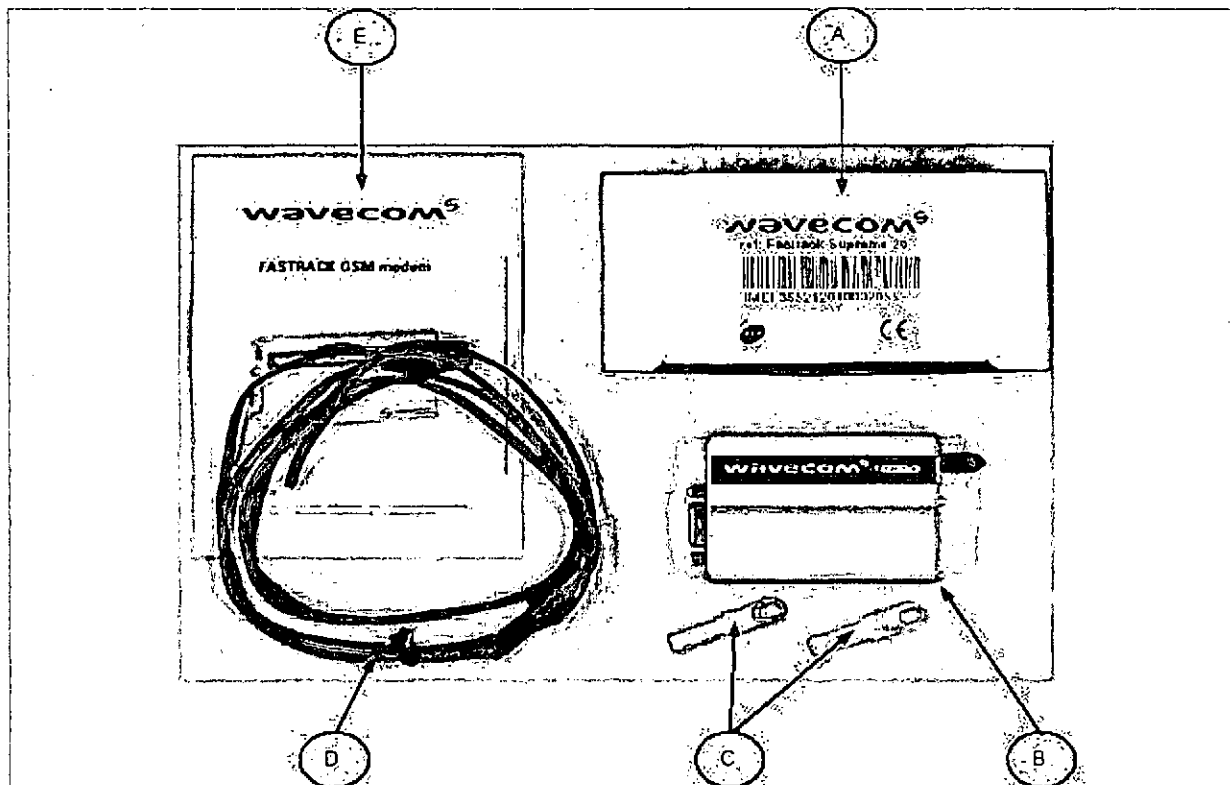

Figure 1: Complete package contents

## Fastrack Supreme User Guide

### Packaging

### 2.2 Packaging Box

The packaging box is a carton box (see) with the following external dimensions:

- width: 54.5 mm,
- height: 68 mm,
- length: 108 mm.

A packaging label is slicked on the packaging box cover and supports the:

- WAVECOM logo,
- Product reference (Supreme),
- CE marking
- 15-digit IMEI code
- Open AT<sup>®</sup> Logo
- RoHS logo
- WEEE logo



Figure 2: Packaging box

The packaging label dimensions are:

- height: 40 mm,
- length: 65 mm.

## Fastrack Supreme User Guide

### Packaging

### 2.3 Production Labelling

A production label (see Figure 3) located at the FASTRACK Supreme back side gives the following information:

- product reference (**FASTRACK Supreme 10** or **FASTRACK Supreme 20**),
- part number (WM19183),
- CE marking,
- 15-digit IMEI code,
- OpenAT<sup>®</sup> logo

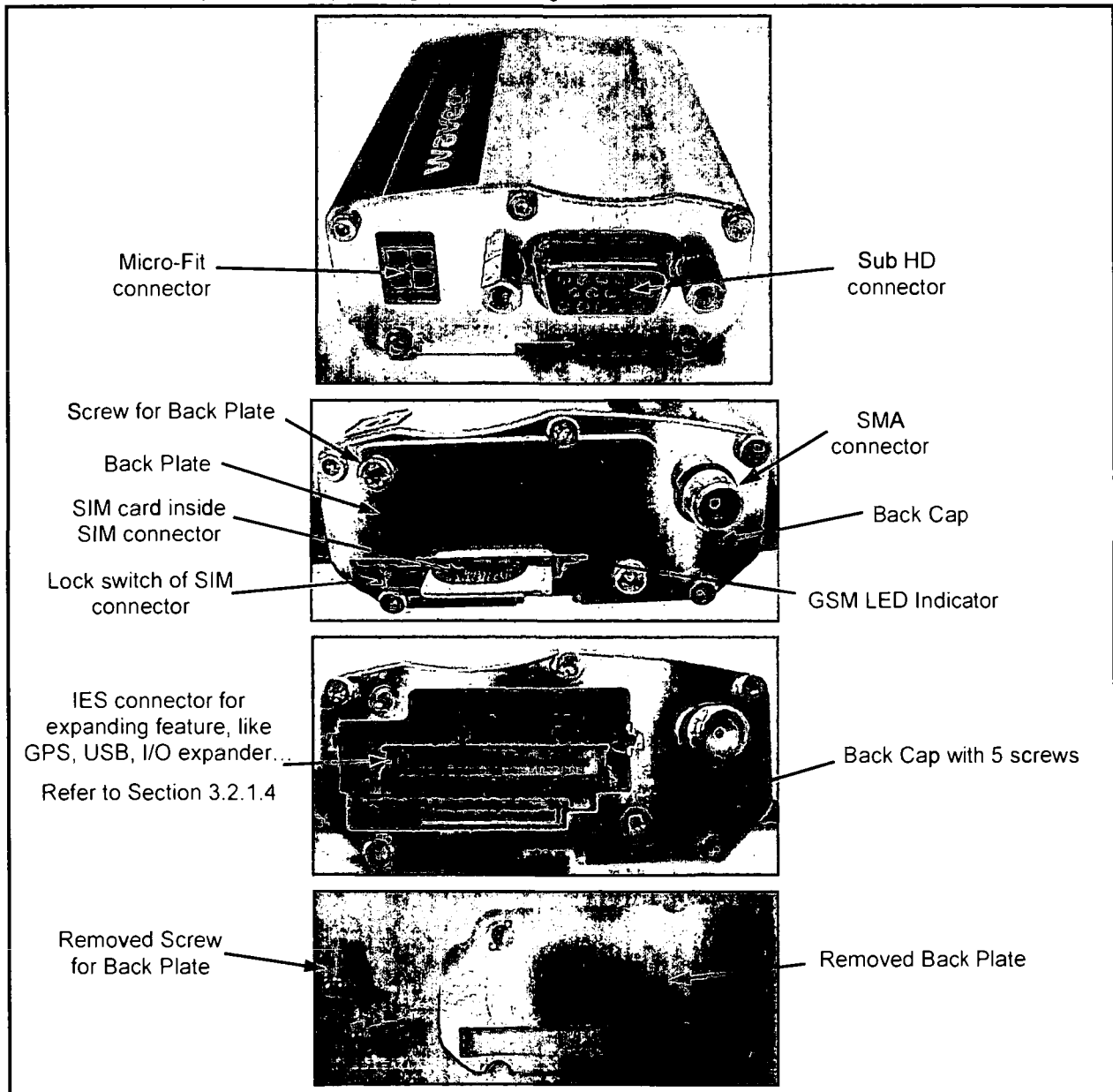

Figure 3: Production Label

### 3 General Presentation

#### 3.1 Description

The FASTRACK Supreme description is given in the Figure 4 below.



**Figure 4: FASTRACK Supreme general description**

## Fastrack Supreme User Guide

### General Presentation

**CAUTION:** Users are free to remove the back plate for IESM board plug in/unplug without voiding the warranty of the FASTRACK Supreme. However, the warranty will be voided if unscrewing any screw of the back cap.

In addition, two holding bridles are provided to tighten the FASTRACK Supreme on a support.

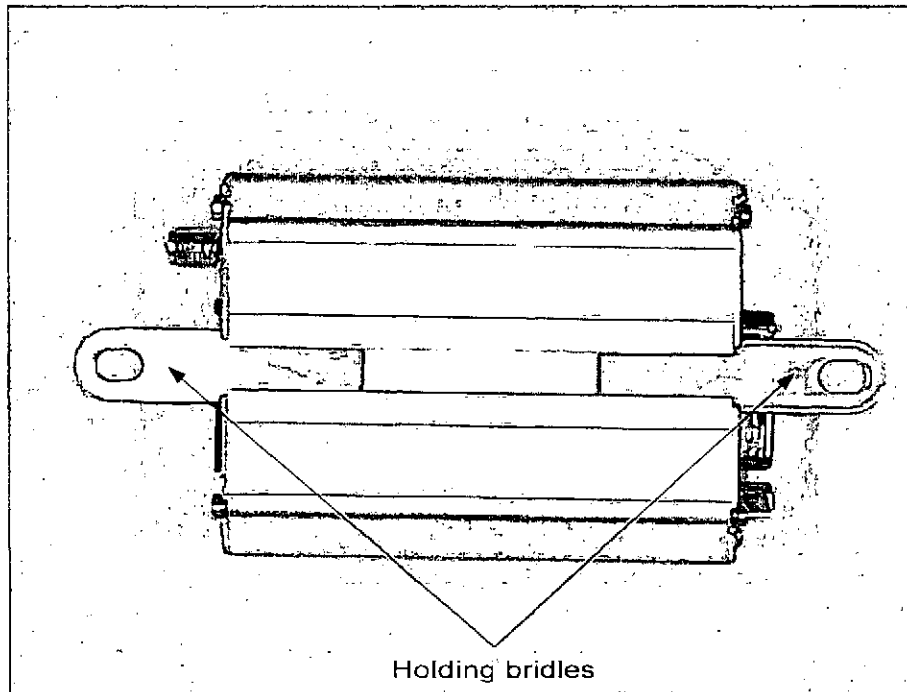

Figure 5: FASTRACK Supreme holding bridles

## Fastrack Supreme User Guide

### General Presentation

### 3.2 External Connections

#### 3.2.1 Connectors

##### 3.2.1.1 Antenna Connector

The antenna connector is a SMA type connector for a 50  $\Omega$  RF connection.

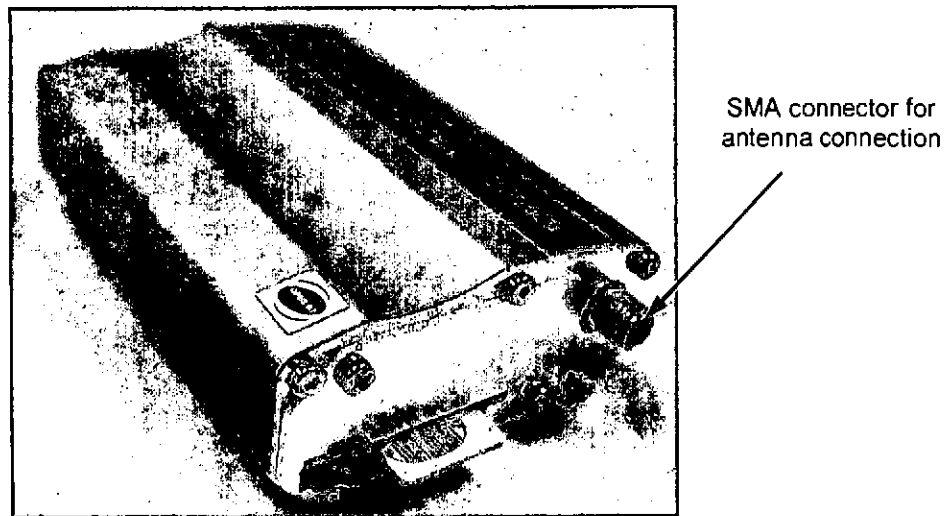

**Figure 6: SMA connector for antenna connection**

##### 3.2.1.2 Power Supply Connector

The power supply connector is a 4-pin Micro FIT connector for:

- external DC Power Supply connection,
- GPIOs connection (two General Purpose Input/Output signals available).



## Fastrack Supreme User Guide

### General Presentation

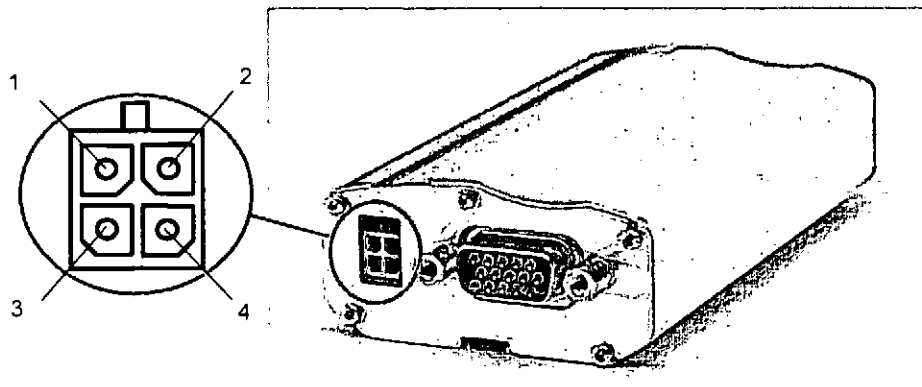

Figure 7: Power supply connector

Table 1: Power supply connector pin description

Pin #	Signal	I/O	I/O type	Description	Reset State	Comment
1	V+BATTERY	I	Power supply	Battery voltage input: <ul style="list-style-type: none"> <li>▪ 5.5 V Min.</li> <li>▪ 13.2 V Typ.</li> <li>▪ 32 V Max.</li> </ul>		High current
2	GND		Power supply	Ground		
3	GPIO21	I/O	2V8	General Purpose Input/output	Undefined	Not mux
4	GPIO25	I/O	2V8	General Purpose Input/output	Z	Multiplex with INT1

#### Warning:

Both pin 3 and pin 4 are used by GPIO interface. It is strictly prohibited to connect them to any power supply at the risk of damage to the FASTRACK Supreme.

#### 3.2.1.3 Sub HD 15-pin Connector

The Sub D high density 15-pin connector is used for:

- RS232 serial link connection,
- Audio lines (microphone and speaker) connection,
- BOOT and RESET signal connection.

**Fastrack Supreme User Guide**  
General Presentation

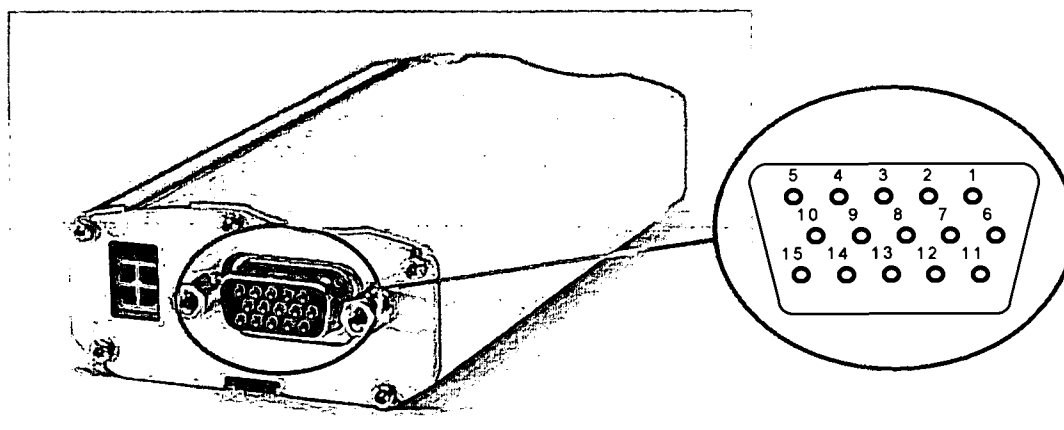

Figure 8: Sub HD 15-pin connector

Table 2: Sub HD 15-pin connector description

Pin #	Signal (CCITT / EIA)	I/O	I/O type	Description	Comment
1	CDCD/CT109	O	STANDARD RS232	RS232 Data Carrier Detect	
2	CTXD/CT103	I	STANDARD RS232	RS232 Transmit serial data	
3	BOOT	I	CMOS	Boot	This signal must not be connected. Its use is strictly reserved to Wavecom or competent retailers.
4	CMIC2P	I	Analog	Microphone positive line	
5	CMIC2N	I	Analog	Microphone negative line	
6	CRXD/CT104	O	STANDARD RS232	RS232 Receive serial data	
7	CDSR/CT107	O	STANDARD RS232	RS232 Data Set Ready	
8	CDTR/CT108-2	I	STANDARD RS232	RS232 Data Terminal Ready	
9	GND	-	GND	Ground	

## Fastrack Supreme User Guide

### General Presentation

Pin #	Signal (CCITT / EIA)	I/O	I/O type	Description	Comment
10	CSPK2P	O	Analog	Speaker positive line	
11	CCTS/CT105	O	STANDARD RS232	RS232 Clear To Send	
12	CRTS/CT105	I	STANDARD RS232	RS232 Request To Send	
13	CRI/CT125	O	STANDARD RS232	RS232 Ring Indicator	
14	RESET	I/O	Schmitt	Supreme Plug & Play reset	Active low
15	CSPK2N	O	Analog	Speaker negative line	

#### 3.2.1.4 IES Connector

The IES connector is a 50 pins board-to-board connector for expanding application features like GPS, USB, I/O expander... Currently there are already 3 IESM boards available for customer to expand the FASTRACK Supreme features immediately. They are:

- IESM-GPS+USB+I/O
- IESM-GPS+USB
- IESM-USB+I/O

For detail, please refer to Document in Section 1.1.5.

**Fastrack Supreme User Guide**  
**General Presentation**

For sales and support, please contact Wavecom sales/FAE or your distributor.

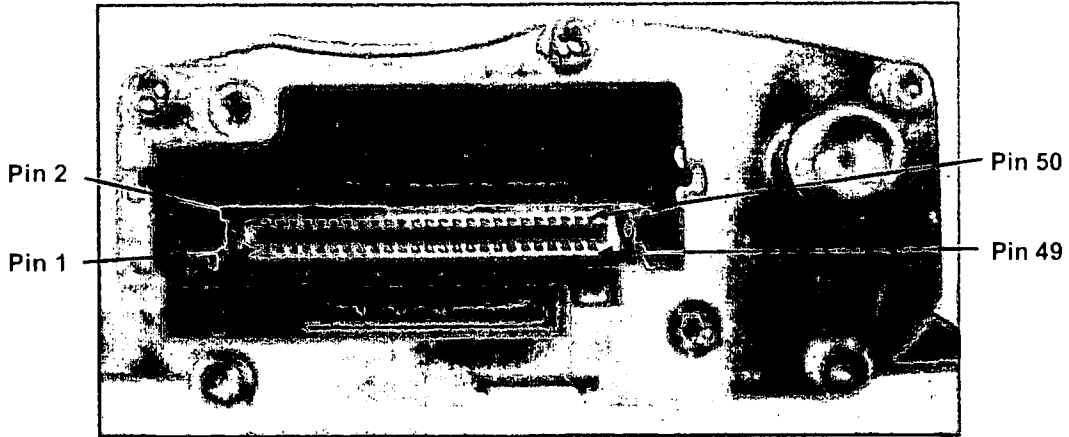

**Figure 9: IES connector for feature expansion**

## Fastrack Supreme User Guide

### General Presentation

Table 3: IES Connector Description

Pin Number	Signal Name		I/O type	Voltage	I/O*	Reset State	Description	Dealing with unused pins
	Nominal	Mux						
1	GND						Ground	
2	GND						Ground	
3	GPIO4	COL0	C8	GSM-1V8	I/O	Pull-up	Keypad column 0	NC
4	GPIO5	COL1	C8	GSM-1V8	I/O	Pull-up	Keypad column 1	NC
5	GPIO6	COL2	C8	GSM-1V8	I/O	Pull-up	Keypad column 2	NC
6	GPIO7	COL3	C8	GSM-1V8	I/O	Pull-up	Keypad column 3	NC
7	VPAD-USB			VPAD-USB	I		USB Power supply input	NC
8	USB-DP			VPAD-USB	I/O		USB Data	NC
9	USB-DM			VPAD-USB	I/O		USB Data	NC
10	GSM-1V8*			GSM-1V8	O		1.8V Supply Output (for GPIO pull-up only)	NC
11	GSM-2V8*			GSM-1V8	O		2.8V Supply Output (for GPIO pull-up only)	NC
12	BOOT			GSM-1V8	I		Not Used	Add a test point / a jumper/ a switch to VCC_1V8 (Pin 10) in case Download Specific mode is used (See product specification for details)
13	~RESET		C4	GSM-1V8	I/O		RESET Input	NC or add a test point
14	AUX-ADC		A2	Analog	I		Analog to Digital Input	Pull to GND
15	~SPI1-CS	GPIO31	C1	GSM-2V8	O	Z	SPI1 Chip Select	NC
16	SPI1-CLK	GPIO32	C1	GSM-2V8	O	Z	SPI1 Clock	NC
17	SPI1-I	GPIO30	C1	GSM-2V8	I	Z	SPI1 Data Input	NC
18	SPI1-IO	GPIO29	C1	GSM-2V8	I/O	Z	SPI1 Data Input / Output	NC
19	SPI2-CLK	GPIO32	C1	GSM-2V8	O	Z	SPI2 Clock	NC
20	SPI2-IO	GPIO33	C1	GSM-2V8	I/O	Z	SPI2 Data Input / Output	NC
21	~SPI2-CS	GPIO35	C1	GSM-2V8	O	Z	SPI2 Chip Select	NC
22	SPI2-I	GPIO34	C1	GSM-2V8	I	Z	SPI2 Data Input	NC
23	CT104-RXD2	GPIO15	C1	GSM-1V8	O	Z	Auxiliary RS232 Receive	Add a test point for firmware upgrade
24	CT103-TXD2	GPIO14	C1	GSM-1V8	I	Z	Auxiliary RS232 Transmit	(TXD2) Pull-up to VCC_1V8 with 100kΩ and add a test point for firmware update
25	~CT106-CTS2	GPIO16	C1	GSM-1V8	O	Z	Auxiliary RS232 Clear To Send	(CTS2) Add a test point for firmware update
26	~CT105-RTS2	GPIO17	C1	GSM-1V8	I	Z	Auxiliary RS232 Request To Send	(RTS2) Pull-up to VCC_1V8 with 100kΩ and add a test point for

## Fastrack Supreme User Guide

## General Presentation

Pin Number	Signal Name		I/O type	Voltage	I/O*	Reset State	Description	Dealing with unused pins
	Nominal	Mux						
								firmware update
27	GPIO8	COL4	C8	GSM-1V8	I/O	Pull-up	Keypad column 4	NC
28	GPIO26	SCL	A1	Open Drain	O	Z	I <sup>2</sup> C Clock	NC
29	GPIO19		C1	GSM-2V8	I/O	Z		NC
30	GPIO27	SDA	A1	Open Drain	I/O	Z	I <sup>2</sup> C Data	NC
31	GPIO20		C1	GSM-2V8	I/O	Undefined		NC
32	INT0	GPIO3	C1	GSM-1V8	I	Z	Interruption 0 Input	If INT0 is not used, it should be configured as GPIO
33	GPIO23	**	C1	GSM-2V8	I/O	Z		NC
34	GPIO22	**	C1	GSM-2V8	I/O	Z		NC
35	~CT108-2-DTR1	GPIO41	C1	GSM-2V8	I	Z	Main RS232 Data Terminal Ready	(DTR1) Pull-up to VCC_2V8 with 100kΩ
36	PCM-SYNC			GSM-1V8	O	Pull-down	PCM Frame Synchro	NC
37	PCM-IN		C5	GSM-1V8	I	Pull-up	PCM Data Input	NC
38	PCM-CLK			GSM-1V8	O	Pull-down	PCM Clock	NC
39	PCM-OUT			GSM-1V8	O	Pull-up	PCM Data Output	NC
40	AUX-DAC			Analog	O		Digital to Analog Output	NC
41	VCC-2V8			VCC_2V8	O		LDO 2.8V Supply Output	NC
42	GND						Ground	
43	DC-IN			DC-IN from 5.5V~32VDC	O		DC voltage input through Micro-Fit connector	NC
44	DC-IN			DC-IN from 5.5V~32VDC	O		DC voltage input through Micro-Fit connector	NC
45	GND						Ground	
46	4V			4V	O		4V DC/DC converter Output	NC
47	4V			4V	O		4V DC/DC converter Output	NC
48	GND						Ground	
49	GND						Ground	
50	GND						Ground	

**Fastrack Supreme User Guide**  
**General Presentation**

**3.2.2 Power supply cable**

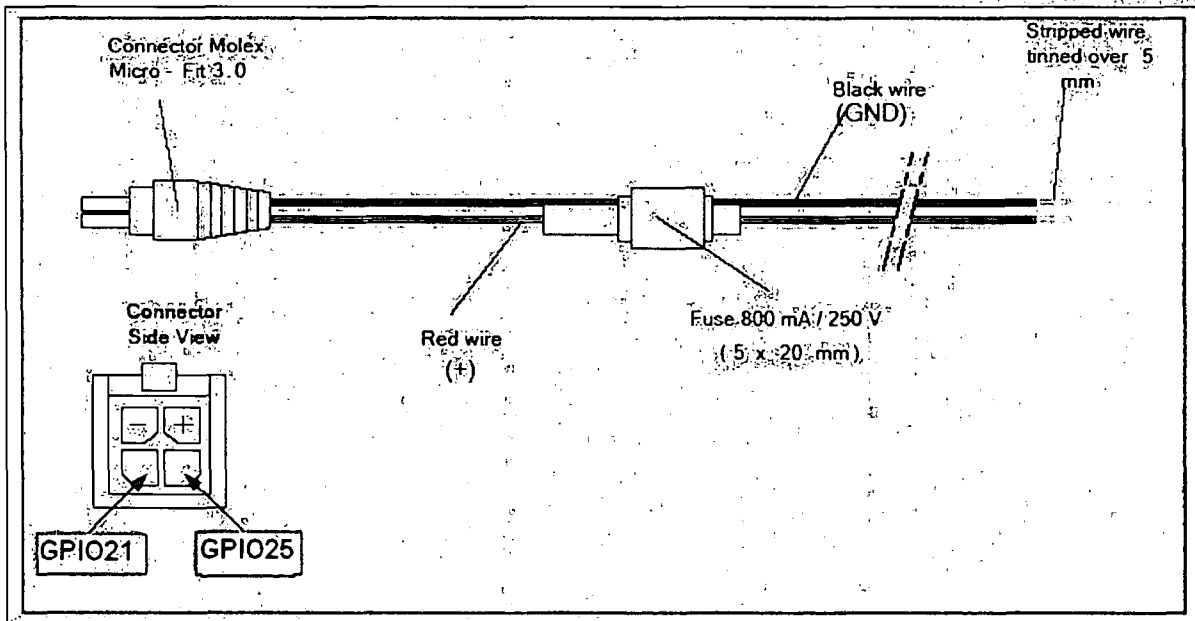

**Figure 10: Power supply cable**

## Fastrack Supreme User Guide

### General Presentation

Component	Characteristics
Micro-Fit connector 4-pin	Part number: MOLEX 43025-0400
Cable	Cable length: ~1.5 m
Wire	Core: tinned copper 24 x 0.2 mm
	Section: 0.75 mm <sup>2</sup>



## Fastrack Supreme User Guide

### Features and Services

## 4 Features and Services

### 4.1 Basic Features and Services

Basic features of the FASTRACK Supreme and available services are summarized in the table below.

**Table 4: Basic features of the FASTRACK Supreme**

Features	GSM850 / GSM900	DCS1800 / PCS1900
<b>Open AT<sup>®</sup></b>	Open AT <sup>®</sup> programmable: Native execution of embedded standard ANSI C applications, Custom AT command creation, Custom application library creation, Standalone operation.	
<b>Standard</b>	850MHz / 900 MHz. E-GSM compliant. Output power: class 4 (2W). Fully compliant with ETSI GSM phase 2 + small MS.	1800 MHz / 1900MHz  Output power: class 1 (1W). Fully compliant with ETSI GSM phase 2 + small MS.
<b>GPRS</b>	Class 10. PBCCH support. Coding schemes: CS1 to CS4. Compliant with SMG31bis. Embedded TCP/IP stack.	
<b>EGPRS</b>  (for FASTRACK Supreme 20 only)	Output power: 0.5W	Output power: 0.4W
	Class 10. PBCCH support. Coding schemes: MCS1 to MCS9. Compliant with SMG31bis. Embedded TCP/IP stack.	

## Fastrack Supreme User Guide

## Features and Services

Features	GSM850 / GSM900	DCS1800 / PCS1900
<b>Interfaces</b>	RS232 (V.24/V.28) Serial interface supporting: <ul style="list-style-type: none"> <li>▪ Baud rate (bits/s): 300, 600, 1200, 2400, 4800, 9600, 19200, 38400, 57600, 115200, 230400, 460800 and 921600.</li> <li>▪ Autobauding (bits/s): from 1200 to 921600.</li> </ul> 2 General Purpose Input/Output gates (GPIOs) available. 1.8 V / 3 V SIM interface. AT command set based on V.25ter and GSM 07.05 & 07.07. Open AT <sup>®</sup> interface for embedded application. Open AT <sup>®</sup> Plug-In Compatible.	
<b>SMS</b>	Text & PDU. Point to point (MT/MO). Cell broadcast.	
<b>Data</b>	Data circuit asynchronous. Transparent and Non Transparent modes. Up to 14.400 bits/s. MNP Class 2 error correction. V42.bis data compression.	
<b>Fax</b>	Automatic fax group 3 (class 1 and Class 2).	
<b>Audio</b>	Echo cancellation Noise reduction Telephony. Emergency calls. Full Rate, Enhanced Full Rate, Half Rate operation and Adaptive Multi-Rate (FR/EFR/HR/AMR). Dual Tone Multi Frequency function (DTMF).	



**Fastrack Supreme User Guide**  
**Features and Services**

Features	GSM850 / GSM900	DCS1800 / PCS1900
<b>GSM supplement services</b>	Call forwarding. Call barring. Multiparty. Call waiting and call hold. Calling line identity. Advice of charge. USSD	
<b>Other</b>	DC power supply Real Time Clock with calendar Complete shielding	

For other detailed technical characteristics, refer to Section 8.

## Fastrack Supreme User Guide

### Features and Services

#### 4.2 Additional NEW Features

##### 4.2.1 Support Additional GSM850/PCS1900 Bands

Apart from GSM900/DCS1800, the FASTRACK Supreme Plug & Play now supports also the GSM850/PCS1900 bands. FASTRACK Supreme is fully compliant to PTCRB and FCC also.

##### 4.2.2 IES Interface for Easy Expansion of Application Features

The FASTRACK Supreme Plug & Play offers a 50 pin Internal Expansion Socket (IES) Interface accessible for customer use. It is the additional interface which is easy for customers to expand their application features without voiding the warranty of the FASTRACK Supreme, by simply plugging in an Internal Expansion Socket Module (IESM) board through the mating connector of the IES interface.

Thanks to the flexible IES interface, customers are ready to expand the application features by plugging in the corresponding Internal Expansion Socket Module (IESM) of GPS, I/O expander..., etc.

For brief description of the interface, please refer to Section 3.2.1.4.

For technical detail, please refer to Document [11] or contact your Wavecom distributor or Wavecom FAE.

##### 4.2.3 Serial Port Auto Shut Down or Improving Power Consumption

In order to save power consumption when there is no data communication between the Plug & Play and the DTE, FASTRACK Supreme has now implemented the Serial Port Auto Shut Down feature. User can activate or deactivate the Serial Port Auto Shut Down mode by simple AT-command.

For detail, please refer to Section 7.3.4.

##### 4.2.4 Real Time Clock (RTC) for Saving Date and Time

The FASTRACK Supreme has now implemented the Real Time Clock for saving date and time when the Plug & Play is unplugged from the DC power supply through the DC power cable.

For detail, please refer to Section 7.8.

**Fastrack Supreme User Guide**  
**Features and Services**

**4.2.5 SIM Card Lock Feature**

The FASTRACK Supreme has now implemented a SIM connector having a carrier with lock. This helps ensuring the user to have proper SIM card insertion and locked before proper use of GSM network.

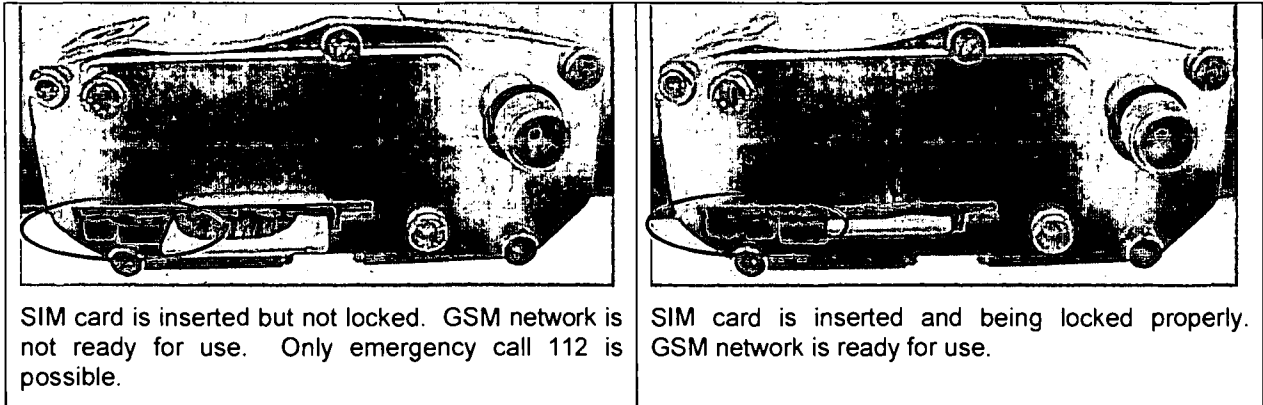

Figure 11: SIM card lock feature

## Fastrack Supreme User Guide

### Using the FASTRACK Supreme Plug & Play

## 5 Using the FASTRACK Supreme Plug & Play

### 5.1 Getting Started

#### 5.1.1 Mount the FASTRACK Supreme

To mount the FASTRACK Supreme on its support, bind it using the holding bridles as shown in the Figure 12 below.

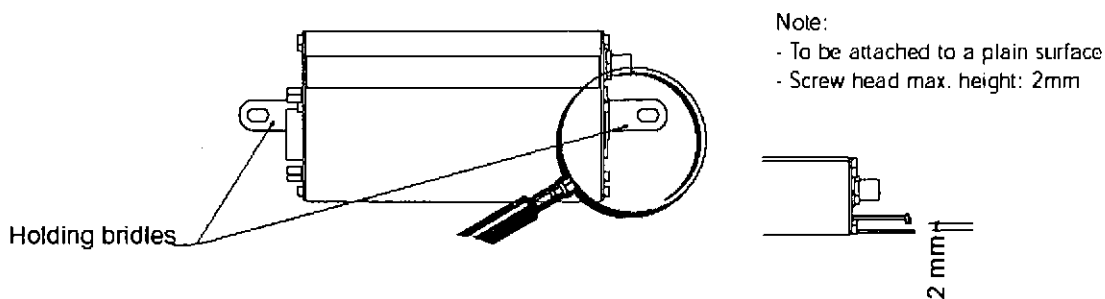

**Figure 12: FASTRACK Supreme mounting**

For the drill template, refer to Figure 18.

#### 5.1.2 Set up the FASTRACK Supreme

To set up the FASTRACK Supreme, perform the following operations:

- Insert the SIM card into the SIM card holder of the FASTRACK Supreme.
- Lock the SIM card by sliding the lever towards the SIM card.
- Connect the antenna to the SMA connector.
- Connect both sides of the serial and control cable (15-pin Sub HD connector on the FASTRACK Supreme side).
- Connect the power supply cable to the external power supply source.

**Note:**

For automotive application, it is recommended to connect the V+BATTERY line of the FASTRACK Supreme directly to the battery positive terminal.

- Plug the power supply cable into the FASTRACK Supreme and switch on the external power supply source.
- The FASTRACK Supreme is ready to work. Refer to Section 5.10 for the description of AT commands used to configure the FASTRACK Supreme.

## Fastrack Supreme User Guide

### Using the FASTRACK Supreme Plug & Play

#### 5.1.3 Check the communication with the FASTRACK Supreme

To check the communication with the FASTRACK Supreme, do the following operations:

- Connect the RS232 link between the DTE (port COM) and the FASTRACK Supreme (DCE).
- Configure the RS232 port of the DTE as follows:
  - Bits per second: **115.200 bps**,
  - Data bits: **8**,
  - Parity: **None**,
  - Stop bits: **1**,
  - Flow control: **hardware**.
- Using a communication software such as a HyperTerminal, enter the **AT+J** command. The response of the FASTRACK Supreme must be **OK** displayed in the HyperTerminal window.
- If the communication cannot be established with the FASTRACK Supreme, do the following:
  - Check the RS232 connection between the DTE and the FASTRACK Supreme (DCE),
  - Check the configuration of the port COM used on the DTE.
- Example of AT commands which can be used after getting started the FASTRACK Supreme:
  - **AT+CGMI** : FASTRACK Supreme answer is "WAVECOM MODEM" when serial link is OK.
  - **AT+CPIN=xxxx** : to enter a PIN code xxxx (if activated).
  - **AT+CSQ**: to verify the received signal strength.
  - **AT+CREG?**: to verify the registration of the FASTRACK Supreme Plug & Play on the network.
  - **ATD<phone number>;** : to initiate a voice call.
  - **ATH**: to hang up (end of call).

For further information on these AT commands and their associated parameters, refer to "AT Commands Interface Guide" [6].

#### 5.1.4 Reset the FASTRACK Supreme

To reset the FASTRACK Supreme, a hardware reset signal is available on pin 14 of the Sub HD 15-pin connector (RESET).

The FASTRACK Supreme reset is carried out when this pin is low for at least 200  $\mu$ s.

**Warning** This signal has to be considered as an emergency reset only. For further details on the FASTRACK Supreme reset, refer to Section 7.7.

## Fastrack Supreme User Guide

### Using the FASTRACK Supreme Plug & Play

#### 5.2 Specific Recommendations when Using the FASTRACK Supreme on Trucks

**Warning:** The power supply connection of the FASTRACK Supreme must NEVER be directly connected to the truck battery.

##### 5.2.1 Recommended Power Supply Connection on Trucks

All trucks have a circuit breaker on the exterior of the cabin. The circuit breaker is used for safety reasons: if a fire blazes in the trucks, (for example, on the wiring trunk) the driver may cut the current source to avoid any damage (explosion). The circuit breaker is connected to the truck ground, most often associated with the fuse box.

Most of truck circuit breakers do not cut the Positive Supply line of the battery, but cut the ground line of the later.

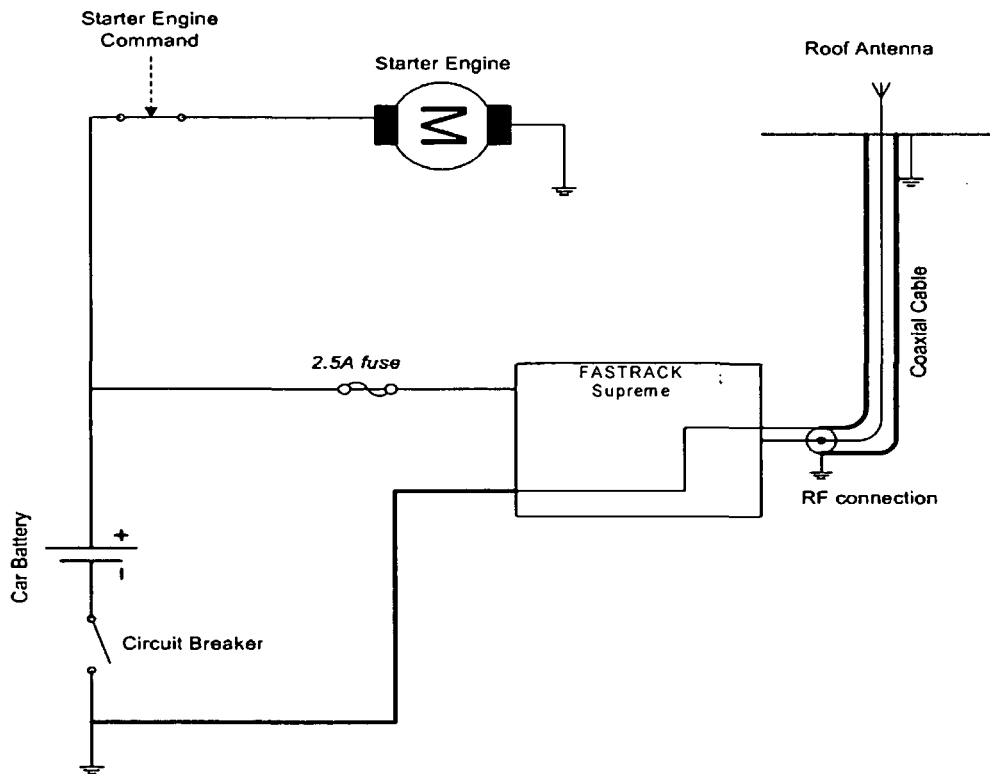

**Figure 13: Recommended power supply connection on trucks**

Figure 13 gives the recommended power supply connection where the ground connection of the FASTRACK Supreme is not directly connected to the battery but is connected after the Circuit Breaker (on the truck ground or the fuse box).

##### 5.2.2 Technical Constraints on Trucks

It is highly not recommended to connect directly the power supply on the battery rather than on the circuit breaker. The FASTRACK Supreme may be damaged when starting the truck if the circuit breaker is switched OFF (in this case, the truck ground and the battery ground will be connected through the FASTRACK Supreme as shown in the figure below).



## Fastrack Supreme User Guide

### Using the FASTRACK Supreme Plug & Play

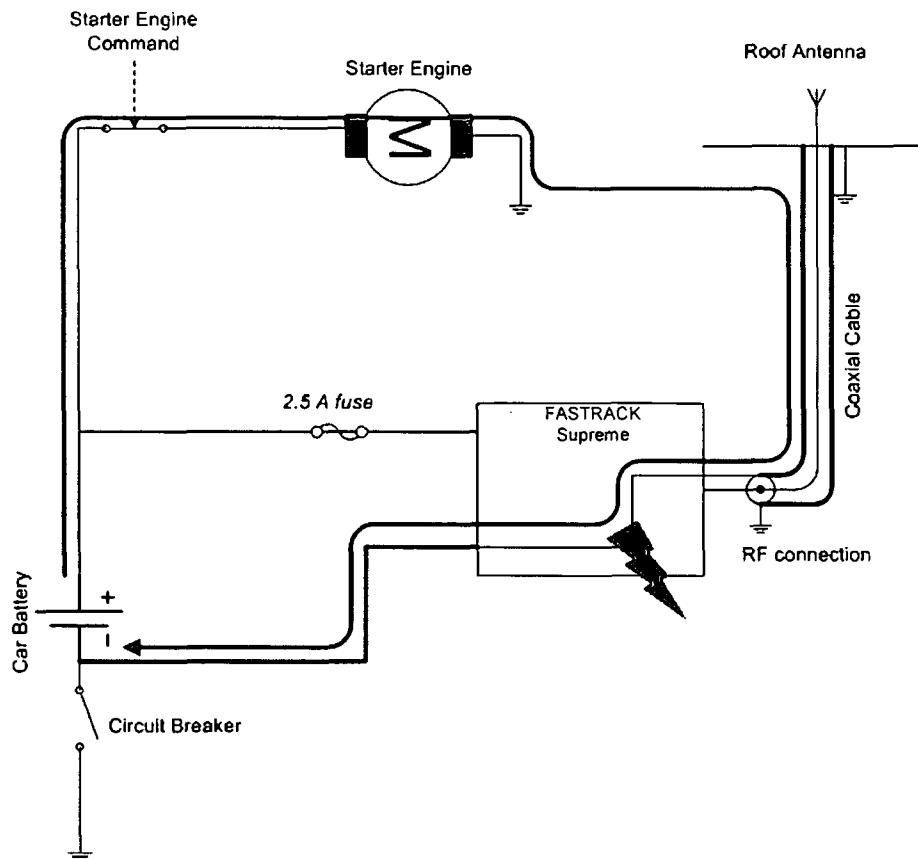

**Figure 14: Example of electrical connection which may dramatically damage the FASTRACK Supreme**

Figure 14 gives an example of electrical connection which may dramatically damage the FASTRACK Supreme when its ground connection is directly connected to the battery ground.

In this example, when the circuit breaker is switched OFF, the current flows through the FASTRACK Supreme and powers the electrical circuit of the truck (for example, dashboard).

Furthermore, when the Starter Engine command will be used, it will destroy the cables or the FASTRACK Supreme.

Since the internal tracks are not designed to support high current (up to 60 A when starting the truck), they will be destroyed.

### 5.3 FASTRACK Supreme Operational Status

The FASTRACK Supreme operational status is given by the red LED status located next to the SIM connector on the FASTRACK Supreme panel.

The Table 5 below gives the meaning of the various statuses available.

## Fastrack Supreme User Guide

### Using the FASTRACK Supreme Plug & Play

Table 5: FASTRACK Supreme operational status

LED Status	LED light activity	FASTRACK Supreme Plug & Play status
ON	LED ON permanent	FASTRACK Supreme is switched ON but not registered on the network
	LED Flashing slowly	FASTRACK Supreme is switched ON and registered on the network, but no communication is in progress (Idle mode)
	LED Flashing rapidly	FASTRACK Supreme is switched ON and registered on the network, and a communication is in progress
OFF	LED OFF	FASTRACK Supreme is switched OFF, or Flash LED is disabled* by the user.

\* : Flash LED can be disabled by user when in Slow Standby mode in order to save power consumption. For detail, please refer to Section 7.9.

#### 5.4 Echo Function Disabled

If no echo is displayed when entering an AT command, that means:

- The "local echo" parameter of your communication software (such as HyperTerminal) is disabled.
- The FASTRACK Supreme echo function is disabled.

To enable the FASTRACK Supreme echo function, enter the **ATE1**.

When sending AT commands to the FASTRACK Supreme by using a communication software, it is recommended:

- to disable the "local echo" parameter of your communication software (such as HyperTerminal),
- to enable the FASTRACK Supreme echo function (**ATE1** command).

In a Machine To Machine communication with the FASTRACK Supreme, it is recommended to disable the FASTRACK Supreme echo function (**ATE0** command) in order to avoid useless CPU processing.

For further information on **ATE0** and **ATE1** commands, refer to "AT Commands Interface Guide" [6].

## Fastrack Supreme User Guide

### Using the FASTRACK Supreme Plug & Play

#### 5.5 Verify the Received Signal Strength

The FASTRACK Supreme establishes a call only if the received signal is sufficiently strong.

To verify the received signal strength, do the following operations:

- Using a communication software such as HyperTerminal, enter the AT command **AT+CSQ**. The response returned has the following format:  
**+CSQ: <rssi>, <ber>** with:
  - **<rssi>** = received signal strength indication,
  - **<ber>** = channel bit error rate.
- Verify the **<rssi>** value returned using the Table 6 below.

**Table 6: Values of received signal strength**

Value of received signal strength indication (<rssi>)	Interpretation of the received signal strength
0 - 10	Insufficient(*)
11 - 31	Sufficient(*)
32 - 98	Not defined
99	No measure available

(\*) Based on general observations.

For further information on AT commands, refer to "AT Commands Interface Guide" [6].

#### 5.6 Check the Pin Code Status

To check that the pin code has been entered, use a communication software such as a HyperTerminal, then enter **AT+CPIN?** command.

The table below gives the main responses returned:

**Table 7: AT+CPIN Responses**

AT+CPIN response (*)	Interpretation
+CPIN: READY	Code PIN has been entered
+CPIN: SIM PIN	Code PIN has not been entered

(\*)For further information on the other possible responses and their meaning, refer to "AT Commands Interface Guide" [6].

#### 5.7 Switch between EU/US Band(s)

To switch between EU/US band(s) for the FASTRACK Supreme, use a communication software such as a HyperTerminal, then enter **AT+WMBS=<band> [, <param>]** command.

The table below gives the commands for various band(s) selection:

## Fastrack Supreme User Guide

### Using the FASTRACK Supreme Plug & Play

**Table 8: AT+WMBS Band Selection**

AT+WMBS response (*)	Interpretation
AT+WMBS=0 , x	Select mono band mode 850MHz.
AT+WMBS=1 , x	Select mono band mode extended 900MHz
AT+WMBS=2 , x	Select mono band mode 1800MHz
AT+WMBS=3 , x	Select mono band mode 1900MHz
AT+WMBS=4 , x	Select dual band mode 850/1900MHz
AT+WMBS=5 , x	Select dual band mode extended 900MHz/1800MHz
AT+WMBS=6 , x	Select dual band mode extended 900MHz/1900MHz

(\*)For further information on the other possible responses and their meaning, refer to "AT Commands Interface Guide" [6].

Remark:

**x=0** : The Plug & Play will have to be reset to start on specified band(s).

**x=1** : The change is effective immediately. This mode is forbidden while in communication and during Plug & Play initialization.

Refer to "AT Commands Interface Guide" [6] for further information on AT commands.

### 5.8 Check the Band(s) Selection

To check the band selection for the FASTRACK Supreme, use a communication software such as a HyperTerminal, then enter **AT+WMBS?** command.

The table below gives the main responses returned:

**Table 9: AT+WMBS Responses**

AT+WMBS response (*)	Interpretation
+WMBS : 0 , x	Mono band mode 850MHz is selected
+WMBS : 1 , x	Mono band mode extended 900MHz is selected
+WMBS : 2 , x	Mono band mode 1800MHz is selected
+WMBS : 3 , x	Mono band mode 1900MHz is selected
+WMBS : 4 , x	Dual band mode 850/1900MHz are selected
+WMBS : 5 , x	Dual band mode extended 900MHz/1800MHz are selected
+WMBS : 6 , x	Dual band mode extended 900MHz/1900MHz are selected

(\*)For further information on the other possible responses and their meaning, refer to "AT Commands Interface Guide" [6].

## Fastrack Supreme User Guide

### Using the FASTRACK Supreme Plug & Play

#### 5.9 Verify the FASTRACK Supreme Network Registration

1. Make sure a valid SIM card has been previously inserted and locked in the FASTRACK Supreme SIM card holder.
2. Using a communication software such as a HyperTerminal, enter the following AT commands:
  - a. **AT+CPIN=xxxx** to enter PIN code xxxx.
  - b. **AT+WMBS?** To check the current band setting in the Plug & Play
  - c. **AT+WMBS=<Band> [ , <param> ]** To switch band/mode when needed
  - d. **AT+CREG?** . To ascertain the registration status.  
The format of the returned response is as follows:  
**+CREG: <mode> , <stat>** with:
    - **<mode>** = unsolicited registration message configuration,
    - **<stat>** = registration state.
3. Verify the state of registration according the returned value given in the table below.

**Table 10: Values of network registration**

Returned Value (*) <mode> , <stat>	Network registration
+CREG: 0,0	No (not registered)
+CREG: 0,1	Yes (registered, home network)
+CREG: 0,5	Yes (registered, roaming)

(\*)For further information on the other returned values and their meaning, refer to "AT Commands Interface Guide" [6].

## Fastrack Supreme User Guide

### Using the FASTRACK Supreme Plug & Play

If the FASTRACK Supreme is not registered, perform the following procedure:

- Check the connection between the FASTRACK Supreme and the antenna.
- Verify the signal strength to determine the received signal strength (refer to Section 5.5).

**Note:** For information on AT command relating to the network registration in GPRS mode, and in particular: CGREG, CGCLASS, CGATT, refer to "AT Commands Interface Guide" [6].

#### 5.10 Main AT Commands for the Plug & Play

The table below lists the main AT commands required for starting the Plug & Play.

For other AT commands available or further information on the AT commands, refer to "AT Commands Interface Guide" [6].

**Table 11: Main usual AT commands for the Plug & Play**

Description	AT commands	FASTRACK Supreme Plug & Play, response	Comment
Check for selected band(s)	AT+WMBS?	+WMBS:<Band>,<ResetFlag> OK	Current selected band mode is return
Band(s) switch	AT+WMBS=<Band>	OK	Band switch is accepted, Plug & Play has to be reset for change to be effective
	AT+WMBS=<Band>,0	OK	Band switch is accepted, Plug & Play has to be reset for change to be effective
	AT+WMBS=<Band>,1	OK	Band switch is accepted and GSM stack restarted
	AT+WMBS=<Band>	+CME ERROR: 3	Band not allowed
Enter PIN Code	AT+CPIN=xxxx (xxxx = PIN code)	OK	PIN Code accepted.
		+CME ERROR: 16	Incorrect PIN Code (with +CMEE = 1 mode) (1*)
		+CME ERROR: 3	PIN code already entered (with +CMEE = 1 mode) (1*)
Network registration checking	AT+CREG?	+CREG: 0,1	FASTRACK Supreme Plug & Play registered on the network.
		+CREG: 0,2	FASTRACK Supreme Plug & Play not registered on the network, registration attempt.

## Fastrack Supreme User Guide

### Using the FASTRACK Supreme Plug & Play

Description	AT commands	FASTRACK Supreme Plug & Play response	Comment
		+CREG: 0,0	FASTRACK Supreme Plug & Play not registered on the network, no registration attempt.
Receiving an incoming call	ATA	OK	Answer the call.
Initiate a call	ATD<phone number>; (Don't forget the « ; » at the end for « voice » call)	OK	Communication established.
		+CME ERROR: 11	PIN code not entered (with +CMEE = 1 mode).
		+CME ERROR: 3	AOC credit exceeded or a communication is already established.
Initiate an emergency call	ATD112; (Don't forget the « ; » at the end for « voice » call)	OK	Communication established.
Communication loss		NO CARRIER	
Hang up	ATH	OK	
Store the parameters in EEPROM	AT&W	OK	The configuration settings are stored in EEPROM.

(1\*) The command "AT+CMEE=1" switch to a mode enabling more complete error diagnostics.

### 5.11 Firmware Upgrade Procedure

The firmware upgrade procedure is used to update the firmware embedded into the FASTRACK Supreme.

That procedure consists in downloading the firmware into internal memories through the RS232 serial link available on the SUB-D 15-pin connector.

Refer to "Firmware upgrade procedure" [8] for a detailed description of this procedure.

## Fastrack Supreme User Guide

### Troubleshooting

## 6 Troubleshooting

This section of the document describes possible problems encountered when using the FASTRACK Supreme and their solutions.

To review other troubleshooting information, refer the 'FAQs' (Frequently Asked Questions) page at [www.wavecom.com](http://www.wavecom.com) or use the following link:  
<http://www.wavecom.com/support/faqs.php>

### 6.1 No Communication with the FASTRACK Supreme through the Serial Link

If the FASTRACK Supreme does not answer to AT commands through the serial link, refer to the table below for possible causes and solutions.

**Table 12: Solutions for no connection with FASTRACK Supreme through serial link**

If the Supreme returns	then ask	Action
Nothing	Is the FASTRACK Supreme powered correctly?	Make sure the external power supply is connected to the FASTRACK Supreme and provides a voltage in the range of 5.5 V to 32 V.
	Is the serial cable connected at both sides?	Check the serial cable connection
	Does the serial cable follow correctly pin assignment shown in paragraph 3.2.1.2.	Connect the cable by following pin assignment given in paragraph 3.2.1.1.
Nothing or non-significant characters	Is the communication program properly configured on PC?	Ensure the setting of the communication program is fit to setting of FASTRACK Supreme. FASTRACK Supreme factory setting is: Data bits = 8 Parity = none Stop bits = 1 Baud = 115 200 bps. Flow control = hardware
	Is there another program interfering with the communication program (i.e. Conflict on communication port access)	Close the interfering program.

### 6.2 Receiving "ERROR" Message

The FASTRACK Supreme returns an "ERROR" message (in reply to an AT command) in the following cases:



## Fastrack Supreme User Guide

### Troubleshooting

- AT command syntax is incorrect: check the command syntax (refer to "AT Commands Interface Guide" [6]),
- AT command syntax is correct, but transmitted with wrong parameters:
- Enter the **AT+CMEE=1** command in order to change the error report method to the verbose method, which includes the error codes.
- Enter again the AT command which previously caused the reception of "ERROR" message in order to get the Mobile Equipment error code.

When the verbose error report method is enabled, the response of the FASTRACK Supreme in case of error is as follows:

- Either +CME ERROR: <error result code>,
- Or +CMS ERROR: <error result code>.

Refer to "AT Commands Interface Guide" [6] for error result code description and further details on the **AT+CMEE** command.

**Note:** It is strongly recommended to always enable the verbose error report method to get the Mobile Equipment error code (enter **AT +CMEE=1** command).

### 6.3 Receiving "NO CARRIER" Message

If the FASTRACK Supreme returns a "NO CARRIER" message upon an attempted call (voice or data), then refer to the table below for possible causes and solutions.

## Fastrack Supreme User Guide

## Troubleshooting

Table 13: Solutions for "NO CARRIER" message

If the Supreme returns...	Then ask...	Action...
"NO CARRIER"	Is the received signal strong enough?	Refer to section 5.5 to verify the strength of the received signal.
	Is the FASTRACK Supreme registered on the network?	Refer to section 5.9 to verify the registration.
	Is the antenna properly connected?	Refer to section 8.2.7.3 for antenna requirements.
	Is the band selection correction?	Refer to Section 7.2 for band switch
"NO CARRIER" (when trying to issue a voice communication)	Is the semicolon (;) entered immediately after the phone number in the AT command?	Ensure that the semicolon (;) is entered immediately after the phone number in the AT command. e.g. <b>ATD#####;</b>
"NO CARRIER" (when trying to issue a data communication)	Is the SIM card configured for data / fax calls?	Configure the SIM card for data / fax calls (Ask your network provider if necessary).
	Is the selected bearer type supported by the called party?	Ensure that the selected bearer type is supported by the called party.
	Is the selected bearer type supported by the network?	Ensure that the selected bearer type is supported by the network.  If no success, try bearer selection type by AT command: <b>AT+CBST=0,0,3</b>

If the FASTRACK Supreme returns a "NO CARRIER" message, you may have the **extended error code** by using AT command **AT+CEER**. Refer to the table below for interpretation of **extended error code**.

## Fastrack Supreme User Guide

### Troubleshooting

**Table 14: Interpretation of extended error code**

Error Code	Diagnostic	Hint
1	Unallocated phone number	
16	Normal call clearing	
17	User busy	
18	No user responding	
19	User alerting, no answer	
21	Call rejected	
22	Number changed	
31	Normal, unspecified	
50	Requested facility not subscribed	
68	ACM equal or greater than ACMmax	Credit of your pre-paid SIM card expired.
252	Call barring on outgoing calls	
253	Call barring on incoming calls	
3, 6, 8, 29, 34, 38, 41, 42, 43, 44, 47, 49, 57, 58, 63, 65, 69, 70, 79, 254	Network causes	See "AT Commands Interface Guide" [6] for further details or call network provider.

**Note:** For all other codes, and/or details, see AT commands documentation [6].

## 7 Functional Description

### 7.1 Architecture

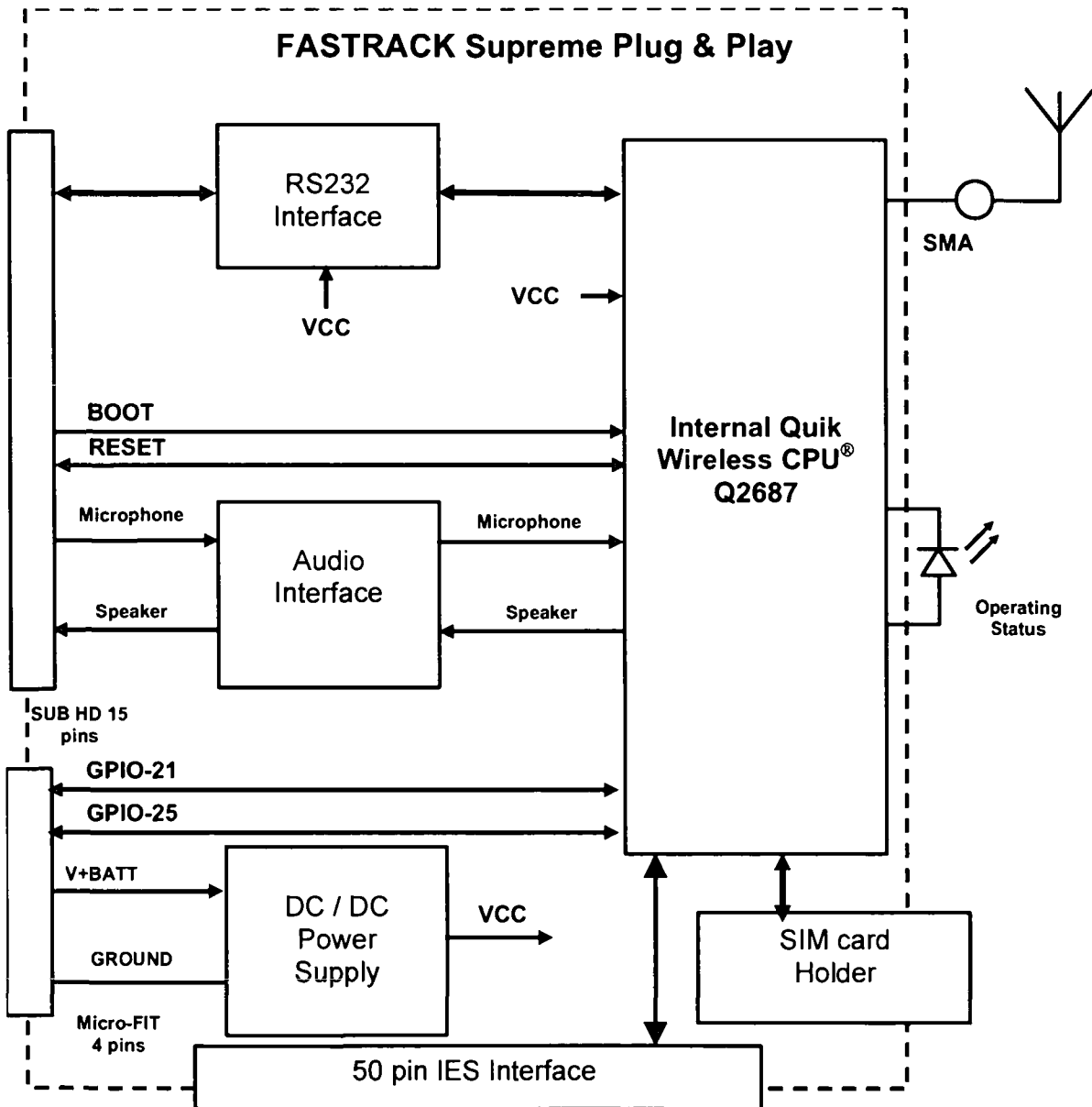

Figure 15: Functional architecture

## Fastrack Supreme User Guide

### Functional Description

## 7.2 EU and US Bands

### 7.2.1 General Presentation

The FASTRACK Supreme is a quad band Plug & Play. It supports either EU bands (EGSM900/DCS1800) or US bands (GSM850/ PCS1900), depending on the band setting within the Plug & Play. Users are free to switch between EU bands and US bands by simple AT commands when the selected bands are supported.

### 7.2.2 AT COMMAND for Bands Switch

EU/US band is easily switched/checked by AT command **AT+WMBS**.

For detail, please refer to Section 5.7 and 5.8.

## 7.3 Power Supply

### 7.3.1 General Presentation

The FASTRACK Supreme is supplied by an external DC voltage (V+BATTERY) from +5.5 V to +32 V at 2.2 A.

Main regulation is made with an internal DC/DC converter in order to supply all the internal functions with a DC voltage.

Correct operation of the FASTRACK Supreme in communication mode is not guaranteed if input voltage (V+BATTERY) falls below 5.5 V.

**Note:** The minimum input voltage specified here is at the FASTRACK Supreme input. Be careful of the input voltage decrease caused by the power cable. See paragraph 8.2.1 for more information.

### 7.3.2 Protections

The FASTRACK Supreme is protected by a 800 mA / 250 V fuse directly bonded on the power supply cable.

The FASTRACK Supreme is also protected against voltage over +32 V.

Filtering guarantees:

- EMI/RFI protection in input and output,
- Signal smoothing.

## 7.4 RS232 Serial Link

### 7.4.1 General Presentation

The RS232 interface performs the voltage level adaptation (V24/CMOS  $\Leftrightarrow$  V24/V28) between the internal FASTRACK Supreme Plug & Play (DCE) and the external world (DTE).

## Fastrack Supreme User Guide

### Functional Description

The RS232 interface is internally protected (by ESD protection) against electrostatic surges on the RS232 lines.

Filtering guarantees:

- EMI/RFI protection in input and output,
- Signal smoothing.

Signals available on the RS232 serial link are:

- TX data (CT103/TX),
- RX data (CT104/RX),
- Request To Send (CT105/RTS),
- Clear To Send (CT106/CTS),
- Data Terminal Ready (CT108-2/DTR),
- Data Set Ready (CT107/DSR),
- Data Carrier Detect (CT109/DCD),
- Ring Indicator (CT125/RI).

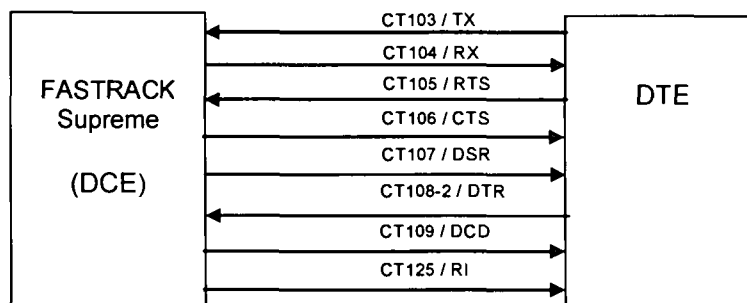

**Figure 16: RS232 Serial Link signals**

RS232 interface has been designed to allow flexibility in the use of the serial interface signals. However, the use of TX, RX, CTS and RTS signals is mandatory, which is not the case for DTR, DSR, DCD and RI signals which can be not used.

#### 7.4.2 Autobauding Mode

The autobauding mode allows the FASTRACK Supreme to detect the baud rate used by the DTE connected to the RS232 serial link.

Autobauding mode is controlled by AT commands. See "AT Commands Interface Guide" [6] for details on this function.

## Fastrack Supreme User Guide

### Functional Description

#### 7.4.3 Pin Description

Signal	Sub HD connector Pin number	I/O	I/O type RS232 STANDARD	Description
CTXD/CT103	2	I	TX	Transmit serial data
CRXD/CT104	6	O	RX	Receive serial data
CRTS/CT105	12	I	RTS	Request To Send
CCTS/CT106	11	O	CTS	Clear To Send
CDSR/CT107	7	O	DSR	Data Set Ready
CDTR/CT108-2	8	I	DTR	Data Terminal Ready
CDCD/CT109	1	O	DCD	Data Carrier Detect
CRI/CT125	13	O	RI	Ring Indicator
CT102/GND	9		GND	Ground

#### 7.4.4 Serial Port Auto shut down Feature

The UART1 can be shut down when there is no activity between the DTE and the FASTRACK Supreme Plug & Play. This can help for improving power consumption performance.

Serial Port Auto shut down feature is easily controlled by AT command **AT+WASR**.

- **AT+WASR=1** for entering the serial port auto shut down mode
- **AT+WASR=0** for exiting the serial port auto shut down mode

Refer to "AT Commands Interface Guide" [6] for further information on AT commands.

**CAUTION:** GPIO24 is reserved for serial port auto shut down feature. It is prohibited for customer use. Improper access to GPIO24 by customer may lead to unexpected behavior on UART1 performance.

## Fastrack Supreme User Guide

### Functional Description

#### 7.5 General Purpose Input/Output (GPIO)

The FASTRACK Supreme provides two General Purpose Input / Output lines available for external use: GPIO21 and GPIO25.

These GPIOs may be controlled by AT commands:

- **AT+WIOW** for a write access to the GPIO value, when the GPIO is used as an output,
- **AT+WIOR** for a read access to the GPIO value, when the GPIO is used as an input.

Refer to "AT Commands Interface Guide" [6] for further information on AT commands.

After reset, both GPIOs are configured as inputs. The **AT+WIOM** command has to be used to change this configuration (refer to "AT Commands Interface Guide" [6] for further details).

Pin description

Signal	Power Supply connector (4-pin Micro-Fit)	I/O	I/O Voltage	Reset state	Description	Multiplex with
GPIO21	3	I/O	2V8	Undefined	General Purpose I/O	No mux
GPIO25	4	I/O	2V8	Z	General Purpose I/O	INT1

#### Notes:

- The power supply cable may need to be modified due to the GPIO signals (GPIO21 & GPIO25) available on the 4-pin Micro-FIT connector of the FASTRACK Supreme.
- The previous generation M1306B have GPIO4 and GPIO5 being replaced by GPIO21 and GPIO25 respectively, for which both are of LOW level at reset state.

#### 7.6 BOOT

This signal must not be connected. Its use is strictly reserved to Wavecom or competent retailers.

Caution: Previous generation M1306B has BOOT signal of HIGH level at 2.8V. But the FASTRACK Supreme now of 1.8V BOOT instead.

#### 7.7 RESET

##### 7.7.1 General presentation

This signal is used to force a reset procedure by providing low level during at least 200  $\mu$ s.

This signal must be considered as an emergency reset only. A reset procedure is automatically driven by an internal hardware during the power-up sequence.



## Fastrack Supreme User Guide

### Functional Description

This signal may also be used to provide a reset to an external device. It then behaves as an output. If no external reset is necessary, this input may be left open, if used (emergency reset), it has to be driven either by an open collector or an open drain output:

- RESET pin 14 = 0, for FASTRACK Supreme Reset,
- RESET pin 14 = 1, for normal mode.

### Pin description

Signal	Sub HD 15-Pin connector Pin number	I/O	I/O type	Voltage	Description
RESET	14	I/O	Open Drain	1V8	FASTRACK Supreme Reset

Caution: Previous generation M1306B has RESET signal of HIGH level at 2.8V. But the FASTRACK Supreme now of 1.8V RESET instead.

#### Additional comments on RESET:

The RESET process is activated either by the external RESET signal or by an internal signal (coming from a RESET generator). This automatic reset is activated at Power-up.

The FASTRACK Supreme remains in RESET mode as long as the RESET signal is held low.

**Caution:** This signal should be used only for "emergency" reset.

A software reset is always preferred to a hardware reset.

**Note:** See "AT Commands Interface Guide" [6] for further information on software reset.

#### 7.7.2 Reset Sequence

To activate the "emergency" reset sequence, the RESET signal has to be set to low for 200  $\mu$ s minimum.

As soon as the reset is done, the AT interface answers "OK" to the application. For this, the application must send **AT**.

If the application manages hardware flow control, the AT command may be sent during the initialization phase. Another solution is to use the **AT+WIND** command to get an unsolicited status from the FASTRACK Supreme.

For further details, refer to AT commands "AT Commands Interface Guide" [6].



Fastrack Supreme User Guide  
Functional Description

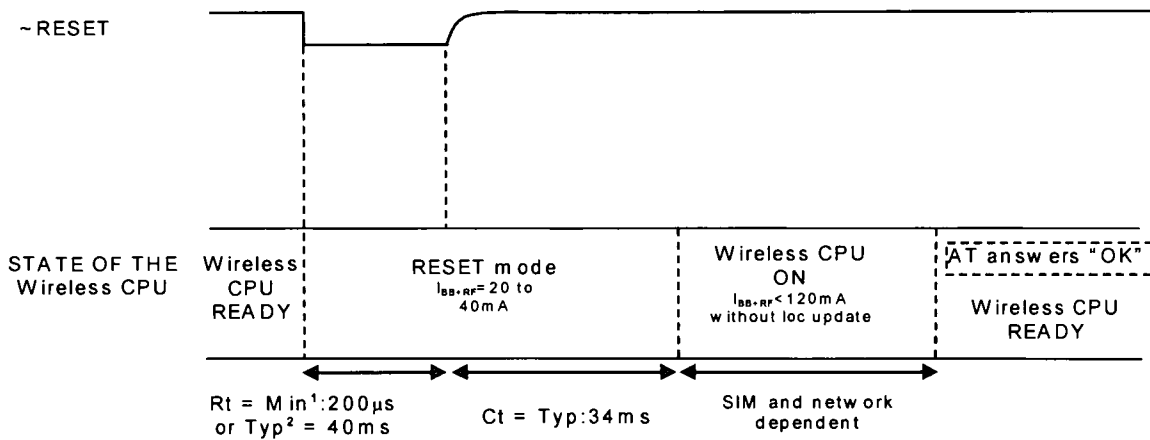

Figure 17: Reset sequence diagram

7.8 Audio

Audio interface is a standard one for connecting a phone handset.

Echo cancellation and noise reduction features are also available to improve the audio quality in case of hand-free application.

7.8.1 Microphone Inputs

The microphone inputs are differential ones in order to reject common mode noise and TDMA noise.

They already include the convenient biasing for an electret microphone (0.5 mA and 2 Volts) and are ESD protected.

This electret microphone may be directly connected to these inputs allowing an easy connection to a handset.

The microphone impedance must be around 2 kΩ.

AC coupling is already embedded in the Wireless CPU®.

The gain of the microphone inputs is internally adjusted and may be tuned from 30 dB to 51 dB using an **AT +VGT** command (refer to AT commands documentation [6]).

Pin description

Signal	Sub D 15-pin Pin #	I/O	I/O type	Description
CMIC2P	4	I	Analog	Microphone positive input
CMIC2N	5	I	Analog	Microphone negative input

## Fastrack Supreme User Guide

### Functional Description

#### 7.8.2 Speaker Outputs

This connection is differential to reject common mode noise and TDMA noise.

Speaker outputs are connected to internal push-pull amplifiers and may be loaded down between 32 to 150 Ohms and up to 1 nF (see details in table *Speaker gain vs Max output voltage*, in "AT Commands Interface Guide" [6]). These outputs may be directly connected to a speaker.

The output power may be adjusted by step of 2 dB. The gain of the speaker outputs is internally adjusted and may be tuned using an **AT +VGR** command (refer to AT commands documentation [6]).

#### Pin description

Signal	Sub D 15-pin Pin #	I/O	I/O type	Description
CSPK2P	10	O	Analog	Speaker positive output
CSPK2N	15	O	Analog	Speaker negative output

## Fastrack Supreme User Guide

### Functional Description

#### 7.9 Real Time Clock (RTC)

The FASTRACK Supreme has now implemented the Real Time Clock for saving date and time when the Plug & Play is unplugged from the DC power supply through the DC power cable.

Item	Min	Typical	Max
Charging Time start from fully discharged to fully charged		940 min	
RTC Time Period*	Guarantee	2475 min	
	Non-guarantee	5225 min	

Remark: The RTC time period is measured from the RTC battery is fully charged before being unplugged from the DC power source.

#### 7.10 FLASH LED

The FASTRACK Supreme has a red LED indicator to show the status of the GSM network. For detail description of the various status, please refer to Section 5.3.

However, during operation mode of Slow Standby, there will be no network registration and so the red LED indicator will always be ON. It is possible for user to deactivate the LED indication during Slow Standby mode, in order to reduce power consumption.

The Flash LED can be deactivated by AT command `at+whcnf=1,0`

The Flash LED can be activated by AT command `at+whcnf=1,1`

However, the new setting will be taken into account only after a restart. For detail, please refer to Document[6].

## Fastrack Supreme User Guide

### Technical Characteristics

## 8 Technical Characteristics

### 8.1 Mechanical Characteristics

Table 15: Mechanical characteristics

<b>Dimensions</b>	73 x 54.5 x 25.5 mm (excluding connectors)
<b>Overall Dimension</b>	88 x 54.5 x 25.5 mm
<b>Weight</b>	≈ 80 grams (FASTRACK Supreme only) < 120 grams (FASTRACK Supreme + bridles + power supply cable)
<b>Volume</b>	101.5 cm <sup>3</sup>
<b>Housing</b>	Aluminum profiled

The next page gives the dimensioning diagram of the FASTRACK Supreme including the clearance areas to take into account for the FASTRACK Supreme installation.

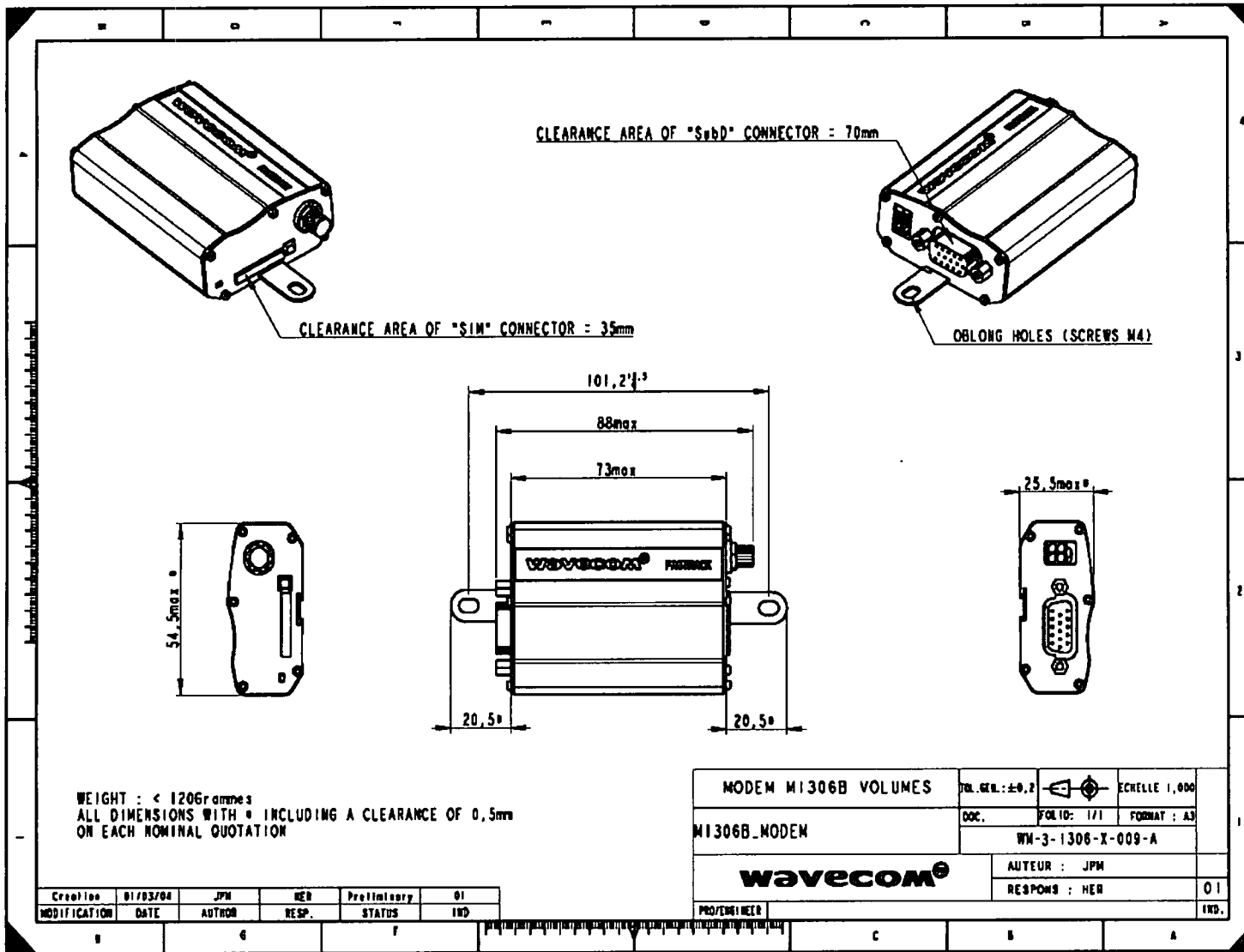

Figure 18: Dimensioning diagram

**wavecom**<sup>®</sup> confidential

This document is the sole and exclusive property of WAVECOM. Not to be disclosed or divulged without prior written agreement.

WA\_DEV\_Fastrack\_SUP\_001

Page: 60 / 77

5 June 2007

## Fastrack Supreme User Guide

### Technical Characteristics

## 8.2 Electrical Characteristics

### 8.2.1 Power Supply

**Table 16: Electrical characteristics**

<b>Operating Voltage ranges</b>	5.5 V to 32 V DC.
<b>Maximum current</b>	480 mA Average at 5.5V. 2.1 A Peak at 5.5 V. (TBC)

**Note:**

The FASTRACK Supreme is permanently powered once the power supply is connected. The following table describes the consequences of over-voltage and under-voltage with the FASTRACK Supreme.

**Warning:**

All the input voltages specification described in this Section are at the FASTRACK Supreme input. While powering the FASTRACK Supreme, take into account the input drop caused by the power cable. With the delivered cable, this input drop is around 700 mV at 5.5 V and 220 mV at 32V.

**Table 17: Effects of power supply defect**

<b>If the voltage</b>	<b>then</b>
falls below 5.5 V,	the GSM communication is not guaranteed.
is over 32 V (Transient peaks),	the FASTRACK Supreme guarantees its own protection.
Is over 32 V (continuous overvoltage)	the protection of the FASTRACK Supreme is done by the fuse (the supply voltage is disconnected).

The fuse is a 800 mA / 250 V FAST-ACTING 5\*20mm. See Section 10 for recommended references.

The following table provides information on power consumption of the FASTRACK Supreme, assuming an operating temperature of +25 °C and using a 3 V SIM card.



**Fastrack Supreme User Guide**  
**Technical Characteristics**

**8.2.2 Power Consumption**

The following table provides information on power consumption of the FASTRACK Supreme, assuming an operating temperature of +25 °C and using a 3 V SIM card.

**Table 18: Power consumption (1\*)**

Power Consumption in E-GSM 900/DCS 1800 MHz - GPRS class 10				E-GSM 900	DCS 1800
GSM	I <sub>peak</sub>	GSM900: During TX bursts @ PCL5 DCS1800 : During TX bursts @ PCL0	@ 5.5V	TBC	TBC
			@ 13.2V	TBC	TBC
			@ 32V	TBC	TBC
	I <sub>avg</sub>	GSM900 : Average @ PCL5 DCS1800 : Average @ PCL0	@ 5.5V	TBC	TBC
			@ 13.2V	TBC	TBC
			@ 32V	TBC	TBC
GPRS Class 2	I <sub>peak</sub>	GSM900: During 1TX bursts @ PCL5 DCS1800 : During 1TX bursts @ PCL0	@ 5.5V	TBC	TBC
			@ 13.2V	TBC	TBC
			@ 32V	TBC	TBC
	I <sub>avg</sub>	GSM900 : Average 1TX/1RX @PCL5 DCS1800 : Average 1TX/1RX @PCL0	@ 5.5V	TBC	TBC
			@ 13.2V	TBC	TBC
			@ 32V	TBC	TBC
GPRS Class 10	I <sub>peak</sub>	GSM900: During 2TX bursts @ PCL5 (Gamma 3) DCS1800 : During 2TX bursts @ PCL0 (Gamma 2)	@ 5.5V	TBC	TBC
			@ 13.2V	TBC	TBC
			@ 32V	TBC	TBC
	I <sub>avg</sub>	GSM900 : Average 2TX/3RX @ PCL5 (Gamma 3) DCS1800 : Average 2TX/3RX @ PCL0 (Gamma 2)	@ 5.5V	TBC	TBC
			@ 13.2V	TBC	TBC
			@ 32V	TBC	TBC
EGPRS Class 2	I <sub>peak</sub>	GSM900: During 1TX bursts @ PCL8 (Gamma 6) DCS1800 : During 1TX bursts @ PCL2 (Gamma 5)	@ 5.5V	TBC	TBC
			@ 13.2V	TBC	TBC
			@ 32V	TBC	TBC
	I <sub>avg</sub>	GSM900 : Average 1TX/1RX @ PCL8 (Gamma 6) DCS1800 : Average 1TX/1RX @ PCL2 (Gamma 5)	@ 5.5V	TBC	TBC
			@ 13.2V	TBC	TBC
			@ 32V	TBC	TBC





**Fastrack Supreme User Guide**  
**Technical Characteristics**

Power Consumption in E-GSM 900/DCS 1800 MHz - GPRS class 10			E-GSM 900	DCS 1800	
<b>EGPRS Class 10</b>	<b>I<sub>peak</sub></b>	GSM900: During 2TX bursts @ PCL8 (Gamma 6) DCS1800 : During 2TX bursts @ PCL2 (Gamma 5)	@ 5.5V	TBC	TBC
			@ 13.2V	TBC	TBC
			@ 32V	TBC	TBC
	<b>I<sub>avg</sub></b>	GSM900 : Average 2TX/3RX @ PCL8 (Gamma 6) DCS1800 : Average 2TX/3RX @ PCL2 (Gamma 5)	@ 5.5V	TBC	TBC
			@ 13.2V	TBC	TBC
			@ 32V	TBC	TBC
<b>I<sub>avg</sub> in Fast Idle mode Page 9 (2*)</b>	Serial port auto shut down deactivated	@ 5.5V	33	TBC	
		@ 13.2V	TBC	TBC	
		@ 32V	TBC	TBC	
	Serial port auto shut down activated	@ 5.5V	17	TBC	
		@ 13.2V	TBC	TBC	
		@ 32V	TBC	TBC	
<b>I<sub>avg</sub> in Slow Idle mode Page 9 (3*)</b>	Serial port auto shut down deactivated	@ 5.5V	23	TBC	
		@ 13.2V	TBC	TBC	
		@ 32V	TBC	TBC	
	Serial port auto shut down activated	@ 5.5V	5	TBC	
		@ 13.2V	TBC	TBC	
		@ 32V	TBC	TBC	
<b>I<sub>avg</sub> in Fast Standby mode (4*)</b>	Serial port auto shut down deactivated	@ 5.5V	52	TBC	
		@ 13.2V	TBC	TBC	
		@ 32V	TBC	TBC	
	Serial port auto shut down activated	@ 5.5V	35	TBC	
		@ 13.2V	TBC	TBC	
		@ 32V	TBC	TBC	

## Fastrack Supreme User Guide

### Technical Characteristics

Power Consumption in E-GSM 900/DCS 1800 MHz - GPRS class 10			E-GSM 900	DCS 1800
<b>I<sub>avg</sub> in Slow Standby mode (with FLASH LED activated) (4*)</b>	Serial port auto shut down deactivated	@ 5.5V	24	TBC
		@ 13.2V	TBC	TBC
		@ 32V	TBC	TBC
	Serial port auto shut down activated	@ 5.5V	8	TBC
		@ 13.2V	TBC	TBC
		@ 32V	TBC	TBC
<b>I<sub>avg</sub> in Slow Standby mode (with FLASH LED deactivated) (4*)</b>	Serial port auto shut down deactivated	@ 5.5V	TBC	TBC
		@ 13.2V	TBC	TBC
		@ 32V	TBC	TBC
	Serial port auto shut down activated	@ 5.5V	4	TBC
		@ 13.2V	TBC	TBC
		@ 32V	TBC	TBC

(1\*): The power consumption might vary by 5 % over the whole operating temperature range (-20 °C to +55 °C).

(2\*): In this Mode, the RF function is active and the FASTRACK Supreme synchronized with the network, but there is no communication.

(3\*): In this Mode, the RF function is disabled, but regularly activated to keep the synchronization with the network. This Mode works only when the DTE send AT command to shut down the serial link by software approach (DTE turns DTR in inactive state).

(4\*): In this Mode, the RF function is disabled, and there is no synchronization with the network.

## Fastrack Supreme User Guide

### Technical Characteristics

#### 8.2.3 Audio Interface

The audio interface is available through the Sub HD 15-pin connector.

**Table 19: Audio parameters characteristics**

Audio parameters	Min	Typ	Max	Unit	Comments
Microphone input current @2 V/2 k $\Omega$		0.5		mA	
Absolute microphone input voltage			100	mVpp	AC voltage
Speaker output current 150 $\Omega$ //1 nF		16		mA	
Absolute speaker impedance	32	50		$\Omega$	
Impedance of the speaker amplifier output in differential mode			1	$\Omega$	+/-10 %

**Table 20: Microphone inputs internal audio filter characteristics**

Frequency	Gain
0-150 Hz	< -22 dB
150-180 Hz	< -11 dB
180-200 Hz	< -3 dB
200-3700 Hz	0 dB
>4000 Hz	< -60 dB

**Table 21: Recommended characteristics for the microphone:**

Feature	Value
Type	Electret 2 V / 0.5 mA
Impedance	Z = 2 k $\Omega$
Sensitivity	-40 dB to -50 dB
SNR	> 50 dB
Frequency response	compatible with the GSM specifications

## Fastrack Supreme User Guide

### Technical Characteristics

**Table 22: Recommended characteristics for the speaker:**

Feature	Value
Type	10 mW, electro-magnetic
Impedance	Z = 32 to 50 $\Omega$
Sensitivity	110 dB SPL min. (0 dB = 20 $\mu$ Pa)
Frequency response	compatible with the GSM specifications

#### 8.2.4 General Purpose Input/Output

Both GPIO21 and GPIO25 may be interfaced with a component that comply with 3 Volts CMOS levels.

**Table 23: Operating conditions**

Parameter	I/O type	Min	Typ	Max	Condition
V <sub>IL</sub>	CMOS			0.84 V	
V <sub>IH</sub>	CMOS	1.96 V			
V <sub>OL</sub>	CMOS			0.4 V	I <sub>OL</sub> = -4 mA
V <sub>OH</sub>	CMOS	2.4 V			I <sub>OH</sub> = 4 mA
I <sub>OH</sub>				4mA	
I <sub>OL</sub>				-4mA	

Clamping diodes are present on I/O pads.

#### 8.2.5 SIM Interface

**Table 24: SIM card characteristics**

SIM card	1.8V / 3 V
----------	------------

#### 8.2.6 RESET Signal

**Table 25: Electrical characteristics**

Parameter	Min	Typ	Max	Unit
Input Impedance ( R )*		330K		k $\Omega$
Input Impedance ( C )		10n		nF

\*Internal pull-up

## Fastrack Supreme User Guide

### Technical Characteristics

**Table 26: Operating conditions**

Parameter	Minimum	Typ	Maximum	Unit
~RESET time (Rt) <sup>1</sup>	200			µs
~RESET time (Rt) <sup>2</sup> at power up only	20	40	100	ms
Cancellation time (Ct)		34		ms
V <sub>H</sub>	0.57			V
V <sub>IL</sub>	0		0.57	V
V <sub>IH</sub>	1.33			V

\* V<sub>H</sub>: Hysteresis Voltage

1 This reset time is the minimum to be carried out on the ~RESET signal when the power supply is already stabilized.

2 This reset time is internally carried out by the Wireless CPU power supply supervisor only when the Wireless CPU power supplies are powered ON.

### 8.2.7 RF Characteristics

#### 8.2.7.1 Frequency Ranges

**Table 27: Frequency ranges**

Characteristic	GSM 850	E-GSM 900	DCS 1800	PCS 1900
Frequency TX	824 to 849 MHz	880 to 915 MHz	1710 to 1785 MHz	1850 to 1910 MHz
Frequency RX	869 to 894 MHz	925 to 960 MHz	1805 to 1880 MHz	1930 to 1990 MHz

## Fastrack Supreme User Guide

### Technical Characteristics

#### 8.2.7.2 RF Performances

RF performances are compliant with the ETSI recommendation GSM 05.05.

The RF performances for receiver and transmitter are given in the table below.

**Table 28: Receiver and transmitter RF performances**

<b>Receiver</b>	
E-GSM900/GSM850 Reference Sensitivity	-104 dBm Static & TUHigh
DCS1800/PCS1900 Reference Sensitivity	-102 dBm Static & TUHigh
Selectivity @ 200 kHz	> +9 dBc
Selectivity @ 400 kHz	> +41 dBc
Linear dynamic range	63 dB
Co-channel rejection	>= 9 dBc
<b>Transmitter</b>	
Maximum output power (E-GSM 900/GSM850) at ambient temperature	33 dBm +/- 2 dB
Maximum output power (DCS1800/PCS1900) at ambient temperature	30 dBm +/- 2 dB
Minimum output power (E-GSM 900/GSM850) at ambient temperature	5 dBm +/- 5 dB
Minimum output power (DCS1800/PCS1900) at ambient temperature	0 dBm +/- 5 dB

## Fastrack Supreme User Guide

### Technical Characteristics

#### 8.2.7.3 External Antenna

The external antenna is connected to the FASTRACK Supreme via the SMA connector.

The external antenna must fulfill the characteristics listed in the table below.

**Table 29: External antenna characteristics**

Antenna frequency range	Quad-band GSM 850/GSM900/DCS1800/PCS1900 MHz
Impedance	50 Ohms nominal
DC impedance	0 Ohm
Gain (antenna + cable)	0 dBi
VSWR (antenna + cable)	2

**Note:** Refer to Section 10 for recommended antenna.

### 8.3 Environmental Characteristics

The FASTRACK Supreme Plug & Play is compliant with the following operating class. To ensure the proper operation of the FASTRACK Supreme, the temperature of the environment must be within a specific range as described in the table below.

**Table 30: Ranges of temperature**

Conditions	Temperature range
Operating / Class A	-20 °C to +55°C
Operating / Class B	-30 °C to +85°C
Storage	-40 °C to +85°C

#### Function Status Classification:

##### **Class A:**

The FASTRACK Supreme remains fully functional, meeting GSM performance criteria in accordance with ETSI requirements, across the specified temperature range.

##### **Class B:**

The FASTRACK Supreme remains fully functional, across the specified temperature range. Some GSM parameters may occasionally deviate from the ETSI/PTCRB specified requirements and this deviation does not affect the ability of the FASTRACK Supreme to connect to the cellular network and function fully, as it does within the Class A range.

## Fastrack Supreme User Guide

### Technical Characteristics

The detailed climatic and mechanics standard environmental constraints applicable to the FASTRACK Supreme are listed in the table below:

**Table 31: Environmental standard constraints**

Environmental Tests (IEC TR 60721-4)		Environmental Classes (IEC 60721-3)			
Tests	Standards	Storage (IEC 60721-3-1) Class IE13	Transportation (IEC 60721-3-2) Class IE23	Operation	
				Stationary (IEC 60721-3-3) Class IE35	Non-Stationary (IEC 60721-3-7) Class IE73
Cold	IEC 60068-2-1 : Ab/Ad	-25°C, 16 h	-40°C, 16 h	-5°C, 16 h	-5°C, 16 h
Dry heat	IEC 60068-2-2 : Bb/Bd	+70°C, 16 h	+70°C, 16 h	+55°C, 16 h	+55°C, 16 h
Change of temperature	IEC 60068-2-14 : Na/Nb	-33°C to ambient 2 cycles, t1=3 h 1 °C.min <sup>-1</sup>	-40°C to ambient 5 cycles, t1=3 h t2<3 min	-5°C to ambient 2 cycles, t1=3 h 0,5 °C.min <sup>-1</sup>	-5°C to ambient 5 cycles, t1=3 h t2<3 min
Damp heat	IEC 60068-2-56 : Cb	+30°C, 93% RH 96 h	+40°C, 93% RH 96 h minimum	+30°C, 93% RH, 96 h	+30°C, 93% RH, 96 h
Damp heat, cyclic	60068-2-30 : Db Variant 1 or 2	+40°C, 90% to 100% RH One cycle Variant 2	+55°C, 90% to 100% RH Two cycles Variant 2	+30°C, 90% to 100% RH Two cycles Variant 2	+40°C, 90% to 100% RH Two cycles Variant 1
Vibration (sinusoidal)	IEC 60068-2-6 : Fc	1-200 Hz 2 m.s <sup>-2</sup> 0,75 mm 3 axes 10 sweep cycles	1-500 Hz 10 m.s <sup>-2</sup> 3,5 mm 3 axes 10 sweep cycles	1-150 Hz 2 m.s <sup>-2</sup> 0,75 mm 3 axes 5 sweep cycles	1-500 Hz 10 m.s <sup>-2</sup> 3,5 mm 3 axes 10 sweep cycles
Vibration (random)	IEC 60068-2-64 : Fh	-	10-100 Hz / 1,0 m <sup>2</sup> .s <sup>-3</sup> 100-200 Hz / -3 dB.octave <sup>-1</sup> 200-2000 Hz / 0,5 m <sup>2</sup> .s <sup>-3</sup> 3 axes 30 min	-	-
Shock (half-sine)	IEC 60068-2-27 : Ea	-	-	50 m.s <sup>-2</sup> 6 ms 3 shocks 6 directions	150 m.s <sup>-2</sup> 11 ms 3 shocks 6 directions
Bump	IEC 60068-2-29 : Eb	-	250 m.s <sup>-2</sup> 6 ms 50 bumps vertical direction	-	-
Free fall	ISO 4180-2	-	Two falls in each specified attitude	-	2 falls in each specified attitude 0,025 m (<1kg)
Drop and topple	IEC 60068-2-31 : Ec	-	One drop on relevant corner One topple about each bottom edge	-	One drop on each relevant corner One topple on each of 4 bottom edges



## Fastrack Supreme User Guide

### Technical Characteristics

#### Notes:

##### **Short description of Class IE13 (For more information see standard IEC 60721-3-1)**

"Locations without controlled temperature and humidity, where heating may be used to raise low temperatures, locations in buildings providing minimal protection against daily variations of external climate, prone to receiving rainfall from carrying wind".

##### **Short description of Class IE23 (For more information, see standard IEC 60721-3-2)**

"Transportation in unventilated compartments and in conditions without protection against bad weather, in all sorts of trucks and trailers in areas of well developed road network, in trains equipped with buffers specially designed to reduce shocks and by boat".

##### **Short description of Class IE35 (For more information see standard IEC 60721-3-3)**

"Locations with no control on heat or humidity where heating may be used to raise low temperatures, to places inside a building to avoid extremely high temperatures, to places such as hallways, building staircases, cellars, certain workshops, equipment stations without surveillance".

##### **Short description of Class IE73 (For more information see standard IEC 60721-3-7)**

"Transfer to places where neither temperature nor humidity are controlled but where heating may be used to raise low temperatures, to places exposed to water droplets, products can be subjected to ice formation, these conditions are found in hallways and building staircases, garages, certain workshops, factory building and places for industrial processes and hardware stations without surveillance".

**Warning:** The specification in the above table applies to the FASTRACK Supreme product only. Customers are advised to verify that the environmental specification of the SIM Card used is compliant with the FASTRACK Supreme environmental specifications. Any application must be qualified by the customer with the SIM Card in storage, transportation and operation.

The use of standard SIM cards may drastically reduce the environmental conditions in which the Product can be used. These cards are particularly sensible to humidity and temperature changes. These conditions may produce oxidation of the SIM card metallic layers and cause, in the long term, electrical discontinuities. This is particularly true in left alone applications, where no frequent extraction/insertion of the SIM card is performed.

In case of mobility when the application is moved through different environments with temperature variations, some condensation may appear. These events have a negative impact on the SIM and may favor oxidation.

If the use of standard SIM card, with exposition to the environmental conditions described above, can not be avoided, special care must be taken in the integration of the final application in order to minimize the impact of these conditions. The solutions that may be proposed are:

- Lubrication of the SIM card to protect the SIM Contact from oxidation.
- Putting the FASTRACK Supreme Plug & Play in a waterproof enclosure with desiccant bags.

Lubrication of the SIM card had been tested by Wavecom (using Tutela Fluid 43EM from MOLYDUVAL) and gives very good results.

If waterproof enclosure with a desiccant solution is used, check with your desiccant retailer the quantity that must be used according to the enclosure dimensions. Ensure humidity has been removed before sealing the enclosure.

Any solution selected must be qualified by the customer on the final application.

To minimize oxidation problem on the SIM card, its manipulation must be done with the greatest precautions. In particular, the metallic contacts of the card must never be touched with bare fingers or any matter which

## Fastrack Supreme User Guide

### Technical Characteristics

may contain polluted materials liable to produce oxidation (such as, e.g. substances including chlorine). In case a cleaning of the Card is necessary, a dry cloth must be used (never use any chemical substance).

### 8.4 Conformity

The complete product complies with the essential requirements of article 3 of R&TTE 1999/5/EC Directive and satisfied the following standards:

Domain	Applicable standard
Safety standard	EN 60950 (ed.1999)
Efficient use of the radio frequency spectrum	EN 301 419-(v 4.1.1) EN 301 511 (V 7.0.1)
EMC	EN 301 489-1 (edition 2002) EN 301 489-7 (edition 2002)
Global Certification Forum – Certification Criteria	GCF-CC V3.13.0
PTCRB	
FCC	
IC	

### 8.5 Protections

#### 8.5.1 Power Supply

The FASTRACK Supreme is protected by a 800 mA / 250 V fuse directly bonded on the power supply cable.  
 The model of fuse used is: **FSD 800 mA / 250 V FAST-ACTING**.

## Fastrack Supreme User Guide

### Technical Characteristics

#### 8.5.2 Overvoltage

The FASTRACK Supreme is protected against voltage over +32 V.

When input voltages exceed +32 V, the supply voltage is disconnected in order to protect the internal electronic components from an overvoltage.

#### 8.5.3 Electrostatic Discharge

The FASTRACK Supreme withstands ESD according to IEC 1000-4-2 requirements for all accessible parts of the FASTRACK Supreme except the RF part:

- 8 kV of air discharge,
- 4 kV of contact discharge.

#### 8.5.4 Miscellaneous

Filtering guarantees:

- EMI/RFI protection in input and output,
- Signal smoothing.

## 9 Safety recommendations

### 9.1 General Safety

It is important to follow any special regulations regarding the use of radio equipment due in particular to the possibility of radio frequency (RF) interference. Please follow the safety advice given below carefully.

Switch OFF your Wireless CPU®:

- When in an aircraft. The use of cellular telephones in an aircraft may endanger the operation of the aircraft, disrupt the cellular network and is illegal. Failure to observe this instruction may lead to suspension or denial of cellular telephone services to the offender, or legal action or both,
- When at a refueling point,
- When in any area with a potentially explosive atmosphere which could cause an explosion or fire,
- In hospitals and any other place where medical equipment may be in use.

Respect restrictions on the use of radio equipment in:

- Fuel depots,
- Chemical plants,
- Places where blasting operations are in progress,
- Any other area where signalization reminds that the use of cellular telephone is forbidden or dangerous.
- Any other area where you would normally be advised to turn off your vehicle engine.

There may be a hazard associated with the operation of your FASTRACK Supreme Plug & Play close to inadequately protected personal medical devices such as hearing aids and pacemakers. Consult the manufacturers of the medical device to determine if it is adequately protected.

Operation of your FASTRACK Supreme Plug & Play close to other electronic equipment may also cause interference if the equipment is inadequately protected. Observe any warning signs and manufacturers' recommendations.

The FASTRACK Supreme Plug & Play is designed for and intended to be used in "**fixed**" and "**mobile**" applications:

- "**Fixed**" means that the device is physically secured at one location and is not able to be easily moved to another location.
- "**Mobile**" means that the device is designed to be used in other than fixed locations and generally in such a way that a separation distance of at least 20 cm (8 inches) is normally maintained between the transmitter's antenna and the body of the user or nearby persons.

The FASTRACK Supreme Plug & Play is not designed for and intended to be used in portable applications (within 20 cm or 8 inches of the body of the user) and such uses are strictly prohibited.

### 9.2 Vehicle Safety

Do not use your FASTRACK Supreme Plug & Play while driving, unless equipped with a correctly installed vehicle kit allowing 'Hands-Free' Operation.

Respect national regulations on the use of cellular telephones in vehicles. Road safety always comes first.

## Fastrack Supreme User Guide

### Safety recommendations

If incorrectly installed in a vehicle, the operation of FASTRACK Supreme Plug & Play telephone could interfere with the correct functioning of vehicle electronics. To avoid such problems, make sure that the installation has been performed by a qualified personnel. Verification of the protection of vehicle electronics should form part of the installation.

The use of an alert device to operate a vehicle's lights or horn on public roads is not permitted.

### 9.3 Care and Maintenance

Your FASTRACK Supreme Plug & Play is the product of advanced engineering, design and craftsmanship and should be treated with care. The suggestion below will help you to enjoy this product for many years.

Do not expose the FASTRACK Supreme Plug & Play to any extreme environment where the temperature or humidity is high.

Do not use or store the FASTRACK Supreme Plug & Play in dusty or dirty areas. Its moving parts (SIM holder for example) can be damaged.

Do not attempt to disassemble the Wireless CPU<sup>®</sup>. There are no user serviceable parts inside.

Do not expose the FASTRACK Supreme Plug & Play to water, rain or spilt beverages. It is not waterproof.

Do not abuse your FASTRACK Supreme Plug & Play by dropping, knocking, or violently shaking it. Rough handling can damage it.

Do not place the FASTRACK Supreme Plug & Play alongside computer discs, credit or travel cards or other magnetic media. The information contained on discs or cards may be affected by the Wireless CPU<sup>®</sup>.

The use of third party equipment or accessories, not made or authorized by Wavecom may invalidate the warranty of the Wireless CPU<sup>®</sup>.

Do contact an authorized Service Center in the unlikely event of a fault in the Wireless CPU<sup>®</sup>.

### 9.4 Your Responsibility

This FASTRACK Supreme Plug & Play is under your responsibility. Please treat it with care respecting all local regulations. It is not a toy. Therefore, keep it in a safe place at all times and out of the reach of children.

Try to remember your Unlock and PIN codes. Become familiar with and use the security features to block unauthorized use and theft.

## Fastrack Supreme User Guide

### Recommended Accessories

## 10 Recommended Accessories

Accessories recommended by Wavecom for the FASTRACK Supreme are given in the table below.

**Table 32: List of recommended accessories**

Designation	Part number	Supplier
Quad-band antenna	1140.26	ALLGON
	MA112VX00	MAT Equipement
	MCA1890 MH/PB/SMA m	HIRSCHMANN
SMA/FME Antenna adaptor		PROCOM
Power adaptor (Europe)	EGSTDW P2 EF9W3 24W Out:12 V - 2A In: 100 to 240 V – 50/60 Hz – 550 mA Mounted with micro-fit connector	EGSTDW (for power adaptor) MOLEX (for micro-fit connector)*
Fuse	F800L250V	Shanghai Fullness
IESM GPS + USB	M13SUE01	WAVECOM
IESM IO + USB	M13SUE02	WAVECOM
IESM IO + USB + GPS	M13SUE03	WAVECOM

\* Information not available for this preliminary version.

## 11 Online Support

Wavecom provides an extensive range on online support which includes the following areas of Wavecom's wireless expertise:

- the latest version of this document
- new versions of our Operating System user guides
- comprehensive support for Open AT<sup>®</sup>
- regulatory certifications
- carrier certifications
- application notes

To gain access to this support, simply visit our web site at [www.wavecom.com](http://www.wavecom.com) or click on the desire link in Page. Privileged access via user login is provided to Wavecom authorized distributors.









**Halmac** Services (Qld) Pty. Ltd.  
A.C.N. 098 852 923  
A.B.N. 40 741 712 113

# HUMAN MACHINE INTERFACE

1. HUMAN MACHINE INTERFACE TECHNICAL DETAILS



Tel +1 (717) 767-6511  
 Fax +1 (717) 764-0839  
 www.redlion.net

Bulletin No. G306A-B  
 Drawing No. LP0666  
 Released 4/08

## MODEL G306A - GRAPHIC COLOR LCD OPERATOR INTERFACE TERMINAL WITH TFT QVGA DISPLAY AND TOUCHSCREEN

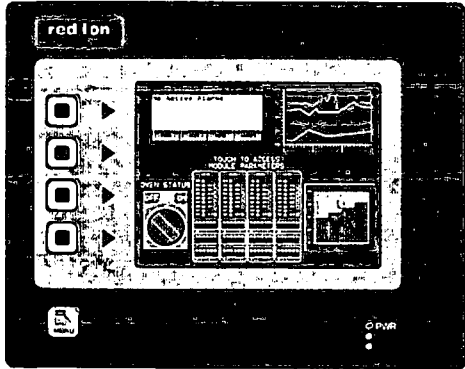

FOR USE IN HAZARDOUS LOCATIONS:  
 Class I, Division 2, Groups A, B, C, and D  
 Class II, Division 2, Groups F and G  
 Class III, Division 2

- CONFIGURED USING CRIMSON® SOFTWARE (BUILD 424 OR NEWER)
- UP TO 5 RS-232/422/485 COMMUNICATIONS PORTS (2 RS-232 AND 1 RS-422/485 ON BOARD, 1 RS-232 AND 1 RS422/485 ON OPTIONAL COMMUNICATIONS CARD)
- 10 BASE T/100 BASE-TX ETHERNET PORT TO NETWORK UNITS AND HOST WEB PAGES
- USB PORT TO DOWNLOAD THE UNIT'S CONFIGURATION FROM A PC OR FOR DATA TRANSFERS TO A PC
- UNIT'S CONFIGURATION IS STORED IN NON-VOLATILE MEMORY (8 MBYTE FLASH)
- COMPACTFLASH® SOCKET TO INCREASE MEMORY CAPACITY
- 5.7-INCH TFT ACTIVE MATRIX 256 COLOR QVGA 320 X 240 PIXEL LCD
- 5-BUTTON KEYPAD FOR ON-SCREEN MENUS
- THREE FRONT PANEL LED INDICATORS
- POWER UNIT FROM 24 VDC ±20% SUPPLY
- RESISTIVE ANALOG TOUCHSCREEN

### GENERAL DESCRIPTION

The G306A Operator Interface Terminal combines unique capabilities normally expected from high-end units with a very affordable price. It is built around a high performance core with integrated functionality. This core allows the G306A to perform many of the normal features of the Paradigm range of Operator Interfaces while improving and adding new features.

The G306A is able to communicate with many different types of hardware using high-speed RS232/422/485 communications ports and Ethernet 10 Base T/100 Base-TX communications. In addition, the G306A features USB for fast downloads of configuration files and access to trending and data logging. A CompactFlash socket is provided so that Flash cards can be used to collect your trending and data logging information as well as to store larger configuration files.

In addition to accessing and controlling of external resources, the G306A allows a user to easily view and enter information. Users can enter data through the touchscreen and/or front panel 5-button keypad.

### SAFETY SUMMARY

All safety related regulations, local codes and instructions that appear in the manual or on equipment must be observed to ensure personal safety and to prevent damage to either the instrument or equipment connected to it. If equipment is used in a manner not specified by the manufacturer, the protection provided by the equipment may be impaired.

Do not use the controller to directly command motors, valves, or other actuators not equipped with safeguards. To do so can be potentially harmful to persons or equipment in the event of a fault to the controller.



The protective conductor terminal is bonded to conductive parts of the equipment for safety purposes and must be connected to an external protective earthing system.



WARNING - EXPLOSION HAZARD - SUBSTITUTION OF COMPONENTS MAY IMPAIR SUITABILITY FOR CLASS I, DIVISION 2/CLASS II, DIVISION 2/CLASS III, DIVISION 2

**CAUTION: Risk Of Danger.**  
 Read complete instructions prior to installation and operation of the unit.

**CAUTION: Risk of electric shock.**

CompactFlash is a registered trademark of CompactFlash Association.

### CONTENTS OF PACKAGE

- G306A Operator Interface.
- Panel gasket.
- Template for panel cutout.
- Hardware packet for mounting unit into panel.
- Terminal block for connecting power.

### ORDERING INFORMATION

MODEL NO.	DESCRIPTION	PART NUMBER
G306A	Operator Interface for indoor applications, textured finish with embossed keys	G306A000
G3CF	64 MB CompactFlash Card <sup>5</sup>	G3CF064M
	256 MB CompactFlash Card <sup>5</sup>	G3CF256M
	512 MB CompactFlash Card <sup>5</sup>	G3CF512M
G3RS	RS232/485 Optional Communication Card	G3RS0000
G3CN	CANopen Optional Communication Card	G3CN0000
G3DN	DeviceNet option card for G3 operator interfaces lated high speed communications ports	G3DN0000
G3PBDP	Profibus DP Optional Communication Card	G3PBDP00
PSDR7	DIN Rail Power Supply	PSDR7000
SFCRM2	Crimson 2.0 <sup>2</sup>	SFCRM200
CBL	RS-232 Programming Cable	CBLPROG0
	USB Cable	CBLUSB00
	Communications Cables <sup>1</sup>	CBLxxxx
DR	DIN Rail Mountable Adapter Products <sup>3</sup>	DRxxxxxx
	Replacement Battery <sup>4</sup>	BNL20000
G3FILM	Protective Films	G3FILM06

- 1 Contact your Red Lion distributor or visit our website for complete selection.
- 2 Use this part number to purchase the Crimson® software on CD with a printed manual, USB cable, and RS-232 cable. Otherwise, download for free from www.redlion.net.
- 3 Red Lion offers RJ modular jack adapters. Refer to the DR literature for complete details.
- 4 Battery type is lithium coin type CR2025.
- 5 Industrial grade two million write cycles.

# SPECIFICATIONS

## 1. POWER REQUIREMENTS:

Must use Class 2 or SELV rated power supply.  
Power connection via removable three position terminal block.

Supply Voltage: +24 VDC ±20%  
Typical Power<sup>1</sup>: 8 W  
Maximum Power<sup>2</sup>: 14 W

**Notes:**

1. Typical power with +24 VDC, RS232/485 communications, Ethernet communications, CompactFlash card installed, and display at full brightness.
2. Maximum power indicates the most power that can be drawn from the G306A. Refer to "Power Supply Requirements" under "Installing and Powering the G306A."
3. The G306A's circuit common is not connected to the enclosure of the unit. See "Connecting to Earth Ground" in the section "Installing and Powering the G306A."
4. Read "Power Supply Requirements" in the section "Installing and Powering the G306A" for additional power supply information.

## 2. BATTERY: Lithium coin cell. Typical lifetime of 10 years.

## 3. LCD DISPLAY:

SIZE	5.7-inch
TYPE	TFT
COLORS	256
PIXELS	320 X 240
BRIGHTNESS	500 cd/m <sup>2</sup>
BACKLIGHT*	40,000 HR TYP.

\*Lifetime at room temperature. Refer to "Display" in "Software/Unit Operation"

## 4. 5-KEY KEYPAD: for on-screen menus.

## 5. TOUCHSCREEN: Resistive analog

## 6. MEMORY:

On Board User Memory: 8 Mbyte of non-volatile Flash memory.  
Memory Card: CompactFlash Type II slot for Type I and Type II CompactFlash cards.

## 7. COMMUNICATIONS:

USB Port: Adheres to USB specification 1.1. Device only using Type B connection.



**WARNING - DO NOT CONNECT OR DISCONNECT CABLES WHILE POWER IS APPLIED UNLESS AREA IS KNOWN TO BE NON-HAZARDOUS. USB PORT IS FOR SYSTEM SET-UP AND DIAGNOSTICS AND IS NOT INTENDED FOR PERMANENT CONNECTION.**

Serial Ports: Format and Baud Rates for each port are individually software programmable up to 115,200 baud.

PGM Port: RS232 port via RJ12.

COMMS Ports: RS422/485 port via RJ45, and RS232 port via RJ12.

DH485 TXEN: Transmit enable; open collector, V<sub>OH</sub> = 15 VDC, V<sub>OL</sub> = 0.5 V @ 25 mA max.

Note: For additional information on the communications or signal common and connections to earth ground please see the "Connecting to Earth Ground" in the section "Installing and Powering the G306A."

Ethernet Port: 10 BASE-T / 100 BASE-TX

RJ45 jack is wired as a NIC (Network Interface Card).

Isolation from Ethernet network to G3 operator interface: 1500 Vrms

## 8. ENVIRONMENTAL CONDITIONS:

Operating Temperature Range: 0 to 50°C

Storage Temperature Range: -20 to 70°C

Operating and Storage Humidity: 80% maximum relative humidity (non-condensing) from 0 to 50°C.

Vibration according to IEC 68-2-6: Operational 5 to 8 Hz, 0.8" (p-p), 8 to 500 Hz, in X, Y, Z direction, duration: 1 hour, 3 g.

Shock according to IEC 68-2-27: Operational 40 g, 9 msec in 3 directions. Altitude: Up to 2000 meters.

## 9. CERTIFICATIONS AND COMPLIANCES:

### SAFETY

UL Recognized Component, File #E179259, UL61010-1, CSA 22.2 No.61010-1 Recognized to U.S. and Canadian requirements under the Component Recognition Program of Underwriters Laboratories, Inc.

UL Listed, File #E211967, UL61010-1, UL1604, CSA 22.2 No. 61010.1, CSA 22.2 No. 213-M1987

LISTED by Und. Lab. Inc. to U.S. and Canadian safety standards

Type 4X Indoor Enclosure rating (Face only), UL50

IECEE CB Scheme Test Certificate #US/12460/UL,

CB Scheme Test Report #E179259-A1-CB-1

Issued by Underwriters Laboratories Inc.

IEC 61010-1, EN 61010-1: Safety requirements for electrical equipment for measurement, control, and laboratory use, Part 1.

IP66 Enclosure rating (Face only), IEC 529

### ELECTROMAGNETIC COMPATIBILITY

Emissions and Immunity to EN 61326: Electrical Equipment for Measurement, Control and Laboratory use.

### Immunity to Industrial Locations:

Electrostatic discharge EN 61000-4-2 Criterion A  
4 kV contact discharge  
8 kV air discharge

Electromagnetic RF fields EN 61000-4-3 Criterion A  
10 V/m

Fast transients (burst) EN 61000-4-4 Criterion A  
2 kV power  
1 kV signal

Surge EN 61000-4-5 Criterion A  
1 kV L-L,  
2 kV L&N-E power

RF conducted interference EN 61000-4-6 Criterion A  
3 V/rms

### Emissions:

Emissions EN 55011 Class A

### Note:

1. Criterion A: Normal operation within specified limits.

## 10. CONNECTIONS: Compression cage-clamp terminal block.

Wire Gage: 12-30 AWG copper wire

Torque: 5-7 inch-pounds (56-79 N-cm)

## 11. CONSTRUCTION: Steel rear metal enclosure with NEMA 4X/IP66 aluminum front plate for indoor use only when correctly fitted with the gasket provided. Installation Category II, Pollution Degree 2.

## 12. MOUNTING REQUIREMENTS: Maximum panel thickness is 0.25" (6.3 mm). For NEMA 4X/IP66 sealing, a steel panel with a minimum thickness of 0.125" (3.17 mm) is recommended.

Maximum Mounting Stud Torque: 17 inch-pounds (1.92 N-m)

## 13. WEIGHT: 3.0 lbs (1.36 Kg)

## DIMENSIONS In inches (mm)

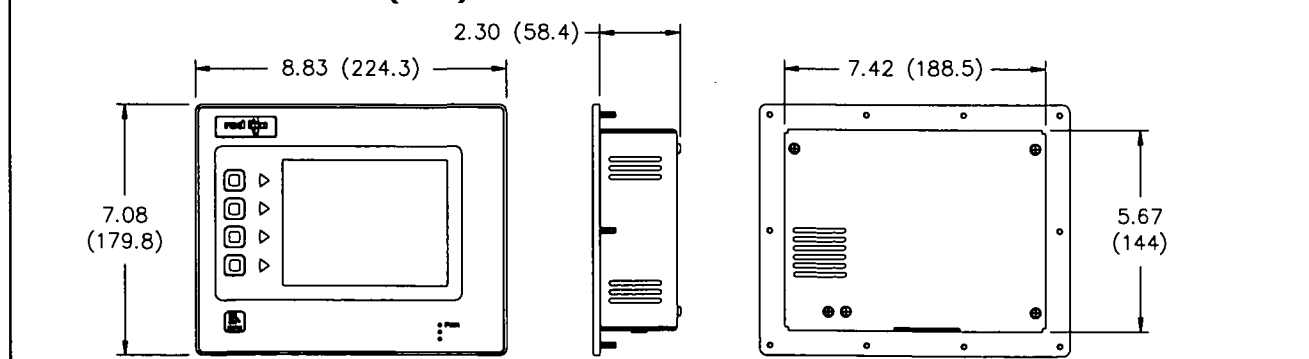

# INSTALLING AND POWERING THE G306A

## MOUNTING INSTRUCTIONS

This operator interface is designed for through-panel mounting. A panel cut-out diagram and a template are provided. Care should be taken to remove any loose material from the mounting cut-out to prevent that material from falling into the operator interface during installation. A gasket is provided to enable sealing to NEMA 4X/IP66 specification. Install the ten keps nuts provided and tighten evenly for uniform gasket compression.

*Note: Tightening the keps nuts beyond a maximum of 17 inch-pounds (1.92 N-m) may cause damage to the front panel.*

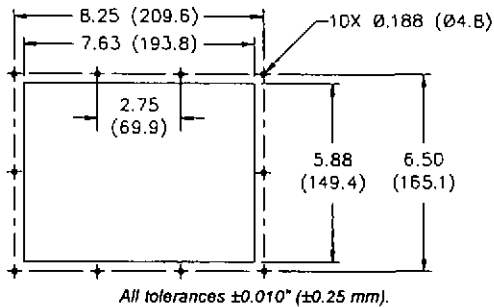

ALL NONINCENDIVE CIRCUITS MUST BE WIRED USING DIVISION 2 WIRING METHODS AS SPECIFIED IN ARTICLE 501-4 (b), 502-4 (b), AND 503-3 (b) OF THE NATIONAL ELECTRICAL CODE, NFPA 70 FOR INSTALLATION WITHIN THE UNITED STATES, OR AS SPECIFIED IN SECTION 19-152 OF CANADIAN ELECTRICAL CODE FOR INSTALLATION IN CANADA.

## CONNECTING TO EARTH GROUND



The protective conductor terminal is bonded to conductive parts of the equipment for safety purposes and must be connected to an external protective earthing system.

Each G306A has a chassis ground terminal on the back of the unit. Your unit should be connected to earth ground (protective earth).

# COMMUNICATING WITH THE G306A

## CONFIGURING A G306A

The G306A is configured using Crimson® software. Crimson is available as a free download from Red Lion's website, or it can be purchased on CD. Updates to Crimson for new features and drivers are posted on the website as they become available. By configuring the G306A using the latest version of Crimson, you are assured that your unit has the most up to date feature set. Crimson® software can configure the G306A through the RS232 PGM port, USB port, or CompactFlash.

The USB port is connected using a standard USB cable with a Type B connector. The driver needed to use the USB port will be installed with Crimson.

The RS232 PGM port uses a programming cable made by Red Lion to connect to the DB9 COM port of your computer. If you choose to make your own cable, use the "G306A Port Pin Out Diagram" for wiring information.

The CompactFlash can be used to program a G3 by placing a configuration file and firmware on the CompactFlash card. The card is then inserted into the target G3 and powered. Refer to the Crimson literature for more information on the proper names and locations of the files.

## USB, DATA TRANSFERS FROM THE COMPACTFLASH CARD



WARNING - DO NOT CONNECT OR DISCONNECT CABLES WHILE POWER IS APPLIED UNLESS AREA IS KNOWN TO BE NON-HAZARDOUS. USB PORT IS FOR SYSTEM SET-UP AND DIAGNOSTICS AND IS NOT INTENDED FOR PERMANENT CONNECTION.

In order to transfer data from the CompactFlash card via the USB port, a driver must be installed on your computer. This driver is installed with Crimson and is located in the folder C:\Program Files\Red Lion Controls\Crimson 2.0\Device\ after Crimson is installed. This may have already been accomplished if your G306A was configured using the USB port.

Once the driver is installed, connect the G306A to your PC with a USB cable, and follow "Mounting the CompactFlash" instructions in the Crimson 2 user manual.

The chassis ground is not connected to signal common of the unit. Maintaining isolation between earth ground and signal common is not required to operate your unit. But, other equipment connected to this unit may require isolation between signal common and earth ground. *To maintain isolation between signal common and earth ground care must be taken when connections are made to the unit.* For example, a power supply with isolation between its signal common and earth ground must be used. Also, plugging in a USB cable may connect signal common and earth ground.<sup>1</sup>

<sup>1</sup> USB's shield may be connected to earth ground at the host. USB's shield in turn may also be connected to signal common.

## POWER SUPPLY REQUIREMENTS

The G306A requires a 24 VDC power supply. Your unit may draw considerably less than the maximum rated power depending upon the options being used. As additional features are used your unit will draw increasing amounts of power. Items that could cause increases in current are additional communications, optional communications card, CompactFlash card, and other features programmed through Crimson.

In any case, it is very important that the power supply is mounted correctly if the unit is to operate reliably. Please take care to observe the following points:

- The power supply must be mounted close to the unit, with usually not more than 6 feet (1.8 m) of cable between the supply and the operator interface. Ideally, the shortest length possible should be used.
- The wire used to connect the operator interface's power supply should be at least 22-gage wire. If a longer cable run is used, a heavier gage wire should be used. The routing of the cable should be kept away from large contactors, inverters, and other devices which may generate significant electrical noise.
- A power supply with a Class 2 or SELV rating is to be used. A Class 2 or SELV power supply provides isolation to accessible circuits from hazardous voltage levels generated by a mains power supply due to single faults. SELV is an acronym for "safety extra-low voltage." Safety extra-low voltage circuits shall exhibit voltages safe to touch both under normal operating conditions and after a single fault, such as a breakdown of a layer of basic insulation or after the failure of a single component has occurred.

## CABLES AND DRIVERS

Red Lion has a wide range of cables and drivers for use with many different communication types. A list of these drivers and cables along with pin outs is available from Red Lion's website. New cables and drivers are added on a regular basis. If making your own cable, refer to the "G306A Port Pin Outs" for wiring information.

## ETHERNET COMMUNICATIONS

Ethernet communications can be established at either 10 BASE-T or 100 BASE-TX. The G306A unit's RJ45 jack is wired as a NIC (Network Interface Card). For example, when wiring to a hub or switch use a straight-through cable, but when connecting to another NIC use a crossover cable.

The Ethernet connector contains two LEDs. A yellow LED in the upper right, and a bi-color green/amber LED in the upper left. The LEDs represent the following statuses:

LED COLOR	DESCRIPTION
YELLOW solid	Link established.
YELLOW flashing	Data being transferred.
GREEN	10 BASE-T Communications
AMBER	100 BASE-TX Communications

On the rear of each unit is a unique 12-digit MAC address and a block for marking the unit with an IP address. Refer to the Crimson manual and Red Lion's website for additional information on Ethernet communications.

## RS232 PORTS

The G306A has two RS232 ports. There is the PGM port and the COMMS port. Although only one of these ports can be used for programming, both ports can be used for communications with a PLC.

The RS232 ports can be used for either master or slave protocols with any G306A configuration.

Examples of RS232 communications could involve another Red Lion product or a PC. By using a cable with RJ12 ends on it, and a twist in the cable, RS232 communications with another G3 product or the Modular Controller can be established. Red Lion part numbers for cables with a twist in them are CBLPROG0<sup>1</sup>, CBLRLC01<sup>2</sup>, or CBLRC02<sup>3</sup>.

CONNECTING A G306A OPERATOR INTERFACE TO AN ICM5

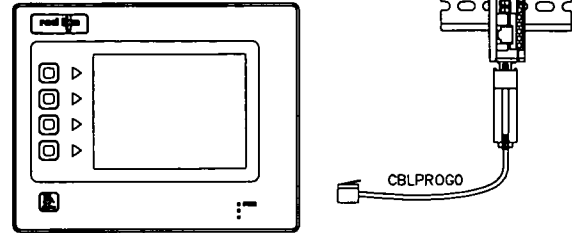

G3 RS232 to a PC

Connections			
G3: RJ12	Name	PC: DB9	Name
4	COMM	1	DCD
5	Tx	2	Rx
2	Rx	3	Tx
	N/C	4	DTR
3	COM	5	GND
	N/C	6	DSR
1	CTS	7	RTS
6	RTS	8	CTS
	N/C	9	RI

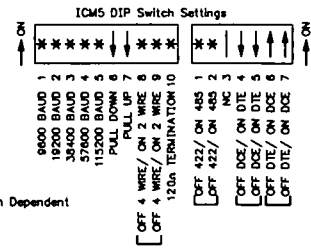

<sup>1</sup> CBLPROG0 can also be used to communicate with either a PC or an ICM5.

<sup>2</sup> DB9 adapter not included, 1 foot long.

<sup>3</sup> DB9 adapter not included, 10 feet long.

G306A PORT PIN OUTS

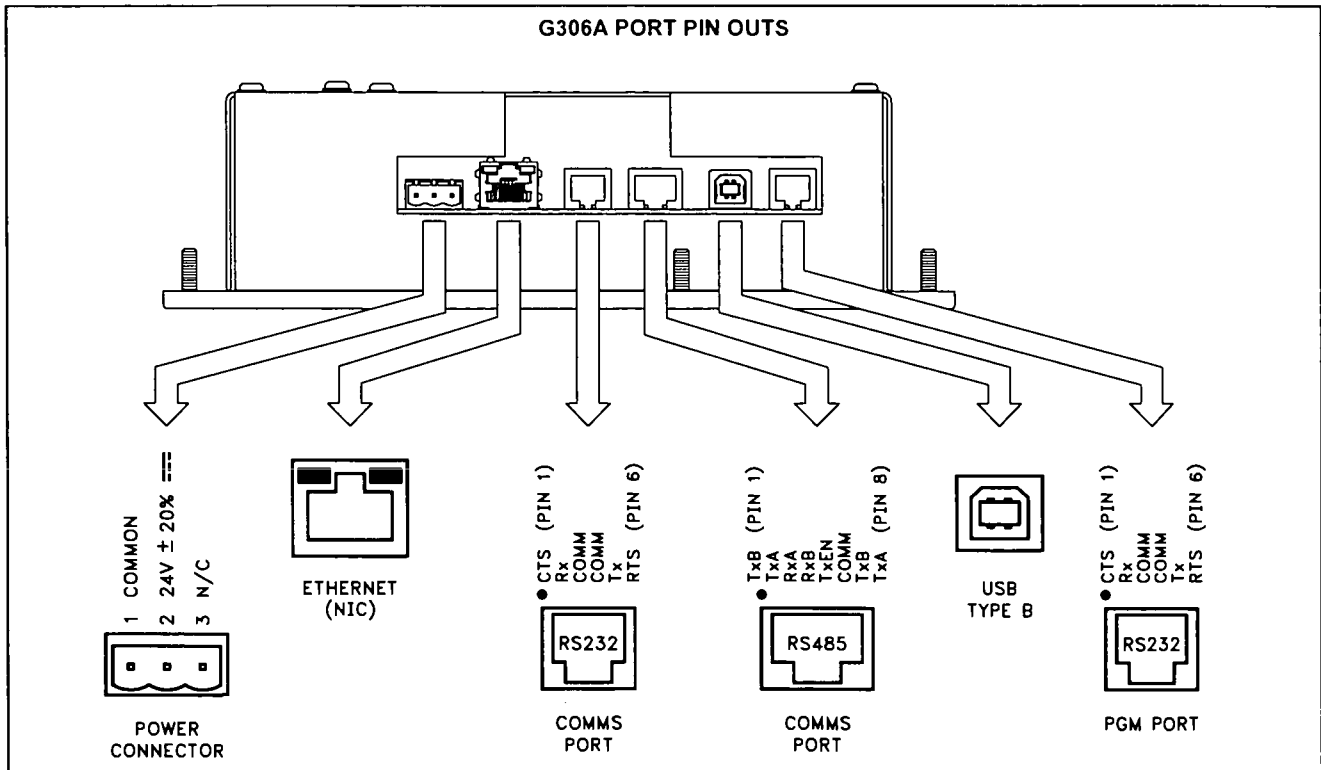

### RS422/485 COMMS PORT

The G306A has one RS422/485 port. This port can be configured to act as either RS422 or RS485.

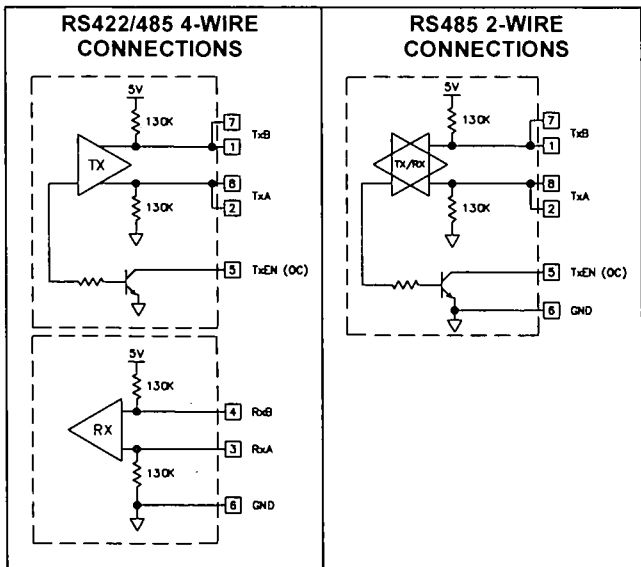

Note: All Red Lion devices connect A to A and B to B, except for Paradigm devices. Refer to [www.redlion.net](http://www.redlion.net) for additional information.

### DH485 COMMUNICATIONS

The G306A's RS422/485 COMMS port can also be used for Allen Bradley DH485 communications.

**WARNING: DO NOT** use a standard DH485 cable to connect this port to Allen Bradley equipment. A cable and wiring diagram are available from Red Lion.

#### G3 to AB SLC 500 (CBLAB003)

Connections			
RJ45: RLC	Name	RJ45: A-B	Name
1	TxB	1	A
2	TxA	2	B
3, 8	RxA	-	24V
4, 7	RxB	-	COMM
5	TxEN	5	TxEN
6	COMM	4	SHIELD
4, 7	TxB	-	COMM
3, 8	TxA	-	24V

### Examples of RS485 2-Wire Connections

#### G3 to Red Lion RJ11 (CBLRLC00) DLC, IAMS, ITMS, PAXCDC4C

Connections			
G3: RJ45	Name	RLC: RJ11	Name
5	TxEN	2	TxEN
6	COM	3	COM
1	TxB	5	B-
2	TxA	4	A+

#### G3 to Modular Controller (CBLRLC05)

Connections			
G3	Name	Modular Controller	Name
1,4	TxB	1,4	TxB
4,1	RxB	4,1	RxB
2,3	TxA	2,3	TxA
3,2	RxA	3,2	RxA
5	TxEN	5	TxEN
6	COM	6	COM
7	TxB	7	TxB
8	TxA	8	TxA

# SOFTWARE/UNIT OPERATION

## CRIMSON® SOFTWARE

Crimson® software is available as a free download from Red Lion's website or it can be purchased on a CD, see "Ordering Information" for part number. The latest version of the software is always available from the website, and updating your copy is free.

## DISPLAY

This operator interface uses a liquid crystal display (LCD) for displaying text and graphics. The display utilizes a cold cathode fluorescent tube (CCFL) for lighting the display. The CCFL tubes can be dimmed for low light conditions.

These CCFL tubes have a limited lifetime. Backlight lifetime is based upon the amount of time the display is turned on at full intensity. Turning the backlight off when the display is not in use can extend the lifetime of your backlight. This can be accomplished through the Crimson® software when configuring your unit.

## FRONT PANEL LEDs

There are three front panel LEDs. Shown below is the default status of the LEDs.

LED	INDICATION
<b>RED (TOP, LABELED "PWR")</b>	
FLASHING	Unit is in the boot loader, no valid configuration is loaded. <sup>1</sup>
STEADY	Unit is powered and running an application.
<b>YELLOW (MIDDLE)</b>	
OFF	No CompactFlash card is present.
STEADY	Valid CompactFlash card present.
FLASHING RAPIDLY	CompactFlash card being checked.
FLICKERING	Unit is writing to the CompactFlash, either because it is storing data, or because the PC connected via the USB port has locked the drive. <sup>2</sup>
FLASHING SLOWLY	Incorrectly formatted CompactFlash card present.
<b>GREEN (BOTTOM)</b>	
FLASHING	A tag is in an alarm state.
STEADY	Valid configuration is loaded and there are no alarms present.

<sup>1</sup> The operator interface is shipped without a configuration. After downloading a configuration, if the light remains in the flashing state continuously, try cycling power. If the LED still continues to flash, try downloading a configuration again.

<sup>2</sup> Do not turn off power to the unit while this light is flickering. The unit writes data in two minute intervals. Later Microsoft operating systems will not lock the drive unless they need to write data; Windows 98 may lock the drive any time it is mounted, thereby interfering with logging. Refer to "Mounting the CompactFlash" in the Crimson 2 User Manual.

## TOUCHSCREEN

This operator interface utilizes a resistive analog touchscreen for user input. The unit will only produce an audible tone (beep) when a touch on an active touchscreen cell is sensed. The touchscreen is fully functional as soon as the operator interface is initialized, and can be operated with gloved hands.

## KEYPAD

The G306A keypad consists of five keys that can be used for on-screen menus.

## TROUBLESHOOTING YOUR G306A

If for any reason you have trouble operating, connecting, or simply have questions concerning your new G306A, contact Red Lion's technical support. For contact information, refer to the back page of this bulletin for phone and fax numbers.

EMAIL: [techsupport@redlion.net](mailto:techsupport@redlion.net)

Web Site: <http://www.redlion.net>



## BATTERY & TIME KEEPING



**WARNING - EXPLOSION HAZARD - THE AREA MUST BE KNOWN TO BE NON-HAZARDOUS BEFORE SERVICING/ REPLACING THE UNIT AND BEFORE INSTALLING OR REMOVING I/O WIRING AND BATTERY.**



**WARNING - EXPLOSION HAZARD - DO NOT DISCONNECT EQUIPMENT UNLESS POWER HAS BEEN DISCONNECTED AND THE AREA IS KNOWN TO BE NON-HAZARDOUS.**

A battery is used to keep time when the unit is without power. Typical accuracy of the G306A time keeping is less than one minute per month drift. The battery of a G306A unit does not affect the unit's memory, all configurations and data is stored in non-volatile memory.



**CAUTION: RISK OF ELECTRIC SHOCK**

The inverter board, attached to the mounting plate, supplies the high voltage to operate the backlight. Touching the inverter board may result in injury to personnel.



**CAUTION:** The circuit board contains static sensitive components. Before handling the operator interface without the rear cover attached, discharge static charges from your body by touching a grounded bare metal object. Ideally, handle the operator interface at a static controlled clean workstation. Also, do not touch the surface areas of the circuit board. Dirt, oil, or other contaminants may adversely affect circuit operation.

To change the battery of a G306A, remove power, cabling, and then the rear cover of the unit. To remove the cover, remove the four screws designated by the arrows on the rear of the unit. Then, by lifting the top side, hinge the cover, thus providing clearance for the connectors on the bottom side of the PCB as shown in the illustration below. Install in the reverse manner.

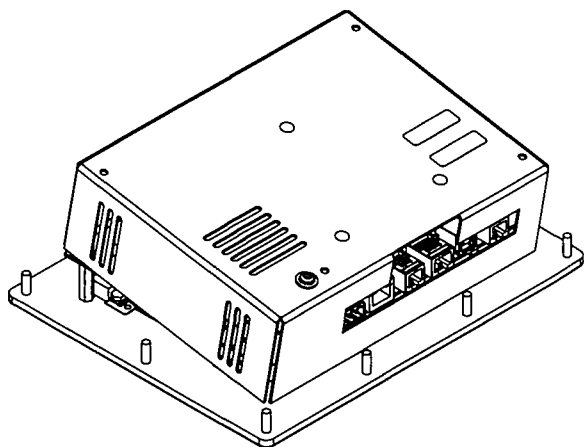

Remove the old battery\* from the holder and replace with the new battery. Replace the rear cover, cables, and re-apply power. Using Crimson or the unit's keypad, enter the correct time and date.

\* Please note that the old battery must be disposed of in a manner that complies with your local waste regulations. Also, the battery must not be disposed of in fire, or in a manner whereby it may be damaged and its contents come into contact with human skin.

The battery used by the G306A is a lithium type CR2025.

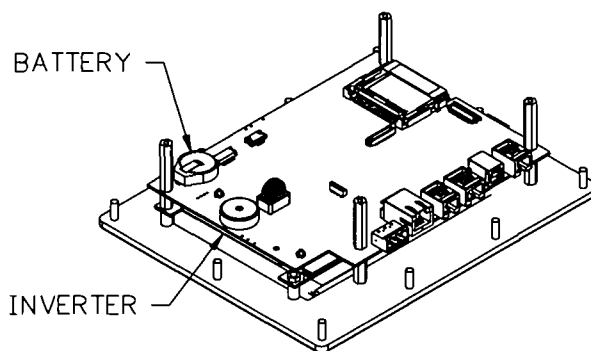
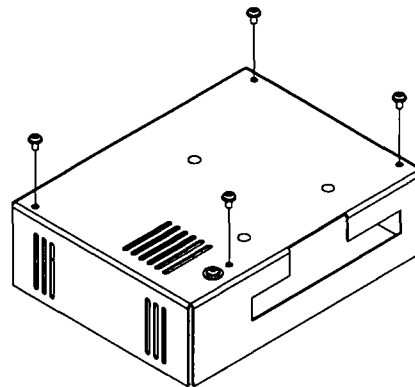

# OPTIONAL FEATURES AND ACCESSORIES

## OPTIONAL COMMUNICATION CARD

Red Lion offers optional communication cards for fieldbus communications. These communication cards will allow your G306A to communicate with many of the popular fieldbus protocols.

Red Lion is also offering a communications card for additional RS232 and RS422/485 communications. Visit Red Lion's website for information and availability of these cards.

## CUSTOM LOGO

Each G3 operator interface has an embossed area containing the Red Lion logo. Red Lion can provide custom logos to apply to this area. Contact your distributor for additional information and pricing.

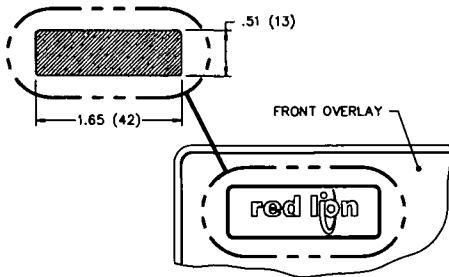

## COMPACTFLASH SOCKET

CompactFlash socket is a Type II socket that can accept either Type I or II cards. Use cards with a minimum of 4 Mbytes and a maximum of 2 Gbytes with the G306A's CompactFlash socket. Cards are available at most computer and office supply retailers.

CompactFlash can be used for configuration transfers, larger configurations, data logging, and trending.

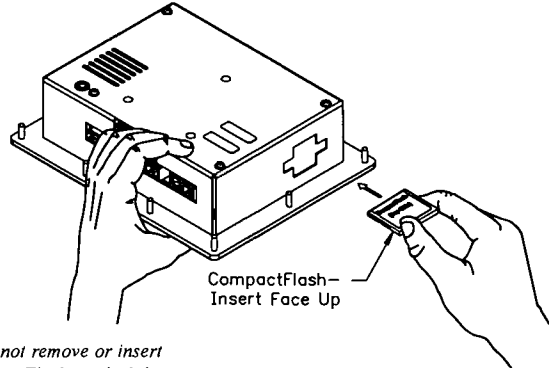

*Note: Do not remove or insert the CompactFlash card while power is applied. Refer to "Front Panel LEDs."*

Information stored on a CompactFlash card by a G306A can be read by a card reader attached to a PC. This information is stored in IBM (Windows®) PC compatible FAT16 file format.

## NOTE

For reliable operation in all of our products, Red Lion recommends the use of SanDisk® and SimpleTech brands of CompactFlash cards.

Industrial grade versions that provide up to two million write/erase cycles minimum are available from Red Lion.

## LIMITED WARRANTY

The Company warrants the products it manufactures against defects in materials and workmanship for a period limited to two years from the date of shipment, provided the products have been stored, handled, installed, and used under proper conditions. The Company's liability under this limited warranty shall extend only to the repair or replacement of a defective product, at The Company's option. The Company disclaims all liability for any affirmation, promise or representation with respect to the products.

The customer agrees to hold Red Lion Controls harmless from, defend, and indemnify RLC against damages, claims, and expenses arising out of subsequent sales of RLC products or products containing components manufactured by RLC and based upon personal injuries, deaths, property damage, lost profits, and other matters which Buyer, its employees, or sub-contractors are or may be to any extent liable, including without limitation penalties imposed by the Consumer Product Safety Act (P.L. 92-573) and liability imposed upon any person pursuant to the Magnuson-Moss Warranty Act (P.L. 93-637), as now in effect or as amended hereafter.

No warranties expressed or implied are created with respect to The Company's products except those expressly contained herein. The Customer acknowledges the disclaimers and limitations contained herein and relies on no other warranties or affirmations.

Red Lion Controls  
20 Willow Springs Circle  
York PA 17406  
Tel +1 (717) 767-6511  
Fax +1 (717) 764-0839

Red Lion Controls BV  
Printerweg 10  
NL - 3821 AD Amersfoort  
Tel +31 (0) 334 723 225  
Fax +31 (0) 334 893 793

Red Lion Controls AP  
Unit 101, XinAn Plaza  
Building 13, No.99 Tianzhou Road  
ShangHai, P.R. China 200223  
Tel +86 21 6113-3688  
Fax +86 21 6113-3683







**Halmac** Services (Qld) Pty. Ltd.  
A.C.N. 098 852 923  
A.B.N. 40 741 712 113

# LEVEL TRANSMITTER

---

## 1. LEVEL TRANSMITTER TECHNICAL DETAILS

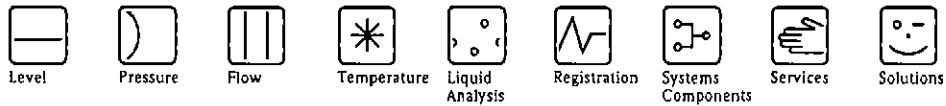

## Technical Information

# Waterpilot FMX21

Hydrostatic level measurement

Reliable and robust level probe with ceramic measuring cell

Compact device for level measurement in fresh water, wastewater and saltwater, communication via HART

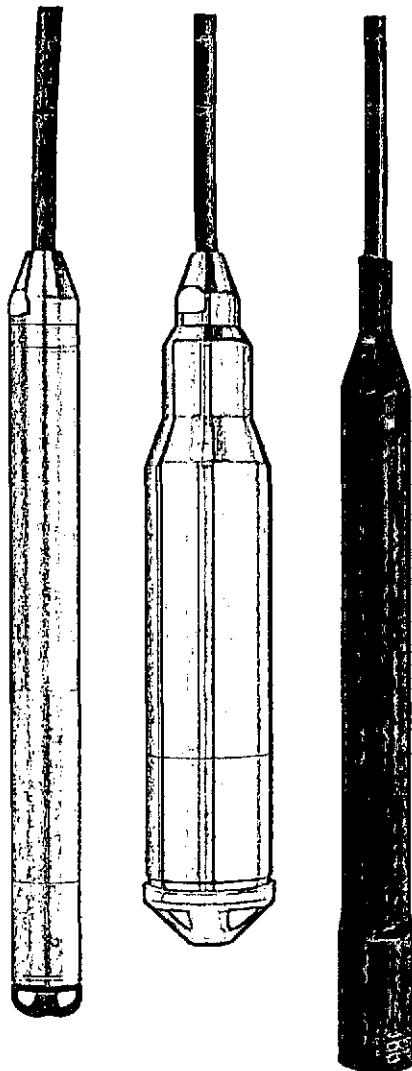

### Application

The Waterpilot FMX21 is a pressure sensor for hydrostatic level measurement.

Endress+Hauser offers three different versions of the FMX21 sensor:

- FMX21 with a stainless steel housing, outer diameter of 22 mm (0.87 inch): Standard version suitable for drinking water applications and for use in bore holes and wells with small diameters.
- FMX21 with a stainless steel housing, outer diameter of 42 mm (1.66 inch): Heavy duty version, easy clean flush-mounted process diaphragm. Ideally suited for wastewater and sewage treatment plants.
- FMX21 with a coated housing, outer diameter of 29 mm (1.15 inch): Corrosion resistant version generally for use in saltwater, particularly for ship ballast water tanks.

### Your benefits

- High resistance to overload and aggressive media
- High-precision, robust ceramic measuring cell with long-term stability
- Climate proofed sensor thanks to completely potted electronics and 2-filter pressure compensation system
- 4 to 20 mA with superimposed HART 6.0 output signal
- Simultaneous measurement of level and temperature with optionally integrated Pt100 temperature sensor
- Accuracy
  - Reference accuracy  $\pm 0.2\%$
  - PLATINUM version  $\pm 0.1\%$
- Automatic density compensation to increase accuracy
- Usage in drinking water: KTW, NSF, ACS
- Approvals: ATEX, FM, CSA
- Extensive range of accessories provides complete measuring point solutions



## Table of contents

<b>Function and system design</b> .....	<b>3</b>	Dimensions of the extension cable mounting screws .....	19
Device selection .....	3	Dimensions of the IP66/IP67 terminal boxes with filters .....	19
Measuring principle .....	4	Dimensions of the TMT182 temperature head transmitter .....	20
Measuring system .....	5	Terminal box with integrated TMT182 temperature head transmitter (4 to 20 mA/HART) .....	20
Level measurement with absolute pressure probe and external pressure signal .....	7	Weight .....	20
Density compensation with Pt100 temperature sensor .....	7	Material .....	21
Communication protocol .....	8	Extension cable .....	21
System integration .....	8	Terminals .....	21
<b>Input</b> .....	<b>9</b>	<b>Human interface</b> .....	<b>22</b>
Measured variable .....	9	Field Xpert SFX100 .....	22
Measuring range .....	9	Field Communicator 375, 475 .....	22
Input signal .....	9	FieldCare .....	22
<b>Output</b> .....	<b>10</b>	<b>Certificates and approvals</b> .....	<b>23</b>
Output signal .....	10	CE mark .....	23
Signal range .....	10	Approvals, types of protection .....	23
Signal on alarm .....	10	Drinking water approval (for FMX21 with outer diameter 22 mm (0.87 in)) .....	23
Load .....	10	Standards and guidelines applied .....	23
Resolution .....	11	<b>Ordering information</b> .....	<b>24</b>
Damping .....	11	FMX21 .....	24
<b>Power supply</b> .....	<b>11</b>	FMX21 (continued) .....	25
Measuring unit electrical connection .....	11	<b>Accessories</b> .....	<b>26</b>
Supply voltage .....	13	Mounting clamp .....	26
Cable specifications .....	13	Terminal box .....	26
Power consumption .....	13	Additional weight .....	
Current consumption .....	13	(for FMX21 with outer diameter of 22 mm (0.87 in) or 29 mm (1.14 in)) .....	26
Residual ripple .....	13	TMT182 temperature head transmitter (4 to 20 mA/HART) .....	26
<b>Performance characteristics</b> .....	<b>14</b>	Extension cable mounting screw .....	26
Reference operating conditions .....	14	Terminals .....	26
Reference accuracy .....	14	Cable shortening kit .....	26
Long-term stability .....	14	Installation tool – indicating the customer-specific length on the cable .....	27
Influence of medium temperature .....	14	Testing adapter (for FMX21 with outer diameter of 22 mm (0.87 in) and 29 mm (1.14 in)) .....	27
Warm-up period .....	14	<b>Additional documentation</b> .....	<b>28</b>
Step response time .....	14	Field of activities .....	28
<b>Installation</b> .....	<b>15</b>	Technical Information .....	28
Installation instructions .....	15	Operating Instructions .....	28
<b>Ambient conditions</b> .....	<b>16</b>	Safety instructions .....	28
Ambient temperature range .....	16	Installation/Control Drawings .....	28
Storage temperature range .....	16	Drinking water approval .....	28
Degree of protection .....	16	<b>Configuration data sheet</b> .....	<b>29</b>
Electromagnetic compatibility (EMC) .....	16	Level .....	29
Overvoltage protection .....	16	Pressure .....	30
<b>Process conditions</b> .....	<b>17</b>		
Medium temperature range .....	17		
Medium temperature limits .....	17		
<b>Mechanical construction</b> .....	<b>18</b>		
Dimensions of the level probe .....	18		
Dimensions of the mounting clamp .....	18		

## Waterpilot FMX21

## Function and system design

## Device selection

Waterpilot FMX21	 PO1-FMX21-xx-10-xx-xx-xx-002	 PO1-FMX21-xx-10-xx-xx-xx-003	 PO1-FMX21-xx-10-xx-xx-xx-004
Field of application	Hydrostatic level measurement in deep wells e.g. drinking water	Hydrostatic level measurement in wastewater	Hydrostatic level measurement in saltwater
	<p>⚠ Caution!</p> <p>The Waterpilot is not suitable for use in biogas plants since the gases can diffuse through the elastomers (seals, extension cable). For applications with biogas Endress+Hauser offers the level transmitter Deltapilot.</p>		
Process connection	<ul style="list-style-type: none"> <li>– Mounting clamp</li> <li>– Extension cable mounting screw with G1 1/2 A or 1 1/2 NPT thread</li> </ul>		
Outer diameter	22 mm (0.87 in)	42 mm (1.65 in)	max. 29 mm (1.14 in)
Extension cable	<ul style="list-style-type: none"> <li>– PE extension cable</li> <li>– PUR extension cable</li> <li>– FEP extension cable</li> </ul>		
Seals	<ul style="list-style-type: none"> <li>– FKM Viton</li> <li>– EPDM <sup>1)</sup></li> </ul>	– FKM Viton	<ul style="list-style-type: none"> <li>– FKM Viton</li> <li>– EPDM <sup>1)</sup></li> </ul>
Measuring ranges	<ul style="list-style-type: none"> <li>– Gauge pressure: from 0 to 0.1 bar to 0 to 20 bar (0 to 1.5 psi to 0 to 300 psi)</li> <li>– Absolute pressure: from 0 to 2 bar to 0 to 20 bar (0 to 30 psi to 0 to 300 psi)</li> </ul>		<ul style="list-style-type: none"> <li>– Gauge pressure: from 0 to 0.1 bar to 0 to 4 bar (0 to 1.5 psi to 0 to 60 psi)</li> <li>– Absolute pressure: from 0 to 2 bar to 0 to 4 bar (0 to 1.5 psi to 0 to 60 psi)</li> </ul>
	<ul style="list-style-type: none"> <li>– Customer-specific measuring ranges; factory-calibrated</li> <li>– The following output units can be configured: %, mbar, bar, kPa, MPa, mmH<sub>2</sub>O, mH<sub>2</sub>O, inH<sub>2</sub>O, ftH<sub>2</sub>O, psi and numerous level units.</li> </ul>		
Overload	Up to 40 bar (580 psi)		Up to 25 bar (362 psi)
Process temperature range	–10 to +70 °C (+14 to +158 °F)		0 to +50 °C (+32 to +122 °F)
Reference accuracy	<ul style="list-style-type: none"> <li>– ±0.2 % of the set span</li> <li>– Optional: ±0.1 % of set span (PLATINUM version)</li> </ul>		
Supply voltage	10.5 to 35 V DC, Ex: 10.5 to 30 V DC		
Output	4 to 20 mA (invertible) with superimposed digital communication protocol HART 6.0, 2-wire (invertible)		
Options	<ul style="list-style-type: none"> <li>– Large selection of approvals, including ATEX, FM, CSA, Drinking water approval</li> <li>– Broad range of accessories</li> <li>– Integrated Pt100 temperature sensor and TMT182 temperature head transmitter (4 to 20 mA/HART)</li> </ul>		
Specialties	<ul style="list-style-type: none"> <li>– High-precision, robust ceramic measuring cell with long-term stability</li> <li>– Automatic density compensation</li> <li>– Customer specific cable marking</li> <li>– Absolute pressure cell</li> </ul>		

1) Recommended for drinking water applications.



**Measuring principle**

The ceramic measuring cell is a dry measuring cell, i.e. pressure acts directly on the robust ceramic process isolating diaphragm of the Waterpilot FMX21.

Any changes in the air pressure are routed through the extension cable, via a pressure compensation tube, to the rear of the ceramic process isolating diaphragm and compensated for. A pressure-dependent change in capacitance caused by the movement of the process isolating diaphragm is measured at the electrodes of the ceramic carrier. The electronics then convert this into a signal which is proportional to the pressure and is linear to the level of the medium.

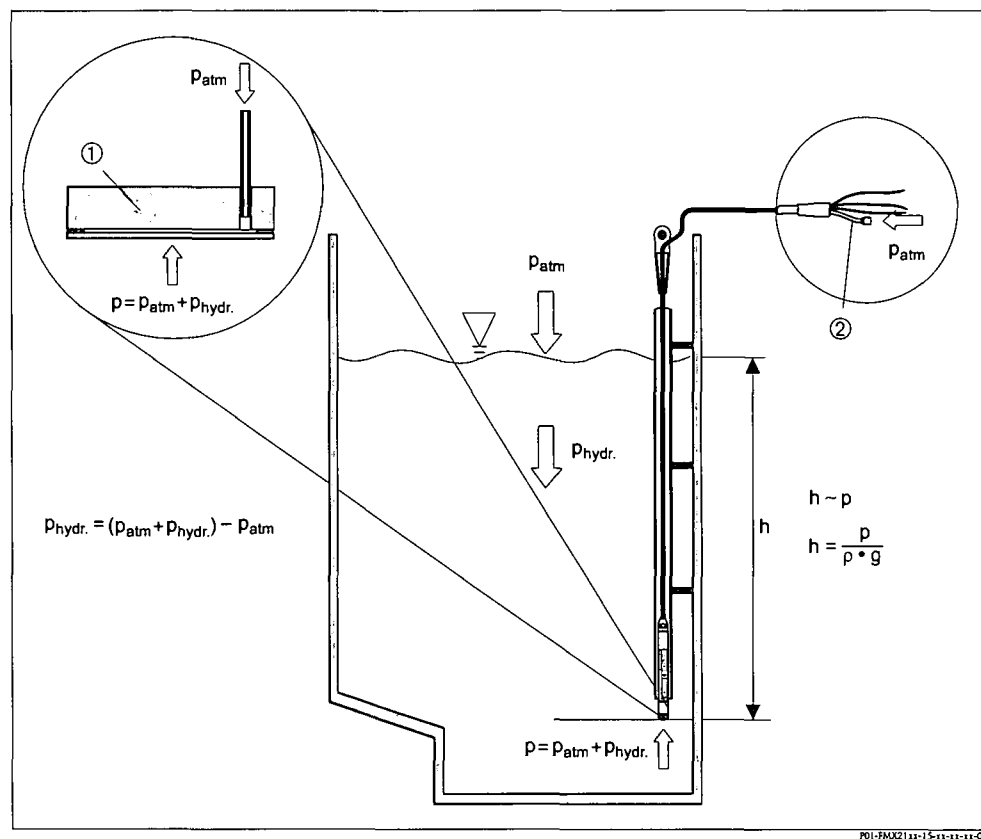
**Measuring principle**

- 1 Ceramic measuring cell
- 2 Pressure compensation tube
- h Level height
- p Total pressure = hydrostatic pressure + atmospheric pressure
- $\rho$  Density of the medium
- g Gravitational acceleration
- $p_{hydr.}$  Hydrostatic pressure
- $p_{atm}$  Atmospheric pressure

**Temperature measurement with optional Pt100 <sup>1)</sup>**

Endress+Hauser also offers the Waterpilot FMX21 with an optional 4-wire Pt100 resistance thermometer to measure level and temperature simultaneously. The Pt100 belongs to Accuracy Class B in accordance with DIN EN 60751, see also → 26 "Accessories".

**Temperature measurement with optional Pt100 and TMT182 temperature head transmitter <sup>1)</sup>**

Endress+Hauser also offers the TMT182 temperature head transmitter with the HART protocol to convert the temperature signal to an analog, scalable 4 to 20 mA output signal superimposed with HART 6.0, see also → 7 "Density compensation with Pt100 temperature sensor" → 24 "Ordering information" → 26 Chap. "Accessories" and Technical Information T1078R.

1) Not for use in hazardous areas.

## Waterpilot FMX21

**Measuring system**

As standard, the complete measuring system consists of a Waterpilot FMX21 and a transmitter power supply unit with a supply voltage of 10.5 to 30 V DC (hazardous areas) or 10.5 to 35 V DC (non-hazardous areas).

Possible measuring point solutions with a transmitter and evaluation units from Endress+Hauser:

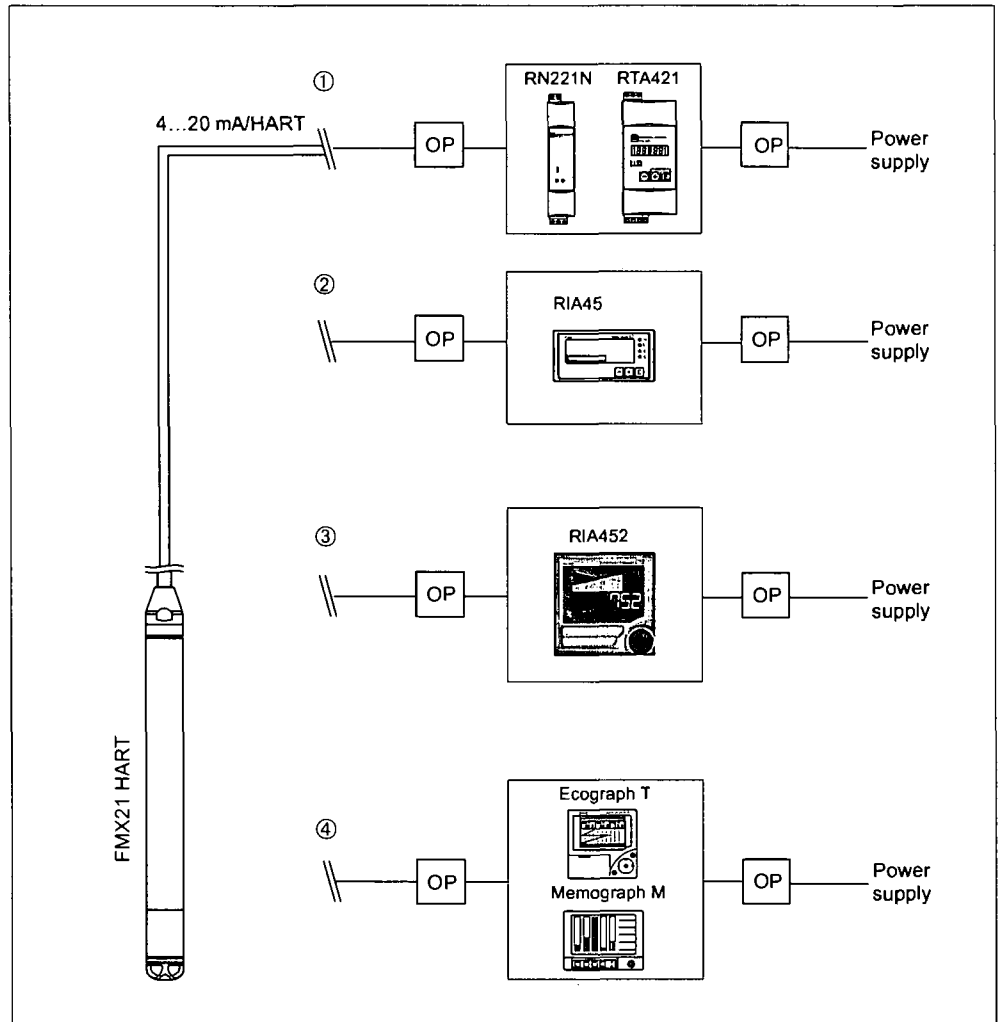
*Sample applications with FMX21*

*OP = Overvoltage protection, e.g. HAW from Endress+Hauser (not for use in hazardous areas)*

*- OP on sensor side for field installation: HAW569/for top-hat/DIN rail: HAW562/intrinsically safe HAW562Z*

*- OP on power supply side for top-hat/DIN rail: HAW561 (115/230 V) and HAW561K (24/48 V AC/DC)*

*The overvoltage protection selected must be appropriate for the supply voltage.*

1. Easy and cost-effective measuring point solution: power supplied to the Waterpilot in hazardous and non-hazardous areas via the RN221N active barrier.  
Power supply and additional control of two appliances, such as pumps, by means of the RTA421 limit value switch with onsite display.
2. The RIA45 units (for panel mounting) offer power supply, an onsite display, two switch outputs and signal adjustment (turndown).
3. If several pumps are used, the pump service life can be prolonged by alternate switching. With alternating pump control, the pump which was out of service for the longest period of time is switched on. The evaluation unit RIA452 (for panel mounting) provide this option in addition to several other functions.
4. State-of-the-art recording technology with graphic display recorders from Endress+Hauser, such as Ecograph T, Memograph M for documenting, monitoring, visualizing and archiving purposes.

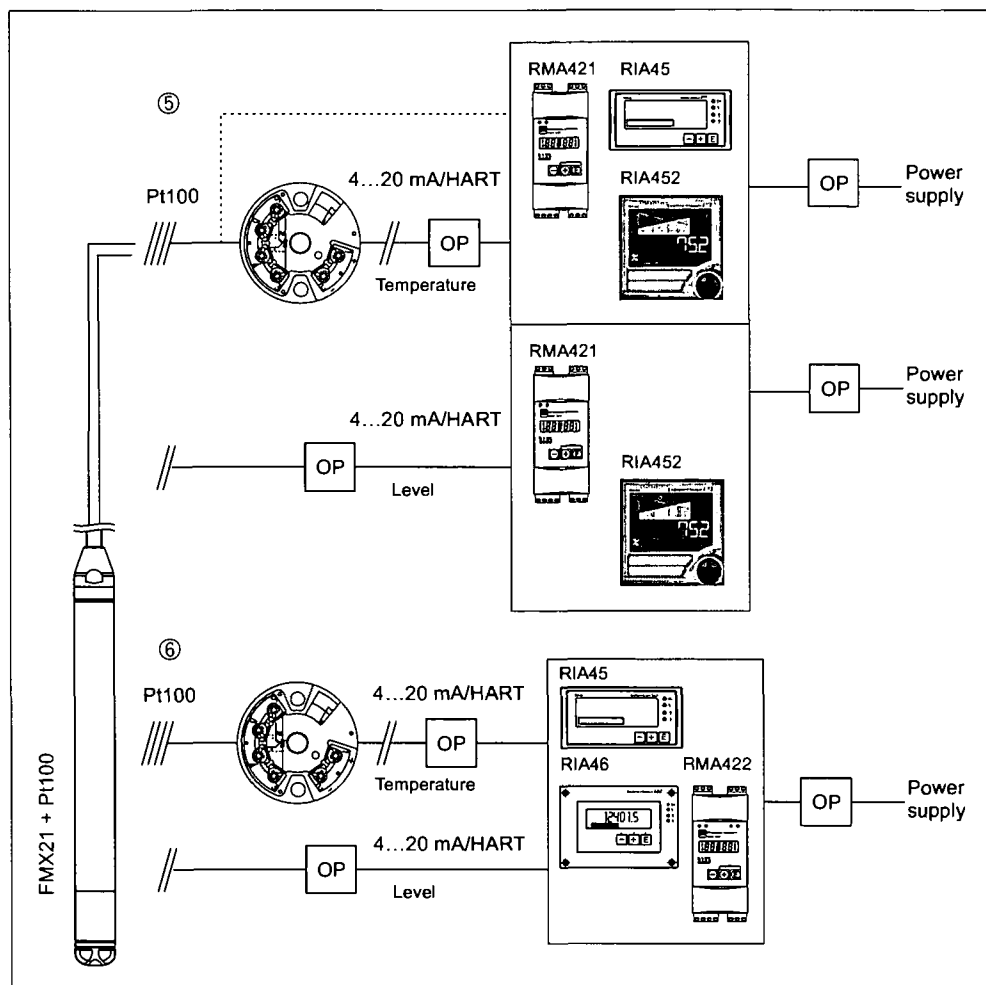

P01-FMX21-14-11-11-en-005

*Sample applications with FMX21 with Pt100*

*OP = Overvoltage protection e.g. HAW from Endress+Hauser (not for use in hazardous areas)*

*- OP on sensor side for field installation: HAW569/for top-hat/DIN rail: HAW562/intrinsically safe HAW562Z*

*- OP on power supply side for top-hat/DIN rail: HAW561 (115/230 V) and HAW561K (24/48 V AC/DC)*

*The overvoltage protection selected must be appropriate for the supply voltage.*

- If you want to measure, display and evaluate the temperature as well as the level, e.g. to monitor temperature in fresh water to detect temperature limits for germ formation, you have the following options:  
The optional TMT182 temperature head transmitter can convert the Pt100 signal to a 4 to 20 mA HART signal and transfer it to any common evaluation unit. The RMA421, RIA45 and RIA452 evaluation units also offer a direct input for the Pt100 signal.
- If you want to record and evaluate the level and temperature measured value with one device, use the RMA422, RIA45 and RIA46 evaluation unit with two inputs. It is even possible to mathematically link the input signals with this unit. These evaluation are not HART permeable.

Waterpilot FMX21

**Level measurement with absolute pressure probe and external pressure signal**

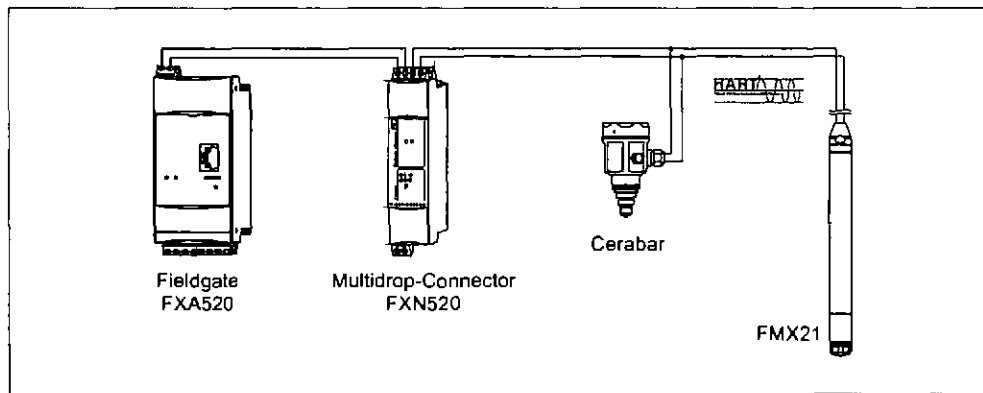

It is advisable to use an absolute pressure probe for applications in which condensation can occur. In the case of level measurement with an absolute pressure probe, the measured value is affected by fluctuations in the ambient air pressure. To correct the resulting measured error, you can connect an external absolute pressure sensor (e.g. Cerabar) to the HART signal cable, switch the waterpilot to the burst mode and the Cerabar to operate in mode "Electr. Delta P".

The external absolute pressure sensor then calculates the difference between the two pressure signals and can thus determine the level precisely. Only one level measured value can be corrected in this way.



**Caution!**  
If using intrinsically safe devices, strict compliance with the rules for interconnecting intrinsically safe circuits as stipulated in IEC60079-14 (proof of intrinsic safety) is mandatory.

**Density compensation with Pt100 temperature sensor**

The Waterpilot FMX21 can correct measured errors that result from fluctuations in the density of the water caused by temperature. Users can choose from the following options:

**Use the internally measured sensor temperature of the FMX21**

The internally measured sensor temperature is calculated in the Waterpilot FMX21 for density compensation. The level signal is thus corrected according to the density characteristic line of the water.

**Use the optional internal temperature sensor for density compensation in a suitable HART master (e.g. PLC)**

The Waterpilot FMX21 is available with an optional Pt100 temperature sensor. Endress+Hauser additionally offers the TMT182 temperature head transmitter to convert the Pt100 signal to a 4 to 20 mA HART signal. The temperature and pressure signal is transmitted to the HART master (e.g. PLC) where a corrected level value can be generated using a stored linearization table or the density function (of a chosen medium).

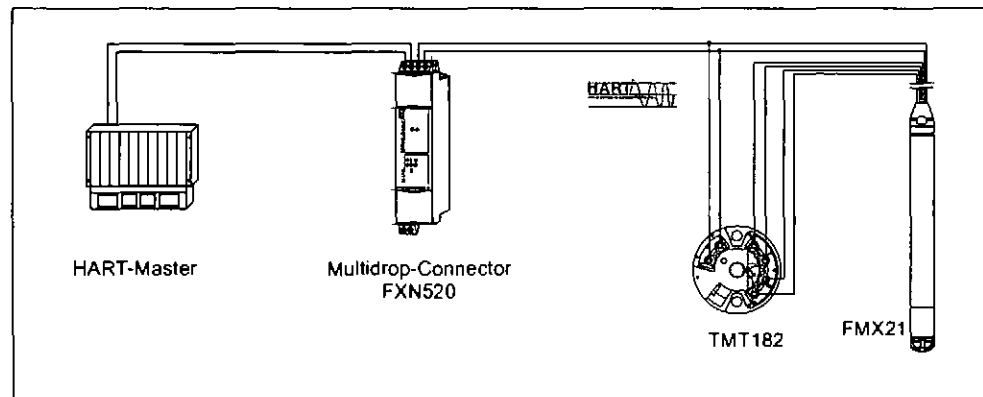

### Use an external temperature signal which is transmitted to the FMX21 via HART burst mode

The Waterpilot FMX21 is available with an optional Pt100 temperature sensor. In this case, the signal of the Pt100 is analyzed using a HART-compliant (at least HART 5.0) temperature transmitter that supports BURST mode. The temperature signal can thus be transmitted to the FMX21. The FMX21 uses this signal for the density correction of the level signal.



Note!

The TMT182 temperature head transmitter is not suitable for this configuration.

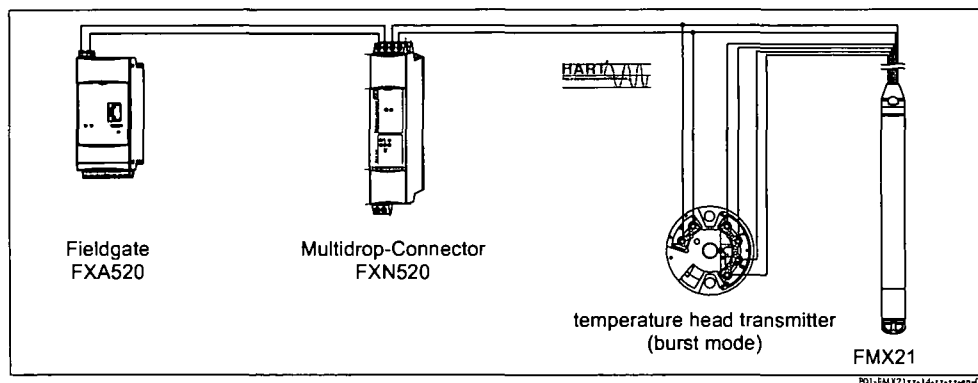

Without compensation additional errors of up to 4 % can occur at a temperature of 70 °C (158 °F) for example. With density compensation, this error can be decreased to 0.5% in the entire temperature range from 0 to 70 °C (32 to 158 °F).



Note!

For further information on the devices, please refer to the appropriate Technical Information:

- TI078R: TMT182 temperature head transmitter (4 to 20 mA/HART)
- TI369F: FXA520 Fieldgate
- TI400F: FXN520 multidrop connector

**Communication protocol** 4 to 20 mA HART with communication protocol

**System integration** The device can be fitted with a tag name, see → 24 ff "Ordering information", feature 895 "Marking" version "Z1".

Waterpilot FMX21

## Input

<b>Measured variable</b>	<b>FMX21 + Pt100 (optional)</b>	<b>TMT182 temperature head transmitter (optional)</b>
	<ul style="list-style-type: none"> <li>■ Hydrostatic pressure of a liquid</li> <li>■ Pt100: temperature</li> </ul>	<ul style="list-style-type: none"> <li>■ Temperature</li> </ul>

**Measuring range**

- Customer-specific measuring ranges; factory-calibrated
- Temperature measurement from -10 to +70 °C (+14 to +158 °F) with Pt100 (optional)
- A sensor measuring range turndown (TD) of up to 10:1 can be set at the factory or directly by the customer.

Sensor measuring range	Smallest span that can be calibrated	Maximum overload/OPL <sup>1)</sup>	Vacuum resistance	Version in the order code <sup>2)</sup>
[bar (psi)]	[bar (psi)]	[bar (psi)]	[bar <sub>abs</sub> (psi <sub>abs</sub> )]	
<b>Gauge pressure</b>				
0.1 (1.5)	0.01 (0.15)	5.0 (75.0)	0.3 (4.5)	1C
0.2 (3.0)	0.02 (0.3)	5.0 (75.0)	0.3 (4.5)	1D
0.4 (6.0)	0.04 (1.0)	6.0 (90.0)	0	1F
0.6 (9.0)	0.06 (1.0)	10.0 (150)	0	1G
1.0 (15.0)	0.1 (1.5)	10.0 (150)	0	1H
2.0 (30.0)	0.2 (3.0)	15.0 (225)	0	1K
4.0 (60.0)	0.4 (6.0)	25.0 (375)	0	1M
10.0 (150) <sup>3)</sup>	1.0 (15)	40.0 (600)	0	1P
20.0 (300) <sup>3)</sup>	2.0 (30)	40.0 (600)	0	1Q
<b>Absolute pressure</b>				
2.0 (30.0)	0.2 (3.0)	15.0 (225)	0	2K
4.0 (60.0)	0.4 (6.0)	25.0 (375)	0	2M
10.0 (150) <sup>3)</sup>	1.0 (15)	40.0 (600)	0	2P
20.0 (300) <sup>3)</sup>	2.0 (30)	40.0 (600)	0	2Q

- 1) OPL: overpressure limit, depending on the weakest element, in terms of pressure, of the selected components
- 2) See → 24 "Ordering information"
- 3) These measuring ranges are not offered for the probe version with a coated housing, outer diameter 29 mm (1.14 in) .

<b>Input signal</b>	<b>FMX21 + Pt100 (optional)</b>	<b>TMT182 temperature head transmitter (optional)</b>
	<ul style="list-style-type: none"> <li>■ Change in capacitance</li> <li>■ Pt100: change in resistance</li> </ul>	<ul style="list-style-type: none"> <li>■ Pt100 resistance signal, 4-wire</li> </ul>

## Output

<b>Output signal</b>	<b>FMX21 + Pt100 (optional)</b> <ul style="list-style-type: none"> <li>4 to 20 mA with overlying digital HART 6.0 communication protocol, 2-wire for hydrostatic pressure measured value</li> <li>Pt100: Temperature-dependent resistance values</li> </ul>	<b>TMT182 temperature head transmitter (optional)</b> <ul style="list-style-type: none"> <li>4 to 20 mA with overlying digital HART 5.0 communication protocol for temperature measured value, 2-wire</li> </ul>
<b>Signal range</b>	<ul style="list-style-type: none"> <li>3.8 to 20.5 mA</li> </ul>	
<b>Signal on alarm</b>	<b>FMX21 + Pt100 (optional)</b> <ul style="list-style-type: none"> <li>4 to 20 mA/HART</li> <li>Options:                             <ul style="list-style-type: none"> <li>Max. alarm (factory setting 22mA): can be set from 21 to 23 mA</li> <li>Hold measured value: last measured value is held</li> <li>Min. alarm: 3.6 mA</li> </ul> </li> </ul>	<b>TMT182 temperature head transmitter (optional)</b> <p>Options:</p> <ul style="list-style-type: none"> <li>Max. alarm <math>\geq 21.0</math> mA</li> <li>Min. alarm <math>\leq 3.6</math> mA</li> </ul>

<b>Load</b>	<b>FMX21</b> $R_{Lmax} \leq \frac{U - 10.5 V}{23 \text{ mA}} - 2 \cdot 0.9 \frac{\Omega}{m} \cdot l - R_{add}$ <p style="text-align: right; font-size: small;">P01-FMX2111-10-11-11-00-000</p>	<b>TMT182 temperature head transmitter (optional)</b> $R_{tot} \leq \frac{U - 11.5 V}{0.023 \text{ A}} - R_{add}$ <p style="text-align: right; font-size: small;">P01-FMX2111-10-11-11-00-001</p>
-------------	--	---

$R_{Lmax}$  = Max. load resistance [ $\Omega$ ]  
 $R_{add}$  = Additional resistances such as resistance of evaluation unit and/or display unit, cable resistance [ $\Omega$ ]  
 $U$  = Supply voltage [V]  
 $l$  = Simple length of extension cable [m] (cable resistance per wire  $\leq 0.09 \Omega/m$ )

**Note!**

When using the measuring device in hazardous areas, installation must comply with the applicable national standards and regulations and the Safety Instructions or Installation or Control Drawings.

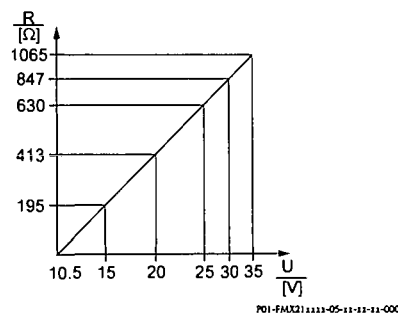

FMX21 load chart for estimating the load resistance. Additional resistances, such as the resistance of the extension cable, have to be subtracted from the value calculated as shown in the equation.

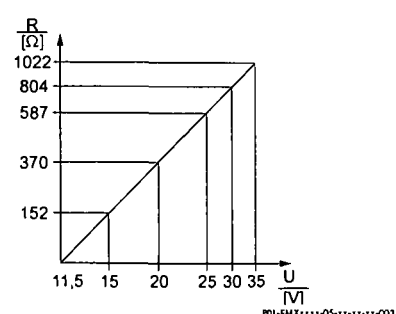

Temperature head transmitter load chart for estimating the load resistance. Additional resistances have to be subtracted from the value calculated as shown in the equation.



**Hinweis!**

When operating using a HART handheld terminal or a PC with an operating program, a minimum communication resistance of 250  $\Omega$  has to be taken into account.

Waterpilot FMX21

**Resolution**

Current output: 1  $\mu$ A

**Read cycle**

HART commands: 2 to 3 per second on average

**Damping**

- Continuously 0 to 999 s via HART handheld terminal or PC with operating program
- Factory setting: 2 s

**Power supply**

**Measuring unit electrical connection**

**Note!**

- When using the measuring device in hazardous areas, installation must comply with the applicable national standards and regulations and the Safety Instructions (XAs) and the Installation or Control Drawings (ZDs). → 28 "Additional documentation", "Safety instructions" and "Installation/Control Drawings".
- Reverse polarity protection is integrated in the Waterpilot FMX21 and in the TMT182 temperature head transmitter. Changing the polarities will not damage the devices.
- The cable must end in a dry room or a suitable terminal box. The terminal box (IP66/IP67) with a GORE-TEX® filter from Endress+Hauser is suitable for outdoor installations. The terminal box can be ordered as an accessory using the order code for FMX21 → 24 version "PS" for feature 620.

The electrical connection is made with the corresponding wires of the probe cable and with the optional use of the terminal box (Commubox FXA) or an active barrier (e.g. RN221N).

**FMX21**

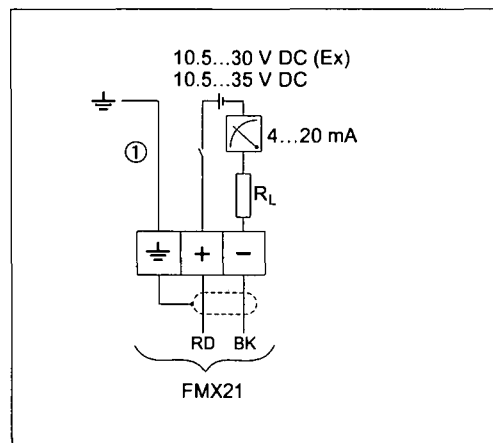

P01-FMX2111-04-11-11-11-000

Electrical connection

**FMX21 with Pt100<sup>1)</sup>**

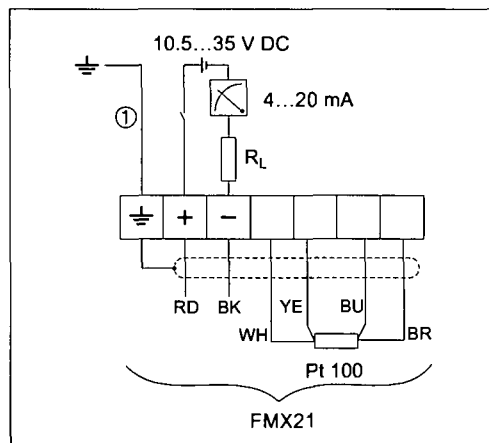

P01-FMX2111-04-11-11-11-000

Electrical connection  
Version "NB" for feature 610 "Accessories" in the order code → 24 ff.

① Not for FMX21 with an outer diameter of 29 mm (1.14 in).

<sup>1)</sup> Not for use in hazardous areas.



**Waterpilot FMX21 with Pt100 and TMT182 temperature head transmitter (4 to 20 mA/HART) <sup>1)</sup>**

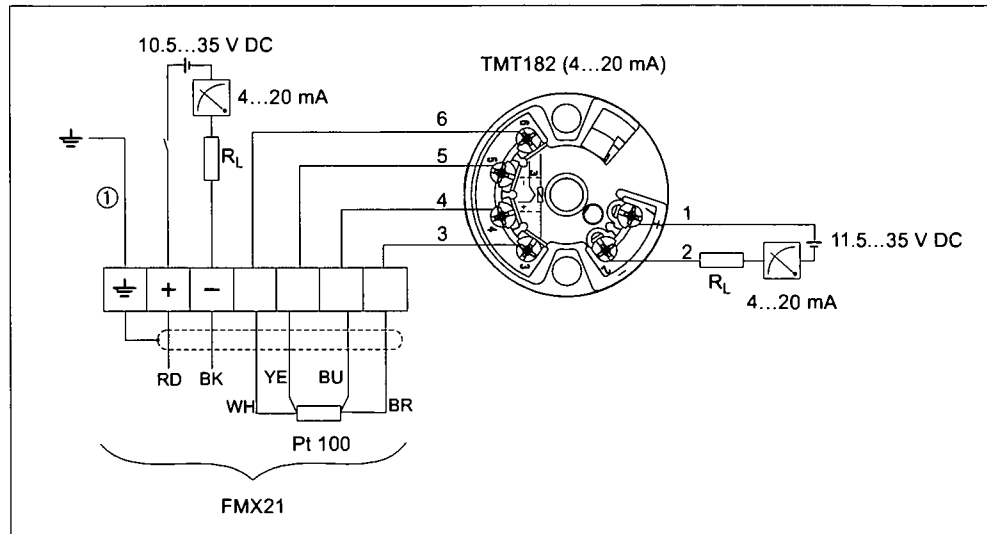

P01-FMX21111-04-11-11-007

FMX21 with Pt100 and TMT182 temperature head transmitter versions "NB" and "PT" for the features 610 and 620 in the order code → 24 ff.

① Not for FMX21 with an outer diameter of 29 mm (1.14 in).

Wire colors: RD = red, BK = black, WH = white, YE = yellow, BU = blue, BR = brown

<sup>1)</sup> Not for use in hazardous areas.

Connection classification as per IEC 61010-1:

- Overvoltage category 1
- Pollution degree 1

**Connection data in the hazardous area**

4 to 20 mA	Ex ia IIC T4 to T6
U <sub>i</sub>	30 V DC
I <sub>i</sub>	133 mA
P <sub>i</sub>	1.0 W
C <sub>i</sub>	10.3 nF (sensor)/180 pF/m (cable)
L <sub>i</sub>	0 μH (sensor)/1 μH/m (cable)
T <sub>a</sub>	-10 °C (+14 °F) ≤ T <sub>a</sub> ≤ +70 °C (+158 °F) for T4; -10 °C (+14 °F) ≤ T <sub>a</sub> ≤ +40 °C (+104 °F) for T6

## Waterpilot FMX21

<b>Supply voltage</b>	<p>Note!</p> <ul style="list-style-type: none"> <li>When using the measuring device in hazardous areas, installation must comply with the applicable national standards and regulations and the Safety Instructions (XAs) and the Installation or Control Drawings (ZDs). All explosion-protection data are given in a separate documentation which is available upon request. This documentation is provided with the devices as standard, see also →  28 "Additional documentation".</li> </ul>	
	<p><b>FMX21 + Pt100 (optional)</b></p> <ul style="list-style-type: none"> <li>10.5 to 35 V (non-hazardous area)</li> <li>10.5 to 30 V (hazardous area)</li> </ul>	<p><b>TMT182 temperature head transmitter (optional)</b></p> <ul style="list-style-type: none"> <li>11.5 to 35 V DC</li> </ul>
<b>Cable specifications</b>	<p><b>FMX21 + Pt100 (optional)</b></p> <ul style="list-style-type: none"> <li>Commercially available shielded instrument cable</li> <li>Terminal, terminal box: 0.08 to 2.5 mm<sup>2</sup> (28 to 14 AWG)</li> <li>If the Pt100 signal is directly connected to a display and/or evaluation unit, Endress+Hauser recommends using a shielded cable.</li> </ul>	<p><b>TMT182 temperature head transmitter (optional)</b></p> <ul style="list-style-type: none"> <li>Commercially available shielded instrument cable</li> <li>Terminal, terminal box: 0.08 to 2.5 mm<sup>2</sup> (28 to 14 AWG)</li> <li>Transmitter connection: max. 1.75 mm<sup>2</sup> (15 AWG)</li> </ul>
	<p><b>Power consumption</b></p> <p><b>FMX21 + Pt100 (optional)</b></p> <ul style="list-style-type: none"> <li>≤ 0.805 W at 35 V DC (non-hazardous area)</li> <li>≤ 0.690 W at 30 V DC (hazardous area)</li> </ul>	<p><b>TMT182 temperature head transmitter (optional)</b></p> <ul style="list-style-type: none"> <li>≤ 0.805 W at 35 V DC</li> </ul>
<b>Current consumption</b>	<p><b>FMX21 + Pt100 (optional)</b></p> <ul style="list-style-type: none"> <li>Max. current consumption: ≤ 23 mA</li> <li>Min. current consumption: ≥ 3.6 mA</li> <li>Pt100: ≤ 0.6 mA</li> </ul>	<p><b>TMT182 temperature head transmitter (optional)</b></p> <ul style="list-style-type: none"> <li>Max. current consumption: ≤ 23 mA</li> <li>Min. current consumption: ≥ 3.5 mA</li> <li>Pt100 via temperature head transmitter: ≤ 0.6 mA</li> </ul>
	<p><b>Residual ripple</b></p> <p><b>FMX21 + Pt100 (optional)</b></p> <ul style="list-style-type: none"> <li>No impact on 4 to 20 mA signal to ±5 % residual ripple within the permitted voltage range (according to HART Hardware Specification HCF_SPEC-54 (DIN IEC 60381-1)).</li> </ul>	<p><b>TMT182 temperature head transmitter (optional)</b></p> <p><math>U_{ss} \geq 3 \text{ V}</math> at <math>U_b \geq 13 \text{ V}</math>, <math>f_{max} = 1 \text{ kHz}</math></p>

## Performance characteristics

<b>Reference operating conditions</b>	<b>FMX21 + Pt100 (optional)</b> <ul style="list-style-type: none"> <li>■ As per IEC 60770</li> <li>■ Ambient temperature <math>T_A = \text{constant}</math>, in range: +21 to +33 °C (+70 °F to +91 °F)</li> <li>■ Humidity <math>\phi = \text{constant}</math>, in range: 20 to 80 % RH</li> <li>■ Ambient pressure <math>p_A = \text{constant}</math>, in range: 860 to 1060 mbar (12.47 to 15.37 psi)</li> <li>■ Position of the measuring cell = constant, in range: vertical: <math>\pm 1^\circ</math></li> <li>■ Supply voltage constant: 21 V DC to 27 V DC</li> <li>■ Load with HART: 250 <math>\Omega</math></li> <li>■ Pt100: DIN EN 60770 <math>T_A = 25^\circ\text{C}</math> (77 °F)</li> </ul>	<b>TMT182 temperature head transmitter (optional)</b> Calibration temperature 25 °C (77 °F) $\pm 5$ K
<b>Reference accuracy</b>	<b>FMX21 + Pt100 (optional)</b> The reference accuracy comprises the non-linearity after limit point configuration, hysteresis and non-repeatability in accordance with IEC 60770. <ul style="list-style-type: none"> <li>■ Setting <math>\pm 0.2</math> %               <ul style="list-style-type: none"> <li>- to TD 5:1: &lt; 0.2 % of the set span</li> <li>- from TD 5:1 to TD 10:1 <math>\pm(0.02 \times \text{TD} + 0.1)</math></li> </ul>               PLATINUM version:             </li> <li>■ Setting <math>\pm 0.1</math> % (optional)               <ul style="list-style-type: none"> <li>- to TD 5:1: &lt; 0.1 % of the set span</li> <li>- from TD 5:1 to TD 10:1 <math>\pm(0.02 \times \text{TD})</math></li> </ul> </li> <li>■ Class B to DIN EN 60751               <ul style="list-style-type: none"> <li>- Pt100: max. <math>\pm 1</math> K</li> </ul> </li> </ul>	<b>TMT182 temperature head transmitter (optional)</b> <ul style="list-style-type: none"> <li>■ <math>\pm 0.2</math> K</li> <li>■ With Pt100: max. <math>\pm 0.9</math> K</li> </ul>
<b>Long-term stability</b>	<b>FMX21 + Pt100 (optional)</b> <ul style="list-style-type: none"> <li>■ <math>\leq 0.1</math> % of URL/year</li> <li>■ <math>\leq 0.25</math> % of URL/5 years</li> </ul>	<b>TMT182 temperature head transmitter (optional)</b> $\leq 0.1$ K per year
<b>Influence of medium temperature</b>	<ul style="list-style-type: none"> <li>■ Thermal change in the zero output and the output span              0 to +30 °C (+32 to +86 °F): <math>&lt;(0.15 + 0.15 \times \text{TD})\%</math>              -10 to +70 °C (+14 to +158 °F): <math>&lt;(0.4 + 0.4 \times \text{TD})\%</math></li> <li>■ Temperature coefficient (<math>T_k</math>) of the zero output and output span              -10 to +70 °C (+14 to +158 °F): 0.1 % / 10 K URL</li> </ul>	
<b>Warm-up period</b>	<b>FMX21 + Pt100 (optional)</b> FMX21: < 6 s Pt100: 20 ms	<b>TMT182 temperature head transmitter (optional)</b> 4 s
<b>Step response time</b>	<b>FMX21 + Pt100 (optional)</b> <ul style="list-style-type: none"> <li>■ FMX21: 400 ms (T90 time), 500 ms (T99 time)</li> <li>■ Pt100: 160 s (T90 time), 300 s (T99 time)</li> </ul>	-

## Installation

### Installation instructions

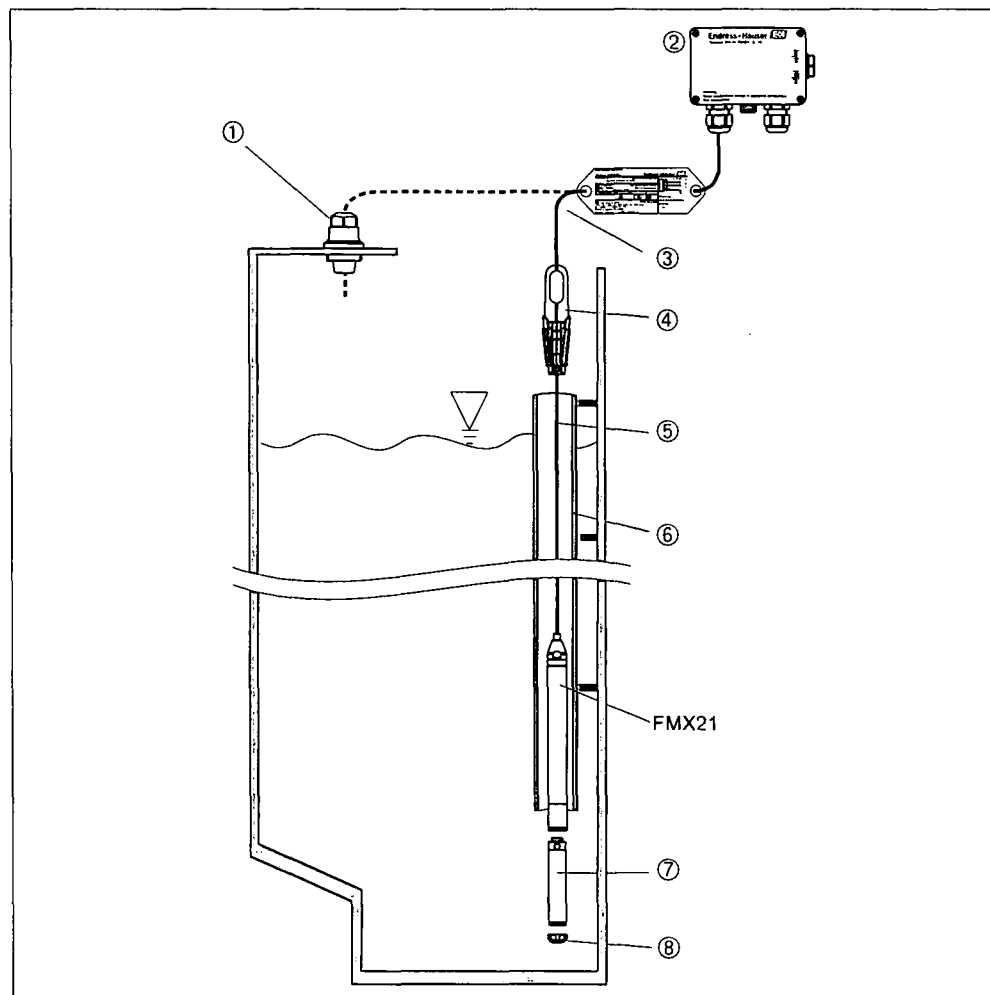

P01-FMX21a-11-11-11-11-001

Installation examples, here illustrated with FMX21 with an outer diameter of 22 mm (0.87 in)

- 1 Extension cable mounting screw can be ordered via order code or as an accessory → 24 ff
- 2 Terminal box can be ordered via order code or as an accessory → 24 ff
- 3 Extension cable bending radius > 120 mm (4.72 in)
- 4 Mounting clamp can be ordered via order code or as an accessory → 24 ff
- 5 Extension cable, length → 21
- 6 Guide pipe
- 7 Additional weight can be ordered as an accessory for FMX21 with an outer diameter of 22 mm (0.87 in) and 29 mm (1.14 in) → 26
- 8 Protection cap



#### Note!

- Sideways movement of the level probe can result in measuring errors. For this reason, install the probe at a point free from flow and turbulence, or use a guide tube. The internal diameter of the guide tube should be at least 1 mm (0.04 in) bigger than the outer diameter of the selected FMX21.
- The cable must end in a dry room or a suitable terminal box. The terminal box from Endress+Hauser provides optimum humidity and climatic protection and is suitable for outdoor installation.
- Protection cap: The device is provided with a protection cap to prevent mechanical damage to the measuring cell. This cap should not be removed during the transportation and installation process.
- If the cable is shortened, the filter at the pressure compensation tube has to be reattached. Endress+Hauser offers a cable shortening kit for this purpose → 24 ff (SD552P/00/A6).
- Endress+Hauser recommends using twisted, shielded cables.

## Ambient conditions

<b>Ambient temperature range</b>	<b>FMX21 + Pt100 (optional)</b> <ul style="list-style-type: none"> <li>■ FMX21 with outer diameter of 22 mm (0.87 in) and 42 mm (1.65 in): -10 to +70 °C (+14 to +158 °F) (= medium temperature)</li> <li>■ FMX21 with outer diameter of 29 mm (1.14 in): 0 to +50 °C (+32 to +122 °F) (= medium temperature)</li> </ul> <b>Terminal box</b> <ul style="list-style-type: none"> <li>■ -40 to +80 °C (-40 to +176 °F)</li> </ul>	<b>TMT182 temperature head transmitter (optional)</b> -40 to +85 °C (-40 to +185 °F)
<b>Storage temperature range</b>	<b>FMX21 + Pt100 (optional)</b> <ul style="list-style-type: none"> <li>■ -40 to +80 °C (-40 to +176 °F)</li> </ul> <b>Terminal box</b> <ul style="list-style-type: none"> <li>■ -40 to +80 °C (-40 to +176 °F)</li> </ul>	<b>TMT182 temperature head transmitter (optional)</b> -40 to +100 °C (-40 to +212 °F)
<b>Degree of protection</b>	<b>FMX21 + Pt100 (optional)</b> <ul style="list-style-type: none"> <li>■ IP68, permanently hermetically sealed at 40 bar (580 psi)(~400 m H<sub>2</sub>O)</li> </ul> <b>Terminal box (optional)</b> <ul style="list-style-type: none"> <li>■ IP66/IP67</li> </ul>	<b>TMT182 temperature head transmitter (optional)</b> <ul style="list-style-type: none"> <li>■ IP00, condensation permitted</li> </ul>
<b>Electromagnetic compatibility (EMC)</b>	<b>FMX21 + Pt100 (optional)</b> <ul style="list-style-type: none"> <li>■ EMC in accordance with all the relevant requirements of the EN 61326 series. Details are provided in the Declaration of Conformity.</li> <li>■ Maximum deviation &lt;0.5 % of the span.</li> </ul>	<b>TMT182 temperature head transmitter (optional)</b> <ul style="list-style-type: none"> <li>■ EMC in accordance with all the relevant requirements of the EN 61326 series. Details are provided in the Declaration of Conformity.</li> </ul>
<b>Overvoltage protection</b>	<b>FMX21 + Pt100 (optional)</b> Integrated overvoltage protection to EN 61000-4-5 (500 V symmetrical/1000 asymmetrical) Install overvoltage protection ≥1.0 kV, external if necessary	<b>TMT182 temperature head transmitter (optional)</b> Install overvoltage protection, external if necessary.

## Waterpilot FMX21

## Process conditions

Medium temperature range	FMX21 + Pt100 (optional)	TMT182 temperature head transmitter (optional)
	<ul style="list-style-type: none"> <li>■ FMX21 with outer diameter of 22 mm (0.87 in) and 42 mm (1.65 in): -10 to +70 °C (+14 to +158 °F)</li> <li>■ FMX21 with outer diameter of 29 mm (1.14 in): 0 to +50 °C (+32 to +122 °F)</li> </ul>	-
Medium temperature limits	FMX21 + Pt100 (optional)	
	<ul style="list-style-type: none"> <li>■ FMX21 with outer diameter of 22 mm (0.87 in) and 42 mm (1.65 in): -20 to +70 °C (-4 to +158 °F)</li> </ul> <p>Note! In hazardous areas incl. CSA GP, the medium temperature limit is at -10 to +70 °C (+14 to +158 °F).</p> <ul style="list-style-type: none"> <li>■ FMX21 with outer diameter of 29 mm (1.14 in): 0 to +50 °C (+32 to +122 °F)</li> </ul> <p>(The FMX21 can be operated in this temperature range. The specification can then be exceeded, e.g. measuring accuracy.)</p>	-

## Mechanical construction

### Dimensions of the level probe

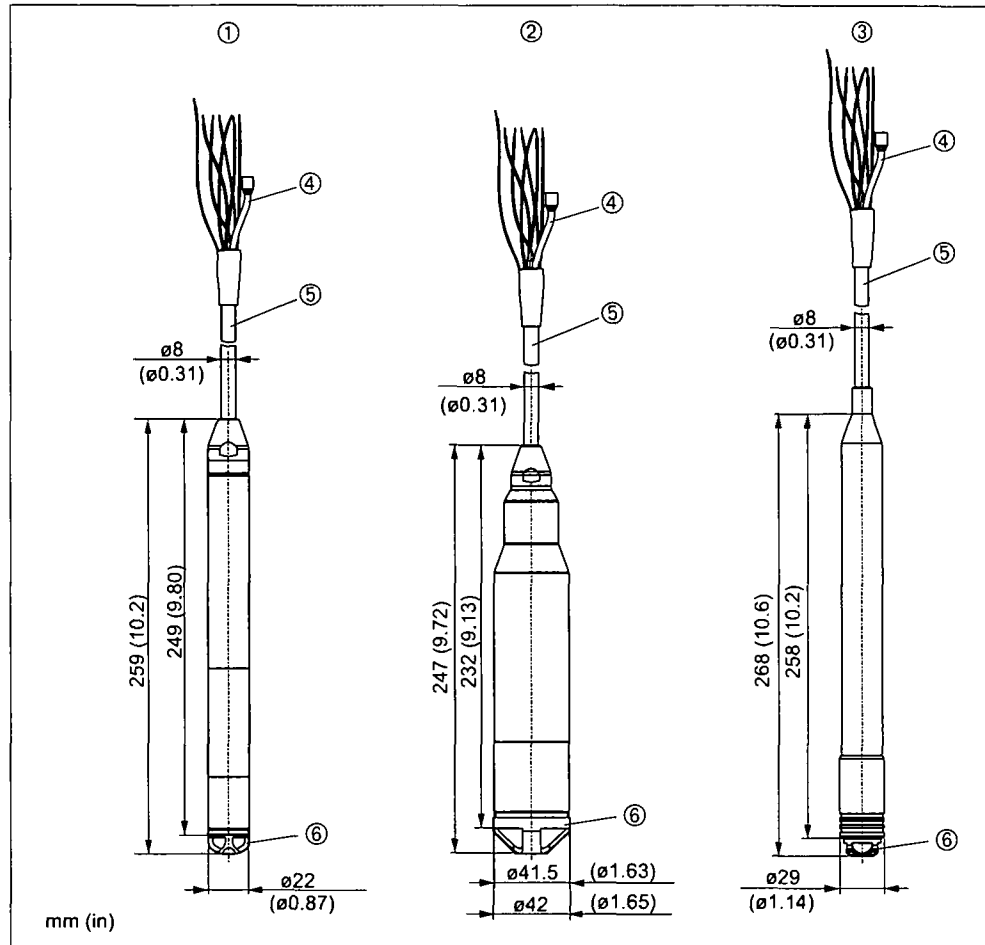

#### Versions of the FMX21

- 1 Version "1" for feature 45 "Probe tube" or "Accessories" in the order code → 24 ff
- 2 Version "2" for feature 45 "Probe tube" in the order code → 24 ff
- 3 Version "3" for feature 45 "Probe tube" in the order code → 24 ff
- 4 Pressure compensation tube
- 5 Extension cable
- 6 Protection cap

### Dimensions of the mounting clamp

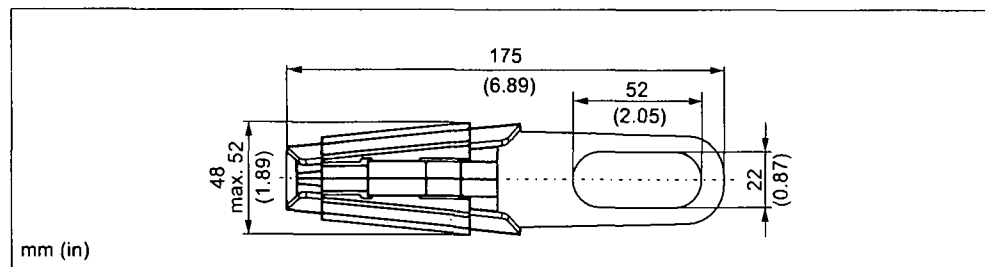

Mounting clamp, version "PO" for feature 620 "Accessories" in the order code → 24 ff

Waterpilot FMX21

**Dimensions of the extension cable mounting screws**

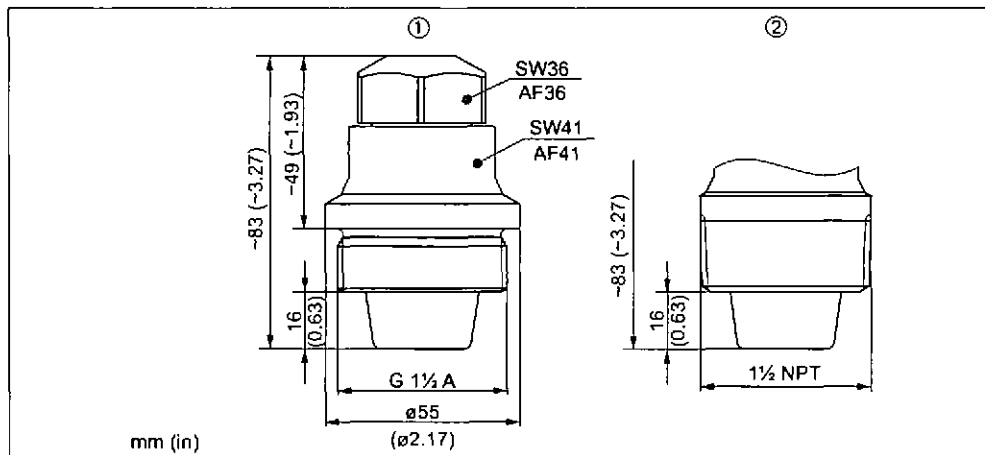

Extension cable mounting screws

- 1 Extension cable mounting screw G 1 1/2 A, version "PQ" for feature 620 "Accessories" in the order code → 24 ff
- 2 Extension cable mounting screw 1 1/2 NPT, version "PR" for feature 620 "Accessories" in the order code → 24 ff



Note!  
Application in unpressurized containers only.

**Dimensions of the IP66/IP67 terminal boxes with filters**

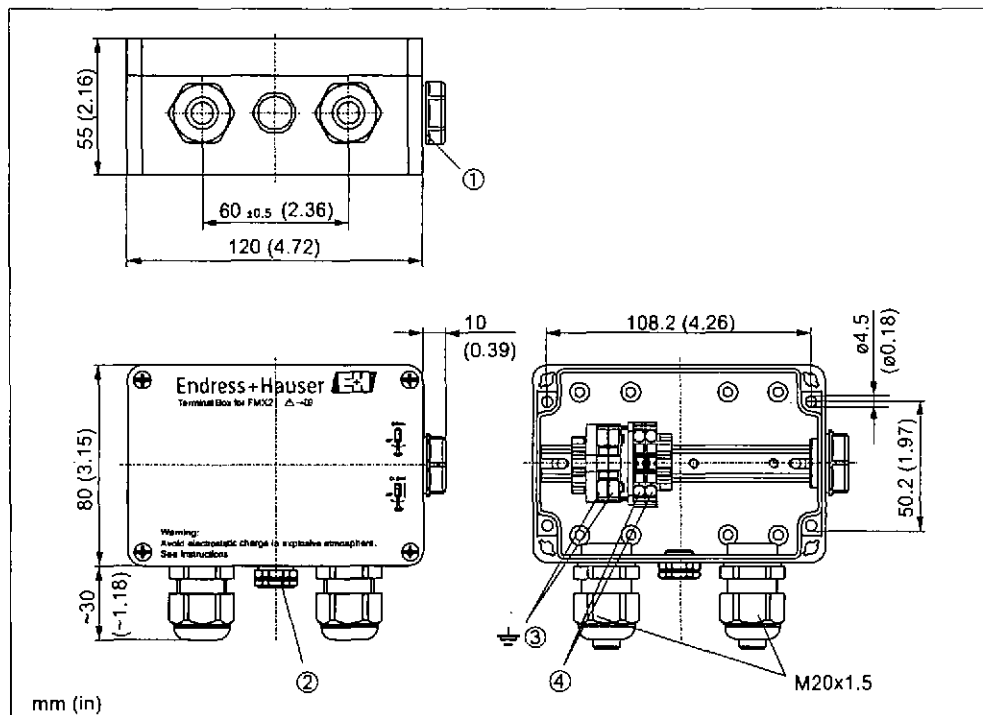

Terminal box / Version "PS" or "PT" for feature 620 "Accessories" in the order code → 24 ff

- 1 Dummy plug M20x1.5
- 2 GORE-TEX® filter
- 3 Ground connection / terminals for 0.08 to 2.5 mm² (28 to 14 AWG)
- 4 4 to 20 mA / terminals for 0.08 to 2.5 mm² (28 to 14 AWG)

If ordered together with FMX21 but without the optional TMT182 temperatur transmitter, the terminal box is incl. a 4-terminal strip.



Note!  
The 4-terminal strip is not intended for use in hazardous areas incl. CSA GP.



### Dimensions of the TMT182 temperature head transmitter

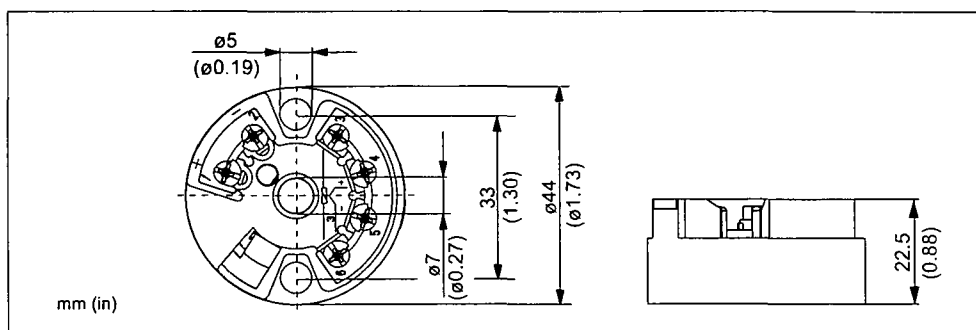

TMT182 temperature head transmitter (4 to 20 mA/HART), version "PT" for feature 620 "Accessories" in the order code  
→ 24 ff.

### Terminal box with integrated TMT182 temperature head transmitter (4 to 20 mA/HART)

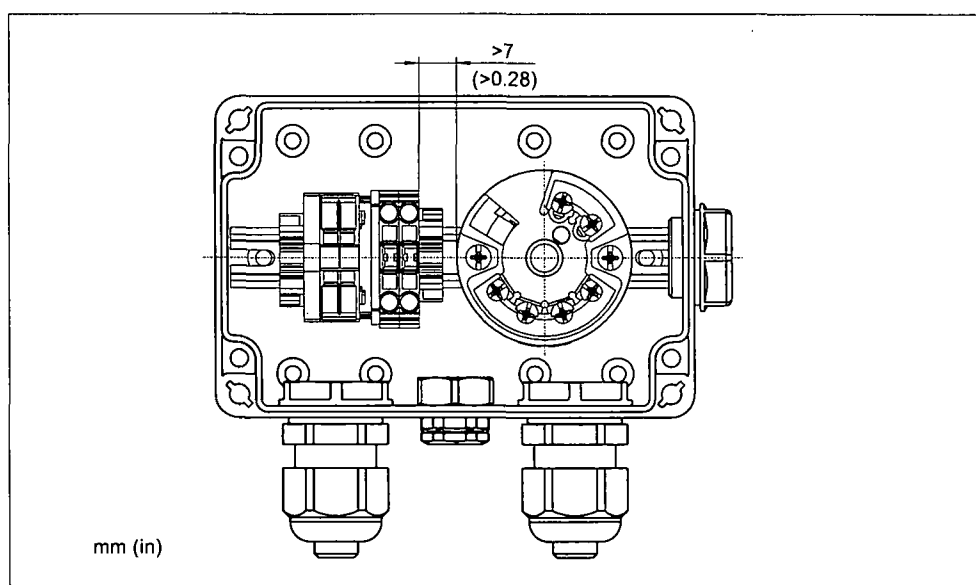

#### Note!

A distance of  $>7$  mm ( $>0.28$  in mm) must be maintained between the terminal strip and the TMT182 temperature head transmitter.

### Weight

- Level probe, outer diameter 22 mm (0.87 in): 344 g (12.133 oz)
- Level probe, outer diameter 29 mm (1.14 in): 394 g (13.896 oz)
- Level probe, outer diameter 42 mm (1.65 in): 1376 g (48.532 oz)
- PE extension cable: 52 g/m (0.33 lbs/1 ft)
- FEP extension cable: 108 g/m (0.072 lbs/1 ft)
- PUR extension cable: 60 g/m (0.039 lbs/1 ft)
- Mounting clamp: 170 g (5.996 oz)
- Extension cable mounting screw G1 1/2 A: 770 g (27.158 oz)
- Extension cable mounting screw 1 1/2 NPT: 724 g (25.535 oz)
- Terminal box: 235 g (8.288 oz)
- Temperature head transmitter: 40 g (1.411 oz)
- Additional weight: 300 g (1.376 oz)
- Adapter weight: 39 g

## Waterpilot FMX21

**Material**

- Level probe, outer diameter 22 mm (0.87 in): 1.4435 (AISI 316L)
- Level probe, outer diameter 29 mm (1.14 in): 1.4435 (AISI 316L)
  - Sensor sleeve: PPS (polyphenylene sulfide); heat-shrink tube/cover: polyolefin.
  - The materials used ensure that metal does not come in contact with the medium.
- Level probe, outer diameter 42 mm (1.65 in): 1.4435 (AISI 316L)
- Process ceramic: Al<sub>2</sub>O<sub>3</sub> aluminum oxide ceramic
- Seal (internal): EPDM or Viton
- Protection cap: – PPO (polyphenylene oxide) for FMX21 with outer diameter 22 mm and 29 mm.
  - PFA (perfluoroalkoxy) for FMX21 with outer diameter 42 mm.
- Extension cable insulation: either PE-LD (low-density polyethylene), FEP (fluorinated ethylene propylene) or PUR (polyurethane), for further information, see → [E 21](#) "Extension cable".
- Mounting clamp: 1.4404 (AISI 316L) and fiberglass reinforced PA (polyamide)
- Extension cable mounting screw G1 ½ A: 1.4301 (AISI 304)
- Extension cable mounting screw 1 ½ NPT: 1.4301 (AISI 304)
- Terminal box: PC (polycarbonate)
- Temperature head transmitter: PC housing (polycarbonate)

**Extension cable****PE extension cable**

- Abrasion-resistant extension cable with Dynema strain-relief members; shielded with aluminum-coated film; insulated with polyethylene (PE), black; copper wires, twisted
- Pressure compensation tube with Teflon filter

**PUR extension cable**

- Abrasion-resistant extension cable with Dynema strain-relief members; shielded with aluminum-coated film; insulated with polyurethane (PUR), black; copper wires, twisted
- Pressure compensation tube with Teflon filter

**FEP extension cable**

- Abrasion-resistant extension cable; shielded with galvanized steel wire netting; insulated with fluorinated ethylene propylene (FEP), black; copper wires, twisted
- Pressure compensation tube with Teflon filter

**Cross-section of PE/PUR/FEP extension cable**

- Total outer diameter: 8.0 mm (0.31 in) ±0.25 mm (±0.01 in)
- FMX21: 3 x 0.227 mm<sup>2</sup> (3 x 26 AWG) + pressure compensation tube with Teflon filter
- FMX21 with Pt100 (optional): 7x 0.227 mm<sup>2</sup> (7x 26 AWG) + pressure compensation tube with Teflon filter
- Pressure compensation tube with Teflon filter: outer diameter 2.5 mm (0.1 in), internal diameter 1.5 mm (0.06 in)

**Cable resistance of PE/PUR/FEP extension cable**

- Cable resistance per wire: ≤ 0.09 Ω/m

**Cable length of PE/PUR/FEP extension cable**

- Please refer also to → [E 10](#), Chap. "Load".
- Cable length that can be ordered
  - Customer-specific length in meters or feet (→ [E 24](#), "Ordering information")
  - Limited cable length when performing installation with freely suspended device with extension cable mounting screw or mounting clamp, as well as for hazardous areas: max. 300 m (984 ft).
- When using the measuring device in hazardous areas, installation must comply with the applicable national standards and regulations and the Safety Instructions (XAs) or the Installation or Control Drawings (ZDs) "Additional documentation".

**Further technical data for PE/PUR/FEP extension cable**

- Minimum bending radius: 120 mm (4.72 in)
- Tensile strength: max. 950 N (213.56 lbf)
- Cable extraction force: typical ≥400 N (89.92 lbf) PE, FEP / typical ≥150 N (33.72 lbf) PUR (The extension cable could be extracted from the level probe with a appropriate tensile force.)
- Resistance to UV light
- PE: Approved for use with drinking water

**Terminals**

- Three terminals as standard in the terminal box
- 4-terminal strip can be ordered as an accessory, Order No: 52008938  
Conductor cross-section 0.08 to 2.5 mm<sup>2</sup> (28 to 14 AWG)

**Note!**

The 4-terminal strip is not intended for use in hazardous areas incl. CSA GP.

---

## Human interface

---

**Field Xpert SFX100**

Field Xpert is an industrial PDA with integrated 3.5" touchscreen from Endress+Hauser based on Windows Mobile. It communicates via wireless with the optional VIATOR® Bluetooth® modem connected to a HART device point-to-point or wireless via WiFi and Endress+Hauser's Fieldgate FXA520. Field Xpert also works as a stand-alone device for asset management applications. For details refer to BA060S/00/EN.

**Field Communicator 375, 475**

The Field Communicator 375, 475 handheld terminal can be used to set all the parameter via menu operation.

**FieldCare**

FieldCare is Endress+Hauser's plant asset management tool based on FDT technology. You can use FieldCare to configure all Endress+Hauser devices as well as third-party devices which support the FDT standard.

FieldCare supports the following functions:

- Configuration of transmitters in offline and online mode
- Loading and saving device data (upload/download)
- Documentation of the measuring point

Connection options:

- Via Commubox FXA195 and the USB port of a computer
- Via Fieldgate FXA520

For further information and free download of FieldCare see → [www.endress.com](http://www.endress.com) → Download → Search: FieldCare

## Certificates and approvals

**CE mark** The device meets the legal requirements of the applicable EC Directives. Endress+Hauser confirms successful testing of the device by affixing to it the CE mark.

**Approvals, types of protection**

- ATEX II 2 G Ex ia IIC T4/T6 <sup>1)2)</sup>
- ATEX II 3 G Ex nA IIC T5/T6 <sup>1)3)</sup>
- FM: IS Cl. I, Div. 1 Gp. A-D; AEx ia Cl. I Zone 1 IIC <sup>1)</sup>
- CSA C/US: IS Cl. I, Div. 1 Gp. A-D; Ex ia Cl. I Zone 1 IIC <sup>1)</sup>
- CSA: General Purpose
- IEC Ex ia IIC T6 Gb <sup>1)</sup>
- NEPSI Ex ia IIC T6

<sup>1)</sup> Only for Waterpilot FMX21 without Pt100 and TMT182

<sup>2)</sup> T4/T6:

Temperature class T4 at  $-10\text{ °C (+14 °F)} < T_a < +70\text{ °C (+158 °F)}$

Temperature class T6 at  $-10\text{ °C (+14 °F)} < T_a < +40\text{ °C (+104 °F)}$

<sup>3)</sup> T5/T6:

Temperature class T5 at  $-10\text{ °C (+14 °F)} < T_a < +70\text{ °C (+158 °F)}$

Temperature class T6 at  $-10\text{ °C (+14 °F)} < T_a < +60\text{ °C (+140 °F)}$



Note!

- Waterpilot FMX21 is only available for use in hazardous areas with the FKM Viton seal.
- All explosion-protection data are given in a separate documentation which is available upon request. The Ex documentation is provided with all Ex-systems as standards, see also → 28 "Additional documentation", "Safety instructions" and "Installation/Control Drawings".

**Drinking water approval  
(for FMX21 with outer  
diameter 22 mm (0.87 in))**

- KTW certificate
- NSF 61 approval
- ACS approval (in preparation)

**Standards and guidelines  
applied** The European standards and guidelines that have been applied are listed in the associated EC Declarations of Conformity. In addition, the following standards were also applied for the Waterpilot FMX21:

- DIN EN 60770 (IEC 60770):  
Transmitters for use in industrial process control systems  
Part 1: Methods for performance evaluation
- DIN 16086:  
Electrical pressure measuring instruments,  
pressure sensors, pressure transmitters,  
pressure measuring instruments, concepts, specifications on data sheets
- EN 61326:  
Electrical equipment for measurement, control and laboratory use – EMC requirements
- EN 61010-1 (IEC 61010-1):  
Safety requirements for electrical equipment for measurement, control and laboratory use
- EN 60529:  
Degrees of protection provided by enclosures

## Ordering information

FMX21

You can enter the versions for the specific feature in the following table. The versions entered make up the complete order code. Options which are mutually exclusive are not marked.

<b>10</b>	<b>Approval:</b>		
	AA	Non-hazardous area	
	BE	ATEX II 2 G Ex ia IIC T6	
	BD	ATEX II 3 G Ex nA IIC T6	
	FE	FM IS, Cl. I Division 1, Groups A - D, AEx ia, zone 1	
	CE	CSA C/US IS Cl. I Division 1, Groups A - D, Ex ia, zone 1	
	CD	CSA General Purpose	
	IC	IEC Ex ia IIC T6 Gb	
	NA	NEPSI Ex ia IIC T6	
<b>20</b>	<b>Output:</b>		
	2	4-20 mA HART	
<b>45</b>	<b>Probe tube:</b>		
	1	Outer diameter d = 22 mm, AISI 316L	
	2	Outer diameter d = 42 mm, flush-mounted, AISI 316L	
	5	Outer diameter d = 29 mm, AISI 316L, PPS/polyolefin for saltwater applications	
<b>70</b>	<b>Sensor range:</b>		
	<b>Measuring range</b>		
	1C	100 mbar/10 kPa/1.5 psi gauge, 1mH <sub>2</sub> O/3ftH <sub>2</sub> O/40inH <sub>2</sub> O	
	1D	200 mbar/20 kPa/3 psi gauge, 2mH <sub>2</sub> O/6ftH <sub>2</sub> O/80inH <sub>2</sub> O	
	1F	400 mbar/40 kPa/6 psi gauge, 4mH <sub>2</sub> O/13ftH <sub>2</sub> O/160inH <sub>2</sub> O	
	1G	600 mbar/60 kPa/9 psi gauge, 6mH <sub>2</sub> O/20ftH <sub>2</sub> O/240inH <sub>2</sub> O	
	1H	1 bar/100 kPa/15 psi gauge, 10mH <sub>2</sub> O/33ftH <sub>2</sub> O/400inH <sub>2</sub> O	
	1K	2 bar/200 kPa/30 psi gauge, 20mH <sub>2</sub> O/67ftH <sub>2</sub> O/800inH <sub>2</sub> O	
	1M	4 bar/400 kPa/60 psi gauge, 40mH <sub>2</sub> O/133ftH <sub>2</sub> O/1600inH <sub>2</sub> O	
	1P	10 bar/1 MPa/150 psi gauge, 100mH <sub>2</sub> O/333ftH <sub>2</sub> O/4000inH <sub>2</sub> O	
	1Q	20 bar/2 MPa/300 psi gauge, 200mH <sub>2</sub> O/667ftH <sub>2</sub> O/8000inH <sub>2</sub> O	
	2K	2 bar/200 kPa/30 psi absolute, 20mH <sub>2</sub> O/67ftH <sub>2</sub> O/800inH <sub>2</sub> O	
	2M	4 bar/400 kPa/60 psi absolute, 40mH <sub>2</sub> O/133ftH <sub>2</sub> O/1600inH <sub>2</sub> O	
	2P	10 bar/1 MPa/150 psi absolute, 100mH <sub>2</sub> O/333ftH <sub>2</sub> O/4000inH <sub>2</sub> O	
	2Q	20 bar/2 MPa/300 psi absolute, 200mH <sub>2</sub> O/667ftH <sub>2</sub> O/8000inH <sub>2</sub> O	
<b>80</b>	<b>Reference accuracy:</b>		
	D	Platinum	
	G	Standard	
<b>90</b>	<b>Calibration, unit:</b>		
	A	Sensor range; %	
	B	Sensor range; mbar/bar	
	C	Sensor range; kPa/MPa	
	D	Sensor range; mm/mH <sub>2</sub> O	
	E	Sensor range; inH <sub>2</sub> O/ftH <sub>2</sub> O	
	F	Sensor range; psi	
	J	Customized pressure; see additional specification	
	K	Customized level; see additional specification	
FMX21-			Order code

→ Ordering information for FMX21 continued on next page.

Waterpilot FMX21

FMX21 (continued)

<b>100</b>						<b>Probe connection:</b>
	10					10 m cable, shortable, PE
	11					20 m cable, shortable, PE
	15					..... m cable, shortable, PE
	20					30 ft cable, shortable, PE
	21					60 ft cable, shortable, PE
	25					..... ft cable, shortable, PE
	30					10 m cable, shortable, FEP
	31					20 m cable, shortable, FEP
	35					..... m cable, shortable, FEP
	40					30 ft cable, shortable, FEP
	41					60 ft cable, shortable, FEP
	45					..... ft cable, shortable, FEP
	50					10 m cable, shortable, PUR
	51					20 m cable, shortable, PUR
55					..... m cable, shortable, PUR	
60					30 ft cable, shortable, PUR	
61					60 ft cable, shortable, PUR	
65					..... ft cable, shortable, PUR	
<b>190</b>						<b>Seal:</b>
	A					FKM Viton
	H					EPDM
FMX21-						Order code

Additional ordering information (optional)

<b>550</b>						<b>Calibration</b>
	F1					Works calib. certificate 5-point
<b>570</b>						<b>Service</b>
	IA					Adjusted min alarm current
	IB					Adjusted HART Burst Mode PV
	IR					... m cable marking>installation
	IS					... ft cable marking>installation
					I9	Special version
<b>590</b>						<b>Additional approval</b>
	LQ					KTW potable water approval
	LR					NSF potable water approval
	LS					ACS potable water approval (in preparation)
<b>610</b>						<b>Accessories mounted</b>
	NB					Temperature sensor Pt100, 4-wire
<b>620</b>						<b>Accessories enclosed</b>
	PO					Suspension clamp, 316L
	PQ					Cable mounting screw G1-1/2, 304
	PR					Cable mounting screw NPT1-1/2, 304
	PS					Terminal box IP66/67
	PT					Temperature head transmitter TMT182, 2-wire, 4-20 mA, -20 to 80 °C
	PU					Additional weight, 316L
	PV					Adapter, function test
PW					Shortening kit, extension cable	
<b>895</b>						<b>Marking</b>
	Z1					Tagging (TAG)
FMX21-						Order code

## Accessories

### Mounting clamp

- Endress+Hauser offers a mounting clamp for easy FMX21 mounting → 18.
- Material: 1.4404 (AISI 316L) and fiberglass reinforced PA (polyamide)
- Order number 52006151, see also "Ordering information" → 24,

### Terminal box

- IP66/IP67 terminal boxes with GORE-TEX® filter incl. 3 integrated terminals.  
The terminal box is also suitable for installing a TMT182 temperature head transmitter or for four additional terminals (Order No. 52008938) → 19.
- "Ordering information" → 24



#### Note!

The terminal box is not intended for the FMX21 with Ex nA explosion protection in the hazardous area.

**Additional weight**  
(for FMX21 with outer diameter of 22 mm (0.87 in) or 29 mm (1.14 in))

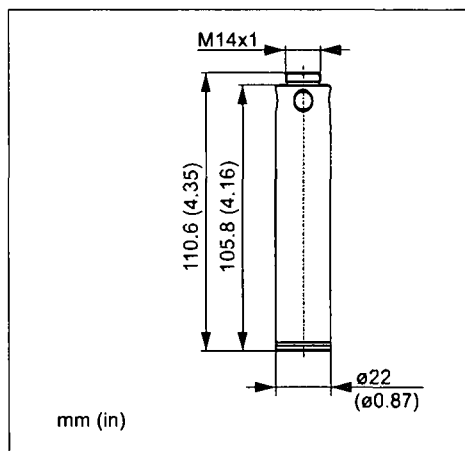

- Endress+Hauser offers additional weights to prevent sideways movement that results in measuring errors, or to make it easier to lower the device in a guide tube.  
You can screw several weights together. The weights are then attached directly to the FMX21. For FMX21 with an outer diameter of 29 mm (1.14 in) a maximum of 5 weights may be attached. In combination with the Ex nA approval, for FMX21 with an outer diameter of 29 mm (1.14 in) a maximum of 1 additional weight may be attached.
- Material: 1.4435 (AISI 316L)
- Weight: 300 g (10.581 oz)
- Order number 52006153, see also "Ordering information" → 24

### TMT182 temperature head transmitter (4 to 20 mA/HART)

- 2-wire temperature head transmitter, configured for a measuring range from  $-20$  to  $+80$  °C ( $-4$  to  $+158$  °F). This setting offers a temperature range of 100 K which can be easily mapped. Please note that the Pt100 resistance thermometer is designed for a temperature range from  $-10$  to  $+70$  °C ( $-14$  to  $+176$  °F) → 20.
- "Ordering information" → 24,



#### Note!

The TM182 temperature head transmitter is not intended for use in hazardous areas incl. CSA GP.

### Extension cable mounting screw

- Endress+Hauser offers extension cable mounting screws to ease FMX21 mounting and to seal the measuring aperture → 19.
- Material: 1.4301 (AISI 304)
- order number 52008264 (G1½ A thread), order number 52009311 (NPT1½ thread), see also "Ordering information" → 24

### Terminals

- Four terminals in strip for terminal box, suitable for wire cross-section: 0.08 to 2.5 mm<sup>2</sup> (28 to 14 AWG)
- Order number: 52008938



#### Note!

The 4-terminal strip is not intended for use in hazardous areas incl. CSA GP.

### Cable shortening kit

- The cable shortening kit is used to easily and professionally shorten a cable.
- → 24, "Ordering information" and the documentation SD552P/00/A6.



#### Note!

The cable shortening kit is not intended for the FMX21 with FM/CSA approval.

Waterpilot FMX21

**Installation tool –  
indicating the customer-  
specific length on the cable**

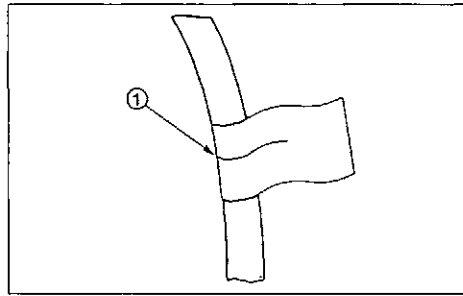

1 cable marking, distance to the lower end of the cable probe

- To make installation easier, Endress+Hauser offers a mark on the extension cable for a customer-specific length, see also → 24 "Ordering information".
- Mark tolerance: up to ±50 mm (1.97 in)  
(The mark tolerance corresponds to a measured error from up to ±50 mm (1.97 in).
- Material: PET
- Adhesive: acrylic
- Immunity to temperature change: -30 to +100 °C (-22 to +212 °F)



**Note!**

The mark is for installation purposes only.  
The mark must be thoroughly removed without trace in the case of devices with drinking water approval. The extension cable must not be damaged in the process.

**Testing adapter  
(for FMX21 with outer  
diameter of 22 mm (0.87 in)  
and 29 mm (1.14 in))**

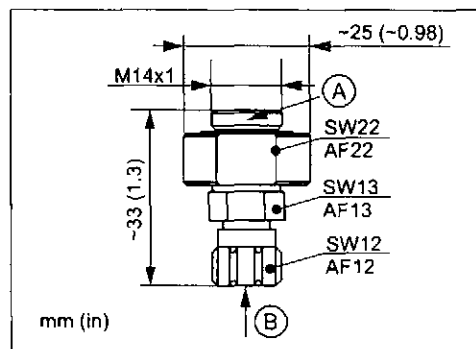

Testing adapter

- A FMX21 level probe connection
- B Compressed air hose connection, internal diameter of quick coupling piece 4 mm (0.16 in)

- Endress+Hauser offers a testing adapter to ease function-testing of the level probes.
- Observe the maximum pressure for the compressed air hose and the maximum overload for the level probe → 24.
- Maximum pressure of the quick coupling piece supplied: 10 bar (145 psi)
- Adapter material: 1.4301 (AISI 304)
- Quick coupling piece material: anodized aluminum
- Adapter weight: 39 g (1.376 oz)
- Order number 52011868, see also → 24 "Ordering information".



---

## Additional documentation

---

<b>Field of activities</b>	<ul style="list-style-type: none"> <li>■ Pressure measurement: FA004P/00/EN</li> <li>■ Recording technology: FA014R/09/EN</li> <li>■ System components: FA016K/09/EN</li> </ul>
<b>Technical Information</b>	<ul style="list-style-type: none"> <li>■ Technical Information Waterpilot FMX167 with 4 to 20 mA analog output: TI351P/00/EN</li> <li>■ Technical Information Deltapilot M: TI437P/00/EN</li> <li>■ Temperature head transmitter iTEMP HART TMT182: TI078R/09/EN</li> </ul>
<b>Operating Instructions</b>	<ul style="list-style-type: none"> <li>■ Waterpilot FMX21: BA380P/00/EN</li> <li>■ Cable shortening kit: SD552P/00/A6</li> <li>■ Field Xpert: BA060S/04/EN</li> </ul>
<b>Safety instructions</b>	<ul style="list-style-type: none"> <li>■ ATEX II 2 G: XA454P/00/A3</li> <li>■ ATEX II 3 G: XA485P/00/A3</li> <li>■ IECEx Ex ia IIC: XA455P/00/EN</li> <li>■ NEPSI Ex ia IIC: XA456P/00/B2</li> </ul>
<b>Installation/ Control Drawings</b>	<ul style="list-style-type: none"> <li>■ FM IS Cl. I, Div. 1, Gp. A – D / Cl. I Zone 1 IIC: ZD231P/00/EN</li> <li>■ CSA C/US IS Cl. I, Div. 1, Gp. A – D / Cl. I Zone 1, IIC: ZD232P/00/EN</li> </ul>
<b>Drinking water approval</b>	<ul style="list-style-type: none"> <li>■ SD289P/00/A3 (NSF)</li> <li>■ SD319P/00/A3 (KTW)</li> <li>■ SD320P/00/A3 (ACS) (in preparation)</li> </ul>

## Configuration data sheet

**Level**

The following configuration data sheet has to be filled in and included with the order if the option "K: customized level" has been selected in feature "090: Calibration; unit" in the product structure.

<p><b>Pressure engineering unit</b></p> <p> <input type="checkbox"/> mbar          <input type="checkbox"/> mmH2O  <input type="checkbox"/> bar            <input type="checkbox"/> mH2O                           <input type="checkbox"/> ftH2O  <input type="checkbox"/> psi             <input type="checkbox"/> inH2O    <input type="checkbox"/> mmHg        <input type="checkbox"/> Pa                           <input type="checkbox"/> kPa  <input type="checkbox"/> kgf/cm2      <input type="checkbox"/> MPa </p>	<p><b>Output unit (Scaled unit)</b></p> <p> <input type="checkbox"/> %    <input type="checkbox"/> m        <input type="checkbox"/> l        <input type="checkbox"/> gal           <input type="checkbox"/> dm     <input type="checkbox"/> hl      <input type="checkbox"/> lgal           <input type="checkbox"/> cm           <input type="checkbox"/> mm      <input type="checkbox"/> m3     <input type="checkbox"/> ft3                                   <input type="checkbox"/> in3     <input type="checkbox"/> kg           <input type="checkbox"/> inch                                    <input type="checkbox"/> t           <input type="checkbox"/> ft                                         <input type="checkbox"/> lb </p>
<p>Empty calibration (a)                  (Empty) low pressure value _____  <span style="margin-left: 300px;">(pres. eng. unit)</span></p>	<p>(Empty) low level value _____  <span style="margin-left: 150px;">(scaled unit)</span></p>
<p>Full calibration (b)                  (Full) high pressure value _____  <span style="margin-left: 300px;">(pres. eng. unit)</span></p>	<p>(Full) high level value _____  <span style="margin-left: 150px;">(scaled unit)</span></p>
<p><b>Damping</b></p> <p>Damping: ____ sec</p>	

**Pressure**

The following configuration data sheet has to be filled in and included with the order if the option "J: customized pressure" has been selected in feature "090: Calibration; unit" in the product structure.

**Pressure Engineering Unit (a)**

- |                               |                                |                                  |                              |
|-------------------------------|--------------------------------|----------------------------------|------------------------------|
| <input type="checkbox"/> mbar | <input type="checkbox"/> mmH2O | <input type="checkbox"/> mmHg    | <input type="checkbox"/> Pa  |
| <input type="checkbox"/> bar  | <input type="checkbox"/> mH2O  |                                  | <input type="checkbox"/> kPa |
|                               | <input type="checkbox"/> ftH2O |                                  | <input type="checkbox"/> MPa |
| <input type="checkbox"/> psi  | <input type="checkbox"/> inH2O | <input type="checkbox"/> kgf/cm2 |                              |

**Calibration Range / Output**

LRV: \_\_\_\_\_ (pressure engineering unit)  
 URV: \_\_\_\_\_ (pressure engineering unit)

**Damping**

Damping \_\_\_\_ sec

**Instruments International**

Endress+Hauser  
Instruments International AG  
Kaegenstrasse 2  
4153 Reinach  
Switzerland

Tel. +41 61 715 81 00  
Fax +41 61 715 25 00  
[www.endress.com](http://www.endress.com)  
[info@ii.endress.com](mailto:info@ii.endress.com)

**Endress+Hauser**   
People for Process Automation

---

TI431P/00/EN/08.10  
71118704  
CCS/FM+SCML 6.0









**Halmac** Services (Qld) Pty. Ltd.  
A.C.N. 098 852 923  
A.B.N. 40 741 712 113

# MULTITRODE LEVEL RELAY

1. MTR LEVEL RELAY TECHNICAL DETAILS
2. MTR WIRING DETAILS
3. MTR INSTALLATION & TROUBLESHOOTING DETAILS

After many years of field use, the simplicity and reliability of these units is unquestionable.

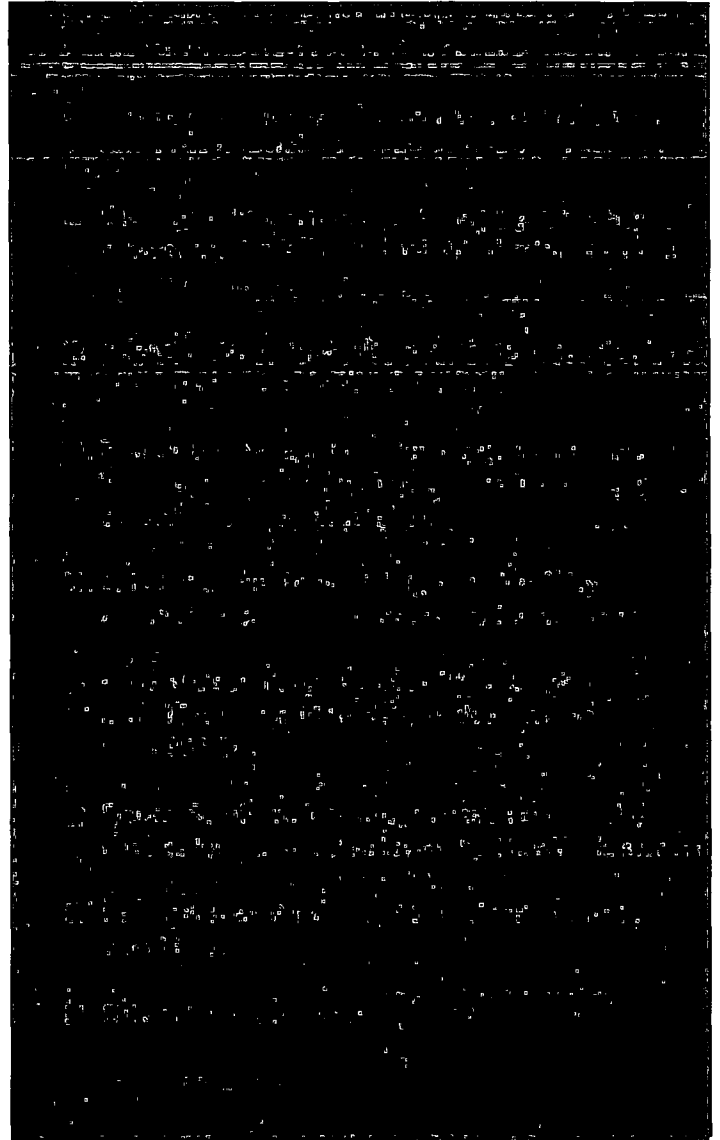
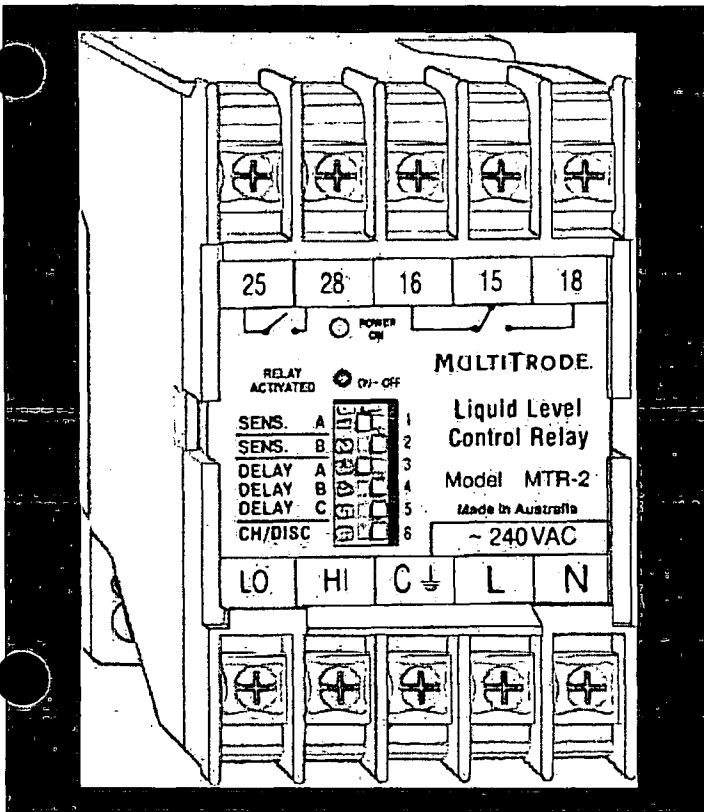

**SAMPLE MTR APPLICATION**

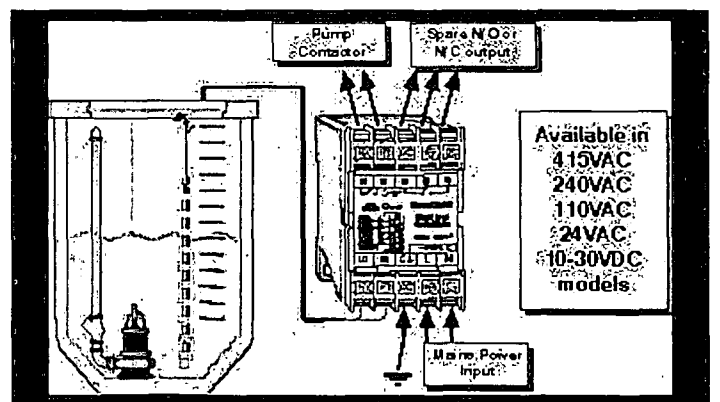



**SAMPLE MTR APPLICATION**

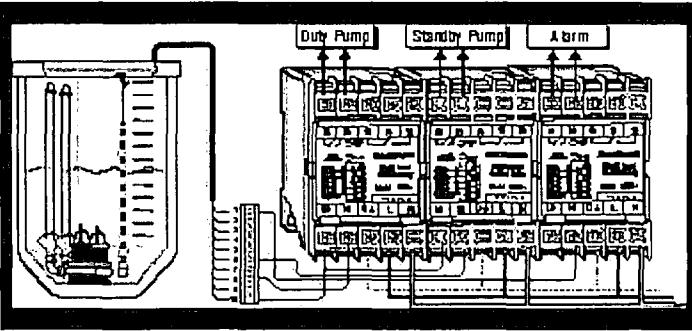

**SAMPLE APPLICATION**

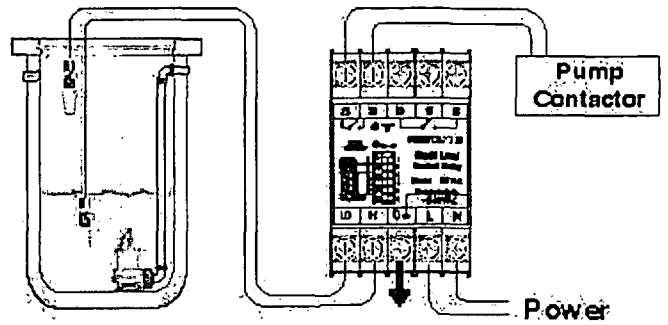

**DIP SWITCH SETTINGS**



**WIRING DIAGRAM**

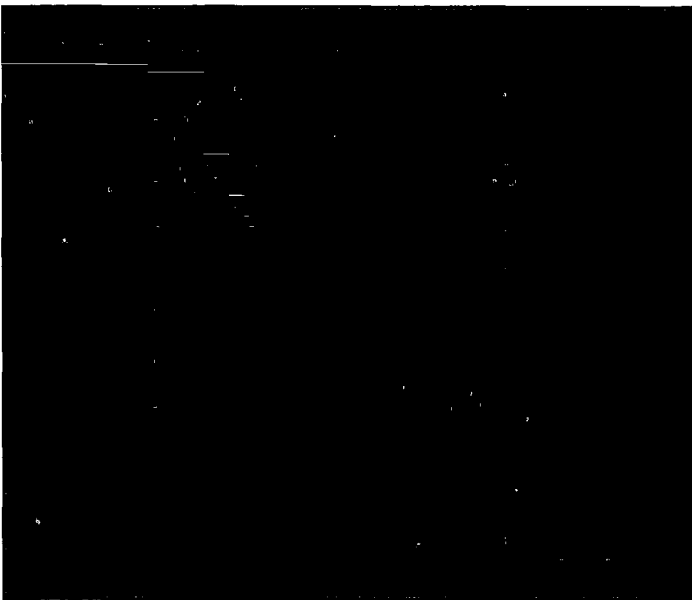

**PRODUCT SPECIFICATIONS**

**AVAILABLE MODELS**

415VAC	MTR1	n/a
240VAC	MTR2	MTRA2
110VAC	MTR3	MTRA3
24VAC	MTR4	MTRA4
24VDC	MTR5	MTRA5
12VDC	MTR6	MTRA6

**Ordering Information & Example**

Model	Voltage
<b>MTRA</b>	<b>2</b>

This order code is for a 240VAC MTRA.

**UL** N1653 US LISTED 2722

**PHYSICAL DIMENSIONS**

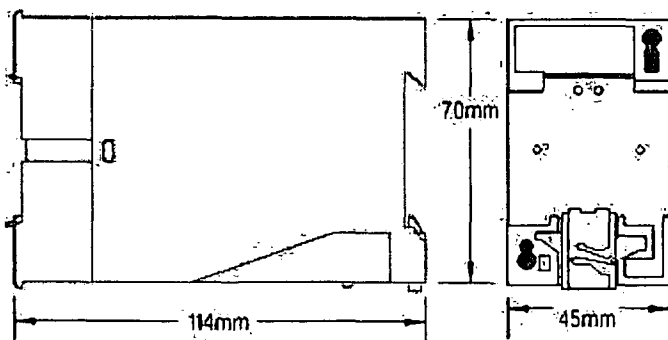

All MultiTrode Products carry a two year warranty

**MultiTrode Pty Ltd Head Office**  
 130 Kingston Road, Underwood Qld 4119  
 PO Box 2465, Logan City D.C. Qld 4114  
 Ph:+61 7 3808 4011 Fax:+61 7 3808 0011  
 sales@multitrode.com.au



**Sydney - Australia**  
 Tel:+61 2 9774 2433  
 Fax:+61 2 9774 2566

**Melbourne - Australia**  
 Tel:+61 3 5978 6900  
 Fax:+61 3 5978 6932

**MultiTrode Inc. - USA**  
 6560 East Rogers Circle,  
 Boca Raton FL 33487  
 Tel:+1 561 994 8090 Fax:+1 561 994 6282  
 E-mail: sales@multitrode.net

# MULTITRODE RELAY 240VAC (MTR 2) INSTALLATION SHEET NO1

## CONTROL OF THREE APPLIANCES IN A CHARGING SITUATION

RELAY PROGRAM FUNCTION			
SWITCH NO SETTING 1	SETTING 2	SENSITIVITY	
OFF	OFF	1k Ω Concentrated Acids, Minerals, Alkalines	
OFF	ON	4k Ω Acids, Alkalines, Diluted brine, Sea water	
ON	OFF	20k Ω Sullage, Sewage effluent, Town water	
ON	ON	80k Ω Low conductive liquids, Purified water	
DELAY ON ACTIVATION			
3	4	5	DELAY ON ACTIVATION
OFF	OFF	OFF	Zero Seconds
OFF	OFF	ON	2.5 Seconds
OFF	ON	OFF	5 Seconds
OFF	ON	ON	10 Seconds
ON	OFF	OFF	20 Seconds
ON	OFF	ON	40 Seconds
ON	ON	OFF	80 Seconds
ON	ON	ON	160 Seconds
6			MODE
OFF			Discharge
ON			Charge

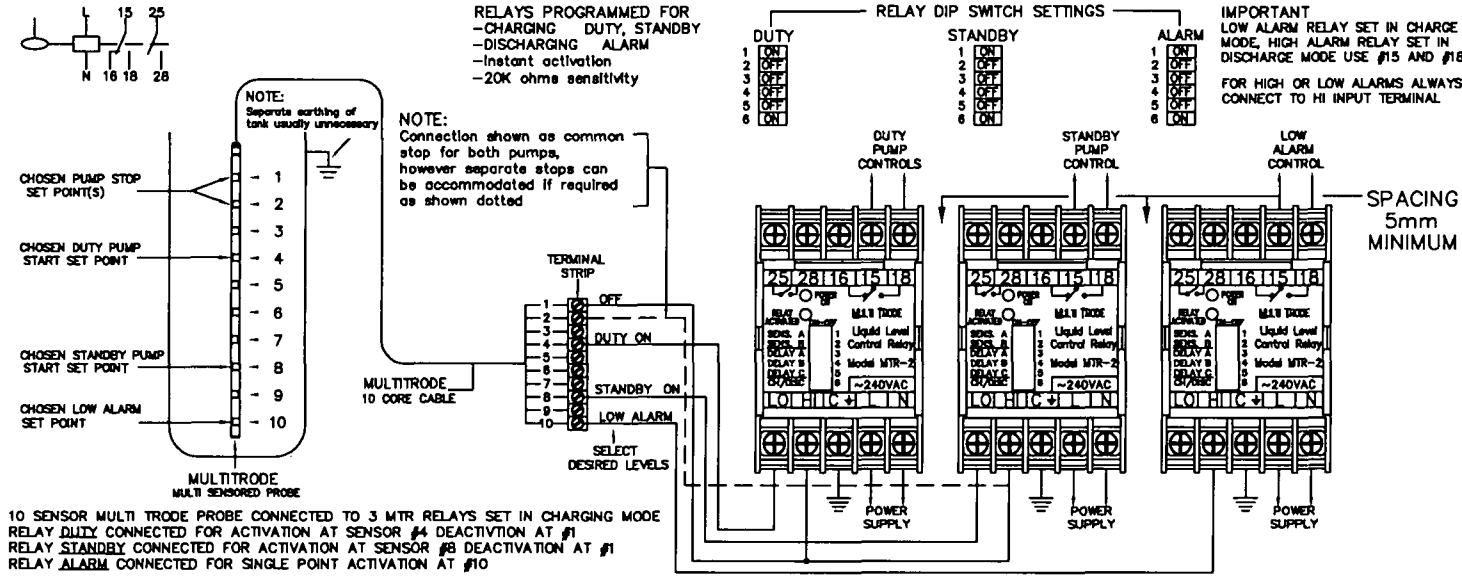

FIGURE-4

### ON-OFF CONTROL IN A CHARGING SITUATION

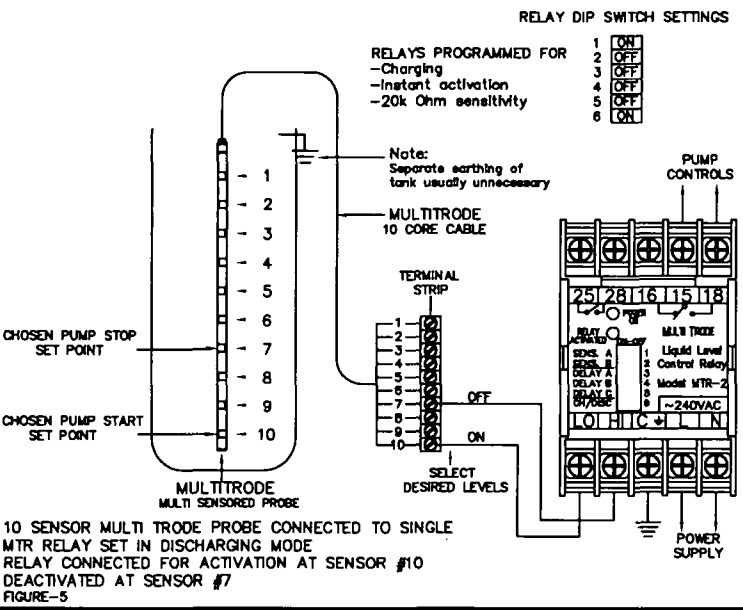

FIGURE-5

### SINGLE POINT OPERATION IN A CHARGING SITUATION

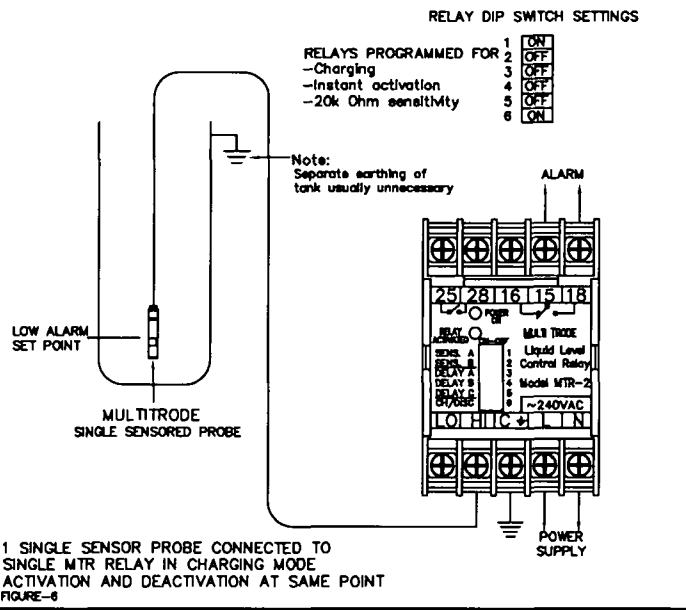
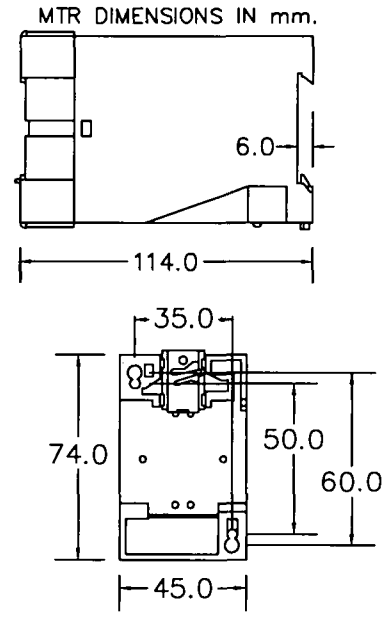

FIGURE-6



PHONE (07) 808-4011 FOR INSTALLATION SHEET - INCLUDED WITH PRODUCT  
 FAX (07) 808-0011 TITLE MTR - WIRING DIAGRAMS Pg. 1 of 2  
 DESIGNED BY REV. 2.1 ISCALE NO  
 CHECKED DATE APRIL 2000  
 DRAWN BY TRAVIS PARKINSON DRAWING # 9956  
 MultiTrobe  
 Designed & Manufactured by MULTITRODE Pty. Ltd. BRISBANE, AUSTRALIA

# MULTITRODE RELAY 240VAC (MTR 2) INSTALLATION SHEET. NO2

## CONTROL OF THREE APPLIANCES IN A DISCHARGING SITUATION

RELAY PROGRAM FUNCTIONS					
SWITCH N° SETTING		SENSITIVITY			
OFF	OFF	1k Ω	Concentrated Acids, Minerals, Alkalines		
OFF	ON	4k Ω	Acids, Alkalines, Diluted brine, Sea water		
ON	OFF	20k Ω	Sullage, Sewage effluent, Town water		
ON	ON	80k Ω	Low conductive liquids, Purified water		
3 4 5		DELAY ON ACTIVATION			
OFF	OFF	OFF	Zero Seconds		
OFF	OFF	ON	2.5 Seconds		
OFF	ON	OFF	5 Seconds		
OFF	ON	ON	10 Seconds		
ON	OFF	OFF	20 Seconds		
ON	OFF	ON	40 Seconds		
ON	ON	OFF	80 Seconds		
ON	ON	ON	160 Seconds		
6		MODE			
OFF		Discharge			
ON		Charge			

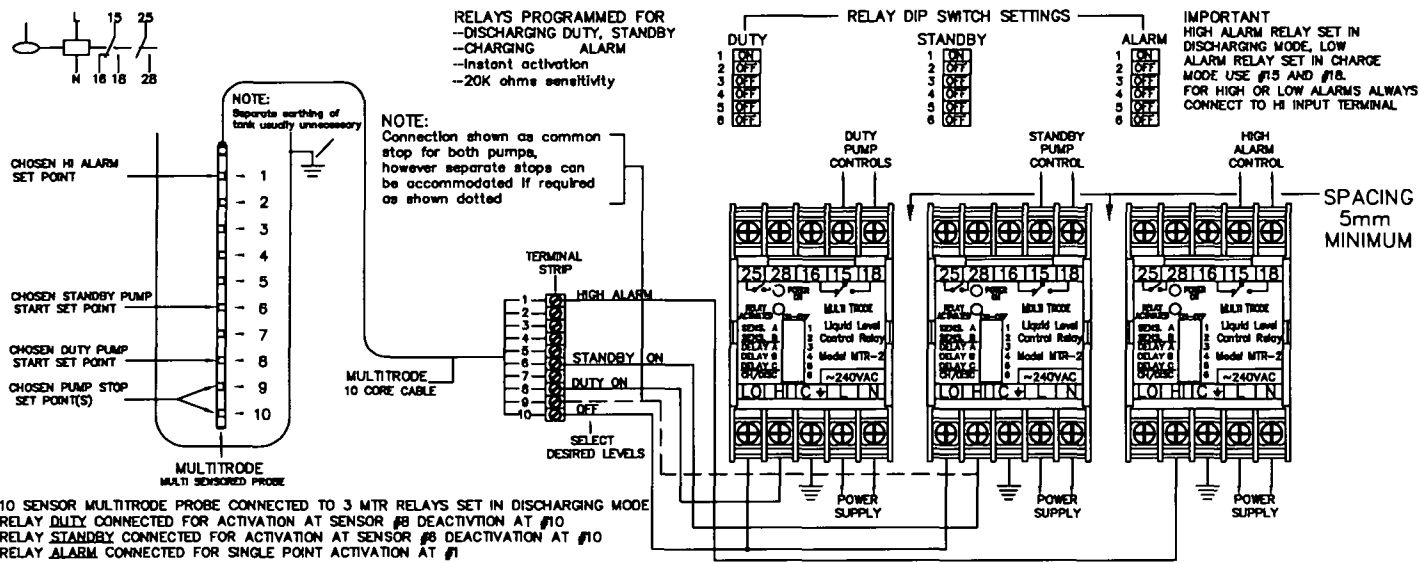

FIGURE-4

### ON-OFF CONTROL IN A DISCHARGING SITUATION

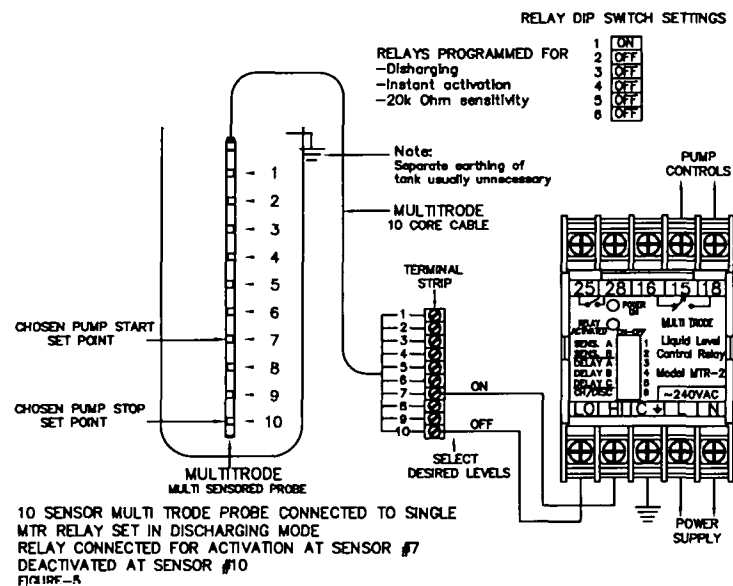

FIGURE-5

### SINGLE POINT OPERATION FOR DISCHARGING

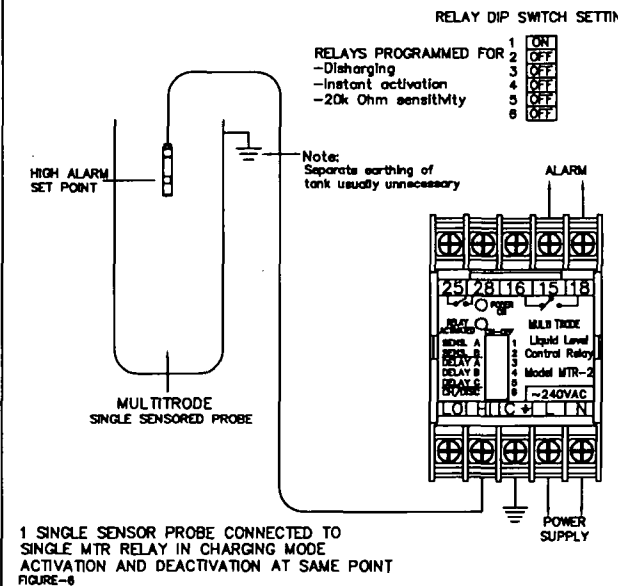

FIGURE-6

SPECIFICATIONS	
SENSOR VOLTAGE	12VAC NOMINAL
NO OF OUTPUTS	2 SETS, 1 NO & 1 CHANGEOVER
CONTACT RATING	5 AMP 250VAC RESISTIVE
CONTACT LIFE	10 <sup>5</sup> OPERATIONS
SUPPLY VOLTAGE(+/-10%)	240, 110, 240VAC, 50/60Hz 24, 12VDC
POWER CONSUMPTION	3.4VA (MAX)
DIMENSIONS mm (inches)	H74(2.78) X W45(1.77) X D114(4.5)
TERMINAL SIZE mm (in)	2 X 2.5mm <sup>2</sup> (0.64" INCH)
DISPLAY LEDS	GREEN - POWER ON RED - ACTIVATION
MOUNTING ARRANGEMENT	DIN RAIL OR 2X4mm SCREWS (3/16")
SENSITIVITY (OHMS)	SELECTABLE VIA SWITCHES 1K, 4K, 20K, 80K
MODE	SELECTABLE VIA SWITCHES CHARGE/DISCHARGE
DELAYS (SECS)	SELECTABLE VIA SWITCHES 2.5, 5, 10, 20, 40, 80, 160
WORKING TEMP C(F)	MINUS 10° C (+14° F) PLUS 60° C (140° F)

PHONE (07) 808-0011 FOR INSTALLATION SHEET - INCLUDED WITH PRODUCT  
 FAX (07) 808-0011 TITLE MTR - WIRING DIAGRAMS Pg. 2 of 2  
 DESIGNED BY REV. 2 SCALE NO.  
 CHECKED BY REV. 2 JANUARY 1995  
 DRAWN BY JAN PARKINSON DRAWING 1 994  
 Designed & Manufactured by MULTITRODE Pty. Ltd. BRISBANE, AUSTRALIA

## 1 Introduction

The MultiTrode level control relay is a solid-state electronic module in a hi-impact plastic case with a DIN rail attachment on the back, making a snap-on-snap-off installation. Any number of relays can be easily added to the DIN metal rail then wired together to form a complex pumping system that other wise may have to be controlled and operated by a programmed PLC.

The relay is normally matched with the MultiTrode probe which works in conjunction with the relay and uses the conductivity of the liquid to complete an electrical circuit.

## 2 Electrical Overview

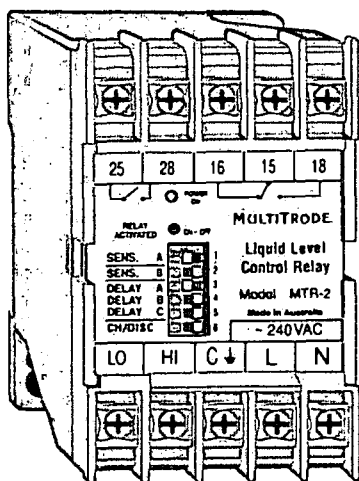

There are 10 screw terminals on the unit. Facing the relay as shown, we look at the bottom terminals (left to right):

- Lo – (Charge mode). This is the point when the probe is dry the relay will turn on.
- Lo – (Discharge mode). This is the point when the probe in the tank is dry the relay will turn off.
- Hi – (Charge mode). This is the point when the probe in the tank is wet a relay will turn off
- Hi – (Discharge mode). This is the point when the probe in the tank is wet a relay will turn on.
- C - is common earth. All earth bonding must be terminated here for correct operation.
- " L " is "live" (240V AC)
- " N " is "neutral" (240V AC)

If the tank is plastic, or if you are conducting tests in a plastic bucket, or the vessel has no earth point inside, you must install an earth rod within the tank, vessel or bucket and make sure that it is bonded back to C on the relay unit.

## 3 DIP Switches

### 3.1 DIP Switches

(See Wiring Diagram for full program functions.)

#### 3.1.1 DIP 1 & 2

DIP 1 and 2 control the Sensitivity, in other words the cleaner the liquid the higher the sensitivity setting must be. Concentrated acids, minerals are by their own chemical composition highly conductive, so a low level of sensitivity is required, purified water is almost an insulator against electrical current flow so a higher sensitivity inside the relay is required.

#### 3.1.2 DIP 3, 4 & 5

DIP switches 3, 4 and 5, control delay on activation. For example, in discharge mode with DIP switches 3, 4 and 5 set to 10 seconds, when the Hi point becomes wet it will activate the motor and it will take 10 seconds of continual coverage of the probe sensor to make the relay close and start the pump. This is invaluable when the probe is in a turbulent part of a well where fluid is splashing around touching the sensors momentarily, and false activation cannot be tolerated.

#### 3.1.3 DIP 6

DIP switch 6 controls the charge/discharge function. Set "ON" for charge, and "OFF" for discharge

### 3.2 Relay Contacts & their Applications

#### 3.2.1 Contacts 15, 16 & 18

Contacts 15, 16, and 18 are used for electronic or visual notification of a change in state at the pump itself. Contacts 15, 16, and 18 are used for more advanced applications because they are a changeover relay, their state may be the same as contacts 25, 28 or the opposite. Both sets of contactors are triggered simultaneously. An example is when in discharge mode, (see Figure 1).

You have a gravity flow coming in so the fluid reaches the lower sensor PB1, contacts 15 and 18 are open (15 being common to both contact 16 and 18) contacts 25 and 28 are also normally open but contacts 15 16 in this current situation are closed, whether PB1 is wet or dry is of no concern all will stay the same. The level now rises to PB2 and both relays change state, contacts 25 and 28 close to turn on the pump, contacts 15 and 16 are open, with 15 and 18 closed.

In advanced applications this state change may be fed into a logic device to indicate the pump is running or the pump has stopped and perhaps light an LED or incandescent light source for visual confirmation that a change has occurred in the relay.

#### 3.2.2 Contacts 25 & 28

Contacts 25 and 28 are used to control pump states. Contacts 25 and 28 are mostly used for turning on motors via a starting relay or solenoid, so, these sets of contacts react to the rising or falling levels of the fluid inside the tank, they will operate to turn on a pump in discharge mode when the top sensor is wet and in charge mode turn on the pump when the bottom sensor is dry.

## 4 Practical Overview

### 4.1 Discharge Mode – DIP switch 6 set to “OFF”

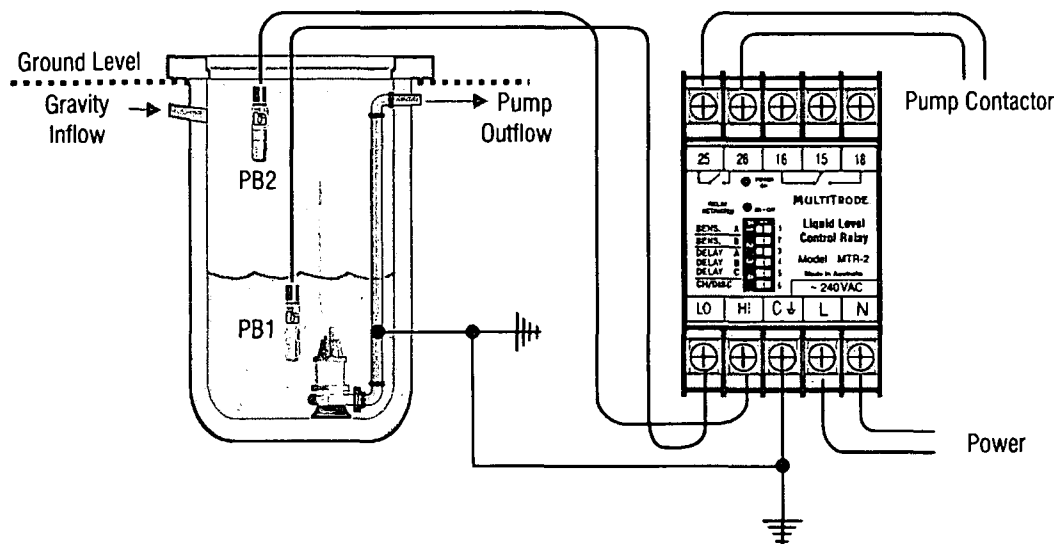
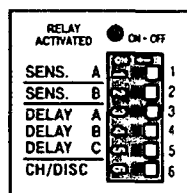

Figure 1 – Discharge Mode

Figure 1 shows two probes, (PB1 connected to Lo and PB2 connected to Hi). The pit is mostly underground and there is a gravity-fed inlet at the top left-hand side. The pit is empty with PB1 completely dry. Dipswitch 6 is set to “OFF.”



The relay operation depends on the electrical conductivity of liquid in the pit, i.e. no liquid = no current flow. The level starts to rise and covers PB1.

This is a discharge operation so we do not want the relay to close and start a pump until the well is full so as the water rises it reaches PB2, the relay closes and the pump starts. The level now drops below PB2 but the pump still continues to run, the level continues to drop below PB1 the relay opens the pump stops.

**4.2 Charge Mode – DIP switch 6 set to “On”**

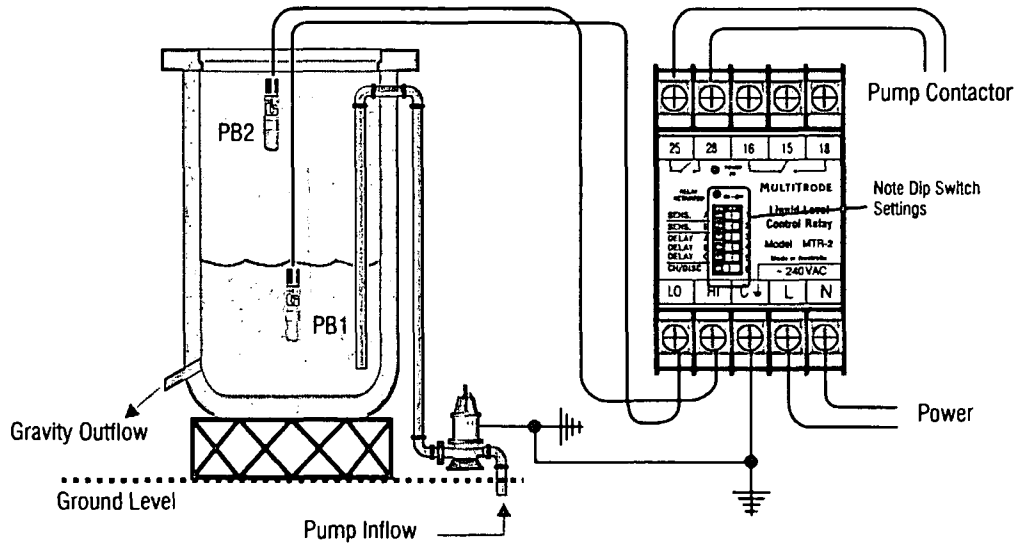

Figure 2 – Charge Mode



**NOTE:**

“C” is connected to common bonded earth. The unit will not operate correctly if not earthed.

Let’s look at the same relay but in a tank that is charging (DIP 6 is now on). See Figure 3, where liquid is being pumped into a tank, and discharging through a gravity feed, the tank is on steel stands “x” metres above the ground.

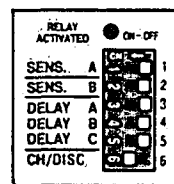

With the tank full, PB1 and PB2 will be wet, the relay is off, and the pump has stopped. Water is slowly fed out from the bottom, and now as PB2 (HI) becomes dry nothing happens; the water now drops to below PB1 (Lo), and the pumps restarts to fill the tank.

The pump will continue to fill the tank until PB2 (HI), becomes wet again.

### 4.3 MTRA Relay with Alarm (Discharge Applications Only)

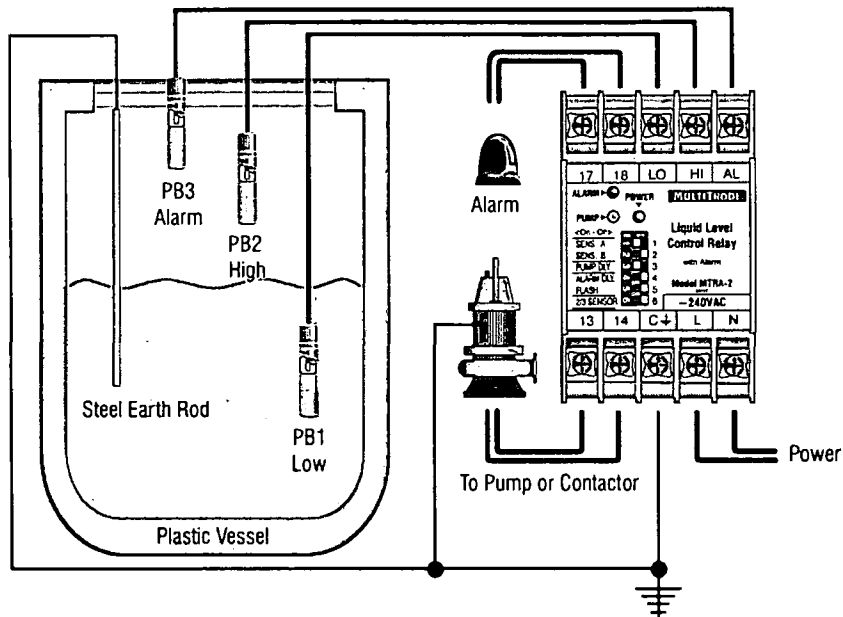

Figure 3 - MTRA Operation

The MTRA relay works in the same way as the MTR relay except the MTRA has a separate alarm output, and does not have a charge mode. The planned application is to close a contact to illuminate a warning alarm light. Various other applications have included introducing a third probe to latch another relay.

In Figure 2 we see three probes in a pit that is plastic, note the steel rod in the tank. (In a plastic vessel a steel rod must be used to create an earth return in the liquid so probes can function.) PB1, PB2, and PB3 are dry, and the relay power LED is on. When water enters the pit and wets PB1, nothing happens, water now reaches PB2 causing contacts 13 and 14 to close, the pump LED to light, and the water to drop.

If, for example, the pump has its inlet partially blocked, the level continues to rise and wets PB3. This closes a separate relay that can activate a red flashing light, an audible fog horn or send a 5 volt pulse into another device with the common cause to warn human beings that a spill is due to occur. If the pumps become unclogged and PB3 becomes dry the alarm opens again and breaks the circuit that stops the light from flashing or the foghorn from sounding.

## 5 Most Common Installation Problems

The relay requires a path between the probes to earth through the liquid. If you are testing in a plastic bucket, have installed the probe in a plastic tank or have no good earthing in the vessel you will need to install a separate earth and make sure all earth bonding comes back to the C terminal. Most problems like these are traced back to a lack of or poor earthing, or open circuits in the probe wiring.

Now is the time to check the relay by using "the bridge testing line technique" remember you must simulate a fluid flow to correctly ascertain a good relay or a bad one. (All DIPswitch settings from 1 to 6 should be off.)

Cut two pieces of insulated flexible copper wire one black one red 250 mm long, strip both ends back 10 mm on both cables, and join one black end and one red end. Insert the joined ends into C on the relay box, observing all safe electrical practises. You should have one black wire and one red wire free.

Set your relay for discharge mode (DIP switch 6 is off) with no sensors connected to the unit, connect the red wire to Lo – nothing should happen (if it does return the relay for replacement or repair\*). Now connect the black wire to the Hi terminal the relay activated LED should light instantly (if it does not, the relay should be returned for repair\*).

### 6 Troubleshooting

<p>I have checked all the DIPswitches and settings but in discharge mode as soon as the bottom sensor gets wet the pump turns on then turns off almost straight away.</p>	<ul style="list-style-type: none"> <li>This is the most common problem encountered with relay set up and commissioning, the probe in the bottom of the tank is wired into the Hi terminal instead of the Lo terminal.</li> </ul>
<p>The installation went fine but now and again the pump will not turn on even though I am sure the probe is wet.</p>	<ul style="list-style-type: none"> <li>Check the sensitivity level set on the relay, some times the level is set for foul water but due to changes in the flow the water becomes grey or clear, try changing the setting from 20KΩ to 80KΩ and monitor the results carefully.</li> </ul>
<p>All wiring is complete and all DIPswitches have been checked but the pump will not turn on at all.</p>	<ul style="list-style-type: none"> <li>If you have completed the test schedule for the relay and it passed then check the wiring to the sensors – for this is now where the problem lies or in the earthing arrangements. If possible check the resistance between the sensor cable and the steel sensor on the probe to prove a solid connection.</li> </ul>

\* Please contact your distributor or agent before returning any product for repair or warranty claim.









**Halmac** Services (Qld) Pty. Ltd.  
A.C.N. 098 852 923  
A.B.N. 40 741 712 113

## POWER SUPPLY & BATTERY

1. 24VDC POWER SUPPLY TECHNICAL DETAILS
2. 24VDC/13VDC CONVERTER TECHNICAL DETAILS
3. BATTERY TECHNICAL DETAILS

# PB251 Series

220-330 WATTS DC UPS

## Features

- Ultra-low noise output
- Independent battery charging output
- DC output OK & battery OK alarms & LEDs
- Battery-LVD and alarm
- Over-temperature protection
- Battery fuse fail LED

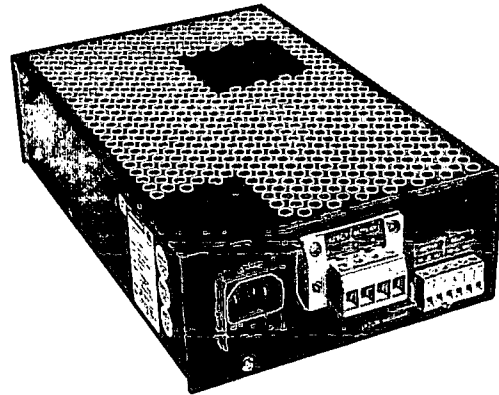

## Specifications

### INPUT

Voltage:	190 to 264 vac, or 190 to 400VDC
Line regulation:	0.2% typical
Current:	1.4A maximum
Inrush current:	10A maximum
Frequency:	45 to 65 Hz

### OUTPUT

Voltage	See table
Current	See table
Load regulation	0.5% typical
Current limit type - load cct	Constant current
Current limit type - batt. cct	Constant current
Short circuit protection	Indefinite, auto-resetting
Over-voltage protection	17.5 to 20V latching (13.8Vdc output) 31.5 to 39V latching (27.6Vdc output)
Ripple & noise 100 MHz bandwidth	28mVp-p (13.8Vdc output) 55mVp-p (27.6Vdc output)

### ENVIRONMENTAL

Operating temperature	0 to 70°C ambient with derating, 5...90% relative humidity (non-condensing)
Over-temperature protection	Automatic & auto-resetting
Cooling requirement	Natural convection
Efficiency	80% minimum

## STANDARDS & APPROVALS

Safety	Complies with AS/NZS 60950, class 1, NSW Office of Fair Trading Approval N20602
EMC	Emissions comply with AS/NZS CISPR11, Group 1, Class B. Complies with ACA EMC Scheme, Safety & EMC Regulatory Compliance Marked
Isolation i/p-o/p i/p-ground o/p-ground	4242VDC for 1 minute 2121VDC for 1 minute 707VDC for 1 minute

## ALARMS & BATTERY FUNCTIONS

Converter ON/OK alarm	Indicated by voltage-free changeover relay contacts &
green LED	ON=PSU OK
Battery low (& fuse) alarm	10.2 to 12.6V for 12V battery, adjustable 20.4 to 25.2V for 24V battery, adjustable Indicated by voltage-free changeover relay contacts & green LED: ON=BATT OK
Low voltage disconnect	9.6 to 12V for 12V battery, adjustable 19.2 to 24V for 24V battery, adjustable
Charger over-load protection	Auto-resetting electronic circuit breaker
Reverse polarity protection	Internal battery fuse
Battery to load voltage drop	0.2 to 0.25V typical

## MECHANICAL

Case size	264 L x 172 W x 67 H mm
Case size with heatsink	264 L x 186 W x 67 H mm
Rack size	232 D x 19" W x 2RU H
Weight	1.9 kg
Weight with heatsink	2.1 kg
Weight (rack mounted version)	5.5 kg

## Selection Table

MODEL NUMBER	OUTPUT			OUTPUT POWER
	VDC	I <sub>LOAD</sub>	I <sub>BATT</sub>	
PB251-12CM	13.8V	16A	2A	220W
PB251-12CM-H	13.8V	20A	2A	275W
PB251-24CM	27.6V	11A	2A	300W
PB251-24CM-H	27.6V	12A	2A	330W
PB251-12RML	13.8V	20A	4A	275W
PB251-12B	13.8V	20A	4A	275W
PB251-24RML	27.6V	12A	2A	330W

Note: Non standard battery charging current available on request. ie PB251-12CM-H-10 for 10A.

**powerbox**

# PB251 Series

275-330 WATTS DC UPS

## Technical Illustrations

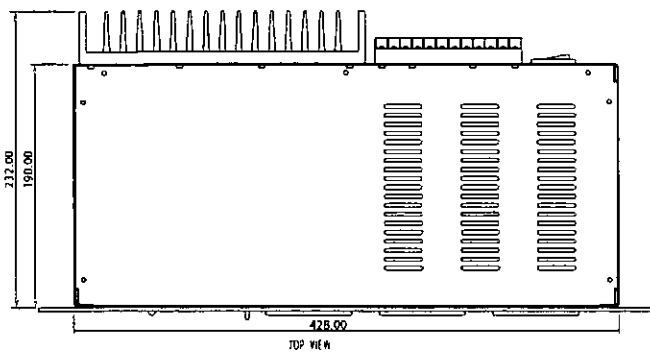
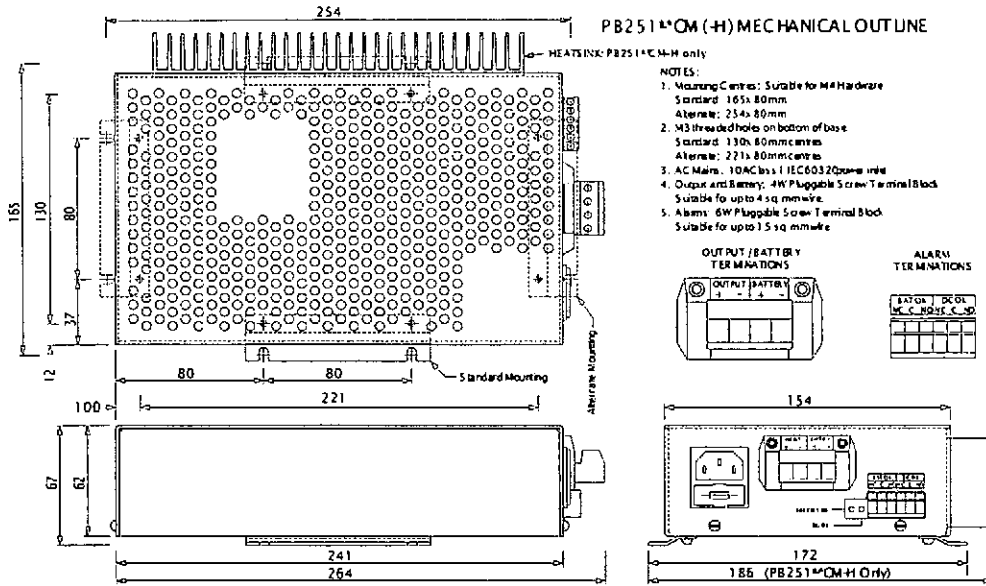

- NOTES:
- 2RU x 19" rack enclosure per IEC 297
  - Mounting slots are suitable for M6 hardware.
  - Input connector is a 10A Class 1 IEC60320 inlet.
  - 2 meter IEC mains cord with Australian plug is supplied with unit.
  - PB251-12B alarm terminals is DB25 female.
  - PB251-12B output and battery connector is Hirose pn. HS28P-4A. Mating connector is Hirose pn. HS28P-4A (not supplied).
  - PB251\*\*RML alarm and output terminals are M3.5 screws suitable for ring or fork lugs up to 8 mm wide.

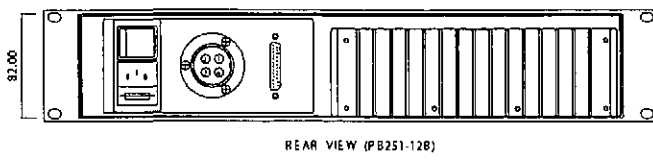
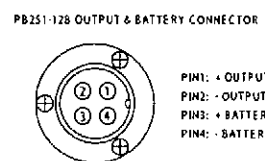
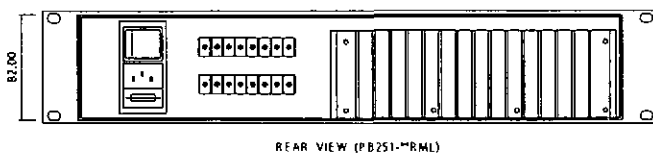
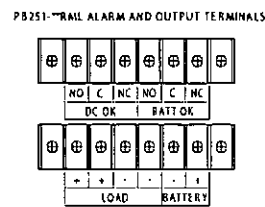
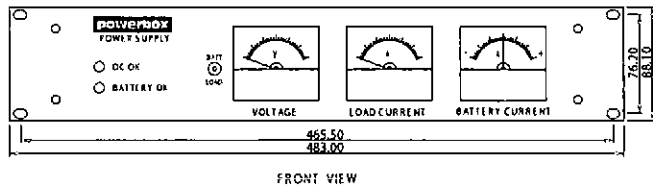

Your dependable power partner - [www.powerbox.com.au](http://www.powerbox.com.au)

SECURITY

OPEN FRAME & ENCASED

# PBIH Series

15-150 WATTS DC/DC SINGLE OUTPUT

## Features

- Wide selection of models
- 4 input voltage ranges
- High efficiency
- Low output ripple
- Proven reliability
- Good thermal margins

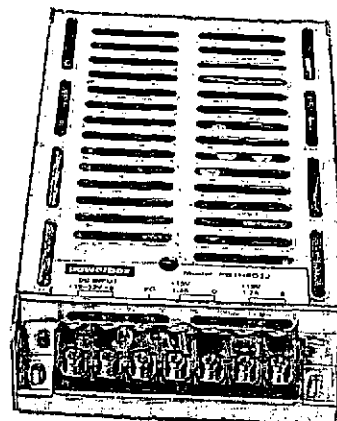

## Specifications

### INPUT

Input voltage	12VDC (9.2–16) 24VDC (19–32) 48VDC (38–63) 110VDC (85–140)
Inrush current	20A max. for 110V only

### OUTPUT

Output voltage	See table
Voltage adjustment	±10%, ±5% for PBIH-F
Output current	See table
Ripple & noise	Output Volts x 1% + 50mV to -100mV pk-pk
Line regulation	0.8% over input range
Load regulation	0.9%, 0%–100% load
Temperature coefficient	0°C to 50°C, 0.03% per °C
Overvoltage protection	O.V. clamp, PBIH-F Output shutdown, PBIH-G, J, M, R – input must be switched off for at least 30s to reactivate
Overcurrent protection	Fold back – PBIH-F Current limiting, PBIH-G, J, M, R (PBIH-R series is adjustable); PBIH110xxR models are not adjustable
Drift	Output V x 0.5% + 15(mV) per 8 hrs after 1 hr warm-up
Rise Time	200mS max. – PBIH-F, M, R 100mS max. – PBIH-G, J (at 25°C)
Holdup time	10mS (only 110V input)
Remote sense	PBIH-R Series only

## OPERATING

Efficiency	70%–89%
Safety isolation (1 minute)	Type – 12, 24, 48V input Input – Output: 1500VAC Input – Case: 1500VAC Output – Case: 500VAC Type – 110V input Input – Output: 2000VAC Input – Case: 2000VAC Output – Case: 500VAC
Insulation resistance	50M (500VDC) Input – Case
Parallel operation	Consult sales office for details
Remote control	PBIH-R Series: Open link: output normal Short link: output off

## ENVIRONMENTAL

Operating temperature	0°C to 50°C full load
Cooling	Convection cooled
Storage temperature	-20°C to +85°C
Humidity	85%
Shock	30G, PBIH-F, G and J
Vibration	(5Hz–10Hz, 10mm), (10Hz–50Hz) 2G, PBIH-F, G and J

## STANDARDS AND APPROVALS

Safety	Designed to UL1950
C-tick	AS/NZS CISPR11 Group 1, Class A

## MECHANICAL

Weight	PBIH-F : 250g PBIH-G : 380g PBIH-J : 410g PBIH-M : 800g PBIH-R : 1.4kg
--------	--

# PBIH Series

15-150 WATTS DC/DC SINGLE OUTPUT

OPEN FRAME & ENCLOSED

Selection Table

MODEL NUMBER	INPUT	OUTPUT	OUTPUT POWER
PBIH-1205F	9.2-16V	5V 3A	15W
PBIH-1212F	9.2-16V	12V 1.2A	15W
PBIH-1215F	9.2-16V	15V 1A	15W
PBIH-1224F	9.2-16V	24V 0.62A	15W
PBIH-2405F	19-32V	5V 3A	15W
PBIH-2412F	19-32V	12V 1.2A	15W
PBIH-2415F	19-32V	15V 1A	15W
PBIH-2424F	19-32V	24V 0.62A	15W
PBIH-4805F	38-63V	5V 3A	15W
PBIH-4812F	38-63V	12V 1.2A	15W
PBIH-4815F	38-63V	15V 1A	15W
PBIH-4824F	38-63V	24V 0.62A	15W
PBIH-11005F	85-140V	5V 3A	15W
PBIH-11012F	85-140V	12V 1.2A	15W
PBIH-11015F	85-140V	15V 1A	15W
PBIH-11024F	85-140V	24V 0.62A	15W
PBIH-1205G	9.2-16V	5V 5A	25W
PBIH-1212G	9.2-16V	12V 2.1A	25W
PBIH-1215G	9.2-16V	15V 1.7A	25W
PBIH-1224G	9.2-16V	24V 1.1A	25W
PBIH-1248G	9.2-16V	48V 0.5A	25W
PBIH-2405G	19-32V	5V 5A	25W
PBIH-2412G	19-32V	12V 2.1A	25W
PBIH-2415G	19-32V	15V 1.7A	25W
PBIH-2424G	19-32V	24V 1.1A	25W
PBIH-2448G	19-32V	48V 0.5A	25W
PBIH-4805G	38-63V	5V 5A	25W
PBIH-4812G	38-63V	12V 2.1A	25W
PBIH-4815G	38-63V	15V 1.7A	25W
PBIH-4824G	38-63V	24V 1.1A	25W
PBIH-4848G	38-63V	48V 0.5A	25W
PBIH-11005G	85-140V	5V 5A	25W

MODEL NUMBER	INPUT	OUTPUT	OUTPUT POWER
PBIH-11012G	85-140V	12V 2.1A	25W
PBIH-11015G	85-140V	15V 1.7A	25W
PBIH-11024G	85-140V	24V 1.1A	25W
PBIH-11048G	85-140V	48V 0.5A	25W
PBIH-1205J	9.2-16V	5V 8A	50W
PBIH-1212J	9.2-16V	12V 3.3A	50W
PBIH-1215J	9.2-16V	15V 2.7A	50W
PBIH-1224J	9.2-16V	24V 1.7A	50W
PBIH-1248J	9.2-16V	48V 0.8A	50W
PBIH-2405J	19-32V	5V 10A	50W
PBIH-2412J	19-32V	12V 4.3A	50W
PBIH-2415J	19-32V	15V 3.4A	50W
PBIH-2424J	19-32V	24V 2.5A	50W
PBIH-2448J	19-32V	48V 1A	50W
PBIH-4805J	38-63V	5V 10A	50W
PBIH-4812J	38-63V	12V 4.3A	50W
PBIH-4815J	38-63V	15V 3.4A	50W
PBIH-4824J	38-63V	24V 2.5A	50W
PBIH-4848J	38-63V	48V 1A	50W
PBIH-11005J	85-140V	5V 10A	50W
PBIH-11012J	85-140V	12V 4.3A	50W
PBIH-11015J	85-140V	15V 3.4A	50W
PBIH-11024J	85-140V	24V 2.5A	50W
PBIH-11048J	85-140V	48V 1A	50W
PBIH-1205M	9.2-16V	5V 18A	100W
PBIH-1212M	9.2-16V	12V 9A	100W
PBIH-1215M	9.2-16V	15V 7A	100W
PBIH-1224M	9.2-16V	24V 4.5A	100W
PBIH-1248M	9.2-16V	48V 2A	100W
PBIH-2405M	19-32V	5V 20A	100W
PBIH-2412M	19-32V	12V 9A	100W
PBIH-2415M	19-32V	15V 7A	100W

MODEL NUMBER	INPUT	OUTPUT	OUTPUT POWER
PBIH-2424M	19-32V	24V 5A	100W
PBIH-2448M	19-32V	48V 2A	100W
PBIH-4805M	38-63V	5V 20A	100W
PBIH-4812M	38-63V	12V 9A	100W
PBIH-4815M	38-63V	15V 7A	100W
PBIH-4824M	38-63V	24V 5A	100W
PBIH-4848M	38-63V	48V 2A	100W
PBIH-11005M	85-140V	5V 20A	100W
PBIH-11012M	85-140V	12V 9A	100W
PBIH-11015M	85-140V	15V 7A	100W
PBIH-11024M	85-140V	24V 5A	100W
PBIH-11048M	85-140V	48V 2A	100W
PBIH-1205R	9.2-16V	5V 27A	150W
PBIH-1212R	9.2-16V	12V 13A	150W
PBIH-1215R	9.2-16V	15V 10A	150W
PBIH-1224R	9.2-16V	24V 6.5A	150W
PBIH-1248R	9.2-16V	48V 3.3A	150W
PBIH-2405R	19-32V	5V 30A	150W
PBIH-2412R	19-32V	12V 14A	150W
PBIH-2415R	19-32V	15V 11A	150W
PBIH-2424R	19-32V	24V 7A	150W
PBIH-2448R	19-32V	48V 3.5A	150W
PBIH-4805R	38-63V	5V 30A	150W
PBIH-4812R	38-63V	12V 14A	150W
PBIH-4815R	38-63V	15V 11A	150W
PBIH-4824R	38-63V	24V 7A	150W
PBIH-4848R	38-63V	48V 3.5A	150W
PBIH-11005R	85-140V	5V 30A	150W
PBIH-11012R	85-140V	12V 14A	150W
PBIH-11015R	85-140V	15V 11A	150W
PBIH-11024R	85-140V	24V 7A	150W
PBIH-11048R	85-140V	48V 3.5A	150W

**PBIH-F**

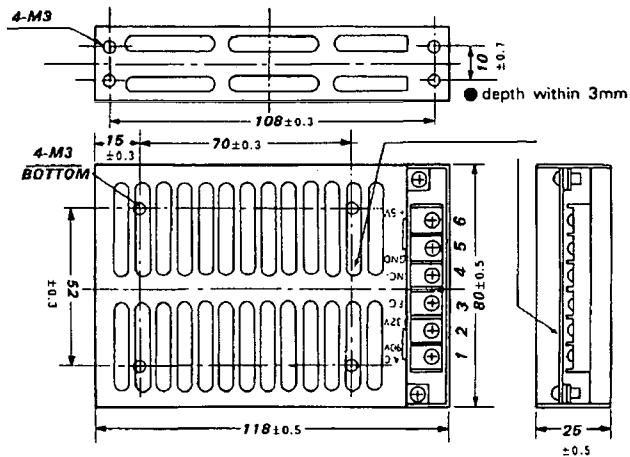

Dimensions in mm

terminal No.	
1	0 V (DC in)
2	+V (DC in)
3	FG
4	NO Connection
5	-V out
6	+V out

Your dependable power partner – [www.powerbox.com.au](http://www.powerbox.com.au)

# PBIH Series

15-150 WATTS SINGLE OUTPUT

## PBIH-G

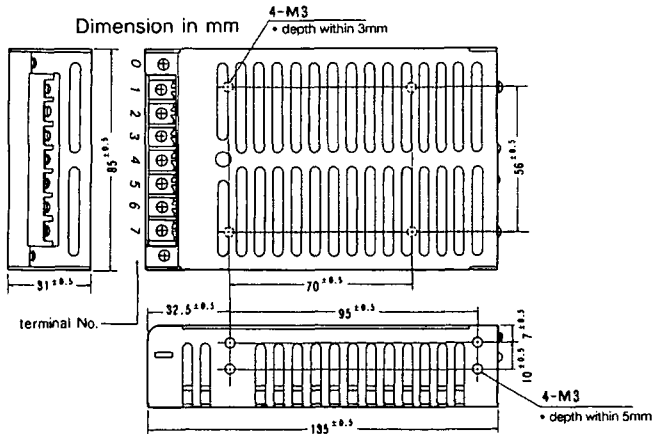

Terminal	Connection
0	FG
1	DC +V in
2	0V in
3	LFG
4	NO
5	NO
6	-V out
7	+V out

## PBIH-J

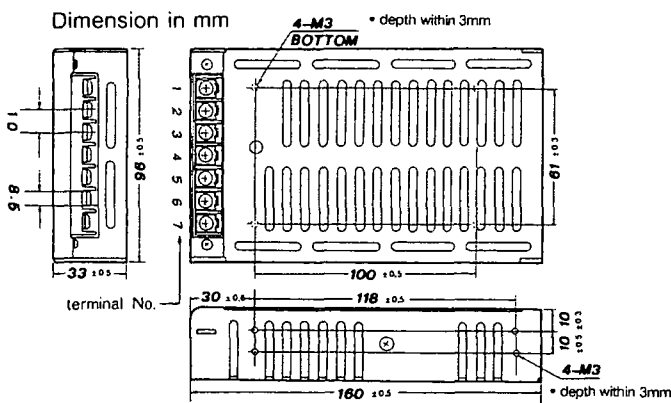

Terminal	Connection
1	FG
2	DC +V in
3	0V in
4	LFG
5	-V out
6	+V out
7	NC

## PBIH-M

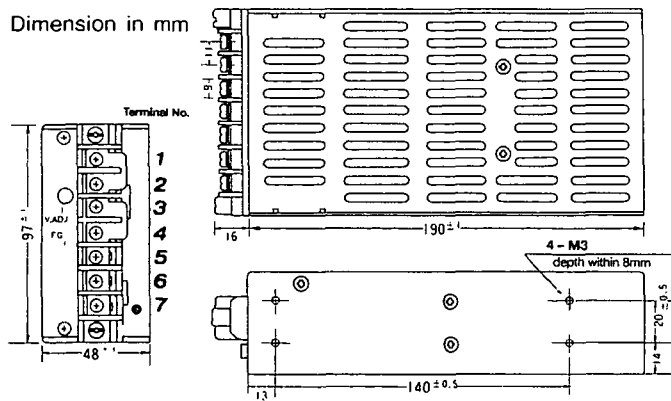

Terminal	Connection
1	+V out
2	+V out
3	-V out
4	-V out
5	FG
6	-V in
7	+V in

## PBIH-R

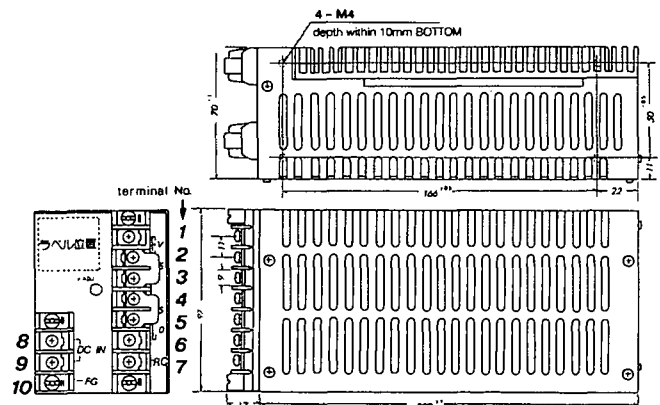

Terminal	Connection
1, 2	+V out
3	+S
4	-S
5, 6	-V out
7	Remote Control
8	DC +V in
9	DC 0V in
10	FG





## General Characteristics

### DISCHARGE CHARACTERISTICS

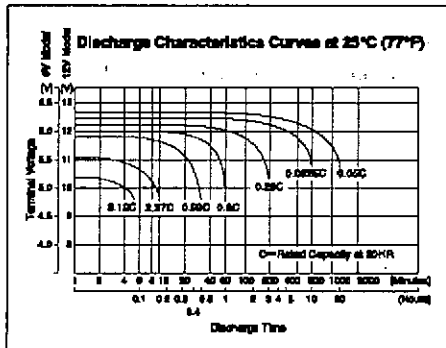

### CHARGING CHARACTERISTICS

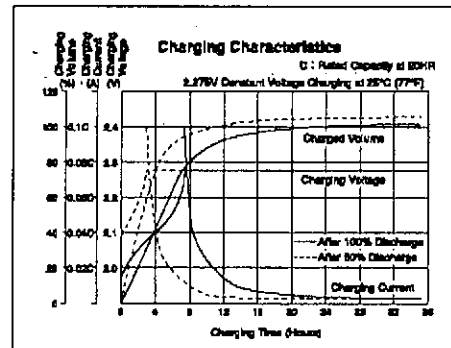

### Peripheral Device

A life diagnostic device for valve regulated lead-acid batteries, "JUST FEEL". The battery monitor, JUST FEEL, diagnoses life of valve regulated lead-acid batteries. Battery life can be diagnosed without disconnecting a power supply as a result of measuring battery internal impedance during floating charge.

- Diagnoses battery life during floating charge.
- A compact, portable device.
- Can be used for a large variety of valve regulated lead-acid batteries.
- Mounted with comparator function.
- May be used for UPS batteries. (Some models may prohibit the use of this device. If you intend to use the device for UPS, please contact us for consultation.)

● Specifications subject to change without prior notice

Distributed by:  
GS Yuasa International Ltd.  
1-8-1, Nishi-Shinjyuku, Minato-ku  
Tokyo 103-0003  
Japan  
Tel +81-3-3587-2403  
Fax +81-3-3587-2409

Cat.No. UXH-13 0806-10 (NIMP) Printed in Japan

# UXH SERIES

The latest in YUASA's state-of-the-art technology has brought about a new UXH series capable of yielding even greater capacity than comparable batteries.

YUASA UXH batteries are designed with unique valve regulating devices and acid free constructions, ensuring safety and suitability to the contemporary business environment.

## Designed Life

10 years

## Features

- Up to 15% more capacity
- Maintenance-free
- Higher energy efficiency
- Negligible gas emissions
- Valve regulated
- Systems compatible
- Fitted with explosion proof filter (Except UXH100-12N and UXH200-6N)
- No equalizing charge required (Option) Flame retardant version available
- No free Acid (Non-spillable Battery)

## Applications

- UPS
- Telecommunications
- Alarm systems
- Fire & security systems
- Emergency lighting
- Engine starting
- Solar powered systems
- Utilities
- Rail

## General Specifications

Battery Model	Nominal Voltage(V)	20HR Rated Capacity(Ah) #1	Internal Resistance(mΩ) #2	Approx. Dimensions, mm(Inch)				Approx. Weight kg(lbs.)	Equivalent Lead Filter
				Length	Width	Height	Overall Height		
UX028-12	12	38	7.0	225 (9.3)	128 (5.0)	190 (7.5)	217 (8.5)	17 (207)	0
UX050-12	12	50	8.0	299 (11.8)	128 (5.0)	190 (7.5)	217 (8.5)	21 (464)	0
UX063-12	12	63	8.0	343 (14.3)	128 (5.0)	190 (7.5)	217 (8.5)	25 (559)	0
UX075-6	6	75	2.3	217 (8.5)	128 (5.0)	190 (7.5)	217 (8.5)	16 (355)	0
UX0100-6	6	100	1.8	281 (11.1)	128 (5.0)	190 (7.5)	217 (8.5)	20 (440)	0
UX0125-6	6	125	1.5	345 (13.6)	128 (5.0)	190 (7.5)	217 (8.5)	24 (530)	0
UX0100-12N	12	100	4.0	407 (16.0)	172.5 (6.8)	210 (8.3)	240 (9.4)	39 (864)	x
UX0200-6N	6	200	1.3	378 (14.9)	174 (6.9)	216 (8.5)	230 (9.1)	39 (864)	x

#1 Final Voltage: 1.80V/cell, Temperature: 25°C(77°F)  
 #2 In a fully charged state and measured through a 1000Hz AC bridge.

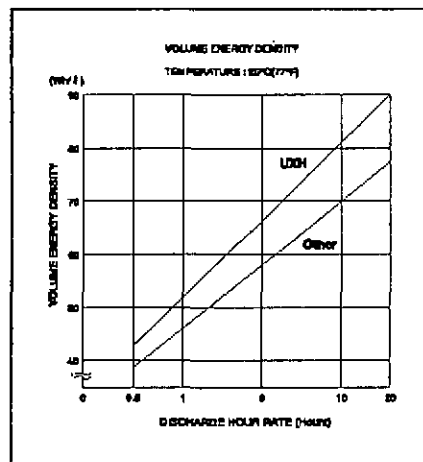

Floot charge voltage: 2.275V per cell  
 Permissible operating temperature: -15~45°C  
 Container material: ABS  
 Terminal: L terminal

## Performance Data at 25°C(77°F)

(Amperes and Watts per cell)  
 Amperes to F.V. 1.60 Volts Per Cell

Battery Model	Time	Time										
		1 min	5 min	10 min	15 min	20 min	25 min	30 min	35 min	40 min	45 min	1 h
UX028-12	A	141.0	119.0	84.3	63.5	50.9	42.6	37.6	33.4	29.4	25.5	22.8
	W	239.0	199.0	154.0	116.0	94.2	79.4	71.1	63.5	58.5	53.6	49.7
UX050-12	A	185.0	156.0	114.0	83.5	67.0	56.0	49.5	44.0	40.5	37.0	34.0
	W	302.0	262.0	209.0	153.0	124.0	105.0	93.5	83.5	77.0	70.5	67.5
UX063-12	A	233.0	197.0	143.0	105.0	84.4	70.6	62.4	55.4	51.0	46.6	43.8
	W	380.0	330.0	255.0	193.0	156.0	132.0	118.0	105.0	97.0	89.0	82.5
UX075-6	A	278.0	234.0	170.0	128.0	101.0	84.0	74.2	66.0	60.8	55.5	51.0
	W	457.0	392.0	304.0	220.0	184.0	157.0	140.0	125.0	116.0	106.0	94.3
UX0100-6	A	370.0	312.0	227.0	167.0	134.0	112.0	99.0	89.0	81.0	74.0	69.0
	W	603.0	514.0	408.0	304.0	248.0	209.0	187.0	167.0	154.0	141.0	115.0
UX0125-6	A	443.0	390.0	284.0	209.0	168.0	140.0	124.0	110.0	101.0	92.5	86.0
	W	744.0	655.0	504.0	383.0	310.0	261.0	234.0	209.0	193.0	176.0	144.0
UX0100-12N	A	370.0	312.0	227.0	167.0	134.0	112.0	99.0	89.0	81.0	74.0	69.0
	W	603.0	524.0	408.0	304.0	248.0	209.0	187.0	167.0	154.0	141.0	115.0
UX0200-6	A	740.0	624.0	452.0	334.0	268.0	224.0	198.0	176.0	162.0	148.0	120.0
	W	1204.0	1048.0	808.0	612.0	498.0	416.0	374.0	334.0	308.0	282.0	230.0

## Amperes to F.V. 1.70 Volts Per Cell

Battery Model	Time	Time										
		1 min	5 min	10 min	15 min	20 min	25 min	30 min	35 min	40 min	45 min	1 h
UX028-12	A	132.0	106.0	78.7	57.4	47.9	41.4	36.5	32.3	29.3	27.0	22.0
	W	211.0	184.0	135.0	106.0	86.9	77.9	69.2	61.6	55.9	51.7	42.6
UX050-12	A	142.0	139.0	97.0	78.6	63.0	54.8	48.0	42.5	38.5	35.3	29.0
	W	277.0	245.0	176.0	139.0	117.0	103.0	91.0	81.0	73.9	68.0	56.0
UX063-12	A	204.0	175.0	122.0	95.1	79.4	68.7	60.5	53.6	48.5	44.7	36.5
	W	349.0	308.0	231.0	175.0	147.0	129.0	115.0	102.0	92.6	85.7	70.6
UX075-6	A	243.0	209.0	146.0	113.0	94.5	81.8	72.0	63.8	57.8	53.2	43.9
	W	416.0	367.0	269.0	209.0	176.0	154.0	137.0	122.0	110.0	102.0	84.0
UX0100-6	A	324.0	278.0	194.0	151.0	126.0	109.0	96.0	85.0	77.0	71.0	58.0
	W	554.0	489.0	351.0	278.0	234.0	205.0	182.0	162.0	147.0	136.0	112.0
UX0125-6	A	403.0	348.0	243.0	189.0	158.0	136.0	120.0	106.0	94.1	88.8	72.5
	W	693.0	611.0	439.0	348.0	293.0	256.0	228.0	203.0	184.0	170.0	140.0
UX0100-12N	A	324.0	278.0	194.0	151.0	126.0	109.0	96.0	85.0	77.0	71.0	58.0
	W	554.0	489.0	351.0	278.0	234.0	205.0	182.0	162.0	147.0	136.0	112.0
UX0200-6	A	648.0	556.0	388.0	302.0	232.0	218.0	192.0	170.0	154.0	142.0	114.0
	W	1104.0	976.0	700.0	556.0	468.0	408.0	364.0	334.0	294.0	272.0	224.0

## Amperes to F.V. 1.80 Volts Per Cell

Battery Model	Time	Time										
		1 min	5 min	10 min	15 min	20 min	25 min	30 min	35 min	40 min	45 min	1 h
UX028-12	A	99.2	84.3	63.8	52.8	44.8	38.8	35.0	31.2	28.1	26.2	21.3
	W	179.0	157.0	118.0	99.3	84.7	73.7	64.9	59.7	54.3	50.5	41.4
UX050-12	A	131.0	114.0	84.0	69.8	59.0	51.0	46.0	41.0	37.0	34.5	28.0
	W	236.0	207.0	156.0	121.0	112.0	97.0	88.0	78.5	71.5	66.5	54.5
UX063-12	A	144.0	142.0	106.0	87.6	74.2	64.3	58.0	51.7	46.4	43.3	31.4
	W	297.0	260.0	196.0	144.0	140.0	122.0	111.0	98.9	90.1	83.8	68.7
UX075-6	A	196.0	170.0	126.0	104.0	88.5	76.5	69.0	61.5	55.5	51.8	42.0
	W	352.0	310.0	232.0	196.0	167.0	146.0	132.0	118.0	107.0	99.8	81.8
UX0100-6	A	261.0	227.0	168.0	139.0	118.0	102.0	92.0	82.0	74.0	69.0	56.0
	W	471.0	413.0	311.0	261.0	223.0	194.0	174.0	157.0	143.0	133.0	109.0
UX0125-6	A	326.0	284.0	210.0	174.0	148.0	128.0	115.0	103.0	92.5	86.3	70.0
	W	589.0	514.0	389.0	326.0	279.0	242.0	220.0	196.0	179.0	166.0	136.0
UX0100-12N	A	261.0	227.0	168.0	139.0	118.0	102.0	92.0	82.0	74.0	69.0	56.0
	W	471.0	413.0	311.0	261.0	223.0	194.0	174.0	157.0	143.0	133.0	109.0
UX0200-6	A	520.0	452.0	336.0	278.0	236.0	204.0	184.0	164.0	148.0	138.0	112.0
	W	940.0	824.0	620.0	520.0	444.0	388.0	332.0	314.0	284.0	264.0	218.0







**Halmac** Services (Qld) Pty. Ltd.  
A.C.N. 098 852 923  
A.B.N. 40 741 712 113

## PROXIMITY SWITCH

1. NCB5-18GM40-Z0 PROXIMITY SWITCH  
TECHNICAL DETAILS

**Inductive sensor**

**NCB5-18GM40-Z0**

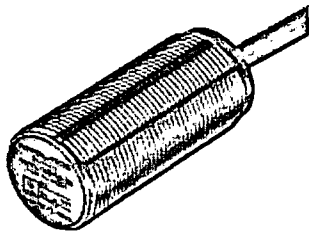

**Model Number**

NCB5-18GM40-Z0

**Features**

- Comfort series
- 5 mm embeddable

**Connection**

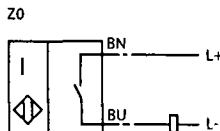

**Accessories**

- EXG-18  
Mounting aid
- BF 18  
Mounting flange

**Dimensions**

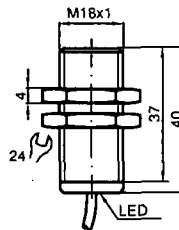

**Technical Data**

General specifications	
Switching element function	DC Make function
Rated operating distance	$s_n$ 5 mm
Installation	embeddable
Output polarity	DC
Assured operating distance	$s_B$ 0 ... 4.05 mm
Reduction factor $r_{AI}$	0.37
Reduction factor $r_{CU}$	0.33
Reduction factor $r_{V2A}$	0.7
Nominal ratings	
Operating voltage	$U_B$ 5 ... 60 V
Switching frequency	$f$ 0 ... 350 Hz
Hysteresis	H 1 ... 10 typ. 5 %
Reverse polarity protection	tolerant
Short-circuit protection	pulsing
Voltage drop	$U_d$ $\leq$ 5 V
Operating current	$I_L$ 2 ... 100 mA
Off-state current	$I_r$ 0 ... 0.5 mA typ.
Indication of the switching state	all direction LED, yellow
Standard conformity	
Standards	IEC / EN 60947-5-2:2004
Ambient conditions	
Ambient temperature	-25 ... 70 °C (248 ... 343 K)
Mechanical specifications	
Connection type	2 m, PUR cable
Cable version	PA
Core cross-section	0.34 mm <sup>2</sup>
Housing material	Stainless steel
Sensing face	PBT
Protection degree	IP67
Approvals and certificates	
CCC approval	Certified by China Compulsory Certification (CCC)

Release date: 2009-05-07 10:31 Date of issue: 2009-05-07 08:25:58\_ENG.xml

Subject to modifications without notice

Pepperl+Fuchs Group  
www.pepperl-fuchs.com

USA: +1 330 486 0001  
fa-info@us.pepperl-fuchs.com

Germany: +49 621 776-4411  
fa-info@pepperl-fuchs.com

Copyright Pepperl+Fuchs  
Singapore: +65 6779 9091  
fa-info@sg.pepperl-fuchs.com

**PEPPERL+FUCHS** 1  
SENSING YOUR NEEDS









**Halmac** Services (Qld) Pty. Ltd.  
A.C.N. 098 852 923  
A.B.N. 40 741 712 113

# PUSHBUTTON & INDICATORS

1. PUSH BUTTON TECHNICAL DETAILS
2. HOUR RUN METER TECHNICAL DETAILS

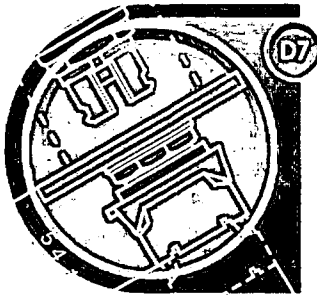

# Economical Devices for High Performance Switching & Control Solutions

## Series D7 Pilot Devices

22mm Design  
Saves Panel Space

Heavy Duty  
Ratings

Modular Design  
Reduces Inventory

Order Assembled  
or by Component

### Features

#### TWO OPERATOR TYPES

- Plastic operator with captive front bezel
- Metal operator with die-cast zinc housing and captive shiny metal bezel

#### LESS INVENTORY, MORE CHOICES

- Wide range of style choices
- Modular design for mix and match flexibility
- Endless configurations from core components

#### QUICK, EASY INSTALLATION

- Tool-less mounting latch for quick assembly
- Anti-rotation tab for one person installation
- Snap-on back panel components

#### LONG ELECTRICAL & MECHANICAL LIFE

- 10 million mechanical operations
- 10 million electrical cycles

#### ENVIRONMENTAL RATINGS

- UL Type 4/4X/13, IP66 Sealing
- Chemical resistant industrial grade thermoplastic body
- Corrosion and UV resistant

Sprecher + Schuh's rugged D7 pilot devices offer maximum flexibility and a wide choice for all applications. This 22mm line is aesthetically appealing and modularly designed to make assembly and interchangeability easy. The D7 operators are available in two different body styles to meet every industrial application need. Both operators exhibit a new lower profile stylish appearance while maintaining the rugged performance necessary for demanding environments.

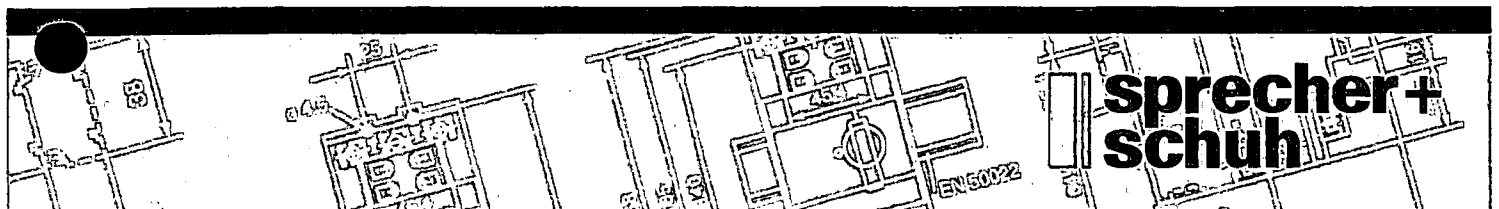

# Fast Mounting

Tool-less, snap-in design for fast assembly

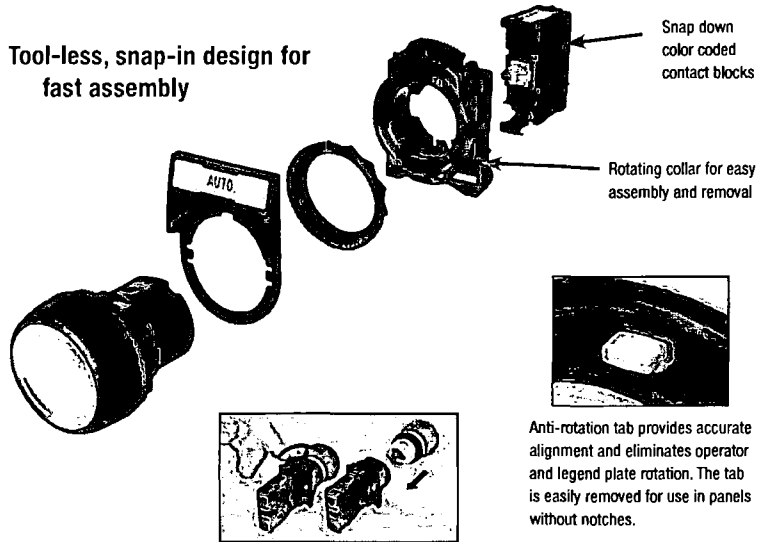

Easy one-person mounting and removal provide both time and cost savings.

# Flexibility

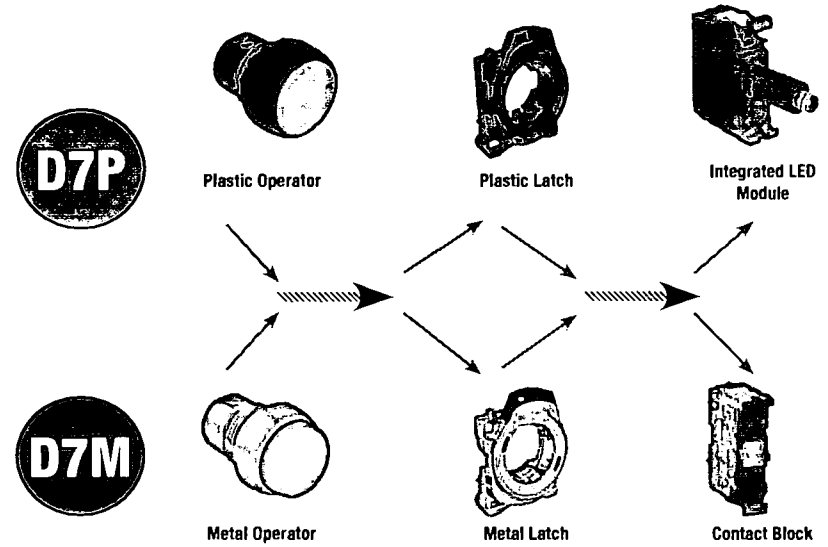

# Complete Accessories

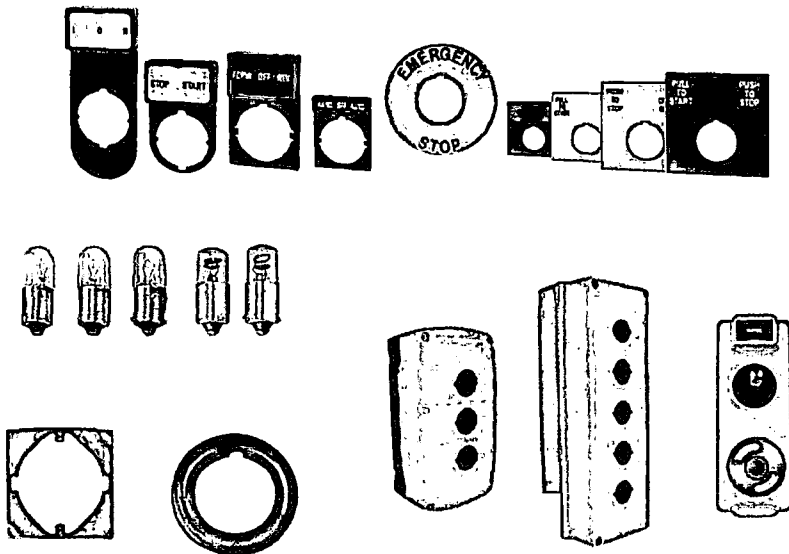

# Superior Design

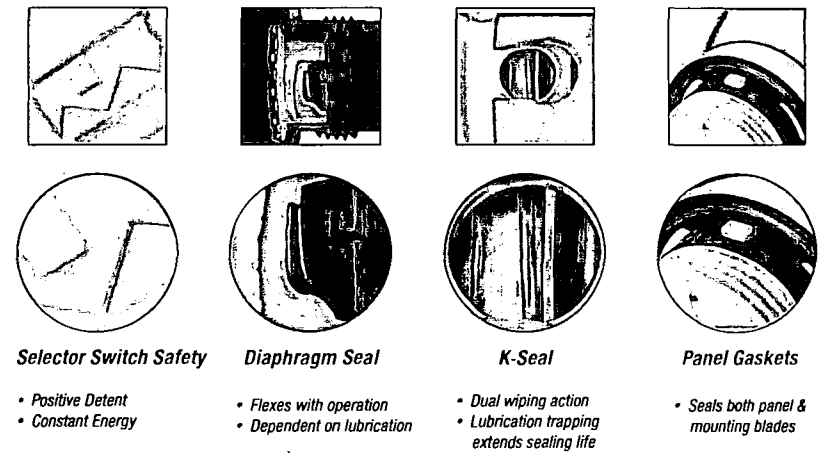

# Push Buttons



Extended



Flush Guarded



Extended



Flush

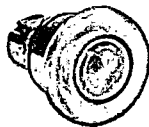

**Illuminated**  
40mm Mushroom, Momentary

Plastic	Metal
• D7P-LMM3	D7M-LMM3
• D7P-LMM4	D7M-LMM4
• D7P-LMM5	D7M-LMM5
• D7P-LMM6	D7M-LMM6
○ D7P-LMM7	D7M-LMM7

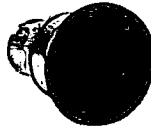

**Non-Illuminated**  
40mm Mushroom, Momentary

Plastic	Metal
• D7P-MM42	D7M-MM42
• D7P-MM43	D7M-MM43
• D7P-MM44	D7M-MM44
• D7P-MM45	D7M-MM45
• D7P-MM46	D7M-MM46

Also available in 60mm Mushroom

## Illuminated

Momentary, Extended		Momentary, Flush*		Maintained, Flush	
Plastic	Metal	Plastic	Metal	Plastic	Metal
• D7P-LE0	D7M-LE0	D7P-LF0	D7M-LF0	D7P-LFA0	D7M-LFA0
• D7P-LE3	D7M-LE3	D7P-LF3	D7M-LF3	D7P-LFA3	D7M-LFA3
• D7P-LE4	D7M-LE4	D7P-LF4	D7M-LF4	D7P-LFA4	D7M-LFA4
• D7P-LE5	D7M-LE5	D7P-LF5	D7M-LF5	D7P-LFA5	D7M-LFA5
• D7P-LE6	D7M-LE6	D7P-LF6	D7M-LF6	D7P-LFA6	D7M-LFA6
○ D7P-LE7	D7M-LE7	D7P-LF7	D7M-LF7	D7P-LFA7	D7M-LFA7
● D7P-LE9	D7M-LE9	D7P-LF9	D7M-LF9	D7P-LFA9	D7M-LFA9

\* Push Button without Cap      \* Guarded available on Momentary Flush only

## Non-Illuminated

Momentary, Extended		Momentary, Flush*		Maintained, Flush	
Plastic	Metal	Plastic	Metal	Plastic	Metal
• D7P-E0	D7M-E0	D7P-F0	D7M-F0	D7P-FA0	D7M-FA0
○ D7P-E1	D7M-E1	D7P-F1	D7M-F1	D7P-FA1	D7M-FA1
• D7P-E2	D7M-E2	D7P-F2	D7M-F2	D7P-FA2	D7M-FA2
• D7P-E3	D7M-E3	D7P-F3	D7M-F3	D7P-FA3	D7M-FA3
• D7P-E4	D7M-E4	D7P-F4	D7M-F4	D7P-FA4	D7M-FA4
• D7P-E5	D7M-E5	D7P-F5	D7M-F5	D7P-FA5	D7M-FA5
• D7P-E6	D7M-E6	D7P-F6	D7M-F6	D7P-FA6	D7M-FA6
● D7P-E9	D7M-E9	D7P-F9	D7M-F9	D7P-FA9	D7M-FA9

\* Push Button without Cap      \* Guarded available on Momentary Flush only

**PUSH** buttons

**MONOLITHIC**

**emergency STOP**

**SELECTOR switches**

**MULTI**function push buttons

**COMPONENTS**

**PILOT** lights

**PUSH-PULL** operators

**RESET** operators

**OTHER** switches

# Emergency Stops



**Illuminated**  
Twist-to-release, 40mm Mushroom

Plastic	Metal
D7P-LMT44	D7M-LMT44

**Complete Unit**  
1NC: D7P-LMT44PX01      D7M-LMT44PX01  
1 Guardian: D7P-LMT44PX01S      D7M-LMT44PX01S



**Non-Illuminated**  
Twist-to-release, 30mm Mushroom

Plastic	Metal
D7P-MT34	D7M-MT34

**Complete Unit**  
1NC: D7P-MT34PX01      D7M-MT34PX01  
1 Guardian: D7P-MT34PX01S      D7M-MT34PX01S



**Keyed**  
Twist-to-release, 40mm Mushroom

Plastic	Metal
D7P-MK44	D7M-MK44

**Complete Unit**  
1NC: D7P-MK44PX01      D7M-MK44PX01  
1 Guardian: D7P-MK44PX01S      D7M-MK44PX01S



**Twist-to-release, 40mm Mushroom**

Plastic	Metal
D7P-MT44	D7M-MT44

**Complete Unit**  
1NC: D7P-MT44PX01      D7M-MT44PX01  
1 Guardian: D7P-MT44PX01S      D7M-MT44PX01S



**Twist-to-release, 60mm Mushroom**

Plastic	Metal
D7P-MT64	D7M-MT64

**Complete Unit**  
1NC: D7P-MT64PX01      D7M-MT64PX01  
1 Guardian: D7P-MT64PX01S      D7M-MT64PX01S

# Push-Pull Operators

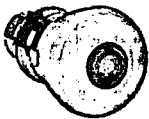

**2 Position Illuminated**  
Push-Pull, 40mm Mushroom

Plastic	Metal
• D7P-LMP43	D7M-LMP43
• D7P-LMP44	D7M-LMP44
• D7P-LMP45	D7M-LMP45

**Complete Unit**  
1NC: D7P-LMP44PX01      D7M-LMP44PX01  
1 Guardian: D7P-LMP44PX01S      D7M-LMP44PX01S

**Push-Pull, 30mm Mushroom**

Plastic	Metal
• D7P-LMP33	D7M-LMP33
• D7P-LMP34	D7M-LMP34
• D7P-LMP35	D7M-LMP35

**Push-Pull, 60mm Mushroom**

Plastic	Metal
• D7P-LMP63	D7M-LMP63
• D7P-LMP64	D7M-LMP64
• D7P-LMP65	D7M-LMP65



**2 Position Non-Illuminated**  
Push-Pull, 40mm Mushroom

Plastic	Metal
• D7P-MP42	D7M-MP42
• D7P-MP44	D7M-MP44

**Complete Unit**  
1NC: D7P-MP44PX01      D7M-MP44PX01  
1 Guardian: D7P-MP44PX01S      D7M-MP44PX01S

## 3 Position Illuminated

**Push-Pull, 40mm Mushroom**

Momentary	Maintained
• D7M-LMM40-E3	D7M-LMP40-E3
• D7M-LMM43-E3	D7M-LMP43-E3
• D7M-LMM44-E3	D7M-LMP44-E3
• D7M-LMM46-E3	D7M-LMP46-E3
• D7M-LMM47-E3	D7M-LMP47-E3

## 3 Position Non-Illuminated

**Push-Pull, 40mm Mushroom**

Momentary	Maintained
• D7M-MM42-E3	D7M-MP42-E3
• D7M-MM43-E3	D7M-MP43-E3
• D7M-MM44-E3	D7M-MP44-E3

# Pilot Lights



Plastic	Metal
• D7P-P0	D7M-P0
• D7P-P3	D7M-P3
• D7P-P4	D7M-P4
• D7P-P5	D7M-P5
• D7P-P6	D7M-P6
○ D7P-P7	D7M-P7
● D7P-P9	D7M-P9

• Pilot light without lens or diffuser

# Reset Operators



Mechanical and/or Electrical Reset

Plastic	Metal
○ D7P-R1	D7M-R1
• D7P-R2	D7M-R2
• D7P-R6	D7M-R6

## Monolithic



### Indicator Light Plastic

- |            |                     |
|------------|---------------------|
| <b>LED</b> | <b>Incandescent</b> |
| • D7D-P0N  | D7D-P0D             |
| • D7D-P3N  | D7D-P3D             |
| • D7D-P4N  | D7D-P4D             |
| • D7D-P5N  | D7D-P5D             |
| • D7D-P6N  | D7D-P6D             |
| • D7D-P7N  | D7D-P7D             |
- Select lamp voltage and terminal type

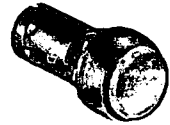

### Push Button Non-Illuminated, Plastic, Momentary

- |                  |                     |
|------------------|---------------------|
| <b>Flush Cap</b> | <b>Extended Cap</b> |
| • D7D-F1         | D7D-E1              |
| • D7D-F2         | D7D-E2              |
| • D7D-F3         | D7D-E3              |
| • D7D-F4         | D7D-E4              |
| • D7D-F5         | D7D-E5              |
| • D7D-F6         | D7D-E6              |
- Select cap test and contact configuration

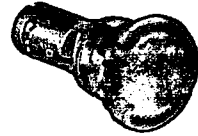

### E-STOP Push Button Push-Pull and Twist-to-release, 40mm Mushroom, Plastic

- |             |         |
|-------------|---------|
| D7D-MT44X01 | 1NC     |
| D7D-MT44X11 | 1ND 1NC |
| D7D-MT44X02 | 2NC     |



### Selector Switch Non-Illuminated, Plastic

- 2 Position, Maintained
- D7D-SM22X10 1ND
  - D7D-SM22X01 1NC
  - D7D-SM22X20 2ND
  - D7D-SM22X02 2NC
  - D7D-SM22X11 1ND, 1NC

- 3 Position, Maintained
- D7D-SM32X20 2ND
  - D7D-SM32X02 2NC
  - D7D-SM32X11 1ND, 1NC

## Selector Switches



### Non-Illuminated

- 2 Position, Maintained
- |            |          |
|------------|----------|
| Plastic    | Metal    |
| • D7P-SM22 | D7M-SM22 |
- Also available with spring return
- 3 Position, Maintained
- |            |          |
|------------|----------|
| Plastic    | Metal    |
| • D7P-SM32 | D7M-SM32 |



### Illuminated

- 2 Position, Maintained
- |             |           |
|-------------|-----------|
| Plastic     | Metal     |
| • D7P-LSM20 | D7M-LSM20 |
| • D7P-LSM23 | D7M-LSM23 |
| • D7P-LSM24 | D7M-LSM24 |
| • D7P-LSM25 | D7M-LSM25 |
| • D7P-LSM26 | D7M-LSM26 |
| • D7P-LSM27 | D7M-LSM27 |



- 3 Position, Maintained
- |             |           |
|-------------|-----------|
| Plastic     | Metal     |
| • D7P-LSM30 | D7M-LSM30 |
| • D7P-LSM33 | D7M-LSM33 |
| • D7P-LSM34 | D7M-LSM34 |
| • D7P-LSM35 | D7M-LSM35 |
| • D7P-LSM36 | D7M-LSM36 |
| • D7P-LSM37 | D7M-LSM37 |

## Multi-function



### Illuminated

- 2 Function
- |          |          |
|----------|----------|
| Plastic  | Metal    |
| D7P-LU2X | D7M-LU2X |



### Non-Illuminated

- 2 Function
- |         |         |
|---------|---------|
| Plastic | Metal   |
| D7P-U2X | D7M-U2X |

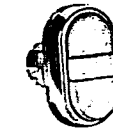

- 3 Functions
- |         |         |
|---------|---------|
| Plastic | Metal   |
| D7P-U3X | D7M-U3X |

## Other Switches

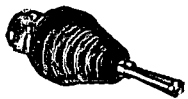

### Toggle Switch Metal

- 2 Position
- |         |            |
|---------|------------|
| D7M-JR2 | Momentary  |
| D7M-JM2 | Maintained |
- 4 Position
- |         |            |
|---------|------------|
| D7M-JR4 | Momentary  |
| D7M-JM4 | Maintained |



### Key Selector Switches

- 2 Position, Maintained
- |          |          |
|----------|----------|
| Plastic  | Metal    |
| D7P-KM21 | D7M-KM21 |
| D7P-KM22 | D7M-KM22 |
| D7P-KM23 | D7M-KM23 |

Also available with spring return

- 3 Position, Maintained
- |          |          |
|----------|----------|
| Plastic  | Metal    |
| D7P-KM31 | D7M-KM31 |
| D7P-KM33 | D7M-KM33 |
| D7P-KM34 | D7M-KM34 |
| D7P-KM35 | D7M-KM35 |

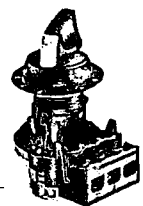

### Potentiometer Single Turn, Assembled

- |                |                          |
|----------------|--------------------------|
| <b>Plastic</b> | <b>Resistive Element</b> |
| D7P-P0T        | None (Operator Only)     |
| D7P-P0T1       | 150 Ω                    |
| D7P-P0T2       | 500 Ω                    |
| D7P-P0T3       | 1000 Ω                   |
| D7P-P0T4       | 2500 Ω                   |
| D7P-P0T5       | 5000 Ω                   |
| D7P-P0T6       | 10000 Ω                  |

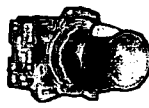

### Selector/Jog Operators

- 2 Position
- |            |          |
|------------|----------|
| Plastic    | Metal    |
| • D7P-SJ22 | D7M-SJ22 |
| • D7P-SJ23 | D7M-SJ23 |

- 3 Position
- |            |          |
|------------|----------|
| Plastic    | Metal    |
| • D7P-SJ32 | D7M-SJ32 |
| • D7P-SJ33 | D7M-SJ33 |

## Components



### Contact Blocks (latch not included)

- |              |                 |
|--------------|-----------------|
| D7-X10       | 1NO             |
| D7-X01       | 1NC             |
| D7-X01B      | 1NC Early Break |
| D7-X10E      | 1NO Early Make  |
| D7-X01L      | 1NC Late Break  |
| D7-X10V(1mA) | 1NO Low Voltage |
| D7-X01V(1mA) | 1NC Low Voltage |
| D7-X01S      | Guardian Block  |
| D7-010       | 1NO Screwless   |
| D7-001       | 1NC Screwless   |



### Integrated LED Module (latch not included)

- Screw Type
- |        |           |
|--------|-----------|
| D7-N3* | 24V AC/DC |
| D7-N5* | 120V AC   |
| D7-N7* | 240V AC   |

- Spring-Clamp
- |        |           |
|--------|-----------|
| D7-03* | 24V AC/DC |
| D7-05* | 120V AC   |
| D7-07* | 240V AC   |

\* Add LED Color, R=red, G=green, Y=yellow, B=blue, W=white



Plastic Latch  
D7-ALP



Metal Latch  
D7-ALM



### Incandescent Power Module (bulb not included)

- |        |              |
|--------|--------------|
| D7-DOC | 6-240V AC/DC |
|--------|--------------|

# D7 Pilot Devices

## Dimensions\* (Approximately in millimeters)

Non-Illuminated and Illuminated Flush Push Button Operators (D7x-F)

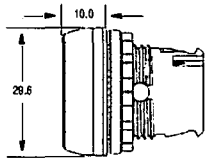

Illuminated and Non-Illuminated Extended Push Button Operators

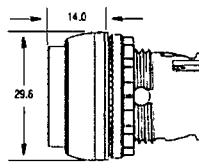

Non-Illuminated 3-Position Multi-Function Operators (D7x-U3)

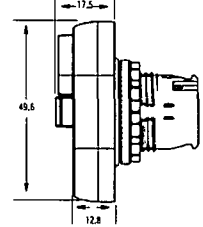

Non-Illuminated Guarded and Non-Illuminated Maintained Push Button Operators (D7x-G and D7x-FA)

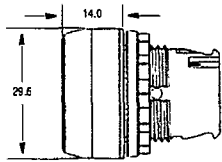

Pilot Light Operators (D7x-P)

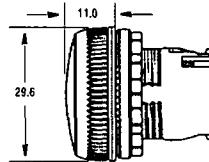

Illuminated and Non-Illuminated 2-Position Multi-Function Operators (D7x-LU2 & D7x-U2)

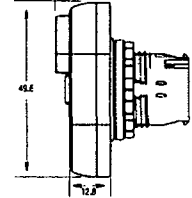

Illuminated and Non-Illuminated Knob Selector Switch Operators (D7x-LS & D7x-S)

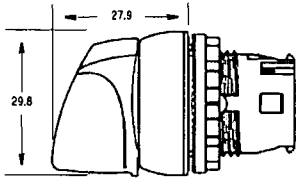

Key Selector Switch Operators (D7x-K)

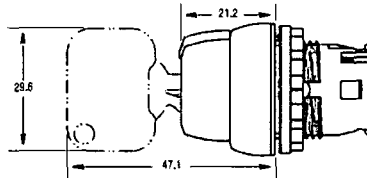

Toggle Switch Operators (D7M-JM)

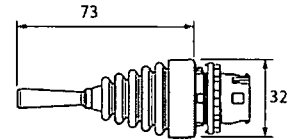

Illuminated and Non-Illuminated Momentary Mushroom Operators 40mm and 60mm (D7x-LMM & D7x-MM)

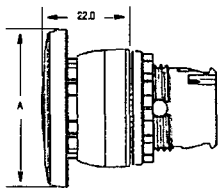

Operator	A
40mm	39.8
60mm	59.8

Illuminated and Non-Illuminated Twist-to-Release Operators 30mm, 40mm, and 60mm (D7x-MT)

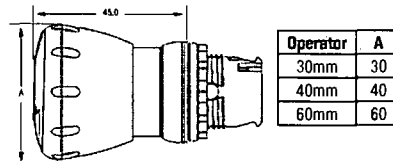

Operator	A
30mm	30
40mm	40
60mm	60

Reset Operators (D7x-R)

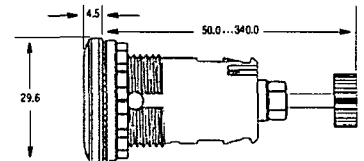

Selector Jog Operators (D7x-SJ)

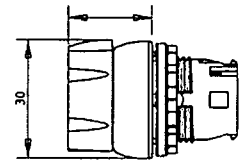

Illuminated and Non-Illuminated Push-Pull Mushroom Operators 30mm, 40mm, and 60mm (D7x-MP)

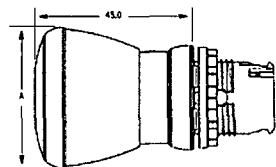

Operator	A
30mm	30
40mm	40
60mm	60

Mushroom Key Release Operator 40mm (D7x-MK)

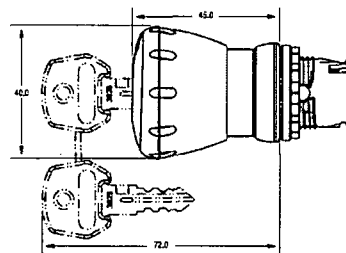

Potentiometer with Resistive Element (D7P- POT)

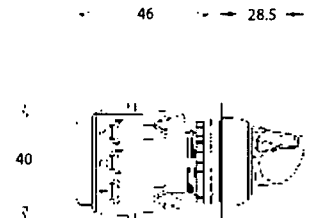

\* For Monolithic Devices see the D7D Monolithic Flyer

**Sprecher + Schuh US Division Headquarters**  
 15910 International Plaza Dr., Houston, TX 77032  
 Tel: (281) 442-9000; Fax: (800) 739-7370  
 www.sprecherschuh.com

**Sprecher + Schuh Canadian Division**  
 3610 Nashua Dr., Unit 10, Mississauga, Ontario L4V 1L2  
 Tel: (905) 677-7514; Fax: (905) 677-7663



Publication No: F-D7Devices\_107 11/07



Front-of-Panel (Operators) ①

Mechanical Ratings

Description	Plastic (D7P)	Metal (D7M)
Vibration (assembled to panel)	[G] Tested at 10 ...2000Hz, 1.52mm displacement (peak-to-peak) max./10G max. for 3hr duration, no damage	
Shock	[G] Tested at 1/2 cycle sine wave for 11ms; no damage at 100G	
Degree of protection ②	UL Type 3/3R/4/4X/12/13 (IP65/66)	UL Type 3/3R/4/12/13 (IP65/66)
Mechanical durability per EN 60947-5-1 (Annex C)	10,000,000 Cycles 1,000,000 Cycles 500,000 Cycles 300,000 Cycles 100,000 Cycles	Momentary push buttons, momentary mushroom Multi-function, Selector Switch, Key Selector Switch, Selector Jog Non-illuminated Push-Pull E-Stop Twist-to-Release E-Stop, Illuminated Push-Pull E-Stop, Maintained Push Buttons, selector switches Potentiometer, Toggle Switch
Operating forces (typical with one contact block)	[N]	Flush/extended = 5N E-stop = 36N Mushroom = 9N
Operating torque (typical application with one contact block)	[N·m]	Selector switch = 0.25 N·m (2.2 lb-in.)
Mounting torque	[N·m]	1.7 N·m (15 lb-in.) 4.4 N·m (40 lb-in.)
<b>Environmental</b>		
Temperature range (operating) ③	[°C]	-25...+70°C (-13...+158°F)
Temperature range (short-term storage)	[°C]	-40...+85°C (-40...+185°F)
Humidity	[%]	50...95% RH from 25...60°C (77...140°F) per: Procedure IV of MIL-STD-810C, Method 507.1 cycling test

Pilot Devices

D7

Back-of-Panel Components ①

Electrical Ratings

Standard contact block ratings	A600, Q600 600V AC AC15, DC 13 to EN 60947-5-1 and UL 508, 17V, 5mA min.		
Low voltage contact block ratings ④	5V, 1mA DC min. C300, R150, AC 15, DC 13 to EN 60947-5-1 and UL 508		
LED Module Ratings	Nominal Voltage	Range	Current Draw
	24V AC	10...29V AC	31 mA
	24V DC	10...30V DC	24 mA
	120V AC	70...132V AC	25 mA
240V AC	180...264V AC	22 mA	50/60 Hz
Thermal current	[A]	10 A max. enclosed (40°C ambient) to UL 508, EN 60947-5-1	
Wire capacity	Screw terminal ⑤ [AWG]	#18...12 AWG (0.75...2.5mm <sup>2</sup> ) Max. (2) #14 AWG or (1) #12 AWG	
	Spring-clamp terminal [AWG]	#18...14 AWG (0.75...1.5mm <sup>2</sup> )	
Recommended tightening torque on screw terminals	[N]	0.7...0.9 N·m (6...8 lb-in.)	
Insulation voltage	[U <sub>i</sub> ]	U <sub>i</sub> = 690 V (screw terminal) U <sub>i</sub> = 300 V (screwless terminal)	
Dielectric strength (minimum)	[V]	2500V for one minute	
External short circuit protection	Standard blocks	10 A type gL/gG cartridge fuse to EN 60269-2-1 or gN (Class J to UL 248-8 or Class C to UL 248-4)	
	Low voltage contact blocks	6 A type gL/gG cartridge fuse to EN 60269-2-1 or gN (Class J to UL 248-8 or Class C to UL 248-4)	
Electrical shock protection	Finger-safe conforming to IP2X		

Mechanical Ratings

Vibration (assembled to panel)	[G]	10...2000 Hz, 1.52mm displacement (peak-to-peak) max./10G max. 6hr
Shock	[G]	Tested at 1/2 cycle sine wave for 11ms and no damage at 100G max.
Contact durability per EN 60947-5-1 (Annex C)		10,000,000 cycles
Contact operation	NO	Slow double make and break
	NC	Slow double make and break - positive opening
	NOEM	Double break / double make / early make
	NCLB	Double break / double make, late break - positive opening
	NCEB	Double break / double make, early break - positive opening
Push button travel to change electrical state		N.C. and N.O.E.M. 1.5 mm (0.060 in.)
		N.O. and N.C.L.B. 2.5 mm (0.1 in.)
Operating forces (typical)	[N]	3.4 N: each single circuit contact block 5...6.5 N: each dual circuit contact block

- ① Performance data given in this publication is provided only as a guide for the user in determining suitability and do not constitute a performance warranty of any kind. Such data may represent the results of accelerated testing at elevated stress levels, and the user is responsible for correlating the data to actual application requirements. ALL WARRANTIES AS TO ACTUAL PERFORMANCE, WHETHER EXPRESS OR IMPLIED, ARE EXPRESSLY DISCLAIMED.
- ② Momentary mushroom operators are IP65, multi-function operators have no Type 13 rating. Plastic operators with keys have no Type 4X rating.
- ③ Operating temperatures below 0°C (32°F) are based on the absence of freezing moisture and liquids, UL recognized to 55°C (131°F) - incandescent module, max 40°C (104°F).
- ④ Low voltage contacts are recommended for applications below 17V, 5 mA.
- ⑤ Wires less than #18 (0.75mm<sup>2</sup>) may not hold in terminal securely.

H76

Discount Schedule B-1



Technical Information

Series D7 – Heavy Duty/Oil Tight

Back-of-Panel Components ❶, continued

**Illumination**

LED dominant wavelength	Green		525 nm
	Red		629 nm
	Yellow	[nm]	590 nm
	Blue		470 nm
	White		—
LED luminous intensity	Green		890 mcd
	Red		890 mcd
	Yellow	(mcd)	690 mcd
	Blue		193 mcd
	White		412 mcd
Incandescent maximum wattage	[W]		2.6W

**Materials**

Springs	Stainless steel and zinc coated music wire		
Electrical contacts	Standard	Silver-nickel	
	Low voltage	Gold-plated over silver	
Terminals	Screw	Brass	
	Screwless	Silver-plated brass	



Pilot Devices

D7

**Environmental Approval Note:** Front elements UL Recognized; Complete assemblies UL Approved. See Table A2 for your application.

This table is extracted from Sprecher + Schuh's UL 508A file and can be used to determine which D7 Pilot Device is approved for a particular enclosure type.

TABLE A2 – Openings in Enclosure	
Enclosure Type	Openings May Be Closed By Equipment Marked...
2	2, 3, 3R, 3S, 4, 4X, 6, 6P, 11, 12, 12K, 13
3	3, 3R, 3S, 4, 4X, 6, 6P
3R	3, 3R, 3S, 4, 4X, 6, 6P
3S	3, 3R, 3S, 4, 4X, 6, 6P
4	4, 4X, 6, 6P
4X	4X
6	6, 6P
6P	6P
11	11
12, 12K	12, 12K, 13
13	13

**Product Certifications**

Certifications	UL, UR, CSA, CCC, CE
Conformity of Standards - CE marked	NEMA ICS-5; UL 508, EN 418, EN 60947-1, EN 60947-5-1, EN 60947-5-5
Terminal identification	IEC 60947-1
Shipping approvals	RINA, LR, ABS
RoHS	✓

❶ Performance data given in this publication is provided only as a guide for the user in determining suitability and do not constitute a performance warranty of any kind. Such data may represent the results of accelerated testing at elevated stress levels, and the user is responsible for correlating the data to actual application requirements. ALL WARRANTIES AS TO ACTUAL PERFORMANCE, WHETHER EXPRESS OR IMPLIED, ARE EXPRESSLY DISCLAIMED.



**Material Listing**

Component	For Use with	Material Used
Panel gasket	All operators	Nitrile, TPE
Diaphragm seal	Illuminated push button, non-illuminated push button	Automotive industry acceptable silicone
K-seal	Selector switch, key selector switch, push/twist-to-release E-stop, key E-stop, push/pull mushroom	Nitrile
Diaphragm retainer, return spring I	Illuminated push button, non-illuminated push button, momentary mushroom	Stainless steel
Return spring II	Reset, selector switch, key selector switch, maintained action, push/twist-to-release E-stop, key E-stop, push/pull mushroom	Zinc coated music wire
Button cap/mushroom head	Non-illuminated push button, momentary mushroom, reset, push/twist-to-release E-stop, key E-stop, push/pull mushroom, multi-function	PBT/polycarbonate blend
2-color molded button cap	Non-illuminated push button	PBT/polycarbonate blend
Lens	Multi-function	Acetal
Lens, knob	Illuminated push button, illuminated momentary mushroom, illuminated selector switch	Polyamide
Knob	Non-illuminated selector switch	Glass-filled polyamide
Plastic bezel/bushing I	Non-illuminated push button, illuminated push button, momentary mushroom, selector switch, key selector switch, push/twist-to-release E-stop, key E-stop, push/pull mushroom, multi-function, reset	Glass-filled polyamide
Plastic bezel/bushing II, jam nut	Pilot light, reset jam nut, reset pusher	Glass-filled PBT
Metal bezel/bushing	All metal operators	Zinc
Diffuser	Illuminated push button, pilot light	Polycarbonate
Legend frames	—	Glass-filled polyamide
Plastic mounting ring	All plastic operators	Glass-filled polyamide
Metal mounting ring	All metal operators	Chromated zinc
Plastic latch	—	Glass-filled polyamide
Metal latch	—	Chromated zinc + stainless steel
Plastic enclosure	—	PBT/polycarbonate blend
Metal enclosure	—	Aluminum
Terminal screws	LED module, incandescent module, contact blocks	Zinc-plated steel with chromate
Terminals	LED module, incandescent module, contact blocks	Brass with silver-nickel contacts
Screwless	LED module, incandescent module, contact blocks	Stainless steel
Lamp socket	Incandescent module	Brass
Housing	Incandescent module, LED module	Glass-filled polyamide
Low voltage terminals	Contact blocks	Gold plated silver-nickel contacts
Low voltage spanner	Contact blocks	Gold-plated silver-nickel contacts
Spanner	Contact blocks	Brass with silver-nickel contacts
Boot	Toggle Switch, illuminated push button, non-illuminated push button, multi-function illuminated an non-illuminated	Automotive industry acceptable silicone

**Pilot Devices**  
 D7



Pilot Devices

Series D7D Monolithic

Specifications

Mechanical Ratings

Vibration (assembled to panel)	Tested at 10...2000 Hz, 1.52 mm displacement (peak-to-peak) max./10 G max. for 3 hr duration, no damage	
Shock	Tested at 1/2 cycle sine wave for 11 ms; no damage at 100 G	
Degree of protection	IP 66 (Type 3/3R/4/4X/12/13)	
mechanical durability per EN 60947-5-1 (Annex C)	2,000,000 Cycles	Momentary Push Button
	300,000 Cycles	Selector Switch and E-Stop
Operating forces	Flush/Extended = 9 N, E-stop = 36 N	
Operating torque (typical application with one contact block)	Selector Switch = 0.25 N•m	
Contact operation	N.O.	Slow double make and break
	N.C.	Slow double make and break - positive opening ⊕
Push button travel to change electrical state	N.O.	2.5 mm (0.1 in.)
	N.C.	1.5 mm (0.060 in.)

⊕ Positive Opening per EN60947-5-1 (applies to all NC contact block styles)

Environmental

Temperature range (operating) ①	-25...+60°C (-13...140°F)
Temperature range (short term storage)	-40...+85°C (-40...185°F)
Humidity	50...95% RH from 25...60°C (77...140°F)

Electrical Ratings

Standard contact block ratings	B300, R300; AC 15, DC 13; 300 VAC; EN/IEC 60947-5-1 and UL 508, 17V, 5 mA min.			
LED Module Ratings	Nominal Voltage	Range	Nominal Current Draw	Frequency
	24V AC	20...26V AC	32 mA	50/60 Hz
	24V DC	18...30V DC	24 mA	DC
	120V AC	102...132V AC	22 mA	50/60 Hz
	240V AC	204...264V AC	22 mA	50/60 Hz
Thermal current	5 A max. enclosed (40°C ambient) to UL508, EN/IEC 60947-5-1			
Insulation voltage (Ui)	300V			
Wire capacity (screw terminal)	#18...14 AWG (0.75...2.5 mm²), Max. (2) #14 AWG, uses same size wire only			
Recommendations for Ring Lug termination option ②	6.35 mm (0.250 in.) Max. outer diameter with 3.8 mm (0.148 in.) hole diameter			
Recommended tightening torque on screw terminals	0.7...0.9 N•m (6...8 lb-in.)			
Dielectric strength (minimum)	2500V for one minute			
External short circuit protection	5 A type gL/gG cartridge fuse to EN 60269-2-1 or gN (Class J to UL 248-8 or Class CC to UL 248-4)			
Electrical shock protection	Finger-safe conforming to IP2X			

Illumination

LED Dominant Wavelength	Green	Red	Yellow	Blue	White
	525 nm	629 nm	590 nm	470 nm	
LED Luminous Wavelength	Green	Red	Yellow	Blue	White
	890 mcd	890 mcd	690 mcd	193 mcd	412 mcd
Incandescent maximum wattage	2.6 W				

Materials

Springs	Stainless steel and zinc coated music wire
Electrical contacts	Brass with silver-nickel contacts
Terminals	Brass and phosphor bronze
Panel gasket	nitrile and polyester-based TPE
Seal	Nitrile
Button cap/mushroom head	Polyester/polycarbonate blend
Lens (pilot light)	Acrylic
Knob (selector switch)	Glass-filled polyamide
Bezel/bushing, housing	Glass filled polyester
Legend frames	Glass filled polyamide
Mounting ring	Glass filled polyamide
Terminal screws	Zinc-plated steel with chromate
Lamp Socket	Brass and Phosphor bronze

Product Certifications

Certifications	UL, CSA, CCC, CE
Conformity to standards - CE marked	UL 508, EN 60947-1, EN 60947-5-1, EN 60947-5-5
Terminal Identification	EN/IEC 60947-1

- ① Operating temperatures below 0°C (32°F) are based on the absence of freezing moisture and liquids.
- ② 3M MV018-R/S # (22...18 AWG) or 3M MVU14-6R/S (#16...14 AWG)

Discount Schedule B-1

H79



D7

**Approximate Dimensions – millimeters** ①

Panel Hole Spacing

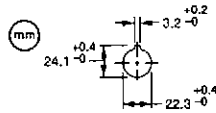

	40	50	40	50	40/60	50/60		70	50	40
							60/90			
	30		48		40/60			30	50	50

Pilot Devices  
D7

**Non-illuminated and Illuminated Flush Push Button Operators (D7x-F)**

**Non-illuminated Guarded and Non-illuminated Maintained Push Button Operators (D7x-G and D7x-FA)**

**Reset Operators (D7x-R)**

**Illuminated and Non-illuminated Extended Push Button Operators (D7x-LE & D7x-E)**

**Illuminated Guarded Push Button Operators (D7x-LG)**

**Pilot Light Operators (D7x-P)**

① Dimensions are not intended to be used for manufacturing purposes.

Approximate Dimensions – millimeters ①

Illuminated and Non-illuminated Momentary Mushroom Operators 40mm and 60mm (D7x-LMM & D7x-MM)

Operator	A
40mm	39.8
60mm	59.8

Illuminated and Non-illuminated Knob Selector Switch Operators (D7x-LS & D7x-S)

Non-illuminated Knob Lever Selector Switch Operators (D7x-H)

Non-illuminated 3-Position Multi-Function Operators (D7x-U3)

Illuminated and Non-illuminated Push-Pull Mushroom Operators 30mm, 40mm, and 60mm (D7x-MP)

Operator	A
30mm	30
40mm	40
60mm	60

Illuminated and Non-illuminated Twist-to-Release Operators 30mm, 40mm, and 60mm (D7x-MT)

Operator	A
30mm	30
40mm	40
60mm	60

Illuminated and Non-illuminated 2-Position Multi-Function Operators (D7x-LU2 & D7x-U2)

Mushroom Key Release Operator 40mm (D7x-MK)

Key Selector Switch Operators (D7x-K)

Back-of-Panel Components — Incandescent Module with Latch (D7-DDC & D7-ALP/M)

Back-of-Panel Components — Contact Cartridges with Latch (D7-X/Q + D7-ALP/M)

30 x 40mm Snap-in-Legend Plate (D7-11)

Back-of-Panel Components — LED Module with Latch (D7-N/Q & D7-ALP/M)

Back-of-Panel Components — Dual Circuit Contact Block (Max. of 1 Deep) (D7x-X\_D/D7-X01S)

30 x 50mm Snap-in-Legend Plate (D7-12)

Pilot Devices  
D7

① Dimensions are not intended to be used for manufacturing purposes.

**Approximate Dimensions – millimeters ①②**

Pilot Devices  
D7

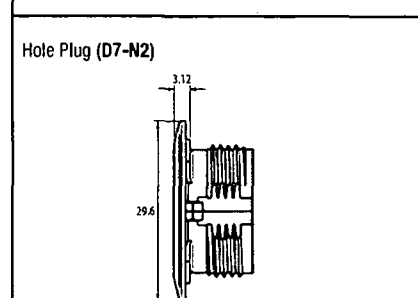
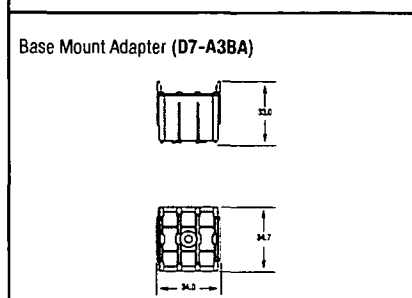
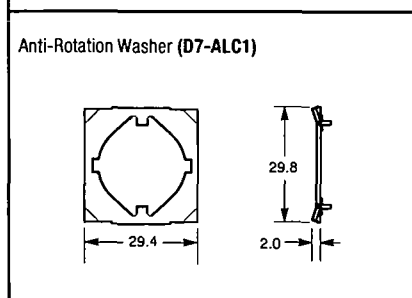
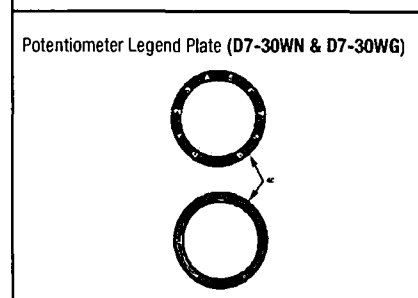
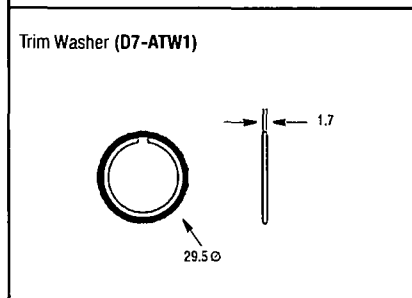
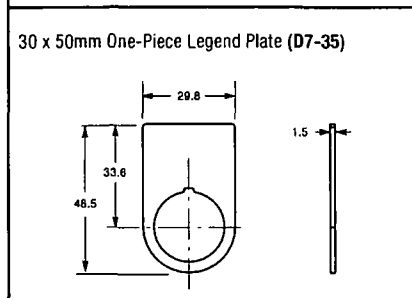
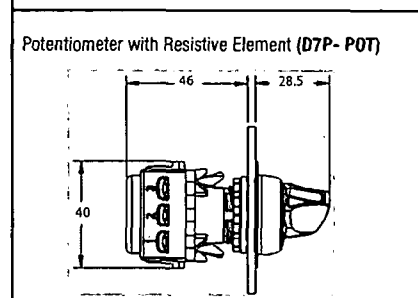
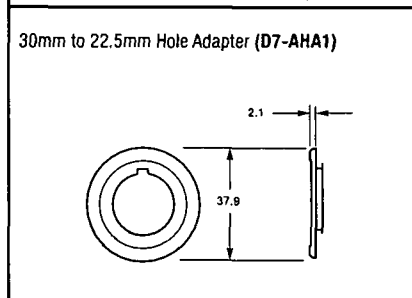
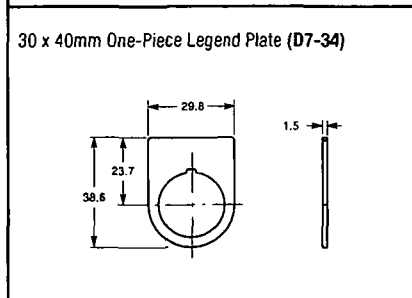
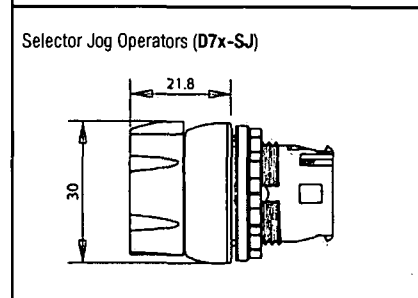
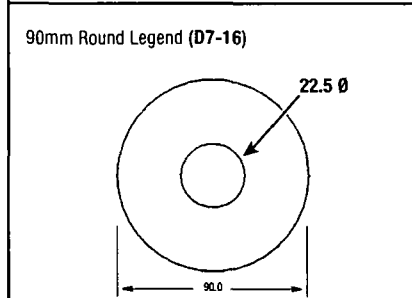
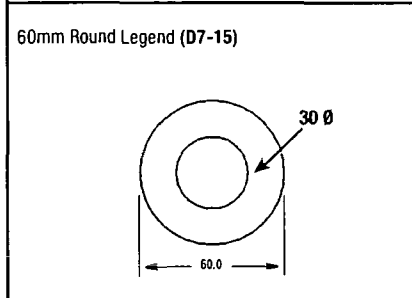
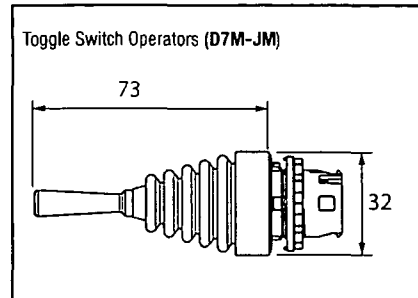
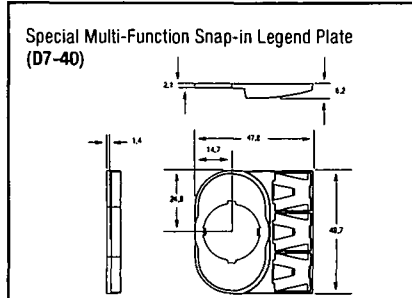
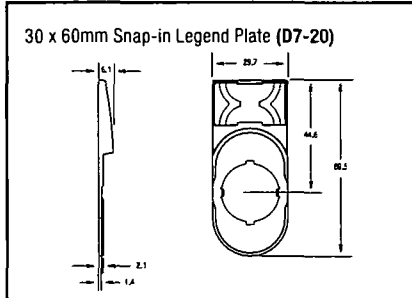

① Dimensions are not intended to be used for manufacturing purposes.  
 ② Panel thickness range is 1.0...6.0 maximum. Panel thickness reduced to 4.5 when optional legend plates are used.

**Approximate Dimensions – millimeters ①**

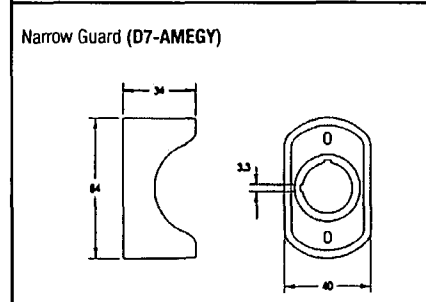
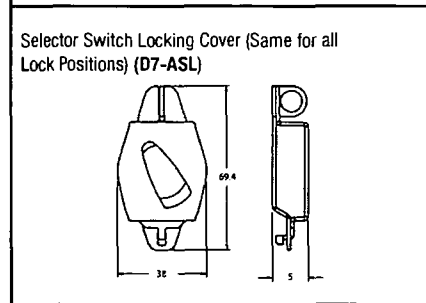
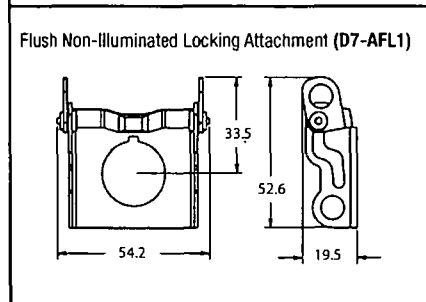
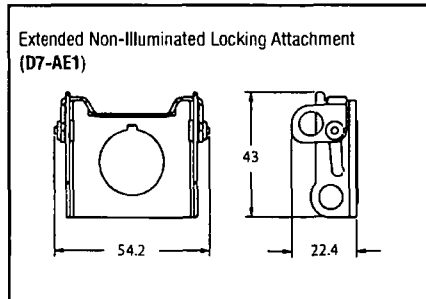
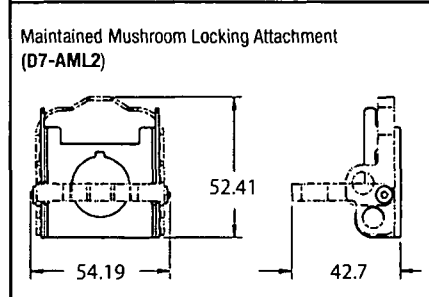
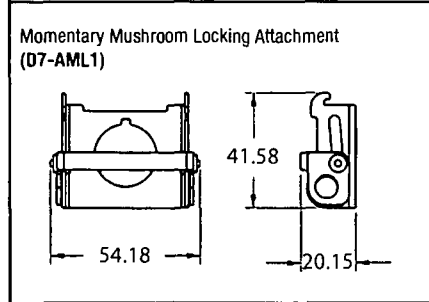
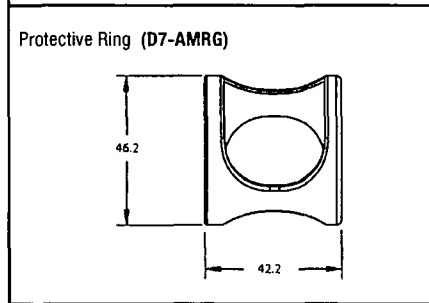
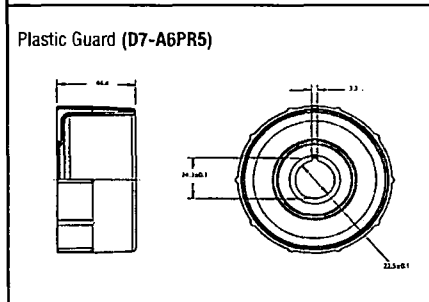
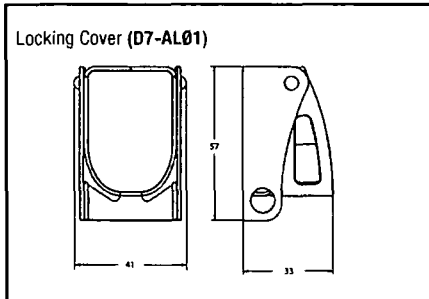







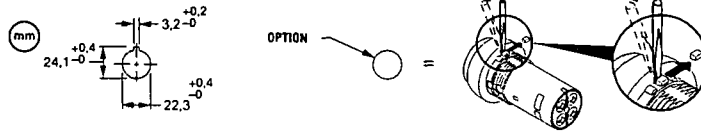







Pilot Devices  
D7

① Dimensions are not intended to be used for manufacturing purposes.

**Approximate Dimensions – millimeters** 



(A)						
(A)						
(B)						
						
	30	40	50	40	50	60, 90
	30		40			60/90

Pilot Devices  
D7

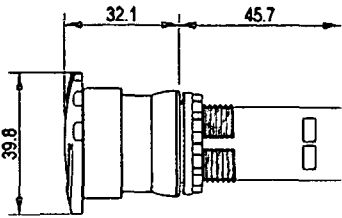
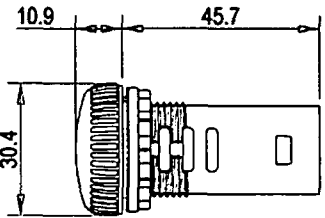
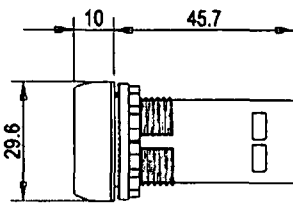
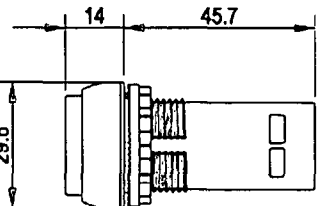
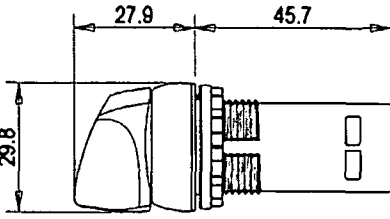
<p>2-Position Push-Pull/Twist-to-Release Mushroom Devices (D7D-MT)</p> 	<p>Pilot Light Devices (D7D-P)</p> 
<p>Momentary Pushbutton Device - Flush (D7D-F)</p> 	<p>Momentary Pushbutton Device - Extended (D7D-E)</p> 
<p>2 &amp; 3 Position Selector Switch Devices (D7D-S)</p> 	

H84

Discount Schedule B-1

**Approximate Dimensions – millimeters ①**

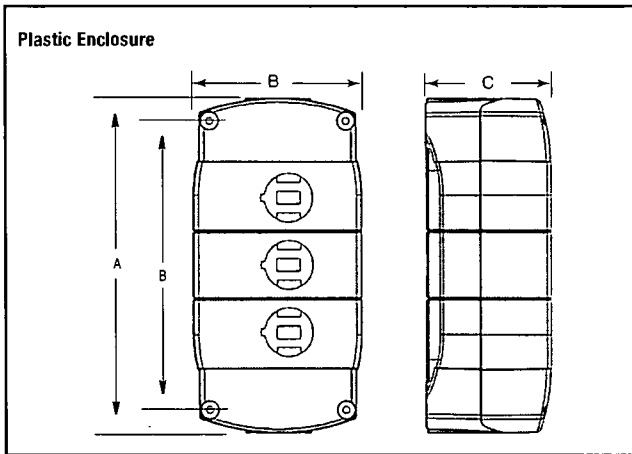

Type - 4/4X/13 (IP66) - Plastic Enclosures					
Cat. No.	No. of Units (Holes)	A	B	C	Knockout/Conduit Openings
D7-1PP (1YP)	1	85 (3-11/32)	89 (3-1/2)	58 (2-9/32)	PG11 PG16
D7-2PP	2	124 (4-7/8)	79 (3-1/8)	58 (2-9/32)	PG11 PG16
D7-3PP	3	155 (6-3/32)	79 (3-1/8)	58 (2-9/32)	PG11 PG16
D7-4PP	4	186 (7-5/16)	79 (3-1/8)	58 (2-9/32)	PG11 PG16
D7-6PP	6	248 (9-3/4)	87 (3-7/16)	64 (2-17/32)	PG16

Pilot Devices

D7

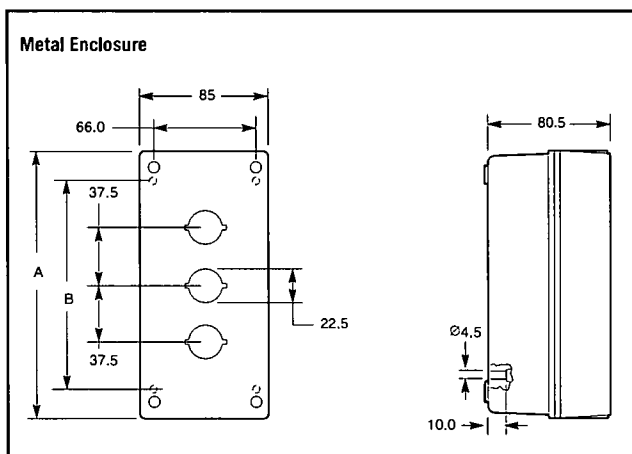

Type 4/13 (IP66) - Metal Enclosures				
Cat. No.	No. of Units (Holes)	A	B	Knockout/Conduit Openings
D7-1MP (1MY)	1	99 (3-9/32)	62 (2-7/16)	PG11 PG16
D7-2MP	2	137 (5-13/32)	100 (3-15/16)	PG11 PG16
D7-3MP	3	174 (6-27/32)	137 (5-13/32)	PG11 PG16
D7-5MP	5	249 (9-13/32)	212 (8-11/32)	PG16

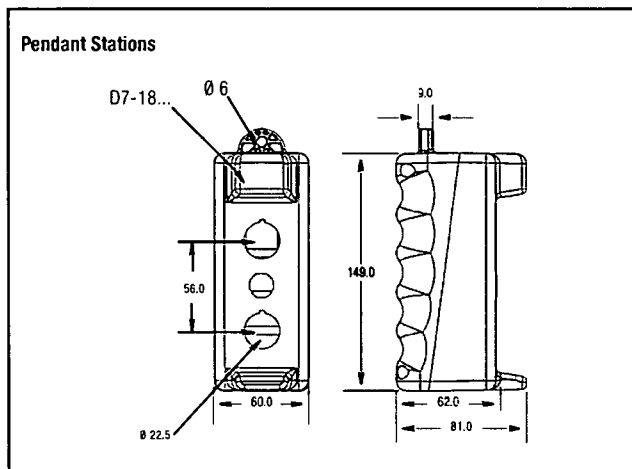

① Dimensions are not intended to be used for manufacturing purposes.



**anasonic**  
ideas for life

**DIN HALF SIZE  
HOUR METER**

**TH63·TH64  
Hour Meters**

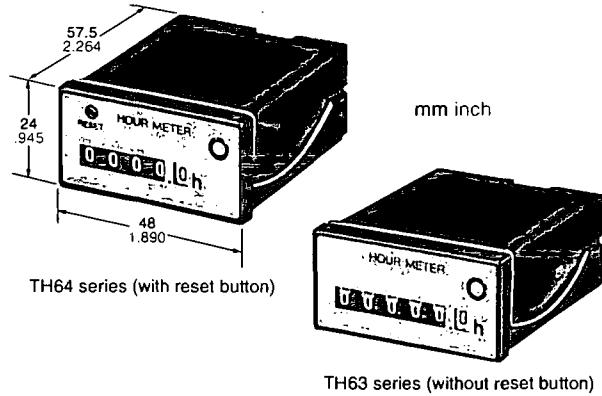

UL File No.: E42876  
CSA File No.: LR39291



**2. Reset button**

The hour meters can be reset to zero (TH64 series).

**3. Wide-ranging measurement display**

The measurement can be displayed from 0.1 hour up to 99999.9 hours (TH63 series). The dial size is the same as that of 48 × 48 DIN size hour meters (TH14 and TH24 series).

**4. Easy to install**

The flat terminals (#187) are used for easier wiring. There is no need to undo the lock spring.

**5. High-performance sync motor with 50/60 Hz selector**

The noise-resistant, accurately turning motor is employed to provide for longer period of measurement. The power frequency can be selected for 50 or 60 Hz.

**6. Rotary indicator**

The rotary indicator makes one turn every 72 seconds for monitoring.

**7. Compliant with UL, CSA and CE.**

RoHS Directive compatibility information  
<http://www.nais-e.com/>

**Features**

**1. Compact to save panel space**

The 24 × 48 mm hour meters are just half the DIN 48 × 48 standard size. They help save the panel space.

**Typical applications**

Management of small generators and food processing machines; hour counting for leased equipment; maintenance management of various equipment, etc.

**Specifications**

Rated operating voltage	12 V AC, 24 V AC, 48 V AC, 100 V AC, 110 V AC, 115 to 120 V AC, 200 V AC, 220 V AC, 240 V AC
Allowable operating voltage range	85 to 115% of rated operating voltage
Rated frequency	50/60 Hz (selectable by switch)
Counting range	0 to 99999.9 hours (TH63 series) 0 to 9999.9 hours (TH64 series)
Minimum time display	0.1 hours (6 min)
Rated power consumption	Approx. 1.5 W
Insulation resistance (Initial value)	Min. 100 MΩ, Between live and dead metal parts (At 500 V DC)
Shutdown voltage (Initial value)	2,000 Vrms, Between live and dead metal parts
Temperature rise	55°C 131°F
Vibration resistance	Functional: 10 to 55 Hz: 1 cycle/min double amplitude of 0.5 mm (10 min on 3 axes)
Shock resistance	Functional: Min 98 m/s <sup>2</sup> {10 G} (4 times on 3 axes)
	Destructive: Min 980 m/s <sup>2</sup> {100 G} (5 times on 3 axes)
Ambient temperature	-10 to +50°C +14 to +122°F
Ambient humidity	Max. 85% RH (non-condensing)
Weight	Approx. 80 g 2.82 oz

**Product types**

Type	Operating voltage	Part number	Operating voltage	Part number	Operating voltage	Part number
TH63 series (without reset button)	100V AC	TH631	24V AC	TH634	115 to 120V AC	TH637
	200V AC	TH632	48V AC	TH635	220V AC	TH638
	12V AC	TH633	110V AC	TH636	240V AC	TH639
TH64 series (with reset button)	100V AC	TH641	24V AC	TH644	115 to 120V AC	TH647
	200V AC	TH642	48V AC	TH645	220V AC	TH648
	12V AC	TH643	110V AC	TH646	240V AC	TH649

Notes) 1. Only the metallic-looking (silver) panel mounting type is available.  
2. Standard products are UL-recognized as well as CSA-certified. There is no need to add "U" at the end of the part number. Just specify the standard part number when ordering.

### Applicable standard

Safety standard	EN61010-1	Pollution Degree 2/Overvoltage Category II
EMC	(EMI)EN61000-6-4 Radiation interference electric field strength Noise terminal voltage (EMS)EN61000-6-2 Static discharge immunity	EN55011 Group1 ClassA EN55011 Group1 ClassA
	RF electromagnetic field immunity EFT/B immunity Surge immunity Conductivity noise immunity Power frequency magnetic field immunity Voltage dip/instantaneous stop/Voltage fluctuation immunity	EN61000-4-2 4 kV contact 8 kV air EN61000-4-3 10 V/m AM modulation (80 MHz to 1 GHz) 10 V/m pulse modulation (895 MHz to 905 MHz) EN61000-4-4 2 kV (power supply line) EN61000-4-5 1 kV (power line) EN61000-4-6 10 V/m AM modulation (0.15 MHz to 80 MHz) EN61000-4-8 30 A/m (50 Hz) EN61000-4-11 10 ms, 30% (rated voltage) 100 ms, 60% (rated voltage) 1,000 ms, 60% (rated voltage) 5,000 ms, 95% (rated voltage)

### Dimensions

mm inch  
General tolerance:  $\pm 0.5 \pm .020$

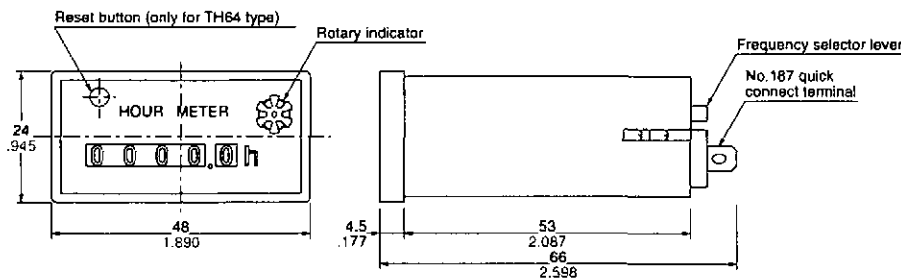

### Wiring diagram

mm inch

#### • Panel cutout dimensions

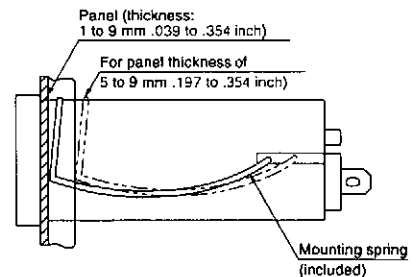
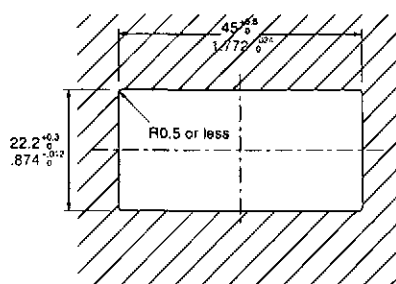
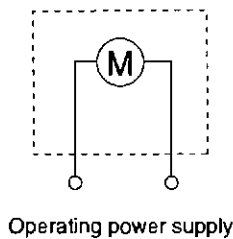

### Mounting

1. Cut a 22.2<sup>+0.3</sup> × 45<sup>+0.6</sup> mm (.874<sup>+0.012</sup> × 1.772<sup>+0.024</sup> inch) opening in the panel.
2. Swing the mounting spring to the rear of the hour meter and fit the hour meter into the panel opening. (There is no need to detach the mounting spring from the hour meter.) If the panel is 5 to 9 mm .197 to .354 inch thick, move the mounting spring to the other hole toward the rear of the hour meter.
3. Swing the mounting spring to the front of the hour meter to secure the hour meter to the panel.
4. Wire the supplied quick connectors and connect to the hour meter. Be sure to use the supplied insulating sleeves to cover the connectors.

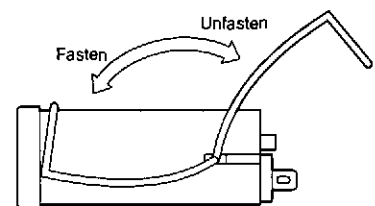

# PRECAUTIONS IN USING THE HOUR METERS

## 1. Frequency setting

Frequency is specified for AC motor-driven hour meters. Before installing, be sure to check your local power frequency.

## 2. Connections

- TH13,23,14,24,40,50,63,64

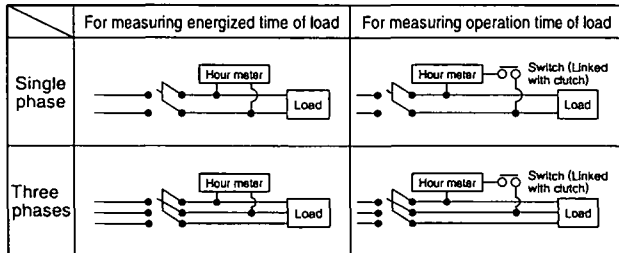

Note) Make the connection with the accompanying flat connector first and then with the hour meter's terminal (#187). In such case, be sure to cover the connection with the accompanying insulating sleeve.

- TH70, TH8

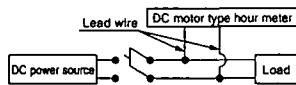

Note) Solder the lead wires in position.

## 3. Safety precautions

Do not use the hour meters in the following places.

- Where ambient temperature is below  $-10^{\circ}$  or above  $+50^{\circ}\text{C}$
- In wet, dusty or gaseous environments
- Where exposed to vibrations and shocks
- Outdoors, or where exposed to rain or direct sunlight

## 4. Compliant with CE.

- LH2H

Ambient conditions:

Overvoltage category III, contamination factor 2, indoor use.

Ambient temperature and humidity  $-10$  and  $+55^{\circ}\text{C}$  and 35% to 85%RH respectively.

- TH13, 23, 14, 24, 40, 50, 63, 64

Ambient conditions:

Overvoltage category II, contamination factor 2, indoor use.

Ambient temperature and humidity  $-10$  and  $+50^{\circ}\text{C}$  and below 85%RH respectively.

## 5. Reset-type hour meter

- Precautions for use

If the number indications are off before use, press the reset button and confirm that all zeroes ("0") are displayed.

- Resetting caution

Exercise due caution as an insufficient amount of pressure on the reset button may result in abnormal readings.

## 6. Acquisition of CE marking

Please abide by the conditions below when using in applications that comply with EN 61010-1/IEC 61010-1

### 1) Ambient conditions

- Overvoltage category II, pollution level 2
- Indoor use
- Acceptable temperature and humidity range:  $-10$  to  $+55^{\circ}\text{C}$ , 35 to 85%RH (with no condensation at  $20^{\circ}\text{C}$ )
- Under 2000 m elevation

### 2) Use the main unit in a location that matches the following conditions.

- There is minimal dust and no corrosive gas.
- There is no combustible or explosive gas.
- There is no mechanical vibration or impacts.
- There is no exposure to direct sunlight.
- Located away from large-volume electromagnetic switches and power lines with large electrical currents.

### 3) Connect a breaker that conforms to EN60947-1 or EN60947-3 to the voltage input section.

### 4) Applied voltage should be protected with an overcurrent protection device (example: T 1A, 250 V AC time lag fuse) that conforms to the EN/IEC standards. (Free voltage input type)







**Halmac** Services (Qld) Pty. Ltd.  
A.C.N. 098 852 923  
A.B.N. 40 741 712 113

# PRESSURE TRANSMITTER & ADJUSTMENT UNIT

1. VEGABAR74 PRESSURE TRANSMITTER  
TECHNICAL DETAILS
2. VEGADIS PRESSURE ADJUSTMENT UNIT  
TECHNICAL DETAILS

**Pressure measurement**

**Process pressure/Hydrostatic**

**VEGABAR-74**  
**VEGABAR-75**

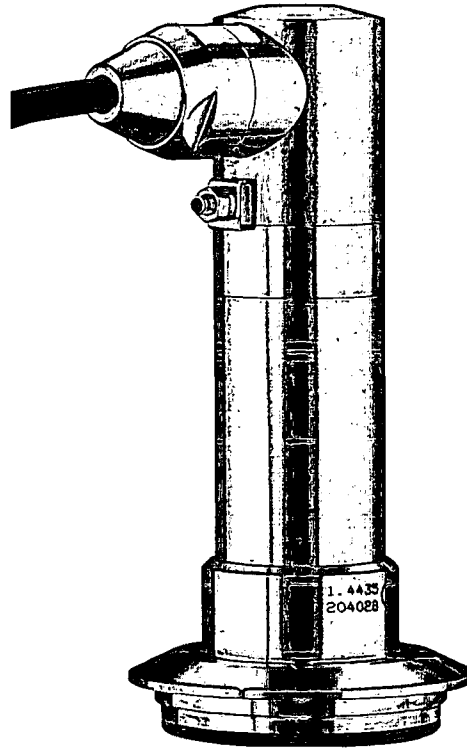

**Product Information**

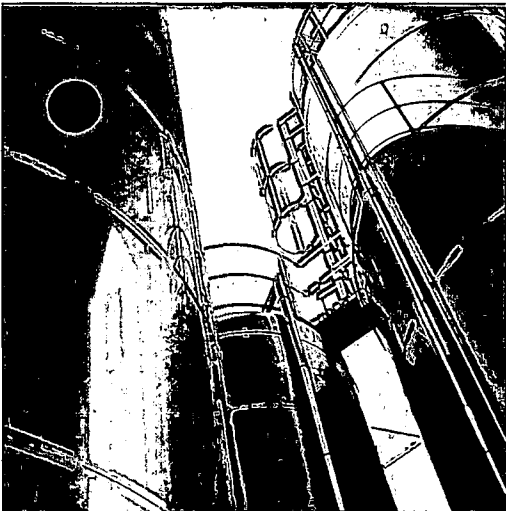

**VEGA**

## Content

<b>1</b>	<b>Description of the measuring principle</b>	<b>3</b>
<b>2</b>	<b>Type overview</b>	<b>4</b>
<b>3</b>	<b>Mounting instructions</b>	<b>5</b>
<b>4</b>	<b>Electrical connection</b>	
4.1	General prerequisites	6
4.2	Voltage supply	6
4.3	Connection cable	6
4.4	Cable screening and grounding	6
4.5	Wiring plan VEGABAR 74, 75	6
<b>5</b>	<b>Operation</b>	
5.1	Overview	7
5.2	Adjustment with VEGADIS 12	7
5.3	Adjustment with PACTware™	7
5.4	Adjustment with other adjustment programs	7
<b>6</b>	<b>Technical data</b>	<b>8</b>
<b>7</b>	<b>Dimensions</b>	<b>12</b>
<b>8</b>	<b>Product code</b>	<b>15</b>

### Take note of safety instructions for Ex applications



Please note the Ex specific safety information which you can find on our homepage [www.vega.com/services/downloads](http://www.vega.com/services/downloads) and which comes with every instrument. In hazardous areas you should take note of the appropriate regulations, conformity and type approval certificates of the sensors and power supply units. The sensors must only be operated on intrinsically safe circuits. The permissible electrical values are stated in the certificate.

29729-EN-07120x



## 1 Description of the measuring principle

### Measuring principle

VEGABAR 74 and 75 pressure transmitters are specially adapted to their respective application areas. That is why different sensor elements and measuring units are implemented.

### VEGABAR 74

The sensor element of VEGABAR 74 is the dry ceramic-capacitive CERTEC<sup>®</sup> measuring cell. Base element and diaphragm consist of high purity sapphire-ceramic<sup>®</sup>.

The process pressure causes via the diaphragm a change in an electrical parameter of the measuring cell. This change is converted into an appropriate output signal.

The CERTEC<sup>®</sup> measuring cell is also equipped with a temperature sensor. The temperature value can be displayed via the indicating and adjustment module or processed via the signal output.

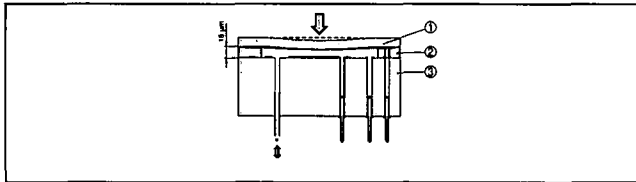

Fig. 1: Configuration of the CERTEC<sup>®</sup> measuring cell in VEGABAR 74

- 1 Diaphragm
- 2 Soldered glass bond
- 3 Base element

The advantages of the CERTEC<sup>®</sup> measuring cell are:

- Very high overload resistance
- No hysteresis
- Excellent long-term stability
- Completely front flush installation
- Good corrosion resistance
- Very high abrasion resistance

### VEGABAR 75

The METEC<sup>®</sup> measuring cell is the measuring unit of VEGABAR 75. This unit consists of a CERTEC<sup>®</sup> measuring cell and a special isolating system with metallic process diaphragm. A special feature of this isolating system is the direct mechanical compensation of temperature influence.

The process pressure causes via the diaphragm a change in an electrical parameter of the measuring cell. This change is converted into an appropriate output signal.

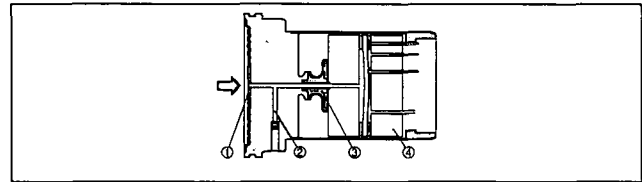

Fig. 2: Configuration of the METEC<sup>®</sup> measuring cell in VEGABAR 75

- 1 Diaphragm Hastelloy C276
- 2 Isolating liquid (approx. 0.3 cm<sup>3</sup>, FDA-listed)
- 3 FeNi adapter
- 4 CERTEC<sup>®</sup> measuring cell

The advantages of the METEC<sup>®</sup> measuring cell are:

- Completely welded, elastomer-free
- Very high overload resistance
- Full vacuum resistance (also with 0.1 bar measuring range)
- Good thermo-shock reaction
- Excellent long-term stability
- High degree of flushness

### Wide application range

VEGABAR 74 and 75 transmitters are designed for front flush process pressure measurement of gases, vapours and liquids. Their application-optimised housings in IP 68 and high resistance materials ensure reliable use even in harsh environments and in extremely moist areas. Thanks to their compact configuration with completely integrated electronics, the instruments can be connected directly to the respective signal processing equipment.

VEGABAR 74 is best suited for use in abrasive media in the paper industry or in waste water treatment.

VEGABAR 75 with its hygienic fittings is particularly suitable for the food processing and pharmaceutical industries.



### Information:

Continuative documentation such as operating instructions manuals:

- 28432 - VEGABAR 74
- 28433 - VEGABAR 75

## 2 Type overview

### VEGABAR 74

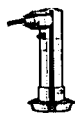

### VEGABAR 75



Measuring cell:	CERTEC®	METEC®
Diaphragm:	Ceramic	Metal
Media:	gas, vapours and liquids, also abrasive	gases, vapours and liquids also with higher temperatures
Process fitting:	Thread from 1½", flanges from DN 40, fittings for the food processing and paper industry	Thread from 1½", flanges from DN 40, fittings for the food processing industry
Material:	316L	316L
Measuring range:	-1 ... 60 bar (-14.5 ... 870 psi)	-1 ... 25 bar (-14.5 ... 363 psi)
Smallest measuring range:	0.1 bar (1.45 psi)	0.1 bar (1.45 psi)
Process temperature:	-40 ... +120 °C (-40 ... +248 °F)	-12 ... +200 °C (-40 ... +392 °F)
Deviation in characteristics:	< 0.075 %	< 0.075 %
Signal output:	4 ... 20 mA/HART	4 ... 20 mA/HART
Remote adjustment/ indication:	VEGADIS 12	VEGADIS 12

### 3 Mounting instructions

#### Installation position

VEGABAR functions in any installation position. Depending on the measuring system, the installation position can influence the measurement. This can be compensated by a position correction.



#### Information:

We recommend using parts from the line of VEGA mounting accessories.

## 4 Electrical connection

### 4.1 General prerequisites

The supply voltage range can differ depending on the instrument version. You can find exact specifications in chapter "Technical data".

The national installation standards as well as the valid safety regulations and accident prevention rules must be observed.



In hazardous areas you should take note of the appropriate regulations, conformity and type approval certificates of the sensors and power supply units.

### 4.2 Voltage supply

Supply voltage and current signal are carried on the same two-wire cable. The requirements on the power supply are specified in chapter "Technical data".

The VEGA power supply units VEGATRENN 149AEx, VEGAS-TAB 690, VEGADIS 371 as well as VEGAMET signal conditioning instruments are suitable for power supply. When one of these instruments is used, a reliable separation of the supply circuits from the mains circuits according to DIN VDE 0106 part 101 is ensured.

### 4.3 Connection cable

#### Generally

The sensors are connected with standard cable without screen. An outer cable diameter of 5 ... 9 mm ensures the seal effect of the cable entry.

#### 4 ... 20 mA/HART two-wire and four-wire

If electromagnetic interference is expected which is above the test values of EN 61326 for industrial areas, screened cable should be used. In HART multidrop mode the use of screened cable is generally recommended.



In Ex applications, the corresponding installation regulations must be noted for the connection cable.

### 4.4 Cable screening and grounding

If screened cable is necessary, the cable screen must be connected on both ends to ground potential. If potential equalisation currents are expected, the connection on the evaluation side must be made via a ceramic capacitor (e.g. 1 nF, 1500 V).

### 4.5 Wiring plan VEGABAR 74, 75

#### Direct connection

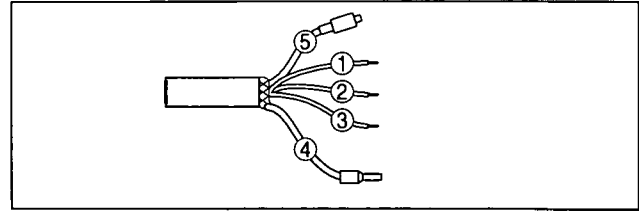

Fig. 3: Wire assignment, connection cable

- 1 brown (+): to power supply or to the processing system
- 2 blue (-): to power supply or to the processing system
- 3 yellow: is only required with VEGADIS 12, otherwise connect to minus
- 4 Screen
- 5 Breather capillaries with filter element

#### Connection via VEGABOX 02

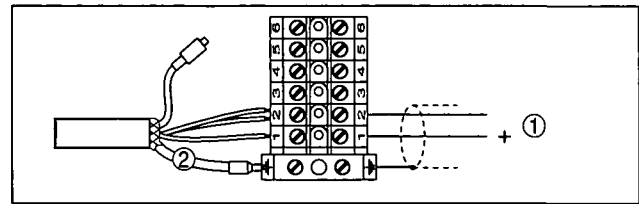

Fig. 4: Terminal assignment VEGABAR

- 1 To power supply or the processing system
- 2 Screen

#### Connection via VEGADIS 12

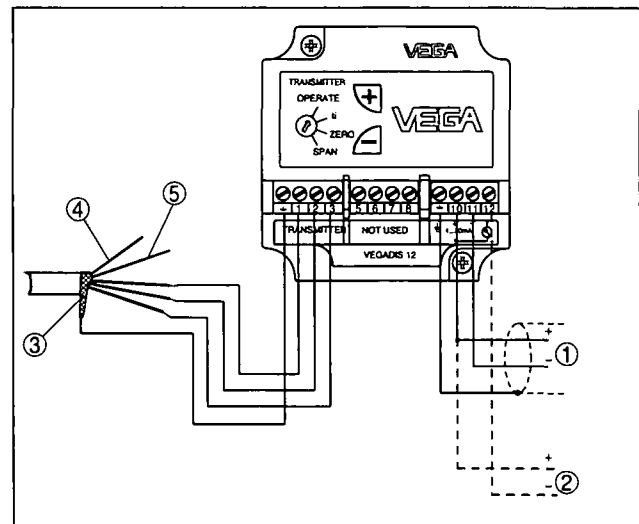

Fig. 5: Terminal assignment, VEGADIS 12

- 1 To power supply or the processing system
- 2 Control instrument (4 ... 20 mA measurement)
- 3 Screen
- 4 Breather capillaries
- 5 Suspension cable

29729-EN-071203

## 5 Operation

### 5.1 Overview

VEGABAR 74 and 75 can be adjusted with the following adjustment media:

- Indication/Adjustment VEGADIS 12
- Adjustment software according to FDT/DTM standard, e.g. PACTware™ and PC
- HART handheld

### 5.2 Adjustment with VEGADIS 12

#### VEGADIS 12

VEGADIS 12 is connected directly to the connection or suspension cable of VEGABAR or VEGAWELL. It is looped into the supply and signal circuit and requires no separate external energy.

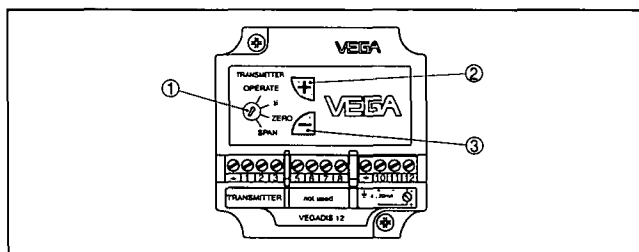

Fig. 6: Adjustment elements of VEGADIS 12

- 1 Rotary switch: choose the requested function
- 2 [+] key change value
- 3 [-] key change value

### 5.3 Adjustment with PACTware™

#### PACTware™/DTM

VEGABAR 74 and 75 sensors are adjusted via the signal cable by means of PACTware™.

An instrument driver for the respective VEGABAR is necessary for the adjustment with PACTware™.

All currently available VEGA DTM's are provided as DTM Collection with the current PACTware™ version on CD. They are available from the responsible VEGA agency for a token fee. The basic version of this DTM Collection incl. PACTware™ is available as a free-of-charge download from the Internet.

To use the entire range of functions of a DTM, incl. project documentation, a DTM licence is required for that particular instrument family, e.g. VEGABAR. This licence can be bought from the VEGA agency serving you.

### Connection of the PC via VEGACONNECT 3

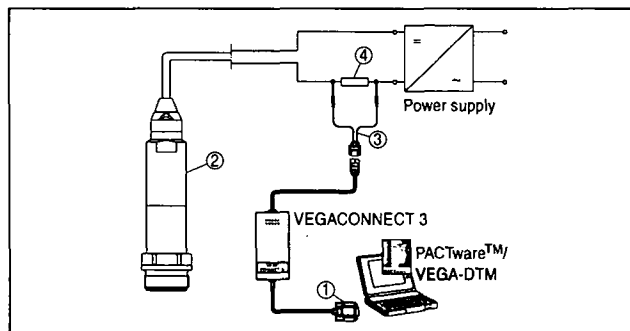

Fig. 7: Connecting the PC to the signal cable

- 1 RS232 connection (with VEGACONNECT 3) or USB connection (with VEGACONNECT 4)
- 2 VEGABAR
- 3 HART adapter cable
- 4 HART resistor 250 Ω

### Connection of the PC via VEGACONNECT 4

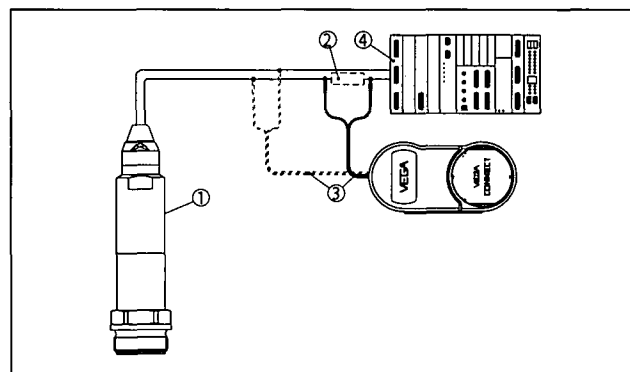

Fig. 8: Connecting the PC via HART to the signal cable

- 1 VEGABAR
- 2 HART resistor 250 Ω (optional depending on processing)
- 3 Connection cable with 2 mm pins and terminals
- 4 Processing system/PLC/Voltage supply

### 5.4 Adjustment with other adjustment programs

#### PDM

For VEGA PA sensors, instrument descriptions for the adjustment program PDM are available as EDD. The instrument descriptions are already implemented in the current version of PDM. For older versions of PDM, a free-of-charge download is available via Internet.

#### AMS

For VEGA FF sensors, instrument descriptions for the adjustment program AMS™ are available as DD. The instrument descriptions are already implemented in the current version of AMS™. For older versions of AMS™, a free-of-charge download is available via Internet.

:9729-EN-071203

## 6 Technical data

### General data

Material 316L corresponds to 1.4404 or 1.4435

#### VEGABAR 74

Materials, wetted parts

- Process fitting
- Diaphragm
- Seal
- Seal process fitting thread G½ A, G1½ A

316L  
sapphire ceramic® (99.9 % oxide ceramic)  
FKM (Viton), Kalrez 6375, EPDM, Chemraz 535  
Klingsil C-4400

#### VEGABAR 75

Materials, wetted parts

- Process fitting
  - Process diaphragm
- Materials, non-wetted parts
- Isolating liquid

316L  
Hastelloy C276  
  
med. white oil, FDA listed (silicone-free)

#### Common data

Materials, non-wetted parts

- Housing
  - Ground terminal
  - Connection cable
  - type label support on cable
- Weight

316L  
316Ti/316L  
PUR, FEP, PE  
PE-HART  
0.8 ... 8 kg (1.764 ... 17.64 lbs), depending on process fitting

### Output variable

Output signal	4 ... 20 mA/HART
Failure signal	22 mA (3.6 mA), adjustable
Max. output current	22.5 mA
Damping (63 % of the input variable)	0 ... 10 s, adjustable
Step response or adjustment time	70 ms (ti: 0 s, 0 ... 63 %)
Fulfilled NAMUR recommendations	NE 43

### Additional output variable - temperature (with VEGABAR 74)

Processing is made via HART-Multidrop

Range	-50 ... +150 °C (-58 ... +302 °F)
Resolution	1 °C (1.8 °F)
Accuracy	
- in the range of 0 ... +100 °C (+32 ... +212 °F)	±3 K
- in the range of -50 ... 0 °C (-58 ... +32 °F) and +100 ... +150 °C (+212 ... +302 °F)	typ. ±4 K

### Input variable

Parameter	Level
Measuring range	see product code
Turn down	
- recommended	1 : 10
- Max.	1 : 30

### Reference conditions and actuating variables (similar to DIN EN 60770-1)

Reference conditions according to DIN EN 61298-1	
- Temperature	+18 ... +30 °C (+64 ... +86 °F)
- Relative humidity	45 ... 75 %
- Air pressure	860 ... 1060 mbar/86 ... 106 kPa (12.5 ... 15.4 psi)
Determination of characteristics	limit point adjustment according to DIN 16086
Characteristics	linear
Calibration position	upright, diaphragm points downward

29729-EN-071203

**Deviation determined according to the limit point method according to IEC 60770<sup>1)</sup>**

Applies to **digital** HART interface as well as to **analogue** current output 4 ... 20 mA. Specifications refer to the set span. Turn down (TD) = nominal measuring range/set span.

Deviation

- Turn down 1 : 1 up to 5 : 1 < 0.075 %
- Turn down > 10 : 1 < 0.015 % x TD

Deviation with absolutely flush process fittings EV, FT

- Turn down 1 : 1 up to 5 : 1 < 0.05 %
- Turn down > 10 : 1 < 0.01 % x TD

Deviation with absolute pressure measuring range 0.1 bar

- Turn down 1 : 1 up to 5 : 1 < 0.25 % x TD
- Turn down > 10 : 1 < 0.05 % x TD

**Influence of the product or ambient temperature**

Applies to **digital** HART interface as well as to **analogue** current output 4 ... 20 mA. Specifications refer to the set span. Turn down (TD) = nominal measuring range/set span.

**Average temperature coefficient of the zero signal**

In the compensated temperature range 0 ... +100 °C (212 °F), reference temperature 20 °C (68 °F).

Average temperature coefficient of the zero signal

- Turn down 1 : 1 < 0.05 %/10 K
- Turn down 1 : 1 up to 5 : 1 < 0.1 %/10 K
- Turn down up to 10 : 1 < 0.15 %/10 K

Outside the compensated temperature range

Average temperature coefficient of the zero signal

- Turn down 1 : 1 typ. < 0.05 %/10 K

**Thermal change, current output**

Applies also to the **analogue** 4 ... 20 mA current output and refers to the set span.

Thermal change, current output < 0.15 % at -40 ... +80 °C (-40 ... +176 °F)

**Long-term stability (similar to DIN 16086, DINV 19259-1 and IEC 60770-1)**

Applies to **digital** interfaces (HART, Profibus PA, Foundation Fieldbus) as well as for the **analogue** current output 4 ... 20 mA. Specifications refer to the set span. Turn down (TD) = nominal measuring range/set span.

Long-term drift of the zero signal < (0.1 % x TD)/1 year

**Ambient conditions**

Ambient, storage and transport temperature

- Connection cable PE -40 ... +60 °C (-40 ... +140 °F)
- Connection cable PUR, FEP -40 ... +85 °C (-40 ... +185 °F)

**Process conditions****VEGABAR 74**

Product temperature depending on the measuring cell seal

- FKM (e.g. Viton) -20 ... +100 °C (-4 ... +212 °F)
- EPDM -40 ... +100 °C (-40 ... +212 °F), 1 h: 140 °C/284 °F cleaning temperature
- Kalrez 6375 (FFKM) -10 ... +100 °C (+14 ... +212 °F)
- Chemraz 535 -30 ... +100 °C (-22 ... +212 °F)

**VEGABAR 75**

Medium temperature (temperature:  $p_{abs} > 1$  bar (14.5 psi)/ $p_{abs} < 1$  bar (14.5 psi))

- Standard -12 ... +150 °C/-12 ... +130 °C (+10 ... +302 °F/+10 ... +266 °F)
- with cooling element -12 ... +180 °C/-12 ... +130 °C (+10 ... +356 °F/+10 ... +266 °F)
- with cooling element and screening sheet -12 ... +200 °C/-12 ... +130 °C (+10 ... +392 °F/+10 ... +266 °F)

<sup>1)</sup> Incl. non-linearity, hysteresis and non-repeatability.

**Common data**

Vibration resistance

mechanical vibrations with 4 g and 5 ... 100 Hz<sup>2)</sup>

Shock resistance

Acceleration 100 g/6 ms<sup>3)</sup>

**Electromechanical data**

Connection cable

- Configuration

four wires, one suspension cable, one breather capillary, screen braiding, metal foil, mantle

- Wire cross-section

0.5 mm<sup>2</sup> (AWG no. 20)

- wire resistance

< 0.036 Ω/m (0.011 Ω/ft)

- Standard length

6 m (19.69 ft)

- max. length with VEGADIS 12

200 m (656.2 ft)

- Min. bending radius at 25 °C/77 °F

25 mm (0.985 in)

- Diameter approx.

8 mm (0.315 in)

- Colour - standard PE

Black

- Colour - standard PUR

Blue

- Colour - Ex-version

Blue

**Voltage supply**

Supply voltage

- Non-Ex instrument

12 ... 36 V DC

- EEx-ia instrument

12 ... 29 V DC

Permissible residual ripple

- < 100 Hz

U<sub>ss</sub> < 1 V

- 100 Hz ... 10 kHz

U<sub>rs</sub> < 10 mV

Load

see diagram

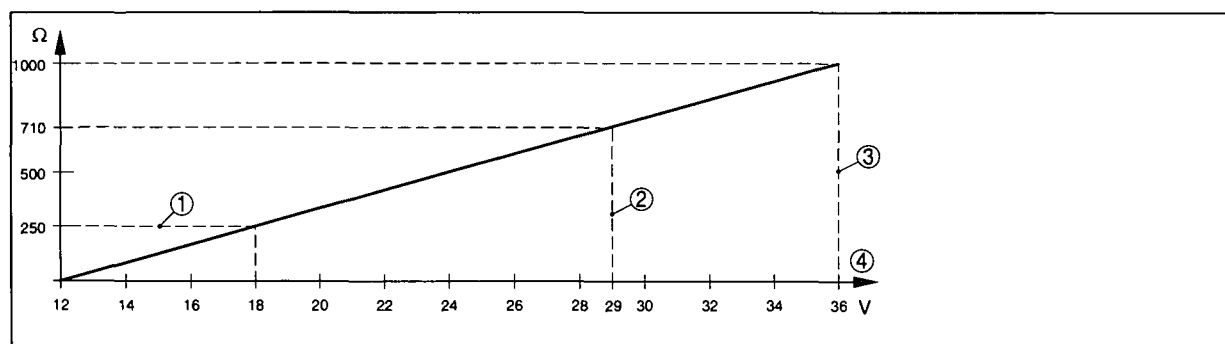

Fig. 9: Voltage diagram

1 HART load

2 Voltage limit Ex instrument

3 Voltage limit non-Ex instrument

4 Supply voltage

Load in conjunction with VEGADIS 12

see diagram

<sup>2)</sup> Tested according to the regulations of German Lloyd, GL directive 2.

<sup>3)</sup> Tested according to EN 60068-2-27.



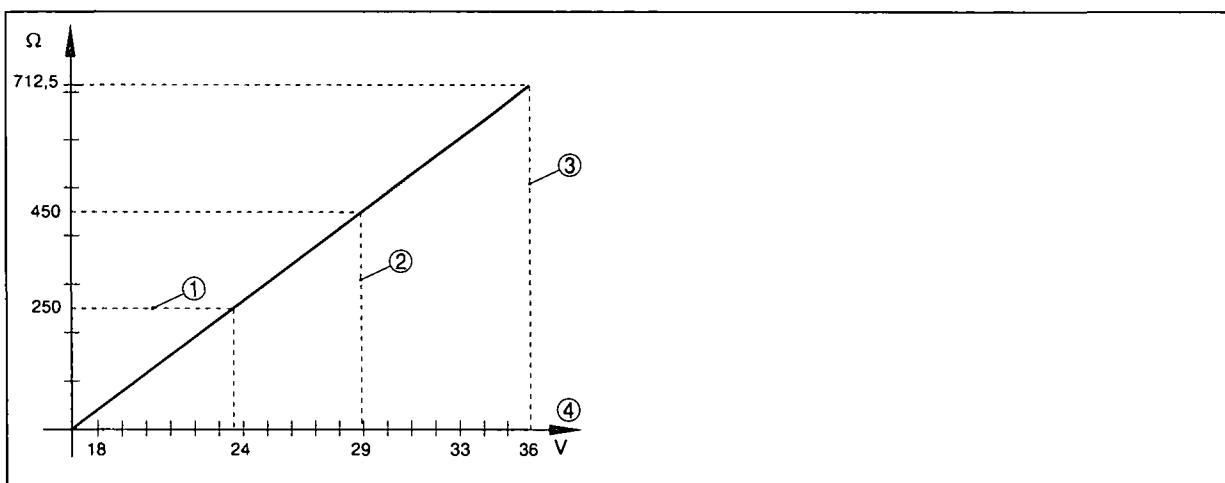

Fig. 10: Voltage diagram

- 1 HART load
- 2 Voltage limit Ex instrument
- 3 Voltage limit non-Ex instrument
- 4 Supply voltage

**Electrical protective measures**

Protection	IP 68 (25 bar)/IP 69K
Overvoltage category	III
Protection class	III

**Approvals<sup>4)5)</sup>**

ATEX ia	ATEX II 1G EEx ia IIC T6, ATEX II 2G EEx ia IIC T6
ATEX D	ATEX II 1/2D, 2D IP6X T
ATEX ia+D	ATEX II 1G EEx ia IIC T6, ATEX II 1/2D, 2D IP6X T
Ship approval	GL, LRS, ABS, CCS, RINA, DNV
Other approvals	WHG

**CE conformity**

EMC (89/336/EWG)	Emission EN 61326: 1997 (class B), susceptibility EN 61326: 1997/A1: 1998
LVD (73/23/EWG)	EN 61010-1: 2001

**Environmental instructions**

VEGA environment management system You can find detailed information under <a href="http://www.vega.com">www.vega.com</a> .	certified according to DIN EN ISO 14001
--	---

9729-EN-071203

<sup>4)</sup> Deviating data in Ex applications: see separate safety instructions.  
<sup>5)</sup> You can find detailed information under [www.vega.com](http://www.vega.com).

7 Dimensions

VEGABAR 74 - threaded fitting

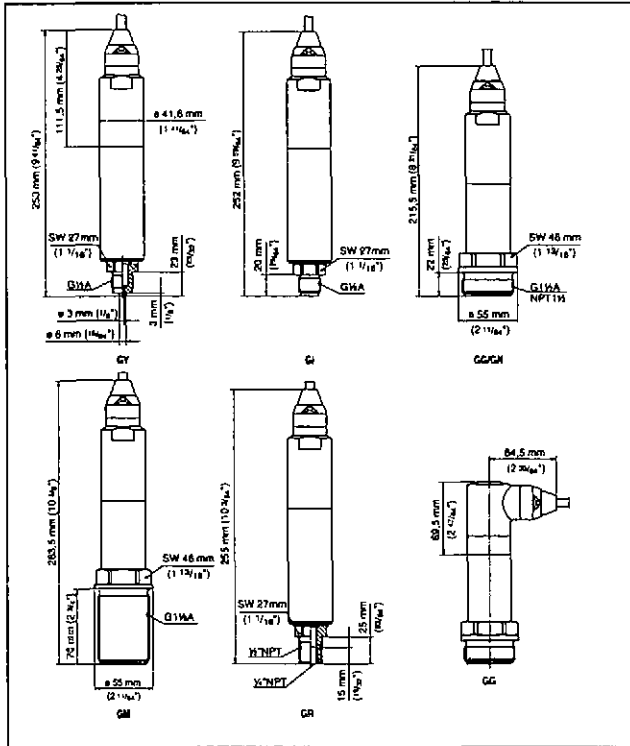

Fig. 11: VEGABAR 74 - threaded fitting: GV = G $\frac{1}{2}$  A manometer connection EN 837, GI = G $\frac{1}{4}$  A inner G $\frac{1}{4}$  A, GG = G $\frac{1}{2}$  A, GN = 1 $\frac{1}{2}$  NPT, GM = G $\frac{1}{2}$  A 70 mm

VEGABAR 74 - hygienic fitting 1

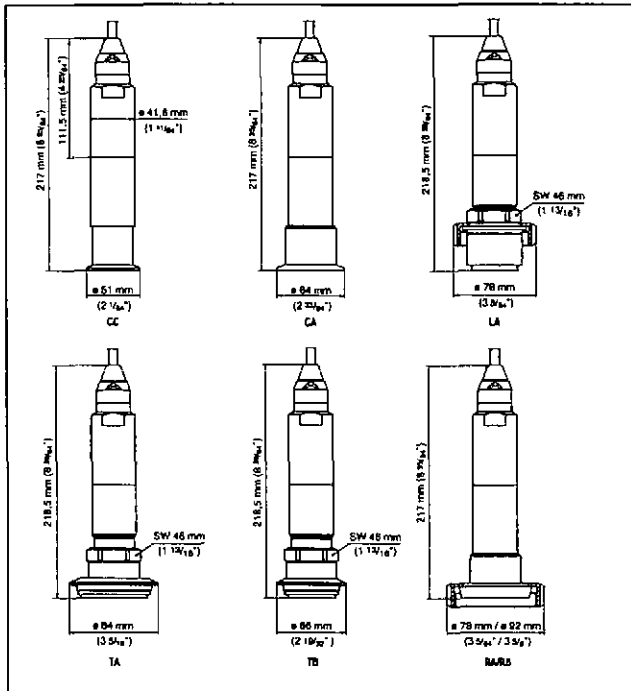

Fig. 12: VEGABAR 74 - hygienic fitting: CC = Tri-Clamp 1 $\frac{1}{2}$ ", CA = Tri-Clamp 2", LA = hygienic fitting with compression nut F40, TA = Tuchenhagen Varivent DN 32, TB =

Tuchenhagen Varivent DN 25, RA/RB = bolting DN 40/DN 50 according to DIN 11851, KA = conus DN 40

VEGABAR 74 - hygienic fitting 2

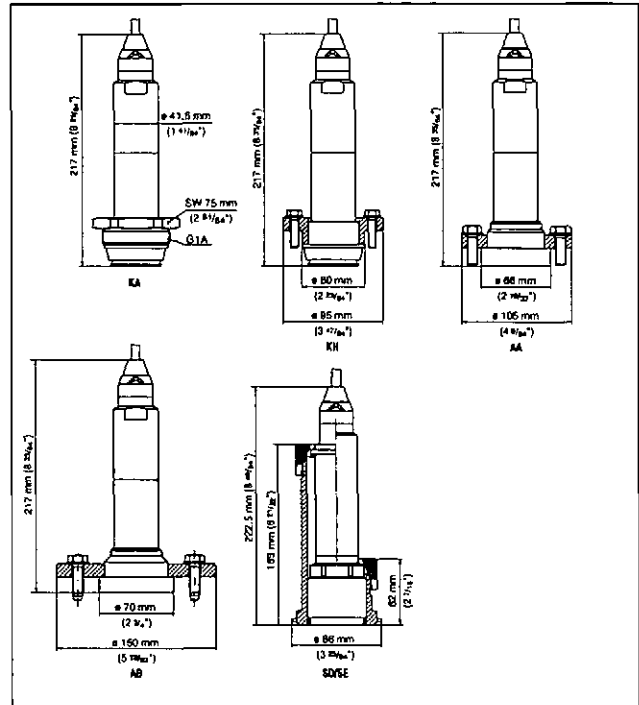

Fig. 13: VEGABAR 74 AA = DRD, KA = conus DN 40

VEGABAR 74 - flange fitting

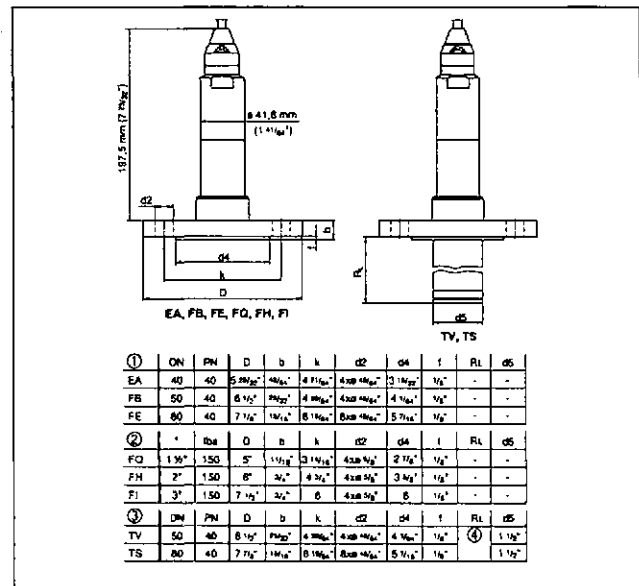

Fig. 14: VEGABAR 74 - flange fitting

- 1 Flange connection according to DIN 2501
- 2 Flange fitting according to ANSI B16.5
- 3 Flange with extension
- 4 Order-specific

29729-EN-071203

**VEGABAR 74 - threaded fitting for paper industry**

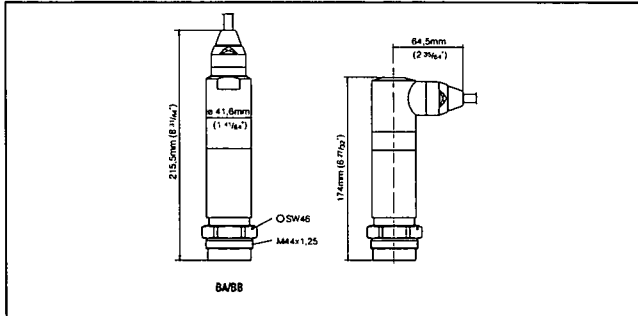

Fig. 15: VEGABAR - connection for paper industry: BA/BB = M44 x 1.25

**VEGABAR 74 - extension fitting for paper industry**

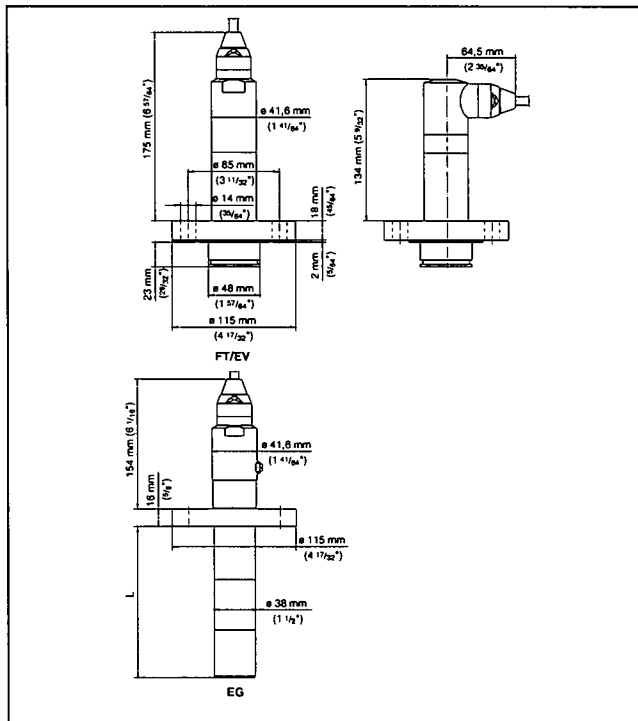

Fig. 16: VEGABAR - extension fitting for paper industry: EV/FT = absolutely flush for pulper (EV 2-times flattened), EG = extension for ball valve fitting (L = order-specific)

**VEGABAR 75 - threaded fitting**

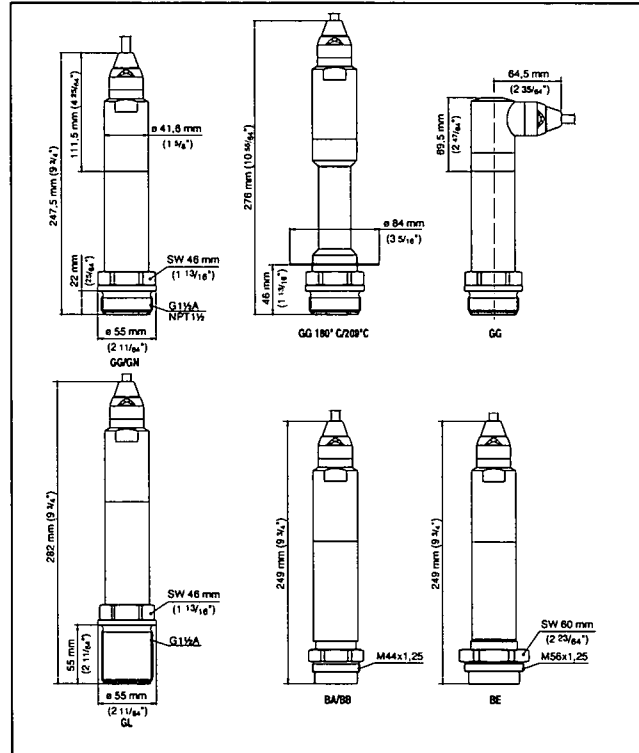

Fig. 17: VEGABAR - threaded fitting: GG = G1 1/2 A, GN = 1 1/2 NPT, GL = G1 1/2 A thread length 55 mm, BB = M44 x 1.25, BE = M56 x 1.25

19729-EN-071203

VEGABAR 75 - hygienic fitting 1

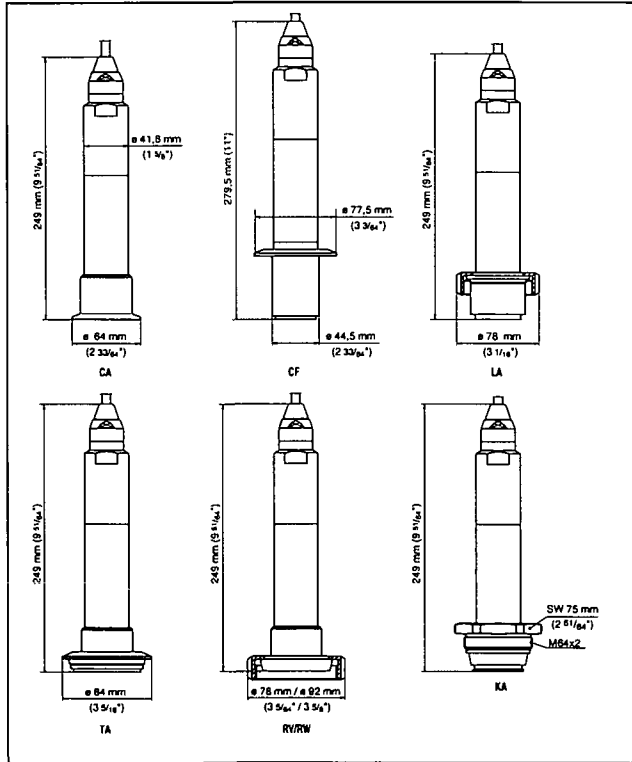

Fig. 18: VEGABAR 75 - hygienic fitting: CA/CF = Tri-Clamp 2"/Tri-Clamp 2½", LA = hygienic fitting with compression nut F40, TA = Tuchenhagen Varivent DN 32, R/RW = bolting DN 40/DN 50 according to DIN 11851, KA = conus DN 40, AA = DRD

VEGABAR 75 - hygienic fitting 2

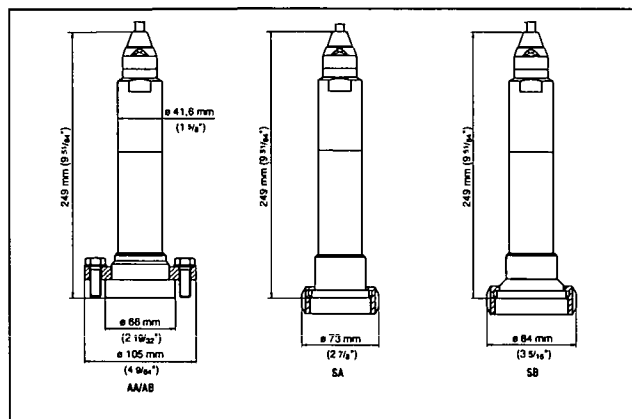

Fig. 19: VEGABAR 75 - hygienic fitting: SA = SMS DN 38, SB = SMS DN 51

VEGABAR 75 - flange fitting

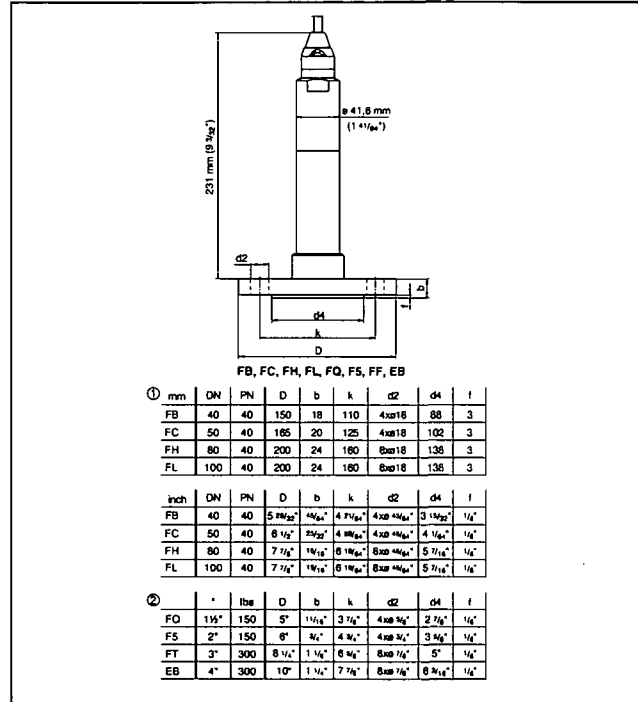

Fig. 20: VEGABAR - flange connection

- 1 Flange connection according to DIN 2501
- 2 Flange fitting according to ANSI B16.5

## 8 Product code

### VEGABAR 74

**Approval**  
 XX without  
 XM Ship approval  
 CX ATEX II 1G EEx ia IIC T6  
 AX ATEX II 2G EEx ia IIC T6  
 AM ATEX II 2G EEx ia IIC T6 + Ship approval

**Process fitting / Material**  
 GI G3/4 inner G3/4 PN160 / 316L  
 GG Thread G1/4 PN60 / 316L  
 GN Thread 1/2NPT PN60 / 316L  
 CA Tri-Clamp 2" PN16 / 316L  
 LA Hyg.connection w. compression nut F40 PN40 / 316L  
 TA Varivent N50-40 PN25 / 316L  
 RA Bolting DN40PN40 DIN11851 / 316L  
 RB Bolting DN50PN25 DIN11851 / 316L  
 AA DRD PN40 / 316L  
 BA M44x1.25 with pressure screw Alu PN25 / 316L  
 BB M44x1.25; with pressure screw PN60 / 316L  
 EA Flange DN40PN40 Form C, DIN2501 / 316L  
 FB Flange DN50PN40 Form C, DIN2501 / 316L  
 FE Flange DN80PN40 Form C, DIN2501 / 316L  
 FH Flange 2" 150lb RF, ANSI B16.5 / 316L  
 FI Flange 3" 150lb RF, ANSI B16.5 / 316L

**Seal measuring cell**  
 1 FKM (Viton)  
 2 Kalrez 6375  
 3 EPDM

**Pressure / Measuring range**  
 A rel. / 0...0.1bar (0...10kPa)  
 B rel. / 0...0.2bar (0...20kPa)  
 C rel. / 0...0.4bar (0...40kPa)  
 D rel. / 0...1.0bar (0...100kPa)  
 E rel. / 0...2.5bar (0...250kPa)  
 F rel. / 0...5.0bar (0...500kPa)  
 G rel. / 0...10.0bar (0...1000kPa)  
 H rel. / 0...25.0bar (0...2500kPa)  
 U rel. / 0...60.0bar (0...6000kPa)  
 P rel. / -1...0.0bar (-100...0kPa)  
 Q rel. / -1...1.5bar (-100...150kPa)  
 R rel. / -1...5.0bar (-100...500kPa)  
 S rel. / -1...10.0bar (-100...1000kPa)  
 T rel. / -1...25.0bar (-100...2500kPa)  
 W rel. / -1...60.0bar (-100...6000kPa)  
 K rel. / -0.05...0.05bar (-5...5kPa)  
 L rel. / -0.1...0.1bar (-10...10kPa)  
 M rel. / -0.2...0.2bar (-20...20kPa)  
 O rel. / -0.5...0.5bar (-50...50kPa)  
 1 abs. / 0...0.1bar (0...10kPa)<sup>1)</sup>  
 1 abs. / 0...1.0bar (0...100kPa)  
 2 abs. / 0...2.5bar (0...250kPa)  
 3 abs. / 0...5.0bar (0...500kPa)  
 4 abs. / 0...10.0bar (0...1000kPa)  
 5 abs. / 0...25.0bar (0...2500kPa)

**Electronics**  
 H 4...20mA/HART®

**Electrical connection / Protection**  
 A Direct cable outlet axial / IP68  
 S Direct cable outlet lateral / IP68

**Cable material / Length**  
 1 PE / 6m  
 2 PE / Special length  
 3 PUR / Special length  
 4 FEP / Special length

**Overvoltage arrester**  
 X without  
 B with<sup>2)</sup>

**BR74.**

<sup>1)</sup> Deviation in characteristic 0.25%  
<sup>2)</sup> Only in conjunction with Approval 'XX' or 'AX'

### VEGABAR 75

**Approval**  
 XX without  
 XM Ship approval  
 CK ATEX II 1G EEx ia IIC T6  
 AX ATEX II 2G EEx ia IIC T6  
 AM ATEX II 2G EEx ia IIC T6 + Ship approval  
 GX ATEX II 1/2D,2D IP6X T

**Process fitting / Material**  
 FB Flange DN40PN40 Form C, DIN2501 / 316L  
 FC Flange DN50PN40 Form C, DIN2501 / 316L  
 FH Flange DN80PN40 Form C, DIN2501 / 316L  
 F5 Flange 2" 150lb RF, ANSI B16.5 / 316L  
 GG Thread G1/4 PN60 / 316L  
 GN Thread 1/2NPT PN60 / 316L  
 CA Tri-Clamp 2" PN16 / 316L  
 LA Hygienic connec. w. compression nut F40PN40 / 316L  
 TA Varivent N50-40 PN25 / 316L  
 RV Bolting DN40PN40, DIN11851 / 316L  
 RW Bolting DN50PN40, DIN11851 / 316L  
 AA DRD PN40 / 316L  
 BB M44x1.25 with pressure screw 316L PN60 / 316L  
 SB SMS DN51 PN6 / 316L

**Isolating liquid / Temperature**  
 M Med.white oil, FDA appr.-12...150°C (Pabs <1bar -12...130°C)  
 S Med.w.oil,cool.(FDA)-12...180°C (Pabs <1bar -12...130°C)  
 R Med.w.oil,cool.(FDA)-12...200°C (Pabs <1bar -12...130°C)

**Pressure / Measuring range**  
 A rel. / 0...0.1bar (0...10kPa)  
 B rel. / 0...0.2bar (0...20kPa)  
 C rel. / 0...0.4bar (0...40kPa)  
 D rel. / 0...1.0bar (0...100kPa)  
 E rel. / 0...2.5bar (0...250kPa)  
 F rel. / 0...5.0bar (0...500kPa)  
 G rel. / 0...10.0bar (0...1000kPa)  
 T rel. / 0...25.0bar (0...2500kPa)  
 P rel. / -1...0.0bar (-100...0kPa)  
 Q rel. / -1...1.5bar (-100...150kPa)  
 R rel. / -1...5.0bar (-100...500kPa)  
 S rel. / -1...10.0bar (-100...1000kPa)  
 H rel. / -1...25.0bar (-100...2500kPa)  
 K rel. / -0.05...0.05bar (-5...5kPa)  
 L rel. / -0.1...0.1bar (-10...10kPa)  
 M rel. / -0.2...0.2bar (-20...20kPa)  
 O rel. / -0.5...0.5bar (-50...50kPa)  
 1 abs. / 0...0.1bar (0...10kPa)  
 2 abs. / 0...2.5bar (0...250kPa)  
 3 abs. / 0...5.0bar (0...500kPa)  
 4 abs. / 0...10.0bar (0...1000kPa)  
 5 abs. / 0...25.0bar (0...2500kPa)

**Electronics**  
 H 4...20mA/HART®

**Electrical connection / Protection**  
 A Direct cable outlet axial / IP68  
 S Direct cable outlet lateral / IP68

**Cable material / Length**  
 1 PE / 6m  
 2 PE / Special length  
 3 PUR / Special length  
 4 FEP / Special length

**Overvoltage arrester**  
 X without  
 B with<sup>1)</sup>

**BR75.**

<sup>1)</sup> Only in conjunction with Approval 'XX' or 'AX'

9729-EN-071203

**Indication and adjustment**

**Indicating and adjustment**

**VEGADIS 11**

**VEGADIS 12**

**VEGADIS 61**

**PLICSCOM**

**VEGADIS 175**

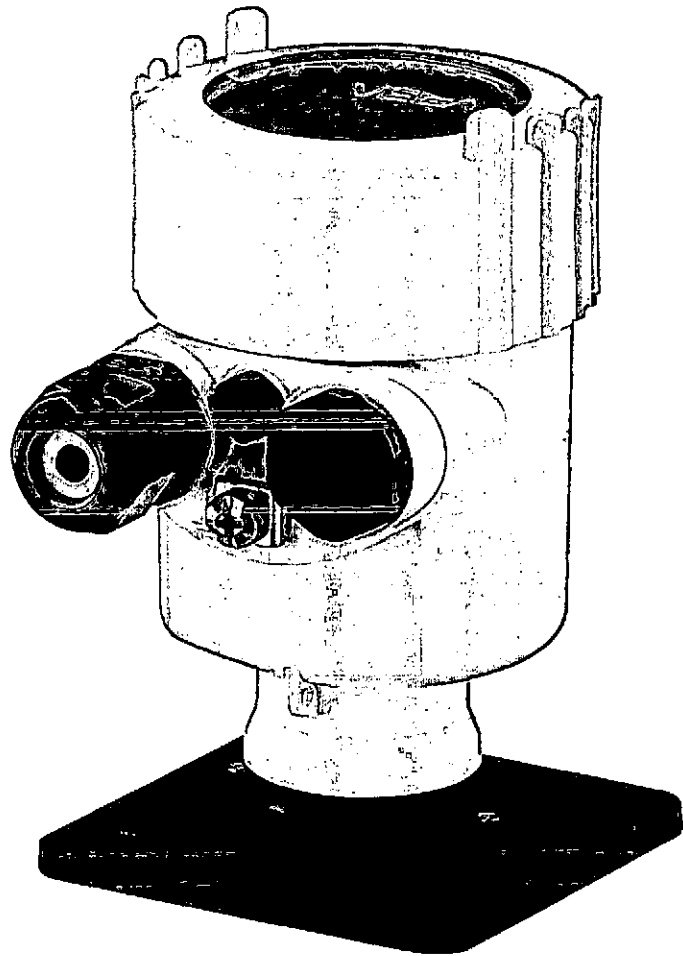

**Product Information**



**VEGA**

## Content

<b>1</b>	<b>Product description</b>	<b>3</b>
<b>2</b>	<b>Type overview</b>	<b>5</b>
<b>3</b>	<b>Mounting instructions</b>	<b>6</b>
<b>4</b>	<b>Connecting to power supply</b>	
4.1	Preparing the connection	8
4.2	Wiring plan, VEGADIS 11	8
4.3	Wiring plan, VEGADIS 12	9
4.4	Wiring plan, VEGADIS 61	9
4.5	Wiring plan, VEGADIS 175	9
<b>5</b>	<b>Operation</b>	
5.1	Adjustment on VEGADIS 11	11
5.2	Adjustment on VEGADIS 12	11
5.3	Adjustment on VEGADIS 61 and PLICSCOM	11
5.4	Adjustment on VEGADIS 61 with PACTware™	12
5.5	Adjustment on VEGADIS 175	12
<b>6</b>	<b>Technical data</b>	<b>13</b>
<b>7</b>	<b>Dimensions</b>	<b>16</b>
<b>8</b>	<b>Product code</b>	<b>17</b>

### Take note of safety instructions for Ex applications



Please note the Ex specific safety information which you will find on our homepage [www.vega.com/services/downloads](http://www.vega.com/services/downloads) and which come with the appropriate instrument with Ex approval. In hazardous areas you should take note of the appropriate regulations, conformity and type approval certificates of the sensors and power supply units. Each VEGADIS with Ex approval is an associated, intrinsically safe instrument and must not be installed in hazardous areas.

30143-EN-071203

## 1 Product description

In continuous measurement, the level in a vessel or the pressure in a pipeline, for example, is detected by a sensor. The measured value is converted into an analogue 4 ... 20 mA output signal or a digital output signal, e.g. Profibus PA. The output signal is then further processed, e.g. in a PLC or a control system.

On-site indication of the measured value or sensor adjustment is often desired. To fulfill this need, VEGA offers a wide range of indicating instruments. Indication, power supply and mounting differ depending on the model. This product information manual provides an overview and helps you select a suitable instrument.

### VEGADIS 11

VEGADIS 11 is a universal, digital indicating instrument that operates without additional power. It is used for remote (i.e. at some distance from the measuring site) measured value indication. VEGADIS 11 can be connected at any point to the 4 ... 20 mA signal cable. It is suitable for any VEGA sensor as well as sensors from other manufacturers, i.e. for active (four-wire) as well as passive (two-wire) sensors.

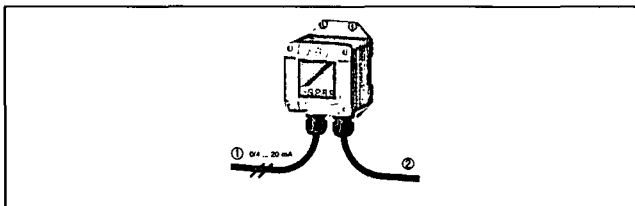

Fig. 1: Configuration VEGADIS 11

- 1 To the sensor
- 2 To the processing system

#### Advantages:

- Universal use for active or passive 4 ... 20 mA sensors
- No separate external energy required
- mounting to the wall or on carrier rail

### VEGADIS 12

VEGADIS 12 is a digital indicating instrument that operates without additional power. It is used for remote (i.e. at some distance from the measuring site) measured value indication and adjustment of VEGABAR 74, 75 and VEGAWELL 72 - 4 ... 20 mA/HART hydrostatic pressure transmitters. VEGADIS 12 can be connected at any point to the 4 ... 20 mA signal cable. It is provided with a breather facility for sensor ventilation via the capillary line in the special cable.

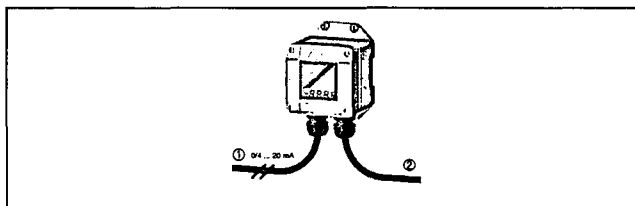

Fig. 2: Configuration VEGADIS 12

- 1 To the sensor
- 2 To the processing system

#### Advantages:

- No separate external energy required
- mounting to the wall or on carrier rail

### VEGADIS 61

VEGADIS 61 is an external indicating and adjustment module that operates without additional power. It is used for remote (i.e. at some distance from the measuring site) measured value indication and adjustment of VEGA plics® sensors. The sensors can be 4 ... 20 mA, Profibus PA or Foundation Fieldbus sensors. VEGADIS 61 is connected to the sensors with a standard four-wire screened cable up to 25 m long. Communication is carried out via this cable and, what is more, VEGADIS 61 is powered by the sensor. An additional power supply is not required.

### PLICSCOM

The indicating and adjustment module PLICSCOM is used for measured value indication, adjustment and diagnosis of VEGA plics® sensors. It is mounted in the respective sensor housing or in the external indicating and adjustment module VEGADIS 61. After mounting, the sensor and PLICSCOM are splash-proof even without housing cover.

An integrated backlight enables reading even under unfavourable lighting conditions. As an option, the display can also be equipped with heating that ensures good readability at low temperatures down to -40 °C (-40 °F).

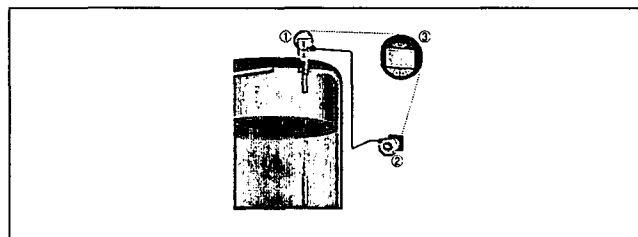

Fig. 3: Configuration VEGADIS 61 and PLICSCOM

- 1 Sensor
- 2 VEGADIS 61
- 3 PLICSCOM

#### Advantages:

- Universal use for all plics® sensors
- Splash-proof adjustment with open cover
- No separate external energy required
- mounting VEGADIS 61 to the wall, on carrier rail or tube

### VEGADIS 175

VEGADIS 175 is a digital indicating instrument for front panel mounting. It can be connected at any point to the 4 ... 20 mA signal cable and is suitable for active (four-wire) as well as passive (two-wire) sensors.



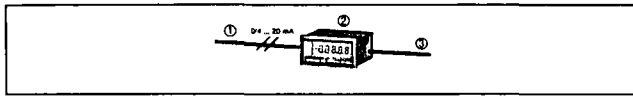

Fig. 4: Configuration VEGADIS 175

- 1 To the sensor
- 2 VEGADIS 175
- 3 To the processing system

#### Advantages:

- Universal use for passive or 4 ... 20 mA sensors
- No separate external energy required

## 1.1 Application examples

### Pump shaft

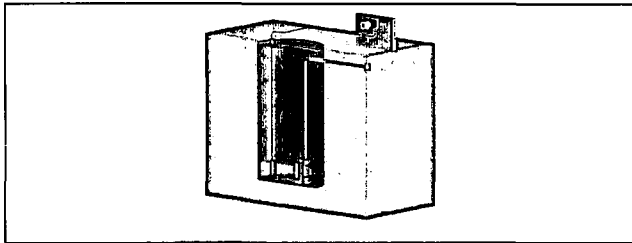

Fig. 5: Level measurement in a pump shaft with VEGAWELL 72, remote indication and adjustment with VEGADIS 12

For hydrostatic level measurement in a pump shaft, VEGADIS 12 together a VEGAWELL 72 is well suited for remote indication and adjustment. The min./max. adjustment is carried out on site and the actual measured value can be read out during operation.

### Chip silo

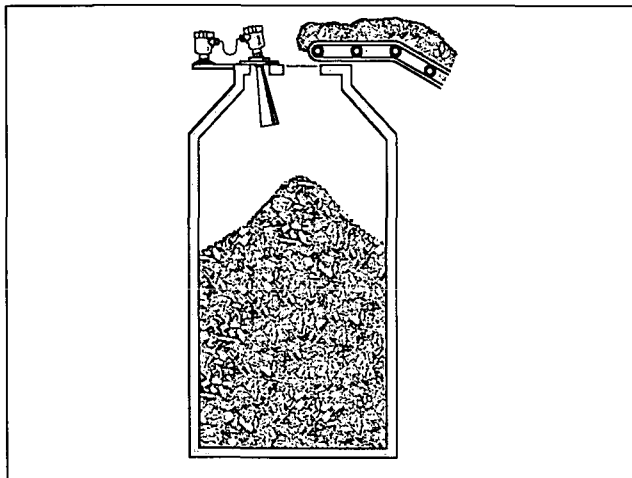

Fig. 6: Level measurement in a chip silo with VEGAPULS 68, remote indication and adjustment with VEGADIS 61

In non-contact level measurement in a chip silo with VEGAPULS 68, the mounting location is not directly accessible. For that reason VEGADIS 61 is an excellent solution for remote indication

and adjustment. The min./max. adjustment can be carried out locally with or without filling.

## 2 Type overview

**VEGADIS 11**

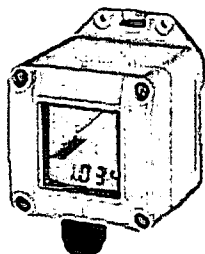

**VEGADIS 12**

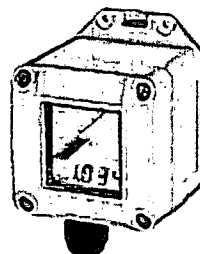

**VEGADIS 61**



Indication:	digital and quasi-analogue	digital and quasi-analogue	Dot-Matrix
Signal:	4 ... 20 mA, 4 ... 20 mA/HART	4 ... 20 mA, 4 ... 20 mA/HART	I <sup>2</sup> C bus
Sensors:	4 ... 20 mA passive or active	VEGABAR 74, 75; VEGAWELL 72 - 4 ... 20 mA/HART	plics <sup>®</sup> sensors
Mounting:	Wall, rail mounting	Wall, rail mounting	Wall, rail, tube mounting
Ambient temperature:	-20 ... +70 °C (-4 ... +158 °F)	-20 ... +70 °C (-4 ... +158 °F)	-20 ... +70 °C (-4 ... +158 °F)

**PLICSCOM**

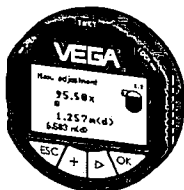

**VEGADIS 175**

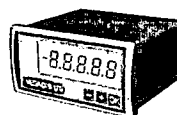

Indication:	Dot-Matrix	digital
Signal:	I <sup>2</sup> C bus	4 ... 20 mA, 4 ... 20 mA/HART
Sensors:	plics <sup>®</sup> sensors	4 ... 20 mA passive or active
Mounting:	in the sensor or in VEGADIS 61	Front panel
Ambient temperature:	-15 ... +70 °C (+5 ... +158 °F)	-10 ... +60 °C (+14 ... +140 °F)

0143-EN-071203

### 3 Mounting instructions

#### VEGADIS 11 and VEGADIS 12

VEGADIS 11 and VEGADIS 12 are configured for the following installation and mounting options:

- Carrier rail 35 x 7.5 according to EN 50022
- Wall mounting

#### Carrier rail mounting

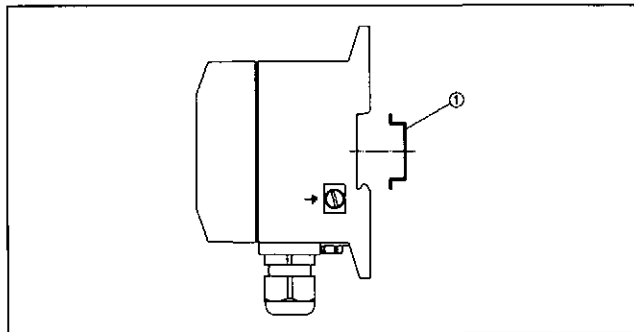

Fig. 7: VEGADIS 11 and VEGADIS 12 carrier rail mounting

- 1 Carrier rail

#### Wall mounting

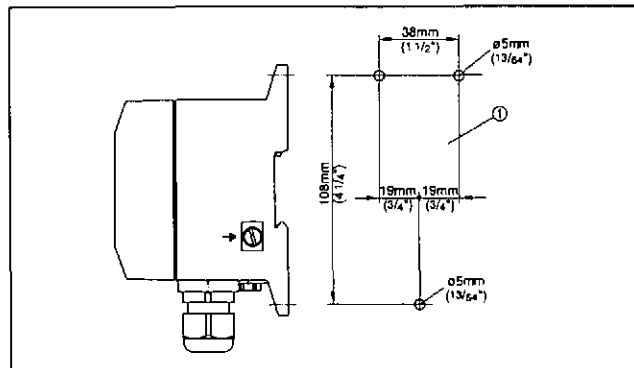

Fig. 8: VEGADIS 11 and VEGADIS 12 wall mounting

- 1 Drill dimension

#### VEGADIS 61

VEGADIS 61 can be mounted in the following ways:

- Carrier rail 35 x 7.5 according to EN 50022
- Wall mounting
- Tube mounting

#### Wall mounting

VEGADIS 61 for wall mounting is supplied with a mounting socket.

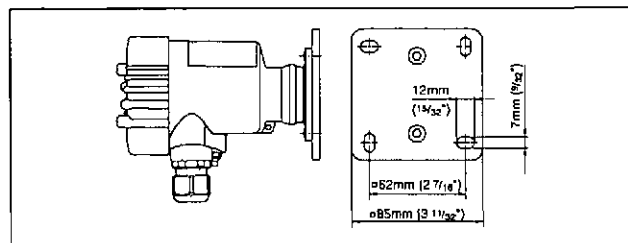

Fig. 9: VEGADIS 61 for wall mounting, bottom view of mounting plate.

- 1 Drill dimension

#### Carrier rail mounting

VEGADIS 61 for mounting on carrier rail is supplied with a mounting adapter.

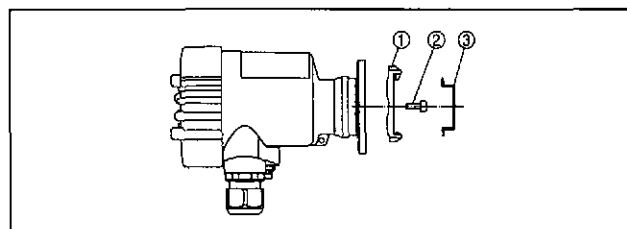

Fig. 10: VEGADIS 61 for mounting on carrier rail

- 1 Adapter plate
- 2 Screw M4 x 6
- 3 Carrier rail

#### Tube mounting

VEGADIS 61 for tube mounting is supplied with the measuring instrument holder BARMONT.C (comes with delivery as mounting accessory).

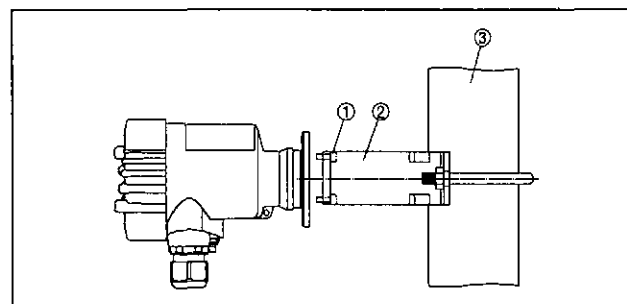

Fig. 11: VEGADIS 61 for tube mounting

- 1 4 screws M5 x 12
- 2 Measuring instrument holder BARMONT.C
- 3 Tube

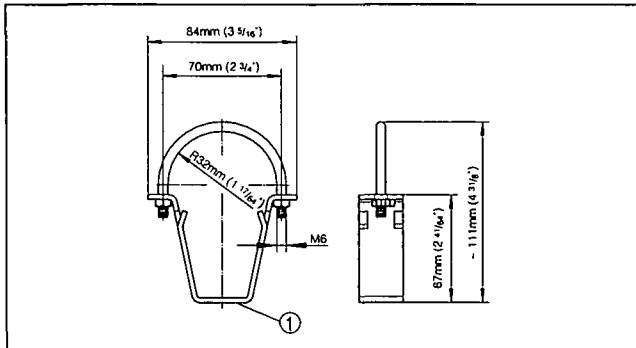

Fig. 12: Measuring instrument holder BARMONT.C

- 1 4 x holes 5 mm for mounting screws M5 x 12

### PLICSCOM

The indicating and adjustment module PLICSCOM can be inserted in the following housing versions and instruments:

- All sensors of the plics<sup>®</sup> instrument family, in the single as well as in the double chamber housing (optionally in the electronics or connection compartment)
- External indicating and adjustment unit VEGADIS 61

### VEGADIS 175

VEGADIS 175 can be mounted in the following ways:

- Front panel mounting

#### Front panel mounting

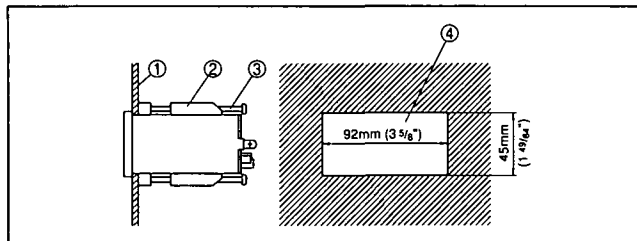

Fig. 13: VEGADIS 175 for panel mounting

- 1 Front panel  
2 Fixing hook  
3 Screw

## 4 Connecting to power supply

### 4.1 Preparing the connection

#### Note safety instructions

Always keep in mind the following safety instructions:

- Connect only in the complete absence of line voltage
- If overvoltage surges are expected, overvoltage arresters should be installed



**Tip:**

We recommend VEGA overvoltage arresters B61-300 (power supply VEGADIS) and B62-36G (sensor supply).

#### Take note of safety instructions for Ex applications



In hazardous areas you should take note of the appropriate regulations, conformity and type approval certificates of the sensors and power supply units.

#### Selecting connection cable

Standard two-wire cable without screen is used for connection of the sensors.

#### Cable screening and grounding

Connect the cable screen on both ends to ground potential. In the sensor, the screen must be connected directly to the internal ground terminal. The ground terminal outside on the housing must be connected to the potential equalisation.

If potential equalisation currents are expected, the screen connection on VEGADIS must be made via a ceramic capacitor (e. g. 1 nF, 1500 V). The low frequency potential equalisation currents are thus suppressed, but the protective effect against high frequency interference signals remains.

#### Select connection cable for Ex applications



Take note of the corresponding installation regulations for Ex applications. In particular, make sure that no potential equalisation currents flow over the cable screen. In case of grounding on both sides this can be achieved by the use of a capacitor or a separate potential equalisation.

### 4.2 Wiring plan, VEGADIS 11

#### Passive sensors

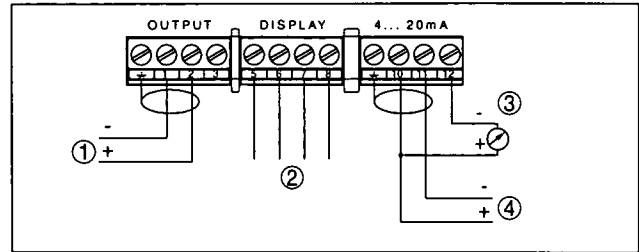

Fig. 14: Wiring plan, VEGADIS 11 for passive sensors

- 1 Sensor (passive)
- 2 Indicating module (assignment see chart)
- 3 Control instrument



**Note:**

Passive sensors need a power supply. They represent current sinks and emboss a current of 4 ... 20 mA to the supply circuit. The supply voltage is loop through VEGADIS 11. On the output (terminals 1/2), VEGADIS 11 provides the power supply for the connected sensors. Power supply and measured value transmission are carried along the same two-wire cable.

#### Active sensors

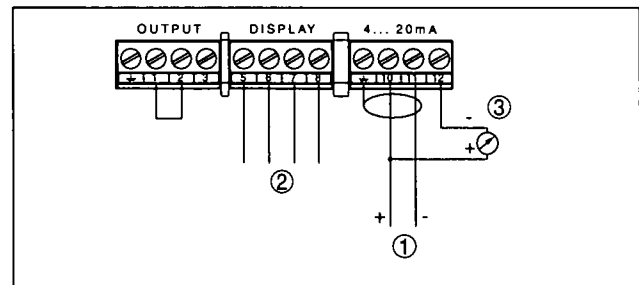

Fig. 15: Wiring plan, VEGADIS 11 for active sensors

- 1 Sensor (active)
- 2 Indicating module
- 3 Control instrument
- 4 Voltage supply/Signal output



**Note:**

The input (terminals 10/11) is provided for connection of transmitters with own, separate power supply. The output (terminal 1/2) is bridged.

Sensors with signal conditioning instrument

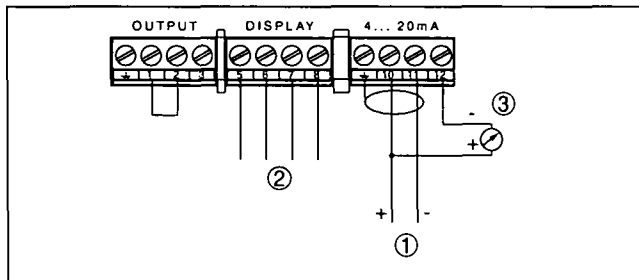

Fig. 16: Wiring plan, VEGADIS 11 for signal conditioning instrument

- 1 Signal conditioning instrument
- 2 Indicating module
- 3 Control instrument



Note:

The input (terminals 10/11) is provided for connection of signal conditioning instruments. Connection and operation in Ex ia is not possible. The output (terminal 1/2) is bridged.

4.3 Wiring plan, VEGADIS 12

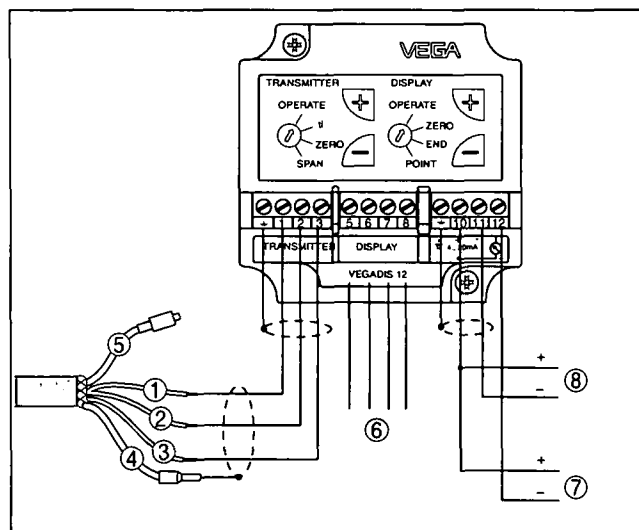

Fig. 17: Wiring plan, VEGADIS 12

- 1 brown (+)
- 2 blue (-)
- 3 Yellow
- 4 Screen
- 5 Breather capillaries with filter element
- 6 Indicating module
- 7 Control instrument
- 8 Voltage supply/Signal output

4.4 Wiring plan, VEGADIS 61

Wiring plan

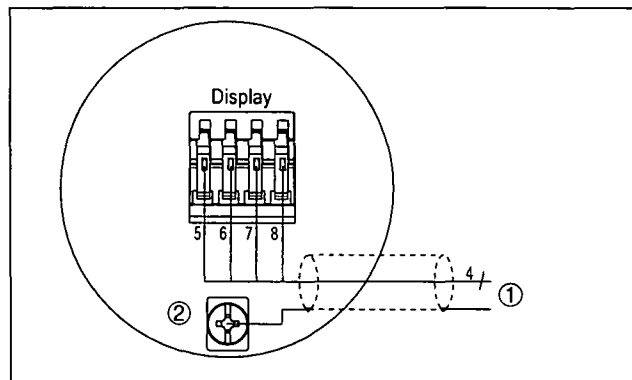

Fig. 18: Wiring plan, single chamber housing

- 1 plics® sensor
- 2 Grounding on both ends with non-Ex. With Ex, grounding at one sensor end is recommended, see EN 60079-14.

4.5 Wiring plan, VEGADIS 175

Passive sensors

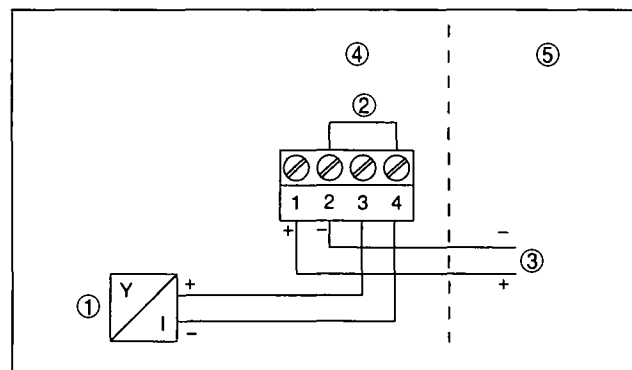

Fig. 19: Wiring plan, VEGADIS 175 for passive sensors

- 1 Sensor (passive)
- 2 Bridged internally
- 3 Voltage supply/Signal output
- 4 Ex area
- 5 Non-Ex area

0143-EN-071203

**Active sensors**

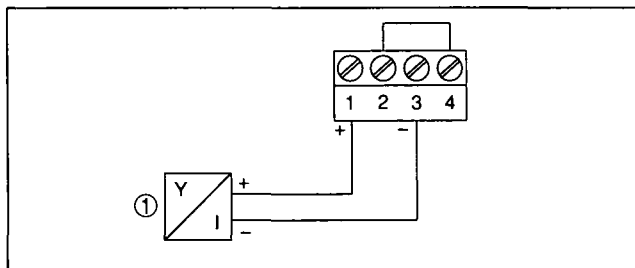

Fig. 20: Wiring plan, VEGADIS 175 for active sensors

- 1 Sensor (active)
- 2 Bridged internally

## 5 Operation

### 5.1 Adjustment on VEGADIS 11

The display is located in the housing cover, the adjustment elements are accessible after removing the cover.

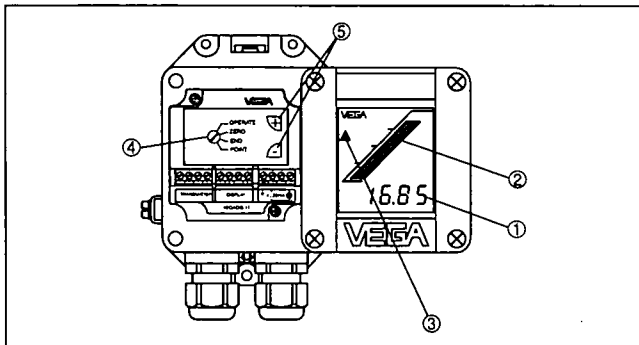

Fig. 21: Indicating and adjustment elements

- 1 Digital indication
- 2 Bar graph indication
- 3 Tendency indication
- 4 Rotary switch
- 5 Adjustment keys +/-

#### Key functions

- **[Rotary switch]** to select:
  - Operate = Measured value indication
  - ZERO = Adjustment of the min. value
  - SPAN = Adjustment of the max. value
  - Point = Shifting of the decimal point
- **[+/-] key:**
  - Change value of the digital indication

### 5.2 Adjustment on VEGADIS 12

The display is located in the housing cover, the adjustment elements are accessible after removing the cover.

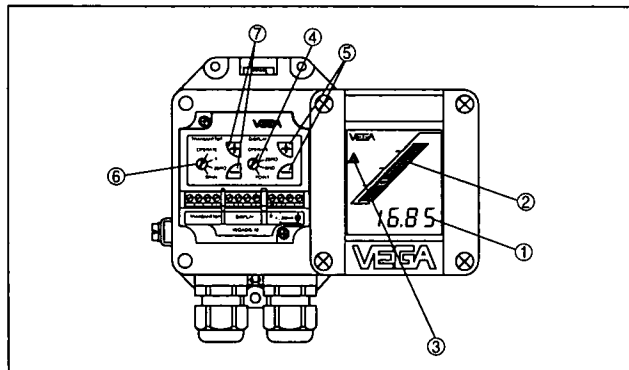

Fig. 22: Indicating and adjustment elements

- 1 Digital indication
- 2 Bar graph indication
- 3 Tendency indication
- 4 Rotary switch "Indication"
- 5 Adjustment keys +/- display
- 6 Rotary switch "Pressure transmitter"
- 7 Adjustment keys +/- Pressure transmitter

#### Key functions

- **[Rotary switch]** to select:
  - Operate = Measured value indication
  - ZERO = Adjustment of the min. value
  - SPAN = Adjustment of the max. value
  - Point = Shifting of the decimal point
- **[+/-] key:**
  - Change value of the digital indication

### 5.3 Adjustment on VEGADIS 61 and PLICSCOM

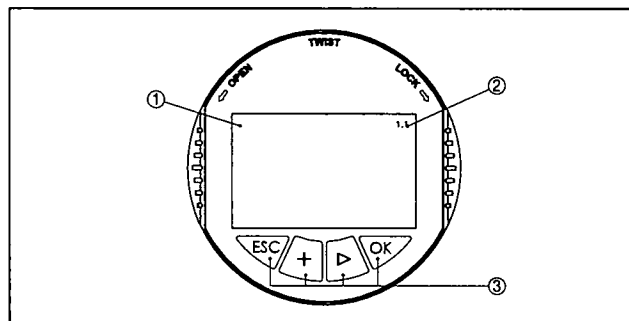

Fig. 23: Indicating and adjustment elements

- 1 LC display
- 2 Indication of the menu item number
- 3 Adjustment keys

0143-EN-071203



**Key functions**

- **[OK] key:**
  - Move to the menu overview
  - Confirm selected menu
  - Edit parameter
  - Save value
  
- **[>] key to select:**
  - menu change
  - list entry
  - Select editing position
  
- **[+] key:**
  - Change value of the parameter
  
- **[ESC] key:**
  - interrupt input
  - jump to the next higher menu

#### 5.4 Adjustment on VEGADIS 61 with PACTware™

**PACTware™/DTM**

plics® sensors can be adjusted via PACTware™ independent of the respective signal output 4 ... 20 mA/HART, Profibus PA or Foundation Fieldbus via VEGADIS 61. To adjust with PACTware™, an instrument driver for the particular sensor is required.

All currently available VEGA DTMs are provided as DTM Collection with the current PACTware™ version on CD. They are available from the responsible VEGA agency for a token fee. The basic version of this DTM Collection incl. PACTware™ is available as a free-of-charge download from Internet.

To use the entire range of functions of a DTM, incl. project documentation, a DTM licence is required for that particular instrument family. This licence can be bought from the VEGA agency serving you.

**Connection of the PC to VEGADIS 61**

Fig. 24: Connection to VEGADIS 61

- 1 RS232 connection
- 2 VEGADIS 61
- 3 I<sup>2</sup>C adapter cable for VEGACONNECT 3

To adjust with PACTware™, a VEGACONNECT 3 with I<sup>2</sup>C adapter cable (art. no. 2.27323) as well as a power supply unit is necessary in addition to the PC and the suitable VEGA-DTM.

**5.5 Adjustment on VEGADIS 175**

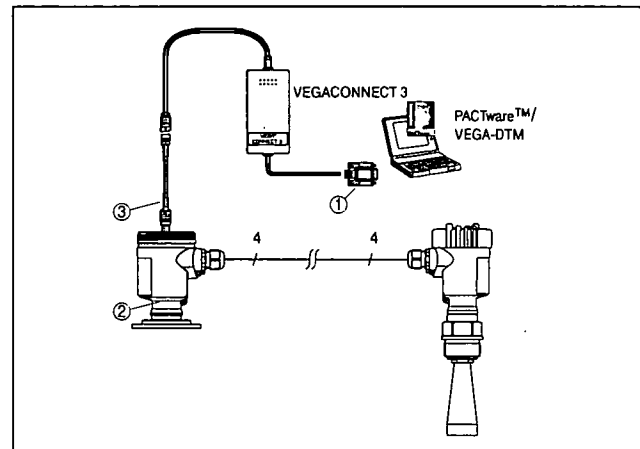
Indication and adjustment are carried out on the front via a clear LC display and three keys.

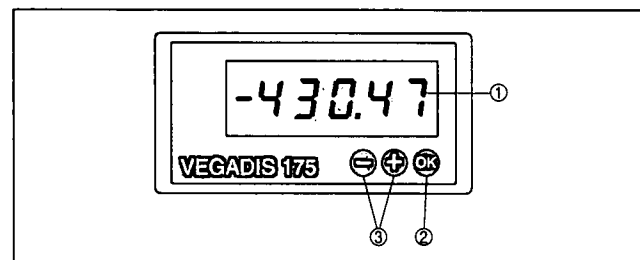

Fig. 25: Indicating and adjustment elements

- 1 Digital indication
- 2 Key (OK)
- 3 Adjustment keys +/-

**Key functions**

- **[OK] key:**
  - Move to the menu overview
  - Confirm selected menu
  - Edit parameter
  - Save value
  
- **[+]/[-] keys:**
  - Change value of the parameter

## 6 Technical data

### General data

#### VEGADIS 11, 12

Series

Instrument for panel or wall mounting or mounting on carrier rail 35 x 7.5 according to EN 50022

Materials

- Housing
- Inspection window of the indication
- Breather facility
- Ground terminal

plastic PBT  
Lexan  
PTFE filter element  
316Ti/316L

Weight approx.

400 g (0.882 lbs)

#### VEGADIS 61

Series

Instrument for panel or wall mounting or mounting on carrier rail 35 x 7.5 according to EN 50022

Materials

- Housing
- Inspection window in housing cover
- Ground terminal

Plastic PBT, Alu die-casting powder-coated, 316L  
Polycarbonate (UL-746-C listed)  
316Ti/316L

Weight, depending on the housing material and mounting technology

500 ... 1300 g (1.10 ... 2.87 lbs)

#### PLICSCOM

Series

Module for insertion in VEGADIS 61

Materials

- Housing
- Inspection window

ABS  
Polyester foil  
100 g (0.22 lbs)

Weight approx.

#### VEGADIS 175

Series

Module unit for front panel mounting

Materials

- Housing front
- Housing
- Rear of the housing

Alu die-casting  
Sheet steel galvanized  
ABS  
300 g (0.66 lbs)

Weight approx.

### Input

#### VEGADIS 11

Connection to

individual passive or active sensors 4 ... 20 mA/HART

Transmission

analogue, 4 ... 20 mA

Max. input current

150 mA

Connection cable to the sensor

2-wire

Voltage loss

4.5 V at 20 mA

#### VEGADIS 12

Connection to

VEGAWELL 72 - 4 ... 20 mA/HART, VEGABAR 74, 75

Transmission

analogue, 4 ... 20 mA

Max. input current

150 mA

Connection cable to the sensor

3-wire (VEGA special cable with breather capillaries or standard cable)

Max. cable length

200 m

Voltage loss

4.5 V at 20 mA

#### VEGADIS 61

Connection to

VEGA plics<sup>®</sup> sensors

Data transmission

digital (I<sup>2</sup>C-Bus)

Connection cable

4-wire, screened

Max. cable length

25 m

#### VEGADIS 175

Transmission

analogue, 4 ... 20 mA (reverse battery protection)

0143-EN-071203

HART protocol	The indicator is suitable for transmission of the HART protocol
Max. input current	150 mA (shortcircuit current)
Voltage loss	< 2 V with 20 mA

**Indications****VEGADIS 11, 12**

LC multiple function display

- Bargraph (quasi-analogue indication)
- Digital value
- Tendency indicators

20 segments

-9999 ... 9999

Symbols for rising or falling values

**VEGADIS 61, PLICSCOM**

LC display

in dot matrix

Power supply display light

through the sensor, voltage range see sensor operating instructions manual

Power supply display heating

- Operating voltage
- Power
- Switch on point

24 V DC +5 %

1.7 W

-5 °C (+23 °F)

**VEGADIS 175**

LC display

- Height of figures
- Indication range
- Offset

17 mm

-19999 ... 19999

-19999 ... 32767

**Ambient conditions****VEGADIS 11, 12**

Ambient temperature

-20 ... +70 °C (-4 ... +158 °F)

Storage and transport temperature

-40 ... +85 °C (-40 ... +185 °F)

**VEGADIS 61, PLICSCOM**

Ambient temperature

-15 ... +70 °C (+5 ... +158 °F)

Ambient temperature with heating

-40 ... +70 °C (-40 ... +158 °F)

Storage and transport temperature

-40 ... +80 °C (-40 ... +176 °F)

**VEGADIS 175**

Ambient temperature

-10 ... +60 °C (+14 ... +140 °F)

Storage and transport temperature

-25 ... +70 °C (-13 ... +158 °F)

Climatic class

according to EN 60654-1, class B2

**Electrical protective measures****VEGADIS 11, 12**

Protection

IP 67

Overvoltage category

III

Protection class

III

**VEGADIS 61**

Protection

IP 66/IP 67

Overvoltage category

III

Protection class

II

**PLICSCOM**

Protection

- unassembled

IP 20

- mounted into VEGADIS 61 without cover

IP 40

**VEGADIS 175**

Protection

- between front frame and front panel

IP 65

- Terminal

IP 20

ESD	6 kV/8 kV
Electromagnetic fields	10 V/m
Burst (power supply)	2 kV
Surge	1 kV
Electromagnetic fields	10 V/m

**Approvals<sup>1)</sup>**

<b>VEGADIS 11</b>	
ATEX	ATEX II 2G EEx ia IIC T6
<b>VEGADIS 12</b>	
ATEX	ATEX II 2G EEx ia IIC T6
UL	Cl. I,II,II; Div. 1; Gr. A-G
<b>VEGADIS 61</b>	
ATEX ia	ATEX II 1G, 2G EEx ia IIC T6
ATEX D	ATEX II 1/2D IP6X T
IEC	IEC Ex ia IIC T6
FM	FM Cl.I-III, Div1 (IS)
CSA	CSA Cl.I-III, Div1 (IS)
<b>VEGADIS 175</b>	
ATEX	ATEX II 1G EEx ia IIC T6

**Environmental instructions**

VEGA environment management system  
You can find detailed information under [www.vega.com](http://www.vega.com).

certified according to DIN EN ISO 14001

<sup>1)</sup> Deviating data in Ex applications: see separate safety instructions.

7 Dimensions

VEGADIS 11, 12

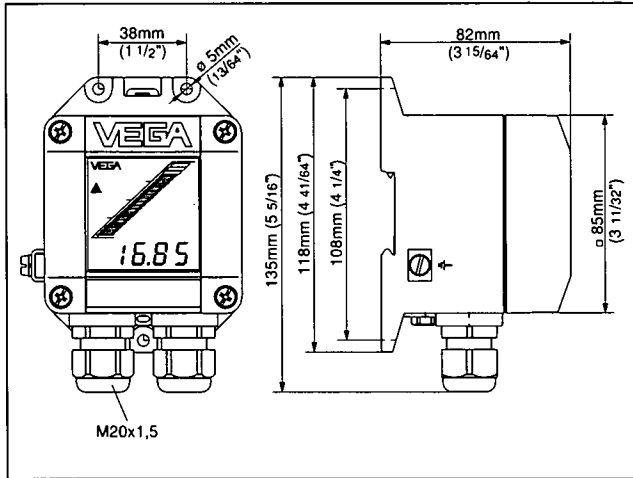

Fig. 26: VEGADIS 11, 12

VEGADIS 61

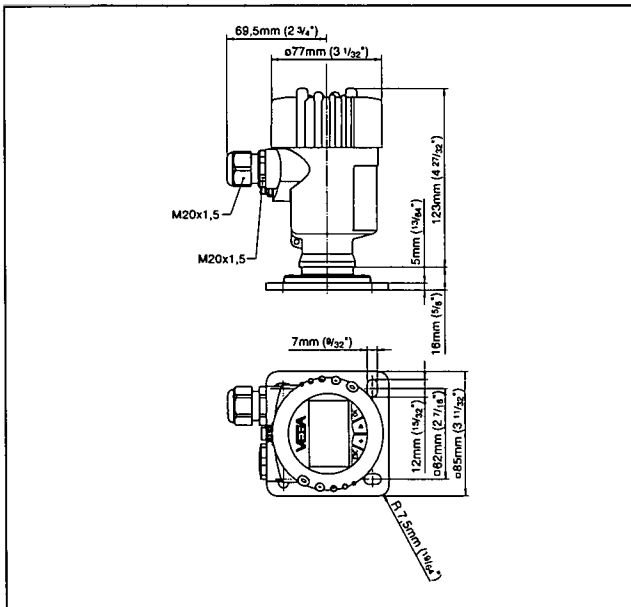

Fig. 27: VEGADIS 61

PLICSCOM

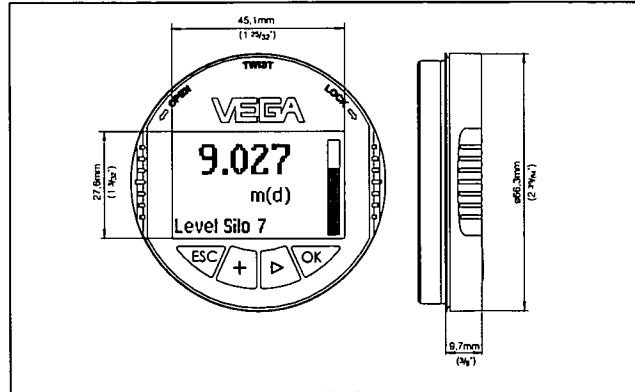

Fig. 28: PLICSCOM

VEGADIS 175

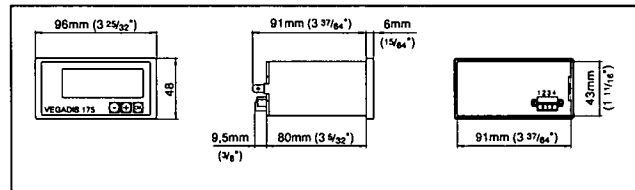
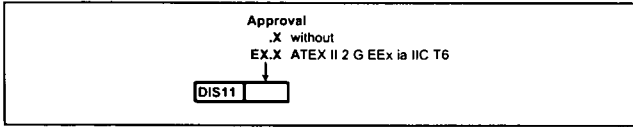

Fig. 29: VEGADIS 175

## 8 Product code

### VEGADIS 11



### VEGADIS 12

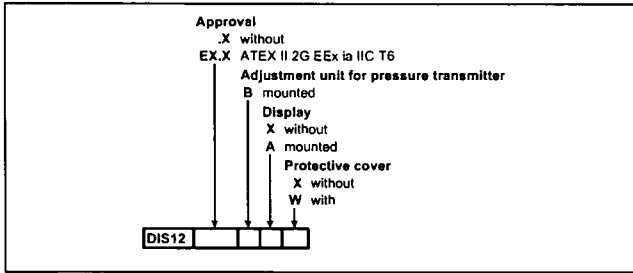

### VEGADIS 61

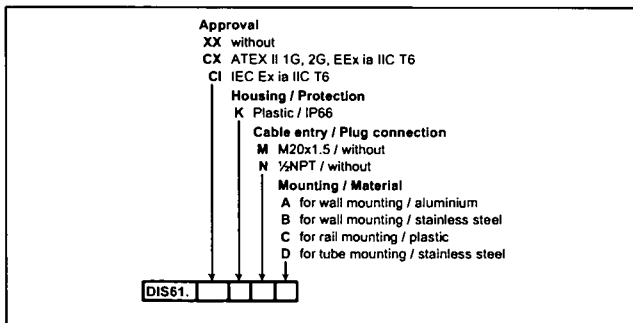

### PLICSCOM

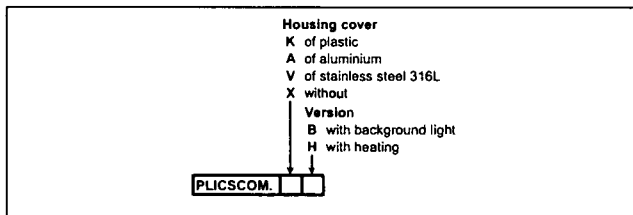

### VEGADIS 175

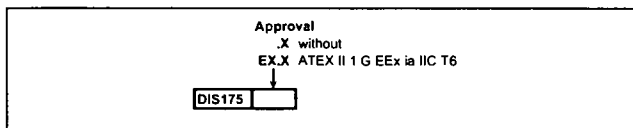

143-EN-071203









**Halmac** Services (Qld) Pty. Ltd.  
A.C.N. 098 852 923  
A.B.N. 40 741 712 113

## RADIO MODEM

---

1. DR-900 DATA RADIO MODEM TECHNICAL DETAILS
2. TC-900DR USER MANUAL

# D Series

## Data Radio Modem

### DR900 - Digital Radios

Trio DataCom's D Series are high performance cost effective data radio modems designed as an alternative to hard wired data transport. Transmit your data over radio with a fully integrated data radio modem designed for fixed point-to-point and point-to-multipoint applications.

The D Series is available as either a half duplex or a full duplex\* 853-929 MHz +/- 5MHz radio, including a fully integrated 4800 / 9600 bps data modem. These units operate equally well in either a stand-alone configuration, or as part of a large communication system.

This complete package forms an attractively priced product for the transmission of data over radio in fixed applications thus providing a viable alternative to costly networks of buried media.

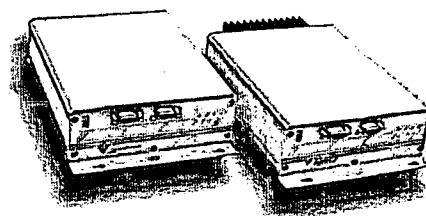

#### Features:

- ❖ Fully integrated half and full duplex\* radio and modem
- ❖ Transparent and non-intrusive remote diagnostic facilities (Optional)
- ❖ Inbuilt data routing and multiplexing capabilities, multi-port operation
- ❖ Simultaneous delivery of multiple protocols using Trio DataCom's unique MultiStream™ technology
- ❖ Digital Signal Processing (DSP) modem
- ❖ Selectable 300-19,200 bps asynchronous RS232 user interface
- ❖ Built-in antenna diplexer\*
- ❖ Integrated supervisory data channel
- ❖ Unique collision avoidance facility, for unsolicited report-by-exception
- ❖ Software selectable configuration parameters
- ❖ Internal repeater operation
- ❖ Housed in an attractive yet robust metal enclosure
- ❖ Range of ancillary equipment - full duplex base / repeater stations and hot-standby base station

#### Radio

The D Series radio has been designed to meet worldwide regulatory guidelines, including FCC, and has adjustable power output up to 5 Watts. This fully synthesised radio is programmable in 6.25/7.5 kHz increments to accommodate various worldwide channel spacings. The receiver section has a wide tuning range with an excellent signal-to-noise ratio. Exceptional frequency stability is achieved by intelligent microprocessor controlled temperature compensation. An extended operating temperature range of -30 to 60°C makes the unit ideal for commercial and industrial applications.

#### Modem

The in-built modem includes a custom DSP developed for data communications over narrow band radio systems.

This system offers minimum occupied bandwidth and optimal data integrity (using the standard HDLC protocol with CCITT CRC error detection) inhibiting the transfer of any rogue unwanted data caused by interference or squelch headers / tails.

The Trio DataCom DSP provides:

- the interface between the asynchronous RS232 user communication and the synchronous radio link layer.
- an inbuilt multiplexer / router which allows for simultaneous transportation of multiple protocols over the one radio network.

#### Applications

The D Series is ideal for use in a variety of sophisticated and critical SCADA and Distributed Information Systems, where complex routing of multiple data protocols and remote diagnostics and wireless network management are important factors.

Remote units and a number of full duplex base station / repeater models, suitable for a variety of requirements, make up the D Series. At the top of the range, the DH model is a genuine, duplicated hot standby base for systems where nothing short of ultra reliability is acceptable.

**Telemetry Systems** - Utilities (Gas, Water, Electricity), Railways, Mining, Telecommunications, Industry. Where network status, system control, data collection and fault conditions are required.

**Transaction Processing** - Point of Sale Credit Terminals, Stock Control, Direct Order, Banks, Building Societies, Stock Brokers, Gambling Organizations, etc, where Point of Sale, inventory, credit, or transaction data requires collection and distribution.

**Common Carrier Data Services** - The high speed, low cost and spectrum efficiency of this device make it well suited to all forms of common carrier data networking.

**Alarm Monitoring** - Fire, Power, Intrusion & Essential Services Alarm Reporting.

designs products & solutions

\* Available for DR900 full duplex 1 W version (853 ± 5 MHz / 929 ± 5 MHz)

## D Series - Data Radio Modem

### DR900 - Digital Radios

#### Configuration

Configuration using Trio's D Series programming software (DRProg) is completely Windows® based for all parameters, such as; frequency, transmitter power, digital mute level, PTT timer, system configurations, port settings.

#### Network Management & Diagnostic (Optional)

A large distributed network, or even a simple point-to-point link, requires comprehensive fault reporting and diagnostics to ensure a high level of availability. Trio D Series data radio modem products offer sophisticated in-built diagnostics using the optional TView™ software. This capability allows the customer to remotely monitor and maintain their system, minimising the likelihood of failures, by pointing out component degradation and decreasing the time to diagnose and repair. There is no necessity to visit the master station or interfere with the host data integrity, other than additional data transfer. For further details, consult the TView data sheet.

#### Specifications:

RADIO	
Frequency Range**	853-929 MHz +/- 5MHz
Channel Selection	Fully programmable
Frequency Splits	76 MHz Tx/Rx frequency split available including simplex
Frequency Stability	±1ppm (-10 to 60°C ambient, opt. -30 to 70°C) Higher frequency stability options are available due to intelligent processor controlled temperature compensation
Aging	<= 1ppm/annum
Half/ Full Duplex	half duplex or full duplex*
Data Rate (rf)	4800 / 9600 bps
Configuration	All configuration via Windows software
TRANSMITTER	
Tx Power	5 W (+37 dBm) or 1 W* (+30 dBm) (software programmable)
Modulation	Narrow band digital filtering binary GMSK
Occupied Bandwidth	Meets various international regulatory guidelines for point-to-point and point-to-multipoint
Tx Attach Time	< 1 mSecond
Timeout Timer	Programmable 1-255 seconds
Tx Spurious	<= -65 dBm
RECEIVER	
Sensitivity	-115 dBm for 12 dB SINAB
Blocking	> 75 dB (EIA)
Intermodulation	<= 70 dB (EIA)
Spurious Response	<= 70 dB (EIA)
Select. and Desense	70 dB (EIA)
AFC Tracking	±3 kHz tracking @ -90 dBm/attack time <10 mS
Mute	Programmable digital mute:

\* Available for DR900 full duplex 1 W version (853 ± 5 MHz / 929 ± 5 MHz)  
 \*\* Various sub-frequency bands available.  
 Note: Model codes previously known as xxxDR are now depicted as DRxxx.

#### Collision Avoidance

A unique fully integrated, yet independent, low speed supervisory data channel embedded within the primary bit-stream provides collision avoidance facilities which are transparent to the user. The use of this feature makes this product ideally suited for reliable, error free data transmissions between stations in high density point-to-multipoint data networks.

The benefits include:

- Multiple asynchronous applications operating on the one radio channel.
- Enhanced performance of report-by-exception networks.

#### Related Products

- ❖ Base Stations (DB900)
- ❖ Hot Standby Base Station (DH900)
- ❖ 9 Port Stream Router Multiplexer (MSR)
- ❖ Network Management and Diagnostic Software (TView™)
- ❖ D Series Programming Software (DRProg™)

CONNECTIONS	
User Data Port	2 x DB9 RS232 female ports
Antenna	SMA female bulkhead (optional N)
Power	2 pin locking. Mating connector supplied
MODEM	
Data Serial Port #1	Full duplex, DB9 RS232, DCE (modem), 300-19,200 bps asynchronous, hardware/software handshaking
Data Serial Port #2	Full duplex, DB9 RS232, 300-9600 bps asynchronous, software handshaking
Data Storage	On-board RAM
Channel Data Rate	4800 / 9600 bps, full duplex
Bit Error Rate	< 1x10 <sup>-6</sup> @ -108 dBm (4800 bps) < 1x10 <sup>-6</sup> @ -105 dBm (9600 bps)
Collision Avoidance	Trio DataCom's unique supervisory channel C/DSMA collision avoidance system
MultiStream™	Trio DataCom's unique simultaneous delivery of multiple data streams (protocols)
GENERAL	
Power Supply	13.8 Vdc nominal (11-16 Vdc)
Transmit Current	600 mA max. @ 1 W 1700 mA max. @ 5 W
Receive Current	175 mA
Dimensions	260 x 161 x 65 mm (robust metal enclosure)
Weight	1.3 kg

Local regulatory conditions may determine the suitability of individual versions in different countries. It is the responsibility of the buyer to confirm these regulatory conditions.

Performance data indicates typical values related to the described unit. Information subject to change without notice.  
 © Copyright 2004 Trio DataCom Pty Ltd. All rights reserved. Issue 11/04

designs products & solutions

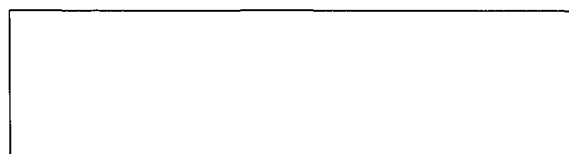

**TRIO DATACOM**  
 41 Aster Avenue  
 Carrum Downs VIC  
 Australia 3201

T +613 9775 0505  
 F +613 9775 0606  
 E frontdesk@trio.com.au  
[www.trio.com.au](http://www.trio.com.au)



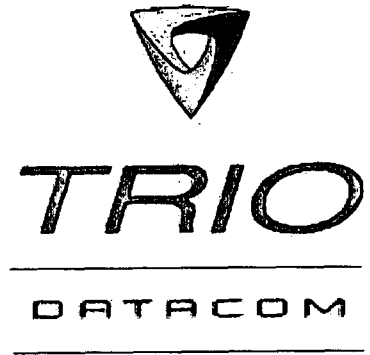

**TC-900DR**

**900 MHz**

**Full Duplex Data Transceiver**

**User Manual**

**Issue 13 : February 2001**

## TABLE OF CONTENTS

<b>1 INTRODUCTION</b>	<b>1</b>
1.1 GENERAL	1
1.2 FACTORY QUALITY ASSURANCE	2
1.3 FEATURES	3
1.4 SPECIFICATIONS	4
1.4.1 RADIO SECTION	4
1.4.2 MODEM SECTION	5
1.4.3 RADIO AND MODEM SECTIONS COMBINED	5
1.4.4 CONNECTORS	6
1.5 OPTIONAL ACCESSORIES	6
<b>2 HARDWARE TECHNICAL DESCRIPTION</b>	<b>7</b>
2.1 GENERAL	7
2.2 RADIO SECTION	8
2.2.1 RECEIVER	9
2.2.2 TRANSMITTER	12
2.2.3 FREQUENCY CONTROL	16
2.2.4 INTERFACES	19
2.3 ANTENNA DIPLEXER SECTION	21
2.3.1 GENERAL	21
2.3.2 INTERFACES	22
2.4 AUDIO HANDSET SECTION	23
2.4.1 GENERAL	23
2.4.2 INTERFACES	24
2.5 MODEM SECTION	25
2.5.1 MODEM CONTROL	26
2.5.2 HOST INTERFACE	28
2.5.3 RADIO INTERFACE	29
2.5.4 TRANSMIT SIGNAL CONDITIONING	31
2.5.5 RECEIVE SIGNAL CONDITIONING	31
2.5.6 USER INDICATIONS	33
2.5.7 POWER SUPPLY	34

2.5.8 INTERFACES	35
<b>3 OPERATIONAL DESCRIPTION</b>	<b>37</b>
3.1 GENERAL	37
3.2 TC-900DR MODEM FIRMWARE REVISION VA2.3.0	39
3.2.1 FUNCTIONAL CHANGES AND ADDITIONS	39
3.2.2 OTHER ENHANCEMENTS	40
3.3 FACILITIES AND CONFIGURATION INFORMATION FIRMWARE VERSION 2.2	41
3.3.1 GENERAL	41
3.3.2 INTERNAL DATA STREAM ROUTING	42
3.3.3 DIAGNOSTICS REPEAT FUNCTION	42
3.3.4 DIAGNOSTICS FRAME STRUCTURE	42
3.3.5 DIAGNOSTICS COMMAND SET	43
3.3.6 PARAMETER SET	49
3.3.7 ADVANCED STREAM ROUTING FUNCTIONS	51
3.4 FACILITIES AND CONFIGURATION INFORMATION VERSION 2	52
3.4.1 GENERAL	52
3.4.2 BRIEF OVERVIEW OF MODEM INTERNAL OPERATION.	52
3.4.3 SELECTING FRAME SIZE	53
3.4.4 CONFIGURING PAD PARAMETERS	54
3.4.5 SUPERVISORY SIGNALLING CHANNEL: APPLICATIONS & CONFIGURATION.	55
3.4.6 SLIP/KISS PROTOCOL DRIVERS	57
3.4.7 RF TRANSMITTER CONTROL AND CHANNEL ACCESS STRATEGIES	60
3.4.8 SELECTING FLOW CONTROL REGIMES	61
3.4.9 SETTING MINIMUM RSSI LEVEL	64
3.4.10 SETTING PTT TIMER	64
3.4.11 DATA STREAM SWITCHING, SELECTING AND ENABLING SID CODES	65
3.4.12 SETTING TRANSMITTER LEAD_IN_DELAY	66
3.5 FACTORS AFFECTING MODEM SYNCHRONISATION TIME	67
3.5.1 (UN)SCRAMBLER AND HDLC STATE MACHINE	67
3.5.2 PHASE LOCKED LOOP	67
3.5.3 ERROR CONTROL	67
3.5.4 TRANSMISSION FORMAT AND TIMING	68
3.5.5 COLLISION AVOIDANCE SCHEME	69

3.6	TEMPERATURE COMPENSATION	70
3.7	USER INDICATIONS	70
3.8	SPECIAL MODES OF OPERATION	71
3.8.1	GENERAL	71
3.8.2	PROGRAMMER MODE	71
3.8.3	BIT ERROR RATE TEST MODE	72
3.8.4	HANDSET MODE	72
3.8.5	ERROR INDICATION MODES	73
3.9	SYNCHRONOUS OPERATION MODE FIRMWARE REVISION: V2.1	75
3.9.1	GENERAL	75
3.9.2	DATA RECEIVER	75
3.9.3	SETTING MINIMUM RSSI LEVEL	75
3.9.4	DATA RECEIVER CLOCK OUTPUT	76
3.9.5	OTHER RS232 RECEIVER CONTROL LINES	76
3.9.6	DATA TRANSMITTER	76
3.9.7	DATA TRANSMITTER CLOCKS	76
3.9.8	TRANSMITTER RTS/CTS LINES	77
3.9.9	PHASE SYNCHRONISM WITH GLOBAL CLOCKS	77
3.9.10	TRANSMIT TIMER	77
3.9.11	LED INDICATORS	77
3.9.12	SPECIAL MODES OF OPERATION	78
3.9.13	WIRING ADAPTOR HARNESS FOR TC-900DR SYNCHRONOUS MODEL	81
<b>4</b>	<b>ALIGNMENT PROCEDURE</b>	<b>82</b>
4.1	GENERAL	82
4.2	TEST EQUIPMENT REQUIRED	82
4.3	TEST POINT LOCATIONS	83
4.3.1	MODEM SECTION PCB	83
4.3.2	RADIO SECTION PCB	84
4.4	ADJUSTMENT POINTS	85
4.5	LINK OPTIONS	85
4.6	HOUSING	86
4.6.1	DISASSEMBLY PROCEDURE	86
4.6.2	MODEM AND POWER SUPPLY PCB	86
4.6.3	ANTENNA DIPLEXER	86

4.6.4 RADIO SECTION PCB	87
4.7 ALIGNMENT DESCRIPTION	88
4.7.1 REFERENCE OSCILLATOR AND SYNTHESIZER	88
4.7.2 121 MHZ MODULATOR	89
4.7.3 TX FINAL	90
4.7.4 RECEIVER	91
<b>5 INSTALLATION OVERVIEW</b>	92
5.1 GENERAL	92
5.2 INSTALLATION	93
5.2.1 DATA CONNECTION	93
5.2.2 MOUNTING	93
5.2.3 POWER CONNECTIONS	93
5.2.4 COAX CABLE CONNECTION	93
5.3 ANTENNA INSTALLATION	95
5.3.1 YAGI ANTENNAS	95
5.3.2 OMNI DIRECTIONAL ANTENNAS	95
5.3.3 ANTENNA PLACEMENT	96
5.3.4 REFLECTIONS AND OUTPUT POWER	96
5.4 COMMISSIONING - RSSI LEVEL	97
5.4.1 CHECKING DATA COMMUNICATIONS	97
5.4.2 BIT ERROR RATE (BER) TESTING	97
5.4.3 OUTPUT POWER - VSWR	98
5.4.4 DATA CONNECTION	98
5.5 GENERAL CHECKLIST	100
<b>6 FAULT FINDING</b>	101
6.1 MODEM/GENERAL	101
6.2 RECEIVER	103
6.2.1 RECEIVE SENSITIVITY LOW	103
6.2.2 RECEIVER LEVEL CHART	104
6.3 TRANSMITTER	105
<b>7 APPENDIX A DRAWINGS</b>	108
<b>8 APPENDIX B GLOSSARY</b>	109



**IMPORTANT NOTICE****© COPYRIGHT - ALL RIGHTS RESERVED**

This handbook is for the installation, operation and maintenance of the TC-900DR. The specifications described are typical only, and are subject to normal manufacturing and service tolerances.

Trio DataCom Pty Ltd reserves the right to modify the equipment, its specifications or this manual without prior notice, in the interest of improving performance, reliability or servicing. At the time of publication all data is correct for the operation of the equipment at the voltage and/or temperature referred to. Performance data indicates typical values related to the particular product.

This manual is copyright © by Trio DataCom Pty Ltd. All rights reserved. No part of the documentation or the information supplied may be divulged to any third party without the express written permission of Trio DataCom Pty Ltd.

Some are proprietary to Trio DataCom Pty Ltd and are supplied for the purposes referred to in the accompanying documentation and must not be used for any other purpose. All such information remains the property of Trio DataCom Pty Ltd and may not be reproduced, copied, stored on or transferred to any other media or used or distributed in any way save for the express purposes for which it is supplied.

Products offered may contain software which is proprietary to Trio DataCom Pty Ltd. However, the offer of supply of these products and services does not include or infer any transfer of ownership of such proprietary information and as such reproduction or re-use without the express permission in writing from Trio DataCom Pty Ltd is forbidden.

Permission may be applied for by contacting Trio DataCom Pty Ltd in writing.

## Modifications

Issue 1	February 1993 (Preliminary)
Issue 2	May 1993 Major Changes to Section 3
Issue 3	September 1993 Minor Changes to sections, 3.1, 3.2.1, 3.2.2.1, 3.2.7, 3.4.3, 3.4.4, 4.4, 4.5, 4.7, 4.7.2, 4.7.3 Major Changes; Inserted new section 3.2.6 KISS/SLIP Deleted section 4 Programming Deleted section 5.7.5, 5.7.6, 5.7.7 AFC Alignment Removed Filter Alignment Setup Diagram Inserted RSSI Level of Received Signal (typical)
Issue 4	February 1994 Minor Changes to all sections Additions to Section 3 for Firmware V2.2 and Synchronous Operation
Issue 5	March 1994 Addition of section 5.2.6.1 and 5.2.6.4 Revised figure on page 75
Issue 6	September 1994 Addition to Section 3.2.5, 4.7.1, 4.7.2, 4.7.3, 4.7.4 Addition of Sections 3.3.11.1, 3.3.11.2, 4.5.1,
Issue 7	April 1995 Addition to Sections 3.8.11.2 and 3.8.12.5 Rev D Sync LED
Issue 8	September 1995 Insertion of new Section 3.2
Issue 9	June 1998 Section 3.3.6 replaced
Issue 10	February 1999

## **Modifications** (cont.)

- |          |                                       |
|----------|---------------------------------------|
| Issue 11 | February 1999                         |
|          | Minor changes to Sections 1.5, 3.3.1, |
|          | Deleted Section 1.6, 4.5.1            |
|          | Replaced Section 5                    |
| Issue 12 | July 2000                             |
|          | Minor Change to Section 7             |
| Issue 13 | February 2001                         |
|          | Change of Company Name                |

---

---

## SECTION 1

### INTRODUCTION

---

---

## 1 INTRODUCTION

### 1.1 GENERAL

The TC-900DR is a Full Duplex 900 MHz Radio, featuring a fully integrated 4800 or 9600 bps data modem.

The entire unit is housed in a robust metal enclosure that provides a compact and transportable means for the transmission of data over radio.

The product has been fully designed and developed in Australia, by an Australian owned and managed company.

The TC-900DR meets the ACA SP4/89 specification which covers radio data transmissions over point-to-point and point-to-multipoint systems.

It is ideally suited for applications such as :

- „ Transaction Processing.
- „ Public Utility Telemetry Systems.
- „ Alarm Monitoring.
- „ Supervisory Control and Data Acquisition.
- „ Energy Distribution.
- „ Inventory Control
- „ Common Carrier Data Services.
- „ Temporary Installations

The modem provides byte oriented packet data communications over narrow band FM systems, using digital filtered binary FSK modulation.

The TC-900DR can be supplied for use with 12.5kHz, 15kHz, 25kHz or 30kHz channel spacings. Its operational parameters can be programmed with the TC-D Series installation programmer. This is a separate software package that runs on an IBM compatible PC under Windows 95/98/NT.

## 1.2 FACTORY QUALITY ASSURANCE

The TC-900DR has been designed and manufactured with particular emphasis placed on the following points :

- { State of the art design techniques.
- { Simple assembly/disassembly.
- { Minimal alignment requirements.
- { Manufactured using quality components.

All units have been manufactured using automated assembly procedures. This assures attention to detail and a high level of quality control.

All components used are of high quality, and conform to Trio DataCom's required specifications. The component suppliers provide batch, date and manufacturing criteria that are required to meet quality control standards.

Each unit is individually tested with an inbuilt self diagnostic program. It is then passed through a set of automatic test procedures with minimal human intervention. This ensures a consistently manufactured and performing product. Many of the alignments are factory set and should not require re-alignment in the field.

Trio DataCom's quality control does not finish here. Once each unit has passed its individual tests, it is placed in a cyclic heat/cooling chamber. This chamber is automatically cycled from -10°C to +65°C, twice, over a twenty hour period. During this time, the modem controller - using external precision calibrated test equipment - monitors and stores frequency stability versus temperature data. The TC-900DR uses this information to achieve its temperature compensated, frequency stability level of 1ppm.

Power output is measured during the temperature cycling. This is achieved by having the unit connected to a PC and various test equipment via a GPIB. Units that fail any of these tests are reported by the test program and corrective action taken before going through the complete cycle once again. Each unit shipped from the factory comes with a factory alignment printout which details:

- „ Configuration.
- „ Transmit frequency.
- „ Receive frequency.
- „ Receiver sensitivity.
- „ Transmitter power output.
- „ Transmitter modulation.

In most cases, the radio transmitter as shipped from the factory will require no re-alignment.

It is this care and quality control that ensures that the purchaser of a TC-900DR radio modem, obtains a consistently manufactured and performance specified product, which has been "burned in" to minimise any operational failures.

### 1.3 FEATURES

Advanced microwave and digital techniques were employed during the design phase of the TC-900DR, ensuring an innovative and state of the art product.

Features include :

- { Fully integrated full duplex radio and modem
- { Built in antenna diplexer
- { Power output +30dBm (1 Watt nom) at antenna connector
- { Radio meets ACA SP4/89 requirements 2/90
- { In-built transparent remote diagnostics capability.
- { Custom single chip modem - digital signal processing
- { 4800 & 9600 bps transfer rates, full duplex
- { Selectable 110..19k2 asynchronous RS-232 host interface
- { Unique collision avoidance facilities
- { Integrated supervisory signalling channel
- { Software selectable configuration parameters
- { Configurable bit error rate testing
- { Excessive temperature power fold-back
- { Auxiliary port for use with an optional supervisory audio handset

## 1.4 SPECIFICATIONS

### 1.4.1 RADIO SECTION

Rx frequency range	:	923MHz to 933MHz (see note 1)
Tx frequency range	:	847MHz to 857MHz (see note 2)
Channel spacing	:	Fully synthesized 12.5kHz / 25kHz, [opt 15/30] with programmable 1/2 channel raster offset
Frequency stability	:	1 ppm (-10°C to 65°C amb), [opt -30°C to 70°C], aging <= 1ppm/Annum
Power output at Antenna connector	:	+30 dBm ±1dBm (1W nom) switchable under software control 200mW/1W
Duty cycle	:	Continuous
Output impedance	:	50 Ohms
Timeout timer	:	Programmable from 1 sec. to 28 minutes (max)
Tx key up time	:	<= to 1mS (output _ 1dB of power).
Rx sensitivity	:	0.5uV at antenna input for 12 dB SINAD at "delayed Rx signal" test point.
Rx intermodulation	:	>= 70 dB spurious free dynamic range.
Rx spurious responses	:	<= -65 dB.
Tx spurious emissions	:	<=-65 dBc (ref unmodulated carrier).
Full duplex with single antenna.		

*Note 1. The reciprocal frequency option for point-to-point operation or point to multi-point base repeaters is available as follows :*

- Rx frequency range 847MHz to 857 MHz.
- Tx frequency range 923MHz to 933 MHz.

*Note 2. The transmitter is normally supplied, with its frequency offset from the receiver by 76 MHz.*

### 1.4.2 MODEM SECTION

User Ports	:	DB-9 connector, EIA RS232, DCE, serial asynchronous, 300..19k2 baud, 7/8 bit, no/odd/even parity.
Data Rate	:	4800/9600 bps Full Duplex.
BER	:	Less than 10E-6 @ -105dbm measured at antenna port
Data Format	:	Narrow band digital filtered binary FSK Modulation, using Trio DataCom's DFM4-9 digital modem chipset, including Trio's unique supervisory signalling channel C/DSMA collision avoidance scheme.
Synchronisation Delay	:	20 milliseconds.

### 1.4.3 RADIO AND MODEM SECTIONS COMBINED

Occupied bandwidth	:	Meets ACA SP4/89 guidelines for point-to-point and point-to-multipoint assignments.
Mean deviation	:	±1.5 kHz (4800bps), ±2.75 kHz (9600bps)
Power requirements	:	14 Volts AC 10VA or 13.8Volts DC (11 to 16V Max).
Transmit current	:	<= to 600 mA.
Receive current	:	175 mA.
Size	:	241mm x 161mm x 65mm.
Weight	:	1.3Kg.



#### 1.4.4 CONNECTORS

User RS-232 Connection	:	DB9 female wired as DCE (modem). (AMP Part # 747844-5)
Mating connectors	:	DB9 male solder type. (AMP Part # 747983-3) Backshell to suit. (AMP Part # 205729-1). Optional supplied to order.
Antenna Connection	:	Gold plated SMA female bulkhead. (E.F.JOHNSON Part # 142-0701-501)
Mating connector	:	SMA male to RG223 crimp type. (E.F.JOHNSON Part # 142-0407-006) Optional supplied to order
AC/DC Power Connector	:	2 pin locking (9A rating). (PCB SOCKET MOLEX Part # M5569-2A2)
Mating connector	:	(RECEPTACLE MOLEX Part# M5557-2R) (RECEPT PINS MOLEX Part # M5556-TL). Supplied with standard unit.
Supervisory Audio Handset Connector	:	6 pin modular jack. (AMP Part # 520250-3)
Mating connector	:	6 pin modular jack plug. (AMP Part # 5-641337-3). Supplied with optional audio handset.

#### 1.5 OPTIONAL ACCESSORIES

Trio stock a large range of ancillary devices including coax cables, RF connectors, antennas, lightning protection, power supplies, etc.

Please contact Sales for further information.

---

---

## SECTION 2

### HARDWARE TECHNICAL DESCRIPTION

---

---

## 2 HARDWARE TECHNICAL DESCRIPTION

### 2.1 GENERAL

The TC-900DR is a 900 MHz full duplex radio complete with radio modem and antenna diplexer. In this and subsequent descriptions to follow, references have been made to block diagrams, circuit diagrams and component loading diagrams.

These can be found in appendix A, at the rear of this manual.

The unit can be divided into five major sub-blocks :

Radio section.

Antenna diplexer section.

Audio handset.

Modem section.

Unit housing assembly.

## 2.2 RADIO SECTION

The radio section is built on a single PCB with approximate dimensions of 193mm x 152mm x 1.6mm.

This section consists of the following main blocks :

- Receiver.
- Transmitter.
- Frequency control.
- Interfaces.

Each of these blocks can be further broken down as follows :

- Receiver.
  - Pre-amplifier.
  - Mixer.
  - 45 MHz I.F. filter.
  - FM I.F. & Demodulator
  - Audio processing.
    - Data.
    - Voice.
  - RSSI processing.

- Transmitter.
  - Audio processing.
    - Data.
    - Voice.
  - Modulator.
  - Multiplier.
  - Mixer.
  - Power amplifier.
  - Control.
    - PTT.
    - Power.

- Frequency control
  - Synthesiser.
  - Local oscillator.
  - AFC

- Interfaces
  - Modem section.
  - Antenna diplexer.
  - Audio handset.

## 2.2.1 RECEIVER

The general form of the receiver circuitry is shown in diagrams "DR9 Macro Block Diagram" (drawing number TC01-05-19 sheet 3/3), and "900 MHz Radio - Block Diagram" (drawing number TC01-05-19 sheet 2/3).

### 2.2.1.1 PRE-AMPLIFIER

The receiver pre-amplifier obtains signal direct from the antenna diplexer port - connector X2. It consists of two stages. The first stage is optimised to give a low noise figure, while the second is optimised to produce gain.

The central devices used are MRF5711 high frequency transistors. They provide the basis for a wide band amplifier that can receive from the lowest band frequency range of 852 to 854 MHz to the higher band frequency range of 928 to 930 MHz.

The RF selectivity is provided by the diplexer filter.

Strip line impedance matching networks are employed to ensure optimum performance of the amplifier.

The overall gain of the pre-amplifier is set to 20dB.

### 2.2.1.2 MIXER

The receiver mixer consists of a 180 "rat race hybrid ring" followed by a passive Schottky mixer diode.

The mixer injection frequency is set 45MHz from the required receive frequency, (high side injection for 930 MHz receive and low side for 850 MHz receive). This results in an I.F. frequency output of 45 MHz.

The level of the injection is set to 6 dBm by the amplifier stage Q3.

### 2.2.1.3 FIRST I.F. STRIP FILTER

The required receiver mixer product is filtered by the first I.F. filter. The filter is a bandpass crystal controlled device, centred on 45 MHz, and provides image rejection for the second IF Mixer.

The filter is aligned for optimum response by adjustment of inductors L4,L3 and L5.

#### 2.2.1.4 FM IF and DEMODULATOR

The heart of the demodulator section is an NE615D high performance low power mixer FM IF system IC.

This device incorporates a mixer/oscillator, two limiting intermediate frequency amplifiers, a quadrature detector, muting circuitry, logarithmic RSSI, and a voltage regulator.

The input to the device is from the output of the 45 MHz first IF strip filter. This is applied at  $RF_{in}$  and  $RF_{bypass}$  pins (U2-p1,p2).

This signal is applied internally to a Gilbert cell mixer, which is set to convert the signal down to 455kHz.

The mixer injection is supplied by an internal oscillator, which is driven by an external oscillating signal applied at the XTAL OSC pins (U2-p3,p4).

The basic injection frequency is governed by the 44.545 MHz crystal XTAL1. This produces a mixer output product of 455 kHz.

The output of the mixer is available at MIXER OUT (U1-p20). This is applied to a 455kHz centred bandpass filter. This acts as the "front end" filter, CF1.

The bandwidth and rolloff characteristics of this filter are set, depending on the required baud rate of the data being used on the modem, and the required channel spacing. Refer to Circuit Diagram for filter types.

The filtered output is then applied to the input of the internal IF amplifier, IF AMPIN (U1-p18). The bandwidth of the amplifier is about 40 MHz, with a gain of about 39 dB(uv). C10 and C11 provide IF amplifier decoupling.

The output is available at IF AMP OUT (U1-p16). This is applied to a 455kHz centered bandpass filter. This acts as the "rear end" filter, CF2.

Again the filter selection depends on the required bandwidth. Refer to Circuit Diagram for filter types.

The filtered output is then applied to the input of the internal IF limiter, LIMITER IN (U1-p14). The bandwidth of the limiter is about 28 MHz, with a gain of about 62 dB(uv). C13 and C14 provide IF limiter decoupling.

The signal from the second limiting amplifier is passed to an internal Gilbert cell quadrature detector, as well as to LIMITER OUT (U1-p11).

One of the Gilbert cell ports is driven directly by the IF, the other by a tuned quadrature network, which is driven by the IF signal from LIMITER OUT. The tuned network is based around a ceramic resonator CF3. The Q of the network is varied depending on the required baud rate used by the modem. For 9600 baud the link LK3 is inserted, giving a higher damping factor than that required for 4800 baud, where the link is removed.

This gives the two input signals applied to the Gilbert cell a 90 degree phase relationship, the output of which is the demodulated audio/data signal.

The output signal is available at UNMUTED AUDIO OUT (U1-p9). A gated output is also available at MUTED AUDIO OUT (U1-p8).

## 2.2.1.5 AUDIO PROCESSING

### 2.2.1.5.1 DATA

The demodulated data signal output has been assigned to the UNMUTED AUDIO OUT pin (U1-p9). This ensures no interruption to the flow of data.

The signal is filtered by the C22, R20, R29 and C23 filter network. This is to remove any high frequency components produced at the output of the quadrature detector.

It is then amplified and DC level shifted by op-amp U1:C. The amount of DC bias applied to the signal can be varied by the potentiometer VR2. For correct processing by the modem, this level is set to 2V. The AC level of the signal is set to about 1 V<sub>p-p</sub>.

### 2.2.1.5.2 AUDIO

The demodulated audio signal output has been assigned to the MUTED AUDIO OUT pin (U1-p8). This allows switching control of the audio passed to the handset earpiece.

The signal is filtered by R23 and C17. This is to remove any high frequency components produced at the output of the quadrature detector.

It is then buffered, amplified and level shifted by op-amp U1:D, and presented to the handset via coupling capacitor C20 and connector X3-p2.

The mute control signal is applied to the NE615 (FM IF system IC) MUTE IN pin (U2-p5). When active, the audio output signal from the IC is attenuated by greater than 60dB.

### 2.2.1.6 RSSI

The RSSI output is presented by the NE615 at RSSI OUT (U2-p7). This signal is logarithmic with an output range greater than 90 dB. It is used for audio mute processing, and by the modem section as a data qualifier signal.

The signal is first passed through a unity gain buffer, op-amp U1:B, before it is split.

The RSSI level is compared with the setting of "audio mute adj" potentiometer VR1, by op-amp U1:A. The result is passed to the MUTE IN pin of the NE615.

This allows a suitable mute cutoff point to be set for the received audio sent to the handset earpiece.

The RSSI signal is also passed to the modem section for processing via R19 and connector X1-p21.

## 2.2.2 TRANSMITTER

The general form of the transmit circuitry is shown in diagrams "DR9 Macro Block Diagram" (drawing number TC01-05-19 sheet 3/3), and "900 MHz Radio - Block Diagram" (drawing number TC01-05-19 sheet 2/3).

### 2.2.2.1 AUDIO PROCESSING

#### 2.2.2.1.1 DATA

The transmit data signal enters the radio section via connector J\*3-p13, from the modem section. It is biased via R68 and R75 to a DC level of about 0.86V. The signal is then passed through a level setting potentiometer VR2, used to set the level of transmit deviation.

It is then presented to the input of the modulator circuit.

#### 2.2.2.1.2 VOICE

The transmit voice signal enters the radio section via connector X3-p4, from the microphone in the handset. The pre-amp in the microphone circuit is given some bias via R76.

The signal is first passed through a clipping circuit. This consists of back to back clamping diode pair D2, AC-coupled via C154. This ensures that a maximum transmit deviation level is imposed.

The modulator circuitry is based around a low power FM transmitter system IC, MC2833. Included in this device is a microphone amplifier and clipper. The audio is passed to the amplifier via R76 at the MIC AMP INPUT pin (U7-p5).

Feedback for gain is supplied by R76, and band limiting by C50. The amplifier output is presented at MIC AMP OUTPUT (U7-p4).

Further low pass filtering is provided by the network of R71, C49, R59.. and C42... C43 provides a rising response below 100Hz. This filtering is needed to shape the base band signal, so as the transmit frequency spectrum stays within channel boundaries.

The audio is coupled into the modulator circuit at the MODULATOR INPUT pin of the MC2833 (U7-p3).

### 2.2.2.2 MODULATOR

The heart of the modulator section is an MC2833 low power FM transmitter system IC. This device is a one chip FM transmitter subsystem designed for FM communication equipment. It includes a microphone amplifier, a variable reactance modulator, a voltage controlled oscillator, and two auxiliary transistors.

Data is fed directly to the input of the reactance modulator at the MODULATOR INPUT pin (U7-p3). The audio channel is fed via an inbuilt clipper amplifier in the MC2833. The output of this variable reactance circuit is used to modulate the FM carrier.

The carrier frequency of the modulator is provided by an internal oscillator, which is driven by an external oscillating signal applied at the RF OSC pins (U7-p15,p16).

This oscillating signal is governed by the 20.166 MHz crystal XTAL3. The actual applied frequency is set by the modulating signal, which slightly varies ("pulls") the crystal frequency. This is achieved by connection of the crystals circuit to the output of the variable reactance circuit VARIABLE REACTANCE OUTPUT (U7-p1). This output is coupled to the crystal via a frequency trimming coil L6.

The output FM signal is presented at the RF OUTPUT pin (U7-p14).

### 2.2.2.3 MULTIPLIER

The output of the modulator is passed to a frequency tripler stage employing auxiliary transistor TR2. This places the carrier frequency at 60.5 MHz.

It then passes to a frequency doubler stage employing auxiliary transistor TR1, where the carrier is moved up to 121 MHz.

The signal is amplified through these stages to a level of about -4 dBm at 121 MHz.

### 2.2.2.4 MIXER

The transmit FM signal at 121 MHz when mixed with the VCO frequency by U8 produces a transmitter signal 76 MHz from the receiver frequency.

The mixer employed is an MCL SBL-1X monolithic doubly balanced mixer (U8).

The transmit VCO signal is amplified to a level of about +6 dBm by Q2, and applied to the "L" input of the mixer. The 121 MHz signal is applied to the "I" input of the mixer.

To select the correct mixing product for the transmitter, a tunable filter using C78 and a coupled stripline circuit is used.

The output signal is then buffered by two MRF5711 transistors Q4 and Q5, to provide about +4 dBm of signal level, which is applied to the final amplifier section.



### 2.2.2.5 POWER AMPLIFIER

The power amplifier provides an overall gain of about 30dB. This is achieved by three stages of amplification.

The first stage uses an MRF5711 transistor (Q8). This device is primarily designed for high gain, low-noise, small signal amplifiers, and is ideal for a transmitter pre amplifier. This stage provides about 13 dB of gain. The power control circuit acts on this stage to provide constant power at the PA. output connector.

The second stage uses an MRF8372 transistor (Q9). This device is primarily designed for wideband, large signal predriver stages, in the 800MHz range. This provides a further 10 dB of gain.

The final stage uses two MRF8372 transistors (Q10, Q11) in a parallel configuration to provide the final output power. Each of these stages provides about 10 dB of gain. The output impedance is matched to 50 ohms via the use of balanced impedance strip lines.

The transmitted signal is presented at connector X4, at a level of about +32 dBm, where it is passed to the diplexer section.

### 2.2.2.6 CONTROL

#### 2.2.2.6.1 PTT

PTT must be activated for the TC-900DR to transmit an RF signal. There are two sources of PTT, the audio handset, and the modem section.

PTT from the audio handset is referred to as "manual PTT". It enters the radio section via connector X3-p6. It is passed to the PTT control switch transistor Q12. PTT is active LOW, and turns on Q12 when applied.

PTT from the modem section enters the radio section via connector X1-p12, "/PTT". It is connected to the PTT control switch transistor Q12.

When PTT is not activated the transmitter is totally disabled. All stages of the transmit chain are turned off. This is to ensure that power consumption is kept to a minimum.

The PTT signal connects to the start of the transmit chain at the multiplier stage.

The internal transistors of the MC2833 IC, TR1 and TR2 have their bases effectively grounded, turning off the devices. Similarly the mixer output buffer and amplifier transistors Q4 and Q5 are turned off as are the final amplifier stages employing Q8, Q9, Q11 and Q10.

When the PTT is activated, bias is applied to all these stages and transmission is possible.

*Note : Tx enable must also be active to allow transmission.*

#### 2.2.2.6.2 TRANSMIT ENABLE

Transmit enable is a further control placed on the transmitter circuits. No transmission is possible unless the transmit enable signal is active. The signal enters the radio section via connector X1-p11, "/TX EN", from the modem section.

This signal basically enables the PTT switching transistor Q12, thus providing VCC for the 20.166 MHz oscillator section of the MC2833 modulator IC, and bias to the handset microphone.

#### 2.2.2.6.3 POWER

The RF power output of the TC-900DR can be set to two levels. Low power level is 200mW, and high power is 1W.

This level is controlled by two dc levels. One signal is a control level from the modem section, the other from an RF detector located at the output of the transmitter itself. These two signals are used in conjunction to hold the output power constant.

The signal from the modem section enters the radio section via connector X1-p10, "TXPWR". The signal is fed to an op-amp comparison circuit U9:A, via level setting potentiometer VR4.

The level is compared to that actually detected at the output of the transmitter, by the circuit based around diode D3. The comparator output is then used to bias the first stage of the P.A. section (Q8) of the transmitter, hence varying the transistor gain performance and ultimately the output RF power. This basic feedback network is required to keep the power at a constant level, regardless of any external conditions.

The detected output power level is also fed back to the modem section for monitoring and analysis via connector X1-p9, "TXPWR SENSE".

#### 2.2.2.6.4 TEMPERATURE SENSE

A temperature sensing device is included in the radio section. The device used is an LM335 precision temperature sensor, U6. It is operated as a two terminal zener diode, with a breakdown voltage directly proportional to absolute temperature, with an output of +10 mV per degree kelvin.

The temperature data output is passed to the modem section for analysis and processing via connector X1-p14, "TEMP SENSE".

During the "Burn In" cycle, that the TC-900DR is passed through during production, the unit calibrates the output of the sensor to the test temperature. In particular it stores the hottest temperature reached by the test cycle (about 65C).

If the unit reaches this maximum temperature setting while operating in the field, the modem section of the TC-900DR will automatically signal the power control circuit to place the transmitter into low power mode (200mW).

This low level of output power is retained until the temperature sensor signals the modem section, that the temperature has fallen back below the maximum temperature. When this occurs the transmitter is placed back to its previous power setting. A hysteresis is built into the microprocessor control circuitry to stop power jitter.

This scheme is referred to as "High Temperature Fold Back". It is used to protect the transmitter final power transistors from any damage that may be encountered under extreme temperature conditions.

## 2.2.3 FREQUENCY CONTROL

### 2.2.3.1 SYNTHESISER

The synthesiser section provides a local oscillator for use by the receiver and transmitter sections.

The synthesiser circuitry is based around a TBB206 PLL frequency synthesiser IC.

This device is a complex PLL circuit in CMOS technology for processor controlled frequency synthesis. The processor resides in the modem section, and three basic control lines are used to interface to the device. The enable "EN", data "DA" and clock "CL" control signals are passed to the TBB206 via connector X1-p16,p17,p18 respectively.

The reference frequency for the synthesiser is applied to the "RI" pin of the TBB206 (U3-p2). This reference is provided by a 12.000 MHz voltage adjustable temperature compensated crystal oscillator (VTCXO), XTAL2. This input has a sensitive preamplifier for a 16-bit (R)eference divider. C33 provides AC coupling for the input.

The VCO frequency is applied to the "FI" input pin of the TBB206 (U3-p8). This input has a highly sensitive preamplifier for a 12-bit N divider and a 7-bit A divider. C29 provides AC coupling for the input.

The actual signal applied to the "FI" input is from the output of a TBB202 dual modulus divider IC (U4-p4). This is to transform the actual VCO frequency of between 786 MHz and 996 MHz, down to a frequency acceptable for use by the "FI" input.

The divider ratio selected by the TBB202 is determined by the state of the "MOD" input pin (U4-p6). If the signal is HIGH, then a ratio of 1:128 is used. If the signal is LOW, a ratio of 1:129 is used. The state of this signal is controlled by the TBB206 synthesiser "MOD" output pin (U3-p7). The TBB206 drives this output LOW at the beginning of a cycle. When the A divider has reached its set value, the "MOD" output is set to HIGH. When the N divider reaches its set value, the output is set LOW again and the cycle is repeated.

The input to the TBB202 divider is from the VCO output via a strip line impedance matching network. The signal is applied to the "I1" pin (U44-p1).

The TBB202 can be placed into standby mode, when not in use. This is achieved by connection of the "STB" pin (U4-p7), to the multi function output port of the TBB206 synthesiser (U3-p6). This port is driven by the DFM4-9 modem IC located in the modem section.

The phase detector signal is provided on the "PD" pin of the TBB206 (U3-p12). This signal has especially short anti backlash pulses to avoid any "dead zones", and to neutralise any small phase deviations. This signal is passed to the loop filter of the VCO circuit.

A lock detect indication is given by the TBB206 synthesiser at the "LD" output pin (U3-p14). This signal is filtered and shaped by the network using R47 and C36, and presented to the modem section for monitoring and processing, via connector X1-p19.

### 2.2.3.2 VCO

The VCO used is an MQC309 series VCO. The exact device used depends on the required frequencies that the unit has to work with.

Two types are used :

- A. MQC309 798 - Frequency range of 784 MHz to 816 MHz

Gives unit frequency ranges of :

- Transmit : 905 MHz to 937 MHz
- Receive : 829 MHz to 861 MHz

- B. MQC309 978 - Frequency range of 962 MHz to 994 MHz

Gives unit frequency ranges of :

- Transmit : 841 MHz to 873 MHz
- Receive : 917 MHz to 949 MHz

The 798 type employs low side injection to the mixers, whereas the 978 type employs high side injection.

The loop filter consists of R44, C40, C41 and R43.

The output of the VCO is passed to the receiver mixer via RXMIX, and to the transmitter mixer via TXMIX signal lines. Each of these is impedance matched by strip line circuits for optimum performance.

The layout and selection of all these components has been done in such a way so as to minimise VCO noise being impressed onto either the transmitted or received RF signals.

### 2.2.3.3 VCO TEMPERATURE COMPENSATION

Frequency temperature compensation is provided for by an input to the reference oscillator circuit.

During the "Burn In" cycle, that the TC-900DR is passed through during production, the unit calibrates the output of the temperature sensor to the test temperature and to any frequency variations that occur, and stores the results.

When the unit is operating in the field, the temperature of the unit is constantly being analysed. Should a frequency offset be required based on the calibration measurements, the modem section signals to the 12.000 MHz reference oscillator to vary its frequency slightly. This signal is passed to the radio section via connector X1-p15, "TEMP COMP". The voltage on this line "pulls" the reference oscillator XTAL2 onto a new frequency, which corresponds to the correct offset required.

*Note : Because the temperature compensation for the installed VTCXO is held in the NVRAM of the modem it is imperative that modems and radio boards are maintained as matched pairs. Should either the VCO or NVRAM require replacement it is highly recommended that the unit be returned to the manufacturer for re-calibration.*

#### 2.2.3.4 RECEIVER AFC

Automatic frequency control is provided for the received signal. The control signal is applied to the radio section from the modem section via connector X1-p22, "AFC CTL".

The basic injection frequency to the front end mixer of the NE615 FM demodulator IC (U2), is governed by the 44.545 MHz crystal XTAL1. The actual applied frequency can be set by the level of the AFC signal, which slightly varies ("pulls") the XTAL1 crystal frequency via the varactor diode DV1.

The modem section monitors the average DC level of the received signal (DATA signal X1-p13), which gives an indication of received frequency drift.

From this the modem section calculates the required compensation necessary and applies it to the "AFC CTL" signal line.

A reference signal is passed back to the modem section from the radio section via connector X1-p23, "AFC REF". This is processed by the modem section, and used to help determine the level of AFC signal level.

## 2.2.4 INTERFACES

### 2.2.4.1 MODEM SECTION

The radio section interfaces to the modem section via connector X1. Attached permanently to this connector is a 90mm length of 26 way ribbon cable, fitted with a female 26 way connector at the other end. This attaches to connector JX3 on the modem section PCB.

Refer to interface diagram "RADIO MODEM INTERFACE", drawing number TC01-05-18 sheet 1/3.

<u>CONNECTOR X1/JX3</u>	<u>SIGNAL DESCRIPTION</u>	<u>PIN NUMBERS</u>
1	13V8 POWER SUPPLY RAIL	
2	13V8 POWER SUPPLY RAIL	
3	13V8 POWER SUPPLY RAIL	
4	GROUND	
5	GROUND	
6	GROUND	
7	8V POWER SUPPLY	
8	8V POWER SUPPLY	
9	TXPWR SENSE	(o/p- TRANSMIT POWER SENSE)
10	TXPWR	(i/p - TRANSMIT POWER LEVEL)
11	/TX EN	(i/p - TRANSMIT ENABLE)
12	/PTT	(i/p - PRESS TO TALK)
13	DATA	(i/p - TRANSMIT DATA)
14	TEMP SENSE	(o/p - TEMPERATURE SENSOR)
15	TEMPCOMP	(i/p-TEMPERATURE COMPENSATION)
16	EN	(i/p - ENABLE FOR SYNTH)
17	DA	(i/p - DATA FOR SYNTH)
18	CK	(i/p - CLOCK FOR SYNTH)
19	LD	(o/p - LOCK DETECT FROM SYNTH)
20	DATA OUT	(o/p - RECEIVED DATA)
21	RSSI	(o/p - RSSI SIGNAL)
22	AFC CTL	(i/p - AFC CONTROL)
23		(UNUSED)
24	SUPPLY/MIC	(UNUSED)
25	TEST1	(UNUSED)
26	TEST2	(UNUSED)

### 2.2.4.2 ANTENNA DIPLEXER

The interface between the radio section and the antenna diplexer section is via coaxial connectors X4 and X2, and low loss coaxial cables.

<u>CONNECTOR</u>	<u>SIGNAL DESCRIPTION</u>
X4	TRANSMITTER OUTPUT
X2	RECEIVER INPUT

### 2.2.4.3 AUDIO HANDSET

The interface between the radio section and the audio handset is via the modular-6 pin connector X3.

<u>CONNECTOR X3 PIN NUMBERS</u>	<u>SIGNAL DESCRIPTION</u>
1	8V POWER SUPPLY
2	AUDIO OUT (o/p - AUDIO TO EARPIECE)
3	GROUND
4	MIC (i/p - MICROPHONE AUDIO)
5	GROUND
6	MANUAL PTT (i/p - HANDSET PTT)

## 2.3 ANTENNA DIPLEXER SECTION

### 2.3.1 GENERAL

The antenna diplexer section of the TC-900DR is a separate plug in module, that "piggy backs" the radio section PCB.

The diplexer performs two major tasks. Firstly it couples both the transmit and receive RF paths to the antenna while providing high isolation between them, and secondly it provides image and spurious rejection for each of these paths, with high Q bandpass filters.

The isolation between the transmit side and the receive side is greater than 50 dB.

The diplexer consists of two teflon PCB's bonded together using a critical temperature and pressure process. The top and bottom outer layers are connected via brass eyelets, that are pressed through the PCB. This eliminates the need for through hole plating of Teflon, which requires the use of dangerous chemicals.

The design is essentially two continuous ground planes, filled in between, with laminate dielectric, and stripline filter tracks which are centrally located between these ground planes.

The etching of the filter tracks is closely monitored and controlled to ensure an accuracy of better than 0.001" in track width and spacing.

The diplexer has been factory tested to ensure bandpass and performance characteristics are met. The diplexer has approximately 3 dB of loss at 930 MHz and 2 dB of loss at 850 MHz.

This diplexer requires no alignment in the field.



### 2.3.2 INTERFACES

The antenna diplexer connects to the radio section via low loss coaxial cables and connectors, and to the units antenna via a SMA connector.

Two versions of the diplexer are available, depending on the transmit and receive frequencies used. The difference between the two is the loading of the SMA connector.

#### TYPE-A CONNECTIONS (*Transmit frequency = 930 MHz range*)

<u>DIPLEXER CONNECTOR</u>	<u>SIGNAL DESCRIPTION AND DESTINATION</u>
850 MHz port	RF RECEIVE - RADIO SECTION X2
930 MHz port	RF TRANSMIT - RADIO SECTION X4
ANT port	ANTENNA

#### TYPE-B CONNECTIONS (*Transmit frequency = 850 MHz range*)

<u>DIPLEXER CONNECTOR</u>	<u>SIGNAL DESCRIPTION AND DESTINATION</u>
850 MHz port	RF TRANSMIT - RADIO SECTION X4
930 MHz port	RF RECEIVE - RADIO SECTION X2
ANT port	ANTENNA

## 2.4 AUDIO HANDSET SECTION

### 2.4.1 GENERAL

Refer to diagram "MTCU HANDSET MAIN PCB & MIC PCB CIRCUIT DIAGRAM", drawing number 5015-A200-50.

The handset provides an audio link between units, to assist in link setup and commissioning. It is not intended for general use and the equipment is not licensed for voice operation only.

Caution : When the handset is inserted into the TC-900DR, reliable data transmission or reception is not possible. Unintentional voice traffic on a point to multi point system may cause data corruption to other units.

The data transmission section of the modem is totally disabled, if the handset is plugged in when the TC-900DR is turned on.

The handset contains two PCB's, a receive board and a microphone board, which are connected by a 10 way ribbon cable. Acoustic padding is also included in the handset for improved performance.

The microphone board contains an ECM30 electret microphone, along with a common emitter preamplifier stage (Q1), to provide transmit voice audio.

There are four indication LED's that are not used by the TC-900DR.

The receiver board contains a 78L05 5V voltage regulator (REG1). This is used to supply power to the LF353 receive amplifier (U2-p7), which drives a DH32-30 ohm earpiece.

The sidetone circuit provided by U2-p1 is disabled and not used by the TC-900DR. Similarly, the LED drivers are disabled.

The PTT switch places a ground connection onto its output signal line, for processing by the radio section.

## 2.4.2 INTERFACES

The audio handset connects directly to the radio section via the RJ11 connector, X3. Attached to the handset is an 8 way flexible curly cord.

<u>PIN NUMBER</u>	<u>HANDSET CONNECTOR</u>	<u>X3 PIN NUMBER</u>	<u>RADIO SECTION CONNECTOR X3</u>
1	LED CLK	-	UNUSED
2	LED DATA	-	UNUSED
3	13V2	1	8V POWER SUPPLY
4	DGND	3	GROUND
5	PTT	6	MANUAL PTT
6	MIC	4	MIC
7	MIC RET	5	GROUND
8	EAR PHONE	2	AUDIO OUT

## 2.5 MODEM SECTION

The modem section is built on a single PCB with approximate overall dimensions of 165mm x 152mm x 18mm.

It consists of the following main blocks :

### Modem control

- DFM4-9 modem.
- Reset and watchdog.
- Memory.
  - External NVRAM.
  - External RAM.

Host interface.

Radio interface.

Transmit signal conditioning.

Receive signal conditioning.

- Data recovery.
- Clock recovery.

User indications.

Power supply

Interfaces.

- Radio section.
- Port A.
- Port B.
- Power.

## 2.5.1 MODEM CONTROL

### 2.5.1.1 DFM4-9 MODEM

The modem section is controlled by a DFM4-9 Trio DataCom modem IC, (U5).

This device is specifically designed to provide data communications from a host computer over a radio channel.

The DFM4-9 is capable of full duplex operation, at data rates of 4800 baud or 9600 baud over the radio channel. The transmitter and receiver data rates may be set independently. The host computer interface provides two RS232 asynchronous serial ports, configurable for a variety of baud rates, and data formats.

In the standard delivery format of the modem, only one asynchronous serial port is operational. (Port A).

Advanced data recovery techniques are employed to ensure excellent performance in both good and noisy signal environments.

The data transmission method used, employs advanced optimal waveform shaping techniques. This maximises the recovered signal at the destination receiver, while remaining within the allocated RF channel bandwidths. The method uses computer generated Finite Impulse Response (FIR) techniques, to derive the transmitted waveform data.

The modem features a unique supervisory signalling channel, which embeds low speed data in the primary bit-stream, and is transparent to the user of the primary channel.

To drive the DFM4-9 modem clocking circuits, an external resonator is required. A 19.6608 MHz crystal (XTAL1) is applied to the OSC pins (U5-p9,10) of the device to achieve this.

A 4 way DIP switch is supplied to set up some configuration parameters of the modem. These are only read by the DFM4-9 at device power up. They connect to the "ESx" pins of the device (U5-p3,p5,p6,p7). Switches 1 and 2 are presently unused, switches 3 and 4 are defined in section 4.5.1.

### 2.5.1.2 RESET AND WATCHDOG

A MAX690 reset and watchdog IC (U3), is used to perform a variety of ancillary functions. This device provides a fixed length reset pulse for the proper initialisation of the modem chip on power up and reinitialisation. The MAX690 monitors the level of the VCC power supply line. If the voltage moves out of specification, the reset output is activated. This ensures that the modem chip recovers correctly in the event of a power failure. The reset signal is applied to the "RESET" pin of the modem (U5-p8).

The MAX690 provides a power monitoring function, which gives advance warning of imminent power supply failure. The DFM4-9 modem checks this signal, applied to its "PF" pin (U5-p2), before performing any transactions with the non-volatile memory, thus preventing accidental corruption of the contents of this memory. This "advance warning", is the length of time that the power supply capacitors hold their charge, after loss of power, before the Vcc supply rail drops below its cutoff level, and a reset pulse is generated.

The MAX690 also includes a "watchdog" timer. This timer must be strobed at a minimum rate, to prevent a reset pulse being generated. The DFM4-9 provides this signal at its "WDO" pin (U5-p22). Should the DFM4-9 modem operation go astray for some reason, it is probable that it will no longer perform this strobing function correctly. This condition is treated as irrecoverable and the MAX690 will timeout on its watchdog function and re-initialise the modem.

### 2.5.1.3 MEMORY

#### 2.5.1.3.1 EXTERNAL NVRAM

The DFM4-9 modem, has a wide variety of configurable operating parameters, all of which are stored in an ST24C04 NVRAM IC, (U4). These parameters are read at power up, and determine the operating characteristics of the modem.

The NVRAM has 4096 bits of memory. It is accessed using the standard I<sup>2</sup>C, two wire, bus interface. A feature of this particular device, is a write protect function for one area of the memory.

This write protect feature prevents configuration data being inadvertently corrupted should some anomaly in modem operation occur. A hardware signal line is used to override this write protection feature, so that the configuration data may be changed by manual means. This signal can be accessed via the front panel connector, and is used when the TC-DFM9IP modem programmer is connected.

#### 2.5.1.3.2 EXTERNAL RAM

External RAM is used to store data frames.

The RAM used may be either a 6264-8K or 62256-32K byte IC (U9). The standard TC-900DR is supplied with an 8K package. The DFM4-9 modem, tests the size of the attached RAM on power up.

All of the externally connected RAM is used to store packet data, and is allocated evenly between transmit and receive data. This memory is connected to the modem chip, by an 8 bit bus, and 3 control lines.

Two 8 bit 74HC573 latches (U8 and U10), are used to latch the memory address off the bus, before the data read or write cycle. The read/write control line to the RAM, is passed as the top address line in the MSB address latch.

The RAM read cycle operates as follows :

- The modem sets the two latch control lines, LADR\_EN and HADR\_EN, high.
- The high-address/R\_select is then placed on the 8 bit bus.
- The HADR\_EN line is set low to latch the data into U8.
- The lower eight address bits are placed on the bus.
- The LADR\_EN line is set to low to latch the data into U10.
- The modem bus port is set to input mode.
- The RAM CE line is set low.
- The modem reads the data off the bus.

The RAM write cycle operates as follows :

- The modem sets the two latch control lines LADR\_EN and HADR\_EN, high.
- The high-address/W\_select is then placed on the 8 bit bus.
- The HADR\_EN line is set low to latch the data into U8.
- The lower eight address bits are placed on the bus.
- The LADR\_EN line is set to low to latch the data into U10.
- The modem bus port is set to output mode.
- The modem writes the data to the bus.
- The RAM CE line is set low to write the data into the RAM.

*Note: WARNING*

*A modem containing a 32K RAM package will not be compatible with a modem containing an 8K RAM package if end to end flow control is being used over the data link.*

## 2.5.2 HOST INTERFACE

The host interface is provided by two RS232 ports, configured as DCE. These ports are presented to the user as 9 way female DMIN connectors, designated as PORT A and PORT B.

With the standard TC-900DR, only PORT A is operational.

The RS232 level translation is performed by two LT1081/MAX232 line transceivers (U1 and U2). These require a single five volt supply, and include internal charge pumps to generator the required +10V and -10V rails.

The four input and four output lines implement one full duplex serial port with RTS/CTS/DTR and DCD. This is PORT A. A second full duplex port with no handshake lines is provided on PORT B.

### 2.5.3 RADIO INTERFACE

The interface to the radio is via a 26 pin PCB header connector, X4.

The modem section has full control over the connected radio transceiver. It provides :

- Four lines for synthesiser control (used for RF channel selection).
- RSSI detection.
- Temperature sense input.
- Transmit power sense input.
- Temperature compensation for the synthesiser reference frequency.
- Receiver AFC.
- PTT control.
- Analogue lines for receive and transmit data signals.
- Regulated +13.8V and +8V power supplies.

Input to the receiver signal port, RXSIG, is offset by 2.0V DC, with a signal level of 1Vp-p AC.

The transmit signal output, TXSIG, has a signal level of 1Vp-p for 4800BPS, and 2Vp-p for 9600BPS, with a nominal DC offset of 2.0V. This offset may vary by  $\pm 1v$  according to the modulator temperature compensation requirements.

An ADC0834 four channel ADC (U6), is used to monitor various analogue quantities within the radio. The DFM4-9 modem communicates with the ADC by controlling 3 lines. An active high chip select, "ADCS" line (U5-p33), a data clock, "DCLK" line (U5-p35), and a serial data, "SD" line (U5-p36).

The state of the data line from the ADC is clocked into internal registers of the DFM4-9 on the rising edge of the clock line. The data stream consists of a four bit preamble, which includes the channel address. From the 5th clock pulse onward, the ADC drives the data line with the data of the conversion, MSB first. The transaction is terminated with the CS line being set to inactive low.

The first channel is used to monitor temperature, by measuring the voltage from an LM335 monolithic temperature sensor U6. The LM335 is situated in the radio section, adjacent to the 20.1666MHz XTAL and VCXO synthesiser reference oscillator, and is fed into the modem section via connector X4-p14, ADC0.

The second channel is used to monitor RSSI, by measuring the RSSI output of the NE615 IF circuit. This signal is fed to the modem section from the radio section via connector X4-p21, ADC1.

The third channel is used to monitor the power level output by the RF transmitter, by measuring a voltage derived in the power control section of the radio. This is used to determine the "health" of the radio transmitter. This signal is fed to the modem section from the radio section via connector X4-p9, ADC2.

The fourth channel of the ADC, is used to measure the voltage of the +13.8 volt supply rail and to sense the presence of the audio handset at power up. The handset derives microphone bias from the modulator stage, and the voltage at this point is measured and compared with a fixed nominal value, to determine if the handset is connected at the time of TC-900DR power up. This signal is fed to the modem section from the radio section via connector X4-p24, ADC3. This 4th ADC channel is also multiplexed to measure the AFC control voltage so that an indication of received signal frequency can be made. U14:D is used to perform this switching function.



An auxiliary latch (U11) is provided to supply some of the output control to the radio section.

The latch receives data from the same data buss as the RAM. The lower six bits are fed to an R/2R ladder network DAC (RN2), which is used to present an analogue voltage to the radio's local oscillator synthesiser frequency reference. This correction voltage provides for excellent temperature stability of the radio. This signal is fed to the radio section via connector X4-p15, TEMP COMP.

The two top bits of the latch, drive auxiliary functions within the radio section.

Bit 6 is used to control the power of the RF transmitter in the radio section. This can be set to a HIGH level of 1W, or to a LOW level of 200mW. This signal is fed to the radio section via connector X4-p10, TXPWR.

Bit 7 provides the RF transmitter enable signal to the radio section. No RF signal can be transmitted unless this signal is set to active. This signal is fed to the radio section via connector X4-p11, TX EN.

#### 2.5.4 TRANSMIT SIGNAL CONDITIONING

The transmit section of the DFM4-9 modem, outputs a byte of data, four times per bit period, on the "TDx" pins (TD1..TD7, U5-p56..49).

The parallel data is presented to an eight bit R/2R ladder network (RN1). This is a simple DAC which produces the transmit waveform at its output.

This signal is fed into opamp (U13:C) for amplification and filtering. This stage is a single pole low pass filter, used to attenuate clocking noise in the waveform. Two more filter stages follow, U13:B and U13:D.

By using 4 samples per bit, and an 8 bit resolution, precise control of the waveform shape is possible.

The gain and pole frequency of amplifier stage U13:C is switched by the DFM4-9 modem, via a 74HC4066 CMOS FET switches (U14:A). This is to produce the required waveform for the two data rates currently available. The bit rate output signal, "BRO" is provided at U5-p44.

For 4800 baud, components C43 and R45, are "included" in the feedback loop of the amplifier stage. When 9600 baud is selected, switch U14:A is turned OFF, and the components are "excluded" from the circuit.

#### 2.5.5 RECEIVE SIGNAL CONDITIONING

The data receiver, consists of several functional blocks. Some of these are implemented by internal functions of the modem IC, and the remainder by external circuitry.

The incoming analogue signal, is routed to two separate sections of circuitry. One to process the received clock, the other to process the received data.

### 2.5.5.1 DATA RECOVERY

The data recovery is based around an "Integrating Data Slicer" circuit.

This circuit consists of a non-inverting, resetable integrator (U16:A, U12:C and U15:D), a dual peak detector (U12:A,B) and a reference divider.

The received signal is passed into the modem section from the radio section via connector X4-p20, "RXSIG".

The signal is integrated by the non-inverting integrator formed by U16:A, and U12:C, and then forwarded on to a comparator (U7:B), where it is "squared up", ready to be read by the DFM4-9 modem.

An output signal is provided by the modem IC, to indicate the sampling point. In fact this signal, called "RxCLKOUT", is pulsed high immediately after the sampling operation has taken place.

The integrator is reset at the end of each bit period, by the 74HC4066 FET switch, U15:D, after the value of the bit has been read. The DFM4-9 provides this reset signal at the reset integrator "RxCLKOUT" pin (U5-p19).

The integrated receive signal, is then fed to the dual peak detector, where the positive and negative peaks of the integrated signal are detected, and stored on the capacitors C28 and C27.

The peak detector's attack time is determined by the output resistance of the opamps (U12:A,B) and the bulk resistance of the diodes (D7, D4). The decay time however is determined by the values of the hold capacitors (C28, C27) and the summing resistors (R24, R25).

Four diodes (D5, D6, D8, D9) are used to clamp the reference rail. If the incoming signal has a large DC shift, this clamping arrangement ensures that the data slicer reference level is quick to settle somewhere near its final operating point. This clamp however does impose a maximum allowable input signal level. Exceeding this level will cause the integrated signal to directly modulate the reference rail. The derived reference voltage level, is amplified and output back to the radio section, where it is used for AFC in the receiver.

### 2.5.5.2 CLOCK RECOVERY

The received clock signal is presented to the DFM4-9 modem at its "RXCLK" input (U5-p4).

Within the DFM4-9, a phase-locked-loop is used for data clock recovery, which relies on level transitions in the data signal.

This mechanism maintains the data sampling point in the center of the bit cells by comparing the signal's level transitions with an internal clock.

An error in the relative phase of the RXCLK signal and the internal clock, causes the internal clock to increase or decrease in speed, to bring the phase error to zero.

The phase-locked-loop clock recovery mechanism within the DFM4-9 modem, maintains the sampling point in the center of the bit cells, but the use of the integrator demands that this take place at the end of the bit cell. This means that the signal fed to the DFM4-9 modem RXCLK input must be delayed by half a bit period.

To obtain this, the received signal is passed through a half bit delay, low-pass filter (U16:D, U12:D, U7:A). The delay characteristics of this filter, are switchable between the available data rates of 4800 and 9600 baud operation, by five 74HC4066 FET switches. These switches are controlled by the "BRO" output of the DFM4-9.

### 2.5.6 USER INDICATIONS

There are four indication LED's supplied for user information. POWER, TXMIT, SYNC and RXSIG. The POWER LED is green, TXMIT LED is red and the other two are yellow.

The POWER LED (LED4), is driven from the 13V8 power supply line. When supply is present the LED is activated.

The TXMIT LED (LED3), is activated when PTT is present. It is driven when the switching transistor Q3 is turned ON by the DFM4-9 modem "PTT" output going active (UX3-p38).

The SYNC LED (LED2), is activated when a valid data stream has been detected. It is driven when the switching transistor Q2 is turned ON by the DFM4-9 modem "SYNC" output going active (U5-p43).

The RXSIG LED (LED1), is activated when the received signal level is at a usable level. It is driven when the switching transistor Q1 is turned ON by the DFM4-9 modem "RXSIG" output going active (U5-p43).

### 2.5.7 POWER SUPPLY

The power supply is based around the use of three voltage regulators that supply +13V8, +8V and +5V.

The incoming power is applied to a bridge rectifier (BR1),. Normally two legs of this bridge are linked out, so it provides only reverse polarity protection shunt diodes. A special manufacturing option allows for AC input, where the links are removed. A 2200uF electrolytic capacitor (C2), provides filtering for AC inputs.

This is then applied to an LT1086 low dropout regulator (REG1). The output of this is set to 13V8 and feeds the RF final amplifier, and the following two regulators.

The 8V regulator (REG2) takes it's input directly from the 13V8 rail, its output is routed to the radio section, and provides supply for one of the amplifier devices.

The 5V regulator (REG3) provides the supply rail for the modem section logic circuits. It takes it's input from the 13V8 rail via diode D1. Extra filtering capacitance is provided by C7.

## 2.5.8 INTERFACES

### 2.5.8.1 RADIO SECTION

The modem section interfaces to the radio section via connector JX3. The physical link between the two sections is achieved via a 90mm length of 26 way ribbon cable.

Refer to interface diagram "RADIO MODEM INTERFACE", drawing number TC01-05-18 sheet 1/3.

<u>CONNECTOR JX3</u>	<u>SIGNAL DESCRIPTION</u>
<u>PIN NUMBER</u>	
1	13V8 POWER SUPPLY RAIL
2	13V8 POWER SUPPLY RAIL
3	13V8 POWER SUPPLY RAIL
4	GROUND
5	GROUND
6	GROUND
7	8V POWER SUPPLY
8	8V POWER SUPPLY
9	ADC2 (i/p - TRANSMIT POWER SENSE)
10	TXPWR (o/p - TRANSMIT POWER LEVEL)
11	/TX EN (o/p - TRANSMIT ENABLE)
12	/PTT OUT (o/p - PRESS TO TALK)
13	TXSIG (o/p - TRANSMIT DATA)
14	ADC0 (i/p - TEMPERATURE SENSOR)
15	TEMPCOMP (o/p - TEMPERATURE COMPENSATION)
16	EN (o/p - ENABLE FOR SYNTH)
17	DA (o/p - DATA FOR SYNTH)
18	CK (o/p - CLOCK FOR SYNTH)
19	LD (i/p - LOCK DETECT FROM SYNTH)
20	RXSIG (i/p - RECEIVED DATA)
21	ADC1 (i/p - RSSI SIGNAL)
22	AFC CTL (o/p - AFC CONTROL)
23	SPARE (UNUSED)
24	ADC3 (FOR SUPPLY/HANDSET)
25	TEST1 (UNUSED)
26	TEST2 (UNUSED)

### 2.5.8.2 PORT A

The modem section interfaces to the host user via the 9 way female DMIN type connector JX1.

<u>CONNECTOR JX1</u> <u>PIN NUMBER</u>	<u>SIGNAL DESCRIPTION</u>	
1	DATA CARRIER DETECT	(DCD)
2	RECEIVE DATA OUTPUT	(RXD)
3	TRANSMIT DATA IN	(TXD)
4	DATA TERMINAL READY	(DTR)
5	COMMON	(COM)
6	DATA SET READY/prog mode	(DSR)
7	REQUEST TO SEND	(RTS)
8	CLEAR TO SEND	(CTS)
9	RING INDICATE/BER Test Mode	(RI)

Note: Pin 6 and pin 9 provide a dual function which depends on the mode that the TC-900DR is operating in.

### 2.5.8.3 PORT B

For the standard delivery version of the TC-900DR, port B is normally not enabled. This port provides no handshake lines except DCD (parallel connected with DCD on Port A) and DSR which is wired active.

<u>CONNECTOR JX1</u> <u>PIN NUMBER</u>	<u>SIGNAL DESCRIPTION</u>	
1	DATA CARRIER DETECT	(DCD)
2	RECEIVE DATA OUTPUT	(RXD)
3	TRANSMIT DATA IN	(TXD)
4		
5	COMMON	(COM)
6	DATA SET READY/prog mode	(DSR)
7		
8		
9	RECEIVE SIGNAL STRENGTH INDICATOR	(RSSI)

Pin 9 is used to output the RSSI signal for external measurement.

The RSSI output ranges from 0 to 5 Volts, where 5 volts indicates the strongest signal. It is important to note that this port output has a high impedance of around 50K ohms and loading will decrease accuracy of the recorded measurement.

### 2.5.8.4 POWER

Power is supplied to the modem section via connector X1. Typically +13.8V DC is applied to the top pin, with the common connected to the bottom pin.

---

---

## SECTION 3

### OPERATIONAL DESCRIPTION

---

---

#### 3 OPERATIONAL DESCRIPTION

##### 3.1 GENERAL

The Trio DataCom TC-900DR radio modem, is a full duplex 4800/9600 bits per second device, which converts digital data into an analogue form suitable for transmission over a radio channel. It uses specially filtered direct binary frequency modulation techniques to achieve this. It conversely, converts the analogue signal derived from a radio channel into a digital data signal.

The heart of the unit is the DFM4-9 modem IC. This performs all waveform shaping, randomising and de-randomising, NRZ/NRZI conversion, clock recovery, and HDLC framing and CRC error generation and checking. These functions are performed simultaneously, allowing full duplex operation at up to 9600bps.

The modem is fully HDLC compatible. The user is provided with two RS232 compatible ports, which may each be configured with a standard PAD interface or SLIP/KISS protocol driver. The unit may also be configured for repeater operation.

It may be configured to use RS232 handshake lines, or XON/XOFF flow control on Port A.

The modem features a unique supervisory signalling channel, which embeds low speed data in the primary bit-stream, and is transparent to the user of the primary channel.

The supervisory signalling channel can be disabled if not required. It could be used to pass low speed data such as E and M status or C/DSMA control schemes.

The data rate of the supervisory signalling channel can be set independently for transmit and receive. It can range from about 40 to 533 bps with the primary channel rate at 4800 baud, and 80 to 1067 bps at a primary channel rate of 9600 baud.

*NOTE: with the supervisory signalling channel active, the bit-stream is not compatible with standard HDLC interface devices (such as 8530).*

The host user port may be configured for baud rates of 300 to 19K2, with 7 or 8 bit character size, 1 or 2 stop bits, and parity off/odd/even.

The DFM4-9 modem includes several data tables which are used to generate waveforms with different characteristics. This is primarily for optimum performance at differing baud rates. A custom data table can be placed into the NVRAM of the modem, for specialised applications.



Configuration of the modem is fully programmable, with parameters held in non-volatile memory. All configuration parameters are accessible with the TC-DFM9IP Installation Program.

Configuration parameters include but are not limited to:

- Supervisory Signalling Channel rate.
- XON/XOFF or RTS/CTS/DTR/DCD handshake mode.
- Default transmitter lead in delay.
- Constant specifying minimum RF RSSI for valid receive.
- Constant specifying minimum Tx power level.
- Asynchronous serial port parameters.
- User interface operating mode :
  - User port interface protocol
  - PAD Parameters

### 3.2 TC-900DR MODEM FIRMWARE REVISION VA2.3.0

#### 3.2.1 FUNCTIONAL CHANGES AND ADDITIONS

The Diagnostics "M" command (serial port Mode) completed. The implementation of this command was not finished in time for VA2.2 release. This command is used to configure either of the two user ports, for character length, number of stop bits, parity odd/even/off.

- 1 Bit 7 is used to address which port is being referenced (set to "0" for Port B, or set to "1" for Port A).
- 2 Bit 6 determines the character size. Set to "0" for 8 bit, or "1" for 7 bit character size.
- 3 Bit 5 is set to "1" to enable parity, "0" to disable parity.
- 4 Bit 4 determines Odd (set bit to "1"), or Even (set bit to "0") parity if Bit 5 is set.
- 5 Bit 3 determines the number of stop bits. Set to "0" for 1 stop bit, or set to "1" for 2 stop bits.
- 6 Bits 2, 1, and 0 are used to select the baud rate. The following table shows the available rates. The 19.2K baud selection should only be made for Port A if Port B is disabled. The last selection of 110 baud may be deleted from future firmware revisions.

Bit	Bit 1	Bit 0	Baud Rate
0	0	0	300
0	0	1	600
0	1	0	1,200
0	1	1	2,400
1	0	0	4,800
1	0	1	9,600
1	1	0	19,200
1	1	1	110

Channel Access Strategy 3 is now defined. This is selected by setting bits 1 and 0 (TxCtrl1 and TxCtrl0) in "Config1", both to "1". This mode forces a randomly generated delay **before** transmission begins, even if the channel is perceived to be clear. This delay mechanism is similar to that used in Channel Access Strategy 2 when the channel is perceived to be busy. This operating mode is useful in systems that include remote terminals that generate reports at regular fixed intervals. In such a system, slight differences in this interval between two remotes, would cause them to become synchronised for some time, and thus transmissions from them would consistently

collide. Inserting a randomly generated delay before all transmissions will reduce the incidence of this effect.

The RS232 DCD handshake line now becomes active only during output of received data. Formerly, the DCD line indicated real time SYNC status of the modem data receiver. To facilitate the use of RS232 to RS422/RS485 converters, the DCD line is driven **active** a short time (approximately 0.5mS) before the received data is output to the user port, and lingers for approximately 2 to 3 character times (i.e. is proportional to baud rate of user port). The modem generates only one DCD function, which is available on pin 1 of both Port A and Port B. Thus the DCD pin of both user ports will be activated when either port is outputting received data.

### 3.2.2 OTHER ENHANCEMENTS

Improvements in handling of the RS232 RTS line (Port A), makes the modem more tolerant in the timing of rapid OFF transitions of this handshake line, immediately after the end of the last character of a message. It has been observed that communications drivers in many PLCs turn their RTS output line OFF very shortly after the end of a message, resulting in the loss of the last character of the message with previous modem firmware revisions. This revision does not suffer this problem.

The random number generator used for the Channel Access Timer, has been improved to make it more random.

### 3.3 FACILITIES AND CONFIGURATION INFORMATION FIRMWARE VERSION 2.2

#### 3.3.1 GENERAL

The TC-900DR provides fully transparent remote diagnostics facilities, and expanded data stream switching, which supports advanced stream trunking applications.

The diagnostics core, supports the reporting of current analogue conditions, including temperature, RSSI (Received Signal Strength Indication), RF transmitter power, AFC (i.e. received signal frequency offset), and supply voltage. Also, an extensive range of operating parameters may be changed remotely, including remote (RF) channel change.

Configuration options, allow various system topology's, so that the location of the system's diagnostics controller is flexible.

The data stream switching mechanism has been upgraded to allow either MUX/DeMUXing or multi-stream routing functions, independently for each port.

A few other minor upgrades to previous revisions of firmware are:

- \* Two different "ticker clocks" implemented, one running at 1mS, and used for a) PAD Character Input Timers, and b) Channel Access Timer when running in Collision Avoidance mode. The other "ticker clock" runs at 10mS, and is used for the PTT timer, and a host of other internal functions, not accessible by configuration programming.
- \* When XON/XOFF flow control is enabled on PortA, the CTS output line continues to operate correctly, indicating the flow control state. XON/XOFF characters are generated in addition to, and reflect state changes on this line. As before, the DTR input line is ignored while XON/XOFF flow control is set, and the RTS line is not required to be true to validate transmit data.
- \* The modem stores data for transmission in buffer memory, which is limited. It also keeps track of frame boundaries of the stored data, and the number of frames it can manage is also limited by the amount of memory used to record the position of the frame boundaries. Thus it is possible that the modem can approach overflow before exhausting data buffer space, if frames are small. This flow control state is activated when the "frame boundary memory" approaches half full, for similar reasons used in data buffer management.
- \* If the Supervisory Signalling Channel is enabled in both transmit and receive directions, and PortA is configured in Repeater Mode, then the received Supervisory Signalling Channel data is also repeated, by being copied from the Supervisory Signalling Channel receiver to the Supervisory Signalling Channel transmitter.
- \* RSSI measurements are full eight bit conversion, so the "min\_RSSI" configuration parameter lies in the range 0 - 255 (decimal). This is only important when setting this parameter without the aid of the DRPROG programmer.

### 3.3.2 INTERNAL DATA STREAM ROUTING

Essentially, all data streams travelling in both directions (transmit and receive), are examined and tested for a match with the diagnostics receive SID header code. If this match test is successful, then the data frame is copied into a buffer for the diagnostics core to process. The data frame also continues in the original direction as well. Thus diagnostics frames received from the radio channel (receive data), and from the stream switcher (transmit data, from one of the physical ports), are copied as they pass between the HDLC "device" and the data stream "switcher". Messages generated by the diagnostics core in response to received commands, are always sent back to the source of the command. That is, if a status request is received from the radio channel side of the modem, then the response is directed back out of the radio channel.

This dual access structure, allows the diagnostics controller to be located on either side of the modem, and thus supports any system topology.

### 3.3.3 DIAGNOSTICS REPEAT FUNCTION

Some applications will require that the "base" unit in a point to multi-point system repeats diagnostics frames. This will be the case where the system diagnostics controller is attached to a remote terminal in the system, and polls the system population from this point. The "base" unit must re-transmit diagnostics frames which are not addressed to itself. A "diagnostics repeat" configuration bit enables this function.

### 3.3.4 DIAGNOSTICS FRAME STRUCTURE

Diagnostics data frames, are structured according to a defined protocol. A frame consists 1st of the SID header code, which would normally (but not necessarily) be 00. Following this is a three byte address of the destination unit, followed by a three byte source address. An addressed unit responding to a diagnostics command, will swap these two address fields around, in the response frame. The destination address in a diagnostics frame to a TC-900DR unit, is in fact the unique (factory) serial number of the unit. By convention, the diagnostics controller (a DOS based PC), will use a unique address for itself, outside the range of permissible TC-900DR addresses (e.g. 000000). Following the two address fields, is a single character command/response code, which is in turn followed by any operands that may or may not be required for the command/response. Total frame size is limited to 17 bytes. After the SID header, address fields, and command/response mnemonic, this allows up to nine bytes of data to be transferred per diagnostics frame.

### 3.3.5 DIAGNOSTICS COMMAND SET

The following is a list of the command set recognised by the diagnostics core in the TC-900DR Firmware. Also is tabulated the response to each command. The following examples use address 123456 for the TC-900DR unit address, and 000000 for the address of the system diagnostics controller. For the purposes of clarity only, each byte in the example messages is separated by a comma. Mnemonics are represented in quoted form to indicate an ASCII character (e.g. "C" is actually binary byte h'43).

#### B Warm Boot Command.

This command forces the addressed unit to perform a "warm boot". Previous to this, the unit will have been halted (see "H" command), and one or more parameters changed with "P" and "W" commands.

Syntax:-

Command:- 12,34,56,00,00,00,"B"

Response:- 00,00,00,12,34,56,"b"

#### C Calibration Constant Poll.

This command requests the addressed unit to reply with it's internal Analogue To Digital Converter (ADC) calibration constants. These are necessary to accurately interpret the data sent in Status Poll ("S") replies. This command has no operands, and the response mnemonic is "c". The form of the command and reply is:

Syntax:-

Command:- 12,34,56,00,00,00,"C"

Response:- 00,00,00,12,34,56,"c",tt,rr,pp,ff,ss

Where:-

tt = Temperature calibration code

rr = RSSI calibration code

pp = Transmit Power calibration code

ff = Received Frequency Offset calibration code

ss = Power Supply calibration code

**D Powered Up Response**

This command is sent from the modem to the controller in response to a status poll ("S") immediately after the modem has been powered up. The modem will continue to send this command in response to a status poll until the controller acknowledges the command with a "d". The modem will then respond normally to a status poll.

This mechanism is used by the controller to determine whether it requires calibration data from the modem.

Syntax:-

Command:- 00,00,00,12,34,56"D"

Response:- 12,34,56,00,00,00"d"

**F Set New RF Synthesiser Frequency.**

This command forces the unit to set the RF synthesiser to a new frequency, thus selecting another radio channel. This command has one operand, which defines the source of the synthesiser data. A value of zero, indicates that the frequency data has already been set with a parameter set command. Values from one to four select one of the channels stored in the NVRAM of the modem configuration. The addressed unit responds with an "f" reply, before executing the channel change command (i.e. on the old channel).

Syntax:-

Command:- 12,34,56,00,00,00,"F",nn

Response:- 00,00,00,12,34,56,"f"

Where:-

nn = 00 to 04 to select data source.

**H Halt Command.**

This command forces the addressed unit to halt all internal operations, except diagnostics processing. This is necessary, when changing some parameters, before a warm boot command is issued to the re-configured unit.

Syntax:-

Command:- 12,34,56,00,00,00,"H"

Response:- 00,00,00,12,34,56,"h"

**M Set Serial Port Mode.**

This command forces the addressed unit to change the operating mode of one or both serial ports. Parameters such as character size, number of stop bits, parity etc. are changed with this command. It should be noted, that data may be lost while the operating mode of the serial ports is changed.

**Syntax:-**

Command:- 12,34,56,00,00,00,"M",xx

Response:- 00,00,00,12,34,56,"m"

**Where:-**

xx = Serial port address bit and mode data

**P Parameter Set command.**

This command stores the contents of the operand string to a storage buffer. No other action is taken. This command should be immediately followed by a "W" command. See "W" command below. The parameter may be either a bit quantity, a byte quantity, a word quantity, or a string quantity. The diagnostics core in the modem firmware determines this from the parameter identifier, which indexes an internal lookup table. String quantities are of indefinite length, and determined by the length of the operand string in the received "P" command. The "P" command response ("p"), echoes the complete received string. This is unique to the "P" and "W" commands.

**Syntax:-**

Command:- 12,34,56,00,00,00,"P",nn,aa,bb,cc,...

Response:- 00,00,00,12,34,56,"p",nn,aa,bb,cc,...

**Where:-**

nn = parameter identifier

aa, bb, cc,... are data value(s) for selected parameter



**R Parameter Readback command.**

This command forces the addressed unit to read the state of the addressed parameter, and send this data back to the command originator (diagnostics controller) in a reply message. Again the size of the parameter (bit, byte, word, or string) is determined by the parameter identifier. String parameters are returned as a string of eight consecutive bytes.

**Syntax:-**

Command:- 12,34,56,00,00,00,"R",nn

Response:- 00,00,00,12,34,56,"r",nn,aa,bb,...hh

**S Status Poll.**

This command requests the addressed unit to reply with the current value of analogue quantities, present temperature, last/present received RSSI, transmit power of last transmission, received frequency offset of last/present received signal, and present supply voltage.

**Syntax:-**

Command:- 12,34,56,00,00,00,"S"

Response:- 00,00,00,12,34,56,"s",tt,rr,pp,ff,ss

**Where:-**

tt = Temperature conversion code

rr = RSSI conversion code

pp = Transmit Power conversion code

ff = Received Frequency Offset conversion code

ss = Power Supply conversion code

**T** Diagnostics Watchdog Timer command.

This command forces the addressed unit to (re)set a special watchdog timer. The operand value is a word (16\_bit) quantity. A zero value will disable the timer. A non-zero value will initialise the timer. This timer, while non-zero, will be decremented periodically. If the timer is decremented to zero, then the TC-900DR will perform a cold boot, thus restoring operating parameters from the NVRAM configuration memory. This command should be used in conjunction with parameter set and write commands. If a parameter change renders the unit in-operable, then either it will not continue to receive further "T" commands to reset the timer, or the system diagnostics controller may cease to send the timer reset commands, thus will eventually cause the unit to cold boot.

## Syntax:-

Command:- 12,34,56,00,00,00,"T",nnnn

Response:- 00,00,00,12,34,56,"t"

## Where:-

nnnn = timer reset value (16 bit value)

**V** Request Firmware Version String command.

This command requests the addressed unit to reply with a string indicating it's firmware version number. Future firmware versions may provide further facilities that may then be used, by sending appropriate commands.

## Syntax:-

Command:- 12,34,56,00,00,00,"V"

Response:- 00,00,00,12,34,56,"v","A2.2.0"

**W Write Parameter command.**

This command is used in conjunction with the "P" parameter set command. This parameter write command must be identical to the previous parameter set command. Providing they are identical (excepting the command mnemonic), then the operand is written to the selected modem operating parameter. Changing some parameters while normal operation continues could produce improper operation, possibly resulting in corrupted parameters, so the unit should be halted with a HALT command before such parameters are changed.

**Syntax:-**

Command:- 12,34,56,00,00,00,"W",nn,aa,bb,cc,...

Response:- 00,00,00,12,34,56,"w",nn,aa,bb,cc,...

**Where:-**

nn = parameter identifier

aa, bb, cc,... are data value(s) for selected parameter

### 3.3.6 PARAMETER SET

The following is a list of parameters which may be remotely set. Parameters marked with a "\*", should only be changed while the unit is in a halted state, followed by a warm boot command. Parameters marked with a "#", may only be referenced in an "R" readback command. Attempts to change these with "P" and "W" commands may produce unpredictable results.

Parameter Identifier	Parameter Type(Size)	Parameter Name
00 (^@)	undefined	not defined, reserved to facilitate future expansion
01 (^A)	undefined	not defined, Trio DataCom test use only
02 (^B)	byte	Drift_Offset
03 (^C)	word	PTT_Time
04 (^D)	string	Synthesiser Data for channel change
05 (^E)	byte	min_RSSI
06 (^F)	byte	Tx_LID
07 (^G)	byte	Slot_Num
08 (^H)	byte	Slot_Time
09 (^I)	word	SIDA1 and SIDA2
0A (^J)	word	SIDB1 and SIDB2
0B (^K)	word	SIDD1 and SIDD2
0C (^L)	byte	KISS_adrA
0D (^M)	byte	KISS_adrB
0E (^N)	byte	EOMA_code
0F (^O)	byte	EOMB_code
10 (^P)	byte	input_timeA
11 (^Q)	byte	input_timeB
12 (^R)	byte	frame_sizeA
13 (^S)	byte	frame_sizeB
14 (^T)	bit *	SLIP/KISS_mode portA
15 (^U)	bit *	SLIP/KISS_mode portB
16 (^V)	bit	EOM_enable portA
17 (^W)	bit	EOM_enable portB
18 (^X)	bit *	KISS_mode portA
19 (^Y)	bit *	KISS_mode portB
1A (^Z)	bit	RTS/CTS_interlock portA
1B (^[)	bit *	PORTB_enable
1C (^\ )	bit *	Repeat_Enable portA
1D (^])	bit *	Repeat_Enable portB

1E (^)	bit *	(Not defined, reserved for Error Recovery Enable)
1F (^_)	bit *	(Not defined, reserved for Error Recovery Enable)
20 ( )	bit	LiveFrame portA
21 (!)	bit	LiveFrame portB
22 (")	bit	XonXoffMode portA
23 (#)	bit	XonXoffMode portB
24 (\$)	byte	PORTA_Config
25 (%)	byte	PORTB_Config
26 (&)	bit	diags_repeat
27 (')	bit	TxPWR_HI/LOW
28 ((	bit	SID_Enable
29 ())	bit	RTS2PTT
2A (*)	bit	SYNC2PTT
2B (+)	bit	SCDO_Default
2C (.)	bit	SupChnFunc
2D (-)	bit	TxCtr1
2E (.)	bit	TxCtr0
2F (/)	byte	Config1
30 (0)	byte #	SMR1 (portA serial port mode)
31 (1)	byte #	SMR0 (portB serial port mode)
32 (2)	byte #	BRR1 (portA serial port baud rate)
33 (3)	byte #	BRR0 (portB serial port baud rate)
		<b>Additions for version A2.3.0</b>
34 (4)	byte	err_limit (Frame Error output for Base Station)
35 (5)	byte	err_flags
36 (6)	word	good_cnt
37 (7)	word	bad_cnt
38 (8)	word	lost_sync_cnt
39 (9)	word	lost_RSSI_cnt
		<b>Additions for version A2.3.1</b>
3A (:)	byte	DCD_timeA
3B (;)	byte	DCD_timeB
3C (<)	byte	Diags_Delay

### 3.3.7 ADVANCED STREAM ROUTING FUNCTIONS

The TC-900DR provides advanced stream routing functions. For each port, there is allocated two SID (Stream Identifier) codes, and a configuration flag that determines how these two codes are used.

With the flag off, SIDx1 (where x is A or B for portA and portB respectively) defines the SID code of received frames that are de-multiplexed to the port, and SIDx2 defines the SID code that is inserted by the modem at the front of every frame it transmits. Thus only one data stream passes through the port, and the modem manages the insertion and extraction of SID header codes.

With the configuration flag on, SIDx1 and SIDx2 define a range of streams that will be passed from the received data to the port. SIDx1 defines the lowest stream, while SIDx2 defines the highest stream. The SID header codes remain on the received frames, and are passed to the port. For transmit data, the modem assumes that the SID header codes are already in place, being inserted by some external device, and no processing is performed on the transmit data. For this application, it is highly desirable that a SLIP (or KISS) driver be employed so that frame boundaries are defined.

These functions are independent for each port, so it is possible to construct (say), a multi-drop, multi-hop repeated data system, where one stream can be "peeled off" at each repeater site. There are many other possibilities, the TC-900DR product simply requiring suitable configuration to construct a vast range of network topologies.

## 3.4 FACILITIES AND CONFIGURATION INFORMATION VERSION 2

### 3.4.1 GENERAL

The TC-900DR, provides two independent user data streams, which are multiplexed onto the radio channel data stream. The stream switching protocol also provides for an embedded remote diagnostics facility.

The two (asynchronous) user ports can be configured for a variety of baud rates, character sizes, parity, and stop bits.

Flow control on user Port\_A may be set to use RTS/CTS/DTR/DCD handshake lines, or XON/XOFF characters. Flow control for Port\_B may be set to use XON/XOFF characters, or no flow control. Port\_B is not supported by RTS/CTS/DTR handshake lines.

Data is transported in (HDLC) frames, protected by a 16 bit CRC error checking sequence, conforming to the CCITT standard. Received frames found to contain errors are discarded. The TC-900DR does not release received data frames to the user port, until completely received, and error checked.

Maximum frame size is configurable for each port independently, and may be set to any value between 4 and 255. Frame size limiting is disabled by setting this parameter to zero (0).

Each user port, is supported with PAD functions conforming to X3, or SLIP\*<sup>1</sup> or KISS\* protocol interface.

For Point To Multipoint applications, a unique collision avoidance mechanism is available, with configurable channel access parameters.

All configuration parameters are held in a non-volatile memory. Normally, this memory can only be written when the radio modem is connected to a programmer.

### 3.4.2 BRIEF OVERVIEW OF MODEM INTERNAL OPERATION.

#### 3.4.2.1 DATA TRANSMITTER

Each physical user port, is supported by a "driver", in this case a PAD (Packet Assembler/Dis-assembler) or SLIP/KISS. This function transfers the data from the port, to a buffer memory. This buffer not only stores the raw user data, but also keeps track of frame boundaries. Another functional block, retrieves that stored data, and feeds it to a third mechanism, which generates the data waveform which is applied to the radio transmitter modulator.

---

<sup>1</sup> \* SLIP ®™ KISS ®™

### 3.4.2.2 DATA RECEIVER.

The receiver extracts data frames from the received signal, and stores the contents of the frames into buffer memory. It may also perform a steering function, if more than one port is enabled. A second function is to retrieve the stored data, and send it to the user port(s), consistent with some flow control regime.

### 3.4.3 SELECTING FRAME SIZE

The selection of maximum frame size is a compromise between channel through-put and data propagation time over the link.

The receiving modem collects and stores the incoming data frame, and on detecting the end of the frame, checks if an error has occurred. If not, then the stored data is released for transfer to the user data port. If an error has occurred, then the stored data is "flushed" from the data store. Thus a delay is introduced between the time the frame data begins to enter the destination radio modem, and the time this data begins to emanate from the user port. This delay is effectively the length of the data frame, which consists of the user's data, plus the framing overhead. This overhead will include at least 24 bits for the HDLC Flag and FCS (error checking data), plus another 8 bits if SID (Stream Identifier) codes are enabled (refer to detailed description elsewhere in this document), plus the duration of the transmitter Lead-In-Delay, if the radio transmitter had to be started up to send the data. Thus larger frames reduce the proportional overhead, but increase the end to end propagation delay.

On the assumption that the radio transmitter was already on, and that the frames include the SID header, then every frame includes 32 bits of overhead.

Assuming that the user port is configured for 8 bit character size (8 bit data no parity, or 7 bit data and parity), and 1 stop bit, then each character is carried as a 10 bit sequence on the asynchronous user channel. On the radio channel data stream, user data is stripped of the start and stop bits used on the asynchronous user port, and transmitted as eight bit "octets", and so the character rate is 1/8th of the bit rate, while on the asynchronous user port, the character rate is 1/10th of the bit rate. For every 16 user characters 32 bits are stripped off, so if the maximum frame size parameter is set to 16, and the nominal baud rates are the same, then the effective character rates on the asynchronous user channel and the synchronous radio data channel will be the same. This also assumes that the supervisory signalling channel is not enabled, and does not allow for the overhead introduced by the HDLC "dummy zero" stuffing mechanism.



### 3.4.4 CONFIGURING PAD PARAMETERS

The Packet Assembler/Dis-assembler (PAD) can be configured with a variety of parameters. Each user port is supported by an identical but independent PAD.

The configuration parameters of the PAD, control how the user data (to be transmitted) is framed. There are three distinct mechanisms that can cause the frame that will carry the user data to be closed.

The first of these is the Maximum Frame Size parameter, already discussed above. As each character is input to the modem, a counter is incremented, and when this counter reaches the set maximum frame size, the data storage mechanism that operates within the modem, will close the frame. This function may be disabled, by setting the parameter to zero.

The second mechanism, is the use of a specified End Of Message (EOM) character. This function is enabled/disabled by a flag in a configuration byte for the port driver. The EOM character may be any 8 bit character. When the EOM function is enabled, all incoming user data is compared to the selected EOM character code, and in the event of a match, the current frame is closed. Note that this match only triggers the frame closure mechanism. The matching character is not deleted from the user data stream, and in fact becomes the last user character in the frame.

The third mechanism, is the implementation of a timer. If the timer is enabled, each character received from the user port re-starts the timer. If the time duration between successive user characters allows the timer to expire, then the frame closure mechanism is invoked. The timer counts in units of "ticker clocks", which is a time interval generated by the modem internally, and is approximately 2.5mS. The reload value for the timer can be set from 1 to 255 ticker clocks. The timer mechanism is disabled by setting the PAD timer parameter to zero.

There is a single bit configuration flag, that allows the radio modem to begin transmitting user data, even before the frame is deemed to be complete. In this case, as soon as there is any data in the storage buffer, the modem begins the transmission procedure. Providing that the input character rate is greater than or equal to the character rate on the synchronous radio channel, then there is no danger of an under-run condition, where the modem transmitter runs out of data before the PAD deems a frame end. However, should this occur, the modem data transmitter function simply closes the frame itself. Further data is carried in the next frame. This may or may not cause problems elsewhere in a system context. If higher protocol layers are employed (e.g. X.25, AX.25 etc.), where address and control fields normally occupy fixed positions in data frames, then the above scenario should not be allowed to occur.

The major advantage of allowing the radio modem to begin the transmission procedure before the frame is deemed to be complete, is that it avoids a (store and forward) delay in the modem transmitter, similar to that required in the receiver. For applications where a transparent point to point link is all that is required, this mode provides the most time efficient transport mechanism.

In fact with the immediate transmission function enabled, there is little necessity to enable the EOM or timer functions of the PAD.

### 3.4.5 SUPERVISORY SIGNALLING CHANNEL: APPLICATIONS & CONFIGURATION.

The reader is referred to drawing number TC01-05-18, which provides a diagrammatic view of this section.

The Supervisory Signalling Channel (SSC) is implemented by the insertion of extra data bits in the primary bit-stream on the synchronous radio channel. These extra bits are inserted between primary data octets, at a rate which can be set to range from once every octet, to once every 15 octets. The SSC operates independently for transmit and receive directions, and can be disabled by setting the rate variable to zero.

The SSC, when enabled, can be configured either to provide end-to-end flow control for Port\_A data, or implement the collision avoidance mechanism.

#### 3.4.5.1 PORT\_A END TO END FLOW CONTROL APPLICATION.

In this configuration, the SSC is used to carry flow control information for data on Port\_A at each end of the link.

SSC data inserted into the transmitted bit-stream, relates to the flow of the primary data stream received. When handshake lines are employed, the DTR line locally controls the flow of receive data to the user port. The state of this line is also logically combined with the "fill" state of the receive buffer, and the result is then sent as SSC data in the transmit data stream. Thus the state of the transmitted SSC data bit is one ("1") if the DTR line is in a "false" state, OR the receive buffer is more than half (approximately) full. In the case where XON/XOFF flow control is used, the DTR line input is instead replaced with the state of the last received XON or XOFF control character.

SSC data extracted from the received bit-stream, is logically combined with the "fill" state of the transmit buffer, and the result is output to the CTS line of the modem. The CTS output line is set to "false" if the transmit buffer is more than half (approximately) full, OR the received SSC data bit is a one ("1"). Thus the CTS line is set to "false" if the local transmit buffer is more than half (approximately) full, OR the remote receive buffer is more than half full, OR the remote DTR input line is "false" (or equivalent XOFF received).

Data flow control is exercised only at the user port. No flow control is used on the radio channel, so once data is entered into the transmit buffer, it will be transmitted. This is the reason why the buffers are only allowed to become half full before the flow control mechanism engages. If the flow of receive data is stopped by deactivating the DTR line, the remaining data in the transmit buffer will not overflow the receive buffer. It should be noted that some hysteresis is used in the buffer occupancy tests, to prevent the CTS line from changing state too often, as some hosts (e.g. DOS machines) appear to get confused when this happens.

If the SSC is not configured for end to end flow control, or is disabled, then the flow control mechanisms still operate at a local level. That is, the CTS line (or equivalent XON/XOFF control regime) reflects the fill state of the local transmit buffer.

### 3.4.5.2 COLLISION AVOIDANCE APPLICATION.

When the SSC is allocated to transporting collision avoidance data, the transmitted SSC data reflects the state of the radio receiver. Other processes in the modem, measure the RSSI signal from the radio receiver, and compare this measurement to a preset threshold level. This threshold value is also held in the non-volatile configuration memory. The result of the comparison is copied to the modem pin that drives the RXSIG LED. The transition of the RXSIG signal from off to on, (re)starts an internal timer. This time is a fixed value of  $35 \pm 5\text{mS}$ . The SSC data transmitted, is simply a copy of the RXSIG pin state, until the timer terminates, and there-after, the modem data receiver must be "SYNC'd" to maintain the "1" state of the SSC transmit data. Thus the SSC data transmitted by the modem will indicate that the radio channel receiver is busy, using only RSSI for the first  $35 \pm 5\text{mS}$ , but after this time, data receiver SYNC is used to qualify this state. This prevents low level RF interference from effectively blocking the channel.

At the receiving end, the recovered SSC data is used by the radio modem to determine when the receiver of the destination station is free. This data can then be used to control it's channel access strategy. Channel access strategies are dealt with in more detail elsewhere in this document.

In such a data transport system, there is a single unit which performs the function of Master, and two or more stations which operate as Slaves. The SSC need only operate in one direction, that from Master to Slaves. In the reverse direction, the SSC can be disabled. That is the SSC in the Slaves is enabled in the data receiver only, while in the Master, it is enabled only in the data transmitter.

### 3.4.5.3 RECEIVED SSC DATA DEFAULT STATE

The received SSC data bit is stored in an internal latch. This latch is updated each time a SSC data bit is extracted from the incoming bit-stream. However, if the radio receiver loses signal, then a default state is forced into the latch. This default state is configurable.

For applications which use the SSC for collision avoidance, this configuration bit would normally be set to "1", so that the remote station would not attempt channel access while the signal from the base is lost.

For applications which use the SSC for end to end flow control, setting the default state of the SSC receive data latch to "0", would cause the CTS output line to indicate local flow control status only, until the destination unit enables it's transmitter, where-upon the received SSC data would reflect the state of the destination receive buffer and DTR input line. Alternatively, setting the default state to "1", would ensure that the CTS output line would be in a "FALSE" state, until the destination unit enables it's transmitter, where-upon the received SSC data would reflect the state of the destination receive buffer and DTR input line.

An associated configuration bit, is one that allows the automatic activation of the radio transmitter, whenever the data receiver attains SYNC. When this configuration bit is set to "1", the modem will automatically activate the radio transmitter's PTT control line when the data receiver is SYNC'd. This could be used at the base end of a small point to multipoint network, using the SSC for flow control, and would not require the host connected to base, to specifically activate the radio transmitter to establish the end to end link.

### 3.4.6 SLIP/KISS PROTOCOL DRIVERS

In addition to a generic PAD, two other host interface protocols are supported, "Serial Line Interface Protocol", SLIP, which hails from the world of UNIX(tm), and an extension of SLIP, KISS "Keep It Simple Stupid", (a rather unfortunate phrase in the present context, but a protocol standard proposed by Phil Kahn, USA, specifically for the control of radio connected data terminals) which includes a facility to send commands which are addressed to the DCE device itself. These commands set operating parameters of the radio-modem DCE, such as transmitter lead-in delay, or radio channel (RF frequency).

Neither of these protocol standards, specify anything about the construction of data packets on the radio channel. Allocation of address, control, and information fields is the user's responsibility.

As standard, the modem is equipped with an 8K (8192 bytes, 32K optional) data storage memory to hold transmit and receive data. This memory is divided equally between transmit and receive buffer space, and equally between the two user ports, so the largest frame size is 4095 bytes, if only PortA is enabled, (or 2047 bytes each if both user ports are enabled), before the frame check sequence (FCS)is appended.

Additionally, the modem can store up to sixty four separate frames for each direction, again split between the two user ports if both are enabled, though the total byte count is still limited to 8192 total.

#### 3.4.6.1 SLIP Protocol Description/Definition

The SLIP protocol, is a data transport protocol, originated and used extensively in UNIX(tm) based systems, and thus also closely associated with TCP/IP networked systems. Although not truly a "standard" it is so widely used that it has become the defacto standard for serial interface in UNIX and many other networked systems. SLIP is a method of framing messages containing binary data, on asynchronous channels. The asynchronous serial channel is configured for eight bit character size, no parity, and one stop.

A specific binary code called FEND (Frame End, hexadecimal value=C0) is reserved to define a frame boundary. Should this same code occur in the data message to be transferred across the channel controlled under SLIP, then an escape sequence is used so that the message byte will not be confused for a FEND. This escape sequence, involves replacing the message hexadecimal C0 code with a two byte sequence FESC, TFEND. FESC (Frame Escape) is the binary code hexadecimal DB, and TFEND (Transposed FEND) is binary code hexadecimal DC. Likewise, if the FESC character ever appears in the user data, it is replaced with the two character sequence FESC, TFESC (Transposed FESC). The TFESC is the binary code hexadecimal DD. The following table clarifies this.

<u>ABBREVIATION</u>	<u>DESCRIPTION</u>	<u>HEX.VALUE</u>
FEND	Frame end	C0 (192)
FESC	Frame escape	DB (219)
TFEND	Transposed frame end	DC (220)
TFESC	Transposed frame escape	DD (221)

As characters arrive at the SLIP receiver, they are appended to a buffer containing the current frame. Receiving a FEND marks the end of the frame, and consequently, succeeding bytes are considered part of the next frame.

Receipt of a FESC code puts the SLIP receiver into "escaped mode", causing it to translate a following TFESC or TFEND back to a FESC or FEND code, appending it to the buffer, and resuming it's normal state. Receipt of any byte other than TFESC or TFEND while in escaped mode, is an error. No translation occurs, and the SLIP receiver leaves escaped mode. A TFESC or TFEND received while not in escaped mode is treated as an ordinary character and stored accordingly. Reception of consecutive FEND characters, causes no action to be taken (i.e. is not interpreted as zero length frames).

An example of a typical SLIP frame is shown below. The message consists of the string DA,C4,C0,C5,DB,20,BD,DC,DD. The SLIP frame will be:-

```
<FEND>,DA,C4,<FESC>,<TFEND>,C5,<FESC>,<TFESC>,20,BD,DC,DD,<FEND>
==>      C0,DA,C4,DB,DC,C5,DB,DD,20,BD,DC,DD,C0
```

### 3.4.6.2 KISS Protocol Description/Definition

The KISS protocol is an extension of SLIP. It uses the same method of framing packets, using FEND, FESC, TFEND, and TFESC codes. However, the first byte in each frame is reserved as a control code, that defines the function/content of the frame, and also contains an address.

This addressing scheme allows up to sixteen "Terminal node controllers" (TNC's), to share a multidrop buss. The top nibble of the control code carries the TNC address, and the lower nibble carries the command code. Normally the address is set at zero for installations containing only one TNC. Note that some extensions have been proposed for the KISS protocol, that properly support addressed multidrop line operation of multiple TNCs, that the present TC-900DR modem firmware does not implement. The following table shows the commands defined by KISS, and the comment column indicates how the TC-900DR modem interprets them.

<u>COMMAND</u>	<u>FUNCTION</u>	<u>COMMENTS</u>
0	<b>Data Frame</b>	The rest of the frame is data to be transmitted.
1	<b>TxDelay</b>	The next byte is the RF transmitter key-up delay in octets.
2	<b>Slotnum</b>	The next byte is the Slotnum parameter.
3	<b>Slot-Time</b>	The next byte is the "Slot" interval in "ticker clocks".
4	<b>TxTail</b>	The next byte is the time to hold up the RF transmitter after the closing FLAG has been sent. This command is obsolete, and not implemented in the TC-900DR.
5	<b>FullDuplex</b>	The next byte is zero for half duplex, non-zero for full duplex. This command is not implemented in the TC-900DR, as it always operates in full duplex mode.
6	<b>SetHardware</b>	Specific for each TNC. This parameter has values between 00 and 03, and commands the TC-900DR to set RF channels 0 to 3. Values above 3 are ignored by the present modem firmware, but may be used in future versions.
F	<b>ExitKISS</b>	Exit KISS and return control to higher level TNC control program. This command is not implemented in the TC-900DR.

### 3.4.7 RF TRANSMITTER CONTROL AND CHANNEL ACCESS STRATEGIES

There are three conditions which cause the modem to activate the radio transmitter. These are: a) receiver SYNC if enabled, as described above; b) RTS if enabled, as described below; and c) the existence of a data frame ready for transmission. The first two mechanisms are absolute, and if enabled, cause an immediate activation of the radio transmitter. There are two configuration bits that control how the availability of a data frame, will activate the radio transmitter, and thus gain access to the channel. For the purposes of this description, these are referred to as Modes A, B, and C.

In Mode A, channel access is immediate. The radio transmitter is activated, and the modem then proceeds to send a preamble sequence, followed by the data. The preamble sequence is necessary for receiver synchronisation, and the length is a configuration parameter. Further discussion of these aspects of the modem configuration are dealt with elsewhere in this document.

In Mode B, the modem will attempt channel access only if the radio receiver is NOT receiving a signal (i.e. the measured RSSI level is below the minimum RSSI threshold as described elsewhere in this document). This method could be used for small point to multipoint systems, where the base station would enable it's radio transmitter on receiving a transmission. Typically this would be done at the base unit by enabling the SYNC-PTT function, as described above. This implements a basic collision avoidance system, without the use of the Supervisory Signalling Channel, which then remains available for flow control applications.

In Mode C, the modem will attempt channel access only if the data receiver is SYNC'd, and the SSC data is "0" (i.e. base receiver free). This is the full Collision Avoidance system as described in detail above.

In the latter two cases, if another data frame is ready for transmission at the time the present one is ending, then it is automatically appended as another frame, and the transmission continues. Obviously since the radio transmitter is already enabled, no preamble is required or sent. The modem itself does not limit the number of consecutive frames it will transmit. If data continues to be input to the modem, once channel access is gained, it continues to be transmitted. It is the responsibility of the user to manage any maximum channel access time in overall system design. However, if the PTT timer is enabled (dealt with in detail elsewhere in this document), and the set time is reached, then the modem will disable the radio transmitter PTT line. User data will now be lost.

For the two latter strategies, if channel access fails (i.e. signal at radio receiver in the former case, or SSC=1 in latter case), then the modem uses a timed delay mechanism before testing for channel availability again.

### 3.4.7.1 SELECTING "SLOTIME" AND "SLOTNUM" VALUES

This delay time is necessary to prevent multiple remotes from attempting to gain access to the channel as soon as it is signalled to be clear after another transmission has finished, as this would result in the transmissions from all these remotes colliding. Instead, when a modem fails to gain channel access, it generates a randomly selected delay time, and when this time has expired, it again tests for channel availability.

There are two parameters which are used to generate the delay time. The "Slotime" parameter defines the size of the time increment used in selecting the delay. This value defines a time counted in "ticker clocks" (approximately 2.5mS), and has an allowable range of 0 to 255. The "SlotNum" parameter defines the upper limit of the random number generator. The random number generator selects an integer between one and the value of "SlotNum", and then multiplies this by the value of "Slotime" to derive the delay time. The "SlotNum" parameter has a maximum allowable range of 1 to 16.

These two parameters together provide a very flexible method of tuning the channel access characteristics of a system, and should be regarded as system tuning parameters. In the absence of any knowledge of a system configuration, Trio DataCom's set default values for these to parameters to 4 and 16 for "Slotime" and "SlotNum" respectively.

### 3.4.7.2 PTT CONTROL BY RTS LINE

Applications relying on establishing a point to point link before data is transferred, would normally require some "manual" method of activating the radio transmitter. A configuration bit enables the RTS input line to be used as a PTT control. The modem is always generating a data signal. During the time when no user data is available, the modem continually generates an "idle" bit-stream of HDLC FLAGS. This sequence produces no data output at the receiving radio modem.

### 3.4.8 SELECTING FLOW CONTROL REGIMES

The type of flow control to be used on the radio modem port(s), depends on the user's application and capabilities of the equipment which the user interfaces to the TC-900DR.

Port\_A, which is always active, can be configured to use the standard RS232 handshake lines RTS/CTS/DTR, or use XON/XOFF protocol.



### 3.4.8.1 PORT\_A, HARDWARE HANDSHAKE FLOW CONTROL

If hardware handshake lines are configured, then RTS must be active to validate characters input to the modem for transmission. As each character is received (i.e. at the end of each character bit sequence) the state of the RTS input line is tested to validate the character. If the RTS line is tested "true", then the character is stored ready for transmission. If "false", then the character is discarded. The modem provides flow control of transmit data with the CTS line. The CTS line is set "false" to indicate that no more transmit data should be input. Normally, most terminals or hosts will still send one or two more characters after the CTS line is set "false", and this is normal and allowed for in the CTS control logic. In fact the modem will continue to accept and store transmit data (providing the RTS line is still active) even though it has set the CTS line to "false", however the user then risks the occurrence of an overflow condition. If the transmit buffer becomes full, then further data is discarded.

A configuration bit, further controls the state of the CTS output line in relation to the RTS input line. If the bit is clear, then the CTS output will always indicate the flow control state, regardless of the state of the RTS input. If the bit is set, the CTS line is conditional on the state of the RTS input. If the RTS input is "false", then the CTS output is also "false". If the RTS input is "true", then the CTS output indicates the flow control state. This latter configuration is typical of a "wired" modem.

The modem's internal data store holds both the raw user data, and records the position of frame boundaries (as defined by PAD operation) in the data. A limited amount of memory is allocated to storing the frame boundary data. When this memory space is full, the modem sets the CTS output to false, even though the character storage space may not be full. The frame boundary storage space is sufficient to hold data for 64 frames. If the modem has both ports (Port\_A and Port\_B) enabled, then this space is evenly divided between the two, or if Port\_B is disabled, then up to 64 frames can be stored for Port\_A. If data continues to be input when the CTS line has been set to "false" because no more frame boundaries can be recorded, then the frame closure mechanism may abort. This has the effect that a frame will not be closed when defined by PAD configuration. An example of this, is where the PAD is configured to close the frame on receiving a <CR> (carriage return) EOM. If the frame boundary space is full, when a <CR> is input, then the subsequent characters will be appended to the same frame. Another attempt to create a new frame will not occur until the same or another frame close condition (as defined by PAD configuration) occurs, in this case another <CR>. This logic avoids the unnecessary loss of data.

Situations where the data storage space or frame boundary storage space become full, would be rare, and would only be likely to occur if the transmitter could not gain access to the channel, or the input data rate exceeds the channel transmission rate for some time.

Normally the TC-900DR is manufactured with an 8 kilobyte memory for data storage. This memory space is divided equally between transmit and receive data storage. If both user ports are enabled, then each half is equally divided between the ports (i.e. 2K/2K/2K/2K for Port\_A transmit, Port\_A receive, Port\_B transmit, Port\_B receive). If Port\_B is disabled, then 4K is available for each of the transmit and receive data storage functions for Port\_A.

The DTR line controls the flow of receive data to the user port. While the DTR input line is "true", available received data is output from the port. If the DTR input is "false", then receive data output ceases.

### 3.4.8.2 PORT\_A XON/XOFF FLOW CONTROL PROTOCOL

When XON/XOFF flow control is configured for Port\_A, the CTS line is set "true", the RTS input line is not required to validate input data, and receive data is not dependent on the state of the DTR line. Instead of controlling the CTS line, the modem sends XON/XOFF characters (embedded in the receive data stream), to the port. The flow of receive data is controlled by the receipt of XON/XOFF characters in the transmit data stream. These control characters are trapped out of the transmit data stream, and are not transmitted.

The underlying flow control logic is the same as RTS/CTS/DTR control. An XON is sent instead of a "false" to "true" transition of the CTS line, and an XOFF is sent instead of a "true" to "false" transition on the CTS line. A received XON is recorded by an internal flag that emulates a "true" state on the DTR line, and a received XOFF is recorded by the flag to emulate a "false" state on the DTR line.

This method of flow control would be considered to be less reliable, since a lost XON or XOFF control character could cause either an overflow condition, or data flow to stop altogether.

### 3.4.8.3 PORT\_B FLOW CONTROL

User Port\_B can be configured for no flow control, or XON/XOFF flow control. When XON/XOFF flow control is configured, it operates identically to Port\_A, except that this port has no CTS line to set "true". Flow control on Port\_B operates at a local level only, since end to end flow control via the SSC is available only for Port\_A.

If XON/XOFF flow control is disabled, then no flow control is used on Port\_B, as there are no RTS/CTS/DTR lines implemented on Port\_B. Users should be careful to avoid overflow conditions, to avoid loss of data.

It will now be obvious that the RTS input line on Port\_A can be used by more than one function in the modem. RTS can have no function, or be used in Port\_A flow control, and/or provide a manual PTT facility.

### 3.4.9 SETTING MINIMUM RSSI LEVEL

The data receiver of the modem is continually running. It will be in one of two states. It is not SYNC'd, and thus looking for HDLC FLAGS in the radio receiver signal, or it is SYNC'd, and recovering frame data to be checked and stored. If the radio receiver is not receiving a signal, then the recovered signal applied to the data receiver of the modem, will consist only of noise. To prevent the modem from erroneously locking onto noise, a minimum RSSI level must be present to validate the recovered signal applied to the modem data decoder. This threshold level, is stored in the non-volatile configuration memory. It should be set by applying a signal to the radio receiver, which produces a desired SiNaD result, a desired bit error rate, or more crudely, a predetermined absolute signal level into the antenna connector of the TC-900DR. The modem (operating in Test/Program mode) is then commanded to measure the RSSI level, which produces a response of a message indicating the measured level, in hexadecimal. This process should be repeated several times, then an average taken. The analogue to digital conversion performed in this way, is an eight bit conversion. In normal operation, the modem performs a six bit conversion when measuring the RSSI level, so the average of the levels measured in the test mode should now be divided by four. The result should now be stored in the configuration memory, at the address reserved for it.

### 3.4.10 SETTING PTT TIMER

The modem implements a PTT timer. This timer can be disabled entirely by setting the PTT Timer configuration value to zero. The timer value is a 16 bit number, that counts in "ticker clocks". If the timer is enabled, whenever the modem activates the PTT control to the radio transmitter, it initialises the timer with the configured value. The timer is decremented while the PTT control remains active, and if it terminates, the PTT control is deactivated. No other action is taken, and all other functions within the modem are oblivious to this condition, so data frames continue to be output, and thus lost. The PTT timer is to be considered an emergency override mechanism only, in case an error occurs in the operation of the user's host equipment and/or software. To reset this time-out state, conditions must be met that would cause the modem to normally deactivate the PTT control. The PTT timer will then be re-initialised the next time the PTT control is activated. The time-out period may be set in "ticker clock" (2.5mS) increments to over 160 seconds.

### 3.4.11 DATA STREAM SWITCHING, SELECTING AND ENABLING SID CODES

The TC-900DR radio modem includes a feature that provides data stream switching. This is achieved by placing a Stream Identifier code (SID) at the beginning of every frame. This code functions as a simple addressing function. If both user ports of the TC-900DR are enabled, then SID codes should also be enabled, so that data frames carry a code which identifies the originating port (A or B), thus the port to which the frame data should be directed when the frame is received at the destination station.

However this stream switching mechanism is not only confined to this simple application. The SID codes for each user port, are contained in the configuration memory, and are thus "soft". It would be possible to engineer a small (up to 256 stations) network using an individual SID code for each remote station. Since the modem receiver will discard frames which are headed by an SID code which is not recognised, only frames specifically addressed would be stored and passed on to the attached host. The SID code is allocated to the port, so the modem uses the same SID code both for transmission and receipt of frames. Therefore in such a system, the master would be configured with SID codes disabled. The host attached to the master would preface each message with the eight bit address of the destination remote. The message from the remote emanating from the port will have the SID code removed. A message received from a remote, will have the SID code of the sending station at the beginning as the first byte. The remote modem itself places this code at the head of the frame.

Another application of the stream switching feature, is a remote diagnostics facility. This is a facility which is planned for release in the next firmware version. A reserved SID code will be used to address a diagnostics function within the modem. A command/addressing protocol is being developed that employs the units own unique serial number for addressing. "Stay tuned for further updates!".

The SID code is placed in the first octet of each frame. This provides up to 256 unique codes. However, to avoid possible future compatibility problems where higher level protocols are in use on the same channel (e.g. AX.25, etc.), it is suggested that the SID codes used have bit0 set to "1". Such higher level protocols normally use extended addressing where more than one octet is used to carry the destination/source address. A frame using an SID code with bit0 set, will fail an address test and be discarded by such systems. Conversely, if this modem receives a frame containing a higher level protocol, bit 0 of the first octet will normally be set to "0", so will not match any SID code stored in the configuration memory, and be discarded.

By default, Trio DataCom sets the SID codes to 03 and 05 for ports A and B respectively. We have also reserved SID code 00 for the diagnostics facilities.

#### 3.4.11.1 Separate Tx And Rx SID Codes. (Firmware Revision V2.1 onwards)

Firmware revision V2.1.0 onwards allows the Transmit and Receive SID codes to be different. Normally the RxSID and TxSID parameters (separate for each port) would be programmed the same. By programming them to be different, means that a TC-900DR unit will receive frames carrying a SID code that matches the configured RxSID code, but transmit frames which carry a SID code that is specified by the TxSID code configuration parameter. Applications for this feature are in small point to multipoint systems, using a central "community" repeater.

### 3.4.11.2 Repeater Operation Mode. (Firmware Revision V2.1 onwards)

The TC-900DR radio modem may also be configured in a repeater mode. The repeater function is enabled as a protocol driver on a port. Thus each user port driver can individually be configured for repeater operation. Essentially, what this does is automatically routes the received data frames back to the transmitter. If SID codes are enabled, then the original SID codes are stored as part of the data frame, and thus the retransmitted frame is identical to that received. Note that only frames received error free will be repeated.

When a port driver is configured for repeater operation, the RxSID and TxSID codes stored in configuration data in the NVRAM are used to define a range of streams to be repeated. The RxSID code configuration parameter defines the lowest SID stream to be repeated, and the TxSID code configuration parameter defines the highest SID stream that will be repeated. Thus it is possible to configure a unit to perform a repeater function for two separate ranges of streams, by configuring both user ports with a repeater driver, or to configure one end of a data link to also be a repeater for a range of other streams.

### 3.4.12 SETTING TRANSMITTER LEAD\_IN\_DELAY

Whenever the radio transmitter is activated a timer is started. No data frames are transmitted until this timer terminates, so that the destination unit receiver has time to synchronise it's data receiver before frame data is begun. The radio transmitter is very fast, reaching final output power and frequency stability in a matter of a few hundred microseconds (other sections of this document deal with the receiver synchronising aspects). This timer counts in octets, not "ticker clocks" as most other timed functions do, so the actual time elapsed is a function of the radio channel bit rate. However, the synchronisation time is primarily a function of the number of bits to the receiver. Trio DataCom would suggest a value of 25 to 50 (decimal) for this parameter, but it's final value will depend on signal strength and quality at the receiving point, and should best be determined by test.

### 3.5 FACTORS AFFECTING MODEM SYNCHRONISATION TIME

#### 3.5.1 (UN)SCRAMBLER AND HDLC STATE MACHINE

It can be shown, that the un-scrambler in the receiving unit will synchronise to the scrambler in the sending unit in 17 bits maximum.

The receiving unit must then detect an HDLC FLAG, which will take another 15 bits maximum. Thus the HDLC state machine and unscrambler should be synchronised in 32 bits maximum.

#### 3.5.2 PHASE LOCKED LOOP

Before valid data can be read for the unscrambler, the phase locked loop (PLL) must lock. The time required for this to occur is affected by signal quality and content. The PLL relies on level transitions of the binary signal, on which to lock. It essentially compares the phase of an internal counter, with the phase of the incoming data bits. A detected phase error, will cause the internal counter to speed up or slow down, to reduce the phase error. The greater the error, then the greater the speed adjustment to the internal counter.

If the incoming data stream has few transitions, then the internal counter will "catch up" to it quicker, since it's speed is adjusted less often. The PLL will synchronise to within 90% of the correct phase (from 0%), in 16 to 36 bits time, depending on the number of transitions.

In practice, even though the PLL has not reached 90% lock, meaningful data will still be obtained as long as a good strength, clean signal is available.

#### 3.5.3 ERROR CONTROL

Having recovered the raw data, the modem then applies the bit-stream to a de-randomiser, which is based on a recursive tapped shift register, described by the polynomial:

$$X^{17} + X^{12} + 1$$

The output of the de-randomiser is then fed through another conversion function, to convert the NRZI data to NRZ.

The data is now an HDLC data stream, conforming to ISO3309. It is then applied to a function which detects HDLC FLAGS, and extracts "dummy zeros", which were inserted by the transmitter. Frame boundaries are detected at this point.

The modem calculates and appends a 16 bit Cyclic Redundancy Checksum (CRC) word to the end of each frame. This calculation uses the polynomial:

$$X^{16} + X^{12} + X^5 + 1$$

This is sometimes referred to as CRC-CCITT since it is a CCITT standard.

The 1's complement is taken of the calculation result and this FCS is appended to the end of the data frame and sent MSB first. (Refer to ISO 3309 for more information)

At the receiver, this calculation is repeated on the received data, and the result checked. A detected error, will cause the receiver to discard the entire frame. A higher protocol level (determined by the user) will detect the lost packet, and initiate a re-send of the packet.

In terms of the reliability of this FCS, it can be claimed that the following will be detected :

- All single bit errors.
- All double bit errors.
- Any odd number of errors.
- Any burst error less than 16 bits long.
- Most large burst errors.

From here emanates the original frame data, provided the FCS was correct. If not then the frame data is discarded. The data is stored in externally addressed memory, connected to the modem IC. Maximum data packet size is determined by the amount of available memory. Normally the modem is fitted with an 8K CMOS RAM, of which half (4096 bytes) is allocated to the receiver. The modem can be fitted with an external memory up to 32K with no other modifications. The receiver section of the modem can store up to 32 separate data packets.

How this data is handled from this point on, depends on the user protocol implemented by the modem on the user interface.

### 3.5.4 TRANSMISSION FORMAT AND TIMING

The data to be transmitted is input to the modem, via the user interface protocol implemented on the user interface. The modem stores the data packet(s) in externally addressed memory, connected to the DFM4-9 modem IC. Maximum data packet size is determined by the amount of available memory. Normally the modem is fitted with an 8K CMOS RAM, of which half (4096 bytes) is allocated to the transmitter. The modem can be fitted with an external memory up to 32K with no other modifications. The transmitter section of the modem can store up to 32 separate data packets.

Most of the transmitter functions are performed internally in the modem IC, with only a DAC (Digital to Analogue Converter) and final low pass filter implemented by external circuitry.

The data is placed into an HDLC frame (consistent with ISO3309), complete with dummy zeroes where required. During transmission, a CRC calculation (CRC-CCITT) is performed, and when the end of the data packet is reached, this FCS (Frame Check Sequence) is appended to the end of the frame, before the closing HDLC FLAG.

Where two or more consecutive frames are sent, only one FLAG octet is used to delimit the frames. All frames are composed of an integral number of octets.

---

<sup>2</sup> "Data and Computer Communications" William Stallings

Data from the HDLC formatting stage is fed through a function, to convert the NRZ data to NRZI format.

The NRZI encoded data stream is now fed to a data randomiser, to ensure that there is no DC component to the data stream. This is based on a recursive seventeen bit shift register with two taps.

### 3.5.5 COLLISION AVOIDANCE SCHEME

The unique supervisory signalling channel facility available in this product is ideally suited to the implementation of a highly effective collision avoidance mechanism. This is a highly desirable feature in a multipoint data network, in that it allows vastly increased usage of the available channel capacity.

For instance, take a point-to-multipoint network, with a central base station, and a large number of remote data terminals scattered around the central station.

This is a split frequency duplex channel, where the central station is able to transmit on frequency F1, and simultaneously receive on frequency F2. Remote stations transmit on frequency F2, and receive on frequency F1.

If a transmission by one remote station is "crashed" by a transmission by another remote station, then the base station may not get the message correctly, and thus not acknowledge it. If there is no control over when the remote stations transmit, then because the remote stations cannot "hear" each other, their transmissions will begin to collide more often as the data traffic increases. This type of system will suffer a total blockage as the total traffic requirement approaches about 50% of the channel capacity.

Now, if the base station could quickly inform all other remote terminals, when the base receiver is busy because one of the remote terminals is transmitting, then this message can be delivered to the base receiver without being "jumped on" by another terminal blindly "crashing in". The next terminal can then deliver its message when the receiver is signaled to be free. Of course collisions are still possible, but the occurrence of these can be dramatically reduced by this type of scheme.

Now to implementation specifics. The supervisory signalling channel in the modem, can be set independently for transmit and receive directions. For the purposes of this collision avoidance scheme, the supervisory signalling channel is only required in the base transmit direction. In the reverse direction, the supervisory signalling channel is disabled. The base transmitter is active full time, sending only FLAGS when it has no real data to send. The base controller, then indicates to the whole population of remote terminals, the current status of the base receiver, in the value of the supervisory signalling channel data bits.

The remote data terminals are programmed so that they will not begin a transmission if the received supervisory signalling channel data indicates that the base receiver is currently busy. This would result in remote terminals queuing for access to the base receiver. To prevent all these remote terminals all beginning a transmission as soon as the base indicates a free receiver, a "windowed" timing mechanism would be implemented, with a random factor added in the terminal's selection of a "window".

There are many factors that would determine the quantification of system variables, but this short description serves to illustrate a basic approach.



### 3.6 TEMPERATURE COMPENSATION

Periodically, the modem controller reads the voltage on the temperature transducer mounted on the radio section. This value is then used in a table look-up procedure, to derive correction data to be applied to the modulator circuitry via a transmit waveform offset voltage. This is provided by the output of the six bit DAC (UX8/RN2), which is fed to the correction voltage input of the 12MHz reference oscillator.

The offset table is constructed in the temperature calibration cycle performed during the factory testing procedure. The radio-modem is temperature cycled twice from -10C to +65C. During this time, the necessary data is determined to correct the temperature induced frequency errors. At the end of the cycle, the final database is constructed and written to the non-volatile memory.

### 3.7 USER INDICATIONS

The TC-900DR provides three LED's that show status information to the user - RXSIG, SYNC, and TXMIT indications.

In all operation modes of the modem except "Programmer mode" (see the section below on special modes of operation), the RXSIG LED indicates the level of the RSSI signal from the radio IF strip, compared to a threshold set in the configuration data read from the non-volatile memory. If the signal is above the threshold, then the LED indicator is turned on. There is no hysteresis applied in this process.

In normal operation, the SYNC LED indicates when the modem has detected a valid data stream. The SYNC LED is activated, when the modem detects a valid HDLC flag sequence, and remains active until an invalid sequence of seven or more consecutive "1" bits is detected. The SYNC LED will not be turned on if the RSSI signal strength (as indicated by the RXSIG LED) is below the minimum threshold. This prevents false SYNC detection from noise. While the modem is SYNC'd, it does not continue to measure RSSI levels.

The TXMIT LED indicator is connected directly to the modem's PTT output transistor. It is active whenever the PTT line to the radio section is active low.

### 3.8 SPECIAL MODES OF OPERATION

#### 3.8.1 GENERAL

Part of the power-up/reset initialisation phase of the TC-900DR modem, is a set of tests to determine whether the modem should enter a special operation mode.

There are three of these "special" modes. *Whilst in these modes the TC-900DR will not operate in its standard run mode.*

- Programmer mode.
- Bit error rate test mode.
- Handset mode.

These modes are only entered if the required setup conditions are present at power up of the TC-900DR. An error mode of operation can also be entered into, if during normal operation of the TC-900DR modem, an error condition occurs.

#### 3.8.2 PROGRAMMER MODE

Pin 6 on the DB9 connector of Port A, is normally the DSR line. This pin is pulled high by a resistor to +13.8v, so that to a connected DTE the DSR signal implies that this DCE is ready.

However, if this pin is connected to pin 5 when the modem is powered up, the controller senses this, and attempts to enter "Programmer mode". The modem sends out of the serial port, an ASCII "?" (question mark) character, and waits for the programmer to reply with a password. The SYNC LED toggles on and off with every output of the "?" prompt until the correct password is entered. This mode is sustained for approximately 30 seconds. Failure to supply the correct password in time, will cause the modem to abandon the "Programmer mode" attempt, and go on with it's normal power-up procedure. This password protection scheme provides some defense against unauthorised tampering with the TC-900DR modems configuration data.

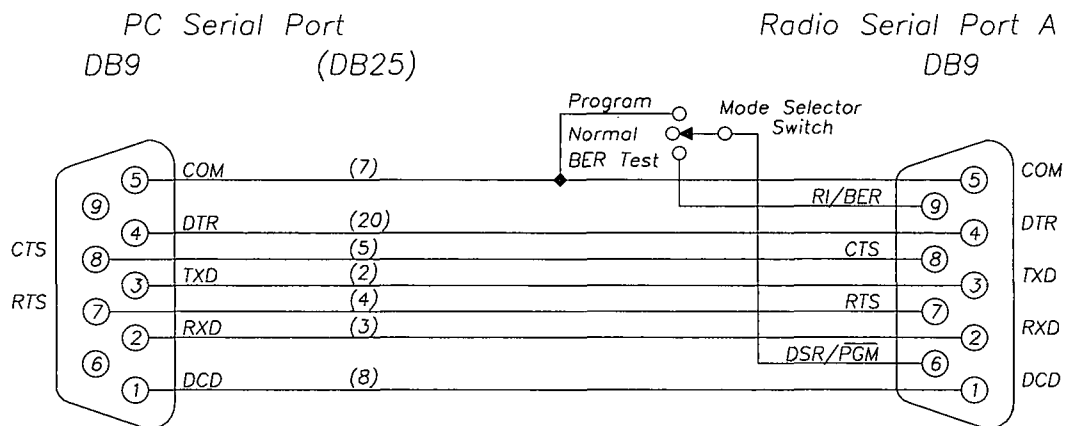

### 3.8.3 BIT ERROR RATE TEST MODE

Pin 9 of the DB9 connector of Port A, is normally the Ring Indicate output line. The modem includes a resistive pulldown to ground to show a negative condition on this line. However, if this pin is driven positive (typically by connecting it to pin 6), then the modem's data transmitter and receiver will enter the BER test mode.

It will activate the RF transmitter and generate a scrambled bit pattern which should be decoded at a receiver as a constant logic "1" level in the unscrambled data.

A test point on the modem section PCB, is available to monitor this point with a frequency counter. (In fact this test point is always active, and may be used to monitor the received data decoded by the DFM4-9 modem IC at any time). Any errors in the decoded bitstream, will be "0", and the receiver portion of the modem in this mode, will activate the SYNC LED every time it sees a "0" bit.

An internal timer is used to generate a time equivalent to 1000 bits. Every error bit detected, will activate the SYNC LED, and restart the timer. If and when the timer expires, the SYNC LED is deactivated. Thus, for error rates of 1 in 10<sup>3</sup> and above, the SYNC LED will be ON most of the time. A 1 in 10<sup>4</sup> error rate will show the SYNC LED active for approximately 10% of the time. This function provides a crude indication of Bit Error Rate for installation purposes.

Other functions performed in this state include RXSIG indication, and temperature compensation. The state of pin 9 is constantly monitored in this mode. If the pin ceases to be driven positive, then the BER Test mode is terminated, and the modem restarts its initialisation phase.

### 3.8.4 HANDSET MODE

The DFM4-9 modem tests for the presence of a handset plugged into the handset audio port at power up.

This is done by measuring the voltage on channel 4 of the analogue to digital converter (UX10-p6). This signal is passed into the modem section from the radio section via connector X4-p24, "ADC3".

If a handset is plugged in, then the measured voltage will be about 2V, but if it isn't installed, then the voltage will be about 4V. The measured voltage is compared to 3V to determine whether the handset is plugged in. If this test succeeds, then the modem will not generate a data stream. However, it will continue to indicate received RF signal strength, and perform temperature compensation. The handset has a PTT button, and this signal is connected across the modem's PTT output. Thus the handset PTT switch will activate the TXMIT LED.

### **3.8.5 ERROR INDICATION MODES**

#### **3.8.5.1 GENERAL**

There are three error conditions that will cause the RXSIG and SYNC LEDs to be used for error indications and not their normal purpose. Two of these are fatal conditions, that cause the modem to restart after the duration of the error indication phase.

#### **3.8.5.2 TRANSMIT POWER LOW**

While the modem activates the radio transmitter, it periodically checks the transmit power. If the power measurement is less than a threshold set in the non-volatile memory, then the RXSIG and SYNC LEDs are made to alternate, approximately four times per second. The TXMIT LED will also be on during this process. This indication condition will persist for the duration of the transmission. As soon as the transmission is discontinued, the error indication will cease, and the two LEDs revert to their normal function.

#### **3.8.5.3 NVRAM READ ERROR**

The DFM4-9DR modem accesses the non-volatile memory as part of its initialisation phase, to get configuration data. If the communication protocol with the device is violated, or the non-volatile memory CRC checksum is found to be incorrect, then the modem indicates this by flashing the RXSIG and SYNC LEDs twice alternately. That is, one LED operates ON and OFF twice, then the other. A total of five cycles of this occurs, then the modem restarts its initialisation from scratch.

### 3.8.5.4 SYNTHESISER LOCK DETECT ERROR

If at any time during normal operation, BER mode, or handset mode, the TBB206 frequency synthesiser indicates an out of lock condition, the modem enters an error indication mode for a short time before restarting. One LED is turned ON (⊗), the LEDs are swapped, then both turned OFF (●). Then the latter LED ON again, swap LEDs, and then OFF. This will give the appearance of a sweeping motion between the LEDs.

The following table shows all error condition displays for comparison.

Tx PWR Error		NVRAM Error		TBB206 Error Synthesiser	
RXSIG	SYNC	RXSIG	SYNC	RXSIG	SYNC
⊗	●	⊗	●	⊗	●
●	⊗	●	●	●	⊗
⊗	●	⊗	●	●	●
●	⊗	●	●	●	⊗
⊗	●	●	⊗	⊗	●
●	⊗	●	●	●	●
⊗	●	●	⊗		repeat
●	⊗	●	●		
continue			repeat		

### 3.9 SYNCHRONOUS OPERATION MODE FIRMWARE REVISION: V2.1

#### 3.9.1 GENERAL

The TC-900DR when operating in Synchronous mode, implements a V.24 like interface. The unit uses a special wiring harness that converts the two 9 pin "D" connectors on the end panel of the TC-900DR to a standard 25 pin "D" connector for user interface.

Synchronous Mode implements a bit level interface. Data is carried on a bit by bit basis. No framing or error detection is performed. Modem operation is full duplex.

Current implementations of SYNC mode, do not provide a DCD signal in the 25 pin RS232 interface.

#### 3.9.2 DATA RECEIVER

While sufficient RF signal is present into the radio receiver, the data decoder is continually extracting data bits from the received signal, and outputting these to the user interface connector. If the received RF signal into the radio receiver falls below the minimum threshold, then the data decoder stops.

#### 3.9.3 SETTING MINIMUM RSSI LEVEL

The data decoder of the modem is continually running while sufficient RF signal is present into the radio receiver. If the radio receiver is not receiving a signal, then the recovered signal applied to the data decoder of the modem, will consist only of noise. To prevent the modem from erroneously locking onto noise and producing "garbage" at the RxD pin, a minimum RSSI level must be present to validate the recovered signal applied to the modem data decoder. This threshold level, is stored in the non-volatile configuration memory. It should be set by applying a signal to the radio receiver, which produces a desired bit error rate, a desired SiNaD result, or more crudely, a predetermined absolute signal level into the antenna connector of the TC-900DR. The modem (operating in Test/Program mode) is then commanded to measure the RSSI level, which produces a response of a message indicating the measured level, in hexadecimal. This process should be repeated several times, then an average taken. The analogue to digital conversion performed in this way, is an eight bit conversion. In normal operation, the modem performs a six bit conversion when measuring the RSSI level, so the average of the levels measured in the test mode should now be divided by four. The result should now be stored in the configuration memory, at the address reserved for it. The DR9\_PRGM programmer available from Trio DataCom Pty Ltd facilitates this process.

\*Use a signal generator modulated with a sine wave frequency of half the nominal bit rate of the unit (e.g. for a 4800BPS unit, use 2400Hz modulation).

### 3.9.4 DATA RECEIVER CLOCK OUTPUT

The receive section of the modem, includes a clock line driven by the modem. This signal is used to synchronise the transfer of receive data to the user system. The RCO (Rx\_Clock\_Output, pin17 in the DB25 connector) line changes from ON (TRUE) to OFF (FALSE) as the RxD (Receive\_Data, pin3 in the DB25 connector) line outputs the next bit, and from OFF (FALSE) to ON (TRUE) in the nominal centre of the bit cell. This conforms to the V.24 specification.

### 3.9.5 OTHER RS232 RECEIVER CONTROL LINES

The DSR (Data\_Set\_Ready) line is driven true by the modem. This line is in fact merely tied to the internal +13.8volt rail via a 4K7 resistor. The DTR (Data\_Terminal\_Ready) input is unused in Synchronous mode.

### 3.9.6 DATA TRANSMITTER

The transmit data input is continually sampled and coded for transmission. This process consists of sampling the data input, randomising the bit pattern so that the DC component of the transmitted stream is zero, and generating a waveform suitable for application to the modulator of the FM radio transmitter.

### 3.9.7 DATA TRANSMITTER CLOCKS

The modem transmit data interface, includes two clock lines. One clock line, TCO (Transmit\_Clock\_Out, pin15 in DB25 connector) is driven by the modem, the other, TCI (Transmit\_Clock\_In, pin24 in the DB25 connector) can be enabled to allow the external user to supply a transmit data clock. This is implemented by synchronising the internal clock generator to the user's clock (within a small frequency range). This function is essentially a Phase Locked Loop, and effectively adjusts the phase of the internal clock to match that of the input clock. If the user clock source stops, then the modem will continue to generate the internal clock at it's nominal rate. In accordance with specification V.24, the state of the transmit data line (TxD, pin2 in the DB25 connector) is sampled on the ON to OFF transition of the clock, the bit cell boundary occurs with the OFF to ON transition of the clock.

### 3.9.8 TRANSMITTER RTS/CTS LINES

Two other control lines are included in the transmitter interface. The RTS (Ready\_To\_Send) input line, is used to control the radio RF transmitter. The CTS (Clear\_To\_Send) output line is driven by the modem, to indicate that the modem transmitter is ready to accept transmit data. The RTS to CTS time is determined by an internal timer. A configuration parameter is used to load the internal timer when the RTS line is activated, which must expire before the modem activates the CTS line. This time is necessary to allow the remote receiver to settle and synchronise to the data stream, before the user at the transmitting end begins sending data. However it should be noted, that the CTS signal does not perform any flow control function within the modem.

### 3.9.9 PHASE SYNCHRONISM WITH GLOBAL CLOCKS

When data is transferred over more than short distances, and synchronism must be maintained to some external global master clock (e.g. Telecom DDN network), then the propagation delay, and thus phase shift of the data becomes significant. A facility is provided, to introduce a phase delay in the transmitted data stream, of up to 3/4 of a bit, in 1/4 bit steps. This delay is adjusted so that minimum phase offset results at the receiver of the destination station.

### 3.9.10 TRANSMIT TIMER

The modem implements a transmit (PTT) timer. This timer can be disabled entirely by setting the PTT Timer configuration value to zero. The timer value is a 16 bit number, that counts in increments of 2.5 milliseconds. If the timer is enabled, whenever the modem activates the PTT control to the radio transmitter, it initialises the timer with the configured value. The timer is decremented while the RTS line remains active, and if it terminates, the PTT control is deactivated. No other action is taken, and all other functions within the modem are oblivious to this condition, including the CTS line, so data continues to be "carried", and thus lost. The PTT timer is to be considered an emergency override mechanism only, in case an error occurs in the operation of the user's host equipment and/or software. To reset this timeout state, the RTS line must be taken from ON to OFF. The PTT timer will then be re-initialised the next time the RTS line is activated. The timeout period may be set in 2.5mS increments to over 160 seconds.

### 3.9.11 LED INDICATORS

#### 3.9.11.1 Received Signal Strength Indication. RXSIG LED

In all operation modes of the modem except "Programmer Mode" (see section below on special modes of operation), the RXSIG LED indicates the level of the RSSI signal from the radio IF strip, compared to a threshold set in the configuration data read from the non-volatile memory. If the signal is above the threshold, then the LED indicator is turned on. There is no hysteresis applied in this process.



### 3.9.11.2 Data Carrier Detect Indication. SYNC LED

In "Synchronous" operation mode (V2.1.x), prior to modem hardware revision "D", and firmware revision "V2.1.4", the SYNC LED is superfluous and not driven.

**Note that firmware revision V2.1.5 onwards should only be used in SYNC mode.**

From modem hardware Revision D onwards, the SYNC LED drive is used to generate a DCD function in the user interface connector, and requires firmware revision V2.1.4 onwards (i.e. firmware revision V2.1.4 onwards drives the SYNC LED ON 20mS after the "leading edge" of the RxSig LED).

**This means that the SYNC LED drive should always show this function and not be allowed to show low Tx Power (see Error indication modes section 3.8.5.2). To facilitate this the Min Tx Pwr parameter in the TC-900DR modem should be set to zero, when the modem is built for synchronous operation.**

### 3.9.11.3 Radio Transmitter Active Indication. TXMIT LED

This LED indicator is connected directly to the modem's PTT output drive. It is illuminated whenever the PTT line to the radio board is active.

## 3.9.12 SPECIAL MODES OF OPERATION

### 3.9.12.1 Programmer Mode

Part of the power-up/reset initialisation phase of the modem, are tests to determine whether the modem should enter a special operation mode. The first, is a test for "Programmer Mode". Pin6 on the DB9 connector of Port A, is normally the DSR line. To this end, this pin is pulled high by a resistor to +13.8v, so that to a connected DTE this signal says that this DCE is ready. However, if this pin is connected to pin5 (Com) when the modem is powered up, the modem senses this, and attempts to enter "Programmer Mode". The modem sends out of PORTA, an ASCII "?" (question mark) character, and waits for the programmer to reply with a password. Failure to supply the correct password in time, will cause the modem to abandon the "Programmer Mode" attempt, and go on with it's normal power-up procedure. This password protection scheme provides some defence against unauthorised tampering with the radio/modem's configuration data.

### 3.9.12.2 Bit Error Rate Test Mode

The next test, is one for "Bit Error Rate Test Mode". Pin9 of the DB9 connector of Port A, is normally the Ring Indicate output line. The modem includes a resistive pulldown to Gnd to show a negative condition on this line. However, if this pin is driven positive (typically by connecting it to pin6), then the modem's data transmitter and receiver will enter the BER test mode. It will activate the RF transmitter and generate a scrambled bit pattern which should be decoded at a receiver as a constant logic "1" level in the unscrambled data. A test point on the modem PCB, is available to monitor this point with

a frequency/event counter. (In fact this test point is always active, and may be used to monitor the received data decoded by the modem IC). Each error bit in the decoded bitstream, will be "0", and the receiver portion of the modem in this mode, will activate the SYNC LED every time it sees a "0" bit. An internal timer is used to generate a time equivalent to 1000 bits. Every error bit detected, will activate the SYNC LED, and restart the timer. If and when the timer expires, the SYNC LED is deactivated. Thus, for error rates of 1 in  $10^3$  and above, the SYNC LED will be ON most of the time. A 1 in  $10^4$  error rate will show the SYNC LED active for approximately 10% of the time. This function provides a crude indication of Bit Error Rate for installation purposes. Other functions performed in this state include RXSIG indication, and temperature compensation. The state of pin9 is constantly monitored in this mode. If the pin ceases to be driven positive, then the BER Test mode is terminated, and the modem restarts it's initialisation phase.

### 3.9.12.3 Order\_Wire/Handset Mode

Failure of the BERT Mode test, brings the modem to test for the presence of a handset plugged into the handset audio port. This is done by measuring the voltage on channel 4 of the analogue to digital converter. If a handset is plugged in, then the measured voltage will be about 2 volt, but if it isn't installed, then the voltage will be about 4 volt. The measured voltage is compared to 3 volt to determine whether the handset is plugged in. If this test succeeds, then the modem will not generate a data waveform to the radio transmitter. However, it will continue to indicate received RF signal strength, and perform temperature compensation. The handset has a PTT button, and this signal is connected across the modem's PTT output. Thus the handset PTT switch will activate the TXMIT LED.

### 3.9.12.4 Error Indication Modes

There are three error conditions that will cause the RXSIG and SYNC LEDs to be used for error indications and not their normal purpose. Two of these are "fatal" conditions, that cause the modem to restart after the duration of the error indication phase.

### 3.9.12.5 Transmit Power Low

While the modem activates the radio transmitter, it periodically checks the level of the radio transmitter output power. If the power measurement is less than a threshold set in the non-volatile memory, then the RXSIG and SYNC LEDs are made to alternate, approximately four times per second. Of course, the TXMIT LED will also be on in this case. This indication condition will persist for the duration of the transmission. As soon as the transmission is discontinued, the error indication will cease, and the two LEDs revert to their normal function. The user should be aware that from Revision D of the modem PCB, this state will cause incorrect operation of the DCD output line. As stated above, the Min Tx Pwr parameter should be set to zero.

**3.9.12.6 NVRAM Read Error**

The modem accesses the non-volatile memory as part of it's initialisation phase, to get configuration data. If the communication protocol with the memory device is violated, or the non-volatile memory CRC checksum is found to be incorrect, then the modem indicates this by flashing the RXSIG and SYNC LEDs twice alternately. That is, one LED winks on and off twice, then the other. A total of five cycles of this occurs, then the modem restarts it's initialisation from scratch.

**3.9.12.7 Radio Frequency Synthesiser, Lock Detect Error**

If at any time during normal operation, BERT mode, or handset mode, the frequency synthesiser indicates an out of lock condition, the modem enters an error indication mode for a short time before restarting. One LED is turned ON, the LEDs are swapped, then both off. Then the latter LED ON again, swap LEDs, and OFF. This will give the appearance of a sweeping motion between the LEDs. The following table shows all three modes for comparison.

Tx PWR Error		NVRAM Error		TBB206 Error Synthesiser	
RXSIG	SYNC	RXSIG	SYNC	RXSIG	SYNC
○	●	○	●	○	●
●	○	●	●	●	○
○	●	○	●	●	●
●	○	●	●	●	○
○	●	●	○	○	●
●	○	●	●	●	●
○	●	●	○		repeat
●	○	●	●		
continue			repeat		

**3.9.13 WIRING ADAPTOR HARNESS FOR TC-900DR SYNCHRONOUS MODEL**

PORT A	1 (DCD)	(RCO)	17	DB25F
	2 (RxD)	(RxD)	3	
	3 (TxD)	(TxD)	2	
	4 (DTR)	(DTR)	20	
	5 (Com)	(Com)	7	
	6 (DSR)	(DSR)	6	
	7 (RTS)	(RTS)	4	
	8 (CTS)	(CTS)	5	
	9 (RI)			
PORT B	1 (DCD)	(DCD)	8	
	2 (RxD)	(TCO)	15	
	3 (TxD)	(TCI)	24	
	4			
	5 (Com)			
	6 (DSR)			
	7			
	8			
	9 (RSSI)			

---

---

## SECTION 4

### ALIGNMENT PROCEDURE

---

---

#### 4 ALIGNMENT PROCEDURE

##### 4.1 GENERAL

This section details operational performance and alignment procedures that may be required for the TC-900DR. During servicing it may also be necessary to measure specific performance parameters as a means of verifying the presence of a fault condition.

##### 4.2 TEST EQUIPMENT REQUIRED

The following list of test equipment is required to carry out all of the procedures detailed below.

- ^ Frequency counter accurate to better than 100 Hz at 1 GHz
- ^ FM Signal generator. 455 kHz to 1 GHz. -120 dBm to +10dbm. Synthesised in 100 Hz steps.
- ^ Spectrum analyser 10 MHz to 1GHz. Dispersion down to 2kHz/cm. 80+ dB dynamic range. IF b/w down to 1 kHz.
- ^ RF Power meter to 1GHz. -20 to +30 dbm. Accuracy  $\pm 0.25$  dB.
- ^ Digital volt meter.
- ^ HP3406 RF Millivoltmeter or similar.
- ^ RF Test leads, MCX male and SMA male.
- ^ Audio noise and distortion test set.
- ^ Audio oscillator.
- ^ Surface mount repair tools.

### 4.3 TEST POINT LOCATIONS

Both the radio section PCB and the modem section PCB contain numerous test points. They are easily located on the PCB's, and are detailed below.

#### 4.3.1 MODEM SECTION PCB

<u>TEST POINT</u>	<u>SIGNAL</u>	<u>DESCRIPTION</u>
TP1	TxCLK	Transmit clock
TP2	BER TST	BER test output
TP3	SYNC	Synchronised output
TP4	RxCLKOUT	Integrator reset
TP5	RxCLK	Receive clock
TP6	RxDATA	Receive data
TP7	DATA OUT	Transmit data
TP8	INTEGRATOR	Rx integrator reset

**4.3.2 RADIO SECTION PCB**

<u>TEST POINT</u>	<u>SIGNAL</u>	<u>DESCRIPTION</u>
<b>FINAL PA SECTION</b>		
TP31	TXPWR-2	Bias to Q8
TP25	TXPWR-3	Bias to Q8
TP27	TXPWR-4	Bias to Q9
TP14	+8v	Power Supply
TP15	TXEN	Transmit enable
TP20	RxMIXOUT	Rx mixer bias
TP28	TXPA-1	Bias to Q10
TP29	TXPA-2	Bias to Q11
TP26	+13V8	Power supply
TP33	PWR CONT	Power control supply
TP30	PTT+8V	Press to talk
<b>121 MHz SECTION</b>		
TP13	DATA	Tx data input
TP17	60.5 MHz	Modulated 60.5MHz
TP16	121 MHz	Output of doubler
TP18	121 MHz	Modulated 121 MHz
TP32	MIC	Tx Mic audio input
<b>NE615 IF SECTION</b>		
TP6	415kHz I/P	455 filter input/second mixer output
TP9	QUAD	Quad detector
TP8	DATA	Rx data out
TP10	AUDIO	Rx audio out
TP7	RSSI	RSSI output
TP4	MUTE	Mute control output
TP1	2nd L.O	Second Xtal oscillator
TP2	2nd L.O	Second Xtal oscillator
TP3	IF Input	45 MHz IF filter input
TP5	IF Output	45 MHz IF filter output
TP19	VCO	VCO oscillator injection
<b>SYNTHESISER/VCO SECTION</b>		
TP12	LOCK DET	Synthesiser lock detect
TP11	+5V	Synthesiser +5v supply
<b>AUXILIARY HANDSET INTERFACE SECTION</b>		
TP21	MIC	Tx mic audio input
TP22	PTT	Manual press to talk
TP23	+8V	Handset +8V supply
TP24	AUDIO OUT	Rx audio output

#### 4.4 ADJUSTMENT POINTS

All adjustment points are located on the radio section PCB. The following is a list of these adjustable components.

<u>COMPONENT</u>	<u>ADJUSTMENT</u>
XTAL2	VCO reference frequency
VR3	Deviation level set
L10	Tripler filter
L9	Doubler filter
L7	121 MHz filter
L8	121 MHz final filter
L6	Tx frequency set (121MHz Osc)
VR4	Tx power control adjust
C78	Tx mixer tunable filter
VR1	Rx audio mute adjust
VR2	Rx data DC BIAS offset adjust
L3	45 MHz filter alignment
L1	44.545 oscillator adjust
L4	45 MHz filter alignment
L5	45 MHz filter alignment

#### 4.5 LINK OPTIONS

Several options are set in the TC-900DR modem by the setting of links on the radio section PCB. Listed below is an option table for the various combinations.

<u>LINK NUMBER</u>	<u>SETTING</u>	<u>DESCRIPTION</u>
LK2	IN	AFC option disabled
	OUT	AFC option enabled (factory standard)
LK4	IN	PWR control disable
	OUT	PWR control enabled



## 4.6 HOUSING

The TC-900DR has been designed with the serviceability of the unit in mind. Construction of the unit is robust yet easily dismantled. The unit is primarily assembled in an aluminium extrusion with a central chassis that is fixed to the front panel.

### 4.6.1 DISASSEMBLY PROCEDURE

To disassemble the unit, simply remove the two silver screws on the underside of the unit and the six black screws located on the front panel (the front panel of the unit has the two DB9 connectors protruding from it). Ensure you do not loose the attached nylon washers, as these prevent the Lexan front panel label being damaged upon replacing and tightening the six screws. Simply slide the unit out of the extrusion clasp front panel and the complete unit is exposed to you.

*Caution : When re-assembling be careful not to foul the ribbon cable against the case when sliding the unit into its case as this may inadvertently damage the cable.*

### 4.6.2 MODEM AND POWER SUPPLY PCB

All components and connections to the modem section PCB are accessible without removing the PCB from the chassis. If access to the rear of the PCB is required, firstly remove two nuts that clamp the C TO-220 power supply regulator to the front panel. Once this is removed, simply remove the four screws securing the PCB to the chassis.

The PCB is now free to work on, and can be folded out so as to service the unit in an open accessible condition whilst still connected to the radio section PCB. If required, the modem section PCB can be separated from the radio section PCB by simply unplugging the ribbon cable.

*NOTE: Regulators will need to have heat-sinks fitted if unit is to be operated in this condition for excessive time periods.*

### 4.6.3 ANTENNA DIPLEXER

The antenna diplexer is mounted on top of the radio section PCB. It is easily removed by firstly disconnecting the two miniature RF connectors (MCX type) from the PCB.

*Care should be taken when unplugging these connectors so as not to damage them, it is important to remove and insert connectors in a vertical direction.*

Secondly, remove the nut securing the antenna output connector from the central mounting chassis. The last two remaining screws must be removed which secure the diplexer to two metal PCB standoffs on the radio section PCB. The diplexer can now be removed.

Testing of the radio section PCB can be continued without the antenna diplexer, by connecting to the receiver and transmitter ports separately.

Miniature MCX RF Connectors are available from Trio DataCom if required.

#### 4.6.4 RADIO SECTION PCB

The radio section consists of a two sided PCB which has surface mount components on one side and conventional components on the other. Several critical test points are accessible on the component side of the PCB which minimises removal of the PCB from the chassis.

To remove the PCB from the chassis, fifteen screws must be removed. Upon removal of these screws, the PCB can be manoeuvred from the chassis and once again can fold out so as to be serviceable as a complete unit.

*NOTE : It is essential that all RF Deck mounting bolts are fitted and secure upon reassembly as many of these bolts provide inter-stage isolation and secure grounding ensuring the product meets all specifications.*

Once service of the unit is complete, reassembly is simply the reversal of the above procedures.

Care should be taken when sliding the complete chassis assembly back into the extrusion. Ensure that the ribbon cable connecting the modem and radio section PCB's is carefully "tucked" away within its designated slot so as not to damage the cable.

## 4.7 ALIGNMENT DESCRIPTION

**CAUTION - As the TC-900DR is capable of full duplex operation, care should be taken to avoid damage to sensitive test equipment such as signal generators or spectrum analysers. It is recommended that a 30db 2 Watt pad be connected between the unit and any test equipment prior to testing.**

This section is for alignment/adjustment of the RF Deck and should be read in conjunction with Section 2 (Hardware Technical Description) and Section 7 (Fault Finding) if faults or difficulties are experienced.

For initial alignment, proceed in the following order :

- Reference oscillator & synthesiser.
- 121 MHz Tx modulated injection oscillator.
- Tx final stage/Power control.
- Receiver and audio mute

### 4.7.1 REFERENCE OSCILLATOR AND SYNTHESIZER

- 1 Check VCXO (XTAL2) for reference frequency o/p at a level of 550 mV rms with an RF Millivoltmeter, and the VCO o/p for an RF level of around 150 mV rms.
- 2 Check that the TBB202 dual modulus prescaler (U4) is producing an output of approximately 7 MHz and a level of 550 mV rms at the "IF" i/p to the TBB206 synthesiser I.C.(U3-p8)
- 3 Ensure that the synthesiser has been programmed to a frequency within the range of the VCO, and check that the VCO is locked by observing a high (5V) level on Lock detect output of the synthesiser I.C.(U3-p14). Note that very short duration pulses to ground is normal.
- 4 Program the synthesiser with the following VCO frequencies according to VCO type and ensure lock occurs at both ends of the frequency range. These frequencies are 2 MHz beyond the published specification.

**VCO TYPE: MQC-798**

Maximum 786MHz VCO = 907MHz Tx or 831MHz Rx

Minimum 814MHz VCO = 935MHz Tx or 859MHz Rx

**VCO TYPE: MQC-978**

Maximum 996MHz VCO = 875MHz Tx or 951MHz Rx

Minimum 960MHz VCO = 839MHz Tx or 915MHz Rx

- 5 Program the VCO to a given frequency within the range as specified above and measuring the VCO o/p frequency, adjust the 12 MHz (VCXO) reference trimmer to bring the frequency within 250 Hz of the VCO frequency.

*Note: Unit is temperature compensated at factory and no field adjustment of Ref. Oscillator is possible. If VCO frequency is not correct ( $\pm 1500$ Hz), consult factory for service advice.*

*Note ensure that the VCXO control input is within its active range (1-4 Volts).*

- 6 Check the VCO power o/p by monitoring the Rx mixer bias at TP20, where approximately 200 mVDC should be measured.
- 7 With a spectrum analyser set to the VCO frequency and a dispersion of about 5 or 10 kHz per cm, check that the reference sidebands are less than -60dBc in the adjacent channel.
- 8 Check VTCXO Reference frequency is  $F(tx) + 121$  MHz for 853 remote units or  $F(tx) - 121$  MHz for master units. If Reference is out by more than  $\pm 1.5$  kHz, drift offset should be applied via the programmer or unit should be returned for factory service. attempting to alter Reference trimmer will void temperature compensation process and should only be done in an emergency and as a temporary measure.

#### 4.7.2 121 MHZ MODULATOR

**Note - make sure the transmitter is loaded with a suitable attenuator on the antenna or Tx o/p socket before energising**

1. For Initial alignment set all coil cores to their nominal positions as per the table below :

Miller coils

L9	5 turns from top of coil can
L10	2 turns
L7	4 turns
L8	5 turns
L6	0 turns

To prevent the final transmitter stages from producing excessive power whilst low level stages are being aligned, it is suggested that the Tx post mixer tunable filter be de-tuned. Energise the transmitter via manual PTT from the auxiliary handset.

2. Tune L7 through L10 for peak o/p. For initial alignment this can be done by monitoring the 121 MHz level at TP18 initially and then at the input to the SBL-1X transmit mixer (U8), where a level of about 75mV should be measured by an RF millivoltmeter (e.g HP11960).

Typical RF millivoltmeter readings for each stage are :

TP17	125 mV RF = 0.25 VDC on HP11960 probe.
TP16	40 mV RF = 0.06 VDC on HP11960 probe.
TP18	550 mV RF = 1.0 VDC on HP11960 probe.
121 MHz i/p to mixer	75 mV RF = 0.13 VDC on HP11960 probe.

*Note: The signal at TP17 is present as long as "Tx En" is active. The subsequent test points require PTT to also be active.*

If the complete transmit chain is known to be operative then the 121 MHz o/p can be peaked by first de-tuning C78 on the tunable Tx filter until the Tx power o/p is less than 100 mW and then tuning Inductors L7 to L10 for maximum output at the Tx frequency.

3. With the radio section links set for the desired data rate (see link table above), set the peak deviation as per the chart below with VR3, and center frequency to 121.000 MHz with L6.

**NOTE : THESE ADJUSTMENTS ARE INTERACTIVE. ENSURE ALL COILS ARE SECURE**

<u>BAUD RATE</u>	<u>DEVIATION LEVEL</u>
4800 bps	± 1.5 kHz peak
9600 bps	± 2.75 kHz peak

4. Note that temperature compensation is applied to the 121MHz oscillator so attempting to adjust either VR3 or L6 will upset compensation and should only be done as a temporary measure. Return unit to factory for repair if errors >±500Hz are detected.

#### 4.7.3 TX FINAL

**NOTE: It is essential that all RF Deck mounting bolts are fitted and secure upon reassembly as many of these bolts provide inter-stage isolation and secure grounding ensuring the product meets all specifications.**

- 1 Ensure the 121 MHz Tx injection is operating correctly.
- 2 Check Q2,4,5,8, are all biased correctly as per the voltage chart. Temporarily disable the Tx power control circuitry by shorting LK4 located on the top side of the board near the ribbon cable. Energise the transmitter via the manual PTT on the auxiliary handset.
- 3 Tune the Tx filter tuning capacitor C78 for a peak output power measured at Antenna port or X4.
- 4 With full drive, Q9 driver collector current as seen across TP26/TP27 should be approximately 45 mA (100mVDC), and NOT MORE THAN 55mA (120mVDC).
- 5 With full drive at Q9 each final transistor should be drawing around 175 mA(385mVDC) as seen across TP26/TP29 or TP28. The output power measured directly at the final connector should be between +32 and +34 dbm without power control.
- 6 Re-enable the power control circuitry and with the 'Txpwr' control line set at +5VDC, set VR4 for +32 dbm±/ 0.25 dB at the tx o/p socket X4. Check that the current in EACH final collector does NOT EXCEED 225 mA.
- 7 Check with the spectrum analyser that the Tx o/p is free from spurious signals.

*Note 1 . Prior to the diplexer the VCO level is nominally about -20 dbc.*

*Note 2 . Close in mixing products (less than +/- 30 MHz) must be greater than 65db below the carrier, as they are not attenuated by the diplexer filters.*

### **D.C. Voltages of Radio Section**

RF Output Power set to +32 dbm at X4 (duplexer input) with 13.8 VDC supply

Transistor	Base	Emitter	Collector
Q2	1.66 VDC	0.92 VDC	6.96 VDC
Q4	1.79 VDC	1.06 VDC	6.46 VDC
Q5	1.80 VDC	1.08 VDC	7.51 VDC
Q8	1.05 VDC	0.31 VDC	4.02 VDC
Q9	0.47 VDC	0 VDC	13.35 VDC
Q10	0.28 VDC	0 VDC	13.05 VDC
Q11	0.29 VDC	0 VDC	13.16 VDC
Q12	7.17 VDC	7.97 VDC	7.88 VDC
Q1	7.29 VDC	7.97 VDC	7.91 VDC
Q13	4.56 VDC	3.84 VDC	7.97 VDC
Q7	1.14 VDC	0.41 VDC	6.68 VDC
Q6	1.13 VDC	0.40 VDC	7.52 VDC
Q3	1.06 VDC	0.33 VDC	7.59 VDC

#### **4.7.4 RECEIVER**

The receiver section requires little or no alignment once factory aligned.

##### **4.7.4.1 No AFC Models (Xtal 1 = 45.455MHz)**

- 1 Adjust L1 for 45.455 MHz measured with pickup loop near L1.
- 2 In emergency adjust coils L3, L4 and L5 for best SINAD at TP8.
- 3 Adjust audio mute VR1 to mute handset audio at 10dB SINAD
- 4 Adjust VR2 for 2.0 VDC at TP8 whilst receiving data off-air.

##### **4.7.4.2 AFC Models**

Monitor 44.545 MHz with pickup at L1. Test for 44.545  $\pm$ 1.5KHz

Consult factory for alignment or service information.

---

---

## SECTION 5

# INSTALLATION AND COMMISSIONING

---

---

### 5 INSTALLATION OVERVIEW

All Data Radio Modem devices needs to be properly installed and commissioned in order to function reliably. It is important that installers are familiar with RF products / installations and are geared up with appropriate tools necessary to confirm the ongoing reliability of a communications system.

This chapter is intended as a short form checklist to ensure such radio devices are installed correctly and that important tests are made and recorded at each site for future reference should a problem eventuate.

Installers should check that each data radio has been programmed to suit their specific requirements before installation.

#### 5.1 GENERAL

Installations play a critical role in network performance. Although this is a known fact, installations are often performed poorly or given little regard. It is essential that the installation is performed in a professional manner with careful attention and consideration to the following items :

1. Adequate primary power cable - relative to the length of cable to minimise voltage drop.
2. Shielded data cable between the unit and any external data equipment.
3. Low loss coax used for antenna feed line.
4. Careful termination of RF connectors.
5. A suitable antenna for the requirement.
6. Suitable placement of the antenna.
7. Adequate signal strength from the base station / other radio communications device.

## 5.2 INSTALLATION

The following information should assist when installing and commissioning data radio systems.

### 5.2.1 DATA CONNECTION

In industrial environments connection to any external device should be by shielded data cable with the shield connected to the connector shell to minimise data corruption, and/or radio interference.

### 5.2.2 MOUNTING

The radio modem should be mounted in a cool, dry, and vibration free environment. Mounting of the unit should be in a location providing easy access to screws and all connections.

### 5.2.3 POWER CONNECTIONS

The power required for 5 Watt (Tx) at 13.8VDC, is typically 2.0 Amps. As the Tx key up current is significant, the gauge of primary power wiring should be considered. It is suggested that a minimum of 18 gauge stranded copper wire be used for distances of up to two metres and a minimum of 14 gauge for longer distances up to 5 metres.

Ensure correct polarity to avoid costly repairs.

### 5.2.4 COAX CABLE CONNECTION

It is important to select the correct cable and connectors for each application as a poor selection can seriously degrade the performance of the unit.

As an example, for each 3dB of cable and connector loss, half the transmitter power is lost and twice the receiver signal power is required to produce the same bit error rate.

In some installations where strong signals are present, a compromise of cable and connector cost may be acceptable.

It is essential that all connector terminations are performed as per the manufacturers specifications (especially at 900MHz and above) and if connectors are to be used outside, it is essential that a sealant such as amalgamating tape be used to seal connectors. DO NOT use acetic cure silicon to seal the connectors.

It is also important that coax cables are not stressed by tight bends, kinking or excessive flexing. Ensure that coax cables have sufficient strain relief and are secure. If large diameter rigid or semi rigid cable is used, it is recommended to use a short length of high quality RG58 or RG223 cable between the unit and main cable feed.



The following chart is a guide to losses in various types of coaxes at 400MHz and 900MHz over distance, please consider this when installing the unit.

CABLE TYPE	LOSS RELATIVE TO DISTANCE							
	1 dB		3 dB		6 dB		9 dB	
	450MHz	900MHz	450MHz	900MHz	450MHz	900MHz	450MHz	900MHz
RG58C/U	2.3m	1.6m	7m	5m	14m	10m	20m	15m
RG223/U	3.1m	2.3m	9m	7m	18m	14m	28m	21m
RG213/U	6.1m	4m	18m	12m	37m	24m	55m	37m
HELIAX LDF4-50A	19m	14m	57m	43m	114m	87m	171m	130m
HELIAX LDF5-50A	38m	25m	114m	75m	229m	150m	343m	225m

### 5.3 ANTENNA INSTALLATION

The selection of antennas and their placement is one of the most important factors when installing a radio based network. People often use a simile, it is like putting square wheels on a Mercedes Benz..... very true comparison.

Antennas are generally mounted to a vertical pole with either vertical or horizontal polarisation as per the licence requirement.

Antennas should be mounted as high as practical and away from metal surfaces which can cause reflections.

Determining the type of antenna is very important and as a typical generic example, Point to Multipoint (PTMP) systems generally employ high gain (3, 6, or 9dB gain) omni directional antennas at the base station sites and either omni directional whips (unity gain) or preferably high gain directional yagi antennas (9 or 14dB gain) at the remote sites.

#### 5.3.1 YAGI ANTENNAS

Yagi antennas not only provide signal gain and directivity, but also provides protection from interfering signals which are outside the beam width of the antenna. Yagi antennas are essential when communicating over very long distances.

Yagi antennas are polarised and must be mounted either vertically (elements pointing from the ground to the sky) or horizontally (elements in parallel with the horizon).

As a general rule, Point to Multipoint remote units are vertically polarised, while Point to Point links are horizontally polarised.

When mounting yagi antennas with vertical polarisation, it should be noted that the dipole (loop section of antenna) has a drain hole. The small drain hole on one end of the dipole must be pointed towards the ground so that water will drain out of the antenna.

#### 5.3.2 OMNI DIRECTIONAL ANTENNAS

Omni directional antennas provide a radiation pattern of equal strength through 360° in the horizontal plane. This makes them ideal for base antennas in point to multipoint systems because they can reach the remote antennas.

Omni directional antennas are also used at remote sites (although yagi antennas are preferred) and are typically ground independent "whip" type antennas. The main reason for using whips at remote sites is for aesthetics as they are far less obtrusive than a yagi.

Regardless of the type, antennas need to be mounted properly and in a suitable location as covered below.

### 5.3.3 ANTENNA PLACEMENT

Antenna placement is of paramount importance and plays a big part of the antennas and in turn systems performance.

When choosing antenna locations the aim is to find the largest path of unobstructed space and locate the antennas within that space. It is important to locate antennas as high as possible and definitely clear of any moving obstructions.

Where possible it is important to avoid mounting antennas:

1. Against or adjacent to steel structures.
2. In an area which will have constant intermittent obstructions - people walking past, vehicles driving past etc. That is, mount antennas well above such moving obstructions.
3. Near any electrical equipment.
4. Near metal beams, structures etc.
5. Inside any metal enclosures, tin sheds / warehouses etc. - note meshed wire fences act like a "brick wall" to RF transmissions.
6. Away from guard rails or support beams.

*Note: Sometimes installations in such environments are unavoidable and where this is the case, certain care can be taken to still ensure a reliable installation. Please consult Trio for assistance on a case by case basis.*

If tests indicate poor signal strength then the antennas at one or both ends of the link should be raised, and/or moved clear of obstructing objects, or if directional antennas are employed they should be checked for correct directional orientation and polarisation (horizontal or vertical signal orientation).

### 5.3.4 REFLECTIONS AND OUTPUT POWER

Ideally, the propagation path should be clear Line of Site (LOS).

The biggest problem with UHF radio when used within "steel" buildings or obstructed paths is the large presence of signals randomly reflected from the surrounding obstructions or "steel" walls. These signals cannot be eliminated, but by maintaining a 10 to 20dB margin between the wanted and unwanted signals, problems should not be experienced. The simplest way to do this is to use directional gain antennas.

These antennas will provide attenuation to all signals arriving from a direction other than the direct path. Where steel walls or structure exist immediately behind the antenna location, the high front to back ratio of such antennas will negate such high level reflections. Power output should be set at the minimum level required to achieve a 25dB fade margin, in order to minimise the amount of RF being reflected, and to avoid saturating the receiver front end and therefore reducing the margin between wanted and unwanted signals.

## 5.4 COMMISSIONING - RSSI LEVEL

When commissioning a data radio network, it is important to ensure that the incoming received signal strength (RSSI) is adequate to provide reliable communications.

*Note: A good signal path should allow for approximately 30dB fade margin.*

Received signal strength (RSSI) of the incoming signal is available as an analogue output on Trio data radio modems. This RSSI output ranges from 0 to approx 4 Volts, where 4 Volts indicates the strongest signal. The actual values of received signal strength can be determined by comparing the output voltage against the calibrated graph supplied in the handbook.

By referring to the RSSI chart alignment of aerials can be optimised to achieve the greatest signal strength (highest output voltage).

*Note: Be sure to stand clear of aerials when measuring this output voltage, touching or standing in close proximity to aerials will give inaccurate readings.*

### 5.4.1 CHECKING DATA COMMUNICATIONS

If the host computer and remote equipment are capable of performing data integrity tests then connect the host and terminal data equipment to the radio modems.

Remove and re-apply power to each radio modem to ensure they are both in data comms mode, and run data tests on the link.

### 5.4.2 BIT ERROR RATE (BER) TESTING

If the connected data equipment is NOT capable of running data integrity tests then the TC-450DS modems can be put into a BER test mode, whereby the data channel can be tested in each direction to a reasonable level without external test equipment. To run a link test with the radio modems themselves, they must BOTH be put into BER test mode.

To place the unit in BER mode connect pin 6 and pin 9 of port A together and apply power..

The transmitter can be activated by driving the RTS pin (7) of port A positive. The unit will then send a predefined pseudo random sequence which is tested for accuracy by the receiving unit and any errors displayed on the front panel 'SYNC' lamp.

Each error bit will illuminate the lamp for approximately 1000 bits duration, therefore error rates above 1 in 1000 will show an almost constant error indication.

To return the unit to normal data transmission mode simply power it up without pin 9 connected to pin 6.

For further information on radio path problems please contact Trio DataCom for detailed advice.

*Note : BER testing is not viable in an operational point to multi-point environment as the BER test will interfere with other operative units.*

### 5.4.3 OUTPUT POWER - VSWR

Upon installation of equipment an output power measurement should be done using a suitable power meter. Forward and reflected power should be measured at the antenna port and recorded for future reference. The reflected power measurement should be as a minimum 3 : 1 of the forward power. If this is not the case, investigate possible causes such as poor terminations, faulty antenna etc.

### 5.4.4 DATA CONNECTION

The data connection is via a DB9 connector labelled 'Port A', which is wired as a DCE as shown below. The port labelled 'Port B' is not used for the standard configuration but can be enabled by the programmer for use as a totally independent second data channel. In industrial environments connection to the modem should be by shielded data cable with the shield connected to the connector shell to minimise data corruption, and radio interference.

#### - User Serial "Port A" Pin Assignment

##### PIN NO. & FUNCTION

1. DATA CARRIER DETECT (DCD)
2. RECEIVE DATA OUTPUT (RXD)
3. TRANSMIT DATA IN (TXD)
4. DATA TERMINAL READY (DTR)
5. COMMON (COM) \_\_\_\_\_
6. PROGRAM PIN (PGM)
7. REQUEST TO SEND (RTS)
8. CLEAR TO SEND (CTS)
9. BIT ERROR RATE PIN (BER)

##### EXTERNAL VIEW OF 'PORT A'

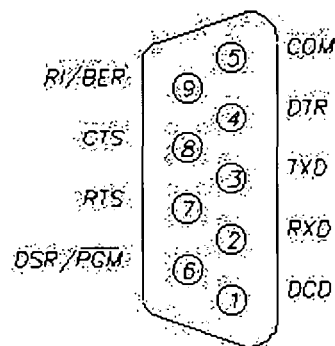

*NOTE: Pin 6 and pin 9 provide a dual function which depends on the mode that the TC-450DR is operating in.*

#### - User Serial "Port B" Pin Assignment.

Port B of the TC450DR is essentially unused in its standard configuration but can be enabled by the Programmer for use as a totally independent second data channel. This port is essentially used for specific applications and only has one connection that may be of use for installation purposes. This connection (Pin 9) is Receive Signal Strength Indicator (RSSI) output.

This RSSI output ranges from 0 to 5 Volts, where 5 Volts indicates the strongest signal. It is important to note that this Port output has a high impedance of around 10K ohms and loading will decrease accuracy of the recorded measurement.

## PIN NO. &amp; FUNCTION

1. DATA CARRIER DETECT
2. RECEIVE DATA O/P (RxD)
3. TRANSMIT DATA O/P (TxD)
4. DATA TERMINAL READY (DTR)
5. COMMON
6. DATA SET READY (DSR)
7. REQUEST TO SEND (RTS)
8. CLEAR TO SEND (CTS)
9. RECEIVE SIGNAL STRENGTH

## EXTERNAL VIEW OF 'PORT B'

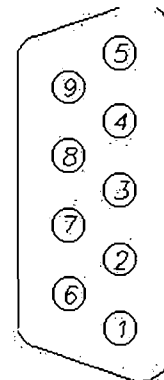

**5.5 GENERAL CHECKLIST**

The following is a simple commissioning checklist which should be used at every site not only to ensure correct installation, but also as a reference list for problems which may eventuate.

<b>TRIO SITE COMMISSIONING CHECK LIST / RECORD</b>			
Company:		Operator:	
Site Location:		Date:	
Link to:		Serial #:	
Radio Type:		Config File Name:	
Antenna Type / Gain		Path Distance	
Tx Power at Radio		Measured RSSI Volts	
Reflected Power		Fade Margin	
VSWR		Line of Site to Base	
Tx Power at Antenna		DC volts at Radio (Tx)	
<b>Site QA Inspection:</b>			
<b>Notes:</b>			
Signed		Date	

---



---

## SECTION 6

### FAULT FINDING

---



---

#### 6 FAULT FINDING

This section is to assist with difficulties that may be experienced when installing or working on the TC-900DR.

##### 6.1 MODEM/GENERAL

The following is a list of possible problem areas, and suggested checks that can be made to isolate any general problem that may have occurred.

##### 1. POWER SUPPLY

- a) Check for +13.8 Volts at supply input.
- b) Check fuse on Modem P/S PCB (1 Amp SLO-BLOW).
- c) Check supply volts:
  - Modem P/S
    - i) 13.8 Volts
    - ii) 8 Volts
    - iii) 5 Volts
  - RF Deck
    - i) 13.8 Volts
    - ii) 8 Volts
    - iii) 5 Volts

##### 2. ANTENNA

- a) Check antenna, cable and connectors for damage or water
- b) Check forward and reflected power at antenna connector of unit.  
VSWR should be  $\leq 1.5:1$

##### 3. PROGRAMMING

- Check programming information. e.g.
- i) Transmit and receive frequencies are within the operating band of the unit
  - ii) User interface configuration.



#### 4. INTERFACE

- a) Check connections to Port A (DB9 Connector).
- b) Check cable to host communications.
- c) Interface commands to unit are incorrect or communications are not established correctly.

#### 5. POOR TRANSMITTER PERFORMANCE

- a) Check correct transmit frequency programmed.
- b) Check transmitter carrier frequency.
- c) Check transmitter deviation.
- d) Check RF output power level.

#### 6. POOR RECEIVER PERFORMANCE

- a) Check correct receive frequency programmed.
- b) Check receive sensitivity.
- c) Check audio output level and DC bias to modem.
- d) Check mute threshold.

## 6.2 RECEIVER

The following is a list of problem areas, and suggested checks that can be made to isolate any receiver specific problems that may have occurred.

### 6.2.1 RECEIVE SENSITIVITY LOW

- 1 Check mixer drive level by measuring DC bias developed across R27.
- 2 Check for correct DC bias conditions and supply volts on RF Amp, Local Osc buffer, and IF Strip, compared to voltage charts.
- 3 Ensure 44.545 MHz oscillator (part of NE615 IF IC) is within  $\pm 250$  Hz. This is best carried out by using a communications test set such as an IFR1200 or similar in receiver mode with frequency error displayed.
- 4 Ensure that the local oscillator is netted to frequency by monitoring the Tx mixer injection with a pick up loop connected to a sensitive frequency counter of high stability. Adjust the VCXO frequency reference until correct L.O. frequency is observed. Note that the VCO and synthesiser use the VCXO as the frequency standard. Measure the Synthesiser LOCK signal to ensure the VCO is in phase lock.
- 5 With a 50 ohm signal generator tuned to 455 kHz, apply signal via a 1nF capacitor to the inputs of the 1st and second IF Amp sections of the 615 IF IC and compare the level required to produce the correct RSSI level.
- 6 With a 50 OHM signal generator tuned to 45.000 MHz, apply signal to the points defined on the IF test chart and compare RF level required to produce the reference RSSI level as specified at TP4.
- 7 Apply signal frequency to the RF input connector at X2 and compare the level required to produce RSSI reference level at TP4 with that shown in the IF Level Chart.
- 8 Reconnect the Antenna Diplexer and apply the signal generator to the Antenna terminal of the diplexer. Adjust the generator level to provide the same Rx mixer bias from applied RF signal as was noted in 7) above. The level required should be no more than 3 dB (Rx diplexer path loss) greater.

*Note that the RSSI signal provided by the IF IC is a fairly accurate logarithmic scale between 0.5 and 4VDC, providing about 0.5 VDC for each 10 dB of signal applied to the input of the IF Strip, and can be used as a reasonable measure of signal providing it is unmodulated and on center frequency at 455 kHz.*

## 6.2.2 RECEIVER LEVEL CHART

The following chart lists the level (terminated) of a 50 OHM signal generator to produce 2.0VDC of RSSI at TP4 when applied as specified to the point shown and at the frequency indicated.

FREQUENCY	CONNECTION POINT AND APPLICATION	NOM LEVEL
455 kHz	Pin 20 of IC U2 NE615 via 1nF	-72 dBm
455 kHz	Pin 18 of IC U2 NE615 via 1nF	-74 dBm
455 kHz	Pin 1(i/p) of IF Filter CF2 via 1nF	-58 dBm
455 kHz	Pin 14 of IC U2 NE615 via 1nF	-43 dBm
45 MHz	Rx i/p at X2 via coax direct	-49 dBm
45 MHz	Mixer i/p following R.F. Amp	-62 dBm
45 MHz	Mixer diode (D1) o/p across C100	-61 dBm
45 MHz	Junction of 1st & 2nd 45 MHz crystal filter	-77 dBm

### 6.3 TRANSMITTER

The following is a list of problem areas, and suggested checks that can be made to isolate any transmitter specific problems that may have occurred.

#### 1. NO TRANSMIT

1. Check PTT circuit.
2. Check unit is programmed within its operational range.
3. Check if manual PTT (Rear Aux connector) keys transmitter.
4. Check if any transmitter output is present. Tuning required?

#### 2. TRANSMITTER SPURIOUS EXCESSIVE

The probable cause is dependent upon the nature of the spurious as follows:

*Carrier  $\pm$  910kHz.* - IF detector signal (2x455) modulating or mixing with carrier. - Check 1n bypass on reference i/p to power control op-amp. Check bypasses on collectors and supply lines of low level transmitter stages, and L.O. buffer.

*Carrier  $\pm$  20.166 and/or 40.333.* - Excessive harmonics of 20.166 crystal oscillator in 121 MHz FM driver IC (U7). Check all pins of IC (U7) for correct DC conditions. Check all tuning inductors for 'normal Q', as 'soft' tuning will almost surely indicate an incorrect or faulty capacitor, or inductor.

*Carrier  $\pm$  VCXO reference frequency (approximately 7 MHz).* - Reference signal modulating VCO, or mixing with carrier in L.O. buffers. - Check Synthesiser supply bypasses, check for defective joints or components in and around the resistive divider at output of VCO.

*Note that it is imperative that low frequency divider products be attenuated before they can reach the base/emitter junctions of the L.O. buffer transistors where they can mix with the VCO frequency.*

*Note also that poor SMD solder joints will provide nonlinear conductance and give rise to frequency mixing in this area. Check for faulty components or poor joints around the Synthesiser to VCO frequency control area, or VCO supply line bypassing.*

Excessive Transmitter power radiated or conducted to the area of the VCO can also cause spurious effects and may enhance the levels of otherwise acceptable levels of spurious. If this is suspected, check that ALL chassis securing bolts are fitted and tight on the RF deck, and that ALL bypass capacitors and chokes are fitted and correct in and around the final Tx stages.

## 3. TRANSMITTER POWER LOW OR UNSTABLE :

- 1 *Firstly - Ensure that ALL RF Deck mounting bolts are fitted and secure.*
- 2 Check that the feed resistors used for current indication on all stages of the final are of correct value and firmly in circuit.
- 3 Check that the Tx L.O. buffer and post mixer buffers are correctly biased as per the voltage charts.
- 4 If necessary disconnect the final stages from the Tx post mixer buffers by removing the solder bridge between Q5 and Q8, and with an appropriate instrument measure the RF power available from the Tx buffers to the final pre-driver.  
*Note that the o/p impedance of the buffer is 50 OHM and must be measured by a 50 OHM instrument. It is highly recommended that a measuring spectrum analyser be used here as this instrument will also display the relationship between the wanted signal and other spurious or unwanted mixing products. The nominal display seen at this point by a spectrum analyser is shown on the spectrum charts attached.*
- 5 To test the final stages separate from the buffers - inject a signal from a 50 OHM generator at Tx frequency into pre-driver (Q8) via C122. The level required to drive the final to full output is shown on the Tx level chart.
- 6 Check that the current drawn by the driver transistor as measured across the feed resistor (TP28 to TP27) is within spec, and if not check and or replace the driver transistor or associated components as necessary.
- 7 Check that the current drawn by each final transistor as indicated by the voltage across the 2.2 OHM (2x4.7 ohm in parallel) collector feed resistors (TP26 to TP28 and TP29) is within the range stated in the voltage charts, and that both are within 10% of each other. If in error check components around final pair and replace final transistors as necessary.

***NOTE it is possible for power transistors to be partly defective due to current or thermal abuse, and the fact that the devices are actually drawing current does not always indicate that they are producing full power at the collector.***

## TX LEVEL CHART :

Frequency	Connection Point & Application	Level Remarks
Base band	Data from modem section TP13 (4800 baud)	2 VD.C
Base band	Applied data signal to modulator U7 pin 3 (4800 baud level from modem)	1 V <sub>p-p</sub>
Base band	Audio signal to modulator TP32	0.84 VD.C 60 mV <sub>p-p</sub> for VR3 set for maximum value 400 mV <sub>p-p</sub> for VR3 set for minimum value
Base band	Audio signal to modulator U7- pin 4	1.3 VD.C 0.5 V <sub>p-p</sub>
121 MHz	Signal level at TP18:A	-5 dBm
Final Tx frequency	Output to diplexer connector X1	3W at maximum power setting

---



---

## SECTION 7

### APPENDIX A

### DRAWINGS

---



---

#### 7 APPENDIX A DRAWINGS

TC01-08-12	Data Radio Mounting Details
TC01-08-11	Data Radio Assembly Details
TC01-04-05	Data Radio Basic Modem 9K6/4K8 Component Loading Details
TC01-00-05	450DR / 900DR Packet Modem (2 sheets)
TC01-08-10	PWB Manufacturing Details 900DR Data Radio - Radio Board (2 sheets)
TC01-00-10	Data Radio Project Sheet
TC01-00-10	Data Radio Final PA (AFC Fitted)
TC01-00-10	Data Radio 121 MHz OSC (AFC Fitted)
TC01-00-10	Data Radio - Synthesiser - VCO (AFC Fitted)
TC01-00-10	Data Radio - NE6154K8/9K6 (AFC Fitted)
TC01-04-15	850-930 MHz Antenna Diplexer Component Side Assembly
TC01-05-10	Radio Board Top Side (C/S) Test Point & Adjustment Location Details
TC01-05-10	Radio Board Bottom Side (S/S) Test Point & Adjustment Location Details
TC01-05-16	Duplex Radio BER/S+N/N vs Sig
TC01-05-17	AFC Alignment Setup - Block Diagram
TC01-05-12	4800/9600 BPS Modem Functional Diagram
TC01-05-23	Asynchronous Modem Functional Diagram
TC01-05-19	Macro Block Diagram
TC01-05-18	Radio Section - Modem Section Interface
DR9-BLOK	900MHz Radio Block Diagram
	RSSI Level of Received Signal (typical)

---

---

## SECTION 8

### APPENDIX B

## GLOSSARY of TERMS and ABBREVIATIONS

---

---

### 8 APPENDIX B GLOSSARY

ADC:	Analogue to digital converter.
AFC:	Automatic frequency control.
BER:	Bit error rate.
bps:	Bits per second.
C/DSMA:	Carrier or data sense, multiple access scheme.
COM:	Common.
CRC:	Cyclic redundancy checksum.
CTS:	Clear to send.
DAC:	Digital to analogue converter.
DCD:	Data carrier detect.
DCE:	Data communications equipment.
DFM4-9:	Trio DataCom digital modem chipset.
DIP:	Dual in line package.
DOTAC:	Department of Transport and Communications.
DSR:	Data set ready.
DTR:	Data terminal ready.
FCS:	Frame check sequence.
FEND:	Frame end.
FESC:	Frame escape.
FIFO:	First in first out.
FIR:	Finite impulse response.



FM :	Frequency modulation.
FSK:	Frequency shift keying.
GPIB:	General purpose interface bus.
HADR_EN:	High address enable signal.
IC :	Integrated circuit.
I.F.:	Intermediate frequency.
i/p:	Input.
KISS:	Keep it simple stupid.
LADR_EN:	Low address enable signal.
MSB:	Most significant bit.
NVRAM:	Non volatile RAM.
NRZ:	Non return to zero.
NRZI:	Non return to zero - inverted.
o/p:	Output.
PCB:	Printed circuit board.
PLL:	Phase locked loop.
PMP:	Point-to-multipoint.
ppm:	Parts per million.
PTP:	Point-to-point.
PTT:	Press to talk.
RF :	Radio frequency.
RI :	Ring indicate.
R_select:	RAM read select signal.
SIO:	Serial input/output.
RSSI:	Receive signal strength indication.
RTS:	Request to send.
Rx :	Receive.
RXD:	Receive data output.
SCADA:	Supervisory control and data acquisition.
SLIP:	Serial line interface protocol.

TC-900DR:	Trio DataCom 900MHz full duplex data transceiver.
TC-DFM9IP:	Trio DataCom TC-900DR parameter programming software suite.
TFEND:	Transposed Frame End.
TFESC:	Transposed Frame Escape.
TNC:	Terminal node controller.
Tx :	Transmit.
TXD:	Transmit data in.
VCO:	Voltage controlled oscillator.
W_select:	RAM write select signal







**Halmac** Services (Qld) Pty. Ltd.  
A.C.N. 098 852 923  
A.B.N. 40 741 712 113

# SOFT STARTER

## 1. MSF SOFT STARTER TECHNICAL DETAILS



Valid for the following Soft starter Models:  
MSF-017 to MSF-1400

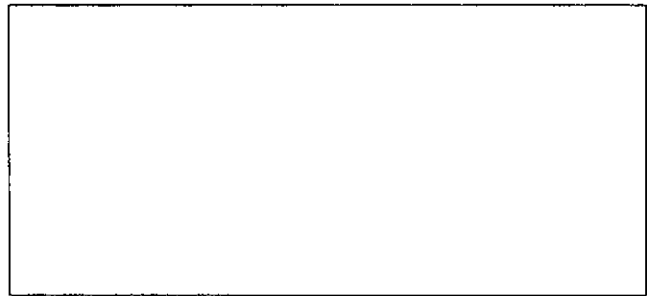

**MSF  
SOFT STARTER  
INSTRUCTION MANUAL**

Document number: 01-1363-01

Edition: r2

Date of release: 2001-04-20

© Copyright Emotron AB 2000

Emotron retain the right to change specifications and illustrations in the text, without prior notification. The contents of this document may not be copied without the explicit permission of Emotron AB.

## SAFETY INSTRUCTIONS

### Safety

The soft starter should be installed in a cabinet or in an electrical control room.

- The device must be installed by trained personnel.
- Disconnect all power sources before servicing.
- Always use standard commercial fuses, slow blow e.g. type gI, gG, to protect the wiring and prevent short circuiting. To protect the thyristors against short-circuit currents, superfast semiconductor fuses can be used if preferred. The normal guarantee is valid even if superfast semiconductor fuses are not used.

### Operating and maintenance personnel

1. Read the whole Instruction Manual before installing and putting the equipment into operation.
2. During all work (operation, maintenance, repairs, etc.) observe the switch-off procedures given in this instruction as well as any other operating instruction for the driven machine or system. See Emergency below.
3. The operator must avoid any working methods which reduce the safety of the device.
4. The operator must do what he can to ensure that no unauthorised person is working on the device.
5. The operator must immediately report any changes to the device which reduce its safety to the user.
6. The user must undertake all necessary measures to operate the device in perfect condition only.

### Installation of spare parts

We expressly point out that any spare parts and accessories not supplied by us have also not been tested or approved by us.

Installing and/or using such products can have a negative effect on the characteristics designed for your device. The manufacturer is not liable for damage arising as a result of using non-original parts and accessories.

### Emergency

You can switch the device off at any time with the mains switch connected in front of the soft starter (both motor and control voltage must be switched off).

### Dismantling and scrapping

The enclosure of the soft starter is made of recyclable material as aluminium, iron and plastic. Legal requirements for disposal and recycling of these materials must be complied with.

The soft starter contains a number of components demanding special treatment, as for example thyristors. The circuit board contain small amounts of tin and lead. Legal requirements for disposal and recycling of these materials must be complied with.



# CONTENTS

<b>1. GENERAL INFORMATION</b> .....	<b>6</b>	5.6	Keyboard lock .....	23
1.1 Integrated safety systems .....	6	5.7	Overview of soft starter operation and parameter set-up. ....	23
1.2 Safety measures .....	6	<b>6. INSTALLATION AND CONNECTION</b> .....	<b>24</b>	
1.3 Notes to the Instruction Manual .....	6	6.1	Installation of the soft starter in a cabinet .....	24
1.4 How to use the Instruction Manual .....	6	6.2	Connections .....	28
1.5 Standards .....	6	6.3	Connection and setting on the PCB control card .....	32
1.6 Tests in accordance with norm EN60204 .....	6	6.4	Minimum wiring .....	33
1.7 Inspection at delivery .....	7	6.5	Wiring examples .....	34
1.7.1 Transport and packing .....	7	<b>7. FUNCTIONAL DESCRIPTION SET-UP MENU</b> .....	<b>35</b>	
1.8 Unpacking of MSF-310 and larger types .....	7	7.1	Ramp up/down parameters .....	36
<b>2. DESCRIPTION</b> .....	<b>8</b>	7.1.1	RMS current [005] .....	36
2.1 General .....	8	7.2	Start/stop/reset command .....	37
2.2 MSF control methods .....	9	7.2.1	2-wire start/stop with automatic reset at start .....	37
2.2.1 General features .....	9	7.2.2	2-wire start/stop with separate reset .....	37
<b>3. HOW TO GET STARTED</b> .....	<b>10</b>	7.2.3	3-wire start/stop with automatic reset at start. ....	37
3.1 Checklist .....	10	7.3	Menu expansion setting. ....	38
3.2 Main functions/Applications .....	10	7.4	Voltage control dual ramp .....	38
3.3 Motor Data .....	10	7.5	Torque control parameters .....	39
3.4 Setting of the start and stop ramps .....	11	7.6	Current limit (Main Function) .....	39
3.5 Setting the start command .....	12	7.6.1	Voltage ramp with current limit .....	39
3.6 Viewing the motor current .....	12	7.6.2	Current limit .....	40
3.7 Starting .....	12	7.7	Pump control (Main Function) .....	40
<b>4. APPLICATIONS AND FUNCTIONS SELECTION</b> .....	<b>13</b>	7.8	Analogue Input Control (Main Function) .....	41
4.1 Soft starter rating according to AC53a .....	13	7.9	Full voltage start, D.O.L. (Main Function) .....	41
4.2 Soft starter rating according to AC53b .....	13	7.10	Torque control (Main function) .....	42
4.3 MSF Soft starter ratings .....	14	7.11	Torque boost .....	43
4.4 The Application Ratings List .....	14	7.12	Bypass .....	43
4.5 The Application Functions List .....	16	7.13	Power Factor Control .....	46
4.6 Function and combination matrix .....	19	7.14	Brake functions .....	46
4.7 Special condition .....	20	7.15	Slow speed and Jog functions .....	48
4.7.1 Small motor or low load .....	20	7.15.1	Slow speed controlled by an external signal. ...	48
4.7.2 Ambient temperature below 0xC .....	20	7.15.2	Slow speed during a selected time .....	49
4.7.3 Phase compensation capacitor .....	20	7.15.3	Jog Functions .....	49
4.7.4 Pole-changing contactor and two speed motor .....	20	7.15.4	DC-brake after slow speed at stop [040] .....	49
4.7.5 Shielded motor cable .....	20	7.16	Motor data setting .....	50
4.7.6 Slip ring motors .....	20	7.17	Programmable relay K1 and K2 .....	51
4.7.7 Pump control with soft starter and frequency inverter together .....	20	7.18	Analogue output .....	52
4.7.8 Starting with counter clockwise rotating loads .....	20	7.19	Digital input selection .....	53
4.7.9 Running motors in parallel .....	20	7.20	Parameter Set .....	54
4.7.10 How to calculate heat dissipation in cabinets .....	20	7.21	Motor protection, overload (F2 alarm) .....	55
4.7.11 Insulation test on motor .....	20	7.22	Mains protection .....	56
4.7.12 Operation above 1000 m .....	20	7.23	Application protection (load monitor) .....	57
4.7.13 Reversing .....	20	7.23.1	Load monitor max and min/protection (F6 and F7 alarms) .....	57
<b>5. OPERATION OF THE SOFT STARTER</b> .....	<b>21</b>	7.23.2	Pre-alarm .....	58
5.1 General description of user interface .....	21	7.24	Resume alarms .....	61
5.2 PPU unit .....	21	7.24.1	Phase input failure F1 .....	61
5.3 LED display .....	22	7.24.2	Run at current limit time-out F4 .....	61
5.4 The Menu Structure .....	22	7.25	Slow speed with JOG .....	61
5.5 The keys .....	23			



7.26 Automatic return menu .....62  
 7.27 Communication option, related Parameters ....62  
 7.28 Reset to factory setting [199] .....63  
 7.29 View operation .....63  
 7.30 Keyboard lock .....65  
 7.31 Alarm list .....65

**8. PROTECTION AND ALARM .... 66**

8.1 Alarm description .....66  
 8.1.1 Alarm with stop and requiring a separate reset66  
 8.1.2 Alarm with stop and requiring only a new start command .....66  
 8.1.3 Alarm with continue run .....66  
 8.2 Alarm overview .....67

**9. TROUBLE SHOOTING ..... 68**

9.1 Fault, cause and solution .....68

**10. MAINTENANCE ..... 71**

**11. OPTIONS ..... 72**

11.1 Serial communication .....72  
 11.2 Field bus systems .....72  
 11.3 External PPU. ....72  
 11.3.1 Cable kit for external current transformers.....72  
 11.4 Terminal clamp .....73

**12. TECHNICAL DATA ..... 74**

**13. SET-UP MENU LIST ..... 79**

**14. INDEX ..... 82**

**REPRESENTATION ..... 85**

**List of tables**

Table 1 Applications Rating List .....15  
 Table 2 Application Function List .....17  
 Table 3 Combination matrix .....19  
 Table 4 Start/stop combination. ....19  
 Table 5 The keys .....23  
 Table 6 Control modes .....23  
 Table 7 MSF-017 to MSF-250. ....25  
 Table 8 MSF-017 to MSF-250 .....25  
 Table 9 MSF-310 to MSF-1400 .....25  
 Table 10 MSF-310 to MSF-1400. ....25  
 Table 11 Busbar distances .....26  
 Table 12 PCB Terminals .....32  
 Table 13 Set-up Menu overview .....35

**List of figures**

Fig. 1	Scope of delivery. ....	7	Fig. 54	Wiring for slow speed external input. ....	53
Fig. 2	Unpacking of MSF-310 and larger models. ....	7	Fig. 55	Parameter overview .....	54
Fig. 3	Voltage control .....	8	Fig. 56	Connection of external control inputs. ....	54
Fig. 4	Current control .....	8	Fig. 57	The thermal curve .....	55
Fig. 5	Torque control .....	8	Fig. 58	Load monitor alarm functions. ....	60
Fig. 6	Standard wiring. ....	10	Fig. 59	The 2 Jog keys. ....	61
Fig. 7	Example of start ramp with main function voltage ramp. ....	12	Fig. 60	Option RS232/485 .....	72
Fig. 8	Rating example AC53a. ....	13	Fig. 61	Option Profibus .....	72
Fig. 9	Duty cycle, non bypass. ....	13	Fig. 62	Shows an example of the External PPU after it has been built in. ....	72
Fig. 10	Rating example AC53b. ....	13	Fig. 63	Cable kit .....	72
Fig. 11	Duty cycle, bypassed .....	13	Fig. 64	The terminal clamp. ....	73
Fig. 12	MSF soft starter models. ....	21			
Fig. 13	PPU unit. ....	21			
Fig. 14	LED indication at different operation situation. ....	22			
Fig. 15	Menu structure. ....	22			
Fig. 16	MSF-017 to MSF-250 dimensions. ....	24			
Fig. 17	Hole pattern for MSF-017 to MSF-250 .....	24			
Fig. 18	Hole pattern for MSF-170 to MSF-250 with upper mounting bracket instead of DIN-rail. ....	24			
Fig. 19	MSF -310 to MSF -835. ....	26			
Fig. 20	Hole pattern for screw attachment, MSF-310 to MSF-835. Hole distance (mm). ....	26			
Fig. 21	Busbar distances MSF -310 to MSF -835. ....	26			
Fig. 22	MSF -1000 to -1400 .....	27			
Fig. 23	Hole pattern busbar MSF -1000 to -1400. ....	27			
Fig. 24	Connection of MSF-017 to MSF -085. ....	28			
Fig. 25	Connection of MSF-110 to MSF-145. ....	29			
Fig. 26	Connection of MSF-170 to MSF-250 .....	30			
Fig. 27	Connection of MSF-170 to MSF-1400. ....	31			
Fig. 28	Connections on the PCB, control card. ....	32			
Fig. 29	Wiring circuit, "Minimum wiring". ....	33			
Fig. 30	Analogue input control, parameter set, analogue output and PTC input. ....	34			
Fig. 31	Forward/reverse wiring circuit. ....	34			
Fig. 32	Menu numbers for start/stop ramps, initial voltage at start and step down voltage at stop. ....	36			
Fig. 33	Menu numbers for dual voltage ramp at start/stop, initial voltage at start and step down-voltage at stop. ....	38			
Fig. 34	Current limit .....	39			
Fig. 35	Current limit .....	40			
Fig. 36	Pump control .....	40			
Fig. 37	Wiring for analogue input. ....	41			
Fig. 38	Setting voltage or current for analogue input. ....	41			
Fig. 39	Full voltage start. ....	41			
Fig. 40	Torque control at start/stop. ....	42			
Fig. 41	Current and speed in torque control. ....	42			
Fig. 42	The principle of the Torque Booster when starting the motor in voltage ramp mode. ....	43			
Fig. 43	Bypass wiring example MSF 310-1400. ....	44			
Fig. 44	Current transformer position when Bypass MSF-017 to MSF-250. ....	45			
Fig. 45	Current transformer position when Bypass MSF-310 to MSF-1400. ....	45			
Fig. 46	Braking time .....	46			
Fig. 47	Soft brake wiring example. ....	47			
Fig. 48	Slow speed controlled by an external signal. ....	48			
Fig. 49	Slow speed at start/stop during a selected time. ....	49			
Fig. 50	Start/stop sequence and relay function "Operation" and "Full voltage". ....	51			
Fig. 51	Wiring for analogue output. ....	52			
Fig. 52	Setting of current or voltage output. ....	52			
Fig. 53	Setting of J1 for current or voltage control. ....	53			

## 1. GENERAL INFORMATION

### 1.1 Integrated safety systems

The device is fitted with a protection system which reacts to:

- Over temperature.
- Voltage unbalance.
- Over- and under voltage.
- Phase reversal
- Phase loss
- Motor overload protection thermal and PTC.
- Motor load monitor, protecting machine or process max or min alarm
- Starts per hour limitation

The soft starter is fitted with a connection for protective earth  $\perp$  (PE).

MSF soft starters are all enclosed IP 20, except MSF-1000 and MSF-1400 which are delivered as open chassi IP00.

### 1.2 Safety measures

These instructions are a constituent part of the device and must be:

- Available to competent personnel at all times.
- Read prior to installation of the device.
- Observed with regard to safety, warnings and information given.

The tasks in these instructions are described so that they can be understood by people trained in electrical engineering. Such personnel must have appropriate tools and testing instruments available. Such personnel must have been trained in safe working methods.

The safety measures laid down in DIN norm VDE 0100 must be guaranteed.

The user must obtain any general and local operating permits and meet any requirements regarding:

- Safety of personnel.
- Product disposal.
- Environmental protection.

**NOTE! The safety measures must remain in force at all times. Should questions or uncertainties arise, please contact your local sales outlet.**

### 1.3 Notes to the Instruction Manual



**WARNING! Warnings are marked with a warning triangle.**

#### Serial number

The information given in these instructions only applies to the device with the serial number given on the label on the front page. A plate with the serial number is fixed to the device.

#### Important

For all enquiries and spare parts orders, please quote the correct name of the device and serial number to ensure that your inquiry or order is dealt with correctly and swiftly.

**NOTE! These instructions only apply to the soft starters having the serial number given on the front page, and not for all models.**

### 1.4 How to use the Instruction Manual

This instruction manual tells you how to install and operate the MSF soft starter. Read the whole Instruction Manual before installing and putting the unit into operation. For simple start-up, read chapter 2. page 8 to chapter 3. page 10.

Once you are familiar with the soft starter, you can operate it from the keyboard by referring to the chapter 13. page 79. This chapter describes all the functions and possible setting.

### 1.5 Standards

The device is manufactured in accordance with these regulations.

- IEC 947-4-2
- EN 60204-1 Electrical equipment of machines, part 1, General requirements and VDE 0113.
- EN 50081-2, EMC Emission
- EN 50081-1, EMC Emission with bypass
- EN 50082-2, EMC Immunity
- GOST
- UL508

### 1.6 Tests in accordance with norm EN60204

Before leaving the factory, the device was subjected to the following tests:

- Through connection of earthing system;
  - a) visual inspection.
  - b) check that earthing wire is firmly connected.
- Insulation
- Voltage
- Function

## 1.7 Inspection at delivery

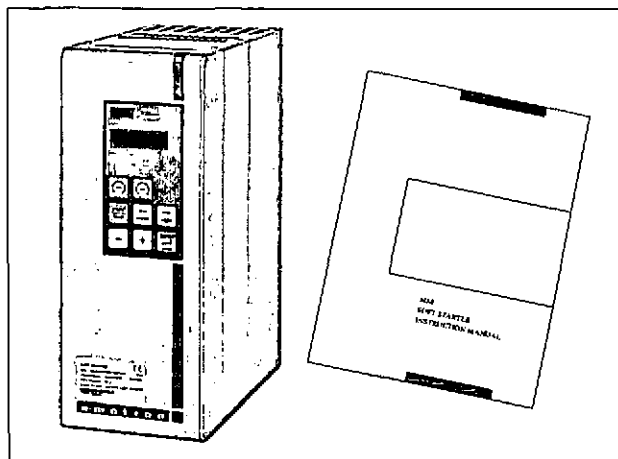

Fig. 1 Scope of delivery.

### 1.7.1 Transport and packing

The device is packed in a carton or plywood box for delivery. The outer packaging can be returned. The devices are carefully checked and packed before dispatch, but transport damage cannot be ruled out.

#### Check on receipt:

- Check that the goods are complete as listed on the delivery note, see type no. etc. on the rating plate.

#### Is the packaging damaged?

- Check the goods for damage (visual check).

#### If you have cause for complaint

If the goods have been damaged in transport:

- Contact the transport company or the supplier immediately.
- Keep the packaging (for inspection by the transport company or for returning the device).

#### Packaging for returning the device

- Pack the device so that it is shock-resistant.

#### Intermediate storage

After delivery or after it has been dismantled, the device can be stored before further use in a dry room.

## 1.8 Unpacking of MSF-310 and larger types

The soft starter is attached to the plywood box/loading stool by screws, and the soft starter must be unpacked as follows:

1. Open only the securing plates at the bottom of the box (bend downwards). Then lift up the box from the loading stool, both top and sides in one piece.
2. Loosen the three (3 pcs) screws on the front cover of the soft starter, down by the lower logo.
3. Push up the front cover about 20 mm so that the front cover can be removed.
4. Remove the two (2 pcs) mounting screws at the bottom of the soft starter.
5. Lift up the soft starter at the bottom about 10 mm and then push backwards about 20 mm so that the soft starter can be removed from the mounting hooks\* at the top. The hooks are placed under the bottom plate and cannot be removed until the soft starter is pulled out.
6. Loosen the screws (2 pcs) for the mounting hooks and remove the hooks.
7. The hooks are used as an upper support for mounting the soft starter.

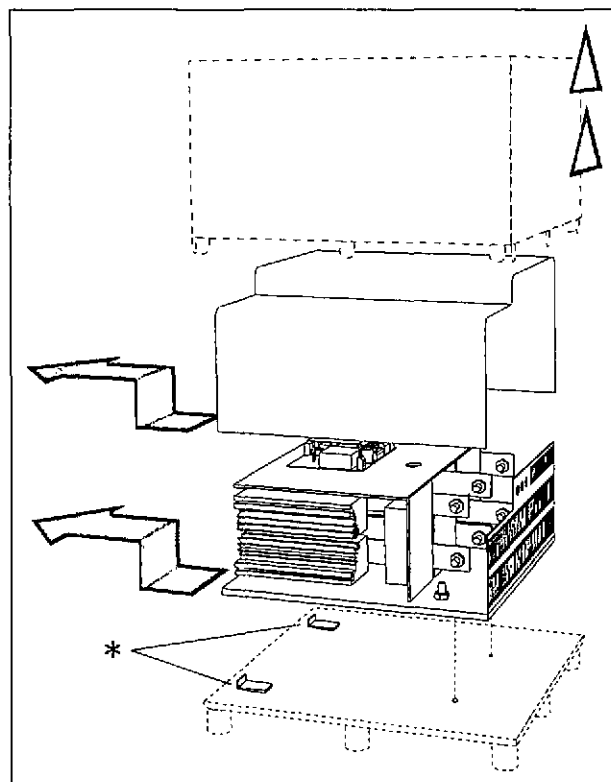
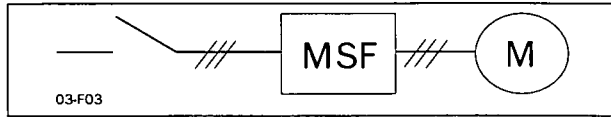

Fig. 2 Unpacking of MSF-310 and larger models.

## 2. DESCRIPTION

### 2.1 General

The MSF is installed directly between the mains and the supply cable to the motor. If a mains contactor is used it can be activated by the integrated K1 relay.



The MSF is developed for soft starting, stopping and braking three-phase motors.

There are 3 different kinds of soft starting control methods:

- **Control method 1-Phase**  
The single phase controlled soft starters provide only a reduction in starting torque no control of current or torque. These starters need a main and bypass contactor as well as external motor protections. This is an open loop voltage controller. These starters are mainly in the power up to 7.5 kW.
- **Control method 2-Phase**  
The two phase starters can start a motor without a mains contactor, but in that case voltage still is present at the motor when it's stopped. These starters are mainly in the power up to 22 kW.
- **Control method 3-Phase**  
In the three phase Soft Starters there are different technologies:
  - Voltage control
  - Current control
  - Torque control

#### Voltage control

This method is the most used control method. The starter gives a smooth start but doesn't get any feedback on current or torque. The typical settings to optimize a voltage ramp are: Initial voltage, ramp time, dual ramp time.

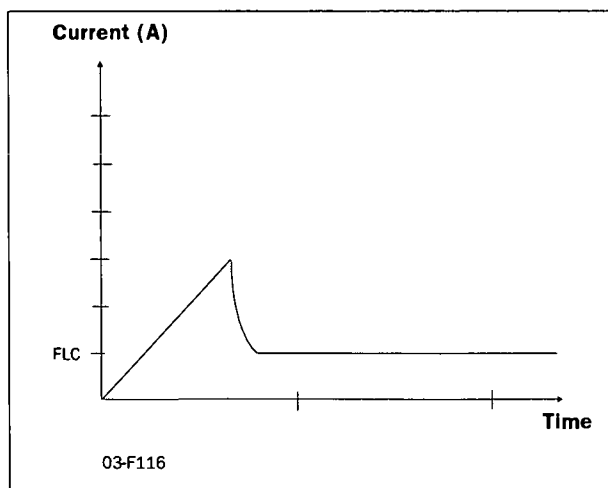

Fig. 3 Voltage control

#### Current control

The voltage ramp can be used with a current limit which stops the voltage ramp when the set maximum current level is reached. The maximum current level is the main setting and must be set by the user depending the maximum current allowed for the application.

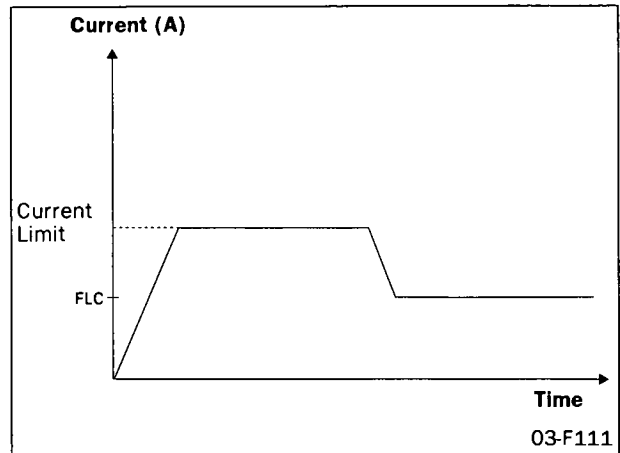

Fig. 4 Current control

#### Torque control

Is the most sufficient way of starting motors. Unlike voltage and current based systems the soft starter monitors the torque need and allows to start with the lowest possible current. Using a closed loop torque controller also linear ramps are possible. The voltage ramp can not hold back the motor starting torque this results in a current peak and unlinear ramps. In the current ramp there will be no peak current, but a higher current for a longer period of time during the start compared to torque control. Current starting doesn't give linear ramps. The linear ramps are very important in many applications. For an example, to stop a pump with an unlinear ramp will give water hammer. Soft starters which doesn't monitor the torque, will start and stop to fast if the load is lighter than the setting of current or ramp time.

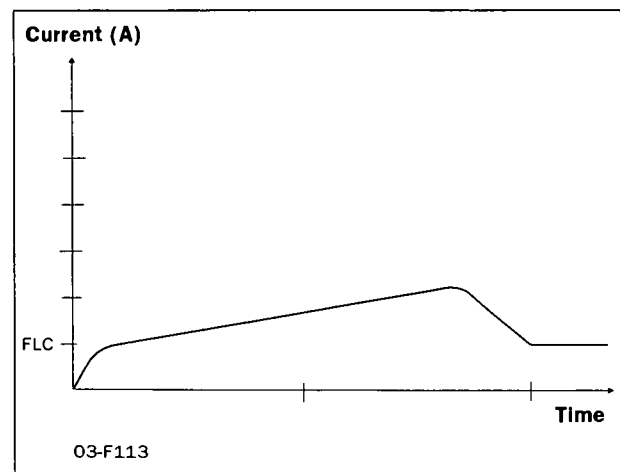

Fig. 5 Torque control



## 2.2 MSF control methods

MSF Soft Starters control all three phases supplied to the motor. It manages all the 3 possible starting methods where the closed loop Torque control is the most efficient way of starting and stopping motors.

### 2.2.1 General features

As mentioned above soft starters offer you several features and the following functions are available:

- Torque controlled start and stop
- Current limit control at start
- Application “Pump”
- External analogue input control
- Torque booster at start
- Full voltage start (D.O.L)
- Dual voltage ramp at start and stop
- Bypass
- Dynamic DC-brake or Softbrake
- Slow speed at start and stop
- Jogging forward and reverse
- Four parameter sets
- Analogue output indicating current, power or voltage
- Viewing of current, voltage, power, torque, power consumption, elapsed time etc.
- Integrated safety system acc. to § 1.1, page 6, with an alarm list.

### 3. HOW TO GET STARTED

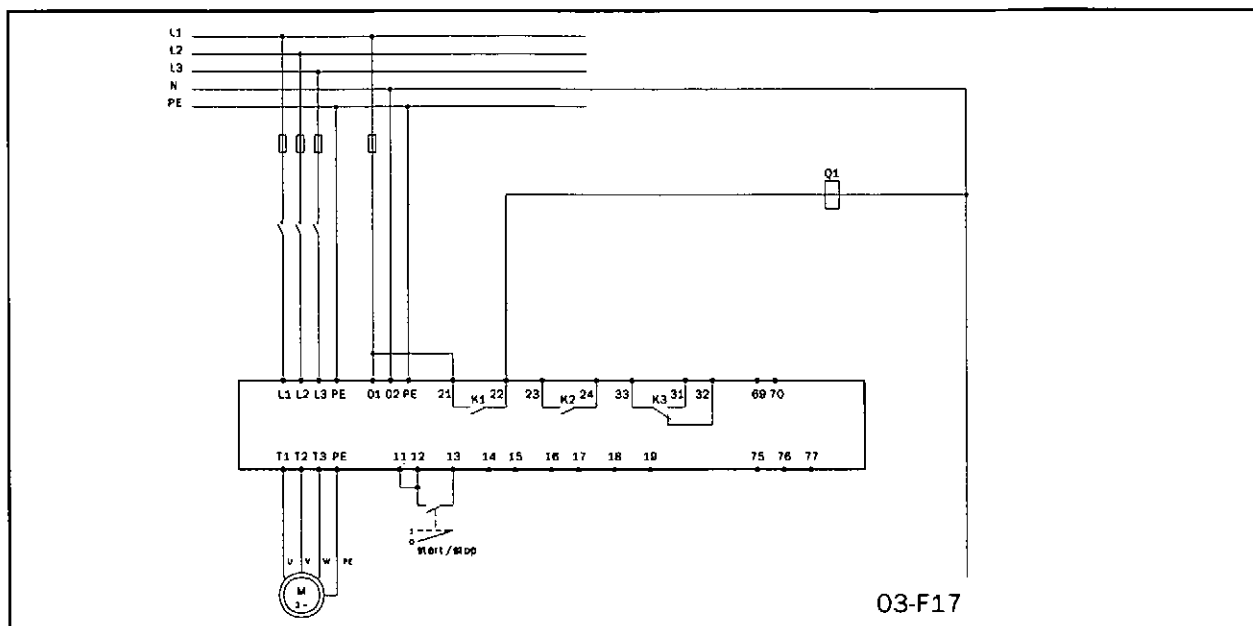

Fig. 6 Standard wiring.

This chapter describes briefly the set-up for basic soft start and soft stop by using the default “Voltage Ramp” function.



**WARNING! Mounting, wiring and setting the device into operation must be carried out by properly trained personnel. Before set-up, make sure that the installation is according to chapter 6, page 24 and the Checklist below.**

#### 3.1 Checklist

- Mount the soft starter in accordance with chapter 6, page 24.
- Consider the power loss at rated current when dimensioning a cabinet, max. ambient temperature is 40°C (see chapter 12, page 74).
- Connect the motor circuit according to Fig. 6.
- Connect the protective earth.
- Connect the control voltage to terminals 01 and 02 (100 - 240 VAC or 380-500 VAC).
- Connect relay K1 (PCB terminals 21 and 22) to the contactor - the soft starter then controls the contactor.
- Connect PCB terminals 12 and 13 to, e.g., a 2-way switch (closing non-return) or a PLC, etc., to obtain control of soft start/soft stop.<sup>1)</sup>
- Check that the motor and supply voltage corresponds to values on the soft starter’s rating plate.
- Ensure the installation complies with the appropriate local regulations.

<sup>1)</sup> The menu 006 must be put to 01 for start/stop command from keyboard.

#### 3.2 Main functions/Applications



**WARNING! Make sure that all safety measures have been taken before switching on the supply.**

Switch on the control voltage (normally 1 x 230 V), all segments in the display and the two LED’s will be illuminated for a few seconds. Then the display will show menu 001. An illuminated display indicates there is supply voltage on the PCB. Check that you have mains voltage on the mains contactor or on the thyristors. The settings are carried out according to following:

The first step in the settings is to set menu 007 and 008 to “ON” to reach the main functions 020-025 and motor data 041-046.

**NOTE! The main function is chosen according to the application. The tables in the applications and functions selection (table 1, page 15), gives the information to choose the proper main function.**

#### 3.3 Motor Data

Set the data, according to the motor type plate to obtain optimal settings for starting, stopping and motor protection.

**NOTE! The default settings are for a standard 4-pole motor acc. to the nominal power of the soft-starter. The soft starter will run even if no specific motor data is selected, but the performance will not be optimal.**



041 <sup>o</sup>	
Nominal motor voltage	
4 0 0	
Default:	400 V
Range:	200-700 V

046 <sup>o</sup>	
Nominal frequency	
5 0	
Default:	50 Hz
Range:	50/60 Hz

**NOTE!** Now go back to menu 007 and set it to "oFF" and then to menu 001.

042 <sup>o</sup>	
Nominal motor current	
4 5	
Default:	Nominal current soft starter
Range:	25% - 150% of $I_{n_{soft}}$ in Amp

### 3.4 Setting of the start and stop ramps

The menu's 002 and 003 can now be set to adjust the start ramp up time and the stop ramp down time.

043 <sup>o</sup>	
Nominal motor power	
2 2	
Default:	Nominal power soft starter
Range:	25% - 300% of $P_{n_{soft}}$ in kW

002 <sup>o</sup>	
Start time ramp 1	
1 0	
Default:	10 sec
Range:	1-60 sec

Estimate the starting-time for the motor/machine. Set "ramp up time" at start (1-60 sec).  
 Key "ENTER ↵" to confirm new value.  
 Key "NEXT →", "PREV ←" to change menu.

044 <sup>o</sup>	
Nominal motor speed	
1 4 5 0	
Default:	Nominal speed soft starter
Range:	500-3600 rpm

004 <sup>o</sup>	
Stop time ramp 1	
o F F	
Default:	oFF
Range:	oFF, 2-120 sec

Set "ramp down time" at stop (2-120 s).  
 "oFF" if only soft start requires.

045 <sup>o</sup>	
Nominal motor cos phi	
. 8 6	
Default:	0.86
Range:	0.50-1.00

### 3.5 Setting the start command

As default the start command is set for remote operation via terminal 11, 12 and 13. For easy commissioning it is possible to set the start command on the start key on the keyboards. This is set with menu 006.

006 <sup>o</sup>					
<b>Selection of control mode</b>					
<table border="1" style="display: inline-table;"> <tr> <td style="width: 20px; height: 20px;"></td> <td style="width: 20px; height: 20px;"></td> <td style="width: 20px; height: 20px;"></td> <td style="width: 20px; height: 20px; text-align: center;">2</td> </tr> </table>					2
			2		
Default:	2				
Range:	1,2,3				

Menu 006 must be set to 1 to be able to operate from keyboard.

**NOTE! Factory default setting is remote control (2).**

To start and stop from the keyboard, the “START/STOP” key is used.

To reset from the keyboard, the “ENTER ↵ / RESET” key is used. A reset can be given both when the motor is running and when the motor is stopped. A reset by the keyboard will not start or stop the motor.

### 3.6 Viewing the motor current

Set the display to menu 005. Now the Motor current can be viewed on the display.

005 <sup>o</sup>					
<b>RMS current read-out</b>					
<table border="1" style="display: inline-table;"> <tr> <td style="width: 20px; height: 20px;"></td> <td style="width: 20px; height: 20px;"></td> <td style="width: 20px; height: 20px; text-align: center;">0.</td> <td style="width: 20px; height: 20px; text-align: center;">0</td> </tr> </table>				0.	0
		0.	0		
Default:	-				
Range:	0.0-9999 Amp.				

**NOTE! The menu 005 can be selected at any time when the motor is running.**

### 3.7 Starting



**WARNING! Make sure that all safety measures have been taken before starting the motor in order to avoid personal injury.**

Start the motor by pressing the “START/STOP” key on the keyboard or through the remote control, PCB terminal 11, 12 and 13. When the start command is given, the mains contactor will be activated by relay K1 (PCB terminal 21 and 22), and the motor then starts softly.

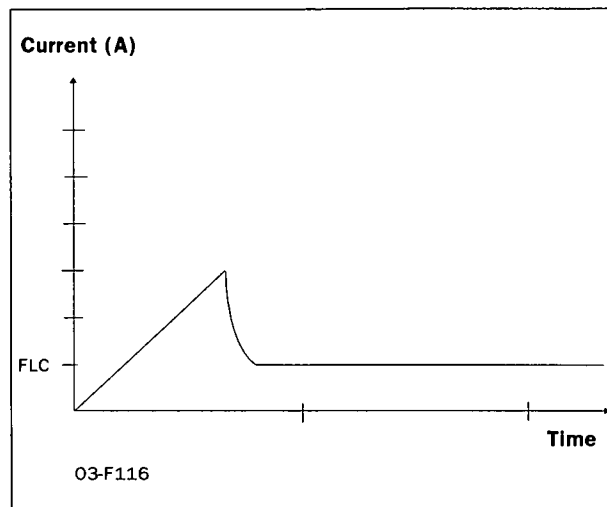

Fig. 7 Example of start ramp with main function voltage ramp.

## 4. APPLICATIONS AND FUNCTIONS SELECTION

This chapter is a guide to select the correct soft starter rating and the selection of the Main function and additional functions for each different application.

To make the right choice the following tools are used:

- The norm AC53a.**  
 This norm helps selecting the soft starter rating with regard to duty cycle, starts per hour and maximum starting current.
- The Application Rating List.**  
 With this list the soft starter rating can be selected depending on the kind of application used. The list use 2 levels of the AC53a norm. See table 1, page 15.
- The Application Function List.**  
 This table gives an complete overview of most common applications and duties. For each applications the menu's that can be used are given. See table 2, page 17.
- Function and Combination matrix.**  
 With these tables it is easy to see which combinations of Main and additional functions are possible, see table 3, page 19 and table 4, page 19.

### 4.1 Soft starter rating according to AC53a

The IEC947-4-2 standard for electronic starters defines AC53a as a norm for dimensioning of a soft starter.

The MSF soft starter is designed for continuous running. In the Applications table (table 1, page 15) two levels of AC53a are given. This is also given in the technical data tables (see chapter 12. page 74).

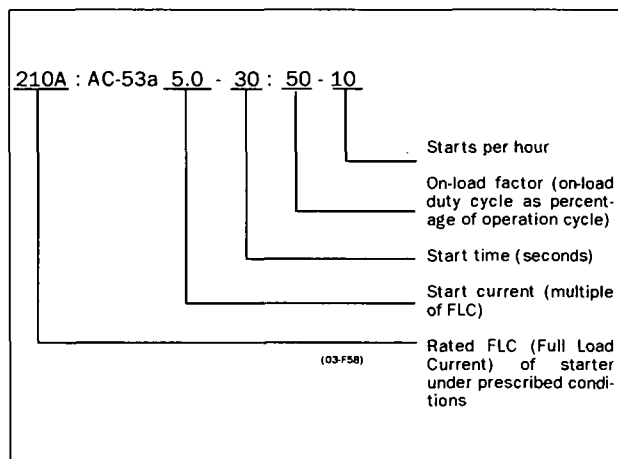

Fig. 8 Rating example AC53a.

The above example indicates a current rating of 210 Amps with a start current ratio of 5.0 x FLC (1050A) for 30 seconds with a 50% duty cycle and 10 starts per hour.

**NOTE! If more than 10 starts/hour or other duty cycles are needed, please contact your supplier.**

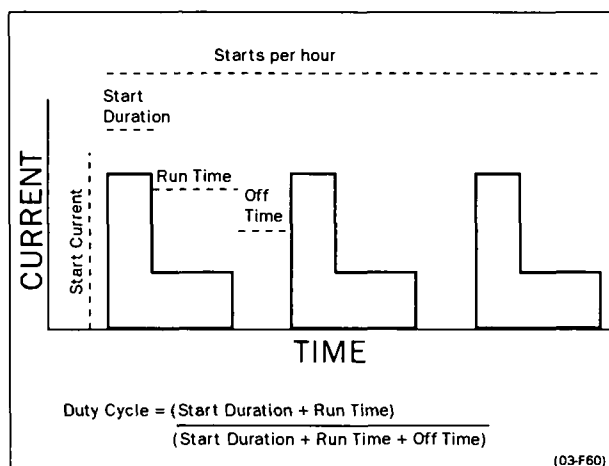

Fig. 9 Duty cycle, non bypass.

### 4.2 Soft starter rating according to AC53b

This norm is made for Bypass operation. Because the MSF soft starter is designed for continuous operation this norm is not used in the selection tables in this chapter.

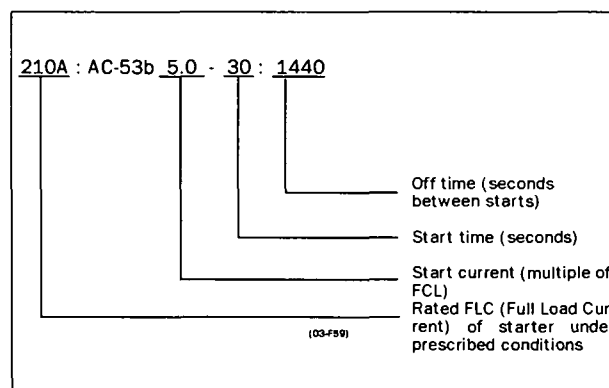

Fig. 10 Rating example AC53b.

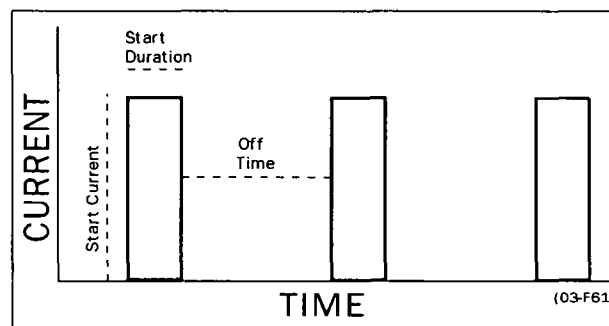

Fig. 11 Duty cycle, bypassed

The above example indicates a current rating of 210 Amps with a start current ratio of 5.0 x FLC (1050A) for 30 seconds with a 24-minute period between starts.

### 4.3 MSF Soft starter ratings

According to the norms AC53a and AC53b a soft starter can have many current ratings.

**NOTE! Because the MSF soft starter is designed for continuous operation the norm AC53b is not used in the application rating list.**

With help of the Application Rating List with typical starting currents and categories in the AC53a level (see table 1, page 15 and table 2, page 17) it is easy to select the proper soft starter rating with the application.

The Application Rating List uses two levels for the AC53a norm:

- **AC53a 5.0-30:50-10 (heavy duty)**  
This level will be able to start all applications and follows directly the type number of the soft starter.  
Example: MSF 370 is 370 Amps FLC and then 5 time this current in starting.
- **AC 53a 3.0-30:50-10 (normal/light duty)**  
This level is for a bit lighter applications and here the MSF can manage a higher FLC.  
Example: MSF 370 in this norm manage 450 Amps FLC and the 3 times this current in starting

**NOTE! To compare Soft Starters it's important to ensure that not only FLC (Full Load Current) is compared but also that the operating parameters are identical.**

### 4.4 The Application Ratings List

Table 1 gives the Application Ratings List. With this list the rating for the soft starter and Main Function menu can be selected.

Description and use of the table:

- **Applications.**  
This column gives the various applications. If the machine or application is not in this list, try to identify a similar machine or application. If in doubt please contact your supplier.
- **AC53a ratings.**  
The rating according to AC53a norm is here classified in 2 ratings. The first for normal/light duty (3.0-30:50-10) and the second for heavy duty (5.0-30:50-10)
- **Typical Starting current.**  
Gives the typical starting current for each application
- **Main Function menu.**  
The Main Function menu is advised here.  
"25;=1", means: program selection 1 in menu 25.
- **Stop function.**  
Gives a possible Stop function if applicable.  
"36;=1 / 38-40", means: program selection 1 in menu 36, also menus 38 to 40 can be selected.

#### EXAMPLE:

Roller Mill:

- This is an application for heavy duty,
- Typical starting current of 350%.
- Main function Torque ramp start (menu 25) will give the best results.
- Stop function Dynamic Brake (menu 36, selection 1) can be used.
- As well as the Slow Speed at start and stop (menu 38-40) can be used for better start and stop performance.

Table 1 Applications Rating List

Applications	AC53a 3.0-30:50-10 (normal/light)	AC 53a 5.0-30:50-10 (heavy)	Typical starting current %	Main function Menu nr.	Stop function Menu nr.
<b>General &amp; Water</b>					
Centrifugal Pump	x		300	22	22
Submersible Pump	x		300	22	22
Conveyor		x	300-400	25;=1	36;=1 / 38-40
Compressor: Screw	x		300	25	-
Compressor, Reciprocating	x		400	25;=1	-
Fan	x		300	25;=2	-
Mixer		x	400-450	25;=1	-
Agitator		x	400	25;=1	-
<b>Metals &amp; Mining</b>					
Belt Conveyor		x	400	25;=1	36;=1 / 38-40
Dust Collector	x		350		-
Grinder	x		300	25;=1	36;=1
Hammer Mill		x	450	25;=1	36;=2
Rock Crusher		x	400	25;=1	-
Roller Conveyor	x	x	350	25;=1	36;=1 / 38-40
Roller Mill		x	450	25;=1	36;=1 or 2
Tumbler		x	400	25;=1	-
Wire Draw Machine		x	450	25;=1	36;=1 or 2
<b>Food Processing</b>					
Bottle Washer	x		300	25;=2	
Centrifuge		x	400	25;=1	36;=1 or 2
Dryer		x	400	25;=2	
Mill		x	450	25;=1	36;=1 or 2
Palletiser		x	450	25;=1	
Separator		x	450	25;=1	36;=1 or 2
Slicer	x		300	25;=1	
<b>Pulp and Paper</b>					
Re-Pulper		x	450	25;=1	
Shredder		x	450	25;=1	
Trolley		x	450	25;=1	
<b>Petrochemical</b>					
Ball Mill		x	450	25;=1	
Centrifuge		x	400	25;=1	36;=1 or 2
Extruder		x	500	25;=1	
Screw Conveyor		x	400	25;=1	
<b>Transport &amp; Machine Tool</b>					
Ball Mill		x	450	25;=1	
Grinder		x	350	25;=1	36;=1
Material Conveyor		x	400	25;=1	36;=1 / 38-40
Palletiser		x	450	25;=1	
Press		x	350	25;=1	
Roller Mill		x	450	25;=1	
Rotary Table		x	400	25;=1	36;=1 / 38-40
Trolley		x	450	25;=1	
Escalator		x	300-400	25;=1	
<b>Lumber &amp; Wood Products</b>					
Bandsaw		x	450	25;=1	36;=1 or 2
Chipper		x	450	25;=1	36;=1 or 2
Circular Saw		x	350	25;=1	36;=1 or 2
Debarker		x	350	25;=1	36;=1 or 2
Planer		x	350	25;=1	36;=1 or 2
Sander		x	400	25;=1	36;=1 or 2

## 4.5 The Application Functions List

This list gives an overview of many different applications/duties and a possible solution with one of the many MSF functions.

Description and use of the table:

- **Application /Duty.**  
This column gives the various applications and level of duty. If the machine or application is not in this list, try to identify a similar machine or application. If in doubt please contact your supplier.
- **Problem.**  
This column describes possible problems that are familiar for this kind of application.
- **Solution MSF.**  
Gives the possible solution for the problem using one of the MSF functions.
- **Menus.**  
Gives the menu numbers and selection for the MSF function.  
"25;=1", means: program selection 1 in menu 25.  
"36;=1 / 34,35", means: program selection 1 in menu 36, menus 34 and 35 are related to this function.

Table 2 Application Function List

Application/ Duty	Problem	Solution MSF	Menus
<b>PUMP</b> Normal	Too fast start and stops	MSF Pump application with following start/stop features	22
	Non linear ramps	Linear ramps without tacho.	
	Water hammer	Torque ramps for quadratic load	
	High current and peaks during starts.		
	Pump is going in wrong direction	Phase reversal alarm	88
	Dry running	Shaft power underload	96-99
	High load due to dirt in pump	Shaft power overload	92-95
<b>COMPRESSOR</b> Normal	Mechanical shock for compressor, motor and transmissions	Linear Torque ramp or current limit start.	25;=1 or 20,21
	Small fuses and low current available.		
	Screw compressor going in wrong direction	Phase sequence alarm	88
	Damaged compressor if liquid ammonia enters the compressor screw.	Shaft power overload	92-95
<b>CONVEYOR</b> Normal/Heavy	Energy consumption due to compressor is running unloaded	Shaft power underload	96-99
	Mechanical shocks for transmissions and transported goods.	Linear Torque ramp	25;=1
	Filling or unloading conveyors	Slow speed and accurate position control.	37-40,57,58
	Conveyor jammed	Shaft power overload	92-95
	Conveyor belt or chain is off but the motor is still running	Shaft power underload	96-99
	Starting after screw conveyor have stopped due to overload.	Jogging in reverse direction and then starting in forward.	
<b>FAN</b> Normal	Conveyor blocked when starting	Locked rotor function	75
	High starting current in end of ramps	Torque ramp for quadratic need	25;=2
	Slivering belts.		
	Fan is going in wrong direction when starting.	Catches the motor and going easy to zero speed and then starting in right direction.	
	Belt or coupling broken	Shaft power underload	96-99
<b>PLANER</b> Heavy	Blocked filter or closed damper.		
	High inertia load with high demands on torque and current control.	Linear Torque ramp gives linear acceleration and lowest possible starting current.	25;=1
	Need to stop quick both by emergency and production efficiency reasons.	Dynamic DC brake without Contactor for medium loads and controlled sensor less soft brake with reversing contactor for heavy loads.	36;=1,34,35 36;=2,34,35
	High speed lines	Conveyor speed set from planer shaft power analog output.	54-56
	Worn out tool	Shaft power overload	92-95
<b>ROCK CRUSHER</b> Heavy	Broken coupling	Shaft power underload	96-99
	High inertia	Linear Torque ramp gives linear acceleration and lowest possible starting current.	25;=1
	Heavy load when starting with material	Torque boost	30,31
	Low power if a diesel powered generator is used.		
	Wrong material in crusher	Shaft power overload	92-95
<b>BANDSAW</b> Heavy	Vibrations during stop	Dynamic DC brake without Contactor	36;=1,34,35
	High inertia load with high demands on torque and current control.	Linear Torque ramp gives linear acceleration and lowest possible starting current.	25;=1
	Need to stop quick both by emergency and production efficiency reasons.	Dynamic DC brake without Contactor for medium loads and controlled sensor less soft brake with reversing contactor for heavy loads.	36;=1,34,35 36;=2,34,35
	High speed lines	Conveyor speed set from band saw shaft power analog output.	54-56
	Worn out saw blade	Shaft power overload	
<b>CENTRIFUGE</b> Heavy	Broken coupling, saw blade or belt	Shaft power underload	
	High inertia load	Linear Torque ramp gives linear acceleration and lowest possible starting current.	25;=1
	To high load or unbalanced centrifuge	Shaft power overload	
	Controlled stop	Dynamic DC brake without Contactor for medium loads and controlled sensor less soft brake with reversing contactor for heavy loads.	36;=1,34,35 36;=2,34,35
	Need to open centrifuge in a certain position.	Braking down to slow speed and then positioning control.	37-40,57,58

Table 2 Application Function List

Application/ Duty	Problem	Solution MSF	Menus
<b>MIXER</b> Heavy	Different materials	Linear Torque ramp gives linear acceleration and lowest possible starting current.	25;=1
	Need to control material viscosity	Shaft power analog output	54-56
	Broken or damaged blades	Shaft power overload	92-95
		Shaft power underload	96-99
<b>HAMMER MILL</b> Heavy	Heavy load with high breakaway torque	Linear Torque ramp gives linear acceleration and lowest possible starting current.	25;=1
		Torque boost in beginning of ramp.	30,31
	Jamming	Shaft power overload	92-95
	Fast stop	Controlled sensor less soft brake with reversing contactor for heavy loads.	36;=2,34,35
	Motor blocked	Locked rotor function	75

**EXAMPLE:**

Hammer Mill:

- This is an application for heavy duty,
- Main function Torque ramp start (menu 25) will give the best results.
- Torque boost to overcome high breakaway torque (menu 30 and 31)
- Overload alarm function for jamming protection (menu 92 and 95)
- Stop function Soft Brake (menu 36, selection 2) can be used. Menu 34 and 35 to set the brake time and strength.



## 4.6 Function and combination matrix

Table 3 gives an overview of all possible functions and combination of functions.

1. Select function in the horizontal “Main Function” column. Only one function can be selected in this column, at a time.
2. In the vertical column “Additional Functions” you will find all possible function that can be used together with your selected main function.

Table 3 Combination matrix

Main Functions	Additional functions											
	Dual ramp start	Dual ramp stop	Bypass (032)	Power factor control (033)	Torque boost (030)	Jogging with keyboard/terminal	Timer controlled slow speed	External controlled slow speed	Complete protection	Parameter sets (061)	Dynamic Vector Brake (036-1)	Softbrake (036-2)
Voltage ramp start/stop (default)	X	X	X	X	X	X	X	X	X	X	X	
Torque control start/stop (menu 025)			X	X	X	X	X	X	X	X	X	
Voltage ramp with current limit (menu 020)		X	X	X	X	X	X	X	X	X	X	X
Current limit start (menu 021)		X	X	X	X	X	X	X	X	X	X	X
Pump control (menu 022)			X						X	X		
Analog input (menu 023)									X	X		
Direct on line start (menu 024)			X						X	X		

By using one parameter set, the following start/stop table is given.

**NOTE! Voltage and torque ramp for starting only with softbrake.**

Table 4 Start/stop combination.

START FUNCTION	STOP FUNCTION						
	Voltage ramp stop	Torque control stop	Pump control	Analog input	Direct on line stop	Dynamic Vector Brake	Softbrake
Voltage ramp start	X				X	X	X
Torque control start		X			X	X	X
Current limit start	X				X	X	X
Voltage ramp with current limit	X				X	X	X
Pump control			X		X		
Analog input				X	X		
Direct on line start					X		

By using different parameter sets for start and stop, it is possible to combine all start and stop functions.

## 4.7 Special condition

### 4.7.1 Small motor or low load

The minimum load current for the soft starter is 10% of the rated current of the soft starter. Except for the MSE-017 there the min. current is 2 A. Example MSE-210, rated current = 210 A. Min. Current 21 A. Please note that this is "min. load current" and not min. rated motor current.

### 4.7.2 Ambient temperature below 0°C

For ambient temperatures below 0°C e.g. an electrical heater must be installed in the cabinet. The soft starter can also be mounted in some other place, due to that the distance between the motor and the soft starter is not critical.

### 4.7.3 Phase compensation capacitor

If a phase compensation capacitor is to be used, it must be connected at the inlet of the soft starter, not between the motor and the soft starter.

### 4.7.4 Pole-changing contactor and two speed motor

The switching device must be connected between the output of the soft starter and the motor.

### 4.7.5 Shielded motor cable

It is not necessary to use shielded wires together with soft starters. This is due to the very low radiated emissions.

**NOTE!** The soft starter should be wired with shielded control cable to fulfill EMC regulations acc. to § 1.5, page 6.

### 4.7.6 Slip ring motors

Slip ring motors can not be used together with the soft starter. Unless the motor is rewinded (as a squirrel cage motor). Or keep the resistors in, please contact your supplier.

### 4.7.7 Pump control with soft starter and frequency inverter together

It is possible e.g. in a pump station with two or more pumps to use one frequency inverter on one pump and soft starters on each of the other pumps. The flow of the pumps can then be controlled by one common control unit.

### 4.7.8 Starting with counter clockwise rotating loads

It is possible to start a motor clockwise, even if the load and motor is rotating counter clockwise e.g. fans. Depending on the speed and the load "in the wrong direction" the current can be very high.

### 4.7.9 Running motors in parallel

When starting and running motors in parallel the total amount of the motor current must be equal or lower than the connected soft starter. Please note that it is not possible to make individual settings for each motor. The start ramp can only be set for an average starting ramp for all the connected motors. This applies that the start time may differ from motor to motor. This is also even if the motors are mechanically linked, depending on the load etc.

### 4.7.10 How to calculate heat dissipation in cabinets

See chapter 12. page 74 "Technical Data", "Power loss at rated motor load ( $I_N$ )", "Power consumption control card" and "Power consumption fan". For further calculations please contact your local supplier of cabinets, e.g. Rittal.

### 4.7.11 Insulation test on motor

When testing the motor with high voltage e.g. insulation test the soft starter must be disconnected from the motor. This is due to the fact that the thyristors will be seriously damage by the high peak voltage.

### 4.7.12 Operation above 1000 m

All ratings are stated at 1000 m over sea level. If a MSF is placed for example at 3000 m it must be derated unless that the ambient temperature is lower than 40 C and compensate for this higher pressure.

To get information about motors and drives at higher altitudes please contact your supplier to get technical information nr 151.

### 4.7.13 Reversing

Motor reversing is always possible. See Fig. 31 on page 34 for the advised connection of the reverse contactors.

At the moment that the mains voltage is switched on, the phase sequence is monitored by the control board. This information is used for the Phase Reverse Alarm (menu 88, see § 7.22, page 56).

However if this alarm is not used (factory default), it is also possible to have the phase reversal contactors in the input of the soft starter.

## 5. OPERATION OF THE SOFT STARTER

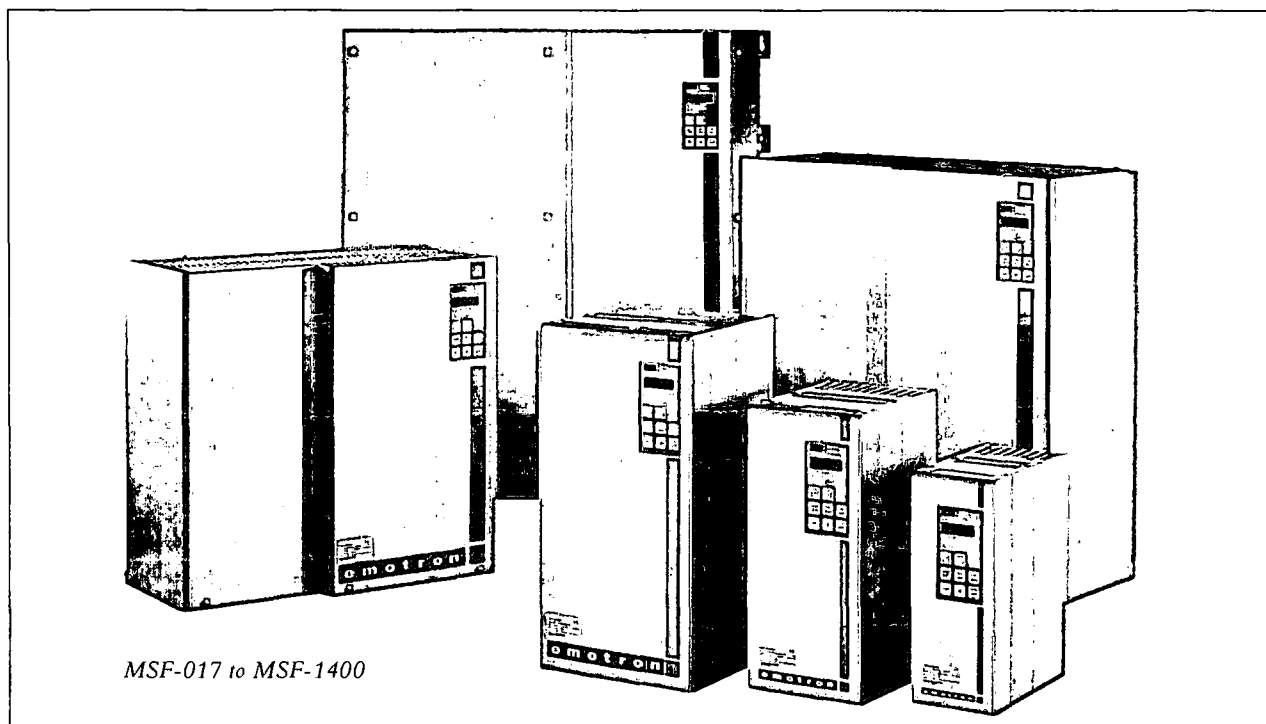

Fig. 12 MSF soft starter models.

### 5.2 PPU unit

#### 5.1 General description of user interface



**WARNING!** Never operate the soft starter with removed front cover.

To obtain the required operation, a number of parameters must be set in the soft starter.

Setting/configuration is done either from the built-in keyboard or by a computer/control system through the serial interface or bus (option). Controlling the motor i.e. start/stop, selection of parameter set, is done either from the keyboard, through the remote control inputs or through the serial interface (option).

#### Setting



**WARNING!** Make sure that all safety measures have been taken before switching on the supply.

Switch on the supply (normally 1 x 230 V), all segments in the display will light up for a few seconds. Then the display will show menu 001. An illuminated display indicates there is supply voltage on the PCB.

Check that you have voltage on the mains contactor or on the thyristors. To be able to use all extended functions and optimize of the performance, program the motor data.

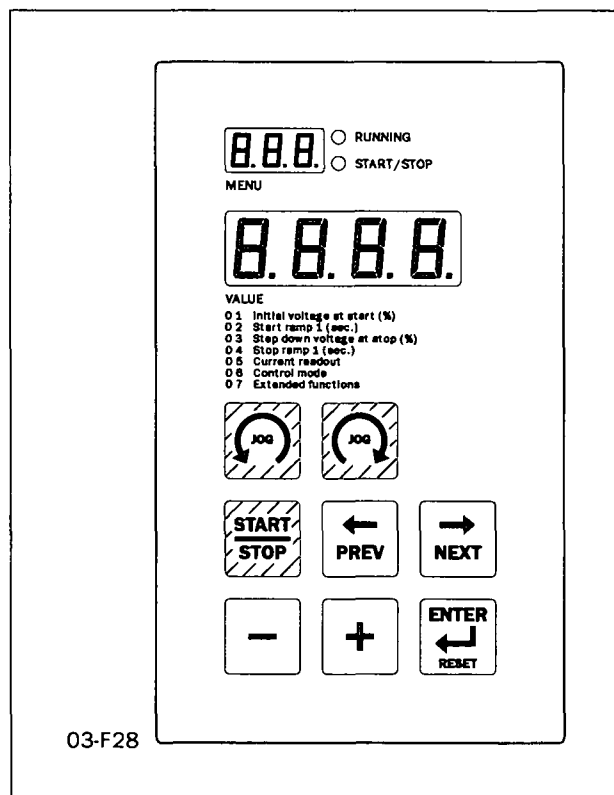

Fig. 13 PPU unit.

The programming and presentation unit (PPU) is a build-in operator panel with two light emitting diodes, three + four seven-segment LED-displays and a keyboard.

### 5.3 LED display

The two light emitting diodes indicates start/stop and running motor/machine. When a start command is given either from the PPU, through the serial interface (option) or through the remote control inputs, the start/stop-LED will be illuminated.

At a stop command the start/stop-LED will switch off. When the motor is running, the running-LED is flashing during ramp up and down and is illuminated continuously at full motor voltage.

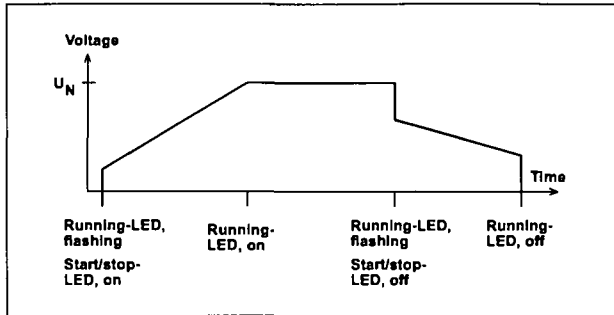

Fig. 14 LED indication at different operation situation.

### 5.4 The Menu Structure

The menus are organised in a simple one level structure with the possibility to limit the number of menus that are reachable by setting the value in menu 007 to "oFF" (factory setting). With this setting only the basic menus 001, 002, 003, 004, 005, 006 and 007 can be reached.

This to simplify the setting when only voltage start/stop ramps are used.

If menu 007 is in "on" and menu 008 "oFF" it is possible to reach all viewing menus and alarm lists as well.

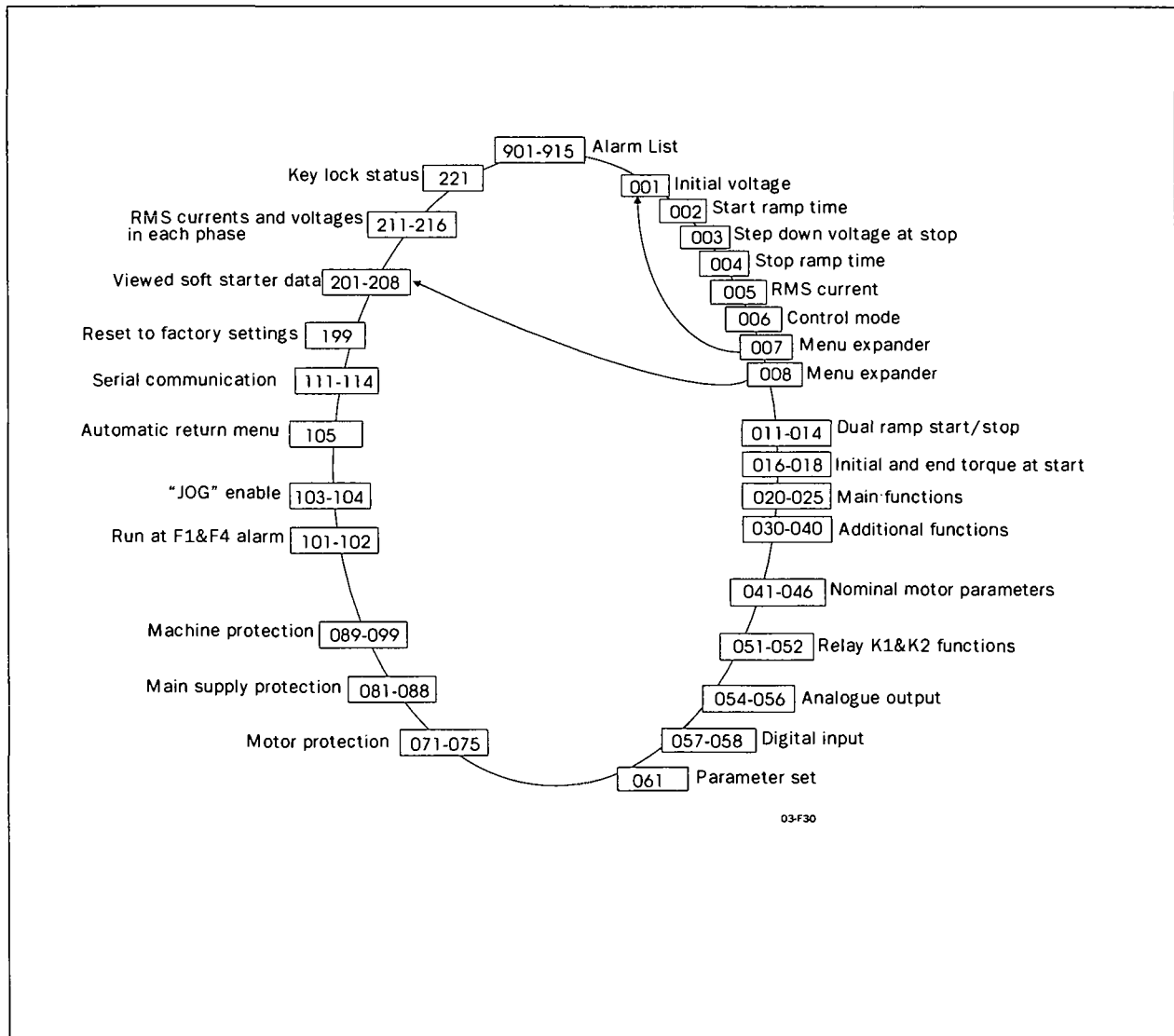

Fig. 15 Menu structure.

### 5.5 The keys



The function of the keyboard are based on a few simple rules. At power up menu 001 is shown automatically. Use the "NEXT →" and "PREV ←" keys to move between menus. To scroll through menu numbers, press and hold either the "NEXT →" or the "PREV ←" key. The "+" and "-" keys are used to increase respectively decrease the value of setting. The value is flashing during setting. The "ENTER ↵" key confirms the setting just made, and the value will go from flashing to stable. The "START/STOP" key is only used to start and stop the motor/machine. The  and  keys are only used for JOG from the keyboard. Please note one has to select enable in menu 103 or 104, see § 7.25, page 61.

Table 5 The keys









Start/stop motor operation.	
Display previous menu.	
Display next menu.	
Decrease value of setting.	
Increase value of setting.	
Confirm setting just made. Alarm reset.	
JOG Reverse	
JOG Forward	

Table 6 Control modes

Operation/ Set-up		Start/Stop	JOG fwd/rev	Alarm reset	Setting of parameters	
					Parameter set with external selection Menu 061=0	Parameter set with internal selection Menu 061=1-4
Control mode						
<b>Keyboard</b> Menu 006=1	Unlocked keyboard	Keyboard	Keyboard	Keyboard	_____	Keyboard
	Locked keyboard	_____	_____	_____	_____	_____
<b>Remote</b> Menu 006=2	Unlocked keyboard	Remote	Remote	Remote and keyboard	Remote	Keyboard
	Locked keyboard	Remote	Remote	Remote	Remote	_____
<b>Serial comm.</b> Menu 006=3	Unlocked keyboard	Serial comm	Serial comm	Serial comm. and keyboard	_____	Serial comm
	Locked keyboard	Serial comm	Serial comm	Serial comm	_____	Serial comm

### 5.6 Keyboard lock

The keyboard can be locked to prohibit operation and parameter setting by an unauthorised. Lock keyboard by pressing both keys "NEXT →" and "ENTER ↵" for at least 2 sec. The message '- Loc' will display when locked. To unlock keyboard press the same 2 keys "NEXT →" and "ENTER ↵" for at least 2 sec. The message 'unlo' will display when unlocked.

In locked mode it is possible to view all parameters and read-out, but it is forbidden to set parameters and to operate the soft starter from the keyboard.

The message '-Loc' will display if trying to set a parameter or operate the soft starter in locked mode.

The key lock status can be read out in menu 221.

221<sup>o</sup>  
o

**Locked keyboard info**

n o
Default: no
Range: no, YES
<b>no</b> Keyboard is not locked
<b>YES</b> Keyboard is locked

### 5.7 Overview of soft starter operation and parameter set-up.

Table with the possibilities to operate and set parameters in soft starter.

Control mode is selected in menu 006 and Parameter set is selected in menu 061. For the keyboard lock function, see § 7.30, page 65.

## 6. INSTALLATION AND CONNECTION

Mounting, wiring and setting the device into operation must be carried out by trained personnel (electricians specialised in heavy current technology):

- In accordance with the local safety regulations of the electricity supply company.
- In accordance with DIN VDE 0100 for setting up heavy current plants.

Care must be taken to ensure that personnel do not come into contact with live circuit components.



**WARNING!** Never operate the soft starter with removed front cover.

### 6.1 Installation of the soft starter in a cabinet

When installing the soft starter:

- Ensure that the cabinet will be sufficiently ventilated, after the installation.
- Keep the minimum free space, see the tables on page 25.
- Ensure that air can flow freely from the bottom to the top.

**NOTE!** When installing the soft starter, make sure it does not come into contact with live components. The heat generated must be dispersed via the cooling fins to prevent damage to the thyristors (free circulation of air).

MSF-017 to MSF-835 soft starters are all delivered as enclosed versions with front opening. The units have bottom entry for cables etc. see Fig. 25 on page 29 and Fig. 27 on page 31. MSF-1000 and MSF-1400 are delivered as open chassis.

**NOTE!** The soft starter should be wired with shielded control cable to fulfill EMC regulations acc. to § 1.5, page 6.

**NOTE!** For UL-approval use 75°C Copper wire only.

#### MSF-017 to MSF-250

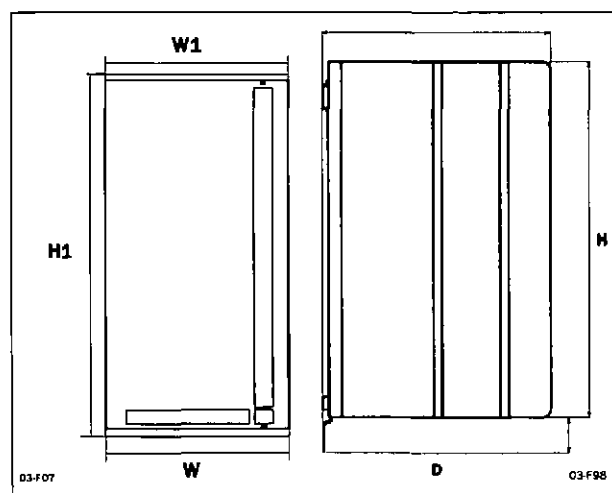

Fig. 16 MSF-017 to MSF-250 dimensions.

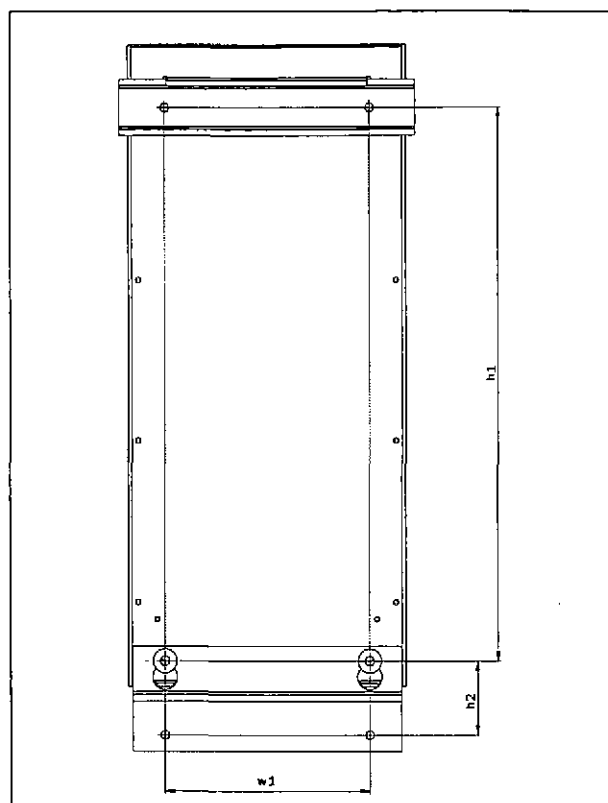

Fig. 17 Hole pattern for MSF-017 to MSF-250 (backside view).

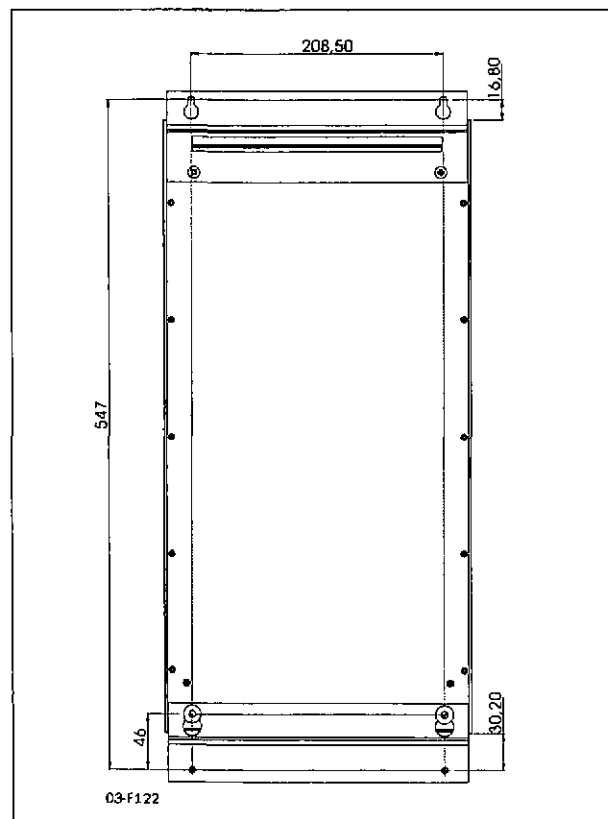

Fig. 18 Hole pattern for MSF-170 to MSF-250 with upper mounting bracket instead of DIN-rail.

## MSF-017 to MSF-250

Table 7 MSF-017 to MSF-250.

MSF model	Class	Connection	Conv./ Fan	Dimension HxWxD (mm)	Hole dist. w1 (mm)	Hole dist. h1 (mm)	Diam./ screw	Weight (kg)
-017, -030	IP 20	Busbars	Convection	320x126x260	78.5	265	5.5/M5	6.7
-045, -060, -075, -085	IP 20	Busbars	Fan	320x126x260	78.5	265	5.5/M5	6.9
-110, -145	IP 20	Busbars	Fan	400x176x260	128.5	345	5.5/M5	12.0
-170, -210, -250	IP 20	Busbars	Fan	500x260x260	208.5	445	5.5/M5	20

Table 8 MSF-017 to MSF-250

MSF model	Minimum free space (mm):			Dimension Connection busbars Cu	Tightening torque for bolt (Nm)		
	above 1)	below	at side		Cable	PE-cable	Supply and PE
-017, -030, -045	100	100	0	15x4 (M6), PE (M6)	8	8	0.6
-060, -075, -085	100	100	0	15x4 (M8), PE (M6)	12	8	0.6
-110, -145	100	100	0	20x4 (M10), PE (M8)	20	12	0.6
-170, -210, -250	100	100	0	30x4 (M10), PE (M8)	20	12	0.6

1) Above: wall-soft starter or soft starter-soft starter

## MSF-310 to MSF-1400

Table 9 MSF-310 to MSF-1400 see Fig. 20 on page 26.

MSF model	Class	Connection	Conv./ Fan	Dimension HxWxD (mm)	Hole dist. w1 (mm)	Hole dist. h1 (mm)	Diam./ screw	Weight (kg)
-310	IP 20	Busbars	Fan	532x547x278	460	450	8.5/M8	42
-370, -450	IP 20	Busbars	Fan	532x547x278	460	450	8.5/M8	46
-570	IP 20	Busbars	Fan	687x640x302	550	600	8.5/M8	64
-710	IP 20	Busbars	Fan	687x640x302	550	600	8.5/M8	78
-835	IP 20	Busbars	Fan	687x640x302	550	600	8.5/M8	80
-1000, -1400	IP00	Busbar	Fan	900x875x336	Fig. 23		8.5/M8	175

Table 10 MSF-310 to MSF-1400.

MSF model	Minimum free space (mm):			Dimension Connection, busbars Al	Tightening torque for bolt (Nm)		
	above 1)	below	at side		Cable	PE-cable	Supply and PE
-310, -370, -450	100	100	0	40x8 (M12)	50	12	0.6
-570, -710, -835	100	100	0	40x10 (M12)	50	12	0.6
-1000, -1400	100	100	100	75x10 (M12)	50	12	0.6

1) Above: Wall-soft starter or soft starter-soft starter

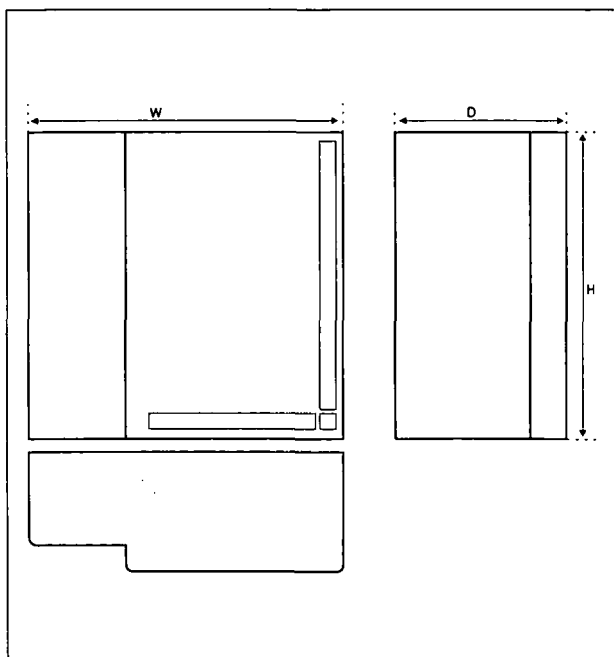

Fig. 19 MSF -310 to MSF -835.

MSF	e	f
-310 to -450	44	39
-570 to -835	45.5	39

Observe that the two supplied mounting hooks (see § 1.8, page 7 and Fig. 2 on page 7 must be used for mounting the soft starter as upper support (only MSF-310 to MSF-835).

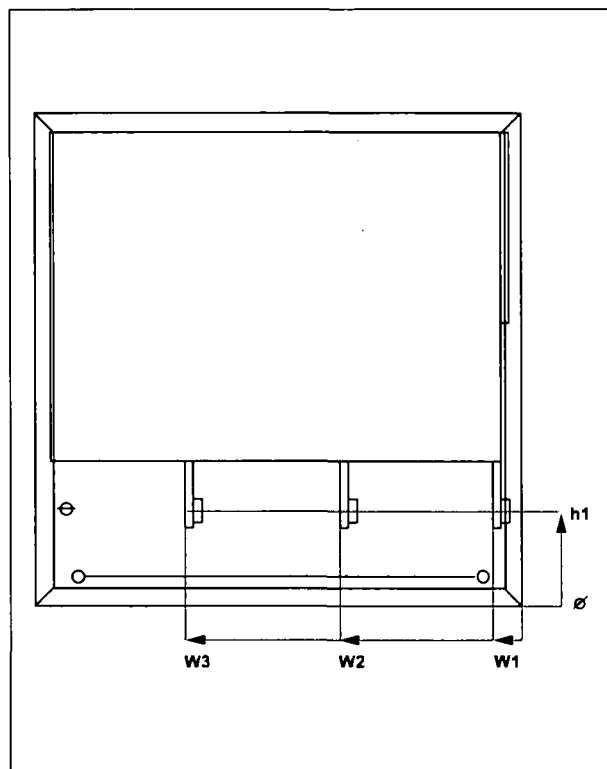

Fig. 21 Busbar distances MSF -310 to MSF -835.

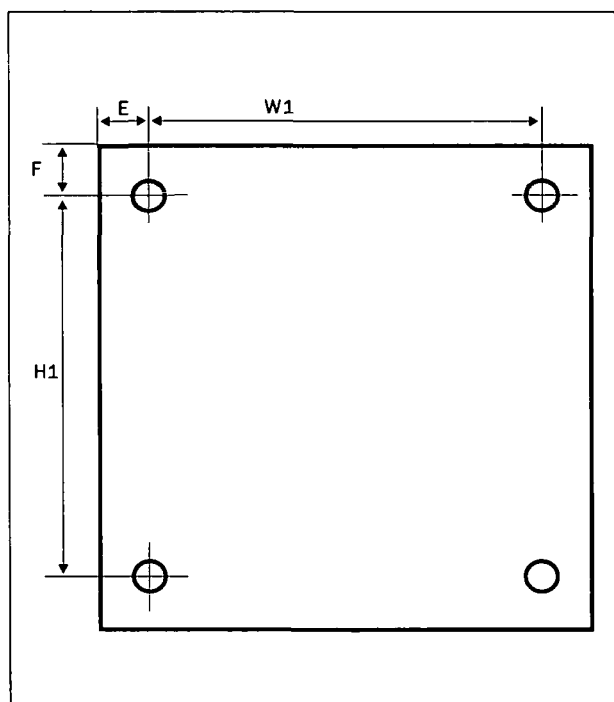

Fig. 20 Hole pattern for screw attachment, MSF-310 to MSF-835. Hole distance (mm).

Table 11 Busbar distances

MSF model	Dist. h1 (mm)	Dist. w1 (mm)	Dist. w2 (mm)	Dist. w3 (mm)
-310 to -450	104	33	206	379
-570 to -835	129	35	239.5	444
-1000 -1400		55	322.5	590.5



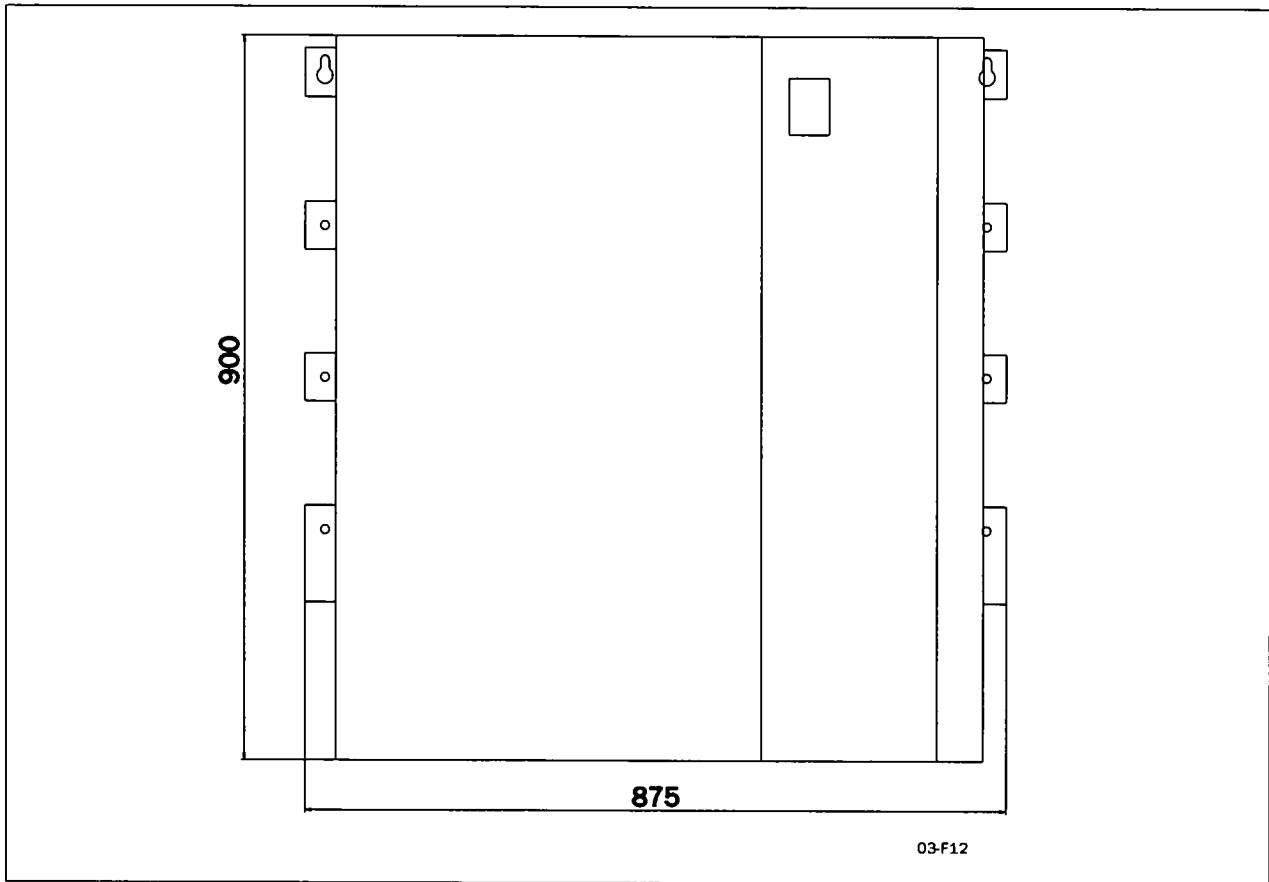

Fig. 22 MSF -1000 to -1400

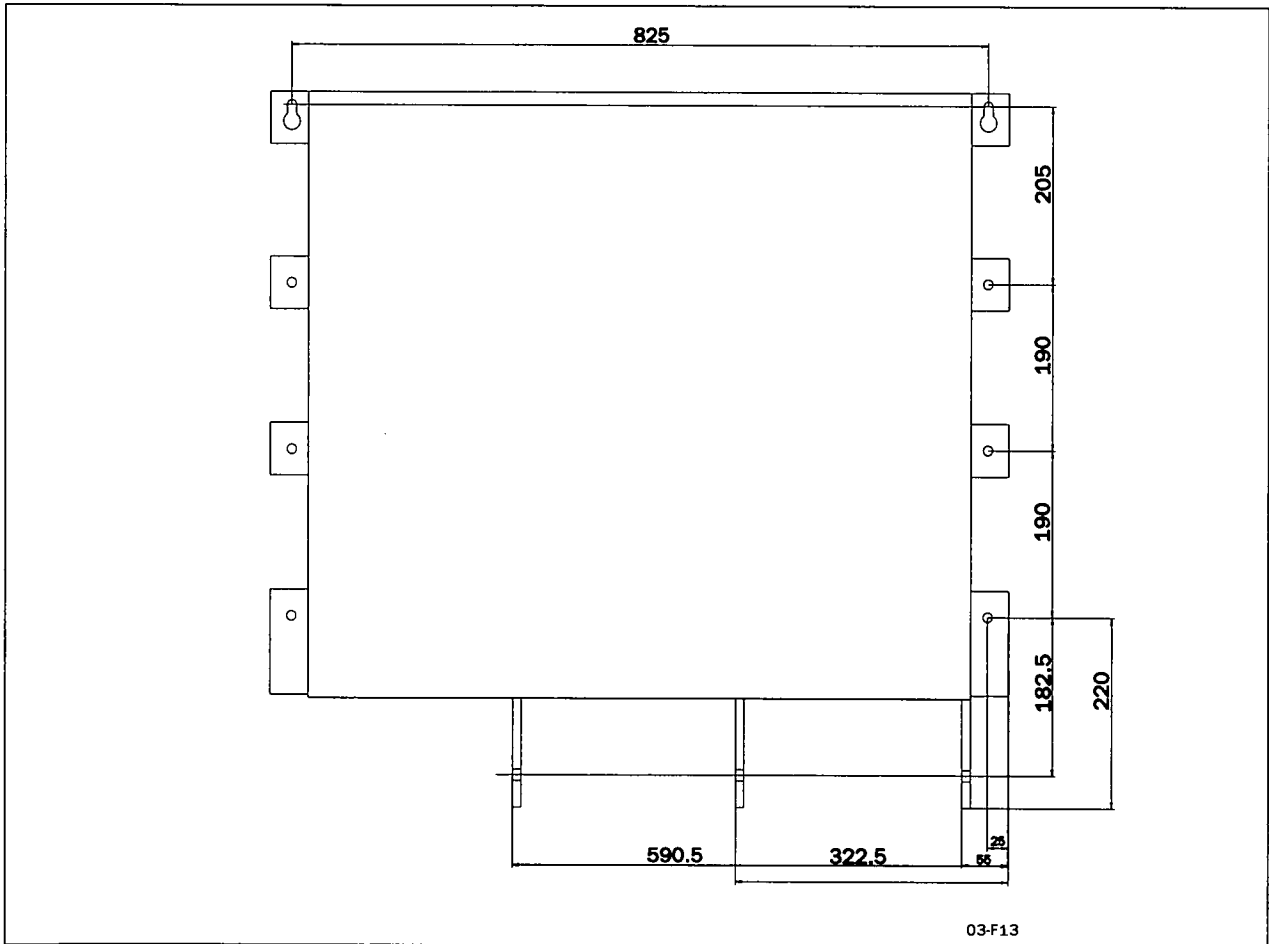

Fig. 23 Hole pattern busbar MSF -1000 to -1400.

## 6.2 Connections

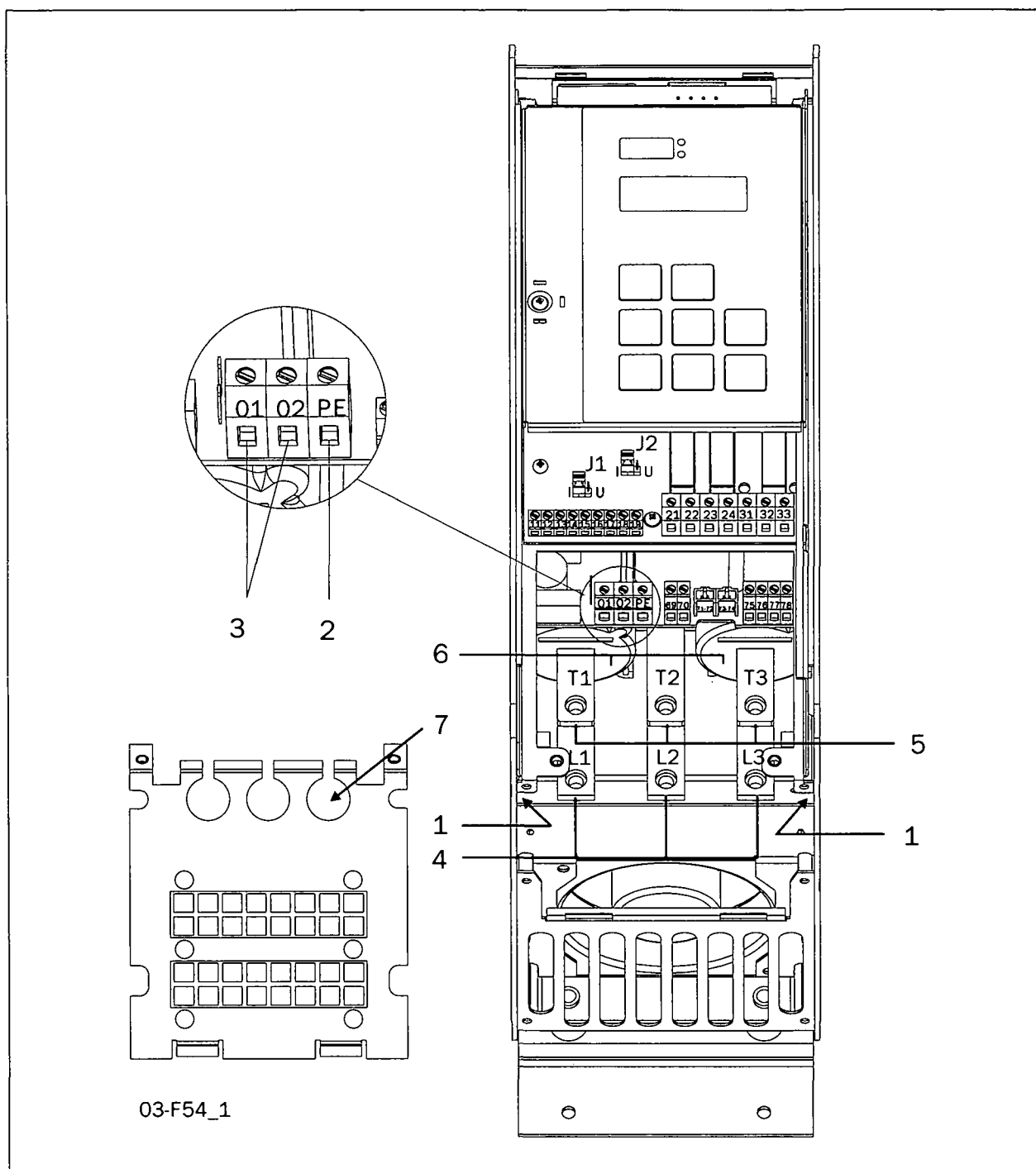

Fig. 24 Connection of MSF-017 to MSF-085.

### Connection of MSF-017 to MSF-085

#### Device connections

1. Protective earth,  $\perp$  (PE), Mains supply, Motor (on the right and left inside of the cabinet)
2. Protective earth,  $\perp$  (PE), Control voltage
3. Control voltage connection 01, 02
4. Mains supply L1, L2, L3
5. Motor power supply T1, T2, T3
6. Current transformers (possible to mount outside for bypass see § 7.12, page 43)
7. Mounting of EMC gland for control cables

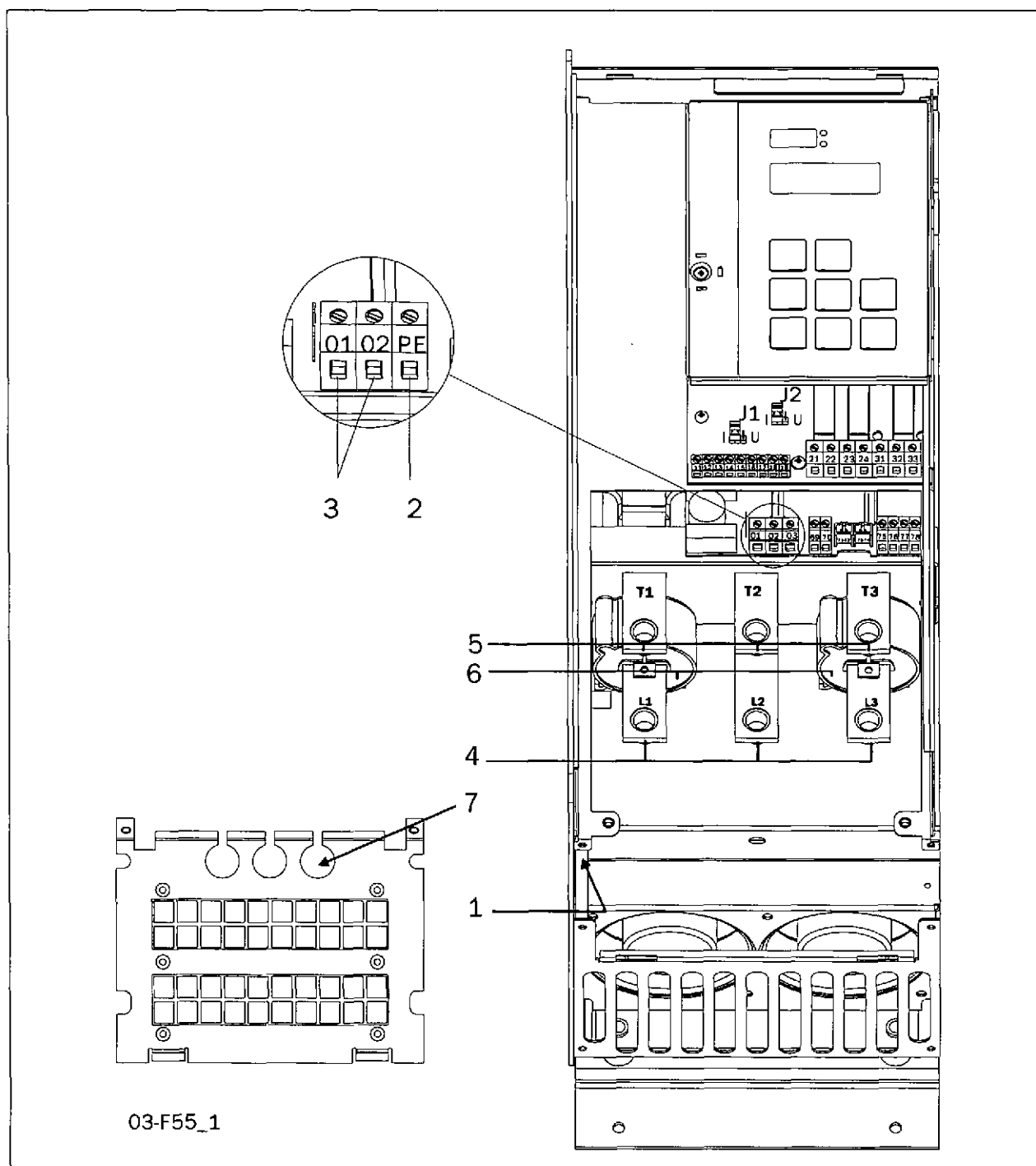

Fig. 25 Connection of MSF-110 to MSF-145.

## Connection of MSF-110 to MSF-145

### Device connections

1. Protective earth,  $\perp$  (PE), Mains supply, Motor (on the left inside of the cabinet)
2. Protective earth  $\perp$  (PE), Control voltage
3. Control voltage connection 01, 02
4. Mains supply L1, L2, L3
5. Motor power supply T1, T2, T3
6. Current transformers (possible to mount outside for bypass see § 7.12, page 43)
7. Mounting of EMC gland for control cables

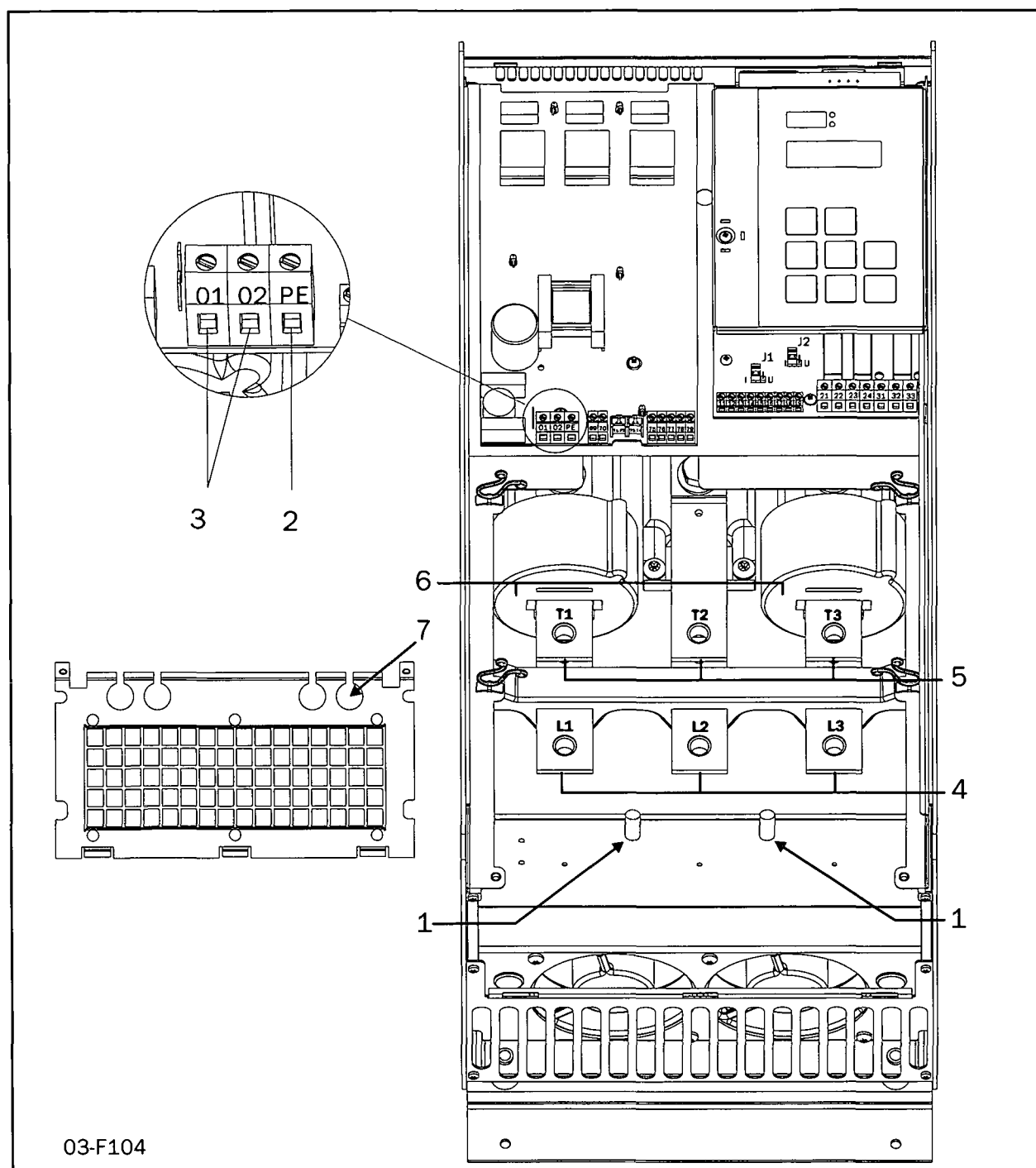

Fig. 26 Connection of MSF-170 to MSF-250

## Connection of MSF-170 to MSF-250

### Device connections

1. Protective earth,  $\perp$  (PE), Mains supply, Motor (on the left inside of the cabinet)
2. Protective earth  $\perp$  (PE), Control voltage
3. Control voltage connection 01, 02
4. Mains supply L1, L2, L3
5. Motor power supply T1, T2, T3
6. Current transformers (possible to mount outside for bypass see § 7.12, page 43)
7. Mounting of EMC gland for control cables

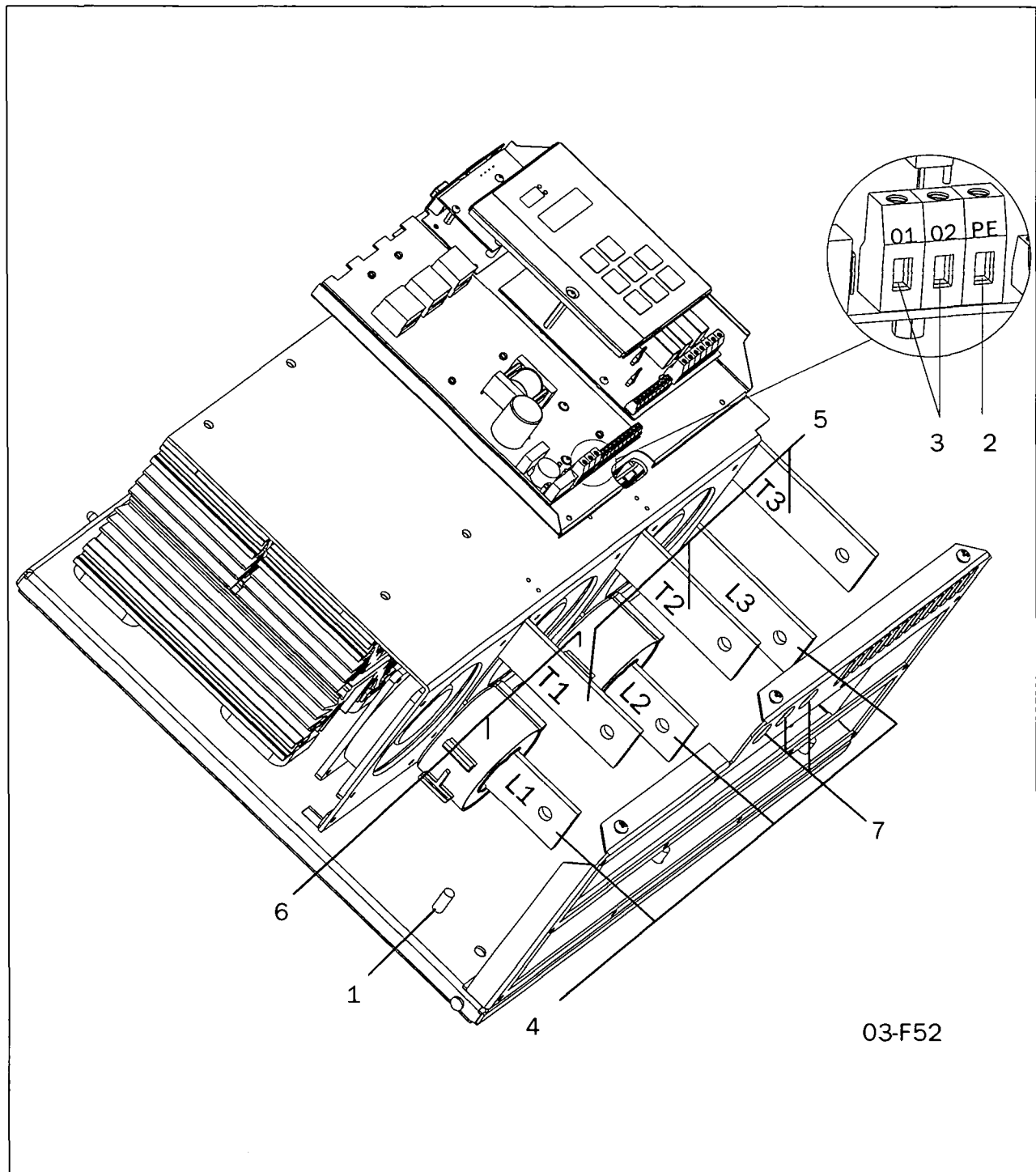

Fig. 27 Connection of MSF-170 to MSF-1400.

### Connection of MSF-310 to MSF-1400

#### Device connections

1. Protective earth,  $\perp$  (PE), Mains supply and Motor
2. Protective earth,  $\perp$  (PE), Control voltage
3. Control voltage connection 01, 02
4. Mains supply L1, L2, L3
5. Motor power supply T1, T2, T3
6. Current transformers (possible to mount outside for bypass see § 7.12, page 43)
7. Mounting of EMC gland for control cables

### 6.3 Connection and setting on the PCB control card

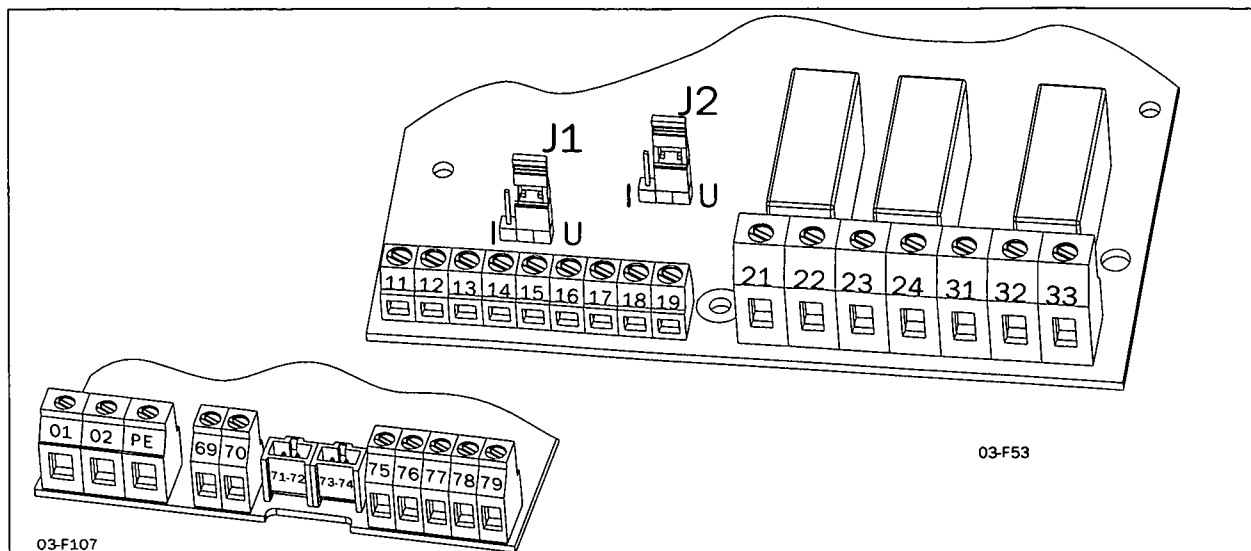

Fig. 28 Connections on the PCB, control card.

Table 12 PCB Terminals

Terminal	Function	Electrical characteristics
01	Supply voltage	100-240 VAC ±10%/380-500 VAC ± 10%
02		
PE		
11	Digital inputs for start/stop and reset.	0-3 V → 0; 8-27 V → 1. Max. 37 V for 10 sec. Impedance to 0 VDC: 2.2 kΩ.
12		
13	Supply/control voltage to PCB terminal 11 and 12, 10 kΩ potentiometer, etc.	+12 VDC ±5%. Max. current from +12 VDC: 50mA. Short circuit proof.
14	Remote analogue input control, 0-10 V, 2-10 V, 0-20 mA and 4-20 mA/digital input.	Impedance to terminal 15 (0 VDC) voltage signal: 125 kΩ, current signal: 100 Ω.
15	GND (common)	0 VDC
16	Digital inputs for selection of parameter set.	0-3 V → 0; 8-27 V → 1. Max. 37 V for 10 sec. Impedance to 0 VDC: 2.2 kΩ.
17		
18	Supply/control voltage to PCB terminal 16 and 17, 10 kΩ potentiometer, etc.	+12 VDC ±5%. Max. current from +12 VDC = 50mA. Short circuit proof.
19	Remote analogue output control	Analogue Output contact: 0-10V, 2-10V; min load impedance 700Ω 0-20mA and 4-20mA; max load impedance 750Ω
21	Programmable relay K1. Factory setting is "Operation" indication by closing terminal 21 - 22.	1-pole closing contact, 250 VAC 8A or 24 VDC 8A resistive, 250 VAC, 3A inductive.
22		
23	Programmable relay K2. Factory setting is "Full voltage" indication by closing terminal 23-24.	1-pole closing contact, 250 VAC 8A or 24 VDC 8A resistive, 250 VAC, 3A inductive.
24		
31	Alarm relay K3, closed to 33 at alarm.	1-pole change over contact, 250 VAC 8A or 24 VDC 8A resistive, 250 VAC, 3A inductive.
32	Alarm relay K3, opened at alarm.	
33	Alarm relay K3, common terminal.	
69-70	PTC Thermistor input	Alarm level 2.4 kΩ Switch back level 2.2 kΩ.
71-72*	Clickson thermistor	Controlling soft starter cooling fine temperature MSF-310 - MSF-1400
73-74*	NTC thermistor	Temperature measuring of soft starter cooling fine
75	Current transformer input, cable S1 (blue)	Connection of L1 or T1 phase current transformer
76	Current transformer input, cable S1 (blue)	Connection of L3, T3 phase (MSF 017 - MSF 250) or L2, T2 phase (MSF 310 - MSF 1400)
77	Current transformer input, cable S2 (brown)	Common connection for terminal 75 and 76
78*	Fan connection	24 VDC
79*	Fan connection	0 VDC

\*Internal connection, no customer use.

## 6.4 Minimum wiring

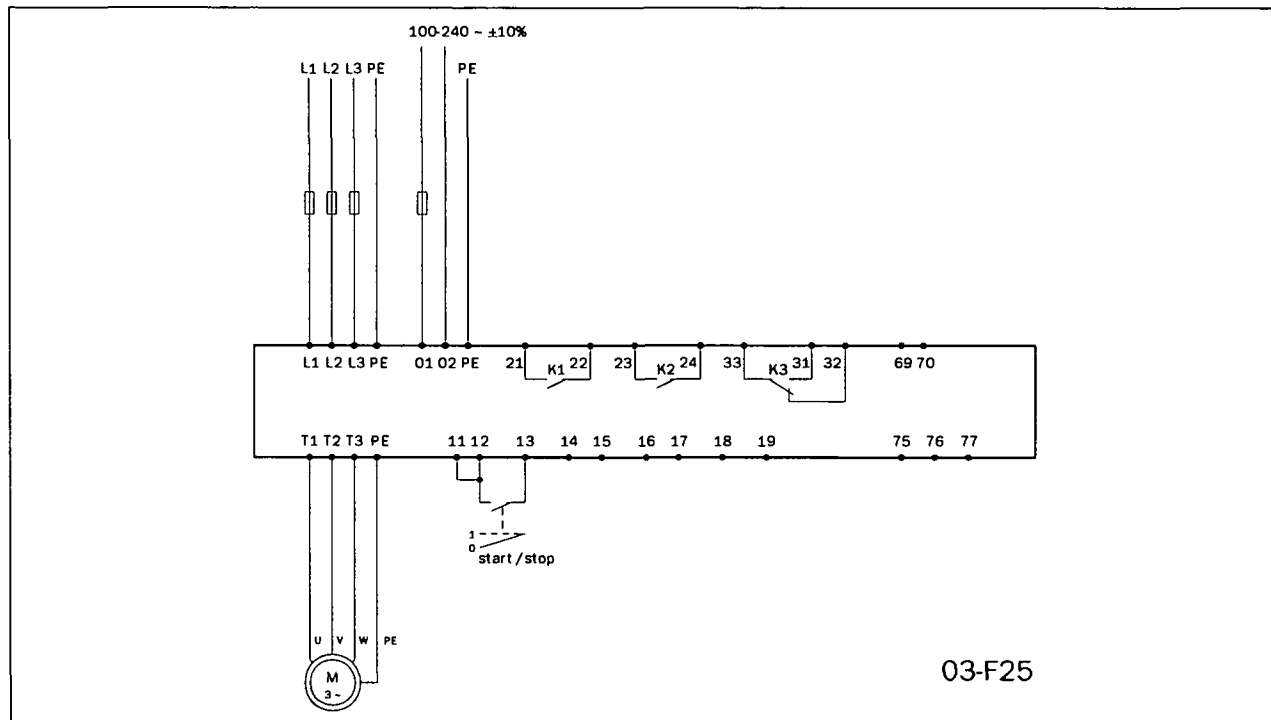

Fig. 29 Wiring circuit, "Minimum wiring".

The figure above shows the "minimum wiring". See § 6.1, page 24, for tightening torque for bolts etc.

1. Connect Protective Earth (PE) to earth screw marked  $\perp$  (PE).
2. Connect the soft starter between the 3-phase mains supply and the motor. On the soft starter the mains side is marked L1, L2 and L3 and the motor side with T1, T2 and T3.
3. Connect the control voltage (100-240 VAC) for the control card at terminal 01 and 02.
4. Connect relay K1 (terminals 21 and 22) to the control circuit.
5. Connect PCB terminal 12 and 13 (PCB terminal 11-12 must be linked) to, e.g. a 2-position switch (on/oFF) or a PLC, etc., to obtain control of soft start/stop. (For start/stop command from keyboard menu 006 must be set to 01).
6. Ensure the installation complies with the appropriate local regulations.

**NOTE!** The soft starter should be wired with shielded control cable to fulfill EMC regulations acc. to § 1.5, page 6.

**NOTE!** If local regulations say that a mains contactor should be used, the K1 then controls it. Always use standard commercial, slow blow fuses, e.g. type gI, gG to protect the wiring and prevent short circuiting. To protect the thyristors against short-circuit currents, superfast semiconductor fuses can be used if preferred. The normal guarantee is valid even if superfast semiconductor fuses are not used. All signal inputs and outputs are galvanically insulated from the mains supply.

### 6.5 Wiring examples

Fig. 30 gives an wiring example with the following functions.

- Analogue input control, see § 7.7, page 40
- Parameter set selection, see § 7.20, page 54
- Analogue output, see § 7.18, page 52
- PTC input, see § 7.21, page 55

For more information see § 6.3, page 32.

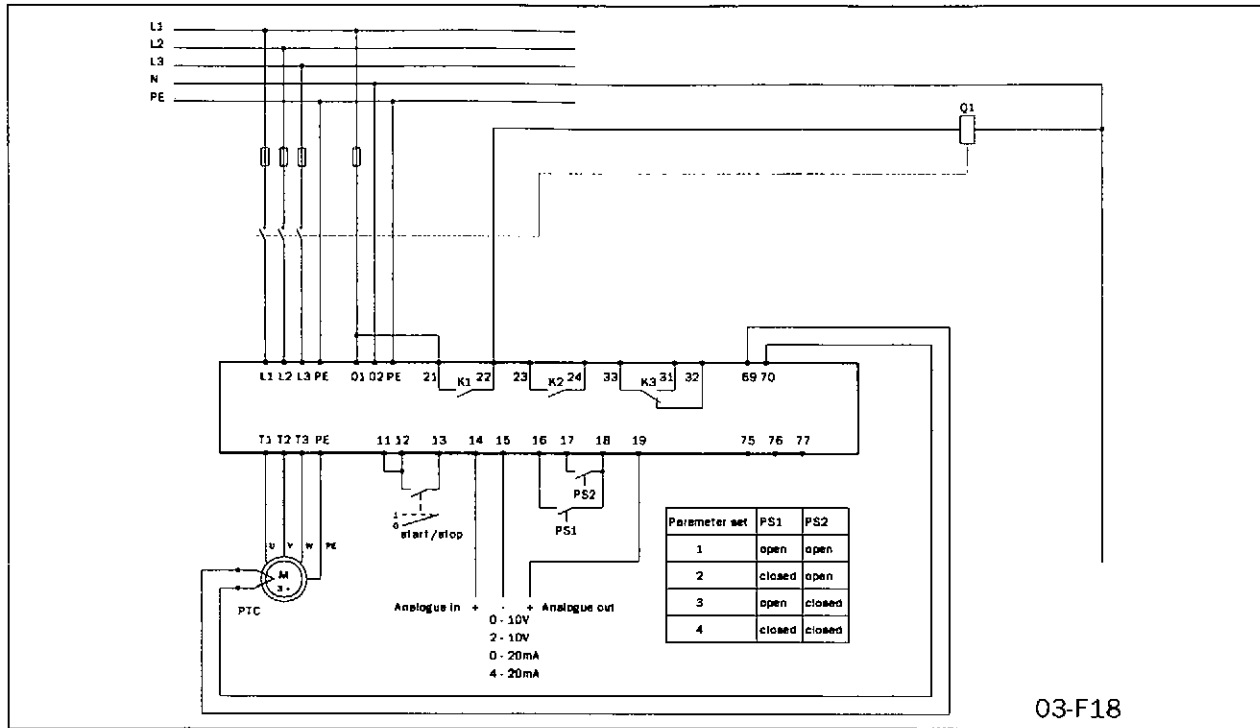

Fig. 30 Analogue input control, parameter set, analogue output and PTC input.

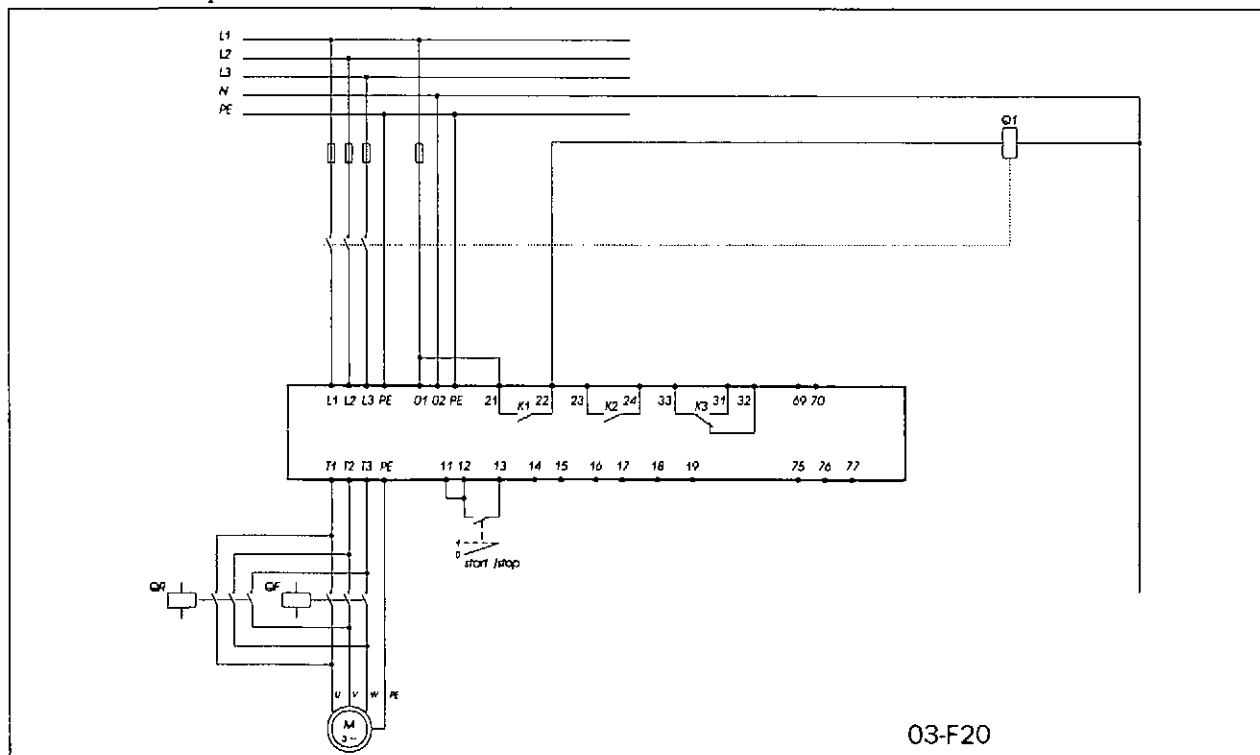

Fig. 31 Forward/reverse wiring circuit.



## 7. FUNCTIONAL DESCRIPTION SET-UP MENU

This chapter describes all the parameters and functions in numerical order as they appear in the MSF. Table 13 gives an overview of the menus, see also Chapter 13, page 79 (set-up menu list).

Table 13 Set-up Menu overview

	Menu number	Parameter group		Menu numbers	See §
<b>Basic functions</b>	001-008	Basic	Ramp up/down parameters	001-005	7.1
			Start/Stop/Reset command	006	7.2
			Menu Expansion	007-008	7.3
<b>Extended functions</b>	011-199	Voltage control dual ramp		011-014	7.4
		Torque control parameters		016-018	7.5
		Main functions		020-025	7.6 - 7.10
		Additional functions		030-036	7.11 - 7.14
		Slow speed and Jog functions		037-040, 57-58, 103-104	7.15, 7.19, 7.25
		Motor Data Setting		041-046	7.16
		Outputs	Relays	051-052	7.17
			Analogue output	054-056	7.18
		Input	Digital input	057-058	7.19
		Parameter set selection		061	7.20
			Motor protection	071-075	7.21
			Main protection	081-088	7.22
			Application protection	089-099	7.23
			Resume alarms	101, 102	7.24
		Auto return menu		105	7.26
Factory defaults		199	7.28		
<b>View functions</b>	201-915	Main view		201-208	7.29
		RMS current per phase		211-213	7.29
		RMS voltage per phase		214-216	7.29
		Keyboard lock status		221	7.30
		Alarm list		901-915	7.31

### 7.1 Ramp up/down parameters

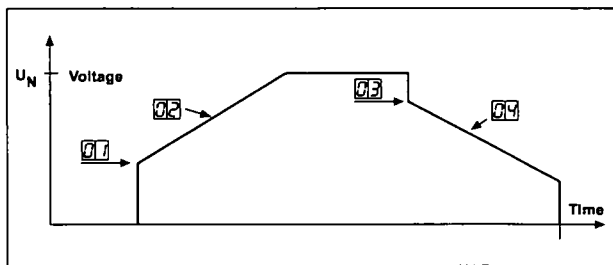

Fig. 32 Menu numbers for start/stop ramps, initial voltage at start and step down voltage at stop.

Determine the starting time for the motor/machine. When setting the ramp times for starting and stopping, initial voltage at start and step down voltage at stop, proceed as follow:

001 <sup>o</sup>	
Setting the initial voltage at start ramp 1	
30	
Default:	30%
Range:	25 - 90% $U_n$
Set the initial voltage. Normally the factory setting, 30% of $U_n$ , is a suitable choice.	

002 <sup>o</sup>	
Setting of start ramp 1	
10	
Default:	10 sec
Range:	1-60 sec
Set "Ramp up time" at start.	

003 <sup>o</sup>	
Setting of step down voltage stop ramp 1	
100	
Default:	100%
Range:	100-40% of $U_n$
Step down voltage at stop can be used to stop smoothly.	

004 <sup>o</sup>	
Setting of stop ramp 1	
OFF	
Default:	oFF
Range:	oFF, 2-120 sec
oFF	Stop ramp disabled
2-120	Set "Ramp down time" at stop



#### 7.1.1 RMS current [005]

005 <sup>o</sup>	
RMS current	
0.0	
Default:	—
Range:	0.0-9999Amp
Read-out of the RMS motor current.	

NOTE! This is the same read-out as function 201, see § 7.28, page 63.

## 7.2 Start/stop/reset command

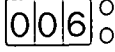
Start/stop of the motor and reset of alarm is done either from the keyboard, through the remote control inputs or through the serial interface (option). The remote control inputs start/stop/reset (PCB terminals 11, 12 and 13) can be connected for 2-wire or 3-wire control.

	
<b>Selection of control mode</b>	
	
Default:	2
Range:	1,2,3
<b>1</b>	START/STOP/RESET command via the keyboard. - Press the "START/STOP" key on the keyboard to start and stop the soft starter. - Press "ENTER/RESET" key to reset a trip condition.
<b>2</b>	Via Remote control. START/STOP/RESET commands. The following control methods are possible: - 2-wire start/stop with automatic reset, see § 7.2.1, page 37. - 2-wire start/stop with separate reset, see § 7.2.2, page 37. - 3-wire start/stop with automatic reset at start, see § 7.2.3, page 37.  <b>WARNING! The motor will start if terminals 11, 12, 13 is in start position.</b>
<b>3</b>	START/STOP/RESET commands via serial interface option. Read the operating instruction supplied with this option.

**NOTE! A reset via the keyboard will not start or stop the motor.**

**NOTE! Factory default setting is 2, remote control.**

To start and stop from the keyboard, the "START/STOP" key is used.

To reset from the keyboard, the "ENTER ↵ / RESET" key is used. A reset can be given both when the motor is running and when the motor is stopped. A reset from the keyboard will not start or stop the motor.

### 7.2.1 2-wire start/stop with automatic reset at start

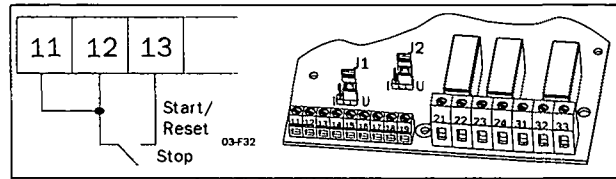

Closing PCB terminals 12 and 13, and a jumper between terminal 11 and 12, will give a start command. Opening the terminals will give a stop. If PCB terminals 12 and 13 is closed at power up a start command is given (automatic start at power up). When a start command is given there will automatically be a reset.

### 7.2.2 2-wire start/stop with separate reset

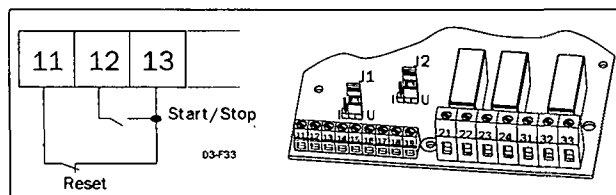

Closing PCB terminals 11, 12 and 13 will give a start and opening the terminals 12 and 13 will give a stop. If PCB terminals 12 and 13 are closed at power up a start command is given (automatic start at power up). When PCB terminals 11 and 13 are opened and closed again a reset is given. A reset can be given both when the motor is running and stopped and doesn't affect the start/stop.

### 7.2.3 3-wire start/stop with automatic reset at start.

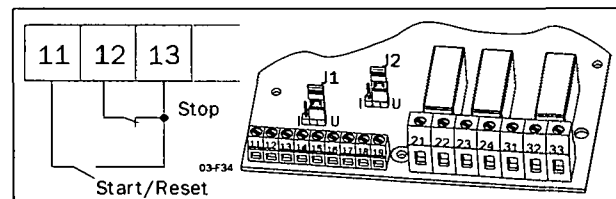

PCB terminal 12 and 13 are normally closed and PCB terminal 11 and 13 are normally open. A start command is given by momentarily closing PCB terminal 11 and 13. To stop, PCB terminal 12 and 13 are momentarily opened.

When a start command is given there will automatically be a reset. There will not be an automatic start at power up.

### 7.3 Menu expansion setting.

In order to use the viewing menus and/or the extended functions menu 007 must be set to "On", then one reach read out of the viewing menus 201-915. To be able to set any extended functions in the menus 011-199 menu 008 must be set to "on" as well.

007 <sup>o</sup>					
<table border="1"> <tr> <td></td> <td>o</td> <td>F</td> <td>F</td> </tr> </table> <b>Selecting of extended functions and viewing functions</b>			o	F	F
	o	F	F		
Default:	oFF				
Range:	oFF, on				
<b>oFF</b>	Only function 1-7 are visible				
<b>on</b>	- View functions 201-915 are visible - Extended functions (menu 008) selectable				

008 <sup>o</sup>					
<table border="1"> <tr> <td></td> <td>o</td> <td>F</td> <td>F</td> </tr> </table> <b>Selecting of extended functions</b>			o	F	F
	o	F	F		
Default:	oFF				
Range:	oFF, on				
<b>oFF</b>	Only view function 201-915 are visible.				
<b>on</b>	All the function menus are visible				

**NOTE!** Menu 007 must be "on".

### 7.4 Voltage control dual ramp

To achieve even smoother ramps at start and or stop, a dual ramp can be used.

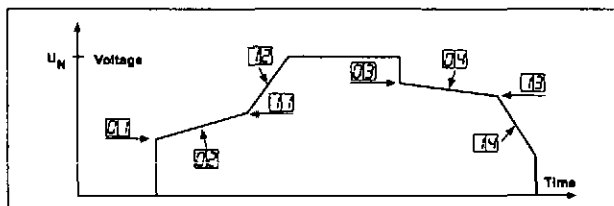

Fig. 33 Menu numbers for dual voltage ramp at start/stop, initial voltage at start and step down-voltage at stop.

The settings are carried out by beginning with the settings in menus 001-004 and 007-008 and proceed with the following steps:

011 <sup>o</sup>					
<table border="1"> <tr> <td></td> <td></td> <td>9</td> <td>0</td> </tr> </table> <b>Setting the initial voltage at start ramp 2</b>				9	0
		9	0		
Default:	90%				
Range:	30-90% U <sub>n</sub>				
Set the start voltage for start ramp 2. The initial voltage for start ramp 2 is limited to the initial voltage at start (menu 001), see § 7.1, page 36.					

012 <sup>o</sup>					
<table border="1"> <tr> <td></td> <td>o</td> <td>F</td> <td>F</td> </tr> </table> <b>Setting of start ramp 2</b>			o	F	F
	o	F	F		
Default:	oFF				
Range:	oFF, 1-60 sec				
<b>oFF</b>	Start ramp 2 disabled				
<b>1-60</b>	Set the start ramp 2 time. A dual voltage ramp is active.				

013 <sup>o</sup>					
<table border="1"> <tr> <td></td> <td></td> <td>4</td> <td>0</td> </tr> </table> <b>Setting of step down voltage in stop ramp 2</b>				4	0
		4	0		
Default:	40%				
Range:	100-40% U <sub>n</sub>				
Set the step down voltage for stop ramp 2. The step down voltage for stop ramp 2 is limited to the step down voltage at stop (menu 003).					

014 <sup>o</sup>					
<table border="1"> <tr> <td></td> <td>o</td> <td>F</td> <td>F</td> </tr> </table> <b>Setting of stop ramp time 2</b>			o	F	F
	o	F	F		
Default:	oFF				
Range:	oFF, 2-120 sec				
<b>oFF</b>	Stop ramp 2 disabled				
<b>1-60</b>	Set the stop ramp 2 time. A dual voltage stop ramp is active.				

### 7.5 Torque control parameters

See also § 7.10, page 42 and chapter 4. page 13 for more information on the Torque control setting.

016 <sup>o</sup>	
Initial torque at start	
10	
Default:	10
Range:	0 - 250% of Tn
Insert initial torque at start in percent of nominal shaft torque (Tn), see chapter 13. page 79.	

017 <sup>o</sup>	
End torque at start	
150	
Default:	150
Range:	50 - 250% of Tn
Insert end torque at start in percent of nominal shaft torque.	

018 <sup>o</sup>	
End torque at stop	
0	
Default:	0
Range:	0 - 100% of Tn
Insert end torque at stop in percent of the nominal motor torque.	

### 7.6 Current limit (Main Function)

The Current Limit function is used to limit the current drawn when starting (150 - 500% of In). This means that current limit is only achieved during set start-up time.

Two kinds of current limit starts are available.

- **Voltage ramp with a limited current.**  
If current is below set current limit, this start will act exactly as a voltage ramp start.
- **Current limit start.**  
The soft starter will control the current up to set current limit immediately at start, and keep it there until the start is completed or the set start-up time expires.

See Fig. 34 Current limit.

**NOTE!** Make sure that nominal motor current in menu 042 is correctly inserted.

#### 7.6.1 Voltage ramp with current limit

The settings are carried out in three steps:

1. Estimate starting-time for the motor/machine and select that time in menu 002 (see § 7.1, page 36).
2. Estimate the initial voltage and select this voltage in menu 001 (see § 7.1, page 36).
3. Set the current limit to a suitable value e.g. 300% of In in menu 020.

020 <sup>o</sup>	
Voltage ramp with current limit at start	
OFF	
Default:	oFF
Range:	oFF, 150 - 500% In
<b>oFF</b>	Voltage Ramp mode with current limit disabled. Voltage Ramp enabled.
<b>150-500</b>	Current limit level in Voltage ramp mode.

**NOTE!** Only possible when Voltage Ramp mode is enabled. Menus 021-025 must be "oFF".

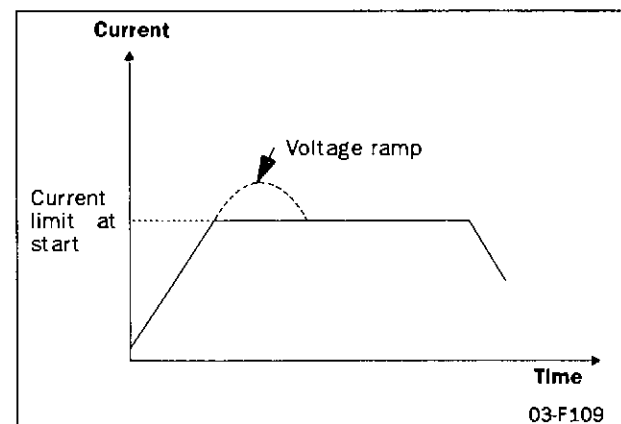

Fig. 34 Current limit

### 7.6.2 Current limit

The settings are carried out in two steps:

1. Estimate starting time for the motor/machine and select that time in menu 002 (see § 7.1, page 36).
2. Set the current limit to a suitable value e.g. 300% of In in menu 021.

021 <sup>o</sup>	
<b>Current limit at start</b>	
o F F	
Default:	oFF
Range:	oFF, 150 - 500% In
<b>oFF</b>	Current limit mode disabled. Voltage Ramp enabled.
<b>150-500</b>	Current limit level in current limit mode.

**NOTE!** Only possible when Voltage Ramp mode is enabled. Menus 020, 022-025 must be "oFF".

**NOTE!** Even though the current limit can be set as low as 150% of the nominal motor current value, this minimum value cannot be used generally. Considerations must be given to the starting torque and the motor before setting the appropriate current limit. "Real start time" can be longer or shorter than the set values depending on the load conditions. This applies to both current limit methods.

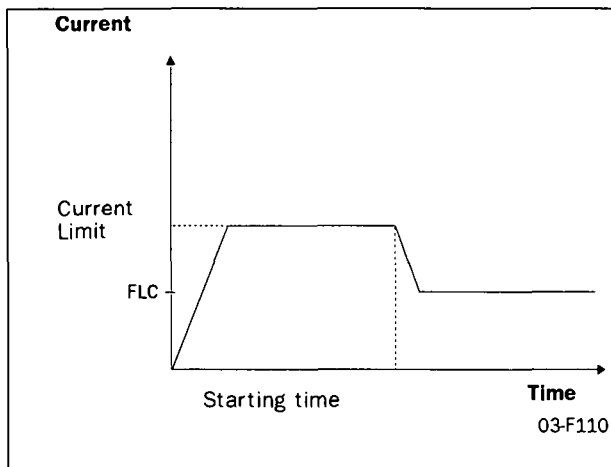

Fig. 35 Current limit

If the starting time is exceeded and the soft starter is still operating at current level, an alarm will be activated. It is possible to let the soft starter to either stop operation or to continue. Note that the current will rise uncontrolled if the operation continues (see § 7.24.2, page 61).

### 7.7 Pump control (Main Function)

By choosing pump control you will automatically get a stop ramp set to 15 sec. The optimising parameters for this main function are start and stop time; initial torque at start and end torque at start and stop. End torque at stop is used to let go of the pump when it's no longer producing pressure/flow, which can vary on different pumps. See Fig. 36.

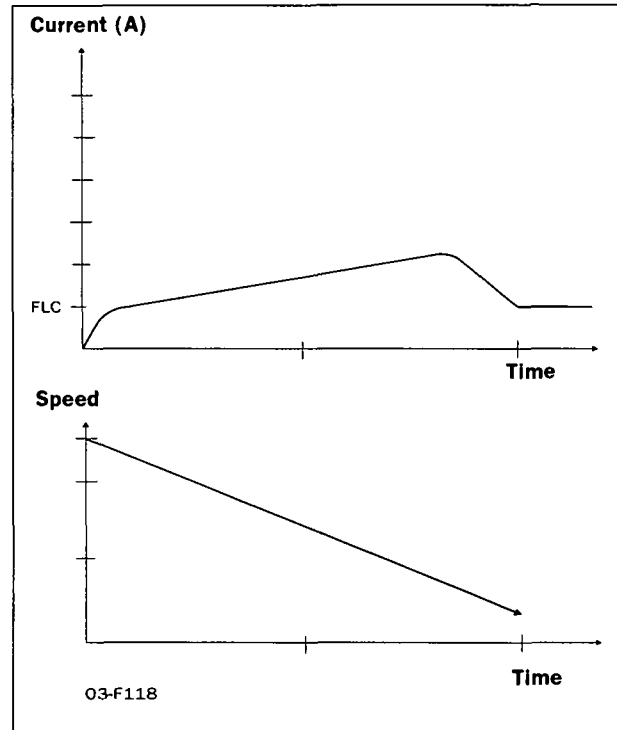

Fig. 36 Pump control

#### Pump application

The pump application is using Torque ramps for quadratic load. This gives lowest possible current and linear start and stop ramps. Related menus are 2, 4 (see § 7.1, page 36), 16, 17 and 18 (see § 7.5, page 39).

022 <sup>o</sup>	
<b>Setting of pump control</b>	
o F F	
Default:	oFF
Range:	oFF, on
<b>oFF</b>	Pump control disabled. Voltage Ramp enabled.
<b>on</b>	Pump control application is enabled.

**NOTE!** Only possible when Voltage Ramp mode is enabled. Menu 020-021, 023-025 must be "oFF".

### 7.8 Analogue Input Control (Main Function)

Soft starting and soft stopping can also be controlled via the Analogue Input Control (0-10 V, 2-10 V, 0-20 mA and 4-20 mA). This control makes it possible to connect optional ramp generators or regulators.

After the start command, the motor voltage is controlled through the remote analogue input.



**WARNING!** The remote analogue control may not be used for continuous speed regulation of standard motors. With this type of operation the increase in the temperature of the motor must be taken into consideration.

To install the analogue input control, proceed by:

1. Connect the ramp generator or regulator to terminal 14 (+) and 15 (-).

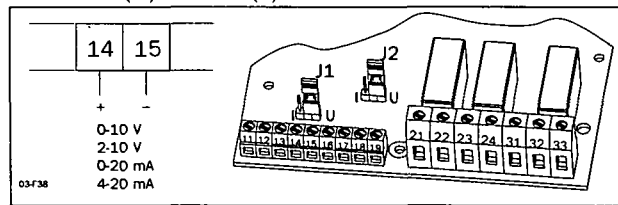

Fig. 37 Wiring for analogue input.

2. Set Jumper J1 on the PCB control card to voltage (U) or current control (I) signal position, see Fig. 38 and Fig. 24 on page 28. Factory setting is voltage (U).

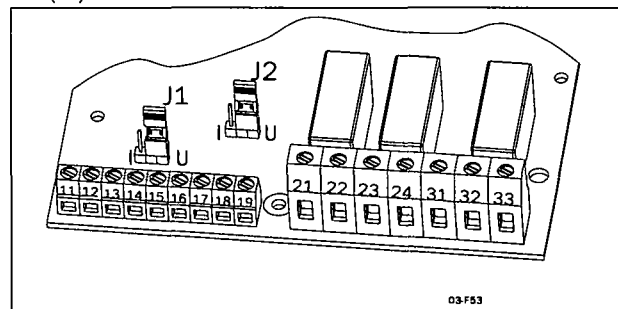

Fig. 38 Setting voltage or current for analogue input.

### 7.9 Full voltage start, D.O.L. (Main Function)

The motor can be accelerated as if it was connected directly to the mains. For this type of operation:

Check whether the motor can accelerate the required load (D.O.L.-start, Direct On Line start). This function can be used even with shorted thyristors.

024

°

o F F

**Setting of D.O.L start**

Default:	oFF
Range:	oFF, on
<b>oFF</b>	D.O.L. start disabled. Voltage Ramp enabled.
<b>on</b>	D.O.L. start enabled

**NOTE!** Only possible when Voltage Ramp mode is enabled. Menu 020-023, 025 must be "oFF".

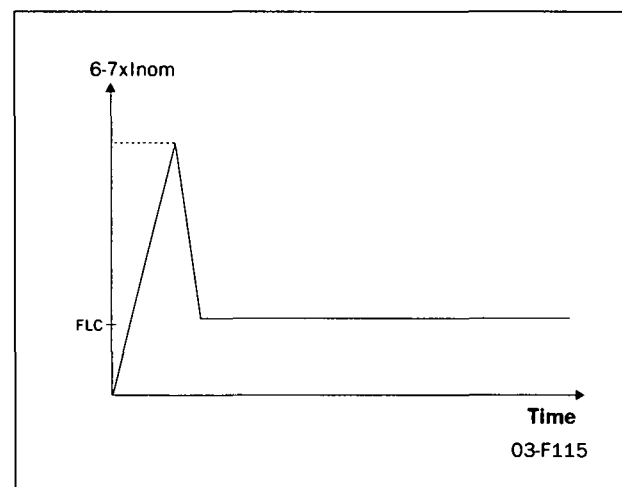

Fig. 39 Full voltage start.

023

°

o F F

**Selection of Analogue input control**

Default:	oFF
Range:	oFF, 1, 2
<b>oFF</b>	Analogue input disabled. Voltage Ramp enabled.
<b>1</b>	Analogue input is set for 0-10V/ 0-20mA control signal
<b>2</b>	Analogue input is set for 2-10V/ 4-20mA control signal.

**NOTE!** Only possible when Voltage Ramp mode is enabled. Menu 020-022, 024, 025 must be "oFF"

### 7.10 Torque control (Main function)

This main function can be used to make a start according to a pre-defined torque reference curve. Two different load characteristics, linear and square, are possible to select.

At start/stop the torque controller will follow the selected characteristic.

A torque start/stop behaviour can be seen in Fig. 40.

A perfect start and stop with torque ramps have a good linearity of current. To optimise this, use the setting of initial torque (menu 16) and end torque (menu 18). See also § 7.5, page 39.

**Example:**

Default for initial torque is 10% so if starting a more heavy load this will result in a small current peak in beginning of ramp. By increasing this value to 30/70% the current peak will not appear.

The end torque is increased mainly if the application has a high inertial load, like planers, saws and centrifuges. A current peak will appear in the end of ramp because the load is pushing the speed more or less by itself. By increasing this level to 150-250% the current will be linear and low.

025

°

OFF

**Torque control at start/stop**

Default:	oFF
Range:	oFF, 1, 2
<b>oFF</b>	Torque control is disabled Voltage Ramp enabled.
<b>1</b>	Torque control with linear torque characteristic
<b>2</b>	Torque control with square torque characteristic

**NOTE!** Torque control mode is only possible when Voltage Ramp mode is enabled (menu 020-024 are "oFF").

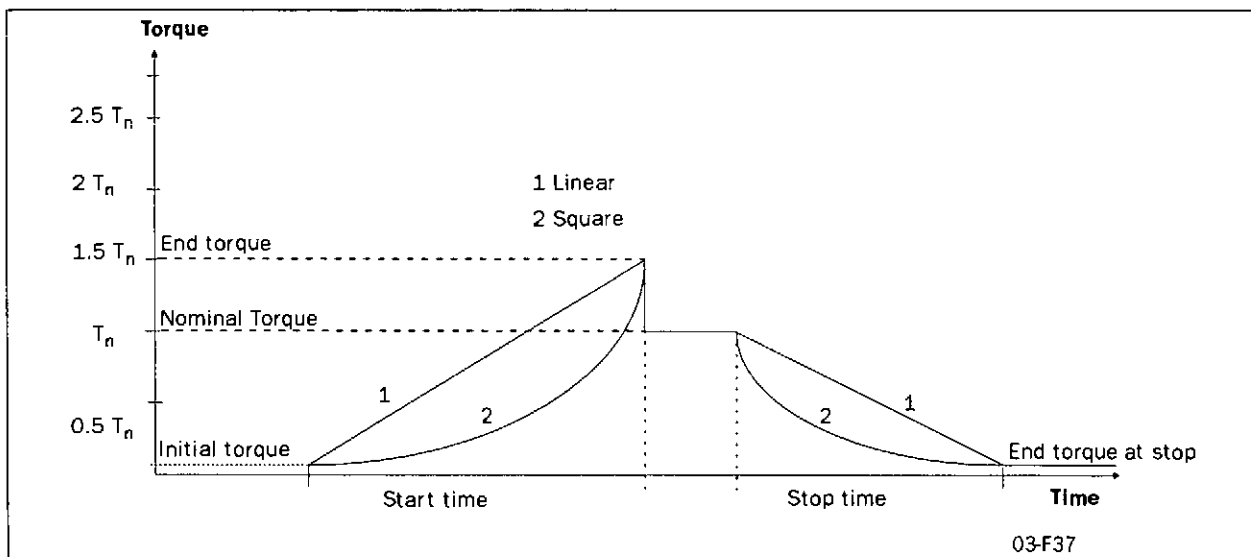

Fig. 40 Torque control at start/stop.

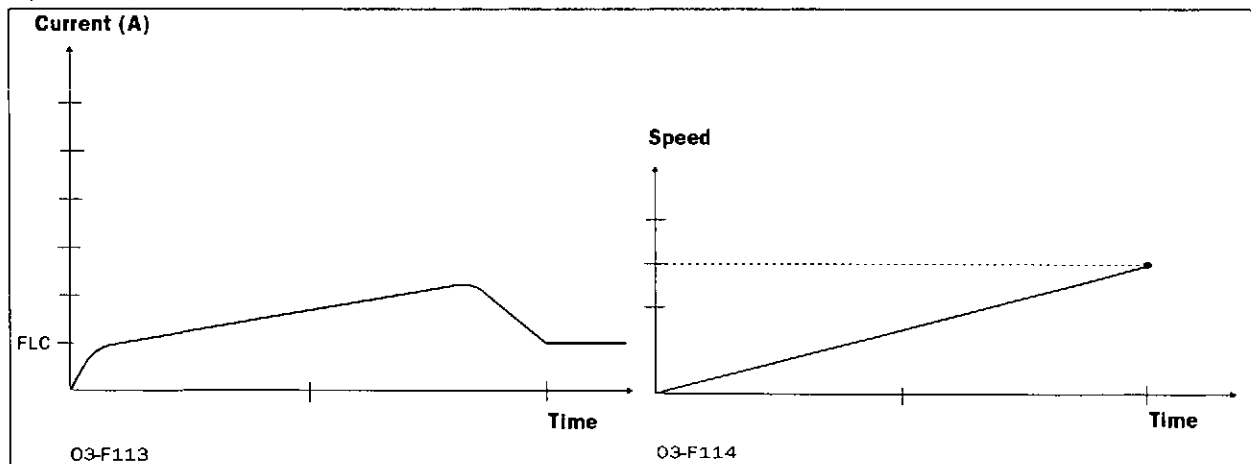

Fig. 41 Current and speed in torque control.



### 7.11 Torque boost

The Torque Booster enables a high torque to be obtained by providing a high current during 0.1 - 2 sec at start. This enables a soft start of the motor even if the break away torque is high at start. For example in crushing mills applications etc.

When the torque booster function has finished, starting continues according to the selected start mode.

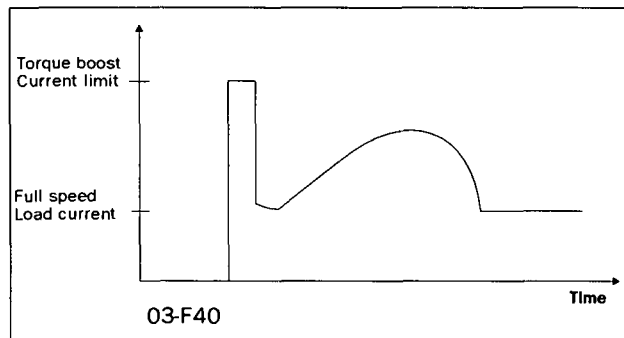

Fig. 42 The principle of the Torque Booster when starting the motor in voltage ramp mode.

See § 4.6, page 19, which main function that can be used with the torque boost.

030 <sup>o</sup>	
<b>Torque boost active time</b>	
OFF	
Default:	oFF
Range:	oFF, 0.1 - 2 sec
oFF	Torque boost disabled
0.1-2.0	Set the Torque boost time.

031 <sup>o</sup>	
<b>Torque boost current limit</b>	
300	
Default:	300
Range:	300 - 700% of In
The Torque boost current controller use selected value as the motor current reference.	

**NOTE!** Check whether the motor can accelerate the load with "Torque booster", without any harmful mechanical stress.

### 7.12 Bypass

In cases of high ambient temperatures or other reason it may sometimes be necessary to use a by-pass contactor to minimize the power loss at nominal speed (see Technical Data). By using the built-in Full Voltage Relay function an external contactor can be used to Bypass the soft starter when operating at nominal speed.

Bypass contactor can also be used if soft stop is required. Normally a Bypass contactor is not necessary as the device is designed for continues running conditions, see Fig. 29 on page 33 for wiring example.

**NOTE!** If one like to use the alarm functions, the extended functions or the viewing functions the 2-pcs current transformers must be mounted outside the soft start as shown in Fig. 44 and Fig. 45 on page 45. For this purpose an optional extension cable for the current transformers is available. Code No 01-2020-00.

032 <sup>o</sup>	
<b>Setting of Bypass</b>	
OFF	
Default:	oFF
Range:	oFF, on
oFF	Bypass disabled
on	Bypass enabled. Program either relay K1 or K2 to function 2 to control the bypass contactor, see menu 51/52.

**CAUTION!** If the current transformers are not mounted as in Fig. 43 on page 44 and § 6.2, page 28, the alarm and viewing functions will not work. Do not forget to set menu 032 to ON, otherwise there will be an F12 alarm and at the stop command will be a freewheeling stop.

For further information see chapter 6.2 page 28.

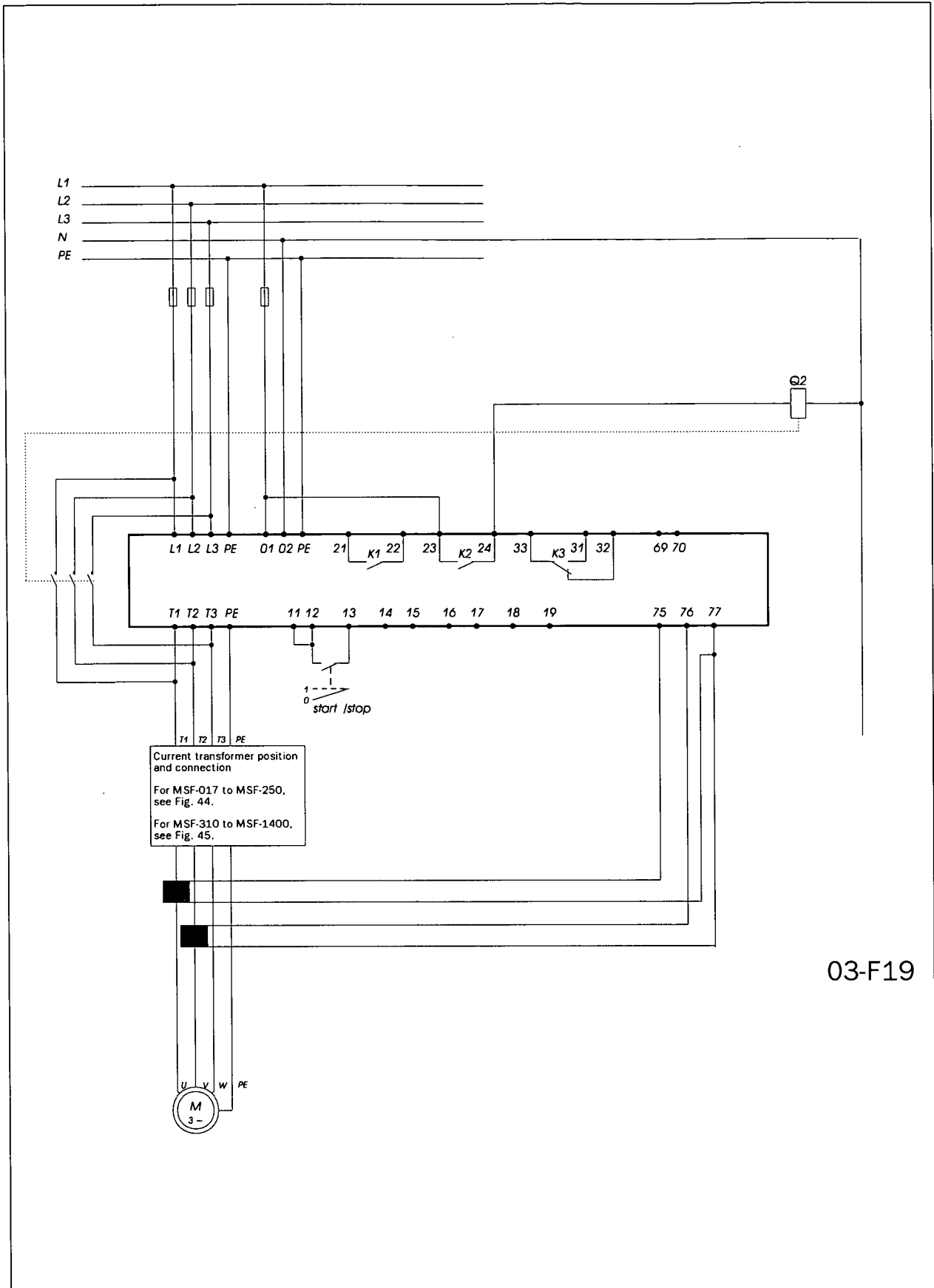

Fig. 43 Bypass wiring example MSF 310-1400.

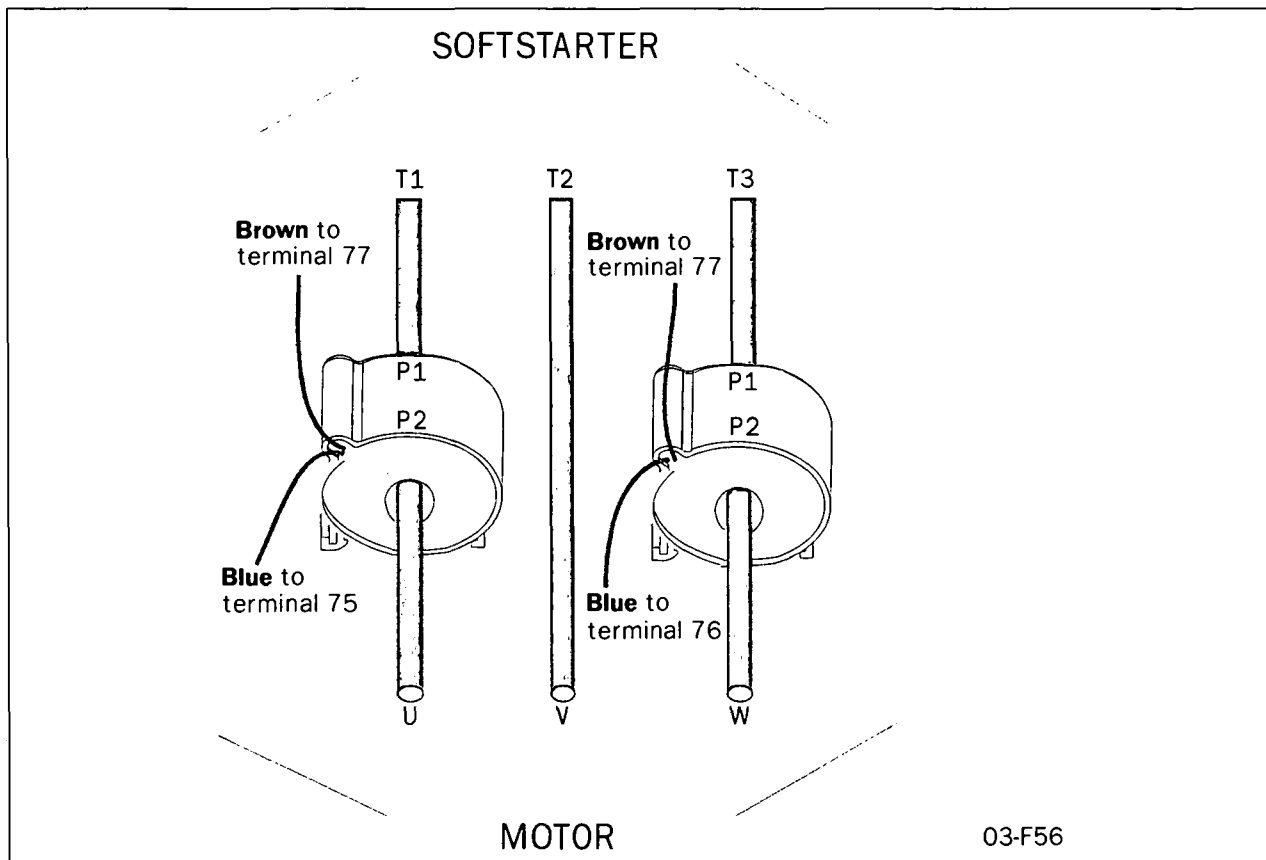

Fig. 44 Current transformer position when Bypass MSF-017 to MSF-250.

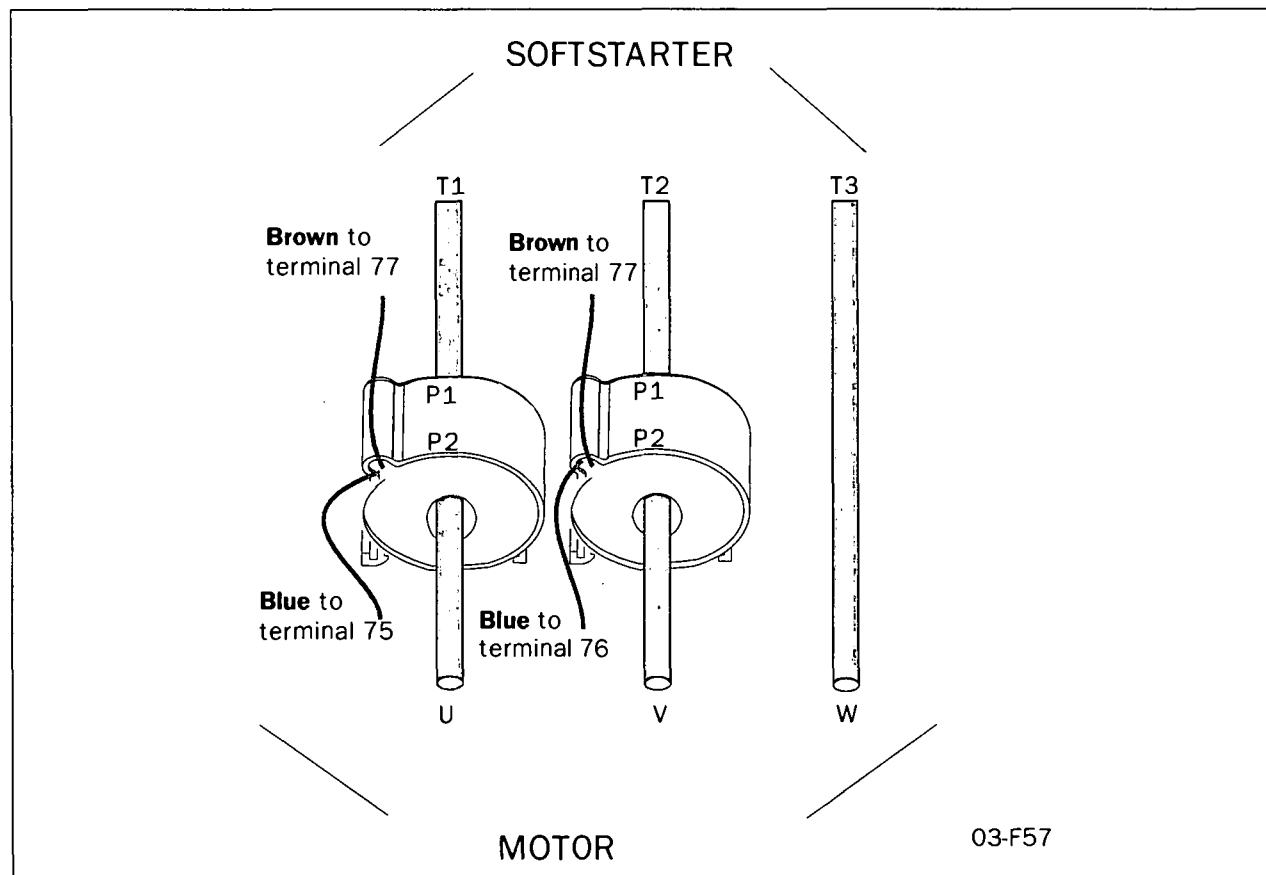

Fig. 45 Current transformer position when Bypass MSF-310 to MSF-1400.

### 7.13 Power Factor Control

During operation, the soft starter continuously monitors the load on the motor. Particularly when idling or when only partially loaded, it is sometimes desirable to improve the power factor. If Power factor control (PFC) is selected, the soft starter reduces the motor voltage when the load is lower. Power consumption is reduced and the degree of efficiency improved.

033 <sup>o</sup>	
<b>Setting of PFC</b>	
OFF	
Default:	oFF
Range:	oFF, on
<b>oFF</b>	PFC disabled
<b>on</b>	PFC enabled. The Full voltage relay function does not work.

**NOTE!** If the PFC is used the EMC-directive is not fulfilled.

### 7.14 Brake functions

There are two built in braking methods for applications where the normal stop ramp is not enough.

- **Dynamic DC-brake**  
Increases the braking torque by decreasing speed.
- **Soft brake**  
Gives a high torque at the start of the braking and then also increasing torque by decreasing speed.

In both methods the MSF detects when the motor is standing still, so rotating in wrong direction is avoided.

#### Dynamic Vector Brake

- Possible to stop motors with high inertia loads from close to synchronous speed.
- At 70% of the nominal speed a DC-brake is activated until the motor is standing still or the selected Braking Time has expired (see menu 34, next page).
- No contactor needed.
- For extra safety, the soft starter has a digital input signal for monitoring standstill so that at real motor standstill will stop the output voltage immediately (see § 7.19, page 53).

#### Soft brake

- Even very high inertia loads can be stopped
- The Soft brake is a controlled reversing of the motor as the MSF measures the speed during braking.
- Two contactors are needed which can be placed on the in- or output of the soft starter. On the input the first contactor is connected to relay K1 which is also used as a mains contactor.
- At 30% of the nominal speed a DC-brake is activated until the motor is standing still or the selected Braking Time has expired (menu 34, next page).

- For extra safety, the soft starter has a digital input signal for monitoring standstill. So that the output voltage is stopped immediately (see menu 57-58, § 7.19, page 53).

See Fig. 47 on page 47 for the following set-up sequence:

- Soft brake is activated if menu 36=2 and menu 34 has a time selected (see next page).
- Menu 51 and 52 are automatically set to 5 and 4 to get the correct relay functions on K1 and K2 (see § 7.17, page 51).
- Relay K1 should be used to connect a contactor for supply L1, L2, L3 to MSF or motor.
- Relay K2 is used to connect phase shifting contactor to change L1, L2 and L3 to MSF or motor.
- At start K1 is activated and connects L1, L2, L3 then the motor starts. At stop K1 opens and disconnects L1, L2, and L3 and after 1s K2 connects with the other phase sequence and the braking of the motor is active.

**NOTE!** Soft brake uses both programmable relays. For other functions, see also the function table in chapter 7. page 35.

**NOTE!** For several start/stops It is recommend to use the PTC input.

**WARNING!** If the Soft Brake function has been selected once and after that the Bypass function is selected, then the relay functions on K1 and K2 remain in the Soft Brake functionality. Therefore it is necessary to change the relay functions in menu 51-52 manually to the Bypass functions (see § 7.17, page 51) or reset to default in menu 199 (see § 7.28, page 63) and select the Bypass function again.

034 <sup>o</sup>	
<b>Braking time</b>	
OFF	
Default:	oFF
Range:	oFF, 1 - 120 sec
<b>oFF</b>	Brake function disabled
<b>1-120</b>	Brake time

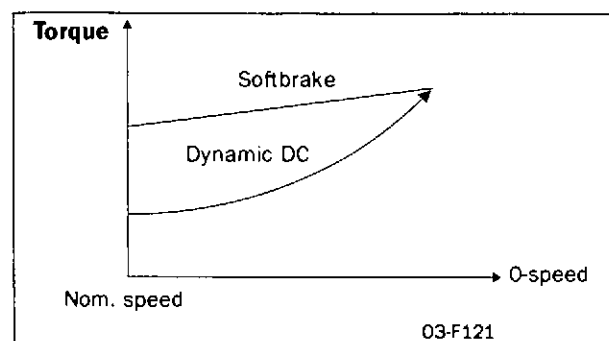

Fig. 46 Braking time

035 <sup>o</sup>	
<b>Braking Strength</b>	
1 0 0	
Default:	100
Range:	100 - 500%

036 <sup>o</sup>	
<b>Brake method</b>	
1	
Default:	1
Range:	1, 2
<b>1</b>	Dynamic vector brake, active
<b>2</b>	Soft brake active

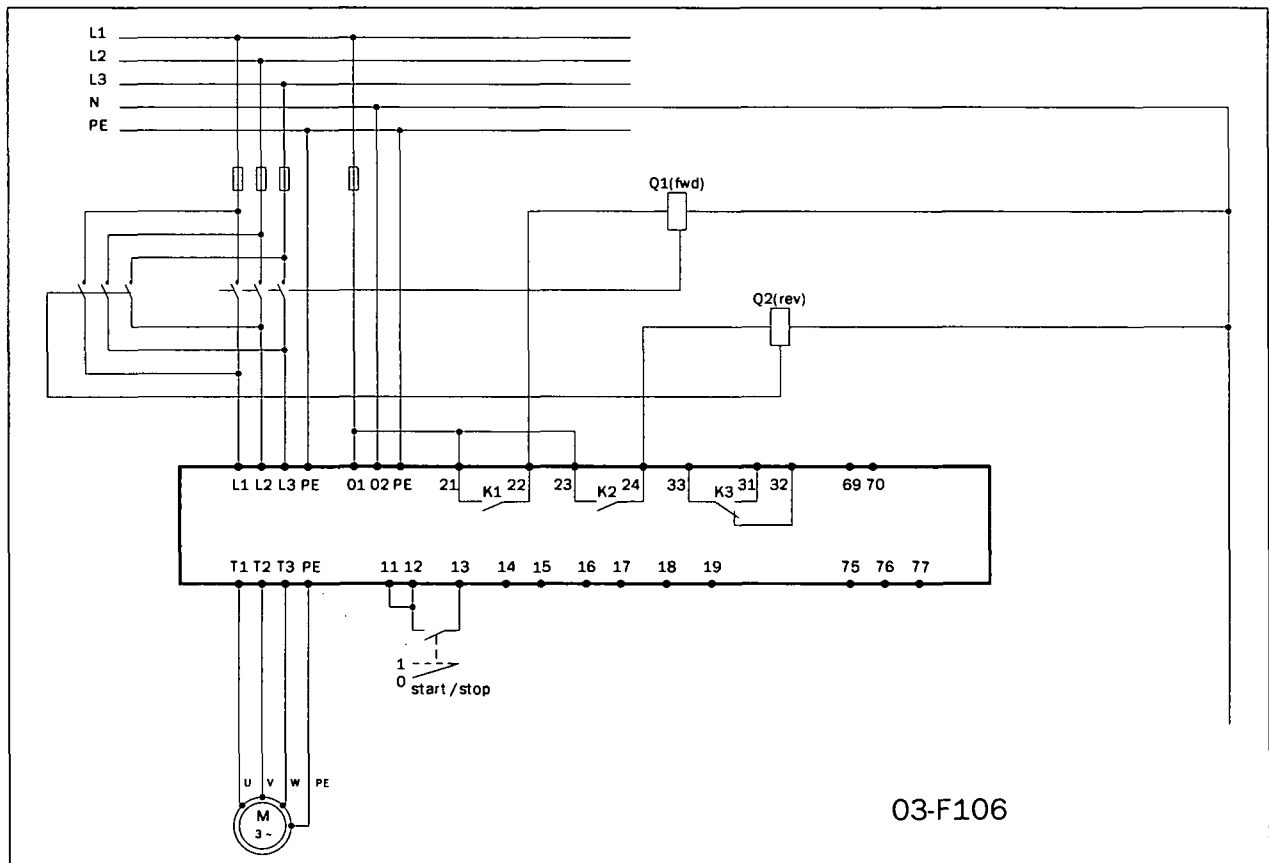

Fig. 47 Soft brake wiring example.

### 7.15 Slow speed and Jog functions

The soft starter is able to run the motor at a fixed slow speed for a limited period of time.

The slow speed will be about 14% of the full speed in the forward direction and 9% in the reverse direction.

The following functions are possible:

- **Slow speed controlled by an external signal.**  
The digital input is used to run at slow speed at a start or stop command for a selected number of pulses (edges) generated by an external sensor (photo cell, micro switch, etc.). See § 7.19, page 53 for more instructions.
- **Slow Speed during a selected time period.**  
The slow speed will be active after a stop command for a selected time period. See § 7.19, page 53 for more instructions.
- **Slow Speed using the "JOG"-commands.**  
The slow speed can be activated via the JOG keys on the keyboard or externally via the analogue input. See § 7.25, page 61 for more instructions.

#### 7.15.1 Slow speed controlled by an external signal.

With these setting it is possible to have an external pulse or edge signal controlling the time that the Slow Speed is active either after a Start command or a Stop command or at both commands. The following menu's are involved:

Menu	Function	See page
57	Digital input selection	page 53
58	Pulse selection	page 53
37	Slow speed torque	page 49
38	Slow speed time at start	page 49
39	Slow speed time at stop	page 49
40	DC-Brake at slow speed	page 49

Installation is as follows:

1. Set the analogue input selection for Slow Speed operation. Menu 57=2. See § 7.19, page 53. See Fig. 37 on page 41 for a wiring example.
2. Select in menu 38 (see § 7.15.2, page 49) the Slow Speed at Start time. This time will now be the absolute maximum time for Slow Speed to be active after a start command, in case the external signal will not appear.
3. Select in menu 39 (see § 7.15.2, page 49) the Slow Speed at Stop time. This time will now be the absolute maximum time for Slow Speed to be active after a stop command, in case the external signal will not appear.
4. Select in menu 57 (see § 7.19, page 53) the number of edges to be ignored by the Slow Speed input, before a start or stop is executed at slow speed. The edges are generated by an external sensor (photo cell, micro switch, etc.).

The Slow Speed torque (menu 37) and DC-Brake after Slow Speed (menu 40) can be selected if needed. (see § 7.15.4, page 49).

When the number of edges exceeds or the time expire, a start according to selected main function is made.

At stop, the motor will ramp down (if selected) and DC brake (if selected) before a slow speed forward at stop will begin. Slow speed will last as long as the number of edges on the external input is below parameter value in menu 036 and the max duration time doesn't expires. When the number of edges exceeds or the time expire, a stop is made.

In Fig. 48 on page 48 the selected number of edges are 4. It is recommended to select DC-brake (see § 7.14, page 46) before a slow speed at stop if it is a high inertia load. See Fig. 29 on page 33 for wiring diagram. In case one use DC-brake, see § 7.15.4, page 49.

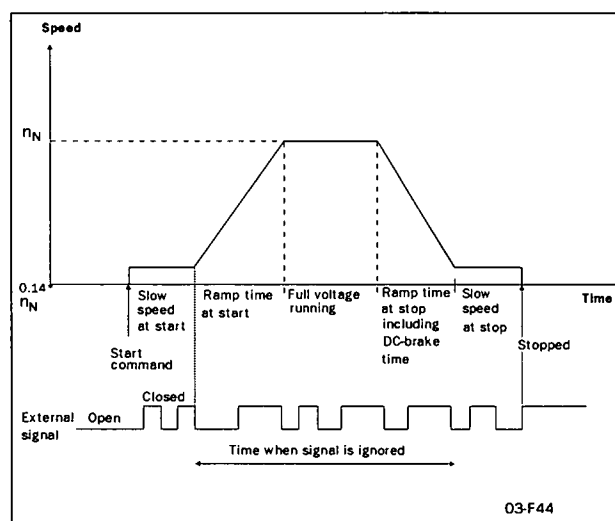

Fig. 48 Slow speed controlled by an external signal.

This additional function can be used together with most of the main functions (see § 4.6, page 19).

037 <sup>0</sup>	
Slow speed torque	
10	
Default:	10
Range:	10-100
Select the magnitude of the slow speed torque.	

### 7.15.2 Slow speed during a selected time

It is possible to have a slow speed in forward direction before a start and after a stop. The duration of the slow speed is selectable in menus 038 and 039.

It is recommended to select DC brake (see § 7.14, page 46) before a slow speed at stop if it is a high inertia load. This slow speed function is possible in all control modes, keyboard, remote and serial communication.

038 <sup>o</sup>	
<b>Slow speed time at start</b>	
o F F	
Default:	oFF
Range:	oFF, 1 - 60 sec
<b>oFF</b>	Slow speed at start is disabled
<b>1-60</b>	Set slow speed time at start.

039 <sup>o</sup>	
<b>Slow speed time at stop</b>	
o F F	
Default:	oFF
Range:	oFF, 1 - 60 sec
<b>oFF</b>	Slow speed at stop is disabled
<b>1-60</b>	Set slow speed time at stop.

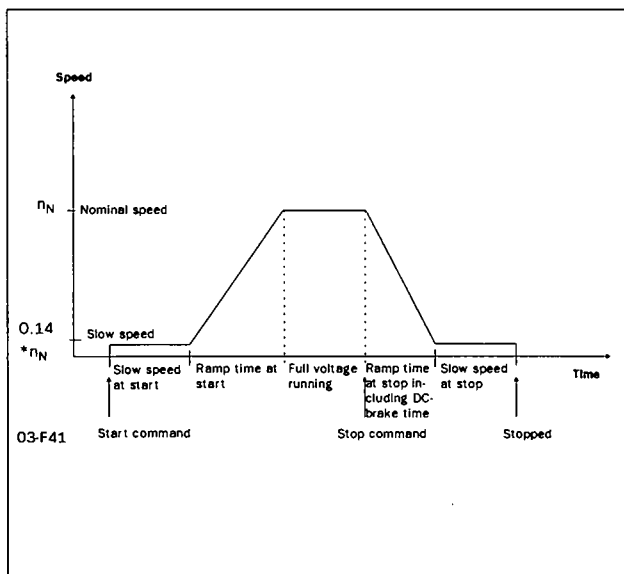

Fig. 49 Slow speed at start/stop during a selected time.

The Slow speed torque (menu 37) and the DC-Brake after Slow speed (menu 40, § 7.15.4, page 49) can be selected if needed.

### 7.15.3 Jog Functions

The Jog commands can be used to let the motor run at a Slow speed (forward or reverse) as long as the Jog command is active.

The Jog commands can be activated in 2 different ways:



- **Jog keys**  
The Jog-Forward and Jog-reverse keys on the control panel. The keys can be programmed separate for each function. See § 7.25, page 61 for more instructions
- **External Jog command**  
The external command is given via terminal 14 at the digital input. Only 1 function (forward or reverse) can be programmed to the digital input at the time. See § 7.19, page 53 for more instructions.

### 7.15.4 DC-brake after slow speed at stop [040]

A DC-brake after a slow speed at stop is possible to have, i.e. for a high inertia load or for a precise stop.

The current is controlled and the reference value for the normal DC-brake function is used (see § 7.15.4, page 49).

The duration for the DC-brake is possible to select.

This DC-brake function is not applied when the "JOG  " and "JOG  " keys are used.

040 <sup>o</sup>	
<b>DC-Brake at slow speed</b>	
o F F	
Default:	oFF
Range:	oFF, 1-60
<b>oFF</b>	DC-brake after slow speed at stop disabled.
<b>1-60</b>	DC-brake duration time after slow speed at stop.

### 7.16 Motor data setting

The first step in the settings is to set menu 007 and 008 to “on” to be able to reach the menus 041-046 and enter the motor data.

**NOTE! The default factory settings are for a standard 4-pole motor acc. to the nominal current and power of the soft starter. The soft starter will run even if no specific motor data is selected, but the performance will not be optimal.**

045 <sup>o</sup>	
<b>Nominal motor cos phi</b>	
0.86	
Default:	0.86
Range:	0.50-1.00

041 <sup>o</sup>	
<b>Nominal motor voltage</b>	
400	
Default:	400 V
Range:	200-700 V
Make sure the soft starters maximum voltage rating is suitable for chosen motor voltage.	

046 <sup>o</sup>	
<b>Nominal frequency</b>	
50	
Default:	50 Hz
Range:	50/60 Hz

**NOTE! Now go back to menu 007, 008 and set it to “oFF” and then to menu 001.**

042 <sup>o</sup>	
<b>Nominal motor current</b>	
17	
Default:	Nominal soft starter current
Range:	25% - 150% of Insoft in Amp.

043 <sup>o</sup>	
<b>Nominal motor power</b>	
7.5	
Default:	Nominal soft starter power
Range:	25% - 300% of Pnsoft in kW

044 <sup>o</sup>	
<b>Nominal motor speed</b>	
1450	
Default:	Nnsoft in rpm
Range:	500-3600 rpm



### 7.17 Programmable relay K1 and K2

The soft starter has three built-in auxiliary relays, K3 (change over contacts), is always used as an alarm relay. The other two relays, K1 and K2 (closing contacts), are programmable.

K1 and K2 can be set to either “Operation”, “Full Voltage” or “Pre-alarm” indication. If DC-brake is chosen the relay K2 will be dedicated to this function.

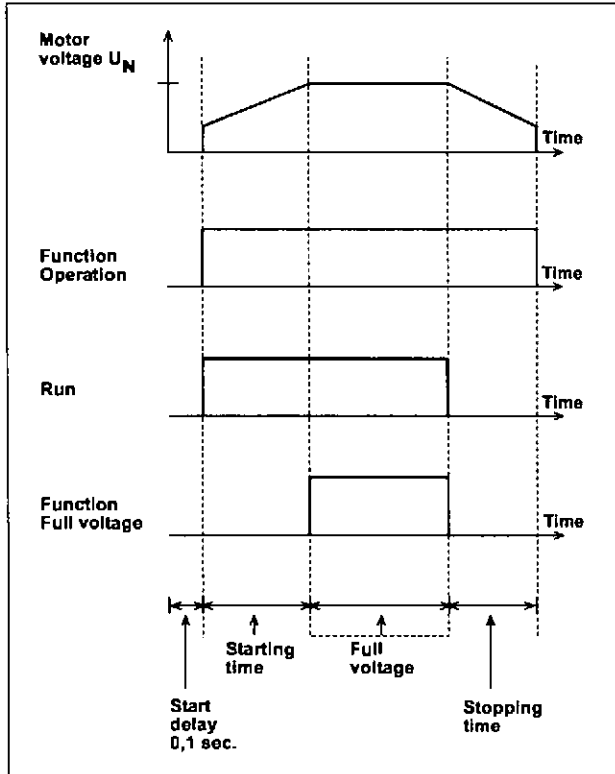

Fig. 50 Start/stop sequence and relay function “Operation” and “Full voltage”.

052<sup>o</sup>

**Setting of K2 indication**

			2
--	--	--	---

Default:	2
Range:	1, 2, 3, 4, 5
<b>1</b>	K2 is set for “Operation”
<b>2</b>	K2 is set for “Full Voltage”
<b>3</b>	K2 is set for “Power pre-alarm”
<b>4</b>	K2 is set for “Softbrake”
<b>5</b>	K2 is set for “Run”



**WARNING!** If the Soft Brake function has been selected once and after that the Bypass function is selected, then the relay functions on K1 and K2 remain in the Soft Brake functionality. Therefore it is necessary to change the relay functions in menu 51-52 manually to the Bypass functions (see § 7.12, page 43) or reset to default in menu 199 (see § 7.28, page 63) and select the Bypass function again.

051<sup>o</sup>

**Setting of K1 indication**

			1
--	--	--	---

Default:	1
Range:	1, 2, 3, 4, 5
<b>1</b>	K1 is set for “Operation”
<b>2</b>	K1 is set for “Full Voltage”
<b>3</b>	K1 is set for “Power pre-alarm”
<b>4</b>	No function
<b>5</b>	K1 is set for “Run”

### 7.18 Analogue output

The soft starter can present current, voltage and power on an analogue output terminal, for connection to a recording instrument or a PLC. The output can be configured in 4 different ways, 0-10V, 2-10V, 0-20mA or 4-20 mA. To install the instrument proceed as follows:

1. Connect the instrument to terminal 19 (+) and 15 (-).

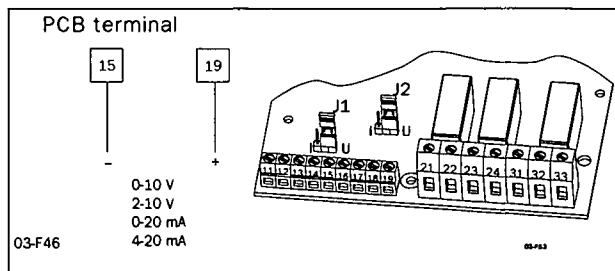

Fig. 51 Wiring for analogue output.

2. Set Jumper J2 on the PCB board to voltage (U) or current (I) signal position. Factory setting is voltage (U). See Fig. 52 on page 52 and Fig. 24 on page 28.

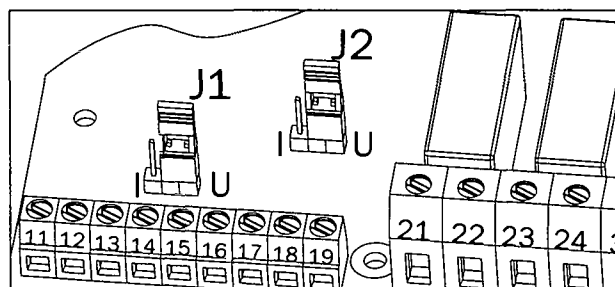

Fig. 52 Setting of current or voltage output.

3. Set the parameter in menu 054.

054 <sup>o</sup>	
<b>Analogue output</b>	
OFF	
Default:	oFF
Range:	oFF, 1, 2
<b>oFF</b>	Analogue output is disabled
<b>1</b>	Analogue output is set to 0-10V/0-20mA
<b>2</b>	Analogue output is set to 0-10V/4-20mA

4. Choose a read-out value in menu 055

055 <sup>o</sup>	
<b>Analogue output value</b>	
1	
Default:	1
Range:	1, 2, 3
<b>1</b>	RMS current, default range 0-5xI <sub>n</sub>
<b>2</b>	Line input RMS voltage, default range 0-720V
<b>3</b>	Output shaft power, default range 0-2xP <sub>n</sub>

5. Set analogue output gain to adjust the range of chosen analogue output value in menu 056.

056 <sup>o</sup>	
<b>Analogue output gain</b>	
100	
Default:	100%
Range:	5-150%

Example on settings:

Set value	I <sub>scale</sub>	U <sub>scale</sub>	P <sub>scale</sub>
100%	0-5xI <sub>n</sub>	0-720V	0-2xP <sub>n</sub>
50%	0-2.5xI <sub>n</sub>	0-360V	0-P <sub>n</sub>

### 7.19 Digital input selection

The analogue input can be used as a digital input. This is programmed in Menu 57. There are 4 different functions:

- Rotation sensor input for braking functions. See § 7.14, page 46.
- Slow speed external controlled. See § 7.15.1, page 48.
- Jog functions forward or reverse enabled. See § 7.25, page 61.

Fig. 53 shows how to set the input for voltage or current control, with jumper J1 the control board. The default setting for J1 is voltage control.

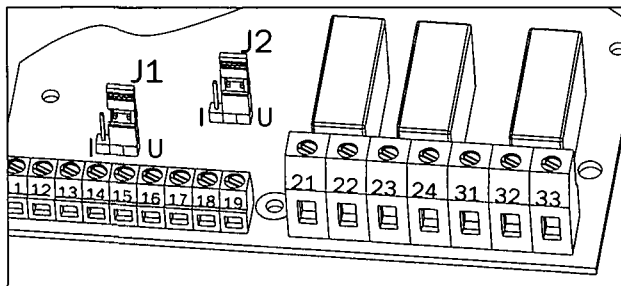

Fig. 53 Setting of J1 for current or voltage control.

Fig. 54 shows a wiring example for the analogue input as it is used for digital input.

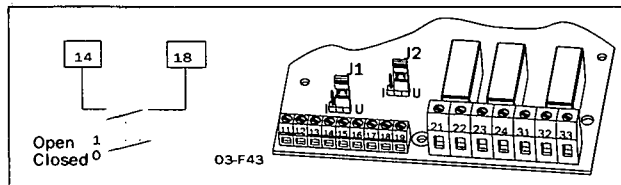

Fig. 54 Wiring for slow speed external input.

**NOTE!** If the Main Function Analogue control is programmed (see § 7.8, page 41) the analogue input can not be used for digital signal input. The menu 57 is then automatically set to OFF.

057 <sup>o</sup>	
<b>Digital input selection</b>	
o F F	
Default:	oFF
Range:	oFF, 1-4
<b>oFF</b>	No digital input control
<b>1</b>	Rotation sensor for brake functions
<b>2</b>	Slow speed function
<b>3</b>	Jog forward command
<b>4</b>	Jog reverse command

**NOTE!** Jog forward, reverse has to be enabled, see § 7.25, page 61.

Depending on the selection made in menu 57, menu 58 is used to program the number of the edges. The edges can be generated by an external sensor (photo cell, micro switch etc.).

058 <sup>o</sup>	
<b>Digital input pulses</b>	
1	
Default:	1
Range:	1-100
If Menu 57=1. A positive or negative edge at analogue input from a rotation sensor will give a signal to stop the braking voltage.	
If Menu 57=2 The number of edges to be ignored by the slow speed input, before a start or stop is executed at slow speed.	

## 7.20 Parameter Set

Parameter Set, an important function which can be handy when using one soft starter to switch in and start different motors, or working under variable load conditions. For example; starting and stopping conveyor belts with different weight on the goods from time to time.

For sets of parameters can be controlled either from the keyboard, the external control inputs or the serial interface (option). Up to 51 different parameters can be set for each Parameter Set.

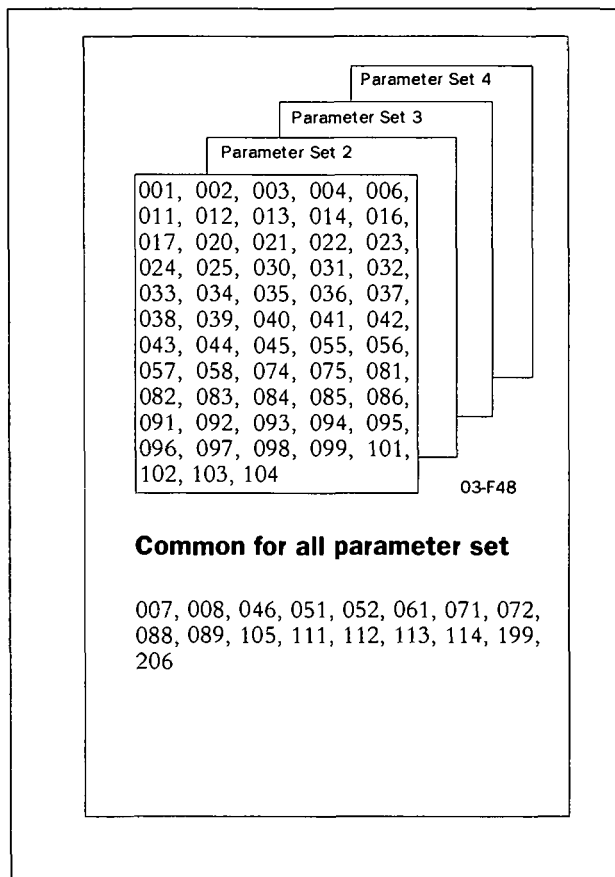

Fig. 55 Parameter overview

When 'Parameter set' in menu 061 is set to 0 (external selection), only parameters in menu 006 (Control mode) and 061 (Parameter set) can be changed. All other parameters are not allowed to change.

It is possible to change parameter set at stop and at full voltage running.

061 <sup>o</sup> <sub>o</sub>	
<b>Parameter set</b>	
1	
Default:	1
Range:	0, 1, 2, 3, 4
0	Parameter set are selected by the external input 16 and 17 (see below).
1, 2, 3, 4	Selection of parameter set 1-4.

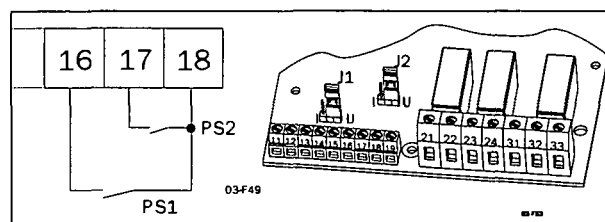

Fig. 56 Connection of external control inputs.

Parameter Set	PS1 (16-18)	PS2 (17-18)
1	Open	Open
2	Closed	Open
3	Open	Closed
4	Closed	Closed

### 7.21 Motor protection, overload (F2 alarm)

In many cases it is convenient to have a complete starter. The soft starter have a possibility to use either an input PTC signal from the motor, an internal thermal model of the motor for thermal protection or both together at the same time. Slight overload for long time and several overloads of short duration will be detected with both methods.

071 <sup>o</sup>	
<b>Motor PTC input</b>	
n o	
Default:	no
Range:	no, YES
<b>no</b>	Motor PTC input is disabled
<b>YES</b>	Motor PTC input is activated: - Connect the PTC to terminals 69 and 70, see table 12, page 32 and § Fig. 30, page 34. - A to hot motor will give an F2 alarm. The alarm can only be reseted after cooling down of the motor.

**NOTE!** Open terminals will give an F2 alarm immediately. Make sure the PTC is always connected or the terminals are shorted.

**NOTE!** The internal motor thermal protection will still generate an alarm if it is not selected oFF.

072 <sup>o</sup>	
<b>Internal motor thermal protection</b>	
1 0	
Default:	10
Range:	oFF, 2-40 sec
<b>oFF</b>	Internal motor protection is disabled.
<b>2-40</b>	Selection of the thermal curve according to Fig. 57 - Check that menu 042 is set to the proper motor current (see § 7.16, page 50). - If the current exceeds the 100% level an F2 alarm is activated. - The motor model thermal capacity must cool down to 95% before reset can be accepted. - Used thermal capacity in menu 073 in § 7.21, page 55.

**NOTE!** If 'Bypass' is used check that the current transformers are placed and connected correctly (see Fig. 43 on page 44).



**CAUTION!** Used thermal capacity is set to 0 if the control board loses its supply (terminal 01 and 02). This means that the internal thermal model starts with a 'cold' motor, which perhaps in reality is not the case. This means that the motor can be overheated.

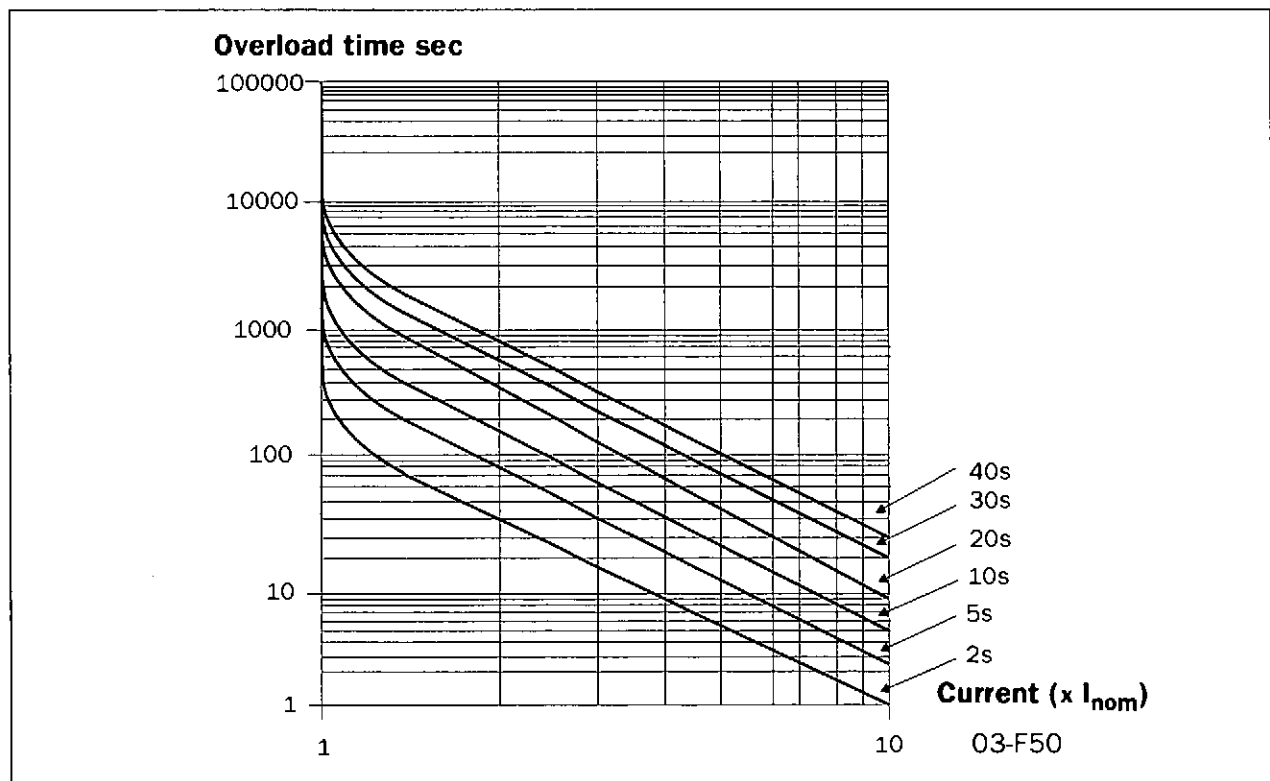

Fig. 57 The thermal curve

## 7.22 Mains protection

073 <sup>o</sup>					
<b>Used thermal capacity</b>					
<table border="1" style="margin: auto;"> <tr> <td style="width: 20px; height: 20px;"></td> <td style="width: 20px; height: 20px;"></td> <td style="width: 20px; height: 20px;"></td> <td style="width: 20px; height: 20px; text-align: center;">0</td> </tr> </table>					0
			0		
Default:	-				
Range:	0-150%				
Read-out of the used thermal capacity. If menu 072 'Internal motor thermal protection' is selected OFF, the capacity is shown as if the default class 10 was selected.					

081 <sup>o</sup>				
<b>Voltage unbalance alarm</b>				
<table border="1" style="margin: auto;"> <tr> <td style="width: 20px; height: 20px;"></td> <td style="width: 20px; height: 20px; text-align: center;">1</td> <td style="width: 20px; height: 20px; text-align: center;">0</td> </tr> </table>			1	0
	1	0		
Default:	10			
Range:	2 -25% U <sub>n</sub>			
Insert limit in % of nominal motor voltage. Max unbalance in voltage between the 3 input phases is compared with the selected value. This is a category 2 alarm.				

074 <sup>o</sup>					
<b>Starts per hour limitation</b>					
<table border="1" style="margin: auto;"> <tr> <td style="width: 20px; height: 20px;"></td> <td style="width: 20px; height: 20px; text-align: center;">o</td> <td style="width: 20px; height: 20px; text-align: center;">F</td> <td style="width: 20px; height: 20px; text-align: center;">F</td> </tr> </table>			o	F	F
	o	F	F		
Default:	oFF				
Range:	oFF, 1-99/hour				
<b>oFF</b>	Starts per hour limitation is disabled.				
<b>1-99</b>	Sets the start per hour limitation alarm. If the selected number is exceeded, alarm F11 occurs.				

082 <sup>o</sup>					
<b>Response delay voltage unbalance alarm</b>					
<table border="1" style="margin: auto;"> <tr> <td style="width: 20px; height: 20px;"></td> <td style="width: 20px; height: 20px; text-align: center;">o</td> <td style="width: 20px; height: 20px; text-align: center;">F</td> <td style="width: 20px; height: 20px; text-align: center;">F</td> </tr> </table>			o	F	F
	o	F	F		
Default:	oFF				
Range:	oFF, 1-60 sec				
<b>oFF</b>	Unbalance voltage alarm is disabled				
<b>1-60</b>	Set the response delay time for unbalanced voltage alarm F8.				

075 <sup>o</sup>					
<b>Locked rotor alarm</b>					
<table border="1" style="margin: auto;"> <tr> <td style="width: 20px; height: 20px;"></td> <td style="width: 20px; height: 20px; text-align: center;">o</td> <td style="width: 20px; height: 20px; text-align: center;">F</td> <td style="width: 20px; height: 20px; text-align: center;">F</td> </tr> </table>			o	F	F
	o	F	F		
Default:	oFF				
Range:	oFF, 1.0-10.0 sec				
<b>oFF</b>	Locked rotor alarm is disabled				
<b>1.0-10.0</b>	An F5 alarm is given when the rotor locks. The alarm is active during starting and running.				

083 <sup>o</sup>				
<b>Over voltage alarm</b>				
<table border="1" style="margin: auto;"> <tr> <td style="width: 20px; height: 20px; text-align: center;">1</td> <td style="width: 20px; height: 20px; text-align: center;">1</td> <td style="width: 20px; height: 20px; text-align: center;">5</td> </tr> </table>		1	1	5
1	1	5		
Default:	115			
Range:	100 -150% U <sub>n</sub>			
Insert limit in % of nominal motor voltage. Max voltage of the 3 input phases is compared with the selected value. This is a category 2 alarm.				

084 <sup>o</sup>					
<b>Response delay over voltage alarm</b>					
<table border="1" style="margin: auto;"> <tr> <td style="width: 20px; height: 20px;"></td> <td style="width: 20px; height: 20px; text-align: center;">o</td> <td style="width: 20px; height: 20px; text-align: center;">F</td> <td style="width: 20px; height: 20px; text-align: center;">F</td> </tr> </table>			o	F	F
	o	F	F		
Default:	oFF				
Range:	oFF, 1-60 sec				
<b>oFF</b>	Overvoltage alarm is disabled				
<b>1-60</b>	Set the response delay time for over voltage alarm F9.				

## 7.23 Application protection (load monitor)

### 7.23.1 Load monitor max and min/protection (F6 and F7 alarms)

MSF has a built in load monitor based on the output shaftpower. This is a unique and important function which enables protection of machines and processes driven by the motor connected to the soft starter. Both a Min and Max limit is possible to select.

In combination with the pre-alarm function, see § 7.23.2, page 58, this create a powerful protection. An auto set function is also included for an automatic setting of the alarm limits. A start-up delay time can be selected to avoid undesired alarms at start-up, see Fig. 58 on page 60.

**NOTE!** The load monitor alarms are all disabled during a stop ramp.

085 <sup>o</sup>	
Under voltage alarm	
OFF	
Default:	85
Range:	75-100 U <sub>n</sub>
Insert limit in % of nominal motor voltage. Min voltage of the 3 input phases is compared with the selected value. This is a category 2 alarm.	

086 <sup>o</sup>	
Response delay under voltage alarm	
OFF	
Default:	oFF
Range:	oFF, 1-60 sec
<b>oFF</b>	Under voltage alarm is disabled
<b>1-60</b>	Set the response delay time for under voltage alarm F10

087 <sup>o</sup>	
Phase sequence	
- - - -	
Default:	-
Range:	L123, L321
L123 is the direct phase sequence. L321 is the reverse phase sequence.	

088 <sup>o</sup>	
Phase reversal alarm	
OFF	
Default:	oFF
Range:	oFF, on
<b>oFF</b>	Phase reversal alarm is disabled
<b>on</b>	Sets the phase reversal Alarm. - Switch on the power supply first. The phase sequence is stored as the correct sequence. - Sets the menu 088 to "on". - Any reversal of phase sequence will cause alarm F16.

**NOTE!** The actual phase sequence can be viewed in menu 87.

089 <sup>o</sup>	
Auto set power limits	
no	
Default:	no
Range:	no, YES
<b>no</b>	Auto set is disabled
<b>YES</b>	Auto set is activated if ENTER is pressed.

090 <sup>o</sup>	
Output shaftpower in %	
0	
Default:	-
Range:	0-200%
Measured output shaftpower in % of nominal motor power.	

**NOTE!** System must be in full voltage running before an auto set is permitted.

The actual power is regarded as 1.00xPact.  
The set levels are:

- Power max alarm limit[092]: 1.15xP actual
- Power max pre-alarm limit[094]: 1.10xP actual
- Power min pre-alarm limit[096]: 0.90xP actual
- Power min alarm limit[098]: 0.85xP actual

A successful auto set shows a message 'Set' for 3 s and if something goes wrong a message 'no' will be showed.

### 7.23.2 Pre-alarm

It could be useful to know if the load is changing towards a load alarm limit. It is possible to insert both a Max and Min pre-alarm limit based on the motor output shaft power. If the load exceeds one of these limits, a pre-alarm condition occurs.

It should be noted that it is not normal alarms. They will not be inserted in the alarm list, not activating the alarm relay output, not displayed on the display and they will not stop operation. But it is possible to activate relay K1 or K2 if a pre-alarm condition occurs. To have pre-alarm status on any of these relays, select value 3 in menu 051 or 052 (see § 7.17, page 51).

A start-up delay time can be selected in menu 091 to avoid undesired pre-alarms at start-up. Note that this time is also shared with power Max and Min alarms.

**NOTE! The pre-alarm status is always available on the serial communication.**

091<sup>o</sup>

**Start delay power limits**

10

Default:	10 sec
Range:	1-250 sec

From start command during selected delay time, all power load monitor alarms and pre-alarms are disabled.

092<sup>o</sup>

**Max power alarm limit**

115

Default:	115
Range:	5-200% Pn

Insert limit in % of nominal motor power. The actual power in % of nominal motor power, could be read out in menu 090. If output shaft power exceeds selected limit, an F6-alarm occurs after the response delay time. The 'Auto set' function in menu 089, affect this limit even if the alarm is set "oFF" in menu 093. This is a category 1 alarm.

093<sup>o</sup>

**Response delay max alarm**

oFF

Default:	oFF
Range:	oFF, 0.1-25.0 sec
<b>oFF</b>	Max Alarm is disabled.
<b>0.1-25.0</b>	Sets the response delay of the Max Alarm level.

094<sup>o</sup>

**Max power pre-alarm limit**

110

Default:	110
Range:	5 -200% Pn

Insert limit in % of nominal motor power. The actual power in % of nominal motor power, could be read out in menu 090. If output shaft power exceeds selected limit, a pre-alarm occurs after the response delay time. The 'Auto set' function in menu 089, affect selected limit even if the pre-alarm is set "oFF" in menu 095.

095<sup>o</sup>

**Max pre-alarm response delay**

oFF

Default:	oFF
Range:	oFF, 0.1 - 25.0 sec
<b>oFF</b>	Max Pre-Alarm is disabled.
<b>0.1-25.0</b>	Sets the response delay of the Max Pre-Alarm level.



096 <sup>o</sup>					
<b>Min power pre-alarm limit</b>					
<table border="1" style="margin: auto;"> <tr> <td style="width: 20px; height: 20px;"></td> <td style="width: 20px; height: 20px;"></td> <td style="width: 20px; height: 20px; text-align: center;">9</td> <td style="width: 20px; height: 20px; text-align: center;">0</td> </tr> </table>				9	0
		9	0		
Default:	90%				
Range:	5 -200% Pn				
<p>Insert limit in % of nominal motor power. The actual power in % of nominal motor power, could be read out in menu 090. If output shaft power goes below selected limit, a pre-alarm occurs after the response delay time. The 'Auto set' function in menu 089, affect selected limit even if the pre-alarm is set "oFF" in menu 097.</p>					

099 <sup>o</sup>					
<b>Min alarm response delay</b>					
<table border="1" style="margin: auto;"> <tr> <td style="width: 20px; height: 20px;"></td> <td style="width: 20px; height: 20px; text-align: center;">o</td> <td style="width: 20px; height: 20px; text-align: center;">F</td> <td style="width: 20px; height: 20px; text-align: center;">F</td> </tr> </table>			o	F	F
	o	F	F		
Default:	oFF				
Range:	oFF, 0.1-25.0 sec				
<b>oFF</b>	Min Alarm is disabled				
<b>0.1-25.0</b>	Sets the response delay of the Min Alarm level. The Min alarm is disabled during a stop ramp down.				

097 <sup>o</sup>					
<b>Min pre-alarm response delay</b>					
<table border="1" style="margin: auto;"> <tr> <td style="width: 20px; height: 20px;"></td> <td style="width: 20px; height: 20px; text-align: center;">o</td> <td style="width: 20px; height: 20px; text-align: center;">F</td> <td style="width: 20px; height: 20px; text-align: center;">F</td> </tr> </table>			o	F	F
	o	F	F		
Default:	oFF				
Range:	oFF, 0.1 - 25.0 sec				
<b>oFF</b>	Min Pre-Alarm is disabled.				
<b>0.1-25.0</b>	Sets the response delay of the Min Pre-Alarm level. The Min Pre-alarm is disabled during a stop ramp down.				

098 <sup>o</sup>					
<b>Min power alarm limit</b>					
<table border="1" style="margin: auto;"> <tr> <td style="width: 20px; height: 20px;"></td> <td style="width: 20px; height: 20px;"></td> <td style="width: 20px; height: 20px; text-align: center;">8</td> <td style="width: 20px; height: 20px; text-align: center;">5</td> </tr> </table>				8	5
		8	5		
Default:	85				
Range:	5-200% Pn				
<p>Insert limit in % of nominal motor power. The actual power in % of nominal motor power, could be read out in menu 090. If output shaft power goes below selected limit, an F7-alarm occurs after the response delay time. The 'Auto set' function in menu 089, affect this limit even if the alarm is set 'oFF' in menu 099. This is a category 1 alarm.</p>					



Fig. 58 Load monitor alarm functions.

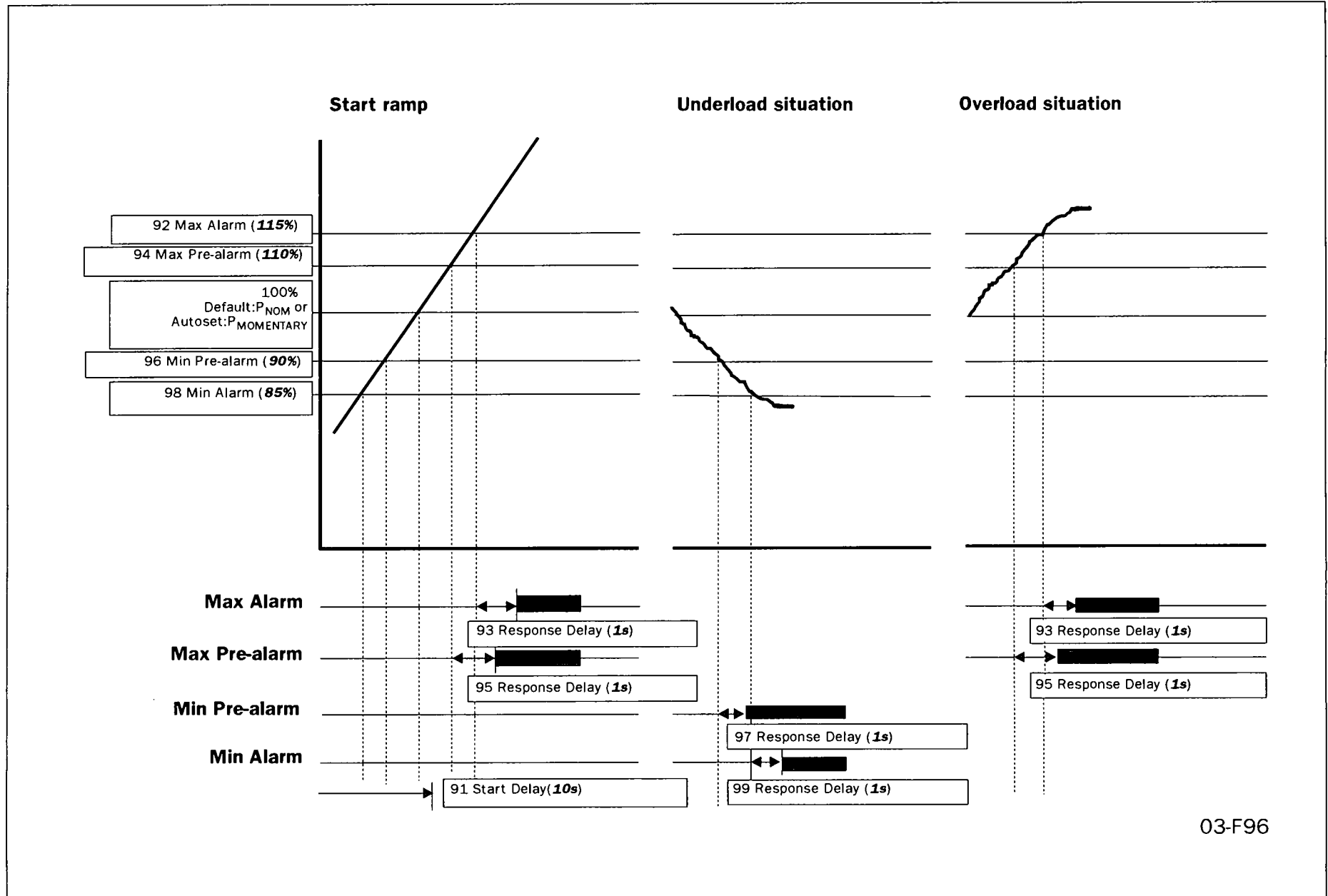

## 7.24 Resume alarms

### 7.24.1 Phase input failure F1

- Multiple phase failure.**  
 Shorter failure than 100ms is ignored. If failure duration time is between 100 ms and 2 s, operation is temporary stopped and a soft start is made if the failure disappears before 2 s. If failure duration time is longer than 2 s, an F1 alarm is given in cat. 2.
- Single phase failure.**  
 During start up (acceleration) the behaviour is like multiple phase failure below. When full voltage running there is a possibility to select the behaviour.

<div style="border: 1px solid black; padding: 2px; display: inline-block;">101<sup>o</sup></div>					
<div style="border: 1px solid black; padding: 2px; display: inline-block;"> <table border="1" style="border-collapse: collapse;"> <tr> <td style="width: 20px; height: 20px;"></td> <td style="width: 20px; height: 20px;"></td> <td style="width: 20px; height: 20px; text-align: center;">n</td> <td style="width: 20px; height: 20px; text-align: center;">o</td> </tr> </table> </div>				n	o
		n	o		
<b>Run at single phase loss</b>					
Default:	no				
Range:	no, YES				
<b>no</b>	Soft starter trips if a single phase loss is detected. Alarm F1 (category 2) will appear after 2 sec.				
<b>YES</b>	Soft starter continues to run after a single phase loss. <ul style="list-style-type: none"> <li>- Alarm F1 appears after 2 sec.</li> <li>- If the loose phase is reconnect the alarm is reset automatically.</li> <li>- If running on 2 phases, a stop command will give a Direct on line stop (freewheel)</li> </ul>				

### 7.24.2 Run at current limit time-out F4

In modes 'Current limit at start' and 'Voltage ramp with current limit at start' an alarm is activated if still operating at current limit level when selected ramp time exceeds. If an alarm occurs there is a possibility to select the behaviour.

<div style="border: 1px solid black; padding: 2px; display: inline-block;">102<sup>o</sup></div>					
<div style="border: 1px solid black; padding: 2px; display: inline-block;"> <table border="1" style="border-collapse: collapse;"> <tr> <td style="width: 20px; height: 20px;"></td> <td style="width: 20px; height: 20px;"></td> <td style="width: 20px; height: 20px; text-align: center;">n</td> <td style="width: 20px; height: 20px; text-align: center;">o</td> </tr> </table> </div>				n	o
		n	o		
<b>Run at current limit time-out</b>					
Default:	no				
Range:	no, YES				
<b>no</b>	Soft starter trips if the current limit time-out is exceeded. Alarm F4 (category 2) appears.				
<b>YES</b>	Soft starter continues to run after the current limit time-out has exceeded: <ul style="list-style-type: none"> <li>- Alarm F4 appears</li> <li>- The current is no longer controlled and the soft starters ramps up to full voltage with a 6s ramp time.</li> <li>- Reset the alarm with either ENTER/RESET key or by giving a stop command.</li> </ul>				

## 7.25 Slow speed with JOG

Slow speed with "JOG" is possible from the "JOG" keys, but also from terminals, see menu 57 page 53 and serial comm. The "JOG" is ignored if the soft starter is running. The slow speed "JOG" function has to be enabled for both forward and reverse directions in menus 103 and 104, see below.

**NOTE! The enable functions is for all control modes.**

<div style="border: 1px solid black; padding: 2px; display: inline-block;">103<sup>o</sup></div>					
<div style="border: 1px solid black; padding: 2px; display: inline-block;"> <table border="1" style="border-collapse: collapse;"> <tr> <td style="width: 20px; height: 20px;"></td> <td style="width: 20px; height: 20px; text-align: center;">o</td> <td style="width: 20px; height: 20px; text-align: center;">F</td> <td style="width: 20px; height: 20px; text-align: center;">F</td> </tr> </table> </div>			o	F	F
	o	F	F		
<b>JOG forward enable</b>					
Default:	oFF				
Range:	oFF, on				
<b>oFF</b>	JOG forward disabled				
<b>on</b>	JOG forward enabled				

<div style="border: 1px solid black; padding: 2px; display: inline-block;">104<sup>o</sup></div>					
<div style="border: 1px solid black; padding: 2px; display: inline-block;"> <table border="1" style="border-collapse: collapse;"> <tr> <td style="width: 20px; height: 20px;"></td> <td style="width: 20px; height: 20px; text-align: center;">o</td> <td style="width: 20px; height: 20px; text-align: center;">F</td> <td style="width: 20px; height: 20px; text-align: center;">F</td> </tr> </table> </div>			o	F	F
	o	F	F		
<b>JOG reverse enable</b>					
Default:	oFF				
Range:	oFF, on				
<b>oFF</b>	JOG reverse disabled				
<b>on</b>	JOG reverse enabled				

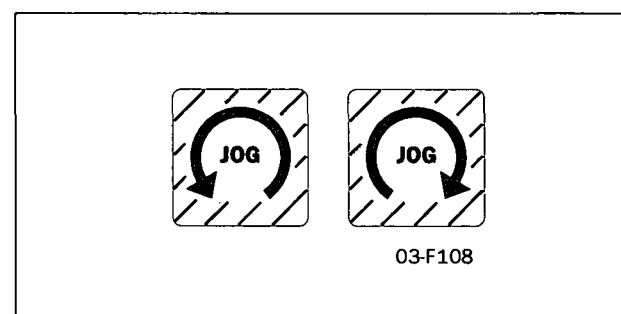

Fig. 59 The 2 Jog keys.

### 7.26 Automatic return menu

Often it is desirable to have a specific menu on the display during operation, i.e. RMS current or power consumption. The Automatic return menu function gives the possibility to select any menu in the menu system.

The menu selected will come up on the display after 60 sec. if no keyboard activity. The alarm messages (F1-F16) have a priority over menu 105 (as they have for all menus).

<div style="border: 1px solid black; padding: 2px; display: inline-block;">105<sup>o</sup></div>					
<b>Automatic return menu</b>					
<div style="border: 1px solid black; padding: 5px; display: inline-block;"> <table border="1" style="border-collapse: collapse;"> <tr> <td style="width: 20px; height: 20px;"></td> <td style="width: 20px; height: 20px; text-align: center;">0</td> <td style="width: 20px; height: 20px;"></td> <td style="width: 20px; height: 20px;"></td> </tr> </table> </div>			0		
	0				
Default:	oFF				
Range:	oFF, 1-999				
1-999	Pressing "+" / "-" will lead through the menu system.				

### 7.27 Communication option, related Parameters

The following parameters have to be set-up:

- Unit address.
- Baud rate.
- Parity
- Behaviour when contact broken.

Setting up the communication parameter must be made in local 'Keyboard control' mode. See § 7.2, page 37.

<div style="border: 1px solid black; padding: 2px; display: inline-block;">111<sup>o</sup></div>					
<b>Serial comm unit address</b>					
<div style="border: 1px solid black; padding: 5px; display: inline-block;"> <table border="1" style="border-collapse: collapse;"> <tr> <td style="width: 20px; height: 20px;"></td> <td style="width: 20px; height: 20px;"></td> <td style="width: 20px; height: 20px;"></td> <td style="width: 20px; height: 20px; text-align: center;">1</td> </tr> </table> </div>					1
			1		
Default:	1				
Range:	1-247				
This parameter will select the unit address.					

<div style="border: 1px solid black; padding: 2px; display: inline-block;">112<sup>o</sup></div>				
<b>Serial comm baudrate</b>				
<div style="border: 1px solid black; padding: 5px; display: inline-block;"> <table border="1" style="border-collapse: collapse;"> <tr> <td style="width: 20px; height: 20px;"></td> <td style="width: 20px; height: 20px;"></td> <td style="width: 20px; height: 20px; text-align: center;">9.6</td> </tr> </table> </div>				9.6
		9.6		
Default:	9.6			
Range:	2.4, 4.8, 9.6, 19.2, 38.4 kBaud			
This parameter will select the baudrate.				

<div style="border: 1px solid black; padding: 2px; display: inline-block;">113<sup>o</sup></div>					
<b>Serial comm parity</b>					
<div style="border: 1px solid black; padding: 5px; display: inline-block;"> <table border="1" style="border-collapse: collapse;"> <tr> <td style="width: 20px; height: 20px;"></td> <td style="width: 20px; height: 20px;"></td> <td style="width: 20px; height: 20px;"></td> <td style="width: 20px; height: 20px; text-align: center;">0</td> </tr> </table> </div>					0
			0		
Default:	0				
Range:	0.1				
This parameter will select the parity.					
0 No parity. 1 Even parity.					

#### Serial comm. broken alarm

If control mode is 'Serial comm. control' and no contact is established or contact is broken after 15 sec, the soft starter consider the contact to be broken after 15 sec, the soft starter can act in three different ways:

- 1 Continue without any action at all.
- 2 Stop and alarm after 15 sec.
- 3 Continue and alarm after 15 sec.

If an alarm occurs, it is automatically reset if the communication is re-established. It is also possible to reset the alarm from the soft starter keyboard.

<div style="border: 1px solid black; padding: 2px; display: inline-block;">114<sup>o</sup></div>					
<b>Serial comm. contact interrupted</b>					
<div style="border: 1px solid black; padding: 5px; display: inline-block;"> <table border="1" style="border-collapse: collapse;"> <tr> <td style="width: 20px; height: 20px;"></td> <td style="width: 20px; height: 20px;"></td> <td style="width: 20px; height: 20px;"></td> <td style="width: 20px; height: 20px; text-align: center;">1</td> </tr> </table> </div>					1
			1		
Default:	1				
Range:	oFF, 1, 2				
This parameter will control the behaviour in the soft starter when the serial comm. is interrupted.					
oFF No alarm and continue operation.					
1 Alarm and stop operation. 2 Alarm and continue operation.					

## 7.28 Reset to factory setting [199]

When selecting reset to factory settings:

- All parameters in all parameter sets will have default factory settings.
- Menu 001 will appear on the display.
- Note that the alarm list, the power consumption and the operation time will **not** have default settings.

199 <sup>o</sup>	
Reset to factory settings	
no	
Default:	no
Range:	no, YES
no	No reset
YES	Reset all functions to the factory defaults incl. all 4 Parameter Sets.

**NOTE!** Reset to factory settings is not allowed at run.

## 7.29 View operation

### General

The soft start includes as standard a numerous metering functions which eliminates the need of additional transducers and meters.

### Measured values

- Current RMS 3-phase current and per phase
- Voltage RMS 3-phase voltage and per phase
- Output shaft power /torque kW/Nm
- Power factor
- Power consumption in kWh
- Operation time in hours

### Viewing of the measured values

After setting motor data and extended functions one can set menu 008 in oFF and will then automatically move to menu 201, the first menu viewing the measured values and thus eliminate to scroll through menu 011 to menu 199.

201 <sup>o</sup>	
RMS current	
0.0	
Default:	-
Range:	0.0 - 9999Amp
Read-out of the RMS motor current.	

**NOTE!** This is the same read-out as menu 005 see § 7.1.1, page 36.

202 <sup>o</sup>	
RMS main voltage	
0.0	
Default:	-
Range:	0-720V
The RMS input main voltage.	

203 <sup>o</sup>	
Output motor shaftpower	
0.0	
Default:	-
Range:	-9999 +9999kW
Viewing will show negative value if generator mode.	

204 <sup>o</sup>	
Power factor	
0.0	
Default:	-
Range:	0.00-1
View the actual power factor.	

**NOTE!** The power factor viewing will not work at bypass even if the current transformers are mounted outside the soft start.

205 <sup>o</sup>	
Total power consumption	
0.0000	
Default:	-
Range:	0.000 -2000MWh
View the total power consumption.	

206<sup>o</sup>

**Reset of power consumption**

no

Default:	no
Range:	no, YES
<b>no</b>	No reset of power consumption.
<b>YES</b>	Reset power consumption in menu 205 to 0.000.

212<sup>o</sup>

**RMS current in phase L2**

0.0

Default:	-
Range:	0.0 - 9999Amp
View the current in phase L2.	

207<sup>o</sup>

**Motor shaft torque**

0.0

Default:	-
Range:	-9999 - + 9999Nm
Viewing will show negative value if generator mode.	

213<sup>o</sup>

**RMS current in phase L3**

0.0

Default:	-
Range:	0.0 - 9999Amp
View the current in phase L3.	

208<sup>o</sup>

**Operation time**

0.0

Default:	-
Range:	Hours
Operation time is calculated when the soft starter is in RUN mode. After 9999 hours the display will show two values.	
Example: 12467 hours shows    1        1 sec 2467     5sec	

214<sup>o</sup>

**Main voltage L1-L2**

0

Default:	-
Range:	0-720V
View main voltage L1-L2.	

211<sup>o</sup>

**RMS current in phase L1**

0.0

Default:	-
Range:	0.0 - 9999Amp
View the current in phase L1.	

215<sup>o</sup>

**Main voltage L1-L3**

0

Default:	-
Range:	0 - 720V
View main voltage L1-L3.	

216<sup>o</sup>

**Main voltage L2-L3**

0

Default:	-
Range:	0 - 720V
View main voltage L2-L3.	

### 7.30 Keyboard lock

The keyboard can be locked to prohibit operation and parameter setting by an unauthorised. Lock keyboard by pressing both keys "NEXT →" and "ENTER ↵" for at least 2 sec. The message '- Loc' will display when locked. To unlock keyboard press the same 2 keys "NEXT →" and "ENTER ↵" for at least 2 sec. The message 'unlo' will display when unlocked.

In locked mode it is possible to view all parameters and read-out, but it is forbidden to set parameters and to operate the soft starter from the keyboard.

The message '-Loc' will display if trying to set a parameter or operate the soft starter in locked mode.

The key lock status can be read out in menu 221.

221 <sup>o</sup>	
Locked keyboard info	
no	
Default:	no
Range:	no, YES
no	Keyboard is not locked
YES	Keyboard is locked

### 7.31 Alarm list

The alarm list is generated automatically. It shows the latest 15 alarms (F1 - F16). The alarm list can be useful when tracing a failure in the soft starter or its control circuit. Press key "NEXT →" or "PREV ←" to reach the alarm list in menus 901-915 (menu 007 has to be ON).

901 <sup>o</sup>	
Alarm	
F 1	
Default:	-
Range:	F1-F16
View actual alarm	

## 8. PROTECTION AND ALARM

The soft starter is equipped with a protection system for the motor, the machine and for the soft starter itself.

Three categories of alarm are available:

### Category 1

Alarm that stops the motor and need a separate reset before a new start can be accepted.

### Category 2

Alarm that stops the motor and accepts a new start command without any separate reset.

### Category 3

Alarm that continues to run the motor.

All alarm, except pre-alarm, will activate the alarm relay output K3, flash a red fault number on the display and it will also be placed in the alarm list. As long as the alarm is active, the display is locked in the alarm indication.

The relay output K3 can be used in the control circuit for actions needed when alarm occurs.

If more than one alarm is active, it is the last alarm that is presented on the display.

## 8.1 Alarm description

### 8.1.1 Alarm with stop and requiring a separate reset

Operation will stop for a category 1 alarm. A separate reset is needed before a new start command is accepted. It is possible to reset from keyboard (pushing "ENTER/RESET") regardless of selected control mode. It is also possible to reset the alarm from the actual control mode (i.e. if control mode is serial communication, a reset is possible to do from serial communication).

A reset is accepted first when the alarm source goes back to normal.

When a reset is made, the alarm relay output K3 is deactivated, the alarm indication on the display disappear and the original menu shows.

After a reset is made the system is ready for a new start command.

### 8.1.2 Alarm with stop and requiring only a new start command

Operation will stop for a category 2 alarm. A restart can be done and at the same time the alarm relay output K3 is deactivated, the alarm indication on the display disappear and the original menu shows.

It is still possible to reset the alarm in the same way as for category 1 alarms (see 8.1.1), if a start is not required at the time.

### 8.1.3 Alarm with continue run

Operation will continue run for a category 3 alarm. Some different reset behaviour is possible (see remarks for the specific alarms in § 8.2, page 67).

- Automatic reset when the alarm source goes back to normal.
- Automatic reset when a stop command is given.
- Manual reset during run.

When the reset occurs, the alarm relay output K3 is deactivated, the alarm indication on the display disappear and the original menu shows.



## 8.2 Alarm overview

Display indication	Protective function	Alarm category	Remark
F1	Phase input failure.	Cat 3. Run with auto reset.	Single phase failure when full voltage running if menu 101 'Run at phase loss' = YES. If the fault phase comes back, an automatic reset is made.
		Cat 2. Stop with reset in start.	Multiple phase failure or single phase failure when not full voltage running or if menu 101 'Run at phase loss' = no.
F2	Motor protection, overload.	Cat 1. Stop with manual reset.	If menu 071 'Motor PTC input' = YES, cool down the motor. If menu 071 'Motor PTC input' = no, the internal model has to 'cool' down.
F3	Soft start overheated	Cat 1. Stop with manual reset.	If not cooled down, a reset will not be accepted.
F4	Full speed not reached at set current limit and start time.	If menu 102 'Run at current limit time-out' = no. Cat 2. Stop with reset in start.	The current limit start is not completed.
		If menu 102 'Run at current limit time-out' = YES. Cat 3. Run with manual reset.	When start time expired, a 6 sec ramp is used to reach full voltage, without control of the current. Reset the alarm with either a manual reset or a stop command.
F5	Locked rotor.	Cat 1. Stop with manual reset.	Motor and/or machine protection.
F6	Above max power limit.	Cat 1. Stop with manual reset.	Machine protection.
F7	Below min power limit.	Cat 1. Stop with manual reset.	Machine protection.
F8	Voltage unbalance.	Cat 2. Stop with reset in start.	Motor protection.
F9	Over voltage.	Cat 2. Stop with reset in start.	Motor protection.
F10	Under voltage.	Cat 2. Stop with reset in start.	Motor protection.
F11	Starts / hour exceeded.	Cat 2. Stop with reset in start.	Motor and/or machine protection.
F12	Shorted thyristor.	Cat 3. Run with manual reset.	When stop command comes, the stop will be a 'Direct On Line' stop, and the soft starter will be resetted. After this fault it is possible to start only in 'Direct On Line' mode. One or more thyristors probably damaged.
F13	Open thyristor.	Cat 1. Stop with manual reset.	One or more thyristors probably damaged.
F14	Motor terminal open.	Cat 1. Stop with manual reset.	Motor not correctly connected.
F15	Serial communication broken.	If menu 114 Serial comm. contact broken = 1. Cat 2. Stop with reset in start.	Serial communication broken will stop operation. Run from keyboard if necessary.
		If menu 114 Serial comm. contact broken = 2. Cat 3. Run with auto reset.	Serial communication broken will not stop operation. Stop from keyboard if necessary.
F16	Phase reversal alarm.	Cat 1. Stop with manual reset.	Incorrect phase order on main voltage input.

## 9. TROUBLE SHOOTING

### 9.1 Fault, cause and solution

Observation	Fault indication	Cause	Solution
The display is not illuminated.	None	No control voltage.	Switch on the control voltage.
The motor does not run.	F1 (Phase input failure)	Fuse defective.	Renew the fuse.
		No mains supply.	Switch the main supply on.
	F2 (Motor protection, overload)	Perhaps PTC connection. Perhaps incorrect nominal motor current inserted (menu 042).	Check the PTC input if PTC protection is used. If internal protection is used, perhaps an other class could be used (menu 072). Cool down the motor and make a reset.
	F3 (Soft start overheated)	Ambient temperature too high. soft starter duty cycle exceeded. Perhaps fan failure.	Check ventilation of cabinet. Check the size of the cabinet. Clean the cooling fins. If the fan(s) is not working correct, contact your local MSF sales outlet.
	F4 (Full speed not reached at set current limit and start time)	Current limit parameters are perhaps not matched to the load and motor.	Increase the starting time and/or the current limit level.
	F5 (Locked rotor)	Something stuck in the machine or perhaps motor bearing failure.	Check the machine and motor bearings. Perhaps the alarm delay time can be set longer (menu 075).
	F6 (Above max power limit)	Overload	Over load. Check the machine. Perhaps the alarm delay time can be set longer (menu 093).
	F7 (Below min power limit)	Underload	Under load. Check the machine. Perhaps the alarm delay time can be set longer (menu 099).
	F8 (Voltage unbalance)	Main supply voltage unbalance.	Check mains supply.
	F9 (Over voltage)	Main supply over voltage.	Check mains supply.
	F10 (Under voltage)	Main supply under voltage.	Check mains supply.
	F11 (Starts / hour exceeded)	Number of starts exceeded according to menu 074.	Wait and make a new start. Perhaps the number of starts / hour could be increased in menu 074.
	F13 (Open thyristor)	Perhaps a damaged thyristor.	Make a reset and a restart. If the same alarm appears immediately, contact your local MSF sales outlet.
	F14 (Motor terminal open)	Open motor contact, cable or motor winding.	If the fault is not found, reset the alarm and inspect the alarm list. If alarm F12 is found, a thyristor is probably shorted. Make a restart. If alarm F14 appears immediately, contact your local MSF sales outlet.

Observation	Fault indication	Cause	Solution
The motor does not run.	F15 (Serial communication broken)	Serial communication broken.	Make a reset and try to establish contact. Check contacts, cables and option board. Verify - System address (menu 111). - Baudrate (menu 112). - Parity (menu 113). If the fault is not found, run the motor with keyboard control if urgent (set menu 006 to "1"). See also manual for serial communication.
	F16 (Phase reversal)	Incorrect phase sequence on main supply.	Switch L2 and L3 input phases.
	----	Start command comes perhaps from incorrect control source. (I.e. start from keyboard when remote control is selected).	Give start command from correct source (menu 006).
	-Loc	System in keyboard lock.	Unlock keyboard by pressing the keys 'NEXT' and 'ENTER' for at least 3 sec.
The motor is running but an alarm is given.	F1 (Phase input failure)	Failure in one phase. Perhaps fuse defective.	Check fuses and mains supply. Deselect 'Run at single phase input failure' in menu 101, if stop is desired at single phase loss.
	F4 (Full speed not reached at set current limit and start time)	Current limit parameters are perhaps not matched to the load and motor.	Increase the starting time and/or the current limit level. Deselect 'Run at current limit time-out' in menu 102, if stop is desired at current limit time-out.
	F12 (Shorted thyristor)	Perhaps a damaged thyristor.	When stop command is given, a free wheel stop is made. Make a reset and a restart. If alarm F14 appears immediately, contact your local MSF sales outlet. If it is urgent to start the motor, set soft starter in 'Direct On Line' (menu 024). It is possible to start in this mode.
		By pass contactor is used but menu 032 'Bypass' is not set to "on".	Set menu 032 'Bypass' to "on".
F15 (Serial communication broken)	Serial communication broken.	Make a reset and try to establish contact. Check contacts, cables and option board. Verify - System address (menu 111). - Baudrate (menu 112). - Parity (menu 113). If the fault is not found, run the motor with keyboard control if urgent, see also manual for serial communication.	

Observation	Fault indication	Cause	Solution
The motor jerks etc.	When starting, motor reaches full speed but it jerks or vibrates.	If 'Torque control' or 'Pump control' is selected, it is necessary to input motor data into the system.	Input nominal motor data in menus 041-046. Select the proper load characteristic in menu 025. Select a correct initial- and end torque at start in menus 016 and 017. If 'Bypass' is selected, check that the current transformers are correct connected.
		Starting time too short.	Increase starting time.
		Starting voltage incorrectly set.	Adjust starting voltage.
		Motor too small in relation to rated current of soft starter.	Use a smaller model of the soft starter.
		Motor too large in relation to load of soft starter.	Use larger model of soft starter.
	Starting or stopping time too long, soft does not work.	Starting voltage not set correctly	Readjust the start ramp. Select the current limit function.
		Ramp times not set correctly.	Readjust the start and/or stop ramp time.
The monitor function does not work.	No alarm or pre-alarm	It is necessary to input nominal motor data for this function. Incorrect alarm levels.	Input nominal motor data in menus 041-046. Adjust alarm levels in menus 091 - 099. If 'Bypass' is selected, check that the current transformers are correct connected.
Unexplainable alarm.	F5, F6, F7, F8, F9, F10	Alarm delay time is to short.	Adjust the response delay times for the alarms in menus 075, 082, 084, 086, 093 and 099.
The system seems locked in an alarm.	F2 (Motor protection, overload)	PTC input terminal could be open. Motor could still be too warm. If internal motor protection is used, the cooling in the internal model take some time.	PTC input terminal should be short circuit if not used. Wait until motor PTC gives an OK (not overheated) signal. Wait until the internal cooling is done. Try to reset the alarm after a while.
	F3 (Soft start overheated)	Ambient temperature too high. Perhaps fan failure.	Check that cables from power part are connected in terminals 073, 074, 071 and 072. MSF-017 to MSF-145 should have a short circuit between 071 and 072. Check also that the fan(s) is rotating.
Parameter will not be accepted.	----	If the menu number is one of 020 - 025, only one can be selected. In other words only one main mode is possible at a time.	Deselect the other main mode before selecting the new one.
		If menu 061, 'Parameter set' is set to "0", the system is in a remote parameter selection mode. It is now impossible to change most of the parameters.	Set the menu 061, 'Parameter set' to a value between "1" - "4" and then it is possible to change any parameter.
		During acceleration, deceleration, slow speed, DC brake and Power factor control mode, it is impossible to change parameters.	Set parameters during stop or full voltage running.
		If control source is serial comm., it is impossible to change parameters from keyboard and vice versa.	Change parameters from the actual control source.
		Some menus include only read out values and not parameters.	Read-out values can not be altered. In table 13, page 35, read-out menus has '----' in the factory setting column.
	-Loc	Keyboard is locked.	Unlock keyboard by pressing the keys 'NEXT' and 'ENTER' for at least 3 sec.

## 10. MAINTENANCE

In general the soft starter is maintenance free. There are however some things which should be checked regularly. Especially if the surroundings are dusty the unit should be cleaned regularly.



**WARNING! Do not touch parts inside the enclosure of the unit when the control and motor voltage is switched on.**

### Regular maintenance

- Check that nothing in the soft starter has been damaged by vibration (loose screws or connections).
- Check external wiring, connections and control signals. Tighten terminal screws and busbar bolts if necessary.
- Check that PCB boards, thyristors and cooling fin are free from dust. Clean with compressed air if necessary. Make sure the PCB boards and thyristors are undamaged.
- Check for signs of overheating (changes in colour on PCB boards, oxidation of solder points etc.). Check that the temperature is within permissible limits.
- Check that the cooling fan/s permit free air flow. Clean any external air filters if necessary.

In the event of fault or if a fault cannot be cured by using the fault-tracing table in chapter 9. page 68.

## 11. OPTIONS

The following option are available. Please contact your supplier for more detailed information.

### 11.1 Serial communication

For serial communication the MODBUS RTU (RS232/RS485) option card is available order number: 01-1733-00.

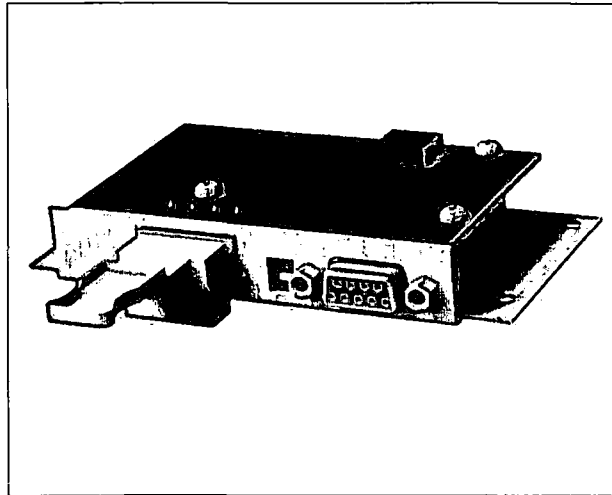

Fig. 60 Option RS232/485

### 11.2 Field bus systems

Various option cards are available for the following bus systems:

- PROFIBUS DP order number: 01-1734-01
- Device NET, order number: 01-1736-01
- LONWORKS: 01-1737-01
- FIP IO: 01-1738-01
- INTERBUS-S: 01-1735-01

Each system has his own card. The option is delivered with an instruction manual containing the all details for the set-up of the card and the protocol for programming.

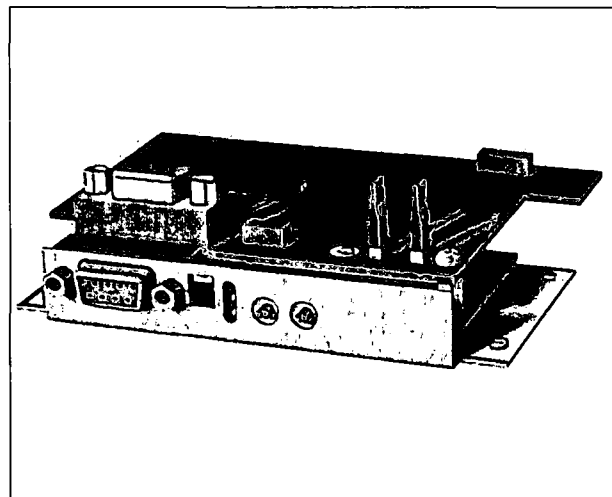

Fig. 61 Option Profibus

### 11.3 External PPU.

The external PPU option is used to move the PPU (keyboard) from the soft starter to the front of a panel door or control cabinet.

The maximum distance between the soft starter and the external PPU is 3 m.

The option can be factory mounted (01-2138-01) or it can be built in later (01-2138-00). For both versions instruction /data sheet are available.

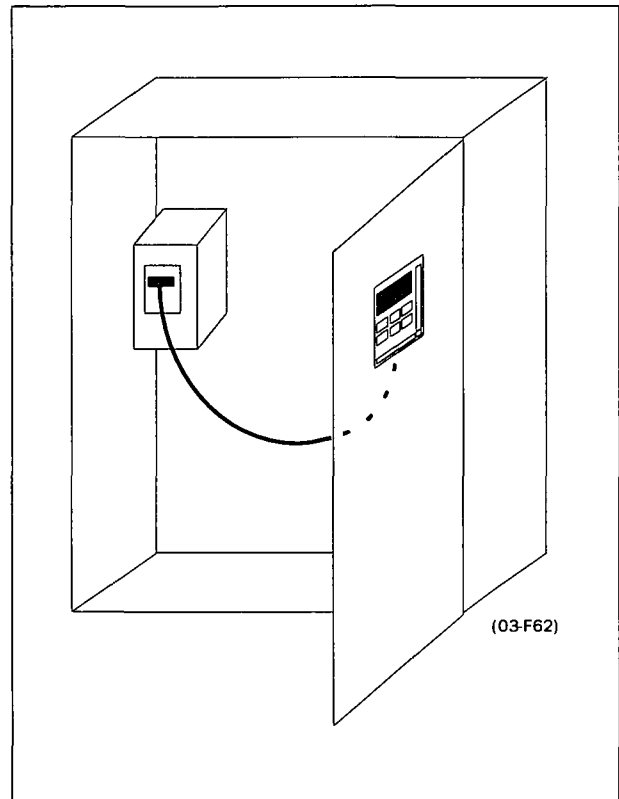

Fig. 62 Shows an example of the External PPU after it has been built in.

#### 11.3.1 Cable kit for external current transformers

This kit is used for the bypass function, to connect the external current transformers more easy. order number: 01-2020-00.

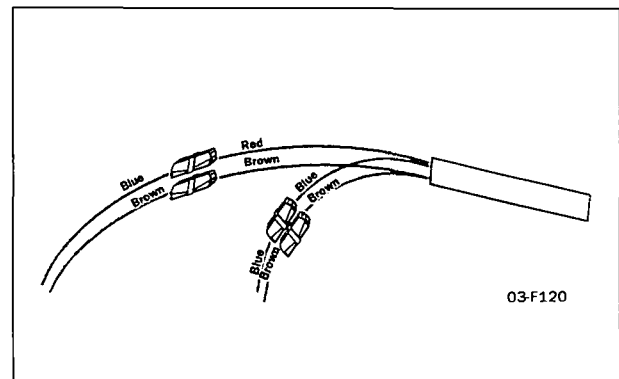

Fig. 63 Cable kit

### 11.4 Terminal clamp

Data: Single cables, Cu or Al	
Cables	95-300 mm <sup>2</sup>
MSF type Cu Cable	310
Bolt for connection to busbar	M10
Dimensions in mm	33x84x47 mm
Order No. single	9350
Data: Parallel cables, Cu or Al	
Cables	2x95-300 mm <sup>2</sup>
MSF type and Cu Cable	310 to -835
Bolt for connection to busbar	M10
Dimensions in mm	35x87x65 mm
Order No. parallel	9351

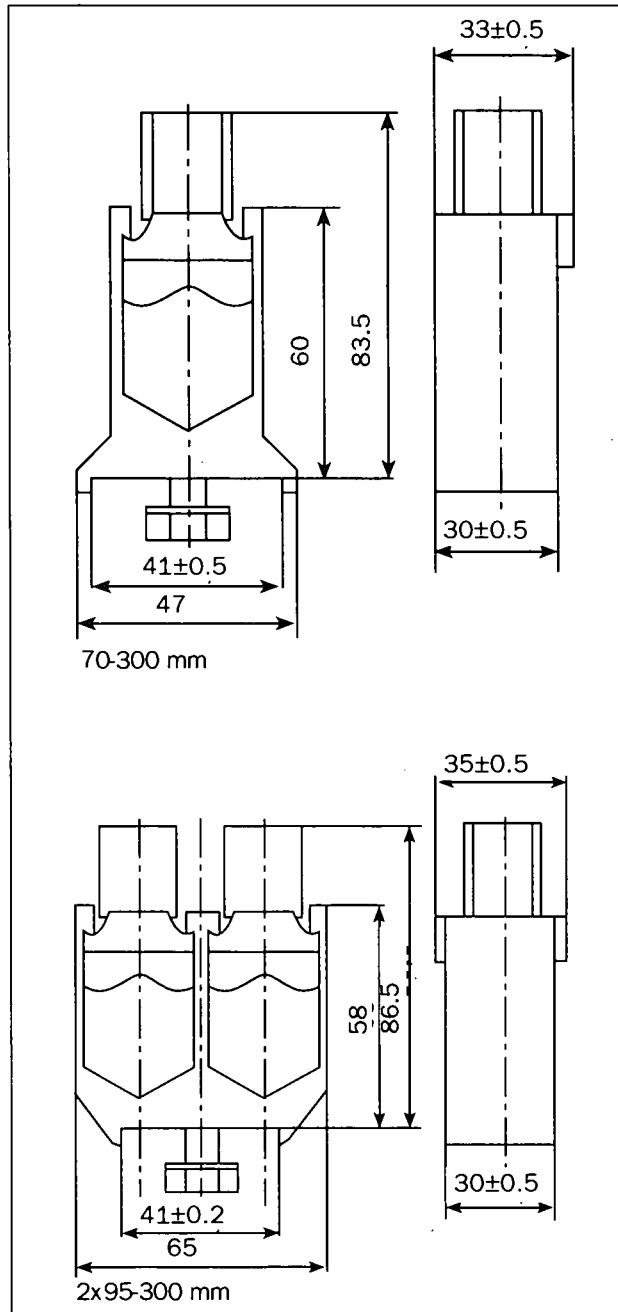

Fig. 64 The terminal clamp.

## 12. TECHNICAL DATA

3x200–525 V 50/60 Hz Model	MSF-017		MSF-030		MSF-045		MSF-060	
	5.0-30:50-10 heavy	3.0-30:50-10 normal/light	5.0-30:50-10 heavy	3.0-30:50-10 normal/light	5.0-30:50-10 heavy	3.0-30:50-10 normal/light	5.0-30:50-10 heavy	3.0-30:50-10 normal/light
Soft starter rating according to AC35a, see chapter 4. page 13								
Rated current of soft starter (A)	17	22	30	37	45	60	60	72
Recommended motor size (kW) for 400 V	7.5	11	15	18.5	22	30	30	37
Recommended motor size (kW) for 525 V	11	15	18.5	22	30	37	37	45
Order number: supply voltage (100-240V)	01-1301-01		01-1302-01		01-1303-01		01-1304-01	
Order number: supply voltage (380-500V)	01-1301-02		01-1302-02		01-1303-02		01-1304-02	
<b>3x200-690V 50/60Hz Model</b>	<b>MSF-017</b>		<b>MSF-030</b>		<b>MSF-045</b>		<b>MSF-060</b>	
Rated current of soft starter (A)	17	22	30	37	45	60	60	72
Motor power for 690V	15	18.5	22	30	37	55	55	75*
Order number: supply voltage (100-240V)	01-1321-01		01-1322-01		01-1323-01		01-1324-01	
Order number: supply voltage (380-500V)	01-1321-02		01-1322-02		01-1323-02		01-1324-02	
<b>Electrical Data</b>								
Recommended wiring fuse (A) 1)	25/50	32	35/80	50	50/125	80	63/160	100
Semi-conductor fuses, if required	80 A		125 A		160 A		200 A	
Power loss at rated motor load (W)	50	70	90	120	140	180	180	215
Power consumption control card	20 VA		20 VA		25 VA		25 VA	
<b>Mechanical Data</b>								
Dimensions in mm HxWxD	320x126x260		320x126x260		320x126x260		320x126x260	
Mounting position (Vertical/Horizontal)	Vertical		Vertical		Vert. or Horiz.		Vert. or Horiz.	
Weight (kg)	6.7		6.7		6.9		6.9	
Connection busbars Cu, (bolt)	15x4 (M6)		15x4 (M6)		15x4 (M6)		15x4 (M8)	
Cooling system	Convection		Convection		Fan		Fan	
<b>General Electrical Data</b>								
Number of fully controlled phases	3							
Voltage tolerance control	Control +/- 10%							
Voltage tolerance motor	Motor 200-525 +/- 10%/200-690 + 5%, -10%							
Recommended fuse for control card (A)	Max 10 A							
Frequency	50/60 Hz							
Frequency tolerance	+/- 10%							
Relay contacts	3 x 8A, 250 V resistive load, 3A 250VAC inductive (PF=0.4)							
<b>Type of protection/Insulation</b>								
Type of casing protection	IP 20							
<b>Other General Data</b>								
Ambient temperatures								
In operation	0 - 40 °C							
Max. e.g. at 80% IN	50 °C							
In storage	(-25) - (+70) °C							
Relative air humidity	95%, non-condensing							
Max. altitude without derating	(See separate: Technical information 151) 1000 m							
Norms/Standards, Conform to:	IEC 947-4-2, EN 292, EN 60204-1, UL508							
EMC, Emission	EN 50081-2, (EN 50081-1 with bypass contactor)							
EMC, Immunity	EN 50082-2							
1) Recommended wiring fuses for:	Heavy (first column): ramp/direct start Normal/Light (second column): ramp start							
<b>NOTE! Short circuit withstand MSF017-060 5000 rms A when used with K5 or RK5 fuses.</b>								

\* 2-pole motor





3x200-525 V 50/60 Hz Model	MSF-075		MSF-085		MSF-110		MSF-145	
Soft starter rating according to AC35a, see chapter 4, page 13	5.0-30:50-10 heavy	3.0-30:50-10 normal/light	5.0-30:50-10 heavy	3.0-30:50-10 normal/light	5.0-30:50-10 heavy	3.0-30:50-10 normal/light	5.0-30:50-10 heavy	3.0-30:50-10 normal/light
Rated current of soft starter (A)	75	85	85	96	110	134	145	156
Recommended motor size (kW) for 400 V	37	45	45	55*	55	75	75	
Recommended motor size (kW) for 525 V	45	55	55	75*	75	90	90	110
Order number for supply voltage (100-240 V)	01-1305-01		01-1306-01		01-1307-01		01-1308-01	
Order number for supply voltage (380-550 V)	01-1305-02		01-1306-02		01-1307-02		01-1308-02	
3x200-690 V 50/60 Hz Model	MSF-075		MSF-085		MSF-110		MSF-145	
Rated current of soft starter (A)	75	85	85	90	110	134	145	156
Motor power for 690V	55	75	75	90	90	110	132	160*
Order number for supply voltage (100-240 V)	01-1325-01		01-1326-01		01-1327-01		01-1328-01	
Order number for supply voltage (380-550 V)	01-1325-02		01-1326-02		01-1327-02		01-1328-02	
<b>Electrical Data</b>								
Recommended wiring fuse (A) 1)	80/200	100	100/250	125	125/315	180	160/400	200
Semi-conductor fuses, if required	250 A		315 A		350 A		450 A	
Power loss at rated motor load (W)	230	260	260	290	330	400	440	470
Power consumption control card	25 VA		25 VA		25 VA		25 VA	
<b>Mechanical Data</b>								
Dimensions in mm HxWxD	320x126x260		320x126x260		400x176x260		400x176x260	
Mounting position (Vertical/Horizontal)	Vert. or Horiz.		Vert. or Horiz.		Vert. or Horiz.		Vert. or Horiz.	
Weight (kg)	6.9		6.9		12		12	
Connection, busbars Cu, (bolt)	15x4 (M8)		15x4 (M8)		20x4 (M10)		20x4 (M10)	
Cooling system	Fan		Fan		Fan		Fan	
<b>General Electrical Data</b>								
Number of fully controlled phases	3							
Voltage tolerance control	Control +/- 10%							
Voltage tolerance motor	Motor 200-525 +/- 10%/200-690 + 5%, -10%							
Recommended fuse for control card (A)	Max 10 A							
Frequency	50/60 Hz							
Frequency tolerance	+/- 10%							
Relay contacts	8A, 250 V resistive load, 3A, 250 V inductive load (PF=0.4)							
<b>Type of protection/Insulation</b>								
Type of casing protection	IP 20							
<b>Other General Data</b>								
Ambient temperatures In operation	0 - 40 °C							
Max. e.g. at 80% I <sub>N</sub>	50 °C							
In storage	(-25) - (+70) °C							
Relative air humidity	95%, non-condensing							
Max. altitude without derating	(See separate: Technical information 151) 1000 m							
Norms/Standards, Conform to:	IEC 947-4-2, EN 292, EN 60204-1, UL508							
EMC, Emission	EN 50081-2, (EN 50081-1 with bypass contactor)							
EMC, Immunity	EN 50082-2							
1) Recommended wiring fuses for:	Heavy (first column): ramp/direct start Normal/Light (second column): ramp start							
<b>NOTE! Short circuit withstand MSF075-145 10000 rms A when used with K5 or RK5 fuses.</b>								

\* 2-pole motor

3x200–525 V 50/60 Hz Model	MSF-170		MSF-210		MSF-250		MSF-310		MSF-370	
Soft starter rating according to AC35a, see chapter 4, page 13	5.0-30: 50-10 heavy	3.0-30: 50-10 normal/light	5.0-30: 50-10 heavy	3.0-30: 50-10 normal/light	5.0-30: 50-10 heavy	3.0-30: 50-10 normal/light	5.0-30: 50-10 heavy	3.0-30: 50-10 normal/light	5.0-30: 50-10 heavy	3.0-30: 50-10 normal/light
Rated current of soft starter (A)	170	210	210	250	250	262	310	370	370	450
Recommended motor size (kW) for 400 V	90	110	110	132	132	160*	160	200	200	250
Recommended motor size (kW) for 525 V	110	132	132	160	160	200*	200	250	250	315
Order no. for supply voltage (100-240V)	01-1309-11		01-1310-11		01-1311-11		01-1312-01		01-1313-01	
Order no. for supply voltage (380-550V)	01-1309-12		01-1310-12		01-1311-12		01-1312-02		01-1313-02	
3x200–690 V 50/60 Hz Model	MSF-170		MSF-210		MSF-250		MSF-310		MSF-370	
Rated current of soft starter (A)	170	210	210	250	250	262	310	370	370	450
Motor power for 690 V	160	200	200	250	250	250	315	355	355	400
Order no. for supply voltage (100-240V)	01-1329-01		01-1330-01		01-1331-01		01-1332-01		01-1333-01	
Order no. for supply voltage (380-550V)	01-1329-02		01-1330-02		01-1331-02		01-1332-02		01-1333-02	
<b>Electrical Data</b>										
Recommended wiring fuse (A) 1)	200/400	200	250/400	315	250/500	315	315/630	400	400/800	500
Semi-conductor fuses, if required	700 A		700 A		700 A		800 A		1000 A	
Power loss at rated motor load (W)	510	630	630	750	750 W		930	1100	1100	1535
Power consumption control card	35 VA		35 VA		35 VA		35 VA		35 VA	
<b>Mechanical Data</b>										
Dimensions mm HxWxD incl. brackets	500x260x260		500x260x260		500x260x260		532x547x278		532x547x278	
Mounting position (Vertical/Horizontal)	Vert. or Horiz.		Vert. or Horiz.		Vert. or Horiz.		Vert. or Horiz.		Vert. or Horiz.	
Weight (kg)	20		20		20		42		46	
Connection, Busbars Al/Cu (bolt)	30x4 (M10)		30x4 (M10)		30x4 (M10)		40x8 (M12)		40x8 (M12)	
Cooling system	Fan		Fan		Fan		Fan		Fan	
<b>General Electrical Data</b>										
Number of fully controlled phases	3									
Voltage tolerance control	Control +/- 10%									
Voltage tolerance motor	Motor 200-525 +/- 10%/200-690 + 5%, -10%									
Recommended fuse for control card (A)	Max 10 A									
Frequency	50/60 Hz									
Frequency tolerance	+/- 10%									
Relay contacts	8A, 250 V resistive load, 3A, 250 V inductive load (PF=0.4)									
<b>Type of protection/Insulation</b>										
Type of casing protection	IP 20									
<b>Other General Data</b>										
Ambient temperatures In operation	0 - 40 °C									
Max. e.g. at 80% I <sub>N</sub>	50 °C									
In storage	(-25) - (+70) °C									
Relative air humidity	95%, non-condensing									
Max. altitude without derating	(See separate: Technical information 151) 1000 m									
Norms/Standards, Conform to:	IEC 947-4-2, EN 292, EN 60204-1, (UL508, only MSF-170 to MSF-250)									
EMC, Emission	EN 50081-2, (EN 50081-1 with bypass contactor)									
EMC, Immunity	EN 50082-2									
1) Recommended wiring fuses for:	Heavy (first column): ramp/direct start Normal/Light (second column): ramp start									
<b>NOTE! Short circuit withstand MSF170-250 18000 rms A when used with K5 or RK5 fuses.</b>										

\* 2-pole motor



3x200-525V 50/60Hz Model	MSF-450		MSF-570		MSF-710		MSF-835		MSF-1000		MSF-1400	
	5.0-30: 50-10 heavy	3.0-30: 50-10 normal/ light	5.0-30: 50-10 heavy	3.0-30: 50-10 normal/ light	5.0-30: 50-10 heavy	3.0-30: 50-10 normal/ light	5.0-30: 50-10 heavy	3.0-30: 50-10 normal/ light	5.0-30: 50-10 heavy	3.0-30: 50-10 normal/ light	5.0-30: 50-10 heavy	3.0-30: 50-10 normal/ light
Soft starter rating according to AC35a, see chapter 4. page 13												
Rated current of soft starter (A)	450	549	570	710	710	835	835	960	1000	1125	1400	1650
Recommended motor size (kW) for 400 V	250	315	315	400	400	450	450	560	560	630	800	930
Recommended motor size (kW) for 525 V	315	400	400	500	500	560	600	630	660	710	1000	250
Order no. for supply voltage (100-240V)	01-1341-01		01-1315-01		01-1316-01		01-1317-01		01-1318-01		01-1319-01	
Order no. for supply voltage (380-550V)	01-1314-02		01-1315-02		01-1316-02		01-1317-02		01-1318-02		01-1319-02	
3x200-690V 50/60Hz Model	MSF-450		MSF-570		MSF-710		MSF-835		MSF-1000		MSF-1400	
Rated current of soft starter (A)	450	549	570	640	710	835	835	880	1000	1125	1400	1524
Motor power for 690 V	400	560	560	630	710	800	800		1000	1120	1400	1600
Order no. for supply voltage (100-240V)	01-1334-01		01-1335-01		01-1336-01		01-1337-01		01-1338-01		01-1339-01	
Order no. for supply voltage (380-550V)	01-1334-02		01-1335-02		01-1336-02		01-1337-02		01-1338-02		01-1339-02	
<b>Electrical Data</b>												
Recommended wiring fuse (A 1)	500/1 k	630	630/1 k	800	800/1 k	1 k	1 k/1.2 k	1 k	1k/1.4 k	1.2 k	1.4 k/1.8 k	1.8 k
Semi-conductor fuses, if required	1250 A		1250 A		1800 A		2500 A		3200 A		4000 A	
Power loss at rated motor load (W)	1400	1730	1700	2100	2100	2500	2500	2875	3000	3375	4200	4950
Power consumption control card	35 VA		35 VA		35 VA		35 VA		35 VA		35 VA	
<b>Mechanical Data</b>												
Dimensions mm HxWxD incl. brackets	532x547x278		687x640x302		687x640x302		687x640x302		900x875x336		900x875x336	
Mounting position (Vertical/Horizontal)	Vert. or Horiz.		Vert. or Horiz.		Vert. or Horiz.		Vert. or Horiz.		Vert. or Horiz.		Vert. or Horiz.	
Weight (kg)	46		64		78		80		175		175	
Connection, Busbars Al (bolt)	40x8 (M12)		40x10 (M12)		40x10 (M12)		40x10 (M12)		75x10 (M12)		75x10 (M12)	
Cooling system	Fan		Fan		Fan		Fan		Fan		Fan	
<b>General Electrical Data</b>												
Number of fully controlled phases	3											
Voltage tolerance control	Control +/- 10%											
Voltage tolerance motor	Motor 200-525 +/- 10%/200-690 + 5%, -10%											
Recommended fuse for control card (A)	Max 10 A											
Frequency	50/60 Hz											
Frequency tolerance	+/- 10%											
Relay contacts	8A, 250 V resistive load, 3A, 250 V inductive load (PF=0.4)											
<b>Type of protection/Insulation</b>												
Type of casing protection	IP 20										IP00	
<b>Other General Data</b>												
Ambient temperatures in operation	0 - 40 °C											
Max. e.g. at 80% I <sub>N</sub>	50 °C											
In storage	(-25) - (+70) °C											
Relative air humidity	95%, non-condensing											
Max. altitude without derating	(See separate: Technical information 151) 1000 m											
Norms/Standards, Conform to:	IEC 947-4-2, EN 292, EN 60204-1											
EMC, Emission	EN 50081-2, (EN 50081-1 with bypass contactor)											
EMC, Immunity	EN 50082-2											
1) Recommended wiring fuses for:	<b>Heavy</b> (first column): ramp/direct start <b>Normal/Light</b> (second column): ramp start											

## Semi-conductor fuses

Always use standard commercial fuses to protect the wiring and prevent short circuiting. To protect the thyristors against short-circuit currents, superfast semiconductor fuses can be used if preferred (e.g. Bussmann type FWP or similar, see table below).

The normal guarantee is valid even if superfast semiconductor fuses are not used.

Type	FWP Bussmann fuse	
	A	$I^2t$ (fuse) x 1000
MSF-017	80	2.4
MSF-030	125	7.3
MSF-045	150	11.7
MSF-060	200	22
MSF-075	250	42.5
MSF-085	300	71.2
MSF-110	350	95.6
MSF-145	450	137
MSF-170B	700	300
MSF-210B	700	300
MSF-250B	800	450
MSF-310	800	450
MSF-370	1000	600
MSF-450	1200	2100
MSF-570	1400	2700
MSF-710	1800	5300
MSF-835	2000	
MSF-1000	2500	
MSF-1400	3500	

## 13. SET-UP MENU LIST

Menu number	Function/Parameter	Range	Par.set	Factory setting	Value	Page
001	Initial voltage at start	25 - 90% of U	1 - 4	30		page 36
002	Start time ramp 1	1 - 60 sec	1 - 4	10		page 36
003	Step down voltage at stop	100 - 40% U	1 - 4	100		page 36
004	Stop time ramp 1	oFF, 2 - 120 sec	1 - 4	oFF		page 36
005	Current	0.0 - 9999 Amp	—	—		page 36
006	Control mode	1, 2, 3	1 - 4	2		page 37
007	Extended functions & metering	oFF, on	—	oFF		page 38
008	Extended functions	oFF, on	—	oFF		page 38
011	Initial voltage start ramp 2	30 - 90% U	1 - 4	90		page 38
012	Start time ramp 2	oFF, 1 - 60 sec	1 - 4	oFF		page 38
013	Step down voltage stop ramp 2	100 - 40% U	1 - 4	40		page 38
014	Stop time ramp 2	oFF, 2 - 120 sec	1 - 4	oFF		page 38
016	Initial torque at start	0 - 250% T <sub>n</sub>	1 - 4	10		page 39
017	End torque at start	50 - 250% T <sub>n</sub>	1 - 4	150		page 39
018	End torque at stop	0-100% T <sub>n</sub>	1 - 4	0		page 39
020	Voltage ramp with current limit at start	oFF, 150 - 500% I <sub>n</sub>	1 - 4	oFF		page 39
021	Current limit at start	oFF, 150 - 500% I <sub>n</sub>	1 - 4	oFF		page 40
022	Pump control	oFF, on	1 - 4	oFF		page 40
023	Remote analogue control	oFF, 1, 2	1 - 4	oFF		page 41
024	Full voltage start D.O.L	oFF, on	1 - 4	oFF		page 41
025	Torque control	oFF, 1, 2	1 - 4	oFF		page 42
030	Torque boost active time	oFF, 0.1 - 2.0 sec	1 - 4	oFF		page 43
031	Torque boost current limit	300 - 700% I <sub>n</sub>	1 - 4	300		page 43
032	Bypass	oFF, on	1 - 4	oFF		page 43
033	Power Factor Control PFC	oFF, on	1 - 4	oFF		page 46
034	Brake active time	oFF, 1 - 120 sec	1 - 4	oFF		page 47
035	Braking strength	100 - 500%	1 - 4	100		page 47
036	Braking methods	1, 2	1 - 4	1		page 47
037	Slow speed torque	10 - 100	1 - 4	10		page 49
038	Slow speed time at start	oFF, 1 - 60 sec	1 - 4	oFF		page 49
039	Slow speed time at stop	oFF, 1 - 60 sec	1 - 4	oFF		page 49
040	DC-Brake at slow speed	oFF, 1-60 sec	1 - 4	oFF		page 49
041	Nominal motor voltage	200 - 700 V	1 - 4	400		page 50
042	Nominal motor current	25-150% I <sub>nsoft</sub> in Amp	1 - 4	I <sub>nsoft</sub> in Amp		page 50
043	Nominal motor power	25 - 300% of P <sub>nsoft</sub> in kW	1 - 4	P <sub>nsoft</sub> in kW		page 50
044	Nominal speed	500 - 3600 rpm	1 - 4	N <sub>nsoft</sub> in rpm		page 50
045	Nominal power factor	0.50 - 1.00	1 - 4	0.86		page 50
046	Nominal frequency	50, 60 Hz	—	50		page 50

Menu number	Function/Parameter	Range	Par.set	Factory setting	Value	Page
051	Programmable relay K1	1, 2, 3, (4), 5		1		page 51
052	Programmable relay K2	1, 2, 3, 4, 5	—	2		page 51
054	Analogue output	oFF, 1, 2	1 - 4	oFF		page 52
055	Analogue output value	1, 2, 3	1 - 4	1		page 52
056	Scaling analogue output	5 - 150%	1 - 4	100		page 52
057	Digital input selection	oFF, 1, 2, 3, 4	1 - 4	oFF		page 53
058	Digital input pulses	1-100	1 - 4	1		page 53
061	Parameter set	0, 1, 2, 3, 4	—	1		page 54
071	Motor PTC input	no, YES	—	no		page 55
072	Internal motor thermal protection class	oFF, 2 - 40 sec	—	10		page 55
073	Used thermal capacity	0 - 150%	—	—		page 55
074	Starts per hour limitation	oFF, 1 - 99/hour	1 - 4	oFF		page 55
075	Locked rotor alarm	oFF, 1.0 - 10.0 sec	1 - 4	oFF		page 55
081	Voltage unbalance alarm	2 - 25% $U_n$	1 - 4	10		page 56
082	Response delay voltage unbalance alarm	oFF, 1 - 60 sec	1 - 4	oFF		page 56
083	Over voltage alarm	100 - 150% $U_n$	1 - 4	115		page 56
084	Response delay over voltage alarm	oFF, 1 - 60 sec	1 - 4	oFF		page 56
085	Under voltage alarm	75 - 100% $U_n$	1 - 4	85		page 57
086	Response delay under voltage alarm	oFF, 1 - 60 sec	1 - 4	oFF		page 57
087	Phase sequence	L123, L321	—	—		page 57
088	Phase reversal alarm	oFF, on	—	oFF		page 57
089	Auto set power limits	no, YES	—	no		page 57
090	Output shaft power	0.0 - 200.0% $P_n$	—	—		page 57
091	Start delay power limits	1 - 250 sec	1 - 4	10		page 58
092	Max power alarm limit	5 - 200% $P_n$	1 - 4	115		page 58
093	Max alarm response delay	oFF, 0.1 - 25.0 sec	1 - 4	oFF		page 58
094	Max power pre-alarm limit	5 - 200% $P_n$	1 - 4	110		page 58
095	Max pre-alarm response delay	oFF, 0.1 - 25.0 sec	1 - 4	oFF		page 58
096	Min pre-alarm power limit	5 - 200% $P_n$	1 - 4	90		page 58
097	Min pre-alarm response delay	oFF, 0.1 - 25.0 sec	1 - 4	oFF		page 59
098	Min power alarm limit	5 - 200% $P_n$	1 - 4	85		page 59
099	Min alarm response delay	oFF, 0.1 - 25.0 sec	1 - 4	oFF		page 59
101	Run at single phase input failure	no, YES	1 - 4	no		page 61
102	Run at current limit time-out	no, YES	1 - 4	no		page 61
103	Jog forward enable	oFF, on	1 - 4	oFF		page 61
104	Jog reverse enable	oFF, on	1 - 4	oFF		page 61
105	Automatic return menu	oFF, 1-999	—	oFF		page 62
111	Serial comm. unit address	1 - 247	—	1		page 62
112	Serial comm. baudrate	2.4 - 38.4 kBaud	—	9.6		page 62

Menu number	Function/Parameter	Range	Par.set	Factory setting	Value	Page
113	Serial comm. parity	0, 1	———	0		page 62
114	Serial comm. contact broken	oFF, 1, 2	———	1		page 62
199	Reset to factory settings	no, YES	———	no		page 63
201	Current	0.0 - 9999 Amp	———	———		page 63
202	Line main voltage	0 - 720 V	———	———		page 63
203	Output shaft power	-9999 - 9999 kW	———	———		page 63
204	Power factor	0.00 - 1.00	———	———		page 63
205	Power consumption	0.000 - 2000 MWh	———	———		page 63
206	Reset power consumption	no, YES	———	no		page 64
207	Shaft torque	-9999 - 9999 Nm	———	———		page 64
208	Operation time	Hours	———	———		page 64
211	Current phase L1	0.0 - 9999 Amp	———	———		page 64
212	Current phase L2	0.0 - 9999 Amp	———	———		page 64
213	Current phase L3	0.0 - 9999 Amp	———	———		page 64
214	Line main voltage L1 - L2	0 - 720 V	———	———		page 64
215	Line main voltage L1 - L3	0 - 720 V	———	———		page 64
216	Line main voltage L2 - L3	0 - 720 V	———	———		page 64
221	Locked keyboard info	no, YES	———	no		page 65
901	Alarm list, Latest error	F1 - F16	———	———		page 65
902 -915	Alarm list, Older error in chronological order	F1 - F16	———	———		page 65

## Explanation of units:

U	Input line voltage
Un	Nominal motor voltage.
In	Nominal motor current.
Pn	Nominal motor power.
Nn	Nominal motor speed.
Tn	Nominal shaft torque.
Insoft	Nominal current soft starter.
Pnsoft	Nominal power soft starter.
Nnsoft	Nominal speed soft starter.

## Calculation shaft torque

$$T_n = \frac{P_n}{\left(\frac{N_n}{60} \times 2\pi\right)}$$

**NOTE! The six main functions for motor control, menus 020–025, can only be selected one at a time.**

## 14. INDEX

### Numerics

2-wire start/stop .....	37
3-wire start/stop .....	37

### A

Above max power limit .....	67
Alarm category .....	67
Alarm list .....	65
Alarm reset .....	23
Ambient temperatures . 10, 20, 74, 75, 77	
analogue control .....	32
Analogue input .....	32, 41
Analogue output .....	32, 52
Analogue output gain .....	52
Analogue output value .....	52
Auto set power limits .....	57
automatic reset .....	37
Automatic return menu .....	62

### B

Basic parameter setting .....	10
Below min power limit .....	67
Brake method .....	47
Braking Strenght .....	47
Braking time .....	46
Busbars .....	25, 26
Bypass .....	43
Bypass contactor .....	44

### C

Cabinet .....	24
Checklist .....	10
Clickson thermistor .....	32
Combination matrix .....	19
Complaint .....	7
Confirm setting .....	23
Connections .....	28, 32
Control mode .....	23, 37
Control voltage .....	32
control voltage .....	33
Control voltage connection .....	28, 31
Cooling fins .....	24
cos phi .....	50
Current .....	63
Current in phase L1 .....	64
Current in phase L2 .....	64
Current in phase L3 .....	64
Current limit .....	39
Current limit time-out .....	61
Current transformer .....	45

### D

D.O.L start .....	41
DC-brake .....	46
DC-Brake at slow speed .....	49
Decrease value .....	23
Decrease value of setting .....	23

Device connections .....	28, 31
different operation situation .....	22
Digital inputs .....	32
Dimension .....	25, 74
DIN VDE 0100 .....	24
Direct On Line start .....	41
Dismantling .....	2
Display next window .....	23
Display previous window .....	23
Dual voltage ramp .....	38

### E

Electrical characteristic .....	32
Electrical Data .....	74, 75, 76, 77
EMC .....	74, 75, 76, 77
Emergency .....	2
End torque .....	39

### F

Factory settings .....	63
Features .....	9
Forward/reverse .....	34
Free circulation of air .....	24
frequency .....	50
Frequency inverter .....	20
Front cover .....	21
Full speed not reached .....	67
Full voltage .....	51
Full voltage start .....	41
Function .....	79

### G

General Data .....	74
General description .....	21

### H

Heat dissipation .....	20
High ambient temperatures .....	43

### I

Increase value .....	23
Increase value of setting .....	23
Initial torque .....	39
Initial voltage at start ramp 1 .....	36
Initial voltage at start ramp 2 .....	38
INSPECTION AT DELIVERY .....	7
Installation .....	24
Insulation test .....	20

### J

JOG Forward .....	23, 61
JOG fwd/rev .....	23
JOG Reverse .....	23, 61
Jumper J1 .....	41
Jumper J2 .....	52

### K

Keyboard .....	23
----------------	----

Keyboard lock .....	23, 65
keys .....	23

### L

LED display .....	22
Live circuit components .....	24
Load monitor .....	57
Locked rotor .....	67
Low load .....	20

### M

Main functions .....	81
Mains contactor .....	10
Mains supply .....	28, 31
Mains voltage .....	10
MAINTENANCE .....	71
Matrix .....	19
Max power alarm limit .....	58
Max power pre-alarm limit .....	58
Max pre-alarm response delay .....	58
Mechanical Data .....	74, 75, 76, 77

### Menu

001 .....	36
002 .....	11, 36
003 .....	36
004 .....	11, 36
005 .....	12, 36
006 .....	12, 37
007 .....	38
008 .....	38
011 .....	38
012 .....	38
013 .....	38
014 .....	38
016 .....	39
017 .....	39
020 .....	39
021 .....	40
022 .....	40
023 .....	41
024 .....	41
025 .....	42
030 .....	43
031 .....	43
032 .....	43
033 .....	46
034 .....	46
035 .....	47
036 .....	47
037 .....	48
038 .....	49
039 .....	49
040 .....	49
041 .....	11, 50
042 .....	50
043 .....	11, 50
044 .....	11, 50
045 .....	11, 50
046 .....	11, 50



051	51	Motor current	50
052	51	Motor data	50
054	52	Motor power	50
055	52	Motor power supply	28, 31
056	52	Motor protection, overload	55, 67
057	53	Motor shaft torque	64
058	53	Motor speed	50
061	54	Motor terminal open	67
071	55	Motor voltage	50
072	55	MOUNTING	24
073	56	MOUNTING/WIRING	24
074	56		
075	56		
081	56		
082	56		
083	56		
084	56		
085	57		
086	57		
087	57		
088	57		
089	57		
090	57		
091	58		
092	58		
093	58		
094	58		
095	58		
096	59		
097	59		
098	59		
099	59		
101	61		
102	61		
103	61		
104	61		
105	62		
199	63		
201	63		
202	63		
203	63		
204	63		
205	63		
206	64		
207	64		
208	64		
211	64		
212	64		
213	64		
214	64		
215	64		
216	64		
221	23, 65		
901	65		
		RMS current read-out	12
		Menu expansion	38
		Menu Structure	22
		Min alarm response delay	59
		Min power alarm limit	59
		Min power pre-alarm limit	59
		Min pre-alarm response delay	59
		Minimum free space	24, 25
		Motor	31
		Motor current	50
		Motor data	50
		Motor power	50
		Motor power supply	28, 31
		Motor protection, overload	55, 67
		Motor shaft torque	64
		Motor speed	50
		Motor terminal open	67
		Motor voltage	50
		MOUNTING	24
		MOUNTING/WIRING	24
		<b>N</b>	
		Next	23
		Nominal frequency	11
		Nominal motor cos phi	11
		Nominal motor current	11
		Nominal motor power	11
		Nominal motor speed	11
		Norms/Standards	74, 75, 76, 77
		NTC thermistor	32
		<b>O</b>	
		Open thyristor	67
		Operation	51
		Operation time	63, 64
		Operation/Set-up	23
		Operator panel	21
		Output motor shaftpower	63
		Output shaftpower	57, 63
		Over voltage	56, 67
		<b>P</b>	
		Parallel	20
		Parallel cables	73
		Parameter	79
		Parameter Set	32, 54
		PFC	46
		Phase compensation capacitor	20
		Phase input failure	67
		Phase loss	61
		Phase reversal alarm	67
		Phase sequence	57
		Pole-changing contactor	20
		Potentiometer	32
		Power consumption	63
		Power factor	63
		Power Factor Control	46
		Power loss	10
		PPU unit	21
		Pre-alarm	51, 58
		Prevent damage to the thyristors	24
		Previous	23
		Programmable relay	51
		Programming and presentation unit (PPU)	21
		protection/insulation	74, 75, 76, 77
		Protective earth	28, 31
		PTC	55
		PTC Thermistor input	32
		Pump control	40
		<b>Q</b>	
		Quick Set-up	10
		<b>R</b>	
		Rating plate	10
		Recyclable material	2
		Regular maintenance	71
		Relay K1	32, 51
		Relay K2	32
		Relay K3	32
		Remote	23
		Reset	23
		reset	66
		Response delay max alarm	58
		RMS current	36, 63
		RMS main voltage	63
		Rotating loads	20
		Running motors	20
		Running-LED	22
		<b>S</b>	
		Safety	2, 6
		Safety measures	10
		Scrapping	2
		Selection of control mode	12
		Semiconductor fuses	33, 78
		Serial comm.	23
		Serial communication broken	67
		Shaftpower	57, 63
		Shielded motor cable	20
		Shorted thyristor	67
		Simple soft start and soft stop	10
		Slip ring motors	20
		Slow blow fuses	33
		Slow speed time at start	49
		Slow speed time at stop	49
		Slow speed torque	48
		Small motor	20
		Softbrake	51
		Softstart overheated	67
		Spare parts	2
		standard commercial fuses	78
		Standard wiring	10, 33
		Standards	6
		Start command	22
		Start delay power limits	58
		Start ramp 1	36
		Start ramp 2	38
		Start the motor	12
		Start time ramp 1	11
		Start/Stop	12, 23
		Start/stop combination	19
		Start/stop/reset from keyboard	12
		Start/stop-LED	22
		Starting	12
		STARTING/OPERATING	79
		Starts per hour	67
		Starts per hour limitation	56
		Step down voltage in stop ramp 2	38
		Step down voltage stop ramp 1	36
		Stop command	22
		Stop ramp 1	36
		<b>INDEX</b>	<b>83</b>



Stop ramp time 2 .....	38
Stop time ramp 1 .....	11
storage .....	7
Supply voltage .....	32, 74
switch .....	2
Switch the device off .....	2
Switch-off procedures .....	2

## T

TECHNICAL DATA .....	74
Terminal .....	32
Terminal clamp .....	78
Terminals .....	32
Thermal capacity .....	56
Thermal protection .....	55
Tightening torque .....	25
Torque boost active time .....	43
Torque boost current limit .....	43
Torque booster .....	43
Torque control .....	42
Trained personnel .....	2, 10
Transport .....	7
TROUBLESHOOTING .....	68
Two speed motor .....	20

## U

Under voltage .....	57, 67
Unpacking .....	7

## V

VIEW OPERATION .....	63
Voltage .....	63
Voltage unbalance .....	56, 67

## W

Weight .....	74
Wiring circuit .....	33
Wiring example .....	34

## REPRESENTATION

ADL Co.  
P.O. Box 47  
12 50 40 MOSCOW  
Russia  
Tel. 00007- 095268 7423  
Fax 00007- 095268 0348  
rouslan@adlserv.aha.ru

AUTOMATECH Sp.zo.o  
ul. Ryżowa 84  
PL-02482 OPACZ-KOLONIA  
Poland  
Tel. 0048- 22-723 06 62  
Fax 0048- 22-723 06 06  
b.kolodziejczyk@automatech.it.pl

Elimko  
8. Cadde 68. Sokak Nr. 16  
06510 Emek-ANKARA  
Turkey  
Tel. 0090 - 312 212 64 50  
Fax 0090 - 312 212 41 43

Elpro Drive , S. R. O.  
ul. Miru 3  
CZ 73961 TRINEC  
Tjeckien Republic  
Tel. 00420W 659434661  
Fax 00420W 659325864  
agorgol@elprocz.cz

**Emotron AB**  
**Box 222 25**  
**SE-250 24 HELSINGBORG**  
**Sweden**  
**Tel. +46 42 169900**  
**Fax +46 42 169949**  
**Info@emotron.com**

**Emotron Antriebssysteme GmbH**  
**Goethestrasse 6**  
**38855 WERNIGERODE**  
**Germany**  
**Tel. 0049- 3943 92050**  
**Fax 0049- 3943 92055**  
**Info@emotron-as.de**

**Emotron B.V.**  
**P.O. Box 132**  
**5531 NX BLADEL**  
**Holland**  
**Tel. 0031- 497 389222**  
**Fax 0031- 497 386275**  
**info@emotron.nl**

**Emotron Drives (UK) Ltd**  
**Spaces Business Centre**  
**Radway Green Park**  
**Alsager**  
**Cheshire**  
**CW2 5PR**  
**Great Britain**  
**Tel. 0044- 1270 879440**  
**Fax 0044- 1270 886119**  
**trevor@emotron.freemove.co.uk**

**Emotron EI-FI SA**  
**Aribau 229**  
**ES-08021 BARCELONA**  
**Spain**  
**Tel. 0034- 93 209 14 99**  
**Fax 0034- 93 209 12 45**  
**emotron@emotron.es**

**Emotron Inc**  
**3440 Granite Circle**  
**TOLEDO, OH 43617**  
**USA**  
**Tel. 001- (419) 841-7774**  
**Fax 001- (419) 843-5816**  
**paul.hackett@usa-emotron.com**

Emsby  
27 Rodwell Street  
QUE - 4108 ARCHERFIELD  
Australia  
Tel. 0061- 7 3274 2566  
Fax 0061- 7 3274 2387  
dkirkegaard@emsby.com

Esquire Engineering sdn bhd  
13, Jln Jurutera U1/23, Seksyen U1  
Hicom-Glenmarie Industrial Park  
40000 Shah Alam SELANGOR  
Malaysia  
Tel. 0060- 3 519 1958  
Fax 0060- 3 519 1960  
barry\_h@tm.net.my

HEDTEC OY  
P.O.B 110  
SF-00201 HELSINGFORS  
Finland  
Tel. 00358- 9 682881  
Fax 00358- 9 674918  
kaj.nyberg@hedengren.fi

Ingeniør Ivar Pettersen ASPostboks  
166  
N-3001 DRAMMEN  
Norway  
Tel. 0047- 32 21 21 21  
Fax 0047- 32 21 21 99  
lars.hennum@pettersen.no

**K.K. EI-FI**  
**2-18-4 Hagooromocho**  
**1900021 Tachakawa**  
**J- TOKYO**  
**Japan**  
**Tel. 0081- 42 528 8820**  
**Fax 0081- 42 528 8821**  
**sato.hroyuki@el-fi.co.jp**

MAS for Eng. & Trad  
From Tahreer St  
12, a-Abee Ema´ma St.  
DOKKI GIZA  
Egypt  
Tel. 0020- 2 3357947  
Fax 0020- 2 3357948

Mohamad Eid Kari  
Marjeh -square,  
Euphorat st. Dagestani  
Bld. 1st. Fl. POB 31203  
DAMASKUS  
Syria  
Tel. 00963- 11 222 3867  
Fax 00963- 11 224 5425

Pardis International  
Golbag W. Kerman  
S. Rahmati E. No.202  
TEHERAN  
Iran  
Tel. 0098- 21 7838571  
Fax 0098- 21 7838571  
mehraban@irtp.com

Saftronics (PTY) LTD  
27 Heronmere Road  
P O Box 38045  
2016 BOOYSENS  
South Africa  
Tel. 0027- 11 434 1345  
Fax 0027- 11 434 1359  
rann@pixie.co.za

TENSON Engineering Ltd  
Room 908, Nan Fung Commercial  
Center  
19 LAM LOK St  
KOWLOON BAY  
Hong Kong  
Tel. +852 2758 0878  
Fax +852 2759 5335  
sammy@tenson.com.hk

WELLFORD CHILE S.A.  
ENCALA 103645  
Madrid No 1602 - Santiago  
SANTIAGO  
Chile  
Tel. 0056- 2 556 26 55  
Fax 0056- 2 556 35 28  
encala@hotmail.com

Voltampere s.a.  
2nd klm Lagada-Redina  
GR-57200 THESSALONIKI  
Greece  
Tel. 0030- 394 26188  
Fax 0030- 394 26189  
automation@voltampere.gr

**www.emotron.com**

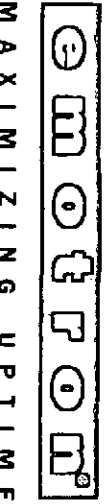







**Halmac** Services (Qld) Pty. Ltd.  
A.C.N. 098 852 923  
A.B.N. 40 741 712 113

# SOCKET OUTLET AND INLET PLUG

1. MARECHAL DS RANGE DECONTACTOR  
TECHNICAL DETAILS
2. MARECHAL PLUGS AND SOCKET-OUTLETS  
TECHNICAL DETAILS

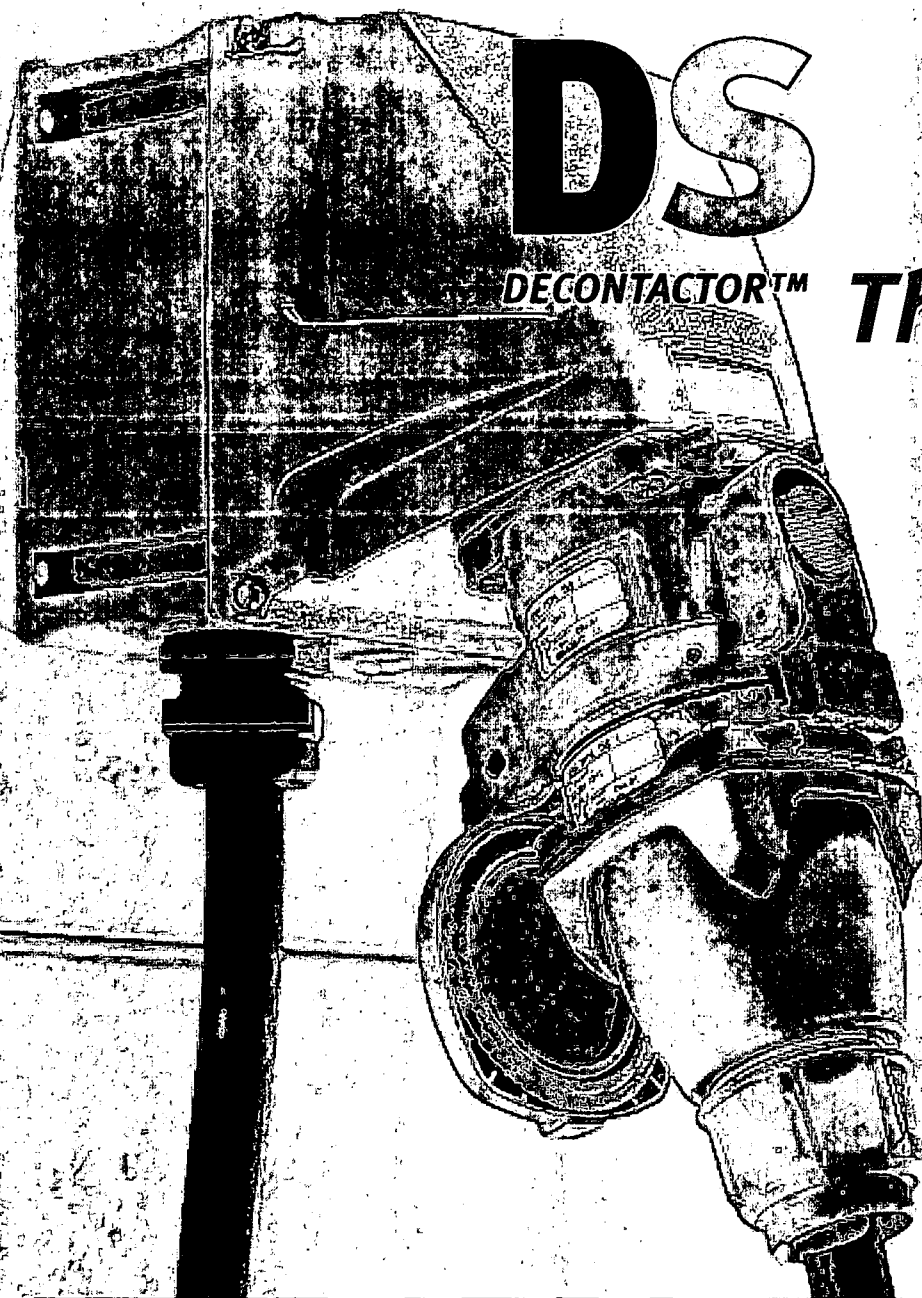

# DS DECONTACTOR™

## The range

<b>Advantages</b>	<b>P. 30</b>
<b>Features</b>	<b>P. 31</b>
<b>Core range</b>	<b>P. 32</b>
<b>DS1 - 30 A</b>	<b>P. 34</b>
<b>DS3 - 50 A</b>	<b>P. 36</b>
<b>DS6 - 90 A</b>	<b>P. 38</b>
<b>DS9 - 150 A</b>	<b>P. 40</b>
<b>DS2 - 250 A</b>	<b>P. 42</b>
<b>Dimensions</b>	<b>P. 44</b>

Spare parts: see page 173



Power supply to production lines



Supply to building sites (shipyards)

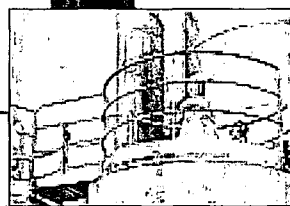

Power supply to motors and pumps

And utilities, services and maintenance, movies, shows, aeronautics, aerospace, etc.

## The quality standard for the manufacturing industry

The DECONTACTOR™ DS range is the broadest and the most complete: it covers rated currents from 30 to 250 A, is available in a metal version from 90 A and offers many options.

Although it is a general range, it offers performances that set a high level quality standard meeting the expectations of the most demanding users. DS decontactors cover most of the needs of manufacturing industries.



**DS****Advantages**

Core range  
 DS1 - 30A  
 DS3 - 50A  
 DS6 - 90A  
 DS9 - 150A  
 DS2 - 250A  
 Dimensions

**Electrical features**

- From **30 to 250 Amps** - Voltage up to 1000 Volts AC and up to 250 Volts DC
- Integral switching device as defined in clause 2.8 of IEC/EN 60309-1 standard
- Equipped with silver-nickel butt-contacts and metallic braid for added reliability and lifetime
- Socket-outlet safety shutter provides **IP4X** protection

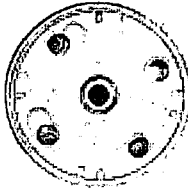

The locked safety shutter prevents access to the electrical contacts of the socket-outlet when the plug is removed (IP4X protection against solid foreign objects and access to hazardous parts).

The socket-outlet contacts are kept clean and inaccessible (to 1 mm diameter wires) even when the socket-outlet lid is open.

- Unique keying system allows discrimination between 24 different power supplies (voltage, frequency, AC and DC current)
- Number of cycles under normal operation and overload conditions from 2 to 8 times (depending on rated current) more than those required by IEC / EN 60309-1 standard
- Versions with auxiliary contacts

**Mechanical features**

- Automatic IP54/55 watertightness. 150A and 250A models available also in IP66/67
- Casings made of glass fibre reinforced **polyester** (30 to 150A) providing excellent electric insulation, high resistance to corrosive, UV and chemical agent environments, and high mechanical resistance (**IK08** impact resistance)
- Casings made of anti-corrosion treated **metal** (90 to 250A) providing high temperature resistance and excellent mechanical resistance (**IK09** impact resistance).
- Ambient temperature: -25 °C to +40 °C (for temperatures outside this range, please contact us)
- Spring-assisted terminals unaffected by vibrations and thermal cycling
- Self-opening lid ; self-returning lid on request

**Regulatory features**

DS decontactors comply with:

- The **IEC 60309-1** International standard and **EN 60309-1** European standard (plugs and socket-outlets for industrial purposes),
- The European Low Voltage Directive (decree N°95-1081 dated 3<sup>rd</sup> October 1995),
- The French décret N° 88-1056 dated 14<sup>th</sup> November 1988 relating to workers' protection,
- The decrees relating to workers' protection in Belgium, Spain and Italy,
- The load breaking capacity according to utilisation categories **AC22** and **AC23** of IEC / EN 60947-3 (switch standard).

Also certified by **VERITAS LCIE**, **UL**, **AS** and **CSA** (French, American, Australian and Canadian inspection laboratories).

**SPECIFICATION**

IP 54/55 Plug and socket-outlet with integral switching device (AC22, AC23 utilisation categories according to IEC / EN 60947-3 standard), safety shutter (IP4X socket-outlet), silver-nickel butt-contacts with metallic braid. Product technical data sheet on e-catalogue - [www.marechal-electric.com](http://www.marechal-electric.com)



**The range** *Quickly find the right items!*



### Marechal's modular system

DSN decontactors meet the modularity system described on the Bookmark. Before consulting the 'part number' pages, determine the parts required for the needed configuration.

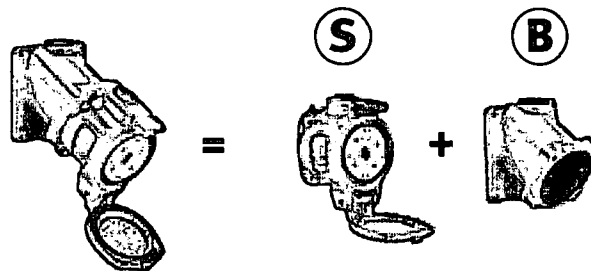
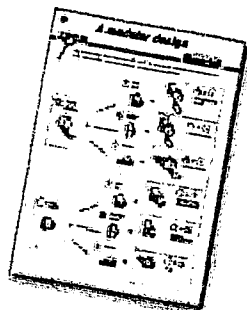

Example : a **wall mounting socket-outlet** includes an active part, the socket-outlet (female) and an installation accessory,

the **wall box**. Each part has its own part number. Therefore, the order should have **two part numbers**.

### DS part number system

- **Standard** DS part numbers are made up of 7 characters. All part numbers start with a '3'.
- The choice of an **option** or a **version with auxiliary contacts** results in adding a suffix (of 1 to 3 characters).

1 <sup>st</sup> character	2 <sup>nd</sup> character	3 <sup>rd</sup> character	4 <sup>th</sup> character	Characters from 5 to 7
Range	Casing	Rated current	Usage	Supply voltage** Frequency Polarity
3 = DS	1 = Blue poly	1 = DS <sub>1</sub> (30A)	4 = Socket-outlet	08A = 20-24V 50Hz 2P
	4 = Grey poly	3 = DS <sub>3</sub> (50A)	8 = Inlet	033 = 190-230V 50Hz 3P+E
	5 = Black poly	6 = DS <sub>6</sub> (90A)		015 = 220-250V 50Hz 1P+N+E
	9 = Blue metal	9 = DS <sub>9</sub> (150A)		013 = 380-440V 50Hz 3P+E
		2 = DS <sub>2</sub> (250A)		017 = 380-440V 50Hz 3P+N+E
			A = Installation accessory	013 = Handle
				027 = Inclined sleeve
				053 = Wall box

\*\* 24 different power supplies (voltage, frequency) and 12 polarities are available: see international standard and colour-code on page 8

### Check that the DS part number meets the need ...

Example : the need is for a 30A, 400V, 3P+E blue poly wall mounting socket.

- The DS with a 30A rated current is **DS<sub>1</sub>** (see pages 34 and 35).
- Order a **30A socket-outlet (S)** and a **wall box (B)**.
- In the standard socket-outlet part numbers table, select the part number for a 400V, 3P+E socket-outlet: **31 14 013**
- In the standard wall box part number table, choose the accessory that suits you e.g. a 30° blue poly wall box with a M20 threaded entry: **31 1A 053**

You can check the two part numbers found:

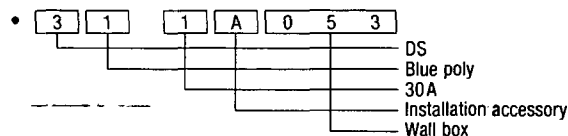
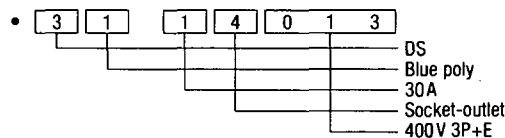

**DS**

Advantages  
**Core range**  
 DS1 - 30A  
 DS3 - 50A  
 DS6 - 90A  
 DS9 - 150A  
 DS2 - 250A  
 Dimensions

## The DS core range

In the following table are described the most frequent configurations. Take a look: If the required configuration is there, do not look further in the 'part number' pages. Each configuration includes two part numbers: one for the active part (*socket-outlet or inlet*) and one for the installation accessory (*wall box, inclined sleeve or handle*).

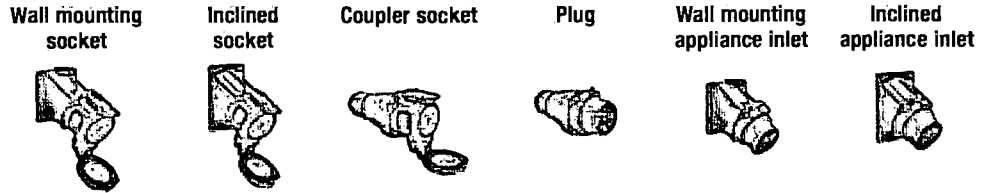

<b>Active part:</b>	Socket-outlet	Socket-outlet	Socket-outlet	Inlet	Inlet	Inlet
+ installation accessory:	B Wall box	Si Inclined sleeve	H Handle	H Handle	B Wall box	Si Inclined sleeve

### DS1 30 A (poly)

Voltage	Polarity	Part Number					
230V	1P+N+E	31 14 015	31 14 015	31 14 015	31 18 015	31 18 015	31 18 015
	+ installation accessory:	31 1A 053	31 1A 027	31 1A 013	31 1A 013	31 1A 053	31 1A 027
400V	3P+E	31 14 013	31 14 013	31 14 013	31 18 013	31 18 013	31 18 013
	+ installation accessory:	31 1A 053	31 1A 027	31 1A 013	31 1A 013	31 1A 053	31 1A 027
400V *	3P+N+E	31 14 017 *	31 14 017 *	31 14 017 *	31 18 017	31 18 017	31 18 017
	+ installation accessory:	31 1A 053	31 1A 027	31 1A 013	31 1A 013	31 1A 053	31 1A 027

Example described at bottom of previous page

### DS3 50 A (poly)

Voltage	Polarity	Part Number					
230V	1P+N+E	31 34 015	31 34 015	31 34 015	31 38 015	31 38 015	31 38 015
	+ installation accessory:	31 3A 053	31 3A 027	31 3A 013	31 3A 013	31 3A 053	31 3A 027
400V	3P+E	31 34 013	31 34 013	31 34 013	31 38 013	31 38 013	31 38 013
	+ installation accessory:	31 3A 053	31 3A 027	31 3A 013	31 3A 013	31 3A 053	31 3A 027
400V *	3P+N+E	31 34 017 *	31 34 017 *	31 34 017 *	31 38 017	31 38 017	31 38 017
	+ installation accessory:	31 3A 053	31 3A 027	31 3A 013	31 3A 013	31 3A 053	31 3A 027

### DS6 90 A (poly or metal)

Voltage	Polarity	Part Number					
400V	3P+E	• 31 64 013	• 31 64 013	• 31 64 013	• 31 68 013	• 31 68 013	• 31 68 013
	+ installation accessory:	• 31 6A 053	• 31 6A 027	31 6A 013	31 6A 013	• 31 6A 053	• 31 6A 027
400V *	3P+N+E	• 31 64 017 *	• 31 64 017 *	• 31 64 017 *	• 31 68 017	• 31 68 017	• 31 68 017
	+ installation accessory:	• 31 6A 053	• 31 6A 027	31 6A 013	31 6A 013	• 31 6A 053	• 31 6A 027



#### Finding the metal version part number is easy!

When a part number is preceded by \*, a metal version is also available: To find its part number, just change the 31 into 39 (1 = poly, 9 = metal).

### DS9 150 A (poly or metal)

Voltage	Polarity	Part Number					
400V	3P+E	• 31 94 013	• 31 94 013	• 31 94 013	• 31 98 013	• 31 98 013	• 31 98 013
	+ installation accessory:	39 9A 053	• 31 9A 027	31 9A 013 (N)	31 9A 013 (N)	39 9A 053	• 31 9A 027
400V *	3P+N+E	• 31 94 017 *	• 31 94 017 *	• 31 94 017 *	• 31 98 017	• 31 98 017	• 31 98 017
	+ installation accessory:	39 9A 053	• 31 9A 027	31 9A 013 (N)	31 9A 013 (N)	39 9A 053	• 31 9A 027

(N) = neoprene

### DS2 250 A (metal)

Voltage	Polarity	Part Number					
400V	3P+E	39 24 013	39 24 013	39 24 013	39 28 013	39 28 013	39 28 013
	+ installation accessory:	39 2A 053	39 2A 027	39 2A 013 (N)	39 2A 013 (N)	39 2A 053	39 2A 027
400V *	3P+N+E	39 24 017 *	39 24 017 *	39 24 017 *	39 28 017	39 28 017	39 28 017
	+ installation accessory:	39 2A 053	39 2A 027	39 2A 013 (N)	39 2A 013 (N)	39 2A 053	39 2A 027

\* A dual voltage 230/400V socket-outlet with 3P+N+E accepts a 400V plug with 3P+N+E or 3P+E as well as a 230V plug with 1P+N+E (see Bookmark)

(N) = neoprene

# DS1

# DECONTACTOR™ 30A



### Main features:

• (socket-outlet) IP	55	• Wiring (mini/ maxi) flexible	1 / 6 mm <sup>2</sup>
• (socket-outlet + Inlet) IP	54	• Wiring (mini/ maxi) stranded	1.5 / 10 mm <sup>2</sup>
• IK (poly)	08	• Other wiring on request	
• U <sub>max</sub>	690 V AC - 250 V DC	maxi flexible / stranded	10 / 16 mm <sup>2</sup>

  

• Rated currents (IEC / EN 60309-1)	30A / 400V	30A / 500V	30A / 690V
• Rated currents and operating voltages (load breaking capacity according to IEC / EN 60947-3)	30A / 400V (AC23)	30A / 500V (AC22)	16A / 690V (AC22)

## S Socket-outlet (female)

## I Inlet (male)

### Main options

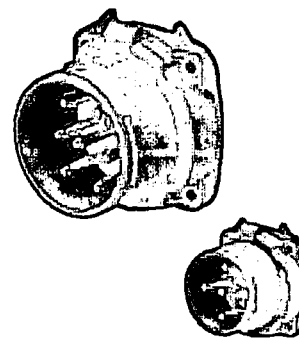
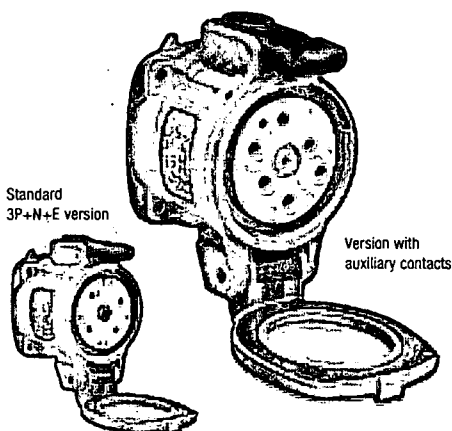
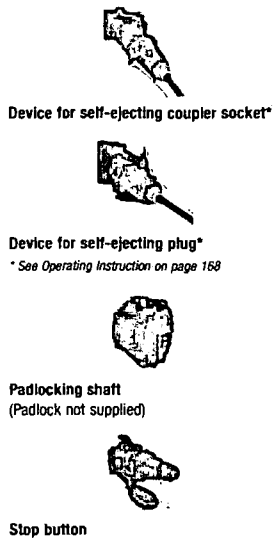

Voltage	Polarity	Material	Part #
20 - 24 V	2P	Polyester	31 14 08A
190 - 230 V	3P+E	Polyester	31 14 033
220 - 250 V	1P+N+E	Polyester	31 14 015
380 - 440 V	3P+E	Polyester	31 14 013
Dual voltage*	3P+N+E	Polyester	31 14 017

Voltage	Polarity	Material	Part #
20 - 24 V	2P	Polyester	31 18 08A
190 - 230 V	3P+E	Polyester	31 18 033
220 - 250 V	1P+N+E	Polyester	31 18 015
380 - 440 V	3P+E	Polyester	31 18 013
380 - 440 V	3P+N+E	Polyester	31 18 017

\* see Bookmark  
Other voltages, polarities: see page 8

### Socket-outlet (U<sub>max</sub> 500 V) with auxiliary contacts

With 2 auxiliary contacts (5A)	Socket # + 972
--------------------------------	----------------

If you want to add an option to this kind of socket-outlet:  
call us at +33 (0) 1 45 11 60 00.

### Socket-outlet options

IP67 watertightness	Socket # + 677
Device for self-ejecting coupler socket	Socket # + 354
Device for self-ejecting plug	Socket # + 352
Self-returning lid	Socket # + R
180°-opening lid	Socket # + 10
180°-opening and self-returning lid	Socket # + 18
Padlocking shaft up to 3 padlocks 8 mm Ø	Socket # + 844
Stop button	Socket # + 453
Rubber cover for polyester latch	Socket # + 833

If you want to equip a socket with two or more options:  
call us at +33 (0) 1 45 11 60 00.

### Socket-outlet accessories

Closing mechanism (finger draw plate)	31 1A 346
---------------------------------------	-----------

### Inlet (U<sub>max</sub> 500 V) with auxiliary contacts

With 2 auxiliary contacts (5A)	Inlet # + 972
--------------------------------	---------------

### Inlet options

IP67 watertightness	Inlet # + 677
---------------------	---------------

### Inlet accessories

IP67 cap	31 1A 126
Self-closing lid	31 1A 226
Closing mechanism (finger draw plate)	31 1A 346
Ejecting mechanism (shark fin)	31 1A 338
Tension cord	31 1A 336

### Accessories

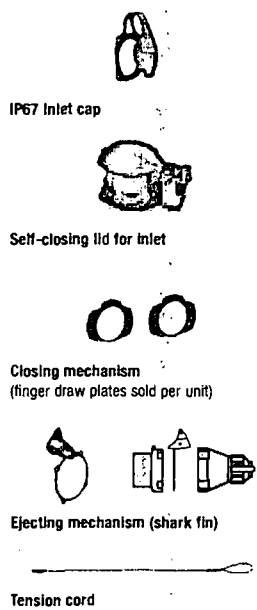

**DS**

Advantages  
Core range  
**DS1 - 30A**  
DS3 - 50A  
DS6 - 90A  
DS9 - 150A  
DS2 - 250A  
Dimensions

Also see:

Full range of boxes page 86  
Dimensions page 44  
Technical Manual page 150

## Installation accessories

### B Box

	Wall box poly 30°	Wall box poly 70°	Wall box metal + poly sleeve 30°	Wall box metal + metal sleeve 30°	Wall box metal 30°	Wall box metal + straight metal sleeve
Entry						
M20	31 1A 053	51 BA 058	31 1A 653	39 1A 653	39 1A 053	39 1A 095
M25	31 1A 083	51 BA 058	31 1A 653 418	39 1A 653 418		39 1A 095 418
M32		51 BA 058	31 1A 653 419	39 1A 653 419		39 1A 095 419
M40			31 1A 653 420	39 1A 653 420		39 1A 095 420

The boxes are supplied without any cable gland. The 70° boxes are not drilled (drilled at extra cost).

### Sl Sleeve

	Inclined poly 30°	Inclined poly 70°	Inclined metal 30°	Straight metal
	31 1A 027	51 BA 757	39 1A 027	39 1A 127

### H Handle

	Straight poly	Straight poly with poly cable gland	for ejection option *	Straight metal with metal cable gland	Straight poly flowerpot with metric threaded entry**		
Tightening							
5-21mm	31 1A 013						
Entry							
M20	31 1A 753	8-13mm	31 1A 463	31 1A 963	6-13mm	M20	31 1A 253 417
M25	31 1A 253 25P	13-19mm	31 1A 443 25P	31 1A 953 25M	10-18mm	M25	31 1A 253 418
M32	31 1A 253 32P	17-25mm	31 1A 443 32P			M32	31 1A 253 419
M40	31 1A 253 40P	24-32mm	31 1A 443 40P			M40	31 1A 253 420

\* Handle with eyelet for tension cord \*\* Cable gland on request Handles for flat or steel armoured cables on request.

### A Industrial - Domestic adapters

Domestic socket-outlet 10/16A 230V + **Marechal** industrial inlet 1P+N+E, 10 A 230 V fuse protection

Type	Material	Part number
UK	Poly	31 18 015 D40 *
FR with safety shutter	Poly	31 18 015 D16

\* All these domestic socket-outlets are available to foreign standards : replace D40 by D11 for France, D30 for Germany, D06 for Italy, D08 for Switzerland, D67 for Australia, D80 for USA etc

**ZOOM**



### Wall boxes and 70° sleeves

These wall boxes are designed for:

- easy wiring, recommended for large conductor cross-sections (up to 5 x 35 mm<sup>2</sup>)
- entries and exit at bottom, top or crossing
- stock reduction, as the same wall box is common to several products

The sleeves are angled (70°) to reduce the socket-outlet protrusion and impact risk (for lifts ...).

See full range of boxes on page 86

# DS3

# DECONTACTOR™ 50A

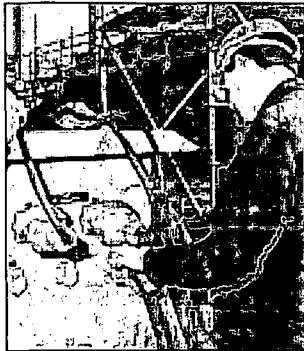

### Main features:

• (socket-outlet) IP	55	• Wiring (min! / max!) flexible	2.5 / 10 mm <sup>2</sup>
• (socket-outlet + Inlet) IP	54	• Wiring (min! / max!) stranded	2.5 / 16 mm <sup>2</sup>
• IK (poly)	08	• Other wiring on request	
• Umax	1000 V AC - 250 V DC	max! flexible	16 mm <sup>2</sup>

  

• Rated currents (IEC / EN 60309-1)	50 A / 400 V	50 A / 690 V	30 A / 1000 V
• Rated currents and operating voltages (load breaking capacity according to IEC / EN 60947-3)	50 A / 400 V (AC23)	32 A / 690 V (AC22)	(-)

## S Socket-outlet (female)

## I Inlet (male)

### Main options

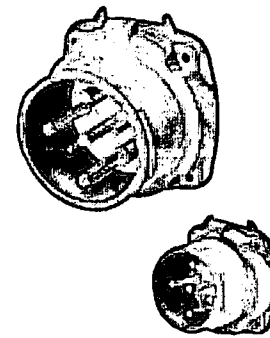
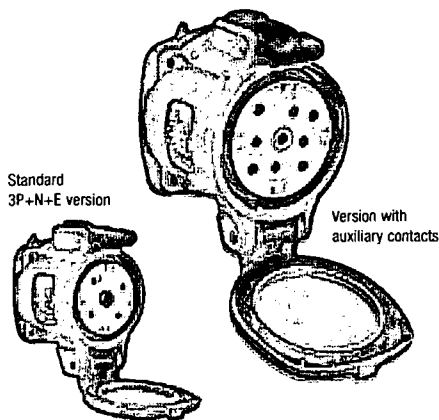
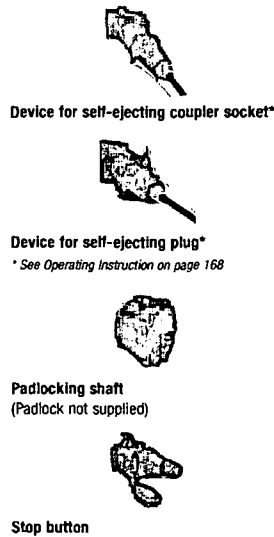

Voltage	Polarity	Material	Part #
20 - 24 V	2P	Polyester	31 34 08A
190 - 230 V	3P+E	Polyester	31 34 033
220 - 250 V	1P+N+E	Polyester	31 34 015
380 - 440 V	3P+E	Polyester	31 34 013
Dual voltage*	3P+N+E	Polyester	31 34 017

Voltage	Polarity	Material	Part #
20 - 24 V	2P	Polyester	31 38 08A
190 - 230 V	3P+E	Polyester	31 38 033
220 - 250 V	1P+N+E	Polyester	31 38 015
380 - 440 V	3P+E	Polyester	31 38 013
380 - 440 V	3P+N+E	Polyester	31 38 017

\* See Bookmark  
Other voltages, polarities: see page 8

### Socket-outlet with auxiliary contacts

With 2 auxiliary contacts (5A)	Socket # + 972
With 4 auxiliary contacts (5A)	Socket # + 264

If you want to add an option to this kind of socket-outlet:  
call us at +33 (0) 1 45 11 60 00.

### Inlet with auxiliary contacts

With 2 auxiliary contacts (5A)	Inlet # + 972
With 4 auxiliary contacts (5A)	Inlet # + 264

### Socket-outlet options

IP67 watertightness	Socket # + 677
Device for self-ejecting coupler socket	Socket # + 354
Device for self-ejecting plug	Socket # + 352
Self-returning lid	Socket # + R
180°-opening lid	Socket # + 10
180°-opening and self-returning lid	Socket # + 18
Padlocking shaft up to 3 padlocks 8 mm Ø	Socket # + 844
Stop button	Socket # + 453
Rubber cover for polyester latch	Socket # + 833

If you want to equip a socket-outlet with two or more options:  
call us at +33 (0) 1 45 11 60 00.

### Inlet options

IP67 watertightness	Inlet # + 677
---------------------	---------------

### Inlet accessories

IP67 cap	31 3A 126
Self-closing lid	31 3A 226
Ejecting mechanism (shark fin)	31 3A 338
Tension cord	31 1A 336

### Accessories

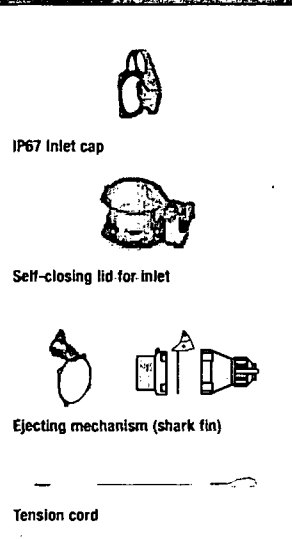

**DS**

Advantages  
Core range  
DS1 - 30 A  
**DS3 - 50 A**  
DS6 - 90 A  
DS9 - 150 A  
DS2 - 250 A  
Dimensions

**Also see:**

Full range of boxes page 86  
Dimensions page 44  
Technical Manual page 150

## Installation accessories

### **B** Box

	Wall box poly 30°	Wall box poly 70°	Wall box metal + poly sleeve 30°	Wall box metal + metal sleeve 30°	Wall box metal 30°	Wall box metal + metal sleeve 70°	Wall box metal + straight metal sleeve
Entry							
M20		51 CA 058	31 3A 653 417	39 3A 653 417		87 3A 053 417	39 3A 095 417
M25	31 3A 053	51 CA 058	31 3A 653	39 3A 653	39 3A 053	87 3A 053	39 3A 095
M32		51 CA 058	31 3A 653 419	39 3A 653 419		87 3A 053 419	39 3A 095 419
M40		51 CA 058	31 3A 653 420	39 3A 653 420		87 3A 053 420	39 3A 095 420

The boxes are supplied without any cable gland. The 70° boxes are not drilled (drilled at extra cost).

### **Sl** Sleeve

	Inclined poly 30°	Inclined poly 70°	Inclined metal 30°	Inclined metal 70°	Straight metal
	31 3A 027	51 CA 757	39 3A 027	87 3A 087	39 3A 127

**ZOOM**

**Handle with built-in finger draw plate.**

This straight handle is recommended for in-line connections.

### **H** Handle

	Straight poly	Straight poly with poly cable gland	for ejection option *	Straight metal with metal cable gland	Straight poly flowerpot with metric threaded entry**
Tightening					
10-30mm	31 3A 013	Entry Tightening		Tightening Entry	
10-30mm	31 3A 473 *	M20 31 3A 253 20P 8-13mm 31 3A 443 20P 31 3A 953 20M 6-13mm M20 31 3A 253 417	M25 31 3A 753 13-19mm 31 3A 463 31 3A 963 10-18mm M25 31 3A 253 418	M32 31 3A 253 32P 17-25mm 31 3A 443 32P 31 3A 953 32M 16-24mm M32 31 3A 253 419	M40 31 3A 253 40P 24-32mm 31 3A 443 40P 31 3A 953 40M 22-32mm M40 31 3A 253 420

\* With built-in finger draw plate (for in-line connections)

\* Handle with eyelet for tension cord \*\* Cable gland on request Handles for flat or steel armoured cables on request



### Perfect cable fit and broad tightening range

A special anchoring system provides a perfect cable fit and a broad tightening range (multilayer lining to choose the best cable fitting ring).

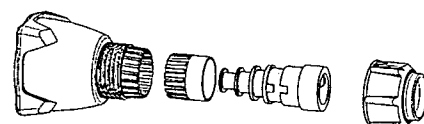

# DS6

# DECONTACTOR™ 90A

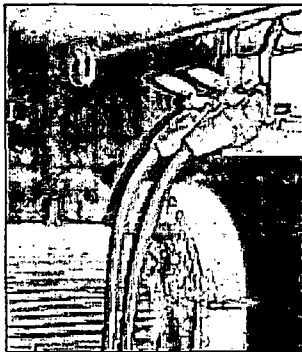

### Main features:

- (socket-outlet) IP 55
- (socket-outlet + Inlet) IP 54
- IK (poly / metal) 08/09
- Umax 1000V AC - 250V DC
- Wiring (minl / maxl) flexible 6 / 25 mm<sup>2</sup>
- Wiring (minl / maxl) stranded 6 / 35 mm<sup>2</sup>
- Other wiring on request maxl flexible / stranded 35 / 50 mm<sup>2</sup>
- Rated currents (IEC / EN 60309-1) 90A / 400V 90A / 690V 63A / 1000V
- Rated currents and operating voltages (load breaking capacity according to IEC / EN 60947-3) 90A / 400V (AC23) 63A / 690V (AC22) (-)

### Main options

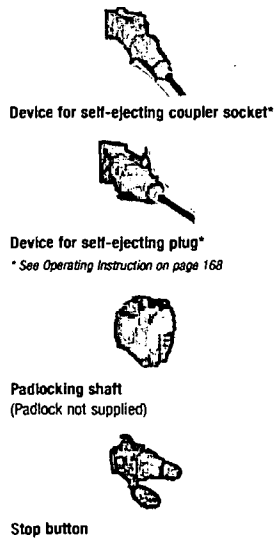

Device for self-ejecting coupler socket\*

Device for self-ejecting plug\*  
\* See Operating Instruction on page 168

Padlocking shaft  
(Padlock not supplied)

Stop button

### Accessories

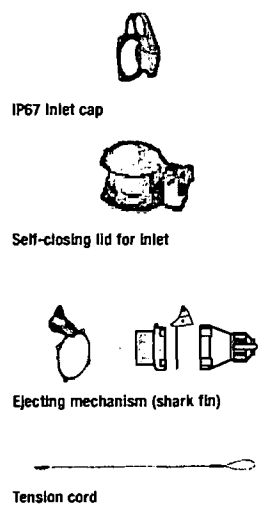

IP67 Inlet cap

Self-closing lid for inlet

Ejecting mechanism (shark fin)

Tension cord

## S Socket-outlet (female)

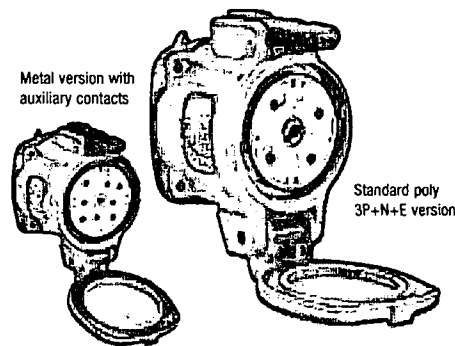

Voltage	Polarity	Material	Part #
20 - 24 V	2P	Polyester	31 64 08A
		Metal	39 64 08A
190 - 230 V	3P+E	Polyester	31 64 033
		Metal	39 64 033
220 - 250 V	1P+N+E	Polyester	31 64 015
		Metal	39 64 015
380 - 440 V	3P+E	Polyester	31 64 013
		Metal	39 64 013
Dual voltage*	3P+N+E	Polyester	31 64 017
		Metal	39 64 017

\* See Bookmark  
Other voltages, polarities: see page 8

### Socket-outlet with auxiliary contacts

With 2 auxiliary contacts (5A)	Socket # + 972
With 3 auxiliary contacts (5A)	Socket # + 263

If you want to add an option to this kind of socket-outlet: call us at +33 (0) 1 45 11 60 00.

### Socket-outlet options

IP67 watertightness	Socket # + 677
Device for self-ejecting coupler socket	Socket # + 354
Device for self-ejecting plug	Socket # + 352
Self-returning lid	Socket # + R
180°-opening lid	Socket # + 10
180°-opening and self-returning lid	Socket # + 18
Padlocking shaft up to 3 padlocks 8 mm Ø	Socket # + 844
Stop button	Socket # + 453
Rubber cover for polyester latch	Socket # + 833
Rubber cover for metal latch	Socket # + 835

If you want to equip a socket-outlet with two or more options: call us at +33 (0) 1 45 11 60 00.

## I Inlet (male)

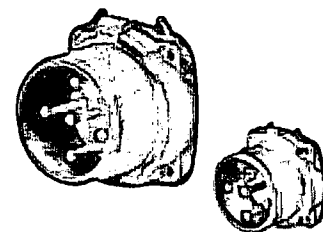

Voltage	Polarity	Material	Part #
20 - 24 V	2P	Polyester	31 68 08A
		Metal	39 68 08A
190 - 230 V	3P+E	Polyester	31 68 033
		Metal	39 68 033
220 - 250 V	1P+N+E	Polyester	31 68 015
		Metal	39 68 015
380 - 440 V	3P+E	Polyester	31 68 013
		Metal	39 68 013
380 - 440 V	3P+N+E	Polyester	31 68 017
		Metal	39 68 017

### Inlet with auxiliary contacts

With 2 auxiliary contacts (5A)	Inlet # + 972
With 3 auxiliary contacts (5A)	Inlet # + 263

### Inlet options

IP67 watertightness	Inlet # + 677
---------------------	---------------

### Inlet accessories

IP67 cap	31 6A 126
Self-closing lid	31 6A 226
Ejecting mechanism (shark fin)	31 6A 338
Tension cord	31 1A 336









**DS**





Advantages  
 Core range  
 DS1 - 30A  
 DS3 - 50A  
**DS6 - 90A**  
 DS9 - 150A  
 DS2 - 250A  
 Dimensions

**Also see:**  
 Full range of boxes page 86  
 Dimensions page 44  
 Technical Manual page 150

## Installation accessories

B	Box							
		Wall box poly 30°	Wall box poly 70°	Wall box metal 30°	Wall box metal + poly sleeve 30°	Wall box metal + metal sleeve 30°	Wall box metal + metal sleeve 70°	Wall box metal + straight metal sleeve
Entry								
M25		51 DA 058			31 6A 653 41B	39 6A 653 41B	87 6A 053 41B	39 6A 095 41B
M32		51 DA 058			31 6A 653 419	39 6A 653 419	87 6A 053 419	39 6A 095 419
M40	31 6A 053	51 DA 058	39 6A 053		31 6A 653	39 6A 653	87 6A 053	39 6A 095
M50					31 6A 653 429	39 6A 653 429	87 6A 053 429	39 6A 095 429

The boxes are supplied without any cable gland. The 70° boxes are not drilled (drilled at extra cost).





S1	Sleeve					
		Inclined poly 30°	Inclined poly 70°	Inclined metal 30°	Inclined metal 70°	Straight metal
		31 6A 027	51 DA 757	39 6A 027	87 6A 087	39 6A 127

**ZOOM**



**Handle with built-in finger draw plate**

This straight handle is recommended for in-line connections.

H	Handle					
		Straight poly	Straight poly with poly cable gland	for ejection option *	Straight metal with metal cable gland	Straight poly flowerpot with metric thread **
Tightening						
13-35 mm		31 6A 013				
13-35 mm		31 6A 473 *				
* With built-in finger draw plate (for in-line connections)						
Entry						
M25	31 6A 253 25P	13-19 mm	31 6A 443 25P	31 6A 953 25M	10-18 mm	M25 31 6A 253 41B
M32	31 6A 253 32P	17-25 mm	31 6A 443 32P	31 6A 953 32M	16-24 mm	M32 31 6A 253 419
M40	31 6A 753	24-32 mm	31 6A 463	31 6A 963	22-32 mm	M40 31 6A 253 420
M50	31 6A 253 50P	28-38 mm	31 6A 443 50P	31 6A 953 50M	29-40 mm	M50 31 6A 253 429
* Handle with eyelet for tension cord ** Cable gland on request Handles for flat or steel armoured cables on request						

**ZOOM**

### Self-ejection

To provide self-ejection to a coupler socket or to a plug, choose an appropriate device, offered as an option or accessory on the previous page. Various devices are offered depending on the DECONTACTOR™ rated current.

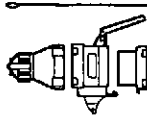
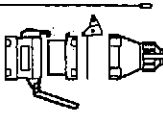
*For more information, see Technical Manual on page 168*

# DS9

# DECONTACTOR™ 150 A

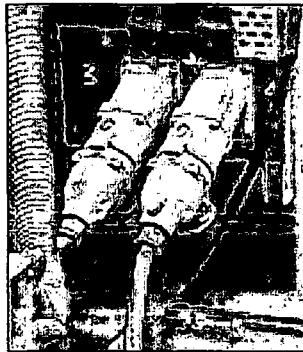

**Main features:**

• (socket-outlet) IP	55	• Wiring (minl / maxl) flexible	16 / 50 mm²
• (socket-outlet + Inlet) IP	54	• Wiring (minl / maxl) stranded	25 / 70 mm²
• IK (poly / metal)	08/09	• Other wiring on request	
• Umax	1000V AC - 250V DC	maxl flexible / stranded	70 / 95 mm²

  

• Rated currents (IEC / EN 60309-1)	150 A / 400V	125 A / 690V	90 A / 1000V
• Rated currents and operating voltages (load breaking capacity according to IEC / EN 60947-3)	150 A / 400V (AC22)	90 A / 690V (AC22)	- (-)

**Main options**

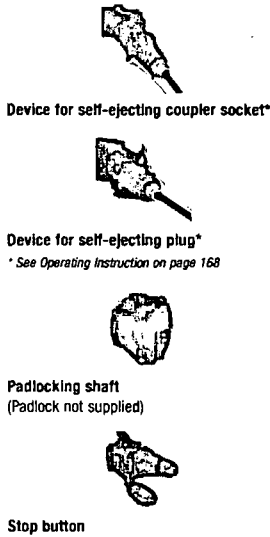

**S Socket-outlet (female)**

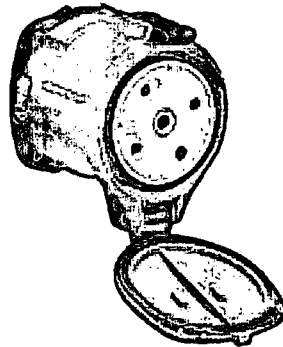

Voltage	Polarity	Material	Part #
20 - 24 V	2P	Polyester	31 94 08A
		Metal	39 94 08A
190 - 230 V	3P+E	Polyester	31 94 033
		Metal	39 94 033
220 - 250 V	1P+N+E	Polyester	31 94 015
		Metal	39 94 015
380 - 440 V	3P+E	Polyester	31 94 013
		Metal	39 94 013
Dual voltage*	3P+N+E	Polyester	31 94 017
		Metal	39 94 017

\* See Bookmark  
Other voltages, polarities: see page 8

**Socket-outlet with auxiliary contacts**

With 2 auxiliary contacts (5A)	Socket # + 972
--------------------------------	----------------

If you want to add an option to this kind of socket-outlet:  
call us at +33 (0) 1 45 11 60 00.

**Socket-outlet options**

Device for self-ejecting coupler socket	Socket # + 365
Device for self-ejecting plug	Socket # + 353
IP66 / 67 watertightness	Socket # + 687
Self-returning lid	Socket # + R
180° opening lid	Socket # + 10
180° opening and self-returning lid	Socket # + 18
Padlocking shaft up to 3 padlocks 8 mm Ø	Socket # + 844
Stop button	Socket # + 453
Rubber cover for polyester latch	Socket # + 833
Rubber cover for metal latch	Socket # + 835

If you want to equip a socket-outlet with two or more options:  
call us at +33 (0) 1 45 11 60 00.

**Socket-outlet accessories**

Closing mechanism (draw lever)	39 9A 876
--------------------------------	-----------

**I Inlet (male)**

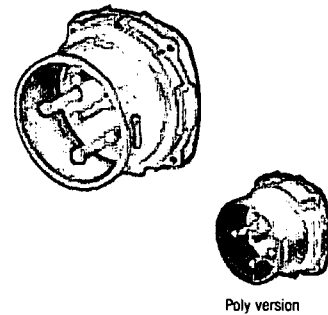

Voltage	Polarity	Material	Part #
20 - 24 V	2P	Polyester	31 98 08A
		Metal	39 98 08A
190 - 230 V	3P+E	Polyester	31 98 033
		Metal	39 98 033
220 - 250 V	1P+N+E	Polyester	31 98 015
		Metal	39 98 015
380 - 440 V	3P+E	Polyester	31 98 013
		Metal	39 98 013
380 - 440 V	3P+N+E	Polyester	31 98 017
		Metal	39 98 017

**Inlet with auxiliary contacts**

With 2 auxiliary contacts (5A)	Inlet # + 972
--------------------------------	---------------

**Inlet options**

Device for self-ejecting coupler socket	Inlet # + 204
Device for self-ejecting plug	Inlet # + 204
IP66 / 67 watertightness	Inlet # + 687

**Inlet accessories**

IP67 cap	31 9A 126
Self-closing lid	31 9A 226
Closing mechanism (draw base)	39 9A 886
Ejecting mechanism (plug release cam)	39 9A 397
Tension cord	31 1A 336

**Accessories**

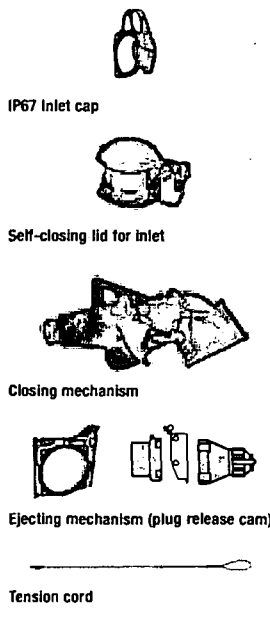





**DS**

Advantages  
 Core range  
 DS1 - 30A  
 DS3 - 50A  
 DS6 - 90A  
**DS9 - 150A**  
 DS2 - 250A  
 Dimensions





Also see:





Dimensions page 44  
 Technical Manual page 150

## Installation accessories

B Box					
	Wall box metal + metal sleeve 20°	Wall box metal + metal sleeve 70°	Wall box metal + poly sleeve 30°	Wall box metal + metal sleeve 30°	Wall box metal + straight metal sleeve
Entry					
M32	39 9A 053 419	87 9A 053 419	31 9A 653 419	39 9A 653 419	39 9A 095 419
M40	39 9A 053 420	87 9A 053 420	31 9A 653 420	39 9A 653 420	39 9A 095 420
M50	39 9A 053	87 9A 053	31 9A 653	39 9A 653	39 9A 095
M63	39 9A 053 463	87 9A 053 463	31 9A 653 463	39 9A 653 463	39 9A 095 463

The boxes are supplied without any cable gland.

Sl Sleeve				
	Inclined poly 30°	Inclined metal 70°	Inclined metal 30°	Straight metal
	31 9A 027	87 9A 087	39 9A 027	39 9A 127

H Handle					
	Straight neoprene	Straight metal	Straight poly with poly cable gland	Straight metal with metal cable gland	Straight poly flowerpot with metric threaded entry*
Tightening					
28-38mm		87 9A 013			
25-45mm	31 9A 013				
Entry					
M32	31 9A 253 32P	17-25 mm	31 9A 953 32M	16-24 mm	M32 31 9A 253 419
M40	31 9A 253 40P	24-32 mm	31 9A 953 40M	22-32 mm	M40 31 9A 253 420
M50	31 9A 753	28-38 mm	31 9A 963	29-40 mm	M50 31 9A 253 429
M63	31 9A 253 63P	34-44 mm	31 9A 953 63M	37-53 mm	M63 31 9A 253 463

\* Cable gland on request. Handle for flat or steel armoured cables on request.

### ZOOM

#### Protection against mechanical shocks

The poly and metal versions do not offer the same level of protection against mechanical shocks (IK). According to standard IEC / EN 50102, the poly version is IK08, whereas the metal version achieves IK09 (impact energy absorption up to 10 joules).

For more informations, see Technical Manual on page 164

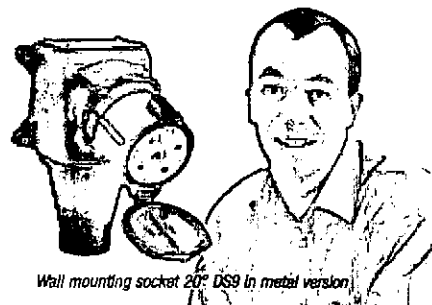

Wall mounting socket 20° DS9 in metal version

# DS2

# DECONTACTOR™ 250 A

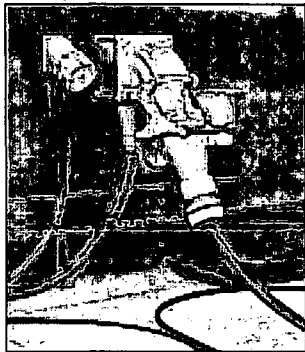

**Main features:**

• (socket-outlet) IP	55	• Wiring (min! / max!) flexible	70 / 95 mm <sup>2</sup>
• (socket-outlet + Inlet) IP	54	• Wiring (min! / max!) stranded	70 / 120 mm <sup>2</sup>
• IK (metal)	09	• Other wiring on request	
• Umax	1000V AC - 250V DC	max! flexible / stranded	150 / 185 mm <sup>2</sup>

---

• Rated currents (IEC / EN 60309-1)	250 A / 400V	200 A / 690V	150 A / 1000V
• Rated currents and operating voltages (load breaking capacity according to IEC / EN 60947-3)	250 A / 400V (AC22)	125 A / 690V (AC22)	(-)

**S Socket-outlet (female)**

**I Inlet (male)**

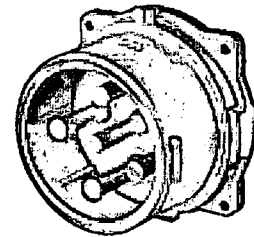
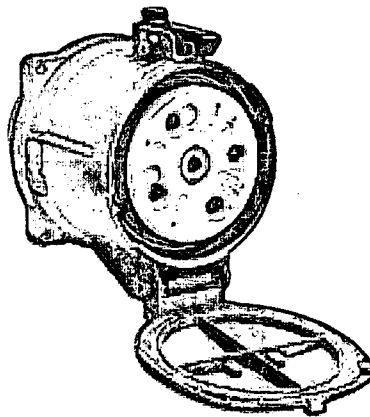

**Main options**



Device for self-ejecting coupler socket\*



Device for self-ejecting plug\*  
\* See Operating Instruction on page 168



Padlocking shaft (Padlock not supplied)



Stop button

**Accessories**



IP67 Inlet cap



Closing mechanism

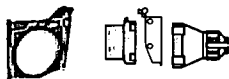

Ejecting mechanism (plug release cam)



Tension cord

Voltage	Polarity	Material	Part #
20 - 24 V	2P	Metal	39 24 08A
190 - 230 V	3P+E	Metal	39 24 033
220 - 250 V	1P+N+E	Metal	39 24 015
380 - 440 V	3P+E	Metal	39 24 013
Dual voltage*	3P+N+E	Metal	39 24 017

\* See Bookmark  
Other voltages, polarities: see page 8

**Socket-outlet with auxiliary contacts**

With 2 auxiliary contacts (5A)	Socket # + 972
--------------------------------	----------------

If you want to add an option to this kind of socket-outlet: call us at +33 (0) 1 45 11 60 00.

**Socket-outlet options**

Device for self-ejecting coupler socket	Socket # + 365
Device for self-ejecting plug	Socket # + 353
IP66 / 67 watertightness	Socket # + 687
Self-returning lid	Socket # + R
180° opening lid	Socket # + 10
180° opening and self-returning lid	Socket # + 18
Padlocking shaft up to 3 padlocks 8 mm Ø	Socket # + 844
Stop button	Socket # + 453
Rubber cover for metal latch	Socket # + 835

If you want to equip a socket-outlet with two or more options: call us at +33 (0) 1 45 11 60 00.

**Socket-outlet accessories**

Closing mechanism (draw lever)	39 2A 876
--------------------------------	-----------

Voltage	Polarity	Material	Part #
20 - 24 V	2P	Metal	39 28 08A
190 - 230 V	3P+E	Metal	39 28 033
220 - 250 V	1P+N+E	Metal	39 28 015
380 - 440 V	3P+E	Metal	39 28 013
380 - 440 V	3P+N+E	Metal	39 28 017

**Inlet with auxiliary contacts**

With 2 auxiliary contacts (5A)	Inlet # + 972
--------------------------------	---------------

**Inlet options**

Device for self-ejecting coupler socket	Inlet # + 204
Device for self-ejecting plug	Inlet # + 204
IP66 / 67 watertightness	Inlet # + 687

**Inlet accessories**

IP67 cap	31 2A 126
Closing mechanism (draw base)	39 2A 886
Ejecting mechanism (plug release cam)	39 2A 397
Tension cord	31 1A 336

**DS**

Advantages  
 Core range  
 DS1 - 30 A  
 DS3 - 50 A  
 DS6 - 90 A  
 DS9 - 150 A  
**DS2 - 250 A**  
 Dimensions

**Also see:**

Dimensions page 44  
 Technical Manual page 150.

**Installation accessories**

**B** Box

Wall box metal + metal sleeve 60°

Entry	
M63	39 2A 053

The boxes are supplied without any cable gland.

**S1** Sleeve

Inclined metal 60°

Entry	39 2A 027
-------	-----------

**H** Handle

	Straight neoprene	Straight metal	Straight poly with poly cable gland	Straight poly flowerpot with metric thread *
Tightening				
34 - 58 mm	39 2A 013			
40 - 54 mm		39 2A 913		
			Entry	
			M63	39 2A 753
			34 - 44 mm	M63 39 2A 253 463

\* Cable gland not included Handles for flat or steel armoured cables on request

**ZOOM**

Wall mounting appliance inlet 60°

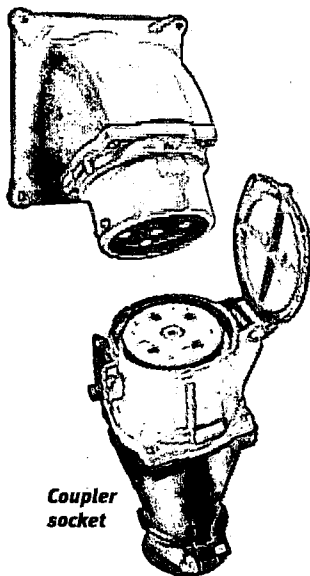

Coupler socket

**DS2: load breaking capacity up to 250 A!**

DS2 is the top of the DECONTACTOR™ range in terms of power: indeed, it can break up to 250 A - 400 V.

Its robust design makes it ideal for heavy-duty industrial applications:

- power supply to medium pumps and motors in places near heat sources: industrial machines and equipment,
- power supply to excavating machines: mines and quarries,
- steel, metallurgy, boiler construction,
- power supply to rocket launch pads, power supply to aircraft on the ground and to aircraft maintenance hangars: aeronautics, aerospace.

Note: With the dimensions of the DS2, a DS4 reaching 400 A is available on request. At that level of power, electric locking is essential, provided by a switch or a contactor controlled by the pilot contacts of the DS4.

Wall mounting socket 60°

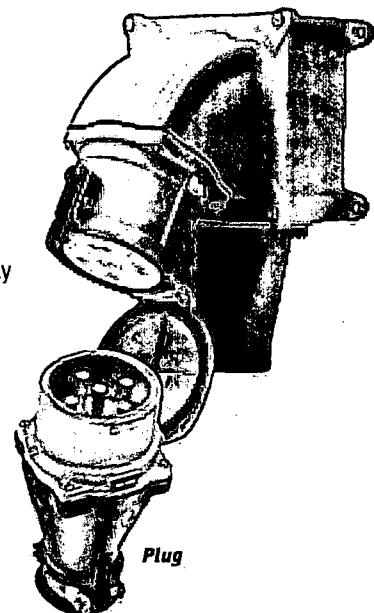

Plug

# DS range dimensions

## Socket-outlet + plug

**Plug**

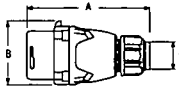

	A	B	Ø
DS1/DS24C	144	70	5-21
DS3/DS37C	148	82	10-30
DS6/DS7C3	175	98	13-36
DS9	195	125	25-45
DS2/DS7C9	260	141	40-58

► **Socket-outlet**

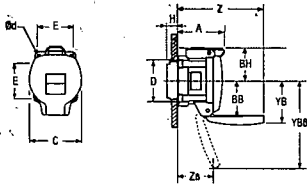

YBB : 180° OPENING LID

	A	BB	BH	C	D	E	H	YB	YB8	Z	ZB	Ød
DS1/DS24C	64.9	50	45	69	58	48.1	15	65	108	120.6	75.9	5
DS3/DS37C	68.6	54.5	53.5	80	70	55.1	21	100	132	121	57.5	5
DS6/DS7C3	76.2	62.5	60	98	80	65.8	27	110	152	146.2	86.7	5.5
DS9	113.1	75	70	113	100	81.3	24	137	197.1		6	
DS2/DS7C9	109.5	75	92	131	118	98	38	115	212.9		6.5	

► **Plug connected (A1)/  
disconnected (A0)  
in a socket-outlet**

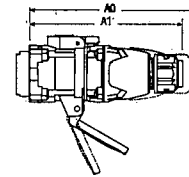

	A1	A0
DS1/DS24C	166	182
DS3/DS37C	174	190
DS6/DS7C3	197	221
DS9	246	275
DS2/DS7C9	310	341

► **30° wall mounting socket**

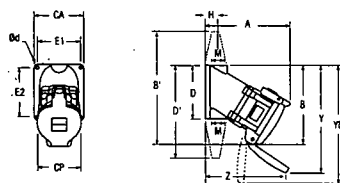

YB : 180° OPENING LID

	A	B	B'	CA	CP	D	E1	E2	H	Y	YB	Z	Ød
DS1/DS24C	135	128		84	69	84	70	70	17.5	175	189	128	6
DS3/DS37C	154	151		89	80	100	77	88	24	216	216	129	6.5
DS6/DS7C3 POLY	192	185		105	98	128	89	112	31	262	269	168	7.5
DS6/DS7C3 METAL	173	151		80	98	130	105	105	27.5	220	239	181	7
DS9	250	188	285	138	113	285	163	116	50	279		258	7
DS2/DS7C9 (60°)	314	256	315	180	131	315	212	154	50	379		187	10

► **Plug connected (A1)/  
disconnected (A0) in a  
30° wall mounting socket**

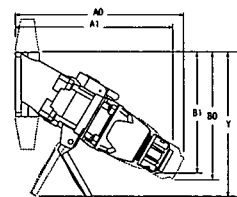

YB : 180° OPENING LID

	A1	A0	B1	B0	Y	YB
DS1/DS24C	211	225	161	169	175	189
DS3/DS37C	232	246	184	192	216	216
DS6/DS7C3 POLY	283	304	220	232	262	269
DS6/DS7C3 METAL	268	289	193	205	220	239
DS9	355	380	243	258	279	
DS2/DS7C9 (60°)	383	399	433	460	379	

► **70° wall mounting socket**

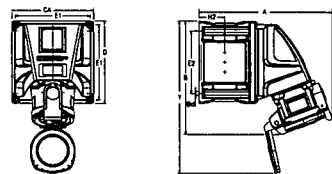

YB : 180° OPENING LID

	A	B	CA	D	E	E1	E2	H2	Y	Ød
DS1/DS24C	205	175	127	127		116	96	39	234	6.5
DS3/DS37C	231	219	170	170	158	159	139	39	289	6.5
DS6/DS7C3 POLY	238	237	170	170	158	159	139	39	316	6.5

► **Plug connected (A1)/  
disconnected (A0) in a  
70° wall mounting socket**

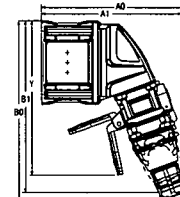

	A1	A0	B1	B0	Y
DS1/DS24C	213	219	260	276	234
DS3/DS37C	245	253	313	335	289
DS6/DS7C3 POLY	251	260	338	362	316

► **30° inclined socket**

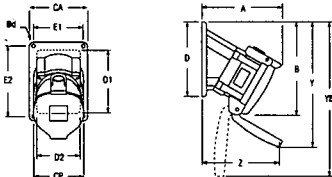

YB : 180° OPENING LID

	A	B	CA	CP	D	D1	D2	E1	E2	Y	YB	Z	Ød
DS1/DS24C	116	137	76	69	107	65	62	63	95	184	198	109	5.5
DS3/DS37C	125	145	76	80	107	65	68	63	95	210	210	109	5.5
DS6/DS7C3	138	177	102	98	136	111	90	87.3	122	254	261	114	6.5
DS9	200	198	140	113	142	110	100	123.8	123.8	299		169	7
DS2/DS7C9 (60°)	223	249	183	131	183	150	150	165	165	380		96	7

► **Plug connected (A1)/  
disconnected (A0) in a  
30° inclined socket**

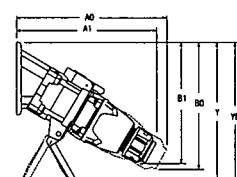

YB : 180° OPENING LID

	A1	A0	B1	B0	Y	YB
DS1/DS24C	192	206	170	178	184	198
DS3/DS37C	203	217	178	186	210	210
DS6/DS7C3	229	250	212	224	254	261
DS9	302	327	242	257	299	
DS2/DS7C9 (60°)	292	308	347	374	293	

► **70° inclined socket**

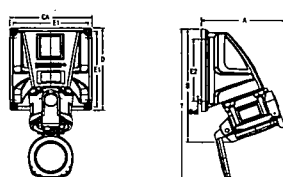

	A	B	Ca	D	E1	Y	Ød
DS1/DS24C	127	175	127	127	116	234	4.2
DS3/DS37C	153	219	170	170	159	289	4.2
DS6/DS7C3 POLY	160	237	170	170	159	316	4.2

► **Plug connected (A1)/  
disconnected (A0) in a  
70° inclined socket**

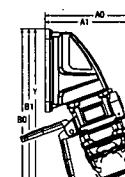

	A1	A0	B1	B0	Y
DS1/DS24C	135	141	260	276	234
DS3/DS37C	167	175	313	335	289
DS6/DS7C3 POLY	173	182	338	362	316

# DS

**Advantages**  
 Core range  
 DS1 - 30A  
 DS3 - 50A  
 DS6 - 90A  
 DS9 - 150A  
 DS2 - 250A  
**Dimensions**

## Coupler socket + inlet

	A	B	Ø
DS1/DS24C	160	95	5-21
DS3/DS37C	165	108	10-30
DS6/DS7C3	179	123	13-36
DS9	227	145	25-45
DS2/DS7C9	291	167	40-58

▶ **Inlet**

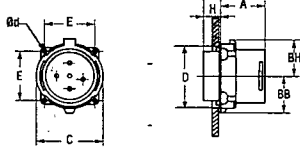

	A	BB	BH	C	D	E	H	Ød
DS1/DS24C	48	32.5	37	66.5	58	48.1	14	5
DS3/DS37C	52	37.5	44.5	78	70	55.1	18	5
DS6/DS7C3	56	45	53	92	80	65.8	27	5.5
DS9	71	61	64	113	100	81.3	26	6
DS2/DS7C9	79	73	68	130	118	98	40	6.5

▶ **Coupler socket connected (A<sub>1</sub>) / disconnected (A<sub>0</sub>) in an inlet**

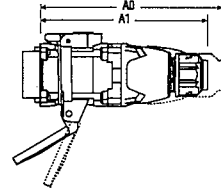

	A1	A0
DS1/DS24C	166	182
DS3/DS37C	174	190
DS6/DS7C3	197	221
DS9	246	275
DS2/DS7C9	310	341

▶ **30° wall mounting appliance inlet**

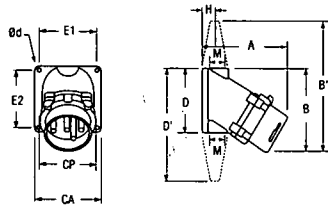

	A	B	B'	CA	CP	D	E1	E2	H	Ød
DS1/DS24C	111	105		84	67	84	70	70	17.5	6
DS3/DS37C	129	126		89	66	100	77	88	24	6.5
DS6/DS7C3 POLY	170	158		105	92	128	89	112	31	7.5
DS6/DS7C3 METAL	150	121		127	92	130	105	105	27.5	7
DS9	203	153	320	183	113	285	163	116	50	7
DS2/DS7C9 (60°)	267	233	400	226	130	315	212	154	50	10

▶ **Coupler socket connected (A<sub>1</sub>) / disconnected (A<sub>0</sub>) in a 30° wall mounting appliance inlet**

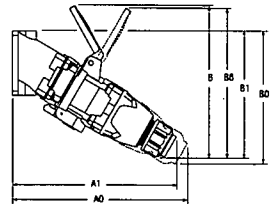

B8 : 180° OPENING LID

	A1	A0	B	B1	B0	B8
DS1/DS24C	211	225	184	161	169	199
DS3/DS37C	232	246	215	184	192	215
DS6/DS7C3 POLY	283	304	248	220	232	254
DS6/DS7C3 METAL	268	289	248	193	205	
DS9	355	380	311	243	258	
DS2/DS7C9 (60°)	383	399	427	433	460	

▶ **70° wall mounting appliance inlet**

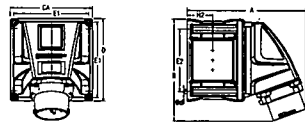

	A	B	Ca	D	E	E1	E2	H2	Ød
DS1/DS24C	182	157	127	127		116	96	39	6.5
DS3/DS37C	208	201	170	170	158	159	139	39	6.5
DS6/DS7C3 POLY	212	212	170	170	158	158	159	39	6.5

▶ **Coupler socket connected (A<sub>1</sub>) / disconnected (A<sub>0</sub>) in a 70° wall mounting appliance inlet**

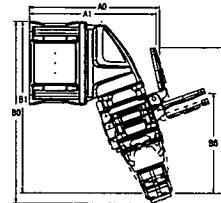

	A1	A0	B	B1	B0	B8
DS1/DS24C	193	199	221	260	276	151
DS3/DS37C	225	217	249	313	334	180
DS6/DS7C3 POLY	245	261	282	338	362	210

▶ **30° inclined appliance inlet**

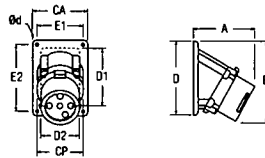

D1 : drilling Ø

	A	B	CA	CP	D	D1	D2	E1	E2	Ød
DS1/DS24C	92	114	76	67	107	65	62	63	95	5.5
DS3/DS37C	100	120	76	66	107	65	68	63	95	5.5
DS6/DS7C3	109	146	102	92	136	111	90	87.3	122	6.5
DS9	153	159	140	113	142	110	100	123.8	123.8	7
DS2/DS7C9 (60°)	176	226	183	130	183	150	150	165	165	7

▶ **Coupler socket connected (A<sub>1</sub>) / disconnected (A<sub>0</sub>) in a 30° inclined appliance inlet**

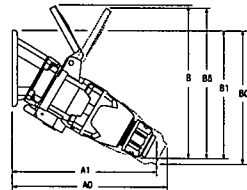

B8 : 180° OPENING LID

	A1	A0	B	B1	B0	B8
DS1/DS24C	192	206	184	170	178	199
DS3/DS37C	203	217	215	178	186	215
DS6/DS7C3	229	250	248	212	224	254
DS9	302	327	311	242	257	
DS2/DS7C9 (60°)	292	308	427	347	374	

▶ **70° inclined appliance inlet**

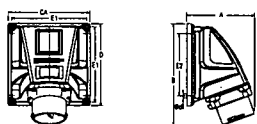

	A	B	CA	D	E1	Ød
DS1/DS24C	104	157	127	127	116	4.2
DS3/DS37C	130	201	170	170	159	4.2
DS6/DS7C3	134	212	170	170	159	4.2

▶ **Coupler socket connected (A<sub>1</sub>) / disconnected (A<sub>0</sub>) in a 70° inclined appliance inlet**

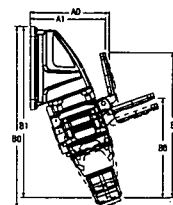

	A1	A0	B	B1	B0	B8
DS1/DS24C	115	121	221	260	276	151
DS3/DS37C	139	147	249	313	334	180
DS6/DS7C3	167	183	282	338	362	210

# Multicontact Plugs and socket-outlets

## The range

Advantages	p. 70
Features	p. 71
PN12c - 5 / 10 A	p. 72
DSN24c - 5 A	p. 74
DSN37c - 5 A	p. 76
PN7c - 16 / 25 A	p. 78
DN9c - 30 A	p. 80
DN20c - 25 A	p. 82

Spare parts: see pages 172, 174 and 175

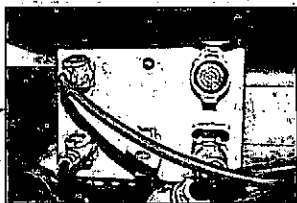
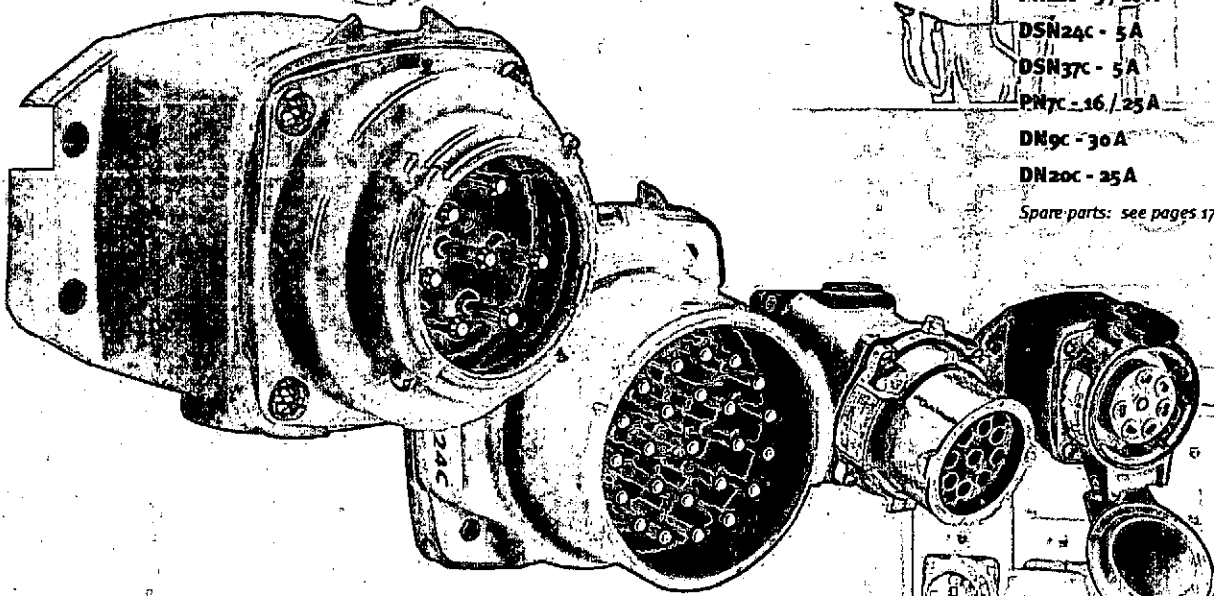

Town equipment, emergency vehicles

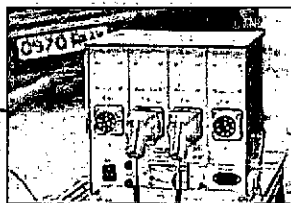

Telephone line connections



Wastewater treatment

And lighting circuits for tunnels, food & beverage industries, chemical industries, small pumps and small motors in locations next to heat sources, etc.

## Combining low currents and high current contacts

MARECHAL ELECTRIC multicontact plugs and socket-outlets are used for signal and control purposes. They convey information (power) and signals (low voltage). Example: telephone line connection, travelling crane controls ...

The silver-nickel alloy used for the contact tips provides optimum conductivity and high durability (several thousand cycles). The casings provide high resistance to the most extreme conditions of use.



### Multicontact plugs & sockets

**Advantages**  
 PN12c - 5/10 A  
 DSN24c - 5 A  
 DSN37c - 5 A  
 PN7c - 16/25 A  
 DN9c - 30 A  
 DN20c - 25 A

### Selection guide

Contacts	5	6	7	9	12	20	24	37
<b>Rated current</b>								
5 A						<b>DSN24c</b>	<b>DSN37c</b>	
10 A	<b>PN12c</b>							
16 A								
25 A	<b>PN7c</b>	<b>DN20c</b>						
30 A	<b>DN9c</b>							

**PN12c    PN7c    DSN24c & 37c    DN9c & 20c**

#### Electrical features

Plugs and socket-outlets for applications where low voltage signals are combined with high currents.

6 to 9 contacts (DN9c) and 6 to 20 contacts (DN20c)

Compact plug and socket-outlet      6 to 12 contacts      6 to 24 contacts (DSN24c) and 25 to 37 contacts (DSN37c)

Current	5 to 10 A	16 to 25 A	5 to 10 A	25 to 30 A
Voltage	max. 500 VAC (1) / 130 VDC		max. 415 VAC / 130 VDC	max. 480 VAC / 130 VDC

Contacts      Silver-nickel butt-contacts with metal braid

Active parts protected (with socket-outlet lid open)	IP2X	IP2X	IP2X	IP2X
Keying system (2)	6	5	3	from 2 (DN9c) to 4 (DN20c)

#### Mechanical features

Automatic watertightness (3)	IP66/67	IP66/67	IP66/67	IP54/55
Watertightness <small>version with self-closing lid</small>	IP55	IP55		
Wiring (terminals) to be ...	soldered	mechanical	soldered	mechanical
Casing in metal (4)	✓	✓		✓
Ambient temperature	-40 °C to +60 °C (for temperatures outside this range, please contact us)			
Casing in polyester (5)	✓	✓	✓	
Ambient temperature	-40 °C to +60 °C (for temperatures outside this range, please contact us)			

(1) metal version: 415 V max

(2) allows discrimination between several different power supplies (voltage, frequency, AC and DC current)

(3) achieved as soon as the plug is fully inserted into the socket-outlet or when the socket lid is closed. No rings to turn.

(4) anti-corrosion treated metal providing high temperature resistance and excellent mechanical resistance (IK09 impact resistance)

(5) glass fibre reinforced polyester providing excellent electric insulation, high resistance to corrosive, UV and chemical agent environments and high mechanical resistance (IK08 impact resistance)

# PN12C

Multicontact

## Plugs and socket-outlets 6 to 12 contacts / 5 or 10 A

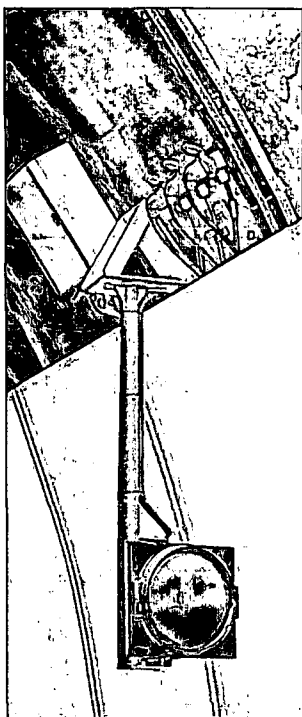

**Main features:**

- (socket-outlet) IP 54 or 66/67
- (socket-outlet + inlet) IP 54 or 66/67
- IK (poly/metal) 08/09
- U<sub>max</sub> AC 500V
- Wiring (min - max) flexible 1 / 1.5 mm<sup>2</sup>
- Wiring (min - max) stranded 1.5 / 2.5 mm<sup>2</sup>
- Keying positions 6

### S Socket-outlet (female)

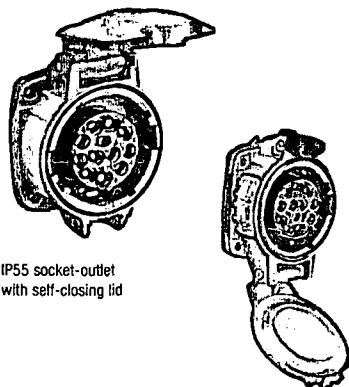

IP55 socket-outlet with self-closing lid

### I Inlet (male)

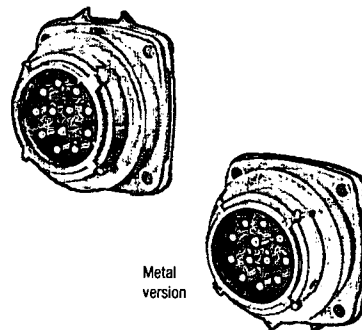

Metal version

**Main options**

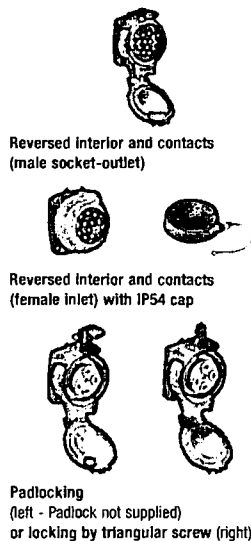

Reversed interior and contacts (male socket-outlet)

Reversed interior and contacts (female inlet) with IP54 cap

Padlocking (left - Padlock not supplied) or locking by triangular screw (right)

For use in highly aggressive environments and/or intensive uses (several thousand cycles), change the letter M for an L. The rated current will be 2 Amps.

**Accessories**



IP67 inlet cap

Polarity	Poly version		Metal version	
	U/I *	Part #	U/I *	Part #
6P	50/10	01 M4 060	50/10	09 M4 060
7P	50/5	01 M4 070	50/5	09 M4 070
8P	50/5	01 M4 080	50/5	09 M4 080
9P	50/5	01 M4 090	50/5	09 M4 090
10P	50/5	01 M4 100	50/5	09 M4 100
11P	50/5	01 M4 110	50/5	09 M4 110
12P	50/5	01 M4 120	50/5	09 M4 120
5P+E	500/10	01 M4 051	415/10	09 M4 051
6P+E	500/5	01 M4 061	415/5	09 M4 061
7P+E	500/5	01 M4 071	415/5	09 M4 071
8P+E	500/5	01 M4 081	415/5	09 M4 081
9P+E	500/5	01 M4 091	415/5	09 M4 091
10P+E	500/5	01 M4 101	415/5	09 M4 101
11P+E	500/5	01 M4 111	415/5	09 M4 111

\* Maximum voltage (V) / Rated current (A)

Polarity	Poly version		Metal version	
	U/I *	Part #	U/I *	Part #
6P	50/10	01 M8 060	50/10	09 M8 060
7P	50/5	01 M8 070	50/5	09 M8 070
8P	50/5	01 M8 080	50/5	09 M8 080
9P	50/5	01 M8 090	50/5	09 M8 090
10P	50/5	01 M8 100	50/5	09 M8 100
11P	50/5	01 M8 110	50/5	09 M8 110
12P	50/5	01 M8 120	50/5	09 M8 120
5P+E	500/10	01 M8 051	415/10	09 M8 051
6P+E	500/5	01 M8 061	415/5	09 M8 061
7P+E	500/5	01 M8 071	415/5	09 M8 071
8P+E	500/5	01 M8 081	415/5	09 M8 081
9P+E	500/5	01 M8 091	415/5	09 M8 091
10P+E	500/5	01 M8 101	415/5	09 M8 101
11P+E	500/5	01 M8 111	415/5	09 M8 111

\* Maximum voltage (V) / Rated current (A)

**Version with self-closing lid (IP55):**

Choose from the part numbers above and change letter M for a T.

**Socket-outlet options**

Reversed interior and contacts	Socket # + 001
Self-returning lid *	Socket # + R
180°-opening lid	Socket # + 10
180°-opening and self-returning lid *	Socket # + 18
Padlocking (padlock 4 mm Ø) without shaft *	Socket # + 843
Locking by triangular screw *	Socket # + 22

\* except for IP55 version

**Inlet options**

Reversed interior and contacts	Inlet # + 137
--------------------------------	---------------

**Inlet accessories**

IP67 cap <sup>1</sup>	01 NA 126
-----------------------	-----------

If you want to equip a socket with two or more options: call us at +33 (0) 1 45 11 60 00.

### Multicontact plugs & sockets

Advantages  
**PN12C - 5 / 10 A**  
 DSN24C - 5 A  
 DSN37C - 5 A  
 PN7C - 16 / 25 A  
 DN9C - 30 A  
 DN20C - 25 A

**Also see:**

Full range of boxes page 86  
 Dimensions page 68  
 Technical Manual page 150

## Installation accessories

**B**

**Box**



Wall box poly 30°



Wall box straight metal



Wall box straight poly



Wall box poly 70°



Wall box metal + metal sleeve 45°

Entry

M20	01 NA 053	09 NA 055	01 NA 055	51 AA 058	09 NA 653
M25				51 AA 058	09 NA 653 418
M32				51 AA 058	09 NA 653 419

The boxes are supplied without any cable gland. The 70° boxes are not drilled (drilled at extra cost)

**Si**

**Sleeve**



Inclined poly 30°



Inclined metal 30°



Inclined poly 70°



Inclined metal 45°

01 NA 027	09 NA 027	51 AA 757	09 2A 027
-----------	-----------	-----------	-----------

**H**

**Handle**



Straight poly



Angled poly



Straight poly with poly cable gland



Straight metal with metal cable gland



Straight poly flowerpot with metric threaded entry \*

Cable dia.

8-18 mm	01 NA 013	01 NA 313
5-21 mm	61 1A 413	

Cable dia.

6-12 mm	01 NA 753
13-18 mm	01 NA 253 25P
18-25 mm	01 NA 253 32P

Cable dia.

6-12 mm	09 NA 963
10-18 mm	09 NA 953 25M
16-24 mm	09 NA 953 32M

Entry

M20	01 NA 253 417
M25	01 NA 253 418
M32	01 NA 253 419

Handle for flat or steel armoured cables on request (see zoom below).

\* Cable gland on request.

**ZOOM**



### Our solutions for flat or steel armoured cables

You need a handle designed for flat or steel armoured cables?  
 Call us at 01 45 11 60 00.



Handle for flat cables

# DSN24C Plugs and socket-outlets

## 13 to 24 contacts / 5A

Multicontact

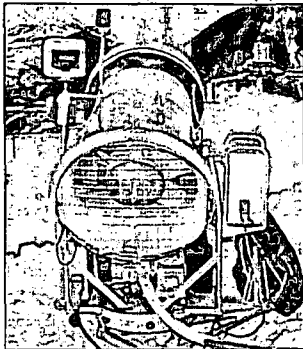

**Main features:**

- (socket-outlet) IP 66/67
- (socket-outlet + inlet) IP 66/67
- IK (poly) 08
- Um<sub>ax</sub> AC 415V
- Wiring (min - max) flexible 1 / 1.5 mm<sup>2</sup>
- Wiring (min - max) stranded 1.5 / 2.5 mm<sup>2</sup>
- Keying positions 3

**S Socket-outlet (female)**

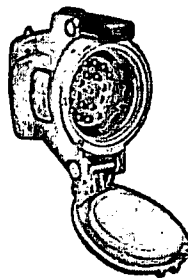

**I Inlet (male)**

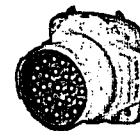

**Main options**

Device for self-ejecting coupler socket / plug\*  
\* See Operating Instruction on page 168

Padlocking shaft  
(Padlock not supplied)

Stop button

For use in highly aggressive environments and/or intensive uses (several thousand cycles), change the figure 0 for an L. The rated current will be 2 Amps.

**Accessories**

IP67 Inlet cap

Self-closing lid for inlet

Closing mechanism  
(finger draw plates sold per unit)

Ejecting mechanism (shark fin)

Tension cord

Polarity	U/I *	Material	Part #
13P	50/5	Poly	61 04 130
14P	50/5	Poly	61 04 140
15P	50/5	Poly	61 04 150
16P	50/5	Poly	61 04 160
17P	50/5	Poly	61 04 170
18P	50/5	Poly	61 04 180
19P	50/5	Poly	61 04 190
20P	50/5	Poly	61 04 200
21P	50/5	Poly	61 04 210
22P	50/5	Poly	61 04 220
23P	50/5	Poly	61 04 230
24P	50/5	Poly	61 04 240
13P+E	415/5	Poly	61 04 131
14P+E	415/5	Poly	61 04 141
15P+E	415/5	Poly	61 04 151
16P+E	415/5	Poly	61 04 161
17P+E	415/5	Poly	61 04 171
18P+E	415/5	Poly	61 04 181
19P+E	415/5	Poly	61 04 191
20P+E	415/5	Poly	61 04 201
21P+E	415/5	Poly	61 04 211
22P+E	415/5	Poly	61 04 221
23P+E	415/5	Poly	61 04 231

\* Maximum voltage (V) / Rated current (A)

**Socket-outlet options**

Device for self-ejecting coupler socket	Socket # + 354
Device for self-ejecting plug	Socket # + 352
Self-returning lid	Socket # + R
180° opening lid	Socket # + 10
180° opening and self-returning lid	Socket # + 18
Padlocking shaft for 1 padlock 3 mm Ø	Socket # + 840
Padlocking shaft up to 3 padlocks 3 mm Ø	Socket # + 844
Stop button	Socket # + 453

**Socket-outlet accessories**

Closing mechanism (finger draw plate)	61 3A 346
---------------------------------------	-----------

Polarity	U/I *	Material	Part #
13P	50/5	Poly	61 08 130
14P	50/5	Poly	61 08 140
15P	50/5	Poly	61 08 150
16P	50/5	Poly	61 08 160
17P	50/5	Poly	61 08 170
18P	50/5	Poly	61 08 180
19P	50/5	Poly	61 08 190
20P	50/5	Poly	61 08 200
21P	50/5	Poly	61 08 210
22P	50/5	Poly	61 08 220
23P	50/5	Poly	61 08 230
24P	50/5	Poly	61 08 240
13P+E	415/5	Poly	61 08 131
14P+E	415/5	Poly	61 08 141
15P+E	415/5	Poly	61 08 151
16P+E	415/5	Poly	61 08 161
17P+E	415/5	Poly	61 08 171
18P+E	415/5	Poly	61 08 181
19P+E	415/5	Poly	61 08 191
20P+E	415/5	Poly	61 08 201
21P+E	415/5	Poly	61 08 211
22P+E	415/5	Poly	61 08 221
23P+E	415/5	Poly	61 08 231

\* Maximum voltage (V) / Rated current (A)

**Inlet accessories**

IP67 cap	61 3A 126
Self-closing lid	31 1A 226
Closing mechanism (finger draw plate)	61 3A 346
Ejecting mechanism (shark fin)	61 3A 338
Tension cord	31 1A 336

If you want to equip a socket-outlet with two or more options: call us at +33 (0) 1 45 11 60 00.







### Multicontact plugs & sockets

*Advantages*  
 PN12C - 5/30 A  
**DSN24C - 5 A**  
 DSN37C - 5 A  
 PN7C - 16/25 A  
 DN9C - 30 A  
 DN20C - 25 A





**Also see:**





Full range of boxes page 86  
 Dimensions page 28  
 Technical Manual page 150

## Installation accessories

B Box						
	Wall box poly 30°	Wall box poly 70°	Wall box metal 30°	Wall box metal + poly sleeve 30°	Wall box metal + metal sleeve 30°	Wall box metal + straight metal sleeve
Entry						
M20	61 3A 053	51 BA 058	69 3A 053	61 3A 653	69 3A 653	69 3A 095
M25	61 3A 083	51 BA 058		61 3A 653 418	69 3A 653 418	69 3A 095 418
M32		51 BA 058		61 3A 653 419	69 3A 653 419	69 3A 095 419
M40				61 3A 653 420	69 3A 653 420	69 3A 095 420

The boxes are supplied without any cable gland. The 70° boxes are not drilled (drilled at extra cost).

S1 Sleeve				
	Inclined poly 30°	Inclined poly 70°	Straight metal	Inclined metal 30°
	61 3A 027	51 BA 757	69 3A 127	69 3A 027

H Handle					
	Straight poly	Straight poly with poly cable gland	for ejection option*	Straight metal with metal cable gland	Straight poly flowerpot with metric threaded entry*
Cable dia.	5-21mm	61 3A 013		6-12mm 10-18mm	
				61 3A 963 61 3A 953 25M	

Handle for flat or steel armoured cables on request.

\* Handle with eyelet for tension cord

\* Cable gland on request.

**ZOOM**

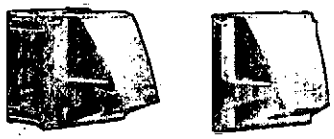

**Wall boxes and 70° sleeves**

These wall boxes are designed for:

- easy wiring, recommended for large conductor cross-sections (up to 5 x 35 mm<sup>2</sup>)
- entries and exits either at top, bottom or sides
- stock reduction, as the same wall box is common to several products

The sleeves are angled (70°) to reduce the socket-outlet protrusion and impact risk (fork lifts ...).

*See full range of boxes on page 86*

**ZOOM**

**Self-ejection**

Both DSN sockets and plugs can be modified for self-ejection purposes eg for use on vehicles, movable vessels, trailers etc.

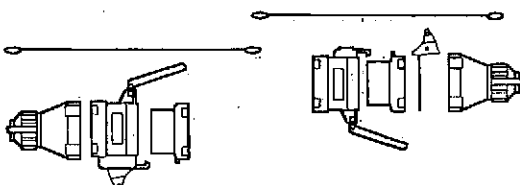

*See page 168 for guidance notes or contact us with your application for assistance.*

# DSN37C

Multicontact

# Plugs and socket-outlets

## 25 to 37 contacts / 5A

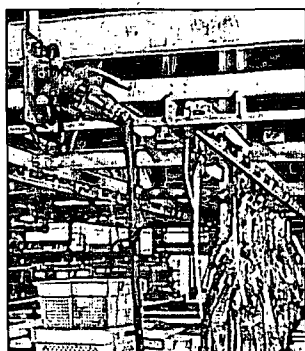

**Main features:**

- (socket-outlet) IP 66/67
- (socket-outlet + inlet) IP 66/67
- IK (poly) 08
- Umax AC 415V
- Wiring (min - max) flexible 1 / 1.5 mm<sup>2</sup>
- Wiring (min - max) stranded 1.5 / 2.5 mm<sup>2</sup>
- Keying positions 3

**Main options:**



Device for self-ejecting coupler socket / plug\*

\* See Operating Instruction on page 168



Padlocking shaft  
(Padlock not supplied)



Stop button

For use in highly aggressive environments and/or intensive use (several thousand cycles), change the figure 0 for an L. The rated current will be 2 Amps.

**Accessories:**



IP67 Inlet cap



Self-closing lid for inlet



Ejecting mechanism (shark fin)



Tension cord

**S Socket-outlet (female)**

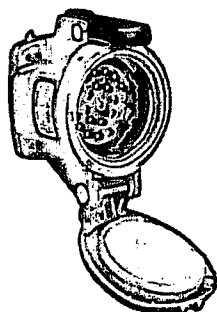

**I Inlet (male)**

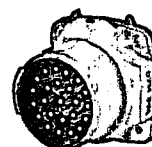

Polarity	U/I *	Material	Part #
25P	50/5	Poly	61 04 250
26P	50/5	Poly	61 04 260
27P	50/5	Poly	61 04 270
28P	50/5	Poly	61 04 280
29P	50/5	Poly	61 04 290
30P	50/5	Poly	61 04 300
31P	50/5	Poly	61 04 310
32P	50/5	Poly	61 04 320
33P	50/5	Poly	61 04 330
34P	50/5	Poly	61 04 340
35P	50/5	Poly	61 04 350
36P	50/5	Poly	61 04 360
37P	50/5	Poly	61 04 370
25P+E	415/5	Poly	61 04 251
26P+E	415/5	Poly	61 04 261
27P+E	415/5	Poly	61 04 271
28P+E	415/5	Poly	61 04 281
29P+E	415/5	Poly	61 04 291
30P+E	415/5	Poly	61 04 301
31P+E	415/5	Poly	61 04 311
32P+E	415/5	Poly	61 04 321
33P+E	415/5	Poly	61 04 331
34P+E	415/5	Poly	61 04 341
35P+E	415/5	Poly	61 04 351
36P+E	415/5	Poly	61 04 361

\* Maximum voltage (V) / Rated current (A)

**Socket-outlet options**

Device for self-ejecting coupler socket	Socket # + 354
Self-returning lid	Socket # + R
180°-opening lid	Socket # + 10
180°-opening and self-returning lid	Socket # + 18
Padlocking shaft for 1 padlock 3 mm Ø	Socket # + 840
Padlocking shaft up to 3 padlocks 3 mm Ø	Socket # + 844
Stop button	Socket # + 453

Polarity	U/I *	Material	Part #
25P	50/5	Poly	61 08 250
26P	50/5	Poly	61 08 260
27P	50/5	Poly	61 08 270
28P	50/5	Poly	61 08 280
29P	50/5	Poly	61 08 290
30P	50/5	Poly	61 08 300
31P	50/5	Poly	61 08 310
32P	50/5	Poly	61 08 320
33P	50/5	Poly	61 08 330
34P	50/5	Poly	61 08 340
35P	50/5	Poly	61 08 350
36P	50/5	Poly	61 08 360
37P	50/5	Poly	61 08 370
25P+E	415/5	Poly	61 08 251
26P+E	415/5	Poly	61 08 261
27P+E	415/5	Poly	61 08 271
28P+E	415/5	Poly	61 08 281
29P+E	415/5	Poly	61 08 291
30P+E	415/5	Poly	61 08 301
31P+E	415/5	Poly	61 08 311
32P+E	415/5	Poly	61 08 321
33P+E	415/5	Poly	61 08 331
34P+E	415/5	Poly	61 08 341
35P+E	415/5	Poly	61 08 351
36P+E	415/5	Poly	61 08 361

\* Maximum voltage (V) / Rated current (A)

**Inlet accessories**

IP67 cap	61 6A 126
Self-closing lid	31 3A 226
Ejecting mechanism (shark fin)	61 6A 338
Tension cord	31 1A 336

If you want to equip a socket-outlet with two or more options: call us at +33 (0) 1 45 11 60 00

**Multicontact  
plugs & sockets**

Advantages  
 PN12C - 5/10 A  
 DSN24C - 5 A  
**DSN37C - 5 A**  
 PN7C - 16/25 A  
 DN9C - 30 A  
 DN20C - 25 A

**Also see:**

Full range of boxes page 86  
 Dimensions page 28  
 Technical Manual page 150

**Installation accessories**

<b>B</b> Box							
	Wall box poly 30°	Wall box poly 70°	Wall box metal 30°	Wall box metal + poly sleeve 30°	Wall box metal + metal sleeve 30°	Wall box metal + straight metal sleeve	Wall box metal + metal sleeve 70°
Entry							
M20		51 CA 058		61 6A 653 417	69 6A 653 417	69 6A 095 417	87 3A 053 417
M25	61 6A 053	51 CA 058	69 6A 053	61 6A 653	69 6A 653	69 6A 095	87 3A 053
M32		51 CA 058		61 6A 653 419	69 6A 653 419	69 6A 095 419	87 3A 053 419
M40		51 CA 058		61 6A 653 420	69 6A 653 420	69 6A 095 420	87 3A 053 420

The boxes are supplied without any cable gland. The 70° boxes are not drilled (drilled at extra cost).

<b>S</b> Sleeve					
	Inclined poly 30°	Inclined poly 70°	Straight metal	Inclined metal 30°	Inclined metal 70°
	61 6A 027	51 CA 757	69 6A 127	69 6A 027	87 3A 087

**ZOOM**

**Handle with built-in finger draw plate**

This straight handle is recommended for in-line connections.

<b>H</b> Handle					
	Straight poly	Straight poly with poly cable gland	for ejection option *	Straight metal with metal cable gland	Straight poly flowerpot with metric threaded entry *
Cable dia.		Cable dia.		Cable dia.	Entry
10-30mm	61 6A 013	6-12mm	61 6A 253 20P 61 6A 443 20P	6-12mm	M20 61 6A 253 417
10-30mm	61 6A 473 *	13-18mm	61 6A 753 81 6A 463	13-18mm	M25 61 6A 253 418
		18-25mm	61 6A 253 32P 61 6A 443 32P	18-25mm	M32 61 6A 253 419
		22-32mm	61 6A 253 40P 61 6A 443 40P	22-32mm	M40 61 6A 253 420

\* With built-in finger draw plate (for in-line connections)

Handle for flat or steel armoured cables on request.

\* Handle with eyelet for tension cord

\* Cable gland on request.

**ZOOM**

**Perfect cable fit and broad tightening range**

A special anchoring system provides a perfect cable fit and a broad tightening range (multi-layer bush to choose best cable fit).

# PN7C

Multicontact

## Plugs and socket-outlets 6 to 7 contacts / 16 or 25 A

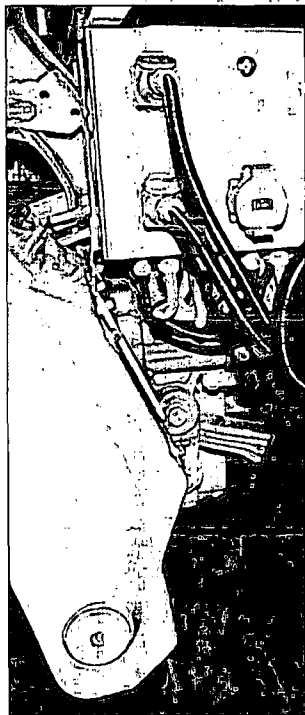

### Main features:

- (socket-outlet) IP 54 or 66/67
- (socket-outlet + inlet) IP 54 or 66/67
- IK (poly/metal) 08/09
- Umex AC 500V
- Wiring (min - max) flexible 1.5 / 4 mm<sup>2</sup>
- Wiring (min - max) stranded 2.5 / 6 mm<sup>2</sup>
- Keying positions 5

### S Socket-outlet (female)

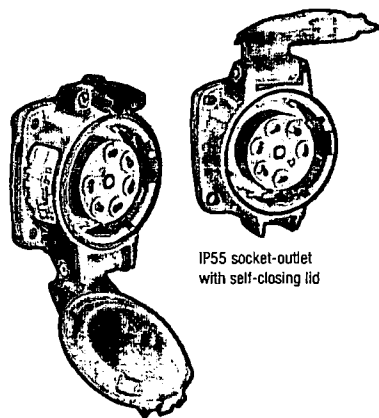

### I Inlet (male)

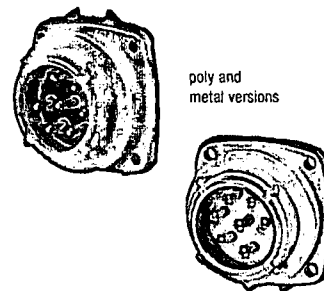

### Main options

Reversed interior and contacts (male socket-outlet)

Reversed interior and contacts (female inlet) with IP54 cap

Padlocking (left - Padlock not supplied) or locking by triangular screw (right)

### Accessories

IP67 Inlet cap

Polarity	Poly version		Metal version	
	U/I *	Part #	U/I *	Part #
5P	50/25	01 P4 050	50/25	09 P4 050
6P	50/16	01 P4 060	50/16	09 P4 060
7P	50/16	01 P4 070	50/16	09 P4 070
4P+E	500/25	01 P4 041	415/25	09 P4 041
5P+E	500/16	01 P4 051	415/16	09 P4 051
6P+E	500/16	01 P4 061	415/16	09 P4 061

\* Maximum voltage (V) / Rated current (A)

#### Version with self-closing lid (IP55):

Choose from the part numbers above and change letter P for an H.

#### Socket-outlet options

Reversed interior and contacts	Socket # + 001
Self-returning lid *	Socket # + R
180°-opening lid	Socket # + 10
180°-opening and self-returning lid *	Socket # + 18
Padlocking (padlock 4mm Ø) without shaft *	Socket # + 843
Locking by triangular screw *	Socket # + 22

\* except for IP55 version

Polarity	Poly version		Metal version	
	U/I *	Part #	U/I *	Part #
5P	50/25	01 P8 050	50/25	09 P8 050
6P	50/16	01 P8 060	50/16	09 P8 060
7P	50/16	01 P8 070	50/16	09 P8 070
4P+E	500/25	01 P8 041	415/25	09 P8 041
5P+E	500/16	01 P8 051	415/16	09 P8 051
6P+E	500/16	01 P8 061	415/16	09 P8 061

\* Maximum voltage (V) / Rated current (A)

#### Inlet options

Reversed interior and contacts	Inlet # + 137
--------------------------------	---------------

#### Inlet accessories

IP67 cap	01 NA 126
----------	-----------

If you want to equip a socket with two or more options: call us at +33 (0) 1 45 11 60 00.







### Multicontact plugs & sockets

Advantages  
 PN12C - 5/10 A  
 DSN24C - 5 A  
 DSN37C - 5 A  
**PN7C - 16 / 25 A**  
 DN9C - 30 A  
 DN20C - 25 A





**Also see:**





Full range of boxes page 86  
 Dimensions page 68  
 Technical Manual page 150

## Installation accessories

B Box					
	Wall box poly 30°	Wall box straight metal	Wall box straight poly	Wall box poly 70°	Wall box metal + metal sleeve 45°
Entry					
M20	01 NA 053	09 NA 055	01 NA 055	51 AA 058	09 NA 653
M25				51 AA 058	09 NA 653 418
M32				51 AA 058	09 NA 653 419

The boxes are supplied without any cable gland. The 70° boxes are not drilled (drilled at extra cost)

Sl Sleeve				
	Inclined poly 30°	Inclined metal 30°	Inclined poly 70°	Inclined metal 45°
	01 NA 027	09 NA 027	51 AA 757	09 2A 027

H Handle					
	Straight poly	Angled poly	Straight poly with poly cable gland	Straight metal with metal cable gland	Straight poly flowerpot with metric threaded entry *
Cable dia.			Cable dia.	Cable dia.	Entry
8-18 mm	01 NA 013	01 NA 313	6-12mm 01 NA 753	6-12mm 09 NA 963	M20 01 NA 253 417
5-21 mm	61 1A 413		13-18mm 01 NA 253 25P	10-18 mm 09 NA 953 25M	M25 01 NA 253 418
			18-25 mm 01 NA 253 32P	16-24 mm 09 NA 953 32M	M32 01 NA 253 419

Handle for flat or steel armoured cables on request (see zoom below).

\* Cable gland on request.



### Our solutions for flat or steel armoured cables

You need a handle designed for flat or steel armoured cables?  
 Call us at 01 45 11 60 00.



**Handle for flat cables**

# DN9C

Multicontact

## Plugs and socket-outlets 6 to 9 contacts / 30 A

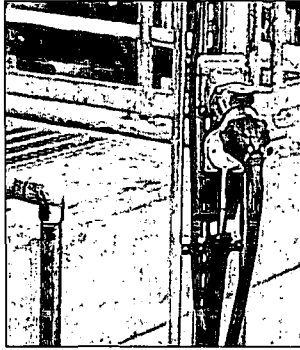

**Main features:**

- |                              |      |                               |                         |
|------------------------------|------|-------------------------------|-------------------------|
| • (socket-outlet) IP         | 55   | • Wiring (min - max) flexible | 1.5 / 6 mm <sup>2</sup> |
| • (socket-outlet + inlet) IP | 54   | • Wiring (min - max) stranded | 2.5 / 6 mm <sup>2</sup> |
| • IK (Metal)                 | 09   | • Keying positions            | 2                       |
| • U <sub>max</sub> AC        | 480V |                               |                         |

**S Socket-outlet (female)**

**I Inlet (male)**

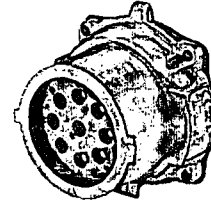
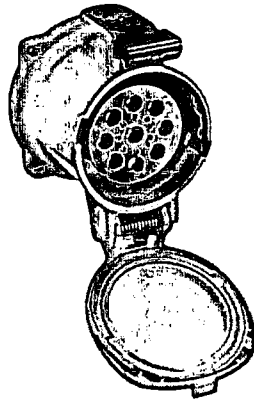

**Main options**

Device for self-ejecting coupler socket\*

Device for self-ejecting plug\*  
\* See Operating Instruction on page 168

Padlocking shaft  
(Padlock not supplied)

Stop button

Rubber cover for metal latch

Polarity	U/I *	Material	Part #
6P	50/30	Metal	19 14 060
7P	50/30	Metal	19 14 070
8P	50/30	Metal	19 14 080
9P	50/30	Metal	19 14 090
5P+E	480/30	Metal	19 14 051
6P+E	480/30	Metal	19 14 061
7P+E	480/30	Metal	19 14 071
8P+E	480/30	Metal	19 14 081

\* Maximum voltage (V) / Rated current (A)

Polarity	U/I *	Material	Part #
6P	50/30	Metal	19 18 060
7P	50/30	Metal	19 18 070
8P	50/30	Metal	19 18 080
9P	50/30	Metal	19 18 090
5P+E	480/30	Metal	19 18 051
6P+E	480/30	Metal	19 18 061
7P+E	480/30	Metal	19 18 071
8P+E	480/30	Metal	19 18 081

\* Maximum voltage (V) / Rated current (A)

**Socket-outlet options**

With 2 auxiliary contacts (5 A)	Socket # + 312
With 4 auxiliary contacts (5 A)	Socket # + 264
Device for self-ejecting coupler socket	Socket # + 365
Device for self-ejecting plug	Socket # + R
Self-returning lid	Socket # + R
180° opening lid	Socket # + 10
180°-opening and self-returning lid	Socket # + 18
Padlocking shaft up to 3 padlocks 8mm Ø	Socket # + 844
Stop button	Socket # + 453
Rubber cover for metal latch	Socket # + 834

**Inlet options**

With 2 auxiliary contacts (5 A)	Inlet # + 312
With 4 auxiliary contacts (5 A)	Inlet # + 264
Device for self-ejecting coupler socket	Inlet # + 204
Device for self-ejecting plug	Inlet # + 204

**Inlet accessories**

IP 54 cap	19 1A 126
Ejecting mechanism (shark fin)	19 1A 338
Tension cord	31 1A 336

If you want to equip a socket-outlet or an inlet with two or more options: call us at +33 (0) 1 45 11 60 00.

**Accessories**

IP54 Inlet cap

Ejecting mechanism (shark fin)

Tension cord

**Multicontact  
plugs & sockets**

*Advantages*  
 PN12C - 5/10 A  
 DSN24C - 5 A  
 DSN37C - 5 A  
 PN7C - 16/25 A  
**DN9C - 30A**  
 DN20C - 25 A

**Also see:**

Full range of boxes page 86  
 Dimensions page 60  
 Technical Manual page 150

**Installation accessories**

**B** Box

	Wall box metal 30°	Wall box metal + metal sleeve 70°	Wall box metal + metal sleeve 30°	Wall box metal + straight metal sleeve
Entry				
M20	19 1A 053	87 3A 053 417	19 1A 653	19 1A 095
M25		87 3A 053	19 1A 653 418	19 1A 095 418
M32		87 3A 053 419	19 1A 653 419	19 1A 095 419
M40		87 3A 053 420	19 1A 653 420	19 1A 095 420

The boxes are supplied without any cable gland..

**Sl** Sleeve

	Inclined metal 30°	Inclined metal 70°	Straight metal
	19 1A 027	87 3A 087	19 1A 127

**ZOOM**

**Handle with built-in finger draw plate**

This straight handle is recommended for in-line connections.

**H** Handle

	Straight poly	Straight poly with poly cable gland	for ejection option *	Straight metal with metal cable gland	Straight poly flowerpot with metric threaded entry *		
Cable dia.		Cable dia.		Cable dia.	Entry		
10-30mm	19 1A 013	6-12mm	19 1A 753    19 1A 463	6-12mm	19 1A 953	M20	19 1A 253 417
10-30mm	19 1A 473 *	13-18mm	19 1A 253 25P    19 1A 443 25P	10-18mm	19 1A 953 25M	M25	19 1A 253 418
		18-25mm	19 1A 253 32P    19 1A 443 32P	16-24mm	19 1A 953 32M	M32	19 1A 253 419
		22-32mm	19 1A 253 40P    19 1A 443 40P	22-32mm	19 1A 953 40M	M40	19 1A 253 420

\* With built-in finger draw plate (for in-line connections)

Handle for flat or steel armoured cables on request (see 'zoom' on page 79).

\* Handle with eyelet for tension cord

\* Cable gland on request.



**Perfect cable fit and broad tightening range**

A special anchoring system provides a perfect cable fit and a broad tightening range (multi-layer bush to choose best cable fit).

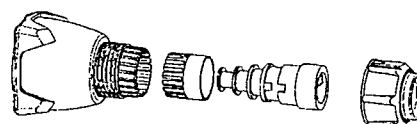

# DN20C

Multicontact

# Plugs and socket-outlets

## 10 to 20 contacts / 25 A

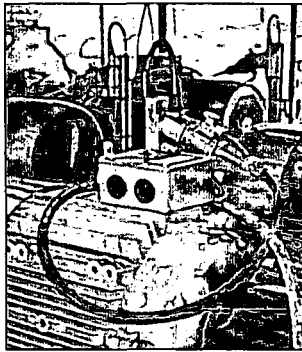

**Main features:**

- (socket-outlet) IP 55
- (socket-outlet + inlet) IP 54
- IK (Metal) 09
- Um<sub>max</sub> AC 480V
- Wiring (min - max) flexible 1.5 / 6 mm<sup>2</sup>
- Wiring (min - max) stranded 2.5 / 6 mm<sup>2</sup>
- Keying positions 4

**S Socket-outlet (female)**

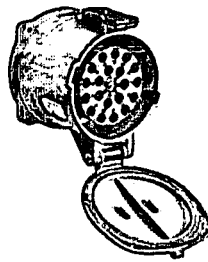

**I Inlet (male)**

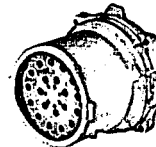

**Main options**

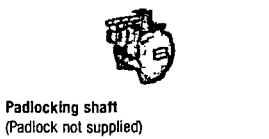

**Accessories**

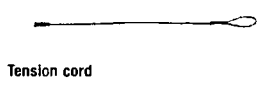
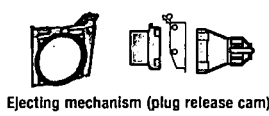

Polarity	U/I *	Material	Part #
10P	50/25	Metal	19 64 100
11P	50/25	Metal	19 64 110
12P	50/25	Metal	19 64 120
13P	50/25	Metal	19 64 130
14P	50/25	Metal	19 64 140
15P	50/25	Metal	19 64 150
16P	50/25	Metal	19 64 160
17P	50/25	Metal	19 64 170
18P	50/25	Metal	19 64 180
19P	50/25	Metal	19 64 180
20P	50/25	Metal	19 64 200
9P+E	480/25	Metal	19 64 091
10P+E	480/25	Metal	19 64 101
11P+E	480/25	Metal	19 64 111
12P+E	480/25	Metal	19 64 121
13P+E	480/25	Metal	19 64 131
14P+E	480/25	Metal	19 64 141
15P+E	480/25	Metal	19 64 151
16P+E	480/25	Metal	19 64 161
17P+E	480/25	Metal	19 64 171
18P+E	480/25	Metal	19 64 181
19P+E	480/25	Metal	19 64 181

\* Maximum voltage (V) / Rated current (A)

**Socket-outlet options**

Device for self-ejecting coupler socket	Socket # + 365
Device for self-ejecting plug	Socket # + R
Self-returning lid	Socket # + R
180° opening lid	Socket # + 10
180° opening and self-returning lid	Socket # + 18
Padlocking shaft up to 3 padlocks 8 mm Ø	Socket # + 844
Stop button	Socket # + 453
Rubber cover for metal latch	Socket # + 834

**Socket-outlet accessories**

Closing mechanism (draw lever)	19 6A 876
--------------------------------	-----------

Polarity	U/I *	Material	Part #
10P	50/25	Metal	19 68 100
11P	50/25	Metal	19 68 110
12P	50/25	Metal	19 68 120
13P	50/25	Metal	19 68 130
14P	50/25	Metal	19 68 140
15P	50/25	Metal	19 68 150
16P	50/25	Metal	19 68 160
17P	50/25	Metal	19 68 170
18P	50/25	Metal	19 68 180
19P	50/25	Metal	19 68 180
20P	50/25	Metal	19 68 200
9P+E	480/25	Metal	19 68 091
10P+E	480/25	Metal	19 68 101
11P+E	480/25	Metal	19 68 111
12P+E	480/25	Metal	19 68 121
13P+E	480/25	Metal	19 68 131
14P+E	480/25	Metal	19 68 141
15P+E	480/25	Metal	19 68 151
16P+E	480/25	Metal	19 68 161
17P+E	480/25	Metal	19 68 171
18P+E	480/25	Metal	19 68 181
19P+E	480/25	Metal	19 68 181

\* Maximum voltage (V) / Rated current (A)

**Inlet options**

Device for self-ejecting coupler socket	Inlet # + 204
Device for self-ejecting plug	Inlet # + 204

**Inlet accessories**

IP54 cap	19 6A 128
Closing mechanism (draw base)	19 6A 886
Ejecting mechanism (plug release cam)	19 6A 397
Tenalon cord	31 1A 336

If you want to equip a socket-outlet with two or more options: call us at +33 (0) 1 45 11 60 00.





**Multicontact  
plugs & sockets**

*Advantages*  
 PN12c - 5/10 A  
 DSN24c - 5 A  
 DSN37c - 5 A  
 PN7c - 16/25 A  
 DN9c - 30 A  
**DN20c - 25 A**



**Also see:**





Full range of boxes page 86  
 Dimensions page 60  
 Technical Manual page 150

**Installation accessories**

<b>B</b> Box				
	Wall box metal + metal sleeve 20°	Wall box metal + metal sleeve 70°	Wall box metal + metal sleeve 30°	Wall box metal + straight metal sleeve
Entry				
M32		87 9A 053 419	19 6A 653 419	19 6A 095 419
M40	19 6A 053	87 9A 053 420	19 6A 653	19 6A 095 420
M50		87 9A 053	19 6A 653 429	19 6A 095
M63		87 9A 053 463	19 6A 653 463	19 6A 095 463

*The boxes are supplied without any cable gland.*

<b>Sl</b> Sleeve			
	Inclined metal 30°	Inclined metal 70°	Straight metal
	19 6A 027	87 9A 087	19 6A 127

<b>H</b> Handle						
	Straight elastomere	Straight poly with metal cable gland	Straight poly with poly cable gland	Straight metal with metal cable gland	Straight poly flowerpot with metric threaded entry *	
Cable dia.			Cable dia.	Cable dia.	Entry	
18-25mm	65 9A 013D25		34-44mm	61 9A 253 63P	16-24mm 19 6A 953 32M	M63 61 9A 253 463
25-35mm	65 9A 013D35				22-32mm 19 6A 963	
34-49mm		61 9A 253 63M			34-44mm 19 6A 953 50M	
35-45mm	65 9A 013D45					

*Handle for flat or steel armoured cables on request (see 'zoom' below).*

**ZOOM**



**Our solutions for flat or steel armoured cables**

You need a handle designed for flat or steel armoured cables?  
 Call us at 01 45 11 60 00.



**Handle for flat cables**







**Halmac** Services (Qld) Pty. Ltd.  
A.C.N. 098 852 923  
A.B.N. 40 741 712 113

# SURGE DIVERTER & SURGE REDUCTION FILTER

1. TDS1100 SURGE DIVERTER TECHNICAL DETAILS
2. DAR ALARM RELAY TECHNICAL DETAILS
3. TDF SURGE REDUCTION FILTER TECHNICAL DETAILS



# CRITEC TDS1100

Asia/Australia  
Europe  
Latin America  
North America

## TDS Surge Diverter - TDS1100 Series

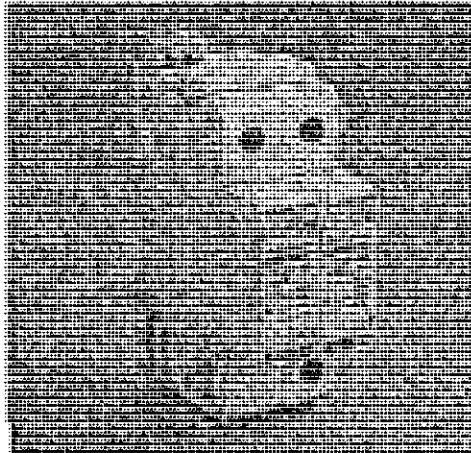

- CRITEC® TD Technology with internal thermal disconnect protection
- Compact design fits into DIN distribution panel boards and motor control centers
- 35 mm DIN rail mount - DIN 43 880 profile matches common circuit breakers
- Indicator flag and voltage-free contacts provide remote status notification
- Separate plug-in base design facilitates replacement of a failed surge module
- 100kA 8/20 surge current rating ensures protection suitable for sub-distribution panels with long operational life
- Available in various operating voltages for most common industrial distribution systems

Surges and voltage transients are a major cause of expensive electronic equipment failure and business disruption. Damage may result in the loss of capital outlays, such as computers and communications equipment, as well as consequential loss of revenue and profits due to unscheduled system down-time.

The TDS1100 series of surge suppressors provide economical and reliable protection from voltage transients on power distribution systems. They are conveniently packaged for easy installation on 35 mm DIN rail within main distribution panelboards.

CRITEC® TD technology helps ensure reliable and continued operation during sustained and abnormal over-voltage events. Internal thermal disconnect devices help ensure safe or at end-of-life. A visual indicator flag provides user-feedback in the event of such operation. As standard, the TDS1100 provides a set of voltage-free contacts for remote signaling that maintenance is due.

The convenient plug-in module and separate base design facilitates replacement of a failed surge module without needing to undo installation wiring.

Model	TDS110025R150	TDS110025R240	TDS110025R277	TDS110025R560
Nominal Voltage U <sub>n</sub>	120-150V~	220-240V~	240-277V~	480-560V~
Max. Cont. Operating Voltage U <sub>c</sub>	170V~	275V~	320V~	610V~
Stand off Voltage	240V~	440V~	480V~	700V~
Frequency	0 - 100Hz			
Short Circuit Current Rating I <sub>sc</sub>	25kAIC			
Required Back-up Fuse	125Agl, if supply > 100A			
Technology Used	TD with thermal disconnect			
<b>Protection</b>				
Maximum Discharge Current I <sub>max</sub>	100kA 8/20µs			
Nominal Discharge Current I <sub>n</sub>	50kA 8/20µs	40kA 8/20µs	40kA 8/20µs	40kA 8/20µs
Protection Modes	Single mode (L-G, L-N or N-G)			
Voltage Protection Level Up @ 3kA	< 400V	< 700V	< 800V	< 1.6kV
Voltage Protection Level Up @ 20kA	< 650	< 1000	< 1.1kV	< 2kV
<b>Alarms and Indicators</b>				
Status Indication	Mechanical flag / remote contacts (R model only) Change-over, 250V~/0.5A, max 1.5 mm <sup>2</sup> (#14AWG) terminals			
<b>Physical Data</b>				
Dimensions	2 modules wide, 90 mm x 68 mm x 35 mm			
Weight	0.24 kg approx.			
Enclosure	DIN 43 880, UL94V-0 thermoplastic, IP 20 (NEMA-1)			
Connection	≤35 mm <sup>2</sup> (#2AWG) solid ≤25 mm <sup>2</sup> (#4AWG) stranded			
Mounting	35 mm top hat DIN rail			
Temperature	-40°C to +80°C (-40°F to +176°F)			
Humidity	0 to 90%			
<b>Test Standards</b>				
Approvals	CE, IEC™ 61643-1, UL® 1449 Pending			
Surge Rated to Meet	IEC 61643-1 Class I and II ANSI/IEEE C62.41-1991 Cat A, Cat B, Cat C			

Due to a policy of continual product development, specifications are subject to change without notice.



# CRITEC® DDI/DAR/TDS SC

Asia/Australia  
Europe  
Latin America

## DIN Decoupling Inductor/ DINLINE Alarm Relay & Surge Counter

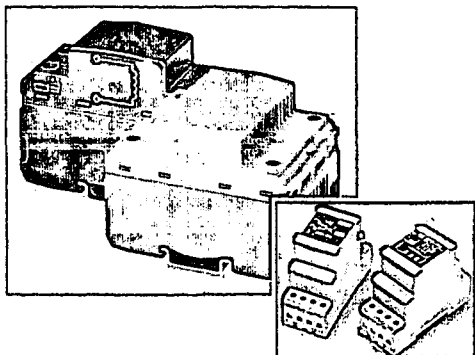

- Use for decoupling of spark gaps and MOVs – allows correct coordination of different SPD technologies
- 35 mm<sup>2</sup> tunnel terminals – accepts large cable size
- 63A model features top and bottom terminals – flexible installation
- The DINLINE Alarm Relay (DAR) is used with TDF products where alarm contacts are required for remote signaling
- The TDS-SC Surge Counter provides a non-resettable record of the number of surges diverted

Decoupling inductors are installed between spark gap and MOV protection devices to ensure correct coordination. As the decoupling inductors are installed in series with the load, two units are available, a compact unit for circuits up to 35A and a larger unit for 63A circuits.

The DAR (DINLINE Alarm Relay) can be connected to TDF units to provide potential free change-over alarm contacts. The TDS SC (Surge Counter) unit is designed to provide visual indication of the number of surges registered. It uses a current transformer through which the ground conductor connecting to one, or all, of the surge protection modules is fed. Current diverted by the operation of the surge module, which exceeds a 300A trip threshold, will be registered on the counter.

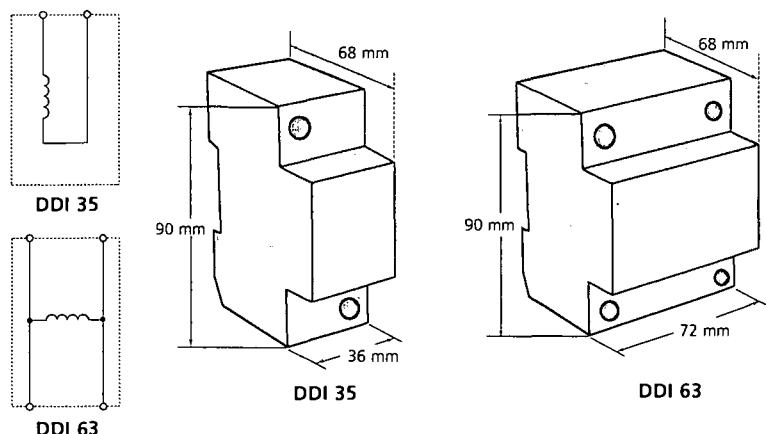

Model	DDI 35	DDI 63	DAR275V	TDS SC
Item Number for Europe	700465	700475	700900	701250
Nominal Voltage U <sub>n</sub>	-	-	20-110V---, 100-240V~	-
System Compatibility(1)	-	-	TN-C, TN-S, TN-C-S & TT	-
Max. Cont. Operating Voltage U <sub>c</sub>	500V~ 200V---	-	275V	-
Stand-off Voltage	-	-	275V	-
Operating Current @ U <sub>n</sub>	-	-	20mA	-
Frequency	0 to 60Hz			
Max. Line Current I <sub>l</sub>	35A @ 40°C	63A @ 40°C	-	-
Temperature Increase	45° C @ max line current (I <sub>l</sub> )			
Inductance	7.5µH	15µH	-	-
Resistance	4.5mΩ	1.7mΩ	-	-
Technology	-			
Status	-		CT - trip threshold 300A 8/20µs	Red/Green LEDs Change-over contact <sup>(1)</sup>
Dimensions	2 M. 90 mm x 68 mm x 36 mm (3.5" x 2.6" x 1.4") approx.	4 M. 90 mm x 68 mm x 72 mm (3.5" x 2.6" x 2.8") approx.	2 M. 90 mm x 68 mm x 36 mm (3.5" x 2.6" x 1.4") (excluding CT)	
Weight	0.45 kg (1 lb) approx.	1 kg (2.2 lb) approx.	0.2 kg (0.44 lb)	
Enclosure	DIN 43 880, UL94V-0 thermoplastic, IP 20 (NEMA-1)			
Connection	≤35 mm <sup>2</sup> (#2AWG) solid ≤25 mm <sup>2</sup> (#4AWG) stranded		1 mm <sup>2</sup> to 6 mm <sup>2</sup> (#18AWG to #10)	
Mounting	35 mm top hat DIN rail			
Back-up Overcurrent Protection	35A	63A	-	-
Temperature	-40°C to +70°C (-40°F to +158°F)		-35°C to +55°C (-31°F to +131°F)	
Humidity	0% to 90%			
Warranty	5 years		CSA22.2	-
Approvals	CE		C-Tick, AS 3260, CE	-

(1) Form C = Change-over contact (Form C dry contact), 400V~/3A 1 mm<sup>2</sup> to 6 mm<sup>2</sup> (#18AWG to #10AWG) connecting wire



Asia/Australia  
Europe  
Latin America  
North America

# Transient Discriminating Filter

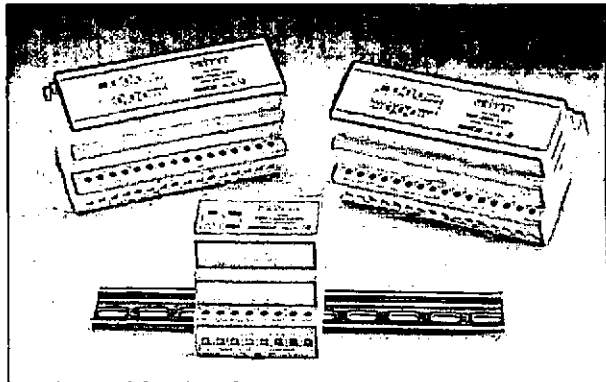

- In-line series protection
- High efficiency low pass sine wave filtering – ideal for the protection of switched mode power supplies
- Three modes of protection: L-N, L-PE & N-PE
- 35 mm DIN rail mount – simple installation
- Transient Discriminating (TD) Technology – provides increased service life
- LED status indication and opto-isolated output – for remote status monitoring

The TDF series has been specifically designed for process control applications to protect the switched mode power supply units on devices such as PLC controllers, SCADA systems and motor controllers. Units are UL Recognized and available for 3A, 10A and 20A loads and suitable for 110-120V ac/dc and 220-240Vac circuits.

The TDF is a series connected, single phase surge filter providing an aggregate surge capacity of 50kA (8/20µs) across L-N, L-PE, and N-PE. The low pass filter provides up to 65dB of attenuation to voltage transients. Not only does this reduce the residual let-through voltage, but it also helps further reduce the steep voltage rate-of-rise providing superior protection for sensitive electronic equipment.

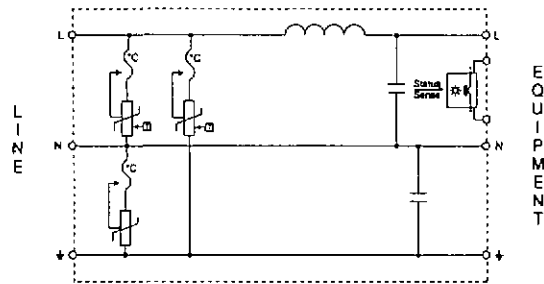

Model	TDF3A 120V	TDF3A 240V	TDF10A 120V	TDF10A 240V	TDF20A 120V	TDF20A 240V
Item Number for Europe	700001	700002	700003	700004	700005	700006
Nominal Voltage $U_n$	120V	240V	120V	240V	120V	240V
Distribution System	1Ph 2W+G, TN-S & TN-C-S					
Max. Cont. Operating Voltage $U_c$	170V	340V	170V	340V	170V	340V
Stand-off Voltage	240V	400V	240V	400V	240V	400V
Frequency	0 to 60Hz	50/60Hz	0 to 60Hz	0 to 60Hz	0 to 60Hz	50/60Hz
Max. Line Current $I_L$	3A		10A		20A	
Operating Current @ $U_n$	135mA	250mA	240mA	480mA	240mA	480mA
Max. Discharge Current $I_{max}$	20kA 8/20 µs L-N 20kA 8/20 µs L-PE 10kA 8/20 µs N-PE					
Protection Modes	All modes protected					
Technology	TD Technology In-line series low pass sine wave filter					
Voltage Protection Level $U_p$ @ 500A, 8/20µs (UL SVR) @ Cat B3, 3kA 8/20µs	500V <250V	700V <600V	500V <250V	700V <600V	500V <250V	700V <600V
Filtering @100kHz	-62dB		-65dB		-53dB	
Status	Green LED, On=Ok. Isolated opto-coupler output <sup>(1)</sup>					
Dimensions	4 M. 90 mm x 68 mm x 72 mm (3.5" x 2.6" x 2.8")		8 M. 90 mm x 68 mm x 144 mm (3.5" x 2.6" x 5.6")			
Weight	0.35 kg (0.77 lb)		0.75 kg (0.77 lb)		0.8 kg (1.7 lb)	
Enclosure	DiN 43 880, UL94V-0 thermoplastic, IP 20 (NEMA-1)					
Connection	1 mm <sup>2</sup> to 6 mm <sup>2</sup> (#18AWG to #10)					
Mounting	35 mm top hat DIN rail					
Back-up Overcurrent Protection	3A		10A		20A	
Temperature	-35°C to +55°C (-31°F to +131°F)					
Humidity	0% to 90%					
Warranty	5 years					
Approvals	UL 1449, UL 1283, CSA 22.2, C-Tick, CE (NOM 3A, 120V)					
Surge Rated to Meet	ANSI/IEEE C62.41.2 Cat A, Cat B, Cat C					

(1) Opto-coupler output can be connected to DAR275V to provide Form C dry contacts, Page 35







4

5



**Halmac** Services (Qld) Pty. Ltd.  
A.C.N. 098 852 923  
A.B.N. 40 741 712 113

# TIMER

---

1. IDEC DIGITAL TIMER TECHNICAL DETAILS
2. ELECTRONIC TIMING RELAY TECHNICAL DETAILS

**GT3D – Digital Timers**

**Key features of the GT3D series include:**

- Precise time setting using digital thumbwheel switches
- Elapsed or time remaining LCD display
- 6 time ranges, 16 timing functions
- Time delays up to 99.9 hours

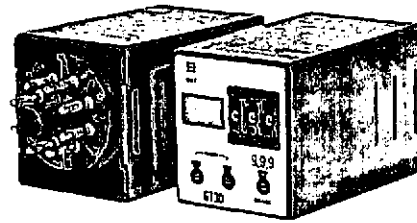

UL Recognized  
File No. E55996



CSA Certified  
File No. LR56183  
File No. LR96764  
File No. LR83814



Cert. No. 8L9601133323911 (LVD)  
Cert. No. E9971113332388 (EMC)

**Specifications**

		GT3D-2	GT3D-3	GT3D-4	GT3D-8
<b>Operation System</b>		Solid state CMOS circuitry			
<b>Operation</b>		Multi-mode			Multi-mode one-shot output
<b>Time Range</b>		0.01s to 99.9 hours			
<b>Rated Voltage</b>		100 to 240V AC (50/60Hz), 24V AC (50/60Hz)/24V DC			
<b>Contact Ratings</b>		125V AC/250V AC, 3A; 30V DC/1A (resistive load)	125V AC/250V AC, 5A; 30V DC/5A (resistive load)		
<b>Contact Form</b>		Delayed SPDT + instantaneous SPDT	Delayed DPDT	Delayed DPDT	Delayed DPDT
<b>Minimum Applicable Load</b>		5V, 10mA (reference value)			
<b>Voltage Tolerance</b>		AF20 (100–240V AC): 85 to 264V AC AD24 (AC): 20.4 to 26.4V AC AD24 (DC): 21.6 to 26.4V DC			
<b>Error</b>		±0.3% ±50ms (voltage, repeat, and temperature)			
<b>Setting Error</b>		±0.5% ±50ms			
<b>Reset Time</b>		60ms maximum			
<b>Insulation Resistance</b>		100MΩ minimum			
<b>Dielectric Strength</b>		Between power and output terminals: 2,000V AC, 1 minute Between contacts of different poles: 2,000V AC, 1 minute Between contacts of the same pole: 750V AC, 1 minute			
<b>Power Consumption (approximate)</b>	<b>AF20</b>	11.8VA	11.6VA	3.7VA (100V AC, 60Hz) 11.6VA (200V AC, 60Hz)	
	<b>AD24 AC/DC</b>	1VA/0.8W	2.1VA/0.9W	2.1VA /0.9W	
<b>Mechanical Life</b>		10,000,000 operations minimum	5,000,000 operations minimum		
<b>Electrical Life (at rated load)</b>		50,000 operations minimum	100,000 operations minimum		
<b>Outputs</b>	<b>Relay</b>	250V AC, 3A, 30V DC, 1A (resistive load)	240V AC/, 24V DC, 5A (resistive load)		
<b>Vibration Resistance</b>		100N (approximate 10G)			
<b>Shock Resistance</b>		Operating extremes: 100N (approximate 10G) Damage limits: 500N (approximate 50G)			
<b>Operating Temperature</b>		–10 to +50°C			
<b>Storage Temperature</b>		–30 to +80°C			
<b>Operating Humidity</b>		45 to 85% RH			
<b>Weight (approximate)</b>		70g	75g	76g	
<b>Housing Color</b>		Gray			

Switches & Pilot Lights

Display Lights

Relays & Sockets

Timers

Terminal Blocks

Circuit Breakers



**Part Number List**

**Part Numbers: GT3D-1/GT3D-2/GT3D-3**

Mode of Operation	Time Range	Output	Contact	Rated Voltage Code	Complete Part No.	
					8-Pin	11-Pin
1-A: ON-delay 1 1-B: Interval 1 first 1-C: Cycle 1 (OFF first) 1-D: Cycle 3 (ON first)	0.01s to 99.9 hours	250V AC, 3A, 30V DC, 1A (resistive load)	Delayed SPDT + instantaneous SPDT	100 to 240V AC (50/60Hz)	GT3D-2AF20	GT3D-2EAF20
				24V AC/DC	GT3D-2AD24	—
		240V AC, 24V DC, 5A (resistive load)	Delayed DPDT	100 to 240V AC (50/60Hz)	GT3D-3AF20	GT3D-3EAF20
				24V AC/DC	GT3D-3AD24	—

**Part Numbers: GT3D-4**

Mode of Operation	Time Range	Output	Contact	Rated Voltage Code	Complete Part No.	
					A (11-Pin)	B (11-Pin)
1-A: ON-delay 1 1-B: Interval 1 first 1-C: Cycle 1 (OFF first) 1-D: Cycle 3 (ON first) 2-A: ON-delay 2 2-B: Cycle 2 2-C: Signal ON/OFF-delay 1 2-D: Signal OFF-delay 1 2-E: Interval 2 2-F: One-shot cycle 3-A: Signal ON/OFF-delay 2 3-B: Signal OFF-delay 2 3-C: One-shot 1 3-D: One-shot ON-delay 3-E: One-shot 2 3-F: Signal ON/OFF-delay 3	0.01s to 99.9 hours	240V AC/24V DC, 5A (resistive load)	Delayed DPDT	100 to 240V AC (50/60Hz)	GT3D-4AF20	GT3D-4EAF20
				24V AC/DC	GT3D-4AD24	—

**Part Numbers: GT3D-8**

Mode of Operation	Time Range	Output	Contact	Rated Voltage Code	Complete Part No. (11-Pin)
1: ON-delay one-shot 1 2: Cycle one-shot 3: ON-delay one-shot 2	0.01s to 99.9 hours	240V AC/24V DC, 5A (resistive load)	Delayed DPDT	100 to 240V AC (50/60Hz)	GT3D-8AF20
				24V AC/DC	GT3D-8AD24

-  1. For wiring schematics and timing diagrams GT3D, see pages 815 to 822.  
2. For more details about time ranges, see instructions on page 823.  
3. A (11-pin) and B (11-pin) differ in the way inputs are wired.  
4. For socket and accessory part numbers, see page 838.  
5. For timing diagrams overview, see page 794.

Switches & Pilot Lights  
Display Lights  
Relays & Sockets  
Timers  
Terminal Blocks  
Circuit Breakers

Timing Diagrams/Schematics

GT3D-2 Timing Diagrams

Delayed SPDT + Instantaneous SPDT

Operation Mode Selection

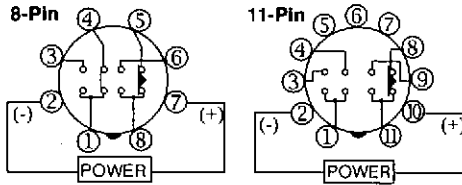

ON-Delay 1

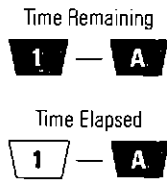

Item	Terminal Number	Operation
Set Time		Set Time
Power	2-7 (Rp) 2-10 (11p)	
Delayed Contact	1-4, 5-8 (Rp) (NC)	
	1-4, 8-11 (11p) (NO)	
	1-3, 6-8 (Rp) (NO) 1-3, 9-11 (11p) (NO)	
Instantaneous Contact	1-4 (NC) 1-3 (NO)	
Indicator	OUT	
Digital Time Display	DOWN UP	

Interval 1

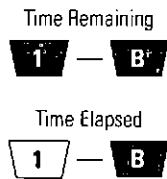

Item	Terminal Number	Operation
Set Time		Set Time
Power	2-7 (Rp) 2-10 (11p)	
Delayed Contact	1-4, 5-8 (Rp) (NC)	
	1-4, 8-11 (11p) (NO)	
	1-3, 6-8 (Rp) (NO) 1-3, 9-11 (11p) (NO)	
Instantaneous Contact	1-4 (NC) 1-3 (NO)	
Indicator	OUT	
Digital Time Display	DOWN UP	

Cycle 1 (OFF first)

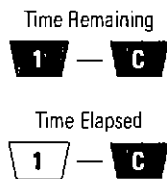

Item	Terminal Number	Operation
Set Time		Set Time
Power	2-7 (Rp) 2-10 (11p)	
Delayed Contact	1-4, 5-8 (Rp) (NC)	
	1-4, 8-11 (11p) (NO)	
	1-3, 6-8 (Rp) (NO) 1-3, 9-11 (11p) (NO)	
Instantaneous Contact	1-4 (NC) 1-3 (NO)	
Indicator	OUT	
Digital Time Display	DOWN UP	

Cycle 3 (ON first)

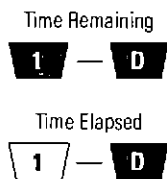

Item	Terminal Number	Operation
Set Time		Set Time
Power	2-7 (Rp) 2-10 (11p)	
Delayed Contact	1-4, 5-8 (Rp) (NC)	
	1-4, 8-11 (11p) (NO)	
	1-3, 6-8 (Rp) (NO) 1-3, 9-11 (11p) (NO)	
Instantaneous Contact	1-4 (NC) 1-3 (NO)	
Indicator	OUT	
Digital Time Display	DOWN UP	

Switches & Pilot Lights

Display Lights

Relays & Sockets



Terminal Blocks

Circuit Breakers

**GT3D-3 Timing Diagrams**  
**Delayed DPDT**

Switches & Pilot Lights

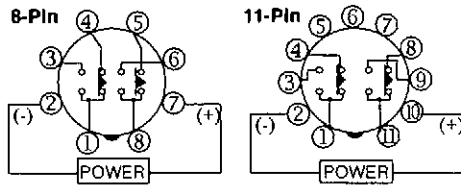

**Operation Mode Selection**

Display Lights

**ON-Delay 1**

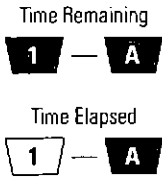

Item	Terminal Number	Operation
Set Time		Set Time
Power	2-7 (Sp) 2-10 (11p)	
Delayed Contact	1-4, 5-8 (Sp) (NC) 1-4, 8-11 (11p) (NO)	
Indicator	OUT	
Digital Time Display	DOWN UP	

Relays & Sockets

**Interval 1**

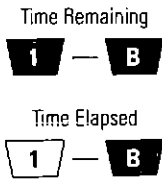

Item	Terminal Number	Operation
Set Time		Set Time
Power	2-7 (Sp) 2-10 (11p)	
Delayed Contact	1-4, 5-8 (Sp) (NC) 1-4, 8-11 (11p) (NO)	
Indicator	OUT	
Digital Time Display	DOWN UP	

**Timers**

**Cycle 1 (OFF first)**

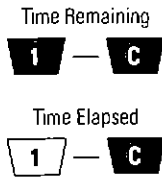

Item	Terminal Number	Operation
Set Time		Set Time
Power	2-7 (Sp) 2-10 (11p)	
Delayed Contact	1-4, 5-8 (Sp) (NC) 1-4, 8-11 (11p) (NO)	
Indicator	OUT	
Digital Time Display	DOWN UP	

Terminal Blocks

**Cycle 3 (ON first)**

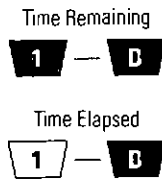

Item	Terminal Number	Operation
Set Time		Set Time
Power	2-7 (Sp) 2-10 (11p)	
Delayed Contact	1-4, 5-8 (Sp) (NC) 1-4, 8-11 (11p) (NO)	
Indicator	OUT	
Digital Time Display	DOWN UP	

Circuit Breakers

GT3D-4 Timing Diagrams

These timers require a start input. A gate and reset input are optional. Inputs are controlled by external pushbuttons. Reset occurs when the power is removed or when the reset input is supplied. The gate signal can be used to interrupt (freeze) timer functions. Timer functions resume when the gate input is removed. 8 style timers are not equipped for gate input.

Delayed DPDT

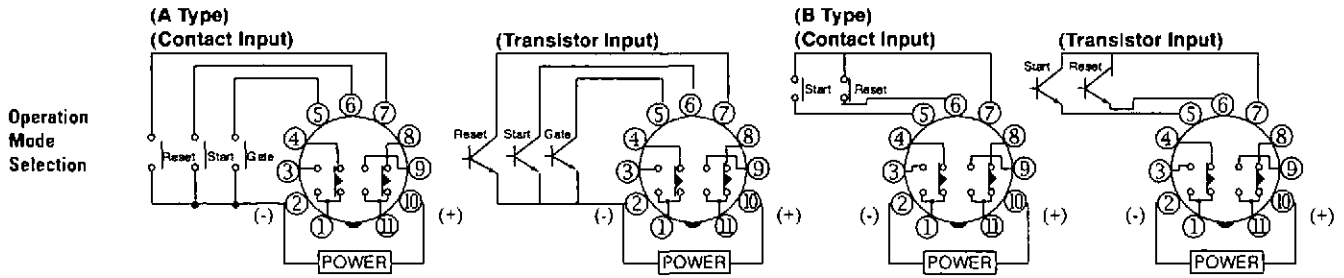

ON-Delay 1

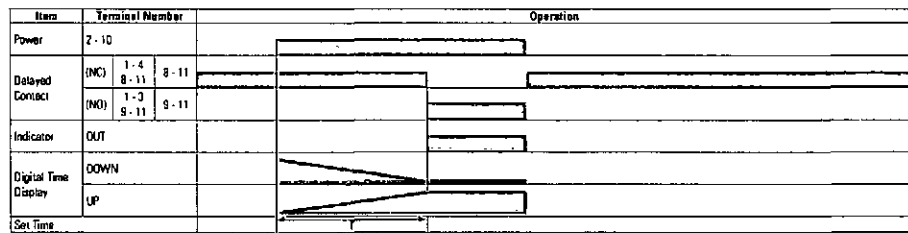
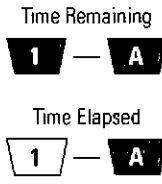

Interval 1

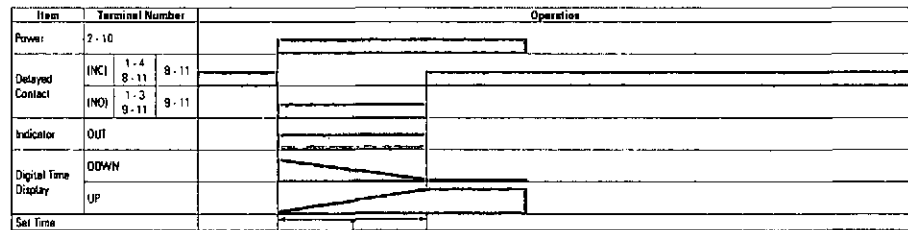
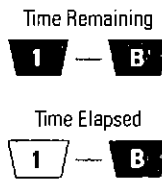

Switches & Pilot Lights

Display Lights

Relays & Sockets



Terminal Blocks

Circuit Breakers

**GT3D-4 Timing Diagrams**

Switches & Pilot Lights

**Cycle 1**  
(OFF first)

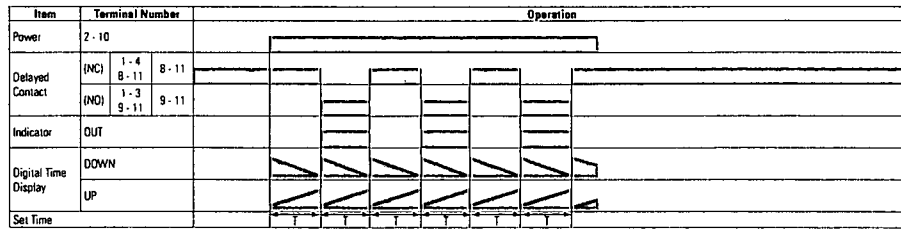
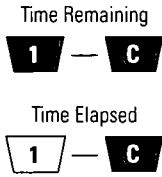

Display Lights

**Cycle 3**  
(ON first)

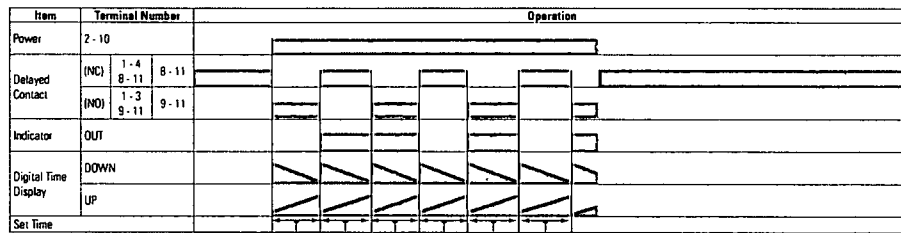
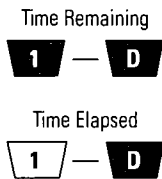

Relays & Sockets

**ON-Delay 2**

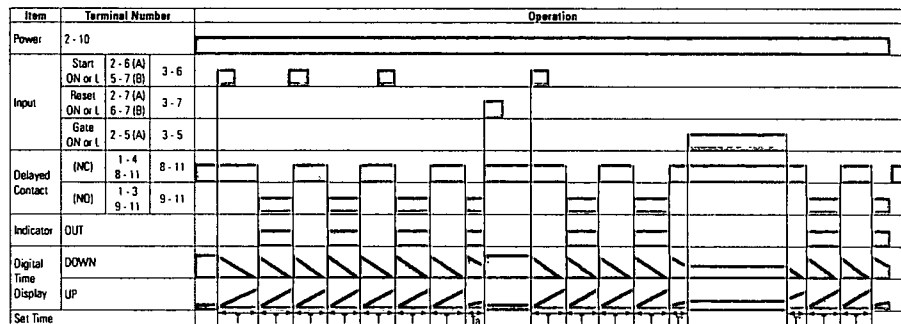
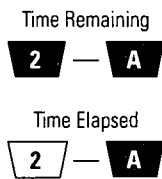

Terminal Blocks

Circuit Breakers

GT3D-4 Timing Diagrams

Cycle 2

Time Remaining

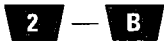

Time Elapsed

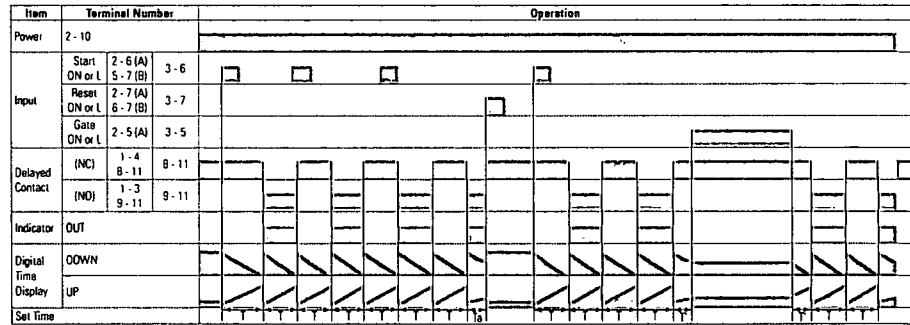
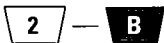

Signal ON/OFF-Delay 1

Time Remaining

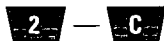

Time Elapsed

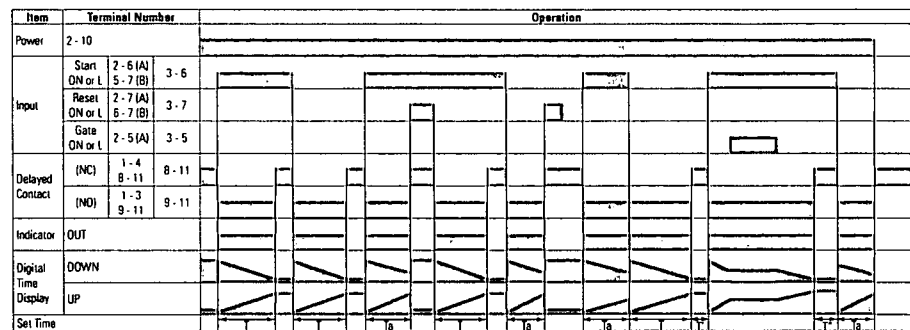
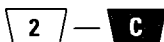

Singal OFF-Delay 1

Time Remaining

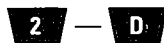

Time Elapsed

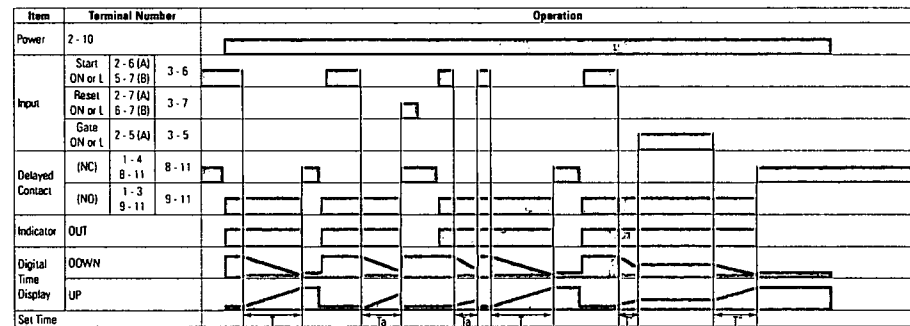
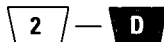

Interval 2

Time Remaining

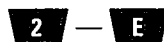

Time Elapsed

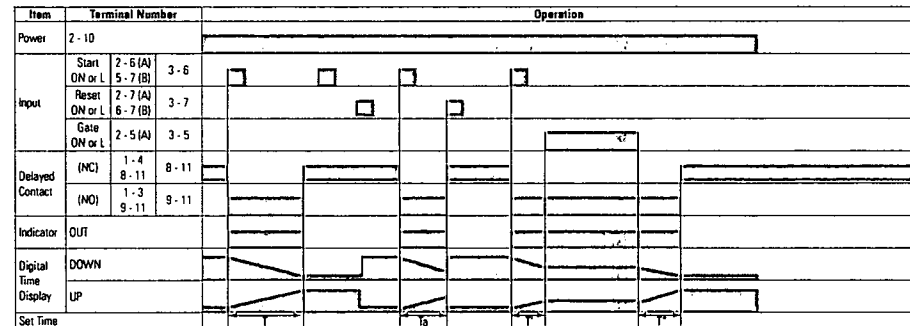
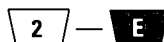

Switches & Pilot Lights

Display Lights

Relays & Sockets

Timers

Terminal Blocks

Circuit Breakers

**GT3D-4 Timing Diagrams**

Switches & Pilot Lights

**One-Shot Cycle**

Time Remaining

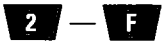

Time Elapsed

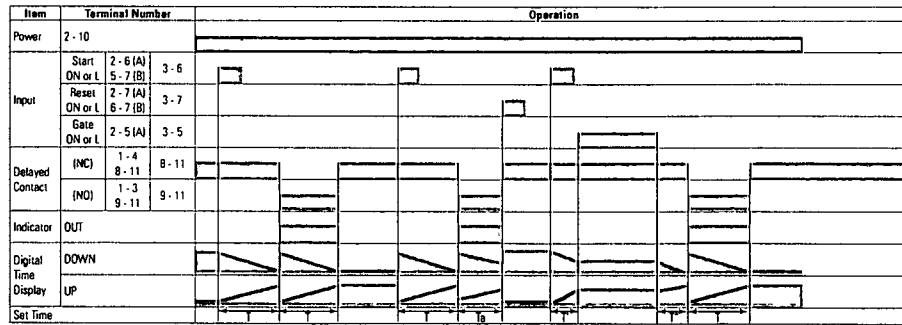
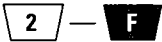

Display Lights

**Signal ON/OFF-Delay 2**

Time Remaining

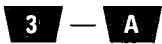

Time Elapsed

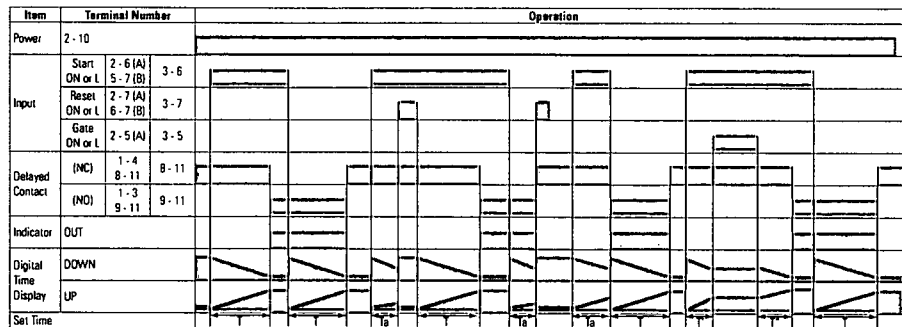
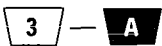

Relays & Sockets

**Signal OFF-Delay 2**

Time Remaining

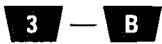

Time Elapsed

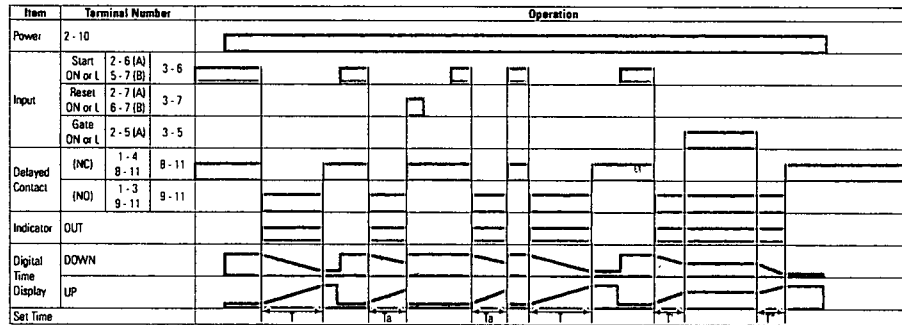
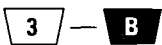

**One-Shot 1**

Time Remaining

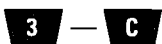

Time Elapsed

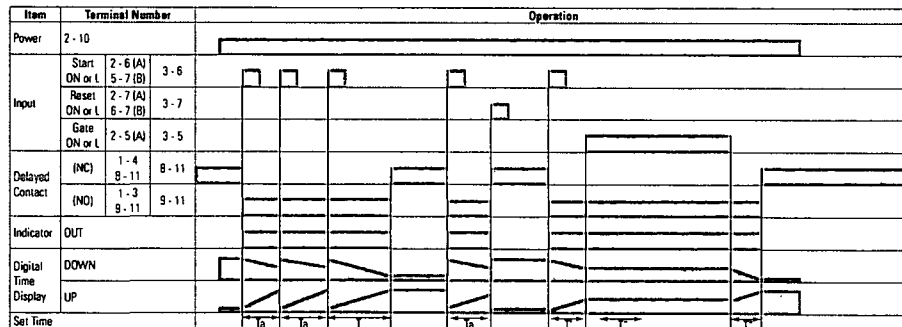
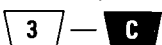

Terminal Blocks

Circuit Breakers

GT3D-4 Timing Diagrams

One-Shot ON-Delay

Time Remaining

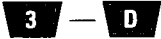

Time Elapsed

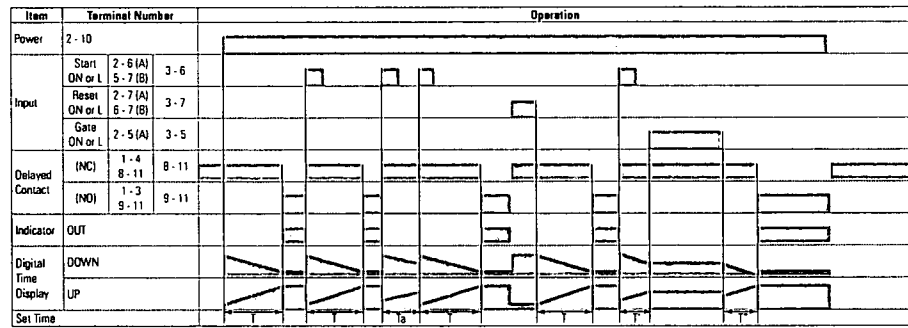
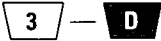

One-Shot 2

Time Remaining

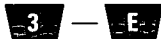

Time Elapsed

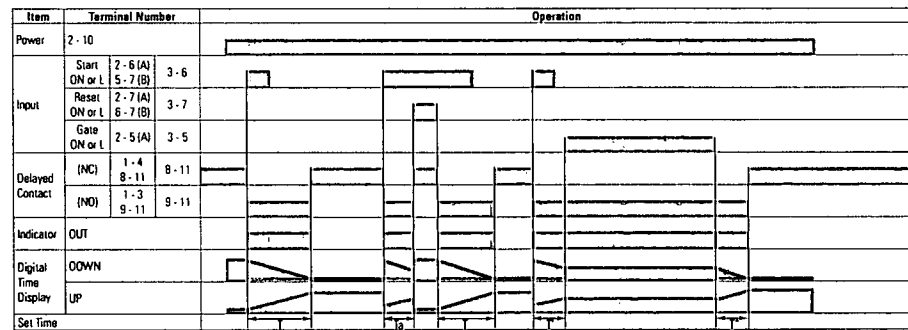
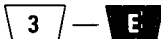

Signal ON/OFF-Delay 3

Time Remaining

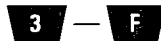

Time Elapsed

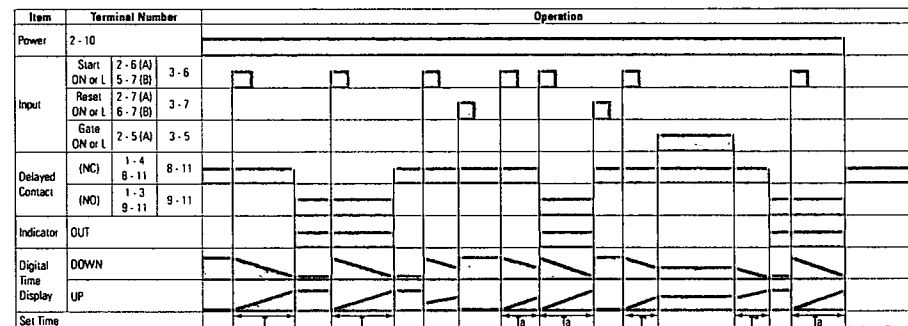
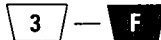

Switches & Pilot Lights

Display Lights

Relays & Sockets



Terminal Blocks

Circuit Breakers



GT3D-8 Timing Diagrams  
Delayed DPDT

Switches & Pilot Lights

Operation  
Mode Selection

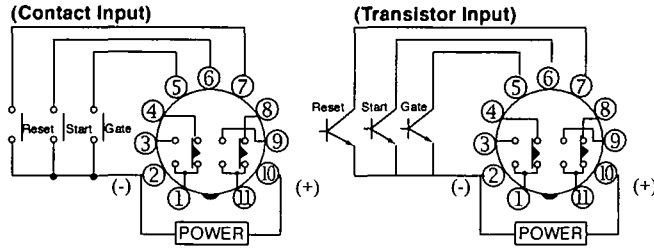

Display Lights

ON-Delay One-Shot 1

Time Remaining **1**

Time Elapsed **1**

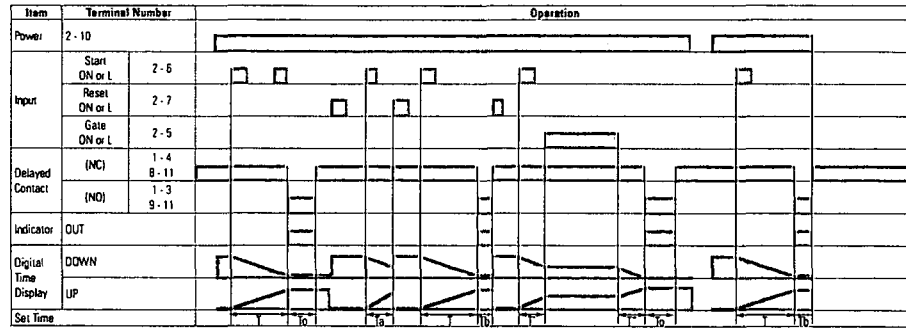

Relays & Sockets

Cycle One-Shot

Time Remaining **2**

Time Elapsed **2**

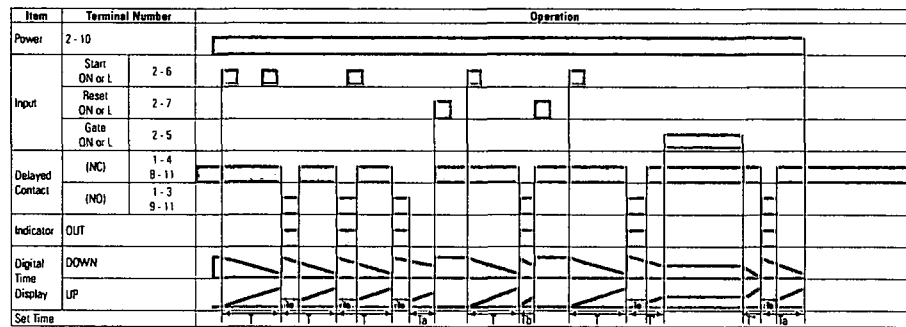

Terminal Blocks

ON-Delay One-Shot 2

Time Remaining **3**

Time Elapsed **3**

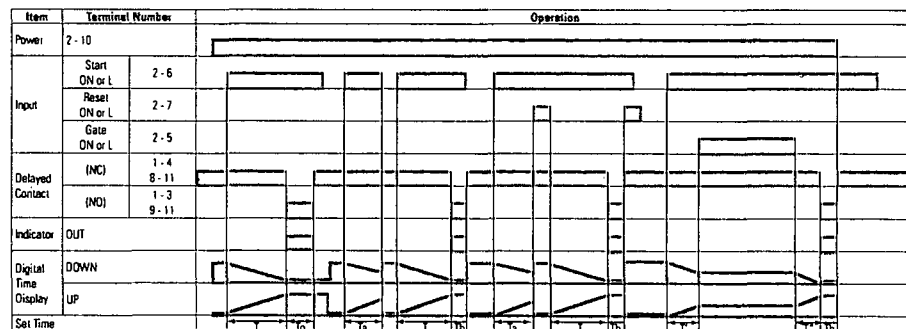

Circuit Breakers



T = Set time  
 Ta = Shorter than set time  
 Tb = Shorter than single-shot output time  
 T = T' + T"  
 T0 = Single-shot output time (selected from A, B, C, D, E or F)

Instructions: Setting GT3D-2, GT3D-3 Timers

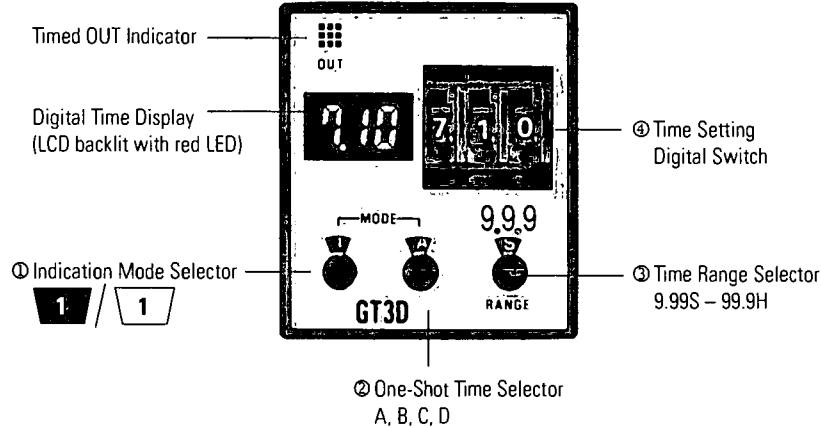

Step 1	Desired Mode/Selection				Remarks
	Time Display Mode	⊖ Indication Mode Selector	Operation Mode	⊖ Operation Mode Selector	
Select the desired time display and operation modes.	Time elapsed	⊖ 1	ON-delay 1	A	1. Use the flat screwdriver to set the selectors. Since selectors do not turn all the way around, both clockwise and counterclockwise rotation may be necessary. 2. The ⊖ Indication Mode Selector determines whether the Digital Time Display shows the time elapsed or time remaining. The ⊖ Operation Mode Selector determines the desired operation mode. Decide which display and mode is desired, then use these two selectors ⊖ ⊖ to set the operation mode. 3. The ⊖ Operation Mode Selector has two blank modes which are not intended for use. Always have this selector set to A, B, C, or D.
	Time remaining	⊖ 1		A	
	Time elapsed	⊖ 1	Interval	B	
	Time remaining	⊖ 1		B	
	Time elapsed	⊖ 1	Cycle 1	C	
	Time remaining	⊖ 1		C	
	Time elapsed	⊖ 1	Cycle 3	D	
	Time remaining	⊖ 1		D	
Step 2	Desired Operation	Selection		Remarks	
Select a time range that contains the desired period of time.	Base Time Ranges	⊖ Time Range Selector		1. The ⊖ Time Range Selector controls both the decimal point indicator (9.99, 99.9, 999) and the time increment indicators S (seconds), M (minutes), and H (hours). 2. Choose which base time range contains the targeted timer setting. Then use the ⊖ Time Range Selector to set the decimal point indicator and time increment indicator to its corresponding pair of settings. 3. Since these configurations offer a complete range of settings from 0.01 seconds to 99.9 hours, the setting of 9.99 for minutes and the 9.99 and 999 settings for hours are not listed and should not be used.	
	0.01 seconds to 9.99 seconds	9.99			
	0.1 seconds to 99.9 seconds	99.9	S		
	1 second to 999 seconds	999			
	0.1 minutes to 99.9 minutes	99.9	M		
	1 minute to 999 minutes	999			
0.1 hours to 99.9 hours	99.9	H			
Step 3	Desired Operation	Selection		Remarks	
Set the precise period of time desired by using the ⊖ Time Setting Digital Switch.				Use the ⊖ Time Setting Digital Switch to set the desired period of time. It is important to remember that the setting of the ⊖ Time Range Selector determines the units of time measurement as well as the implied decimal point location.	

It is important to remember that the ⊖ Time Range Selector not only selects the time range but also influences the interpretation of the Digital Time Display. Changing the ⊖ Time Range Selector setting changes the units of time measurement (seconds, minutes, hours) as well as the decimal point location.

Switches & Pilot Lights

Display Lights

Relays & Sockets

Timers

Terminal Blocks

Circuit Breakers

**Instructions: Setting GT3D-4 Timers**

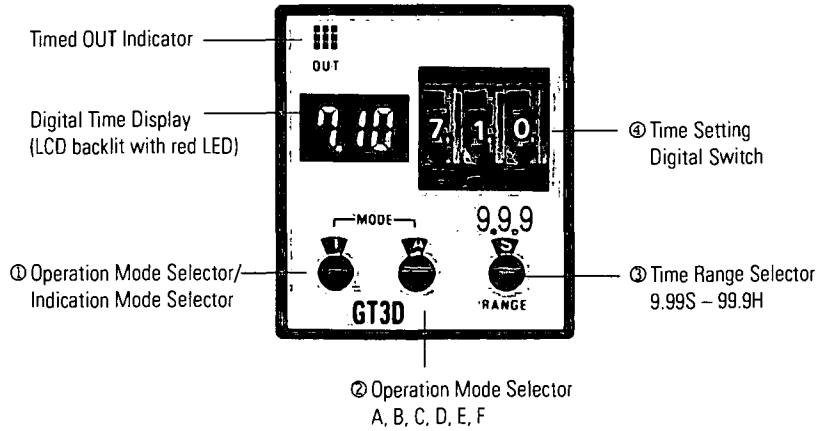

Switches & Pilot Lights

Display Lights

Relays & Sockets



Terminal Blocks

Circuit Breakers

Step 1	Desired Mode/Selection				Remarks
	Time Display Mode	Indicator Mode Selector	Operation Mode	Operation Mode Selector	
Select the desired time display and operation modes.	Time elapsed	1	ON-delay 1 Interval 1	A B C D	1. Use a flat screwdriver to set the selectors. Since selectors do not turn all the way around, both clockwise and counterclockwise rotation is necessary.  2. The Indicator Mode Selector determines whether the Digital Time Display shows the time elapsed or time remaining. The Operation Mode Selector determines the desired operation mode. Decide which display and mode is desired; then use these two selectors to set the operation mode.  3. When using the indicator mode setting "1," the Operation Mode Selector has two blank modes which are not intended for use. When using mode setting "1," always have the operation mode selector set to A, B, C, or D.
	Time remaining	1	Cycle 1 D: Cycle 3		
	Time elapsed	2	ON-delay 2 Cycle 2	A B C D E F	
	Time remaining	2	Signal ON/OFF-delay 2 Signal OFF-delay 1 Interval 2 One-shot cycle		
	Time elapsed	3	Signal ON/OFF-delay 2 Signal OFF-delay 2	A B C D E F	
	Time remaining	3	One-shot 1 One-shot ON-delay One-shot 2 Signal ON/OFF-delay 3		
Step 2	Desired Operation		Selection		Remarks
Select a time range that contains the desired period of time.	<b>Base Time Ranges</b>		<b>Time Range Selector</b>		1. The Time Range Selector controls both the decimal point indicator (9.99, 99.9, 999) and the time increment indicators S (seconds), M (minutes), and H (hours).  2. Choose which base time range contains the targeted timer setting. Then use the Time Range Selector to set the decimal point indicator and time increment indicator to its corresponding pair of settings.  3. Since these configurations offer a complete range of settings from 0.01 seconds to 99.9 hours, the setting of 9.99 for minutes and the 9.99 and 999 settings for hours are not listed and should not be used.
	0.01 seconds to 9.99 seconds	9.99			
	0.1 seconds to 99.9 seconds	99.9	S		
	1 second to 999 seconds	999			
	0.1 minutes to 99.9 minutes	99.9	M		
	1 minute to 999 minutes	999			
0.1 hours to 99.9 hours	99.9	H			
Step 3	Desired Operation				Remarks
	Set the precise period of time desired by using the Time Setting Digital Switch.				Use the Time Setting Digital Switch to set the desired period of time. It is important to remember that the setting of the Time Range Selector determines the units of time measurement as well as the implied decimal point location.

**⚠** It is important to remember that the Time Range Selector not only selects the time range but also influences the interpretation of the Digital Time Display. Changing the Time Range Selector setting changes the units of time measurement (seconds, minutes, hours) as well as the decimal point location.

Instructions: Setting GT3D-8 Timers

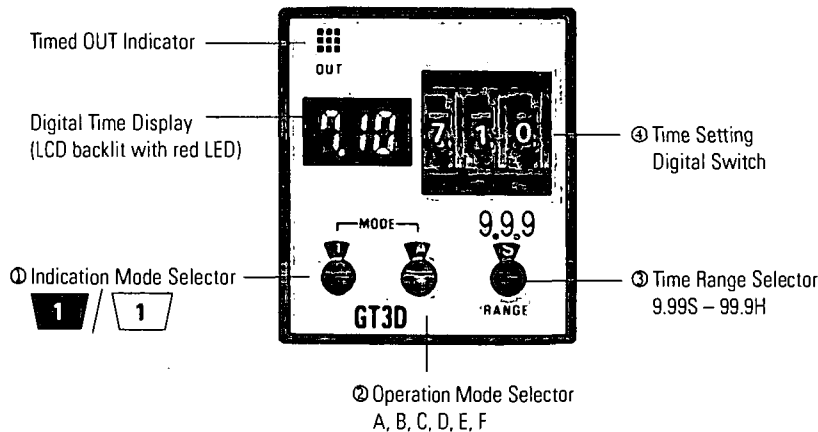

Switches & Pilot Lights

Display Lights

Relays & Sockets

Timers

Terminal Blocks

Circuit Breakers







Step 1	Desired Mode of Operation		Selection	Remarks
Select the time display and operation modes.	ON-Delay One-Shot	Time elapsed	1	1. Use a flat screwdriver to set the selectors. Since selectors do not turn all the way around, both clockwise and counterclockwise rotation is necessary. 2. The GT3D-8 Indication Mode Selector selects both whether the Digital Time Display displays the time elapsed or time remaining and also the mode of operation. Decide which display and mode is desired. Then use this selector to set the operation mode.
		Time remaining	1	
	Cycle One-Shot	Time elapsed	2	
		Time remaining	2	
	ON-Delay One-Shot 2	Time elapsed	3	
		Time remaining	3	
Step 2	Desired Mode of Operation		Selection	Remarks
Select the single shot output time.	Desired Single-Shot Output Time		One-Shot Output Time Selector	On the GT3D-8 timers, the desired single-shot output time can be selected from the A, B, C, D, E, and F modes using the One-Shot Output Time Selector.
	0.1 seconds		A	
	0.5 seconds		B	
	1 second		C	
	5 seconds		D	
	10 seconds		E	
50 seconds		F		
Step 3	Desired Operation		Selection	Remarks
Select a time range that contains the desired period of time.	Base Time Ranges		Time Range Selector	1. The Time Range Selector controls both the decimal point indicator (9.99, 99.9, 999) and the time increment indicators S (seconds), M (minutes), and H (hours). 2. Chose which base time range contains the targeted timer setting. Then use the Time Range Selector to set the decimal point indicator and time increment indicator to its corresponding pair of settings. 3. Since these configurations offer a complete range of settings from 0.01 seconds to 99.9 hours, the setting of 9.99 for minutes and the 9.99 and 999 settings for hours are not listed and should not be used.
			Decimal Point Indicator	
	0.01 seconds to 9.99 seconds		9.99	
	0.1 seconds to 99.9 seconds		99.9	
	1 second to 999 seconds		999	
	0.1 minutes to 99.9 minutes		99.9	
	1 minute to 999 minutes		999	
0.1 hours to 99.9 hours		99.9		
		S		
		M		
		H		
Step 4	Desired Operation		Selection	Remarks
Set the precise period of time desired by using the Time Setting Digital Switch.				Use the Time Setting Digital Switch to set the desired period of time. It is important to remember that the setting of the Time Range Selector determines the units of time measurement as well as the implied decimal point location.

It is important to remember that the Time Range Selector not only selects the time range but also influences the interpretation of the Digital Time Display. Changing the Time Range Selector setting changes the units of time measurement (seconds, minutes, hours) as well as the decimal point location.

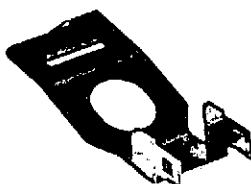
**GT3 Series  
Accessories**

**DIN Rail Mounting Accessories**

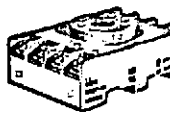
**DIN Rail/Surface Mount Sockets and Hold-Down Springs**

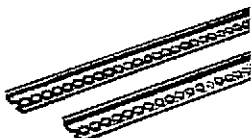
	DIN Rail Mount Socket				Applicable Hold-Down Springs	
	Style	Appearance	Use with Timers	Part No.	Appearance	Part No.
Switches & Pilot Lights	8-Pin Screw Terminal (dual tier)		GT3A-1, 2, 3 (8-pin) GT3D-1, 2, 3 (8-pin) GT3F-1, 2 (8-pin) GT3W (8-pin) GT3S	SR2P-05		SFA-203
	11-Pin Screw Terminal (dual tier)		GT3A-1, 2, 3 (11-pin) GT3A-4, 5, 6 GT3D-1, 2, 3 (11-pin) GT3D-4, 8 GT3F-1, 2 (11-pin) GT3W (11-pin)	SR3P-05		
Display Lights	8-Pin Fingersafe Socket		GT3A-1, 2, 3 (8-pin) GT3D-1, 2, 3 (8-pin) GT3F-1, 2 (8-pin) GT3W (8-pin) GT3S	SR2P-05C		
	11-Pin Fingersafe Socket		GT3A-1, 2, 3 (11-pin) GT3A-4, 5, 6 GT3D-1, 2, 3 (11-pin) GT3D-4, 8 GT3F-1, 2 (11-pin) GT3W (11-pin)	SR3P-05C		
Relays & Sockets	8-Pin Screw Terminal		GT3A-1, 2, 3 (8-pin) GT3D-1, 2, 3 (8-pin) GT3F-1, 2 (8-pin) GT3W (8-pin) GT3S	SR2P-06		SFA-202
	11-Pin Screw Terminal		GT3A-1, 2, 3 (11-pin) GT3A-4, 5, 6 GT3D-1, 2, 3 (11-pin) GT3D-4, 8 GT3F-1, 2 (11-pin) GT3W (11-pin)	SR3P-06		
Terminal Blocks	DIN Mounting Rail Length 1000mm		—	BNDN1000		

**Installation of Hold-Down Springs**  
DIN Rail Mount Socket

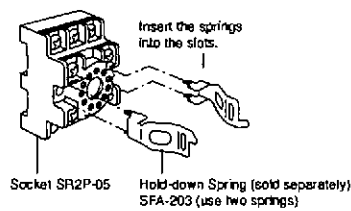
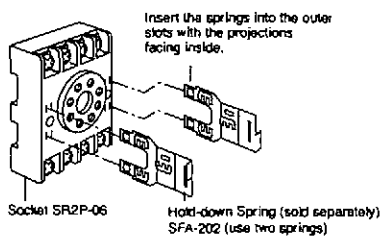

**Panel Mount Socket**

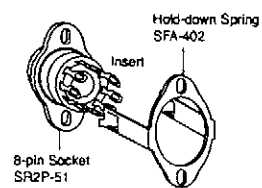



Timers

GT3 Series Accessories

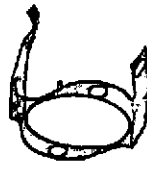

Panel Mounting Accessories

Panel Mount Sockets and Hold-Down Springs



Panel Mount Socket				Applicable HD Springs	
Style	Appearance	Use with Timers	Part No.	Appearance	Part No.
8-Pin Solder Terminal		GT3A- (8-pin) GT3D- (8-pin) GT3W- (8-pin) GT3F- (8-pin) GT3S	SR2P-51		SFA-402
11-Pin Solder Terminal		GT3A- (11-pin) GT3D- (11-pin) GT3W- (11-pin) GT3F- (11-pin)	SR3P-51		

Switches & Pilot Lights

Display Lights

 For information on installing the hold-down springs, see page 838.

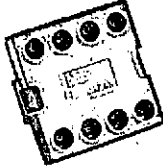
Flush Panel Mount Adapter and Sockets that use an Adapter

Accessory	Description	Appearance	Use with Timers	Part No.
Panel Mount Adapter	Adaptor for flush panel mounting GT3 timers		All GT3 timers	RTB-G01
Sockets for use with Panel Mount Adapter	8-pin screw terminal	 (Shown: SR6P-M08G for Wiring Socket Adapter)	All 8-pin timers	SR6P-M08G
	11-pin screw terminal		All 11-pin timers	SR6P-M11G
	8-pin solder terminal		All 8-pin timers	SR6P-S08
	11-pin solder terminal		All 11-pin timers	SR6P-S11

Relays & Sockets

Timers

Terminal Blocks

Circuit Breakers

 No hold down springs are available for flush panel mounting.

Instructions: Wiring Inputs for GT3 Series

Switches & Pilot Lights

Inputs Inputs

To avoid electric shock, do not touch the input signal terminal during power voltage application.

When connecting the input signal terminals of two or more GT3A timers to the same contact or transistor, the input terminals of the same number should be connected. (Connect Terminals No.2 in common.)

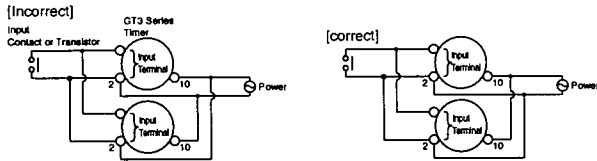

Display Lights

In a transistor circuit for controlling input signals, with its primary and secondary power circuits isolated, do not ground the secondary circuit.

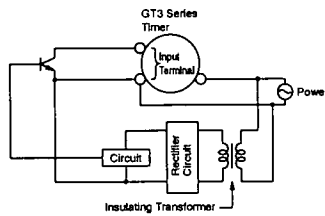

Relays & Sockets

Connect the input signal terminals of the GT3A timers to Terminal No.2 only. Never apply voltage to other terminals; otherwise, the internal circuit may be damaged.

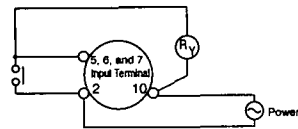

Input signal lines must be made as short as possible and installed away from power cables and power lines. Use shielded wires or a separate conduit for input wiring.

Terminal Blocks

Circuit Breakers

Inputs Instructions, continued

For contact input, use gold-plated contacts to make sure that the residual voltage is less than 1V when the contacts are closed.

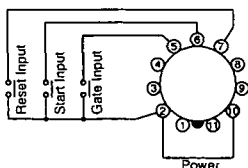

For transistor input, use transistors with the following specifications; VCE = 40V, VCES = 1V or less, IC = 50 mA or more, and ICBO = 50µA or less. The resistance should be less than 1kΩ when the transistor is on. When the output transistor switches on, a signal is input to the timer.

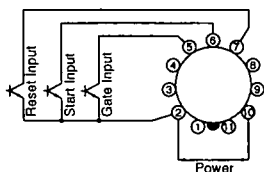

Inputs: GT3A-1, -2, -3

Transistor output equipment such as proximity switches and photoelectric switches can input signals if they are voltage/current output type, with power voltage ranges from 18 to 30V and have 1V. When the signal voltage switches from H to L, a signal is input to the timer

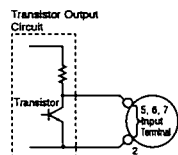

Inputs: GT3A-4, -5, -6

<b>Start Input</b>	The start input initiates a time-delay operation and controls output status.	No-voltage contact inputs and NPN open collector transistor inputs are applicable. 24V DC, 1mA maximum Input response time: 50msec maximum
<b>Reset Input</b>	When the reset input is activated, the time is reset, and contacts return to original state.	
<b>Gate Input</b>	The time-delay operation is suspended while the gate input is on (pause).	

Switches & Pilot Lights

Display Lights

Relays & Sockets



Terminal Blocks

Circuit Breakers



Dimensions

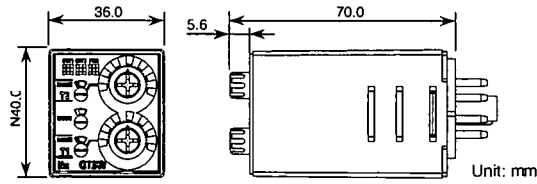

NOTE: GT3W series are UL Listed when used in combination with following IDEC's sockets:  
 GT3W-A11, A33: SR2P-06\* pin type socket.  
 GT3W-A11E: SR3P-05\* pin type socket.  
 (\*-May be followed by A,B,C or U)  
 The socket to be used with these timers are rated:  
 -Conductor Temperature Rating 60°C min.  
 -Use 14AWG max.(2mm<sup>2</sup>max.) Copper conductors only  
 -Terminal Torque 1.0 to 1.3 N-m

Switches & Pilot Lights

Display Lights

Relays & Sockets

Analog GT3 Timer, 8-Pin with SR2P-06

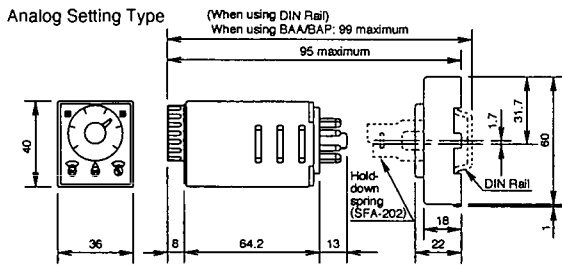

Analog GT3 Timer, 11-Pin with SR3P-06

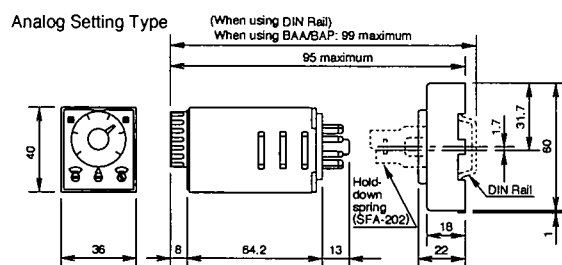

Digital GT3 Timer, 8-Pin with SR2P-06

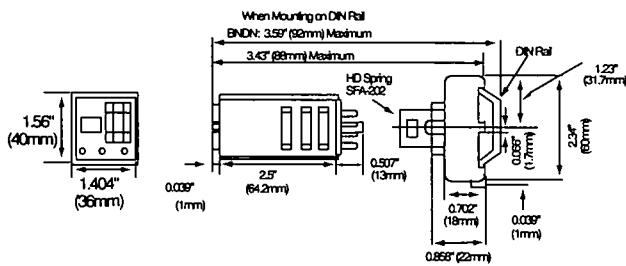

Digital GT3 Timer, 11-Pin with SR3P-06

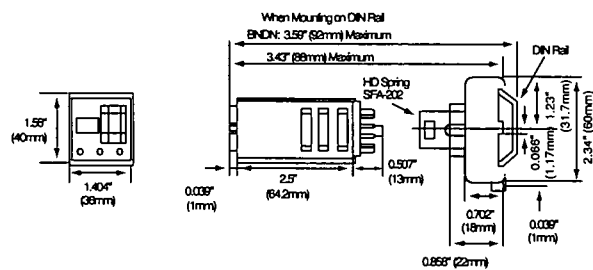

Analog GT3 Timer, 11-Pin with SR3P-05

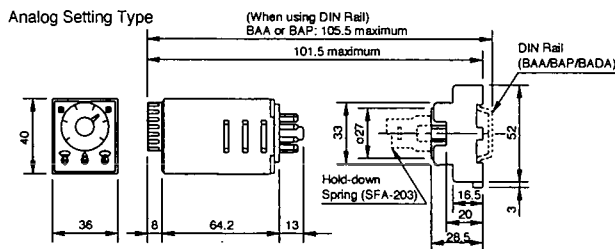

Digital GT3 Timer, 11-Pin with SR3P-05

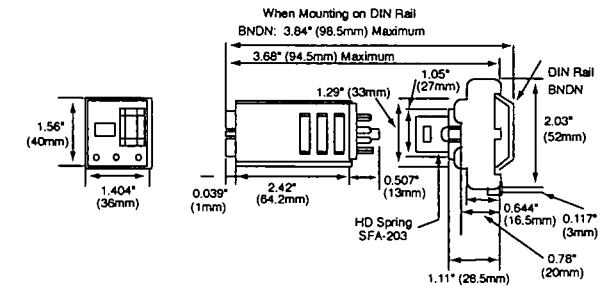

Terminal Blocks

Circuit Breakers

Timers

GT3 Series Dimensions



Panel Mount Adapter

Analog GT3 Timer, 8-Pin and 11-Pin with SR6P-S08 or SR6P-S11

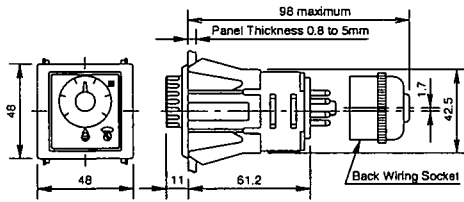

Digital GT3 Timer, 8-Pin and 11-Pin with SR6P-S08 or SR6P-S11

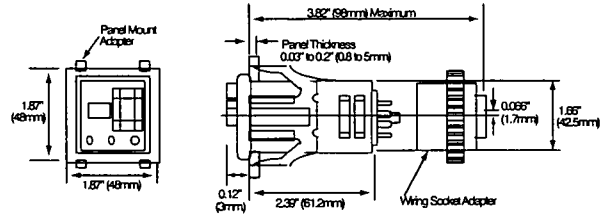

Mounting Hole Layout

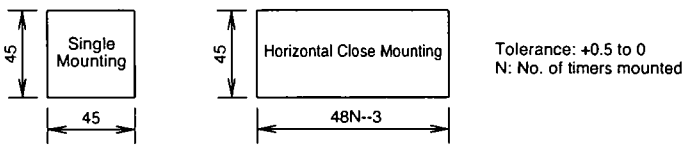

Analog and Digital GT3 Timer, 8-Pin with SR6P-M08G

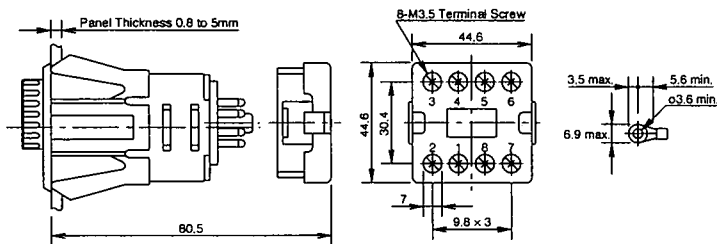

Analog and Digital GT3 Timer, 11-Pin with SR6P-M11G

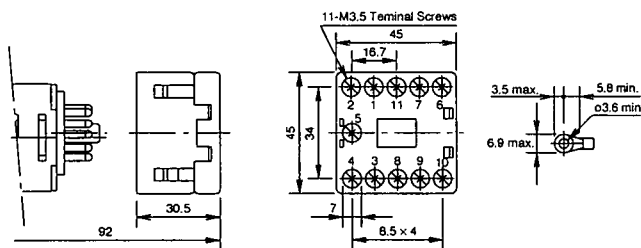

Switches & Pilot Lights

Display Lights

Relays & Sockets



Terminal Blocks

Circuit Breakers

### General Instructions for All Timer Series

Switches & Pilot Lights

**Load Current**

With inductive, capacitive, and incandescent lamp loads, inrush current more than 10 times the rated current may cause welded contacts and other undesired effects. The inrush current and steady-state current must be taken into consideration when specifying a timer.

**Contact Protection**

Switching an inductive load generates a counter-electromotive force (back EMF) in the coil. The back EMF will cause arcing, which may shorten the contact life and cause imperfect contact. Application of a protection circuit is recommended to safeguard the contacts.

**Temperature and Humidity**

Use the timer within the operating temperature and operating humidity ranges and prevent freezing or condensation. After the timer has been stored below its operating temperature, leave the timer at room temperature for a sufficient period of time to allow it to return to operating temperatures before use.

**Environment**

Avoid contact between the timer and sulfurous or ammonia gases, organic solvents (alcohol, benzene, thinner, etc.), strong alkaline substances, or strong acids. Do not use the timer in an environment where such substances are prevalent. Do not allow water to run or splash on the timer.

Display Lights

Relays & Sockets

**Vibration and Shock**

Excessive vibration or shocks can cause the output contacts to bounce, the timer should be used only within the operating extremes for vibration and shock resistance. In applications with significant vibration or shock, use of hold down springs or clips is recommended to secure a timer to its socket.

**Time Setting**

The time range is calibrated at its maximum time scale; so it is desirable to use the timer at a setting as close to its maximum time scale as possible. For a more accurate time delay, adjust the control knob by measuring the operating time with a watch before application.

**Input Contacts**

Use mechanical contact switch or relay to supply power to the timer. When driving the timer with a solid-state output device (such as a two-wire proximity switch, photoelectric switch, or solid-state relay), malfunction may be caused by leakage current from the solid-state device. Since AC types comprise a capacitive load, the SSR dielectric strength should be two or more times the power voltage when switching the timer power using an SSR.

Generally, it is desirable to use mechanical contacts whenever possible to apply power to a timer or its signal inputs. When using solid state devices, be cautious of inrushes and back-EMF that may exceed the ratings on such devices. Some timers are specially designed so that signal inputs switch at a lower voltage than is used to power the timer (models designated as "B" type).

**Timing Accuracy Formulas**

Timing accuracies are calculated from the following formulas:

**Repeat Error** =  $\pm \frac{1 \times \text{Maximum Measured Value} - \text{Minimum Measured Value}}{2 \text{ Maximum Scale Value}} \times 100\%$

**Voltage Error** =  $\pm \frac{T_v - T_r}{T_r} \times 100\%$

T<sub>v</sub>: Average of measured values at voltage V  
T<sub>r</sub>: Average of measured values at the rated voltage

**Temperature Error** =  $\pm \frac{T_t - T_{20}}{T_{20}} \times 100\%$

T<sub>t</sub>: Average of measured values at °C  
T<sub>20</sub>: Average of measured values at 20°C

**Setting Error** =  $\pm \frac{\text{Average of Measured Values} - \text{Set Value}}{\text{Maximum Scale Value}} \times 100\%$



Terminal Blocks

Circuit Breakers

Technical Data

Timing Characteristics (according to VDE 0435, Part 2021)		
Timing ranges for		
RZ7-FSM-A, B, C, D, E, F, I, & L	(1s)	0.05...1 sec
RZ7-FSH	(3s)	0.15...3 sec
	(10s)	0.5...10 sec
	(1mn)	0.05...1 min
	(3mn)	0.15...3 min
	(10mn)	0.5...10 min
	(1h)	0.05...1 hour
	(3h)	0.15...3 hours
	(10h)	0.5...10 hours
	(60h)	3...60 hours
RZ7-FSQ	(2.5s)	0.15...2.5 sec
	(10s)	0.5...10 sec
	(80s)	4...80 sec
	(10mn)	0.5...10 min
Setting accuracy	±5% of full scale value	
Repeatability	±0.2% of the setting values	
Tolerance	Voltage: ±0.001%/°ΔU Temperature: ±0.025%/°C	
<b>Power Supply</b>		
Supply voltages	24...48VDC and 24...240VAC, 50/60Hz (dual voltage) 12VDC 24...240V AC or DC (universal voltage) 346...440VAC, 50/60Hz	
Voltage tolerance	AC: -15%... +10% DC: -20%... +20%	
Power consumption	AC: 5VA at 240V DC: 0.5W at 24V	
Time energized	100%	
Reset time	50ms	
Voltage interruption	≤20ms without reset (supply voltage)	
Input Impedance	Relay On: 3k-13k ohms Relay Off: 0.7k-4k ohms	
Cable length (supply voltage control)	250 meters (800 ft.) max.	
<b>Pulse Control (B1)</b>		
Impulse duration	≥50ms (AC), ≥30ms (DC)	
Input voltage	Supply voltage range	
Input current	1 mA	
Max. Leakage Current	400 micro Amps	
Cable length	max. 250 m (800 ft.) without parallel load between B1 & A2 max. 50 m (160 ft.) with load (<3kΩ) between B1 & B2	
<b>Outputs</b>		
Type of outputs	Relay contacts: hard silver	
Maximum admissible operating voltage	Alternating current: 440VAC	
Dielectric Coil to contact Withstand Voltage	5,000 V	
Switching capacity		
Current $I_m$ : (AC1)	8A (5A for RZ7-FSQ)	
Power:	2000VA according to IEC947-5-1: 3A/440VAC (inductive load, AC14) 3A/250VAC (inductive load, AC15) 1A/24VDC (inductive load, DC13) according to UL 508: 1.5A/250VAC (B300) 3A/120VAC (B300)	
Short circuit resistance	10 A gL (fast blow fuse)	

Life expectancy (electrical)	4 million ops. at 1A/250VAC, $\cos\phi = 1$ 0.2 million ops. at 6A/250VAC, $\cos\phi = 1$ 1.5 million ops. at 1A/250VAC, $\cos\phi = 0.3$ 0.3 million ops. at 3A/250VAC, $\cos\phi = 0.3$ 0.5 million ops. at 6A/24VDC, resistive 2 million ops. at 4A/24VDC, resistive 2 million ops. at 0.2A/230VDC, resistive 1 million ops. at 0.4A/24VDC, L/R = 20ms 1 million ops. at 0.2A/110VDC, L/R = 20ms 1 million ops. at 0.1A/230VDC, L/R = 20ms
Life expectancy (mechanical)	30 million operations
<b>General Data</b>	
Insulation Characteristics	2 kVAC/50 Hz test voltage according to VDE 0435 and 6 kV 1.2/50 $\mu$ s surge voltage according to IEC 947-1 between all inputs and outputs
EMC/Interference Immunity	Performance of following requirements: - Surge capacity of the supply voltage according to IEC1000-4-5: 4 kV 1.2/50 $\mu$ s - Burst according to IEC 1000-4-4: 6 kV/ 6/50ns - ESD discharge according to IEC 1000-4-2: - Contact 8 kV, air 8 kV - Electromagnetic HF field according to IEC 801-3 and conducted electromagnetic HF signal according to IEC 801-6: Level 3
EMC/Emission	Electromagnetic fields according to EN 55 022: Class B
Safe isolation	According to VDE 106, part 101
Climatic withstand	56 cycles (24h) at 25...40°C and 95% relative humidity according to IEC 68-2-30 and IEC 68-2-3.
Vibration resistance	4 g in 3 axis at 10...500 Hz, test FC according
Shock resistance	50 g according to IEC 68-2-27
Protection class	Enclosure: IP40 Terminal: IP20 according to IEC 947-1
Weight	100g
Approvals/Standards	UL, C-UL up to 240VAC, Germanischer Lloyd, CE
Ambient temperature	Open: -25°C...+60°C Enclosed: -25°C...+45°C Storage: -25°C...+85°C
Connections	Screw terminal - M3.5 for Pozidrive No.2, Phillips and slotted screws No.2 suitable for power screwdriver. Rated tightening torque - 0.8 Nm (max. 1.2 Nm) - [8.8 lb-in] Wire Size - Dual-chamber system for terminal cross-sections of 1 x 0.5mm <sup>2</sup> (solid) or 2 x 2.5mm <sup>2</sup> (flexible with sleeve), AWG 20...14. Finger Protection - According to VDE 0106
Mounting	- Snap-on mounting (35mm DIN-rail) - Side mounting on CA7/CA4 contactors and CS7/CS4 with dovetail joint [surface mounting in any position] - Screw fixing by Panel Mount Adapter and two screws (M4) [surface mounting in any position]
Relays	
Disposal	Synthetic material without dioxin according to EC/EFTA notification No. 93/0141/D. Electrical contacts contain cadmium.
Standards	EN 60947-1, EN 60947-5-1, EN 50081-1, IEC 947, UL 508, CSA 22.2

Control & Timing Relays  
RZ7-FS

RZ7 Relative Scale Setting Knob

Series RZ7 Timing Relays have a "relative scale" setting knob numbered 0 to 1.0. Think about this as 0 to 100% of the relay's built-in time range. Example: To set an RZ7-FS timing relay (with a 0.05 to 1 minute range) to activate after 25 seconds:

- 1) Divide the desired activation time (25 seconds) by the maximum time limit of the relay (60 seconds).  
 $25 \div 60 = .416$
- 2) Rotate the setting knob to just past the .4 mark.

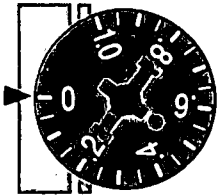



**Dimensions**

**Control & Timing Relays**

**RZ7-FS**

**Series RZ7-FS Timing Relays (one and two pole)**

- Dimensions are in millimeters
- Dimensions not intended for manufacturing purposes

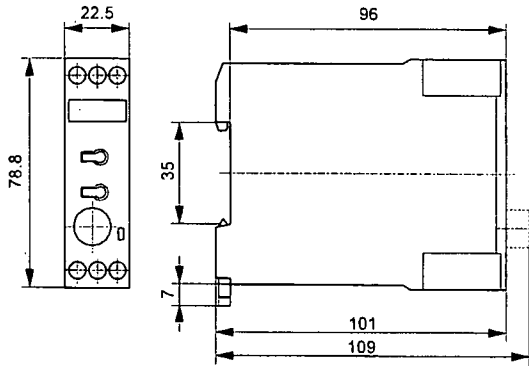

*RZ7-FS (1 SPDT contact)*

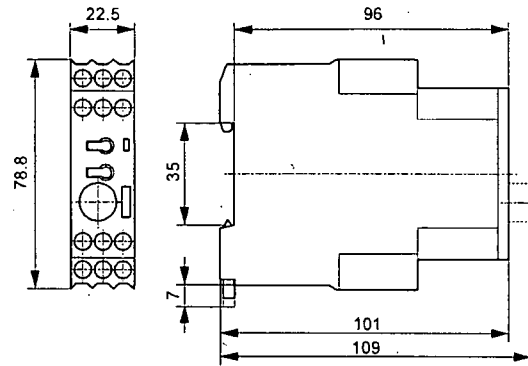

*RZ7-FS (2 SPDT contacts)*

**Panel Mount Adaptor (26.506.221-01)**

- Dimensions are in millimeters
- Dimensions not intended for manufacturing purposes

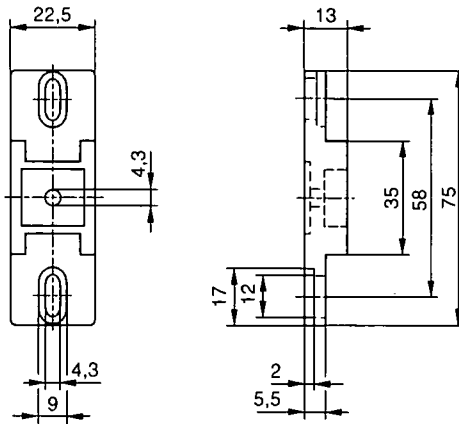







**Halmac** Services (Qld) Pty. Ltd.  
A.C.N. 098 852 923  
A.B.N. 40 741 712 113

# TEST SHEET

1. PUMP STATION SP148 TEST SHEET



# Halmac Services (Qld) Pty Ltd

ACN 098 852 923 ABN 40 741 712 113 ECL 53064

30 Palmer Place, Murarrie Qld 4172  
 All hours Telephone (07) 3249 9500  
 Email: [info@halmac.net.au](mailto:info@halmac.net.au)

PO Box 3467, Tingalpa DC Qld 4173  
 Facsimile (07) 3249 9599  
 Web: [www.halmac.net.au](http://www.halmac.net.au)

## CERTIFICATE OF:

(Please mark relevant check-box)

**TESTING AND COMPLIANCE** ( **Electrical installations** )

Issued in accordance with s159 of the *Electrical Safety Regulation 2002*

**TESTING AND SAFETY** ( **Electrical equipment** )

Issued in accordance with s15 of the *Electrical Safety Regulation 2002*

\* Work performed for:

* Name	<u>QUEENSLAND URBAN</u>	<u>UTILITIES</u>
	<small>Title</small>	<small>Surname</small>
	<small>Given name/s</small>	
* Address	<u>LEVEL 2, T.C.BEIRNE CENTRE, 315 BRUNSWICK STREET</u>	
	<small>Street</small>	
	<u>FORTITUDE VALLEY</u>	<u>4006</u>
	<small>Suburb/town</small>	<small>Postcode</small>

\* Electrical installation / equipment tested (detailed list of all work done):

REPLACEMENT OF SEWERAGE PUMP STATION SP148  
 AS PER QUU DRAWINGS 486/5/7-0185-000 TO 027

\* Date of test 28 / 08 / 2010      \* Electrical contractor licence number 53064

Name on contractor licence Halmac Services Qld Pty Ltd

Electrical contractor phone number 07 3249 9500

For **electrical installations**, this certifies that the electrical installation, to the extent it is affected by the electrical work, has been tested to ensure that it is electrically safe and is in accordance with the requirements of the wiring rules and any other standard applying under the *Electrical Safety Regulation 2002* to the electrical installation.

For **electrical equipment**, this certifies that the electrical equipment, to the extent it is affected by the electrical work, is electrically safe.

Name DAVE JACKSON (C16507)

Person who performed, or person who is responsible for work

Signature       Date 30 / 08 / 2010

\* Indicates a mandatory field

V2.02-2008

**DESIGN & INSPECTION ROUTE SCHEDULE**

CUSTOMER: QUU PROJECT NAME: SP148 PROJECT OFFICER: MN  
 JOB NO: A9230 SWITCHBOARD NAME: DONALDSON RD DRAWING NO: QUU

IS THIS SWITCHBOARD IDENTICAL, OR SIMILAR, TO A PREVIOUS DESIGN? YES (DELETE AS APPLICABLE)  
 IF "NO" COMPLETE SWITCHBOARD DESIGN REVIEW. IF "YES" PROVIDE PREVIOUS DRAWING NO. REFERENCE .....

(TICK APPLICABLE SECTION BELOW: YES / NO / N/A (Not Applicable))

DESCRIPTION	INSPECTION/TEST			INSP.	DATE	IF BUSBARS ARE APPLICABLE COMPLETE DETAIL BELOW																																			
	YES	NO	N/A																																						
SHEET METALWORK - UNPAINTED		✓		MN	05/08	• Sizing as per approved shop drawings • Accessible terminations and fixings • Adequate supports and spacing • Bolts correct type and torque tension • Compartment segregation • Phase-Phase & Phase-Earth Clearance																																			
SHEET METALWORK - PAINTED	✓			MN	05/08																																				
FRONT LAYOUT AS PER DWG																																									
DITTO - SHARP EDGES REMOVED	✓			MN	05/08																																				
WIRING BUILDING WIRE		✓		MN	05/08	<b>INSULATION TEST</b> 1. Megger between phases, phase to N/A phases to earth, with MEN link removed. Note details below in Table "Megger 1" 2. Megger N/A to earth with MEN link removed. 3. Apply 2.5kV for (1) min., phase to phase, phase to NL, and S-phases to earth. 4. Remove HI VOLT tester and repeat item (1). Note details below in Table "Megger 2". HV TEST Set Details: ..... "MEGGER" Detail: <u>3111V</u> Serial No. <u>1180891</u> "HI POT" TEST VOLTAGE: ..... kV Duration: ..... mins "MEGGER" TEST VOLTAGE: <u>1500</u> Volts D.C. INSTRUMENT CALIBRATION: .....																																			
FLEX	✓			MN	09/08																																				
CRIMP LUGS	✓			MN	05/08																																				
BUSBARS AFTER MANUFACTURE				X																																					
BUSBARS - AFTER ASSEMBLY				X		<table border="1"> <thead> <tr> <th>TEST</th> <th>MEGGER 1</th> <th>"HI POT"</th> <th>MEGGER 2</th> </tr> </thead> <tbody> <tr> <td>Red-White</td> <td><u>202.5M Ohm</u></td> <td>..... mA</td> <td>..... M Ohm</td> </tr> <tr> <td>White-Blue</td> <td><u>200.5 M Ohm</u></td> <td>..... mA</td> <td>..... M Ohm</td> </tr> <tr> <td>Red-Blue</td> <td><u>202.1M Ohm</u></td> <td>..... mA</td> <td>..... M Ohm</td> </tr> <tr> <td>Red-Neutral</td> <td><u>200.1 M Ohm</u></td> <td>..... mA</td> <td>..... M Ohm</td> </tr> <tr> <td>White-Neutral</td> <td><u>200.1 M Ohm</u></td> <td>..... mA</td> <td>..... M Ohm</td> </tr> <tr> <td>Blue-Neutral</td> <td><u>200.1 M Ohm</u></td> <td>..... mA</td> <td>..... M Ohm</td> </tr> <tr> <td>R,W,B.-Earth</td> <td><u>200.1 M Ohm</u></td> <td>..... mA</td> <td>..... M Ohm</td> </tr> </tbody> </table>				TEST	MEGGER 1	"HI POT"	MEGGER 2	Red-White	<u>202.5M Ohm</u>	..... mA	..... M Ohm	White-Blue	<u>200.5 M Ohm</u>	..... mA	..... M Ohm	Red-Blue	<u>202.1M Ohm</u>	..... mA	..... M Ohm	Red-Neutral	<u>200.1 M Ohm</u>	..... mA	..... M Ohm	White-Neutral	<u>200.1 M Ohm</u>	..... mA	..... M Ohm	Blue-Neutral	<u>200.1 M Ohm</u>	..... mA	..... M Ohm	R,W,B.-Earth	<u>200.1 M Ohm</u>	..... mA	..... M Ohm
TEST	MEGGER 1	"HI POT"	MEGGER 2																																						
Red-White	<u>202.5M Ohm</u>	..... mA	..... M Ohm																																						
White-Blue	<u>200.5 M Ohm</u>	..... mA	..... M Ohm																																						
Red-Blue	<u>202.1M Ohm</u>	..... mA	..... M Ohm																																						
Red-Neutral	<u>200.1 M Ohm</u>	..... mA	..... M Ohm																																						
White-Neutral	<u>200.1 M Ohm</u>	..... mA	..... M Ohm																																						
Blue-Neutral	<u>200.1 M Ohm</u>	..... mA	..... M Ohm																																						
R,W,B.-Earth	<u>200.1 M Ohm</u>	..... mA	..... M Ohm																																						
FITTING OUT - BEFORE WIRING	✓			MN	05/08																																				
FITTING OUT - AFTER WIRING	✓			MN	05/08																																				
NAME PLATES - BEFORE FITTING	✓			MN	05/08																																				
NAME PLATES - AFTER FITTING	✓			MN	05/08																																				
MEGGER &/OR H.V. TEST	✓			MN	05/08																																				
FUSES/C-B'S - CORRECT SIZE	✓			MN	05/08																																				
WIRE & TERMINALS NUMBERED	✓			MN	05/08																																				
CONTROL & POWER CONN. TIGHT	✓			MN	05/08																																				
POINT TO POINT TEST	✓			MN	05/08																																				
FUNCTIONAL TEST	✓			MN	05/08																																				
COMPLETE S/BOARD TESTING																																									
PLC/PROGRAMMING																																									
FULL DOCUMENTATION IN DWG POCKET																																									
CORRECT DRAWING IN BOARD																																									
PACKING																																									

**REQUEST FOR RELEASE**

'As Built' Dwgs-Completed	✓			MN	05/10
Test Reports - O.K.	✓			MN	05/10
Delivery Docket - Completed					
Packaging - Completed					

I certify that the electrical switchboard has been tested in accordance with the prescribed procedure and is suitable for connection to supply.  
 Certificate of Competency No: 100347  
 Signature of Electrical Mechanic: [Signature]

WIRE COLOURS	240V ACTIVE: <u>RED</u>	240V NEUTRAL: <u>BLACK</u>
ELV-AC ACTIVE:	ELV-AC COMMON:	ELV DEVICES:
ELV-DC POSITIVE: <u>ORANGE</u>	ELV-DC NEGATIVE: <u>VIOLET</u>	TELEMETRY:

NOTES: Free issue gears not powered up.

Inspected by: [Signature] of Halmac DATE: 06/08/10  
 Accepted by: [Signature] of HALMAC DATE: 06/08/10  
 Release Authorized by: ..... of ..... DATE: .....









<b>Halmac Services (Qld) Pty Ltd</b> ACN 098 852 923 ABN 40 741 712 113 ECL 53064 30 Palmer Place, Murarrie Qld 4172 PO Box 3467, Tingalpa DC Qld 4173 Telephone (07) 3249 9500 Facsimile (07) 3249 9599 Web www.halmac.net.au	JOB NAME: <u>DONALDSON RL SP148</u>	No: <u>A9030</u>
	CLIENT: <u>QULU</u>	CC: _____

**MCC CELL INSPECTION AND TEST REPORT**

TIER: _____ CELL: _____	DESIGNATION: _____	SIZE: _____ KW or _____ AMPS
-------------------------	--------------------	------------------------------

PHYSICAL INSPECTION	RESULT	COMMENTS	FUNCTION / OPERATIONAL TEST	RESULT	COMMENTS
Paint Finish good/no marks	✓		Phase Check (voltage)	✓	
Labels complete/correct	✓		Neutral Check (continuity)	✓	
Door Handles operational	✓		Earth Check (continuity)	✓	
Door Handle Interlocks	✓		MCCB Check (operation/voltage)	✓	
Components good/correct	✓		Control MCB/Fuse Check (voltage)	✓	
Phase Colour Markings	✓		Remote/Off/Local Selector	✓	
Shrouds secure/fitted	✓		Emergency Stop	✓	
Danger Labels attached	✓		Available Lamp	N/A	
Earthing connections made	✓		Local Start	✓	
Termination Layout	✓		Run Lamp	N/A	
Wire Colours correct	✓		Local Stop	✓	
Wire Sizes appropriate	✓		Remote (Command) Start/Stop	N/A	
Wire Numbers fitted/readable	✓		Contacto Aux Check	✓	
Wire Connections made/firm	✓		Control Relay Aux Check	✓	
Cleanliness			Overload Trip	N/A	
			Shunt Trip	N/A	
			Thermistor Trip	N/A	
<b>REFERENCE DRAWINGS FOR CELL</b>			CT Ratio Check	✓	
			Ammeter Check	N/A	
<b>DRAWING TITLE</b>	<b>DRAWING NUMBER</b>	<b>REV</b>	Transducer 4-20mA Check	N/A	
<u>Panel NO #2</u>	<u>486/5/7-0185-003</u>	<u>A</u>	Connected Load Test	✓	
			Speed Control Check	N/A	
			Speed Feedback Check	N/A	
			Ramp Up/ Ramp Down Check	N/A	
<b>OVERALL COMMENTS</b>			Communications Check	N/A	
			PLC Input/Output Check	N/A	

TESTED BY: <u>[Signature]</u>	DATE: <u>06/07/10</u>	WITNESSED BY: <u>[Signature]</u>	DATE: <u>06/07/10</u>	CLIENT: _____	DATE: _____
-------------------------------	-----------------------	----------------------------------	-----------------------	---------------	-------------



**CA17a - Factory Inspection Tests**

**Major Projects & Commercial Services**  
 SQUV SP Reliability Improve – Stage2

SP148 DONALDSON ROAD	<b>Date</b>	05/08/10
----------------------	-------------	----------

**A. Electrical Installation Test Records**

AS/NZS 3000:2007 requires that prior to place an electrical installation or any part thereof in service following its construction, alteration, addition or repair, it shall be inspected and tested to verify that the installation is safe to energize and that it will operate correctly in accordance with the requirements of AS3000:2007.

This section is aimed to ensure that the switchboard manufacturer has carried out and documented all applicable AS3000:2007 tests considered as mandatory, prior to execution of the Factory Acceptance Test.

AS/NZS 3017 Electrical Installations – Verification Guidelines provides inspection, test methods and test acceptance parameters to verify AS3000:2007 safety requirements, however these methods are provided for guidance and other alternative methods are acceptable, AS3017:2007 may be applied through legislative requirements made in each State and Territory of Australia and in New Zealand.

Item No.	Activity Description	Results			Signed QUU	Comments
		Acc	Rej	N/A		
A.1	Records for the verification of the continuity and resistance of the earthing system shall include:  a) Main earthing conductor b) Protective earthing conductors c) Earth bonding conductors.					For acceptance criteria and test methods refer to:  AS3000:2007 Section 8.3.5  AS3017:2007 Section 3.1

Doc Id: CA-17a  
 Printed: 9/07/2010

Rev: 15  
 Owr Jfonso Chavez

Queensland Urban Utilities Confidential  
 Page 1 of 1

No Printed copies of this document should be verified for current against the published electronic copy.





**CA17a - Factory Inspection Tests**

**Major Projects & Commercial Services**  
 SQUV SP Reliability Improve – Stage2

Item No.	Activity Description	Results			Signed QUU	Comments
		Acc	Rej	N/A		
A.2	Records for the verification of Insulation Resistance shall include: a) Insulation resistance test of complete installation b) Insulation resistance test of consumers mains c) Insulation resistance test of single circuits					For acceptance criteria and test methods refer to: AS3000:2007 Section 8.3.6 AS3017:2007 Section 3.2
A.3	Records for the verification of Polarity Tests records shall include: a) Consumer mains b) Submains incorporating an earthing conductor c) Submains not incorporating a protective earthing conductor d) Subcircuit polarity connections test (including single pole switches) e) Phase sequence tests					For acceptance criteria and test methods refer to: AS3000:2007 Section 8.3.7 AS3017:2007 Sections 3.3 and 3.5

Doc Id: CA-17a  
 Printed: 9/07/2010  
 Note: Printed copies of this document should be verified for currency against the published electronic copy.

Rev: 15  
 Owner: Alfonso Chavez

Queensland Urban Utilities Confidential  
 Page 2 of 17



**CA17a - Factory Inspection Tests**

**Major Projects & Commercial Services**  
 SQUV SP Reliability Improve – Stage2

Item No.	Activity Description	Results			Signed QUU	Comments
		Acc	Rej	N/A		
A.4	Records for the verification of Correct Circuit connection tests records shall include: a) Interconnection between conductors of different circuits b) Socket-Outlet Sub-Circuits c) Ligthing Points d) Equipment Sub-circuits					For acceptance criteria and test methods refer to: AS3000:2007 Section 8.3.8 AS3017:2007 Section 3.4
A.5	Records for the verification of earth fault-loop for impedance shall include: a) Circuits not protected by an RCD					For acceptance criteria and test methods refer to: AS3000:2007 Section 8.3.9 AS3017:2007 Section 3.6
A.6	Records for the verification of operation of RCDs shall include: a) Circuits protected by an RCD					For acceptance criteria and test methods refer to: AS3000:2007 Section 8.3.10 AS3017:2007 Section 3.7

**Contractor's Tester Signature**

..... Date .....

**Queensland Urban Utilities Electrical Inspector**

.....John Clayton..... Date ...17/06/10.

Doc Id: CA-17a  
 Printed: 9/07/2010  
 No: Printed copies of this document should be verified for current against the published electronic copy.

Rev: 15  
 Own: Alfonso Chavez

Queensland Urban Utilities Confidential  
 Page 3 of 3



**CA17a - Factory Inspection Tests**

**Major Projects & Commercial Services**  
SQUV SP Reliability Improve – Stage 2

**B. Testing Area, Documentation and Test Set Up Arrangements**

This section is aimed to ensure that all documentation and test set up arrangements have been provided to allow execution and readiness to carry out the FAT.

Item No.	Activity Description	Results			Signed QUU	Comments
		Acc	Rej	N/A		
B.1	Verify that a suitable test area has been provided, the test area shall be: <ul style="list-style-type: none"> <li>Clearly identified and barricaded</li> <li>Test bench with enough space for testing equipment and documentation</li> <li>Well ventilated</li> </ul>	✓			<i>AK</i>	<i>Yes.</i>
B.2	All testing equipment to simulate field inputs and outputs including field instruments and motors shall be pre-connected	✓				
B.3	"As Built" drawings marked up available.	✓				
B.4	"Point to Point" test drawing mark-ups provided	✓				

Contractor's Tester Signature

*[Signature]*

Date *06/08/10*

Queensland Urban Utilities Electrical Inspector

.....John Clayton..... Date ...17/06/10.



## CA17a - Factory Inspection Tests

**Major Projects & Commercial Services**  
SQUV SP Reliability Improve – Stage2

### C. Visual Inspections - Sheet Metal / Mechanical Construction Works

The following visual inspections shall take place previous to energising the switchboard circuits. All power supplies shall be disconnected, including the main power supply, generator power supplies and battery power supplies.

Item No.	Activity Description	Results			Signed QUU	Comments
		Acc	Rej	N/A		
C.1	Switchboard dimensions correct as per contract drawings	✓				
C.2	Panel layout as per drawings	✓				
C.3	All equipment is to be removable from switchboard via front access.	✓				
C.4	Power distribution chassis not to be installed too close to the left of the door aperture	✓				
C.5	Check operation and orientation of doors and door handles	✓				
C.6	Switchboard mounting feet as per drawing	✓				
C.7	Material finish as per specification	✓				
C.8	IP Rating as per specifications. Fitting of sun shields shall maintain IP56 rating.	✓				
C.9	All bolts fitted / tight	✓				
C.10	All sheet metal edging to be de-burred, special attention given to handle/lock access heat shield cuts.	✓				

Doc Id: CA-17a

Printed: 9/07/2010

Not Printed copies of this document should be verified for current

Rev: 15

Own fonso Chavez

Queensland Urban Utilities Confidential

Page 5 of 5

inst the published electronic copy.



## CA17a - Factory Inspection Tests

**Major Projects & Commercial Services**  
SQUV SP Reliability Improve – Stage 2

Item No.	Activity Description	Results			Signed QUU	Comments
		Acc	Rej	N/A		
C.11	Door, hinges and locks are properly fitted to allow closing without forcing the door or being loose.	✓				Check distribution Section
C.12	Lock barrels are mounted neatly. Door penetration and holes shall be suited to the particular lock barrel type.	✓				
C.13	Lock barrel types are provided as required and operate correctly	✓				
C.14	Energex Padlock Supplied	✓				
C.15	All doors sealing shall be properly fitted and firmly secured to the switchboard. Glue shall be provided if necessary.	✓				
C.16	Verify that proximity switch metal plates are fixed to doors as indicated in the drawings.	✓				
C.17	Ensure to pre-drill holes in plates that are difficult to access after the construction or installation of the switchboard on site.					
	Particular attention shall be given to internal barrier plates and access plate on distribution board.	✓				
C.18	Cut outs from one cubicle to another please shall be large enough to accommodate all cables.	✓				
C.19	Sealing between plinth and switchboard.	✓				
C.20	Sealing of disconnect zone.	✓				

Doc Id: CA-17a

Printed: 9/07/2010

Note: Printed copies of this document should be verified for currency against the published electronic copy.

Rev: 15

Owner: Alfonso Chavez

Queensland Urban Utilities Confidential

Page 6 of 17



## CA17a - Factory Inspection Tests

**Major Projects & Commercial Services**  
SQUV SP Reliability Improve – Stage2

Item No.	Activity Description	Results			Signed QUU	Comments
		Acc	Rej	N/A		
C.21	Verify that portable generator cable access plate allows the generator plug pass into the switchboard and reach the generator connection outlet.	✓				
C.22	Inspection plates are properly labelled and not used as gland plates. Inspection plates are only provided to ease access to field wiring.	N/A				
C.23	Verify that all gland entries are sealed – No split gland plates	✓				
C.24	All spare holes to be plugged with conduit plugs.					
C.25	Enclosure free of debris	✓				
C.26	Lap top support tray provided including 1/4 turn wing knob on laptop support shelf. Knobs types that cannot be operated by hand are not acceptable.	✓				
C.27	Drawings & log book holder provided	✓				
C.28	Aerial support is adjustable	✓				
C.29	A minimum clearance of 55mm shall be provided around the Redlion HMI to other components mounted in common controls door.	✓				
C.30	Check that selector switches are correctly engraved	✓				

Doc Id: CA-17a

Printed: 9/07/2010

No Printed copies of this document should be verified for current

against the published electronic copy.

Rev: 15

Owr Alfonso Chavez

Queensland Urban Utilities Confidential

Page 7 c



**CA17a - Factory Inspection Tests**

**Major Projects & Commercial Services**  
 SQUV SP Reliability Improve – Stage2

Item No.	Activity Description	Results			Signed QUU	Comments
		Acc	Rej	N/A		
C.31	Check that Indicators are fitted with correct coloured bezels	✓				
C.32	Verify that all external labels are fitted to the switchboard.	✓				
C.33	Labelling is correct and complete - wording, size, fixing, material, level.	✓				
C.34	All internal and external labels are to have bevelled edges, sharp edges are not allowed.	✓				
C.35	Verify that 240VAC warning sign is fitted to the switchboard.	✓				

Contractor's Tester Signature

*John Clayton* ..... Date *05/08/10*

Queensland Urban Utilities Electrical Inspector

.....John Clayton..... Date ...17/06/10.



**CA17a - Factory Inspection Tests**

**Major Projects & Commercial Services**  
SQUV SP Reliability Improve – Stage2

**D. Visual Inspections- Neutral and Earthing**

A visual inspection shall be made when work on an electrical installation has been completed in order to verify that the work complies with the requirements of AS/NZS 3000.

The visual inspection shall be carried out before, or in association with testing, and as far as possible it should be made before the electrical installation is placed in service.

Item No.	Activity Description	Results			Signed QUU	Comments
		Acc	Rej	N/A		
D.1	N/L & E/L have adequate bolts for main Neutral & Earth	✓				
D.2	Earth bar / earth connections fitted & OK	✓				
D.3	All neutral connections are accessible	✓				
D.4	MEN connections provided	✓				
D.5	Neutral & earth connections are not in CT section	✓				
D.6	Surge diverter earthed to adjacent stud.	✓				Only Neutral Connections
D.7	Confirm a Direct connection from main earth bar to switchboard chassis	✓				

**Contractor's Tester Signature**

.....*[Signature]*.....

Date .....05/08/10.....

**Queensland Urban Utilities Electrical Inspector**

.....John Clayton.....

Date ...17/06/10.



### E. Visual Inspections - Electrical Components Mounting, Wiring and Labelling

As a minimum a visual inspection shall be made when work on an electrical installation has been completed in order to verify that the work complies with the requirements of AS/NZS 3000. This visual inspection section includes AS/NZS 3000 checks as well as several checks to verify that the electrical installation meets the specific design and quality requirements and scope of work.

The visual inspection shall be carried out before, or in association with testing, and as far as possible it should be made before the electrical installation is placed in service.

Item No.	Activity Description	Results			Signed QUU	Comments
		Acc	Rej	N/A		
E.1	Busbars appropriately shielded	✓				
E.2	Verify that main switches/circuit breakers and fuses are supplied to the specification (equipment schedule)	✓				
E.3	Main switches lockable/ defeatable as per spec.	✓				
E.4	Check operation of Main Supply and Generator supply mechanical and/or key interlocks as applicable.	✓				
E.5	Verify that metering fuses & CT's are fed off from main switch line side	✓				
E.6	Verify that cable lugs are provided into CRITEC 20 kA surge filter circuit breaker (in most cases Q17)	✓				
E.7	Equipment fed from line side shall be appropriately labelled.	✓				

Item No.	Activity Description	Results			Signed QUU	Comments
		Acc	Rej	N/A		
E.8	Include 2nd label for Surge Diverter and Surge Diverter fuses "FED FROM LINE SIDE OF MAIN SWITCH" as applicable (Items 37/38 on switchboard label schedule).	✓				
E.9	All Circuit Breakers shall be set as indicated in the electrical schematic drawings.	✓				
E.10	All circuit breakers shall be wired line side at the top / load side at the bottom	✓				
E.11	Verify that cables current carrying capacity is as indicated in the electrical schematic drawings.	✓				
E.12	Colour coding of wiring as per specification.	✓				
E.13	Wiring in PVC ducting shall be kept tidy.	✓				
E.14	Check cable access dimensions	✓				
E.15	Check cable access & routes for field cabling.	✓				
E.16	Check phasing of circuits are as per drawing.	✓				
E.17	Electrical components fitted are as specified in the equipment schedule	✓				
E.18	Verify that quantity and location of GPOs are provided as required in the drawings.	✓				
E.19	Confirm all Idéc relays are LED type and wired the correct polarity	✓				

Doc Id: CA-17a

Pr: 9/07/2010

No: Printed copies of this document should be verified for current

against the published electronic copy.

Rev: 15

Ow: Alfonso Chavez

Queensland Urban Utilities Confidential

Page 11



## CA17a - Factory Inspection Tests

**Major Projects & Commercial Services**  
SQUV SP Reliability Improve - Stage2

Item No.	Activity Description	Results			Signed QUU	Comments
		Acc	Rej	N/A		
E.20	Verify that digital timer is mounted on its own specific base (IDEC base) as specified in the equipment list (Item 99 -EMGDT)	✓				
E.21	Check that generator plug has protective cover fitted	✓				
E.22	Verify that power disconnection outlets and plugs are supplied with the switchboard as required	✓				
E.23	Verify that terminals & busbar connections are tight	✓				
E.24	Verify that terminals are identified as per drawings and spares are provided	✓				
E.25	All terminals shall be correct part number, shrouded to IP20 and labelled.	✓				
E.26	All cable cores ferruled & numbered.	✓				
E.27	24VDC power supply shall be mounted to prevent obstruction to the field instrument terminals.	✓				
E.28	Multicore cables shall be used for RTU harnesses to provide neat wiring installation. Use of individual wires for each I/O is not acceptable.	✓				As per the old job.
E.29	Verify that adequate access to RTU and communication plug is provided	✓				
E.30	Modbus communication cables (RS 485) shall be 120ohm impedance twisted pair's.	✓				

Doc Id: CA-17a

Printed: 9/07/2010

Note: Printed copies of this document should be verified for currency against the published electronic copy.

Rev: 15

Owner: Alfonso Chavez

Queensland Urban Utilities Confidential

Page 12 of 17



**CA17a - Factory Inspection Tests**

**Major Projects & Commercial Services**  
 SQUV SP Reliability Improve – Stage2

Item No.	Activity Description	Results			Signed QUU	Comments
		Acc	Rej	N/A		
E.31	Aerial surge arrestor shall be mounted with a small section of DIN rail the earthed as directly as possible	✓				
E.32	When externally installing soft starter CT's for bypass circuit, verify proper size to match the SS and wiring polarity. (if SS is MSF-017 the corresponding CT shall be CTS-017)	✓				
E.33	When externally installing soft starter CT's for bypass circuit, please ensure proper Bypass operation parameter [340] shall be enabled.	✓				
E.34	Motor Starter CT ratios are as specified and mounted to correct polarity	✓				
E.35	Soft starter CT leads to be cut to size / kept short.	✓				

Contractor's Tester Signature

*[Signature]*  
 .....  
 ..... John Clayton.....

Date *05/08/10*

Date ...17/06/10.

Queensland Urban Utilities Electrical Inspector



## CA17a - Factory Inspection Tests

**Major Projects & Commercial Services**  
SQUV SP Reliability Improve – Stage2

### F. Live Power and Operational Tests

The following tests shall be made with all switchboard electrical circuits energized in order to check that the switchboard meets all operational requirements.

Item No.	Activity Description	Results			Signed QUU	Comments
		Acc	Rej	N/A		
F.1	Verify that all circuit breakers isolate their stated circuits	✓				
F.2	Verify that all electrical components energize when power circuits are energized	✓				
F.3	Switchboard lights operate	✓				
F.4	Confirm that E-Stops actually stop its corresponding drive.	✓				
F.5	Thermal overloads or soft starter protection appropriately set	✓				
F.6	Set up all of the soft starter parameters	✓				
F.7	Verify that all Soft starter operation and all display parameters are displaying correctly. Confirm current CTs are the correct polarity	✓				
F.8	A copy of Soft Starter and/or VSD parameter configuration to match site equipment shall be provided to the switchboard manufacturer by the commissioning manager.	✓				
F.9	Record output of 24VDC power supply when connected to 240 VAC main.	✓				27.47V

Doc Id: CA-17a

Printed: 9/07/2010

Note: Printed copies of this document should be verified for currency against the published electronic copy.

Rev: 15

Owner: Alfonso Chavez

Queensland Urban Utilities Confidential

Page 14 of 17



**CA17a - Factory Inspection Tests**

**Major Projects & Commercial Services**  
 SQUV SP Reliability Improve – Stage2

Item No.	Activity Description	Results			Signed QUU	Comments
		Acc	Rej	N/A		
F.10	Record output of 24VDC power supply when disconnected to 240 VAC main.	✓				24.47V -
F.11	Logica RTU provided with corresponding firmware/ software	N/A				Software Version: _____.
F.12	Redlion HMI provided with corresponding software configuration	N/A				Software Version: _____.
F.13	I/O tested to RTU terminals					Only Point to point
F.14	Manual functions tested	✓				

**Contractor's Tester Signature**

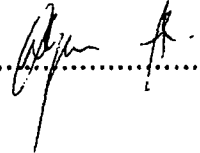
.......... Date 05/08/10

**Queensland Urban Utilities Electrical Inspector**

.....John Clayton..... Date ...17/06/10.

Doc Id: CA-17a  
 P 9/07/2010  
 N Printed copies of this document should be verified for current against the published electronic copy.

Rev: 15  
 Ov Alfonso Chavez

Queensland Urban Utilities Confidential  
 Page 15



**CA17a - Factory Inspection Tests**

**Major Projects & Commercial Services**  
 SQUV SP Reliability Improve – Stage2

**G. Non-Conformances and Unauthorised Modifications**

G.1	
G.2	
G.3	
G.4	
G.5	
G.6	
G.7	
G.8	
G.9	
G.10	

**Contractor's Tester Signature**

..... **Date** .....

**Queensland Urban Utilities Electrical Inspector**

.....John Clayton..... **Date** ...17/06/10.

Doc Id: CA-17a  
 Printed: 9/07/2010  
 Note: Printed copies of this document should be verified for currency against the published electronic copy.

Rev: 15  
 Owner: Alfonso Chavez

Queensland Urban Utilities Confidential  
 Page 16 of 17



**CA17a - Factory Inspection Tests**

**Major Projects & Commercial Services**  
SQUV SP Reliability Improve – Stage2

**This section is to be completed only at the conclusion of the FAT:**

Final FAT Results	YES	NO	Comments
Pre-FAT Completed	✓		
Minor NCRs Generated			
Major NCRs Generated			
Pre-FAT Accepted			

**Notes:**

1. FAT results to be recorded above by Contractor.
2. FAT results to be approved by Queensland Urban Utilities Electrical Inspector.
3. Pre-FAT results to be approved by Queensland Urban Utilities Electrical Inspector at Pre-FAT (if present) or at the start of the FAT.
4. NCRs are to be generated by the Queensland Urban Utilities Electrical Inspector for all NCRs not resolved by the end of the test.

**Contractor's Tester Signature**

..... Date ...17/06/10

**Queensland Urban Utilities Electrical Inspector**

.....John Clayton..... Date ...17/06/10.



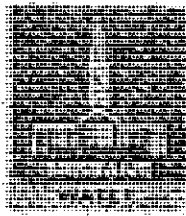

SSM089

## STANDARD SEWAGE PUMP STATION

### SWITCHBOARD CHANGEOVER COMMISSIONING PLAN

Site ID and Name	SP148 DONALDSON RD.
Commissioning Date	26/8/10

**In Attendance**

Name	Role During Commissioning	Company
JOHN CLAYTON	COMMISSIONING MANAGER	SULU
DAVE JACKSON	SUPERVISOR	HALMAC
SAM WALLIN	ELECTRICIAN	HALMAC
JOHN THOMAS	TA	HALMAC

Doc Id: 006142

Active Date: 1-11 - 10 Dec 2008

Brisbane Water Confidential

Printed: 10/12/2008

Owner: Alex Wirshoft

Version 1.00

Note: Printed copies of this document should be verified for currency against the published electronic copy.

## 1 INTRODUCTION

This document is the standard testing procedure for a switchboard change over at a sewage pumping station. The procedure ensures that for a two pump sewage pump station, at least one pump will be operational at all times. The basic cutover procedure is as follows:

1. Install temporary pumping system (pump controller and generator).
2. Disconnect sewage Pump #2 from existing switchboard and connect to temporary pumping system.

**PUMP #1 IS NOW RUNNING THE STATION FROM EXISTING SWITCHBOARD**

3. Fully commission Pump #2 on the temporary pumping system.

**PUMP #2 IS NOW RUNNING THE STATION FROM TEMPORARY PUMPING SYSTEM**

4. Disconnect Pump #1, consumer mains, on site generator and all field instrumentation from the existing switchboard.
5. Install new switchboard and connect to consumer mains.
6. Connect Pump #1 to the new switchboard and test in "emergency pumping" mode (via the "Emergency Start" switch).

**PUMP #2 IS STILL RUNNING THE STATION FROM THE TEMPORARY PUMPING SYSTEM AND PUMP #1 CAN BE RUN UNDER "EMERGENCY PUMPING" MODE FROM NEW SWITCHBOARD.**

7. Connect all field instrumentation.
8. Test Pump #1 on the new switchboard to operate in "Local" and "Remote" modes. Full commissioning done separately

**PUMP #1 IS NOW RUNNING THE STATION FROM NEW SWITCHBOARD**

9. Connect Pump #2 to the new switchboard and Test on the new switchboard. Full commissioning done separately.
10. Complete the Site Acceptance Test (SAT) including pumps, RTU and SCADA testing.

NOTE: This testing procedure will only be acceptable on sites that do NOT need two pumps to run during the cut over procedure.

(Confirm the current running conditions of the existing switchboard before commencing).

For sites that require two pumps to run simultaneously under dry weather conditions during the proposed cut over period, a site-specific cut over procedure must be developed to incorporate adequate flow control measures (ie tankers or temporary pumps).

SSM089 - Standard Sewage Pumping Station - Commissioning Plan - Changeover

## 2 PRE - CHANGE OVER WORKS CHECKLIST

The following checklist is to be completed and signed by the electrical contractor.

### 2.1 SWITCHBOARD FACTORY ACCEPTANCE TEST

Contractor Task	Completed
FAT has been completed as per BW FAT Document and all defects that were identified have been rectified.	✓

### 2.2 CONCRETE SLAB EXTENSION

Contractor Task	Result
Confirm the concrete slab extension is complete including all necessary conduits.	OK <input type="checkbox"/> N/A

### 2.3 SUPPLY AUTHORITY

Contractor Task	Outcome
The relevant supply authority has been organised to install the metering into the New Switchboard.	Company _____ Booked for / / @ _____ (time) Ref # _____
If direct metering supply authority not required. NA <input checked="" type="checkbox"/>	

### 2.4 NEW RADIO ANTENNA MAST LOCATION

Contractor Task	Result
Check the location of the antenna mast and ensure that the new position will not be directly below electrical transmission lines.	Location OK <input checked="" type="checkbox"/> Antenna dir. °

### 2.5 DISCHARGE MAINS PRESSURE TRANSDUCER

Contractor Task	Completed
Install delivery pressure transducer on the discharge rising main. Transducer is calibrated to the specified range (as per spec). 0kPA to 250 kPA	Installed OK <input checked="" type="checkbox"/> Range 0(m) to 25(m)

### 2.6 TEMPORARY GENERATOR SIZE

Contractor Task	Completed
Note the kW of each pump.	Pump #1 7.8 kW Pump #2 7.8 kW
If a Hire Generator is required	Genset Size 60 kVA Date Booked 18/12/10 Delivery Date 28/12/10 Delivery Time 0700

Electrical Contactor's Supervisor

BW Commissioning Manager

Name: DAVE JACKSON Date: 28/12/10

Name: JOHN W. CLAYTON Date: 28/12/10

Signature: *Dave Jackson*

Signature: *J. Clayton*

Doc Id: 006142

Active Date: 1-11 - 10 Dec 2008

Brisbane Water Confidential

Printed: 10/12/2008

Owner: Alex Withoff

Note: Printed copies of this document should be verified for currency against the published electronic copy.

SSM089 - Standard Sewage Pumping Station - Commissioning Plan - Changeover

2.7 PUMP STATION PRELIMINARY OPERATIONAL CHECKS

BW Task	Checked
These are checks are helpful to ensure the pump station is fully operational and that no delay will be incurred due to any pump station problem out side of the contract. These task are desirable to have completed before the SAT but are not essential. The job can proceed if they are not done. Commissioning Manager to request networks maintenance to inspect and rectify if necessary	
The reflux valves and associated limit switches are working correctly.	N/A. OK <input type="checkbox"/>
The discharge pressure connection point is available and that the isolation valve is functioning correctly.	OK <input checked="" type="checkbox"/>
The dry well exhaust fan is working correctly and quietly.	N/A. OK <input type="checkbox"/>
The wet well does not need pumping out.	N/A. OK <input type="checkbox"/>
The flow meter is functioning correctly.	N/A. OK <input type="checkbox"/>
The stand by generator can start and has sufficient fuel.	OK <input checked="" type="checkbox"/>

Electrical Contactor's Supervisor

Name: DAVE JACKSON Date: 28/8/10

Signature: *D Jackson*

BW Commissioning Manager

Name: John CLAYTON Date: 28/8/10

Signature: *J Clayton*

Doc Id: 006142

Active Date: 1-11-10 Dec 2008

Brisbane Water Confidential

Printed: 10/12/2008

Owner: Alex Withoft

Note: Printed copies of this document should be verified for currency against the published electronic copy.

SSM089 - Standard Sewage Pumping Station - Commissioning Plan - Changeover

### 3 CHANGE OVER WORKS

The following sequence of change over works is the order in which they must be followed. One pump must be operational at all times. After each phase has been completed, the commissioning manager will record the results and instruct the commissioning team to commence work on the next phase.

#### 3.1 INSTALL TEMPORARY PUMPING SYSTEM

##### 3.1.1 Register with Control Room

Contractor Task	Outcome
Call the Brisbane Water Control Room Operator (CRO) and inform him that you are on site. Record the CRO's Name and Officer Code and record the time of the call. Advise CRO that you are performing a switchboard changeover and that you will initially be taking one pump off line. Give the operator your contact name and number and advise the operator that communications will be lost to the pump station until the job is finished.	Name: <u>JOHN</u> CRO: _____ Time: <u>06.00.</u>

##### 3.1.2 Existing Switchboard Parameters

Contractor Task	Outcome
Ensure that the station is fully functional (pumps can run)	OK <input checked="" type="checkbox"/>
Record the direction of the installed antenna for later reference.	Antenna dir. _____°
Record the kWhr meter serial numbers.	# _____
Record 3 phase motor currents	Pump #1 U. <u>126V. 12.6W. 12.6.</u> Pump #2 U. <u>130V. 13.0W. 13.0</u>

##### 3.1.3 Prepare and Install Temporary Pump Controller and Generator

Contractor Task	Outcome
Position generator in an appropriate location. Locate away from the work site to reduce noise and fumes.	OK <input checked="" type="checkbox"/>
Position fire extinguisher and oil spill bund as per risk analysis.	OK <input checked="" type="checkbox"/>
Connect the temporary pump controller 3 phases to the generator.	OK <input checked="" type="checkbox"/>
Install Multitrode level sensors and set the Start and Stop levels to be equivalent to the current Start and Stop levels of the existing switchboard parameters.	OK <input checked="" type="checkbox"/>
Install the backup audible and visual alarm system (powered by separate battery). Test electrodes back to temporary pump controller to confirm operation.	OK <input checked="" type="checkbox"/>
Ensure that the generator fuel will be sufficient to enable the generator to run loaded for 12 hours. (This may require extra fuel – arrange if required).	OK <input checked="" type="checkbox"/>
Start the generator and measure the 3 phase volts	OK <input checked="" type="checkbox"/>

Electrical Contactor's Supervisor

BW Commissioning Manager

Name: DAVE JACKSON Date: 28/8/10.

Name: JOHN CLAYTON Date: 28/8/10.

Signature: [Signature]

Signature: [Signature]

Doc id: 006142

Active Date: 1-11 - 10 Dec 2008

Brisbane Water Confidential

Printed: 10/12/2008

Owner: Alex Withoft

Note: Printed copies of this document should be verified for currency against the published electronic copy.

SSM089 - Standard Sewage Pumping Station - Commissioning Plan - Changeover

**3.2 CONNECT PUMP #2 TO TEMPORARY PUMPING SYSTEM**

Contractor Task	Outcome
On the existing switchboard, isolate sewage pump (Pump #2) as per BW Isolation Tag and Lock Out procedure. (Unplug from Decontactor).	OK <input checked="" type="checkbox"/>
Disconnect Pump #2 from the existing switchboard and remove the power cables from the switchboard.	OK <input checked="" type="checkbox"/>
Connect Pump #2 power cables to the temporary pump controller.	OK <input checked="" type="checkbox"/>
Electrically test Pump #2 to temporary pump controller connections.	OK <input checked="" type="checkbox"/>
Switch the existing switchboard to "Local" and confirm Pump #1 is stopped.	OK <input checked="" type="checkbox"/>
<b>Manual Test of Temporary Pumping System: (Confirm Pump Direction)</b> Manually start the submersible pump and closely monitor wet well level to confirm that the level is dropping. When confirmed, stop pump.	OK <input checked="" type="checkbox"/>
<b>Auto Test of Temporary Pumping System: (Confirm Pump Cycle)</b> Allow the temporary pumping system to complete one full start and stop cycle automatically to confirm complete system is functioning correctly. <b>This is a HOLD point. Do not proceed until the temporary pump is confirmed to be controlling the wet well level.</b>	OK <input checked="" type="checkbox"/> TIME: 08:30

**3.3 DISCONNECT AND REMOVE EXISTING SWITCHBOARD**

**3.3.1 Disconnect Pump #1 and Remove Existing Switchboard**

Contractor Task	Outcome
On the existing switchboard, isolate sewage pump (Pump #1) as per BW Isolation Tag and Lock Out procedure. (Unplug from Decontactor).	OK <input checked="" type="checkbox"/>
Disconnect Pump #1 from the existing switchboard and remove the power and control cables from the switchboard consider the possible need for a quick changeover from the temporary system, Pump #2 to Pump #1, if required.	OK <input checked="" type="checkbox"/>
Isolate main incomer at the switchboard. Ensure all secondary sources of power (ie on site Generator) are also isolated from the switchboard. Confirm there is no load.	OK <input checked="" type="checkbox"/>
Remove primary 3-phase fuses from power pole. Lock fuses in lockout box as per BW Isolation and Lock Out procedure.	OK <input checked="" type="checkbox"/>
Disconnect supply authority mains cable from the switchboard.	OK <input checked="" type="checkbox"/>
Disconnect all other control and communication cables from the switchboard then remove the switchboard away from adjacent job site so not to interfere with the work.	OK <input checked="" type="checkbox"/>

Electrical Contactor's Supervisor

BW Commissioning Manager

Name: DAVE JACKSON Date: 28/8/10.

Name: JOHN CLAYTON Date: 28/8/10.

Signature: *Dave Jackson*

Signature: *John Clayton*

Doc Id: 006142

Active Date: 1-11 - 10 Dec 2008

Brisbane Water Confidential

Printed: 10/12/2008

Owner: Alex Wirhofer

Note: Printed copies of this document should be verified for currency against the published electronic copy.

SSM089 - Standard Sewage Pumping Station - Commissioning Plan - Changeover

3.4 INSTALL NEW SWITCHBOARD

3.4.1 Install new switchboard (For Sites with Option F Only)

Contractor Task	Outcome
Install and connect the required (new or existing) earth cable	New <input type="checkbox"/> Existing <input checked="" type="checkbox"/>
Install and connect the required (new or existing) mains cable	New <input type="checkbox"/> Existing <input checked="" type="checkbox"/>
Record the 3 phases mains cable insulation resistance to earth.	A <u>750</u> Megohm B <u>750</u> Megohm. C <u>750</u> Megohm
Record earth resistance	_____ ohms
Point to point phase continuity	R to L1 OK <input checked="" type="checkbox"/> W to L2 OK <input checked="" type="checkbox"/> B to L3 OK <input checked="" type="checkbox"/> N to Neutral OK <input checked="" type="checkbox"/>

3.4.2 Install Supply Authority Metering

Task	Outcome
Install the direct connected kWhr Meter	OK <input checked="" type="checkbox"/>

3.4.3 Energise New Switchboard

Contractor Task	Outcome
Retrieve mains 3-phase pole fuses from lock out box as per BW Isolation and Lock Out procedure.	OK <input checked="" type="checkbox"/>
Ensure new switchboard main incomer is turned "Off".	OK <input checked="" type="checkbox"/>
Install the 3-phase pole fuses.	OK <input checked="" type="checkbox"/>
Turn on mains switch	OK <input checked="" type="checkbox"/>
Check 3 phase voltages	AB <u>418</u> V BC <u>415</u> V CA <u>416</u> V
Check phase rotation and ensure it is the same as determined earlier.	OK <input checked="" type="checkbox"/>
Check MEN connection.	OK <input checked="" type="checkbox"/>

Electrical Contactor's Supervisor

BW Commissioning Manager

Name: DAVE JACKSON Date: 28/8/10

Name: JOHN CLAYTON Date: 28/8/10

Signature: [Signature]

Signature: [Signature]

Doc Id: 006142

Active Date: 1-11 - 10 Dec 2008

Brisbane Water Confidential

Printed: 10/12/2008

Owner: Alex Withoff

Note: Printed copies of this document should be verified for currency against the published electronic copy.

SSM089 - Standard Sewage Pumping Station - Commissioning Plan - Changeover

3.5 CONNECT PUMP #1 TO THE NEW SWITCHBOARD

Contractor Task	Outcome
At the beginning of this procedure, Pump #2 is operating under the control of the temporary switchboard running from the Generator.	OK <input checked="" type="checkbox"/>
Isolate submersible Pump #1 and Pump #2 at the new switchboard, as per BW Isolation and Lock Out procedure. (Decontactors)	OK <input checked="" type="checkbox"/>
Via the MERACHAL plug in sockets provided on the switchboard reconnect the power and control cables for Pump #1 (this is the pump that is not connected to the generator set)	OK <input checked="" type="checkbox"/>
Install and connect the hydrostatic level probe to the transmitter.	Range 0 to <u>4</u> m
Confirm that level is indicating on the display.	OK <input checked="" type="checkbox"/>
Before beginning the next step ensure that the well level is between 'Start' and 'Stop' level and Pump #2 is not running. Isolate Pump #2 to prevent it from running during the next test	OK <input checked="" type="checkbox"/>
De-isolate this now connected Pump #1. Check the rotation by starting the pump via the local "Emergency Start" switch and confirming the wet well level drops by at least 1%.	OK <input checked="" type="checkbox"/>
Start Pump # 1 again and Check the 3 phase motor current and compare with original readings.  PUMP #1 Can now be run in emergency and local, under the control of the new switchboard.	A <u>13.5</u> Amps B <u>13.6</u> Amps C <u>13.8</u> Amps
De-isolate Pump #2 so that the station is again under the control of the temporary switchboard.	OK <input checked="" type="checkbox"/>

3.6 CONNECT FIELD INSTRUMENTATION TO THE NEW SWITCHBOARD

3.6.1 Field Devices

Contractor Task	Outcome
Connect the delivery pressure probe to the transmitter	OK <input type="checkbox"/> 0 to <u>2.7</u> Mtrs
Install and connect the Multitrode LR3 wet well high level relay Probe	OK <input type="checkbox"/> at ___ Mtrs
Install and connect the Multitrode SIR surcharge imminent level relay Probe	OK <input type="checkbox"/> at ___ Mtrs
Connect the thermistors for each pump (sites with option I only)	OK <input checked="" type="checkbox"/> N/A <input type="checkbox"/>
Connect the moisture in oil sensor for each pump (sites with option A only)	OK <input type="checkbox"/> N/A <input checked="" type="checkbox"/>
Connect the moisture in stator for each pump (sites with option B1 only)	OK <input type="checkbox"/> N/A <input checked="" type="checkbox"/>
Connect the motor bearing temperature for each pump (sites with option B2 only)	OK <input type="checkbox"/> N/A <input checked="" type="checkbox"/>
Connect the reflux valve micro switch for each pump (sites with option C only)	OK <input type="checkbox"/> N/A <input checked="" type="checkbox"/>
Connect the upstream manhole surcharge imminent probe (sites with option D only)	OK <input type="checkbox"/> N/A <input checked="" type="checkbox"/>
Connect the Multitrode LR2 sump pump start/ stop probes (sites with option E only)	OK <input type="checkbox"/> N/A <input checked="" type="checkbox"/>
Connect the Multitrode LR4 sump pump high/trip probes (sites with option E only)	OK <input type="checkbox"/> N/A <input checked="" type="checkbox"/>
Connect the sump pump (sites with option E only)	OK <input type="checkbox"/> N/A <input checked="" type="checkbox"/>

Electrical Contactor's Supervisor

BW Commissioning Manager

Name: DAVE JACKSON Date: 28/8/10

Name: JOHN CLAYTON Date: 28/8/10

Signature: [Signature]

Signature: [Signature]

Doc Id: 006142

Active Date: 1-11 - 10 Dec 2008

Brisbane Water Confidential

Printed: 10/12/2008

Owner: Alex Withoff

Note: Printed copies of this document should be verified for currency against the published electronic copy.



SSM089 - Standard Sewage Pumping Station - Commissioning Plan - Changeover

3.7 CONNECT PUMP #2 TO THE NEW SWITCHBOARD

3.7.1 Connect Pump #2 to New Switchboard

Contractor Task	Outcome
At the beginning of this procedure, Pump #1 is operating under the control of the new switchboard running from the supply authority.	OK <input checked="" type="checkbox"/>
Shut down the generator and disconnect Pump #2 from the temporary switchboard	OK <input checked="" type="checkbox"/>
Ensure Pump #2 circuit breaker at the new switchboard is still isolated and locked out as per BW Isolation and Lock Out procedure.	OK <input checked="" type="checkbox"/>
Via the MERACHAL plug in sockets provided on the switchboard, connect the power and control cables for Pump #2.	OK <input checked="" type="checkbox"/>
De-isolate this now connected submersible pump. Check the rotation by starting the pump via the local "Emergency Start" switch and confirming the wet well level drops by at least 1%.	OK <input checked="" type="checkbox"/>
Start Pump # 2 again and Check the 3 phase motor current and compare with original readings.  <b>PUMP #2 Can now be run in emergency and local, under the control of the new switchboard.</b>	A <u>13.2</u> Amps B <u>13.5</u> Amps C <u>13.4</u> Amps

3.8 COMMISSIONING OF THE PUMP STATION COMMUNICATIONS

3.8.1 Radio Antenna Installation

BW Programmer Task	Outcome
Install new mast with Antenna, orientate antenna to the position determined in section 3.1.2 connect coaxial cable plugs.	OK <input checked="" type="checkbox"/>

3.8.2 Telemetry and SCADA Communications Checks

BW Programmer Task	Outcome
Brisbane Water programmer must complete the following procedures <i>From the SSM086 Standard Fixed Speed Sewage Pumping Station (S.A.T.) Section 1: Setup and Pre-Commissioning Checks 1.1 to 1.8</i>	OK <input type="checkbox"/>

Electrical Contactor's Supervisor

Name: DAVE JACKSON Date: 28/8/10

Signature: [Signature]

BW Commissioning Manager

Name: JOHN CLAYTON Date: 28/8/10

Signature: [Signature]

Doc Id: 006142

Active Date: 1-11 - 10 Dec 2008

Brisbane Water Confidential

Printed: 10/12/2008

Owner: Alex Withoft

Note: Printed copies of this document should be verified for currency against the published electronic copy.

SSM089 - Standard Sewage Pumping Station - Commissioning Plan - Changeover

3.9 COMMISSIONING OF THE PUMP STATION PUMPING SYSTEM

3.9.1 Commissioning of Pump #1 and Pump#2

BW Programmer & Contractor Task	Outcome
Before beginning the next step ensure that the well level is between "Start and Stop" level (Station under the control of the new board)	OK <input checked="" type="checkbox"/>
Brisbane Water Programmer must complete the following procedures <i>From the SSM086 Standard Fixed Speed Sewage Pumping Station (S.A.T.) Section2: On Site Commissioning Procedure 2.1 to 2.9</i>	OK <input checked="" type="checkbox"/>

3.9.2 Commissioning of the SCADA Monitor and Control System

BW Programmer & Contractor Task	Outcome
Brisbane Water Programmer must complete the following procedures <i>From the SSM086 Standard Fixed Speed Sewage Pumping Station (S.A.T.) Section3: On Site Commissioning Procedure</i>	OK <input checked="" type="checkbox"/>

3.10 INSTALL GENERATOR MAINS (FOR SITES WITH PERMANENT GENERATORS – OPTION F)

Contractor Task	Outcome
Record insulation resistance of the 3-phases	A _____ Megohm B _____ Megohm. C _____ Megohm
Record earth resistance	_____ ohms
Connect the generator IO cables	OK <input type="checkbox"/>
Point to point phase continuity	R to L1 OK <input type="checkbox"/> W to L2 OK <input type="checkbox"/> B to L3 OK <input type="checkbox"/>

N/A

Electrical Contactor's Supervisor

Name: DAVE JACKSON Date: 20/8/10

Signature: [Signature]

BW Commissioning Manager

Name: JOHN CLAYTON Date: 20/8/10

Signature: [Signature]

Doc Id: 006142

Active Date: 1-11 - 10 Dec 2008

Brisbane Water Confidential

Printed: 10/12/2008

Owner: Alex Witthoft

Note: Printed copies of this document should be verified for currency against the published electronic copy.

SSM089 - Standard Sewage Pumping Station - Commissioning Plan - Changeover

3.11 SITE ACCEPTANCE TESTING

3.11.1 Site Acceptance Testing (S.A.T) – Remaining Tests

BW Programmer & Contractor Task	Outcome
Once pump 2 has been commissioned Complete any <u>remaining procedures in Section 2</u> <i>from the SSM086 Standard Fixed Speed Sewage Pumping Station (S.A.T.)</i>	OK <input checked="" type="checkbox"/>
Check operation of SIR for 20 sec. with probe to prove probe operation and operation of 2 pumps	OK <input type="checkbox"/>
Check operation LR3 with probe to prove RTU and probe	OK <input type="checkbox"/>
Seal conduits with denso and grout under switchboard.	OK <input checked="" type="checkbox"/>
Check Energex Phase Fail Input.	OK <input checked="" type="checkbox"/>
Confirm automatic control of pumps.	OK <input checked="" type="checkbox"/>
Check Parameter 203 of Soft Starter is a positive value	OK <input checked="" type="checkbox"/>
Confirm correct operation of all door locks	OK <input checked="" type="checkbox"/>
Confirm Operation & Maintenance Manual left on site.	OK <input type="checkbox"/>

3.11.2 SCADA Testing

BW Programmer & Contractor Task	Outcome
The Brisbane Water Programmer must complete the following procedures with the assistance from the Commissioning Engineer and SCADA Commissioning Engineer in the Control Room. <i>From the SSM086 Standard Fixed Speed Sewage Pumping Station (S.A.T.)</i> <i>Section3 : SCADA Commissioning Procedure</i>	OK <input checked="" type="checkbox"/>

3.11.3 Preliminary Work Completion by Electrical Contractors

Contractor Task	Outcome
Leave the site clean and tidy and hazard free.	OK <input checked="" type="checkbox"/>
Confirm with BW that the job is complete and their staff can leave.	OK <input checked="" type="checkbox"/>
Confirm with BW that BW staff will lock up the site on completion of the switchboard change over work.	OK <input checked="" type="checkbox"/>
Note: If there is a problem with finishing the work due to unforeseen circumstance refer to the Risk Analysis attached.	OK <input checked="" type="checkbox"/>

3.11.4 Register Control Room

BW Programmer & Contractor Task	Outcome
Commissioning Engineer to call the Control Room Operator (CRO) and inform him that the site works is complete and that the site is now fully in "Remote" control and that all alarms are to be acted on as per the alarm instructions. C.R.O. to confirm that the site is healthy and that there are no alarms active. Record the C.R.O.'s name and Officer Code and record the time of the call.	Name: _____ CRO _____ TIME: 1730 hrs

BW Commissioning Manager

Name: John Clayton Date: 28/8/10

Signature: [Handwritten Signature]

Doc Id: 006142

Active Date: 1-11 - 10 Dec 2008

Brisbane Water Confidential

Printed: 10/12/2008

Owner: Alex Wirthoft

Note: Printed copies of this document should be verified for currency against the published electronic copy.

## 4 POST CHANGE OVER CHECKLIST

### 4.1 DELIVERABLES FROM RTU PROGRAMMER

BW Programmer	Date Completed
Within 7 days of the change over the following must be completed and signed off by the BW Programmer0 Complete <u>Section 4: Post Commissioning</u> <b>from the SSM086 Standard Fixed Speed Sewage Pumping Station (S.A.T.)</b>	/ /
The BW Programmer will ensure that the Control Room Acceptance (CRA) form is signed by the Manager of the Control Room Officers. The form is to be handed to the Contracts Manager (CM).	/ /

### 4.2 DELIVERABLES FROM ELECTRICAL CONTRACTOR

Contractor Task	Date Completed
All documentation required under the contract is to be provided with the time specified (AS BUILT's, Electrical Certificates etc).	/ /

### 4.3 DELIVERABLES FROM COMMISSIONING MANAGER

Commissioning Manager	Date Completed
All documentation is handed to the Project Manager to that the new switchboard asset can be capitalised and handed over to the customer.	
Factory Acceptance Test Sheet – Completed & signed off.	OK <input type="checkbox"/>
Electrical Inspection Sheet – Completed & signed off.	OK <input type="checkbox"/>
Site Acceptance Test Sheet – Completed & signed off.	OK <input type="checkbox"/>
Commissioning Plan – Completed & signed off.	OK <input type="checkbox"/>
Control Room Acceptance Form – Completed & signed off	OK <input type="checkbox"/>
As built Drawings have been updated, drafted and taken to site along with the Site Specific Functional Specification,	/ /

### 4.4 SUGGESTIONS FOR IMPROVEMENT

Suggestion	Recommended By

BW Commissioning Manager

Name:..... Date: .....

Signature: .....

Doc Id: 006142

Active Date: 1-11 - 10 Dec 2008

Brisbane Water Confidential

Printed: 10/12/2008

Owner: Alex Withoft

Note: Printed copies of this document should be verified for currency against the published electronic copy.





5



6



7















