



FCC RF Test Report

APPLICANT : TCL Communication Ltd.
EQUIPMENT : CDMA EVDO BC0/BC1 mobile phone
BRAND NAME : ALCATEL ONETOUCH
MODEL NAME : A462C
MARKETING NAME : A462C
FCC ID : 2ACCJB013
STANDARD : FCC Part 15 Subpart C §15.247
CLASSIFICATION : (DTS) Digital Transmission System

The product was received on May 12, 2015 and testing was completed on Jun. 18, 2015. We, SPORTON INTERNATIONAL (SHENZHEN) INC., would like to declare that the tested sample has been evaluated in accordance with the test procedures and has been in compliance with the applicable technical standards.

The test results in this report apply exclusively to the tested model / sample. Without written approval of SPORTON INTERNATIONAL (SHENZHEN) INC., the test report shall not be reproduced except in full.

Reviewed by: Joseph Lin / Supervisor

Approved by: Jones Tsai / Manager



SPORTON INTERNATIONAL (SHENZHEN) INC.

1F & 2F, Building A, Morning Business Center, No. 4003 ShiGu Rd., Xili Town,
Nanshan District, Shenzhen, Guangdong, P. R. China



TABLE OF CONTENTS

REVISION HISTORY..... 3

SUMMARY OF TEST RESULT 4

1 GENERAL DESCRIPTION 5

 1.1 Applicant 5

 1.2 Manufacturer 5

 1.3 Product Feature of Equipment Under Test 5

 1.4 Product Specification subjective to this standard 6

 1.5 Accessories and Support Equipment 6

 1.6 Modification of EUT 6

 1.7 Testing Location 7

 1.8 Applicable Standards 8

2 TEST CONFIGURATION OF EQUIPMENT UNDER TEST 9

 2.1 Carrier Frequency Channel 9

 2.2 Pre-Scanned RF Power 10

 2.3 Test Mode 11

 2.4 Connection Diagram of Test System 12

 2.5 Support Unit used in test configuration and system 13

 2.6 EUT Operation Test Setup 13

 2.7 Measurement Results Explanation Example 13

3 TEST RESULT 14

 3.1 6dB Bandwidth Measurement 14

 3.2 Output Power Measurement 16

 3.3 Power Spectral Density Measurement 17

 3.4 Conducted Band Edges and Spurious Emission Measurement 19

 3.5 Radiated Band Edges and Spurious Emission Measurement 29

 3.6 AC Conducted Emission Measurement 33

 3.7 Antenna Requirements 38

4 LIST OF MEASURING EQUIPMENT 39

5 UNCERTAINTY OF EVALUATION 40

APPENDIX A. CONDUCTED TEST RESULTS

APPENDIX B. RADIATED TEST RESULTS

APPENDIX C. SETUP PHOTOGRAPHS



REVISION HISTORY

REPORT NO.	VERSION	DESCRIPTION	ISSUED DATE
FR551204C	Rev. 01	Initial issue of report	Jun. 29, 2015



SUMMARY OF TEST RESULT

Report Section	FCC Rule	Description	Limit	Result	Remark
3.1	15.247(a)(2)	6dB Bandwidth	$\geq 0.5\text{MHz}$	Pass	-
3.2	15.247(b)	Power Output Measurement	$\leq 30\text{dBm}$	Pass	-
3.3	15.247(e)	Power Spectral Density	$\leq 8\text{dBm}/3\text{kHz}$	Pass	-
3.4	15.247(d)	Conducted Band Edges	$\leq 20\text{dBc}$	Pass	-
		Conducted Spurious Emission		Pass	-
3.5	15.247(d)	Radiated Band Edges and Radiated Spurious Emission	15.209(a) & 15.247(d)	Pass	Under limit 5.15 dB at 2389.920 MHz
3.6	15.207	AC Conducted Emission	15.207(a)	Pass	Under limit 4.34 dB at 3.470 MHz
3.7	15.203 & 15.247(b)	Antenna Requirement	N/A	Pass	-



1 General Description

1.1 Applicant

TCL Communication Ltd.

5F, C building, No. 232, Liang Jing Road ZhangJiang High-Tech Park, Pudong Area Shanghai, P.R. China. 201203

1.2 Manufacturer

TCL Communication Ltd.

5F, C building, No. 232, Liang Jing Road ZhangJiang High-Tech Park, Pudong Area Shanghai, P.R. China. 201203

1.3 Product Feature of Equipment Under Test

Product Feature	
Equipment	CDMA EVDO BC0/BC1 mobile phone
Brand Name	ALCATEL ONETOUCH
Model Name	A462C
Marketing Name	A462C
FCC ID	2ACCJB013
EUT supports Radios application	CDMA/EVDO WLAN 2.4GHz 802.11b/g/n HT20 Bluetooth v3.0 + EDR/Bluetooth v4.0 LE
MEID Code	Conducted: A1000047D0C943 Radiation: A1000047D0C946 Conduction: A1000047D0C942
HW Version	PIO
SW Version	v7AT6
EUT Stage	Identical Prototype

Remark: The above EUT's information was declared by manufacturer. Please refer to the specifications or user's manual for more detailed description.

1.4 Product Specification subjective to this standard

Product Specification subjective to this standard	
Tx/Rx Channel Frequency Range	802.11b/g/n : 2412 MHz ~ 2462 MHz
Maximum (Peak) Output Power to Antenna	802.11b : 20.13 dBm (0.1030 W) 802.11g : 21.87 dBm (0.1538 W) 802.11n HT20 : 21.25 dBm (0.1334 W)
Antenna Type	802.11b/g/n : Monopole Antenna with gain 0.29 dBi
Type of Modulation	802.11b : DSSS (DBPSK / DQPSK / CCK) 802.11g/n : OFDM (BPSK / QPSK / 16QAM / 64QAM)

1.5 Accessories and Support Equipment

Specification of Accessory				
AC Adapter	Brand Name	ALCATEL	Model Name	WUS550mA5V00-02
	Power Rating	INPUT:AC100-240V ~50/60Hz 0.15A OUTPUT:DC5.0V-0.55A		
	Power Cord	1.2meter,non-shielded cable, without ferrite core		
	P/N	CBA0066AG1C1		
Battery	Brand Name	ALCATEL	Model Name	TLi014A1
	Power Rating	3.7Vdc, 1400mAh		
	P/N	CAB1400029C1		

1.6 Modification of EUT

No modifications are made to the EUT during all test items.



1.7 Testing Location

Test Site	SPORTON INTERNATIONAL (SHENZHEN) INC.	
Test Site Location	1F & 2F, Building A, Morning Business Center, No. 4003 ShiGu Rd., Xili Town, Nanshan District, Shenzhen, Guangdong, P. R. China TEL: +86-755-8637-9589 FAX: +86-755-8637-9595	
Test Site No.	Sporton Site No.	
	TH01-SZ	CO01-SZ

Test Site	SPORTON INTERNATIONAL (SHENZHEN) INC.	
Test Site Location	No. 3 Building, the third floor of south, Shahe River west, Fengzeyuan warehouse, Nanshan District, Shenzhen, Guangdong, P. R. China TEL: +86-755- 3320-2398	
Test Site No.	Sporton Site No.	FCC Registration No.
	03CH01-SZ	831040

Note: The test site complies with ANSI C63.4 2009 requirement.



1.8 Applicable Standards

According to the specifications of the manufacturer, the EUT must comply with the requirements of the following standards:

- ♦ FCC Part 15 Subpart C §15.247
- ♦ FCC KDB Publication No. 558074 D01 DTS Meas. Guidance v03r02
- ♦ ANSI C63.10-2013

Remark:

1. All test items were verified and recorded according to the standards and without any deviation during the test.
2. FCC permits the use of the 1.5 meter table as an alternative in C63.10-2013 through inquiry tracking number 961829.
3. This EUT has also been tested and complied with the requirements of FCC Part 15, Subpart B, recorded in a separate test report.



2 Test Configuration of Equipment Under Test

The EUT has been associated with peripherals and configuration operated in a manner tended to maximize its emission characteristics in a typical application. Frequency range investigated: conducted emission (150 kHz to 30 MHz) and radiated emission (9 kHz to the 10th harmonic of the highest fundamental frequency or to 40 GHz, whichever is lower). For radiated measurement, pre-scanned in three orthogonal panels, X, Y, Z. The worst cases (X plane) were recorded in this report.

The final configuration from all the combinations and the worst-case data rates were investigated by measuring the maximum power across all the data rates and modulation modes under section 2.2.

Based on the worst configuration found above, the RF power setting is set individually to meet FCC compliance limit for the final conducted and radiated tests shown in section 2.3.

2.1 Carrier Frequency Channel

Frequency Band	Channel	Freq. (MHz)	Channel	Freq. (MHz)
2400-2483.5 MHz	1	2412	7	2442
	2	2417	8	2447
	3	2422	9	2452
	4	2427	10	2457
	5	2432	11	2462
	6	2437	-	-



2.2 Pre-Scanned RF Power

Preliminary tests were performed in different data rate and data rate associated with the highest power were chosen for full test shown in the following tables.

2.4GHz 802.11b RF Output Power (dBm)						
Power vs. Channel			Power vs. Data Rate			
Channel	Frequency (MHz)	Data Rate	Channel	2Mbps	5.5Mbps	11Mbps
		1Mbps				
CH 01	2412 MHz	19.77	CH 06	19.98	20.01	20.06
CH 06	2437 MHz	20.13				
CH 11	2462 MHz	19.37				

2.4GHz 802.11g RF Output Power (dBm)										
Power vs. Channel			Power vs. Data Rate							
Channel	Frequency (MHz)	Data Rate	Channel	9Mbps	12Mbps	18Mbps	24Mbps	36Mbps	48Mbps	54Mbps
		6Mbps								
CH 01	2412 MHz	21.87	CH 01	21.71	21.64	21.73	21.68	21.76	21.67	21.64
CH 06	2437 MHz	21.85								
CH 11	2462 MHz	21.43								

2.4GHz 802.11n HT20 RF Output Power (dBm)										
Power vs. Channel			Power vs. MCS Index							
Channel	Frequency (MHz)	MCS Index	Channel	MCS1	MCS2	MCS3	MCS4	MCS5	MCS6	MCS7
		MCS0								
CH 01	2412 MHz	21.25	CH 01	21.20	21.12	21.13	21.06	21.07	21.19	21.21
CH 06	2437 MHz	21.18								
CH 11	2462 MHz	20.78								



2.3 Test Mode

Final test mode of conducted test items and radiated spurious emissions are considering the modulation and worse data rates from the power table described in section 2.2.

<2.4GHz>

Modulation	Data Rate
802.11b	1 Mbps
802.11g	6 Mbps
802.11n HT20	MCS0

Test Cases	
AC Conducted Emission	Mode 1 : CDMA850 Idle + Bluetooth Link + WLAN Link + Earphone + Adapter
Remark: For Radiated test cases, the tests were performed with adapter and earphone.	

2.4 Connection Diagram of Test System

<WLAN Tx Mode>

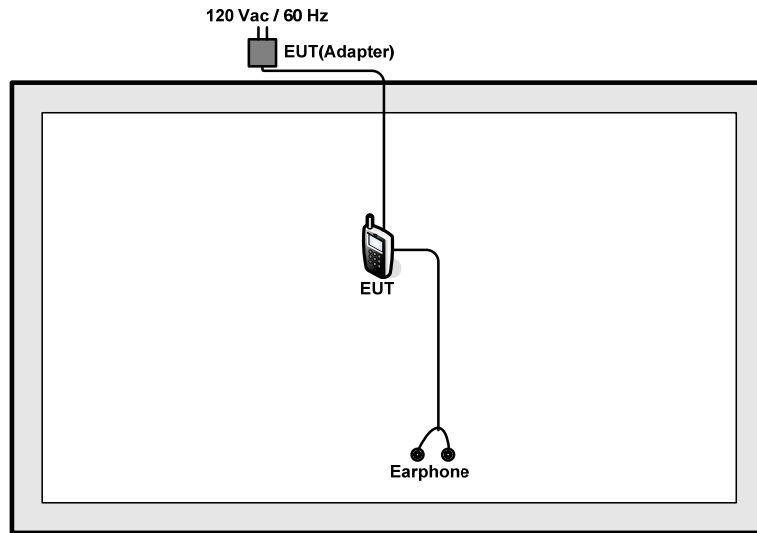

<AC Conducted Emission Mode>

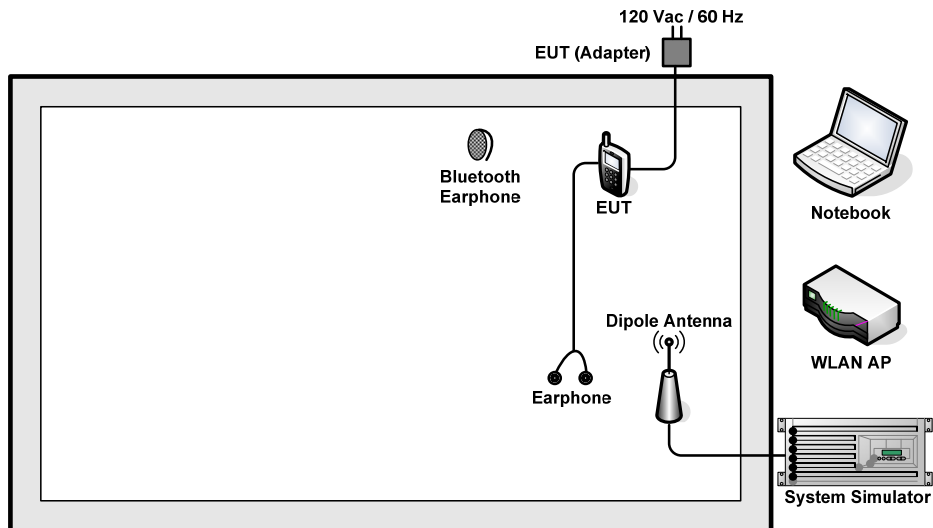

2.5 Support Unit used in test configuration and system

Item	Equipment	Trade Name	Model Name	FCC ID	Data Cable	Power Cord
1.	System Simulator	R&S	CMU 200	N/A	N/A	Unshielded, 1.8 m
2.	Bluetooth Earphone	Nokia	BH-108	PYAHS-107W	N/A	N/A
3.	WLAN AP	D-Link	DIR-628	KA2DIR628A2	N/A	Unshielded, 1.8 m
4.	Notebook	Lenovo	E540	FCC DoC	N/A	AC I/P: Unshielded, 1.2 m DC O/P: Shielded, 1.8 m
5.	iPod Earphone	Apple	MC690ZP/A	FCC DoC	Unshielded, 1.6 m	N/A

2.6 EUT Operation Test Setup

For WLAN RF test items, an engineering test program was provided and enabled to make EUT continuously transmit/receive.

For AC power line conducted emissions, the EUT was set to connect with the WLAN AP under large package sizes transmission.

2.7 Measurement Results Explanation Example

For all conducted test items:

The offset level is set in the spectrum analyzer to compensate the RF cable loss and attenuator factor between EUT conducted output port and spectrum analyzer. With the offset compensation, the spectrum analyzer reading level is exactly the EUT RF output level.

Example :

The spectrum analyzer offset is derived from RF cable loss and attenuator factor.

Offset = RF cable loss + attenuator factor.

Following shows an offset computation example with cable loss 5 dB and 10dB attenuator.

$$\begin{aligned} \text{Offset}(dB) &= \text{RF cable loss}(dB) + \text{attenuator factor}(dB). \\ &= 5 + 10 = 15 \text{ (dB)} \end{aligned}$$

3 Test Result

3.1 6dB Bandwidth Measurement

3.1.1 Limit of 6dB Bandwidth

The minimum 6 dB bandwidth shall be at least 500 kHz.

3.1.2 Measuring Instruments

The measuring equipment is listed in the section 4 of this test report.

3.1.3 Test Procedures

1. The testing follows FCC KDB Publication No. 558074 DTS D01 Meas. Guidance v03r02.
2. The RF output of EUT was connected to the spectrum analyzer by RF cable and attenuator. The path loss was compensated to the results for each measurement.
3. Set to the maximum power setting and enable the EUT transmit continuously.
4. Make the measurement with the spectrum analyzer's resolution bandwidth (RBW) = 100 kHz. Set the Video bandwidth (VBW) = 300 kHz. In order to make an accurate measurement. The 6 dB bandwidth must be greater than 500 kHz.
5. Measure and record the results in the test report.

3.1.4 Test Setup

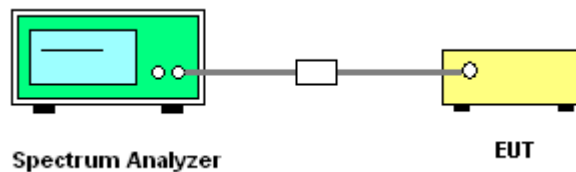



3.1.5 Test Result of 6dB and 99% Occupied Bandwidth

Please refer to Appendix A of this test report.

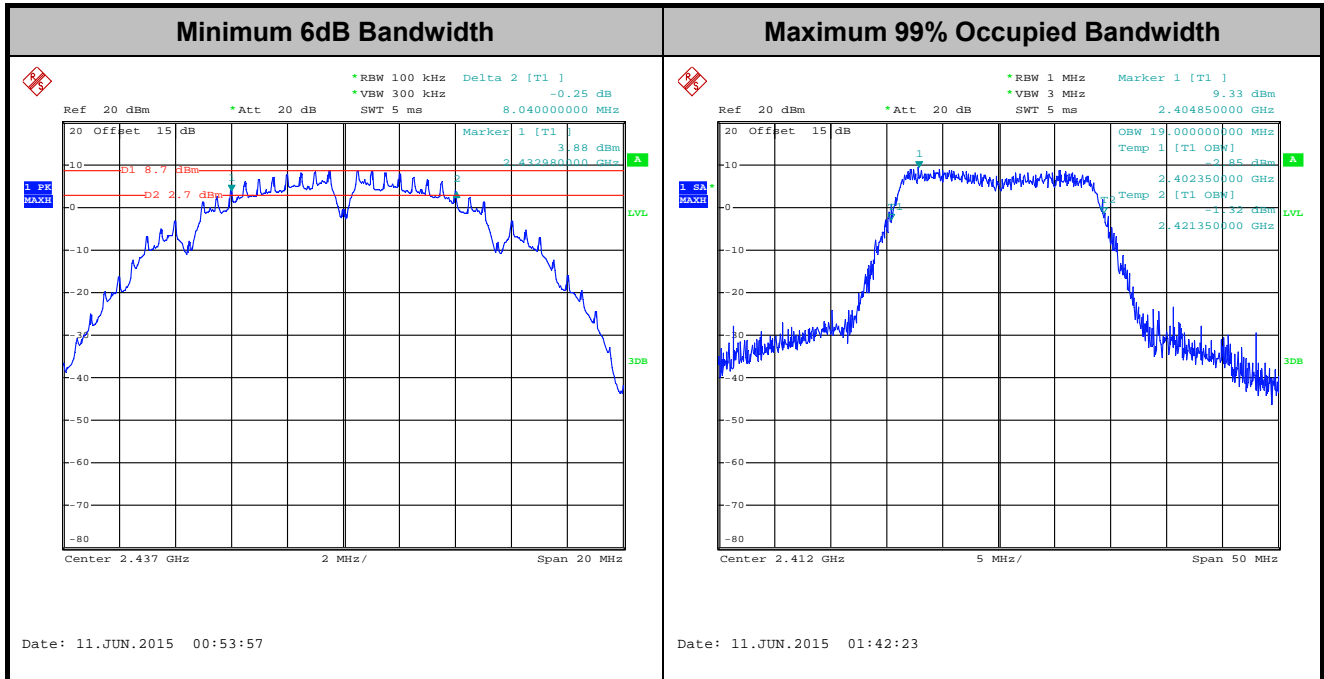

Note: The occupied channel bandwidth is maintained within the band of operation for all of the modulations.

3.2 Output Power Measurement

3.2.1 Limit of Output Power

For systems using digital modulation in the 2400-2483.5MHz, the limit for peak output power is 30dBm. If transmitting Antenna of directional gain greater than 6dBi are used the peak output power from the intentional radiator shall be reduced below the above stated value by the amount in dB that the directional gain of the Antenna exceeds 6 dBi. In case of point-to-point operation, the limit has to be reduced by 1dB for every 3dB that the directional gain of the Antenna exceeds 6dBi.

3.2.2 Measuring Instruments

The measuring equipment is listed in the section 4 of this test report.

3.2.3 Test Procedures

1. The testing follows the Measurement Procedure of FCC KDB No. 558074 DTS D01 Meas. Guidance v03r02.
2. The RF output of EUT was connected to the power meter by RF cable and attenuator. The path loss was compensated to the results for each measurement.
3. Set to the maximum power setting and enable the EUT transmit continuously.
4. Measure the conducted output power and record the results in the test report.

3.2.4 Test Setup

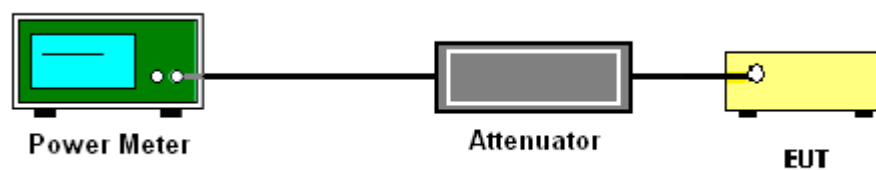

3.2.5 Test Result of Peak Output Power

Please refer to Appendix A of this test report.

3.2.6 Test Result of Average output Power (Reporting Only)

Please refer to Appendix A of this test report.

3.3 Power Spectral Density Measurement

3.3.1 Limit of Power Spectral Density

The peak power spectral density shall not be greater than 8dBm in any 3kHz band at any time interval of continuous transmission.

3.3.2 Measuring Instruments

The measuring equipment is listed in the section 4 of this test report.

3.3.3 Test Procedures

1. The testing follows Measurement Procedure 10.2 Method PKPSD of FCC KDB Publication No. 558074 D01 DTS Meas. Guidance v03r02
2. The RF output of EUT was connected to the spectrum analyzer by RF cable and attenuator. The path loss was compensated to the results for each measurement.
3. Set to the maximum power setting and enable the EUT transmit continuously.
4. Make the measurement with the spectrum analyzer's resolution bandwidth (RBW) = 3 kHz. Video bandwidth VBW = 10 kHz In order to make an accurate measurement, set the span to 1.5 times DTS Channel Bandwidth. (6dB BW)
5. Detector = peak, Sweep time = auto couple, Trace mode = max hold, Allow trace to fully stabilize. Use the peak marker function to determine the maximum power level.
6. Measure and record the results in the test report.

3.3.4 Test Setup

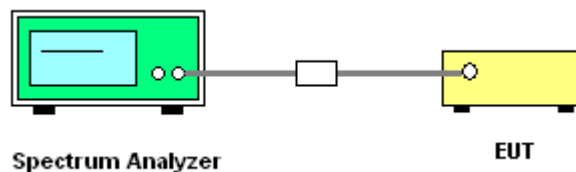



3.3.5 Test Result of Power Spectral Density

Please refer to Appendix A of this test report.

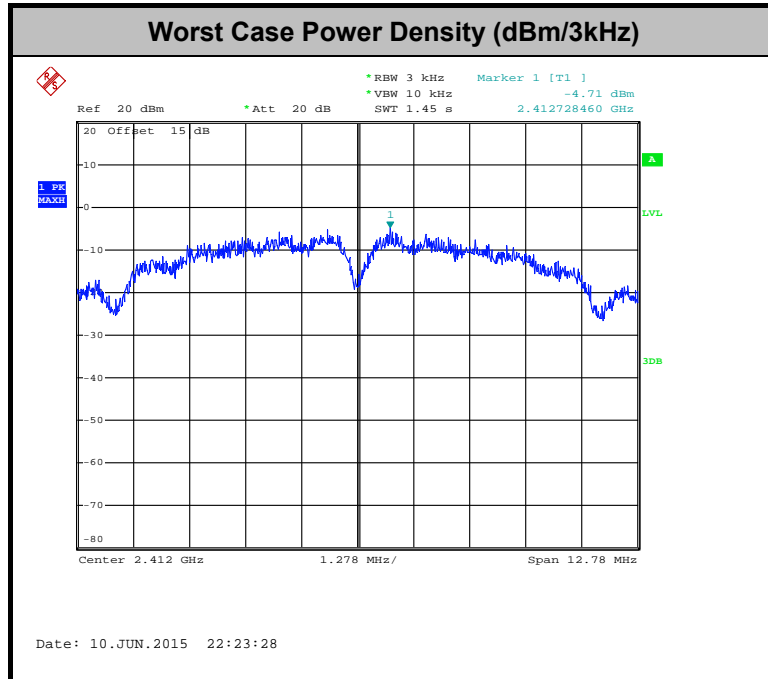

3.4 Conducted Band Edges and Spurious Emission Measurement

3.4.1 Limit of Conducted Band Edges and Spurious Emission Measurement

In any 100 kHz bandwidth outside of the authorized frequency band, the emissions which fall in the non-restricted bands shall be attenuated at least 20 dB / 30dB relative to the maximum PSD level in 100 kHz by RF conducted measurement and radiated emissions which fall in the restricted bands, as defined in Section 15.205(a), must also comply with the radiated emission limits specified in Section 15.209(a).

3.4.2 Measuring Instruments

The measuring equipment is listed in the section 4 of this test report.

3.4.3 Test Procedures

1. The testing follows FCC KDB Publication No. 558074 D01 DTS Meas. Guidance v03r02.
2. The RF output of EUT was connected to the spectrum analyzer by RF cable and attenuator. The path loss was compensated to the results for each measurement.
3. Set to the maximum power setting and enable the EUT transmit continuously.
4. Set RBW = 100 kHz, VBW=300 kHz, Peak Detector. Unwanted Emissions measured in any 100 kHz bandwidth outside of the authorized frequency band shall be attenuated by at least 20 dB relative to the maximum in-band peak PSD level in 100 kHz when maximum peak conducted output power procedure is used. If the transmitter complies with the conducted power limits based on the use of RMS averaging over a time interval, the attenuation required under this paragraph shall be 30 dB instead of 20 dB per 15.247(d).
5. Measure and record the results in the test report.
6. The RF fundamental frequency should be excluded against the limit line in the operating frequency band.

3.4.4 Test Setup

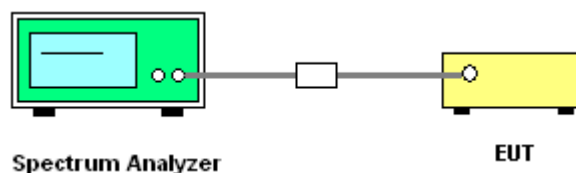



3.4.5 Test Result of Conducted Band Edges and Spurious Emission

Test Mode :	802.11b	Temperature :	21~25°C
Test Band :	2.4GHz Low	Relative Humidity :	51~54%
Test Channel :	01	Test Engineer :	Mygai Mo

WLAN 802.11b Channel 01

100kHz PSD reference Level

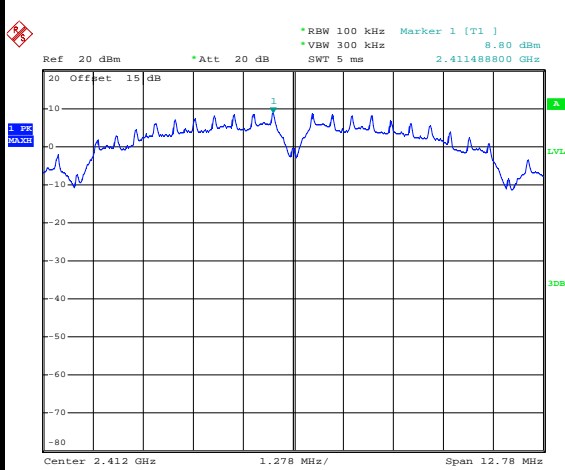

Date: 10.JUN.2015 22:24:10

Low Channel Plot

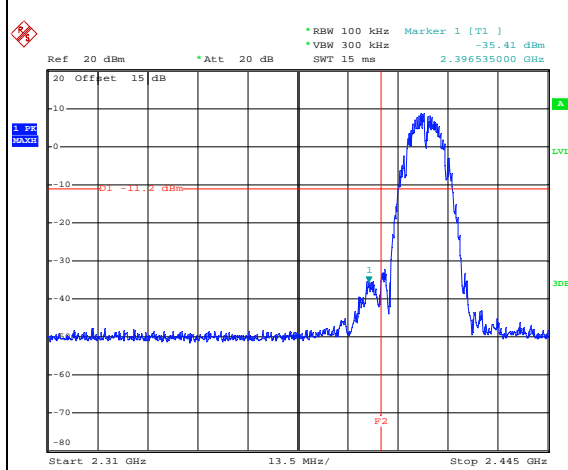

Date: 11.JUN.2015 02:21:08

Spurious Emission 30MHz~3GHz

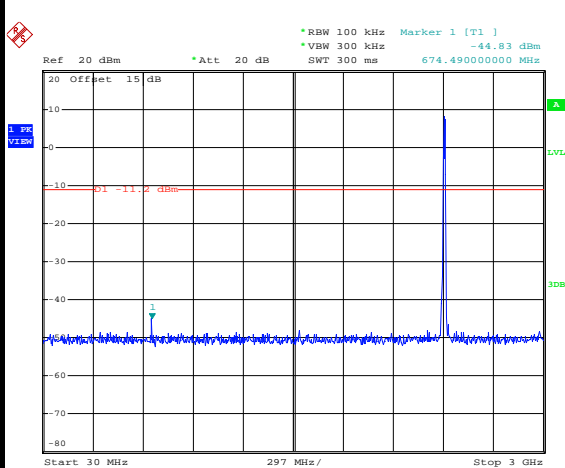

Date: 10.JUN.2015 22:28:11

Spurious Emission 2GHz~25GHz

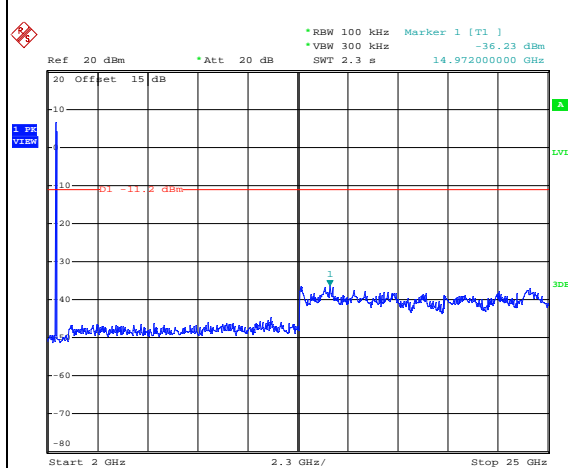

Date: 10.JUN.2015 22:28:29



Test Mode :	802.11b	Temperature :	21~25°C
Test Band :	2.4GHz Mid	Relative Humidity :	51~54%
Test Channel :	06	Test Engineer :	Mygai Mo

WLAN 802.11b Channel 06

100kHz PSD reference Level

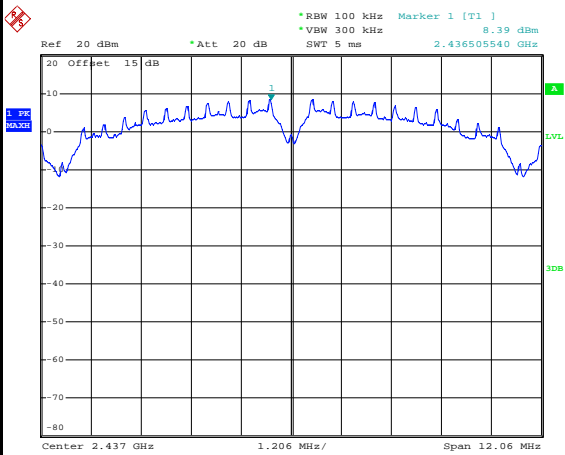

Date: 11.JUN.2015 01:01:45

Spurious Emission 30MHz~3GHz

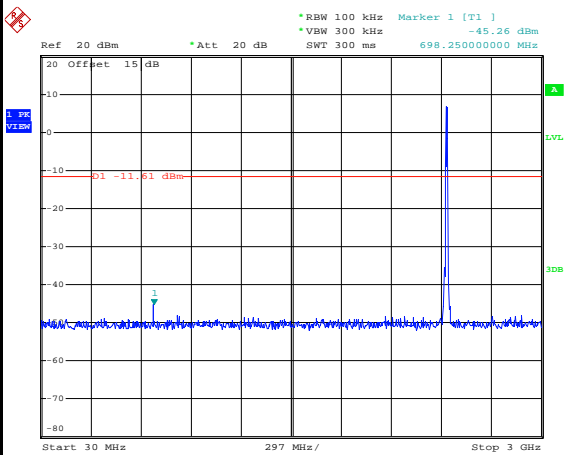

Date: 11.JUN.2015 01:07:46

Spurious Emission 2GHz~25GHz

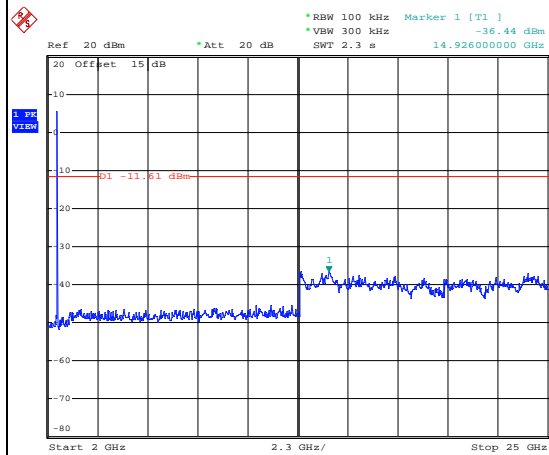

Date: 11.JUN.2015 01:08:03



Test Mode :	802.11b	Temperature :	21~25°C
Test Band :	2.4GHz High	Relative Humidity :	51~54%
Test Channel :	11	Test Engineer :	Mygai Mo

WLAN 802.11b Channel 11

100kHz PSD reference Level

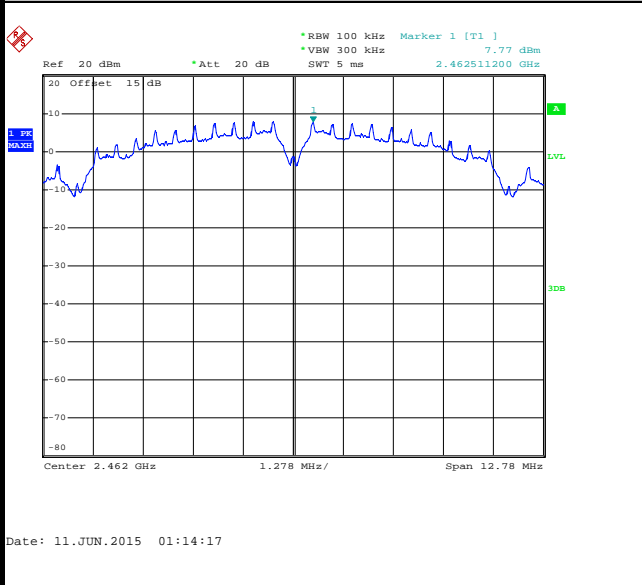

High Channel Plot

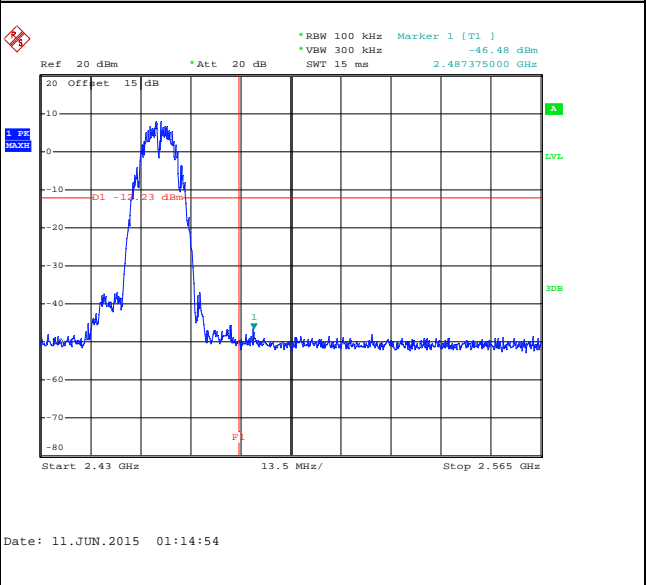

Spurious Emission 30MHz~3GHz

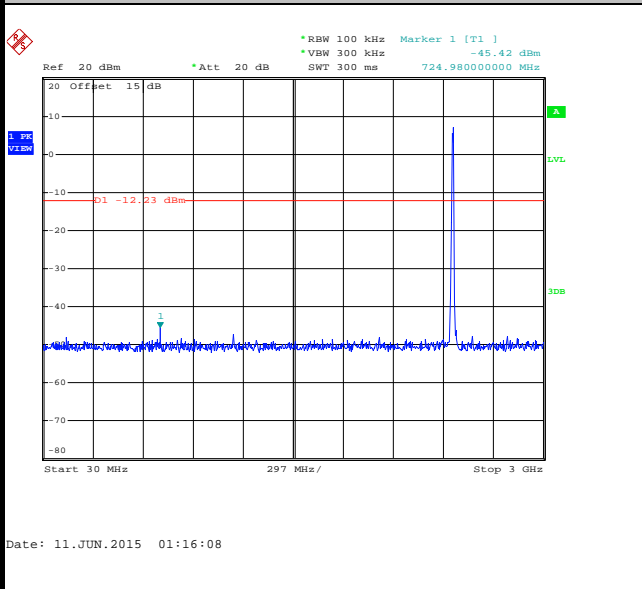

Spurious Emission 2GHz~25GHz

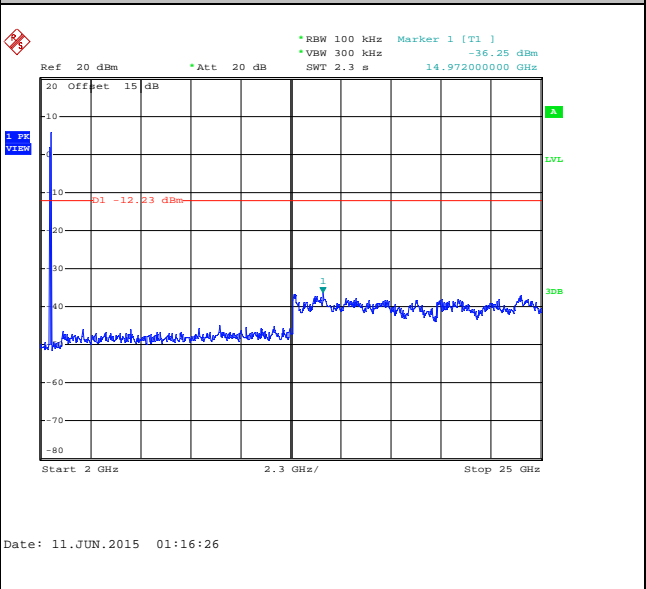



Test Mode :	802.11g	Temperature :	21~25°C
Test Band :	2.4GHz Low	Relative Humidity :	51~54%
Test Channel :	01	Test Engineer :	Mygai Mo

WLAN 802.11g Channel 01

100kHz PSD reference Level

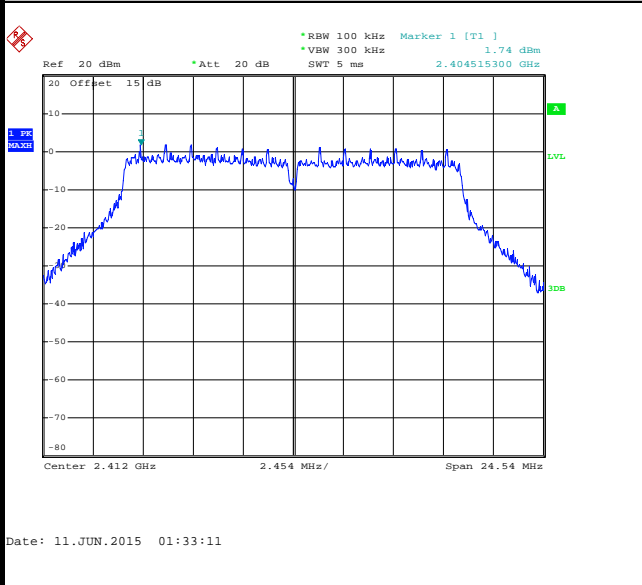

Low Channel Plot

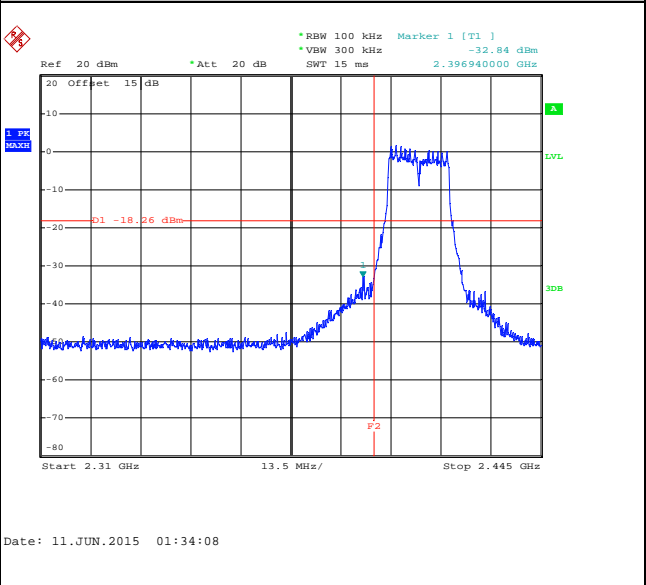

Spurious Emission 30MHz~3GHz

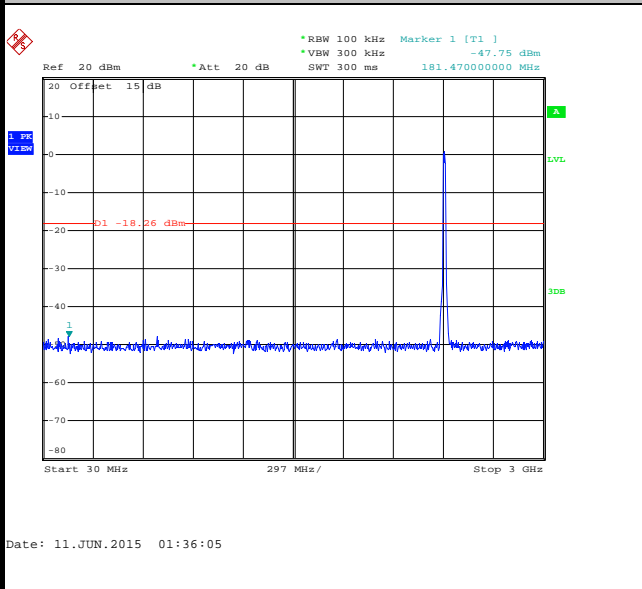

Spurious Emission 2GHz~25GHz

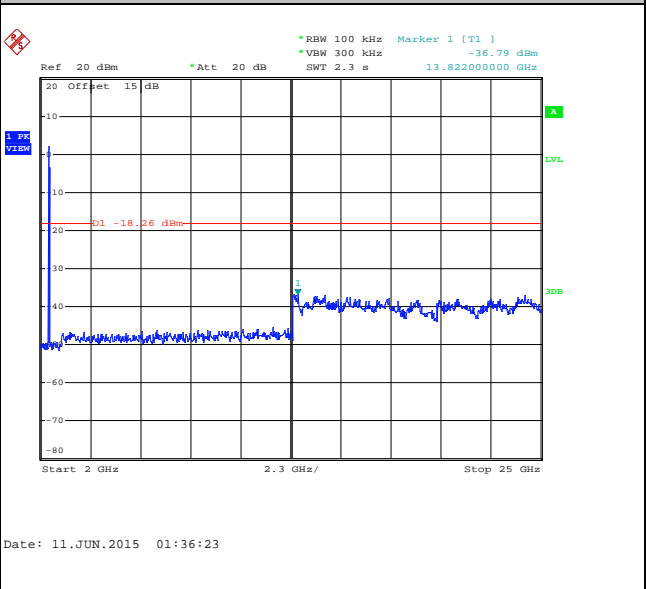



Test Mode :	802.11g	Temperature :	21~25°C
Test Band :	2.4GHz Mid	Relative Humidity :	51~54%
Test Channel :	06	Test Engineer :	Mygai Mo

WLAN 802.11g Channel 06

100kHz PSD reference Level

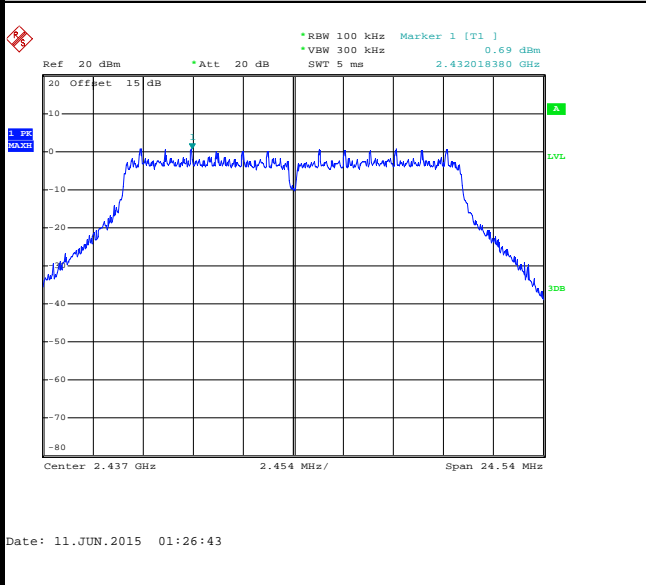

Spurious Emission 30MHz~3GHz

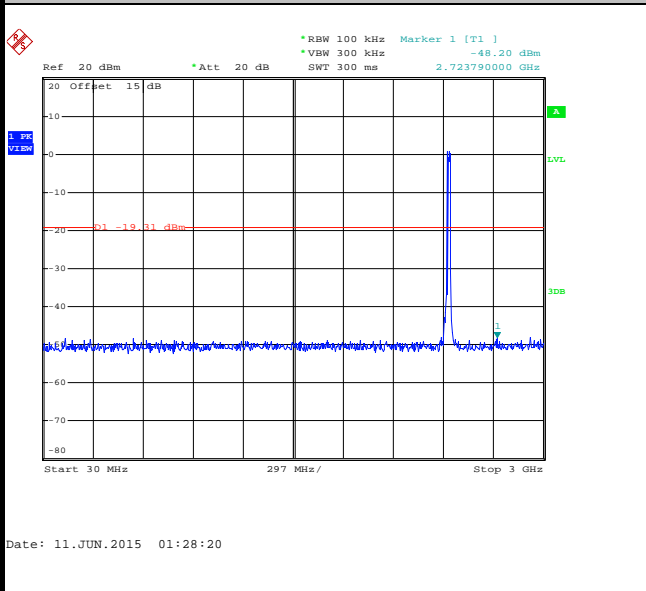

Spurious Emission 2GHz~25GHz

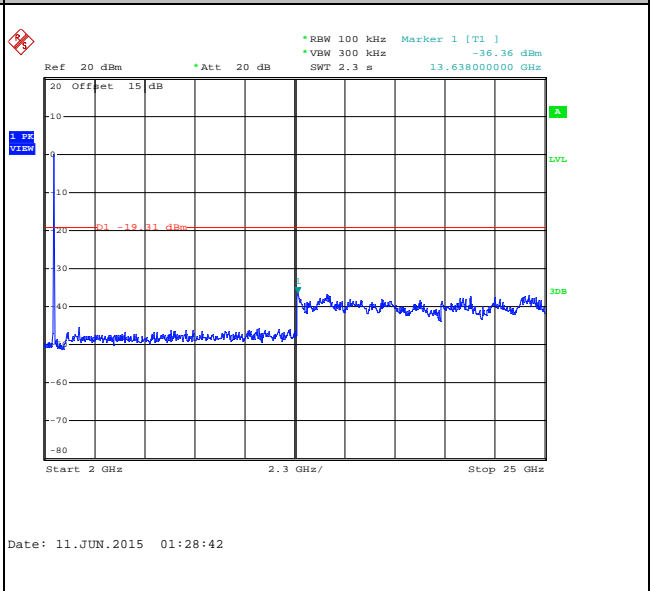



Test Mode :	802.11g	Temperature :	21~25°C
Test Band :	2.4GHz High	Relative Humidity :	51~54%
Test Channel :	11	Test Engineer :	Mygai Mo

WLAN 802.11g Channel 11

100kHz PSD reference Level

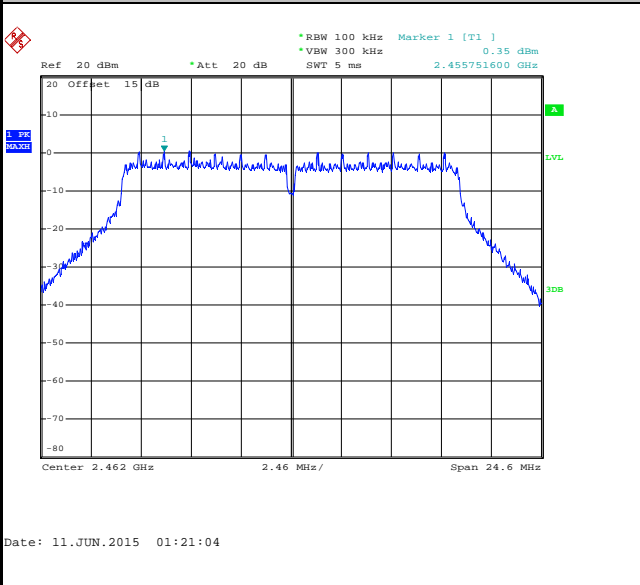

High Channel Plot

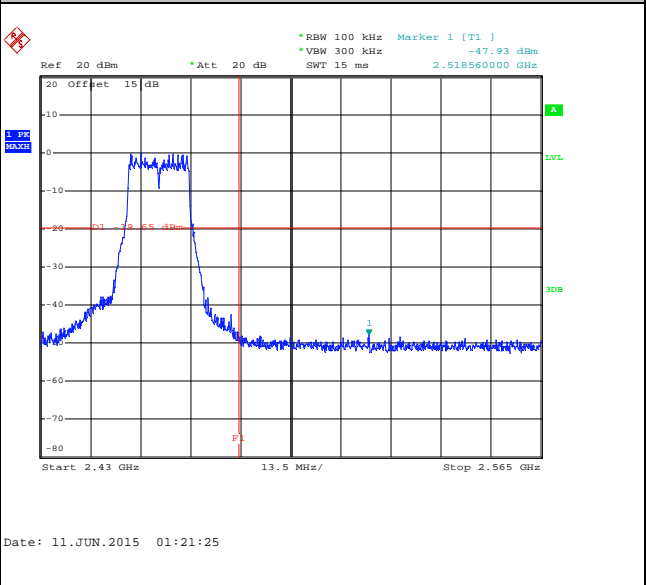

Spurious Emission 30MHz~3GHz

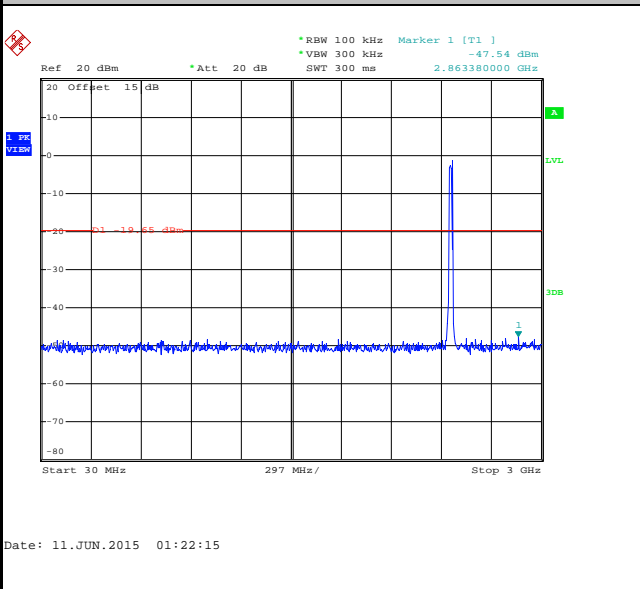

Spurious Emission 2GHz~25GHz

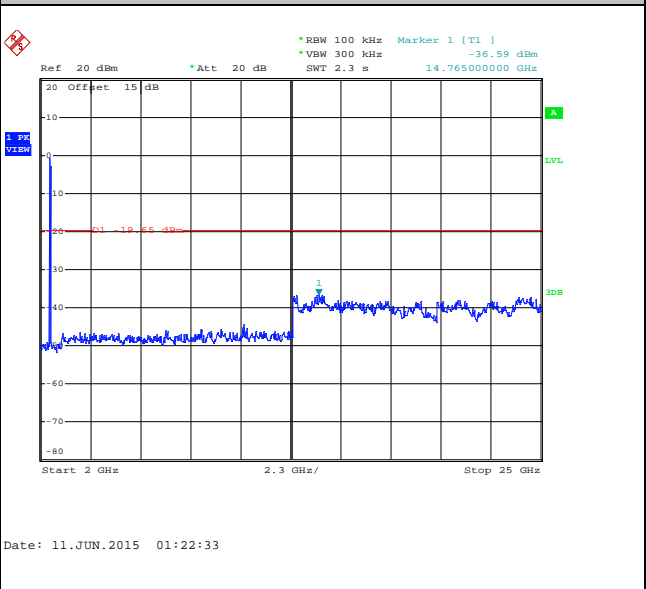



Test Mode :	802.11n HT20	Temperature :	21~25°C
Test Band :	2.4GHz Low	Relative Humidity :	51~54%
Test Channel :	01	Test Engineer :	Mygai Mo

WLAN 802.11n HT20 Channel 01

100kHz PSD reference Level

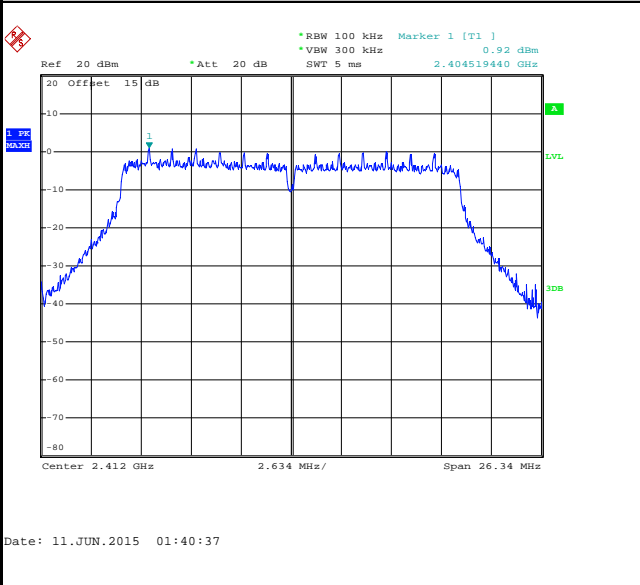

Low Channel Plot

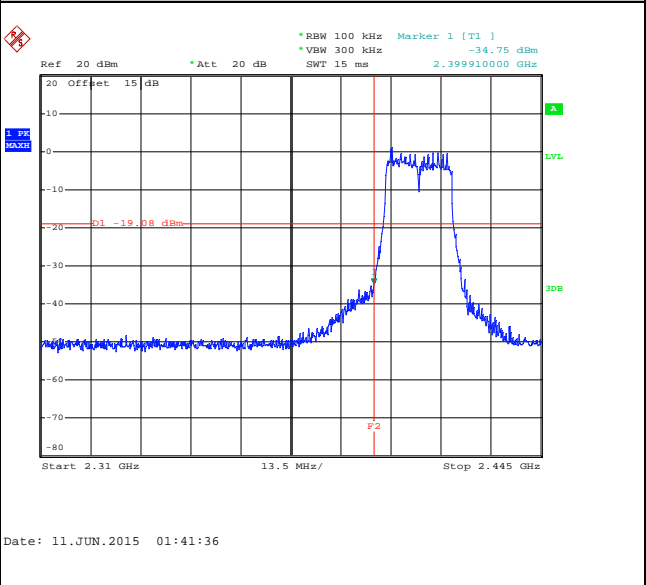

Spurious Emission 30MHz~3GHz

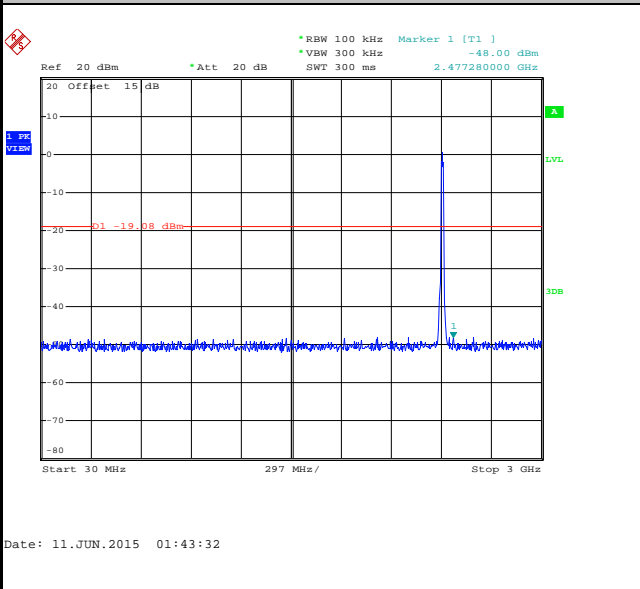

Spurious Emission 2GHz~25GHz

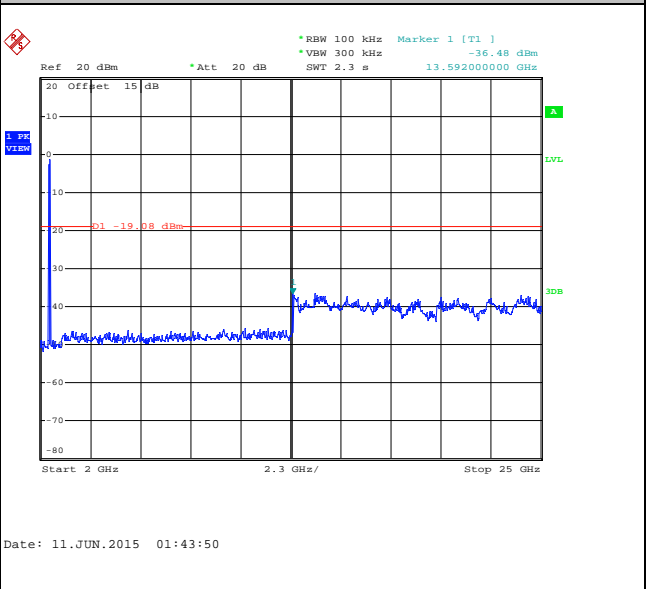



Test Mode :	802.11n HT20	Temperature :	21~25°C
Test Band :	2.4GHz Mid	Relative Humidity :	51~54%
Test Channel :	06	Test Engineer :	Mygai Mo

WLAN 802.11n HT20 Channel 06

100kHz PSD reference Level

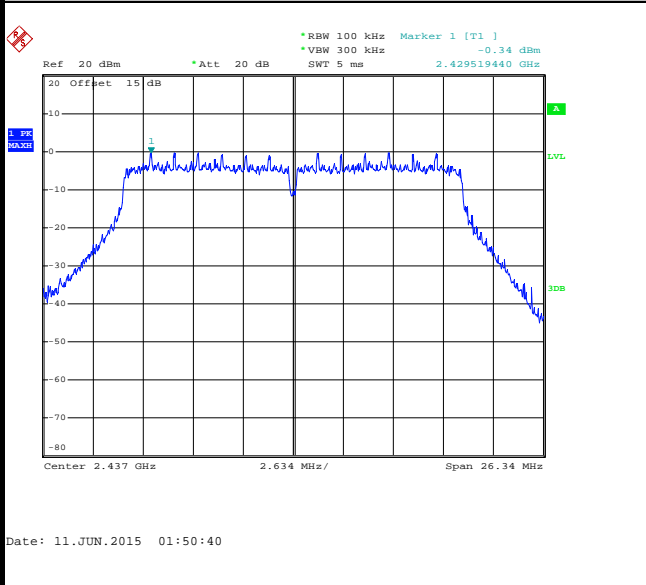

Spurious Emission 30MHz~3GHz

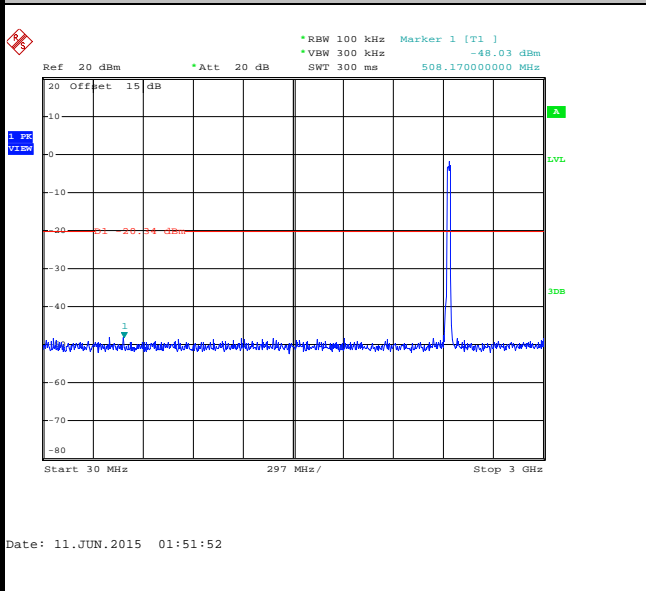

Spurious Emission 2GHz~25GHz

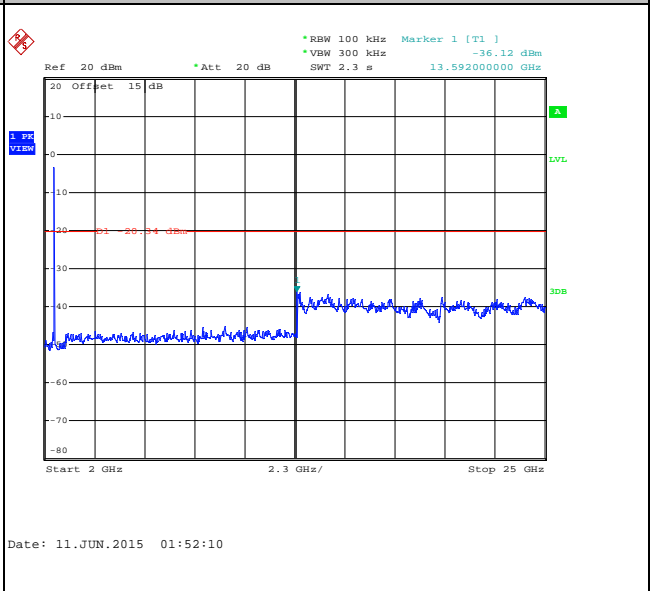



Test Mode :	802.11n HT20	Temperature :	21~25°C
Test Band :	2.4GHz High	Relative Humidity :	51~54%
Test Channel :	11	Test Engineer :	Mygai Mo

WLAN 802.11n HT20 Channel 11

100kHz PSD reference Level

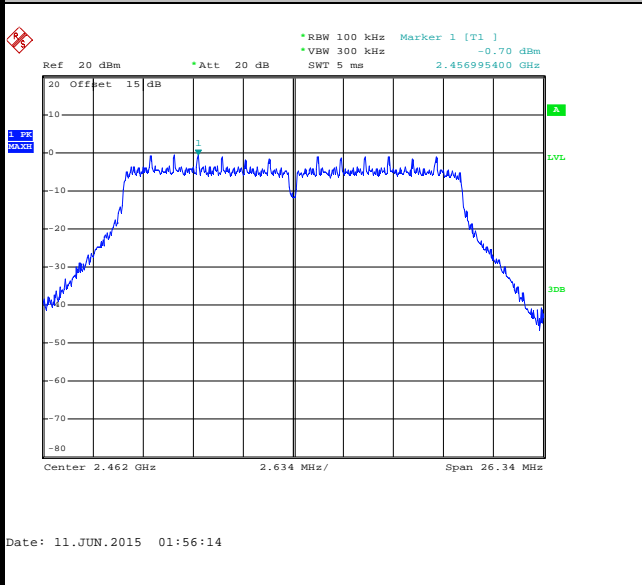

High Channel Plot

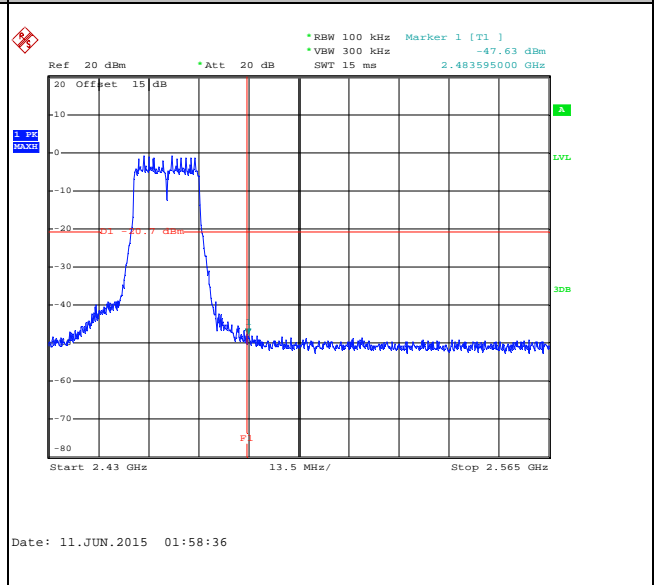

Spurious Emission 30MHz~3GHz

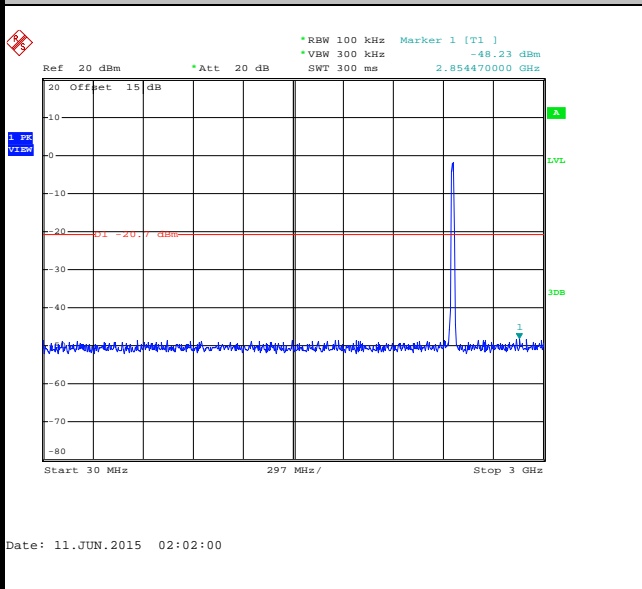

Spurious Emission 2GHz~25GHz

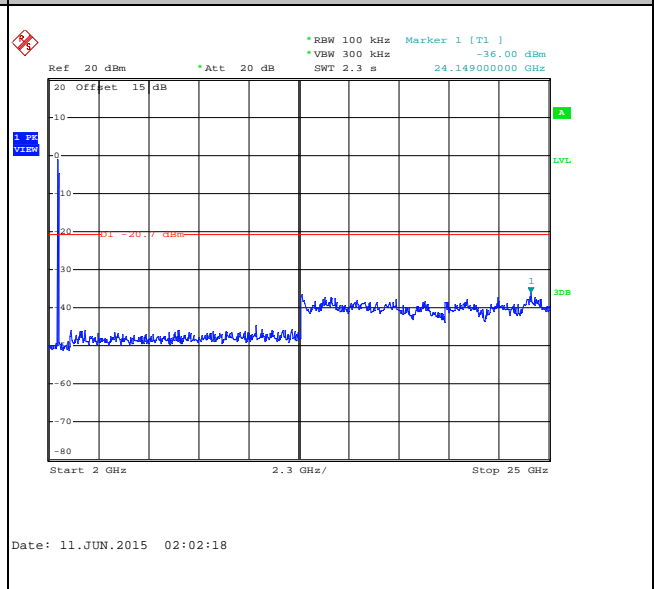



3.5 Radiated Band Edges and Spurious Emission Measurement

3.5.1 Limit of Radiated band edge and Spurious Emission Measurement

In any 100 kHz bandwidth outside the intentional radiator frequency band, all harmonics/spurious must be at least 20 dB below the highest emission level within the authorized band. If the output power of this device was measured by spectrum analyzer, the attenuation under this paragraph shall be 30 dB instead of 20 dB. In addition, radiated emissions which fall in the restricted bands must also comply with the FCC section 15.209 limits as below.

Frequency (MHz)	Field Strength (microvolts/meter)	Measurement Distance (meters)
0.009 – 0.490	2400/F(kHz)	300
0.490 – 1.705	24000/F(kHz)	30
1.705 – 30.0	30	30
30 – 88	100	3
88 – 216	150	3
216 - 960	200	3
Above 960	500	3

3.5.2 Measuring Instruments

The measuring equipment is listed in the section 4 of this test report.



3.5.3 Test Procedures

1. The testing follows FCC KDB Publication No. 558074 D01 DTS Meas. Guidance v03r02.
2. The EUT was arranged to its worst case and then tune the antenna tower (from 1 m to 4 m) and turntable (from 0 degree to 360 degrees) to find the maximum reading. A pre-amp and a high pass filter are used for the test in order to get better signal level.
3. The EUT was placed on a turntable with 0.8 meter for frequency below 1GHz and 1.5 meter for frequency above 1GHz respectively above ground.
4. The EUT was set 3 meters from the interference receiving antenna, which was mounted on the top of a variable height antenna tower.
5. Corrected Reading: Antenna Factor + Cable Loss + Read Level - Preamp Factor = Level
6. For measurement below 1GHz, If the emission level of the EUT measured by the peak detector is 3 dB lower than the applicable limit, the peak emission level will be reported. Otherwise, the emission measurement will be repeated using the quasi-peak detector and reported.
7. Use the following spectrum analyzer settings:
 - (1) Span shall wide enough to fully capture the emission being measured;
 - (2) Set RBW=100 kHz for $f < 1$ GHz; $VBW \geq RBW$; Sweep = auto; Detector function = peak; Trace = max hold;
 - (3) Set RBW = 1 MHz, VBW= 3MHz for $f \geq 1$ GHz for peak measurement.

For average measurement:

 - $VBW = 10$ Hz, when duty cycle is no less than 98 percent.
 - $VBW \geq 1/T$, when duty cycle is less than 98 percent where T is the minimum transmission duration over which the transmitter is on and is transmitting at its maximum power control level for the tested mode of operation.

Band	Duty Cycle(%)	T(ms)	1/T(kHz)	VBW Setting
802.11b	97.65	8.23	0.12	300Hz
802.11g	87.24	1.37	0.73	1kHz
2.4GHz 802.11n HT20	86.41	1.27	0.79	1kHz

3.5.4 Test Setup

For radiated emissions below 30MHz

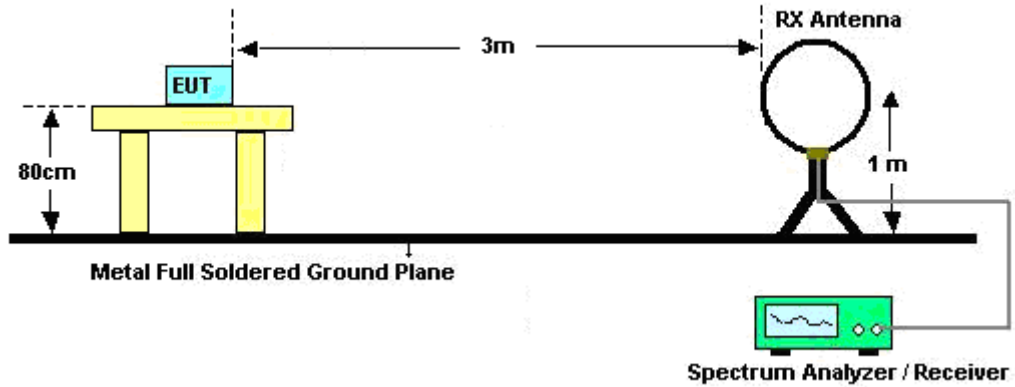

For radiated emissions from 30MHz to 1GHz

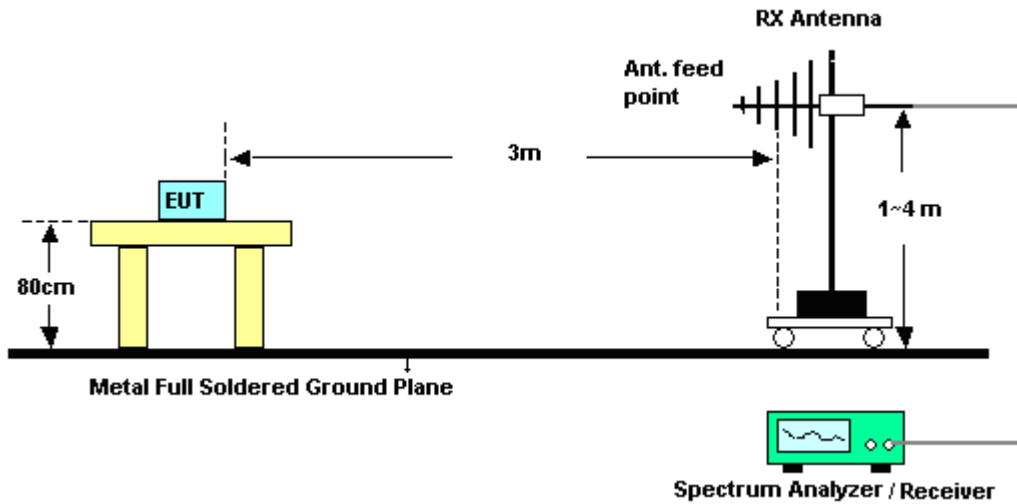

For radiated emissions above 1GHz

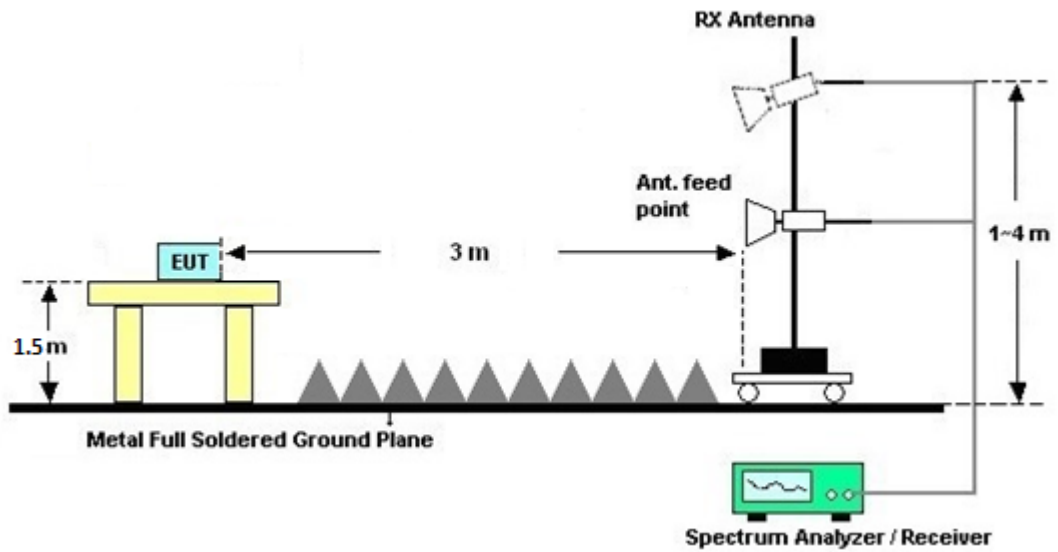

3.5.5 Test Results of Radiated Spurious Emissions (9kHz ~ 30MHz)

The low frequency, which started from 9 kHz to 30MHz, was pre-scanned and the result which was 20dB lower than the limit line per 15.31(o) was not reported.

3.5.6 Test Result of Radiated Spurious at Band Edges

Please refer to Appendix B.

3.5.7 Test Result of Radiated Spurious Emission (30MHz ~ 10th Harmonic)

Please refer to Appendix B.



3.6 AC Conducted Emission Measurement

3.6.1 Limit of AC Conducted Emission

For equipment that is designed to be connected to the public utility (AC) power line, the radio frequency voltage that is conducted back onto the AC power line on any frequency or frequencies within the band 150 kHz to 30 MHz shall not exceed the limits in the following table.

Frequency of Emission (MHz)	Conducted Limit (dB μ V)	
	Quasi-Peak	Average
0.15-0.5	66 to 56*	56 to 46*
0.5-5	56	46
5-30	60	50

*Decreases with the logarithm of the frequency.

3.6.2 Measuring Instruments

The measuring equipment is listed in the section 4 of this test report.

3.6.3 Test Procedures

1. The EUT was placed 0.4 meter from the conducting wall of the shielding room, and it was kept at least 80 centimeters from any other grounded conducting surface.
2. Connect EUT to the power mains through a line impedance stabilization network (LISN).
3. All the support units are connecting to the other LISN.
4. The LISN provides 50 ohm coupling impedance for the measuring instrument.
5. The FCC states that a 50 ohm, 50 microhenry LISN should be used.
6. Both sides of AC line were checked for maximum conducted interference.
7. The frequency range from 150 kHz to 30 MHz was searched.
8. Set the test-receiver system to Peak Detect Function and specified bandwidth (IF bandwidth = 9kHz) with Maximum Hold Mode.

3.6.4 Test Setup

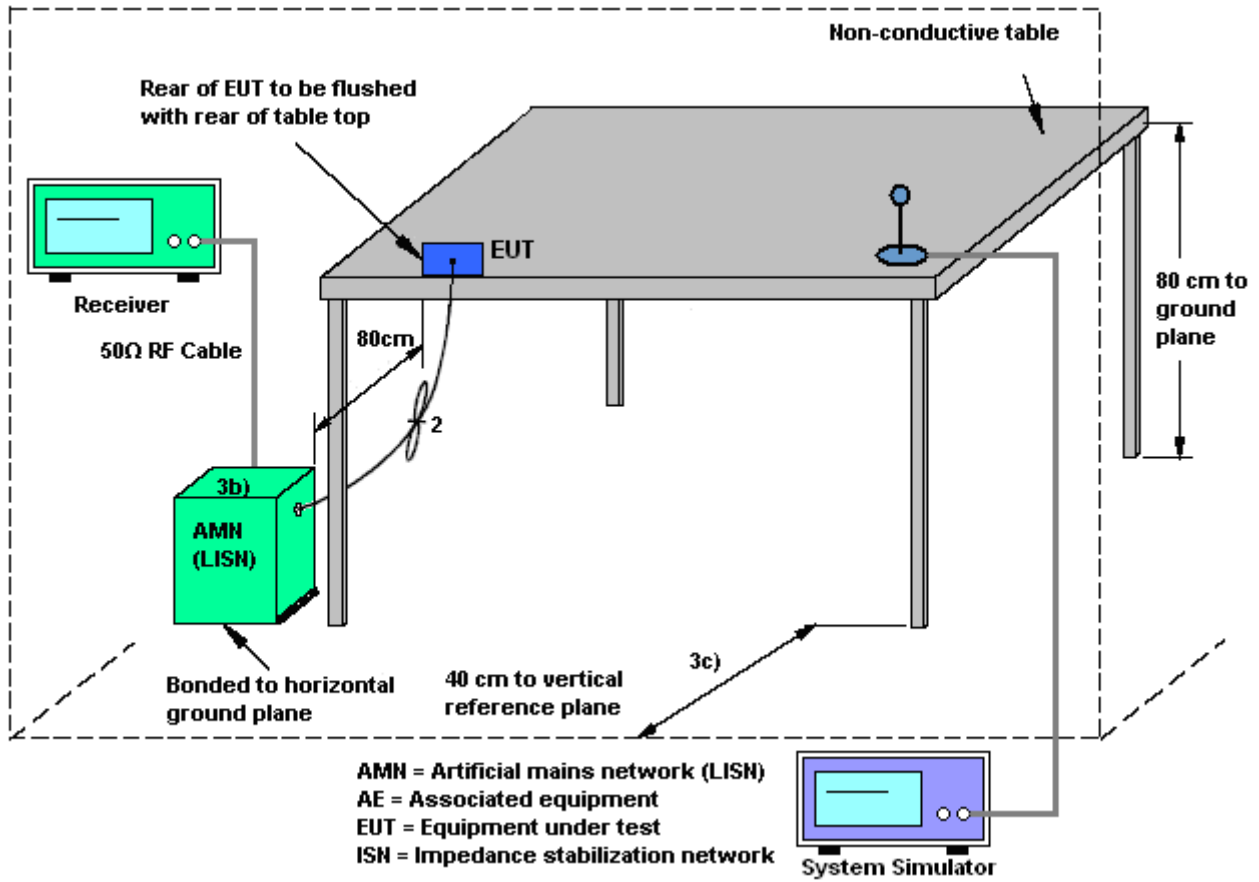



3.6.5 Test Result of AC Conducted Emission

Test Mode :	Mode 1	Temperature :	21~23°C
Test Engineer :	Jacky Yang	Relative Humidity :	41~42%
Test Voltage :	120Vac / 60Hz	Phase :	Line
Function Type :	CDMA850 Idle + Bluetooth Link + WLAN Link + Earphone + Adapter		

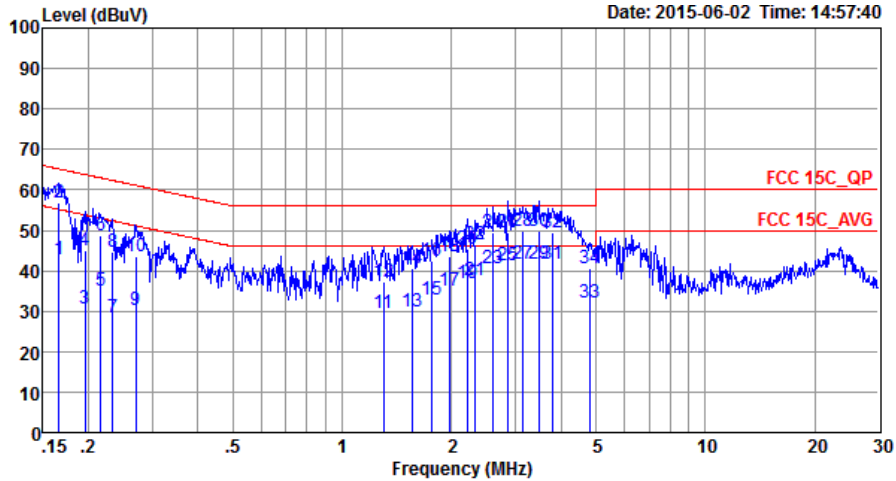

Site : C001-SZ
 Condition: FCC 15C_QP LISN_L_20140304 LINE

	Freq	Level	Over Limit	Limit Line	Read Level	LISN Factor	Cable Loss	Remark
	MHz	dBuV	dB	dBuV	dBuV	dB	dB	
1	0.17	42.86	-12.30	55.16	32.30	0.22	10.34	Average
2	0.17	56.86	-8.30	65.16	46.30	0.22	10.34	QP
3	0.20	30.72	-23.08	53.80	20.20	0.22	10.30	Average
4	0.20	45.12	-18.68	63.80	34.60	0.22	10.30	QP
5	0.22	35.10	-17.86	52.96	24.59	0.23	10.28	Average
6	0.22	48.70	-14.26	62.96	38.19	0.23	10.28	QP
7	0.23	28.49	-23.86	52.35	18.00	0.23	10.26	Average
8	0.23	44.59	-17.76	62.35	34.10	0.23	10.26	QP
9	0.27	30.37	-20.75	51.12	19.90	0.25	10.22	Average
10	0.27	43.67	-17.45	61.12	33.20	0.25	10.22	QP
11	1.30	29.41	-16.59	46.00	19.01	0.24	10.16	Average
12	1.30	37.41	-18.59	56.00	27.01	0.24	10.16	QP
13	1.56	29.91	-16.09	46.00	19.51	0.23	10.17	Average
14	1.56	40.61	-15.39	56.00	30.21	0.23	10.17	QP
15	1.76	33.01	-12.99	46.00	22.60	0.23	10.18	Average
16	1.76	42.31	-13.69	56.00	31.90	0.23	10.18	QP
17	1.97	34.91	-11.09	46.00	24.50	0.22	10.19	Average
18	1.97	43.41	-12.59	56.00	33.00	0.22	10.19	QP
19	2.21	36.84	-9.16	46.00	26.41	0.24	10.19	Average
20	2.21	45.44	-10.56	56.00	35.01	0.24	10.19	QP
21	2.32	37.65	-8.35	46.00	27.20	0.25	10.20	Average
22	2.32	46.65	-9.35	56.00	36.20	0.25	10.20	QP
23	2.61	40.68	-5.32	46.00	30.20	0.28	10.20	Average
24	2.61	49.38	-6.62	56.00	38.90	0.28	10.20	QP
25	2.87	41.21	-4.79	46.00	30.70	0.30	10.21	Average
26	2.87	49.61	-6.39	56.00	39.10	0.30	10.21	QP
27	3.16	41.53	-4.47	46.00	31.00	0.32	10.21	Average
28	3.16	49.73	-6.27	56.00	39.20	0.32	10.21	QP
29 *	3.47	41.66	-4.34	46.00	31.10	0.34	10.22	Average



Test Mode :	Mode 1	Temperature :	21~23°C
Test Engineer :	Jacky Yang	Relative Humidity :	41~42%
Test Voltage :	120Vac / 60Hz	Phase :	Line
Function Type :	CDMA850 Idle + Bluetooth Link + WLAN Link + Earphone + Adapter		

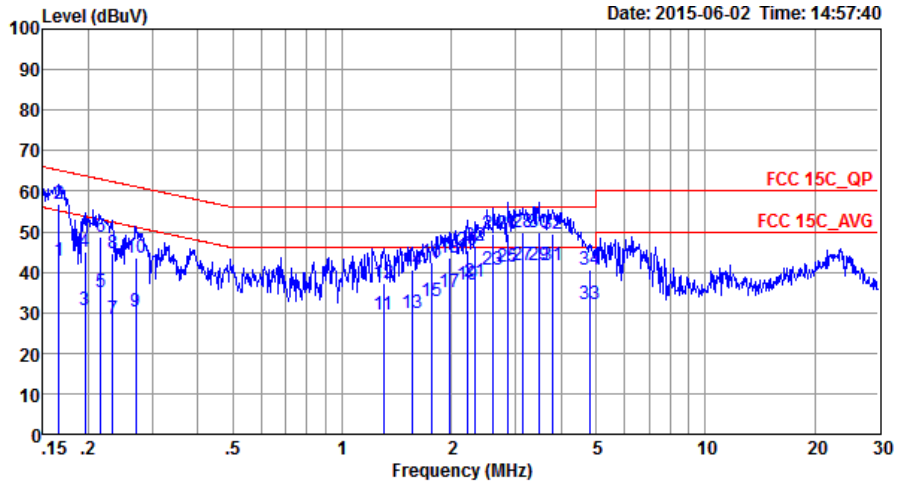

Site : C001-SZ
 Condition: FCC 15C_QP LISN_L_20140304 LINE

	Freq	Level	Over	Limit	Read	LISN	Cable	Remark
	MHz	dBuV	Limit	Line	Level	Factor	Loss	
			dB	dBuV	dBuV	dB	dB	
30	3.47	49.66	-6.34	56.00	39.10	0.34	10.22	QP
31	3.78	41.58	-4.42	46.00	31.00	0.36	10.22	Average
32	3.78	49.38	-6.62	56.00	38.80	0.36	10.22	QP
33	4.82	32.05	-13.95	46.00	21.40	0.41	10.24	Average
34	4.82	40.45	-15.55	56.00	29.80	0.41	10.24	QP



Test Mode :	Mode 1	Temperature :	21~23°C
Test Engineer :	Jacky Yang	Relative Humidity :	41~42%
Test Voltage :	120Vac / 60Hz	Phase :	Neutral
Function Type :	CDMA850 Idle + Bluetooth Link + WLAN Link + Earphone + Adapter		

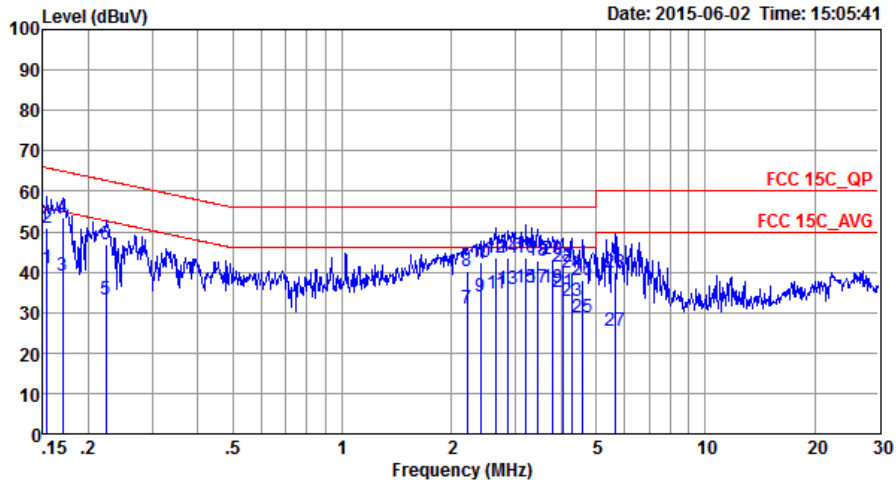

Site : CO01-SZ
 Condition: FCC 15C_QP LISN_N_20140304 NEUTRAL

	Freq	Level	Over Limit	Limit Line	Read Level	LISN Factor	Cable Loss	Remark
	MHz	dBuV	dB	dBuV	dBuV	dB	dB	
1	0.15	40.98	-14.80	55.78	30.30	0.33	10.35	Average
2	0.15	50.78	-15.00	65.78	40.10	0.33	10.35	QP
3	0.17	39.26	-15.68	54.94	28.60	0.33	10.33	Average
4	0.17	53.36	-11.58	64.94	42.70	0.33	10.33	QP
5	0.22	33.10	-19.60	52.70	22.50	0.33	10.27	Average
6	0.22	46.90	-15.80	62.70	36.30	0.33	10.27	QP
7	2.21	31.08	-14.92	46.00	20.51	0.38	10.19	Average
8	2.21	40.08	-15.92	56.00	29.51	0.38	10.19	QP
9	2.41	33.99	-12.01	46.00	23.40	0.39	10.20	Average
10	2.41	42.49	-13.51	56.00	31.90	0.39	10.20	QP
11	2.65	34.81	-11.19	46.00	24.20	0.41	10.20	Average
12	2.65	43.61	-12.39	56.00	33.00	0.41	10.20	QP
13	2.87	35.83	-10.17	46.00	25.20	0.42	10.21	Average
14	2.87	43.73	-12.27	56.00	33.10	0.42	10.21	QP
15	3.21	36.15	-9.85	46.00	25.50	0.43	10.22	Average
16	3.21	43.55	-12.45	56.00	32.90	0.43	10.22	QP
17	3.45	36.06	-9.94	46.00	25.40	0.44	10.22	Average
18	3.45	42.96	-13.04	56.00	32.30	0.44	10.22	QP
19	3.80	36.28	-9.72	46.00	25.61	0.45	10.22	Average
20	3.80	43.28	-12.72	56.00	32.61	0.45	10.22	QP
21	4.05	34.99	-11.01	46.00	24.30	0.46	10.23	Average
22	4.05	41.39	-14.61	56.00	30.70	0.46	10.23	QP
23	4.29	32.90	-13.10	46.00	22.20	0.47	10.23	Average
24	4.29	40.00	-16.00	56.00	29.30	0.47	10.23	QP
25	4.60	28.81	-17.19	46.00	18.09	0.48	10.24	Average
26	4.60	38.12	-17.88	56.00	27.40	0.48	10.24	QP
27	5.62	25.33	-24.67	50.00	14.61	0.47	10.25	Average
28	5.62	40.03	-19.97	60.00	29.31	0.47	10.25	QP



3.7 Antenna Requirements

3.7.1 Standard Applicable

If directional gain of transmitting antennas is greater than 6dBi, the power shall be reduced by the same level in dB comparing to gain minus 6dBi. For the fixed point-to-point operation, the power shall be reduced by one dB for every 3 dB that the directional gain of the antenna exceeds 6 dBi. The use of a permanently attached antenna or of an antenna that uses a unique coupling to the intentional radiator shall be considered sufficient to comply with the FCC rule.

3.7.2 Antenna Anti-Replacement Construction

An embedded-in antenna design is used.

3.7.3 Antenna Gain

The antenna peak gain of EUT is less than 6 dBi. Therefore, it is not necessary to reduce maximum peak output power limit.



4 List of Measuring Equipment

Instrument	Manufacturer	Model No.	Serial No.	Characteristics	Calibration Date	Test Date	Due Date	Remark
Spectrum Analyzer	R&S	FSP30	101400	9kHz~40GHz	Jan. 28, 2015	Jun. 10, 2015~ Jun. 11, 2015	Jan. 27, 2016	Conducted (TH01-SZ)
Pulse Power Senor	Anritsu	MA2411B	1207253	30MHz~40GHz	Jan. 28, 2015	Jun. 10, 2015~ Jun. 11, 2015	Jan. 27, 2016	Conducted (TH01-SZ)
Power Meter	Anritsu	ML2495A	1218010	50MHz Bandwidth	Jan. 28, 2015	Jun. 10, 2015~ Jun. 11, 2015	Jan. 27, 2016	Conducted (TH01-SZ)
EMI Test Receiver&SA	Agilent Technologies	N9038A	MY522601 85	20Hz~26.5GHz	May 26, 2015	Jun. 18, 2015	May 25, 2016	Radiation (03CH01-SZ)
Spectrum Analyzer	R&S	FSV40	101041	10kHz~40GHz; Max 30dBm	Sep. 25, 2014	Jun. 18, 2015	Sep. 24, 2015	Radiation (03CH01-SZ)
Loop Antenna	R&S	HFH2-Z2	100354	9kHz~30MHz	May 06, 2015	Jun. 18, 2015	May 05, 2016	Radiation (03CH01-SZ)
Bilog Antenna	TeseQ	CBL6112D	23188	30MHz~2GHz	Nov. 07, 2014	Jun. 18, 2015	Nov. 06, 2015	Radiation (03CH01-SZ)
Double Ridge Horn Antenna	ETS-Lindgren	3117	00119436	1GHz~18GHz	Oct. 15, 2014	Jun. 18, 2015	Oct. 14, 2015	Radiation (03CH01-SZ)
SHF-EHF Horn	com-power	AH-840	101071	18GHz~40GHz	Sep. 04, 2014	Jun. 18, 2015	Sep. 03, 2015	Radiation (03CH01-SZ)
Amplifier	ADVANTEST	BB525C	E9007003	9kHz~3000MHz / 30 dB	Jan. 28, 2015	Jun. 18, 2015	Jan. 27, 2016	Radiation (03CH01-SZ)
Amplifier	Agilent Technologies	83017A	MY395013 02	500MHz~26.5G Hz	Jan. 28, 2015	Jun. 18, 2015	Jan. 27, 2016	Radiation (03CH01-SZ)
AC Power Source	Chroma	61601	616010001 985	N/A	NCR	Jun. 18, 2015	NCR	Radiation (03CH01-SZ)
Turn Table	EM	EM1000	N/A	0~360 degree	NCR	Jun. 18, 2015	NCR	Radiation (03CH01-SZ)
Antenna Mast	EM	EM1000	N/A	1 m~4 m	NCR	Jun. 18, 2015	NCR	Radiation (03CH01-SZ)
EMI Receiver	R&S	ESCI7	100724	9kHz~3GHz	Jan. 28, 2015	Jun. 02, 2015	Jan. 27, 2016	Conduction (CO01-SZ)
AC LISN	EMCO	3816/2SH	103892	9kHz~30MHz	Feb. 02, 2015	Jun. 02, 2015	Feb. 01, 2016	Conduction (CO01-SZ)
AC LISN (for auxiliary equipment)	MessTec	AN3016	16850	9kHz~30MHz	Feb. 02, 2015	Jun. 02, 2015	Feb. 01, 2016	Conduction (CO01-SZ)
AC Power Source	Chroma	61602	616020000 891	100Vac~250Vac	Sep. 29, 2014	Jun. 02, 2015	Sep. 28, 2015	Conduction (CO01-SZ)
Pulse Limiter	COM-POWER	LIT-153 Transient Limiter	53139	150kHz~30MHz	Oct. 24, 2014	Jun. 02, 2015	Oct. 23, 2015	Conduction (CO01-SZ)



5 Uncertainty of Evaluation

Uncertainty of Conducted Emission Measurement (150kHz ~ 30MHz)

Measuring Uncertainty for a Level of Confidence of 95% ($U = 2Uc(y)$)	2.3dB
---	-------

Uncertainty of Radiated Emission Measurement (30 MHz ~ 1000 MHz)

Measuring Uncertainty for a Level of Confidence of 95% ($U = 2Uc(y)$)	3.9dB
---	-------



Appendix A. Conducted Test Results

Test Engineer:	Mygai Mo	Temperature:	21~25	°C
Test Date:	2015/6/10~2015/6/11	Relative Humidity:	51~54	%

TEST RESULTS DATA
6dB and 99% Occupied Bandwidth

2.4GHz Band								
Mod.	Data Rate	NTX	CH.	Freq. (MHz)	99% Occupied BW (MHz)	6dB BW (MHz)	6dB BW Limit (MHz)	Pass/Fail
11b	1Mbps	1	1	2412	13.35	8.52	0.50	Pass
11b	1Mbps	1	6	2437	13.20	8.04	0.50	Pass
11b	1Mbps	1	11	2462	13.20	8.52	0.50	Pass
11g	6Mbps	1	1	2412	18.20	16.36	0.50	Pass
11g	6Mbps	1	6	2437	18.30	16.36	0.50	Pass
11g	6Mbps	1	11	2462	18.25	16.40	0.50	Pass
HT20	MCS0	1	1	2412	19.00	17.56	0.50	Pass
HT20	MCS0	1	6	2437	18.95	17.56	0.50	Pass
HT20	MCS0	1	11	2462	18.95	17.56	0.50	Pass

TEST RESULTS DATA
Peak Power Table

2.4GHz Band										
Mod.	Data Rate	NTX	CH.	Freq. (MHz)	Peak Conducted Power (dBm)	Conducted Power Limit (dBm)	DG (dBi)	EIRP Power (dBm)	EIRP Power Limit (dBm)	Pass /Fail
11b	1Mbps	1	1	2412	19.77	30.00	0.29	20.06	36.00	Pass
11b	1Mbps	1	6	2437	20.13	30.00	0.29	20.42	36.00	Pass
11b	1Mbps	1	11	2462	19.37	30.00	0.29	19.66	36.00	Pass
11g	6Mbps	1	1	2412	21.87	30.00	0.29	22.16	36.00	Pass
11g	6Mbps	1	6	2437	21.85	30.00	0.29	22.14	36.00	Pass
11g	6Mbps	1	11	2462	21.43	30.00	0.29	21.72	36.00	Pass
HT20	MCS0	1	1	2412	21.25	30.00	0.29	21.54	36.00	Pass
HT20	MCS0	1	6	2437	21.18	30.00	0.29	21.47	36.00	Pass
HT20	MCS0	1	11	2462	20.78	30.00	0.29	21.07	36.00	Pass

TEST RESULTS DATA
Average Power Table
(Reporting Only)

2.4GHz Band						
Mod.	Data Rate	N _{TX}	CH.	Freq. (MHz)	Duty Factor (dB)	Average Conducted Power (dBm)
11b	1Mbps	1	1	2412	0.10	17.15
11b	1Mbps	1	6	2437	0.10	17.27
11b	1Mbps	1	11	2462	0.10	16.64
11g	6Mbps	1	1	2412	0.59	12.74
11g	6Mbps	1	6	2437	0.59	12.57
11g	6Mbps	1	11	2462	0.59	12.03
HT20	MCS0	1	1	2412	0.63	11.76
HT20	MCS0	1	6	2437	0.63	11.52
HT20	MCS0	1	11	2462	0.63	10.92

TEST RESULTS DATA
Peak Power Density

2.4GHz Band								
Mod.	Data Rate	NTX	CH.	Freq. (MHz)	Peak PSD (dBm /3kHz)	DG (dBi)	Peak PSD Limit (dBm /3kHz)	Pass/Fail
11b	1Mbps	1	1	2412	-4.71	0.29	8.00	Pass
11b	1Mbps	1	6	2437	-6.06	0.29	8.00	Pass
11b	1Mbps	1	11	2462	-5.77	0.29	8.00	Pass
11g	6Mbps	1	1	2412	-12.40	0.29	8.00	Pass
11g	6Mbps	1	6	2437	-13.30	0.29	8.00	Pass
11g	6Mbps	1	11	2462	-13.77	0.29	8.00	Pass
HT20	MCS0	1	1	2412	-13.72	0.29	8.00	Pass
HT20	MCS0	1	6	2437	-14.95	0.29	8.00	Pass
HT20	MCS0	1	11	2462	-13.44	0.29	8.00	Pass



Appendix B. Radiated Spurious Emission

2.4GHz 2400~2483.5MHz

WIFI 802.11b (Band Edge @ 3m)

WIFI	Note	Frequency	Level	Over	Limit	Read	Antenna	Cable	Preamp	Ant	Table	Peak	Pol.
Ant.				Limit	Line	Level	Factor	Loss	Factor	Pos	Pos	Avg.	
1		(MHz)	(dBμV/m)	(dB)	(dBμV/m)	(dBμV)	(dB/m)	(dB)	(dB)	(cm)	(deg)	(P/A)	(H/V)
802.11b CH 01 2412MHz		2389.65	53.1	-20.9	74	41.24	32.6	8.6	29.34	178	319	P	H
		2389.83	41.74	-12.26	54	29.92	32.6	8.6	29.38	178	319	A	H
	*	2412	104.65	-	-	92.82	32.61	8.6	29.38	178	319	P	H
	*	2412	101.85	-	-	90.02	32.61	8.6	29.38	178	319	A	H
		2390.01	52.54	-21.46	74	40.72	32.6	8.6	29.38	184	22	P	V
		2389.74	41.88	-12.12	54	30.02	32.6	8.6	29.34	184	22	A	V
	*	2412	106.79	-	-	94.96	32.61	8.6	29.38	184	22	P	V
	*	2412	104.65	-	-	92.82	32.61	8.6	29.38	184	22	A	V
802.11b CH 06 2437MHz		2387.58	50.78	-23.22	74	38.92	32.6	8.6	29.34	176	323	P	H
		2380.29	39.76	-14.24	54	28.01	32.58	8.51	29.34	176	323	A	H
	*	2437	105.55	-	-	93.56	32.65	8.69	29.35	176	323	P	H
	*	2437	103.53	-	-	91.54	32.65	8.69	29.35	176	323	A	H
		2492.08	51.1	-22.9	74	38.9	32.7	8.78	29.28	176	323	P	H
		2492.92	39.71	-14.29	54	27.51	32.7	8.78	29.28	176	323	A	H
		2362.29	50.63	-23.37	74	38.87	32.56	8.51	29.31	158	22	P	V
		2381.46	39.85	-14.15	54	28.1	32.58	8.51	29.34	158	22	A	V
	*	2437	107.42	-	-	95.43	32.65	8.69	29.35	158	22	P	V
	*	2437	105.27	-	-	93.28	32.65	8.69	29.35	158	22	A	V
		2492	51.02	-22.98	74	38.82	32.7	8.78	29.28	158	22	P	V
	2493.04	40.68	-13.32	54	28.48	32.7	8.78	29.28	158	22	A	V	



802.11b CH 11 2462MHz	*	2462	104.29	-	-	92.26	32.67	8.69	29.33	169	321	P	H
	*	2462	102.1	-	-	90.07	32.67	8.69	29.33	169	321	A	H
		2489.32	52.42	-21.58	74	40.25	32.7	8.78	29.31	169	321	P	H
		2487.56	41.46	-12.54	54	29.29	32.7	8.78	29.31	169	321	A	H
	*	2462	106.45	-	-	94.42	32.67	8.69	29.33	157	23	P	V
	*	2462	104.39	-	-	92.36	32.67	8.69	29.33	157	23	A	V
		2485.76	52.74	-21.26	74	40.59	32.68	8.78	29.31	157	23	P	V
		2487.68	43.36	-10.64	54	31.19	32.7	8.78	29.31	157	23	A	V
Remark	1. No other spurious found. 2. All results are PASS against Peak and Average limit line.												



2.4GHz 2400~2483.5MHz
WIFI 802.11b (Harmonic @ 3m)

WIFI Ant. 1	Note	Frequency (MHz)	Level (dBμV/m)	Over Limit (dB)	Limit Line (dBμV/m)	Read Level (dBμV)	Antenna Factor (dB/m)	Cable Loss (dB)	Preamp Factor (dB)	Ant Pos (cm)	Table Pos (deg)	Peak Avg. (P/A)	Pol. (H/V)
802.11b CH 01 2412MHz		4824	43.43	-30.57	74	24.37	34.4	12.86	28.2	110	360	P	H
		4824	44.65	-29.35	74	25.59	34.4	12.86	28.2	110	360	P	V
802.11b CH 06 2437MHz		4874	42.58	-31.42	74	23.42	34.43	12.92	28.19	100	360	P	H
		7311	46.62	-27.38	74	22.58	36.22	14.71	26.89	174	100	P	H
		4874	44.15	-29.85	74	24.99	34.43	12.92	28.19	100	360	P	V
		7311	48.08	-25.92	74	24.04	36.22	14.71	26.89	174	100	P	V
802.11b CH 11 2462MHz		4924	43.77	-30.23	74	24.45	34.46	13.04	28.18	146	347	P	H
		7386	46.3	-27.7	74	22.14	36.26	14.75	26.85	145	274	P	H
		4924	43.71	-30.29	74	24.39	34.46	13.04	28.18	146	347	P	V
		7386	47.62	-26.38	74	23.46	36.26	14.75	26.85	145	274	P	V
Remark	1. No other spurious found. 2. All results are PASS against Peak and Average limit line.												



2.4GHz 2400~2483.5MHz
WIFI 802.11g (Band Edge @ 3m)

WIFI Ant. 1	Note	Frequency (MHz)	Level (dBμV/m)	Over Limit (dB)	Limit Line (dBμV/m)	Read Level (dBμV)	Antenna Factor (dB/m)	Cable Loss (dB)	Preamp Factor (dB)	Ant Pos (cm)	Table Pos (deg)	Peak Avg. (P/A)	Pol. (H/V)
802.11g CH 01 2412MHz		2388.39	59.03	-14.97	74	47.17	32.6	8.6	29.34	179	322	P	H
		2389.92	46.59	-7.41	54	34.77	32.6	8.6	29.38	179	322	A	H
	*	2412	100.69	-	-	88.86	32.61	8.6	29.38	179	322	P	H
	*	2412	92.76	-	-	80.93	32.61	8.6	29.38	179	322	A	H
		2389.65	63.05	-10.95	74	51.19	32.6	8.6	29.34	172	323	P	V
		2389.83	48.43	-5.57	54	36.61	32.6	8.6	29.38	172	323	A	V
	*	2412	103.23	-	-	91.4	32.61	8.6	29.38	172	323	P	V
	*	2412	95.57	-	-	83.74	32.61	8.6	29.38	172	323	A	V
802.11g CH 06 2437MHz		2384.61	51.65	-22.35	74	39.81	32.58	8.6	29.34	176	323	P	H
		2384.88	41.05	-12.95	54	29.21	32.58	8.6	29.34	176	323	A	H
	*	2437	101.24	-	-	89.25	32.65	8.69	29.35	176	323	P	H
	*	2437	93.51	-	-	81.52	32.65	8.69	29.35	176	323	A	H
		2498.6	52.08	-21.92	74	39.88	32.7	8.78	29.28	176	323	P	H
		2489.12	41.57	-12.43	54	29.4	32.7	8.78	29.31	176	323	A	H
		2384.7	51.44	-22.56	74	39.6	32.58	8.6	29.34	181	307	P	V
		2384.88	41.72	-12.28	54	29.88	32.58	8.6	29.34	181	307	A	V
	*	2437	103.77	-	-	91.78	32.65	8.69	29.35	181	307	P	V
	*	2437	95.34	-	-	83.35	32.65	8.69	29.35	181	307	A	V
		2489.44	51.4	-22.6	74	39.23	32.7	8.78	29.31	181	307	P	V
		2489.88	41.52	-12.48	54	29.35	32.7	8.78	29.31	181	307	A	V



802.11g CH 11 2462MHz	*	2462	99.97	-	-	87.94	32.67	8.69	29.33	170	321	P	H
	*	2462	91.67	-	-	79.64	32.67	8.69	29.33	170	321	A	H
		2484.32	55	-19	74	42.85	32.68	8.78	29.31	170	321	P	H
		2483.64	42.04	-11.96	54	29.89	32.68	8.78	29.31	170	321	A	H
	*	2462	102.51	-	-	90.48	32.67	8.69	29.33	175	306	P	V
	*	2462	94.02	-	-	81.99	32.67	8.69	29.33	175	306	A	V
		2483.96	56.67	-17.33	74	44.52	32.68	8.78	29.31	175	306	P	V
		2483.56	43.68	-10.32	54	31.53	32.68	8.78	29.31	175	306	A	V
Remark	1. No other spurious found. 2. All results are PASS against Peak and Average limit line.												



2.4GHz 2400~2483.5MHz
WIFI 802.11g (Harmonic @ 3m)

WIFI Ant. 1	Note	Frequency (MHz)	Level (dBμV/m)	Over Limit (dB)	Limit Line (dBμV/m)	Read Level (dBμV)	Antenna Factor (dB/m)	Cable Loss (dB)	Preamp Factor (dB)	Ant Pos (cm)	Table Pos (deg)	Peak Avg. (P/A)	Pol. (H/V)
802.11g CH 01 2412MHz		4824	43.5	-30.5	74	24.44	34.4	12.86	28.2	110	360	P	H
		4824	43.61	-30.39	74	24.55	34.4	12.86	28.2	110	360	P	V
802.11g CH 06 2437MHz		4874	43.53	-30.47	74	24.37	34.43	12.92	28.19	100	360	P	H
		7311	47.41	-26.59	74	23.37	36.22	14.71	26.89	174	100	P	H
		4874	44.43	-29.57	74	25.27	34.43	12.92	28.19	100	360	P	V
		7311	47.48	-26.52	74	23.44	36.22	14.71	26.89	174	100	P	V
802.11g CH 11 2462MHz		4924	44.24	-29.76	74	24.92	34.46	13.04	28.18	146	347	P	H
		7386	47.83	-26.17	74	23.67	36.26	14.75	26.85	145	274	P	H
		4924	44.12	-29.88	74	24.8	34.46	13.04	28.18	146	347	P	V
		7386	46.9	-27.1	74	22.74	36.26	14.75	26.85	145	274	P	V
Remark	1. No other spurious found. 2. All results are PASS against Peak and Average limit line.												



**2.4GHz 2400~2483.5MHz
WIFI 802.11n HT20 (Band Edge @ 3m)**

WIFI Ant. 1	Note	Frequency (MHz)	Level (dBμV/m)	Over Limit (dB)	Limit Line (dBμV/m)	Read Level (dBμV)	Antenna Factor (dB/m)	Cable Loss (dB)	Preamp Factor (dB)	Ant Pos (cm)	Table Pos (deg)	Peak Avg. (P/A)	Pol. (H/V)
802.11n HT20 CH 01 2412MHz		2389.92	59.44	-14.56	74	47.62	32.6	8.6	29.38	150	323	P	H
		2389.74	45.31	-8.69	54	33.45	32.6	8.6	29.34	150	323	A	H
	*	2412	100.46	-	-	88.63	32.61	8.6	29.38	150	323	P	H
	*	2412	90.92	-	-	79.09	32.61	8.6	29.38	150	323	A	H
		2389.74	62.55	-11.45	74	50.69	32.6	8.6	29.34	188	355	P	V
		2389.92	48.85	-5.15	54	37.03	32.6	8.6	29.38	188	355	A	V
	*	2412	101.96	-	-	90.13	32.61	8.6	29.38	188	355	P	V
	*	2412	93.85	-	-	82.02	32.61	8.6	29.38	188	355	A	V
802.11n HT20 CH 06 2437MHz		2386.86	52.12	-21.88	74	40.26	32.6	8.6	29.34	150	322	P	H
		2385.42	41.57	-12.43	54	29.73	32.58	8.6	29.34	150	322	A	H
	*	2437	101.56	-	-	89.57	32.65	8.69	29.35	150	322	P	H
	*	2437	93.01	-	-	81.02	32.65	8.69	29.35	150	322	A	H
		2489.04	51.25	-22.75	74	39.08	32.7	8.78	29.31	150	322	P	H
		2488.44	40.75	-13.25	54	28.58	32.7	8.78	29.31	150	322	A	H
		2385.15	52.83	-21.17	74	40.99	32.58	8.6	29.34	188	355	P	V
		2385.33	43.57	-10.43	54	31.73	32.58	8.6	29.34	188	355	A	V
	*	2437	101.87	-	-	89.88	32.65	8.69	29.35	188	355	P	V
	*	2437	93.65	-	-	81.66	32.65	8.69	29.35	188	355	A	V
		2488.72	51.84	-22.16	74	39.67	32.7	8.78	29.31	188	355	P	V
	2488.8	41.32	-12.68	54	29.15	32.7	8.78	29.31	188	355	A	V	



802.11n HT20 CH 11 2462MHz	*	2462	100.68	-	-	88.65	32.67	8.69	29.33	166	321	P	H
	*	2462	90.65	-	-	78.62	32.67	8.69	29.33	166	321	A	H
		2483.64	55.79	-18.21	74	43.64	32.68	8.78	29.31	166	321	P	H
		2483.52	42.64	-11.36	54	30.49	32.68	8.78	29.31	166	321	A	H
	*	2462	101.39	-	-	89.36	32.67	8.69	29.33	182	349	P	V
	*	2462	93.28	-	-	81.25	32.67	8.69	29.33	182	349	A	V
		2483.56	55.16	-18.84	74	43.01	32.68	8.78	29.31	182	349	P	V
		2483.52	43.54	-10.46	54	31.39	32.68	8.78	29.31	182	349	A	V
Remark	1. No other spurious found. 2. All results are PASS against Peak and Average limit line.												



2.4GHz 2400~2483.5MHz
WIFI 802.11n HT20 (Harmonic @ 3m)

WIFI Ant. 1	Note	Frequency (MHz)	Level (dBμV/m)	Over Limit (dB)	Limit Line (dBμV/m)	Read Level (dBμV)	Antenna Factor (dB/m)	Cable Loss (dB)	Preamp Factor (dB)	Ant Pos (cm)	Table Pos (deg)	Peak Avg. (P/A)	Pol. (H/V)
802.11n HT20 CH 01 2412MHz		4824	43.74	-30.26	74	24.68	34.4	12.86	28.2	110	360	P	H
		4824	43.97	-30.03	74	24.91	34.4	12.86	28.2	110	360	P	V
802.11n HT20 CH 06 2437MHz		4874	44.9	-29.1	74	25.74	34.43	12.92	28.19	100	360	P	H
		7311	47.53	-26.47	74	23.49	36.22	14.71	26.89	174	100	P	H
		4874	44	-30	74	24.84	34.43	12.92	28.19	100	360	P	V
		7311	47.9	-26.1	74	23.86	36.22	14.71	26.89	174	100	P	V
802.11n HT20 CH 11 2462MHz		4924	43.65	-30.35	74	24.33	34.46	13.04	28.18	146	347	P	H
		7386	48.09	-25.91	74	23.93	36.26	14.75	26.85	145	274	P	H
		4924	43.7	-30.3	74	24.38	34.46	13.04	28.18	146	347	P	V
		7386	48.13	-25.87	74	23.97	36.26	14.75	26.85	145	274	P	V
Remark	1. No other spurious found. 2. All results are PASS against Peak and Average limit line.												



Emission below 1GHz
2.4GHz WIFI 802.11n HT20 (LF)

WIFI	Note	Frequency	Level	Over	Limit	Read	Antenna	Cable	Preamp	Ant	Table	Peak	Pol.
Ant.				Limit	Line	Level	Factor	Loss	Factor	Pos	Pos	Avg.	
1		(MHz)	(dBμV/m)	(dB)	(dBμV/m)	(dBμV)	(dB/m)	(dB)	(dB)	(cm)	(deg)	(P/A)	(H/V)
2.4GHz 802.11n HT20 LF		30.97	22.42	-17.58	40	28.53	19.09	0.86	26.06			P	H
		191.99	20.72	-22.78	43.5	32.29	11.56	2.16	25.29			P	H
		384.05	24.42	-21.58	46	31.79	15.2	3.12	25.69			P	H
		514.03	26.3	-19.7	46	29.57	19.44	3.64	26.35			P	H
		648.86	28.23	-17.77	46	30.46	19.99	4.19	26.41			P	H
		820.55	29.73	-16.27	46	28.78	22.32	4.74	26.11	100	360	P	H
		31.94	28.79	-11.21	40	35.39	18.58	0.87	26.05	100	200	P	V
		74.62	21.76	-18.24	40	36.99	9.33	1.32	25.88			P	V
		289.96	19.32	-26.68	46	27.92	13.77	2.69	25.06			P	V
		518.88	25.62	-20.38	46	28.82	19.46	3.7	26.36			P	V
		815.7	29.42	-16.58	46	28.46	22.36	4.72	26.12			P	V
	976.72	28.91	-25.09	54	27.81	21.29	5.1	25.29			P	V	
Remark	1. No other spurious found. 2. All results are PASS against limit line.												



Note symbol

*	Fundamental Frequency which can be ignored. However, the level of any unwanted emissions shall not exceed the level of the fundamental frequency.
!	Test result is over limit line.
P/A	Peak or Average
H/V	Horizontal or Vertical



A calculation example for radiated spurious emission is shown as below:

WIFI	Note	Frequency	Level	Over	Limit	Read	Antenna	Cable	Preamp	Ant	Table	Peak	Pol.
Ant.				Limit	Line	Level	Factor	Loss	Factor	Pos	Pos	Avg.	
1		(MHz)	(dBμV/m)	(dB)	(dBμV/m)	(dBμV)	(dB/m)	(dB)	(dB)	(cm)	(deg)	(P/A)	(H/V)
802.11b		2390	55.45	-18.55	74	54.51	32.22	4.58	35.86	103	308	P	H
CH 01													
2412MHz		2390	43.54	-10.46	54	42.6	32.22	4.58	35.86	103	308	A	H

- 1. Level(dBμV/m) =
Antenna Factor(dB/m) + Cable Loss(dB) + Read Level(dBμV) - Preamp Factor(dB)
- 2. Over Limit(dB) = Level(dBμV/m) – Limit Line(dBμV/m)

For Peak Limit @ 2390MHz:

- 1. Level(dBμV/m)
= Antenna Factor(dB/m) + Cable Loss(dB) + Read Level(dBμV) - Preamp Factor(dB)
= 32.22(dB/m) + 4.58(dB) + 54.51(dBμV) – 35.86 (dB)
= 55.45 (dBμV/m)
- 2. Over Limit(dB)
= Level(dBμV/m) – Limit Line(dBμV/m)
= 55.45(dBμV/m) – 74(dBμV/m)
= -18.55(dB)

For Average Limit @ 2390MHz:

- 1. Level(dBμV/m)
= Antenna Factor(dB/m) + Cable Loss(dB) + Read Level(dBμV) - Preamp Factor(dB)
= 32.22(dB/m) + 4.58(dB) + 42.6(dBμV) – 35.86 (dB)
= 43.54 (dBμV/m)
- 2. Over Limit(dB)
= Level(dBμV/m) – Limit Line(dBμV/m)
= 43.54(dBμV/m) – 54(dBμV/m)
= -10.46(dB)

Both peak and average measured complies with the limit line, so test result is “PASS”.