



FCC RADIO TEST REPORT

FCC ID : UZ7TC210K
Equipment : Touch computer
Brand Name : Zebra
Model Name : TC210K
Applicant : Zebra Technologies Corporation
1 Zebra Plaza, Holtsville, NY 11742
Manufacturer : Zebra Technologies Corporation
1 Zebra Plaza, Holtsville, NY 11742
Standard : FCC Part 15 Subpart C §15.247

The product was received on Jan. 20, 2020 and testing was started from Jan. 30, 2020 and completed on Feb. 29, 2020. We, SPORTON INTERNATIONAL INC., EMC & Wireless Communications Laboratory, would like to declare that the tested sample has been evaluated in accordance with the test procedures and has been in compliance with the applicable technical standards.

The report must not be used by the client to claim product certification, approval, or endorsement by TAF or any agency of government.

The test results in this report apply exclusively to the tested model / sample. Without written approval of SPORTON INTERNATIONAL INC. EMC & Wireless Communications Laboratory, the test report shall not be reproduced except in full.

Louis Wu

Reviewed by: Louis Wu

SPORTON INTERNATIONAL INC. EMC & Wireless Communications Laboratory

No. 52, Huaya 1st Rd., Guishan Dist., Taoyuan City, Taiwan (R.O.C.)



Table of Contents

History of this test report.....	3
Summary of Test Result.....	4
1 General Description.....	5
1.1 Product Feature of Equipment Under Test.....	5
1.2 Product Specification of Equipment Under Test.....	6
1.3 Modification of EUT	6
1.4 Testing Location	6
1.5 Applicable Standards.....	7
2 Test Configuration of Equipment Under Test.....	8
2.1 Carrier Frequency Channel	8
2.2 Test Mode.....	9
2.3 Connection Diagram of Test System.....	14
2.4 Support Unit used in test configuration and system	15
2.5 EUT Operation Test Setup	15
2.6 Measurement Results Explanation Example.....	15
3 Test Result.....	16
3.1 Number of Channel Measurement	16
3.2 Hopping Channel Separation Measurement	18
3.3 Dwell Time Measurement.....	24
3.4 20dB and 99% Bandwidth Measurement	26
3.5 Output Power Measurement.....	37
3.6 Conducted Band Edges Measurement.....	40
3.7 Conducted Spurious Emission Measurement	47
3.8 Radiated Band Edges and Spurious Emission Measurement	57
3.9 AC Conducted Emission Measurement.....	61
3.10 Antenna Requirements.....	63
4 List of Measuring Equipment	64
5 Uncertainty of Evaluation.....	65
Appendix A. AC Conducted Emission Test Result	
Appendix B. Radiated Spurious Emission	
Appendix C. Radiated Spurious Emission Plots	
Appendix D. Duty Cycle Plots	
Appendix E. Setup Photographs	



History of this test report

Report No.	Version	Description	Issued Date
FR010732A	01	Initial issue of report	Mar. 03, 2020



Summary of Test Result

Report Clause	Ref Std. Clause	Test Items	Result (PASS/FAIL)	Remark
3.1	15.247(a)(1)	Number of Channels	Pass	-
3.2	15.247(a)(1)	Hopping Channel Separation	Pass	-
3.3	15.247(a)(1)	Dwell Time of Each Channel	Pass	-
3.4	15.247(a)(1)	20dB Bandwidth	Pass	-
3.4	2.1049	99% Occupied Bandwidth	Reporting only	-
3.5	15.247(b)(1)	Peak Output Power	Pass	-
3.6	15.247(d)	Conducted Band Edges	Pass	-
3.7	15.247(d)	Conducted Spurious Emission	Pass	-
3.8	15.247(d)	Radiated Band Edges and Radiated Spurious Emission	Pass	Under limit 6.32 dB at 44.550 MHz
3.9	15.207	AC Conducted Emission	Pass	Under limit 11.89 dB at 13.560 MHz
3.10	15.203 & 15.247(b)	Antenna Requirement	Pass	-

Declaration of Conformity:

The test results with all measurement uncertainty excluded are presented in accordance with the regulation limits or requirements declared by manufacturers.

Comments and Explanations:

The declared of product specification for EUT presented in the report are provided by the manufacturer, and the manufacturer takes all the responsibilities for the accuracy of product specification.

Reviewed by: Wii Chang**Report Producer: Amy Chen**



1 General Description

1.1 Product Feature of Equipment Under Test

Product Specification subjective to this standard	
Equipment	Touch computer
Brand Name	Zebra
Model Name	TC210K
FCC ID	UZ7TC210K
Sample 1	WLAN, GMS, SE4710, NFC, 3G/32GB, Rear camera, 2-pin connector
Sample 2	WLAN, GMS, No scanner, NFC, 3G/32GB, Front & Rear camera, 2-pin connector
EUT supports Radios application	NFC WLAN 11a/b/g/n HT20/HT40 WLAN 11ac VHT20/VHT40/VHT80 Bluetooth BR/EDR/LE
HW Version	Meteor_EV1_MB_V11
OS Version	Android version 10
SW Version	FUSION_QA_2_1.0.0.007_Q
FW Version	Zebra/TC21MG/TC21:10/03-08-17.00-QG-U00-PRD/88:userdebug/release-keys
MFD	27DEC19
EUT Stage	Engineering Sample

Remark: The above EUT's information was declared by manufacturer.

Specification of Accessories				
AC Adapter	Brand Name	Zebra	Part Number	PWR-WUA5V12W0US
Battery 1	Brand Name	Zebra	Part Number	BT-000409-00
Battery 2	Brand Name	Zebra	Part Number	BT-000410-50
Battery 3	Brand Name	Zebra	Part Number	BT-000411-08
USB Cable (TypeA plug to TypeC plug)	Brand Name	Zebra	Part Number	CBL-TC5X-USBC2A-01
Adapter Cable PTT headset (3.5mm to 3.5mm)	Brand Name	Zebra	Part Number	CBL-TC51-HDST35-01
Headset 3.5mm type with PTT/micassy	Brand Name	Zebra	Part Number	HDST-35MM-PTVP-01
Snap on Trigger handle	Brand Name	Zebra	Part Number	TRG-TC2Y-SNP1-01
Belt Holster	Brand Name	Zebra	Part Number	SG-TC2Y-HLSTR1-01
Wearable Arm Mount	Brand Name	Zebra	Part Number	SG-TC2Y-ARMNT-01

Support Unit used in test configuration and system				
Type C to 3.5mm headset adaptor	Trade Name	Google	Model name	Pixel-2-2XL



1.2 Product Specification of Equipment Under Test

Standards-related Product Specification	
Tx/Rx Frequency Range	2402 MHz ~ 2480 MHz
Number of Channels	79
Carrier Frequency of Each Channel	2402+n*1 MHz; n=0~78
Maximum Output Power to Antenna	<Class I> Bluetooth BR(1Mbps) : 8.91 dBm (0.0078 W) Bluetooth EDR (2Mbps) : 8.01 dBm (0.0063 W) Bluetooth EDR (3Mbps) : 8.39 dBm (0.0069 W) <Class II> Bluetooth BR(1Mbps) : 3.84 dBm (0.0024 W) Bluetooth EDR (2Mbps) : 2.97 dBm (0.0020 W) Bluetooth EDR (3Mbps) : 3.20 dBm (0.0021 W)
99% Occupied Bandwidth	Bluetooth BR(1Mbps) : 0.854 MHz Bluetooth EDR (2Mbps) : 1.169 MHz Bluetooth EDR (3Mbps) : 1.172 MHz
Antenna Type	PIFA Antenna type with gain 0.60 dBi
Type of Modulation	Bluetooth BR (1Mbps) : GFSK Bluetooth EDR (2Mbps) : $\pi/4$ -DQPSK Bluetooth EDR (3Mbps) : 8-DPSK

1.3 Modification of EUT

No modifications are made to the EUT during all test items.

1.4 Testing Location

Test Site	SPORTON INTERNATIONAL INC. EMC & Wireless Communications Laboratory	
Test Site Location	No.52, Huaya 1st Rd., Guishan Dist., Taoyuan City, Taiwan (R.O.C.) TEL: +886-3-327-3456 FAX: +886-3-328-4978	
Test Site No.	Sporton Site No.	
	TH05-HY	CO05-HY

Note: The test site complies with ANSI C63.4 2014 requirement.

Test Site	SPORTON INTERNATIONAL INC. EMC & Wireless Communications Laboratory	
Test Site Location	No.58, Aly. 75, Ln. 564, Wenhua 3rd, Rd., Guishan Dist., Taoyuan City, Taiwan (R.O.C.) TEL: +886-3-327-0868 FAX: +886-3-327-0855	
Test Site No.	Sporton Site No.	
	03CH16-HY	

Note: The test site complies with ANSI C63.4 2014 requirement.

FCC designation No.: TW1190 and TW0007



1.5 Applicable Standards

According to the specifications of the manufacturer, the EUT must comply with the requirements of the following standards:

- ♦ FCC Part 15 Subpart C §15.247
- ♦ FCC KDB Publication No. 558074 D01 DTS Meas. Guidance v05r02
- ♦ FCC KDB 414788 D01 Radiated Test Site v01r01.
- ♦ ANSI C63.10-2013

Remark:

1. All test items were verified and recorded according to the standards and without any deviation during the test.
2. This EUT has also been tested and complied with the requirements of FCC Part 15, Subpart B, recorded in a separate test report.



2 Test Configuration of Equipment Under Test

2.1 Carrier Frequency Channel

Frequency Band	Channel	Freq. (MHz)	Channel	Freq. (MHz)	Channel	Freq. (MHz)
2400-2483.5 MHz	0	2402	27	2429	54	2456
	1	2403	28	2430	55	2457
	2	2404	29	2431	56	2458
	3	2405	30	2432	57	2459
	4	2406	31	2433	58	2460
	5	2407	32	2434	59	2461
	6	2408	33	2435	60	2462
	7	2409	34	2436	61	2463
	8	2410	35	2437	62	2464
	9	2411	36	2438	63	2465
	10	2412	37	2439	64	2466
	11	2413	38	2440	65	2467
	12	2414	39	2441	66	2468
	13	2415	40	2442	67	2469
	14	2416	41	2443	68	2470
	15	2417	42	2444	69	2471
	16	2418	43	2445	70	2472
	17	2419	44	2446	71	2473
	18	2420	45	2447	72	2474
	19	2421	46	2448	73	2475
	20	2422	47	2449	74	2476
	21	2423	48	2450	75	2477
	22	2424	49	2451	76	2478
	23	2425	50	2452	77	2479
	24	2426	51	2453	78	2480
	25	2427	52	2454	-	-
	26	2428	53	2455	-	-

2.2 Test Mode

<Class I>

Channel	Frequency	Bluetooth Average Output Power		
		GFSK / 1Mbps		
		DH1	DH3	DH5
Ch00	2402MHz	8.45 dBm	8.46 dBm	8.47 dBm
Ch39	2441MHz	8.30 dBm	8.32 dBm	8.26 dBm
Ch78	2480MHz	7.72 dBm	7.74 dBm	7.77 dBm

Channel	Frequency	Bluetooth Average Output Power		
		$\pi/4$ -DQPSK / 2Mbps		
		2DH1	2DH3	2DH5
Ch00	2402MHz	5.24 dBm	5.22 dBm	5.28 dBm
Ch39	2441MHz	5.18 dBm	5.19 dBm	5.23 dBm
Ch78	2480MHz	4.67 dBm	4.69 dBm	4.72 dBm

Channel	Frequency	Bluetooth Average Output Power		
		8-DPSK / 3Mbps		
		3DH1	3DH3	3DH5
Ch00	2402MHz	5.29 dBm	5.32 dBm	5.34 dBm
Ch39	2441MHz	5.21 dBm	5.19 dBm	5.23 dBm
Ch78	2480MHz	4.67 dBm	4.70 dBm	4.71 dBm



Channel	Frequency	Bluetooth Peak Output Power		
		GFSK / 1Mbps		
		DH1	DH3	DH5
Ch00	2402MHz	8.85 dBm	8.89 dBm	8.91 dBm
Ch39	2441MHz	8.83 dBm	8.85 dBm	8.88 dBm
Ch78	2480MHz	8.31 dBm	8.33 dBm	8.35 dBm

Channel	Frequency	Bluetooth Peak Output Power		
		$\pi/4$ -DQPSK / 2Mbps		
		2DH1	2DH3	2DH5
Ch00	2402MHz	7.89 dBm	7.81 dBm	7.93 dBm
Ch39	2441MHz	7.95 dBm	7.98 dBm	8.01 dBm
Ch78	2480MHz	7.49 dBm	7.53 dBm	7.55 dBm

Channel	Frequency	Bluetooth Peak Output Power		
		8-DPSK / 3Mbps		
		3DH1	3DH3	3DH5
Ch00	2402MHz	8.32 dBm	8.35 dBm	8.38 dBm
Ch39	2441MHz	8.31 dBm	8.36 dBm	8.39 dBm
Ch78	2480MHz	8.01 dBm	8.05 dBm	8.11 dBm

Remark: The data rate was set in 1Mbps for all the test items due to the highest RF output power.



<Class II>

Channel	Frequency	Bluetooth Average Output Power		
		GFSK / 1Mbps		
		DH1	DH3	DH5
Ch00	2402MHz	1.92 dBm	1.95 dBm	1.97 dBm
Ch39	2441MHz	2.14 dBm	2.18 dBm	2.21 dBm
Ch78	2480MHz	1.98 dBm	2.01 dBm	2.02 dBm

Channel	Frequency	Bluetooth Average Output Power		
		$\pi/4$ -DQPSK / 2Mbps		
		2DH1	2DH3	2DH5
Ch00	2402MHz	-1.54 dBm	-1.52 dBm	-1.51 dBm
Ch39	2441MHz	-1.22 dBm	-1.20 dBm	-1.16 dBm
Ch78	2480MHz	-1.30 dBm	-1.28 dBm	-1.27 dBm

Channel	Frequency	Bluetooth Average Output Power		
		8-DPSK / 3Mbps		
		3DH1	3DH3	3DH5
Ch00	2402MHz	-1.48 dBm	-1.54 dBm	-1.57 dBm
Ch39	2441MHz	-1.17 dBm	-1.20 dBm	-1.16 dBm
Ch78	2480MHz	-1.33 dBm	-1.28 dBm	-1.26 dBm

Channel	Frequency	Bluetooth Peak Output Power		
		GFSK / 1Mbps		
		DH1	DH3	DH5
Ch00	2402MHz	3.65 dBm	3.68 dBm	3.71 dBm
Ch39	2441MHz	3.73 dBm	3.75 dBm	3.84 dBm
Ch78	2480MHz	3.64 dBm	3.65 dBm	3.68 dBm

Channel	Frequency	Bluetooth Peak Output Power		
		$\pi/4$ -DQPSK / 2Mbps		
		2DH1	2DH3	2DH5
Ch00	2402MHz	2.61 dBm	2.68 dBm	2.72 dBm
Ch39	2441MHz	2.87 dBm	2.90 dBm	2.97 dBm
Ch78	2480MHz	2.72 dBm	2.81 dBm	2.84 dBm

Channel	Frequency	Bluetooth Peak Output Power		
		8-DPSK / 3Mbps		
		3DH1	3DH3	3DH5
Ch00	2402MHz	3.09 dBm	2.84 dBm	2.77 dBm
Ch39	2441MHz	2.92 dBm	3.15 dBm	3.18 dBm
Ch78	2480MHz	3.03 dBm	3.09 dBm	3.20 dBm

Remark: The class II was tested with power only.

- a. The EUT has been associated with peripherals and configuration operated in a manner tended to maximize its emission characteristics in a typical application. Frequency range investigated: conduction emission (150 kHz to 30 MHz), radiation emission (9 kHz to the 10th harmonic of the highest fundamental frequency or to 40 GHz, whichever is lower). For radiated measurement, pre-scanned in three orthogonal panels, X, Y, Z. The worst cases (X plane) were recorded in this report, and the worst mode of radiated spurious emissions is Bluetooth 1Mbps mode, and recorded in this report.
- b. AC power line Conducted Emission was tested under maximum output power.



The following summary table is showing all test modes to demonstrate in compliance with the standard.

Summary table of Test Cases			
Test Item	Data Rate / Modulation		
	Bluetooth BR 1Mbps GFSK	Bluetooth EDR 2Mbps $\pi/4$ -DQPSK	Bluetooth EDR 3Mbps 8-DPSK
Conducted Test Cases	Mode 1: CH00_2402 MHz Mode 2: CH39_2441 MHz Mode 3: CH78_2480 MHz	Mode 4: CH00_2402 MHz Mode 5: CH39_2441 MHz Mode 6: CH78_2480 MHz	Mode 7: CH00_2402 MHz Mode 8: CH39_2441 MHz Mode 9: CH78_2480 MHz
Radiated Test Cases	Bluetooth BR 1Mbps GFSK		
	Mode 1: CH00_2402 MHz Mode 2: CH39_2441 MHz Mode 3: CH78_2480 MHz		
AC Conducted Emission	Mode 1 : WLAN (2.4GHz) Link + Bluetooth Link + NFC On + USB Cable (CBL-TC5X-USBC2A-01) + AC Adapter (PWR-WUA5V12W0US) + Battery1_1X(BT-000409) for Sample 1		
Remark:			
<ol style="list-style-type: none"> For radiated test cases, the worst mode data rate 1Mbps was reported only since the highest RF output power in the preliminary tests. The conducted spurious emissions and conducted band edge measurement for other data rates were not worse than 1Mbps, and no other significantly frequencies found in conducted spurious emission. For Radiated Test Cases, the tests were performed with Battery 1 and Sample 1. 			

2.3 Connection Diagram of Test System

<Bluetooth Tx Mode>

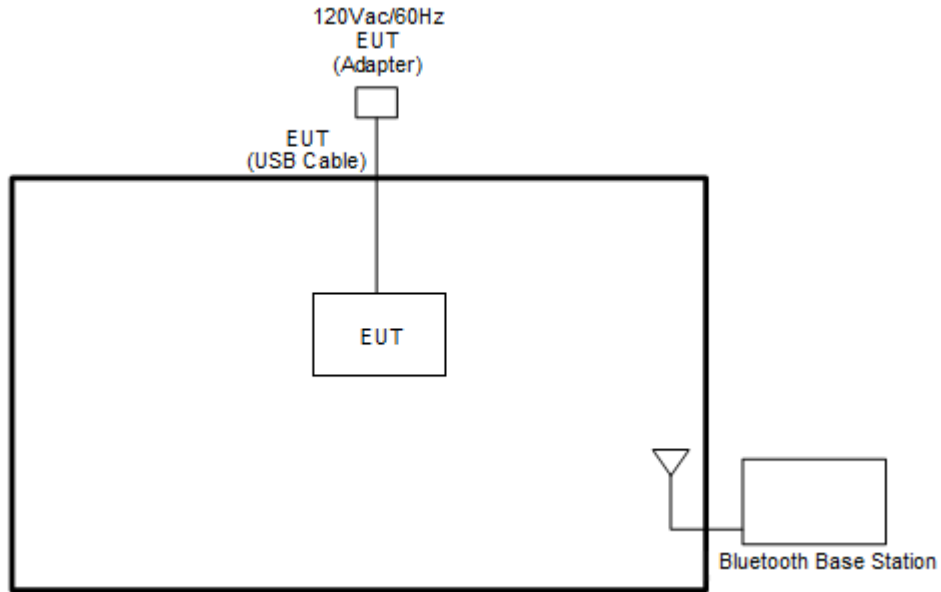

<AC Conducted Emission Mode>

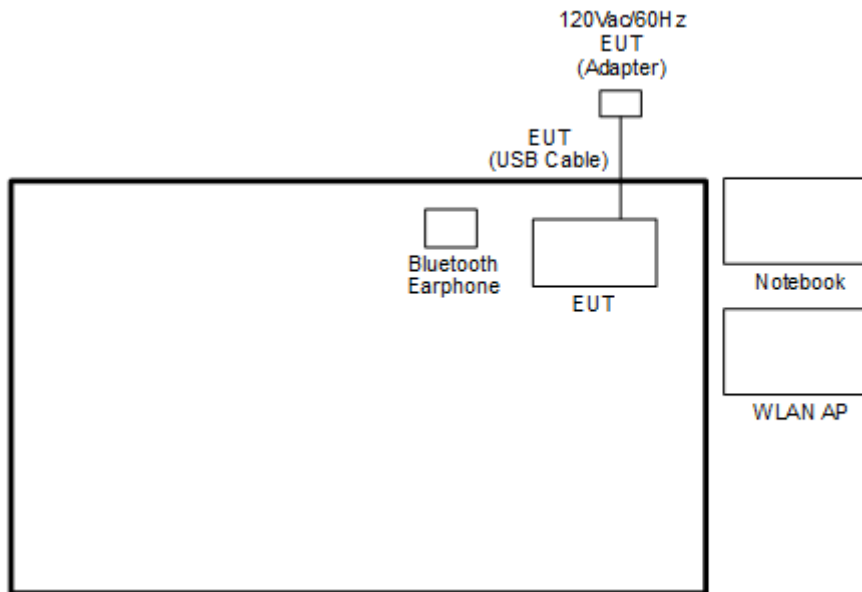

2.4 Support Unit used in test configuration and system

Item	Equipment	Trade Name	Model Name	FCC ID	Data Cable	Power Cord
1.	Bluetooth Base Station	R&S	CBT32	N/A	N/A	Unshielded, 1.8 m
2.	Bluetooth Earphone	Sony Ericsson	MW600	PY7DDA-2029	N/A	N/A
3.	WLAN AP	ASUS	RT-AC66U	MSQ-RTAC66U	N/A	Unshielded, 1.8 m
4.	Notebook	Dell	Latitude 3400	FCC DoC	N/A	AC I/P : Unshielded, 1.2m DC O/P : Shielded, 1.8m
5.	SD Card	SanDisk	MicroSD HC	FCC DoC	N/A	N/A

2.5 EUT Operation Test Setup

The RF test items, utility "QRCT4" was installed in Notebook which was programmed in order to make the EUT get into the engineering modes to contact with base station to provide channel selection, power level, data rate and the application type and for continuous transmitting signals.

2.6 Measurement Results Explanation Example

For all conducted test items:

The offset level is set in the spectrum analyzer to compensate the RF cable loss and attenuator factor between EUT conducted output port and spectrum analyzer. With the offset compensation, the spectrum analyzer reading level is exactly the EUT RF output level.

Example:

The spectrum analyzer offset is derived from RF cable loss and attenuator factor.

Offset = RF cable loss + attenuator factor.

Following shows an offset computation example with cable loss 4.2 dB and 10dB attenuator.

$$\begin{aligned}
 \text{Offset(dB)} &= \text{RF cable loss(dB)} + \text{attenuator factor(dB)} \\
 &= 4.2 + 10 = 14.2 \text{ (dB)}
 \end{aligned}$$

3 Test Result

3.1 Number of Channel Measurement

3.1.1 Limits of Number of Hopping Frequency

Frequency hopping systems in the 2400-2483.5 MHz band shall use at least 15 channels.

3.1.2 Measuring Instruments

See list of measuring equipment of this test report.

3.1.3 Test Procedure

1. The testing follows ANSI C63.10-2013 clause 7.8.3.
2. The RF output of EUT was connected to the spectrum analyzer by RF cable and attenuator. The path loss was compensated to the results for each measurement.
3. Set to the maximum power setting and enable the EUT transmit continuously.
4. Enable the EUT hopping function.
5. Use the following spectrum analyzer settings: Span = the frequency band of operation; RBW = 300kHz; VBW \geq RBW; Sweep = auto; Detector function = peak; Trace = max hold.
6. The number of hopping frequency used is defined as the number of total channel.
7. Record the measurement data derived from spectrum analyzer.

3.1.4 Test Setup

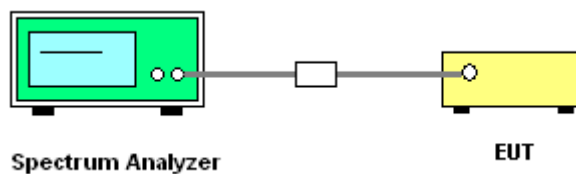



3.1.5 Test Result of Number of Hopping Frequency

Test Engineer :	Luffy Lin	Temperature :	21~25°C
		Relative Humidity :	51~54%

Number of Hopping (Channel)	Adaptive Frequency Hopping (Channel)	Limits (Channel)	Pass/Fail
79	20	> 15	Pass

Number of Hopping Channel Plot on Channel 00 - 78

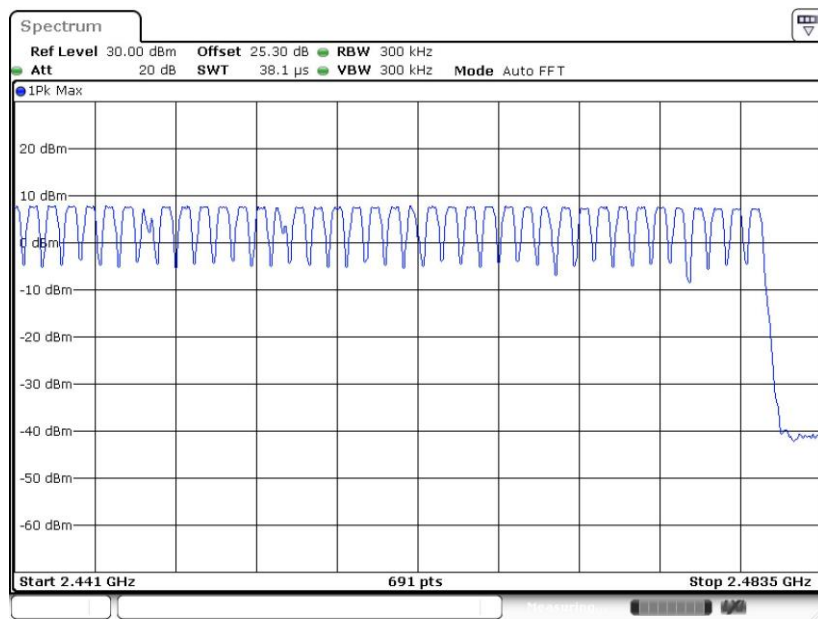
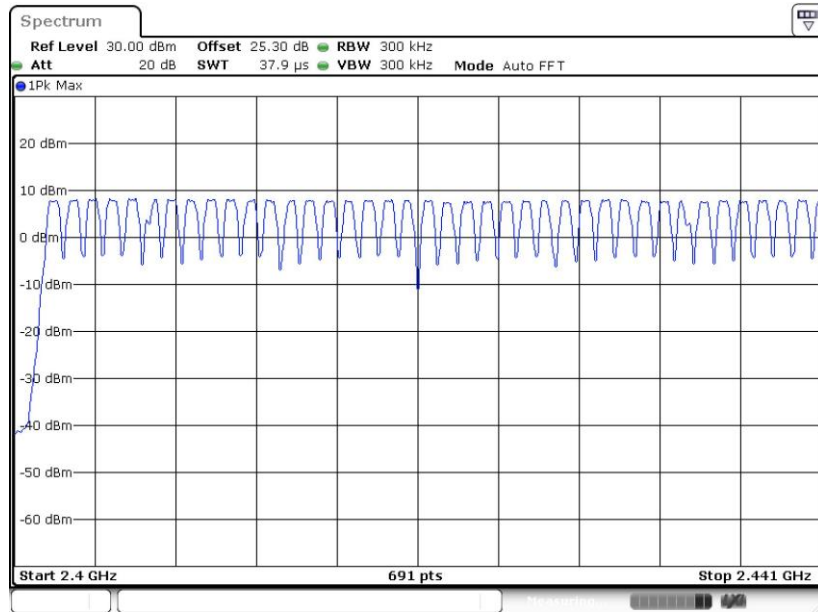

3.2 Hopping Channel Separation Measurement

3.2.1 Limit of Hopping Channel Separation

Frequency hopping systems operating in the 2400-2483.5 MHz band may have hopping channel carrier frequencies that are separated by 25 kHz or two-thirds of the 20 dB bandwidth of the hopping channel, whichever is greater.

3.2.2 Measuring Instruments

See list of measuring equipment of this test report.

3.2.3 Test Procedures

1. The testing follows ANSI C63.10-2013 clause 7.8.2.
2. The RF output of EUT was connected to the spectrum analyzer by RF cable and attenuator. The path loss was compensated to the results for each measurement.
3. Set to the maximum power setting and enable the EUT transmit continuously.
4. Enable the EUT hopping function.
5. Use the following spectrum analyzer settings:
Span = wide enough to capture the peaks of two adjacent channels;
RBW = 300kHz; VBW \geq RBW; Sweep = auto; Detector function = peak; Trace = max hold.
6. Measure and record the results in the test report.

3.2.4 Test Setup

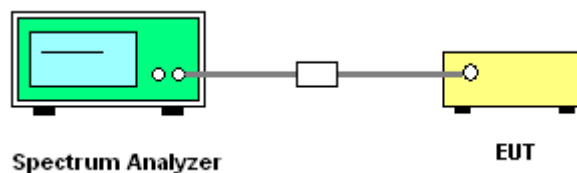



3.2.5 Test Result of Hopping Channel Separation

Test Engineer :	Luffy Lin	Temperature :	21~25°C
		Relative Humidity :	51~54%

Mod.	Data Rate	NTX	CH.	Freq. (MHz)	Hopping Channel Separation Measurement (MHz)	Hopping Channel Separation Measurement Limit (MHz)	Pass/Fail
DH	1Mbps	1	0	2402	0.999	0.6291	Pass
DH	1Mbps	1	39	2441	0.999	0.6310	Pass
DH	1Mbps	1	78	2480	0.999	0.6291	Pass
2DH	2Mbps	1	0	2402	0.999	0.8540	Pass
2DH	2Mbps	1	39	2441	1.007	0.8567	Pass
2DH	2Mbps	1	78	2480	0.999	0.8567	Pass
3DH	3Mbps	1	0	2402	0.994	0.8507	Pass
3DH	3Mbps	1	39	2441	0.986	0.8627	Pass
3DH	3Mbps	1	78	2480	0.968	0.8627	Pass

<1Mbps>

Channel Separation Plot on Channel 00 - 01

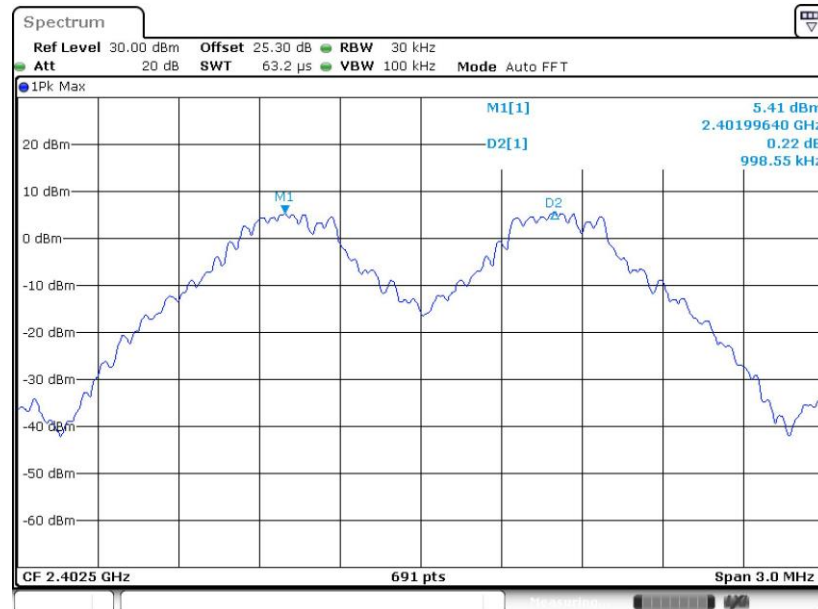



Channel Separation Plot on Channel 39 - 40

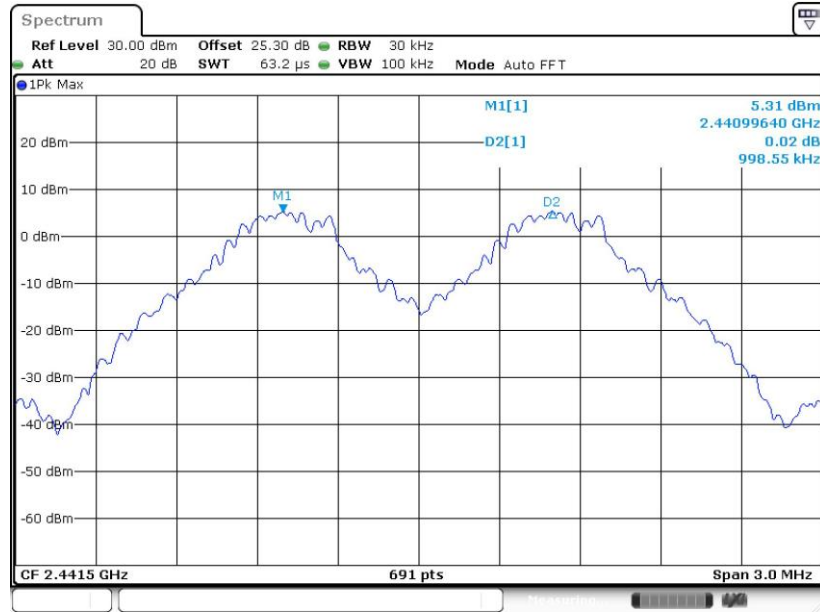

Date: 22.FEB.2020 03:29:57

Channel Separation Plot on Channel 77 - 78

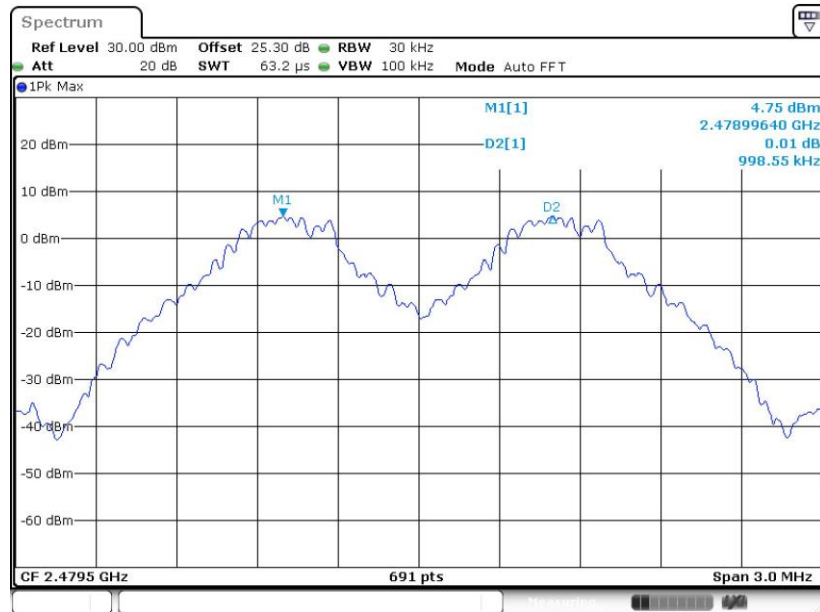

Date: 22.FEB.2020 03:31:23



<2Mbps>

Channel Separation Plot on Channel 00 - 01



Date: 22.FEB.2020 03:34:18

Channel Separation Plot on Channel 39 - 40

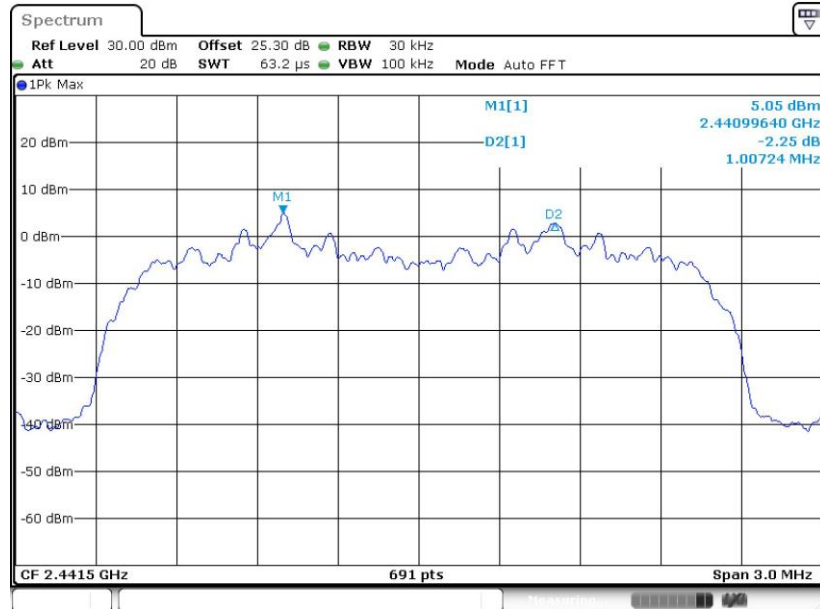

Date: 22.FEB.2020 03:35:42



Channel Separation Plot on Channel 77 - 78

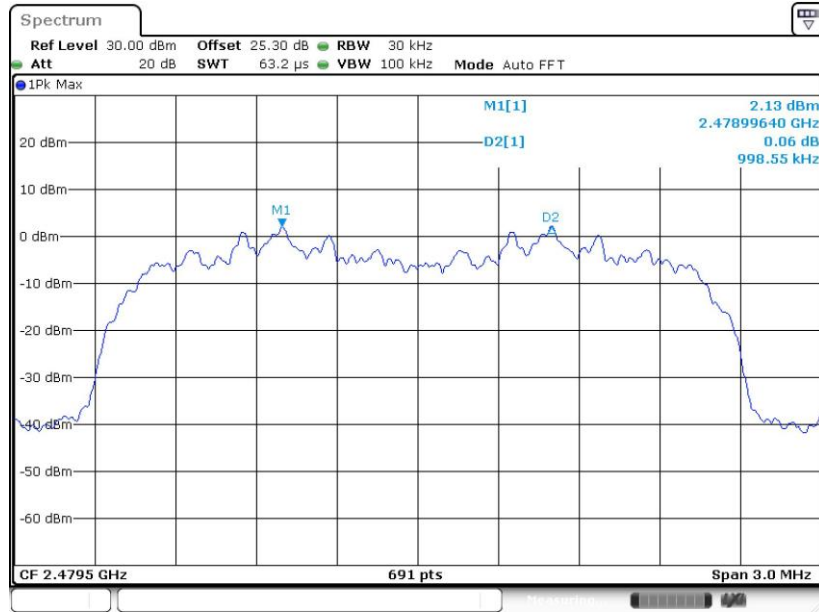

Date: 22.FEB.2020 03:36:37

<3Mbps>

Channel Separation Plot on Channel 00 - 01



Date: 22.FEB.2020 03:38:49



Channel Separation Plot on Channel 39 - 40



Date: 22.FEB.2020 03:40:25

Channel Separation Plot on Channel 77 - 78



Date: 22.FEB.2020 03:41:17

3.3 Dwell Time Measurement

3.3.1 Limit of Dwell Time

The average time of occupancy on any channel shall not be greater than 0.4 seconds within a period of 0.4 seconds multiplied by the number of hopping channels employed.

3.3.2 Measuring Instruments

See list of measuring equipment of this test report.

3.3.3 Test Procedures

1. The testing follows ANSI C63.10-2013 clause 7.8.4.
2. The RF output of EUT was connected to the spectrum analyzer by RF cable and attenuator. The path loss was compensated to the results for each measurement.
3. Set to the maximum power setting and enable the EUT transmit continuously.
4. Enable the EUT hopping function.
5. Use the following spectrum analyzer settings: Span = zero span, centered on a hopping channel; RBW = 1 MHz; VBW \geq RBW; Sweep = as necessary to capture the entire dwell time per hopping channel; Detector function = peak; Trace = max hold.
6. Measure and record the results in the test report.

3.3.4 Test Setup

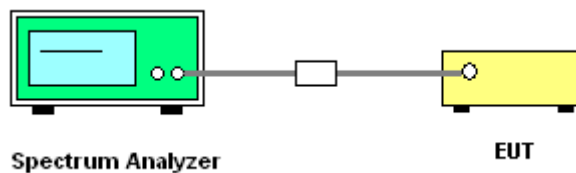



3.3.5 Test Result of Dwell Time

Test Engineer :	Luffy Lin	Temperature :	21~25°C
		Relative Humidity :	51~54%

Mod.	Hopping Channel Number Rate	Hops Over Occupancy Time(hops)	Package Transfer Time (msec)	Dwell Time (sec)	Limits (sec)	Pass/Fail
Nomal	79	106.67	2.90	0.31	0.4	Pass
AFH	20	53.33	2.90	0.15	0.4	Pass

Package Transfer Time Plot

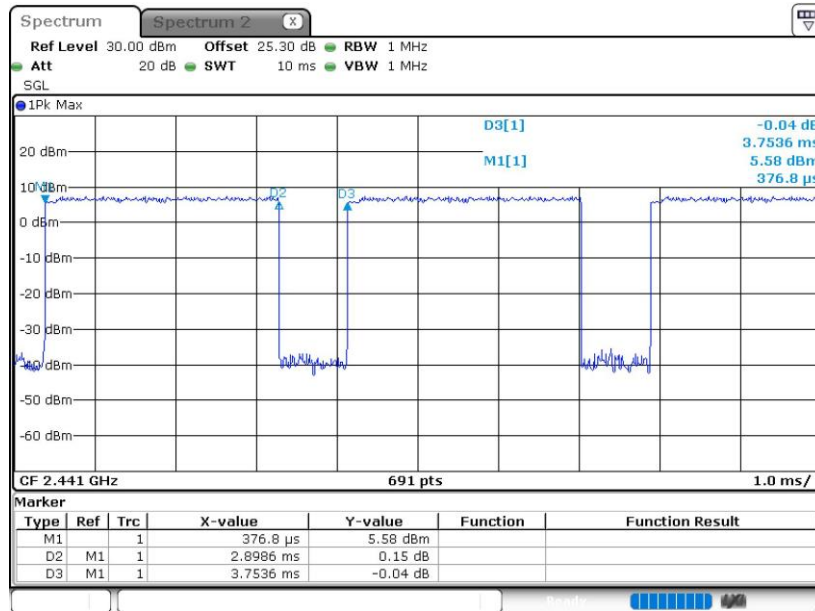

Date: 13.FEB.2020 02:40:17

Remark:

- In normal mode, hopping rate is 1600 hops/s with 6 slots in 79 hopping channels. With channel hopping rate (1600 / 6 / 79) in Occupancy Time Limit (0.4 x 79) (s), Hops Over Occupancy Time comes to (1600 / 6 / 79) x (0.4 x 79) = 106.67 hops.
- In AFH mode, hopping rate is 800 hops/s with 6 slots in 20 hopping channels. With channel hopping rate (800 / 6 / 20) in Occupancy Time Limit (0.4 x 20) (s), Hops Over Occupancy Time comes to (800 / 6 / 20) x (0.4 x 20) = 53.33 hops.
- Dwell Time(s) = Hops Over Occupancy Time (hops) x Package Transfer Time

3.4 20dB and 99% Bandwidth Measurement

3.4.1 Limit of 20dB and 99% Bandwidth

Reporting only

3.4.2 Measuring Instruments

See list of measuring equipment of this test report.

3.4.3 Test Procedures

1. The testing follows ANSI C63.10-2013 clause 6.9.2 and 6.9.3.
2. The RF output of EUT was connected to the spectrum analyzer by RF cable and attenuator. The path loss was compensated to the results for each measurement.
3. Set to the maximum power setting and enable the EUT transmit continuously.
4. Use the following spectrum analyzer settings for 20dB Bandwidth measurement.
Span = approximately 2 to 5 times the 20 dB bandwidth, centered on a hopping channel;
RBW \geq 1% of the 20 dB bandwidth; VBW \geq RBW; Sweep = auto; Detector function = peak;
Trace = max hold.
5. Use the following spectrum analyzer settings for 99 % Bandwidth measurement.
Span = approximately 1.5 to 5 times the 99% bandwidth, centered on a hopping channel;
RBW \geq 1-5% of the 99% bandwidth; VBW \geq 3 * RBW; Sweep = auto; Detector function = peak;
Trace = max hold.
6. Measure and record the results in the test report.

3.4.4 Test Setup

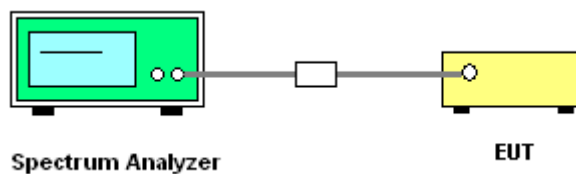



3.4.5 Test Result of 20dB Bandwidth

Test Engineer :	Luffy Lin	Temperature :	21~25°C
		Relative Humidity :	51~54%

Mod.	Data Rate	NTX	CH.	Freq. (MHz)	20db BW (MHz)	Pass/Fail
DH	1Mbps	1	0	2402	0.944	Pass
DH	1Mbps	1	39	2441	0.947	Pass
DH	1Mbps	1	78	2480	0.944	Pass
2DH	2Mbps	1	0	2402	1.281	Pass
2DH	2Mbps	1	39	2441	1.285	Pass
2DH	2Mbps	1	78	2480	1.285	Pass
3DH	3Mbps	1	0	2402	1.276	Pass
3DH	3Mbps	1	39	2441	1.294	Pass
3DH	3Mbps	1	78	2480	1.294	Pass

<1Mbps>

20 dB Bandwidth Plot on Channel 00

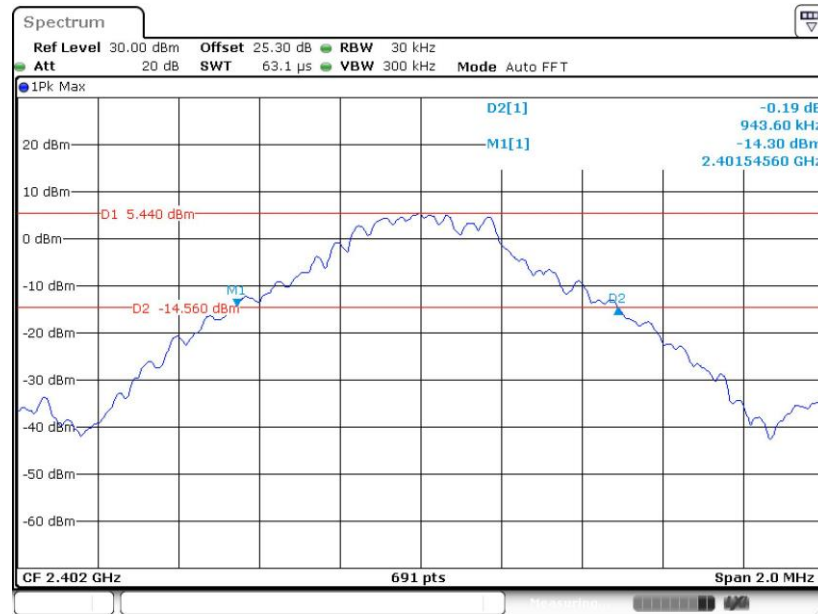

Date: 22.FEB.2020 03:48:01



20 dB Bandwidth Plot on Channel 39

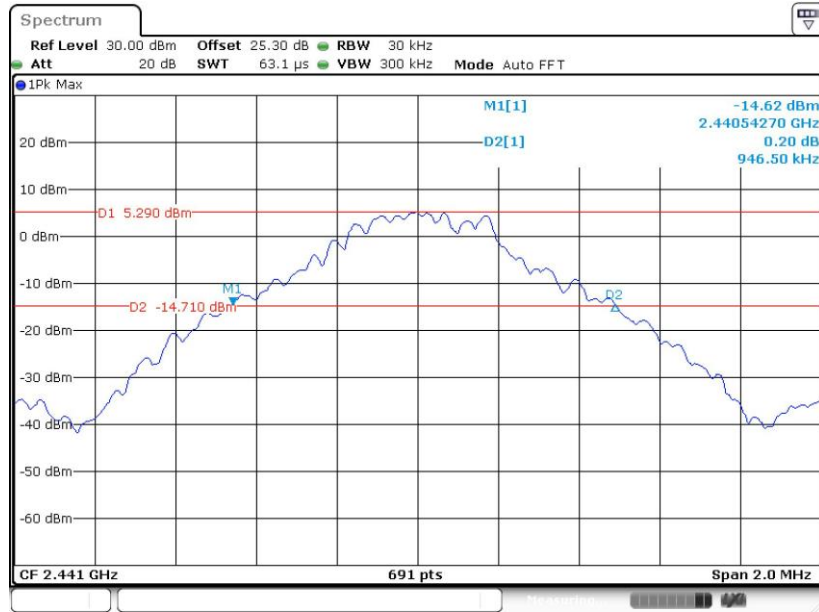

Date: 22.FEB.2020 03:51:08

20 dB Bandwidth Plot on Channel 78

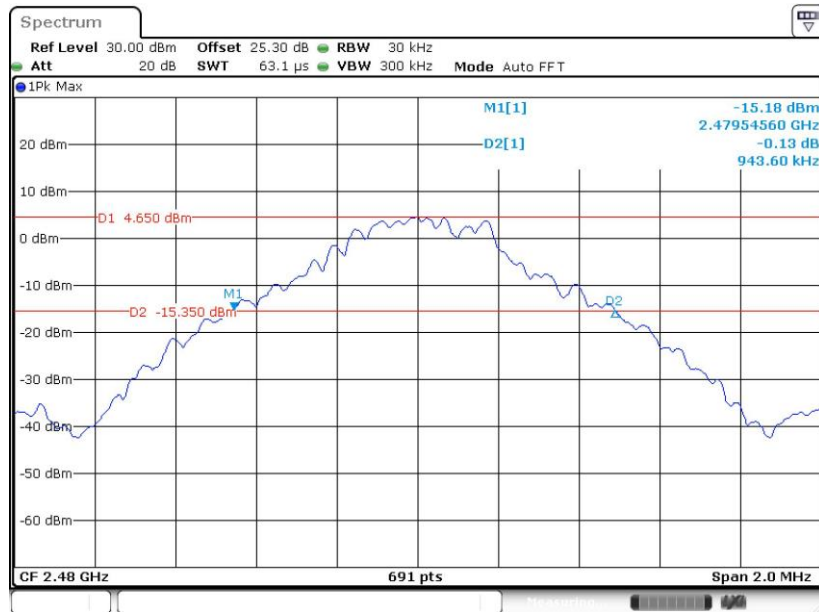

Date: 22.FEB.2020 03:58:46



<2Mbps>

20 dB Bandwidth Plot on Channel 00

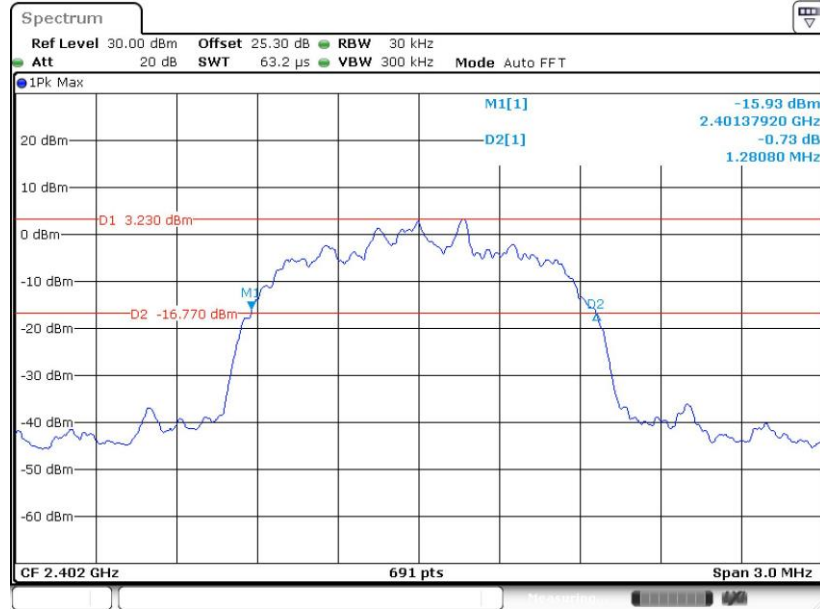

Date: 22.FEB.2020 04:05:08

20 dB Bandwidth Plot on Channel 39

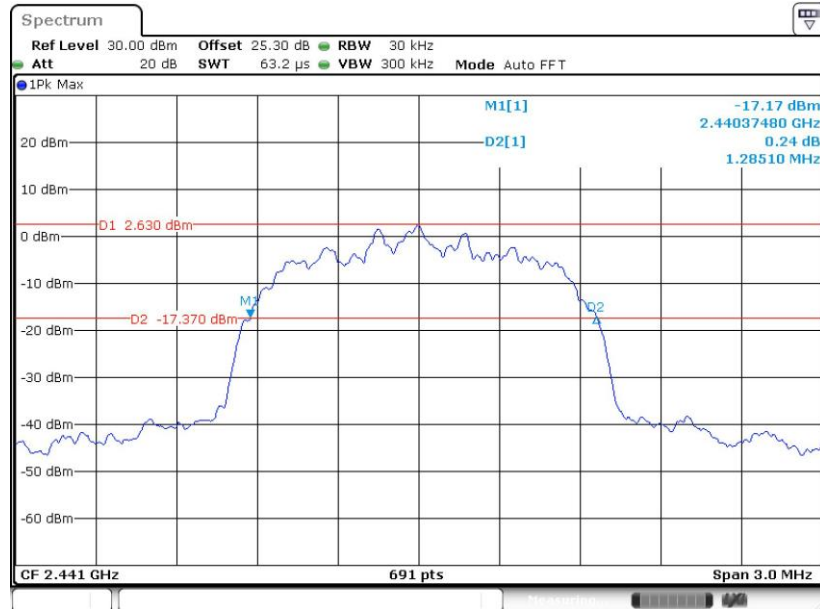

Date: 22.FEB.2020 04:09:58



20 dB Bandwidth Plot on Channel 78

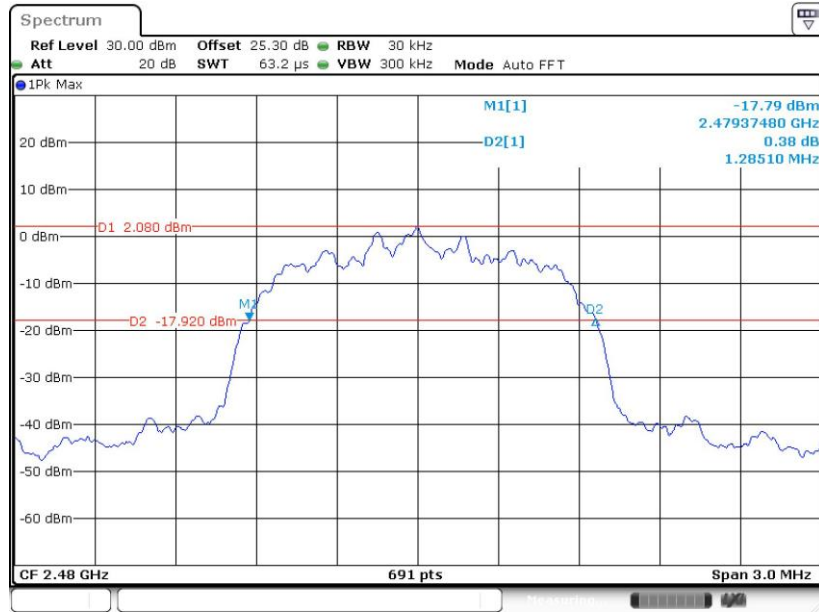

Date: 22.FEB.2020 04:14:12

<3Mbps>

20 dB Bandwidth Plot on Channel 00

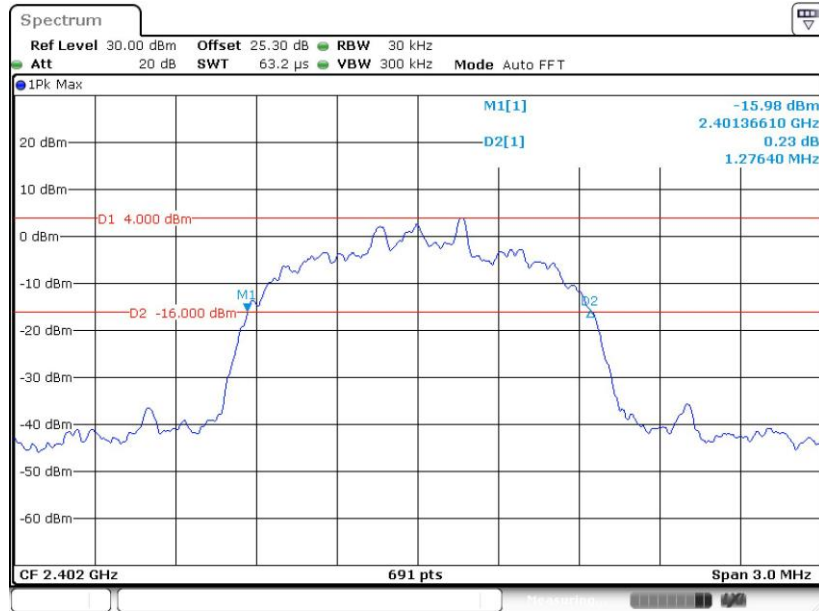

Date: 22.FEB.2020 04:19:40



20 dB Bandwidth Plot on Channel 39

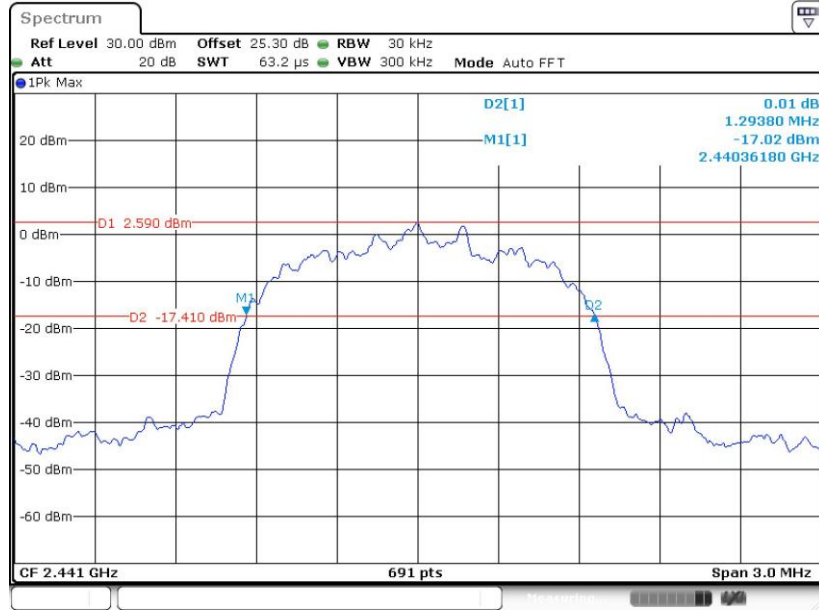

Date: 22.FEB.2020 04:22:56

20 dB Bandwidth Plot on Channel 78

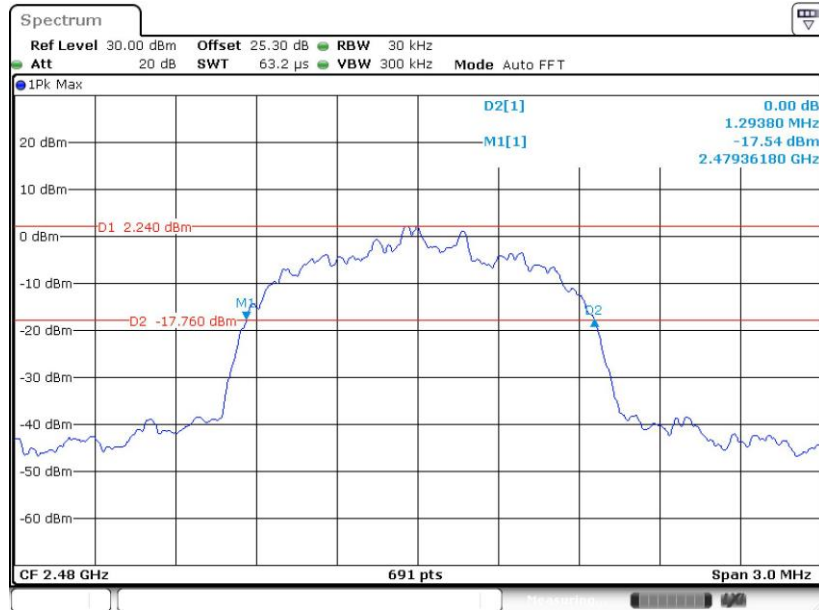

Date: 22.FEB.2020 04:28:32



3.4.6 Test Result of 99% Occupied Bandwidth

Test Engineer :	Luffy Lin	Temperature :	21~25°C
		Relative Humidity :	51~54%

Mod.	Data Rate	N _{TX}	CH.	Freq. (MHz)	99% Bandwidth (MHz)	Pass/Fail
DH	1Mbps	1	0	2402	0.854	Pass
DH	1Mbps	1	39	2441	0.854	Pass
DH	1Mbps	1	78	2480	0.854	Pass
2DH	2Mbps	1	0	2402	1.164	Pass
2DH	2Mbps	1	39	2441	1.169	Pass
2DH	2Mbps	1	78	2480	1.169	Pass
3DH	3Mbps	1	0	2402	1.161	Pass
3DH	3Mbps	1	39	2441	1.172	Pass
3DH	3Mbps	1	78	2480	1.172	Pass

<1Mbps>

99% Occupied Bandwidth Plot on Channel 00

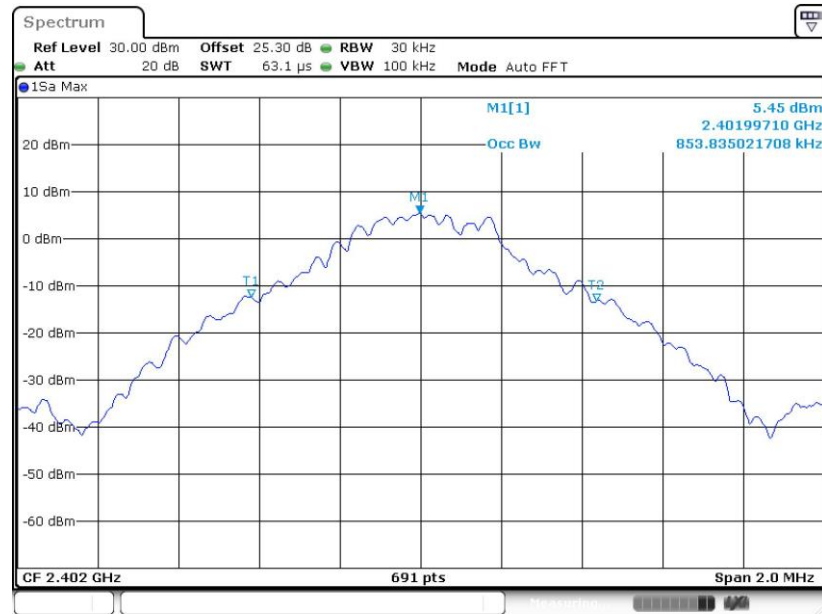



99% Occupied Bandwidth Plot on Channel 39

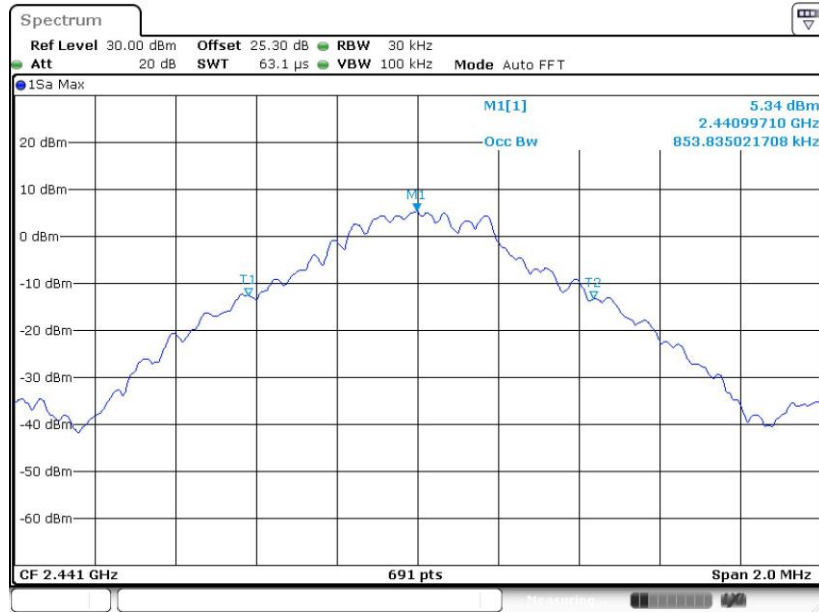

Date: 22.FEB.2020 03:49:47

99% Occupied Bandwidth Plot on Channel 78

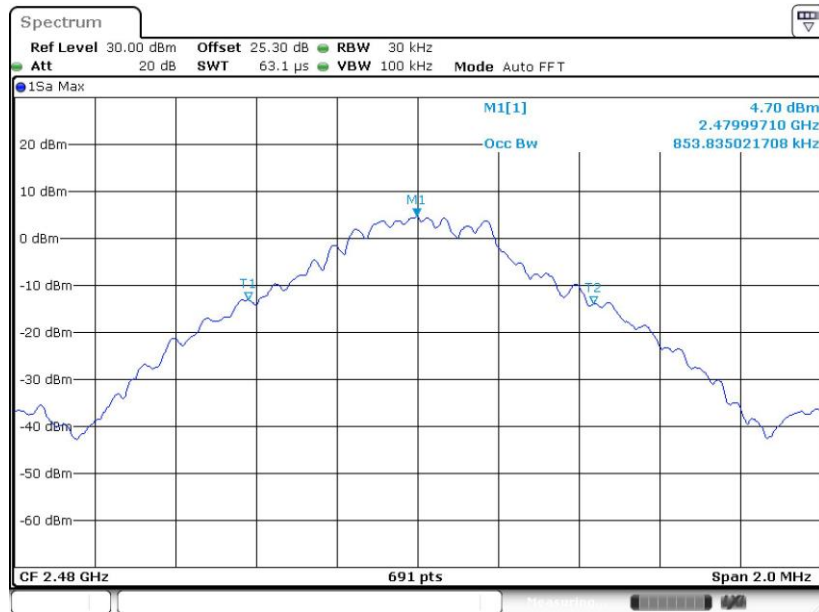

Date: 22.FEB.2020 03:57:04



<2Mbps>

99% Occupied Bandwidth Plot on Channel 00

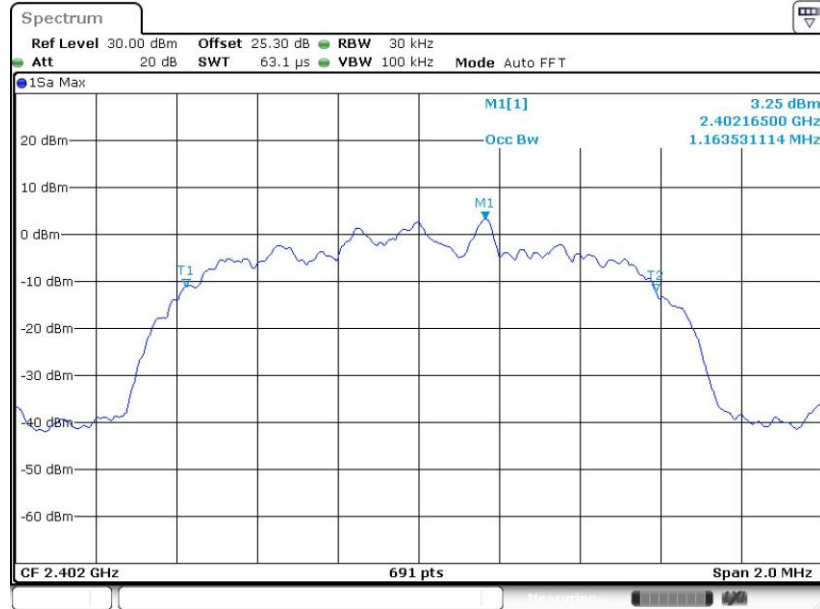

99% Occupied Bandwidth Plot on Channel 39

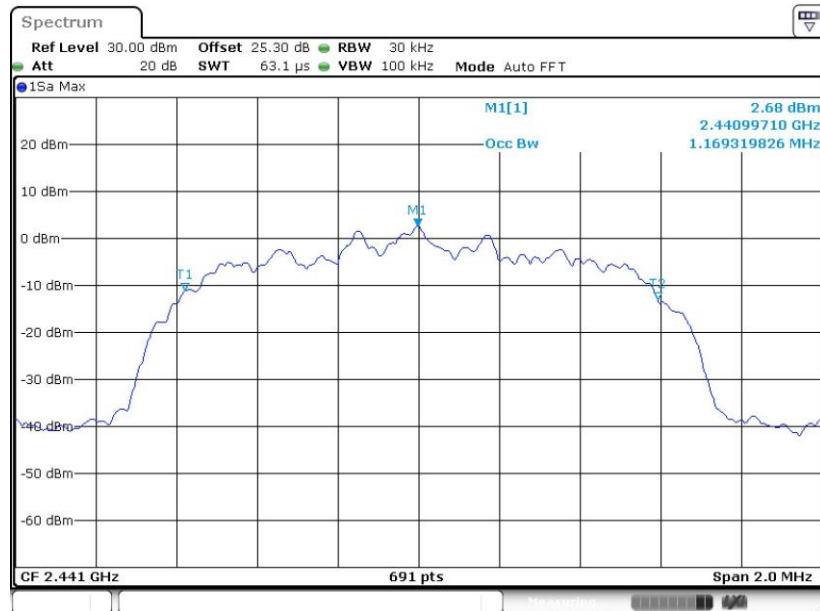



99% Occupied Bandwidth Plot on Channel 78



Date: 22.FEB.2020 04:12:04

<3Mbps>

99% Occupied Bandwidth Plot on Channel 00



Date: 22.FEB.2020 04:18:05



99% Occupied Bandwidth Plot on Channel 39



Date: 22.FEB.2020 04:21:46

99% Occupied Bandwidth Plot on Channel 78

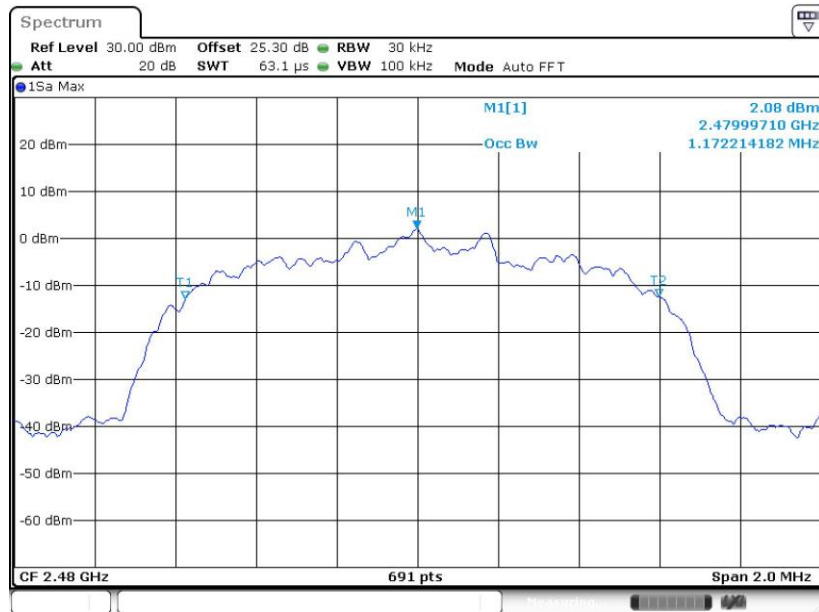

Date: 22.FEB.2020 04:26:51

Note: The occupied channel bandwidth is maintained within the band of operation for all of the modulations.

3.5 Output Power Measurement

3.5.1 Limit of Output Power

The maximum peak conducted output power of the intentional radiator shall not exceed the following:
For frequency hopping systems operating in the 2400-2483.5 MHz band employing at least 75 non-overlapping hopping channels, and all frequency hopping systems in the 5725-5850 MHz band: 1 watt. For all other frequency hopping systems in the 2400-2483.5 MHz band 0.125 watts.

3.5.2 Measuring Instruments

See list of measuring equipment of this test report.

3.5.3 Test Procedures

1. The testing follows ANSI C63.10-2013 clause 7.8.5.
2. The RF output of EUT was connected to the power meter by RF cable and attenuator. The path loss was compensated to the results for each measurement.
3. Set to the maximum power setting and enable the EUT transmit continuously.
4. Measure the conducted output power with cable loss and record the results in the test report.
5. Measure and record the results in the test report.

3.5.4 Test Setup

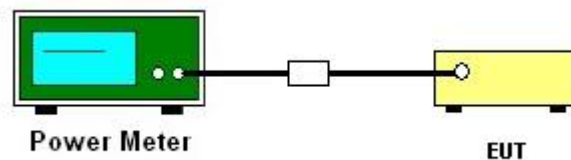



3.5.5 Test Result of Peak Output Power

Test Engineer :	Luffy Lin	Temperature :	21~25°C
		Relative Humidity :	51~54%

< Class I >

DH	CH.	NTX	Peak Power (dBm)	Power Limit (dBm)	Test Result
DH1	0	1	8.91	30.00	Pass
	39	1	8.88	30.00	Pass
	78	1	8.35	30.00	Pass

2DH	CH.	NTX	Peak Power (dBm)	Power Limit (dBm)	Test Result
2DH1	0	1	7.93	20.97	Pass
	39	1	8.01	20.97	Pass
	78	1	7.55	20.97	Pass

3DH	CH.	NTX	Peak Power (dBm)	Power Limit (dBm)	Test Result
3DH1	0	1	8.38	20.97	Pass
	39	1	8.39	20.97	Pass
	78	1	8.11	20.97	Pass

< Class II >

DH	CH.	NTX	Peak Power (dBm)	Power Limit (dBm)	Test Result
DH1	0	1	3.71	20.97	Pass
	39	1	3.84	20.97	Pass
	78	1	3.68	20.97	Pass

2DH	CH.	NTX	Peak Power (dBm)	Power Limit (dBm)	Test Result
2DH1	0	1	2.72	20.97	Pass
	39	1	2.97	20.97	Pass
	78	1	2.84	20.97	Pass

3DH	CH.	NTX	Peak Power (dBm)	Power Limit (dBm)	Test Result
3DH1	0	1	2.77	20.97	Pass
	39	1	3.18	20.97	Pass
	78	1	3.20	20.97	Pass



3.5.6 Test Result of Average Output Power (Reporting Only)

Test Engineer :	Luffy Lin	Temperature :	21~25°C
		Relative Humidity :	51~54%

<Class I>

DH	CH.	N _{TX}	Average Power (dBm)	Duty Factor (dB)
DH1	0	1	8.47	1.14
	39	1	8.26	1.14
	78	1	7.77	1.14

2DH	CH.	N _{TX}	Average Power (dBm)	Duty Factor (dB)
2DH1	0	1	5.28	1.14
	39	1	5.23	1.14
	78	1	4.72	1.14

3DH	CH.	N _{TX}	Average Power (dBm)	Duty Factor (dB)
3DH1	0	1	5.34	1.12
	39	1	5.23	1.12
	78	1	4.71	1.12

<Class II>

DH	CH.	N _{TX}	Average Power (dBm)	Duty Factor (dB)
DH1	0	1	1.97	1.14
	39	1	2.21	1.14
	78	1	2.02	1.14

2DH	CH.	N _{TX}	Average Power (dBm)	Duty Factor (dB)
2DH1	0	1	-1.51	1.14
	39	1	-1.16	1.14
	78	1	-1.27	1.14

3DH	CH.	N _{TX}	Average Power (dBm)	Duty Factor (dB)
3DH1	0	1	-1.57	1.14
	39	1	-1.16	1.14
	78	1	-1.26	1.14

3.6 Conducted Band Edges Measurement

3.6.1 Limit of Band Edges

In any 100 kHz bandwidth outside the intentional radiation frequency band, the radio frequency power shall be at least 20 dB below the highest level of the radiated power. In addition, radiated emissions which fall in the restricted bands must also comply with the radiated emission limits.

3.6.2 Measuring Instruments

See list of measuring equipment of this test report.

3.6.3 Test Procedures

1. The testing follows ANSI C63.10-2013 clause 7.8.6.
2. Set to the maximum power setting and enable the EUT transmit continuously.
3. Set RBW = 100kHz, VBW = 300kHz. Band edge emissions must be at least 20 dB down from the highest emission level within the authorized band as measured with a 100kHz RBW. The attenuation shall be 30 dB instead of 20 dB when RMS conducted output power procedure is used.
4. Enable hopping function of the EUT and then repeat step 2. and 3.
5. Measure and record the results in the test report.

3.6.4 Test Setup





3.6.5 Test Result of Conducted Band Edges

Test Engineer :	Luffy Lin	Temperature :	21~25°C
		Relative Humidity :	51~54%

<1Mbps>

Low Band Edge Plot on Channel 00

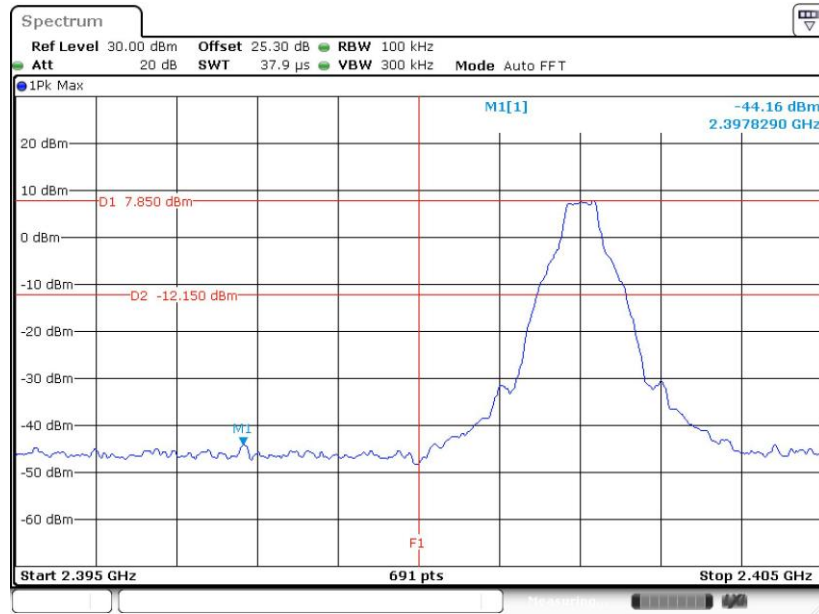

Date: 22.FEB.2020 03:51:47

High Band Edge Plot on Channel 78

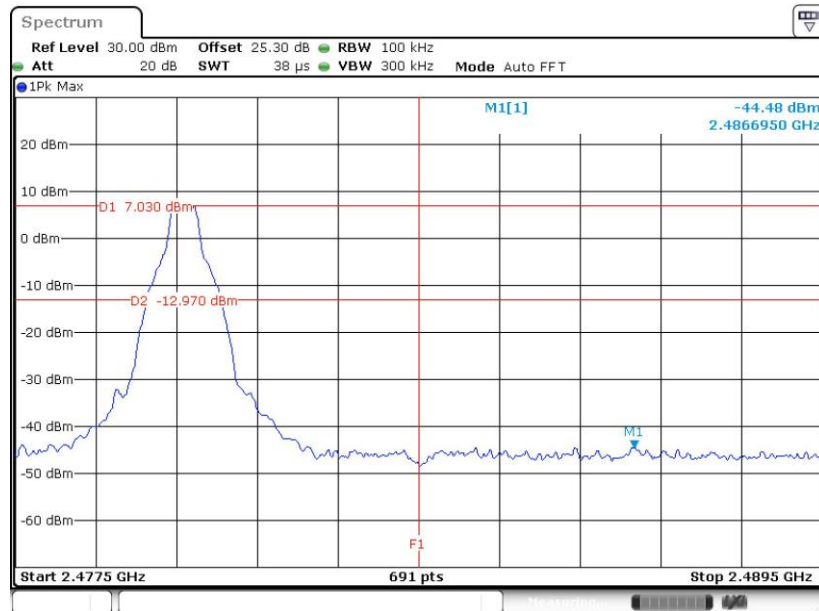

Date: 22.FEB.2020 03:57:44



<2Mbps>

Low Band Edge Plot on Channel 00

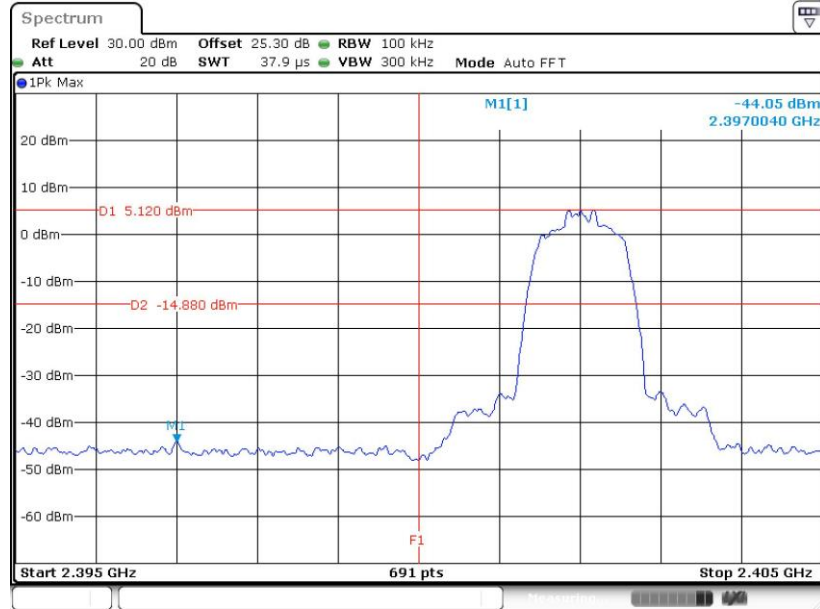

Date: 22.FEB.2020 04:03:48

High Band Edge Plot on Channel 78

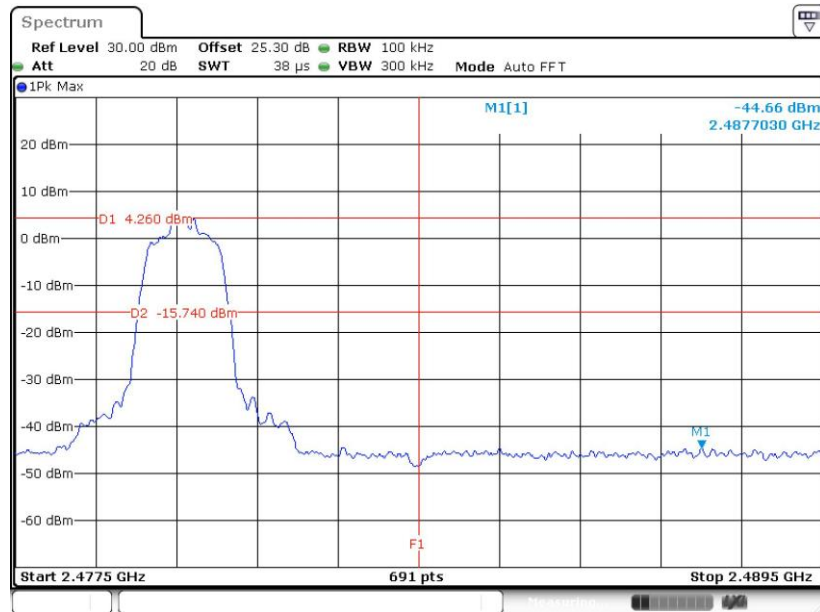

Date: 22.FEB.2020 04:12:28



<3Mbps>

Low Band Edge Plot on Channel 00

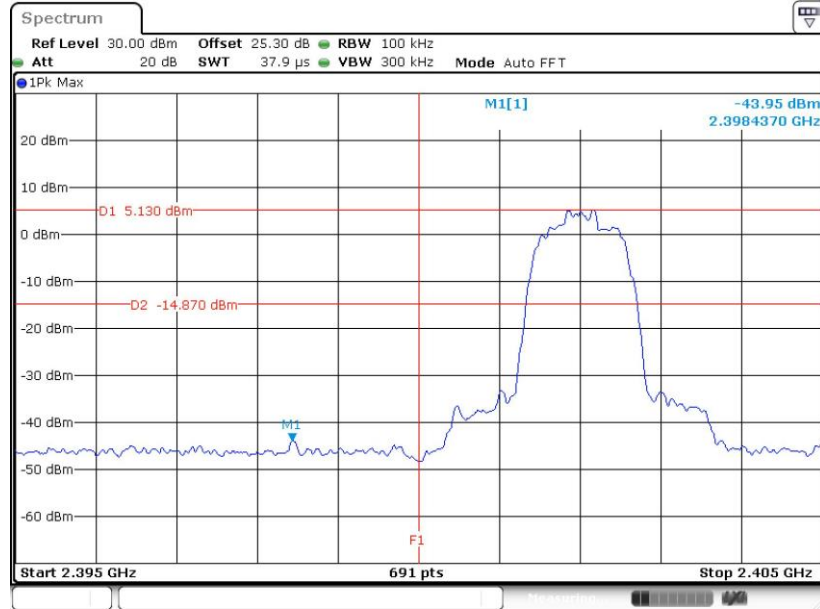

Date: 22.FEB.2020 04:18:29

High Band Edge Plot on Channel 78

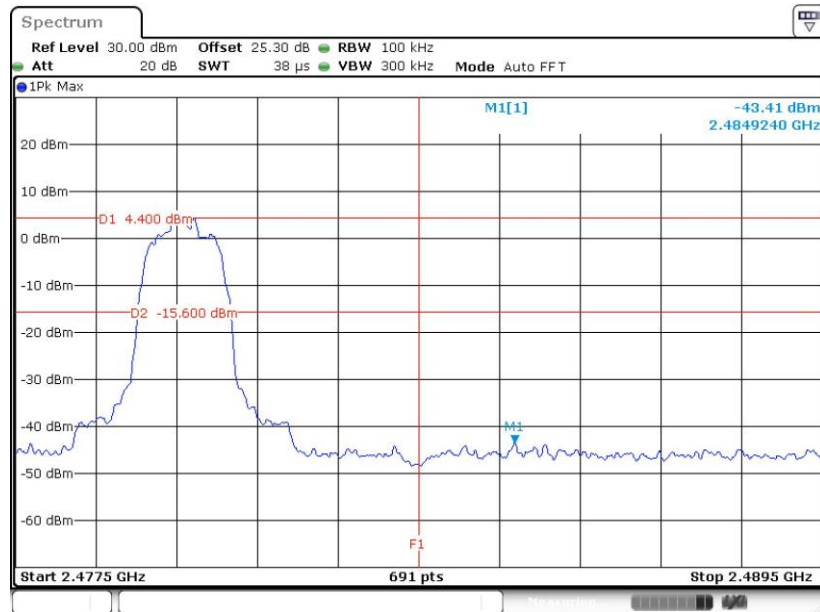

Date: 22.FEB.2020 04:27:14



3.6.6 Test Result of Conducted Hopping Mode Band Edges

Test Engineer :	Luffy Lin	Temperature :	21~25°C
		Relative Humidity :	51~54%

<1Mbps>

Hopping Mode Low Band Edge Plot

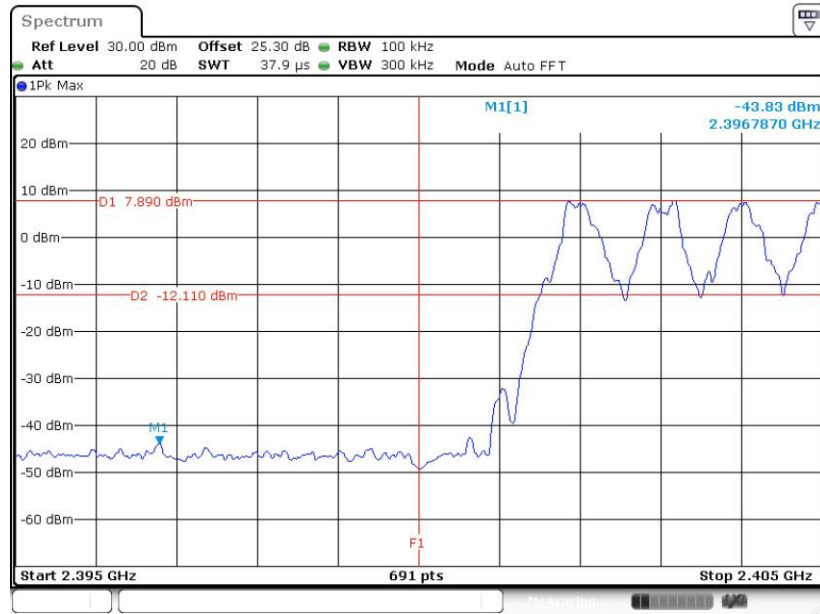

Date: 22.FEB.2020 03:12:23

Hopping Mode High Band Edge Plot

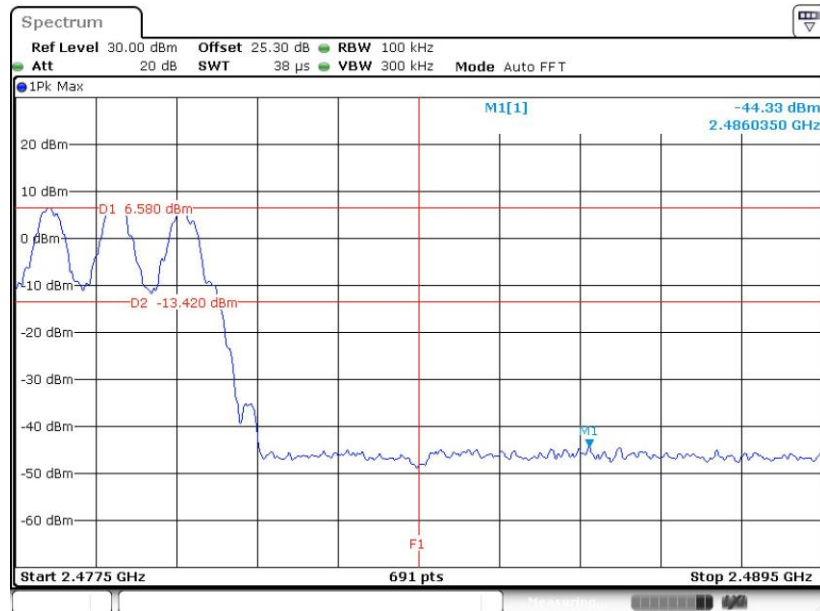

Date: 22.FEB.2020 03:12:42



<2Mbps>

Hopping Mode Low Band Edge Plot

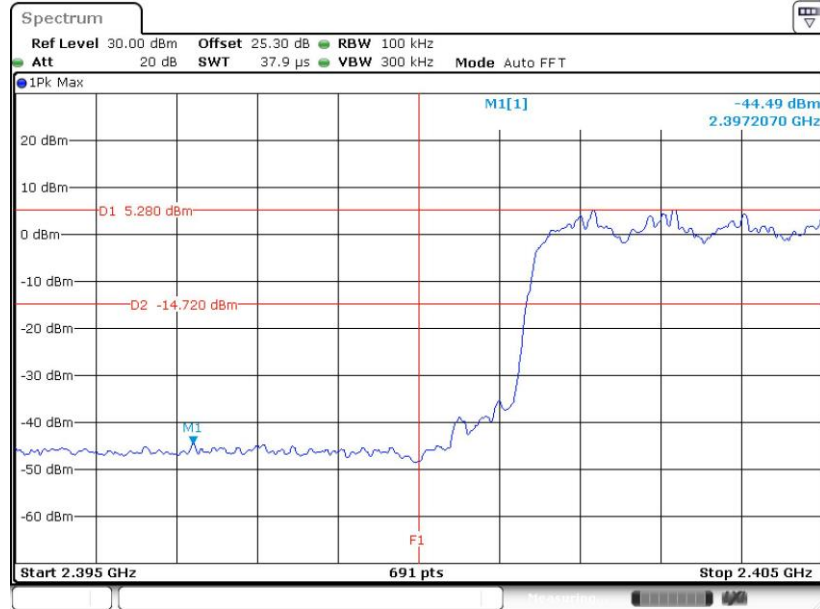

Date: 22.FEB.2020 03:17:08

Hopping Mode High Band Edge Plot

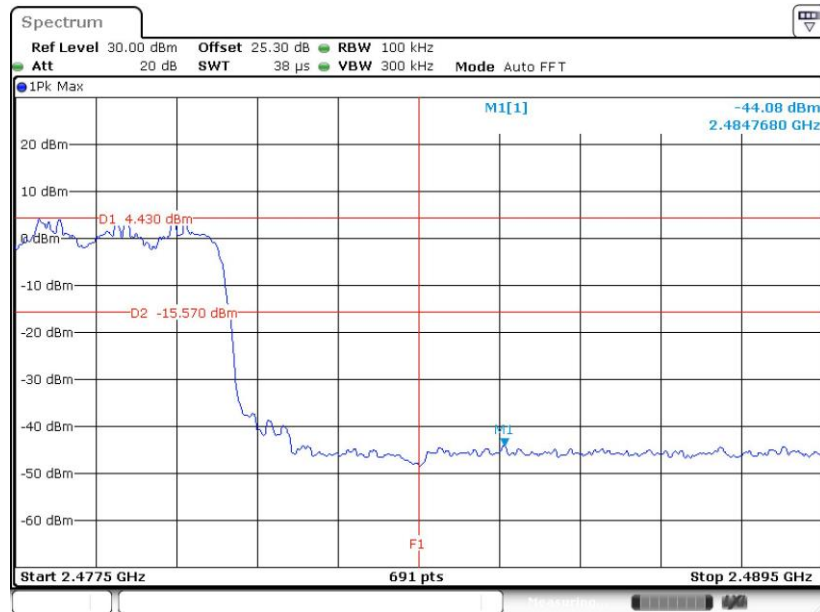

Date: 22.FEB.2020 03:17:47



<3Mbps>

Hopping Mode Low Band Edge Plot

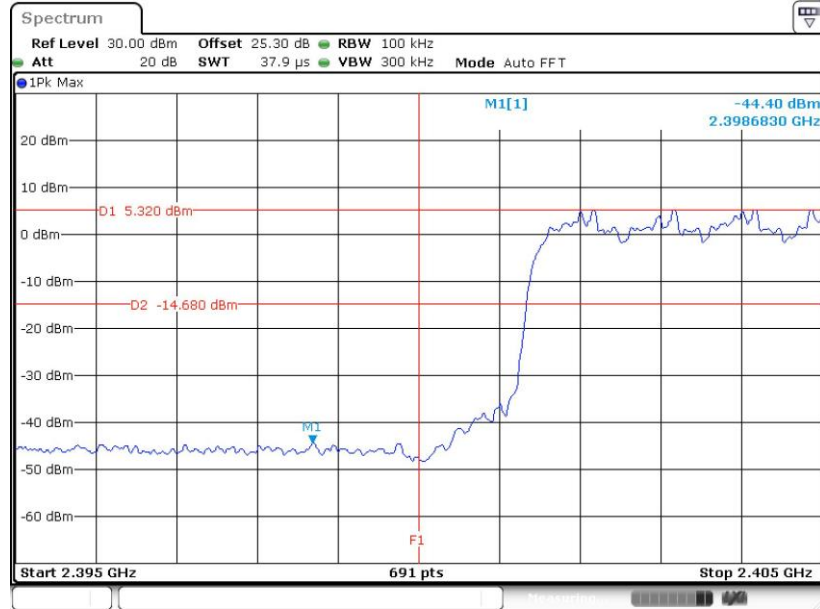

Date: 22.FEB.2020 03:18:32

Hopping Mode High Band Edge Plot

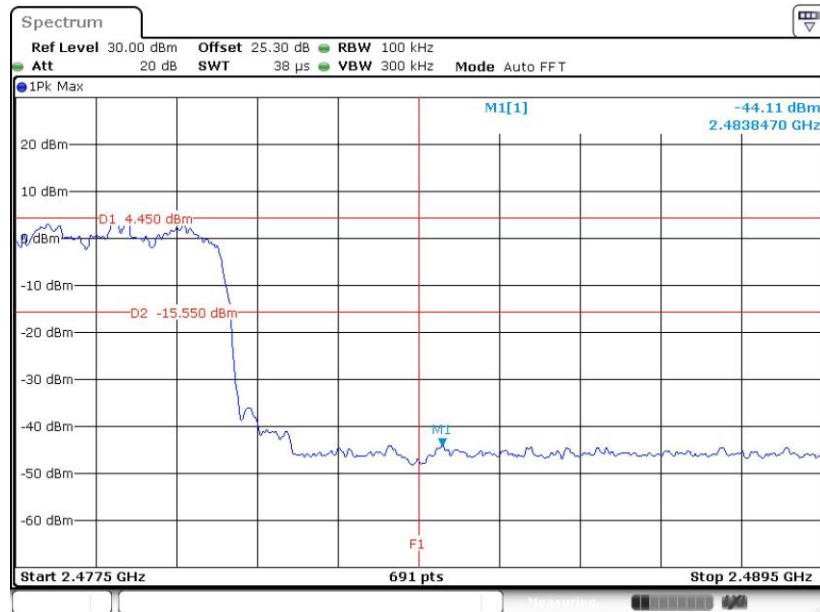

Date: 22.FEB.2020 03:19:10

3.7 Conducted Spurious Emission Measurement

3.7.1 Limit of Spurious Emission Measurement

In any 100 kHz bandwidth outside the intentional radiation frequency band, the radio frequency power shall be at least 20 dB below the highest level of the radiated power. In addition, radiated emissions which fall in the restricted bands must also comply with the radiated emission limits.

3.7.2 Measuring Instruments

See list of measuring equipment of this test report.

3.7.3 Test Procedure

1. The testing follows ANSI C63.10-2013 clause 7.8.8.
2. The RF output of EUT was connected to the spectrum analyzer by RF cable and attenuator. The path loss was compensated to the results for each measurement.
3. Set to the maximum power setting and enable the EUT transmit continuously.
4. Set RBW = 100 kHz, VBW = 300kHz, scan up through 10th harmonic. All harmonics / spurs must be at least 20 dB down from the highest emission level within the authorized band as measured with a 100 kHz RBW.
5. Measure and record the results in the test report.
6. The RF fundamental frequency should be excluded against the limit line in the operating frequency band.

3.7.4 Test Setup

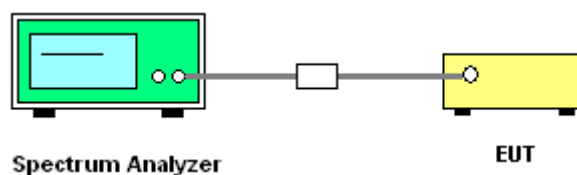



3.7.5 Test Result of Conducted Spurious Emission

Test Engineer :	Luffy Lin	Temperature :	21~25°C
		Relative Humidity :	51~54%

<1Mbps>

CSE Plot on Ch 00 between 30MHz ~ 3 GHz

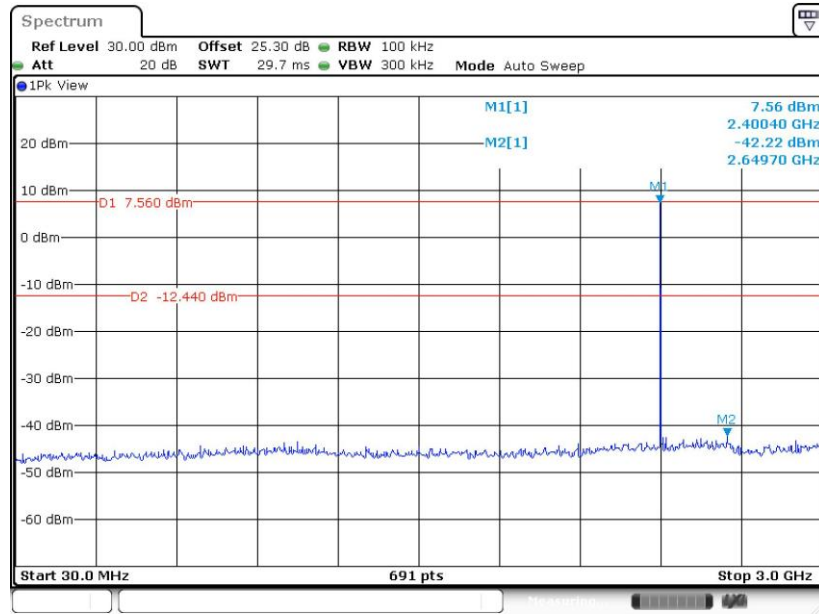

Date: 22.FEB.2020 03:44:59

1Mbps CSE Plot on Ch 00 between 2 GHz ~ 25 GHz

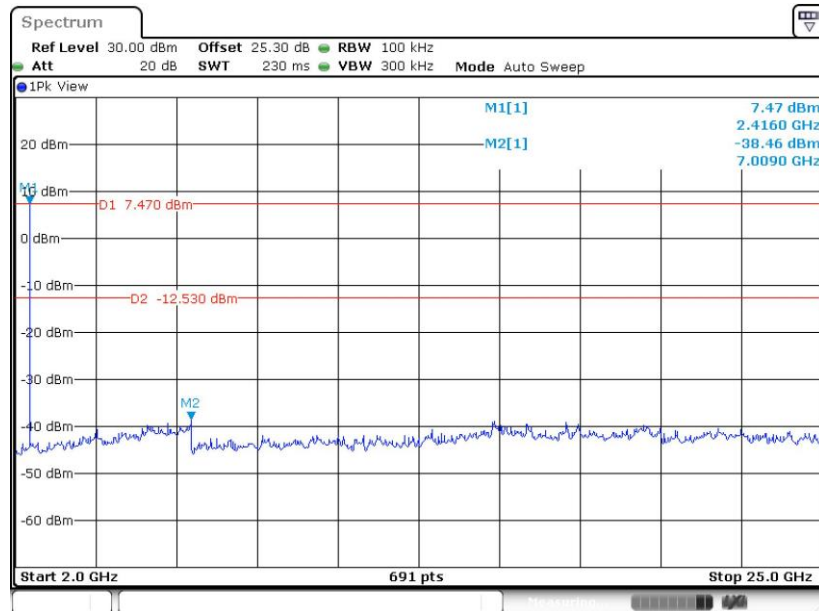

Date: 22.FEB.2020 03:45:28



CSE Plot on Ch 39 between 30MHz ~ 3 GHz

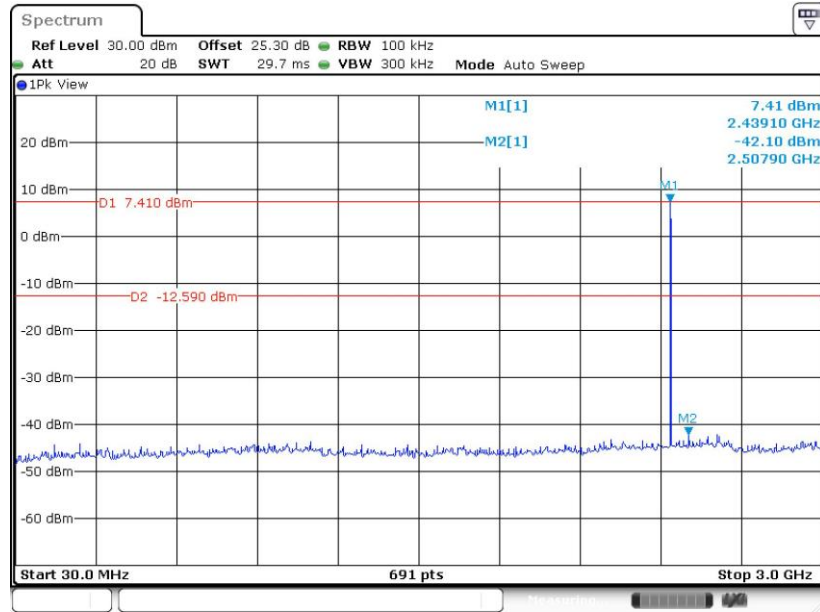

Date: 22.FEB.2020 03:48:42

CSE Plot on Ch 39 between 2 GHz ~ 25 GHz

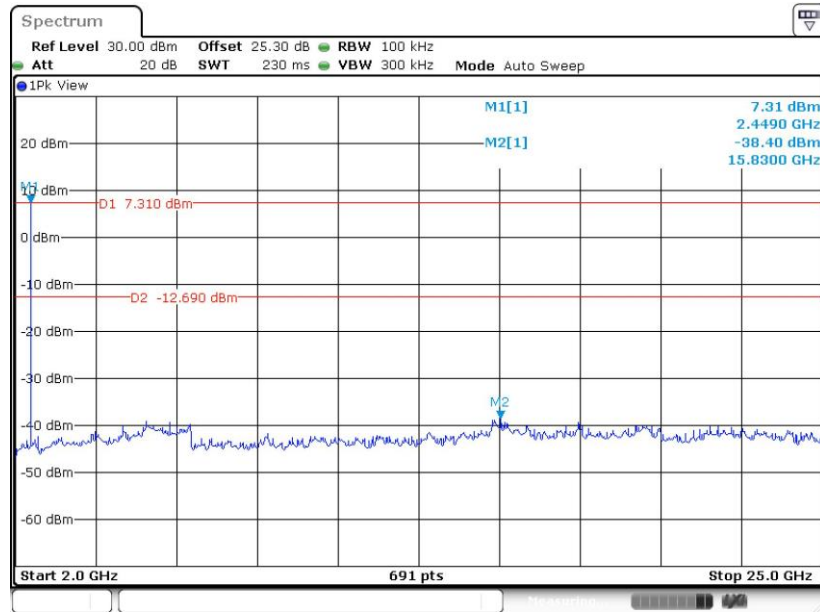

Date: 22.FEB.2020 03:49:11



CSE Plot on Ch 78 between 30MHz ~ 3 GHz

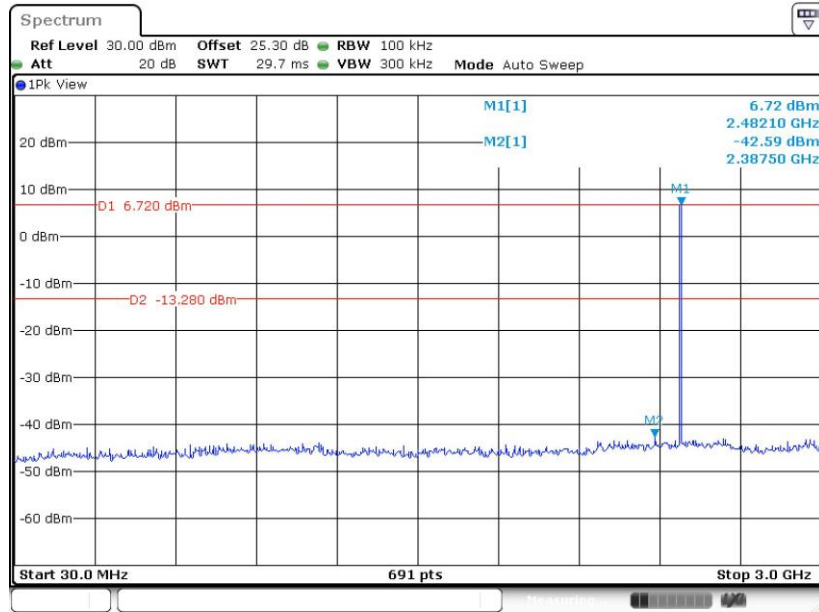

Date: 22.FEB.2020 03:55:55

CSE Plot on Ch 78 between 2 GHz ~ 25 GHz

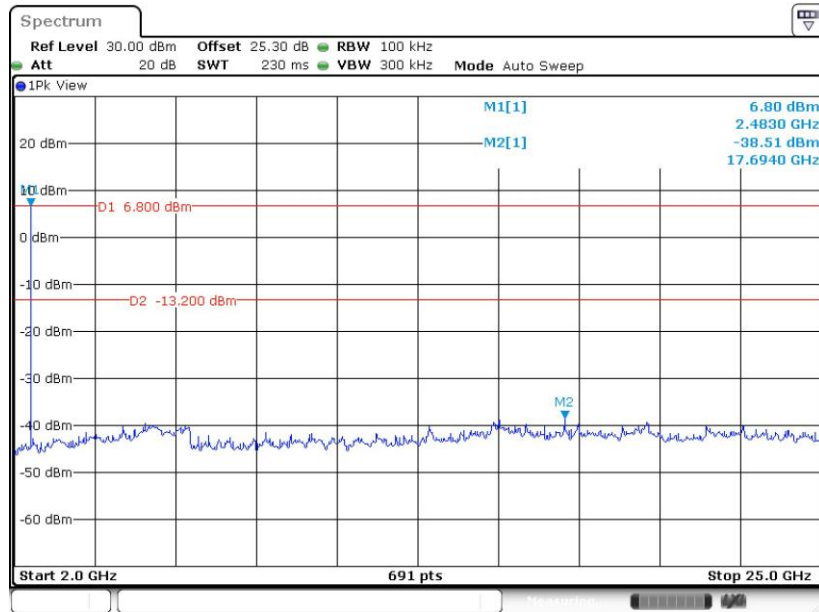

Date: 22.FEB.2020 03:56:26



<2Mbps>

CSE Plot on Ch 00 between 30MHz ~ 3 GHz

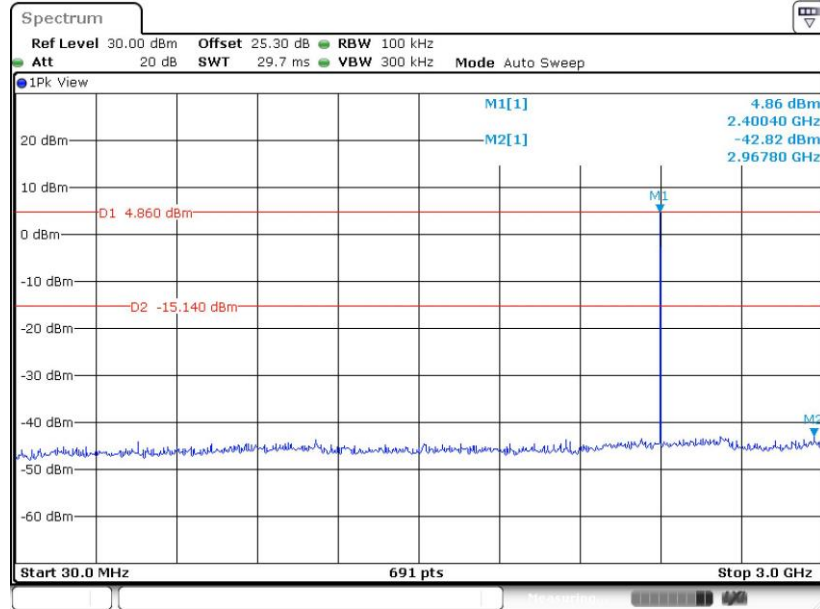

Date: 22.FEB.2020 04:01:58

CSE Plot on Ch 00 between 2 GHz ~ 25 GHz

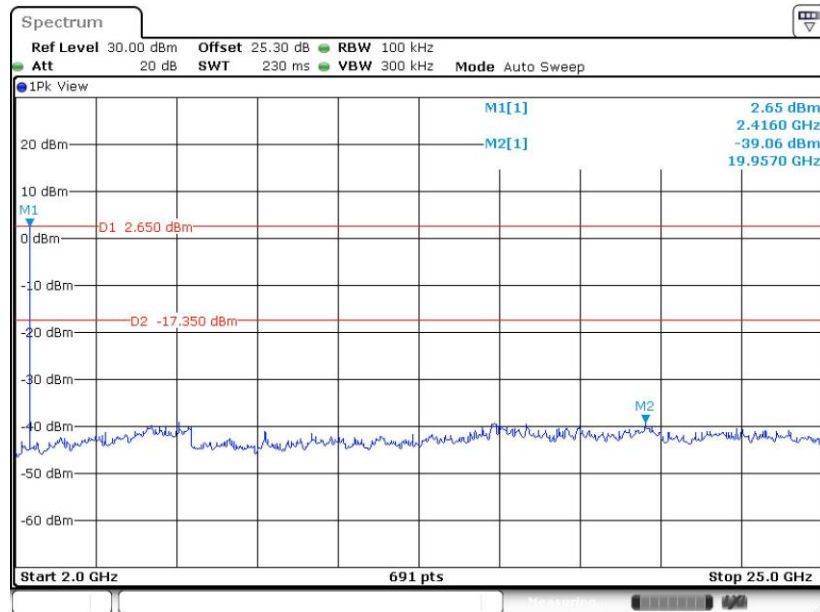

Date: 22.FEB.2020 04:02:27



CSE Plot on Ch 39 between 30MHz ~ 3 GHz

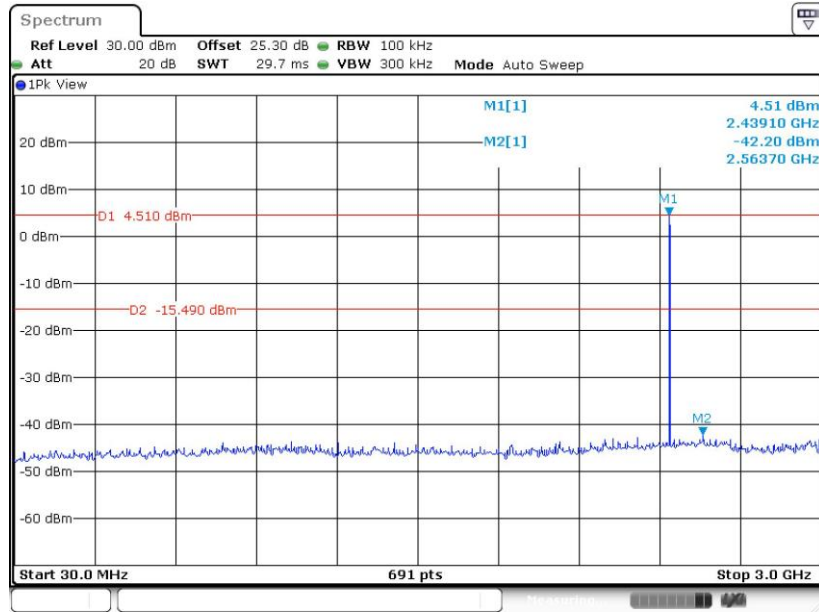

Date: 22.FEB.2020 04:07:16

CSE Plot on Ch 39 between 2 GHz ~ 25 GHz

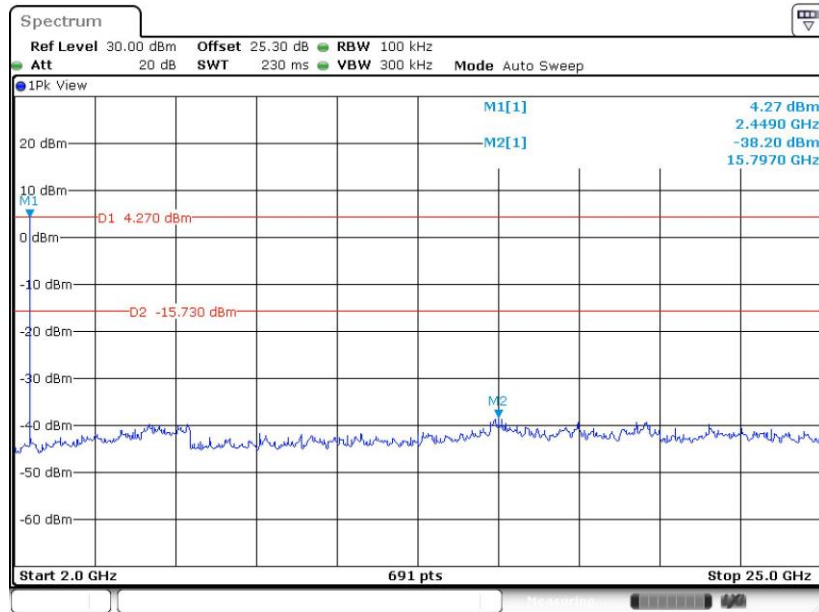

Date: 22.FEB.2020 04:07:45



CSE Plot on Ch 78 between 30MHz ~ 3 GHz

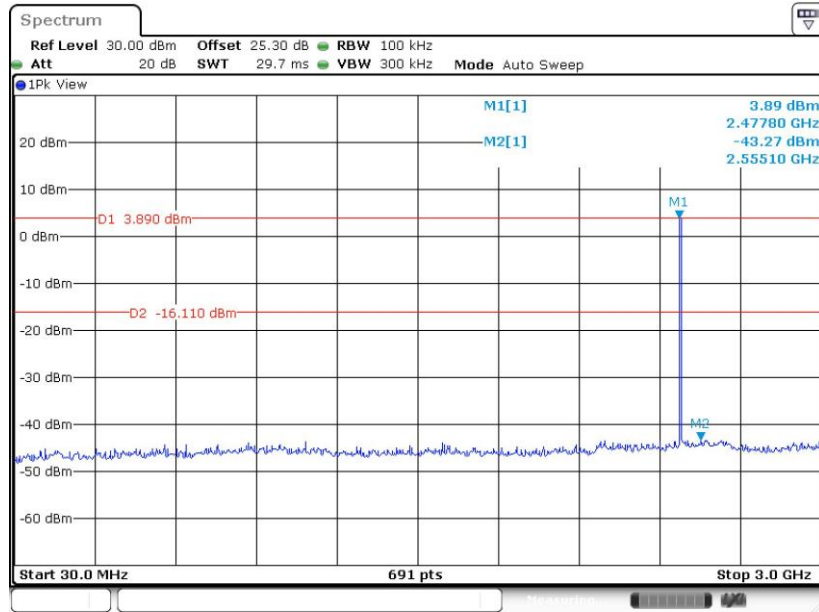

Date: 22.FEB.2020 04:10:53

CSE Plot on Ch 78 between 2 GHz ~ 25 GHz

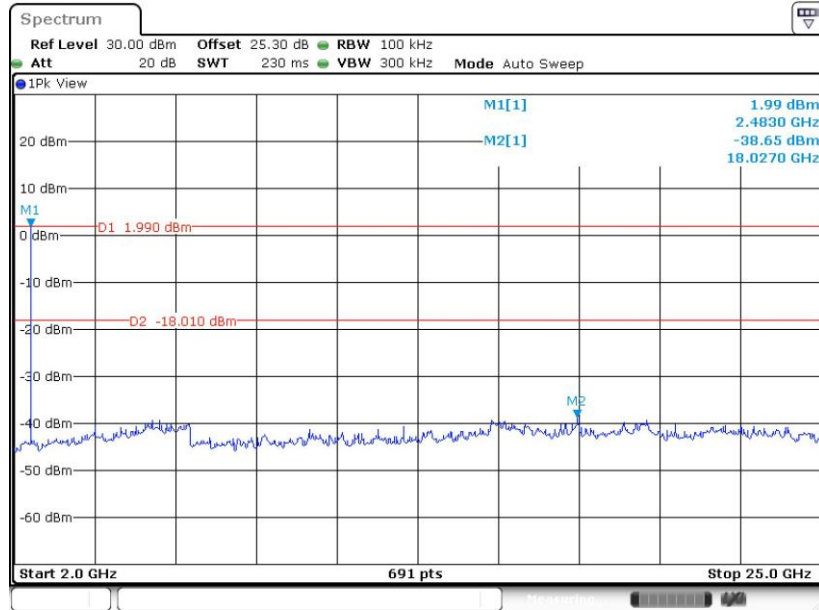

Date: 22.FEB.2020 04:11:23



<3Mbps>

CSE Plot on Ch 00 between 30MHz ~ 3 GHz

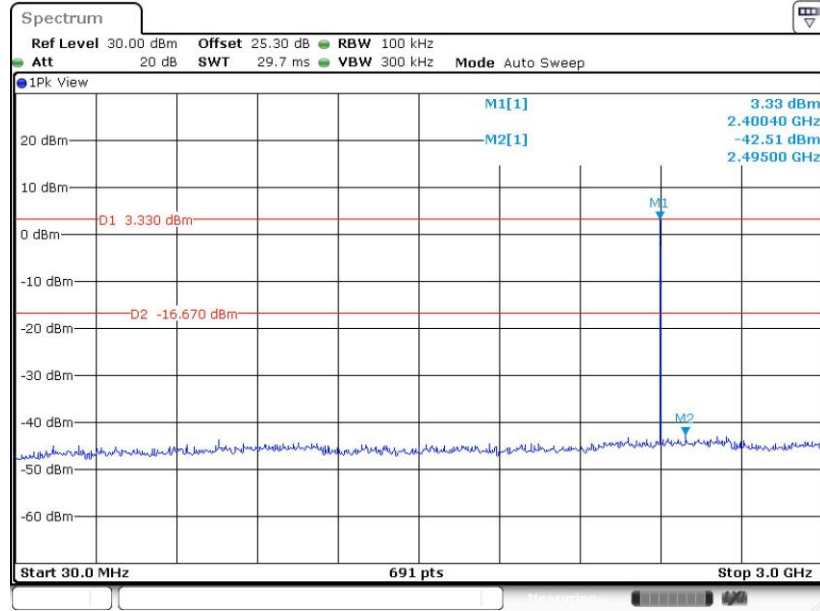

Date: 22.FEB.2020 04:17:03

CSE Plot on Ch 00 between 2 GHz ~ 25 GHz

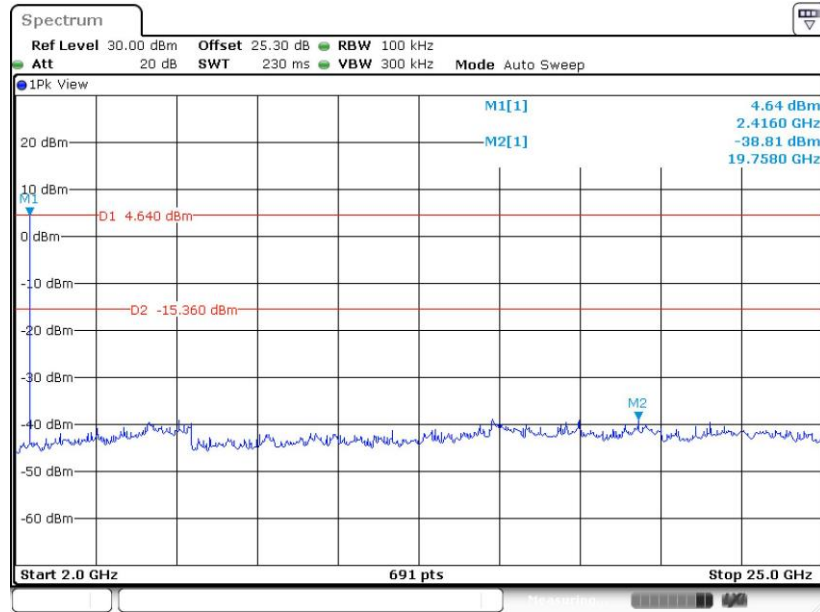

Date: 22.FEB.2020 04:17:32



CSE Plot on Ch 39 between 30MHz ~ 3 GHz

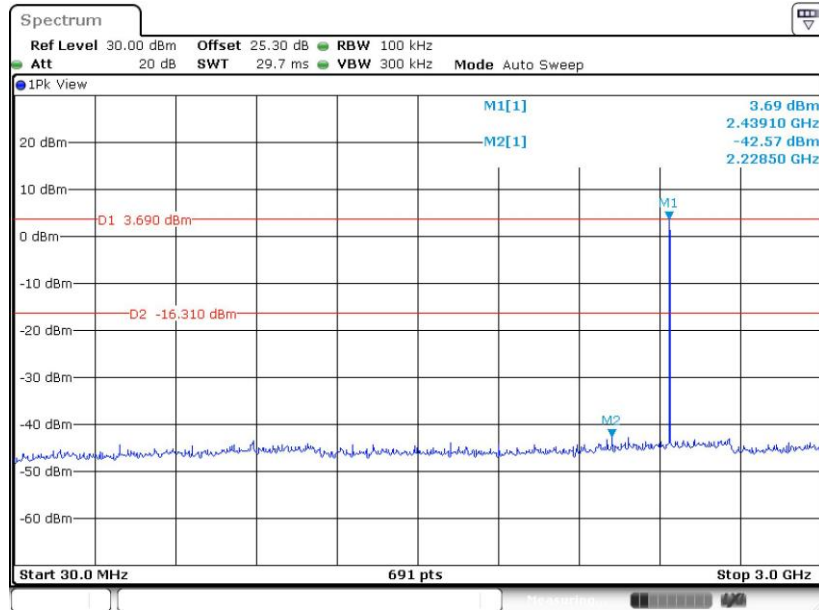

Date: 22.FEB.2020 04:20:38

CSE Plot on Ch 39 between 2 GHz ~ 25 GHz

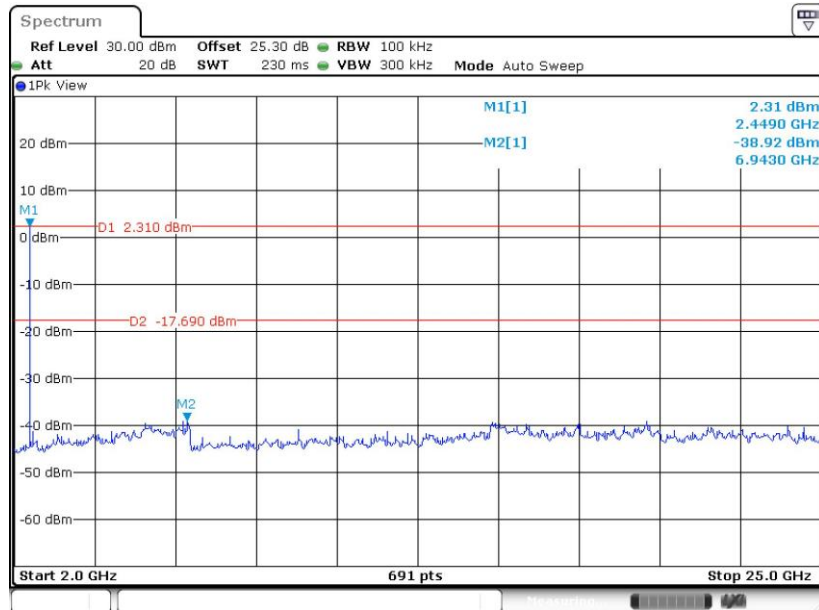

Date: 22.FEB.2020 04:21:06



CSE Plot on Ch 78 between 30MHz ~ 3 GHz

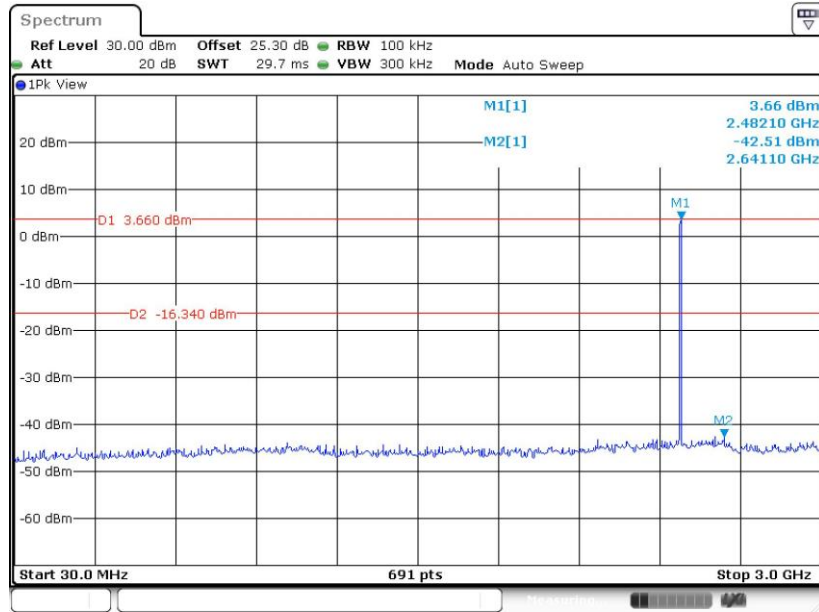

Date: 22.FEB.2020 04:25:05

CSE Plot on Ch 78 between 2 GHz ~ 25 GHz

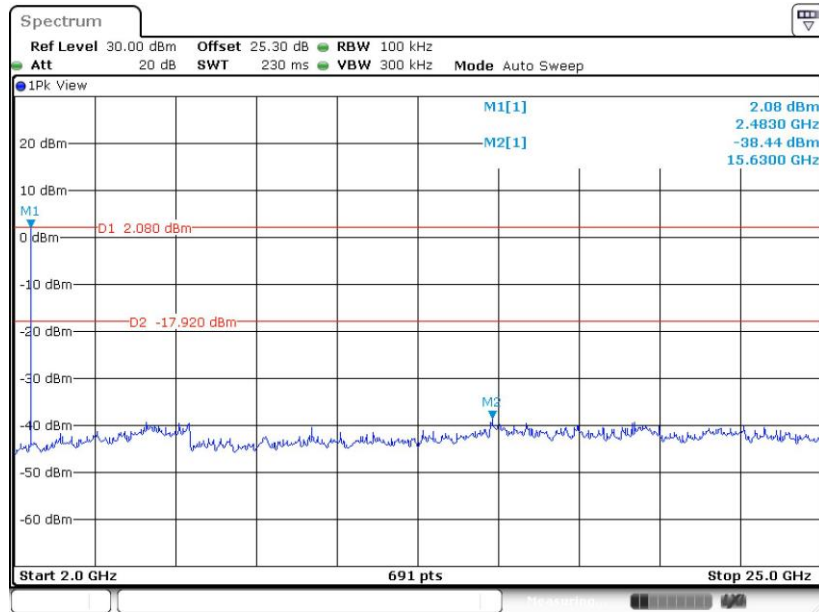

Date: 22.FEB.2020 04:25:35



3.8 Radiated Band Edges and Spurious Emission Measurement

3.8.1 Limit of Radiated Band Edges and Spurious Emission

In any 100 kHz bandwidth outside the intentional radiator frequency band, all harmonics/spurious must be at least 20 dB below the highest emission level within the authorized band. In addition, radiated emissions which fall in the restricted bands must also comply with the limits as below.

Frequency (MHz)	Field Strength (microvolts/meter)	Measurement Distance (meters)
0.009 – 0.490	2400/F(kHz)	300
0.490 – 1.705	24000/F(kHz)	30
1.705 – 30.0	30	30
30 – 88	100	3
88 – 216	150	3
216 - 960	200	3
Above 960	500	3

3.8.2 Measuring Instruments

See list of measuring equipment of this test report.

**3.8.3 Test Procedures**

1. The EUT was placed on a turntable with 0.8 meter for frequency below 1GHz and 1.5 meter for frequency above 1GHz respectively above ground.
2. The EUT was set 3 meters from the interference receiving antenna, which was mounted on the top of a variable height antenna tower.
3. For each suspected emission, the EUT was arranged to its worst case and then tune the Antenna tower (from 1 m to 4 m) and turntable (from 0 degree to 360 degrees) to find the maximum reading. A pre-amp and a high pass filter are used for the test in order to get better signal level to comply with the guidelines.
4. Set to the maximum power setting and enable the EUT transmit continuously.
5. Use the following spectrum analyzer settings:
 - (1) Span shall wide enough to fully capture the emission being measured;
 - (2) Set RBW=100 kHz for $f < 1$ GHz, RBW=1MHz for $f > 1$ GHz ; VBW \geq RBW; Sweep = auto; Detector function = peak; Trace = max hold for peak
 - (3) For average measurement: use duty cycle correction factor method per 15.35(c).
Duty cycle = On time/100 milliseconds
On time = $N_1 * L_1 + N_2 * L_2 + \dots + N_{n-1} * L_{n-1} + N_n * L_n$
Where N_1 is number of type 1 pulses, L_1 is length of type 1 pulses, etc.
Average Emission Level = Peak Emission Level + $20 * \log(\text{Duty cycle})$
6. Corrected Reading: Antenna Factor + Cable Loss + Read Level - Preamp Factor = Level
7. For testing above 1GHz, the emission level of the EUT in peak mode was 20dB lower than average limit (that means the emission level in average mode also complies with the limit in average mode), then peak values of EUT will be reported, otherwise, the emissions will be measured in average mode again and reported.

Note: The average levels were calculated from the peak level corrected with duty cycle correction factor (-24.76dB) derived from $20 \log(\text{dwell time}/100\text{ms})$. This correction is only for signals that hop with the fundamental signal, such as band-edge and harmonic. Other spurious signals that are independent of the hopping signal would not use this correction.

3.8.4 Test Setup

For radiated emissions below 30MHz

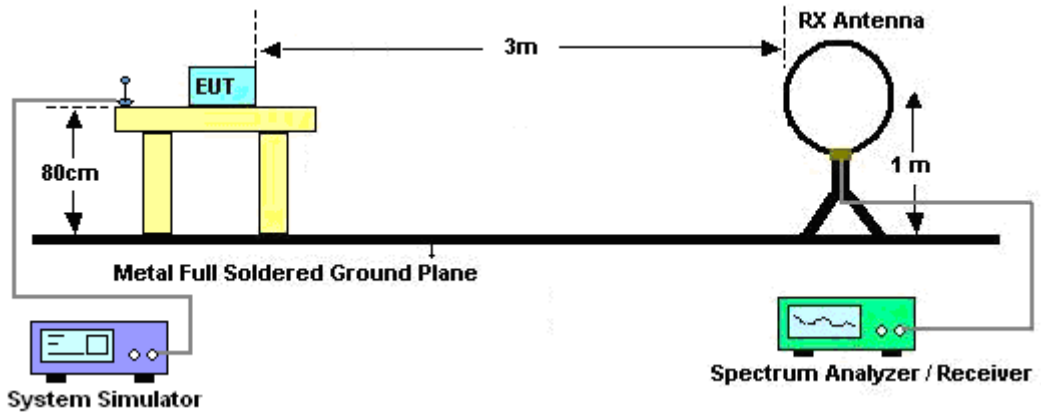

For radiated emissions from 30MHz to 1GHz

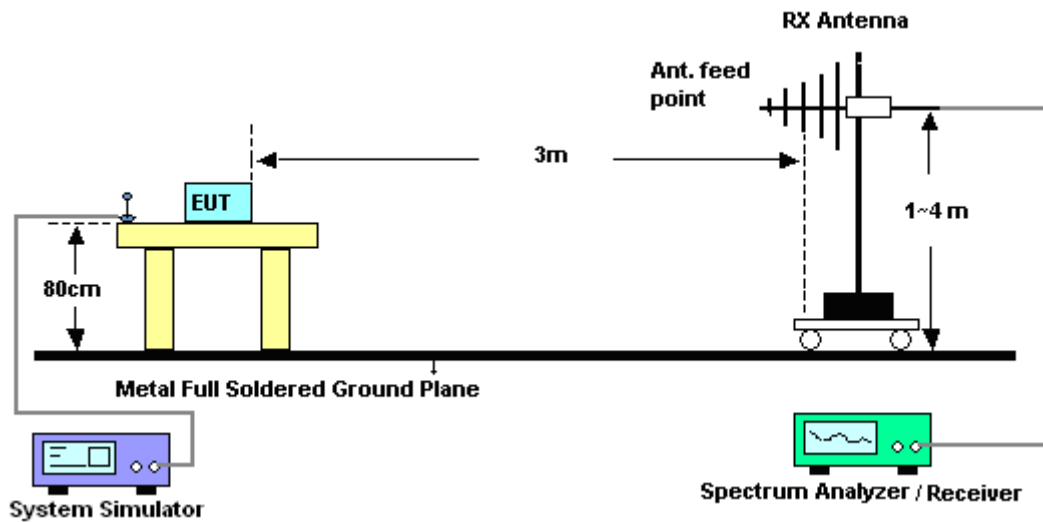

For radiated emissions above 1GHz

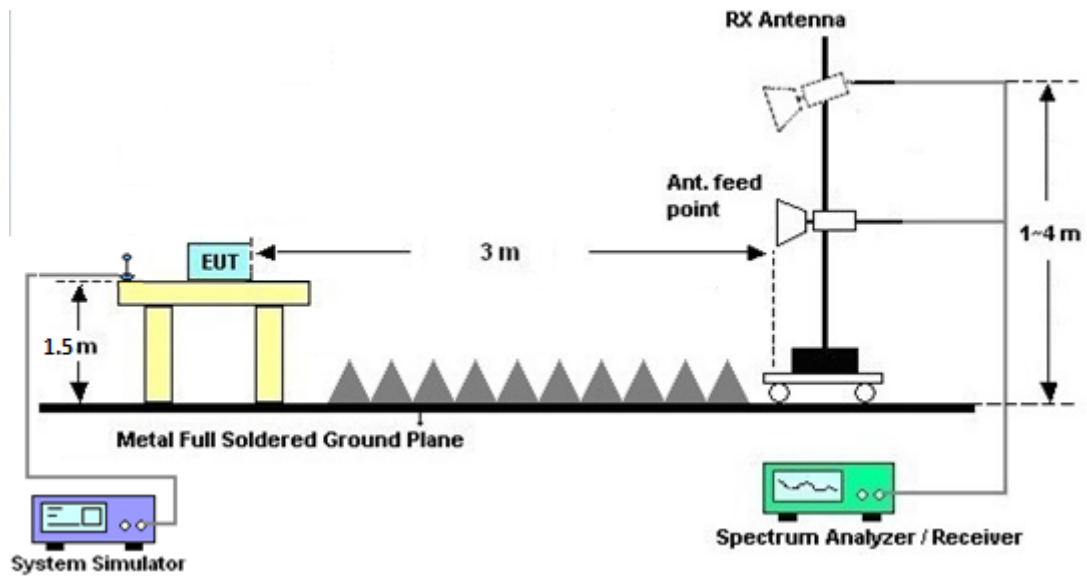

3.8.5 Test Results of Radiated Spurious Emissions (9 kHz ~ 30 MHz)

The low frequency, which started from 9 kHz to 30MHz, was pre-scanned and the result which was 20dB lower than the limit line was not reported.

There is a comparison data of both open-field test site and alternative test site - semi-Anechoic chamber according to 414788 D01 Radiated Test Site v01r01, and the result came out very similar.

3.8.6 Test Result of Radiated Spurious at Band Edges

Please refer to Appendix B and C.

3.8.7 Duty Cycle

Please refer to Appendix D.

3.8.8 Test Result of Radiated Spurious Emission (30MHz ~ 10th Harmonic)

Please refer to Appendix B and C.



3.9 AC Conducted Emission Measurement

3.9.1 Limit of AC Conducted Emission

For equipment that is designed to be connected to the public utility (AC) power line, the radio frequency voltage that is conducted back onto the AC power line on any frequency or frequencies within the band 150 kHz to 30 MHz shall not exceed the limits in the following table.

Frequency of emission (MHz)	Conducted limit (dBµV)	
	Quasi-peak	Average
0.15-0.5	66 to 56*	56 to 46*
0.5-5	56	46
5-30	60	50

*Decreases with the logarithm of the frequency.

3.9.2 Measuring Instruments

See list of measuring equipment of this test report.

3.9.3 Test Procedures

1. The EUT was placed 0.4 meter from the conducting wall of the shielding room was kept at least 80 centimeters from any other grounded conducting surface.
2. Connect EUT to the power mains through a line impedance stabilization network (LISN).
3. All the support units are connecting to the other LISN.
4. The LISN provides 50 ohm coupling impedance for the measuring instrument.
5. The FCC states that a 50 ohm, 50 microhenry LISN should be used.
6. Both sides of AC line were checked for maximum conducted interference.
7. The frequency range from 150 kHz to 30 MHz was searched.
8. Set the test-receiver system to Peak Detect Function and specified bandwidth (IF Bandwidth = 9kHz) with Maximum Hold Mode. Then measurement is also conducted by Average Detector and Quasi-Peak Detector Function respectively.

3.9.4 Test Setup

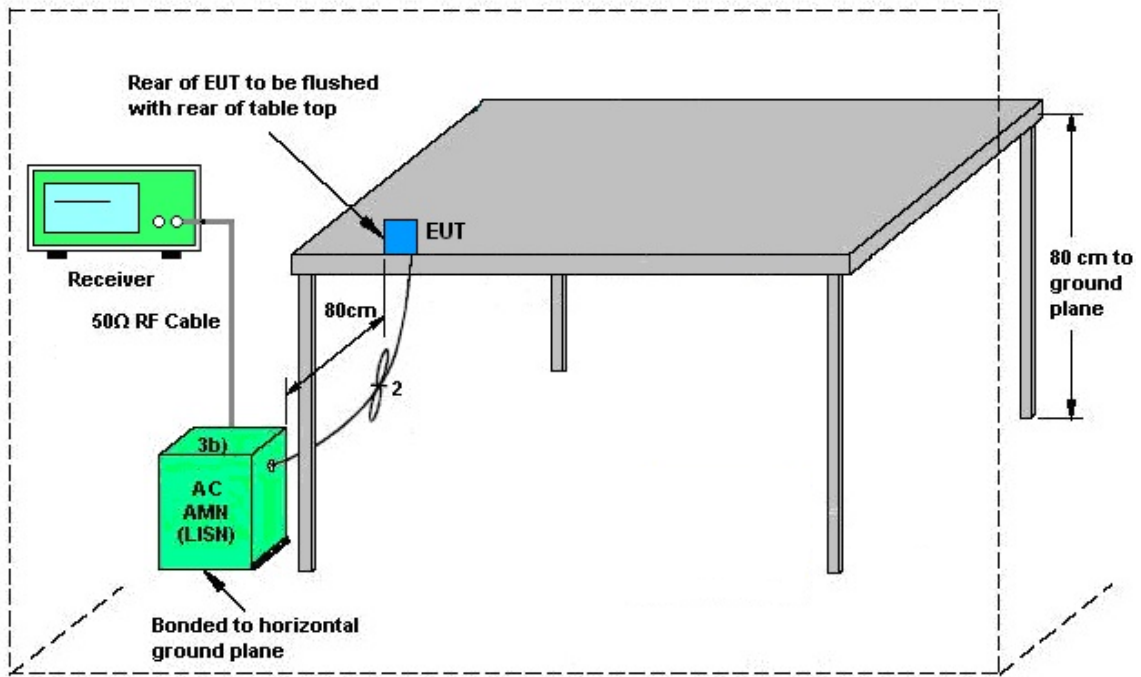

AMN = Artificial mains network (LISN)
 AE = Associated equipment
 EUT = Equipment under test
 ISN = Impedance stabilization network

3.9.5 Test Result of AC Conducted Emission

Please refer to Appendix A.



3.10 Antenna Requirements

3.10.1 Standard Applicable

If directional gain of transmitting antennas is greater than 6dBi, the power shall be reduced by the same level in dB comparing to gain minus 6dBi. The use of a permanently attached antenna or of an antenna that uses a unique coupling to the intentional radiator shall be considered sufficient to comply with the rule.

3.10.2 Antenna Anti-Replacement Construction

An embedded-in antenna design is used.

3.10.3 Antenna Gain

The antenna peak gain of EUT is less than 6 dBi. Therefore, it is not necessary to reduce maximum peak output power limit.



4 List of Measuring Equipment

Instrument	Manufacturer	Model No.	Serial No.	Characteristics	Calibration Date	Test Date	Due Date	Remark
Loop Antenna	Rohde & Schwarz	HFH2-Z2	100488	9 kHz~30 MHz	Dec. 26, 2019	Jan. 30, 2020~ Feb. 29, 2020	Dec. 25, 2020	Radiation (03CH16-HY)
Bilog Antenna	TESEQ	CBL6111D&0 0802N1D01N- 06	47020&06	30MHz to 1GHz	Oct. 13, 2019	Jan. 30, 2020~ Feb. 29, 2020	Oct. 12, 2020	Radiation (03CH16-HY)
Horn Antenna	SCHWARZBE CK	BBHA 9120 D	9120D-152 2	1G~18GHz	Sep. 19, 2019	Jan. 30, 2020~ Feb. 29, 2020	Sep. 18, 2020	Radiation (03CH16-HY)
SHF-EHF Horn Antenna	SCHWARZBE CK	BBHA 9170	BBHA9170 576	18GHz~40GHz	May 14, 2019	Jan. 30, 2020~ Feb. 29, 2020	May 13, 2020	Radiation (03CH16-HY)
Amplifier	SONOMA	310N	371607	9kHz~1000MHz	Oct. 01, 2019	Jan. 30, 2020~ Feb. 29, 2020	Sep. 30, 2020	Radiation (03CH16-HY)
Preamplifier	Keysight	83017A	MY532702 64	1GHz~26.5GHz	Dec. 11, 2019	Jan. 30, 2020~ Feb. 29, 2020	Dec.10, 2020	Radiation (03CH16-HY)
Preamplifier	Jet-Power	JPA0118-55-3 03	171000180 0054001	1GHz~18GHz	May 19, 2019	Jan. 30, 2020~ Feb. 29, 2020	May 18, 2020	Radiation (03CH16-HY)
Preamplifier	EMEC	EM18G40G	060715	18GHz~40GHz	Dec. 13, 2019	Jan. 30, 2020~ Feb. 29, 2020	Dec. 12, 2020	Radiation (03CH16-HY)
EMI Test Receiver	Keysight	N9038A(MXE)	MY572901 11	3Hz~26.5GHz	Dec. 05, 2019	Jan. 30, 2020~ Feb. 29, 2020	Dec. 04, 2020	Radiation (03CH16-HY)
Spectrum Analyzer	Agilent	E4446A	MY501801 36	3Hz~44GHz	Apr. 29, 2019	Jan. 30, 2020~ Feb. 29, 2020	Apr. 28, 2020	Radiation (03CH16-HY)
RF Cable	HUBER + SUHNER	SUCOFLEX 104	MY11680/ 4PE	NA	Aug. 30, 2019	Jan. 30, 2020~ Feb. 29, 2020	Aug. 29, 2020	Radiation (03CH16-HY)
RF Cable	HUBER + SUHNER	SUCOFLEX 104	MY11688/ 4PE	NA	Aug. 30, 2019	Jan. 30, 2020~ Feb. 29, 2020	Aug. 29, 2020	Radiation (03CH16-HY)
RF Cable	HUBER + SUHNER	SUCOFLEX 102	EC-A5-300 -5757	NA	Aug. 30, 2019	Jan. 30, 2020~ Feb. 29, 2020	Aug. 29, 2020	Radiation (03CH16-HY)
Hygrometer	TECPEL	DTM-303B	TP161243	N/A	Jun. 17, 2019	Jan. 30, 2020~ Feb. 29, 2020	Jun. 16, 2020	Radiation (03CH16-HY)
Software	Audix	E3 6.2009-8-24	RK-001136	N/A	N/A	Jan. 30, 2020~ Feb. 29, 2020	N/A	Radiation (03CH16-HY)
Hygrometer	Testo	608-H2	41410069	N/A	Jun. 17, 2019	Feb. 13, 2020~ Feb. 24, 2020	Jun. 16, 2020	Conducted (TH05-HY)
Power Meter	Agilent	E4416A	GB412923 44	N/A	Dec. 27, 2019	Feb. 13, 2020~ Feb. 24, 2020	Dec. 26, 2020	Conducted (TH05-HY)
Signal Analyzer	Rohde & Schwarz	FSV40	101566	10Hz~40GHz	Jul. 15, 2019	Feb. 13, 2020~ Feb. 24, 2020	Jul. 14, 2020	Conducted (TH05-HY)
BT Base Station	Rohde & Schwarz	CBT	101136	BT 3.0	Oct. 27, 2019	Feb. 13, 2020~ Feb. 24, 2020	Oct. 26, 2020	Conducted (TH05-HY)
Switch Box & RF Cable	Burgeon	ETF-058	EC120838 2	N/A	Mar. 27, 2019	Feb. 13, 2020~ Feb. 24, 2020	Mar. 26, 2020	Conducted (TH05-HY)
AC Power Source	ChainTek	APC-1000W	N/A	N/A	N/A	Feb. 14, 2020	N/A	Conduction (CO05-HY)
EMI Test Receiver	Rohde & Schwarz	ESR3	102388	9kHz~3.6GHz	Nov. 15, 2019	Feb. 14, 2020	Nov. 14, 2020	Conduction (CO05-HY)
Hygrometer	Testo	608-H1	34913912	N/A	Mar. 19, 2019	Feb. 14, 2020	Mar. 18, 2020	Conduction (CO05-HY)
LISN	Rohde & Schwarz	ENV216	100080	9kHz~30MHz	Nov. 20, 2019	Feb. 14, 2020	Nov. 19, 2020	Conduction (CO05-HY)
Software	Rohde & Schwarz	EMC32 V10.30	N/A	N/A	N/A	Feb. 14, 2020	N/A	Conduction (CO05-HY)
LF Cable	HUBER + SUHNER	RG-214/U	LF01	N/A	Jan. 02, 2020	Feb. 14, 2020	Jan. 01, 2021	Conduction (CO05-HY)
Pulse Limiter	Rohde & Schwarz	ESH3-Z2	100851	N/A	Jan. 02, 2020	Feb. 14, 2020	Jan. 01, 2021	Conduction (CO05-HY)



5 Uncertainty of Evaluation

Uncertainty of Conducted Emission Measurement (150 kHz ~ 30 MHz)

Measuring Uncertainty for a Level of Confidence of 95% ($U = 2Uc(y)$)	2.0
---	-----

Uncertainty of Radiated Emission Measurement (30 MHz ~ 1000 MHz)

Measuring Uncertainty for a Level of Confidence of 95% ($U = 2Uc(y)$)	4.9
---	-----

Uncertainty of Radiated Emission Measurement (1000 MHz ~ 18000 MHz)

Measuring Uncertainty for a Level of Confidence of 95% ($U = 2Uc(y)$)	6.7
---	-----

Uncertainty of Radiated Emission Measurement (18000 MHz ~ 40000 MHz)

Measuring Uncertainty for a Level of Confidence of 95% ($U = 2Uc(y)$)	3.9
---	-----



Appendix A. AC Conducted Emission Test Results

Test Engineer :	Tom Lee	Temperature :	21~25°C
		Relative Humidity :	41~52%
Test Voltage :	120Vac / 60Hz	Phase :	Line

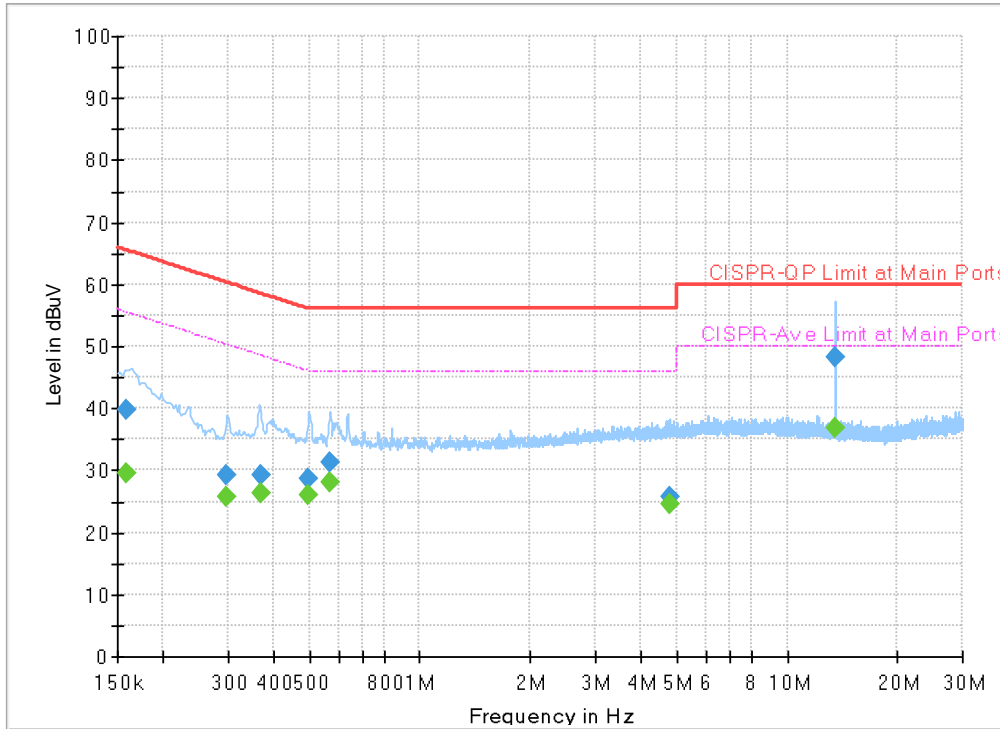

Final Result :

Frequency (MHz)	QuasiPeak (dBuV)	CAverage (dBuV)	Limit (dBuV)	Margin (dB)	Line	Filter	Corr. (dB)
0.159540	---	29.50	55.49	25.99	L1	OFF	19.5
0.159540	39.63	---	65.49	25.86	L1	OFF	19.5
0.297150	---	25.84	50.32	24.48	L1	OFF	19.5
0.297150	29.13	---	60.32	31.19	L1	OFF	19.5
0.369420	---	26.24	48.51	22.27	L1	OFF	19.5
0.369420	29.20	---	58.51	29.31	L1	OFF	19.5
0.498120	---	25.93	46.03	20.10	L1	OFF	19.5
0.498120	28.69	---	56.03	27.34	L1	OFF	19.5
0.569850	---	27.97	46.00	18.03	L1	OFF	19.5
0.569850	31.34	---	56.00	24.66	L1	OFF	19.5
4.776000	---	24.65	46.00	21.35	L1	OFF	19.7
4.776000	25.69	---	56.00	30.31	L1	OFF	19.7
13.560000	---	36.91	50.00	13.09	L1	OFF	20.1
13.560000	48.11	---	60.00	11.89	L1	OFF	20.1



Test Engineer :	Tom Lee	Temperature :	21~25°C
		Relative Humidity :	41~52%
Test Voltage :	120Vac / 60Hz	Phase :	Neutral

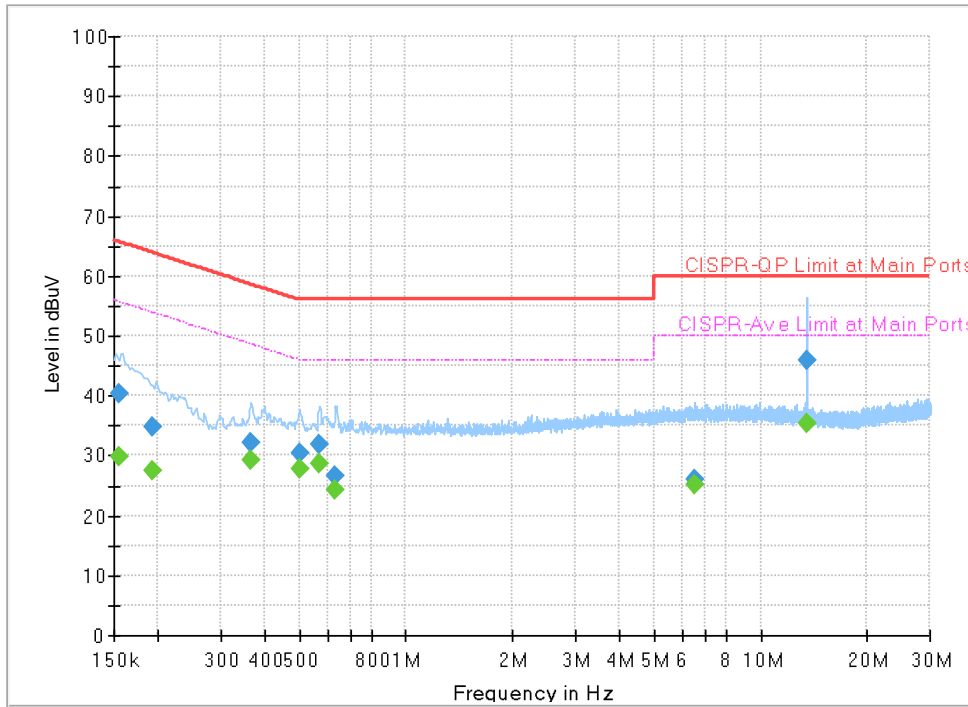

Final Result :

Frequency (MHz)	QuasiPeak (dBuV)	CAverage (dBuV)	Limit (dBuV)	Margin (dB)	Line	Filter	Corr. (dB)
0.155400	---	29.77	55.71	25.94	N	OFF	19.6
0.155400	40.47	---	65.71	25.24	N	OFF	19.6
0.192750	---	27.38	53.92	26.54	N	OFF	19.6
0.192750	34.90	---	63.92	29.02	N	OFF	19.6
0.364740	---	29.20	48.62	19.42	N	OFF	19.6
0.364740	32.15	---	58.62	26.47	N	OFF	19.6
0.501990	---	27.72	46.00	18.28	N	OFF	19.6
0.501990	30.33	---	56.00	25.67	N	OFF	19.6
0.567960	---	28.71	46.00	17.29	N	OFF	19.6
0.567960	31.92	---	56.00	24.08	N	OFF	19.6
0.627900	---	24.36	46.00	21.64	N	OFF	19.6
0.627900	26.55	---	56.00	29.45	N	OFF	19.6
6.547380	---	25.17	50.00	24.83	N	OFF	19.9
6.547380	25.96	---	60.00	34.04	N	OFF	19.9
13.560000	---	35.44	50.00	14.56	N	OFF	20.1
13.560000	45.79	---	60.00	14.21	N	OFF	20.1



Appendix B. Radiated Spurious Emission

Test Engineer :	Jacky Hung, Andy Yang and CR Liro	Temperature :	20~25°C
		Relative Humidity :	50~60%



<Sample 1 with Battery1>

2.4GHz 2400~2483.5MHz

BT (Band Edge @ 3m)

BT	Note	Frequency	Level	Over Limit	Limit Line	Read Level	Antenna Factor	Path Loss	Preamp Factor	Ant Pos	Table Pos	Peak Avg.	Pol.	
		(MHz)	(dBμV/m)	(dB)	(dBμV/m)	(dBμV)	(dB/m)	(dB)	(dB)	(cm)	(deg)	(P/A)	(H/V)	
BT CH00 2402MHz		2336.46	47.49	-26.51	74	41.31	27.85	8.09	29.76	156	75	P	H	
		2336.46	22.73	-31.27	54	-	-	-	-	-	-	A	H	
	*	2402	105.03	-	-	99.03	27.6	8.19	29.79	156	75	P	H	
	*	2402	80.27	-	-	-	-	-	-	-	-	A	H	
		2331.525	47.58	-26.42	74	41.39	27.87	8.08	29.76	311	356	P	V	
		2331.525	22.82	-31.18	54	-	-	-	-	-	-	A	V	
	*	2402	100.93	-	-	94.93	27.6	8.19	29.79	311	356	P	V	
	*	2402	76.17	-	-	-	-	-	-	-	-	A	V	
BT CH 39 2441MHz		2319.8	47.08	-26.92	74	40.85	27.92	8.06	29.75	137	74	P	H	
		2319.8	22.32	-31.68	54	-	-	-	-	-	-	A	H	
	*	2441	104.89	-	-	98.84	27.6	8.26	29.81	137	74	P	H	
	*	2441	80.13	-	-	-	-	-	-	-	-	A	H	
		2496.43	46.83	-27.17	74	40.81	27.51	8.34	29.83	137	74	P	H	
		2496.43	22.07	-31.93	54	-	-	-	-	-	-	A	H	
		2352.84	47.11	-26.89	74	40.98	27.79	8.11	29.77	304	359	P	V	
		2352.84	22.35	-31.65	54	-	-	-	-	-	-	A	V	
	*	2441	100.5	-	-	94.45	27.6	8.26	29.81	304	359	P	V	
	*	2441	75.74	-	-	-	-	-	-	-	-	A	V	
		2497.2	47.01	-26.99	74	40.98	27.51	8.35	29.83	304	359	P	V	
	2497.2	22.25	-31.75	54	-	-	-	-	-	-	A	V		



BT CH 78 2480MHz	*	2480	103.76	-	-	97.72	27.54	8.32	29.82	139	73	P	H
	*	2480	79	-	-	-	-	-	-	-	-	A	H
		2483.52	51.66	-22.34	74	45.63	27.53	8.32	29.82	139	73	P	H
		2483.52	26.9	-27.1	54	-	-	-	-	-	-	A	H
													H
													H
	*	2480	98.85	-	-	92.81	27.54	8.32	29.82	294	359	P	V
	*	2480	74.09	-	-	-	-	-	-	-	-	A	V
		2488	48.18	-25.82	74	42.15	27.52	8.33	29.82	294	359	P	V
		2488	23.42	-30.58	54	-	-	-	-	-	-	A	V
													V
													V
Remark	1. No other spurious found. 2. All results are PASS against Peak and Average limit line.												



2.4GHz 2400~2483.5MHz
BT (Harmonic @ 3m)

BT	Note	Frequency (MHz)	Level (dBμV/m)	Over Limit (dB)	Limit Line (dBμV/m)	Read Level (dBμV)	Antenna Factor (dB/m)	Path Loss (dB)	Preamp Factor (dB)	Ant Pos (cm)	Table Pos (deg)	Peak Avg. (P/A)	Pol. (H/V)
BT CH 00 2402MHz		4804	43.67	-30.33	74	58.27	31.11	12.4	58.11	100	0	P	H
		4804	18.91	-35.09	54	-	-	-	-	-	-	A	H
													H
													H
		4804	45.66	-28.34	74	60.26	31.11	12.4	58.11	100	0	P	V
		4804	20.9	-33.1	54	-	-	-	-	-	-	A	V
													V
													V
BT CH 39 2441MHz		4882	37.8	-36.2	74	52.36	31.07	12.5	58.13	100	0	P	H
		4882	13.04	-40.96	54	-	-	-	-	-	-	A	H
		7323	41.53	-32.47	74	46.93	36.49	15.6	57.49	100	0	P	H
		7323	16.77	-37.23	54	-	-	-	-	-	-	A	H
		4882	42.46	-31.54	74	57.02	31.07	12.5	58.13	100	0	P	V
		4882	17.7	-36.3	54	-	-	-	-	-	-	A	V
		7323	41.29	-32.71	74	46.69	36.49	15.6	57.49	100	0	P	V
		7323	16.53	-37.47	54	-	-	-	-	-	-	A	V
BT CH 78 2480MHz		4960	40.19	-33.81	74	54.51	31.26	12.56	58.14	100	0	P	H
		4960	15.43	-38.57	54	-	-	-	-	-	-	A	H
		7440	40.46	-33.54	74	45.49	36.58	15.72	57.33	100	0	P	H
		7440	15.7	-38.3	54	-	-	-	-	-	-	A	H
		4960	43.68	-30.32	74	58	31.26	12.56	58.14	100	0	P	V
		4960	18.92	-35.08	54	-	-	-	-	-	-	A	V
		7440	40.89	-33.11	74	45.92	36.58	15.72	57.33	100	0	P	V
		7440	16.13	-37.87	54	-	-	-	-	-	-	A	V
Remark	1. No other spurious found. 2. All results are PASS against Peak and Average limit line.												



Emission below 1GHz

2.4GHz BT (LF)

BT	Note	Frequency (MHz)	Level (dBμV/m)	Over	Limit	Read	Antenna	Path	Preamp	Ant	Table	Peak	Pol.	
				Limit (dB)	Line (dBμV/m)	Level (dBμV)	Factor (dB/m)	Loss (dB)	Factor (dB)	Pos (cm)	Pos (deg)	Avg. (P/A)		
2.4GHz BT LF		44.55	22.84	-17.16	40	37.2	16.91	1.1	32.37	-	-	P	H	
		95.96	28.55	-14.95	43.5	43.86	15.29	1.66	32.26	-	-	P	H	
		287.05	24.13	-21.87	46	34.52	18.98	2.98	32.35	-	-	P	H	
		559.62	28.22	-17.78	46	29.99	26.17	4.05	31.99	-	-	P	H	
		888.45	38.56	-7.44	46	36.42	28.99	5.12	31.97	100	0	P	H	
		967.99	34.86	-19.14	54	29.47	31.14	5.37	31.12	-	-	P	H	
														H
														H
														H
														H
														H
														H
			44.55	33.68	-6.32	40	48.04	16.91	1.1	32.37	100	0	P	V
			183.26	26.38	-17.12	43.5	41.55	14.78	2.36	32.31	-	-	P	V
			565.44	28.38	-17.62	46	30.17	26.11	4.08	31.98	-	-	P	V
			728.4	30.64	-15.36	46	30.74	27.47	4.64	32.21	-	-	P	V
			901.06	38.39	-7.61	46	36.13	29.02	5.15	31.91	-	-	P	V
			967.99	35.1	-18.9	54	29.71	31.14	5.37	31.12	-	-	P	V
														V
														V
														V
													V	
													V	
													V	
													V	
Remark	1. No other spurious found. 2. All results are PASS against limit line.													



Note symbol

*	Fundamental Frequency which can be ignored. However, the level of any unwanted emissions shall not exceed the level of the fundamental frequency.
!	Test result is over limit line.
P/A	Peak or Average
H/V	Horizontal or Vertical



A calculation example for radiated spurious emission is shown as below:

BT	Note	Frequency	Level	Over	Limit	Read	Antenna	Path	Preamp	Ant	Table	Peak	Pol.
		(MHz)	(dBμV/m)	(dB)	(dBμV/m)	(dBμV)	(dB/m)	(dB)	(dB)	(cm)	(deg)	(P/A)	(H/V)
BT CH 00 2402MHz		2390	55.45	-18.55	74	54.51	32.22	4.58	35.86	103	308	P	H
		2390	43.54	-10.46	54	42.6	32.22	4.58	35.86	103	308	A	H

1. Path Loss(dB) = Cable loss(dB) + Filter loss(dB) + Attenuator loss(dB)
2. Level(dBμV/m) =
Antenna Factor(dB/m) + Path Loss(dB) + Read Level(dBμV) - Preamp Factor(dB)
3. Over Limit(dB) = Level(dBμV/m) – Limit Line(dBμV/m)

For Peak Limit @ 2390MHz:

1. Level(dBμV/m)
= Antenna Factor(dB/m) + Path Loss(dB) + Read Level(dBμV) - Preamp Factor(dB)
= 32.22(dB/m) + 4.58(dB) + 54.51(dBμV) – 35.86 (dB)
= 55.45 (dBμV/m)
2. Over Limit(dB)
= Level(dBμV/m) – Limit Line(dBμV/m)
= 55.45(dBμV/m) – 74(dBμV/m)
= -18.55(dB)

For Average Limit @ 2390MHz:

1. Level(dBμV/m)
= Antenna Factor(dB/m) + Path Loss(dB) + Read Level(dBμV) - Preamp Factor(dB)
= 32.22(dB/m) + 4.58(dB) + 42.6(dBμV) – 35.86 (dB)
= 43.54 (dBμV/m)
2. Over Limit(dB)
= Level(dBμV/m) – Limit Line(dBμV/m)
= 43.54(dBμV/m) – 54(dBμV/m)
= -10.46(dB)

Both peak and average measured complies with the limit line, so test result is “PASS”.



Appendix C. Radiated Spurious Emission Plots

Test Engineer :	Jacky Hung, Andy Yang, and CR Liro	Temperature :	20~25°C
		Relative Humidity :	50~60%

<Sample 1 with Battery1>

2.4GHz 2400~2483.5MHz

BT (Band Edge @ 3m)

BT	2.4GHz 2400~2483.5MHz Band Edge @ 3m	
	BT CH00 2402MHz	
	Horizontal	Fundamental
Peak	<p>Site : 03CH16-HY Condition : PEAK_BE_74 3m 91200_1522 HORIZONTAL : RBW:1000.000kHz VBW:3000.000kHz SWT:Auto Detector : Peak Project : 010732</p>	<p>Site : 03CH16-HY Condition : PEAK_74 3m 91200_1522 HORIZONTAL : RBW:1000.000kHz VBW:3000.000kHz SWT:Auto Detector : Peak Project : 010732</p>

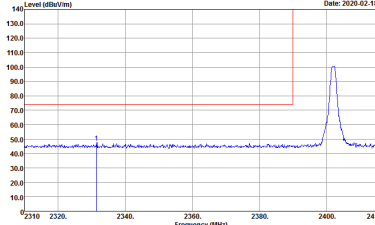
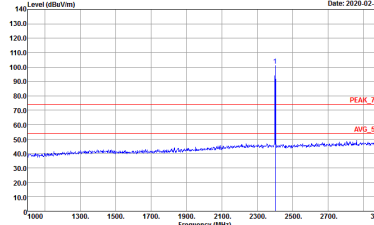

BT	2.4GHz 2400~2483.5MHz Band Edge @ 3m	
BT CH00 2402MHz		
	Vertical	Fundamental
<p>Peak</p>	 <p>Date: 2020-02-18</p> <p>Site : 03CH16-HY Condition : PEAK_8E_74 3m 91200_1522 VERTICAL RBW:1000.000KHz VBW:3000.000KHz SWT:Auto Detector : Peak Project : 010732</p>	 <p>Date: 2020-02-18</p> <p>Site : 03CH16-HY Condition : PEAK_74 3m 91200_1522 VERTICAL RBW:1000.000KHz VBW:3000.000KHz SWT:Auto Detector : Peak Project : 010732</p>

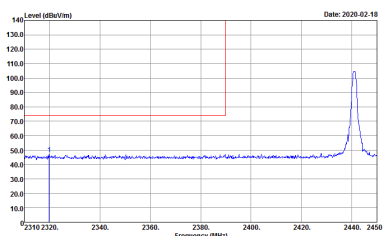
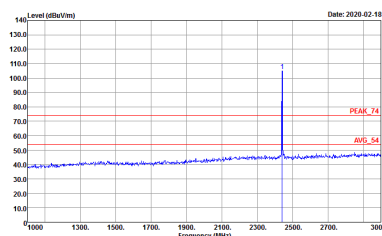
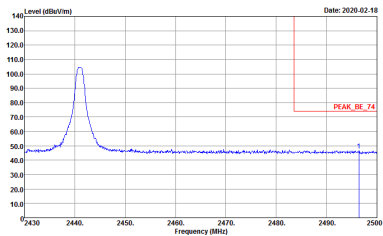

BT	2.4GHz 2400~2483.5MHz Band Edge @ 3m	
BT CH39 2441MHz		
	Horizontal	Fundamental
<p>Peak</p>	 <p>Site : 03CH16-HY Condition : PEAK_BE_74 3m 91200_1522 HORIZONTAL : RBW:1000.000KHz VBW:3000.000KHz SWT:Auto Detector : Peak Project : 010732</p>	 <p>Site : 03CH16-HY Condition : PEAK_74 3m 91200_1522 HORIZONTAL : RBW:1000.000KHz VBW:3000.000KHz SWT:Auto Detector : Peak Project : 010732</p>
<p>Peak</p>	 <p>Site : 03CH16-HY Condition : PEAK_BE_74 3m 91200_1522 HORIZONTAL : RBW:1000.000KHz VBW:3000.000KHz SWT:Auto Detector : Peak Project : 010732</p>	<p>Left blank</p>

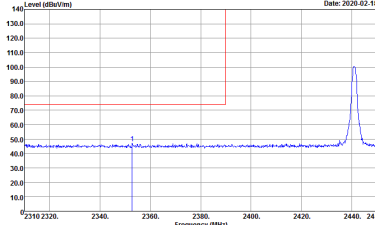
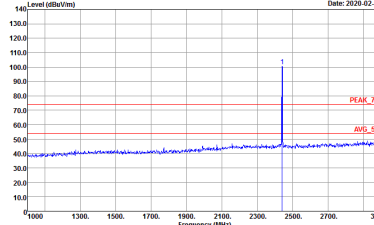
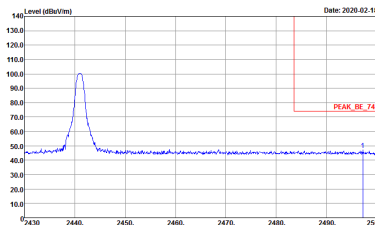

BT	2.4GHz 2400~2483.5MHz Band Edge @ 3m	
BT CH39 2441MHz		
	Vertical	Fundamental
Peak	 <p> Site : 03CH16-HY Condition : PEAK_BE_74 3m 91200_1522 VERTICAL RBW:1000.000KHz VBW:3000.000KHz SWT:Auto Detector : Peak Project : 010732 </p>	 <p> Site : 03CH16-HY Condition : PEAK_74 3m 91200_1522 VERTICAL RBW:1000.000KHz VBW:3000.000KHz SWT:Auto Detector : Peak Project : 010732 </p>
Peak	 <p> Site : 03CH16-HY Condition : PEAK_BE_74 3m 91200_1522 VERTICAL RBW:1000.000KHz VBW:3000.000KHz SWT:Auto Detector : Peak Project : 010732 </p>	Left blank

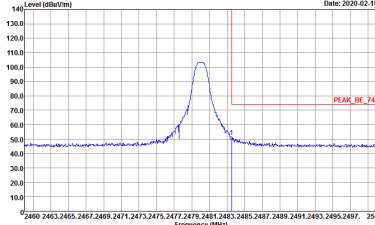
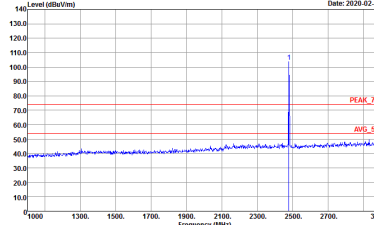

BT	2.4GHz 2400~2483.5MHz Band Edge @ 3m	
BT CH78 2480MHz		
	Horizontal	Fundamental
Peak	 <p>Date: 2020-02-18</p> <p>Site : 03CH16-HY Condition : PEAK_BE_74 3m 91200_1522 HORIZONTAL RBW:1000.000KHz VBW:3000.000KHz SWT:Auto Detector : Peak Project : 010732</p>	 <p>Date: 2020-02-18</p> <p>Site : 03CH16-HY Condition : PEAK_74 3m 91200_1522 HORIZONTAL RBW:1000.000KHz VBW:3000.000KHz SWT:Auto Detector : Peak Project : 010732</p>

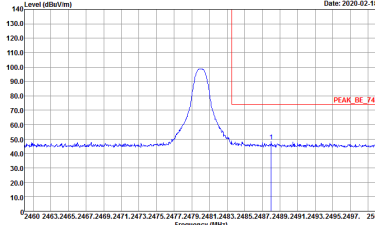
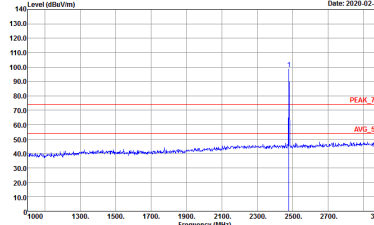

BT	2.4GHz 2400~2483.5MHz Band Edge @ 3m	
BT CH78 2480MHz		
	Vertical	Fundamental
Peak	 <p>Date: 2020-02-18</p> <p>Site : 03CH16-HY Condition : PEAK_BE_74 3m 91200_1522 VERTICAL RBW:1000.000KHz VBW:3000.000KHz SWT:Auto Detector : Peak Project : 010732</p>	 <p>Date: 2020-02-18</p> <p>Site : 03CH16-HY Condition : PEAK_74 3m 91200_1522 VERTICAL RBW:1000.000KHz VBW:3000.000KHz SWT:Auto Detector : Peak Project : 010732</p>



2.4GHz 2400~2483.5MHz

BT (Harmonic @ 3m)

BT	2.4GHz 2400~2483.5MHz Harmonic @ 3m	
	BT CH00 2402MHz	
	Horizontal	Vertical
Peak Avg.	<p>Site : 03CH16-1FY Condition : PEAK_74 3m 91200_1522 HORIZONTAL Detector : Peak Project : 010732</p>	<p>Site : 03CH16-1FY Condition : PEAK_74 3m 91200_1522 VERTICAL Detector : Peak Project : 010732</p>

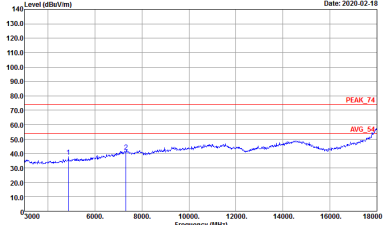
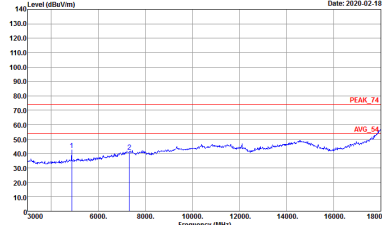

BT	2.4GHz 2400~2483.5MHz Harmonic @ 3m	
BT CH39 2441MHz		
	Horizontal	Vertical
Peak Avg.	 <p data-bbox="430 712 670 761">Site : 03CH16-HY Condition : PEAK_74 3m 91200_1522 HORIZONTAL Detector : Peak Project : 010732</p>	 <p data-bbox="901 712 1141 761">Site : 03CH16-HY Condition : PEAK_74 3m 91200_1522 VERTICAL Detector : Peak Project : 010732</p>

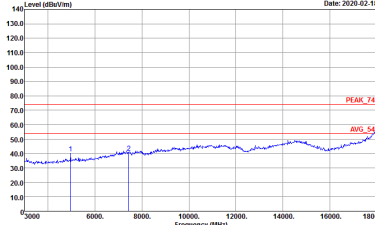
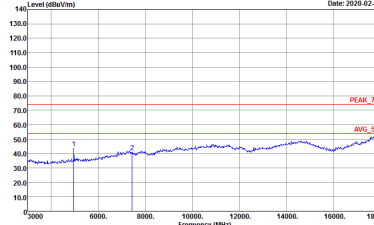

BT	2.4GHz 2400~2483.5MHz Harmonic @ 3m	
BT CH78 2480MHz		
	Horizontal	Vertical
<p>Peak Avg.</p>	 <p>Site : 03CH16-HY Condition : PEAK_74 3m 91200_1522 HORIZONTAL Detector : Peak Project : 010732</p>	 <p>Site : 03CH16-HY Condition : PEAK_74 3m 91200_1522 VERTICAL Detector : Peak Project : 010732</p>



Emission below 1GHz

2.4GHz BT (LF)

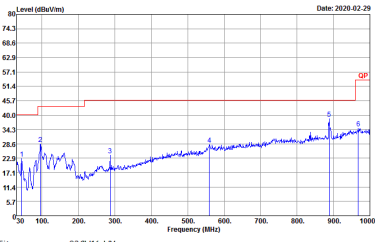
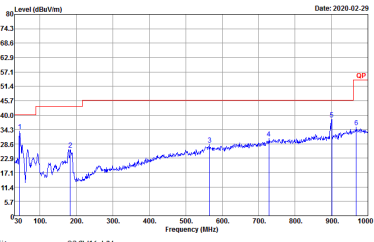
BT	2.4GHz 2400~2483.5MHz	
ANT	BT LF	
1	Horizontal	Vertical
<p>QP / Peak</p>	 <p>Site : 03CH16-1FY Condition : QP 3m BTL0G_47020406 HORIZONTAL Detector : Peak Project : 010732</p>	 <p>Site : 03CH16-1FY Condition : QP 3m BTL0G_47020406 VERTICAL Detector : Peak Project : 010732</p>



Appendix D. Duty Cycle Plots

DH5 on time (One Pulse) Plot on Channel 39

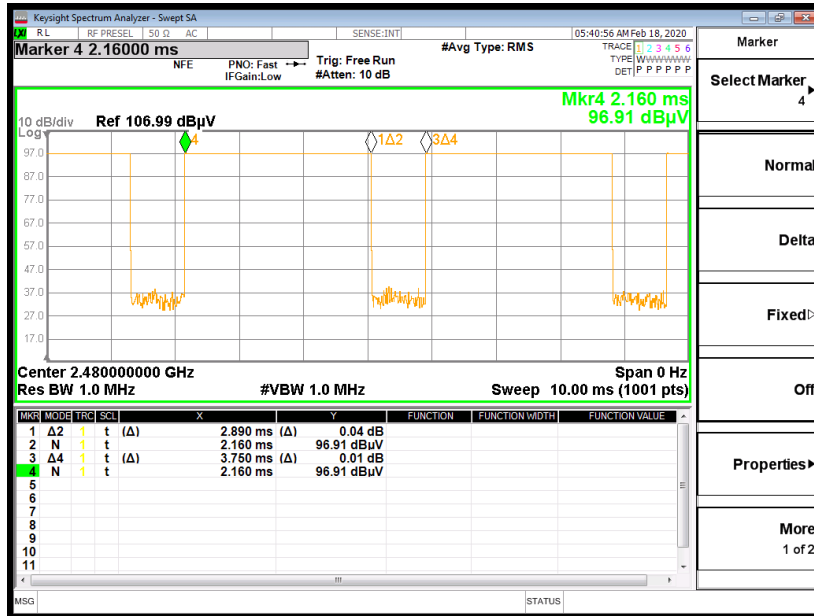

on time (Count Pulses) Plot on Channel 39

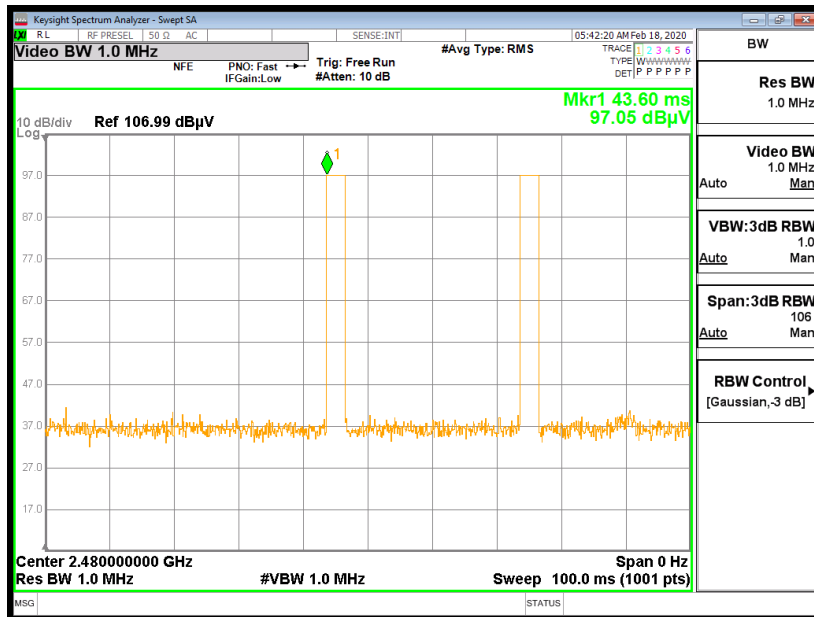

Note:

1. Worst case Duty cycle = on time/100 milliseconds = $2 * 2.89 / 100 = 5.78 \%$
2. Worst case Duty cycle correction factor = $20 * \log(\text{Duty cycle}) = -24.76 \text{ dB}$
3. DH5 has the highest duty cycle worst case and is reported.



Duty Cycle Correction Factor Consideration for AFH mode:

Bluetooth normal hopping rate is 1600Hz and reduced to 800Hz in AFH mode; due to the reduced number of hopping frequencies, with the same packet configuration the dwell time in each channel frequency within 100msec period is longer in AFH mode than normal mode.

In AFH mode, the minimum hopping frequencies are 20, to get the longest dwell time DH5 packet is observed; the period to have DH5 packet completing one hopping sequence is

$$2.89 \text{ ms} \times 20 \text{ channels} = 57.8 \text{ ms}$$

There cannot be 2 complete hopping sequences within 100ms period, considering the random hopping behavior, maximum 2 hops can be possibly observed within the period. $[100\text{ms} / 57.8\text{ms}] = 2$ hops

Thus, the maximum possible ON time:

$$2.89 \text{ ms} \times 2 = 5.78 \text{ ms}$$

Worst case Duty Cycle Correction factor, which is derived from the maximum possible ON time,

$$20 \times \log(5.78 \text{ ms}/100\text{ms}) = -24.76 \text{ dB}$$