

INTEGRA



WELLJET Dispenser
WELLJET Dispenser Stacker

Operating Instructions



Declaration of Conformity

INTEGRA Biosciences AG – 7205 Zizers, Switzerland

declares on its own responsibility that the devices

Description	Models
WELLJET Dispenser	5000
WELLJET Dispenser Stacker	5001
Accessory	128909

comply with:

EU Directives	Scope	Date effective
2014/35/EU	Low voltage directive (LVD)	20.04.2016
2014/30/EU	Electromagnetic compatibility (EMC)	20.04.2016
2014/53/EU	Radio Equipment directive (RED)	13.06.2016
2012/19/EU	Waste electrical and electronic equipment (WEEE)	14.02.2014
2011/65/EU	Restriction of hazardous substances (RoHS)	03.01.2013
EU Regulations	Scope	Date effective
1907/2006	Registration, evaluation, authorisation and restriction of chemicals (REACH)	01.06.2007
EU Standards	Scope	
EN 9001:2015	Quality Management	
EN 61010-1:2020	Safety general laboratory equipment	
EN 61326-1:2013	Electromagnetic compatibility laboratory equipment	
EN 61010-2-081:2020	Safety automatic laboratory equipment	
EN 62368-1:2021	Safety information technology equipment	
EN 301 489-1 V2.2.3	EMC radio equipment: technical requirements	
EN 301 489-3 V2.2.0	EMC radio equipment: conditions for operating	
EN 300 330 V2.1.1	Short range devices	
EN 50364:2019	Human exposure to electromagnetic fields	

WELLJET – Declaration of conformity

GBR Regulations	Scope	Date effective
S.I. 2016/1101	Electrical equipment safety	08.12.2016
S.I. 2016/1091	Electromagnetic compatibility (EMC)	08.12.2016
S.I. 2017/1206	Radio equipment (RED)	26.12.2017
S.I. 2013/3113	Waste electrical and electronic equipment (WEEE)	01.01.2019
S.I. 2012/3032	Restriction of hazardous substances (RoHS)	02.01.2013

GBR Standards	Scope
BS 61010-1:2010	Safety general laboratory equipment
BS 61010-2-081:2020	Safety automatic laboratory equipment
BS 62368-1:2020	Safety information technology equipment
BS 63000:2018	Restriction of hazardous substances (RoHS)

USA Regulations	Scope
47 CFR Part 15 (FCC)	Electromagnetic compatibility (EMC)
17 CFR Parts 240 & 249b	Dodd frank “Conflict minerals”
27 CCR Parts 25102-27001	Proposition 65: The safe drinking water and toxic enforcement act
TSCA 40 CFR Part 751	Toxic substances control act

USA Standards	Scope
UL 61010-1:2012	Safety general laboratory equipment
UL 61010-2-081:2019	Safety automatic laboratory equipment

CAN Standards	Scope
CAN/CSA-C22.2 No. 61010-1	Safety general laboratory equipment
CAN/CSA C22.2 No. 61010-2-81	Safety automatic laboratory equipment

WELLJET – Declaration of conformity

CHN Regulations	Scope	Date effective
Order 32/2016	Restriction of hazardous substances (RoHS)	01.07.2016

CHN Standards	Scope
SJ/T 11364-2014	Restriction of hazardous substances (RoHS)

JPN Regulations	Scope	Date effective
PSE (Denan) Law	Electrical appliance and material safety law	01.01.2014

EAC Технический регламент Таможенного союза	
TP TC 004/2011	О безопасности низковольтного оборудования
TP TC 020/2011	Электромагнитная совместимость технических средств

KOR Regulations	
KC 61010-1	Safety general laboratory equipment
KC 61010-2-081	Safety automatic laboratory equipment
KC 62368-1	Safety information technology equipment

AUS/NZL Regulations	
AS/NZ 61010-1:2003	Safety general laboratory equipment
IEC 61010-2-081:2019	Safety automatic laboratory equipment
AS/NZ 62368-1:2022	Safety information technology equipment

Zizers, August 4, 2023

Urs Hartmann
CEO

Daniel Bächli
Head of Corporate Quality

Table of contents

Chapter 1	Introduction	
	1.1 Symbols used.....	7
	1.2 Intended use.....	8
	1.3 Safety notes	8
	1.4 Regulatory notes	9
Chapter 2	Description of the device	
	2.1 Scope of delivery	10
	2.2 Overview of the WELLJET	10
	2.2.1 Dispenser.....	10
	2.2.2 Interfaces.....	10
	2.2.3 Dispenser Stacker.....	11
	2.2.4 Dispensing cassette.....	11
Chapter 3	Installation	
	3.1 Operating environment.....	12
	3.2 Assembling the WELLJET.....	12
	3.2.1 Installing/removing dispensing cassettes.....	12
	3.2.2 Breaking off anti-collision rib	13
	3.2.3 6 through 48 well dispensing	14
	3.2.4 Reduce dead volume	14
	3.2.5 Tube holder.....	15
	3.2.6 Waste tubing.....	15
	3.3 WELLJET Dispenser Stacker	16
	3.3.1 Inserting the towers.....	16
	3.3.2 Inserting plates into the left tower	16
	3.3.3 Removing a tower	16
	3.3.4 Plate loading adapter	17
	3.4 Settings - Adapt your WELLJET	18
	3.4.1 System settings.....	18
	3.4.2 Dispense and cleaning settings	19
Chapter 4	Operation	
	4.1 Turn on the device.....	20
	4.2 Overview of Main Menu functions	20
	4.3 Running a program.....	21
	4.3.1 Quick start guide	21
	4.3.2 Description of buttons	22

4.4	Plate library	23
4.4.1	Plate dimensions for stacker	24
4.4.2	Teach plate heights	25
4.5	Creating a new dispense program	26
4.5.1	Main functions	26
4.5.2	Advanced functions	28
4.5.3	Stacker options (model 5001 only)	29
4.6	Modifying dispense programs	29
4.7	Troubleshooting/FAQ	30

Chapter 5 Maintenance

5.1	Daily procedure	31
5.2	Dispensing cassettes	31
5.2.1	Creating a cleaning program	31
5.2.2	Modifying a cleaning program	31
5.2.3	Flushing the tubing after use	32
5.2.4	Cleaning the nozzles	32
5.2.5	Decontamination	32
5.2.6	Performance for non-aqueous solutions	33
5.3	WELLJET	35
5.3.1	Cleaning	35
5.3.2	Decontamination	35
5.3.3	Regularly data backup	35
5.4	Servicing	36
5.5	Equipment disposal	36

Chapter 6 Technical Data

6.1	Environmental conditions	37
6.2	Specification of the WELLJET	37
6.3	Intellectual property	38
6.4	Dispensing cassettes	38
6.4.1	Volumes	38
6.4.2	Dispensing times	39
6.4.3	Accuracy and precision specifications	39
6.4.4	Life time expectancy	40
6.4.5	Compatibility of cassettes with plate type	41
6.4.6	Chemical compatibility	42

Chapter 7 Accessories and consumables

7.1	Accessories	43
7.2	Consumables	43

Imprint	44
----------------------	-----------

1 Introduction

These operating instructions contain all the information required for installation, operation and maintenance of the WELLJET.

1.1 Symbols used

The operating instructions specifically advise of residual risks with the following symbols:



WARNING

This safety symbol warns against hazards that could result in injury. It also indicates hazards for machinery, materials and the environment. It is essential that you follow the corresponding precautions.



CAUTION

This symbol cautions against potential material damage or the loss of data in a microprocessor controller. Follow the instructions.



NOTE

This symbol identifies important notes regarding the correct operation of the device and labor-saving features.

The device is marked with the following symbols:



BIOHAZARD

The instrument can be potentially biohazardous due to the use of biohazardous substances by the operator.



CRUSHING OF HANDS

Keep the plate carrier area free of any labware and keep hands away. The hands may be squeezed, pulled in or otherwise injured by moving parts of the instrument.



LASER CLASS 1

The sensor contains a class 1 laser which is inherently safe under reasonably foreseeable conditions of operation.

1.2 Intended use

WELLJET a is a bulk reagent dispenser in the volume range of 0.5–9'999 µl using a variety of tubing sets. Any use of this device in a medical or IVD setting is the responsibility of the user.

This product may only be operated in a secure, protected network with validated, trustworthy clients. The operator must ensure that network security measures are always up-to-date and state-of-the-art. This product may not be directly exposed to the internet.

If WELLJET is used in a manner not specified by INTEGRA Biosciences, the protection provided by the WELLJET may be impaired.

1.3 Safety notes

WELLJET complies to the recognized safety regulations and is safe to operate. WELLJET can only be operated when in perfect condition and while observing these operating instructions.

The device may be associated with residual risks if it is used or operated improperly by untrained personnel. Any person operating the WELLJET must have read and understood these operating instructions, and particularly, the safety notes, or must have been instructed by supervisors so that safe operation of the device is guaranteed.



WARNING

Do not use the WELLJET near flammable material or in explosive areas. Also, do not dispense highly flammable liquids such as acetone or ether.

When handling dangerous substances, comply with the material safety data sheet (MSDS) and with all safety guidelines such as the use of protective clothing and safety goggles.



CAUTION

Avoid dispensing of liquids whose vapors could attack the materials PA (polyamide), POM (polyoxymethylene), FPM (fluor-rubber), NBR (nitrile-rubber), CR (chloroprene), silicone. Corrosive vapors could also damage metallic parts inside the device.

Do not open or modify the WELLJET in any way. The cover must not be removed. Repairs may only be performed by INTEGRA Biosciences or by an authorized after-sales service member.

Parts may be replaced with original INTEGRA Biosciences parts only.



NOTE

Prolonged exposure of the WELLJET to UV-light can cause discoloration and/or yellowing of the housing. However, this will not affect the performance of the device in any way.

Regardless of the listed safety notes, additional applicable regulations and guidelines of trade associations, health authorities, trade supervisory offices, etc. must be observed.

Please visit our website www.integra-biosciences.com on a regular basis for up to date information regarding REACH classified chemicals contained in our products.

1.4 Regulatory notes

Changes or modifications not expressly approved by the manufacturer could void the user's authority to operate the equipment.

This device complies with Part 15 of the FCC rules. Operation is subject to the following two conditions:

- (1) This device may not cause harmful interference, and
- (2) this device must accept any interference received, including interference that may cause undesired operation.

This device complies with Industry Canada licence-exempt RSS standard(s). Operation is subject to the following two conditions:

- (1) This device may not interference, and
- (2) this device must accept any interference, including interference that may cause undesired operation of the device.

This device contains licence-exempt transmitter(s)/receiver(s) that comply with Innovation, Science and Economic Development Canada's licence-exempt RSS(s). Operation is subject to the following two conditions:

This device may not cause interference.

This device must accept any interference, including interference that may cause undesired operation of the device.

In order to comply with FCC/ISED RF Exposure requirements, this device must be installed to provide at least 5 mm separation from the human body at all times.

ISED Canada ICES-003 Compliance "CAN ICES-3 (B)/NMB-3(B)".

2 Description of the device

2.1 Scope of delivery

- WELLJET Dispenser or WELLJET Dispenser Stacker
- Waste trough
- Waste tubing
- Rib removal tool (Dispenser) or plate measuring tool (Dispenser Stacker)
- Mains adapter
- Power cord
- Quick start guide



CAUTION

Verify the scope of delivery when unpacking the device and check for potential transportation damage. Do not operate a device that is damaged, instead contact your local INTEGRA representative.

2.2 Overview of the WELLJET

2.2.1 Dispenser

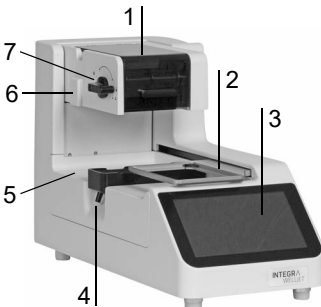

- 1 **Hood** of pump unit, open to install dispensing cassette
- 2 **Plate carrier** with clamp mechanism
- 3 **Display**
- 4 **Waste trough** with drain fitting for waste tubing, serves also as reservoir holder
- 5 **Deck**
- 6 **Mounting bar** for attaching the tube holder
- 7 **Lever** for tightening and releasing the dispensing cassette

2.2.2 Interfaces



- 8 **Ethernet port** for remote mode
- 9 **USB-A ports** for data backup and software updates
- 10 **USB-B port**
- 11 **Main switch**
- 12 **Socket for mains adapter**

2.2.3 Dispenser Stacker

The WELLJET Dispenser Stacker allows for microplates to be stored, dispensed to and then stacked. Two plate towers are available with the capacity of 25 plates or 50 plates and must be ordered separately.

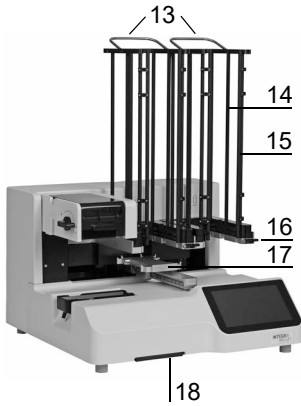

- 13 **Towers with tower handles**
- 14 **Guiding rods**
- 15 **Tower doors**, 2 in front of each tower
- 16 **Tower bar with tower release lever**
- 17 **Plate carrier**
- 18 **Loading adapter**, facilitates manual plate loading, stored underneath the device
- 19 **Plate measuring tool**



2.2.4 Dispensing cassette

The dispensing cassette has a RFID tag integrated.

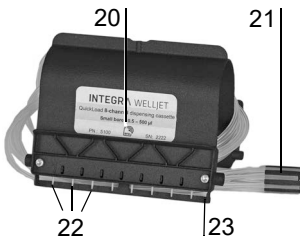

- 20 **Label**
- 21 **Tubing weight**
- 22 **Nozzles**
- 23 **Anti-collision rib**

3 Installation

3.1 Operating environment

The WELLJET has been designed for use in a laboratory. It shall be operated in a dry and dust-free location without large temperature fluctuations or direct sunlight. Place the WELLJET on a flat, dry, clean and vibration-proof bench. Leave at least 10 cm (3.9 in.) space on both sides and on the back to allow adequate air circulation.

3.2 Assembling the WELLJET

Unpack the WELLJET from the packaging configuration. Two persons are required to lift the WELLJET Dispenser Stacker. Hold the WELLJET firmly on both sides of the instrument base. In addition, you can lift the WELLJET Dispenser Stacker on the silver tower bars (16).

Connect the WELLJET to the power supply with the supplied mains adapter.

3.2.1 Installing/removing dispensing cassettes

Different dispensing cassettes can be used with the WELLJET, see [7.2](#):

EasySnap™ dispensing cassette	Can be used for
8 channel, small bore	96, 384 or 1536 well plates
8 channel, large bore	96 or 384 well plates
16 channel, small bore	384 or 1536 well plates

The life time depends on the volume dispensed, see [6.4.2](#).

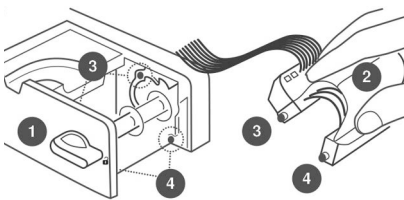

- 1) To insert the cassette, open the hood and turn the lever to the right (🔒).
- 2) Hold the cassette with one hand, the tubings are showing backwards.
- 3) Insert the two pins (3) into the slots of the holder.
- 4) Move the front part of the cassette down until the two pins (4) audibly click into position.

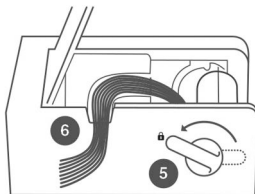

- 5) Turn the lever backwards (🔒) to tighten the cassette. Alternatively, press down the rear part of the cassette (3) until it clicks into position (🔒).
- 6) Place the tubings in the opening of the holder and close the hood.



NOTE

The tutorial for cassette loading/removal can be switched on/off under System settings - Display.

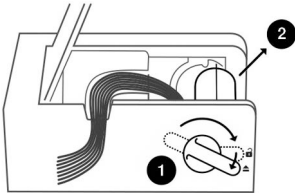

- 1) To remove the cassette, open the hood and turn the lever to the right as far as possible (▲).
- 2) Pull the cassette straight out.

3.2.2 Breaking off anti-collision rib

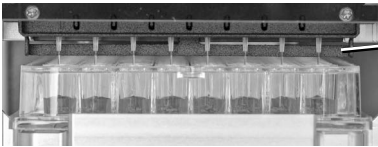

Anti-collision rib of dispensing cassette, protects the nozzles from crashes

Removing the rib allows dispensing inside the wells, which can improve precision when dispensing into a 384 or 1536 well plate and can also prevent the buildup of liquid on the nozzles when dispensing viscous reagents.

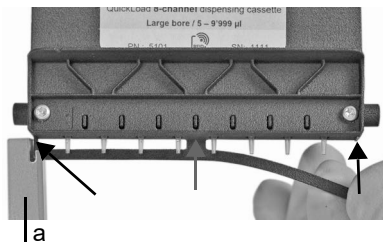

Guide the slit of the delivered rib removal tool or of the scale bar (part of plate measuring tool) and break off the anti-collision rib carefully at the three predetermined breaking points (see arrows).

Ensure the dispensing nozzles are not damaged.



Rip removal tool

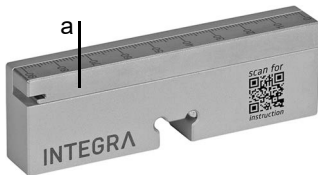

Plate measuring tool with scale bar (a)

3.2.3 6 through 48 well dispensing

For use of an 8 channel cassette to dispense 2, 3, 4, or 6 rows on 6, 12, 24, or 48 well plates respectively, the tubings must be adapted.



Attach an 8 channel cassette.

Follow the instructional diagram below to disconnect the appropriate source tubing from the tubing weight (21). Tubing one is the leftmost in the cassette.

	Connected tubings							
	1	2	3	4	5	6	7	8
6 well plate (2 x 3)	x	✓	x	x	x	✓	x	x
12 well plate (3 x 4)	x	✓	x	✓	x	x	✓	x
24 well plate (4 x 6)	✓	x	✓	x	x	✓	x	✓
48 well plate (6 x 8)	✓	✓	x	✓	✓	x	✓	✓

In the dispensing program select the correct 8 channel tubing set and the number of wells.

3.2.4 Reduce dead volume

To reduce the dead volume of the dispensing cassette, you can shorten the source tubings. Hang the tubing into a source vessel and determine the length to be cut. Note the length! The original length of source tubing is 50 cm.



Remove the tubing weight.

Lay out the tubings on a lint free, flat surface. Use a ruler to measure the length that should be cut.

Using a razor blade or a pair of shaping scissors, cut pieces of equal length from all the tubing ends, one after the other and as straight as possible.

Subtract the cut length from the original length. For example, if you cut off 10 cm, the new length is 50 cm - 10 cm = 40 cm. Enter the new length under Dispense/Cleaning Settings - Tubing length to enable the calculation of the new dead volume.

3.2.5 Tube holder



Slide the tube holder over the mounting bar (6).

Please ensure that the tubes are compatible with the tube holder. Measure the middle part of the tube. Maximum width of a

50 ml tube: 28.7 mm

15 ml tube: 16.7 mm

3.2.6 Waste tubing



Connect the waste tubing to the drain fitting of the waste trough.

Alternatively insert a 25 ml reservoir in the waste trough, see [“7.2 Consumables”](#) on page 43.

3.3 WELLJET Dispenser Stacker

3.3.1 Inserting the towers

Hold a tower on the guiding rods and put it on the stacker. Slide the tower to the back until it audible clicks into position. Repeat with the second tower.

3.3.2 Inserting plates into the left tower



Open the tower doors (15) and slide a stack of empty plates to the back of the left tower.

Close the tower doors.



CAUTION

The right tower needs to be empty when starting a run. Otherwise the plates will fall down.

3.3.3 Removing a tower



The dispensed plates are stacked in the right tower.

While pressing the tower release lever (16) hold a guiding rod and slide the tower a little bit to the front.

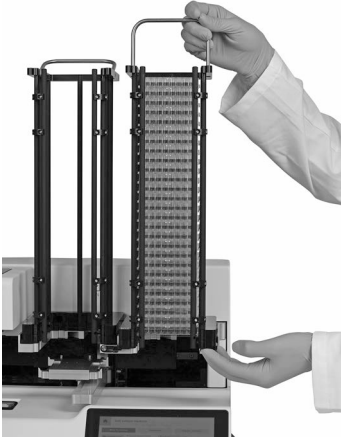

Hold the tower with one hand on the handle and the other hand on the frame at the bottom of the tower.

Lift and remove the tower.



3.3.4 Plate loading adapter



Pull out the loading adapter (18) from underneath the device.

Put the adapter on the plate carrier. It serves as a frame for the plate to facilitate plate loading.

3.4 Settings - Adapt your WELLJET

Press the -icon in the upper right corner of the WELLJET Main menu to access the Settings. Press  to save your settings.

3.4.1 System settings

System Settings	Description
Language	Choose the language in which all screens are displayed.
Date and Time	Sets date and time.
Sounds	Allows beep tones to be turned on or off. Move the bar beside an option to the right to activate the sound, e.g. at program end, and set the volume (low, medium, high).
Display	Sets brightness of the display (low, medium, high). Allows to switch off the display of tutorials (white bar).
Device Information	Displays the serial number and software version. Allows to enter an owner name.
Software Update	Allows to load the latest software version from INTEGRA's website via a USB drive.
Password	Allows to change or remove a device password of 4-12 digits. Enter the default password "WELLJET". The password is used to protect programs or plate layouts.
Backup	Backups the settings, labware library and dispense and cleaning programs to a USB drive inserted in one of the two USB ports (9). The data can be imported to another device.
Import	Imports the device settings, labware library and dispense and cleaning programs from a USB drive. It also removes the device password.
Reset Device	Resets the device with all settings including the password and deletes all programs and the labware library.
Park position	Moves the device to its park position and fixes all axes for save relocation.
Maintenance	Shows the date of the last maintenance, allows to set a service reminder and to save the device log file to a USB drive.
Remote Mode	Remote mode settings, for integration of the WELLJET Dispenser in automated systems.

Software update

Download the latest software from INTEGRA's website to a newly formatted USB drive of the standard FAT32 format. Unzip the software on the USB with the Windows unzip program installed. Move both software files (.bin and .upd) to the top level of the USB drive. On your WELLJET select System settings - Software update, connect the USB drive

and press Reboot. Follow the steps outlined on the screen to perform the update. If the USB drive is not detected by the device, please contact INTEGRA.

3.4.2 Dispense and cleaning settings

Dispense/Cleaning Settings	Description
Prime	Defines the prime speed and the default volume in number of cassette volumes.
Clog Prevention	Activates an automatic pump backward rotation in direction of the source container after a defined idle time in order to prevent clog building in the dispensing nozzles.
Program Categories	Allows to define, edit and delete program categories.
Recover	Defines the recover speed and the default volume in cassette volumes.
Cassette Information	Shows information on the RFID tag ¹ of the inserted cassette, such as lot number, number of channels, cassette validation date, life time, volume counter.
Cleaning Reagents	Allows to define, edit and delete cleaning reagents.
Shake	Sets the shake speed (fast, medium, slow) and shake time.
Tubing Length	Allows to save the tubing length of the cassette, e.g. if you had to shorten the tubing length to reduce the dead volume. Insert the cassette, enter the new tubing length and save it to the RFID tag of the cassette. The length is considered for priming and washing volume when using cassette volumes.

1. The RFID tag allows tracking of cassette usage by incrementing rotations of the pump. The number of rotations is compared to the specific lifetime value of each cassette.

4 Operation

4.1 Turn on the device

Turn on the WELLJET by pressing the **main switch** (11).









CAUTION

Remove hands from WELLJET during initialization.

Press OK to start initialization. After initialization the Main Menu is displayed.

4.2 Overview of Main Menu functions

The Main menu shows the recently used dispense programs. On the right side additional options are available:

Programs	Description
 Library	Opens the plate library where dimensions of the used microplates or tube racks can be defined.
 Settings	The system, dispense and cleaning settings provide options to adapt the WELLJET to appropriate applications.
 New: Dispense	Creates a new dispense program. On the Main Functions screen all commonly used parameters can be defined. The Advanced menu offers additional settings.
 Dispense Programs	Opens a list of saved dispense programs in alphabetical order. Plate, category, author, protections and favorite filters can be set.
 New: Cleaning	Creates a new cleaning program to wash the cassette.
 Cleaning Programs	Opens the list of saved cleaning programs.

To return to the Main menu, press home ()

4.3 Running a program

4.3.1 Quick start guide

To run a program, proceed as follows:

- 1) Turn on the WELLJET.
- 2) Insert an appropriate dispensing cassette.
- 3) Select one of the dispense programs.
- 4) Hang the tubing ends with the weight into the reagent vessel.

**CAUTION**

When operating with small bore dispensing cassettes, ensure that the liquid does not contain any particles >50 µm.

- 5) Press **Prime** until liquid is dispensed from nozzles.
- 6) Load the plate(s).

**CAUTION**

For dispensing with the WELLJET Dispenser Stacker make sure that the right tower is empty, and only insert the loading adapter (18) if manual loading is selected, see [3.3.4](#).

- 7) Press **Run** to start the dispense program.
- 8) At the end of a program and if your protocol allows, press **Recover** to empty the tubings.
- 9) Release the tubing tension by turning the lever (7) to the right as far as possible (▲).

**CAUTION**

Leave the cassette in this rest position whenever the WELLJET is not in use! This will extend the life of the cassette.

- 10) Before prolonged standby, flush the cassette and store it in the original packaging, see [5.2](#).
- 11) Turn off the WELLJET.

4.3.2 Description of buttons

After clicking on a program, the **Run** button is active.





Run	Description
Run	Starts a program.
Pause	Pauses a currently running process. Once is paused, press Cont. to resume or Abort to cancel the process.
Prime	The prime function prepares the tubings for dispensing. It draws the defined volume of source fluid through the tubings of the dispensing cassette in the waste reservoir. Keeping the button pressed for more than 0.5 s switches to manual priming as long as the button is pressed.
Shake	Shakes the plate to homogenize the liquid while simultaneously reducing air bubbles within the liquid.
Recover	The recover function should be used when dispensing with dispensing cassettes is finished. It reverses the pump motion and pulls the defined volume from the tubings back into the source container. Keeping the button pressed for more than 0.5 s switches to manual recovering as long as the button is pressed.

The time and other parameters of **Pause**, **Prime**, **Shake** and **Recover** buttons can be defined in the Dispense settings.

When one of these buttons is pressed, the button becomes dark green and each motion specified is operated. The operation can be paused at any time.

4.4 Plate library

The plate library is used to define the dimensions of the used microplates or tube racks. You can set a filter by number of wells, type, write protection and favorites.

Icon	Description
	New: To define a new labware.
	Edit: Opens the selected labware for editing.
	View: Labware which is used in a dispensing program or is write- or password-protected cannot be edited or deleted.
	Duplicate: Copies the selected labware. Enter a new name.
	Delete: Deletes the selected labware.

In the Plate window select the number of wells (6, 12, 24, 48, 96, 384 or 1536) and enter the maximal volume per well. Press the right arrow to proceed on the next pages.

The well dimensions are set per default to ANSI-standard and should only be changed if not standardized plates are used. Enter the plate height on the next page.

The well number and the plate height are displayed in the library per default. You can add a short prefix to the name, e. g. the name of the manufacturer. It is possible to write-protect the plate. Press **Save**.

Press **Tube Rack** to enter the tube rack dimensions as described above (available for the WELLJET dispenser only).

4.4.1 Plate dimensions for stacker

The WELLJET Dispenser Stacker allows for microplates to be stored, dispensed to and then re-stacked. If plates are lidded, the lids are retained in the tower and re-attached after each dispense. To ensure a reliable process, use the plate measuring tool to determine the requested heights in mm:

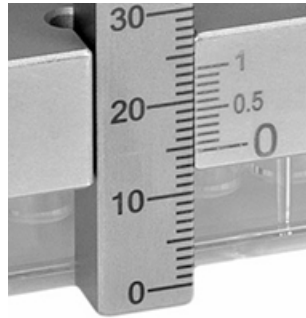
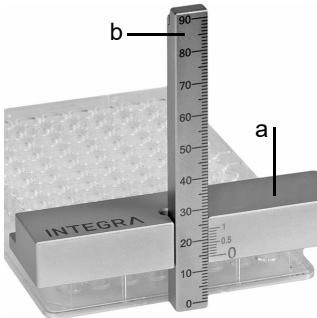

See also:



On a planar surface put the measuring block (a) on the short side of the plate(s).

Attach the scale bar (b) and read off the height where the “0” of the measuring block (a) points to the scale bar, e.g. 14 mm for the example above.

Read the first decimal point where the decimal line of the measuring block exactly matches to a line on the scale bar, e.g. 14.4 mm for the example above.

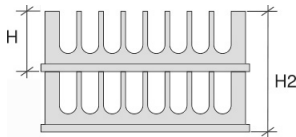

Plates without lids:

H: Height of 1 plate

H2: Total height of 2 plates

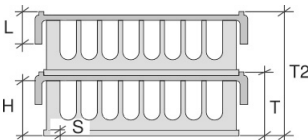

Lidded plates:

H: Height of 1 plate without lid

T: Total plate height with lid

T2: Total height of 2 plates with lid

L: Lid height including stacking rim

S: Skirt height: measure H and F, $S = H - F$

(the flank F is the distance between the top edges of the plate and the skirt).

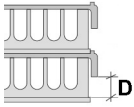

For de-lidding the distance (D) between skirt and lid must be at least 1.5 mm. Secure de-lidding needs a minimum distance of 2.5 mm.

It is possible to process plates with a critical distance between skirt and lid (D = 1.5 mm - 2.5 mm), however in addition to reduced reliability a reduced lifetime of the upper gripper must be expected.

Test the de-lidding function with only two lidded plates to ensure the correct heights are entered.

4.4.2 Teach plate heights

All plate heights except the skirt height (S) can be easily taught by the WELLJET.



NOTE

To ensure processing of the last plate of a stack, the lid height must be at least 6 mm.

On the **Define Plate Height Parameter** screen select a height to be measured and press **Teach Parameter**. The plate carrier is moved to loading position.

Remove all plates from the towers, load the plate and press **OK**. After measurement the plate is moved back to the loading position and the height is displayed. Remove the plate from the carrier and press **OK** to save the measured height.

4.5 Creating a new dispense program

Select the **New Dispense** from the **Main Menu**. Click on a button to set the desired parameters and press ✓ to save your settings.

4.5.1 Main functions

1) Cassette type

Select 8 channel large, 8 channel small or 16 channel small dispensing cassette.

2) Plate

Choose a plate from the library. If your plate is not listed, select **Default Plate** and choose the number of wells and teach the heights, see "Unknown plate dimensions" on page 27. For filling less than 96-well plates some tubings need to be removed from the weight, see "3.2.3 6 through 48 well dispensing" on page 14.



NOTE

Heavy plates (>120 g) may not be positioned correctly in the plate carrier and need to be checked individually for compatibility with the system.

3) Volume

Define the volume for a **Full Plate**. The option **Custom** allows the definition of different volumes for the selected columns in the plate map:

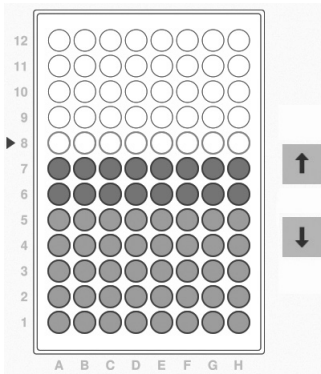

← Columns →

Enter the first dispense volume. Press **Fill** to assign this volume to the selected column (displayed with filled wells A-H). Press **Fill** again to fill the column above, and so on.

Enter the next dispense volume and repeat the procedure to add more columns with that volume.

Up/down arrows: move the cursor to select any column (displayed with colored well border).

Delete: deletes the filling definition of the selected column.

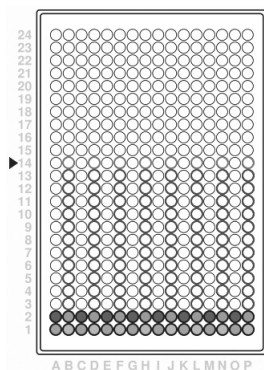

If a 384 well plate should be filled with an 8 channel cassette or a 1536 well plate with a 16 channel cassette, you can define a different filling volume for every quadrant.

Click on the **Rows** icon to select respective left rows, add columns with the plus button, enter the dispense volume and fill the map as described above. Repeat the procedure with the respective right rows.

Rows (.....): toggles between all rows, every second left rows or every second right rows.

4) Height



If the plate is sourced from the **Plate Library**, the heights are per default 2 mm above the plate. The **Dispense Height (Z)** is the height of each column dispense. To change the height, press **Custom** and either set the desired height directly or press **Teach, Move Plate to Teaching Position** and lower the dispensing cassette with the down arrow to the desired height. If the height is lower than the plate height plus 1 mm, break the anti-collision rib from the dispensing cassette, see [3.2.2](#), to allow a deeper dispensing.

The **Clearance Height** is the height at which the nozzles move above the plate relative to the plate carrier. If it is necessary to adjust this height, do not choose a plate from the **Plate Library**, but use the option **Default Plate**.

Unknown plate dimensions



If the plate height is not known and only the well number has been defined with **Default Plate** select **Custom** and **Move Plate to Teaching Position**. Use the down arrow to move the cassette to the desired dispense height and save your settings. Repeat the procedure for the clearance height.

5) Speed

Set the dispense and plate carrier movement speeds (fast, medium, slow).

Dispense speed	Velocity (rpm)	Small bore tubing (µl/s)	Large bore tubing (µl/s)
Fast	420	154	265
Medium	320	117	202
Slow	220	81	139

Use dispense speed slow when dispensing viscous reagents.

6) Prime

Define the prime volume in number of cassette volumes and set the prime speed (fast, medium, slow). Select **Manual** to define the prime speed for priming of the cassette manually.

7) Save your program

Press **Save as** to store your newly defined program. The keypad will appear to enter a program name. Optionally enter a default category, the name of the author and a comment. It is possible to write protect your program with a password, see "[Modifying dispense programs](#)" on page 29. Once everything is entered, press **Save**.

4.5.2 Advanced functions

1) Offset

By default, the liquid is dispensed in the middle of the wells. Press Custom to set an Offset in X- and Y-direction. **Teach** allows the offset setting with arrow buttons.

2) Pre-dispense

Set a volume per channel to be pre-dispensed to the waste trough. The total volume required is displayed.

3) Shake

Press **Shake** to define shaking after or/and before dispensing the plate. Set the shake speed (fast, medium, slow) and the shake time.

4) Delay

Stacker only: After stacking a plate, a delay of up to 900 s can be defined before the next plate is dispensed. This allows synchronization of the dispensing with further processing steps, e.g. equally long incubation times of the plates on the stacker before reading.

5) Message

Enter a message that is prompted before or after the run.

6) Liquid factor

The cassettes are manufactured and validated for precise dispensing of aqueous solutions. For any non-aqueous liquid a program specific liquid factor must be empirically determined to increase accuracy, see [5.2.6](#).

7) Direction

The function only applies when using an 8 channel cassette to dispense to a 384 well plate or when using a 16 channel cassette to dispense to a 1536 well plate. The plates are filled in two steps, depending on the defined pipetting direction.

Row Dispense: Every second row (A, C, E, ...) is completely dispensed starting from the first column (1, 2, 3, ...) and then followed by the remaining rows (B, D, F,...) starting from the last column. This direction is recommended.

Column Dispense: A column is completely filled before moving to the next column. First every other wells (A, C, E,...) are dispensed, starting from the first column, and then the plate shifts sideways to fill the remaining wells (B, D, F,...) of the same column. This direction greatly slows down the filling process because of the frequent plate movement.

4.5.3 Stacker options (model 5001 only)

1) Plate source

Click on **Stacker** if the plates of the left input tower shall be used, or **Manual** if plates are loaded manually.

2) Number of plates

Select **All** if all plates filled in the left tower shall be used, or **Define** to set the number of plates.





3) Re-stack plates

Press the **Yes** button to activate the plate re-stack function. After filling all plates, the stacker will then re-stack the plates back to the left tower position. This ensures that the plates return to the same order that they were loaded in.

Select **Ask** to decide for any of the options 1) to 3) before run start.

4.6 Modifying dispense programs

To edit an existing dispense program press **Dispense Programs**. You can set a program filter by plate, category, author, write protection and favorites. Select a program and press one of the following buttons. Press **✓** to save your settings.

Icon	Description
	Opens the program for editing.
	Deletes the program.
	Duplicates the opened program. Enter a new name and the optional descriptions.
	Opens the program information window.
	Enables write-protection of a program against accidental modification. Move the upper bar to the right to the closed lock (🔒). To activate additional password protection, click on the lower bar and enter the password defined in the device settings (🔒). Press Cancel to exit the screen without activation.

4.7 Troubleshooting/FAQ

Problem	Probable cause	Remedy
Plate sledge does not move.	Software malfunction.	Switch the device off and on. Contact service technician.
Position error of pump unit.	Heights defined too low.	Define appropriate dispense and clearance heights, see 4.5.1 .
The dispensing nozzles do not line up with the center of the wells.	A well offset has been defined for the program. The well dimensions of the plate has not been set correctly.	Check the well offset, see 4.5.1 . Check the plate dimensions, see 4.7 .
The lid function is not working properly.	Incorrect plate heights entered for stacker.	Enter the correct heights, see 4.4.1 .
General error	No plate loaded.	Load a plate.
Database anomaly detected	Unknown.	Enter the Settings - Maintenance menu. Insert a USB drive and save the device log file. Contact service technician and send the log file.

5 Maintenance

5.1 Daily procedure

Before prolonged standby, proceed as follows:

- 1) Flush the tubing after use by running a cleaning program, see [5.2.3](#).
- 2) Release the tubing tension by turning the lever (2) to the right as far as possible (▲), see [3.2.1](#)
- 3) Remove the cassette and store it in the original tray in the in the optionally available storage box.



CAUTION

Handle the dispensing cassettes with great care so that the tubings and nozzles do not get damaged.

5.2 Dispensing cassettes

5.2.1 Creating a cleaning program

Select the **New Cleaning** from the **Main Menu**. Click on a Step to define the desired reagent, volume, speed and incubation time. Press **Save as** to store and name your newly defined cleaning program. Press ✓ to save your settings.

Recommended parameters: Wash the cassette by priming it with deionized water or, if necessary, with washing detergent followed with deionized water. Choose a volume ensuring that all tubings are washed properly. At the last step air should be aspirated in to empty the tubings.

5.2.2 Modifying a cleaning program

To edit an existing cleaning program press **Cleaning Programs**. You can set a filter by author, write protection and favorites. Open a program and adapt the steps with one of the following buttons.

Icon	Description
+	New: To define a new step.
/	Edit: Opens the selected step for editing.
🔍	View: Steps which are used in a cleaning program or is write- or password-protected cannot be edited or deleted.
📄	Duplicate: Copies the selected step. Enter a new number.
🗑️	Delete: Deletes the selected step.

Press **Save as** to store and name your modified cleaning program.

5.2.3 Flushing the tubing after use

- 1) Select one of the cleaning programs.
- 2) Hang the tubing ends connected to the weight into a vessel filled e.g. with deionized water.



CAUTION

When operating with small bore dispensing cassettes, ensure that the liquid does not contain any particles >50 µm.

- 3) Press **Prime** until liquid is dispensed from nozzles.
- 4) Press **Run** to start the cleaning program. Hang the tubings in the next rinsing vessel as instructed on the screen.

The cassette can be dried at room temperature.

5.2.4 Cleaning the nozzles



NOTE

Place the source tubing in a separate bottle filled with deionized water to prevent particles re-entering the reagent.

If any nozzles of the dispensing cassettes are clogged, try one of the following procedures:

- Rinse the nozzles by pressing the **Recover** and the **Prime** button alternatively.
- Dismount the dispensing cassette. Fill a 20 ml syringe with deionized water or ethanol, attach a round sterile filter and put a suitable short tubing on the syringe and on the outlet of the nozzle. Press liquid through the nozzle. To verify the cleaning, put the syringe to the nozzle inlet and check if liquid is coming out of the nozzle while pressing liquid through.

5.2.5 Decontamination

The whole dispensing cassettes with tubings can be autoclaved a maximum of ten times each at 1 bar pressure at 121°C for 20 min. Replace dispensing cassette after ten autoclave cycles!



CAUTION

After autoclaving, the dispensing cassettes must cool down to room temperature before use.

Do not autoclave any other parts of the WELLJET than specified.

Alternatively, the dispensing cassettes can be decontaminated in Virkon 1–3%, Ethanol 70% or glutaraldehyde 4%, or 3-10 % H₂O₂ solution for 10 minutes. Afterwards rinse them with deionized water.

5.2.6 Performance for non-aqueous solutions

The cassette performance is validated for aqueous solutions, see "Accuracy and precision specifications" on page 39.

The accuracy, i.e. the ability to dispense the exact volume desired, depends on the viscosity and vapor pressure of the liquid. The volume of the dispensing program is correct for aqueous solutions. For non-aqueous liquids, the dispensed volume must be empirically, e.g. gravimetrically, determined and adapted:

Materials

- Validated precision balance with 0.01 mg readability
- Microplate(s)
- Thermometer
- Non-aqueous liquid to be tested

Test conditions and environment

- Temperature needs to be between 18–25 °C and remain constant (± 0.5 °C) throughout the test.
- Optimal relative humidity of the environment is >50%.
- The balance needs to be situated in a draft-free environment.
- The dispensing cassette and the liquid need to be in the laboratory for at least 2 hours prior to testing to reach temperature equilibrium with the environment.

Dispensing

- 1) Weigh an empty microplate, e.g. $m_p = 46.55$ g for a 96 well plate.
- 2) Put the plate on the WELLJET and prime the dispensing cassette.
- 3) Dispense the liquid into the half plate, e.g. 100 μ l into the first 6 columns (48 wells), and weigh the plate, e.g. $m_d = 51.61$ g.

Calculations

The following variables are used in the calculations:

V_t = Selected test volume (ml)

m_p = Weight of empty plate (g)

m_d = Weight of half dispensed plate (g)

m_a = Actual liquid weight (g)

n = Number of dispensed wells

d = Density of dispensed liquid (g/ml)

m_t = Calculated target weight of the liquid (g)

- 1) Consult one of the several tables available on the internet to determine the density of the liquid to be dispensed at the lab temperature, e.g. 1.0727 g/ml for 30 % glycerol at 20 °C.
- 2) Calculate the target weight of the liquid in the half dispensed plate $m_t = V_t \times n \times d$, e.g. $m_t = 0.1 \text{ ml} \times 48 \times 1.0727 \text{ g/ml} = 5.15 \text{ g}$.
- 3) To obtain the actual weight m_a , subtract the weight of the empty plate from the dispensed plate $m_a = m_d - m_p$, e.g. $m_a = 51.61 \text{ g} - 46.55 \text{ g} = 5.06 \text{ g}$.
- 4) Determine the percent deviation of the actual weight m_a to the target weight m_t .
Accuracy = $100 \times (m_a - m_t) / m_t$, e.g. accuracy = $100 \% \times -0.09 \text{ g} / 5.15 \text{ g} = -1.75 \%$.
- 5) Adjust the cassette **Liquid Factor** of the corresponding dispense program under **Advanced Functions**, if necessary. A liquid factor of e.g. 1.01 increases the dispense volume of all channels by 1%. For the example above, enter 1.0175. The **Liquid Factor** is rounded up to 1.02.

**NOTE**

The method described above is a simple and practical approach, which do not consider the liquid correction factor Z, which also depends on air pressure, and evaporation loss.

5.3 WELLJET



WARNING

Always turn off power and unplug the power supply before cleaning the exterior.

Spilled fluids can damage the outer surface and internal components.

5.3.1 Cleaning

For reliable daily operation, keep the WELLJET free of dust and liquid spills. Immediately wipe away spilled acids, solvents, alkaline or saline solutions to prevent damage.

The materials used on the exterior of the WELLJET support regular cleaning intervals. Clean the external components periodically with a moistened lint-free cloth or Kim wipe lightly soaked with mild soap solution in distilled water. Also, a 70% dilution of Isopropyl or Ethanol alcohol mix can be used. Never use acetone or other solvents.

5.3.2 Decontamination

Decontamination is not required for the proper functioning of the WELLJET. Only if any surfaces have been in direct contact with biohazardous material, they must be decontaminated in accordance to good laboratory practice. Wipe the clean surface with a lint-free cloth, lightly soaked e. g. with the following disinfectants:

- Ethanol 70%
- Microcide SQ 1:64
- Glutaraldehyde solution 4%
- Virkon solution 1–3%

Follow the instructions provided with the reagents.

The device may be decontaminated with H₂O₂ gas (maximal concentration 35 %) for 60 minutes.

5.3.3 Regularly data backup

It is recommended to save your dispense and cleaning programs, your labware library and your settings regularly. Select System settings - Backup and save your data on a USB drive. This backup can be imported on another device.

5.4 Servicing

INTEGRA Biosciences recommends annual preventative maintenance service for the WELLJET. Please contact INTEGRA for pricing and details.

If liquid ever enters the internals of your WELLJET, please contact INTEGRA Biosciences for service advice.

In case of a technical error, enter the Settings - Maintenance menu and save the device log files on a USB drive. Contact you local customer service department.



WARNING

If working with infectious materials, e. g. human pathogens, WELLJET needs to be decontaminated before sending them to service and the declaration on the absence of health hazards must be signed. This is necessary to protect service personnel.

5.5 Equipment disposal



The WELLJET must not be disposed of with unsorted municipal waste.

Dispose the WELLJET in accordance with the laws and regulations in your area governing disposal of devices. In certain regions and countries, e.g. in EU member states, the distributor is obliged to take back this product free of charge at the end of life. Please contact your local distributor for more details.

6 Technical Data

6.1 Environmental conditions

	Operation
Temperature range	5–35°C
Humidity range	Max. rel. humidity 80% for temperatures up to 31°C, decreasing linearly to 50 % rel. humidity at 40°C.
Altitude range	< 2000 m
Pollution degree 2	According to IEC EN/UL 61010-1, i.e. non-conductive pollution only.
Overvoltage Category I	According to IEC 60364-4-44, i.e. equipment intended to be connected to a mains supply

6.2 Specification of the WELLJET

	Dispenser	Dispenser Stacker
Dimensions (L x D x H)	20 x 46 x 29 cm	46 x 46 x 63 cm, tower 25 plates ¹ 46 x 46 x 102 cm, tower 50 plates ¹
Weight	8.8 kg	20.9 kg (without towers) 22.1 kg (with 2 towers 25 plates) 22.6 kg (with 2 towers 50 plates)
Electricity supply	Mains adapter input: 100–240 VAC, 47–63 Hz Device input: 22.8–25.2 VDC, 100 W	
Noise emission	< 60 dBA	< 60 dBA
User interface	17.8 cm / 7" high resolution touch screen	
Integration	Ethernet interface, API commands available for Dispenser only	
Detection method	-	optical sensor
Dispense time (100 µl to 96 well plate)	10 s	19 s (1 plate, non-lidded) 25 s (1 plate, lidded)
Compatible plate formats	6, 12, 24, 48, 96, 384, 1536, shallow & deep well plates	
Compatible plate heights	5 – 64 mm	9-25 mm (stacker mode) 5-64 mm (manual mode)

1. The number of plates may vary depending on their height and might be lower for plates with lids.

6.3 Intellectual property

The WELLJET is covered under the following patent:

Patent Number	Country	Title
US 2022/ 0074405A1	USA	DISPENSER CASSETTE FOR USE IN A PERISTALTIC PUMP
US 2022/ 0074404A1	USA	INJECTION-MOLDED HOSE
00737/21	CH	Stacking device for microtiter plates Stapel-Vorrichtung für Mikrotiterplatten

Third party licenses

WELLJET contains copyrighted open source software components. Please refer to the list in the [Download center](#) of our website under "Open Source Licenses".

For other requests concerning open source and instrument software or if you encounter problems accessing above, please contact INTEGRA Biosciences via support@integra-biosciences.com or call us on +41 81 286 95 11. This service is free of charge. If you request physical copies you will be charged a fee covering the cost of reproduction and shipment.

6.4 Dispensing cassettes

6.4.1 Volumes

	Dispensing cassette		
	5100 (8-ch small)	5101 (8-ch large)	5110 (16-ch small)
Volume range	0.5-500 µl	5.0-9999 µl	0.5-500 µl
Dispensing increments	0.1 µl (small and large bore tubing)		
Dead volume per channel	< 0.26 ml	< 0.64 ml	< 0.26 ml
Dead volume per cassette (= cassette cycle volume with standard source tubing length of 50 cm)	< 2.1 ml	< 5.0 ml	< 4.2 ml
Tubing inner diameter	0.9 mm	1.2 mm	0.9 mm
Orifice of dispensing nozzles	0.3 mm	0.46 mm	0.3 mm
For processing of well plates	96, 384 or 1536	96 or 384	384 or 1536

6.4.2 Dispensing times

The tables below list the times for dispensing one plate.

Conditions: fast dispense and movement speeds.

Dispenser:

Dispensing option	Well plate	Volume	Duration
8 Channel small bore cassette	96 well	10 µl	3.9 s
8 Channel small bore cassette	384 well	10 µl	14.5 s
8 Channel large bore cassette	96 well	100 µl	10.0 s
8 Channel large bore cassette	384 well	100 µl	29.4 s
16 Channel small bore cassette	384 well	10 µl	7.3 s
16 Channel small bore cassette	1536 well	10 µl	21.1 s

Stacker:

Dispensing option	Well plate	Volume	Without lid	With lid
8 Channel small bore cassette	96 well	10 µl	18 s	24 s
8 Channel small bore cassette	384 well	10 µl	29 s	35 s
8 Channel large bore cassette	96 well	100 µl	19 s	25 s
8 Channel large bore cassette	384 well	100 µl	44 s	50 s
16 Channel small bore cassette	384 well	10 µl	22 s	28 s
16 Channel small bore cassette	1536 well	10 µl	43 s	49 s

6.4.3 Accuracy and precision specifications

Cassette part no.	Test volume (µl)	Accuracy (±%, typical)	Precision (≤%)
5100 (8-ch small)	50	1.0	1.0
	10	1.0	2.5
	2	6.0	4.0
5101 (8-ch large)	100	1.0	1.0
	50	1.0	1.5
	20	1.5	2.5
5110 (16-ch small)	50	1.0	1.0
	10	1.0	2.5
	2	6.0	4.0

The specifications apply only to dispenses of aqueous solutions.

6.4.4 Life time expectancy

The life time of the dispensing cassettes depends on the dispensed volume per channel.

Cassette part no.	Max. volume/ channel (l)	Examples		
		Well plates	Dispense volume (µl)	Number of plates
5100 (8-ch small)	1.2	96	100	1000
			50	2000
			25	4000
		384	100	250
25	1000			
10	2500			
5101 (8-ch large)	2.4	96	250	800
			100	2000
			50	4000
		384	100	500
			25	2000
			10	5000
5110 (16-ch small)	1.2	384	25	2000
			10	5000
			5	10000
		1536	25	500
			10	1250
			5	2500

6.4.5 Compatibility of cassettes with plate type

Plate type	5100 (8-ch small)	5101 (8-ch large)	5110 (16-ch small)
6-well	yes	yes	no
12-well	yes	yes	no
24-well	yes	yes	no
48-well	yes	yes	no
96-well	yes	yes	no
384-well	yes	yes	yes
1536-well	yes	yes ¹	yes

1. The use of an 8-channel large bore cassette with 1536-well plates is not recommended. Correct plate and cassette alignment cannot be guaranteed.

6.4.6 Chemical compatibility

A particular advantage of the dispensing cassettes is that the fluid remains enclosed inside the tubing. Even chemical aggressive liquids can be transferred without the risk of damaging parts of the pump as long they are compatible with the components coming in contact with the liquid:

Component	Material
Tubing weight	Glass fiber and mineral filled polypropylene sulfide
Source tubing	High consistency silicone, platinum cured
Cassette tubing	Molded silicone, platinum cured
Dispensing nozzles and connector	Polypropylene

The table below rates the compatibility to a few of the chemicals commonly used in laboratories. INTEGRA Biosciences assumes no liability for the information contained in the table.

Chemical		Ratings	
		Silicone	Polypropylene
Acetic acid	CH ₃ COOH	B	A
Acetone	C ₃ H ₆ O	C	B
Acetonitrile	C ₂ H ₃ N	C	A
Dimethyl sulfoxide (DMSO)	DMSO	A	A
Ethanol 70%	C ₂ H ₅ OH	B	A
Glycerine	C ₃ H ₈ O ₃	A	A
Hydrochloric acid 33%	HCl	C	B
Phenol 50%	C ₆ H ₅ OH	C	C
Sodium carbonate	Na ₂ CO ₃	A	A
Sodium hydroxide 50%	NaOH	B	A
Sodium hypochlorite (JAVEL, < 20%)	NaClO	A	A
Sulfuric acid 30%	H ₂ SO ₄	B	A

Compatibility ratings for silicone tubing:

A = good, little to minor effects (0-5% volume swell).

B = fair, moderate effects, not recommended for continuous use (5-10% volume swell).

C = critical, not recommended (10% or greater volume swell).

To determine the compatibility to a chemical not listed in the table, please consult one of the several tables available on the internet.

It is the responsibility of the users to ensure the chemical compatibility. Before using a critical chemical, immerse a short piece of the tubing in a closed container of the chemical for 48 hours. Check the tubing for signs of swelling, softening, discoloration, embrittlement or any other attack.

7 Accessories and consumables

7.1 Accessories

Accessories	Part no.
Plate stacker tower, capacity of 25 plates	5400
Plate stacker tower, capacity of 50 plates	5401
Tube holder 15 ml / 50 ml centrifuge tubes	5402
Waste trough with silicone tubing	5410
Silicone tubing for waste trough	5411
Plate measuring tool	5412
Mains adapter	128909

7.2 Consumables

Dispensing cassettes	Part no.
EasySnap™, 8 channel, small bore, 0.5-999 µl, sterile	5100
EasySnap™, 8 channel, large bore, 5.0-9999 µl, sterile	5101
EasySnap™, 16 channel, small bore, 0.5-999 µl, sterile	5110

Multichannel reagent reservoirs 25 ml	Part no.
Reservoir base 25 ml, pack of 10	4304



polystyrene	Trial pack, sterile (3 reservoirs, 1 base)	4310
	Sterile, pack of 30 (30 individually wrapped, 1 base)	4311
	Sterile, pack of 200 (4 sleeves, 1 base)	4312
polypropylene	Trial pack, sterile (3 reservoirs, 1 base)	4315
	Sterile, pack of 30 (30 individually wrapped, 1 base)	4316
	Sterile, pack of 200 (4 sleeves, 1 base)	4317

Imprint

Copyright © 2023 by INTEGRA Biosciences AG.

All rights reserved. No part of this work may be reproduced or transmitted in any form or by any means, electronic or mechanical, including photocopying and recording, or by any information storage or retrieval system, except as may be expressly permitted in writing by INTEGRA Biosciences AG.

This operating instruction manual has part number 191950, the version is V05. It applies as of (see Settings - Device information):

WELLJET Dispenser software version	V1.04 or higher
------------------------------------	-----------------

WELLJET Dispenser Stacker software version	V1.04 or higher
--	-----------------

until a newer revision is released.

Manufacturer and customer service

Your local INTEGRA Biosciences representative, further information, and operating instructions in other languages can be found at www.integra-biosciences.com or are available on request info@integra-biosciences.com.

INTEGRA Biosciences AG

Tardisstrasse 201
CH-7205 Zizers, Switzerland
T +41 81 286 95 30

INTEGRA Biosciences Corp.

22 Friars Drive
Hudson, NH 03051, USA
T +1 603 578 5800

INTEGRA Biosciences SAS

8 avenue du Fief
95310 Saint Ouen l'Aumône, FR
T +33 1 34 30 76 76

INTEGRA Biosciences Deutschland GmbH

An der Amtmannsmühle 1
35444 Biebertal, DE
T +49 6409 81 999 15

INTEGRA Biosciences Ltd

2 Rivermead Business Park
Thatcham, Berks, RG19 4EP, UK
T +44 1635 797 00

INTEGRA Biosciences Nordic ApS

Vallensbækvej 22A 3TV
Brøndby 2605, DK
T +45 3173 5373

INTEGRA Biosciences KK

Higashikanda 1-5-6, Chiyoda-ku
Tokyo, 101-0031, JP
T +813 5962 4936

INTEGRA Biosciences (Shanghai) Co., Ltd.

Room 1110, No. 515 Huanke Road
Shanghai 201315, CN
T +86 21 5844 7203
