



# Axiomtek tBOX110-APL-MR2 Intel Atom x5-E3940 Fanless Embedded System for Rail PC

## Key Features:

- CE, FCC, LVD, EN 45545-2 and EN 50155 certified; ISO7637-2 compliant
- Intel Atom x5-E3940 processor
- Fanless and wide operating temperatures from -40°C to +70°C
- Supports 9 to 36VDC and 12/24VDC typical in-vehicle power input
- Supports 24 to 110VDC for railway power input
- Compact size with multiple COM, CANBus, and DIO for communication
- Smart Ignition for power on/off schedule, vehicle battery protection, and different power modes
- Suitable for transportation gateway applications

## Description

### Diverse Communication Options

The highly integrated transportation PC combines diverse communication interfaces, including two COM, two CANBus (two COM for option), and one DIO.

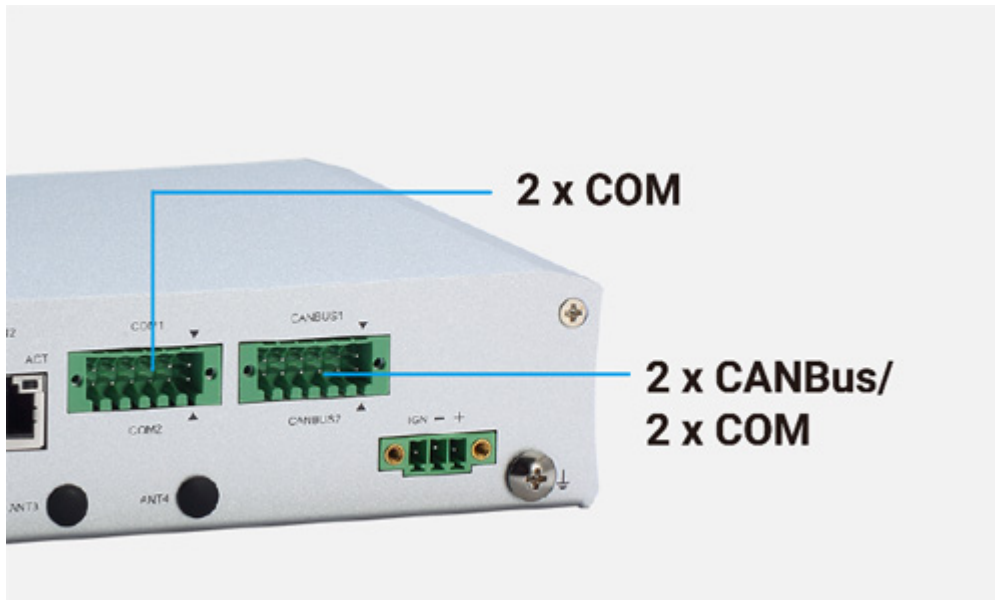

### Smart Ignition Support

Equipped with smart ignition power control, the tBOX110 enables to schedule power on/off events to protect the vehicle battery from unstable voltage and supports different power modes.



### Comprehensive Transportation Gateway Solutions

Axiomtek's tBOX110 offers comprehensive transportation gateway solutions, catering to a wide range of applications, from in-vehicle to railway. This transportation-grade embedded system not only meets ISO 7637-2 standards but also has full certification to EN 45545-2 and EN 50155. By choosing the tBOX110, customers can benefit from significant cost savings and reduced waiting time, since they no longer need to bear verification fees or lengthy certification processes. This makes the tBOX110 a highly efficient and reliable choice for transportation-related projects.

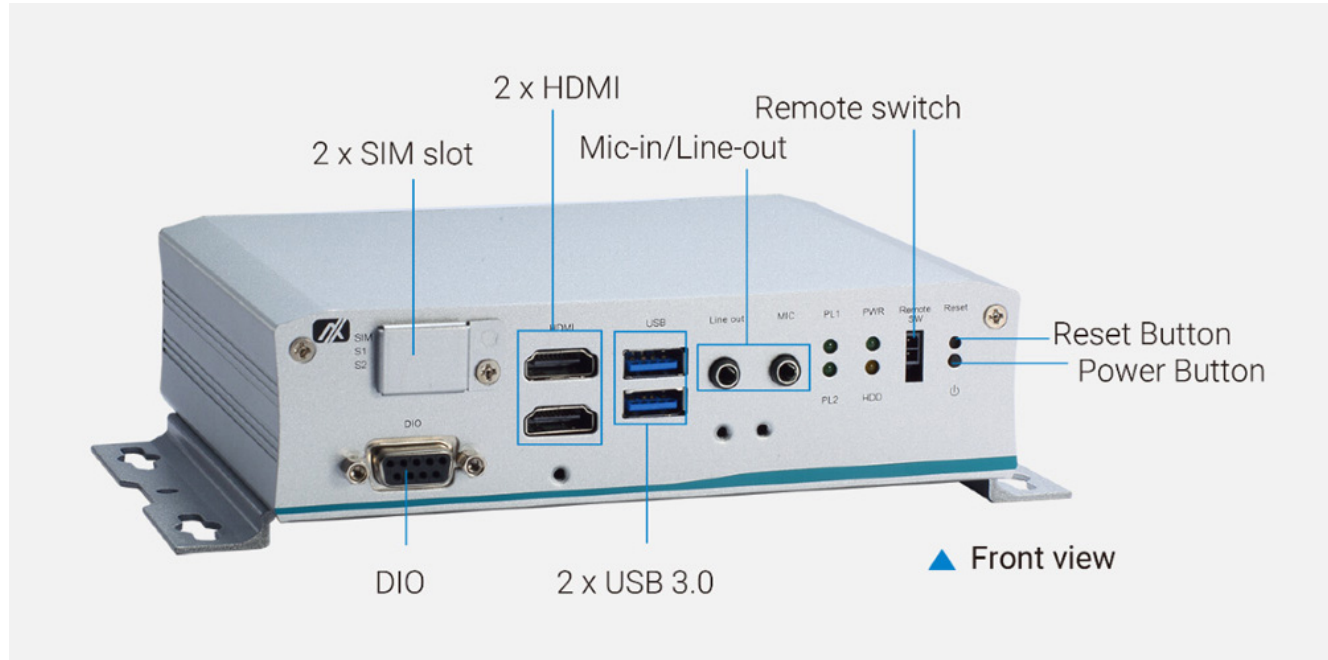

### Compact Size and Low Power

The tBOX110 is designed with low power consumption and heavy-duty construction that can withstand challenging day-to-day operational conditions. The DIN-rail and wall-mountable tBOX110 measures only 164 x 128 x 44 mm and weighs 1.0 kg.

### Rugged Design

The tBOX110 has a wide operating temperature range of -40°C to +70°C and 3Grms vibration resistance. It supports 12/24 VDC typical automotive power input with smart ignition, or 24 to 110 VDC for railway use, and a wide-range 9 to 36V DC power input for general purposes. Equipped with smart ignition power control, the tBOX110 enables to schedule power on/off events to protect the vehicle battery from unstable voltage and supports different power modes.

### Rich I/O Interfaces

The tBOX110 has two COM, two CANBus, two RS-232/422/485 with shield grounding, two RJ-45 LAN ports, two USB 3.0 ports, two HDMI 1.4b with keylock, one Mic-in, one Line-out, one DB9 8-bit programmable DIO, one power input with smart ignition.

# tBOX110 NEW

Fanless Embedded System with Intel Atom® x5-E3940 Processor for Vehicle and Rail PC

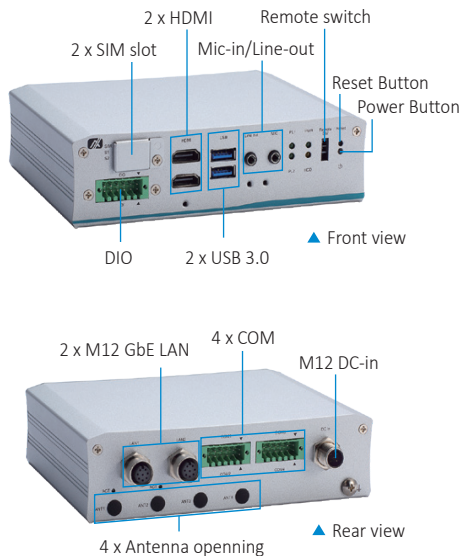

## Features

- CE, FCC, LVD, EN 45545-2 and EN 50155 certified; ISO7637-2 compliant
- Intel Atom® x5-E3940 processor
- Fanless and wide operating temperatures from -40°C to +70°C
- Supports 9 to 36VDC and 12/24VDC typical in-vehicle power input
- Supports 24 to 110VDC for railway power input
- Compact size with multiple COM, CANBus, and DIO for communication
- Smart Ignition for power on/off schedule, vehicle battery protection, and different power modes
- Suitable for transportation gateway applications

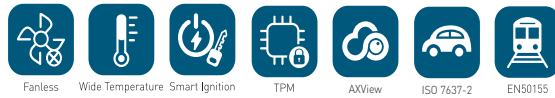

## Specifications

Standard Color	Silver	
Construction	Aluminum extrusion and heavy-duty steel, IP20	
CPU	Intel Atom® x5-E3940 4C @1.6 GHz, TDP: 9.5W	
Chipset	SoC integrated	
System Memory	1 x DDR3L-1866 SO-DIMM, up to 8GB	
BIOS	AMI	
System I/O Outlet	Serial	Vehicle: 2 x RS-232/422/485 (4-wire) with shield grounding Railway: 4 x Isolated RS-232/422/485 (4-wire) with shield grounding
	Display	2 x HDMI 1.4b (with keylock)
	CANBus	Vehicle: 2 x Isolated CANBus 2.0 A/B, support SocketCAN
	Audio	1 x Mic-in, 1 x Line-out
	Ethernet	Vehicle : 2 x RJ-45 10/100/1000 Mbps Ethernet (Intel® I210-IT) Railway: 2 x M12 A-coded 10/100/1000 Gbps Ethernet (Intel® I210-IT) 2 x M12 X-coded 10/100/1000 Gbps Ethernet (Intel® I210-IT)
System I/O Outlet	USB	2 x USB 3.0
	DIO	Vehicle: 1 x DB9 8-bit programmable DIO Railway: 1 x Terminal block isolated DIO 4-in/4-out (isolation voltage: 2 kV)
	Others	1 x Reset button 1 x Power button 1 x Remote switch 4 x Antenna opening
Expansion Interface	2 x Full-size Rev.1.2 PCI Express Mini Card slot: • 1 x USB/PCIe with external SIM socket • 1 x mSATA/USB/PCIe with external SIM socket	
Storage	SATA Drive	1 x Internal 2.5" SATA drive (9.5 mm height)
	mSATA	1 x mSATA (occupied 1 x PCI Express Mini Card slot)



## Specifications

Watchdog Timer	255 levels, 1 to 255 sec.	
Power	Power Supply	General use: 1 x Terminal block/M12, 9- 36 VDC Vehicle: 1 x Terminal block, 12/24VDC with Smart Ignition Railway: 1 x M12, 24 to 110VDC
	Power Consumption	Vehicle: 9 VDC, 3.742A; 36VDC, 0.907A Railway: 24 to 110VDC, 0.98A - 0.33A
System Indicator	1 x LED indicator for SATA drive activity 1 x LED indicator for power 2 x LED indicator for LAN activity 2 x Programmable indicator	
Operating Temperature	-40°C to +70°C (-40°F to +158°F) with W.T. peripheral*	
Humidity	0% to 95%, non-condensing	
Dimensions	164.1 mm (6.46") (W) x 128 mm (5.04") (D) x 44.1 mm (1.74") (H) (without wall mount)	
Mounting	Wall mount, DIN-rail (optional)	
Weight (net/gross)	1.02 kg (2.24 lb)/1.44 kg (3.17 lb)	
Certifications	CE, FCC, LVD, EN 45545-2 and EN 50155 certified ; ISO 7637-2 compliant	
EMC	CE/FCC	EN 55022 (Class A), EN 55024, EN 50155, EN 50121-3-2, IEC 62236-3-2, FCC part 15 B (Class A)
Vibration Endurance	3 Grms w/ SSD (5 to 500Hz, X/Y/Z direction; random, operating) 1 Grms w/ HDD (5 to 500Hz, X/Y/Z direction; random, operating) 2 Grms w/ HDD & Anti-Vibration Kit (5 to 500Hz, X/Y/Z direction; random, operating) MIL-STD-810G, Method 514.6C-VI Category 4 compliant	
EOS Support	Windows® 10 64-bit, Ubuntu 20.04	
Software Support	AXView	

\*Wide temperature . All W.T. supported products have to be sorted by Axiomtek.

## Ordering Information

### System

tBOX110-APL-TV (P/N: E26N110100)	Fanless vehicle grade embedded system with Intel Atom® x5-E3940, 2 RJ-45 GbE LAN, terminal block DC-in, 2 USB 3.0, 2 HDMI, 2 COM, DIO, 2 CAN, audio mic-in/line-out, Smart Ignition, TPM 2.0, and 12/24 VDC	
tBOX110-APL-MR2 (P/N: E26N110102)	Fanless embedded system with Intel Atom® x5-E3940, 2 M12 A-code GbE LAN, M12 DC-in, 2 USB 3.0, 2 HDMI, 4 COM, DIO, audio mic-in/line-out, TPM 2.0, and 24 to 110VDC	
tBOX110-APL-MR4 (P/N: TBD)	Fanless embedded system with Intel Atom® x5-E3940, 2 M12 X-code GbE LAN, M12 DC-in, 2 USB 3.0, 2 HDMI, 4 COM, DIO, audio mic-in/ line-out, TPM 2.0, and 24 to 110VDC	

### Optional

Communication modules	886N32410A0E	MCR8822CE-P WiFi KIT (20) for tBOX (E)
	886N11012A0E	LTE NL668-JP tBOX110 M1R 2020(E)
	886N11010A0E	LTE LE910C4-AP (20) for tBOX110 (E)
AC to DC adapter	509000001500	PWS FSP120-AAAN3(9NA1206647) FSP 120W
	509000002200	PWS 9NA0908344 FSP 90W
Mounting Kit	886N11011A0E	tBOX110 DIN RAIL KITS (E)
Anti-vibration Kit	8816N1000A0E	tBOX Anti-vibration kit(S) (E)

\*Specifications and certifications may vary based on different requirements.

## Packing List

- 1 x Wall mount kit
- 1 x Thermal pad for memory
- 4 x Wall mount kit screw
- 1 x HDMI bracket
- 1 x Audio bracket
- 1 x DIO terminal block connector (MR only)
- 1 x Power 3-pin terminal block connector (TV only)
- 1 x Rubber for HDD
- 1 x Cable holder kit

## Power Protection

OCP (over current protection)

OVP (over voltage protection)

UVP (under voltage protection)

RPP (reverse polarity protection)

ISO 7637-2 pulse 1, 2a, 2b, 3a, 3b, 4 (vehicle version)

Setting for in-vehicle battery protection: system will be automatically turned down at low voltage level

Setting for ignition control: system will activate a counter while in-vehicle battery at low voltage, ACC-ON delay and shut down delay

## Dimensions

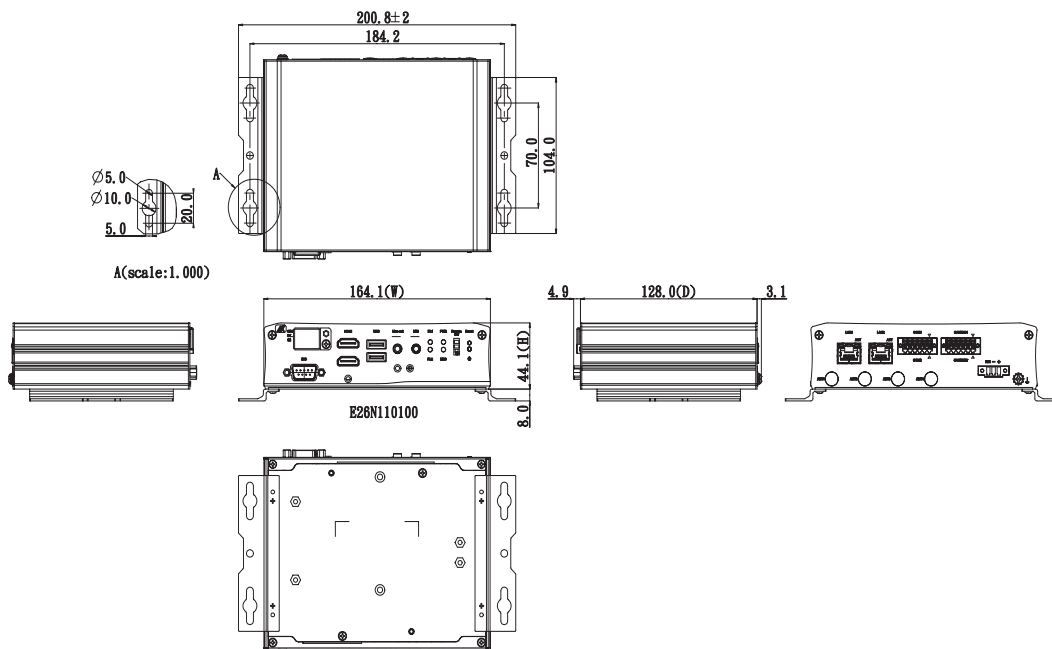

## Images



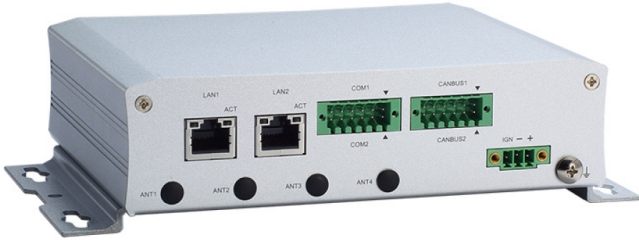



## Ordering Information

**tBOX110-APL-TV (P/N-E26N110100):** Fanless vehicle embedded system with Intel Atom x5-E3940, 2 RJ-45 GbE LAN, terminal block DC-in, 2 USB 3.0, 2 HDMI, 2 COM, DIO, 2 CAN, audio mic-in/line-out, Smart Ignition, TPM 2.0, and 12/24 VDC

**tBOX110-APL-MR2 (P/N-E26N110102):** Fanless railway embedded system with Intel Atom x5-E3940, 2 M12 A-code GbE LAN, M12 DC-in, 2 USB 3.0, 2 HDMI, 4 COM, DIO, audio mic-in/line-out, TPM 2.0, and 24 to 110VDC

**tBOX110-APL-MR4:** Fanless embedded system with Intel Atom x5-E3940, 2 M12 X-code GbE LAN, M12 DC-in, 2 USB 3.0, 2 HDMI, 4 COM, DIO, audio mic-in/ line-out, TPM 2.0, and 24 to 110VDC

## Assured Systems

Assured Systems is a leading technology company with over 1,500 regular clients in 80 countries, deploying over 85,000 systems to a diverse customer base in 12 years of business. We offer high-quality and innovative rugged computing, display, networking and data collection solutions to the embedded, industrial, and digital-out-of-home market sectors.

### US

[sales@assured-systems.com](mailto:sales@assured-systems.com)

Sales: +1 347 719 4508  
Support: +1 347 719 4508

1309 Coffeen Ave  
Ste 1200  
Sheridan  
WY 82801  
USA

### EMEA

[sales@assured-systems.com](mailto:sales@assured-systems.com)

Sales: +44 (0)1785 879 050  
Support: +44 (0)1785 879 050

Unit A5 Douglas Park  
Stone Business Park  
Stone  
ST15 0YJ  
United Kingdom

VAT Number: 120 9546 28  
Business Registration Number: 07699660