



Sacral Neuromodulation System

Tined Lead Implant Manual

Model 1201, 2201 Tined Lead

Model 1801 Lead Implant Kit

Rx only

Axonics®, Axonics Modulation®, Axonics Modulation Technologies®, and Axonics Sacral Neuromodulation System® are trademarks of Axonics Modulation Technologies, Inc., registered or pending registration in the U.S. and other countries.



Axonics Modulation Technologies, Inc.

26 Technology Drive

Irvine, CA 92618 (USA)

























www.axonicsmodulation.com

Tel. +1-877-929-6642

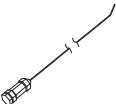
Fax +1-949-396-6321

LABEL SYMBOLS

This section explains the symbols found on the product and packaging.

Symbol	Description	Symbol	Description
	Manufacturer		Sterilized using Ethylene oxide
	Product Model Number		Use by
	Manufacturing Date		Do not use if package is damaged
	Conformité Européenne (European Conformity):2019. This symbol means that the device fully complies with AIMD Directive 90/385/EEC (Notified Body reviewed) and RED 2014/53/EU (self-certified)		For USA audiences only Caution: U.S. Federal law restricts this device for sale by or on the order of a physician
	Refer to instructions for use (Consult accompanying documents)		Authorized representative in the European community
	Temperature limitation		Open here
	Humidity limitation		Warning / Caution
	Pressure limitation		Product Literature
	Lot number		Do not reuse
	Curved Stylet		Do not resterilize
			Magnetic Resonance (MR) Conditional
	Directional Guide		Foramen Needle
	Straight Stylet		Introducer Sheath and Dilator







Symbol	Description	Symbol	Description
	Tined Lead Test Stimulation Cable		Torque Wrench
	Needle Test Stimulation Cable		Tunneling Tool
	Percutaneous Extension		Indicates two sterile barrier systems

Table of Contents

LABEL SYMBOLS	3
INTRODUCTION	6
INDICATIONS, WARNINGS, AND PRECAUTIONS	6
PURPOSE OF THE TRIAL SYSTEM	6
DEVICE DESCRIPTION	6
Package contents	6
Storage and Usage Environment	8
Sterilization	8
SPECIFICATIONS	9
LEAD IMPLANT PROCEDURE	10
Procedure supplies	10
Procedure preparation	10
Needle placement and test stimulation	11
Tined lead placement	12
Tined lead tunneling	16
CONNECTING TO THE PERCUTANEOUS EXTENSION (FOR MODEL 2201 ONLY)	16
REMOVING THE PERCUTANEOUS EXTENSION	18
CONNECTING TO THE NEUROSTIMULATOR (PERMANENT IMPLANT)	19
COMPLETING A LEAD IMPLANT PROCEDURE	19
Post-surgery treatment	19
POST-SURGERY LEAD REMOVAL	19
CUSTOMER SERVICE	19

INTRODUCTION

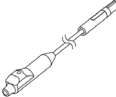
This manual provides information about the Axonics Sacral Neuromodulation (SNM) System tined lead (Model 1201 and 2201) and the lead implantation procedure. The tined lead can be used with the Axonics Model 1101 Neurostimulator and Model 1601 Trial Stimulator

The tined lead connects to a stimulation device, which creates a series of electrical pulses to stimulate the S3 or S4 sacral nerve. A set of accessories, including procedure-specific surgical tools, Axonics Model 1801, and stimulation cables, and a Clinician Programmer (CP) are used to implant the tined lead.

Instructions for connections to the Neurostimulator and the Trial Stimulator are found in their respective manuals.

INDICATIONS, WARNINGS, AND PRECAUTIONS

- Refer to Indications for Use insert for indications and contraindications
- Refer to Information for Prescribers booklet for warnings, precautions, adverse events, patient selection and clinical summary.
- Refer to MRI Physician Guidelines for MRI specific conditions and contraindications.

PURPOSE OF THE TRIAL SYSTEM

The Axonics SNM Trial System is used for a test period to evaluate if a subject should be treated with the Axonics SNM System. Trial stimulation with the tined lead is expected to last 14 days and should not exceed 14 days.

DEVICE DESCRIPTION

The Axonics tined lead (**Figure 1**) has four cylindrical electrodes. These are designed to be implanted adjacent to one of the sacral nerve roots (most often the third sacral nerve root). All four electrodes are equal in length and spaced equidistantly along the lead.

The distal end of the lead has tines to anchor the lead in the sacrum and surrounding connective tissue. There are also markers to indicate lead depth and level of tine deployment during implantation. The proximal end of the lead has a marker to facilitate complete insertion of the lead into the Neurostimulator header. Markers B, C, and D can only be seen visually, while marker A can also be seen under fluoroscopy.

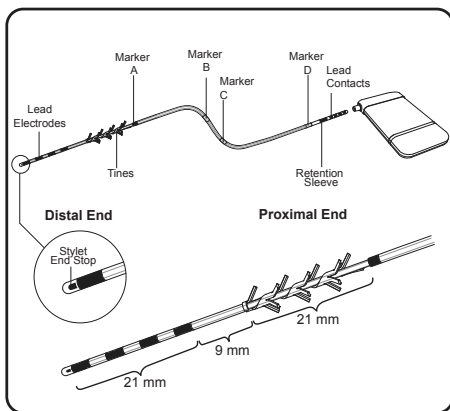

Figure 1. Axonics Tined Lead

Package contents

The **Tined Lead Kit**, Model 1201 contains the following:

- Tined lead
- Straight stylet (in situ)
- Curved stylet
- Tined lead test stimulation cable

The **Tined Lead Kit**, Model 2201 contains the following:

- Tined lead

- Straight stylet (in situ)
- Curved stylet
- Tined lead test stimulation cable
- Percutaneous extension cable

The contents of the inner packages are STERILE. The contents of the Tined Lead Kit are intended for single use only.

The **Tined Lead Implant Kit** (Axonics Model 1801) contains Lead implant tools (**Figure 2**) and Lead implant cables (**Figure 3**):

Package contents:

- Foramen needle (x2)
- Directional guide
- Introducer sheath and dilator
- Tunneling tool (including a tip and 2 sheaths)
- Torque wrench
- Needle test stimulation cable

The contents of the inner packages are STERILE. The Stimulation ground cable and pad are provided separately and are not sterile.

The contents of the Tined Lead Implant Kit are intended for single use only.

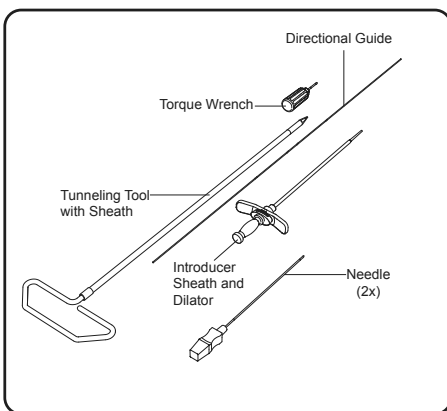

Figure 2. Lead implant tools

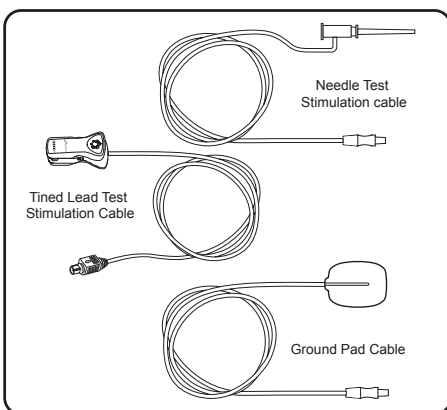

Figure 3. Lead implant cables

Storage and Usage Environment

Component packaging – Do not use the component if any of the following have occurred:

- The storage package or sterile pack has been damaged, pierced, or altered. In this case the sterility cannot be guaranteed, which may lead to infection.
- The component itself shows any signs of damage. The component may not function properly.
- The use-by date has expired. In this case, component sterility cannot be guaranteed and infection may occur.
- The sterile component was dropped onto a non-sterile surface. In this case, the sterility cannot be guaranteed and infection may occur.

Usage environment – The following lists the appropriate temperature, humidity, and pressure condition for use of the Axonics components:

- Temperature (leads): 20 °C to 45 °C
- Temperature (accessories): 5 °C to 40 °C
- Humidity (accessories): 15% to 95%
- Pressure (accessories): 70 kPa to 106 kPa
- Pressure (leads): The Leads should function at up to 10 m (33 feet) underwater (200 kPa) and at altitudes up to 3000 m (10,000 feet) associated with activities like hiking and skydiving (as low as 70 kPa)

Shipping and Storage environment – The following lists the appropriate temperature, humidity, and pressure condition for shipping and storage of Axonics components:

- Temperature (short term: 3 days, Lead): -10 °C to 55 °C
- Temperature (short term: 3 days, accessories): -25 °C to 70 °C
- Temperature (long term, Lead and accessories): 20 °C to 30 °C
- Humidity (short term: 3 days, Lead and accessories): 15% to 95%
- Humidity (long term, Lead and accessories): 30% to 85%
- Pressure (short term: 3 days, Lead and accessories): 57 kPa to 106 kPa
- Pressure (long term, Lead and accessories): 70 kPa to 106 kPa

If the components are exposed to extreme temperatures, they may be permanently damaged and should not be used, even if they returned to a temperature that is within the specified operating range.

Sterilization

The contents of this package have been sterilized using ethylene oxide. This device is for single use only and should not be resterilized.

SPECIFICATIONS

Table 1 shows the Tined lead specifications. **Table 2** shows the Percutaneous Extension specifications. For detailed descriptions and specifications for other components and accessories, refer to the product literature packaged with those devices.

Table 1. Tined lead specifications

<i>Physical and Electrical Properties</i>	
Lead length	30 cm
Lead diameter	1.3 mm
Connector	In-line
Number of electrodes	4
Electrode shape	Cylindrical
Electrode length	3 mm
Electrode spacing	3 mm
Number of conductor wires	4
Conductor resistance	135 Ohms (maximum)
<i>Materials</i>	
• Conductor wires	35N LT
• Proximal connector	Platinum-iridium
• Stimulating electrodes	Platinum-iridium
• Tines/Anchor	Polyurethane
• Retention sleeve	MP35N
• Conductor wires Insulation	Fluoropolymer
• Jacket tubing	Polyurethane

Note: All dimensions are approximate.

Table 2. Percutaneous Extension specifications
(for Model 2201 only)

<i>PHYSICAL PROPERTIES</i>	
LENGTH	96 CM
NUMBER OF ELECTRODES	4

Note: All dimensions are approximate.

LEAD IMPLANT PROCEDURE

The following section describes the procedure for implanting the Axonics tined lead.

Procedure supplies

In addition to the surgical tools required by the physician, the following supplies are needed for the implantation of the tined lead:

- Axonics Tined Lead Kit (Model 1201 or 2201)
- Axonics Clinician Programmer (CP) (Model 2501).
- Axonics Lead Implant Kit (Model 1801)
- Medical images from previous test or permanent lead implants to be used to inform correct lead placement (if applicable).

Procedure preparation

1. Place the patient prone with an approximate 30° flexion at the hip and knees. Place a pillow underneath the patient abdomen/hips if necessary to flatten the sacrum in the horizontal plane.
2. Prep the patient's lower back out laterally to the hips and extending the prep down to the buttocks, perianal area and perineum for sterile surgery.
3. Administer local anesthesia or general anesthesia/sedation, if applicable. Note: Do not use muscle relaxants or paralytic agents. Use of muscle relaxants or paralytic agents during anesthesia will diminish or eliminate muscle response to stimulation.
4. Affix the stimulation ground pad (non-sterile) to the skin.
 - a. Clean and dry skin area where ground pad is to be affixed (trimming hair from area is often helpful).
 - b. Open the pouch of the ground pad.
 - c. Peel the plastic packing off the ground pad.
 - d. Apply ground pad to the skin area. Hold in place for 15 seconds.
 - e. Insert the black plug into the CP ground (\perp) next to Needle Test Stimulation Cable (**Figure 4**).
5. Remove the needle test stimulation cable from the packaging.
6. Ensure that the stimulation amplitude on the CP is set to zero.
7. Insert the black plug of the needle test stimulation cable into the CP outside the sterile field (**Figure 4**). Keep the clip end of the cable in the sterile field.
8. Remove the tined lead test stimulation cable from the packaging.
9. Insert the grey plug of the tined lead test stimulation cable into the CP outside the sterile field (**Figure 4**). Keep the clip end of the cable in the sterile field.

Note: Ensure all cable connections are secure.

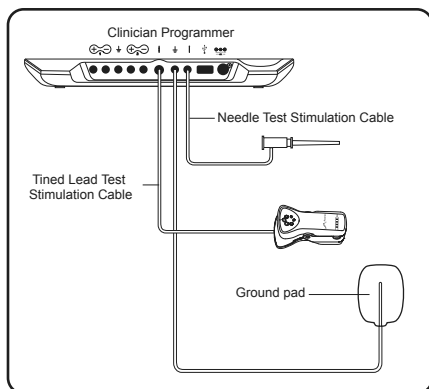

Figure 4. Clinician Programmer cable connections for the lead implant procedure.

10. Arrange sterile drapes to allow visualization of the pelvic floor to verify an appropriate motor response to stimulation.

11. Ensure that the motor response of the toes and/or soles of the feet can also be observed.

Needle placement and test stimulation

Needle placement adjacent to the sacral nerve is assisted by anatomical landmarks and/or fluoroscopy and confirmed using test stimulation

Note: For instructions on using the CP, refer to the Axonics Clinician Programmer Manual.

1. Using bony landmarks and/or fluoroscopy to guide placement, insert a foramen needle into the sacral foramen with an approximate 60-degree insertion angle relative to the skin.

Notes: The foramen needle has depth markings to aid in needle placement. The depth markings are 1 cm apart.

2. Place the needle into the foramen at an approximate 60-degree angle to the bony surface. The nerve lies along the superior-medial aspect of the foramen. (Figure 5)

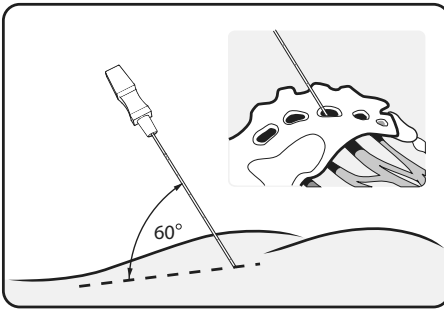

Figure 5. Insert the foramen needle at a 60-degree angle

CAUTION

The number of needle insertions into the foramen and the implant depth should be limited. Stop the needle insertion at the point where the desired stimulation response usually occurs, usually about 2.5 to 4.0 cm (1.0 to 1.5 in) in depth. The needle tip should be at the anterior surface of the sacral foramen for initial stimulation. A low opening threshold of less than 2 mA indicates close proximity to the nerve and this threshold should be the goal for initial needle placement.

3. Attach the clip end of the needle test stimulation cable to the non-insulated section of the foramen needle (just below hub and above the triple dash mark on the foramen needle) (Figure 6).

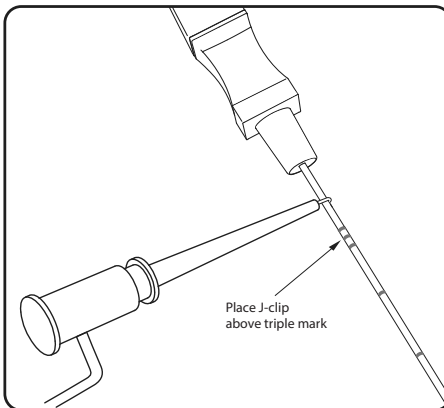

Figure 6. Connect needle test stimulation cable to the foramen needle

4. Using the CP (outside the sterile field), gradually increase the stimulation amplitude to obtain appropriate S3 motor and/or sensory response (Table 2).

Table 2. Motor and sensory responses to sacral nerve stimulation

Nerve	Motor response		Sensory response
	Pelvic Floor	Leg/Foot	
S2	Potential clamp response (anterior-posterior contraction of the perineal structures; a clamp-like contraction of the anal sphincter, and in males, a retraction of the penis base)	Rotation of the leg/hip rotation, rotation of the heel, calf contraction	Generally none or may have a sensation in the buttocks
S3	Bellows (flattening and deepening of the buttock groove due to the lifting and dropping of the pelvic floor)	Flexing great toe, occasionally flexing of other toes	Pulling in rectum, extending forward to scrotum or labia
S4	Bellows	None	Pulling in rectum

5. Observe the patient's motor responses to stimulation.
6. Look for the desired gross motor responses in the buttocks/perineum and leg/foot.
7. If the patient is awake, ask the patient to describe the sensation of the stimulation including the location (pelvic floor, vagina, testes, rectum/anus, bladder, scrotum, etc.) and quality (pulling, tapping, etc.) of the sensation.
8. Use the CP to reduce the stimulation amplitude to zero once appropriate responses are noted.
9. If the desired responses are not seen, reposition the needle higher and more medially in the foramen and/or change the angle of the needle as deemed appropriate. If the response is still not as desired, test at one foramen level above or below. Testing the contralateral side should also be considered as this may also improve the response.

Note: Due to anatomical variations in nerve location, the appropriate nerve responses may be seen at different foramen levels.

10. When testing is complete, decrease the stimulation amplitude to zero and disconnect the needle test stimulation cable from the needle.

Tined lead placement

1. Make a small incision on the lateral side of the foramen needle (in the direction where the tunneling will occur towards the Neurostimulator pocket).
2. Remove the stylet from the foramen needle (**Figure 7**).

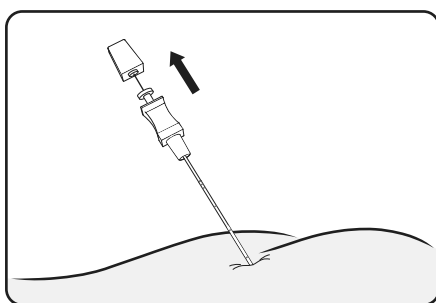

Figure 7. Remove the stylet from the foramen needle

3. Insert the directional guide into the foramen needle, aligning the appropriate depth marker on the directional guide with the top of the foramen needle (**Figure 8**).

Note: The most distal depth marker should be used for alignment with the shorter foramen needle (9.0 cm or 3.5 in). The second most distal marker should be used with the longer foramen needle (12.5 cm or 5 in).

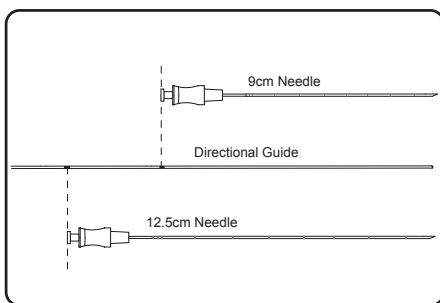

Figure 8. Insert the directional guide until the appropriate depth marker is aligned with the hub of the foramen needle

4. While keeping the directional guide in place, gently slide the foramen needle out of the foramen over the directional guide, leaving the guide in place (**Figure 9**).

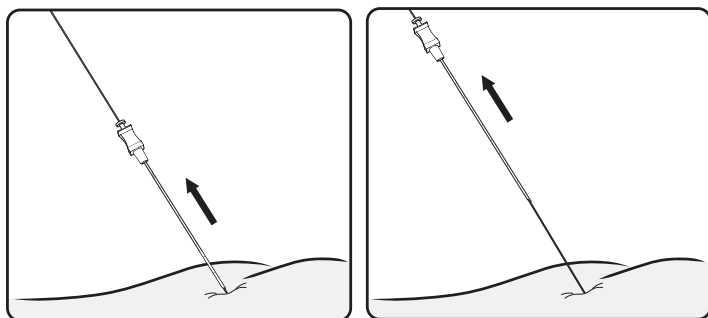

Figure 9. Remove the foramen needle

5. Hold the directional guide in place at the incision. Place the dilator and introducer sheath over the directional guide and advance them into the foramen. The third most proximal depth marker on the directional guide should be aligned with the top of the dilator (**Figure 10**). If available, confirm with fluoroscopy that the introducer sheath radiopaque marker is 1/2-2/3rd the way through the sacral plate

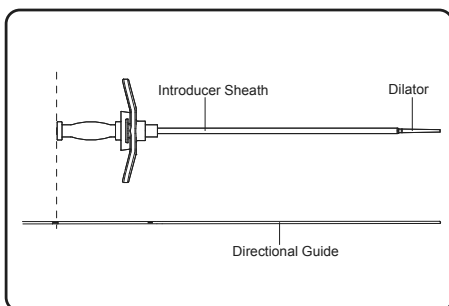

Figure 10. Align the dilator sheath hub with the appropriate mark on the directional guide

6. Rotate the dilator 90 degrees to unlock it from the introducer sheath (**Figure 11**). Being careful to leave the introducer sheath in place, remove the directional guide and dilator (**Figure 12**).

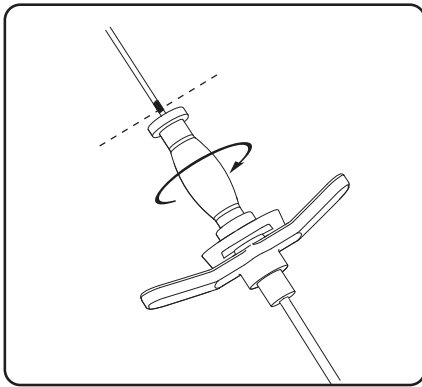

Figure 11. Unlock dilator from introducer sheath

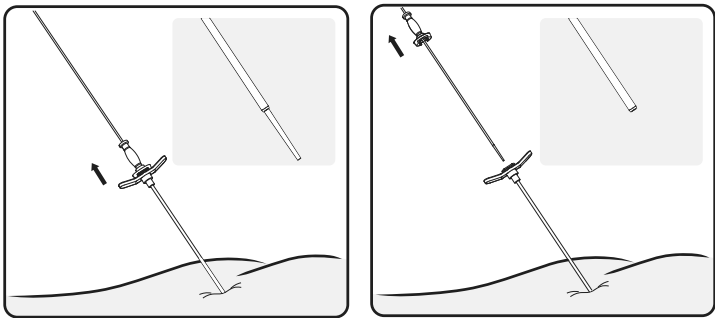

Figure 12. Remove the directional guide and dilator.

7. The tined lead is provided with the straight stylet. If desired, remove the straight stylet from the lead and replace with the curved stylet.
8. Carefully insert the tined lead (with stylet) into the introducer sheath until visual marker B on the tined lead is aligned with the top of the introducer sheath handle. Confirm with fluoroscopy that all electrodes on the lead are proximal to the distal tip of the sheath (**Figure 13**).

Notes:

- Use the tined lead markers to determine at what point the tines will be deployed. Refer to Figure 1 on page 16.
- The stylet supplied is 5mm longer than the tined lead and should not be forced into the lead.
- Sterile water can be used as a lubricant if necessary to insert the tined lead into the introducer sheath.

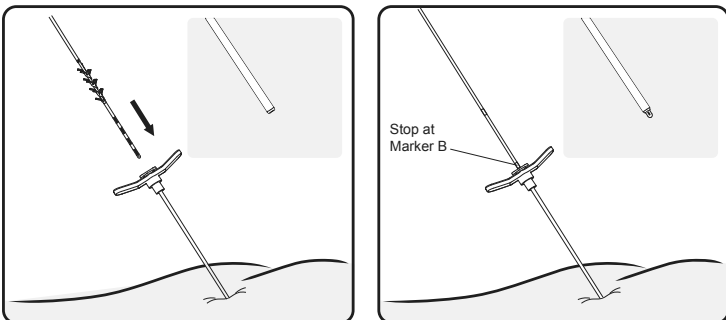

Figure 13. Insert the lead through the introducer sheath.

9. Advance the lead further through the introducer sheath until visual marker C is aligned with the introducer sheath handle while holding the introducer sheath in place. Use fluoroscopy to confirm that the distal tip of the sheath is proximal to the electrodes (**Figure 14**).

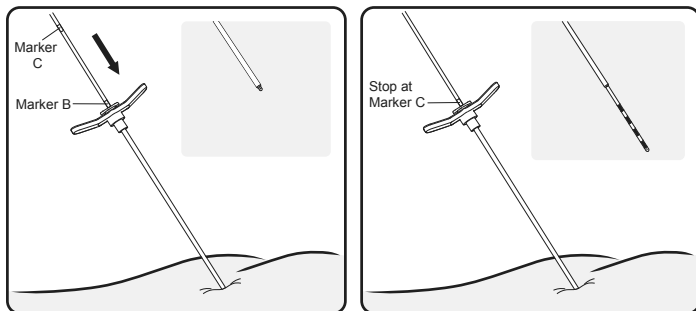

Figure 14. Advance the lead into the introducer sheath to expose the electrodes.

10. Connect the tined lead test stimulation cable to the lead (**Figure 15**). Using the CP, ensure electrical connections are made with all 4 contacts

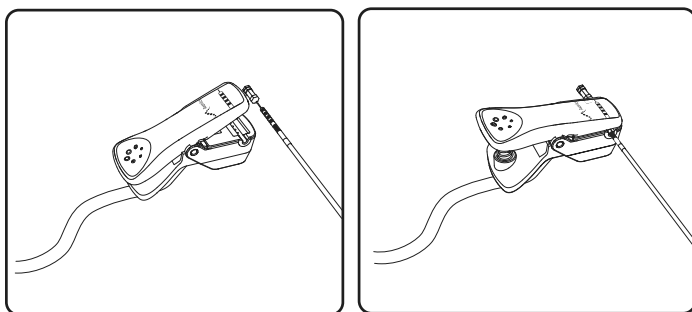

Figure 15. Connect the lead stimulation cable to the tined lead

11. Test the tined lead placement by stimulating and observing patient motor and/or sensory responses (**Table 2**). If necessary, reposition the lead within the foramen if optimal responses are not obtained. If repositioning the lead using the curved stylet, retract the lead so the electrodes are in the introducer sheath before rotating the curved stylet, then reintroduce the electrodes into the tissue

Notes:

- For instructions on how to use the CP for test stimulation of the tined lead placement, refer to the Clinician Programmer Manual.
- Hold sheath and lead together when adjusting lead position.

CAUTION

Optimal motor responses should be observed intraoperatively at < 3 mA during test stimulation of the lead. If the amplitude required to obtain a motor response is larger than 3.0 mA, the lead may not allow for optimal long-term therapy. Consider repositioning the lead to achieve the desired range.

12. When the tined lead is in its final location, remove the tined lead stimulation cable then carefully withdraw the introducer sheath and lead stylet under fluoroscopic guidance while holding the tined lead in place (**Figure 16**).

Note: Withdrawing the introducer sheath deploys the tines, anchoring the tined lead in place.

CAUTIONS

- Be careful to not displace the tined lead when removing the sheath and stylet.
- Do not deploy the tines until the tined lead is in the correct position.

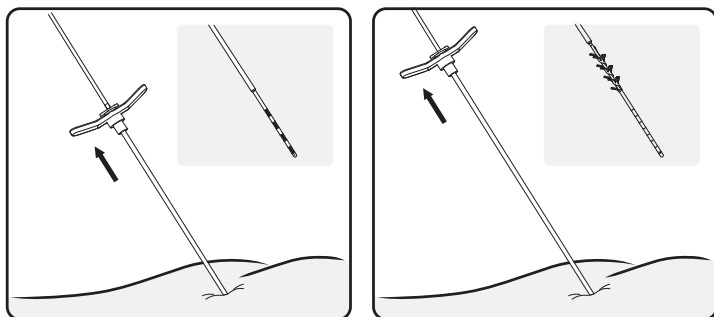

Figure 16. Grasp the tined lead to hold it in place. Withdraw the introducer sheath and lead stylet. Tines are deployed as the sheath is removed.

13. Reconnect the tined lead test stimulation cable to the lead and test stimulation with each electrode to confirm the previous responses.

Notes:

- To advance the lead after the tines are deployed, reinsert the lead stylet and gently adjust the lead position.
- To retract the lead after the tines are deployed, remove the lead completely using gentle traction and replace the lead.

Tined lead tunneling

For instructions on creating a Neurostimulator pocket, refer to the Neurostimulator Implant Manual.

1. Screw the tunneling tip to the tunneling tool and remove the tunneling tip protector. Make sure the clear tunneling sheath is in place over the tunneling tool when performing the tunneling part of the procedure.
2. If necessary, bend the tunneling tool to conform to the patient's body.
3. Create a subcutaneous tunnel from the lead to the Neurostimulator pocket.

Note: Deep tunneling is not desirable.

4. Leaving the tunneling sheath in the tunnel, remove the tunneling tool.
5. Gently insert the lead through the sheath.
6. Leaving the lead in position, gently remove the sheath from the tunnel.
7. Close the lead implant incision and dress the wound appropriately.

CONNECTING TO THE PERCUTANEOUS EXTENSION (FOR MODEL 2201 ONLY)

For trial stimulation with the Trial Stimulator (model 1601), the tined lead should be connected to the percutaneous extension cable.

CAUTIONS

- The site where the percutaneous extension is connected should be irrigated with antibiotic solution, and it is recommended that IV antibiotics be administered perioperatively. Do not soak the percutaneous extension in antibiotic solution as this may affect lead connections.
- The percutaneous extension has been sterilized. The percutaneous extension should not be placed on any non-sterile surface. The percutaneous extension should not be placed on skin. An infection may require surgical removal of the trial system.

1. The components should be wiped and dried to remove any fluids before making the connections. If necessary, use sterile water or a non-ionic antibiotic solution, then wipe dry.

 **CAUTION**

Failure to completely dry the components could lead to undesired stimulation, intermittent stimulation, or loss of therapy.

2. Ensure that the percutaneous extension connector block is dry and clean.
3. Use the torque wrench to turn the setscrew counterclockwise to back up the setscrew. Do not remove the setscrew from the connector block (**Figure 17**)

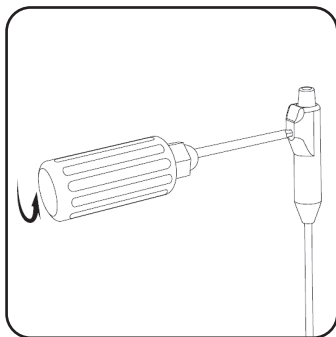

Figure 17. Use the torque wrench to turn the setscrew counterclockwise to back up the percutaneous extension setscrew and allow for insertion of the lead.

4. Insert the lead into the percutaneous extension connector block until fully seated and the lead cannot be inserted further. Marker D on the lead should be inside the percutaneous extension strain relief (**Figure 18**). The retention sleeve on the tined lead should be positioned under the percutaneous extension setscrew.

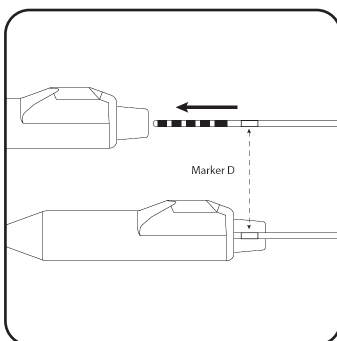

Figure 18. Insert lead fully into the Percutaneous extension connector block.

 **CAUTIONS**

- Avoid pulling the lead body taut when implanted.
- Do not attempt to insert the lead into the Percutaneous extension if the setscrew is not sufficiently retracted. Doing so may cause damage to the lead and/or cause the lead to not seat fully into the connector block.
- Ensure that the setscrew tightens on the retention sleeve, not an electrode. Tightening the setscrew onto the contact could damage the contact, leading to lack of therapy.

5. Fully insert the torque wrench into the hole of the percutaneous extension connector block. Tighten the setscrew by turning the torque wrench clockwise until it clicks (**Figure 19**).

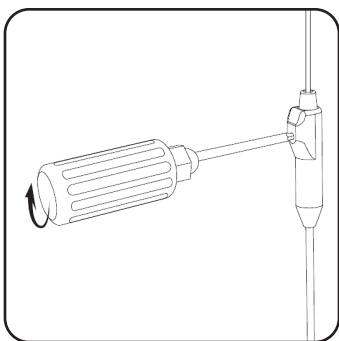

Figure 19. Secure the lead by tightening the setscrew clockwise onto the retention sleeve.

CAUTIONS

- Ensure that the torque wrench is fully inserted into the setscrew. Otherwise the setscrew may be damaged. This can result in intermittent or loss of stimulation.
 - The torque wrench is designed for single use only and cannot be assured to work appropriately if used for multiple surgeries. Discard the torque wrench after use.
6. Screw the tunneling tip to the tunneling tool. Make sure the clear tunneling sheath is in place over the tunneling tool when performing the tunneling.
 7. If necessary, bend the tunneling tool to conform to the patient's body.
 8. Create a subcutaneous tunnel from the lead connection site that exits the skin at least 10 cm away from the connection site.
 - Note:** Deep tunneling is not desirable.
 9. Leaving the tunneling sheath in the tunnel, remove the tunneling tool.
 10. Gently insert the percutaneous extension through the sheath.
 - Note:** The stopper tube on the percutaneous extension should be visible outside the sheath.
 11. Leaving the percutaneous extension in position, gently remove the sheath from the tunnel.
 - Note:** The stopper tube on the percutaneous extension should be outside the body.
 - Note:** No aspect of the tined lead should be outside the body.
 - Note:** Avoid sharp bends or kinks in the lead and percutaneous extension when positioning the connection within the pocket.
 12. Close and dress the wound appropriately.
 13. To connect the percutaneous extension to the Trial Stimulator, refer to the Trial Stimulator manual.

REMOVING THE PERCUTANEOUS EXTENSION

1. Carefully open the pocket site where the percutaneous extension connects to the tined lead.
2. Fully insert the torque wrench into the hole of the percutaneous extension connector block. Loosen the setscrew by turning the torque wrench counterclockwise.
 - NOTE:** Do not fully remove the setscrew.
3. Gently remove the lead from the percutaneous extension connector block.
 - NOTE:** If significant resistance is encountered while removing the lead, further loosen the setscrew with the torque wrench.
 - Inspect the lead for any signs of damage if there was difficulty in the removal process.
4. Cut off the percutaneous extension connector block at the lead body region and discard the connector block.
5. Remove the Percutaneous extension by pulling it out from the exit site where it was previously tunneled out of the body.

Note: Do not pull the percutaneous extension out from the Neurostimulator site. Doing so will increase the risk of infection.

6. Close and dress the percutaneous extension exit site appropriately if the patient is not proceeding to a Neurostimulator implant.

CONNECTING TO THE NEUROSTIMULATOR (PERMANENT IMPLANT)

For the steps to connect the lead to the Axonics Model 1101 Neurostimulator, refer to the Neurostimulator manual.

COMPLETING A LEAD IMPLANT PROCEDURE

1. Close and dress all incisions.
2. Give the patient the Remote Control and patient ID card prior to discharge.

CAUTION

The patient must carry the Remote Control at all times to be able to adjust or turn off the Stimulator.

3. Complete the patient and system registration paperwork and return to Axonics.
4. Train the patient on the use of the Remote Control and, if a Neurostimulator was implanted, the Charger.
5. Schedule the patient's follow-up visits at regular intervals to ensure that the stimulation is programmed optimally.

Post-surgery treatment

Administer prophylactic antibiotics for 24 hours.

POST-SURGERY LEAD REMOVAL

At the end of the useful life of the product, all implanted components should be removed. If the tined lead needs to be removed, make a small incision at the lead insertion site. Use sharp and blunt dissection to access and release lead tines from surrounding tissue. Gentle traction can be used in conjunction with dissection to remove the lead.

CAUTION

Do not use excessive force to remove the tined lead. A force larger than gentle traction may cause lead breakage. This can result in device fragments left in the patient's body.

If resistance occurs during lead removal, additional dissection may be needed to release the lead tines and remove the entire lead.

CUSTOMER SERVICE

For questions regarding the Axonics SNM System, call our Customer Support Center toll-free at +1-877-929-6642.

Additional information and product manuals can be found at our website: www.axonics.com



CE :2019
2797

(2020-09-18)
All Rights Reserved. Copyright 2020.
Axonics Modulation Technologies

110-0128-001 rev C