

DFI

Small 5G Cell Needs Big Changes

DFI Adds Horsepower to 5G Small Cellular and Multi Access Edge Computing

For the purpose of boosting up the speed of internet traffic and cloud-computing applications that require fast response, DFI gladly introduces you to the newest COM Express Type 7 module DV970. It provides not only enhanced computing performance and low-power consumption, but also versatile expansion capability. Therefore, a leading cellular carrier partnered with DFI to integrate DV970 in its 5G small cells.

Region: Taiwan

Application: 5G Small Cell POC (Proof-of-Concept)

Solution: DFI DV970

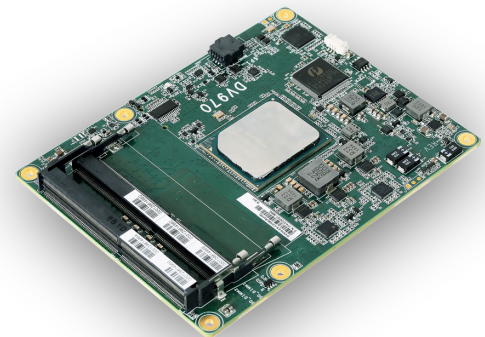

Scaling 5G for the Future

The popularity of 5G mobile networks is an irresistible trend. Compared to 4G, users can expect 100x faster download speeds, 10x lower latency, and support for 500x devices in the same geographic space. These enhancements are expected to help users in a wave of new applications from autonomous vehicles, delivery drones, augmented reality, to 4K/8K video streaming, which are all areas where 5G show great potential. 5G is a unified connectivity fabric that will connect everything around us.

Even more than speed, 5G is about capacity

As an old saying goes, “great oaks grow from little acorns”. Before moving to the era of the Internet of

things, an infrastructure that can support massive data processing must be established, and there must be enough margin to support the substantial increase in data usage in the next ten years, along with satisfying the low-latency requirements of real-time applications.

According to the Ericsson Mobile Report 2020 Q2, the total traffic driven by 5G networks will be multiplied by 4 in 2025 years, which means in the small cell as the backbone of 4G networks must have more powerful computing performance and share the workload of cloud computing. Based on the consideration of reducing long-term operating costs arisen from dramatically increased small cells to cope with the 5G millimeter wave (mmWave) due to the shorter transmission distance, incorporating the spirit of software-defined networking (SDN) and network function virtualization (NFV), and adopting

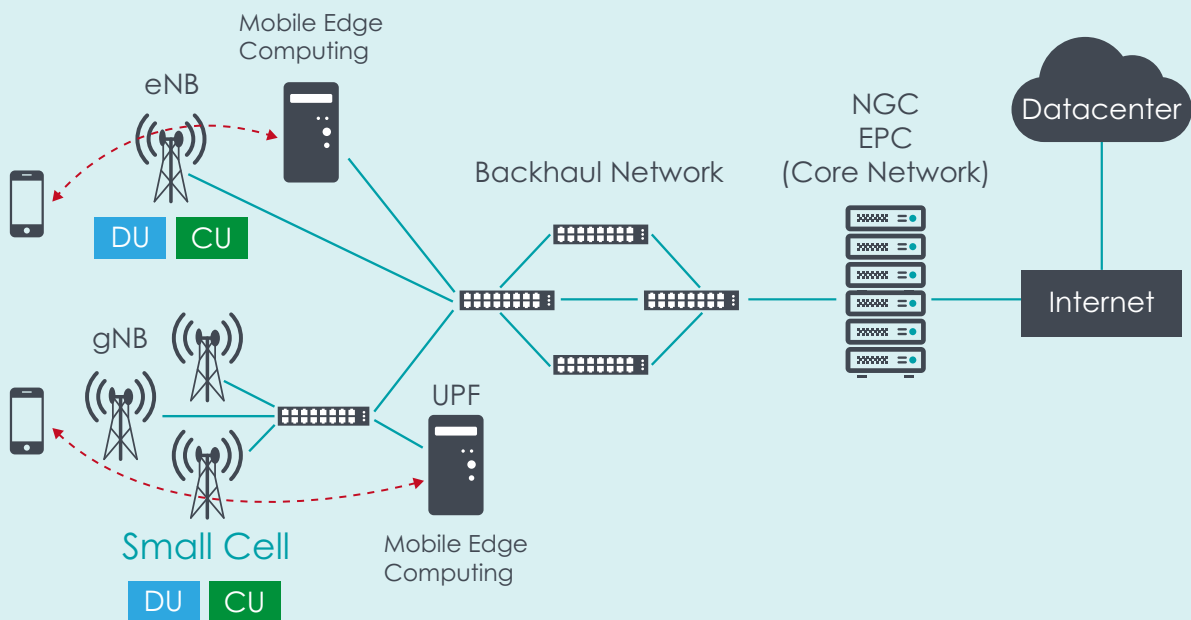

a COTS (Commercial Off-The-Shelf) and general-purpose hardware platform are even more indispensable.

“Latency does matter more than ever”

From near to far, the latency issues of 5G networks can be divided into two levels: "signal processing" and "quality of service."

According to the Time Division Duplex (TDD) architecture of 5G NR (New Radio), if the theoretical transmission bandwidth of 10Gb/s (carrier bandwidth 400MHz, sub-carrier spacing 120kHz) is to be achieved, the small cell needs to have a slot that processes 14 OFDM symbols (Symbol) within 125 second (μ s), in other words, 8000 slots must be processed within one second.

5G NR (New Radio) Frame Structure.

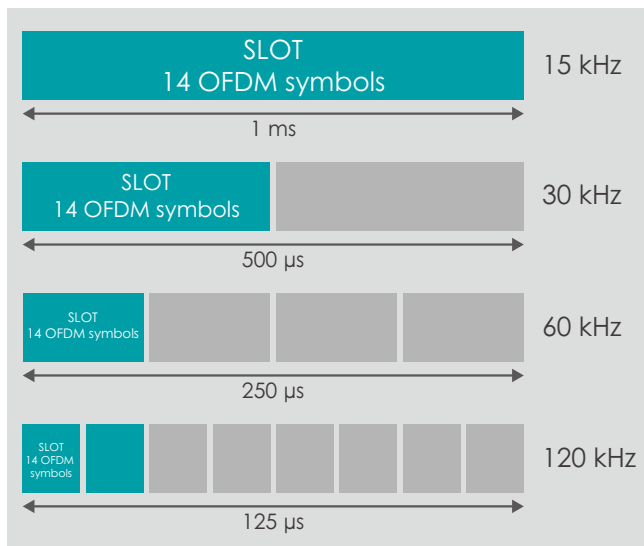

Due to the trend of software-defined networking (SDN) and network function virtualization (NFV), general-purpose processors are becoming more and more suitable for computing cores of small cells.

Intel Atom® processors are used as network processors (NPUs), combined with FPGA in charge of baseband processing to effectively backhaul the broadband data traffic of the local small cell to the core network, and bring more flexibility for application deployment.

To confirm the technical feasibility of 5G small cell, one leading cellular carrier began investigating the use of DFI's DV970 embedded with Intel Atom® C3958 Processor with FPGA and 5G communication modules to conduct a proof of concept (POC). However, each device needed to be synchronized at any time, and periodically sent a signal pulse to ensure the coherence of data and actions. Therefore, it was a challenge to effectively reduce the latency. Longer latency meant that the processor must consume higher utilization of computing power.

DFI 5G Baseband POC.

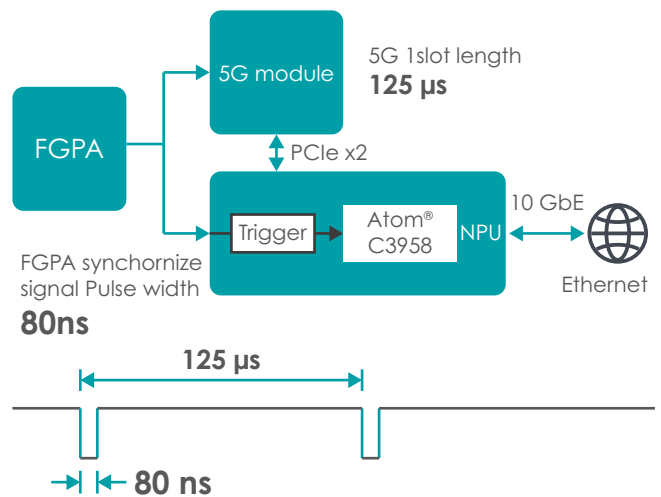

To overcome the latency problem, DFI took a two-pronged approach from both software and hardware. First, DFI optimized the hardware circuit to detect the signal pulse as soon as possible, and at the same time improved the PCIe connection

between the processor and the 5G communication module to increase the overall system performance. Second, DFI strived for more processing time by using a low-latency Linux kernel, and released more processor performance to support other network service requirements.

In order to realize both low latency and high bandwidth, the 5G base station divided the BBU (Baseband Unit) into CU and DU. CU (Centralized Unit) was responsible for processing non-real-time protocols and services, and DU (Distribute Unit) for physical layer protocols and real-time services.

By utilizing SDN/NFV technology, the BBU should be compatible with 4G/5G, and support could-radio access networks (C-RAN), distributed-RAN (D-RAN), and both 5G central and distributed units (CU/DU), which equips it with a robust ability for flexible deployment in the future. The new generation of modular baseband processing platform based on Intel architecture has increased capacity, high-level integration, and multi-mode flexible networking features, to reduce total cost of ownership (TCO).

“Refined for edge computing server with industry-grade reliability”

After achieving the 10Gb/s data transmission rate, there was another major requirement of 5G networks: network service quality of "less than one millisecond latency", but this was not a problem that could be solved by simply deploying a 5G network. The servers that provide network services also needed to be closer to users and provided edge computing functions to utilize the real-time applications. More importantly, the server should adopt the popular x86 architecture to achieve maximum flexibility of application deployment.

The European Telecommunications Standards Institute (ETSI) proposed Network Function Virtualization (NFV) in 2012, attempting to integrate different types of network equipment with virtualization technology into a common hardware platform based on x86 servers to simplify network equipment and overall architecture. It gave birth to Cloud RAN (Radio Access Network), which centralizes the baseband signal processing in the cloud data center, to reduce overall operating costs.

Overall architecture of Cloud RAN

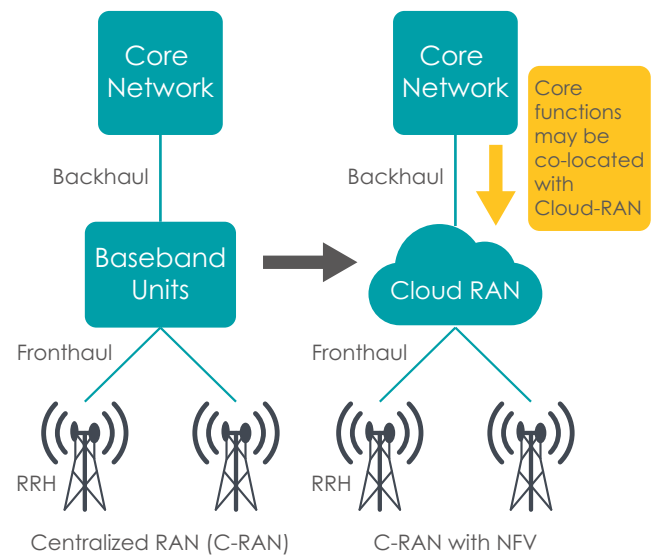

Based on NFV, ETSI further proposed multi-access edge computing (MEC, Multi-access Edge Computing) in 2015, so that it could be deployed close to small cell to provide ultra-low-latency and real-time services, and even combining both as one unity with powerful computing power, complementary to Massive MIMO and Beamforming, which allowed small cells and multiple users to transmit data simultaneously within same frequency resources. When the architecture of access networks adopted separate CU (Centralized Unit) and DU (Distributed Unit), edge computing of CU could be deployed on MEC platforms to provide ultra-low

latency services. Furthermore, according to the viewpoint from ETSI, Cloud RAN and MEC were a perfect pairing, because of the benefits of co-deployment.

Overall architecture of ETSI MEC

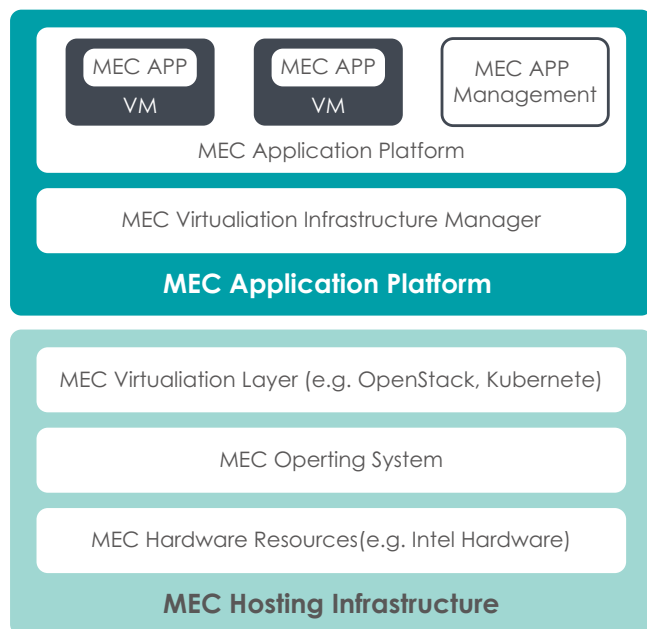

The Intel Atom® C3000 series adopted by DFI DV970 has wide range of SKUs (2-16 cores), QuickAssist Technology (QAT) that can accelerate encryption, decryption, and decompression, up to 16 x SATA, 16 x PCIe 3.0, 4 x USB 3, and 4 x 10 GbE Ethernet. It addresses extreme low power requirements (less than 10W TDP) and high-density form factors such as MEC. For boosting up the speed of internet traffic and cloud-computing applications that require fast response, DFI DV970 based on COM Express Type 7 provides not only enhanced computing performance and low-power consumption, but also versatile expansion capability. The DV970 supports 4 ports of 10GbE-KR Ethernet to strengthen connection between server and equipment, and is capable for a 24/7 stable operation in an extended-temp environment,

therefore of being ideal solution for 5G Small Cell and MEC.

Emerging challenges for management

MEC servers and numerous 5G small cells are often deployed in a relatively harsh environment within limited space. In addition to the wide temperature support, the overall design must adopt industrial computer specifications, which is by no means competent with a general server. DFI has been working in the field of industrial-grade computers for a long time across industrial motherboards, system-on-modules, industrial computers, and industrial panel PC & displays. It also provides fast customized services for various types of applications to meet customer's requirements.

“RemoGuard Ensure the Availability of Numerous Small Cells and Edge Computing Servers”

Many 5G small cells and edge computing servers are deployed in a very wide range. If the operating system crashes and the general in-band remote management cannot be used, it is necessary to allocate manpower for on-site maintenance. The more the number of devices, the higher the costs, and it will lead to rapid growth of the overall operation expenses (OPEX), and lower quality of service.

RemoGuard, a cloud management platform co-developed by both DFI and Innodisk, introduces out-of-band management and moves the entire management system to the cloud. The platform can automatically backup the data and recover the

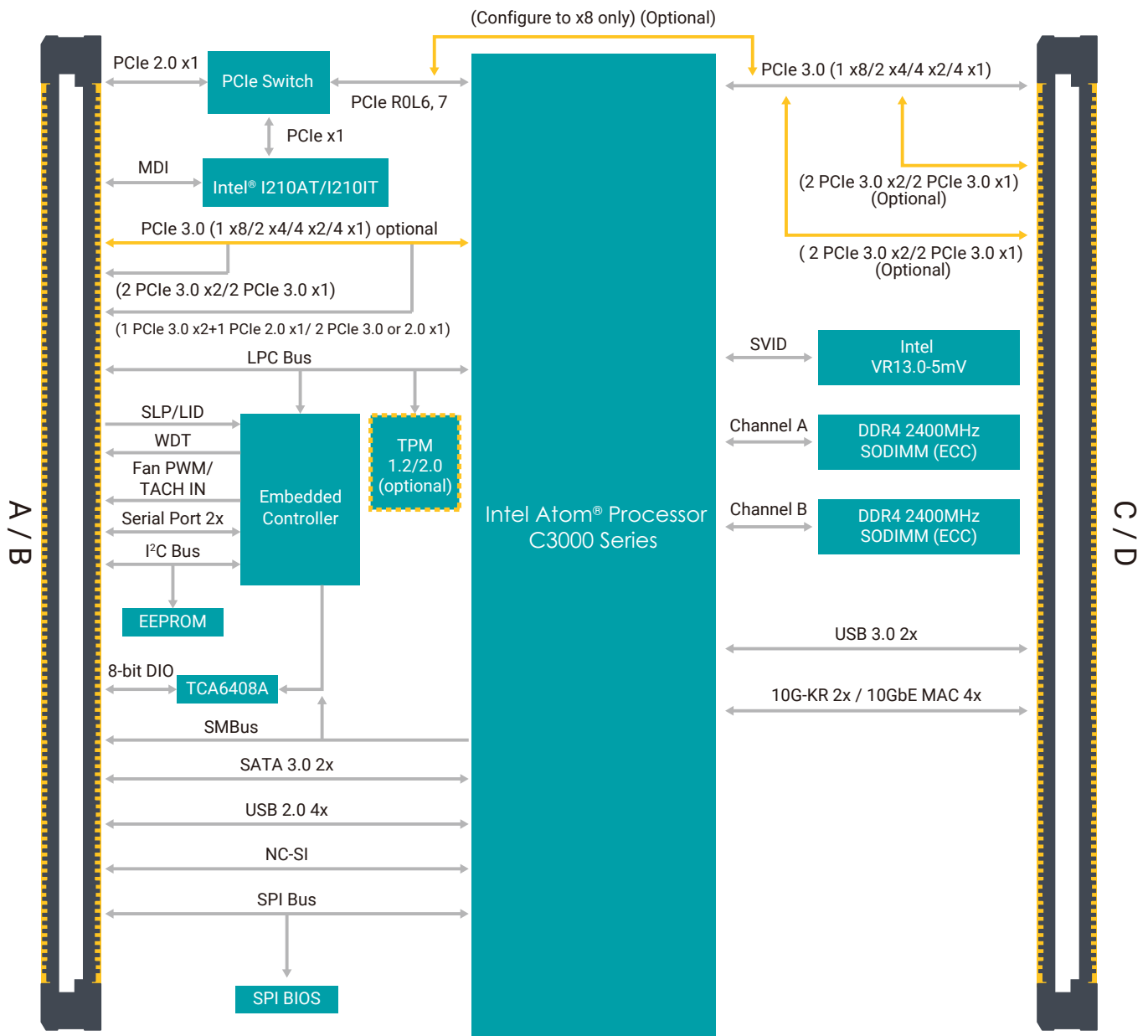

operating system remotely when the edge devices crash, which exactly meets the managing attributes of 5G small cells – to maintain numerous stations allocated at multiple sites.

Besides remote OS recovery, RemoGuard also has device monitoring services. The platform updates the real-time updated data of logging temperature,

input/output voltage, and power consumption for in-time action, and proactively estimates the lifespan of SSDs, turning passive notification to active prediction to pin down a precise benchmark of replacement timing as well as yielding benefits for inventory control, maintenance efficiency, and service continuity of the 5G small stations.

Block diagram of DFI RemoGuard.

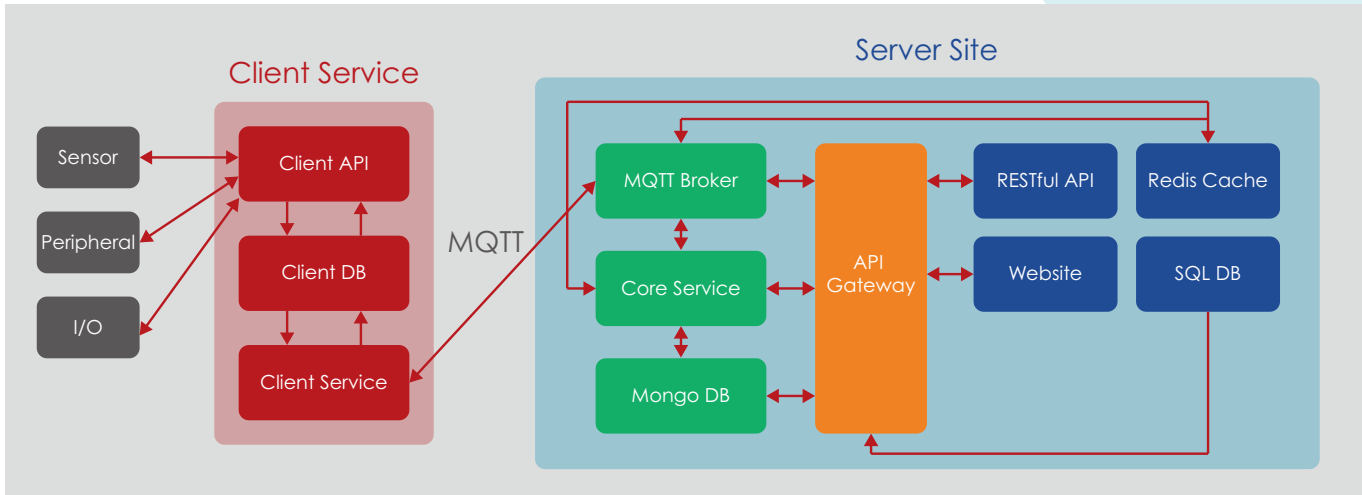

As the management is conducted through both in-band and out-of-band, both the connection to the cloud and data itself should be protected. The advanced AES encryption is adopted to prevent data from tampering, and the Transport Layer Security Protocol (TLS) adopted by Azure Sphere further ensures communication confidentiality. Moreover, in the case of potential data breaches or improper violation to the physical equipment, secure erasure and self-destruction can also be triggered as specially required in mission-critical settings, ensuring comprehensive data security under transmission.

“DFI assists customers to scale 5G into the future”

In the advent of the 5G era, whether from radio access network (RAN), multi-access edge computing (MEC), or evolved data packet core (EPC), it is necessary to create a good 5G application environment and take into account the capital expenditures (CAPEX) and operating expenses

(OPEX). The x86 server platform with high application flexibility, high reliability, and high availability is the most ideal choice, fully implementing the spirit of software-defined networking (SDN) and network function virtualization (NFV) core.

DFI, who focuses on industrial computers, not only provides complete hardware solutions and cloud management systems for 5G small cell and edge computing servers, but also combines 16-core Atom C3958 processor and 5G small station by its DV970 COM Express module to provide sufficient performance for today’s workloads. DFI has enough expansion space to adapt to the ever-increasing data flow in the future and makes the vision of the internet of things no longer unattainable and unreachable.

Please click or scan the QR code to fill out an inquiry form if you would like us to contact you.

DFI

Founded in 1981, DFI is a global leading provider of high-performance computing technology across multiple embedded industries. With its innovative design and premium quality management system, DFI's industrial-grade solutions enable customers to optimize their equipment and ensure high reliability, long-term life cycle, and 24/7 durability in a breadth of markets including factory automation, medical, gaming, transportation, smart energy, defense, and intelligent retail.

Website: www.dfi.com

eStore: estore.dfi.com



Copyright © 2020 DFI Inc. All rights reserved. DFI is a registered trademark of DFI Inc. All other trademarks are the property of their respective owners.

For more information, please contact your DFI regional sales representative or send us an email: inquiry@dfi.com