

# 600 CFM In-Line Blower DHI1FZUC



## Features and Benefits

### Key Features

#### Convenience

- Use the EXTNCB25 Blower Cable Connection Accessory for install with select hoods. Separate purchase required.

#### Design

- Designed to be mounted inline with the ducting installation

Notes: All height, width and depth dimensions are shown in inches. \*Please refer to installation instructions prior to making cutout. BSH reserves the absolute and unrestricted right to change product materials and specifications, at any time, without notice. Consult the product's installation instructions for final dimensional data and other details. Applicable product warranty can be found in a accompanying product literature or you may contact your account manager for further details.

For more information on our entire line of products, go to [boschappliances.com](http://boschappliances.com) or call 1-800-944-2904.

Copyright ©2022 BSH Home Appliances Corporation. All rights reserved. Bosch is a registered trademark of Robert Bosch GmbH.

Litho Date: 05/2022

# 600 CFM In-Line Blower DHI1FZUC

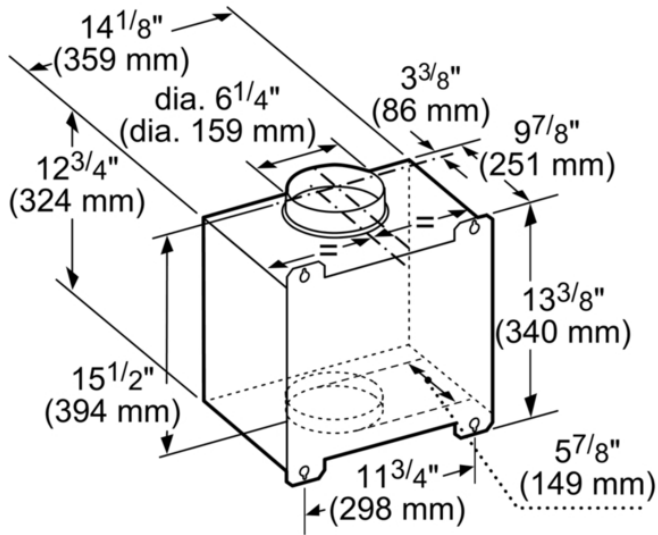

measurements in inches (mm)

## Features

Product Description	
Brand	Accessory Bosch
Product name / series name	
SKU	DHI1FZUC
Internal article number	DHI1FZUC
EAN code	4242005271771
Product packaging dimensions (HxWxD)	16.22 x 25.98 x 22.59
	23
	24
Quantity per packing unit	
Standard number of units per pallet	
UPC code	825225964841
Product image	MCSA036961_DHG6015DUC_def.jpg

## Technical Specification

Notes: All height, width and depth dimensions are shown in inches. \*Please refer to installation instructions prior to making cutout. BSH reserves the absolute and unrestricted right to change product materials and specifications, at any time, without notice. Consult the product's installation instructions for final dimensional data and other details. Applicable product warranty can be found in a accompanying product literature or you may contact your account manager for further details.

For more information on our entire line of products, go to [boschappliances.com](http://boschappliances.com) or call 1-800-944-2904.  
Copyright ©2022 BSH Home Appliances Corporation. All rights reserved. Bosch is a registered trademark of Robert Bosch GmbH.

Litho Date: 05/2022