



# Maintenance and Service Guide

## SUMMARY

This guide provides information about spare parts, removal and replacement of parts, security, backing up, and more.

© Copyright 2020 HP Development Company, L.P.

AMD is a trademark of Advanced Micro Devices, Inc. Bluetooth is a trademark owned by its proprietor and used by HP Inc. under license. Intel, Core, Thunderbolt, vPro, and Xeon are trademarks of Intel Corporation or its subsidiaries in the U.S. and/or other countries. Microsoft and Windows are either registered trademarks or trademarks of Microsoft Corporation in the United States and/or other countries. NVIDIA and Quadro are trademarks and/or registered trademarks of NVIDIA Corporation in the U.S. and other countries. USB Type-C and USB-C are registered trademarks of USB Implementers Forum. DisplayPort™ and the DisplayPort™ logo are trademarks owned by the Video Electronics Standards Association (VESA®) in the United States and other countries.

The information contained herein is subject to change without notice. The only warranties for HP products and services are set forth in the express warranty statements accompanying such products and services. Nothing herein should be construed as constituting an additional warranty. HP shall not be liable for technical or editorial errors or omissions contained herein.

First Edition: September 2020

Document Part Number: M18835-001

## Product notice

This guide describes features that are common to most models. Some features may not be available on your computer.

Not all features are available in all editions or versions of Windows. Systems may require upgraded and/or separately purchased hardware, drivers, software or BIOS update to take full advantage of Windows functionality. Windows 10 is automatically updated, which is always enabled. ISP fees may apply and additional requirements may apply over time for updates. Go to <http://www.microsoft.com> for details.

To access the latest user guides, go to <http://www.hp.com/support>, and follow the instructions to find your product. Then select **Manuals**.

## Software terms

By installing, copying, downloading, or otherwise using any software product preinstalled on this computer, you agree to be bound by the terms of the HP End User License Agreement (EULA). If you do not accept these license terms, your sole remedy is to return the entire unused product (hardware and software) within 14 days for a full refund subject to the refund policy of your seller.

For any further information or to request a full refund of the price of the computer, please contact your seller.

## Safety warning notice

Reduce the possibility of heat-related injuries or of overheating the computer by following the practices described.

---

 **WARNING!** To reduce the possibility of heat-related injuries or of overheating the computer, do not place the computer directly on your lap or obstruct the computer air vents. Use the computer only on a hard, flat surface. Do not allow another hard surface, such as an adjoining optional printer, or a soft surface, such as pillows or rugs or clothing, to block airflow. Also, do not allow the AC adapter to come into contact with the skin or a soft surface, such as pillows or rugs or clothing, during operation. The computer and the AC adapter comply with the user-accessible surface temperature limits defined by applicable safety standards.

---



---

# Table of contents

<b>1 Product description .....</b>	<b>1</b>
<b>2 Components .....</b>	<b>7</b>
Right .....	7
Left .....	8
Display .....	9
Touchpad components .....	10
Button, speakers, and fingerprint reader .....	11
Special keys .....	13
<b>3 Illustrated parts catalog .....</b>	<b>17</b>
Computer major components .....	17
Display assembly subcomponents .....	26
Mass storage devices .....	28
Cables .....	28
Miscellaneous parts .....	29
<b>4 Removal and replacement procedures preliminary requirements .....</b>	<b>31</b>
Tools required .....	31
Service considerations .....	32
Plastic parts .....	32
Cables and connectors .....	32
Drive handling .....	32
Workstation guidelines .....	32
Electrostatic discharge information .....	34
Generating static electricity .....	34
Preventing electrostatic damage to equipment .....	35
Personal grounding methods and equipment .....	35
Grounding the work area .....	35
Recommended materials and equipment .....	36
Packaging and transporting guidelines .....	36

<b>5 Removal and replacement procedures for authorized service provider parts .....</b>	<b>39</b>
Component replacement procedures .....	40
Preparation for disassembly .....	40
Bottom cover .....	40
Battery .....	41
Memory module .....	43
Solid-state drive .....	44
Fans .....	45
Display assembly .....	46
Sensor board cable .....	54
Sensor board .....	55
Fingerprint reader module cable .....	56
Fingerprint reader module .....	57
RTC battery .....	58
Touchpad cable .....	59
NFC module cable .....	59
NFC module .....	60
Card reader board cable .....	61
Card reader board .....	62
System board .....	64
Heat sink .....	68
Touchpad .....	70
Speakers .....	71
<b>6 Troubleshooting guide .....</b>	<b>73</b>
Resources .....	73
General troubleshooting steps .....	75
Identify the issue .....	76
1. Understand the issue .....	77
Boot up sequence .....	77
Failure classification .....	78
2. Examine the environment .....	80
3. Perform a visual inspection of hardware .....	80
4. Update BIOS and drivers .....	82
Manually updating BIOS and drivers .....	82
Remotely deploying the BIOS and drivers .....	82
Analyze the issue .....	83
5. Remove or uninstall recently added hardware, software .....	83
6. HP Hardware Diagnostics and Tools .....	84
HP PC Hardware Diagnostics (UEFI) .....	84
HP BIOS Configuration Utility (BCU) .....	85

	HP Image Diagnostic Tool .....	86
	HP Thermal Monitor .....	86
	Non HP diagnostics tools .....	86
	7. Status lights, blinking light codes, troubleshooting lights, and POST error messages .....	87
	Status lights .....	87
	Blinking light codes .....	87
	POST error messages .....	88
	Resolve the issue .....	90
	8. Hard reset .....	90
	9. Soft reset (Default Settings) .....	91
	10. Reseat cables and connections .....	91
	11. Test with minimum configuration .....	93
	Essential hardware configuration .....	93
	Safe mode .....	94
	12. Test with verified working configuration (hardware or operating system) .....	94
	13. Replace the system board .....	94
	Verify solution .....	95
Helpful Hints .....		96
At startup .....		96
During operation .....		96
Consulting with HP Service .....		97
Common issues and possible solutions .....		98
Power-on issues .....		99
No power .....		99
Intermittent power-on, shutdown, reboot .....		101
AC adapter issue .....		102
Battery not recognized, not charging .....		103
Battery discharges too fast .....		105
Burnt smell .....		105
POST .....		107
No video (with power) .....		107
Blinking lights .....		108
Diagnostic error messages .....		108
BIOS password .....		109
Performance (OS) .....		110
Intermittent shutdown .....		110
Blue screen .....		111
Freeze at Windows Logo (hang or lockup) .....		111
Electromagnetic Interference (EMI) .....		112
No wake up .....		113

Unresponsive .....	114
Slow performance .....	115
HP Smart Adapter warning message .....	115
Incorrect time and date .....	116
Display .....	117
Display anomalies .....	118
Symptom .....	118
Quick check .....	119
HP PC Hardware Diagnostics (UEFI) for video test .....	119
Display assembly diagram .....	119
Dead pixel .....	120
No video (internal) .....	120
No video (external) .....	120
DisplayPort/VGA .....	121
HDMI .....	121
No or bad external video via docking .....	122
Incorrect or missing color/distorted image .....	122
Touch screen .....	123
I/O devices .....	125
Keyboard .....	125
Keyboard pointing stick (select products only) .....	126
Keyboard backlight .....	126
Touchpad .....	127
Network connectivity (RJ-45 jack) .....	127
Network connectivity wireless (WLAN) .....	128
WWAN .....	128
USB .....	129
Smart card reader .....	130
Speaker, headphone - audio issues .....	131
Thunderbolt (TB) .....	132
Storage .....	134
Hard drive or solid-state drive not recognized .....	134
No boot to operating system (no read-write error) .....	135
Read-write error .....	136
Slow performance .....	137
Blue screen (BSOD) error .....	137
Noisy hard drive .....	137
Mechanical .....	139
Noise (sound) .....	139
Fan runs constantly .....	139
Thermal shutdown (hot) .....	141



Additional information .....	143
Acronyms .....	143
Blinking lights and boot error codes .....	144
Processor not executing code .....	144
BIOS recovery code unable to find valid BIOS recovery image .....	144
Memory module error .....	144
Graphics Controller Error (No Controller) .....	145
Failure System Board Error .....	145
Intel Trusted Execution Technology (TXT) Error .....	145
Sure Start unable to find valid BIOS Boot Block image .....	145
Sure Start has identified a problem (Manual Recovery Policy Set) .....	146
POST error messages and user actions .....	146
Routine maintenance for performance improvement .....	148
Common blue screen error messages .....	149
Error message list .....	149
Bug check symbolic names .....	149
Microsoft general troubleshooting of Windows bug check codes .....	149
Use Windows Debugging Tool .....	151
Windows Software Development Kit (SDK) .....	151
Display issue: pixel anomalies .....	154
Cable management .....	155
Connector types .....	157
Flex cable .....	157
Horizontal cable insertion .....	157
Multiple-pin horizontal connector (LVDS cable to display panel) .....	158
Multiple-pin vertical connector (LVDS cable to system board) .....	158
<b>7 Using Setup Utility (BIOS) .....</b>	<b>159</b>
Starting Setup Utility (BIOS) .....	159
Updating Setup Utility (BIOS) .....	160
Determining the BIOS version .....	160
Preparing for a BIOS update .....	161
Downloading a BIOS update .....	161
Installing a BIOS update .....	161
<b>8 Backing up, restoring, and recovering .....</b>	<b>163</b>
Backing up information and creating recovery media .....	164
Using Windows tools for backing up .....	164
Using the HP Cloud Recovery Download Tool to create recovery media (select products only) .....	164
Restoring and recovering your system .....	165
Creating a system restore .....	165

Restoring and recovery methods .....	165
Recovering using HP Recovery media .....	165
Changing the computer boot order .....	166
Using HP Sure Recover (select products only) .....	166
<b>9 Using HP PC Hardware Diagnostics .....</b>	<b>167</b>
Downloading the HP PC Hardware Diagnostics Windows from the Microsoft Store .....	167
Customizing Remote HP PC Hardware Diagnostics UEFI settings .....	167
<b>10 Specifications .....</b>	<b>169</b>
Computer specifications .....	169
39.6 cm (15.6 in) display specifications .....	171
Hard drive specifications .....	171
Solid-state drive specifications .....	172
Solid-state drive specifications (SATA-3) .....	172
<b>11 Statement of memory volatility .....</b>	<b>175</b>
Current BIOS steps .....	175
Nonvolatile memory usage .....	177
Questions and answers .....	178
<b>12 Power cord set requirements .....</b>	<b>181</b>
Requirements for all countries .....	181
Requirements for specific countries and regions .....	181
<b>13 Recycling .....</b>	<b>185</b>
<b>Index .....</b>	<b>187</b>

# 1 Product description

This table provides detailed product information.

**Table 1-1** Product components and their descriptions

Category	Description
Product Name	HP ZBook Power G7 Mobile Workstation Model number: tbd CTO number: bd
Processor	<ul style="list-style-type: none"><li>Intel® Xeon™ W-10855M 2.8 GHz (max turbo frequency 5.1 GHz) processor (6 cores, 12 MB Intel Smart Cache, 45 W)</li><li>Intel Core™ i9-10885H 2.4 GHz (max turbo frequency 5.3 GHz) processor (8 cores, 16 MB Intel Smart Cache, 45 W)</li><li>Intel Core i7-10850H 2.7 GHz (max turbo frequency 5.1 GHz) processor (6 cores, 12 MB Intel Smart Cache, 45 W)</li><li>Intel Core i7-10750H 2.6 GHz (max turbo frequency 5.0 GHz) processor (6 cores, 12 MB Intel Smart Cache, 45 W)</li><li>Intel Core i5-10400H 2.6 GHz (max turbo frequency 4.6 GHz) processor (4 cores, 8 MB Intel Smart Cache, 45 W)</li><li>Intel Core i5-10300H 2.5 GHz (max turbo frequency 4.5 GHz) processor (4 cores, 8 MB Intel Smart Cache, 45 W)</li></ul>
Graphics controller	<ul style="list-style-type: none"><li>NVIDIA® Quadro® T2000 N19P-Q3 graphics controller with Max-Q design (only on computer models equipped with an Intel Xeon, Intel Core i9, or Intel Core i7 processor)</li><li>NVIDIA Quadro T1000 N19P-Q1 graphics controller with Max-Q design (only on computer models equipped with an Intel Core i9 or Intel Core i7 processor)</li><li>NVIDIA Quadro P620 N19M-Q3 graphics controller (only on computer models equipped with an Intel Core i7 or Intel Core i5 processor)</li></ul>
Display	<b>39.6 cm (15.6 in), liquid crystal display (LCD), white light-emitting diode (WLED), UWVA</b>

Table 1-1 Product components and their descriptions (continued)

Category	Description
	<ul style="list-style-type: none"> <li data-bbox="946 258 1444 373">• Ultra high-definition (UHD) (3840 × 2160), antiglare, sRGB 100, eDP 1.4 + PSR 2, low power, bent non-touchscreen display panel with narrow bezel; typical brightness: 400 nits</li> <li data-bbox="946 384 1444 520">• Full high-definition (FHD) (1920 × 1080), antiglare, sRGB 100, eDP 1.4 + PSR 2, low power, bent non-touchscreen display panel with narrow bezel, equipped with an HD + infrared webcam; typical brightness: 400 nits</li> <li data-bbox="946 531 1444 657">• FHD (1920 × 1080), antiglare, sRGB 100, eDP 1.4 + PSR 2, low power, bent non-touchscreen display panel with narrow bezel, equipped with an HD webcam; typical brightness: 400 nits</li> <li data-bbox="946 667 1444 783">• FHD (1920 × 1080), antiglare, sRGB 100, eDP 1.4 + PSR 2, low power, bent non-touchscreen display panel with narrow bezel; typical brightness: 400 nits</li> <li data-bbox="946 793 1444 888">• FHD (1920 × 1080), antiglare, 45%, eDP 1.2 without PSR, bent touchscreen display panel with narrow bezel; typical brightness: 250 nits</li> <li data-bbox="946 898 1444 1014">• FHD (1920 × 1080), antiglare, 45% eDP, bent touchscreen display panel with narrow bezel, equipped with an HD webcam; typical brightness: 250 nits</li> <li data-bbox="946 1024 1444 1119">• FHD (1920 × 1080), antiglare, 45%, eDP 1.2 without PSR, bent non-touchscreen display panel with narrow bezel; typical brightness: 250 nits</li> <li data-bbox="946 1129 1444 1224">• FHD (1920 × 1080), antiglare, 45%, eDP, bent non-touchscreen display panel with narrow bezel; typical brightness: 250 nits</li> <li data-bbox="946 1234 1444 1350">• FHD (1920 × 1080), antiglare, 45%, eDP, bent non-touchscreen display panel with narrow bezel, equipped with an HD + infrared webcam; typical brightness: 250 nits</li> <li data-bbox="946 1360 1444 1476">• FHD (1920 × 1080), antiglare, 45%, eDP, bent non-touchscreen display panel with narrow bezel, equipped with an HD webcam; typical brightness: 250 nits</li> </ul>
<b>Memory</b>	<p data-bbox="946 1491 1444 1543">Two nonaccessible memory module slots supporting up to 64 GB of RAM</p> <p data-bbox="946 1564 1444 1596">DDR4-3200 and DDR4-2600 dual-channel support</p> <p data-bbox="946 1617 1444 1648">Supports the following configurations:</p> <ul style="list-style-type: none"> <li data-bbox="946 1669 1444 1753">• <b>64 GB</b> – available on all computer models 32 × 2 @ DDR4-3200 1.2 V SODIMM</li> <li data-bbox="946 1764 1444 1848">• <b>48 GB</b> – available on all computer models 32 × 1 + 16 × 1 @ DDR4-3200 1.2 V SODIMM</li> </ul>

**Table 1-1** Product components and their descriptions (continued)

Category	Description
	<ul style="list-style-type: none"> <li> <b>32 GB</b>            32 × 1 @ DDR4-3200 1.2 V SODIMM – available on all computer models             16 × 2 @ DDR4-3200 1.2 V SODIMM – available on all computer models             16 × 2 @ DDR4-2666 1.2 V SODIMM ECC – available only on computer models equipped with an Intel Xeon processor         </li> </ul>
	<ul style="list-style-type: none"> <li> <b>24 GB</b>            16 × 1 + 8 × 1 @ DDR4-3200 1.2 V SODIMM – available on all computer models             16 × 1 + 8 × 1 @ DDR4-2666 1.2 V SODIMM ECC – available on all computer models         </li> </ul>
	<ul style="list-style-type: none"> <li> <b>16 GB</b>            16 × 1 @ DDR4-3200 1.2 V SODIMM – available on all computer models             16 × 1 @ DDR4-2666 1.2 V SODIMM ECC – available only on computer models equipped with an Intel Xeon processor             8 × 2 @ DDR4-3200 1.2 V SODIMM – available on all computer models             8 × 2 @ DDR4-2666 1.2 V SODIMM ECC – available only on computer models equipped with an Intel Xeon processor         </li> </ul>
	<ul style="list-style-type: none"> <li> <b>8 GB</b>            8 × 1 @ DDR4-3200 1.2 V SODIMM – available on all computer models             8 × 1 @ DDR4-2666 1.2 V SODIMM ECC – available only on computer models equipped with an Intel Xeon processor         </li> </ul>
<b>Primary storage</b>	<p><b>M.2 solid-state drive:</b></p> <ul style="list-style-type: none"> <li>512 GB, M.2 2280, Peripheral Component Interconnect Express (PCIe)-3×4, Non-Volatile Memory Express (NVMe), Secure Seal (SS) solid-state drive with three-layer cell (TLC)</li> <li>512 GB, M.2 2280, PCIe, NVMe, self-encrypted (SED) solid-state drive with TLC OPAL2</li> <li>256 GB, M.2 2280, Peripheral Component Interconnect Express (PCIe)-3×4, Non-Volatile Memory Express (NVMe), Secure Seal (SS) solid-state drive with three-layer cell (TLC)</li> <li>256 GB, M.2 2280, PCIe, NVMe, self-encrypted (SED) solid-state drive with TLC OPAL2</li> </ul>

**Table 1-1** Product components and their descriptions (continued)

Category	Description
	<p><b>Solid-state drive:</b></p> <ul style="list-style-type: none"> <li>• 2 TB, 2280, PCIe-3×4, NVMe, SS solid-state drive with TLC</li> <li>• 1 TB, 2280, PCIe-3×4, NVMe, SS solid-state drive with TLC</li> <li>• 512 GB, 2280, PCIe-3×4, NVMe, SED solid-state drive with TLC OPAL2</li> </ul>
Audio and video	<p><b>Integrated HD Camera:</b> (on select models)</p> <p>Infrared (on select models)</p> <p>Dual-array, world-facing, digital microphone</p>
Wireless	<p><b>Wireless Local Area Network (WLAN):</b></p> <p>Intel Wi-Fi 6 AX201 ax 2×2 + Bluetooth® 5.0 MU-MIMO M.2 1216 vPro® 160 MHz MIPI + BRI WW with 2 antennas</p>
Near field communication (NFC)	NFC Mirage WNC XRAV-1
Keyboard/pointing devices	Standard notebook keyboard with clickpad, numeric keypad, and backlight, spill-resistant
Power requirements	<p><b>Battery:</b> 6 cell, 83 WHr long life, PL Fast Charge</p> <p><b>HP Smart AC adapters:</b></p> <p>150 watt AC adapter HP Smart (PFC, 4.5 mm, slim barrel)</p> <p>120 watt AC Adapter HP Smart (PFC, 4.5 mm, slim barrel)</p> <p><b>Power cord:</b></p> <p>C5, 1.0 m (3.3 ft), conventional with sticker</p> <p>C5, 1.0 m (3.3 ft), premium with sticker</p>
Security	Integrated fingerprint reader and SmartCard reader

**Table 1-1** Product components and their descriptions (continued)

Category	Description
Operating system	<ul style="list-style-type: none"> <li>• Windows® 10 Enterprise 64</li> <li>• Windows 10 Enterprise 64 LTSC 1809 (RS5)</li> <li>• Windows 10 Home 64</li> <li>• Windows 10 Home 64 Advanced</li> <li>• Windows 10 Home 64 Advanced Single Language</li> <li>• Windows 10 Home 64 High-End Chinese Market CPPP</li> <li>• Windows 10 Home 64 Plus Single Language</li> <li>• Windows 10 Home 64 Plus Single Language Africa Market PPP</li> <li>• Windows 10 Home 64 Plus Single Language APAC EM PPP</li> <li>• Windows 10 Home 64 Plus Single Language India Market PPP</li> <li>• Windows 10 Home 64 Plus Single Language Indonesia Market PPP</li> <li>• Windows 10 Professional 64 CBB 1903</li> <li>• Windows 10 Professional 64</li> <li>• Windows 10 Professional 64 CBB 1909</li> <li>• Windows 10 Professional 64 Chinese Market</li> <li>• Windows 10 Professional 64 for Workstations Plus</li> <li>• Windows 10 Professional 64 for Workstations Plus Chinese Market</li> <li>• Windows 10 Professional 64 High End</li> <li>• Windows 10 Professional 64 High End Chinese Market</li> <li>• FreeDOS®</li> </ul>
Serviceability	<b>End user replaceable part:</b> AC adapter





# 2 Components



Your computer features top-rated components. This chapter provides details about your components, where they are located, and how they work.

## Right

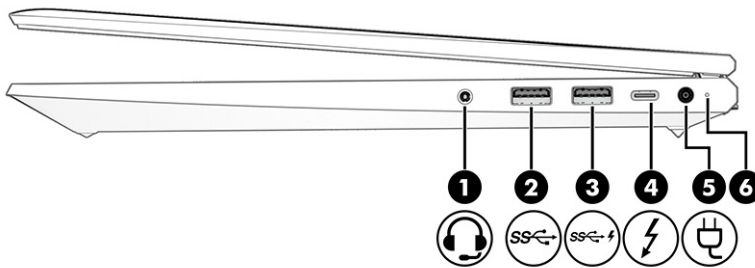

Use the illustration and table to identify the components on the right side of the computer.



**Table 2-1** Right-side components and their descriptions

Component	Description
(1)  Audio-out (headphone)/Audio-in (microphone) combo jack	Connects optional powered stereo speakers, headphones, earbuds, a headset, or a television audio cable. Also connects an optional headset microphone. This jack does not support optional standalone microphones.  <b>WARNING!</b> To reduce the risk of personal injury, adjust the volume before putting on headphones, earbuds, or a headset. For additional safety information, see the <i>Regulatory, Safety, and Environmental Notices</i> .  To access this guide: <ul style="list-style-type: none"> <li>▲ Type <code>HP Documentation</code> in the taskbar search box, and then select <b>HP Documentation</b>.</li> </ul> <b>NOTE:</b> When a device is connected to the jack, the computer speakers are disabled.
(2)  USB SuperSpeed port	Connects a USB device, provides high-speed data transfer, and (for select products) charges small devices when the computer is on or in Sleep mode.
(3)  USB SuperSpeed port with HP Sleep and Charge	Connects a USB device, provides high-speed data transfer, and charges small devices, even when the computer is off.

**Table 2-1** Right-side components and their descriptions (continued)

Component	Description
(4)  USB Type-C® Thunderbolt™ port with HP Sleep and Charge	<p>Connects a USB device, provides high-speed data transfer, and charges small devices, even when the computer is off.</p> <p>– and –</p> <p>Connects a display device that has a USB Type-C connector, providing DisplayPort™ output.</p> <p><b>NOTE:</b> Your computer might also support a Thunderbolt docking station.</p> <p><b>NOTE:</b> Cables, adapters, or both (purchased separately) might be required.</p>
(5)  Power connector	Connects an AC adapter.
(6) Battery light	<p>When AC power is connected:</p> <ul style="list-style-type: none"> <li>• White: The battery charge is greater than 90%.</li> <li>• Amber: The battery charge is from 0 to 90%.</li> <li>• Off: The battery is not charging.</li> </ul> <p>When AC power is disconnected (battery not charging):</p> <ul style="list-style-type: none"> <li>• Blinking amber: The battery has reached a low battery level. When the battery has reached a critical battery level, the battery light begins blinking rapidly.</li> <li>• Off: The battery is not charging.</li> </ul>

## Left



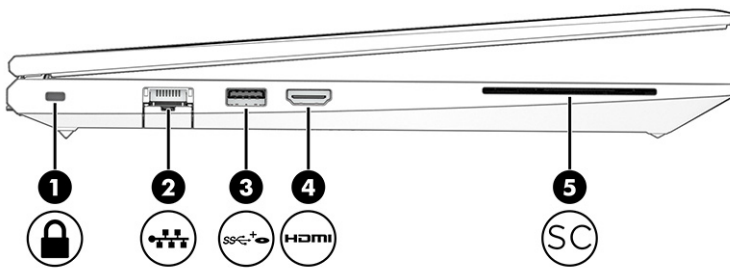

Use the illustration and table to identify the components on the left side of the computer.



**Table 2-2** Left-side components and their descriptions

Component	Description
(1)  Security cable slot	<p>Attaches an optional security cable to the computer.</p> <p><b>NOTE:</b> The security cable is designed to act as a deterrent, but it might not prevent the computer from being mishandled or stolen.</p>

**Table 2-2** Left-side components and their descriptions (continued)

Component	Description
(2)  RJ-45 (network) jack/status lights	Connects a network cable. <ul style="list-style-type: none"> <li>Green (left): The network is connected.</li> <li>Amber (right): Activity is occurring on the network.</li> </ul>
(3)  USB SuperSpeed powered port	Connects and supplies power to a USB device, provides high-speed data transfer, and (for select products) charges small devices when the computer is on or in Sleep mode.
(4)  HDMI port	Connects an optional video or audio device, such as a high-definition television, any compatible digital or audio component, or a high-speed High Definition Multimedia Interface (HDMI) device.
(5)  Smart card reader	Supports optional smart cards.

## Display

Use the illustration and table to identify the display components.

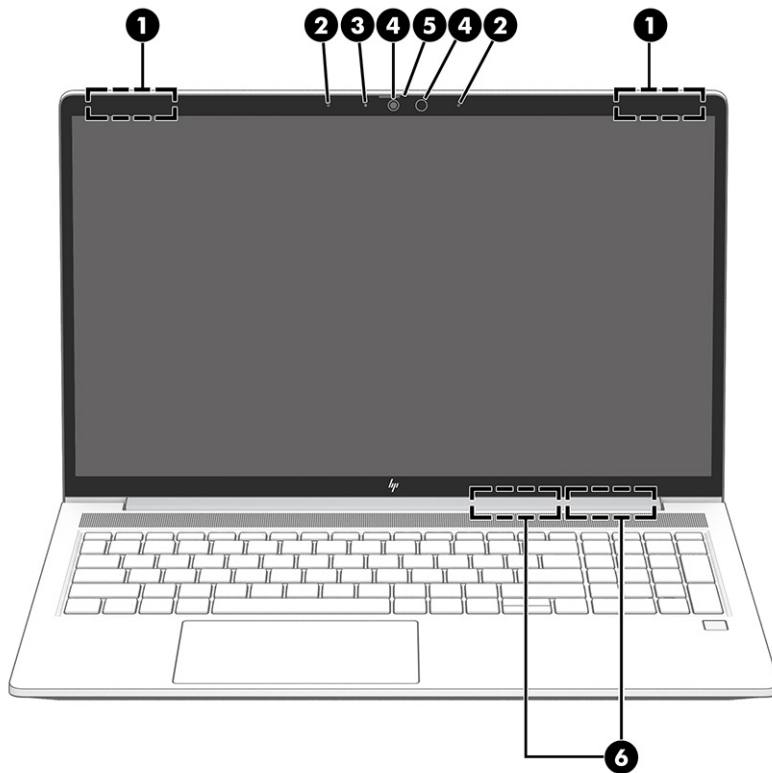

**Table 2-3** Display components and their descriptions

Component	Description
(1) WLAN antennas*	Send and receive wireless signals to communicate with wireless local area networks (WLANs).

**Table 2-3** Display components and their descriptions (continued)

Component	Description
(2) Internal microphones	Record sound.
(3) Camera light	On: The camera is in use.
(4) Camera(s)	Allow(s) you to video chat, record video, and record still images. Some cameras also allow a facial recognition logon to Windows, instead of a password logon.  <b>NOTE:</b> Camera functions vary depending on the camera hardware and software installed on your product.
(5) Camera privacy cover (select products only)	By default, the camera lens is uncovered, but you can slide the camera privacy cover to block the camera's view. To use the camera, slide the camera privacy cover in the opposite direction to reveal the lens.  <b>NOTE:</b> If you have both front-facing and rear-facing cameras, when one camera lens is revealed and ready to use, the other is concealed.
(6) WWAN antennas*	Send and receive wireless signals to communicate with wireless wide area networks (WWANs).

\*The antennas are not visible from the outside of the computer. For optimal transmission, keep the areas immediately around the antennas free from obstructions.

For wireless regulatory notices, see the section of the *Regulatory, Safety, and Environmental Notices* that applies to your country or region.

To access this guide:

▲ Type **HP Documentation** in the taskbar search box, and then select **HP Documentation**.

## Touchpad components

Use the illustration and table to identify the touchpad components.

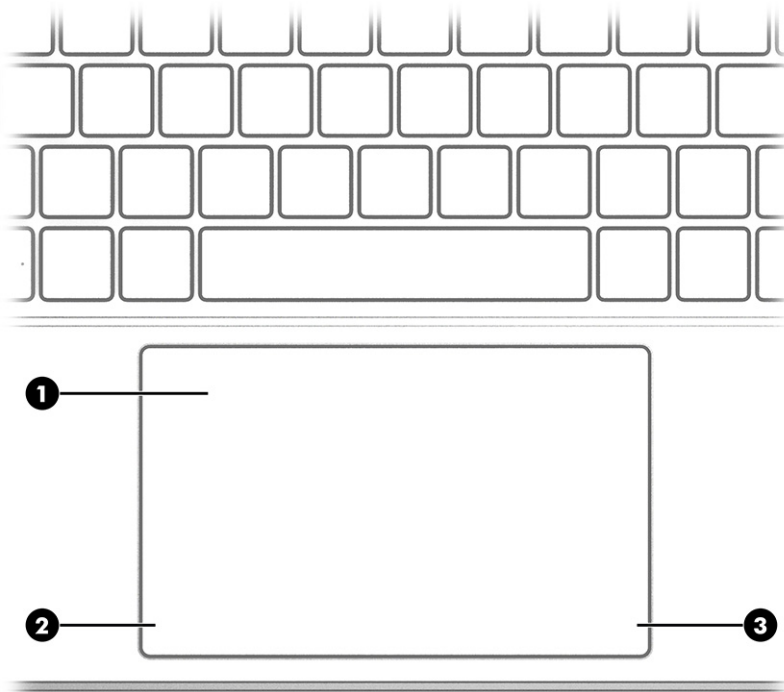

**Table 2-4** Touchpad components and their descriptions

Component	Description
(1) Touchpad zone	Reads your finger gestures to move the pointer or activate items on the screen.
(2) Left touchpad button	Functions like the left button on an external mouse.
(3) Right touchpad button	Functions like the right button on an external mouse.

## Button, speakers, and fingerprint reader

Fingerprint readers can be located on the touchpad, on a side panel of the computer, or on the top cover below the keyboard.

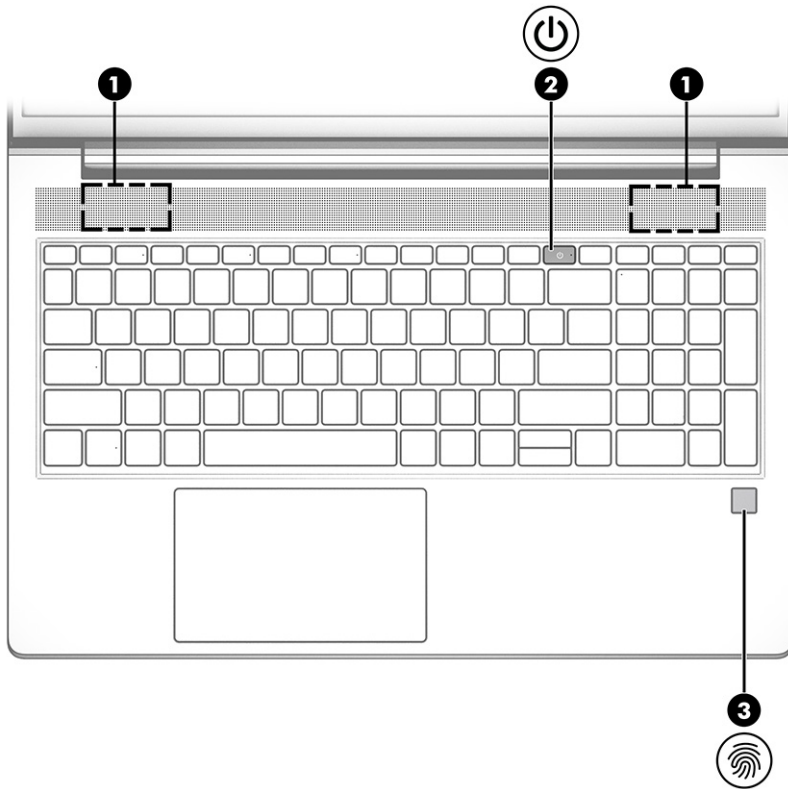

 **IMPORTANT:** To verify that your computer supports fingerprint reader sign-in, type `Sign-in options` in the taskbar search box and follow the on-screen instructions. If **Fingerprint reader** is not listed as an option, then your notebook does not include a fingerprint reader.



**Table 2-5** Button, speakers, and fingerprint reader and their descriptions

Component	Description
(1) Speakers	Produce sound.

**Table 2-5** Button, speakers, and fingerprint reader and their descriptions (continued)

Component	Description
(2)  Power button	<ul style="list-style-type: none"> <li>• When the computer is off, press the button briefly to turn on the computer.</li> <li>• When the computer is on, press the button briefly to initiate Sleep.</li> <li>• When the computer is in the Sleep state, press the button briefly to exit Sleep (select products only).</li> <li>• When the computer is in Hibernation, press the button briefly to exit Hibernation.</li> </ul> <p><b>IMPORTANT:</b> Pressing and holding down the power button results in the loss of unsaved information.</p> <p>If the computer has stopped responding and shutdown procedures are ineffective, press and hold the power button for at least 4 seconds to turn off the computer.</p> <p>To learn more about your power settings, see your power options.</p> <p>▲ Right-click the <b>Power meter</b> icon  and then select <b>Power Options</b>.</p>
(3) Fingerprint reader (select products only)	<p>Allows a fingerprint logon to Windows, instead of a password logon.</p> <p>▲ Swipe down across the fingerprint reader.</p> <p><b>IMPORTANT:</b> To prevent fingerprint logon issues, make sure when you register your fingerprint that all sides of your finger are registered by the fingerprint reader.</p>

## Special keys

Use the illustration and table to identify the special keys.

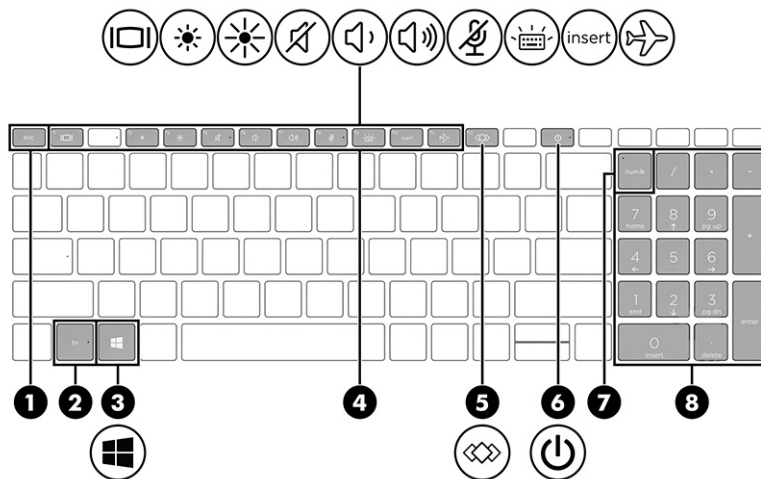

**Table 2-6** Special keys and their descriptions





Component	Description
(1) <span style="margin-left: 20px;">esc key</span>	Displays system information when pressed in combination with the <b>fn</b> key.
(2) <span style="margin-left: 20px;">fn key</span>	Executes frequently used system functions when pressed in combination with another key. Such key combinations are called <i>hot keys</i> .
(3)  <span style="margin-left: 10px;">Windows key</span>	<p>Opens the Start menu.</p> <p><b>NOTE:</b> Pressing the Windows key again will close the Start menu.</p>
(4) <span style="margin-left: 20px;">Action keys</span>	Execute frequently used system functions.
(5)  <span style="margin-left: 10px;">Programmable key</span>	<p>Executes frequently used tasks. Some tasks might not be available on all products.</p> <ul style="list-style-type: none"> <li>• Opens an application, file, or website</li> <li>• Enters frequently used text into a permanent clipboard</li> <li>• Ability to change system profiles</li> <li>• Ability to change system properties</li> <li>• Executes user-defined key sequences</li> </ul>
(6)  <span style="margin-left: 10px;">Power button</span>	<ul style="list-style-type: none"> <li>• When the computer is off, press the button briefly to turn on the computer.</li> <li>• When the computer is on, press the button briefly to initiate Sleep.</li> <li>• When the computer is in the Sleep state, press the button briefly to exit Sleep (select products only).</li> <li>• When the computer is in Hibernation, press the button briefly to exit Hibernation.</li> </ul> <p><b>IMPORTANT:</b> Pressing and holding down the power button results in the loss of unsaved information.</p> <p>If the computer has stopped responding and shutdown procedures are ineffective, press and hold the power button for at least 4 seconds to turn off the computer.</p> <p>To learn more about your power settings, see your power options.</p> <ul style="list-style-type: none"> <li>▲ Right-click the <b>Power meter</b> icon  and then select <b>Power Options</b>.</li> </ul>



Table 2-6 Special keys and their descriptions (continued)

Component	Description
(7) <code>num lk</code> key	<p>Turns the embedded numeric keypad on and off when pressed in combination with the <code>fn</code> key.</p> <p>– or –</p> <p>Turns the embedded numeric keypad on and off.</p> <p>– or –</p> <p>Alternates between the navigational and numeric functions on the integrated numeric keypad.</p>
(8) Integrated numeric keypad	<p>A separate keypad to the right of the alphabet keyboard. When <code>num lk</code> is pressed, the integrated keypad can be used like an external numeric keypad.</p> <p><b>NOTE:</b> If the keypad function is active when the computer is turned off, that function is reinstated when the computer is turned back on.</p>



---

## 3 Illustrated parts catalog

Use this table to determine the spare parts that are available for the computer.

### Computer major components

To identify the computer major components, use this illustration and table.

---

 **NOTE:** HP continually improves and changes product parts. For complete and current information about supported parts for your computer, go to <http://partsurfer.hp.com>, select your country or region, and then follow the on-screen instructions.

 **NOTE:** Details about your computer, including model, serial number, product key, and length of warranty, are on the service tag at the bottom of your computer.

---

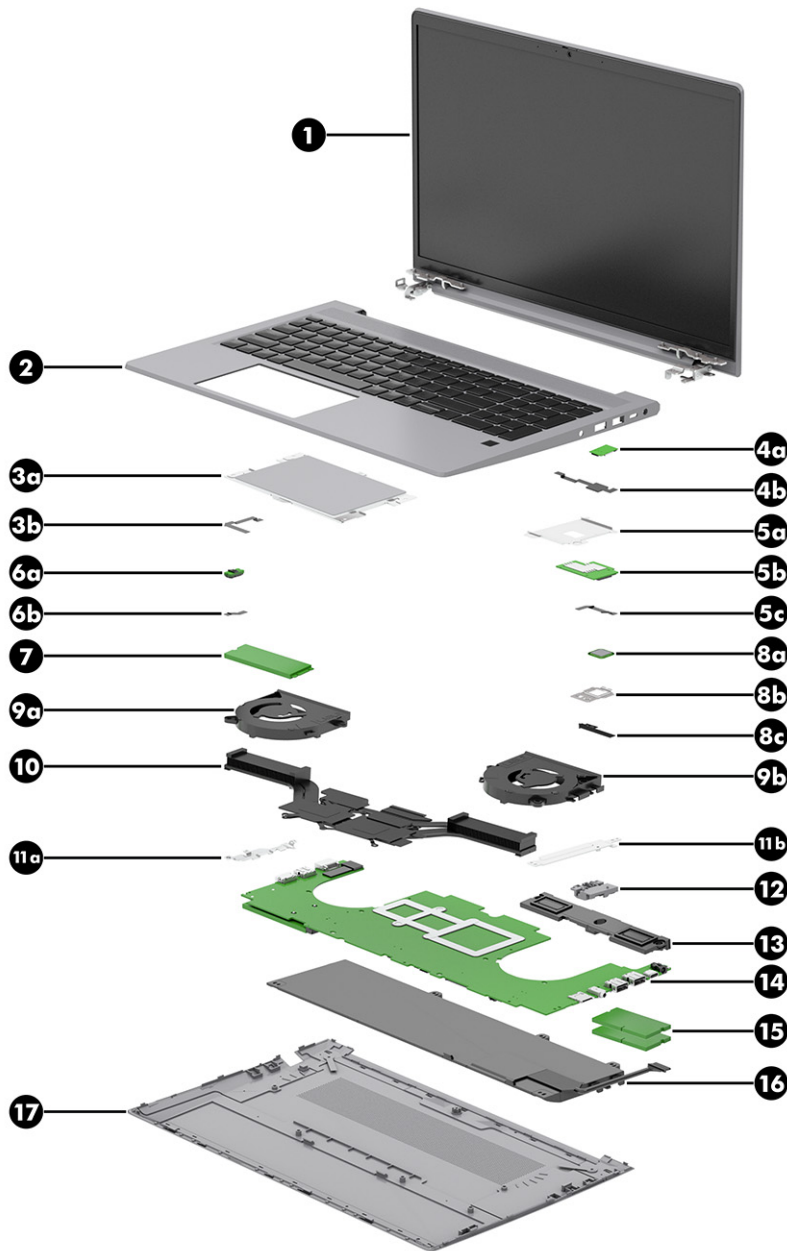

**Table 3-1** Computer major component descriptions and part numbers

Item	Component	Spare part number
(1)	<b>39.6 cm (15.6 in) display assembly:</b> The display assembly is available as spare parts at the subcomponent level only. For more display assembly spare part information, see <a href="#">Display assembly subcomponents on page 26</a> .	
(2)	<b>Keyboard with backlight and clickpad</b> for use only on computer models equipped with a graphics subsystem with discrete memory (includes backlight cable, clickpad cable, and keyboard cable):	
	For use in Belgium	M26112-A41
	For use in Bulgaria	M26112-261
	For use in Brazil	M26112-201
	For use in Canada	M26112-DB1

**Table 3-1 Computer major component descriptions and part numbers (continued)**

Item	Component	Spare part number
	For use in the Czech Republic and Slovakia	M26112-FL1
	For use in Denmark	M26112-081
	For use in France	M26112-051
	For use in Germany	M26112-041
	For use in Greece	M26112-151
	For use in Hungary	M26112-211
	For use in Iceland	M26112-DD1
	For use in India	M26112-D61
	For use in Israel	M26112-BB1
	For use in Italy	M26112-061
	For use in Japan	M26112-291
	For use in Latin America	M26112-291
	For use in the Netherlands	M26112-B31
	For use in Northwest Africa	M26112-FP1
	For use in Portugal	M26112-131
	For use in Romania	M26112-271
	For use in Russia	M26112-251
	For use in Saudi Arabia	M26112-171
	For use in Slovenia	M26112-BA1
	For use in South Korea	M26112-AD1
	For use in Spain	M26112-071
	For use in Sweden and Finland	M26112-B71
	For use in Switzerland	M26112-BG1
	For use in Taiwan	M26112-AB1
	For use in Thailand	M26112-281
	For use in Turkey	M26112-141
	For use in Turkey-F	M26112-541
	For use in the United Kingdom	M26112-031
	For use in the United States	M26112-001
	<b>Keyboard with clickpad</b> for use only on computer models equipped with a graphics subsystem with discrete memory (includes clickpad cable and keyboard cable):	
	For use in Belgium	M26113-A41
	For use in Bulgaria	M26113-261
	For use in Brazil	M26113-201

**Table 3-1 Computer major component descriptions and part numbers (continued)**

Item	Component	Spare part number
	For use in Canada	M26113-DB1
	For use in the Czech Republic and Slovakia	M26113-FL1
	For use in Denmark	M26113-081
	For use in France	M26113-051
	For use in Germany	M26113-041
	For use in Greece	M26113-151
	For use in Hungary	M26113-211
	For use in Iceland	M26113-DD1
	For use in India	M26113-D61
	For use in Israel	M26113-BB1
	For use in Italy	M26113-061
	For use in Japan	M26113-291
	For use in Latin America	M26113-291
	For use in the Netherlands	M26113-B31
	For use in Northwest Africa	M26113-FP1
	For use in Portugal	M26113-131
	For use in Romania	M26113-271
	For use in Russia	M26113-251
	For use in Saudi Arabia	M26113-171
	For use in Slovenia	M26113-BA1
	For use in South Korea	M26113-AD1
	For use in Spain	M26113-071
	For use in Sweden and Finland	M26113-B71
	For use in Switzerland	M26113-BG1
	For use in Taiwan	M26113-AB1
	For use in Thailand	M26113-281
	For use in Turkey	M26113-141
	For use in Turkey-F	M26113-541
	For use in the United Kingdom	M26113-031
	For use in the United States	M26113-001
	<b>Keyboard with backlight and clickpad</b> for use only on computer models equipped with a graphics subsystem with UMA memory (includes backlight cable, clickpad cable, and keyboard cable):	
	For use in Belgium	M26110-A41
	For use in Bulgaria	M26110-261

**Table 3-1 Computer major component descriptions and part numbers (continued)**

Item	Component	Spare part number
	For use in Brazil	M26110-201
	For use in Canada	M26110-DB1
	For use in the Czech Republic and Slovakia	M26110-FL1
	For use in Denmark	M26110-081
	For use in France	M26110-051
	For use in Germany	M26110-041
	For use in Greece	M26110-151
	For use in Hungary	M26110-211
	For use in Iceland	M26110-DD1
	For use in India	M26110-D61
	For use in Israel	M26110-BB1
	For use in Italy	M26110-061
	For use in Japan	M26110-291
	For use in Latin America	M26110-291
	For use in the Netherlands	M26110-B31
	For use in Northwest Africa	M26110-FP1
	For use in Portugal	M26110-131
	For use in Romania	M26110-271
	For use in Russia	M26110-251
	For use in Saudi Arabia	M26110-171
	For use in Slovenia	M26110-BA1
	For use in South Korea	M26110-AD1
	For use in Spain	M26110-071
	For use in Sweden and Finland	M26110-B71
	For use in Switzerland	M26110-BG1
	For use in Taiwan	M26110-AB1
	For use in Thailand	M26110-281
	For use in Turkey	M26110-141
	For use in Turkey-F	M26110-541
	For use in the United Kingdom	M26110-031
	For use in the United States	M26110-001
	<b>Keyboard with clickpad</b> for use only on computer models equipped with a graphics subsystem with discrete memory (includes clickpad cable and keyboard cable):	
	For use in Belgium	M26111-A41

**Table 3-1 Computer major component descriptions and part numbers (continued)**

<b>Item</b>	<b>Component</b>	<b>Spare part number</b>
	For use in Bulgaria	M26111-261
	For use in Brazil	M26111-201
	For use in Canada	M26111-DB1
	For use in the Czech Republic and Slovakia	M26111-FL1
	For use in Denmark	M26111-081
	For use in France	M26111-051
	For use in Germany	M26111-041
	For use in Greece	M26111-151
	For use in Hungary	M26111-211
	For use in Iceland	M26111-DD1
	For use in India	M26111-D61
	For use in Israel	M26111-BB1
	For use in Italy	M26111-061
	For use in Japan	M26111-291
	For use in Latin America	M26111-291
	For use in the Netherlands	M26111-B31
	For use in Northwest Africa	M26111-FP1
	For use in Portugal	M26111-131
	For use in Romania	M26111-271
	For use in Russia	M26111-251
	For use in Saudi Arabia	M26111-171
	For use in Slovenia	M26111-BA1
	For use in South Korea	M26111-AD1
	For use in Spain	M26111-071
	For use in Sweden and Finland	M26111-B71
	For use in Switzerland	M26111-BG1
	For use in Taiwan	M26111-AB1
	For use in Thailand	M26111-281
	For use in Turkey	M26111-141
	For use in Turkey-F	M26111-541
	For use in the United Kingdom	M26111-031
	For use in the United States	M26111-001



**Table 3-1 Computer major component descriptions and part numbers (continued)**

Item	Component	Spare part number
(3a)	<p><b>Touchpad:</b></p> <p><b>NOTE:</b> The touchpad spare part kit does not include the touchpad cable. The touchpad cable is available using spare part number M21856-001.</p>	
	For use only on computer models equipped with NFC capability	M21853-001
	For use only on computer models not equipped with NFC capability	M21854-001
(3b)	<b>Touchpad cable</b> (included in the Cable Kit, spare part number M21856-001)	
(4a)	<p><b>NFC module</b> (includes double-sided adhesive)</p> <p><b>NOTE:</b> The NFC module spare part kit does not include the NFC module antenna, NFC module cable, or NFC module tape. Use the following spare part kits for these components:</p> <ul style="list-style-type: none"> <li>• M21859-001—NFC module antenna</li> <li>• M21856-001—NFC module cable</li> <li>• M31370-001—NFC module tape</li> </ul>	
(4b)	<b>NFC module cable</b> (included in the Cable Kit, spare part number M21856-001)	
(5a)	<b>Card reader board bracket</b> (included in the Bracket Kit, spare part number M21855-001)	
(5b)	<b>Card reader board</b>	M21398-001
	<b>NOTE:</b> The card reader board spare part kit does not include the card reader board cable. The card reader board cable is included in the Cable Kit, spare part number M21856-001.	
(5c)	<b>Card reader board cable</b> (included in the Cable Kit, spare part number M21856-001)	
(6a)	<b>Sensor board</b>	M21844-001
	<b>NOTE:</b> The sensor board spare part kit does not include the sensor board cable. The sensor board cable is included in the Cable Kit, spare part number M21856-001.	
(6b)	<b>Sensor board cable</b> (included in the Cable Kit, spare part number M21856-001)	
(7)	<b>Solid-state drive:</b>	
	2 TB, M.2 2280, PCIe-NVMe-3×4, SS solid-state drive with TLC	L85358-002
	1 TB, M.2 2280, PCIe-NVMe-3×4, SS solid-state drive with TLC	L85348-002
	512 GB, M.2 2280, PCIe-NVMe, SED solid-state drive with TLC	L85368-002
	512 GB, M.2 2280, PCIe-3×4, solid-state drive with TLC	L85360-002
	256 GB, M.2 2280, PCIe, NVMe, SED solid-state drive with TLC	M07245-002
	256 GB, M.2 2280, PCIe-3×4, SS solid-state drive with TLC	L85350-002
(8a)	<b>Fingerprint reader module</b>	M21402-001
	<b>NOTE:</b> The fingerprint reader module spare part kit does not include the fingerprint reader module cable. The fingerprint reader module cable is included in the Cable Kit, spare part number M21856-001.	
(8b)	<b>Fingerprint reader module bracket</b> (included in the Bracket Kit, spare part number M21855-001)	
(8c)	<b>Fingerprint reader module cable</b> (included in the Cable Kit, spare part number M21856-001)	
	<b>Fans</b> (2, each include cable):	

**Table 3-1 Computer major component descriptions and part numbers (continued)**

Item	Component	Spare part number
(9a)	Left fan	M21848-601
(9b)	Right fan	M21849-001
(10)	<b>Heat sink</b> (includes replacement thermal material):	
	For use only on computer models with a graphics subsystem with discrete memory	M21846-601
	For use only on computer models with a graphics subsystem with UMA memory	M21845-001
(11a)	<b>I/O bracket</b> (included in the Bracket Kit, spare part number M21855-001)	
(11b)	<b>Battery support bracket</b> (included in the Bracket Kit, spare part number M21855-001)	
(12)	<b>RJ-45 (network) jack cover</b> (not available as a spare part component)	
(13)	<b>Speakers</b> (includes left and right speakers, cables, and four rubber isolators)	M21850-001
(14)	<b>System board</b> (includes the processor and replacement thermal material):	
	Equipped with an Intel Xeon W-10855M processor, an NVIDIA Quadro T2000 N19P-Q3 graphic controller with 4 GB of discrete memory, and the Windows 10 operating system	M21835-601
	Equipped with an Intel Xeon W-10855M processor, an NVIDIA Quadro T2000 N19P-Q3 graphic controller with 4 GB of discrete memory, and a non-Windows operating system	M21835-001
	Equipped with an Intel Core i9-10885H processor, an NVIDIA Quadro T2000 N19P-Q3 graphic controller with 4 GB of discrete memory, and the Windows 10 operating system	M21833-001
	Equipped with an Intel Core i9-10885H processor, an NVIDIA Quadro T2000 N19P-Q3 graphic controller with 4 GB of discrete memory, and a non-Windows operating system	M21833-001
	Equipped with an Intel Core i9-10885H processor, an NVIDIA Quadro T1000 N19P-Q1 graphic controller with 4 GB of discrete memory, and the Windows 10 operating system	M21827-601
	Equipped with an Intel Core i9-10885H processor, an NVIDIA Quadro T1000 N19P-Q1 graphic controller with 4 GB of discrete memory, and a non-Windows operating system	M21827-001
	Equipped with an Intel Core i7-10850H processor, an NVIDIA Quadro T2000 N19P-Q3 graphic controller with 4 GB of discrete memory, and the Windows 10 operating system	M21831-601
	Equipped with an Intel Core i7-10850H processor, an NVIDIA Quadro T2000 N19P-Q3 graphic controller with 4 GB of discrete memory, and a non-Windows operating system	M21831-001
	Equipped with an Intel Core i7-10850H processor, an NVIDIA Quadro T2000 N19P-Q3 graphic controller with 4 GB of discrete memory, and the Windows 10 operating system, but not equipped with WLAN or Bluetooth capability	M21841-601
	Equipped with an Intel Core i7-10850H processor, an NVIDIA Quadro T2000 N19P-Q3 graphic controller with 4 GB of discrete memory, and a non-Windows operating system, but not equipped with WLAN or Bluetooth capability	M21841-001
	Equipped with an Intel Core i7-10850H processor, an NVIDIA Quadro T1000 N19P-Q1 graphic controller with 4 GB of discrete memory, and the Windows 10 operating system	M21825-601
	Equipped with an Intel Core i7-10850H processor, an NVIDIA Quadro T1000 N19P-Q1 graphic controller with 4 GB of discrete memory, and a non-Windows operating system	M21825-001
	Equipped with an Intel Core i7-10850H processor, an NVIDIA Quadro T1000 N19P-Q1 graphic controller with 4 GB of discrete memory, and the Windows 10 operating system, but not equipped with WLAN or Bluetooth capability	M21839-601
	Equipped with an Intel Core i7-10850H processor, an NVIDIA Quadro T1000 N19P-Q1 graphic controller with 4 GB of discrete memory, and a non-Windows operating system, but not equipped with WLAN or Bluetooth capability	M21839-001

**Table 3-1 Computer major component descriptions and part numbers (continued)**

Item	Component	Spare part number
	Equipped with an Intel Core i7-10850H processor, an NVIDIA Quadro P620 N19M-Q3 graphic controller with 4 GB of discrete memory, and the Windows 10 operating system	M21821-601
	Equipped with an Intel Core i7-10850H processor, an NVIDIA Quadro P620 N19M-Q3 graphic controller with 4 GB of discrete memory, and a non-Windows operating system	M21821-001
	Equipped with an Intel Core i7-10850H processor, a graphics subsystem with UMA memory, and the Windows 10 operating system	M21813-601
	Equipped with an Intel Core i7-10850H processor, a graphics subsystem with UMA memory, and a non-Windows operating system	M21813-001
	Equipped with an Intel Core i7-10850H processor, a graphics subsystem with UMA memory, and the Windows 10 operating system, but not equipped with WLAN or Bluetooth capability	M21811-601
	Equipped with an Intel Core i7-10850H processor, a graphics subsystem with UMA memory, and a non-Windows operating system, but not equipped with WLAN or Bluetooth capability	M21811-001
	Equipped with an Intel Core i7-10750H processor, an NVIDIA Quadro T2000 N19P-Q3 graphic controller with 4 GB of discrete memory, and the Windows 10 operating system	M21829-601
	Equipped with an Intel Core i7-10750H processor, an NVIDIA Quadro T2000 N19P-Q3 graphic controller with 4 GB of discrete memory, and a non-Windows operating system	M21829-001
	Equipped with an Intel Core i7-10750H processor, an NVIDIA Quadro T1000 N19P-Q1 graphic controller with 4 GB of discrete memory, and the Windows 10 operating system	M21823-601
	Equipped with an Intel Core i7-10750H processor, an NVIDIA Quadro T1000 N19P-Q1 graphic controller with 4 GB of discrete memory, and a non-Windows operating system	M21823-001
	Equipped with an Intel Core i7-10750H processor, an NVIDIA Quadro T1000 N19P-Q1 graphic controller with 4 GB of discrete memory, and the Windows 10 operating system, but not equipped with WLAN or Bluetooth capability	M21837-601
	Equipped with an Intel Core i7-10750H processor, an NVIDIA Quadro T1000 N19P-Q1 graphic controller with 4 GB of discrete memory, and a non-Windows operating system, but not equipped with WLAN or Bluetooth capability	M21837-001
	Equipped with an Intel Core i7-10750H processor, an NVIDIA Quadro P620 N19M-Q3 graphic controller with 4 GB of discrete memory, and the Windows 10 operating system	M21819-601
	Equipped with an Intel Core i7-10750H processor, an NVIDIA Quadro P620 N19M-Q3 graphic controller with 4 GB of discrete memory, and a non-Windows operating system	M21819-001
	Equipped with an Intel Core i7-10750H processor, a graphics subsystem with UMA memory, and the Windows 10 operating system	M21809-601
	Equipped with an Intel Core i7-10750H processor, a graphics subsystem with UMA memory, and a non-Windows operating system	M21809-001
	Equipped with an Intel Core i5-10400H processor, an NVIDIA Quadro P620 N19M-Q3 graphic controller with 4 GB of discrete memory, and the Windows 10 operating system	M21817-601
	Equipped with an Intel Core i5-10400H processor, an NVIDIA Quadro P620 N19M-Q3 graphic controller with 4 GB of discrete memory, and a non-Windows operating system	M21817-001
	Equipped with an Intel Core i5-10400H processor, a graphics subsystem with UMA memory, and the Windows 10 operating system	M21807-601
	Equipped with an Intel Core i5-10400H processor, a graphics subsystem with UMA memory, and a non-Windows operating system	M21807-001
	Equipped with an Intel Core i5-10400H processor, a graphics subsystem with UMA memory, and the Windows 10 operating system, but not equipped with WLAN or Bluetooth capability	M21805-601

**Table 3-1 Computer major component descriptions and part numbers (continued)**

Item	Component	Spare part number
	Equipped with an Intel Core i5-10400H processor, a graphics subsystem with UMA memory, and a non-Windows operating system, but not equipped with WLAN or Bluetooth capability	M21805-001
	Equipped with an Intel Core i5-10300H processor, an NVIDIA Quadro P620 N19M-Q3 graphic controller with 4 GB of discrete memory, and the Windows 10 operating system	M21815-601
	Equipped with an Intel Core i5-10300H processor, an NVIDIA Quadro P620 N19M-Q3 graphic controller with 4 GB of discrete memory, and a non-Windows operating system	M21815-001
	Equipped with an Intel Core i5-10300H processor, a graphics subsystem with UMA memory, and the Windows 10 operating system	M21803-601
	Equipped with an Intel Core i5-10300H processor, a graphics subsystem with UMA memory, and a non-Windows operating system	M21803-001
<b>(15)</b>	<b>Memory modules (2):</b>	
	32 GB DDR4-3200 1.2 V	M09713-002
	16 GB DDR4-3200 1.2 V	L67710-002
	16 GB DDR4-2666 1.2 V ECC	L24981-002
	8 GB DDR4-3200 1.2 V	L46598-002
	8 GB DDR4-2666 1.2 V ECC	L24983-002
<b>(16)</b>	<b>Battery</b> (6 cell, 83 WHr, includes cable)	M02029-005
<b>(17)</b>	<b>Bottom cover:</b>	
	For use only on computer models with a graphics subsystem with discrete memory	M21852-601
	For use only on computer models with a graphics subsystem with UMA memory	M21851-001

## Display assembly subcomponents

To identify the display assembly subcomponents, use this illustration and table.

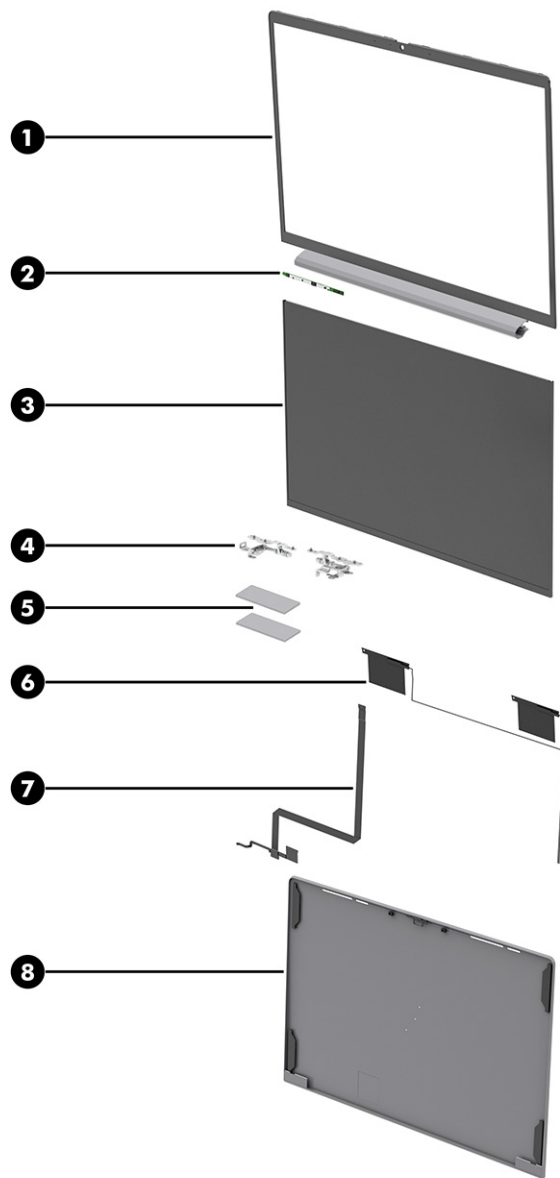

**Table 3-2** Display component descriptions and part numbers

Item	Component	Spare part number
(1)	<b>Display bezel:</b>	
	For use only on computer models equipped with an HD webcam and infrared sensor	M21864-001
	For use only on computer models equipped with an HD webcam	M21863-001
	For use only on computer models not equipped with a webcam	M21865-001
(2)	<b>Webcam/microphone module (includes double-sided adhesive):</b>	
	For use only on computer models equipped with an HD webcam and infrared sensor	M21872-001
	For use only on computer models equipped with an HD webcam	M21873-001
(3)	<b>Display panel:</b>	
	39.6 cm (15.6 in), UHD, antiglare, UWVA, ePSR2, 400 nit, non-touchscreen display panel	M21871-001

**Table 3-2** Display component descriptions and part numbers (continued)

Item	Component	Spare part number
	39.6 cm (15.6 in), FHD, antiglare, UWVA, ePSR2, 400 nit, non-touchscreen display panel	M21869-001
	39.6 cm (15.6 in), FHD, antiglare, UWVA, EDP, 250 nit, touchscreen display panel	M21870-001
	39.6 cm (15.6 in), FHD, antiglare, UWVA, EDP, 250 nit, non-touchscreen display panel	M21868-001
(4)	<b>Display hinges</b> (2, includes left and right hinges)	M21867-001
(5)	<b>Display hinge covers</b> (2, includes left and right hinge covers; included in the Display Support Kit, spare part number M27375-001)	
(6)	<b>Wireless Antenna Kit</b> (includes antenna cables and transceivers)	M21862-001
(7)	<b>Display panel cable</b> (includes webcam/microphone module cable)	M21866-001
(8)	<b>Display back cover:</b>	
	For use only on computer models equipped with a 400 nit display assembly	M21861-001
	For use only on computer models equipped with a 250 nit display assembly	M21860-001

## Mass storage devices

To identify the mass storage devices, use this illustration and table.

**Table 3-3** Solid-state drive descriptions and part numbers

Item	Component	Spare part number
	<b>Solid-state drive:</b>	
	2 TB, M.2 2280, PCIe-NVMe-3×4, SS solid-state drive with TLC	L85358-002
	1 TB, M.2 2280, PCIe-NVMe-3×4, SS solid-state drive with TLC	L85348-002
	512 GB, M.2 2280, PCIe-NVMe, SED solid-state drive with TLC	L85368-002
	512 GB, M.2 2280, PCIe-3×4, solid-state drive with TLC	L85360-002
	256 GB, M.2 2280, PCIe, NVMe, SED solid-state drive with TLC	M07245-002
	256 GB, M.2 2280, PCIe-3×4, SS solid-state drive with TLC	L85350-002
	1 TB, M.2 2280, PCIe + 32 GB, 3D Xpoint solid-state drive	L85374-005
	512 GB, M.2 2280, PCIe + 32 GB, 3D Xpoint solid-state drive	L85366-005
	<b>Solid-state drive shield</b> (not available as a spare part)	

## Cables

To identify the cables, use this illustration and table.

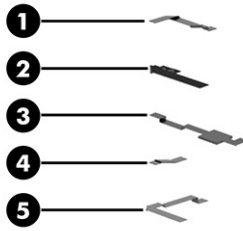

**Table 3-4** Cable descriptions and part numbers

Item	Component	Spare part number
The cables in the following list are included in the Cable Kit, spare part number M21856-001.		
(1)	Card reader board cable	
(2)	Fingerprint reader module cable	
(3)	NFC module cable	
(4)	Sensor board cable	
(5)	Touchpad cable	

## Miscellaneous parts

To identify the miscellaneous parts, use this table.

**Table 3-5** Miscellaneous part descriptions and part numbers

Component	Spare part number
<b>AC adapter:</b>	
150 W HP Smart Adapter (PFC, 4.5 mm, slim barrel)	917649-850
120 W HP Smart Adapter (PFC, RC, 4.5 mm, slim barrel)	L41856-001
<b>Bracket Kit:</b> (includes battery support bracket, card reader bracket, fingerprint reader module bracket, I/O bracket, and touchpad bracket)	M21855-001
<b>Power cord</b> (C5, 1.0 m [3.3 ft], conventional with sticker):	
For use in Argentina	L31379-001
For use in Australia	L31380-001
For use in Brazil	L31381-001
For use in Denmark	L31382-001
For use in Europe	L31383-001
For use in India	L31385-001
For use in Israel	L31384-001
For use in Italy	L31386-001
For use in Japan	L31387-001
For use in North America	L31389-001

**Table 3-5** Miscellaneous part descriptions and part numbers (continued)

<b>Component</b>	<b>Spare part number</b>
For use in the People's Republic of China	L31390-001
For use in South Africa	L31391-001
For use in South Korea	L31388-001
For use in Switzerland	L31392-001
For use in Taiwan	L31394-001
For use in Thailand	L31393-001
For use in the United Kingdom	L31395-001
<b>Power cord</b> (C5, 1.0 m [3.3 ft], premium with sticker):	
For use in Argentina	920689-003
For use in Australia	L30679-001
For use in Brazil	L30770-001
For use in Denmark	L30771-001
For use in Europe	L30772-001
For use in India	920689-016
For use in Israel	L30773-001
For use in Italy	L30774-001
For use in Japan	L30775-001
For use in North America	920689-001
For use in the People's Republic of China	920689-014
For use in South Africa	L30777-001
For use in South Korea	L30776-001
For use in Switzerland	L30778-001
For use in Taiwan	L30780-001
For use in Thailand	L30779-001
For use in the United Kingdom	L30781-001
<b>Screw Kit</b>	M21874-001



---

## 4 Removal and replacement procedures preliminary requirements

Use this information to properly prepare to disassemble and reassemble the computer.

### Tools required

You need the following tools to complete the removal and replacement procedures:

- Tweezers
- Nonconductive, nonmarking pry tool
- Magnetic Phillips P1 screwdriver
- Torx T8 screwdriver

## Service considerations

The following sections include some of the considerations that you must keep in mind during disassembly and assembly procedures.

---

 **NOTE:** As you remove each subassembly from the computer, place the subassembly (and all accompanying screws) away from the work area to prevent damage.

---

### Plastic parts

Using excessive force during disassembly and reassembly can damage plastic parts.

### Cables and connectors

Handle cables with extreme care to avoid damage.

---

 **IMPORTANT:** When servicing the computer, be sure that cables are placed in their proper locations during the reassembly process. Improper cable placement can damage the computer.

---

Apply only the tension required to unseat or seat the cables during removal and insertion. Handle cables by the connector whenever possible. In all cases, avoid bending, twisting, or tearing cables. Be sure that cables are routed so that they cannot be caught or snagged as you remove or replace parts. Handle flex cables with extreme care; these cables tear easily.

### Drive handling

Note the following guidelines when handling drives.

---

 **IMPORTANT:** Drives are fragile components. Handle them with care. To prevent damage to the computer, damage to a drive, or loss of information, observe these precautions:

Before removing or inserting a hard drive, shut down the computer. If you are unsure whether the computer is off or in Hibernation, turn the computer on, and then shut it down through the operating system.

Before handling a drive, be sure that you are discharged of static electricity. While handling a drive, avoid touching the connector.

Before removing an optical drive, be sure that a disc is not in the drive, and be sure that the optical drive tray is closed.

Handle drives on surfaces covered with at least 2.54 cm (1 inch) of shock-proof foam.

Avoid dropping drives from any height onto any surface.

After removing a hard drive or an optical drive, place it in a static-proof bag.

Avoid exposing an internal hard drive to products that have magnetic fields, such as monitors or speakers.

Avoid exposing a drive to temperature extremes or liquids.

If a drive must be mailed, place the drive in a bubble pack mailer or other suitable form of protective packaging, and label the package “FRAGILE.”

---

### Workstation guidelines

Follow these grounding workstation guidelines:

- Cover the workstation with approved static-shielding material.
- Use a wrist strap connected to a properly grounded work surface and use properly grounded tools and equipment.
- Use conductive field service tools, such as cutters, screw drivers, and vacuums.
- When fixtures must directly contact dissipative surfaces, use fixtures made only of static-safe materials.
- Keep the work area free of nonconductive materials, such as ordinary plastic assembly aids and polystyrene foam.
- Handle ESD-sensitive components, parts, and assemblies by the case or PCM laminate. Handle these items only at static-free workstations.
- Avoid contact with pins, leads, or circuitry.
- Turn off power and input signals before inserting or removing connectors or test equipment.

# Electrostatic discharge information

A sudden discharge of static electricity from your finger or other conductor can destroy static-sensitive devices or microcircuitry. Often the spark is neither felt nor heard, but damage occurs. An electronic device exposed to electrostatic discharge (ESD) might not appear to be affected at all and can work perfectly throughout a normal cycle. The device might function normally for a while, but it has been degraded in the internal layers, reducing its life expectancy.

Networks built into many integrated circuits provide some protection, but in many cases, the discharge contains enough power to alter device parameters or melt silicon junctions.

 **IMPORTANT:** To prevent damage to the device when you remove or install internal components, observe these precautions:

Keep components in their electrostatic-safe containers until you are ready to install them.

Before touching an electronic component, discharge static electricity by using the guidelines described [Personal grounding methods and equipment on page 35](#).

Avoid touching pins, leads, and circuitry. Handle electronic components as little as possible.

If you remove a component, place it in an electrostatic-safe container.

## Generating static electricity

Follow these static electricity guidelines.

- Different activities generate different amounts of static electricity.
- Static electricity increases as humidity decreases.

**Table 4-1** Static electricity occurrence based on activity and humidity

Event	Relative humidity		
	55%	40%	10%
Walking across carpet	7,500 V	15,000 V	35,000 V
Walking across vinyl floor	3,000 V	5,000 V	12,000 V
Motions of bench worker	400 V	800 V	6,000 V
Removing DIPs (dual in-line packages) from plastic tube	400 V	700 V	2,000 V
Removing DIPs from vinyl tray	2,000 V	4,000 V	11,500 V
Removing DIPs from polystyrene foam	3,500 V	5,000 V	14,500 V
Removing bubble pack from PCB (printed circuit board)	7,000 V	20,000 V	26,500 V
Packing PCBs in foam-lined box	5,000 V	11,000 V	21,000 V

Multiple electric components can be packaged together in plastic tubes, trays, or polystyrene foam.

 **NOTE:** As little as 700 V can degrade a product.

## Preventing electrostatic damage to equipment

Many electronic components are sensitive to ESD. Circuitry design and structure determine the degree of sensitivity. The following packaging and grounding precautions are necessary to prevent static electricity damage to electronic components.

- To avoid hand contact, transport products in static-safe containers such as tubes, bags, or boxes.
- Protect all electrostatic parts and assemblies with conductive or approved containers or packaging.
- Keep electrostatic-sensitive parts in their containers until they arrive at static-free stations.
- Place items on a grounded surface before removing them from their container.
- Always be properly grounded when touching a sensitive component or assembly.
- Avoid contact with pins, leads, or circuitry.
- Place reusable electrostatic-sensitive parts from assemblies in protective packaging or conductive foam.

## Personal grounding methods and equipment

Using certain equipment can prevent static electricity damage to electronic components.

- **Wrist straps** are flexible straps with a maximum of  $1\text{ M}\Omega \pm 10\%$  resistance in the ground cords. To provide proper ground, a strap must be worn snug against bare skin. The ground cord must be connected and fit snugly into the banana plug connector on the grounding mat or workstation.
- **Heel straps/Toe straps/Boot straps** can be used at standing workstations and are compatible with most types of shoes or boots. On conductive floors or dissipative floor mats, use them on both feet with a maximum of  $1\text{ M}\Omega \pm 10\%$  resistance between the operator and ground.

**Table 4-2** Static shielding protection levels

Static shielding protection levels	
Method	Voltage
Antistatic plastic	1,500
Carbon-loaded plastic	7,500
Metallized laminate	15,000

## Grounding the work area

To prevent static damage at the work area, follow these precautions.

- Cover the work surface with approved static-dissipative material. Provide a wrist strap connected to the work surface and properly grounded tools and equipment.
- Use static-dissipative mats, foot straps, or air ionizers to give added protection.
- Handle electrostatic sensitive components, parts, and assemblies by the case or PCB laminate. Handle them only at static-free work areas.
- Turn off power and input signals before inserting and removing connectors or test equipment.
- Use fixtures made of static-safe materials when fixtures must directly contact dissipative surfaces.

- Keep work area free of nonconductive materials such as ordinary plastic assembly aids and polystyrene foam.
- Use field service tools, such as cutters, screwdrivers, and vacuums, that are conductive.

## Recommended materials and equipment

HP recommends certain materials and equipment to prevent static electricity.

- Antistatic tape
- Antistatic smocks, aprons, or sleeve protectors
- Conductive bins and other assembly or soldering aids
- Conductive foam
- Conductive tabletop workstations with ground cord of  $1\text{ M}\Omega \pm 10\%$  resistance
- Static-dissipative table or floor mats with hard tie to ground
- Field service kits
- Static awareness labels
- Wrist straps and footwear straps providing  $1\text{ M}\Omega \pm 10\%$  resistance
- Material handling packages
- Conductive plastic bags
- Conductive plastic tubes
- Conductive tote boxes
- Opaque shielding bags
- Transparent metallized shielding bags
- Transparent shielding tubes

## Packaging and transporting guidelines

Follow these grounding guidelines when packaging and transporting equipment.

- To avoid hand contact, transport products in static-safe tubes, bags, or boxes.
- Protect ESD-sensitive parts and assemblies with conductive or approved containers or packaging.
- Keep ESD-sensitive parts in their containers until the parts arrive at static-free workstations.
- Place items on a grounded surface before removing items from their containers.
- Always be properly grounded when touching a component or assembly.

- Store reusable ESD-sensitive parts from assemblies in protective packaging or nonconductive foam.
- Use transporters and conveyors made of antistatic belts and roller bushings. Be sure that mechanized equipment used for moving materials is wired to ground and that proper materials are selected to avoid static charging. When grounding is not possible, use an ionizer to dissipate electric charges.







---

## 5 Removal and replacement procedures for authorized service provider parts

This chapter provides removal and replacement procedures for authorized service provider parts.

---

 **IMPORTANT:** Components described in this chapter should be accessed only by an authorized service provider. Accessing these parts can damage the computer or void the warranty.

 **NOTE:** Details about your computer, including model, serial number, product key, and length of warranty, are on the service tag at the bottom of your computer.

---

# Component replacement procedures

To remove and replace computer components, use these procedures.

 **NOTE:** HP continually improves and changes product parts. For complete and current information about supported parts for your computer, go to <http://partsurfer.hp.com>, select your country or region, and then follow the on-screen instructions.

You must remove, replace, or loosen as many as 57 screws when you service the parts described in this chapter. Make special note of each screw size and location during removal and replacement.

## Preparation for disassembly

To remove and replace computer components, use these procedures.

See [Removal and replacement procedures preliminary requirements on page 31](#) for initial safety procedures.

1. Turn off the computer. If you are unsure whether the computer is off or in Hibernation, turn the computer on, and then shut it down through the operating system.
2. Disconnect the power from the computer by unplugging the power cord from the computer.
3. Disconnect all external devices from the computer.

## Bottom cover

To remove the bottom cover, use this procedure and illustration.

**Table 5-1** Bottom cover descriptions and part numbers

Description	Spare part number
For use only on computer models with a graphics subsystem with discrete memory	M21852-601
For use only on computer models with a graphics subsystem with UMA memory	M21851-001

Before removing the bottom cover, prepare the computer for disassembly ([Preparation for disassembly on page 40](#)).

Remove the bottom cover:

1. Close the computer and rest it upside down on a flat work surface with the front toward you.
2. Remove the three Phillips M2.5 × 8.2 screws **(1)** that secure the bottom cover to the computer.

3. Remove the two Phillips M2.5 × 4.6 screws (2) that secure the bottom cover to the computer.

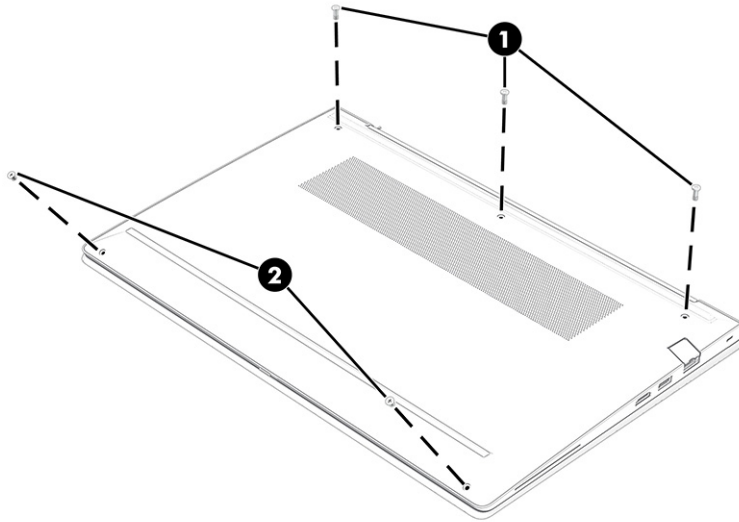

4. Use a case utility tool (1) or similar thin, plastic tool to separate the rear edge (2) of the bottom cover from the top cover.
5. Remove the bottom cover (3).

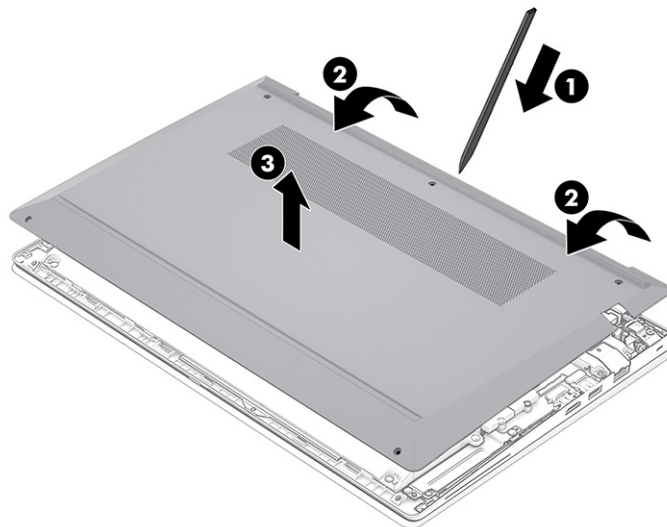

To replace the bottom cover, reverse the removal procedures.

## Battery

To remove the battery, use this procedure and illustration.

**Table 5-2 Battery description and part number**

Description	Spare part number
6 cell, 83 Whr battery, includes cable	M02029-005

 **WARNING!** To avoid personal injury and damage to the product:

- Do *not* puncture, twist, or crack the battery.
- Do *not* cause an external puncture or rupture to the battery. They can cause a short inside the battery, which can result in battery thermal runaway.
- Do *not* handle or touch the battery enclosure with sharp objects such as tweezers or pliers, which might puncture the battery.
- Do *not* compress or squeeze the battery case with tools or heavy objects stacked on top of the case. These actions can apply undue force on the battery.
- Do *not* touch the connectors with any metallic surface or object, such as metal tools, screws, or coins, which can cause shorting across the connectors.

Before removing the battery, follow these steps:

1. Prepare the computer for disassembly ([Preparation for disassembly on page 40](#)).
2. Remove the bottom cover ([Bottom cover on page 40](#)).

 **WARNING!** To reduce potential safety issues, use only the user-replaceable battery provided with the computer, a replacement battery provided by HP, or a compatible battery purchased from HP.

 **IMPORTANT:** Removing a battery that is the sole power source for the computer can cause loss of information. To prevent loss of information, save your work or shut down the computer through Windows before you remove the battery.

Remove the battery:

1. Disconnect the battery cable **(1)** from the system board.
2. Remove the six Phillips M2.0 × 4.7 screws **(2)** that secure the battery to the top cover.

3. Remove the battery (3).

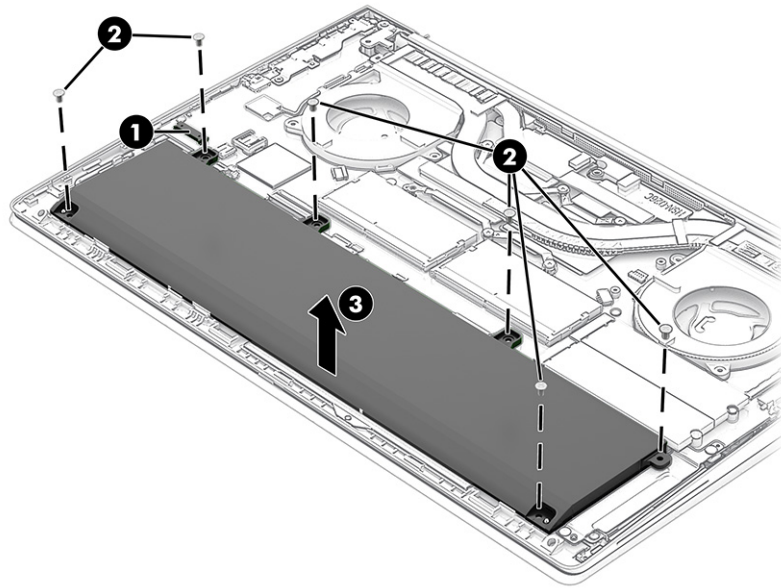

To insert the battery, reverse the removal procedures.

## Memory module

To remove a memory module, use this procedure and illustration.

**Table 5-3** Memory module descriptions and part numbers

Description	Spare part number
32 GB DDR4-3200 1.2 V	M09713-002
16 GB DDR4-3200 1.2 V	L67710-002
16 GB DDR4-2666 1.2 V ECC	L24981-002
8 GB DDR4-3200 1.2 V	L46598-002
8 GB DDR4-2666 1.2 V ECC	L24983-002

Before removing a memory module, follow these steps:

1. Prepare the computer for disassembly ([Preparation for disassembly on page 40](#)).
2. Remove the bottom cover ([Bottom cover on page 40](#)).
3. Disconnect the battery cable from the system board (see [Battery on page 41](#)).

If you are replacing a memory module, remove the existing memory module:

- ▲ Spread the two retention clips outward (1) until the memory module tilts up at a 45° angle, and then remove the module (2). Use the same procedure to remove all memory modules.

 **IMPORTANT:** To prevent damage to the memory module, hold the memory module by the edges only. Do not touch the components on the memory module.

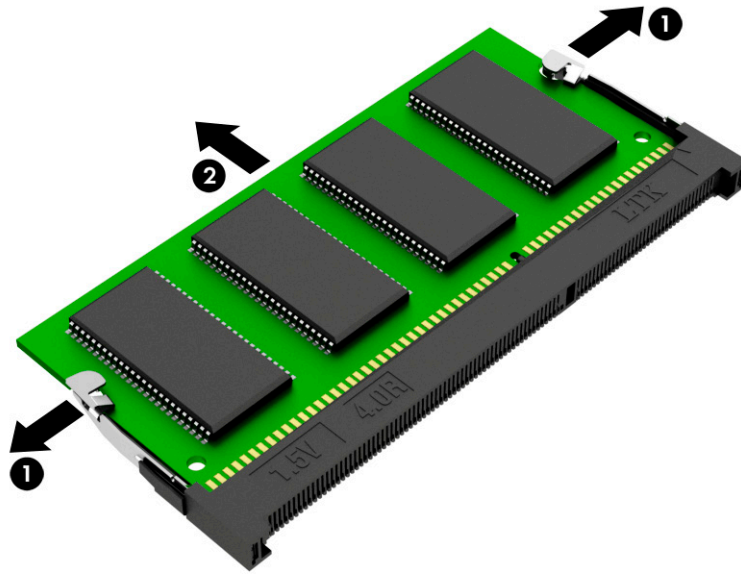

To protect a memory module after removal, place it in an electrostatic-safe container.

To install a memory module:

1. Align the notched edge of the module with the tab in the slot (1), and then press the module into the slot at an angle until it is seated (2).
2. Press down on the module until the side retention clips snap into place (3).

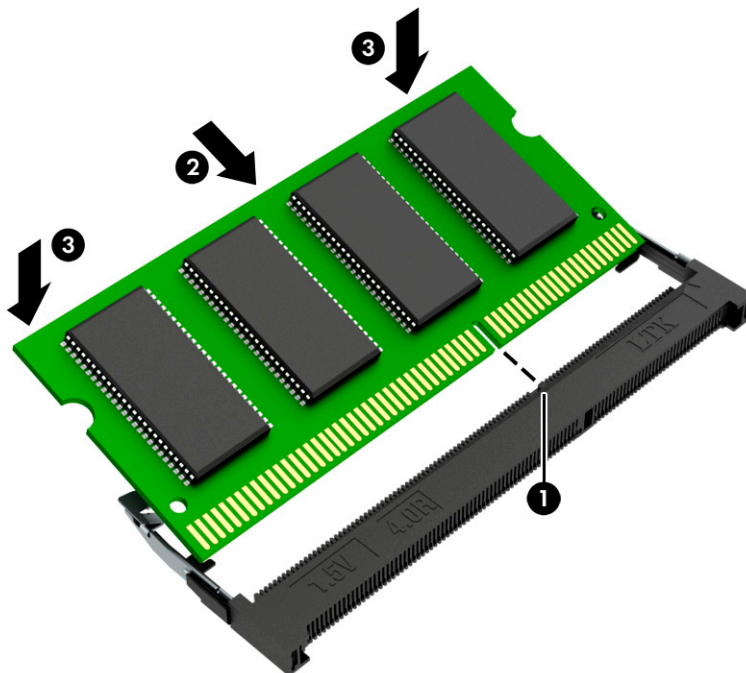

## Solid-state drive

To remove a solid-state drive, use this procedure and illustration.

**Table 5-4** Solid-state drive descriptions and part numbers

Description	Spare part number
2 TB, M.2 2280, PCIe-NVMe-3×4, SS solid-state drive with TLC	L85358-002
1 TB, M.2 2280, PCIe-NVMe-3×4, SS solid-state drive with TLC	L85348-002
512 GB, M.2 2280, PCIe-NVMe, SED solid-state drive with TLC	L85368-002
512 GB, M.2 2280, PCIe-3×4, solid-state drive with TLC	L85360-002
256 GB, M.2 2280, PCIe, NVMe, SED solid-state drive with TLC	M07245-002
256 GB, M.2 2280, PCIe-3×4, SS solid-state drive with TLC	L85350-002

Before removing a solid-state drive, follow these steps:

1. Prepare the computer for disassembly ([Preparation for disassembly on page 40](#)).
2. Remove the bottom cover ([Bottom cover on page 40](#)).
3. Disconnect the battery cable from the system board (see [Battery on page 41](#)).

Remove the solid-state drive:

1. Remove the Phillips M2.0 × 2.9 screw **(1)** that secures the solid-state drive to the computer.  
(The solid-state drive tilts up at an angle.)
2. Remove the solid-state drive **(2)** by pulling it away from the slot at an angle.

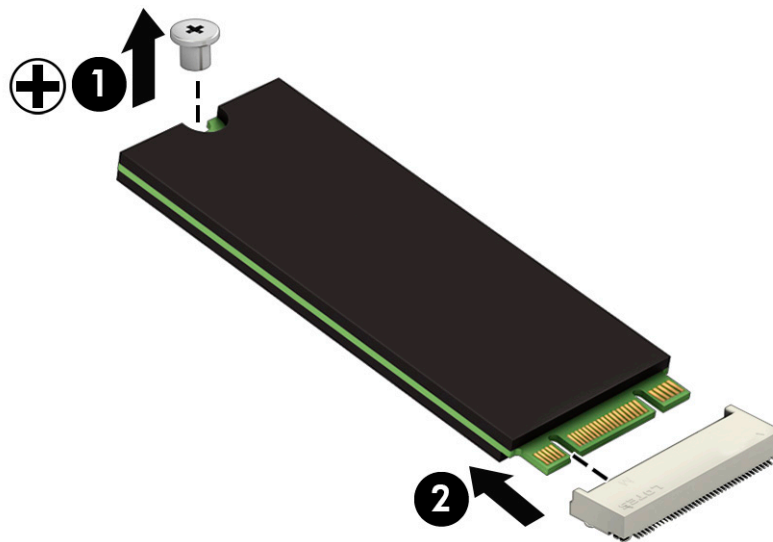

Reverse this procedure to install a solid-state drive.

## Fans

To remove the fans, use these procedures and illustrations.

**Table 5-5** Fan descriptions and part numbers

Description	Spare part number
Left fan	M21848-601
Right fan	M21849-001

Before removing the fans, follow these steps:

1. Prepare the computer for disassembly ([Preparation for disassembly on page 40](#)).
2. Remove the bottom cover ([Bottom cover on page 40](#)).
3. Disconnect the battery cable from the system board (see [Battery on page 41](#)).

Remove the fans:

1. Disconnect the fan cables (1) from the system board.
2. Remove the six Phillips M2.0 × 4.7 screws (2) that secure the fans to the computer.
3. Remove the fans (3).

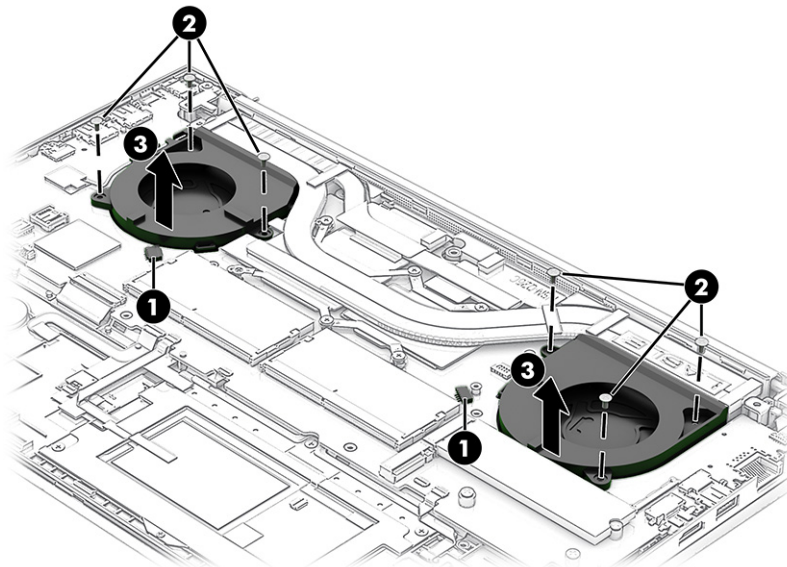

Reverse this procedure to install the fans.

## Display assembly

To remove and disassemble the display assembly, use these procedures and illustrations.

Display assembly spare part components are available only at the subcomponent level. Subcomponent level spare part information is available in the subcomponent level disassembly subsection.

Before removing the display assembly, follow these steps:



1. Prepare the computer for disassembly ([Preparation for disassembly on page 40](#)).
2. Remove the bottom cover ([Bottom cover on page 40](#)).
3. Disconnect the battery cable from the system board (see [Battery on page 41](#)).

Remove the display assembly:

1. Remove the WLAN module shield (1).

The WLAN module shield is included in the Kit, spare part number M23349-001.

2. Disconnect the wireless antenna cables (2) from the WLAN module.

The #1/MAIN WLAN antenna cable connects to the WLAN module #1/Main terminal. The #2/AUX WLAN antenna cable connects to the WLAN module #2/Aux terminal.

3. Release the display panel cable from the retention clip (3) built into the display left hinge.
4. Release the support bar (4) that secures the display panel cable to the system board.
5. Disconnect the display panel cable (5) from the system board.
6. Release the wireless antenna cables from the retention clip (6) built into the display right hinge.
7. Release the wireless antenna cables from the routing channel (7) built into the right fan.

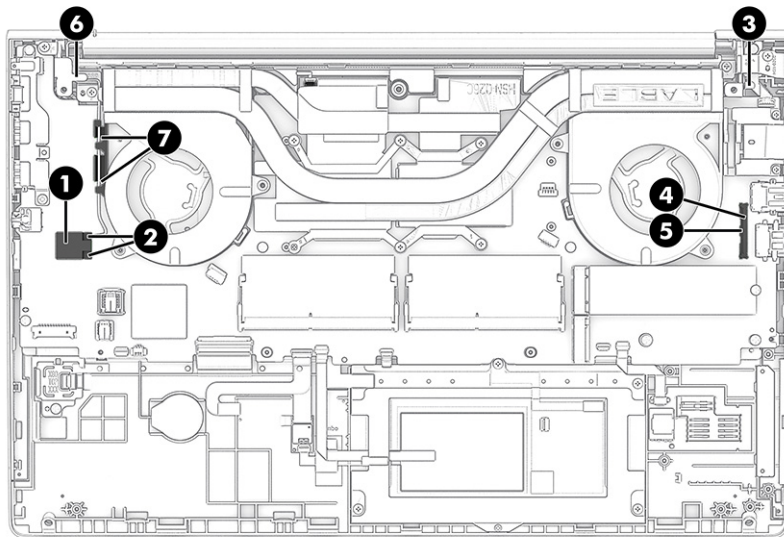

8. Remove the four Phillips M2.5 × 5.2 screws that secure the display assembly to the computer.

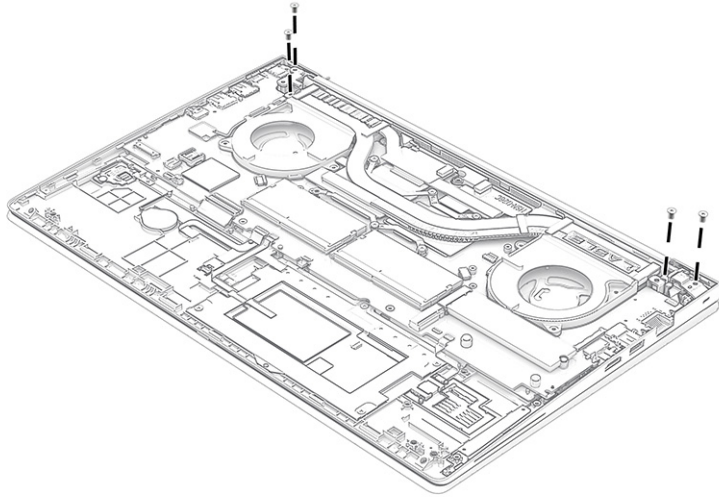

9. Swing the top edge of the display assembly (1) away from the top cover. (The top cover disengages from the display assembly hinges.)
10. Separate the display assembly (2) from the top cover.

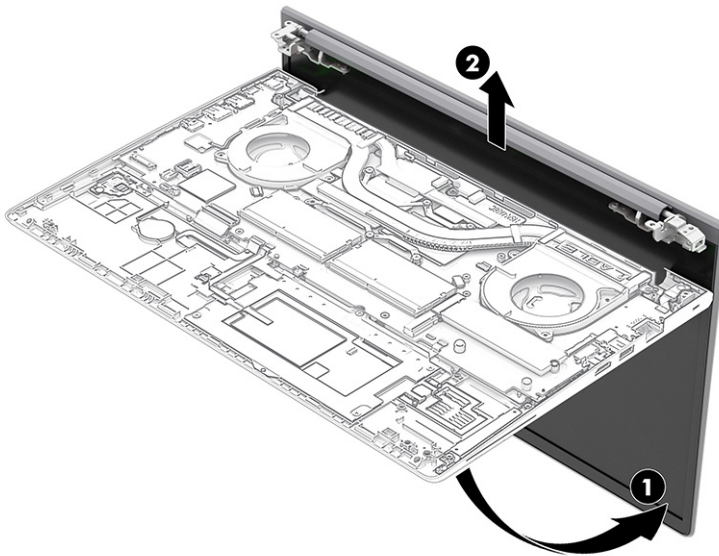

11. If you need to replace the display bezel or the display assembly internal subcomponents:
  - a. Flex the inside edges of the bottom (1) of the display bezel, the left (2) and right sides of the bezel, and the top edge of the bezel (3) to release the bezel from the display back cover.
  - b. Remove the display bezel (4).

The bezel is available using the following spare part number:

- M21864-001—For use only on computer models equipped with an FHD webcam + infrared sensor
- M21863-001—For use only on computer models equipped with an FHD webcam
- M21865-001—For use only on computer models equipped with an FHD webcam

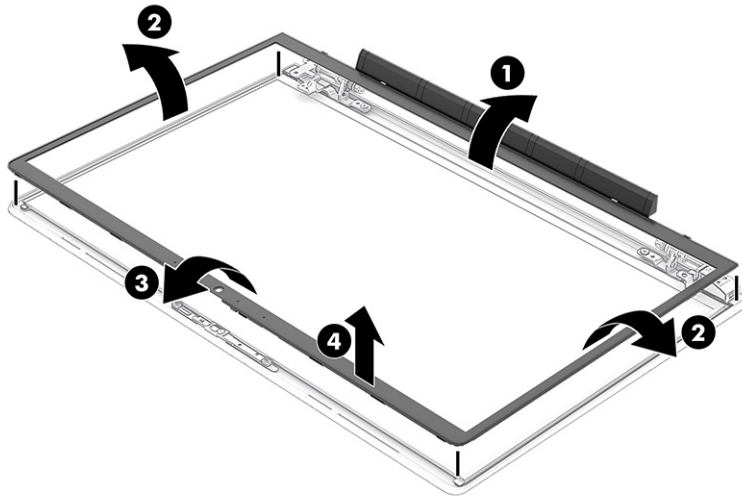

12. If you need to remove the hinges:

- Remove the display bezel.
- Remove the rubber hinge covers.

The display hinge covers are included in the Display Support Kit, spare part number M27375-001.

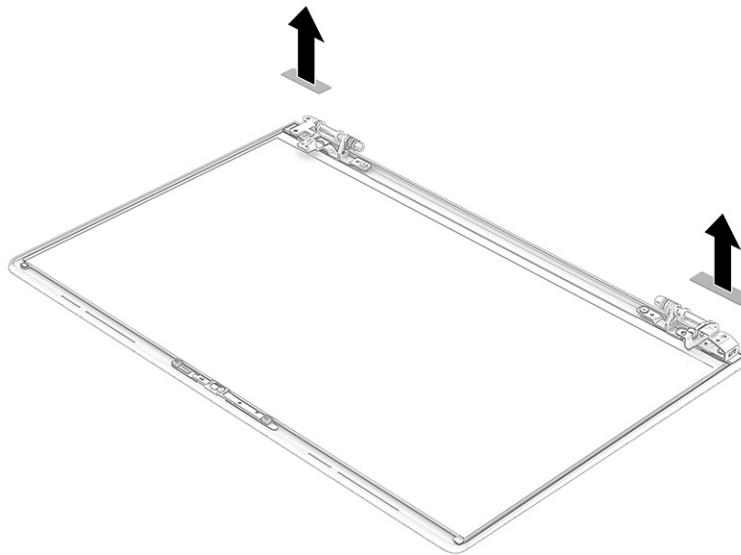

- Remove the six Phillips M2.5 × 5.2 screws (1) that secure the hinges to the display back cover.

- d. Remove the display hinges (2).

The display hinges are available using spare part number M21867-001

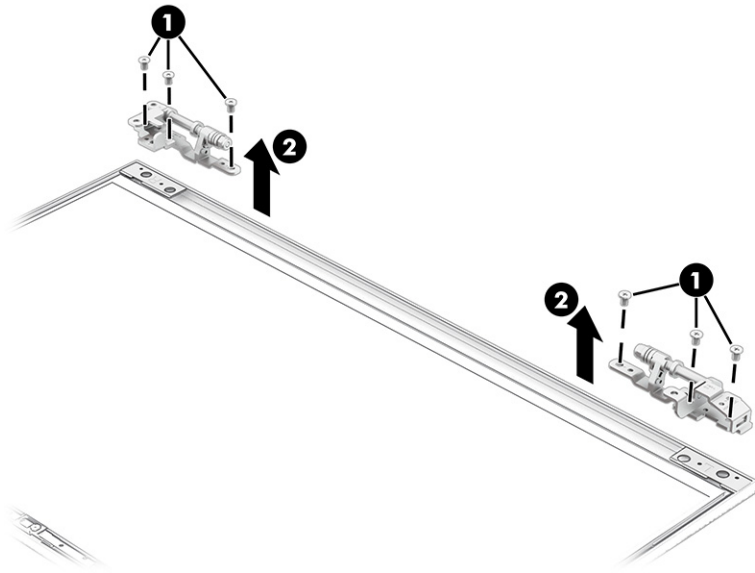

- 13. If you need to remove the display panel:

- a. Remove the display bezel.
- b. Remove the display hinges.
- c. Use tweezers to grasp the end of the retention tape that is installed under the left (1) and right sides of the panel.
- d. While turning the tweezers (2), wrap the tape around the tweezers as you continue to pull the tape (3) out from behind the display panel.

- e. Once you have released the tape as far as it will go and the adhesive has been released, separate the top edge of the display panel **(4)** from the back cover.

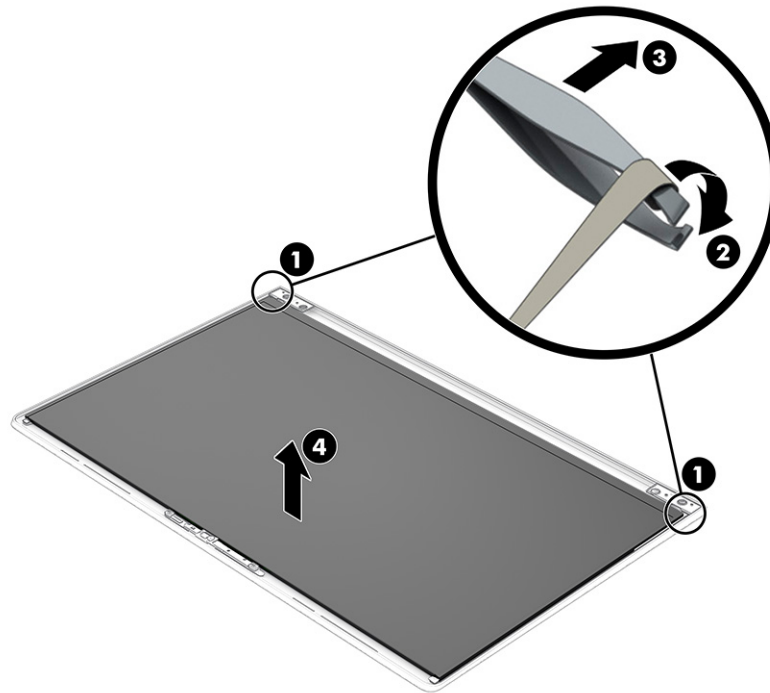

- f. Position the display assembly with the top edge facing you.
- g. Swing the display panel **(1)** away from the display back cover until it rests face down in front of the back cover.
- h. Release the adhesive support strip **(2)** that secures the display panel cable to the display panel.
- i. Release the retention bar **(3)** that secures the display panel cable to the display panel.
- j. Disconnect the display panel cable **(4)** from the display panel.
- k. Remove the display panel **(5)**.

The display panel is available using the following spare part numbers:

- M21871-001—39.6 cm (15.6 in), UHD, antiglare, UWVA, ePSR2, 400 nit, non-touchscreen display panel
- M21869-001—39.6 cm (15.6 in), FHD, antiglare, UWVA, ePSR2, 400 nit, non-touchscreen display panel
- M21870-001—39.6 cm (15.6 in), FHD, antiglare, UWVA, EDP, 250 nit, touchscreen display panel
- M21868-001—39.6 cm (15.6 in), FHD, antiglare, UWVA, EDP, 250 nit, non-touchscreen display panel

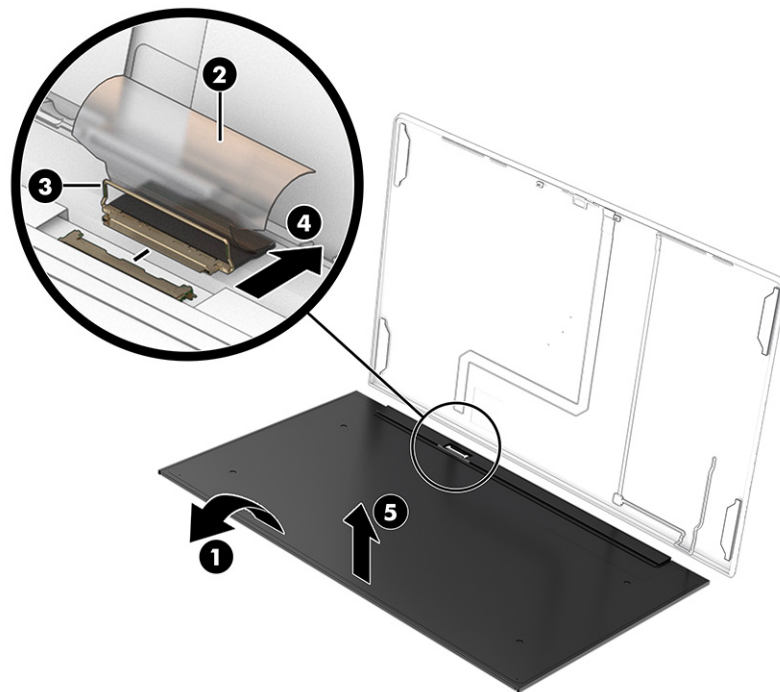

14. If you need to remove the display panel cable and webcam/microphone module:
  - a. Remove the display bezel.
  - b. Remove the display hinges.
  - c. Remove the display panel.
  - d. Detach the webcam/microphone module (1) from the display back cover. (The webcam/microphone module is attached to the display back cover with double-sided adhesive in two locations.)
  - e. Detach the webcam/microphone module cable (2) from the display back cover. (The webcam/microphone module cable is attached to the display back cover with double-sided adhesive in two locations.)

- f. Release the ZIF connector **(3)** to which the webcam/microphone module cable is connected, and then disconnect the webcam/microphone module cable from the webcam/microphone module cable.

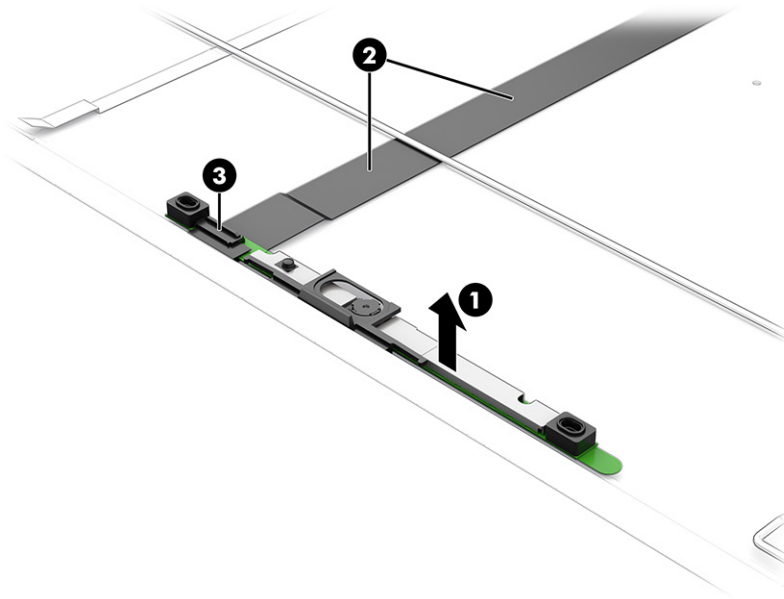

- g. Remove the webcam/microphone module and cable.

The display panel cable and webcam/microphone module is available using spare part number M21866-001.

**15.** If you need to remove the WLAN antenna:

- a. Remove the display bezel.
- b. Remove the display hinges.
- c. Remove the display panel.
- d. Detach the wireless antenna transceivers **(1)** from the display back cover. (The wireless antenna transceivers are attached to the display back cover with double-sided adhesive.)
- e. Release the retention tabs **(2)** that secure the wireless antenna cables.

- f. Release the wireless antenna cables from the retention clips **(3)** built right hinge area of the display back cover.

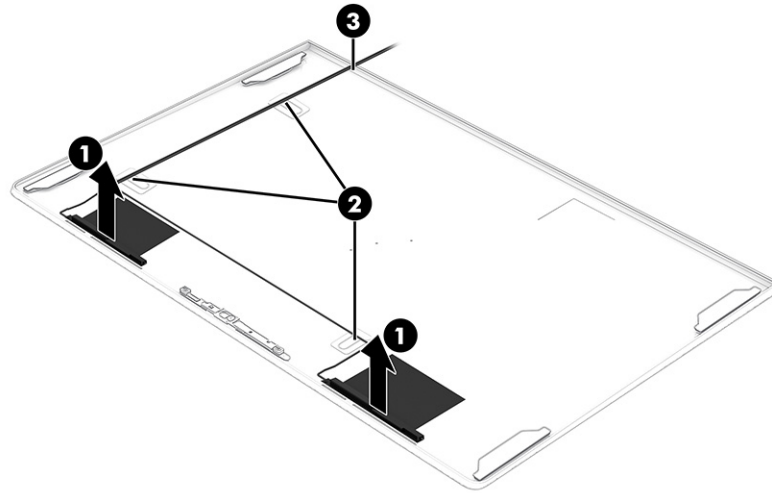

- g. Remove the WLAN antenna.

The wireless antenna are available using spare part number M21862-001.

Reverse this procedure to reassemble and replace the display assembly.

## Sensor board cable

To remove the sensor board cable, use this procedure and illustration.

The sensor board cable is available in the Cable Kit, spare part number M21856-001.

Before removing the sensor board cable, follow these steps:

1. Prepare the computer for disassembly ([Preparation for disassembly on page 40](#)).
2. Remove the bottom cover ([Bottom cover on page 40](#)).
3. Disconnect the battery cable from the system board (see [Battery on page 41](#)).

Remove the sensor board cable:

1. Release the ZIF connector **(1)** to which the sensor board cable is connected, and then disconnect the sensor board cable from the system board.
2. Release the ZIF connector **(2)** to which the sensor board cable is connected, and then disconnect the sensor board cable from the sensor board module.



3. Remove the sensor board cable (3).

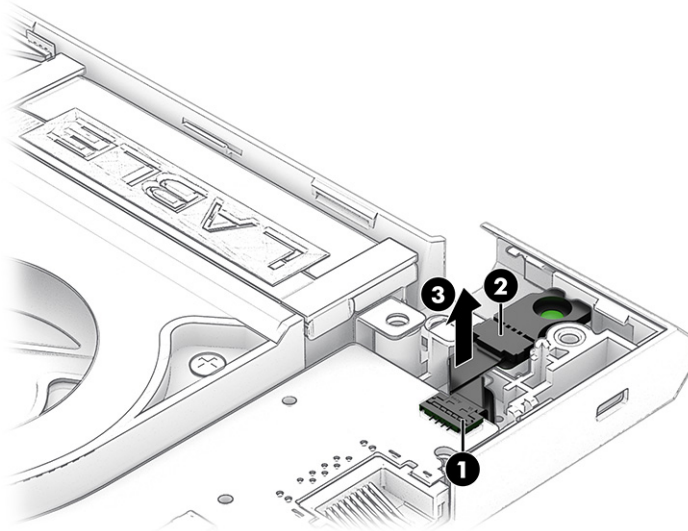

Reverse this procedure to install the sensor board cable.

## Sensor board

To remove the sensor board, use this procedure and illustration.

**Table 5-6** Sensor board description and part number

Description	Spare part number
Sensor board	M21844-001

**NOTE:** The sensor board spare part kit does not include the sensor board cable. The sensor board cable is included in the Cable Kit, spare part number M21856-001.

Before removing the sensor board, follow these steps:

1. Prepare the computer for disassembly ([Preparation for disassembly on page 40](#)).
2. Remove the bottom cover ([Bottom cover on page 40](#)).
3. Disconnect the battery cable from the system board (see [Battery on page 41](#)).

Remove the sensor board:

1. Release the ZIF connector (1) to which the sensor board cable is connected, and then disconnect the sensor board cable from the system board.
2. Remove the Phillips M2.0 × 2.9 screw (2) that secures the sensor board to the top cover.

3. Remove the sensor board (3).

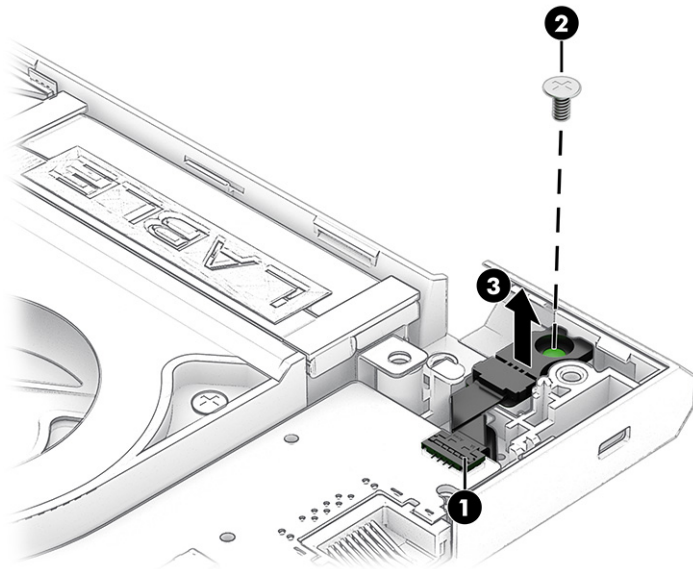

Reverse this procedure to install the sensor board and cable.

## Fingerprint reader module cable

To remove the fingerprint reader module cable, use this procedure and illustration.

The fingerprint reader module cable is available in the Cable Kit, spare part number M21856-001.

Before removing the fingerprint reader module cable, follow these steps:

1. Prepare the computer for disassembly ([Preparation for disassembly on page 40](#)).
2. Remove the bottom cover ([Bottom cover on page 40](#)).
3. Remove the battery (see [Battery on page 41](#)).

Remove the fingerprint reader module cable:

1. Release the zero insertion force (ZIF) connector (1) to which the fingerprint reader module cable is connected, and then disconnect the fingerprint reader module cable from the system board.
2. Release the ZIF connector (2) to which the fingerprint reader module cable is connected, and then disconnect the fingerprint reader module cable from the fingerprint reader module.

3. Remove the fingerprint reader module cable (3).

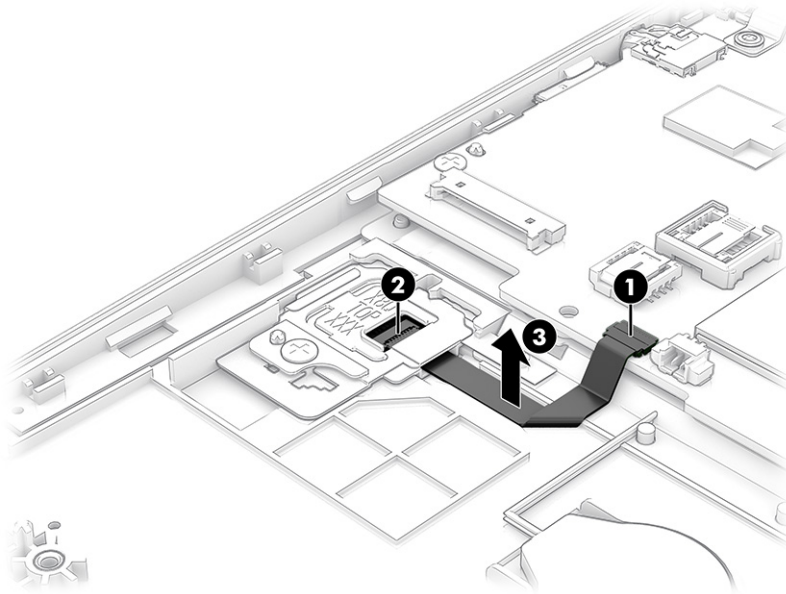

Reverse this procedure to install the fingerprint reader module cable.

## Fingerprint reader module

To remove the fingerprint reader module, use this procedure and illustration.

**Table 5-7** Fingerprint reader module description and part number

Description	Spare part number
Fingerprint reader module	M21402-001

**NOTE:** The fingerprint reader module spare part kit does not include the fingerprint reader module cable. The fingerprint reader module cable is available in the Cable Kit, spare part number M21856-001.

Before removing the fingerprint reader module, follow these steps:

1. Prepare the computer for disassembly ([Preparation for disassembly on page 40](#)).
2. Remove the bottom cover ([Bottom cover on page 40](#)).
3. Remove the battery (see [Battery on page 41](#)).

Remove the fingerprint reader module:

1. Release the ZIF connector (1) to which the fingerprint reader module cable is connected, and then disconnect the fingerprint reader module cable from the system board.
2. Remove the Phillips M2.0 × 2.5 broad head screw (2) that secures the fingerprint reader module to the top cover.
3. Remove the fingerprint reader module bracket (3).

The fingerprint reader module bracket is included in the Bracket Kit, spare part number M21855-001.

4. Remove the fingerprint reader module (4) and cable.

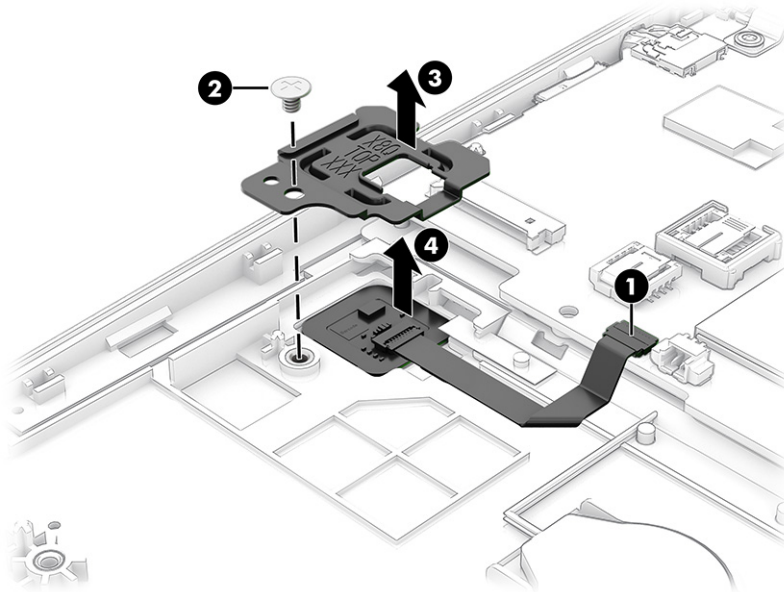

Reverse this procedure to install the fingerprint reader module and cable.

## RTC battery

To remove the RTC battery, use this procedure and illustration.

The RTC battery is not available as a spare part component.

Remove the RTC battery:

1. Detach the RTC battery (1) from the system board. (The RTC battery is attached to the system board with double-sided tape.)
2. Disconnect the RTC battery cable (2) from the system board.

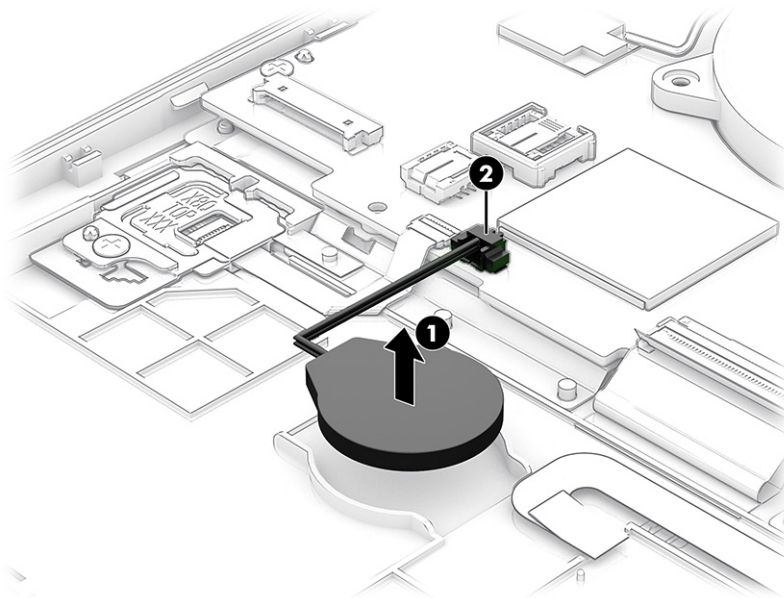

Reverse this procedure to install the RTC battery.

## Touchpad cable

To remove the touchpad cable, use this procedure and illustration.

The touchpad cable is available in the Cable Kit, spare part number M21856-001.

Before removing the touchpad cable, follow these steps:

1. Prepare the computer for disassembly ([Preparation for disassembly on page 40](#)).
2. Remove the bottom cover ([Bottom cover on page 40](#)).
3. Remove the battery (see [Battery on page 41](#)).

Remove the touchpad cable:

1. Detach the touchpad cable (**1**) from the top cover. (The touchpad cable is attached to the top cover with double-sided adhesive.)
2. Release the ZIF connector (**2**) to which the touchpad cable is connected, and then disconnect the touchpad cable from the system board.
3. Release the ZIF connector (**3**) to which the touchpad cable is connected, and then disconnect the touchpad cable from the touchpad.

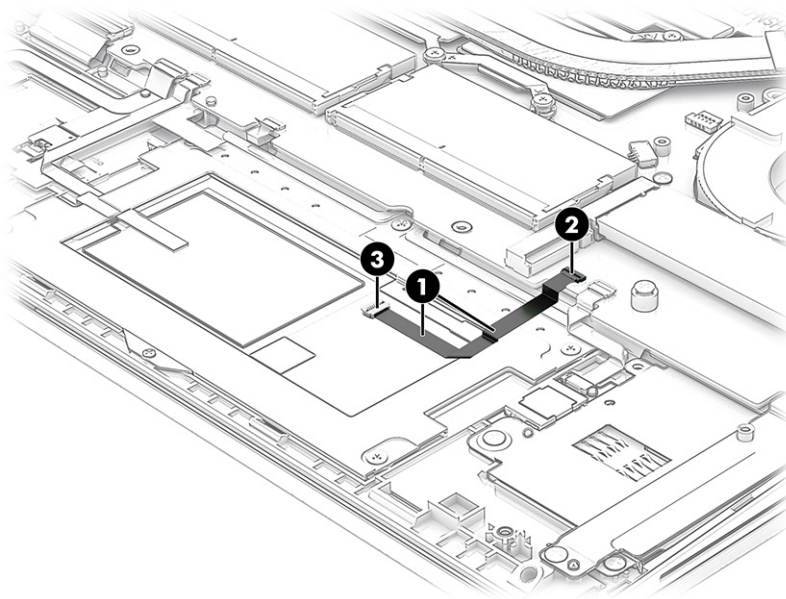

4. Remove the touchpad cable.

Reverse this procedure to install the touchpad cable.

## NFC module cable

To remove the NFC module cable, use this procedure and illustration.

The NFC module cable is available in the Cable Kit, spare part number M21856-001.

Before removing the NFC module cable, follow these steps:

1. Prepare the computer for disassembly ([Preparation for disassembly on page 40](#)).
2. Remove the bottom cover ([Bottom cover on page 40](#)).
3. Remove the battery (see [Battery on page 41](#)).

Remove the NFC module cable:

1. Release the ZIF connector **(1)** to which the NFC module cable is connected, and then disconnect the NFC module cable from the system board.
2. Release the ZIF connector **(2)** to which the NFC module cable is connected, and then disconnect the NFC module cable from the SD card board.
3. Detach the NFC module cable **(3)** from the top cover. (The NFC module cable is attached to the top cover with double-sided adhesive.)
4. Remove the NFC module cable **(4)**.

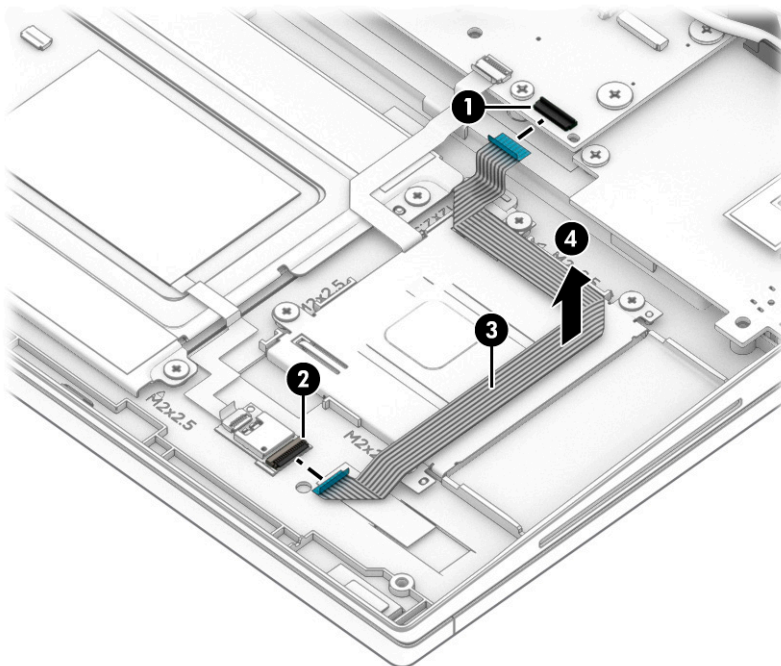

Reverse this procedure to install the NFC module cable.

## NFC module

To remove the NFC module, use this procedure and illustration.



**NOTE:** The NFC module spare part kit includes NFC module.

**Table 5-8** NFC module description and part number

Description	Spare part number
NFC module	L02249-001

**NOTE:** The NFC module spare part kit does not include the NFC module cable. The NFC module cable is available in the Cable Kit, spare part number M21856-001.

Before removing the NFC module, follow these steps:

1. Prepare the computer for disassembly ([Preparation for disassembly on page 40](#)).
2. Remove the bottom cover ([Bottom cover on page 40](#)).
3. Remove the battery (see [Battery on page 41](#)).

Remove the NFC module:

1. Release the ZIF connector **(1)** to which the NFC module cable is connected, and then disconnect the NFC module cable from the system board.
2. Release the ZIF connector **(2)** to which the NFC module cable is connected, and then disconnect the NFC module cable from the NFC module.
3. Detach the NFC module cable **(3)** from the top cover. (The NFC module cable is attached to the top cover with double-sided adhesive.)
4. Detach the NFC module **(4)** from the top cover. (The NFC module is attached to the top cover with double-sided adhesive.)

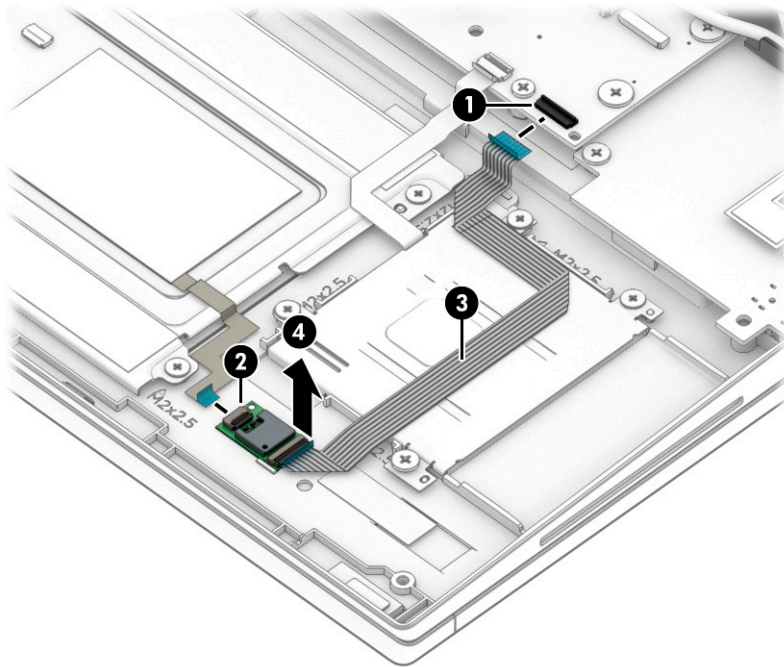

Reverse this procedure to install the NFC module and cable.

## Card reader board cable

To remove the card reader board cable, use this procedure and illustration.

The card reader board cable is available in the Cable Kit, spare part number M21856-001.

Before removing the card reader board cable, follow these steps:

1. Prepare the computer for disassembly ([Preparation for disassembly on page 40](#)).
2. Remove the bottom cover ([Bottom cover on page 40](#)).
3. Remove the battery (see [Battery on page 41](#)).

Remove the card reader board cable:

1. Release the ZIF connector (1) to which the card reader board cable is connected, and then disconnect the card reader board cable from the system board.
2. Release the ZIF connector (2) to which the card reader board cable is connected, and then disconnect the card reader board cable from the card reader board.
3. Remove the card reader board cable (3).

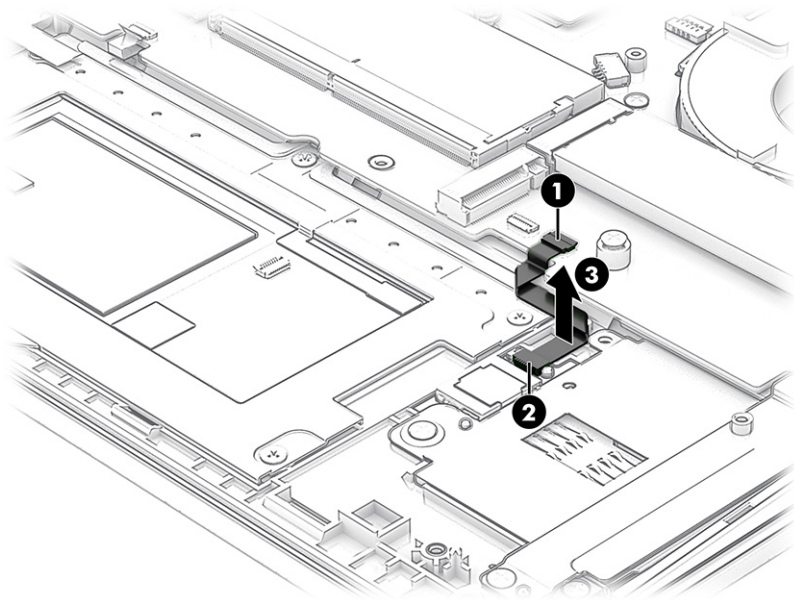

Reverse this procedure to install the card reader board cable.

## Card reader board

To remove the card reader board, use this procedure and illustration.

**Table 5-9** Card reader board description and part number

Description	Spare part number
Card reader board	M21398-001

**NOTE:** The card reader board spare part kit does not include the card reader board cable. The card reader board cable is included in the Cable Kit, spare part number M21856-001.

Before removing the card reader board, follow these steps:



1. Prepare the computer for disassembly ([Preparation for disassembly on page 40](#)).
2. Remove the bottom cover ([Bottom cover on page 40](#)).
3. Remove the battery (see [Battery on page 41](#)).

Remove the card reader board:

1. Remove the Phillips M2.0 × 4.5 screw (1) that secures the bottom edge of the battery support bracket to the top cover.
2. Remove the Phillips M2.0 × 5.6 screw (2) that secures the top edge of the battery support bracket to the top cover.
3. Remove the battery support bracket (3).

The battery support bracket is included in the Bracket Kit, spare part number M21855-001.

4. Remove the three Phillips M2.0 × 2.3 screws (4) that secure the card reader board bracket to the top cover.
5. Remove the card reader board bracket (5).

The card reader board bracket is included in the Bracket Kit, spare part number M21855-001.

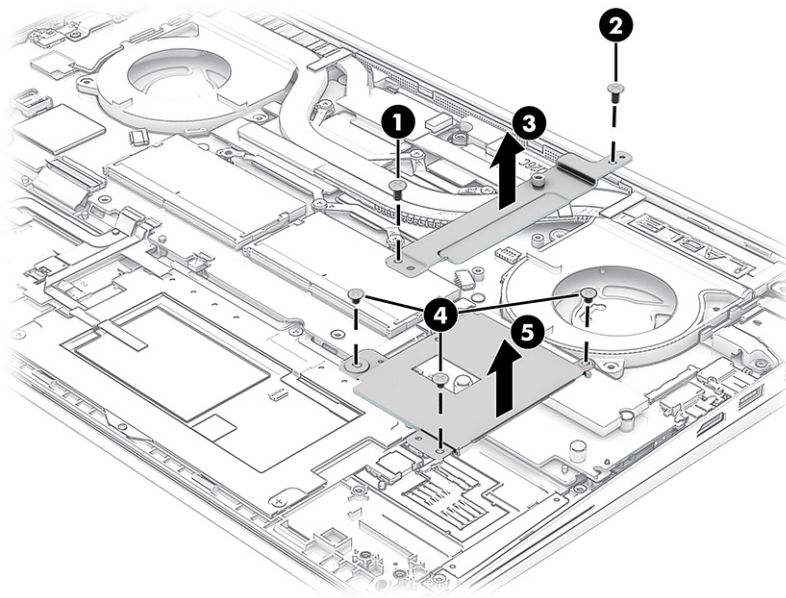

6. Release the ZIF connector (1) to which the card reader board cable is connected, and then disconnect the card reader board cable from the system board.

- Remove the card reader board (2) and cable.

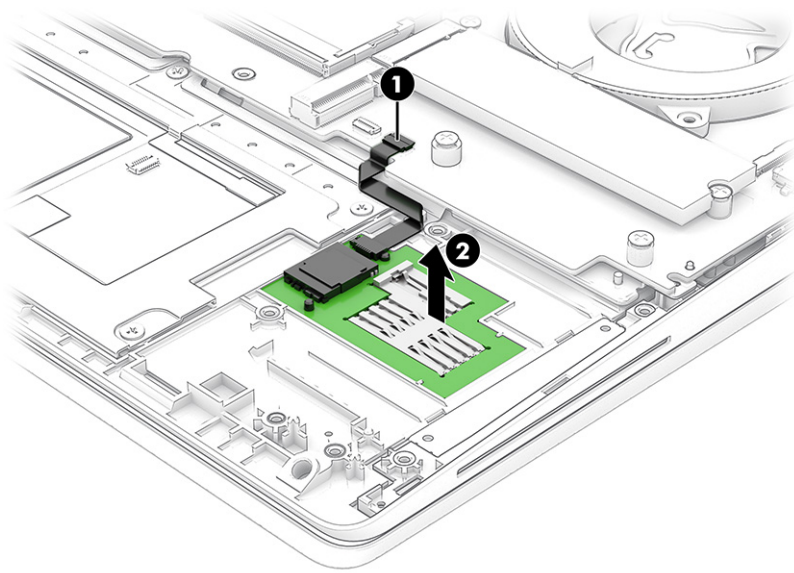

Reverse this procedure to install the card reader board and cable.

## System board

To remove the system board, use these procedures and illustrations.

**Table 5-10** System board descriptions and part numbers

Description	Spare part number
<b>NOTE:</b> All system board spare part kits include the processor, the RTC battery, and replacement thermal material.	
Equipped with an Intel Xeon W-10855M processor, an NVIDIA Quadro T2000 N19P-Q3 graphic controller with 4 GB of discrete memory, and the Windows 10 operating system	M21835-601
Equipped with an Intel Xeon W-10855M processor, an NVIDIA Quadro T2000 N19P-Q3 graphic controller with 4 GB of discrete memory, and a non-Windows operating system	M21835-001
Equipped with an Intel Core i9-10885H processor, an NVIDIA Quadro T2000 N19P-Q3 graphic controller with 4 GB of discrete memory, and the Windows 10 operating system	M21833-001
Equipped with an Intel Core i9-10885H processor, an NVIDIA Quadro T2000 N19P-Q3 graphic controller with 4 GB of discrete memory, and a non-Windows operating system	M21833-001
Equipped with an Intel Core i9-10885H processor, an NVIDIA Quadro T1000 N19P-Q1 graphic controller with 4 GB of discrete memory, and the Windows 10 operating system	M21827-601
Equipped with an Intel Core i9-10885H processor, an NVIDIA Quadro T1000 N19P-Q1 graphic controller with 4 GB of discrete memory, and a non-Windows operating system	M21827-001
Equipped with an Intel Core i7-10850H processor, an NVIDIA Quadro T2000 N19P-Q3 graphic controller with 4 GB of discrete memory, and the Windows 10 operating system	M21831-601
Equipped with an Intel Core i7-10850H processor, an NVIDIA Quadro T2000 N19P-Q3 graphic controller with 4 GB of discrete memory, and a non-Windows operating system	M21831-001
Equipped with an Intel Core i7-10850H processor, an NVIDIA Quadro T2000 N19P-Q3 graphic controller with 4 GB of discrete memory, and the Windows 10 operating system, but not equipped with WLAN or Bluetooth capability	M21841-601

**Table 5-10 System board descriptions and part numbers (continued)**

Description	Spare part number
Equipped with an Intel Core i7-10850H processor, an NVIDIA Quadro T2000 N19P-Q3 graphic controller with 4 GB of discrete memory, and a non-Windows operating system, but not equipped with WLAN or Bluetooth capability	M21841-001
Equipped with an Intel Core i7-10850H processor, an NVIDIA Quadro T1000 N19P-Q1 graphic controller with 4 GB of discrete memory, and the Windows 10 operating system	M21825-601
Equipped with an Intel Core i7-10850H processor, an NVIDIA Quadro T1000 N19P-Q1 graphic controller with 4 GB of discrete memory, and a non-Windows operating system	M21825-001
Equipped with an Intel Core i7-10850H processor, an NVIDIA Quadro T1000 N19P-Q1 graphic controller with 4 GB of discrete memory, and the Windows 10 operating system, but not equipped with WLAN or Bluetooth capability	M21839-601
Equipped with an Intel Core i7-10850H processor, an NVIDIA Quadro T1000 N19P-Q1 graphic controller with 4 GB of discrete memory, and a non-Windows operating system, but not equipped with WLAN or Bluetooth capability	M21839-001
Equipped with an Intel Core i7-10850H processor, an NVIDIA Quadro P620 N19M-Q3 graphic controller with 4 GB of discrete memory, and the Windows 10 operating system	M21821-601
Equipped with an Intel Core i7-10850H processor, an NVIDIA Quadro P620 N19M-Q3 graphic controller with 4 GB of discrete memory, and a non-Windows operating system	M21821-001
Equipped with an Intel Core i7-10850H processor, a graphics subsystem with UMA memory, and the Windows 10 operating system	M21813-601
Equipped with an Intel Core i7-10850H processor, a graphics subsystem with UMA memory, and a non-Windows operating system	M21813-001
Equipped with an Intel Core i7-10850H processor, a graphics subsystem with UMA memory, and the Windows 10 operating system, but not equipped with WLAN or Bluetooth capability	M21811-601
Equipped with an Intel Core i7-10850H processor, a graphics subsystem with UMA memory, and a non-Windows operating system, but not equipped with WLAN or Bluetooth capability	M21811-001
Equipped with an Intel Core i7-10750H processor, an NVIDIA Quadro T2000 N19P-Q3 graphic controller with 4 GB of discrete memory, and the Windows 10 operating system	M21829-601
Equipped with an Intel Core i7-10750H processor, an NVIDIA Quadro T2000 N19P-Q3 graphic controller with 4 GB of discrete memory, and a non-Windows operating system	M21829-001
Equipped with an Intel Core i7-10750H processor, an NVIDIA Quadro T1000 N19P-Q1 graphic controller with 4 GB of discrete memory, and the Windows 10 operating system	M21823-601
Equipped with an Intel Core i7-10750H processor, an NVIDIA Quadro T1000 N19P-Q1 graphic controller with 4 GB of discrete memory, and a non-Windows operating system	M21823-001
Equipped with an Intel Core i7-10750H processor, an NVIDIA Quadro T1000 N19P-Q1 graphic controller with 4 GB of discrete memory, and the Windows 10 operating system, but not equipped with WLAN or Bluetooth capability	M21837-601
Equipped with an Intel Core i7-10750H processor, an NVIDIA Quadro T1000 N19P-Q1 graphic controller with 4 GB of discrete memory, and a non-Windows operating system, but not equipped with WLAN or Bluetooth capability	M21837-001
Equipped with an Intel Core i7-10750H processor, an NVIDIA Quadro P620 N19M-Q3 graphic controller with 4 GB of discrete memory, and the Windows 10 operating system	M21819-601
Equipped with an Intel Core i7-10750H processor, an NVIDIA Quadro P620 N19M-Q3 graphic controller with 4 GB of discrete memory, and a non-Windows operating system	M21819-001
Equipped with an Intel Core i7-10750H processor, a graphics subsystem with UMA memory, and the Windows 10 operating system	M21809-601
Equipped with an Intel Core i7-10750H processor, a graphics subsystem with UMA memory, and a non-Windows operating system	M21809-001

**Table 5-10 System board descriptions and part numbers (continued)**

Description	Spare part number
Equipped with an Intel Core i5-10400H processor, an NVIDIA Quadro P620 N19M-Q3 graphic controller with 4 GB of discrete memory, and the Windows 10 operating system	M21817-601
Equipped with an Intel Core i5-10400H processor, an NVIDIA Quadro P620 N19M-Q3 graphic controller with 4 GB of discrete memory, and a non-Windows operating system	M21817-001
Equipped with an Intel Core i5-10400H processor, a graphics subsystem with UMA memory, and the Windows 10 operating system	M21807-601
Equipped with an Intel Core i5-10400H processor, a graphics subsystem with UMA memory, and a non-Windows operating system	M21807-001
Equipped with an Intel Core i5-10400H processor, a graphics subsystem with UMA memory, and the Windows 10 operating system, but not equipped with WLAN or Bluetooth capability	M21805-601
Equipped with an Intel Core i5-10400H processor, a graphics subsystem with UMA memory, and a non-Windows operating system, but not equipped with WLAN or Bluetooth capability	M21805-001
Equipped with an Intel Core i5-10300H processor, an NVIDIA Quadro P620 N19M-Q3 graphic controller with 4 GB of discrete memory, and the Windows 10 operating system	M21815-601
Equipped with an Intel Core i5-10300H processor, an NVIDIA Quadro P620 N19M-Q3 graphic controller with 4 GB of discrete memory, and a non-Windows operating system	M21815-001
Equipped with an Intel Core i5-10300H processor, a graphics subsystem with UMA memory, and the Windows 10 operating system	M21803-601
Equipped with an Intel Core i5-10300H processor, a graphics subsystem with UMA memory, and a non-Windows operating system	M21803-001

Before removing the system board, follow these steps:

1. Prepare the computer for disassembly ([Preparation for disassembly on page 40](#)).
2. Remove the bottom cover ([Bottom cover on page 40](#)).
3. Remove the battery (see [Battery on page 41](#)).
4. Remove the battery support bracket (see [Card reader board on page 62](#)).

When you replace the system board, be sure to remove the following components (as applicable) from the defective system board and install them on the replacement system board:

- Memory modules (see [Memory module on page 43](#)).
- Solid-state drive (see [Solid-state drive on page 44](#)).
- Heat sink (see [Heat sink on page 68](#)).

Remove the system board:

1. Close the computer.
2. Remove the WLAN module shield **(1)**.

The WLAN module shield is included in the Kit, spare part number M23344-001.

3. Disconnect the wireless antenna cables **(2)** from the WLAN module.  
The #1/MAIN WLAN antenna cable connects to the WLAN module **#1/Main** terminal. The #2/AUX WLAN antenna cable connects to the WLAN module **#2/Aux** terminal.
4. Disconnect the speaker cable **(3)** from the system board.
5. Release the ZIF connector **(4)** to which the sensor board cable is connected, and then disconnect the sensor board cable from the system board.
6. Release the support bar **(5)** that secures the display panel cable to the system board.
7. Disconnect the display panel cable **(6)** from the system board.
8. Release the wireless antenna cables from the routing channel **(7)** built into the right fan.
9. Disconnect the following cables from the system board:
  - Card reader board cable (ZIF) **(8)**
  - Touchpad cable (ZIF) **(9)**
  - Backlight cable (ZIF) **(10)**
  - Keyboard cable **(11)**
10. Disconnect the RTC battery cable **(12)** from the system board.
11. Release the ZIF connector **(13)** to which the fingerprint reader module cable is connected, and then disconnect the fingerprint reader module cable from the system board.

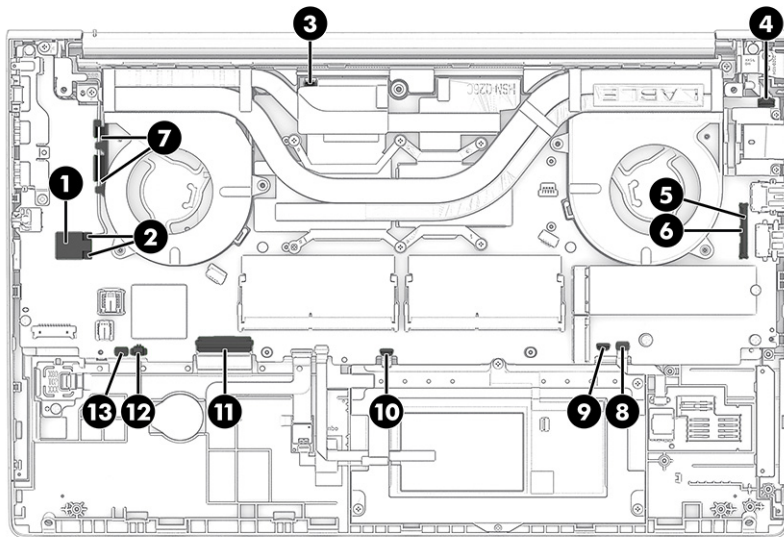

12. Remove the three Phillips M2.0 × 4.7 screws **(1)** that secure the I/O bracket and system board to the top cover.
13. Remove the I/O bracket **(2)**.  
The I/O bracket is included in the Bracket Kit, spare part number M21855-001.
14. Remove the two Phillips M2.0 × 3.4 screws **(3)** that secure the system board to the top cover.

15. Remove the two Phillips M2.0 × 5.6 screws (4) that secure the RJ-45 (network) jack cover and the system board to the top cover.
16. Remove the RJ-45 (network) jack cover (5).

The RJ-45 (network) jack cover is not available as a spare part component.

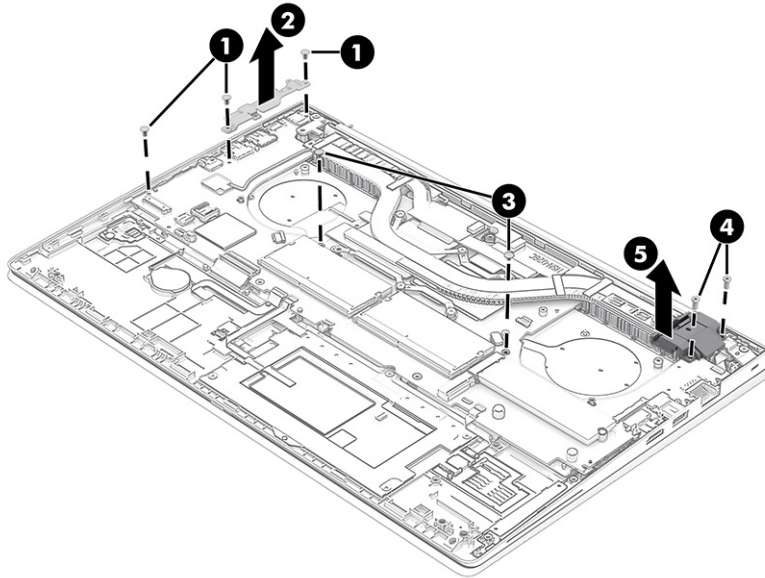

17. Lift the right edge of the system board (1) until it rests at an angle.
18. Remove the system board (2) by sliding it up and to the right at an angle.

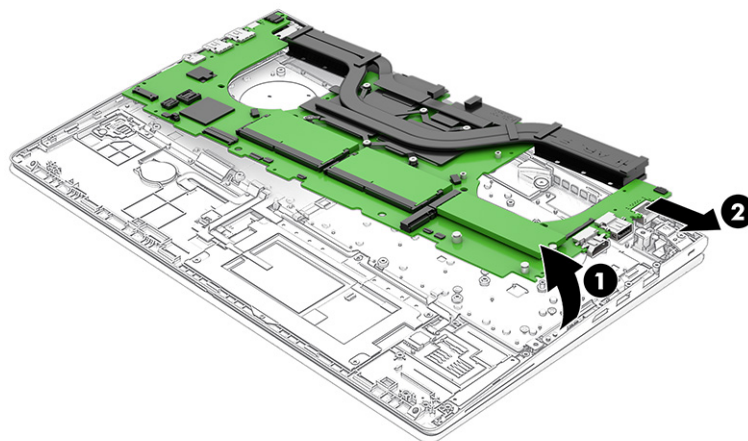

Reverse this procedure to install the system board.

## Heat sink

To remove the heat sink, use these procedures and illustrations.

**Table 5-11 Heat sink descriptions and part numbers**

Description	Spare part number
All heat sink spare part kits include replacement thermal material.	
For use only on computer models with a graphics subsystem with discrete memory	M21846-601
For use only on computer models with a graphics subsystem with UMA memory	M21845-001

Before removing the heat sink, follow these steps:

1. Prepare the computer for disassembly ([Preparation for disassembly on page 40](#)).
2. Remove the bottom cover ([Bottom cover on page 40](#)), and then remove the following components:
  1. Battery (see [Battery on page 41](#))
  2. Battery support bracket (see [Card reader board on page 62](#))
  3. System board (see [System board on page 64](#))

Remove the heat sink:

1. In the order indicated on the heat sink, remove the six Phillips M2.5 × 6.0 screws (1) that secure the the heat sink to the system board.
2. Remove the heat sink (2).

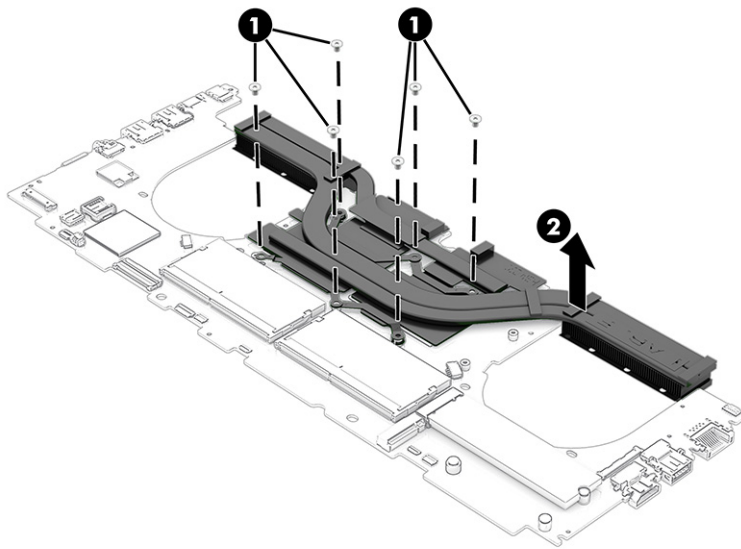

3. Thoroughly clean the thermal material from the surfaces of the heat sink and the system board components each time the heat sink is removed. Replacement thermal material is included with the heat sink and system board spare part kits. The following illustrations show the replacement thermal material locations.

Thermal paste is used on the processor (1) and on the heat sink area (2) that services the processor. A thermal pad is used on the VGA chip (3) and on the heat sink area (4) that services it. Thermal pads are used on the other system board components (5).

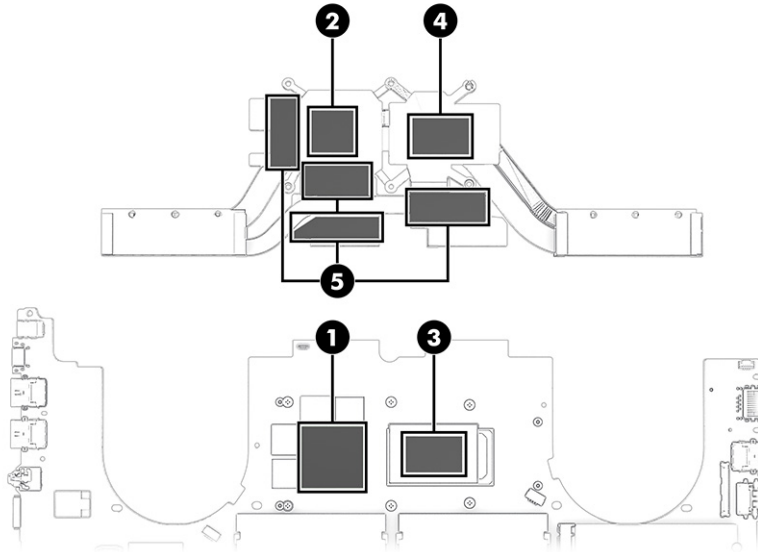

Reverse this procedure to install the heat sink.

## Touchpad

To remove the touchpad, use this procedure and illustration.

**Table 5-12** Touchpad description and part number

Description	Spare part number
<b>NOTE:</b> The touchpad spare part kit does not include the touchpad cable. The touchpad cable is available using spare part number L94509-001.	
For use only on computer models equipped with NFC capabilities	M21853-001
For use only on computer models not equipped with NFC capabilities	M21854-001

Before removing the touchpad, follow these steps:

1. Prepare the computer for disassembly ([Preparation for disassembly on page 40](#)).
2. Remove the bottom cover ([Bottom cover on page 40](#)), and then remove the following components:
  1. Battery (see [Battery on page 41](#))
  2. Battery support bracket (see [Card reader board on page 62](#))
  3. System board (see [System board on page 64](#))



Remove the touchpad:

1. Detach the touchpad cable (1) from the top cover. (The touchpad cable is attached to the top cover with double-sided adhesive.)
2. Release the ZIF connector (2) to which the touchpad cable is connected, and then disconnect the touchpad cable from the system board.
3. Detach the grounding tape (3) the secures the touchpad to the top cover.
4. Detach the clear tape (4) the secures the top edge if the touchpad to the top cover.
5. Remove the five Phillips M2.0 × 2.5 screws (5) that secure the touchpad to the top cover.
6. Remove the Phillips M1.5 × 2.5 screw (6) that secures the touchpad to the top cover.
7. Remove the touchpad (7).

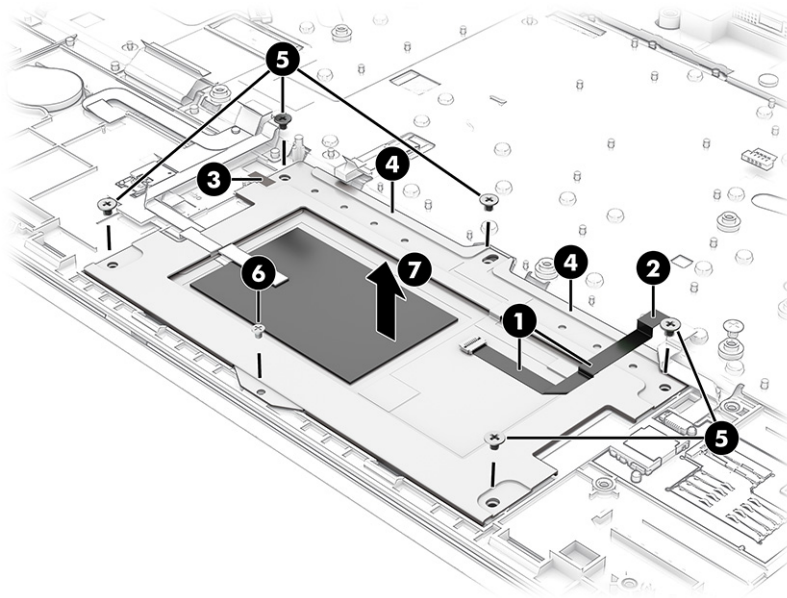

Reverse this procedure to install the touchpad.

## Speakers

To remove the speakers, use this procedure and illustration.

**Table 5-13** Speaker description and part number

Description	Spare part number
Speaker Kit (includes left and right speakers, cables, and four rubber isolators)	M21850-001

Before removing the speakers, follow these steps:

1. Prepare the computer for disassembly ([Preparation for disassembly on page 40](#)).
2. Remove the bottom cover ([Bottom cover on page 40](#)), and then remove the following components:

1. Battery (see [Battery on page 41](#))
2. Battery support bracket (see [Card reader board on page 62](#))
3. System board (see [System board on page 64](#))

Remove the speakers:

1. Remove the three Phillips M2.0 × 2.6 broad head screws (1) that secure the speakers to the top cover.
2. Remove the speakers from the computer (2).

When removing the speakers, make note of the location of the rubber isolator locations (3). The absence of or damage to these isolators can result in degraded speaker performance.

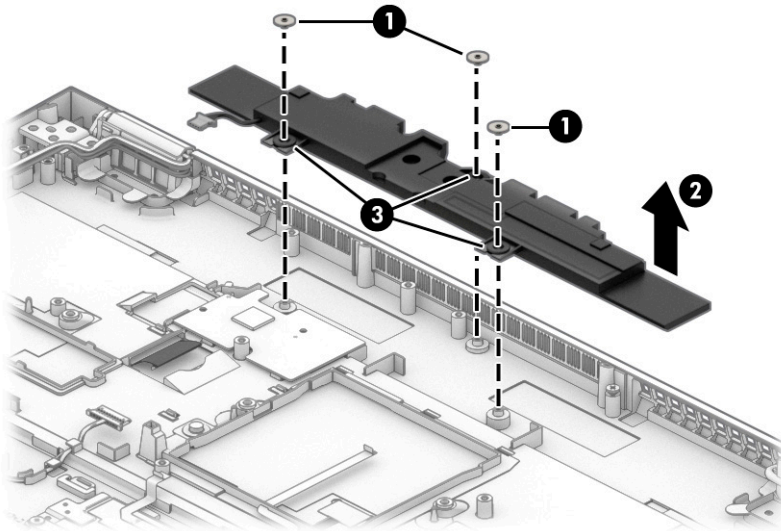

Reverse this procedure to install the speakers.

---

# 6 Troubleshooting guide

This chapter primarily focuses on troubleshooting HP Mobile Workstations. The information is provided so that you can solve problems yourself or at least narrow down the number of possible causes.

Based on some of the most common symptoms, this chapter identifies logical steps and available resources or tools for resolving an issue. HP recommends that you follow the instructions carefully, observe safety precautions, and note any observations or results. Capturing this information can help identify and resolve the problem more quickly.

---

 **WARNING!** To reduce the risk of electric shock or damage to the equipment:

- Do not disable the power cord grounding plug. The grounding plug is an important safety feature.
- Plug the power cord into a grounded (earthed) outlet that is easily accessible at all times.
- Disconnect power from the equipment by unplugging the power cord from the AC outlet.
- Before disassembling notebooks, always disconnect power and remove the battery.

 **IMPORTANT:** Static electricity can damage the electronic components of the computer. To prevent damage to the computer, carefully observe the electrostatic discharge precautions.

- Discharge static electricity by briefly touching a grounded metal object before you begin.
- Work on a static-free mat.
- Wear a static strap to ensure that any accumulated electrostatic charge is discharged from your body to the ground.
- Create a common ground for the equipment that you are working on by connecting the static-free mat, static strap, and peripheral units to that piece of equipment.
- For more information, see [Electrostatic discharge information on page 34](#).

**IMPORTANT:** The computer includes customer self-repair parts and parts that should be accessed only by an authorized service provider. Accessing parts described in the chapter titled "Removal and replacement procedures for authorized service provider only parts" can damage the computer or void the computer warranty.

---

## Resources

Use this table to locate troubleshooting resources.

**Table 6-1 Troubleshooting resources and their descriptions**

HP Resource Tool	Description	Link
HP Elite Support	Provides live HP Premium support (available 24/7) to Elite computers.	<a href="http://www8.hp.com/us/en/ads/elite-products/overview.html">http://www8.hp.com/us/en/ads/elite-products/overview.html</a>
HP Customer Support	Provides important support, such as warranty, support cases, drivers, Customer Advisories, Customer and Security Bulletins, and Product Change Notices.	<a href="https://support.hp.com/us-en/contact-hp">https://support.hp.com/us-en/contact-hp</a>
Subscribers Choice	Allows you to sign up for HP product updates.	<a href="http://www8.hp.com/us/en/subscribe/">http://www8.hp.com/us/en/subscribe/</a>
HP Support Forums	Provide discussions about HP products and issues.	<a href="http://h30434.www3.hp.com/psg/">http://h30434.www3.hp.com/psg/</a>
Service Access Workbench (SAW) (available for technicians and Business Partners only)	Provides navigable content intended for use by internal and outsourced call center staff and can be a resource for support and product division professionals.	<a href="http://sawpro.atlanta.hp.com/km/saw/home.do">http://sawpro.atlanta.hp.com/km/saw/home.do</a>
Vendors' web sites	Provide additional information for associated components such as Intel (processor, WLAN), Microsoft (Windows 7, 8, 10), AMD®/NVIDIA® (GPU), and so on.	<a href="http://www.intel.com/content/www/us/en/homepage.html">http://www.intel.com/content/www/us/en/homepage.html</a> <a href="http://www.amd.com">http://www.amd.com</a> <a href="http://www.nvidia.com">http://www.nvidia.com</a>

# General troubleshooting steps

This section helps you become familiar with troubleshooting methodology and efficiently resolve problems.

Proceed through the steps in the following table until the issue is resolved, and then move on to the next step that is relevant to the issue. For example, if you resolve a memory issue using the HP PC Diagnostics (UEFI) tool in step 6, you can then move on to step 10 to reseat the memory into its memory slot.



**NOTE:** You can ignore troubleshooting steps that do not apply to your issue.

**Table 6-2** Troubleshooting methodology and general troubleshooting steps

Identify issue	Analyze issue	Resolve issue	Verify solution
<a href="#">1. Understand the issue on page 77</a>	<a href="#">5. Remove or uninstall recently added hardware, software on page 83</a>	<a href="#">8. Hard reset on page 90</a>	<a href="#">Verify solution on page 95</a>
<a href="#">2. Examine the environment on page 80</a>	<a href="#">6. HP Hardware Diagnostics and Tools on page 84</a>	<a href="#">9. Soft reset (Default Settings) on page 91</a>	
<a href="#">3. Perform a visual inspection of hardware on page 80</a>	<a href="#">7. Status lights, blinking light codes, troubleshooting lights, and POST error messages on page 87</a>	<a href="#">10. Reseat cables and connections on page 91</a>	
<a href="#">4. Update BIOS and drivers on page 82</a>		<a href="#">11. Test with minimum configuration on page 93</a>	
		<a href="#">12. Test with verified working configuration (hardware or operating system) on page 94</a>	
		<a href="#">13. Replace the system board on page 94</a>	

## Identify the issue

Use these guidelines to correctly determine the problem.

## 1. Understand the issue

It is important to understand the issue that occurred, including related symptoms. It helps to understand the basic computer boot-up sequence as well as the failure itself.

### *Boot up sequence*

The computer performs several steps after you press the power button or restart the computer.

It is important to understand where in the boot-up sequence the symptoms occur. The following table lists the phases of the boot-up sequence and explains the symptoms that may occur in each phase. For example, a blue screen error (BSOD) often occurs during the performance phase.

**Table 6-3** Boot-up sequence and associated failures

Item	Procedure
<b>Startup</b>	<p>After you press the power button, the computer boots after all internal power rails (such as 5 V, 3.3 V) are stable.</p> <p>Confirm that power lights are on and fan is spinning.</p> <p>Common issues: all lights are off; troubleshooting lights are on; computer does not boot; video is absent.</p>
<b>POST (UEFI/BIOS)</b>	<p>Power-On Self-Test (POST) verifies that hardware components (such as processor, hard drive, memory) are functional. When POST is complete, the HP logo appears briefly and then disappears.</p> <p>If there are errors, the computer may exhibit blinking lights and POST error messages, and so on.</p> <p>Common issues: lights blink; error message appears; system hangs (lock up or freezes)</p>
<b>Performance (operating system)</b>	<p>System boots to operating system, and Windows logo screen appears.</p> <p>Common issues: hangs, blue screen, distorted video, driver conflict, slow performance, display issue (dead pixel), I/O issue (no speaker sound), wireless/audio unavailable, noise.</p> <p>See <a href="#">Analyze the issue on page 83</a> table for detailed troubleshooting information.</p>

## Failure classification

*Failure classification* is a breakdown of different types of failures and symptoms that could occur during the boot-up sequence.

[Failure classification by boot-up sequence on page 78](#) and [Failure classification by hardware devices on page 79](#) represent the failure classification for common notebook failures.

[Failure classification by boot-up sequence on page 78](#) categorizes failures by the boot-up sequence.

1. Power-on: Common issues are no power, recycle, or reboot.
2. POST: Common issues are no boot (despite power), light flash, or diagnostics error.
3. Performance: Common issues are Intermittent Loss of Power, Blue Screen, Hang. In many cases, issues can be identified and associated with particular hardware (for example, display or storage).

[Failure classification by hardware devices on page 79](#) categorizes failures by hardware:

- Display
- I/O (input/output) devices
- Storage
- Mechanical

A single symptom can be listed under different groups. For example, No Video can belong to (1) power-on or (4) display; but flickering when turned on should be listed in (4) display. Or, in another example, a blue screen can be caused by a driver conflict in performance (4), but it can also be caused by a defective hard drive under (6) storage. Therefore, failures that share similar symptoms are noted.

If possible, make a record of the failure symptom, the phase of the boot-up sequence where the failure occurs, and the most likely location in the failure tree ([Failure classification by boot-up sequence on page 78](#) and [Failure classification by hardware devices on page 79](#)). This record helps isolate the issue and indicate the next steps. For example, when the computer is running the operating system, it can experience an issue with (4) display, (5) I/O devices (keyboard, wireless, and so on), (6) storage, or (7) mechanical components (stuck buttons, thermal shutdown, and so on).



---

**NOTE:** *Uncategorized* is used if an issue found is not listed. For example, Bluetooth is offered on certain hardware configurations; therefore, you can classify a Bluetooth issue under I/O Device if needed.

---

## Failure classification by boot-up sequence

Use this table to locate failure classification information.



**Table 6-4** Failure classification by boot-up sequence

1. Power-on	2. POST	3. Performance
1. <a href="#">No power on page 99</a>	1. <a href="#">No video (with power) on page 107</a>	1. <a href="#">Intermittent shutdown on page 110<sup>a</sup></a>
2. <a href="#">Intermittent power-on, shutdown, reboot on page 101<sup>a</sup></a>	2. <a href="#">Blinking lights on page 108</a>	2. <a href="#">Blue screen on page 111<sup>b</sup></a>
3. <a href="#">AC adapter issue on page 102</a>	3. <a href="#">Diagnostic error messages on page 108</a>	3. <a href="#">Freeze at Windows Logo (hang or lockup) on page 111</a>
4. <a href="#">Battery not recognized, not charging on page 103</a>	4. <a href="#">BIOS password on page 109</a>	4. <a href="#">Electromagnetic Interference (EMI) on page 112</a>
5. <a href="#">Battery discharges too fast on page 105</a>		5. <a href="#">No wake up on page 113</a>
6. <a href="#">Burnt smell on page 105</a>		6. <a href="#">Unresponsive on page 114</a>
		7. <a href="#">Slow performance on page 115<sup>c</sup></a>
		8. <a href="#">HP Smart Adapter warning message on page 115</a>
		9. <a href="#">Incorrect time and date on page 116</a>

<sup>a,b,c</sup> similar symptoms

### Failure classification by hardware devices

To determine failure by device, use this table.

**Table 6-5 Failure classification by hardware devices**

4. Display	5. I/O devices	6. Storage	7. Mechanical
1. <a href="#">Display anomalies on page 118</a>	1. <a href="#">Keyboard on page 125</a>	1. <a href="#">Hard drive or solid-state drive not recognized on page 134</a>	1. <a href="#">Noise (sound) on page 139</a>
2. <a href="#">Dead pixel on page 120</a>	2. <a href="#">Keyboard pointing stick (select products only) on page 126</a>	2. <a href="#">No boot to operating system (no read-write error) on page 135</a>	2. <a href="#">Fan runs constantly on page 139</a>
3. <a href="#">No video (internal) on page 120<sup>d</sup></a>	3. <a href="#">Keyboard backlight on page 126</a>	3. <a href="#">Read-write error on page 136</a>	3. <a href="#">Thermal shutdown (hot) on page 141</a>
4. <a href="#">No video (external) on page 120<sup>d</sup></a>	4. <a href="#">Touchpad on page 127</a>	4. <a href="#">Slow performance on page 137<sup>c</sup></a>	
5. <a href="#">DisplayPort/VGA on page 121</a>	5. <a href="#">Network connectivity (RJ-45 jack) on page 127</a>	5. <a href="#">Blue screen (BSOD) error on page 137<sup>b</sup></a>	
6. <a href="#">HDMI on page 121</a>	6. <a href="#">Network connectivity wireless (WLAN) on page 128</a>	6. <a href="#">Noisy hard drive on page 137</a>	
7. <a href="#">No or bad external video via docking on page 122</a>	7. <a href="#">WWAN on page 128</a>		
8. <a href="#">Incorrect or missing color/distorted image on page 122</a>	8. <a href="#">USB on page 129</a>		
9. <a href="#">Touch screen on page 123</a>	9. <a href="#">Smart card reader on page 130</a>		
	10. <a href="#">Speaker, headphone - audio issues on page 131</a>		
	11. <a href="#">Thunderbolt (TB) on page 132</a>		

<sup>b,c,d</sup> similar symptoms

## 2. Examine the environment

It is important to examine the computer's environment. If you can quickly identify the cause of the issue, fewer resolution steps might be needed. Perform the following environment inspections:

- Check all cables and connections to be sure that no connections are loose.
- Confirm that power sources are good, such as AC outlet or adapter (110 V/220 V ac), power strip. Test with a verified working AC outlet.
- Check for compatibility issues between the computer and third-party devices, peripherals, uncertified devices, incompatible hardware (for instance, Mac OS device). Incompatibility can result in blue screen errors, improper operation, and so on.
- Isolate the computer from sources of electromagnetic interference (EMI), such as cell phones, two-way radios, floor mats, fans (and other electronic motors). EMI may contribute to a display freeze issue or lock-up.

## 3. Perform a visual inspection of hardware

Perform a physical inspection of the computer.

- Look for abnormalities such as a cracked display, dented battery, broken latches for battery bay, keyboard key caps popped out, dust over connectors, liquid spill over keyboard.
- Look for signs of drop, movement, or vibration that may cause internal and external loose connections.

## 4. Update BIOS and drivers

Whenever possible, update to the latest BIOS, firmware, and drivers before troubleshooting.

---

 **IMPORTANT:** Note that some customer company policies prohibit updates. Check your company policy before taking action.

---

The updates may include fixes for your computer issues, and they may also enhance system performance. HP continually improves the update process to make it easier. You can update the BIOS locally through a manual process, through an automatic installation, or through a remote installation on multiple units.

### *Manually updating BIOS and drivers*

Use this information to update the BIOS.

- To manually update the BIOS and drivers, see the Setup Utility (BIOS) chapter.
- See the specific BIOS update installation instructions that accompany the download.

### *Remotely deploying the BIOS and drivers*

Instead of manually searching for and downloading each SoftPaq, users and IT personnel can use two tools to identify and download all appropriate SoftPaqs for the selected HP models.

- HP SoftPaq Download Manager (SDM) is a software tool that streamlines the download, extraction, and installation process of SoftPaqs, including BIOS and drivers.
- HP System Software Manager (SSM) is a software tool that simplifies the deployment of SoftPaqs to HP computers.

## Analyze the issue

Use these steps to evaluate and interpret the problem.

### 5. Remove or uninstall recently added hardware, software

HP has designed this computer and validated it using a full-range hardware and software qualification matrix. If an issue appears to have started recently, it may be related to the recent addition of hardware or software.

A good method to determine the root cause is to remove recently added components or uninstall applications one at a time and restart the computer when necessary.

---

 **IMPORTANT:** After you have completed the process of uninstalling hardware or software and are ready to reinstall, be sure that the new device seated properly and all cables are correctly connected. After installing the device, restart the computer, and make sure the new device is turned on. In addition, if the new device is a root cause of a problem, it could cause a conflict in drivers or incompatibility issues with other installed programs. For any new hardware you have added, be sure to install the latest drivers available from the device vendor website.

---

## 6. HP Hardware Diagnostics and Tools

HP offers diagnostics and tools to diagnose hardware failure. This section describes how to use some of these tools. Make sure to check for the latest versions before use.

### HP PC Hardware Diagnostics (UEFI)

HP PC Hardware Diagnostics is a Unified Extensible Firmware Interface (UEFI) that allows you to run diagnostic tests to determine whether the computer hardware is functioning properly.

The HP PC Hardware Diagnostics (UEFI) tool is built within BIOS (basic memory and hard drive diagnostics only), or within new hard drives themselves. These drives contain more advanced versions of the diagnostic tool than the BIOS-based version.

In addition, for HP authorized service partners and IT professionals who need to support a mixed environment of older and newer HP/Compaq PCs, the HP PC Hardware Diagnostics Tool ([http://www8.hp.com/us/en/campaigns/hpsupportassistant/pc-diags.html?jumpid=va\\_r602\\_us/en/any/pps/pl\\_ot\\_ob\\_ds\\_pd/HP\\_PC\\_Hardware\\_Diagnostics\\_cc/dt](http://www8.hp.com/us/en/campaigns/hpsupportassistant/pc-diags.html?jumpid=va_r602_us/en/any/pps/pl_ot_ob_ds_pd/HP_PC_Hardware_Diagnostics_cc/dt)) supports a wide range of HP computers.

The tool runs outside the operating system so that it can isolate hardware failures from software issues, whether caused by the operating system or applications. In reality, you can determine many problems using this tool if the issue is a defective part or a loose connection (for example, reseating the keyboard cable after the tool reports a keyboard error).

The tool has three major functions:

- System Tests check the computer's hardware to verify that everything is functioning properly. If your system won't boot into Windows, try the Quick System Test. For more comprehensive testing, use the Extensive System Test option. If the System Test did not detect a hardware problem, continue with the Component Tests.
  - Component Tests focus on selected hardware components in your computer.
  - Firmware Management update your computer's BIOS to the latest version (available separately) or rolls back to a previous version.
1. Turn on or restart the computer, quickly press the **esc** key on the computer, and then press **f2**. The BIOS searches three places for the diagnostic tools, in the following order:
    - 1. Connected USB drive
    - 2. Hard drive
    - 3. BIOS

2. When the diagnostic tool opens, use the keyboard arrow keys to select the type of diagnostic test you want to run, and then follow the on-screen instructions.

Screen capture appearance may vary.

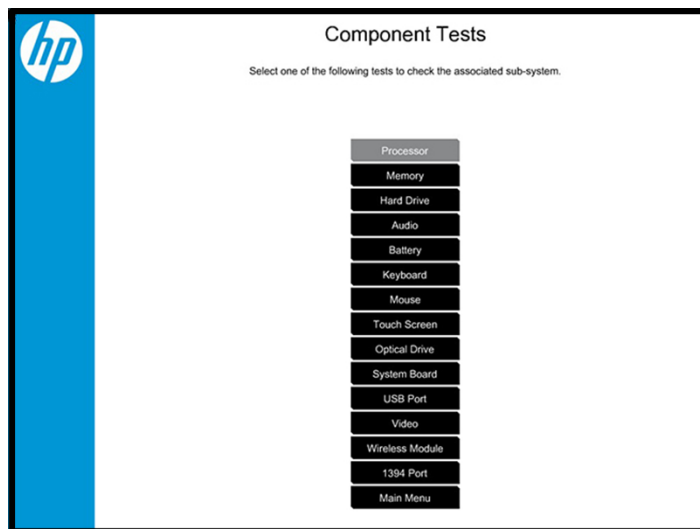
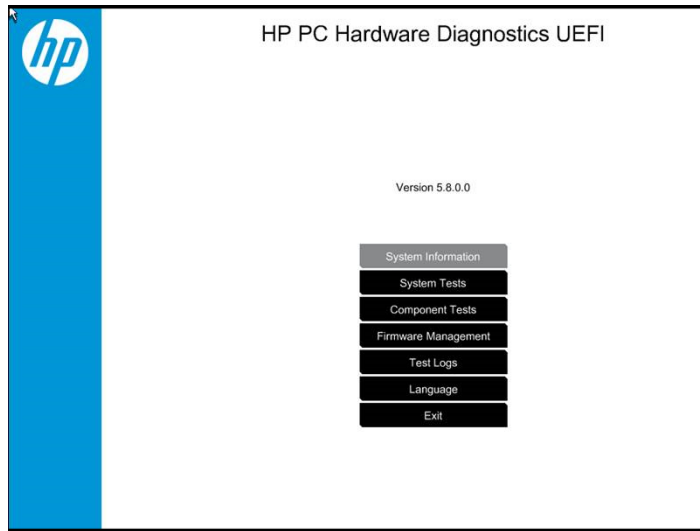

---

 **NOTE:** Use this tool, especially when the computer cannot boot to Windows.

 **NOTE:** If a component fails a test, write down the information so that it is available when you contact support. The information is also available in **Test Logs** on the Main Menu.

---

For more information, see [Using HP PC Hardware Diagnostics on page 167](#)

### HP BIOS Configuration Utility (BCU)

HP BCU is a free utility that captures the BIOS settings and their values. This tool provides a text file of the computer's BIOS configuration. This file can help identify any settings that may be contributing to an issue.

In some cases, it may help to compare this BIOS text file to the default settings of the computer.

For more information, see the [http://ftp.hp.com/pub/caps-softpaq/cmit/whitepapers/BIOS\\_Configuration\\_UTILITY\\_User\\_Guide.pdf](http://ftp.hp.com/pub/caps-softpaq/cmit/whitepapers/BIOS_Configuration_UTILITY_User_Guide.pdf).



---

**NOTE:** HP recommends that you reset BIOS before trying BCU. Resetting the BIOS is always available and relatively quick to try, whereas BCU takes extra time and effort.

---

### HP Image Diagnostic Tool

Available to HP Authorized Support Partners (ASPs) and users, this tool collects information about the current state of the computer, including product serial number, platform and BIOS information, and information about user-installed software and hardware components.

Access this tool at <ftp://ftp.hp.com/pub/idr/ImageDiags/>. HP encourages you to review the report before sending it to support. The report may assist you with diagnostics and solutions to problems you encounter.

### HP Thermal Monitor

You can use HP Thermal Monitor to stress the processor and GPU and monitor the temperature values of various components in the system.



---

**NOTE:** Available only to authorized service providers and technicians.

---

The components that are currently monitored include the processor, GPU, ACPI thermal zones, hard drive, and battery. The tool reads the temperatures of the components, logs the data, and helps to determine whether the computer would overheat in the event of thermal shutdown, fan spinning loud, and so on.

### Non HP diagnostics tools

Refer to the following diagnostic tools for troubleshooting help.

#### *Windows-to-Go USB*

Windows-To-Go USB is a Microsoft-based tool for Enterprise editions of Windows that can help in troubleshooting. You can find a process online about how to create a live Windows USB drive. For more information, see <https://technet.microsoft.com/en-us/library/hh831833.aspx>.

#### *Intel Processor Diagnostic Tool*

Determine what processor is in your computer and verify the processor operating frequency. The tool also tests specific processor features and performs a stress test on the processor. For more information, see [http://www.intel.com/support/processors/sb/CS-031726.htm?iid=subhdr+tools\\_procdiagtool](http://www.intel.com/support/processors/sb/CS-031726.htm?iid=subhdr+tools_procdiagtool).



## 7. Status lights, blinking light codes, troubleshooting lights, and POST error messages

Carefully observe any behavior that the computer may be exhibiting: status lights, blinking lights, and POST error messages during boot. It is important to understand what these indicators mean.

### Status lights

The following table describes basic lights on the computer.

**Table 6-6** Power button functions and lights and their descriptions

Component	Description
Power button	<p>When the computer is off, press the button to turn on the computer.</p> <p>When the computer is on, press the button briefly to initiate Sleep (Windows) or Suspend (Linux®).</p> <p>When the computer is in the Sleep state, press the button briefly to exit Sleep (Windows) or Suspend (Linux).</p> <p>When the computer is in Hibernation, press the button briefly to exit Hibernation.</p> <p><b>IMPORTANT:</b> Pressing and holding down the power button results in the loss of unsaved information.</p> <p>If the computer stops responding and operating system shutdown procedures are ineffective, press and hold the power button.</p>
Front power light	<p>On: The computer is on.</p> <p>Blinking: The computer is in the Sleep state.</p> <p>Off: The computer is off.</p>
Front AC adapter and battery light	<p>White: The computer is connected to external power, and the battery is charged from 90% to 99%.</p> <p>Amber: The computer is connected to external power, and the battery is charged from 0 to 90%.</p> <p>Blinking amber: A battery that is the only available power source has reached a low battery level. When the battery reaches a critical battery level, the battery light blinks rapidly. By default, the critical battery level is defined in Power Options as 5%.</p> <p>Off: The battery is fully charged.</p>
Front hard drive light	<p>Blinking white: The hard drive is being accessed.</p> <p>Amber: HP 3D DriveGuard has temporarily parked the hard drive.</p>
Rear AC adapter light	<p>White: The computer is connected to external power.</p> <p>Off: The computer is not connected to external power.</p>

### Blinking light codes

During startup, the computer may not boot properly. If this occurs, blinking light codes can help identify the cause.

The computer uses the following blinking lights to identify a hardware component that reports an error during startup. For more information, see [Blinking lights and boot error codes on page 144](#).

**Table 6-7** Blinking light codes and what they mean

Blink codes	Error
Amber battery light: blinks 1 Hz continuously	Embedded controller unable to load firmware
Caps and num lk lights = 1 blink	Processor not executing code
Caps and num lk lights = 2 blinks	BIOS recovery code unable to find valid BIOS recovery image
Caps and num lk lights = 3 blinks	Memory module error
Caps and num lk lights = 4 blinks	Graphics controller error
Caps and num lk lights = 5 blinks	System board error
Caps and num lk lights = 6 blinks	Intel Trusted Execution Technology (TXT) Error
Caps and num lk lights = 7 blinks	Sure Start unable to find valid BIOS Boot Block image
Caps and num lk lights = 8 blinks	Sure Start has identified a problem (Manual Recovery Policy Set)

### POST error messages

The Power-On Self-Test (POST) is a series of diagnostic tests that runs automatically when the computer is turned on. If the POST encounters a problem, visual error messages are displayed before the operating system starts.

POST checks the following items to ensure that the computer system is functioning properly:

- Memory
- Processors
- BIOS
- Mass storage devices
- Fans

The following table describes errors encountered during HP PC Hardware Diagnostics (UEFI).

**Table 6-8** System diagnostics failure codes and actions to address the failure

Test description	Failure description	Error code	Suggested user actions
Startup Test	Memory module	200	Attempt to reseat the memory module, and then repeat the test.  For details on troubleshooting issues related to the memory module, search for support documentation at <a href="http://www.hp.com/support">http://www.hp.com/support</a> .
Startup Test	Hard Disk 1 SMART	301	Attempt to reseat the hard drive, and repeat the test. The hard drive may have failed.
Boot Device Manager	Boot device not found	3F0	Reset BIOS. Then reseat the hard drive, and repeat the test.
BIOS Recovery	BIOS Recovery Occurred	500	This message indicates that BIOS recovery was completed successfully. No further action is required.
BIOS Application	BIOS Application Error	501	The BIOS installation may have become corrupted. Download the latest version of the BIOS and install it.  If reinstalling the BIOS fails, contact support for further assistance.

**Table 6-8** System diagnostics failure codes and actions to address the failure (continued)

Test description	Failure description	Error code	Suggested user actions
CMOS Recovery	CMOS Recovery Occurred	502	This message indicates that CMOS recovery was completed successfully. No further action is required.
Battery Check	Primary Battery Replace	601	This message indicates that the primary battery has very low capacity. Search for support documentation at <a href="http://www.hp.com/support">http://www.hp.com/support</a> for details on using the HP Support Assistant to verify the battery capacity and, if necessary, order a replacement.
Wireless Modules	Not installed or responding	701	Reseat the wireless LAN adapter module and antennas.  Because seating or reseating a wireless LAN adapter is unique to each computer model, see the WLAN module removal section in the removal and replacement chapter for further details.  Contact support if third-party wireless adapters are installed in the computer.
Fan	Fan not operating correctly	90B	The system fan may be malfunctioning. Replace the fan.

## Resolve the issue

The following sections help you fix the issue.

### 8. Hard reset

A hard reset (or forced reset) erases all information in the computer's memory and may restore functionality. Resetting the computer forces the system to clear and reestablish the connections between the BIOS and the hardware.

For more information, see <http://support.hp.com/us-en/document/c01684768>.

Performing a hard reset might fix the following common conditions:

- Windows stops responding.
- Computer stops before Windows loads, indicated by incomplete startup, blinking cursor on a black background, and errors relating to operating system not found or a missing drive.
- Display suddenly goes blank and stays blank.
- Software freezes.
- Keyboard stops responding.
- The computer does not exit Sleep or Suspend state.
- An external device stops responding. Turn off the power to that device in addition to performing the steps in this document.

Before performing a hard reset, you must disconnect or remove all peripheral devices. Start and test the computer by itself, and if the problem is not resolved, reconnect one peripheral device at a time. To resolve the startup or operational problem, run HP Support Assistant, or manually install all updated drivers from Microsoft and HP.

Before beginning, turn the computer over and look for a battery compartment door (service door). On some platforms, the battery is considered removable but not accessible.

1. Turn off the computer.
2. Remove the computer from any port replicator or docking station.
3. Disconnect all external connected peripheral devices such as USB storage devices, external displays, and printers.
4. Unplug the AC adapter from the computer.
5. Disconnect the battery.
6. Press and hold the power button for at least 15 seconds to drain residual power.
7. Reconnect the battery and plug the AC adapter back into the computer, but do not connect any of the peripheral devices.
8. Press the power button to turn on the computer.

9. If a startup menu appears, use the arrow keys to select **Start Windows Normally**, and then press the **enter** key.
10. After reconnecting each of the peripheral devices, run Windows Update and HP Support Assistant to update all device drivers.

CMOS refers to the battery-powered semiconductor chip located on computer's system board. Notebooks store low-level settings like the system time and hardware settings in CMOS. Sometimes you must clear CMOS, which requires removing and reinserting the 3 V RTC battery for a short time (a few minutes before reinserting), in addition to removing the AC adapter and battery.

---

 **NOTE:** Clearing the CMOS should only be performed for troubleshooting purposes. There is no reason to clear CMOS if the computer is working properly.

You must remove the notebook service door to access the CMOS battery. If the computer has a replaceable RTC battery, see the RTC battery replacement section for the battery removal or replacement.

---

## 9. Soft reset (Default Settings)

If your computer has issues booting, has errors during boot, has issues after you add hardware, or has other abnormal system behaviors that you cannot resolve through any other methods (for example, hard reset), it may be necessary to reset the system BIOS to default settings.

---

 **NOTE:** Some company policies prohibit updates or changes. Check whether the computer has custom BIOS settings before taking action.

---

To load BIOS to default settings: Reboot the computer, and then press **f10 > Main > Restore defaults**. For more information, see <http://support.hp.com>, and the search for **BIOS Setup Utility Information and Menu Options**.

## 10. Reseat cables and connections

Many problems are caused by improper connections or loose connections because of abnormal movement and vibration.

---

 **NOTE:** Before disassembling the computer to reseat cables and connections, always disconnect power and remove the battery, or disconnect a nonremovable battery.

---

See [Cable management on page 155](#) and [Connector types on page 157](#) for suggested cable management practices when you remove and install components.

You can access and reseat connections for Customer Self-Repair (CSR) parts. Examples of reseating hardware include:

- Reseating the battery into the battery bay can resolve no-battery found and no-charging issues.
- Reseating memory modules can resolve memory error, no-boot, and blue screen issues.
- Reseating the hard drive can resolve a POST error 3F0 (no boot device) issue (see [POST error messages and user actions on page 146](#)).
- Reseating the keyboard cable can resolve an unrecognized keys error.
- Reseating the wireless module and antenna cable can resolve a wireless connection issue.

For field replaceable units (FRUs), authorized service providers can try the following steps. For more information, see [Removal and replacement procedures for authorized service provider parts on page 39](#).

- Reseating the fan cable can fix POST error 90B (no fan detected) issue (see [POST error messages and user actions on page 146](#)).
- Reseating the power cable can fix a no-boot issue.
- Reseating the daughterboards can resolve their functional issues. Some models may have items such as a power button board, VGA board, and others.
- Reseating graphics cables and panel connectors can fix distorted or flickering video.
- Replacing thermal pads may resolve thermal power-down issue.

## 11. Test with minimum configuration

The factory-shipped computer (hardware configuration and preinstalled operating system image) is well tested and ready for use. Therefore, using the original factory hardware configuration or booting to operating system safe mode often resolves issues quickly.

- Disconnect any external USB storage, remove any discs in optical drives, remove the computer from a docking station, remove external video, and others.
- In addition to removing recently added components, you can narrow the issue down further with a minimum configuration. For example, if HP PC Diagnostics reports a memory error, test one memory module at a time to isolate the defective module.
- If the computer does not successfully boot the operating system, booting to safe mode may help identify the following possible causes of the issue.

### Essential hardware configuration

If none of the previous steps resolve the issue, start the computer with essential hardware only. The purpose is to remove as much as hardware as possible while still maintaining the computer's ability to turn on.



---

**NOTE:** This step is to be used by authorized service providers only. HP will not honor the warranty for a system tested with the system board removed without the heat sink or fan.

---

This essential configuration is often used to troubleshoot power-on related issues, such as no-boot, reboot, and freezing issues.

The essential hardware consists of the following components:

- System board
- AC adapter (unplug nonremovable battery or remove battery)
- Processor (and heat sink or fan). (Processor may be integrated into the system board.)
- Memory (one verified working memory DIMM)
- Graphics card (if no VGA port is available on the system board). Platform may have both Intel integrated graphics and discrete graphics. Therefore, you might not need a discrete graphics card.
- External VGA monitor
- External USB keyboard
- External mouse



---

**NOTE:** After you remove the service door, disconnect all connections (internal keyboard, display, discrete GPU, hard drive or solid-state drive, daughterboards, and so on) to achieve the essential hardware configuration. **Do not** disassemble the system board from its enclosure at this time.

---

Reverse the previous procedure by reinstalling each piece of hardware removed, one piece at a time, and testing your computer after each installation. Because your computer works with only the essential hardware installed, those parts must be working properly. This means that one of the hardware components removed is causing the computer to fail. By installing each device back into the computer and testing each time, you eventually identify the failing hardware.

## Safe mode

A driver conflict often results in a blue screen error message. Booting in safe mode can resolve many issues in Windows because safe mode forces the computer to load a limited version of Windows which contains only essential files.

Safe mode is useful for troubleshooting problems with programs and drivers that might not start correctly or that might prevent Windows from starting correctly. If a problem does not reappear when you start in safe mode, eliminate the default settings and basic device drivers as possible causes. Refer to the following links for how to start your computer in safe mode:

- <http://support.hp.com/us-en/document/c01835750>
- <http://support.hp.com/us-en/document/c03439317>

## 12. Test with verified working configuration (hardware or operating system)

One troubleshooting technique that can quickly isolate an issue is using a verified working part while testing. A good example is to use an external keyboard, mouse, or VGA monitor when you have issues with an internal keyboard, touchpad, or display.

Testing with a verified working AC adapter can identify an error caused by a faulty one. Similarly, testing with a verified working operating system can determine bad behaviors of the current operating system. See [Non HP diagnostics tools on page 86](#) for instructions about obtaining and using a Windows-To-Go USB.



**NOTE:** In some situations, more than one item may contribute to a problem.

---

## 13. Replace the system board

Only authorized service providers may replace the system board. This should not be considered an initial step taken to resolve an issue.

Review and perform all steps discussed previously before replacing the system board. [4. Update BIOS and drivers on page 82](#), [7. Status lights, blinking light codes, troubleshooting lights, and POST error messages on page 87](#), [8. Hard reset on page 90](#), and [9. Soft reset \(Default Settings\) on page 91](#), or [10. Reseat cables and connections on page 91](#) can resolve many system board issues without requiring the effort of replacing unnecessary hardware.



**IMPORTANT:** System board failure is not common. Do not replace the system board until you have tried all other troubleshooting options.



**NOTE:** Determine whether a previous service case might be related to the current problem. For example, a fan detection issue could be caused by a loose connection resulting from previous service.



**TIP:** Without an RTC battery (3 V coin-cell battery), the computer automatically reboots. This feature is useful when the power connector cable (between external AC adapter and system board) is defective.



 **NOTE:** Most of the time, effective troubleshooting can prevent a system board replacement.

Situations that can prevent resolution of the issue:

- The information provided about the issue omits key details, including any actions taken before the issue occurred.
  - BIOS, software, and drivers have not been updated.
  - Cables or connections are loose.
  - Technician is unaware of information available from the HP Support website (CA - Customer Advisory).
  - The issue is related to existing or known issues that might be identified in existing support articles.
  - Technician might have omitted steps in the provided repair instructions (for example, Spare Part Replacement Instructions).
  - Skipping one of steps from Troubleshooting Methodology table results in No Defect Found (NDF)/No Fault Found (NFF)/No Issue Detected (NID) messages.
- 

## Verify solution

Confirm that the implemented solution works.

- Reboot the system or device, and try to complete the task that produced the issue.
- If a part has been replaced, verify other basic functions. For example, GPU replacement requires keyboard removal. Therefore, it is good practice to verify all basic components to be sure that the solution is complete.
- Explain to the customer why the issue occurred and what was done to resolve it. If the solution you used was in an HP public document, provide the document information to the customer, letting them know they can locate it on <http://www.hp.com>. Also, tell them that there are other solutions available on the website. Advise the customer to check the website first when they have an issue. It might save them time calling in.
- Document the correct issue. Update the case with as many details as possible for other agents and engineers to analyze and study for lessons learned.

## Helpful Hints

After you become familiar with the troubleshooting steps, use the helpful hints before running diagnostics and troubleshooting.

### At startup

These steps provide simple, useful checks that you can perform when troubleshooting.

---

 **TIP:** If you have installed an operating system other than the factory-installed operating system, go to <http://www.hp.com/go/quickspecs> and verify that it is supported on your system.

---

1. Be sure that the computer is plugged into a working AC outlet.
2. Be sure that power is connected to the docking station if you use a dock.
3. Be sure that the AC adapter light is on.
4. Be sure that the AC adapter is connected when you update BIOS to avoid BIOS corruption.
5. Be sure that the computer is turned on, the rear power light is solid white (connected to an external power source), and the front power light is solid white (normal operation).
6. Remove all optical and flash drives from your system before turning it on.
7. Be sure that the boot option is set to a working operating system drive.
8. Be sure that externally connected monitors are turned on and their power lights are on. Not all monitors are equipped with lights to indicate their functionality.
9. Turn up the brightness and contrast controls of a display or external display device if the screen is dim.

### During operation

The following steps provide simple, useful checks that you can perform when troubleshooting.

1. To wake the computer:
  - a. Press the power button or any key on the keyboard.
  - b. If the system remains in the Sleep (Windows), Suspend (Linux), or Hibernate state, shut down the system by pressing and holding the power button for at least 4 seconds.
  - c. If the system does not shut down, unplug the power cord, wait a few seconds, and then plug it in again. Then press the power button again to restart the system.
2. Look for blinking lights on the computer. The blinking lights could be error codes that help diagnose the problem.
3. Check all cables for loose or incorrect connections (external devices, power cords, dock, and so on).
4. After installing a non-Plug and Play expansion board or other option, reconfigure the computer. For example, if you upgrade to a solid-state drive, you might have to reconfigure the boot order.
5. Be sure that all required device drivers have been installed. For example, if you have connected a printer, you must install a printer driver.
6. If there is a network connection issue, plug another computer with a different cable into the network connection. There might be a problem with the network plug or cable.

7. If hardware has recently been installed, remove it and determine whether the computer functions properly.
8. If software has recently been installed, uninstall it and determine whether the computer functions properly.
9. If the screen is blank, confirm the display choice by pressing **Windows logo**  + **p** and set to screen only.  
Or plug an external monitor into a different video port on the computer, if one is available, and close the computer lid.
10. Verify that the latest version of BIOS, drivers, and software are installed. A new release might support new features or fix the problem.
11. Press the **caps lock** or **num lk** key. If the **caps lock** or **num lk** light toggles on or off, the keyboard is likely operating correctly.
12. Press the touchpad On/Off button light. If the light toggles on or off, the touchpad is likely operating correctly.

## Consulting with HP Service

If further HP support is required, this information may be requested when you call. So it may be helpful to take notes.

- Technical support registration number (if applicable)
- Product serial number
- Product model name and number
- Product identification number
- Applicable error messages
- Add-on boards or hardware
- Third-party hardware or software
- Operating system type and revision level
- Description of symptom or failure

## Common issues and possible solutions

This section contains common issues, symptoms, and a series of tables that describe possible solutions to issues from Failure Classification tables. The following sections identify the issue with symptoms and solutions to resolve an issue.

## Power-on issues

Use the following sections to troubleshooting power issues.

### No power

When a unit experiences no power, there are several contributing factors to consider. Be sure to consider all symptoms related to this behavior when troubleshooting.

**Table 6-9** Issues, possible causes, and fixes

Items	Procedures
<i>Symptoms</i>	<i>Possible causes</i>
<ul style="list-style-type: none"><li>• Computer does not start</li><li>• Display is black or blank</li><li>• No fan noise</li><li>• No hard drive spinning</li><li>• Lights do not glow</li></ul>	<p>Failed power input to the computer (external power source, AC adapter, faulty battery).</p> <p>Bad connection to the computer (bad power button, power connector).</p> <p>Defective parts (memory, hard drive, graphics) or failed system board.</p>
	<i>Troubleshooting steps</i>
	<b>Perform quick check</b>
	Remove all external devices, including docking station.
	Verify external power source ( <a href="#">2. Examine the environment on page 80</a> ).
	Perform a hard reset ( <a href="#">8. Hard reset on page 90</a> ).
	<b>Verify AC adapter</b>
	Verify the battery before verifying the AC adapter. However, you can verify the AC adapter first, before opening the service door for a battery check.
	<ul style="list-style-type: none"><li>• Verify AC adapter is compatible with product. Verify that the part number is for this computer if possible.</li><li>• Verify AC adapter and power cord are good (no physical damage, bent middle ID pin).</li><li>• Verify AC adapter works on a verified working computer.</li><li>• Plug in AC adapter and power on computer without battery.</li><li>• Inspect power port on computer side for any damage, dust, or debris.</li><li>• Check power light (<a href="#">7. Status lights, blinking light codes, troubleshooting lights, and POST error messages on page 87</a>). Rear power light indicates external power to the computer is good.</li></ul>

**Table 6-9** Issues, possible causes, and fixes (continued)

Items	Procedures
	<p><b>Verify battery condition and status</b></p> <ol style="list-style-type: none"> <li>1. Check battery condition (overall result, cycle life, voltage) using HP PC Hardware Diagnostics (UEFI) tool.</li> <li>2. Verify that battery is installed properly in battery bay without a gap and that latch locks are tight (for models with removable batteries).</li> <li>3. Check battery status light (<a href="#">7. Status lights, blinking light codes, troubleshooting lights, and POST error messages on page 87</a>). Be sure that battery is not fully discharged, preventing system from booting.</li> <li>4. Determine whether the computer can turn on with battery only.</li> <li>5. Remove service door and test with a verified working battery. If the computer boots, inspect original battery before replacement.</li> <li>6. Test battery with a verified working computer to verify that it works.</li> <li>7. If the computer still does not boot, remove battery and boot on AC power only.</li> </ol>
<p>The following steps are for authorized providers or technicians.</p>	
	<p><b>Verify AC adapter – voltage</b></p> <ol style="list-style-type: none"> <li>1. Measure DC voltage output, which should be approximately 19.5 V dc. Acceptable voltage range is from 18.5 to 20.5 V dc.</li> <li>2. If the DC voltage is out of range, replace the AC adapter.</li> </ol> <p><b>NOTE:</b> This action requires a digital voltmeter.</p>
<p><b>NOTE:</b> Select models include a power cable between the system board and chassis power connector.</p>	<p><b>Verify power button, power connector</b></p> <ol style="list-style-type: none"> <li>1. Be sure that power button is not stuck.</li> <li>2. Reseat power connector cable (if applicable).</li> <li>3. Replace new power connector cable (if the cable exists and is defective)</li> <li>4. To isolate faulty power connector cable and power button, technicians can short power-on pads or pins to turn on the computer. Contact HP Engineering for this information.</li> </ol>
	<p><b>Verify blinking lights</b> (<a href="#">7. Status lights, blinking light codes, troubleshooting lights, and POST error messages on page 87</a>)</p> <p>At this point, there should be sufficient power from the AC adapter to the system board. Expect to hear the fan spinning and see blinking lights or error messages (for example, faulty memory, HDD).</p>
	<p><b>Verify system board</b></p> <ol style="list-style-type: none"> <li>1. Test essential hardware configuration (<a href="#">11. Test with minimum configuration on page 93</a>, <a href="#">12. Test with verified working configuration (hardware or operating</a></li> </ol>

**Table 6-9 Issues, possible causes, and fixes (continued)**

Items	Procedures
	<p><a href="#">system</a>) on page 94, 13. <a href="#">Replace the system board on page 94</a>) by removing nonessential parts.</p>
	<p>2. If the computer still does not boot, replace system board.</p>
<b>Tips</b>	<p>Computer automatically boots without pressing power button when the RTC 3 V battery is removed. Therefore, after the service door and RTC 3 V battery are removed, you do not have to press power button from top side.</p>
	<p>In essential hardware configuration, mWS G1 and G2 may require discrete graphics processing unit (GPU) to boot. However, mWS G3 can boot with integrated graphics.</p>

## Intermittent power-on, shutdown, reboot

Use this information to troubleshoot power-on, shutdown, and reboot issues.

**Table 6-10 Issues, possible causes, and fixes**

Items	Procedures
<i>Symptoms</i>	<i>Possible causes</i>
<ul style="list-style-type: none"> <li>• Does not always turn on</li> <li>• Intermittently hangs</li> <li>• Intermittently shuts down</li> <li>• Spontaneously reboots</li> </ul>	<p>Electrical short, fluctuating power source, unstable power rails, loose connections, bent pins, stray wires, dust, obvious damage, nearly faulty parts (bulging or leaking capacitor).</p> <p>Potentially turn into a no-power issue (<a href="#">No power on page 99</a>).</p>
	<i>Troubleshooting steps</i>
	<ol style="list-style-type: none"> <li>1. Visually check power ports on both AC adapter and computer sides.</li> <li>2. Inspect power sources:               <ol style="list-style-type: none"> <li>a. Verify that the AC adapter is working correctly. Use a confirmed working adapter to test.</li> <li>b. Verify that battery is not depleted while system is in the Sleep state. Test with a confirmed working battery.</li> </ol> </li> </ol>

The following steps are for authorized providers or technicians.

1. Follow actions in [No power on page 99](#).
  - a. Be sure that AC adapter has correct DC voltage.
  - b. Verify battery: test with a confirmed working battery.
  - c. Verify that power button is not stuck.
  - d. Verify that power connector is not loose.
  - e. Remedy loose connections and reseal major components (processor, memory, GPU, hard drive, solid-state drive, and others).
2. Perform visual check for loose connections, bent pins, stray wires, dust, nearly faulty parts (bulging or leaking capacitor).
3. Test **essential hardware configuration** ([1.1. Test with minimum configuration on page 93](#))

**Table 6-10** Issues, possible causes, and fixes (continued)

Items	Procedures
	<ul style="list-style-type: none"> <li>a. If system boots, reinstall nonessential hardware one component at a time to isolate issue.</li> <li>b. If system does not boot, replace essential hardware with verified working parts, one component at a time. If system still does not boot, replace system board.</li> </ul>

## AC adapter issue

Use this information to troubleshoot AC adapter issues.

**Table 6-11** Issues, possible causes, and fixes

Solution	
<i>Symptoms</i>	<i>Possible causes</i>
<ul style="list-style-type: none"> <li>• No sign of power</li> <li>• No boot</li> <li>• No rear power light</li> <li>• No front power light</li> <li>• Battery does not charge when AC adapter is connected</li> </ul>	AC adapter and others (for example, external power source).
	<i>Troubleshooting steps</i>
	<b>Quick check</b>
	<ol style="list-style-type: none"> <li>1. Verify external power source (<a href="#">2. Examine the environment on page 80</a>).</li> <li>2. Remove all external devices, including docking station.</li> <li>3. Perform a hard reset for the computer (<a href="#">8. Hard reset on page 90</a>).</li> <li>4. Disconnect and reassemble the power cord and adapter in case the adapter experienced short circuit, over current, over temperature events.</li> <li>5. Use a verified working adapter. If the computer operates normally, there is a problem with the original adapter.</li> <li>6. Verify that the AC adapter works on a verified working computer. If the computer operates normally, there is no problem with the adapter. See <a href="#">HP Smart Adapter warning message on page 115</a> for further information.</li> </ol>



**Table 6-11** Issues, possible causes, and fixes (continued)

Solution	
<b>Verify AC adapter</b>	
<ol style="list-style-type: none"> <li>1. Remove working battery.</li> <li>2. Verify that AC adapter is compatible with product. Verify that part number is for this computer if possible.</li> <li>3. Inspect AC adapter and power cord for physical damage, bent middle ID pin.</li> <li>4. Plug in AC adapter and power the computer without battery.</li> <li>5. Inspect the power port on computer side for any damage, dust, debris.</li> <li>6. Check power light (<a href="#">7. Status lights, blinking light codes, troubleshooting lights, and POST error messages on page 87</a>). Rear power light indicates that external power to the computer is good.</li> <li>7. If there is still no rear power light or no boot, replace the AC adapter.</li> </ol>	
<b>Tips</b>	<p>The HP Smart AC adapter has a special pin in the middle, called the ID pin, for power rating and throttling. If this pin is broken, the rear power light turns on, but the power button and front power lights blink continuously, and the computer does not turn on. Third-party AC adapters do not work with the computer.</p> <p>Use the AC adapter that came with the computer for better performance.</p>

## Battery not recognized, not charging

Use this information to troubleshoot battery issues.

**Table 6-12** Issues, possible causes, and fixes

Items	Procedures
<i>Symptoms</i>	<i>Possible causes</i>
<ul style="list-style-type: none"> <li>• No battery status light</li> </ul>	Defective AC adapter , battery, or both.
<ul style="list-style-type: none"> <li>• Blinking amber (critically low battery level)</li> </ul>	<b>NOTE:</b> Before proceeding, verify that the computer can boot to BIOS or Windows with a good AC adapter.
<ul style="list-style-type: none"> <li>• No boot without AC adapter</li> </ul>	

Table 6-12 Issues, possible causes, and fixes (continued)

Items	Procedures
	<p data-bbox="619 260 810 289"><i>Troubleshooting steps</i></p> <p data-bbox="619 310 778 340"><b>Visual inspections</b></p> <ol data-bbox="619 361 1433 541" style="list-style-type: none"><li data-bbox="619 361 1114 390">1. Inspect battery connectors for any signs of damage.</li><li data-bbox="619 411 1401 466">2. Verify that battery is installed properly in battery bay without gap or obstructions and latch locks are tight. Reseat battery (for models with removable batteries).</li><li data-bbox="619 487 1433 541">3. Determine whether battery gets hot (batteries heat up when charging, but not too hot to touch).</li></ol> <p data-bbox="619 562 1407 617"><b>Check battery warranty</b> to see whether the battery is new or its warranty is expired. Battery capacity degrades over time.</p> <p data-bbox="619 638 890 667"><b>Verify front battery status light</b></p> <ol data-bbox="619 688 1216 772" style="list-style-type: none"><li data-bbox="619 688 1088 718">1. Battery status light is off: battery not recognized.</li><li data-bbox="619 739 1216 768">2. Battery status light is blinking amber: critically low battery level.</li></ol> <p data-bbox="619 793 673 823"><b>Reset</b></p> <ol data-bbox="619 844 1136 928" style="list-style-type: none"><li data-bbox="619 844 992 873">1. Hard reset (<a href="#">8. Hard reset on page 90</a>)</li><li data-bbox="619 894 1136 924">2. Soft reset (<a href="#">9. Soft reset (Default Settings) on page 91</a>)</li></ol> <p data-bbox="619 949 769 978"><b>Verify AC adapter</b></p> <ol data-bbox="619 999 1439 1230" style="list-style-type: none"><li data-bbox="619 999 1439 1075">1. Determine whether the computer needs the AC adapter to boot and operate. Sometimes, an intermittently bad AC adapter and loose connection between adapter and computer results in inability to charge battery, which causes short run time.</li><li data-bbox="619 1096 1088 1125">2. Inspect AC adapter to verify that it is functioning.</li><li data-bbox="619 1146 1289 1176">3. Test with a working AC adapter and confirm whether battery is charging.</li><li data-bbox="619 1197 1343 1226">4. Be sure that battery is fully charged (AC adapter plugged in at least 2.5 hours).</li></ol> <p data-bbox="619 1251 1417 1306"><b>Diagnostics:</b> HP tools report results such as passed, calibrate, weak, replace, no battery, and unknown, and they suggest corresponding actions.</p> <p data-bbox="619 1327 1375 1356"><b>Use HP Hardware Diagnostics (UEFI)</b> (<a href="#">6. HP Hardware Diagnostics and Tools on page 84</a>)</p> <p data-bbox="619 1377 1439 1432">HP PC Hardware Diagnostics (UEFI) is a good tool to use to isolate and determine faulty battery, especially for quickly discharging (short life) battery.</p> <ol data-bbox="619 1453 1423 1738" style="list-style-type: none"><li data-bbox="619 1453 1066 1482">1. Verify that battery is recognized and charging.</li><li data-bbox="619 1503 1423 1558">2. Verify battery condition if battery cycle life is past its life expectancy (that is, past 1000-cycle life and 3-year warranty). Battery might need to be replaced.</li><li data-bbox="619 1579 1423 1633">3. If issue remains, test with a verified working battery and verify battery status lights and battery conditions.</li><li data-bbox="619 1654 1008 1684">4. If issue remains, replace system board.</li><li data-bbox="619 1705 912 1734">5. Verify the new replacement.</li></ol>
<b>Tips</b>	See the computer user guide for instructions regarding battery maintenance and increasing battery life. Also see <a href="http://support.hp.com/us-en/document/c01297640?jumpid=hpr_r1002_usen_link3">http://support.hp.com/us-en/document/c01297640?jumpid=hpr_r1002_usen_link3</a> .

## Battery discharges too fast

Use this information to troubleshoot battery issues.

**Table 6-13** Issues, possible causes, and fixes

Items	Procedures
<i>Symptoms</i>	<i>Possible causes</i>
Battery has good status light but discharges too fast	AC adapter, battery, or both.
	<i>Troubleshooting steps</i>
	<b>Verify AC adapter</b>
	Determine whether the computer needs the AC adapter to boot and operate. Sometimes an intermittently bad AC adapter and loose connection between adapter and computer results in the inability to charge the battery and causes short runtime.
	<ol style="list-style-type: none"><li>1. Inspect AC adapter to verify that it is working.</li><li>2. Test with AC adapter alone and with a verified working AC adapter.</li></ol>
	<b>Verify battery:</b> Because battery capacity can degrade over time, check the warranty coverage. Run a battery test to confirm whether issue is hardware related.
	<ol style="list-style-type: none"><li>1. Review battery power plans in <b>Control Panel &gt; Power Options</b> that may consume more energy and discharge battery faster. Resetting default to <b>Power Saver</b> option can conserve battery power.</li><li>2. Determine whether any graphics are processing.</li><li>3. Verify battery maintenance and operations. Leaving the battery at a high level of charge in a high-temperature environment for extended periods accelerates the loss of capacity.</li><li>4. Test and calibrate battery using HP PC Hardware Diagnostics (UEFI).</li><li>5. Verify battery life cycle using HP Support Assistant tool.</li></ol>
	If battery cycle life is past its life expectancy (past the 1000-cycle life and 3-year warranty), the battery might need to be replaced.
	<ol style="list-style-type: none"><li>6. Compare discharge time with a verified working battery (remove AC adapter) using <b>Hardware Diagnostics (UEFI)&gt;Hard Drive Tests&gt;Extensive Test&gt;Loop until error.</b></li></ol>
<b>Tips</b>	To conserve battery power, turn off Wireless On-Off button and other peripherals and USB devices, applications, processes (in Task Manager) when not in use; also, reduce screen brightness.
	Follow HP instructions about how to maintain battery and increase battery life. Also reference <a href="http://support.hp.com/us-en/document/c01297640?jumpid=hpr_r1002_usen_link3">http://support.hp.com/us-en/document/c01297640?jumpid=hpr_r1002_usen_link3</a> .

## Burnt smell

Use this information to troubleshoot burnt-odor issues.

**Table 6-14** Issues, possible causes, and fixes

<b>Items</b>	<b>Procedures</b>
<i>Symptoms</i>	<i>Possible causes</i>
Emits smoke, burnt smell	Defective on-board components.
	<i>Troubleshooting steps</i>
	<b>General visual inspection</b>
	1. Disconnect the computer from power source (AC adapter and battery).
	2. Inspect for visual damage on AC adapter and battery. Test on a known working computer to isolate issue. If issue follows AC adapter or battery, replace it.
	3. Inspect any sign of liquid spill on the computer (back of keyboard).
<b>The following steps are for authorized providers or technicians.</b>	
	<b>Further inspection on components</b>
	1. Inspect further sources internally after disassembling chassis, such as burnt or damaged components.
	2. If the issue persists, replace boards, AC adapter, and battery for safety concern, and report issues to HP.

# POST

Use the following sections to troubleshoot Power-on Self Test issues.

## No video (with power)

Use this information to troubleshoot video issues.

**Table 6-15** Issues, possible causes, and fixes

Items	Procedures
<i>Symptoms</i>	<i>Possible causes</i>
<ul style="list-style-type: none"><li>• No video (black or blank image) but have power</li><li>• Light activity</li><li>• No error messages</li><li>• Fan noise</li><li>• Hard drive light blinking and hard drive noise</li></ul>	<p>Failed display</p> <p>Failed critical components (memory, hard drive, system board)</p> <p>Loose connection</p> <p>Recently added hardware</p> <p><b>NOTE:</b> These suggestions assume that the computer has not previously been set up for multiple displays.</p>
	<i>Troubleshooting steps</i>
	<b>Quick check</b>
	<ol style="list-style-type: none"><li>1. Verify that system light activity is OK.</li><li>2. Remove all external devices, including docking station. Recently added hardware or applications may cause graphics driver conflict and result in loss of video.</li><li>3. Perform hardware reset (<a href="#">8. Hard reset on page 90</a>) and verify that HP Logo is presented correctly on display screen when pressing <b>f10</b>.</li><li>4. Test with external monitor via VGA port (or DisplayPort, HDMI, or other). Press power button and close the computer lid to force video output to external video. If unsuccessful, contact HP service.</li><li>5. If external video is OK, update BIOS, software, and drivers (<a href="#">4. Update BIOS and drivers on page 82</a>), and perform soft reset (<a href="#">9. Soft reset (Default Settings) on page 91</a>) if needed. Go to next step to verify display.</li></ol>
	<b>Verify display</b>
	<ul style="list-style-type: none"><li>• When booting to Windows, determine whether image appears on display screen (via Windows Screen Solutions or <a href="#">Windows logo</a>  + <b>p</b> for display switcher).</li><li>• If there is video on the display, disconnect external display device, open the computer lid, and restart.</li></ul>

The following steps are for authorized providers or technicians.

**Table 6-15** Issues, possible causes, and fixes (continued)

Items	Procedures
	<ol style="list-style-type: none"> <li>1. Reseat display cable connection on system board.</li> <li>2. Reseat display cable connection on display panel side.</li> <li>3. Examine and reseat major components, such as hard drive and memory.</li> <li>4. Test with minimum configuration (<a href="#">11. Test with minimum configuration on page 93</a>) by removing hard drive to isolate operating system issues and testing video in F10 Setup.</li> <li>5. If video is present, restart and retest the computer.</li> <li>6. If video is present but bad, go to <a href="#">Display on page 117</a> section.</li> <li>7. If issue persists (no video), test with external video.</li> <li>8. If issue persists, test or replace a confirmed working display.</li> <li>9. If issue persists, replace discrete graphics card.</li> <li>10. If issue persists, replace system board because of defective video function.</li> </ol>
<b>Tips</b>	Swipe a metal piece (screwdriver) over wireless or mute buttons to act as if closing lid to force video output to external display device.

## Blinking lights

Use this information to interpret blinking lights on the computer.

**Table 6-16** Issues, possible causes, and fixes

Items	Procedures
<i>Symptoms</i>	<i>Possible causes</i>
Lights blink on keyboard <a href="#">caps lock/num lock</a> keys	Blinking lights on startup usually indicate a problem with basic functionality of a critical component (processor, BIOS, graphics cards, memory, and so on) because of a loose connection, defective parts, or recently added parts.
	<i>Troubleshooting steps</i>
	<ol style="list-style-type: none"> <li>1. Check for any blink patterns. Count the number of blinks in a sequence, followed by a pause for a few seconds.</li> <li>2. See status, blinking lights, and error message (<a href="#">7. Status lights, blinking light codes, troubleshooting lights, and POST error messages on page 87</a>) for corrective actions.</li> <li>3. If internal hardware components (such as memory, hard drive) have been recently added, a component may not be connected properly. Remove and reseat new components (<a href="#">10. Reseat cables and connections on page 91</a>) one at a time.</li> </ol>
<b>Note</b>	Because the display might not be functional, lights are used to indicate an error.

## Diagnostic error messages

Use the information in the table to help you understand diagnostic error messages.

**Table 6-17** Issues, possible causes, and fixes

Items	Procedures
<i>Symptoms</i>	<i>Possible causes</i>
<ul style="list-style-type: none"> <li>• Computer has power</li> <li>• POST error message displays (Windows logo has not yet appeared)</li> </ul>	Diagnostic error messages indicate a problem. There may be a problem with the instruction being sent from the BIOS to a hardware component (for example, keyboard failures), or incompatible hardware. Can usually be resolved by installing updated firmware for the component.
	<i>Troubleshooting steps</i>
	<ol style="list-style-type: none"> <li>1. See <a href="#">7. Status lights, blinking light codes, troubleshooting lights, and POST error messages on page 87</a> for corrective actions. An example of a POST error message might be "Boot Device Not Found."</li> <li>2. If there is power, you might be able to access BIOS. Reset BIOS to its default condition. (<a href="#">9. Soft reset (Default Settings) on page 91</a>)</li> <li>3. Restore hardware to its original condition (for example, bootable solid-state drive instead of hard drive).</li> <li>4. Reseat suspected components and verify connection.</li> <li>5. Test suspected components using HP PC Hardware Diagnostics (UEFI) tool.</li> </ol>
<b>Note</b>	An Error Message means that the system has finished BIOS hardware validation and is ready to launch the <b>Startup Menu</b> . To access the <b>Startup Menu</b> for further options, press the <b>esc</b> key while restarting the computer.

## BIOS password

Use the information in the table to troubleshoot BIOS password issues.

**Table 6-18** Issues, possible causes, and fixes

Items	Procedures
<i>Symptoms</i>	<i>Possible causes</i>
Some sections are unavailable (grayed out)	You must use an administrator password.
	<i>Troubleshooting steps</i>
	<ol style="list-style-type: none"> <li>1. Review F10 BIOS Setup Overview to determine which features must be enabled.</li> <li>2. Your BIOS settings may be managed by a BIOS administrator password setup.</li> <li>3. If you lost or forgot the user password, contact your IT personnel.</li> </ol>
<b>Reference</b>	<b>HP F10 Setup Overview</b> <a href="http://h10032.www1.hp.com/ctg/Manual/c04460979">http://h10032.www1.hp.com/ctg/Manual/c04460979</a> <a href="http://h10032.www1.hp.com/ctg/Manual/c04685655">http://h10032.www1.hp.com/ctg/Manual/c04685655</a> 2015 Business PC models: see the HP PC BIOS F10 Setup Guide at <a href="http://support.hp.com">http://support.hp.com</a> .

## Performance (OS)

Most software problems occur as a result of certain situations.

- The application was not installed or configured correctly.
- There is insufficient memory available to run the application.
- There is a conflict between applications.

Make sure that all the necessary device drivers are installed.

If an operating system other than the factory operating system is installed, check whether the operating system is supported and the application is certified for the version of the operating system.

## Intermittent shutdown

Use this information to troubleshoot shutdown issues.

**Table 6-19** Issues, possible causes, and fixes

Items	Procedures
<i>Symptoms</i>	<i>Possible causes</i>
<ul style="list-style-type: none"><li>• Shutdown during startup</li><li>• Shutdown during operation</li></ul>	<p>It is often difficult to troubleshoot an intermittent issue. Possible causes include:</p> <p>Power-related issue: defective or insufficient power sources, poor connection.</p> <p>OS Custom Setting: Energy Saver (Power Management).</p> <p>Thermal-related issue: thermal sensors reach limits.</p> <p>Hardware related issue, voltage, out-of-range current, electrical short.</p>
	<i>Troubleshooting steps</i>
	<ol style="list-style-type: none"><li>1. Update BIOS and drivers. (<a href="#">4. Update BIOS and drivers on page 82</a>)</li><li>2. Perform hard reset (<a href="#">8. Hard reset on page 90</a>)</li><li>3. Perform soft reset (<a href="#">9. Soft reset (Default Settings) on page 91</a>)</li></ol>
	<b>Power-related issue</b>
	<ol style="list-style-type: none"><li>1. Verify functionality of AC adapter alone. If it does not work, test with a verified working adapter.</li><li>2. Verify battery alone. Verify that battery is not depleted. Test battery using HP PC Hardware Diagnostics (UEFI) tool.</li><li>3. Verify connection of power button and cable.</li></ol>
	<b>OS custom settings</b>
	<ol style="list-style-type: none"><li>1. Advise users to reset power options and close all applications that are not in use, including applications in the background.</li><li>2. Test with a confirmed working operating system to isolate custom settings by users or any conflicting applications that cause shutdown.</li></ol>
<b>The following steps are for authorized providers or technicians.</b>	



**Table 6-19** Issues, possible causes, and fixes (continued)

Items	Procedures
	<p><b>Thermal-related issue</b></p> <ol style="list-style-type: none"><li>1. Verify thermal condition:<ol style="list-style-type: none"><li>a. Test fan using HP PC Hardware Diagnostics (UEFI) tool (<a href="#">6. HP Hardware Diagnostics and Tools on page 84</a>)</li><li>b. Check fan and connection. Reseat fan cable.</li><li>c. Be sure that no obstructions or dust are in heat sink fan, fin, or vent.</li><li>d. Test with a verified working fan.</li><li>e. Remove old thermal compound and pads and replace with new compound and pads.</li></ol></li><li>2. Verify thermal solution:<ul style="list-style-type: none"><li>o Use Thermal Monitor tool (available only to authorized service providers/technicians) to perform stress test (processor and GPU) (<a href="#">6. HP Hardware Diagnostics and Tools on page 84</a>), and verify that thermal sensors are within limits after thermal condition is serviced.</li></ul></li></ol>
	<p><b>Hardware-related issue</b></p> <ol style="list-style-type: none"><li>1. Check for any signs of loose connections, bent pins, stray wires, dust, nearly faulty parts (bulging/leaking capacitor).</li><li>2. Verify that lights are solid.</li><li>3. If shutdown is reproducible, test essential hardware configuration:<ol style="list-style-type: none"><li>a. If no issue with hardware configuration, reinstall one nonessential component at a time to determine faulty hardware.</li><li>b. If issue persists, replace essential hardware with a confirmed working part, one at a time. If the computer does not boot, replace system board.</li></ol></li></ol>
<p><b>Tips</b></p>	<p>Intermittent issues are difficult to reproduce and troubleshoot. It is important to record details about shutdown frequencies, system configuration (3D video application), and operating conditions.</p>

## Blue screen

Use this information to troubleshoot blue screen issues.

## Freeze at Windows Logo (hang or lockup)

Use the following information to troubleshoot hang or lockup issues.

**Table 6-20** Issues, possible causes, and fixes

Items	Procedures
<p><i>Symptoms</i></p> <ul style="list-style-type: none"><li>• Has power, light activity, fan spinning</li><li>• HP Logo displays briefly</li><li>• Attempt to boot to operating system and freeze/hang at Windows logo</li><li>• No response to pressing <b>num lk</b> or <b>caps lock</b> key</li></ul>	<p><i>Possible causes</i></p> <p>Conflict of instructions from multiple programs or drivers; installing a new hardware or program that is not compatible (may also cause a blue screen error—see blue screen issue).</p>
	<p><i>Troubleshooting steps</i></p> <p>Perform the following steps one at a time to verify normal boot process:</p> <ol style="list-style-type: none"><li>1. Disconnect all external peripherals, and perform a hard reset (<a href="#">8. Hard reset on page 90</a>).</li><li>2. Perform soft reset (<a href="#">9. Soft reset (Default Settings) on page 91</a>).</li><li>3. Update BIOS and drivers (<a href="#">4. Update BIOS and drivers on page 82</a>).<ol style="list-style-type: none"><li>a. Roll back to previous version may be necessary.</li><li>b. Go to safe mode to install drivers.</li></ol></li><li>4. Run Hardware Diagnostics (<a href="#">6. HP Hardware Diagnostics and Tools on page 84</a>) to isolate hardware issue.</li><li>5. Undo recent changes in Windows (<a href="#">5. Remove or uninstall recently added hardware, software on page 83</a>).</li><li>6. Reseat cables and connections (<a href="#">10. Reseat cables and connections on page 91</a>).</li><li>7. Start Windows in safe mode (<a href="#">11. Test with minimum configuration on page 93</a>).</li><li>8. Use Startup Repair Windows to fix Windows damaged files.</li><li>9. Test with essential hardware configuration (<a href="#">11. Test with minimum configuration on page 93</a>) with a verified working operating system (for instance, USB Windows-To-Go), if available, to isolate the software issue.</li></ol>
<p><b>Tips</b></p>	<p>For more information, see <a href="http://support.hp.com/us-en/document/c03671001">http://support.hp.com/us-en/document/c03671001</a>.</p>

## Electromagnetic Interference (EMI)

Use this information to troubleshoot EMI issues.

**Table 6-21** Issues, possible causes, and fixes

Items	Procedures
<i>Symptoms</i>	<i>Possible causes</i>
System locks up, freezes in certain physical area or location	Electromagnetic interference (EMI).
	<i>Troubleshooting steps</i>
	<ol style="list-style-type: none"><li>1. See <a href="#">(2. Examine the environment on page 80)</a>. Pay attention to external power source, high-frequency signals such as cell phones, microwave ovens.</li><li>2. Move the computer to different locations nearby to determine where it fails and where it does not fail.</li><li>3. Test with a verified working computer in original factory configuration.</li><li>4. Consult with support.</li></ol>

## No wake up

Use this information to troubleshoot wake-up issues.

**Table 6-22** Issues, possible causes, and fixes

Items	Procedures
<i>Symptoms</i>	<i>Possible causes</i>
When resuming from a power management state the computer may display:	Power-saving mode; multiple-display setting.
<ul style="list-style-type: none"><li>• Blank screen</li><li>• Some light activity</li></ul>	

Table 6-22 Issues, possible causes, and fixes (continued)

Items	Procedures
	<i>Troubleshooting steps</i>
	<ol style="list-style-type: none"><li>1. Verify that front power light (<a href="#">7. Status lights, blinking light codes, troubleshooting lights, and POST error messages on page 87</a>) is blinking (indicating Sleep state). Press power button to exit Sleep.</li><li>2. Reset BIOS to default (associated with <b>OS Power Management</b> in <b>Power Menu</b>) (<a href="#">4. Update BIOS and drivers on page 82</a>)</li><li>3. Check power management settings in Windows <b>Power Options</b>. Disable Sleep options if the issue is resolved.</li></ol>

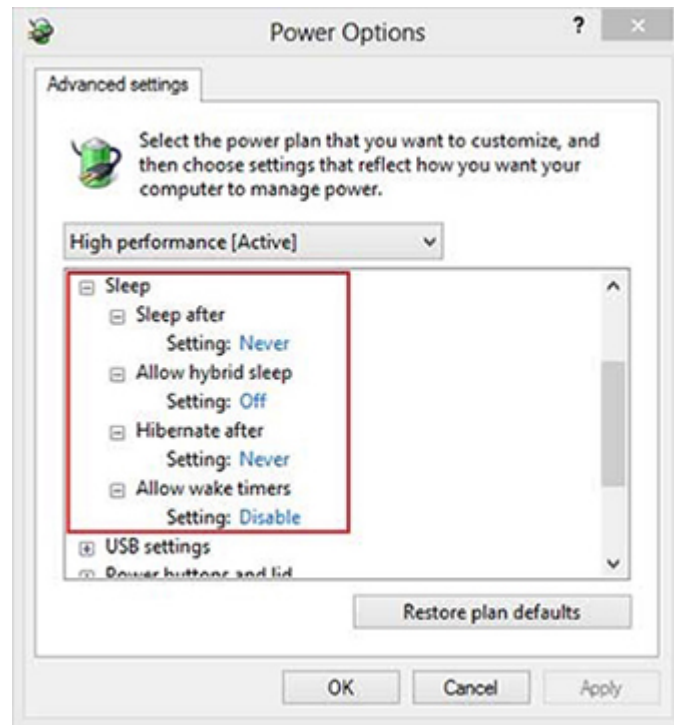

4. Screen saver is set. Press any key or touch touchpad to resume.
5. Verify that Display Choice is set to external video only. Toggle screen control key combination **fn + f4** or **Windows logo + P**.

**Tips**

If you are using a docking station, set your notebook display as a primary display. When the computer is undocked, you may think it is in a power-saving state, but the screen image may actually appear on an external display device in the docking configuration.

## Unresponsive

Use this information to troubleshoot issues with responsiveness.

**Table 6-23** Issues, possible causes, and fixes

Items	Procedures
<i>Symptom</i>	<i>Possible causes</i>
Unresponsive	Program in use has stopped responding to commands.
	<i>Troubleshooting steps</i>
	<ol style="list-style-type: none"><li>1. If possible, use the Windows Task Manager to isolate and terminate the offending process.</li><li>2. Attempt the normal Windows shutdown procedure.</li><li>3. Restart the computer using the power button.</li></ol>

## Slow performance

Use this information to troubleshoot performance issues.

**Table 6-24** Issues, possible causes, and fixes

Items	Procedures
<i>Symptom</i>	<i>Possible causes</i>
Slow performance when performing small tasks, or even in idle mode	Processor is hot or hard drive is full.
	<i>Troubleshooting steps</i>
	<b>Processor is hot</b>
	<ol style="list-style-type: none"><li>1. Verify that airflow to the computer is not blocked.</li><li>2. Verify that chassis fans are connected and working properly. Some fans operate only when needed.</li><li>3. Verify that the processor heat sink is installed properly.</li></ol>
	<b>Hard drive is full</b>
	<ol style="list-style-type: none"><li>1. Transfer data from the hard drive to create more space on the hard drive. Microsoft recommends at least 200 MB to sync system files.</li><li>2. Perform disk defragmentation to consolidate fragmented data on the hard drive so it works more efficiently.</li></ol>
<b>Tips</b>	See <a href="#">Routine maintenance for performance improvement on page 148</a> ). See <a href="http://windows.microsoft.com/en-us/windows-8/free-up-disk-space">http://windows.microsoft.com/en-us/windows-8/free-up-disk-space</a> . See <a href="http://windows.microsoft.com/en-us/windows/optimize-windows-better-performance#optimize-windows-better-performance=windows-vista">http://windows.microsoft.com/en-us/windows/optimize-windows-better-performance#optimize-windows-better-performance=windows-vista</a> .

## HP Smart Adapter warning message

Use this information to troubleshoot power adapter warning messages.

**Table 6-25** Issues, possible causes, and fixes

Items	Procedures
<i>Symptom</i>	<i>Possible causes</i>
Warning message appears in window	Less powerful AC adapter, BIOS out of date.
	
	<i>Troubleshooting steps</i>
	<ol style="list-style-type: none"> <li>1. Update BIOS, which may contain information that assigns an appropriate adapter for the configuration.</li> <li>2. Update the latest <b>HP Hotkey Support</b> software from Drivers website.</li> <li>3. Be sure that the power source is sufficient (where adapter is connected).</li> <li>4. Use appropriate AC adapter (often supplied with system) for optimum system performance.</li> <li>5. Test with a verified working AC adapter.</li> <li>6. Test the adapter on a verified working computer.</li> <li>7. Contact HP for configuration details.</li> </ol>
<b>Note</b>	<p><b>HP Smart AC adapter warning message:</b> informs you that as power demands increase, the notebook may not perform at full capacity, which may result in longer battery-charging time. In cases of extreme power demands, the system may also throttle back the processor, or with systems that have a discrete video subsystem, a video balance mode may occur to further balance the power needs of the system.</p> <p>Because system processor functions always have priority over battery charging, charging delays occur first.</p>

## Incorrect time and date

Use the following information to troubleshoot time and date issues.

**Table 6-26** Issues, possible causes, and fixes

Item	Procedure
<i>Symptom</i>	<i>Possible cause</i>
Incorrect date and time	Real-time clock (RTC) battery might need replacement.
	<i>Troubleshooting steps</i>
	<ol style="list-style-type: none"> <li>1. Reset the date and time in the operating system Control Panel.</li> <li>2. Replace the RTC battery.</li> <li>3. Verify that date and time are correct.</li> </ol>

## Display

Use these sections to troubleshoot display issues.

## Display anomalies



The display panel is a field-replaceable unit (FRU) and must be replaced by only authorized technicians. However, HP highly recommends that users and technicians observe symptoms and use the HP PC Hardware Diagnostics (UEFI) tool before any replacement.

### Symptom

This section includes common display issues with symptoms:

- Blank or black video
  - Incorrect color, missing color, distorted image
  - Flickering image
  - Vertical lines (because of LDVS, decreased signal integrity, and data loss)
  - Horizontal lines (because of video memory)
  - Dead pixel (because of display liquid, internal transistor, and others)
  - Horizontal lines (because of video memory)
  - Distorted when hot (because of thermal issue)
  - Cracked screen/image (physical damage)
  - Light leakage/bleeding
  - Humming noise (due to frequency settings)
- Contact support for assistance.
- Contact support for assistance.

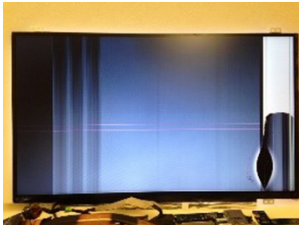
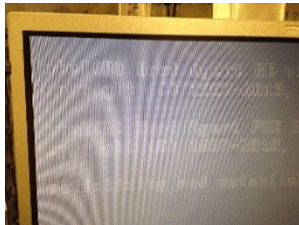
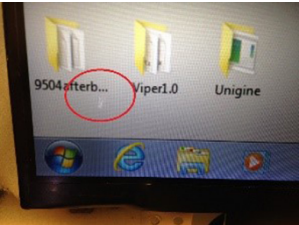
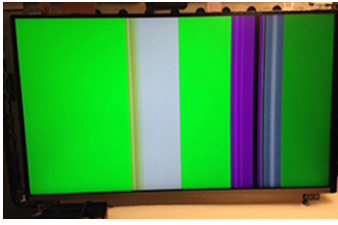
**Table 6-27** Display anomaly illustrations

Display anomalies		
		
Cracked screen	Cracked image	Blurred image
		
Dead pixel	Vertical lines	Horizontal lines



## Quick check

Use these steps to check the display.

- Visually examine the display for cracked screen, liquid crystal leak, dirty spots on glass, and other issues.
- Reset and update BIOS and docking firmware.
- Update operating system (OS), graphics or video drivers (Intel, AMD, NVIDIA, and others).

For custom images, HP highly recommends upgrading or installing Windows in UEFI mode (or Legacy disabled) to fully support hybrid graphics and avoid unexpected behaviors (for example, blue screen error, graphics or video issues) in the BIOS Legacy setting.

- Configure Windows settings (Power options, Screen brightness, Personalization, Screen resolution, and so on).
- Test with a verified working external display.
- Boot to Windows in safe mode.
- Test with a verified working operating system (for instance, shipping image).

## HP PC Hardware Diagnostics (UEFI) for video test

Use this tool to quickly determine if the display issue is related to a real hardware issue.

To start HP PC Hardware Diagnostics (UEFI) ([6. HP Hardware Diagnostics and Tools on page 84](#)), when the computer is at boot, press the **f2** key, select **Component Tests**, and then select **Video**.

There are three options:

- **Video Memory Check:** to test video memory
- **Palette Check:** to test the three video color components (red, green, blue)
- **Dead Pixel Check:** to check dead pixels in eight different colors (Dead Pixel Check is available with the HP PC Diagnostics 3-in-1 USB Key tool)

Review the video troubleshooting in the following Display section for specific issues and possible solutions. For additional information about display problems, see documentation provided by the product manufacturer.

## Display assembly diagram

The display assembly diagram shows basic video components: system board, graphics cards, display cables, display connectors, operating system (OS), graphics driver, and LCD display panel. Any component or a combination of these components can contribute to a video issue.

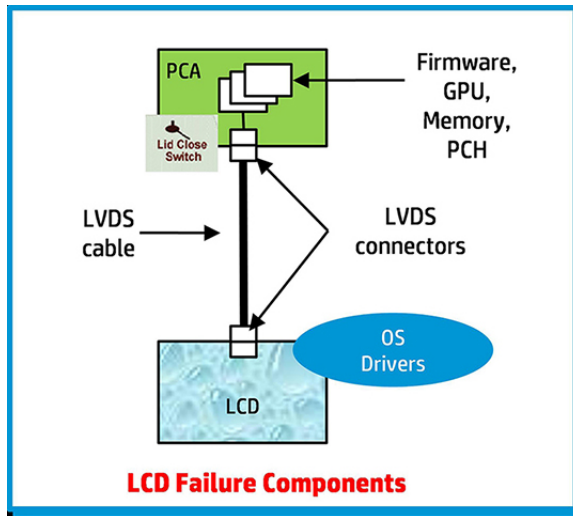

**NOTE:** The lid close switch is a Hall-effect sensor located in the top cover. When the display is closed, the sensor acts like a switch is closed. A notebook can force a video output to an external monitor, or go to hibernation or standby mode through power management. If the display screen does not light up when the display is open, the lid close switch (Hall-effect sensor) could be faulty.

## Dead pixel

Display panel may show one or more pixels that are not properly lit when displaying a single color over the screen area. Use HP PC Hardware Diagnostics (UEFI) tool to determine those defective pixels.

There is no solution for dead pixels. See [Display issue: pixel anomalies on page 154](#) for the HP dead pixel policy.

## No video (internal)

Use this information to troubleshoot video issues.

**Table 6-28** Issues, possible causes, and fixes

Items	Procedures
<i>Symptoms</i>	<i>Possible causes</i>
No internal video with certain programs (for example, video-intensive games)	Display resolution, brightness, faulty lid switch, running a program requiring a higher resolution than the display screen can support.  Faulty lid switch may put the system into Sleep or Hibernation mode.
	<i>Troubleshooting steps</i>
	Use an external monitor with higher resolution.  Test with external monitor using HDMI or HP port. Press the power button and close the computer lid to force video output to external video. If there is still no video, contact support.
<b>References</b>	See section <a href="#">No video (with power) on page 107</a> for display information.

## No video (external)

Use this information to troubleshoot external video issues.

**Table 6-29** Issues, possible causes, and fixes

Items	Procedures
<i>Symptom</i>	<i>Possible causes</i>
No image on external monitor	External monitor, resolution, display configuration, drivers.
	<i>Troubleshooting steps</i>
	<ol style="list-style-type: none"> <li>1. Be sure external monitor is compatible with the computer.</li> <li>2. Be sure that external monitor is turned on.</li> <li>3. Press any key to exit the power-saving mode.</li> <li>4. Adjust the brightness of the monitor.</li> <li>5. Test with a verified working monitor.</li> <li>6. Test the monitor via internal ports (VGA, DP ports).</li> <li>7. Install latest video driver.</li> <li>8. Reset the screen resolution as described in the documentation.</li> <li>9. Configure display choice, and then force output to external video by closing the notebook lid or pressing <b>fn + f4</b> to switch screen output.</li> </ol>

## DisplayPort/VGA

Use this information to troubleshoot DisplayPort and VGA issues.

See [No video \(external\) on page 120](#).

## HDMI

Use this information to troubleshoot HDMI issues.

**Table 6-30** Issues, possible causes, and fixes

Items	Procedures
<i>Symptoms</i>	<i>Possible causes</i>
<ul style="list-style-type: none"> <li>• Display issue</li> <li>• Sound issue</li> </ul>	Cable, connection, settings.
	<i>Troubleshooting steps</i>
	<b>Quick Check</b>
	<ol style="list-style-type: none"> <li>1. Verify that the HDMI device input source is set correctly (for example, HDMI1).</li> <li>2. Be sure you are using the correct HDMI cable.</li> <li>3. Check connection and reconnect the HDMI cable.</li> <li>4. Verify whether sound output is configured correctly in <b>Control Panel &gt; Sound Manager</b>.</li> </ol>

**Table 6-30** Issues, possible causes, and fixes (continued)

Items	Procedures
	<ol style="list-style-type: none"> <li>1. Perform hard reset (<a href="#">4. Update BIOS and drivers on page 82</a>).</li> <li>2. Update BIOS and drivers (<a href="#">4. Update BIOS and drivers on page 82</a>) when you hear sound but do not see video on HDTV.</li> </ol>
<b>References</b>	<a href="http://support.hp.com/us-en/document/c01186408">http://support.hp.com/us-en/document/c01186408</a>

## No or bad external video via docking

Use this information to troubleshoot video issues while docking.

**Table 6-31** Issues, possible causes, and fixes

Items	Procedures
<i>Symptoms</i>	<i>Possible causes</i>
No or bad image on external monitor via ports of docking station (such as VGA, DP, TB, display port, and others)	Rooted from system board, software or drivers, dock connectors, docking station hardware or firmware, dock video ports (DP, VGA, and others).
	<i>Troubleshooting steps</i>
	<ol style="list-style-type: none"> <li>1. Be sure that external monitor is turned on.</li> <li>2. Be sure that external monitor is compatible with the computer.</li> <li>3. If applicable, plug the dock in different Type-C ports.  For more information, see the technical white paper titled "HP Elite Dock with Thunderbolt 3 &amp; HP ZBook Dock with Thunderbolt 3." Go to <a href="http://www.hp.com/">http://www.hp.com/</a> and search for HP ZBook Thunderbolt 3 Dock User Guide.</li> <li>4. If the screen image is distorted, try a DP-to-VGA adapter. Connect the adapter to each DisplayPort and VGA port of the dock.</li> <li>5. Test the monitor via internal ports (such as VGA, DP, HDMI, and others).</li> <li>6. Verify that dock connectors of the notebook and the dock are clean, without dust, debris (for example, using air duster).</li> <li>7. Ideally, use a verified working operating system or system connected to the dock to isolate the issue of the current operating system.</li> <li>8. Ideally, use a verified working docking station to isolate the faulty dock.</li> <li>9. Update latest dock firmware. Follow the installation instructions carefully. You may want to try a DP-to-VGA adapter if you have a distorted screen image. Connect the adapter to each DisplayPort of the dock. If you still cannot update the dock, attempt to update it on a confirmed working notebook before having the dock replaced.</li> </ol>
<b>Note</b>	See the technical white paper titled "Multiple displays on HP ZBook Mobile Workstations" from HP platform support website. Go to <a href="http://h20195.www2.hp.com/v2/getpdf.aspx/4aa5-2657enw">http://h20195.www2.hp.com/v2/getpdf.aspx/4aa5-2657enw</a> .

## Incorrect or missing color/distorted image

Use this information to troubleshoot image issues.

**Table 6-32** Issues, possible causes, and fixes

Items	Procedures
<i>Symptoms</i>	<i>Possible causes</i>
System works normally but the display shows:	Loose connection, display cable, display, graphics card.
<ul style="list-style-type: none"><li>• Missing or strange color</li><li>• Image distortion</li></ul>	<i>Troubleshooting steps</i> <b>Verify with external monitor</b> <ol style="list-style-type: none"><li>1. Use combination <b>fn + f4</b> to enable output to external monitor.</li><li>2. Close the lid.</li></ol> If the external monitor also shows incorrect color, it is graphics card issue. Test with a verified working graphics card. <b>Verify monitor cable and cable connection</b> (Monitor disassembly is required.) <p>Be sure the monitor cables are not pinched or damaged.</p> <p>Be sure the monitor cables have good connection at both ends (system board and display panel).</p> <ul style="list-style-type: none"><li>• If moving cables affects the image, the monitor cable is the cause of the issue. Test with a confirmed working cable.</li><li>• If moving cables does not affect the image, the monitor has an issue. Test with a confirmed working monitor.</li></ul>

## Touch screen

Use this information to troubleshoot touch screen issues.

**Table 6-33** Issues, possible causes, and fixes

Items	Procedures
<i>Symptoms</i>	<i>Possible causes</i>
Unresponsive	Dirt and smudge, driver, touch display configuration, power management.
Inaccurate	<i>Troubleshooting steps</i> <b>Quick check</b> <p>Turn off the computer, spray glass cleaner onto a soft, damp cloth, and gently wipe the screen to remove dirt and smudge.</p> <b>NOTE:</b> Do not spray cleaner directly onto the screen.

Table 6-33 Issues, possible causes, and fixes (continued)

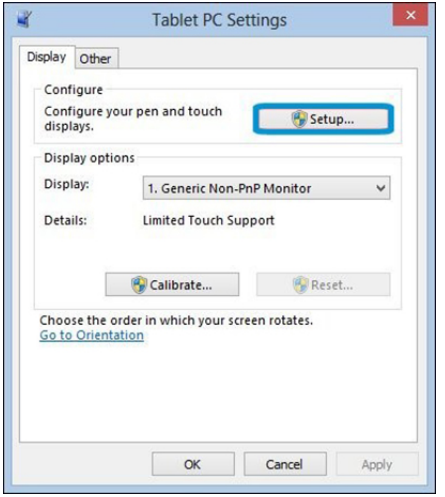
Items	Procedures
Configure the touch display in <b>Control Panel &gt; Tablet PC Settings</b>	<ol style="list-style-type: none"><li>1. Restart the computer.</li><li>2. Verify touch screen and graphics drivers.</li><li>3. Configure the touch display to identify the screen as a touch screen as shown in the image at left.</li><li>4. Calibrate the screen and reset if touch functionality is still not working correctly.</li><li>5. Perform diagnostic test in HP Hardware Diagnostics under <b>Component Tests &gt; Touch Screen</b>.  If the diagnostics tests pass but the touch screen still does not respond, continue following the steps.</li><li>6. Adjust the power management settings for your touch screen.  If the touch screen stops working after waking from sleep, adjust the power management settings so that the touch screen device stays active while the computer is in Sleep mode.</li><li>7. Perform Microsoft System Restore, and restore to a time when the system was working.</li><li>8. Perform HP System Recovery if none of the previous actions resolve the issue.</li></ol>
	
<b>References</b>	<a href="https://support.hp.com/us-en/document/c03488148">https://support.hp.com/us-en/document/c03488148</a>

## I/O devices

Use this information to troubleshoot I/O device issues.

### NOTE:

- Make sure external devices are supported and compliant (for example, USB Type-C, Thunderbolt 3, PCI Express).
- If you have problems with external devices not provided by HP, contact device manufacturers for compatibility and latest drivers before troubleshooting (for example, USB devices, Thunderbolt devices, PCI express card reader, VGA, display, HDMI monitors, speakers).
- Be sure I/O devices are properly inserted into the I/O ports, and then be sure that Windows Device Manager recognizes the I/O devices.

## Keyboard

Use this information to troubleshoot keyboard issues.

**Table 6-34** Issues, possible causes, and fixes

Items	Procedures
<i>Symptoms</i>	<i>Possible causes</i>
Keystrokes not recognized	Dust trapped under keycap, loose keycap, loose keyboard connection, defective keyboard.
Characters not matched	<i>Troubleshooting steps</i>
	<ol style="list-style-type: none"><li>1. Inspect the keyboard for any signs of dust, liquid, or debris trapped under sticky keys that might prevent keystroke recognition.</li><li>2. Check for incomplete connection between keyboard and system board by verifying that <b>caps lock</b> or <b>num lk</b> light turns on when you press the key.</li><li>3. Verify whether the keyboard is recognized in Windows Device Manager, and verify whether the keyboard driver is installed properly.</li><li>4. Test with a working external keyboard (such as a USB keyboard). Also test in Windows for special keys (<b>caps lock</b>, <b>shift</b>, <b>ctrl</b>, <b>fn</b>, <b>Windows</b>, <b>alt</b>) if necessary.</li><li>5. Test with HP PC Hardware Diagnostics (UEFI) to isolate a hardware issue from a software issue.</li><li>6. Verify that BIOS is up to date. If so, resetting BIOS to default may help.</li><li>7. Test with a verified working operating system, or restore the operating system to be sure that the issue is not caused by items such as different language settings, sticky keys feature, and so on.</li><li>8. Verify that keyboard flex cables are fully inserted and in good condition.</li></ol>

The following steps are for authorized providers and technicians.

**Table 6-34** Issues, possible causes, and fixes (continued)

Items	Procedures
	<ol style="list-style-type: none"> <li>1. Verify whether keyboard flex cable is in good condition (no delamination or torn cable end, no missing or cracked tracks, pads).</li> <li>2. Verify that keyboard flex cable ends are fully inserted and aligned with connectors on system board, and those connector tabs are properly closed. Reseat cables.</li> <li>3. Replace new internal keyboard and retest.</li> </ol>
<b>Tips</b>	If a key works only when pressed with force, inspect and remove debris trapped under keycap.

## Keyboard pointing stick (select products only)

Use this information to troubleshoot pointing stick issues.

**Table 6-35** Issues, possible causes, and fixes

Items	Procedures
<i>Symptom</i>	<i>Possible causes</i>
Point stick not working properly	Dust trapped under point stick, loose point stick cap.
	<i>Troubleshooting steps</i>
	<ol style="list-style-type: none"> <li>1. Inspect for any signs of dust or liquid spill that prevents point stick from working.</li> <li>2. Check whether point stick cap is loose, and reseat it if necessary.</li> </ol>

The following steps are for authorized providers and technicians.

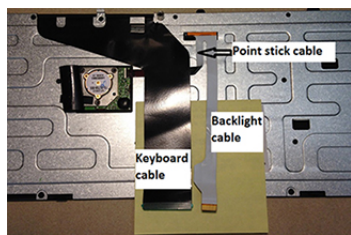

1. Verify whether keyboard flex cables are in good condition (no delamination or torn cable end, no missing or cracked tracks, pads).
2. Verify that keyboard flex cable ends are fully inserted and aligned with connectors on system board and back of keyboard, and that connector tabs are properly closed.
3. Reseat point stick cables.

Example of back of keyboard, including keyboard, point stick, and backlight cables.

## Keyboard backlight

Use this information to troubleshoot keyboard backlight issues.

**Table 6-36** Issues, possible causes, and fixes

Items	Procedures
<i>Symptom</i>	<i>Possible causes</i>
Backlight function not working properly	Backlight disabled, loose connection.



**Table 6-36** Issues, possible causes, and fixes (continued)

Items	Procedures
	<i>Troubleshooting steps</i>
	<b>NOTE:</b> Not all notebook computers have backlit keyboards.
	A keyboard function key lets you turn the light on and off. Verify whether backlit feature is not disabled by pressing a combination of <b>fn + backlit</b> key.
<b>The following steps are for authorized providers or technicians.</b>	
	<ol style="list-style-type: none"> <li>1. Verify whether backlight flex cables are in good condition (no delamination or torn cable end, no missing or cracked tracks or pads).</li> <li>2. Verify that backlight flex cable ends are fully inserted and aligned with connectors on system board and that connector tabs are properly closed.</li> <li>3. Reseat backlight cable.</li> </ol>

## Touchpad

Use this information to troubleshoot touchpad issues.

**Table 6-37** Issues, possible causes, and fixes

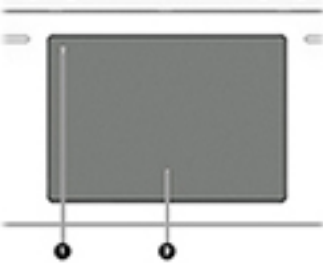
Items	Procedures
<i>Symptoms</i>	<i>Possible causes</i>
Not working properly	Touchpad turned off, driver, settings.
(1) Touchpad on/off button	<i>Troubleshooting steps</i>
(2) Touchpad	<ol style="list-style-type: none"> <li>1. Ensure touchpad on/off light is not amber (disabled). Double tap to enable.</li> <li>2. Verify whether touchpad device is listed in <b>Device Manager &gt; Mice and other pointing devices</b>.</li> <li>3. Install the latest touchpad driver.</li> <li>4. Adjust touchpad settings (<b>Control Panel &gt; Mouse</b>).</li> <li>5. Test touchpad controller using the HP PC Hardware Diagnostics (UEFI) tool (<b>f2 &gt; Component Tests &gt; Mouse Test &gt; Pointer Test &amp; Drag and Drop Test</b>).</li> </ol>
	
<b>The following steps are for authorized service providers/technicians.</b>	
	<ol style="list-style-type: none"> <li>1. Check the touchpad cable for damage or a loose connection, and then reseat the touchpad cable.</li> <li>2. If issue persists, replace the touchpad and verify the change.</li> </ol>

## Network connectivity (RJ-45 jack)

Use this information to troubleshoot network issues.

**Table 6-38** Issues, possible causes, and fixes

Items	Procedures
<i>Symptoms</i>	<i>Possible causes</i>
<ul style="list-style-type: none"><li>• Unable to find networks (yellow bang)</li><li>• Connection dropouts</li><li>• Slow performance</li></ul>	Network source, cable, connection, RJ-45 (network) jack, driver, settings.
	<i>Troubleshooting steps</i>
	<b>Quick Check:</b> verify the network status lights that supposed to flash when there is network activity.

## Network connectivity wireless (WLAN)

Use this information to troubleshoot wireless connectivity issues.

**Table 6-39** Issues, possible causes, and fixes

Items	Procedures
<i>Symptoms</i>	<i>Possible causes</i>
<ul style="list-style-type: none"><li>• Unable to find networks (yellow bang)</li><li>• Connection dropouts</li><li>• Slow performance</li></ul>	Network source, cable, connection, wireless module, driver, settings.
<b>The following steps are for authorized providers or technicians.</b>	
	<ol style="list-style-type: none"><li>1. Verify that the wireless module and its antenna cables are fully inserted and in good condition (see WLAN module removal and replacement section). Reseat wireless module and antenna connection.</li><li>2. Verify the module antenna cable connection is not loose.</li><li>3. Verify that antenna cables are properly connected to the MAIN and AUX terminals (see WLAN module removal and replacement section).</li></ol>

## WWAN

Use this information to troubleshoot WWAN issues.

**Table 6-40** Issues, possible causes, and fixes

Items	Procedures
<i>Symptom</i>	<i>Possible causes</i>
Unable to find networks or service	Network source, cable, connection, driver, settings.

Table 6-40 Issues, possible causes, and fixes (continued)

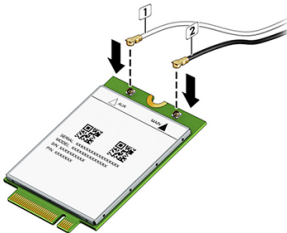
Items	Procedures
	<i>Troubleshooting steps</i>
	<ol style="list-style-type: none"><li>1. Update to the latest driver and utility.</li><li>2. Check with network service provider for signal coverage.</li><li>3. Be sure signal strength is good.</li><li>4. Be sure that your service is active.</li></ol>
<b>The following steps are for authorized providers or technicians.</b>	
	<ul style="list-style-type: none"><li>• Verify module and antenna cable connections are not loose.</li><li>• Verify antenna cables are properly connected to the correct terminals. For example, the antenna cable labeled <b>1</b> connects to the Main terminal labeled <b>1</b>. The antenna cable labeled <b>2</b> connects to the Aux terminal labeled <b>2</b>.</li></ul>

## USB

Use this information to troubleshoot USB port issues.

**Table 6-41** Issues, possible causes, and fixes

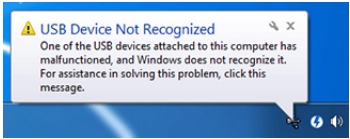
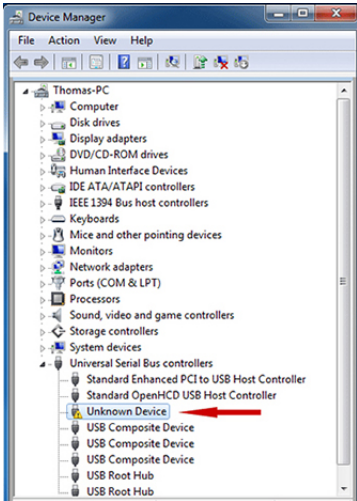
Items	Procedures
<p><i>Symptoms</i></p> <ul style="list-style-type: none"> <li>• USB devices are not recognized</li> <li>• USB devices are not charging</li> </ul>	<p><i>Possible causes</i></p> <p>USB devices do not have the latest software drivers or port insufficient power, or the devices are not compliant.</p> <p><b>NOTE:</b> USB Type-C uses a different connector entirely.</p>
<p>Examples of USB device Not Recognized</p>  	<p><i>Troubleshooting steps</i></p> <ol style="list-style-type: none"> <li>1. Unplug the USB device. Restart the computer (wait for 2–5 minutes) to reset the USB port or hub in case of a power surge.</li> <li>2. Perform a soft reset (<a href="#">9. Soft reset (Default Settings) on page 91</a>), and verify if the USB device is recognized.</li> <li>3. Verify whether the USB device is recognized in <b>Device Manager &gt; Universal Serial Bus Controller</b>, or the USB is recognized without a yellow warning symbol, or bang.</li> <li>4. Verify whether the latest USB driver, USB chipset driver, or both are installed. You can remove or reinstall the USB driver.</li> <li>5. Be sure the USB device is supported, for example, USB 3.0 device requires more power draw (0.9 A) from a USB port than a USB 2.0 device (0.5 A). As a result, identify the USB charging port to be used for charging a USB device, or an external AC power adapter might be required for an external USB storage device to work properly.</li> <li>6. Test with verified working USB devices (keyboard, mouse, USB key) to be sure USB ports are functional.</li> <li>7. Test the USB device on a verified working computer to be sure the USB device is not malfunctioning.</li> </ol>

## Smart card reader

Use this information to troubleshoot smart card reader issues.

**Table 6-42** Issues, possible causes, and fixes

Items	Procedures
<p><i>Symptoms</i></p> <ul style="list-style-type: none"> <li>• Not recognized</li> <li>• Unable to write</li> </ul>	<p><i>Possible causes</i></p> <p>Physical damage, incorrect insertion, dirt, driver, malfunctioning card reader.</p> <p><b>NOTE:</b> Some cards have a read-write security switch on the card. Be sure that switch is set to Write Enabled before attempting to write data to it.</p>

**Table 6-42** Issues, possible causes, and fixes (continued)

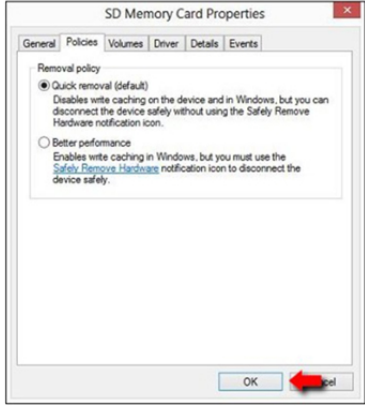
Items	Procedures
Card Reader Removal Policy	<i>Troubleshooting steps</i>
	<ol style="list-style-type: none"> <li>1. Verify card reader removal policy.</li> <li>2. Make sure there is no physical damage to the card.</li> <li>3. Inspect the ends of the memory cards for dirt or material closing a hole or spoiling a metal contact. Clean the contacts with a lint-free cloth and small amounts of isopropyl alcohol. Replace the memory card if necessary.</li> <li>4. Reinstall and update the drivers for the card reader.</li> <li>5. Make sure the smart card reader is compliant with ISO 7816 Class A, B, and C.</li> <li>6. Reinsert the card reader with correct face as described in its documentation.</li> <li>7. Check reader function with a verified working card.</li> </ol>

**IMPORTANT:** If the card reader has an in-use indicator light, do not insert or remove memory cards while the light is flashing. Doing so might cause loss of data on the card or might permanently damage the card reader.

## Speaker, headphone - audio issues

Use this information to troubleshoot audio issues.

**Table 6-43** Issues, possible causes, and fixes

Items	Procedures
<i>Symptoms</i>	<i>Possible causes</i>
<ul style="list-style-type: none"> <li>• No sound from external or internal speakers</li> <li>• Distorted sound, too soft, too loud, intermittent</li> </ul>	<p>Volume turned down, sound card not recognized, malfunctioning hardware, electronic interference.</p>

**Table 6-43** Issues, possible causes, and fixes (continued)

Items	Procedures
	<p><i>Troubleshooting steps</i></p> <ol style="list-style-type: none"> <li>1. Remove any device connected to the audio jack to enable the internal speaker.</li> <li>2. Close all open programs.</li> <li>3. Adjust volume by pressing <b>fn + f6</b> or <b>f7</b>. Be sure that volume button light is not amber (mute).  - or -  Adjust Windows volume control by clicking the speaker icon on the Windows taskbar. Be sure that the sound is not muted.</li> <li>4. Verify that the sound card is detected in Windows Device Manager.</li> <li>5. Reinstall the <b>latest audio driver</b>.</li> <li>6. Test audio device using HP PC Hardware Diagnostics (UEFI) tool (<b>f2 &gt; Component Tests &gt; Audio</b>).</li> <li>7. Test with a verified working operating system. If issue is resolved, restore full operating system.</li> <li>8. Test with verified working external speakers or headset.</li> <li>9. Reseat internal speaker connections.</li> <li>10. Test with verified working internal speakers.</li> <li>11. Replace internal speakers.</li> </ol>
No sound from headphones	<ol style="list-style-type: none"> <li>1. Adjust volume by pressing <b>fn + f6</b> or <b>f7</b>. Be sure that volume button light is not amber (mute). Or adjust Windows volume control by clicking the speaker icon on the Windows taskbar. Be sure that the sound it not muted.</li> <li>2. Check headphone cable connection.</li> <li>3. Test with a verified working audio board.</li> <li>4. Replace audio board and verify the change.</li> </ol>
No sound from external speakers	<ol style="list-style-type: none"> <li>1. Verify that external speakers are turned on.</li> <li>2. Disconnect headphones from headphone jack.</li> <li>3. Adjust volume by pressing <b>fn + f6</b> or <b>f7</b>. Be sure that volume button light is not amber (mute).  - or -  Adjust Windows volume control by clicking the speaker icon on the Windows taskbar. Be sure that the sound is not muted.</li> <li>4. Check for possible interference devices nearby that might affect the audio (cell phone or portable communications handset.)</li> </ol>

## Thunderbolt (TB)

Use this information to troubleshoot Thunderbolt issues.

**Table 6-44** Issues, possible causes, and fixes

Items	Procedures
<i>Symptom</i>	<i>Possible causes</i>
Thunderbolt device not working	BIOS, drivers, and user settings.
	<i>Troubleshooting steps</i>
	<ol style="list-style-type: none"><li>1. Update to the latest BIOS and choose appropriate TB Port settings.</li><li>2. Reset <b>User Account Settings</b> to default.</li><li>3. Update Intel Thunderbolt software that includes firmware version (for TB controller), driver version (operating system driver), and application version.</li></ol>

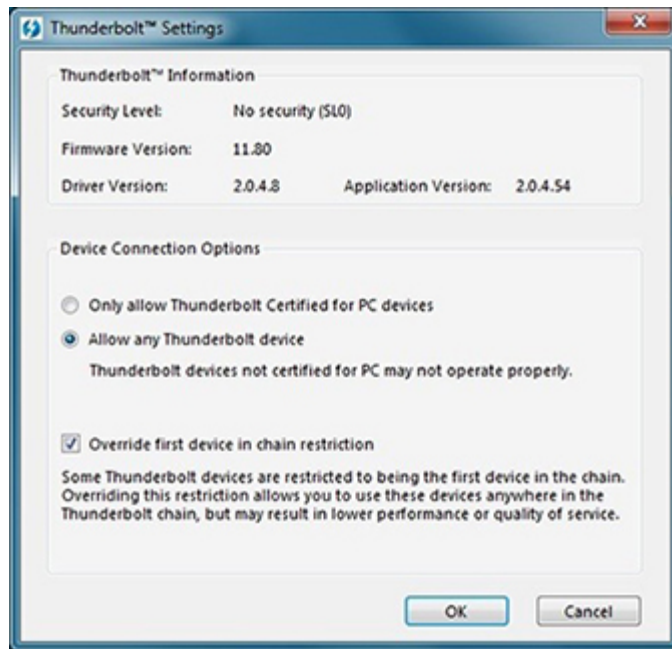

4. Verify that Windows Device Manager detects the TB device.
5. Verify cable connection to TB port.
6. Test with a verified working TB board, if possible.

**NOTE:** Thunderbolt is new technology. Thunderbolt cable and Thunderbolt device must be compatible with Windows. To determine whether your device is Thunderbolt Certified for Windows, see <https://thunderbolttechnology.net/products>.

## Storage

Use this information to troubleshoot storage issues.

### NOTE:

- Back up all critical data before troubleshooting the drive.
- Before contacting support, HP recommends that you run a drive (HDD, SSD, M.2 drive) test using the HP PC Hardware Diagnostics (UEFI) tool on the suspected failed drive.
- Diagnose the hard drive using BIOS, Diagnostics built in the shipping image, or an external USB ([http://www8.hp.com/us/en/campaigns/hpsupportassistant/pc-diags.html?jumpid=va\\_r602\\_us/en/any/pps/pl\\_ot\\_ob\\_ds\\_pd/HP\\_PC\\_Hardware\\_Diagnostics\\_cc/dt](http://www8.hp.com/us/en/campaigns/hpsupportassistant/pc-diags.html?jumpid=va_r602_us/en/any/pps/pl_ot_ob_ds_pd/HP_PC_Hardware_Diagnostics_cc/dt)).
- HP recommends the drive quick test to quickly (less than 10 minutes) identify the malfunctioning drive. If the issue still exists, run Extensive Test (more than 2 hours, or loop mode, which runs until an error occurs).
- If any test fails, record failure code and contact support for instructions about how to order a replacement hard drive.
- If all of the tests pass, the hard drive is not damaged. As a rule, HP will not replace a hard drive under warranty that does not fail the HP Hard Drive Self-Test.
- If there is no physical problem with the hard drive (or memory), then try reinstalling the Windows operating system to troubleshoot the problem.

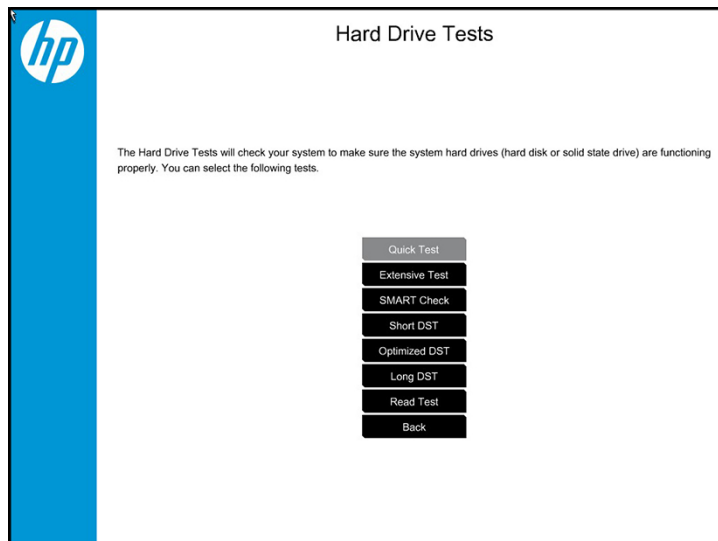

### Hard drive or solid-state drive not recognized

Use this information to troubleshoot storage device issues.



**Table 6-45 Issues, possible causes, and fixes**

Items	Procedures
<i>Symptom</i>	<i>Possible causes</i>
Hard drive is not recognized during POST	Loose connection, faulty hard drive, faulty drive configuration/BIOS setting.
	<i>Troubleshooting steps</i>
	<ol style="list-style-type: none"><li>1. Perform a hard reset (<a href="#">8. Hard reset on page 90</a>).</li><li>2. Reset BIOS to default.</li><li>3. Verify hard drive connection and flex cable. Reseat hard drive and cable connection. For multiple storage devices, keep the primary drive with the operating system and remove other devices.</li><li>4. Use the HP Hardware Diagnostics tool to verify that the drive is recognized and test it.</li><li>5. If the hard drive fails diagnostics, record failure and have the drive replaced.</li><li>6. Identify when the issue is related to software. If the hard drive passes diagnostics, test the drive on a verified working computer. If the failure follows the drive, reinstall the operating system to make sure that software is not an issue.</li><li>7. Test with a verified working hard drive. If it is still not recognized, the system board is faulty.</li></ol>
	<b>NOTE:</b> If the drive is seen in BIOS and Diagnostics, try a secure erase before replacing a drive as this might resolve related issues.

## No boot to operating system (no read-write error)

Use this information to troubleshoot issues with booting to the operating system.

**Table 6-46 Issues, possible causes, and fixes**

Items	Procedures
<i>Symptoms</i>	<i>Possible causes</i>
<ul style="list-style-type: none"><li>• POST error message: Boot Device not found (3F0)</li><li>• Hang when booting to operating system</li></ul>	Operating system, loose connection, faulty hard drive, BIOS configuration, Secure Boot.

**Table 6-46** Issues, possible causes, and fixes (continued)

Items	Procedures
	<i>Troubleshooting steps</i>
	<ol style="list-style-type: none"> <li>1. Verify whether Secure Boot is enabled in BIOS. Secure Boot prevents legacy boot devices from starting the computer, including bootable CDs and DVDs. For more information, see <a href="http://support.hp.com/us-en/document/c03653226">http://support.hp.com/us-en/document/c03653226</a>.</li> <li>2. Reset BIOS to default. Be sure that BIOS <b>Boot Mode</b> in <b>Boot Option</b> is set up properly for bootable device and its operating system (for example, UEFI Native for Windows 8).  Another example, choosing <b>Legacy Boot Order</b> for an UEFI device causes "Boot Device not found (3F0)" error.</li> <li>3. Verify hard drive connection and flex cable. Reseat connection. For multiple storage devices, keep the primary drive with the operating system and remove other devices.</li> <li>4. Use PC Hardware Diagnostics tool to test. Record failure code and have the hard drive replaced.</li> <li>5. If there is no error, reinstall the operating system using HP Restore.</li> <li>6. Test with a verified working operating system hard drive, if available.</li> </ol>
<b>Note</b>	If there is a hard drive POST error message, see <a href="#">POST error messages and user actions on page 146</a> .

## Read-write error

Use this information to troubleshoot read and write errors.

**Table 6-47** Issues, possible causes, and fixes

Items	Procedures
<i>Symptoms</i>	<i>Possible causes</i>
<ul style="list-style-type: none"> <li>• POST error message (for example, error code 301)</li> </ul>	Loose connection, faulty hardware.
<ul style="list-style-type: none"> <li>• Hang when working on data, files, documents</li> </ul>	<i>Troubleshooting steps</i>
	<ol style="list-style-type: none"> <li>1. Perform a hard reset (<a href="#">8. Hard reset on page 90</a>).</li> <li>2. Reset BIOS to default (<a href="#">9. Soft reset (Default Settings) on page 91</a>).</li> <li>3. Verify the drive connection and flex cable. Reseat connection (<a href="#">10. Reseat cables and connections on page 91</a>).</li> <li>4. Use the HP Hardware Diagnostics tool to test. If failed, record failure code and have the hard drive replaced.</li> <li>5. If no error with HP PC Hardware Diagnostics (UEFI) tool, try to repair the hard drive and its files in Windows (using command "CHKDSK /F /r /x"). Use HP Restore to reinstall the operating system, if needed.</li> <li>6. Test with a verified working hard drive. If it is not recognized, the system board is faulty.</li> </ol>
<b>Note</b>	If there is a hard drive POST error message, see <a href="#">POST error messages and user actions on page 146</a> .

## Slow performance

Use this information to troubleshoot performance issues.

**Table 6-48** Issues, possible causes, and fixes

Items	Procedures
<i>Symptoms</i>	<i>Possible causes</i>
Slow performance even when performing small read-write operations	Operating system files, hard drive is full.
	<i>Troubleshooting steps</i>
	<ol style="list-style-type: none"><li>1. Transfer data from the hard drive to create more space. Microsoft recommends at least 200 MB to sync system files.</li><li>2. Perform disk defragmentation to consolidate fragmented data on the hard drive so that it works more efficiently.</li></ol>
	<b>NOTE:</b> Do not defragment an SSD.
<b>Tips &amp; tricks</b>	For optimal system performance, place your operating system and all of your most commonly used applications and files on the fastest hard drive (solid-state drive) and fastest areas on the drive (primary partition of 200 GB max).
	See <a href="#">Routine maintenance for performance improvement on page 148</a> .

## Blue screen (BSOD) error

A faulty hard drive can cause a blue screen error. Perform the drive tests using the HP Diagnostics Tool to make sure that the drive is functional.

If all of the tests are successful, see [Common blue screen error messages on page 149](#) for detailed troubleshooting steps.

## Noisy hard drive

Use this information to troubleshoot a noisy hard drive.

 **IMPORTANT:** Because an SSD has no moving parts, it does not make loud or clicking noises.

Depending on type and rotational speed, some hard drives make more noise than others.

Not all noises are related to the fan or hard drive.

**Table 6-49** Issues, possible causes, and fixes

Items	Procedures
<i>Symptoms</i>	<i>Possible causes</i>
<ul style="list-style-type: none"><li>• Loud noise from hard drive</li><li>• Clicking noise from hard drive</li><li>• Still boots to operating system and operates normally</li></ul>	BIOS, hard drive firmware, driver, faulty drive, power supply (AC adapter).

**Table 6-49** Issues, possible causes, and fixes (continued)

Items	Procedures
	<p data-bbox="619 260 815 289"><i>Troubleshooting steps</i></p> <ol data-bbox="619 310 1442 772" style="list-style-type: none"><li data-bbox="619 310 991 340">1. Update BIOS and hard drive firmware.</li><li data-bbox="619 361 1347 415">2. Examine AC adapter to be sure that it is not faulty or overloaded. Disconnect all peripherals (USB storages, dock, and others).</li><li data-bbox="619 436 1007 466">3. Remove hard drive to isolate the noise.</li><li data-bbox="619 487 1442 571">4. Test the hard drive on a verified working computer if the noise continues. If the hard drive makes the same noise or clicking sounds, the sounds are either normal sounds for the hard drive or a fault with the hard drive.</li><li data-bbox="619 592 1401 621">5. Verify original hard drive connection and flex cable. Reseat hard drive and connection.</li><li data-bbox="619 642 1401 697">6. Run HP PC Hardware Diagnostics (UEFI). If failed, record failure code and replace hard drive replace.</li><li data-bbox="619 718 1385 772">7. If you find no error with HP PC Hardware Diagnostics (UEFI), perform disk defragmentation. Some hard drives make a clicking noise when highly fragmented.</li></ol>
<b>Tips</b>	<p data-bbox="619 793 1442 877">For optimal system performance, place your operating system and all of your most commonly used applications and files on the fastest hard drive or solid-state drive and on the fastest areas on the drive (primary partition of 200 GB max).</p> <p data-bbox="619 898 1230 928">See <a href="#">Routine maintenance for performance improvement on page 148</a>.</p>

## Mechanical

Use this information to troubleshoot mechanical issues.

### Noise (sound)

Use this information to troubleshoot abnormal noise issues.

**Table 6-50** Issues, possible causes, and fixes

Items	Procedures
<i>Symptoms</i>	<i>Possible causes</i>
Computer emits abnormal noise	Aside from basic components (power adapter, supply, fan, speaker, hard drive, optical drive, display panel, external devices), it is also common for electronic components to produce noise.
	<i>Troubleshooting steps</i>
	<ol style="list-style-type: none"><li>1. Inspect external power source and change to verified working one.</li><li>2. Determine whether the noise comes from AC power adapter. Test with a verified working AC adapter.</li></ol>
	Disconnect external devices and all cables connected to the computer to isolate issue to computer only.
<b>Noisy fan</b>	Determine whether the noise comes from the fan. Disconnect the fan briefly to isolate whether noise originates from fan. If noise is absent with fan disconnected, see <a href="#">Fan runs constantly on page 139</a> .
<b>Noisy hard drive</b>	Determine whether the noise comes from the hard drive.  See <a href="#">Noisy hard drive on page 137</a> .
<b>Noisy optical drive</b>	<ol style="list-style-type: none"><li>1. Determine whether the noise comes from an optical drive.</li><li>2. Remove CD/DVD from the optical drive.</li></ol>
<b>Noisy speaker</b>	<ol style="list-style-type: none"><li>1. Determine whether the noise comes from speaker.</li><li>2. Test with a verified working external headset/speaker.</li></ol>
<b>Noisy display</b>	Determine whether the noise comes from display panel (humming noise). Change display frequency settings. See <a href="#">Display on page 117</a> .
<b>The section below is intended for authorized service providers and technicians.</b>	
	<ol style="list-style-type: none"><li>1. After disassembling the chassis, inspect components of the interior for excessive wear or damage.</li><li>2. If noise issues persist, proceed with process of elimination for battery, AC adapter, or boards.</li></ol>

### Fan runs constantly

Use this information to troubleshoot a constantly running fan.

**Table 6-51** Issues, possible causes, and fixes

Items	Procedures
<p><i>Symptoms</i></p> <ul style="list-style-type: none"> <li>• Fan never stops running</li> <li>• Generates heat</li> <li>• Decreased computer performance</li> </ul>	<p><i>Possible causes</i></p> <ul style="list-style-type: none"> <li>• BIOS not up to date.</li> <li>• Thermal condition (fan, air flow)—fan might not be defective but must run constantly to remove excess heat generated by electrical components.</li> <li>• Inappropriate configuration.</li> </ul>
	<p><i>Troubleshooting steps</i></p>
	<p><b>General actions</b></p>
	<ol style="list-style-type: none"> <li>1. Verify whether BIOS is set to <b>Fan Always on while on AC Power</b> F10 Setup. When booting the computer, press <b>f10</b> to open Setup, and then select <b>Advanced &gt; Built-In Device Options Menu</b>.</li> <li>2. Update BIOS and drivers (<a href="#">4. Update BIOS and drivers on page 82</a>) and reset BIOS to default. BIOS can implement new fan characteristics and updates for other components.</li> <li>3. Perform a hard reset (<a href="#">8. Hard reset on page 90</a>). Performing a hard reset can reset recorded thermal values in memory.</li> </ol>
	<p><b>Thermal-related issue</b></p>
	<ol style="list-style-type: none"> <li>1. Verify that fan is spinning. Reseat fan cable before moving to next step.             <ol style="list-style-type: none"> <li>a. Check fan and connection. Reseat fan cable.</li> <li>b. Be sure that no obstructions or dust are in heat sink fan, heat sink fin, or vent.</li> <li>c. Test fan using HP PC Hardware Diagnostics (UEFI) tool (<a href="#">6. HP Hardware Diagnostics and Tools on page 84</a>). Be sure that the fan is not producing loud noise and that fan blades spin correctly.</li> <li>d. Test with a verified working fan.</li> <li>e. Replace the fan.</li> </ol> </li> <li>2. Verify thermal solution             <p>Use Thermal Monitor tool (available only to authorized service providers and technicians) (<a href="#">HP Thermal Monitor on page 86</a>) to run stress test (processor and GPU) and verify that thermal sensors are within limits after thermal condition is serviced.</p> </li> </ol>

**Table 6-51** Issues, possible causes, and fixes (continued)

Items	Procedures
	<p><b>User configuration</b></p> <p>Change Power Options in Windows (for example, choosing <b>Balanced mode</b> instead of <b>High performance</b>). High performance and extensive graphics might cause the fan run constantly to release the heat.</p>
<b>Notes</b>	<p>BIOS currently omits fan presence detection to shorten boot time delay less than four seconds. Therefore, the fan error is generated based on previous boot to operating system that found system fan error.</p> <p>Fan often is part of thermal solution, including heat sink, heat sink fin/muffler, and thermal grease. Fan replacement requires reboot and fan function verification using HP PC Hardware Diagnostics (UEFI) tool.</p> <p>For more information, see the following links:</p> <ul style="list-style-type: none"> <li>• <a href="http://support.hp.com/us-en/document/c01007591">http://support.hp.com/us-en/document/c01007591</a>.</li> <li>• <a href="https://support.hp.com/us-en/document/c01657439">https://support.hp.com/us-en/document/c01657439</a>.</li> </ul>

## Thermal shutdown (hot)

Use this information to troubleshoot a thermal shutdown.

**Table 6-52** Issues, possible causes, and fixes

Items	Procedures
<i>Symptoms</i>	<i>Possible causes</i>
Similar to fan runs constantly issue ( <a href="#">Fan runs constantly on page 139</a> )	BIOS not up to date, thermal condition (fan, air flow)
	<i>Troubleshooting steps</i>
<ul style="list-style-type: none"> <li>• System shutdown</li> <li>• Abnormal heat</li> <li>• Continually running fan</li> <li>• Decreased computer performance</li> </ul>	<ol style="list-style-type: none"> <li>1. Update BIOS and drivers (<a href="#">4. Update BIOS and drivers on page 82</a>) and reset BIOS to default. BIOS can implement new fan characteristics and updates for other component.</li> <li>2. Perform a hard reset (<a href="#">8. Hard reset on page 90</a>). Performing a hard reset can reset recorded thermal values in memory.</li> <li>3. Determine whether you are using a correct AC adapter.</li> <li>4. Be sure to turn power off completely when putting a notebook in a travel bag.</li> </ol>
	<b>Thermal-related issue</b>
	<ol style="list-style-type: none"> <li>1. Verify thermal condition: <ol style="list-style-type: none"> <li>a. Check fan and connection. Check if fan is spinning when computer is on. Reseat fan cable.</li> <li>b. Be sure that no obstructions or dust are in heat sink fan, fin, or vent.</li> <li>c. Be sure that the notebook is not sitting on a hot surface that blocks vent intakes.</li> <li>d. Test fan using HP PC Hardware Diagnostics (UEFI) tool (<a href="#">6. HP Hardware Diagnostics and Tools on page 84</a>). Be sure that the fan is not producing a loud noise and that fan blades spin correctly.</li> </ol> </li> </ol>

**Table 6-52** Issues, possible causes, and fixes (continued)

Items	Procedures
	<ul style="list-style-type: none"><li data-bbox="655 260 979 287">e. Test with a verified working fan.</li><li data-bbox="655 310 1382 338">f. Remove old thermal compound and pads, and replace properly with new pads.</li></ul> <p data-bbox="608 361 863 388">2. Verify thermal solution:</p> <ul style="list-style-type: none"><li data-bbox="655 411 1422 499">o Use Thermal Monitor tool (available only to authorized service providers and technicians) to run stress test (processor and GPU), and verify that thermal sensors are within limits after thermal condition is serviced.</li></ul>
<b>Note</b>	See <a href="https://support.hp.com/us-en/document/c01657439">https://support.hp.com/us-en/document/c01657439</a> .



## Additional information

The following sections provide additional information that you can use during the troubleshooting process.

### Acronyms

These acronyms are used in this chapter.

**Blue screen (BSOD)**—A Windows error screen that can occur if a problem causes your computer to shut down or restart unexpectedly. When you experience this type of error, you cannot see items such as the Start menu or the taskbar when your computer is turned on. Instead you might see a blue screen with a message that your computer ran into a problem and needs to restart.

**CPU**—Central processing unit

**DIMM**—Dual in-line memory module

**Daughterboard**—Type of circuit board that plugs into or is attached to the system board or similar expansion card to extend its features and services.

**GPU**—Graphics processor unit

**GTS**—General Troubleshooting Step

**HDD**—Hard drive

**KB**—Keyboard

**LVDS**—Low-Voltage Differential Signaling

**MSG**—Maintenance and Service Guide

**mWS**—Mobile Workstations

**WS**—Workstations

**OS**—Operating system

**PC**—Personal computer

**POST**—Power-On Self-Test

**SSD**—Solid-state drive

**TSG**—Troubleshooting Guide

**UEFI**—Unified Extensible Firmware Interface

**WLAN**—Wireless local area network

**WWAN**—Wireless wide area network

## Blinking lights and boot error codes

In some cases, when the host processor is not executing code or does not have the necessary code to drive the display, light blink codes inform you of a problem.

The following information is from the white paper <http://h10032.www1.hp.com/ctg/Manual/c04685655>.

**Table 6-53** Blinking lights and boot error codes

Blink codes	Error
Amber battery light: blinks 1 Hz continuously	Embedded Controller unable to load firmware
Caps and num lk lights = 1 blink	Processor not executing code
Caps and num lk lights = 2 blinks	BIOS recovery code unable to find valid BIOS recovery image
Caps and num lk lights = 3 blinks	Memory module error
Caps and num lk lights = 4 blinks	Graphics controller error
Caps and num lk lights = 5 blinks	System board error
Caps and num lk lights = 6 blinks	Intel Trusted Execution Technology (TXT) Error
Caps and num lk lights = 7 blinks	Sure Start unable to find valid BIOS Boot Block image
Caps and num lk lights = 8 blinks	Sure Start has identified a problem (Manual Recovery Policy Set)

### Processor not executing code

This computer experienced a problem due to the failure of certain code to execute, resulting in a failed startup of the processor.

The issue could be related to the processor or the system board in the computer. If the processor is socketed, be sure that the processor is seated correctly in the socket. If this error reoccurs, see [General troubleshooting steps on page 75](#).

 **NOTE:** The computer attempts to notify you of this problem through a series of blinking lights. When you attempt to turn on the computer from an Off or Hibernated state, lights associated with the **caps lock** and **num lk** keys both **blink once**, followed by a pause, and then continue in a repeating pattern.

### BIOS recovery code unable to find valid BIOS recovery image

This computer has experienced a problem in locating a valid BIOS image, resulting in a failed startup.

You can resolve this problem by placing a clean copy of the system BIOS on a USB key or in the appropriate hard drive directory and performing a reboot. If this error reoccurs, see [General troubleshooting steps on page 75](#).

 **NOTE:** The computer attempts to notify you of this problem through a series of blinking lights. When you attempt to turn on the computer from an Off or Hibernated state, lights associated with the **caps lock** and **num lk** keys both **blink twice**, followed by a pause, and then continue in a repeating pattern.

### Memory module error

This computer has experienced a memory initialization problem resulting in a failed startup. This issue might be related to the memory modules in the computer. You can resolve this problem by ensuring that memory modules are correctly inserted and seated.

If this error reoccurs, you must use a service event to determine the source of the error (memory modules or system board) and take the appropriate corrective action.

---

 **NOTE:** The computer attempts to notify you of this problem through a series of blinking lights. When you attempt to turn on the computer from an Off or Hibernated state, lights associated with the **caps lock** and **num lock** keys both **blink three times**, followed by a pause, and then continue in a repeating pattern.

---

## Graphics Controller Error (No Controller)

This computer has experienced a graphics controller initialization problem resulting in a failed startup. This issue might be related to the graphics controller in your machine.

You can resolve this problem by ensuring that the graphics controller module is seated correctly in machines with modular graphics. If this error reoccurs, you must use a service event to identify the source of the error and take the appropriate corrective action.

---

 **NOTE:** The computer attempts to notify you of this problem through a series of blinking lights. When you attempt to turn on the computer from an Off or Hibernated state, lights associated with the **caps lock** and **num lock** keys both **blink four times**, followed by a pause, and then continue in a repeating pattern.

---

## Failure System Board Error

This computer has experienced a system board initialization problem resulting in a failed startup. This issue might be related to the system board in the computer. You must use a service event to identify the source of the error and take the appropriate corrective action.

---

 **NOTE:** The computer attempts to notify you of this problem through a series of blinking lights. When you attempt to turn on the computer from an Off or Hibernated state, lights associated with the **caps lock** and **num lock** keys both **blink five times**, followed by a pause, and then continue in a repeating pattern.

---

## Intel Trusted Execution Technology (TXT) Error

This computer has experienced a problem related to the Intel Trusted Execution Technology resulting in a failed startup. The error occurs when three situations are true:

- The Intel Trusted Execution Technology (TXT) has been enabled on the computer.
- Policies have been set to prevent startup if the BIOS measurement has changed.
- The BIOS measurement has changed.

For more information about Intel TXT, go to <http://www.intel.com/content/dam/www/public/us/en/documents/white-papers/trusted-execution-technology-security-paper.pdf>.

You must use a service event to resolve this issue.

---

 **NOTE:** The computer attempts to notify you of this problem through a series of blinking lights. When you attempt to turn on the computer from an Off or Hibernated state, lights associated with the **caps lock** and **num lock** keys both **blink six times**, followed by a pause, and then continue in a repeating pattern.

---

## Sure Start unable to find valid BIOS Boot Block image

This computer has experienced a problem in locating a valid BIOS image, resulting in a failed startup. You must use a service event to identify the source of the error and take appropriate corrective action.



**NOTE:** The computer attempts to notify you of this problem through a series of blinking lights. When you attempt to turn on the computer from an Off or Hibernated state, lights associated with the **caps lock** and **num lock** keys both **blink seven times**, followed by a pause, and then continue in a repeating pattern.

## Sure Start has identified a problem (Manual Recovery Policy Set)

This computer has experienced a problem in locating a valid BIOS image, resulting in a failed startup. HP Sure Start normally repairs this type of issue; however, on this computer HP Sure Start has been configured to operate in manual mode key sequence.

To proceed with the repair, press and hold the following keys: **esc + up arrow + down arrow**. To avoid the need for this manual recovery step, set the HP Sure Start recovery policy to automatic. If this error reoccurs, you must use a service event to identify the source of the error and take appropriate corrective action.



**NOTE:** The computer attempts to notify you of this problem through a series of blinking lights. When you attempt to turn on the computer from an Off or Hibernated state, lights associated with the **caps lock** and **num lk** keys both **blink eight times**, followed by a pause, and then continue in a repeating pattern.

## POST error messages and user actions

Use this information to determine the meaning of POST error messages.

**Table 6-54** POST error messages and user actions to address the error

Test description	Failure descriptions	Error code	Possible user actions
Product information	Invalid value	00A	Contact support for assistance.
Startup test	Memory module	200	Attempt to reseat the memory module and then repeat the test.  Search <a href="http://www.hp.com/support">http://www.hp.com/support</a> for details about troubleshooting issues related to the memory module.  If the memory module still fails, contact support.
Startup test	Hard Disk 1 SMART	301	Attempt to reseat the hard drive and repeat the test.  The hard disk drive might have failed. Contact support for assistance.
Startup test	Hard Disk 2 SMART	302	The hard drive might have failed. Contact support for assistance.
Startup test	Hard Disk 1 Quick	303	The hard drive might have failed. Contact support for assistance.
Startup test	Hard Disk 2 Quick	304	The hard drive might have failed. Contact support for assistance.
Run-in test	Memory module	200	Attempt to reseat the memory module and then repeat the test.  Search <a href="http://www.hp.com/support">http://www.hp.com/support</a> for details about troubleshooting issues related to the memory module.  If the memory module still fails, contact support.
Run-in test	Hard Disk 1 SMART	301	Attempt to reseat the hard drive and repeat the test.  The hard drive might have failed. Contact support for assistance.
Run-in test	Hard Disk 2 SMART	302	The hard drive might have failed. Contact support for assistance.
Run-in test	Hard Disk 1 Quick	303	The hard drive might have failed. Contact support for assistance.
Run-in test	Hard Disk 2 Quick	304	The hard drive might have failed. Contact support for assistance.

**Table 6-54** POST error messages and user actions to address the error (continued)

Test description	Failure descriptions	Error code	Possible user actions
Hard Disk Test	Hard Disk 1 SMART	301	Attempt to reseal the hard drive and repeat the test.  The hard drive might have failed. Contact support for assistance.
Hard Disk Test	Hard Disk 2 SMART	302	The hard drive might have failed. Contact support for assistance.
Hard Disk Test	Hard Disk 1 Quick	303	The hard drive might have failed. Contact support for assistance.
Hard Disk Test	Hard Disk 2 Quick	304	The hard drive might have failed. Contact support for assistance.
Hard Disk Test	Hard Disk 1 Full	305	The hard drive might have failed. Contact support for assistance.
Hard Disk Test	Hard Disk 2 Full	306	The hard drive might have failed. Contact support for assistance.
Boot Device Manager	Boot device not found	3F0	This code indicates a potential problem with the hard drive. Run the hard drive test.  See <a href="https://support.hp.com/emea_africa-en/document/c01443371">https://support.hp.com/emea_africa-en/document/c01443371</a> for more information.
Boot Device Manager	Hard Disk 1 Error	3F1	Indicates a potential problem with the hard drive. Run the hard drive test.  See <a href="https://support.hp.com/emea_africa-en/document/c01443371">https://support.hp.com/emea_africa-en/document/c01443371</a> for more information.
Boot Device Manager	Hard Disk 2 Error	3F2	This code indicates a potential problem with the hard drive. Run the hard drive test.  See <a href="https://support.hp.com/emea_africa-en/document/c01443371">https://support.hp.com/emea_africa-en/document/c01443371</a> for more information.
Boot Device Manager	Hard Disk 1 SMART	301	This code indicates a potential problem with the hard drive. Run the hard drive test.  See <a href="https://support.hp.com/emea_africa-en/document/c01443371">https://support.hp.com/emea_africa-en/document/c01443371</a> for more information.
Boot Device Manager	Hard Disk 2 SMART	302	This code indicates a potential problem with the hard drive. Run the hard drive test.  See <a href="https://support.hp.com/emea_africa-en/document/c01443371">https://support.hp.com/emea_africa-en/document/c01443371</a> for more information.
BIOS Recovery	BIOS Recovery Occurred	500	This message indicates that BIOS recovery was completed successfully. No further action is required.
BIOS Application	BIOS Application Error	501	The BIOS installation might have become corrupted. Download the latest version of the BIOS and install it. See <a href="#">4. Update BIOS and drivers on page 82</a> for more information.  If reinstalling the BIOS fails, contact support for further assistance.
CMOS Recovery	CMOS Recovery Occurred	502	This message indicates that CMOS recovery was completed successfully. No further action is required.
Battery Check	Primary Battery Replace	601	This code indicates that the primary battery has very low capacity.  Search <a href="http://www.hp.com/support">http://www.hp.com/support</a> for details about using the HP Support Assistant to verify the battery capacity and, if necessary, order a replacement.

**Table 6-54** POST error messages and user actions to address the error (continued)

Test description	Failure descriptions	Error code	Possible user actions
Battery Check	Secondary Battery Replace	602	This indicates that the secondary battery has very low capacity.  Search <a href="http://www.hp.com/support">http://www.hp.com/support</a> for details about using the HP Support Assistant to verify the battery capacity and, if necessary, order a replacement.
Wireless Module	Not installed or responding	701	Reseat the wireless LAN adapter module, if your notebook supports it.  Because seating or reseating a wireless LAN adapter is unique to each computer model.
Fan	Fan not operating correctly	90B	The system fan might be malfunctioning.  For information about troubleshooting heat-related issues, see <a href="http://support.hp.com/us-en/document/c01007591">http://support.hp.com/us-en/document/c01007591</a> .  A hard reset can sometimes restore the system fan to working order. See <a href="https://support.hp.com/us-en/document/c01684768">https://support.hp.com/us-en/document/c01684768</a> for details.  If the system fan continues to malfunction, contact support.

## Routine maintenance for performance improvement

The table presents a summary of the suggested times for performing the routine maintenance tasks that are described in this document.

**Table 6-55** Routine maintenance tasks to improve performance

Tasks	Weekly	Monthly	Occasionally
Perform a system tune up.	X		
Run Windows Update.	X		
Scan for and remove viruses.	X		
Scan for and remove spyware and adware.	X		
Empty the Recycle Bin.	X		
Delete temporary Internet files.	X		
Back up user files.		X	
Create a restore point.		X	
Defragment the hard drive.		X	
Run Scan Disk.		X	
Clean the exterior of the computer.			X
Close programs that are not being used.			X
Prevent programs from loading at startup.			X
Remove rear cover and clean fan blades and vents with compressed air.			X

## Common blue screen error messages

The following sections define blue screen error messages.

### Error message list

For an example of a Bug Check Code Reference, use this image.

For more information, see [https://msdn.microsoft.com/en-us/library/windows/hardware/hh994433\(v=vs.85\).aspx](https://msdn.microsoft.com/en-us/library/windows/hardware/hh994433(v=vs.85).aspx).

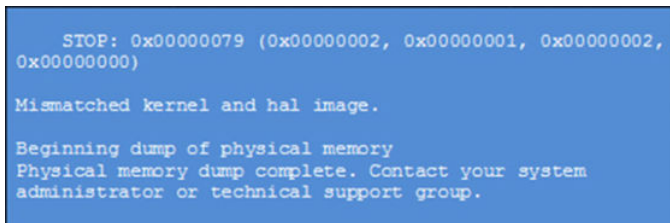
A screenshot of a Windows blue screen error message. The text is white on a blue background. It reads: "STOP: 0x00000079 (0x00000002, 0x00000001, 0x00000002, 0x00000000)", "Mismatched kernel and hal image.", "Beginning dump of physical memory", "Physical memory dump complete. Contact your system administrator or technical support group."/>

```
STOP: 0x00000079 (0x00000002, 0x00000001, 0x00000002,
0x00000000)

Mismatched kernel and hal image.

Beginning dump of physical memory
Physical memory dump complete. Contact your system
administrator or technical support group.
```

Note that the hexadecimal number following the word "STOP" is called the bug check code or Stop code.

### Bug check symbolic names

Each bug check code also has an associated symbolic name.

In the example, the screen shows [https://msdn.microsoft.com/en-us/library/windows/hardware/ff559209\(v=vs.85\).aspx](https://msdn.microsoft.com/en-us/library/windows/hardware/ff559209(v=vs.85).aspx)

### Microsoft general troubleshooting of Windows bug check codes

Use this information to troubleshoot Windows bug codes.

- If you recently added hardware to the system, try removing or replacing it. Or check with the manufacturer to see if any patches are available.
- Try running HP PC Hardware Diagnostics (UEFI).
- Check with the manufacturer to see if an updated system BIOS or firmware is available.
- Be sure that any expansion board is properly seated and all cables are completely connected.
- Confirm that any new hardware that is installed is compatible with the installed version of Windows.
- If new device drivers or system services have been added recently, try removing or updating them.



**NOTE:** Use safe mode when removing or disabling components. Safe mode loads only the minimum required drivers and system services during the Windows startup. To enter safe mode, restart your computer and press **F8** at the menu that displays the operating system choices. At the resulting **Windows Advanced Options** menu, choose **Safe Mode**.

- Run a virus detection program. Viruses can infect all types of hard drives formatted for Windows, and resulting drive corruption can generate system bug check codes. Be sure that the virus detection program checks the Master Boot Record for infections.
- Verify that the system has the latest service pack installed. To detect which service pack, if any, is installed on your system, click **Start**, click **Run**, type `winvver`, and then press **enter**. The **About Windows** dialog box displays the Windows version number and the version number of the service pack, if one has been installed.

- Disable BIOS memory options such as caching or shadowing.
- Check the System Log and Application Log in Event Viewer to see if any additional error messages have been logged recently. These might pinpoint the cause of the error.



## Use Windows Debugging Tool

Debugging Tools for Windows are the primary tools used by Microsoft software developers to analyze and resolve errors that result in memory dumps.

Use the tool ([https://msdn.microsoft.com/library/windows/hardware/ff551063%20\(v=vs.85\).aspx](https://msdn.microsoft.com/library/windows/hardware/ff551063%20(v=vs.85).aspx)) to determine the cause of the error. Follow general steps for downloading, setting up, and using the Windows 10 debugging tool. A similar process is used for Windows 7 or Windows 8.

---

 **NOTE:** The following screen shots provide only an example of the tool. Specifics shown are not representative of all applications of the debugging tool. This is a Microsoft tool supported by Microsoft.

---

## Windows Software Development Kit (SDK)

Use these steps to download and use the Windows SDK.

1. Download the SDK from the following link:  
<https://dev.windows.com/en-US/downloads/windows-10-sdk>
2. Set up the SDK in the configuration window (Windows 10 shown).

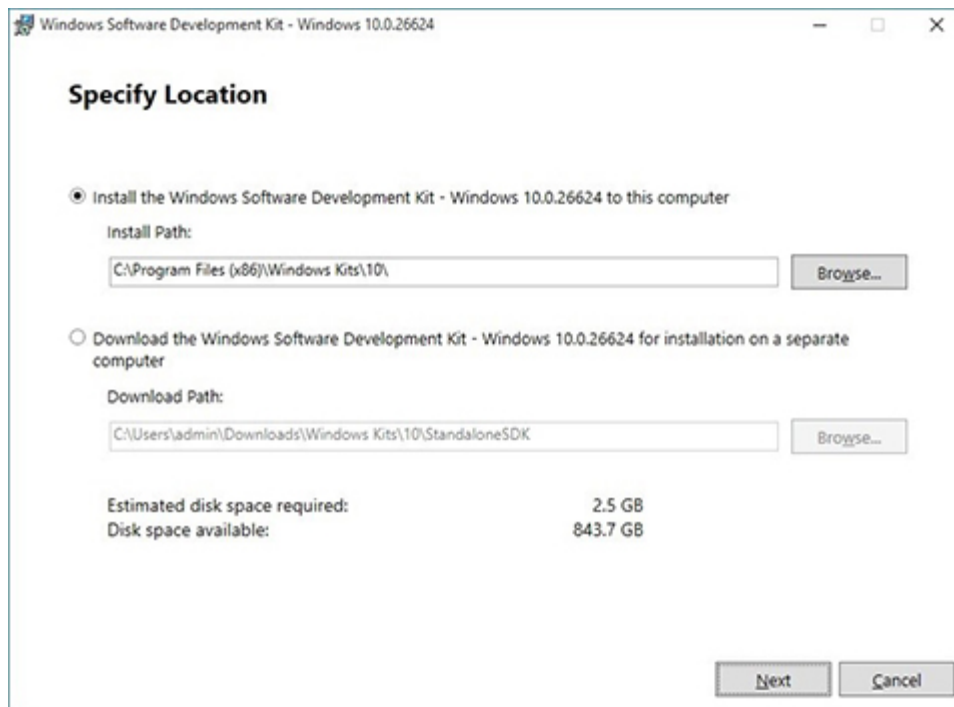

3. Select features to install.

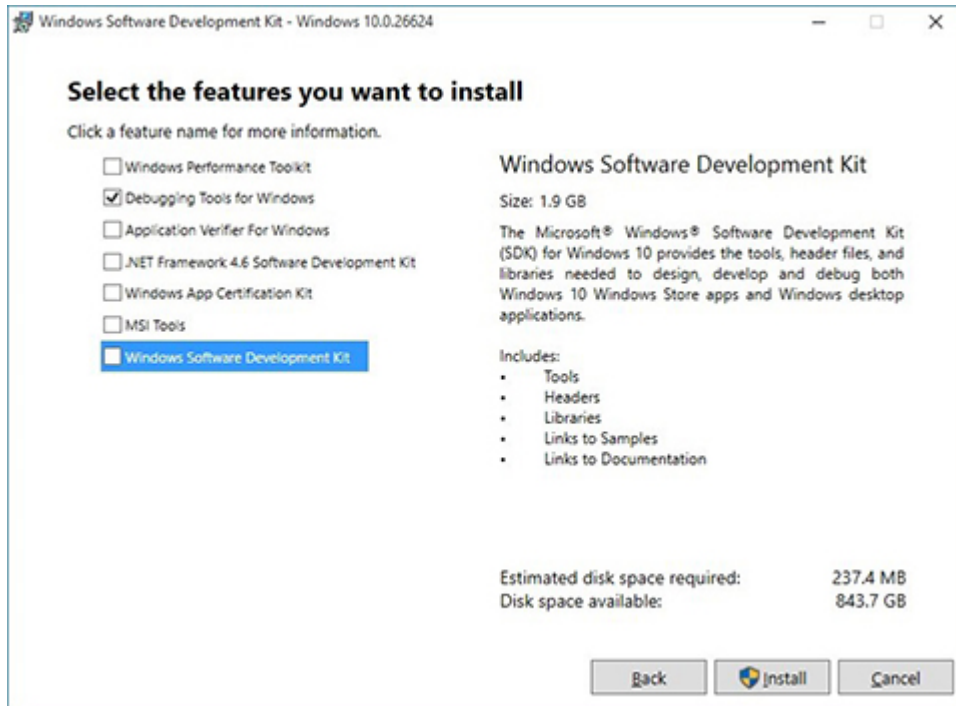

4. Run the SDK as an administrator.

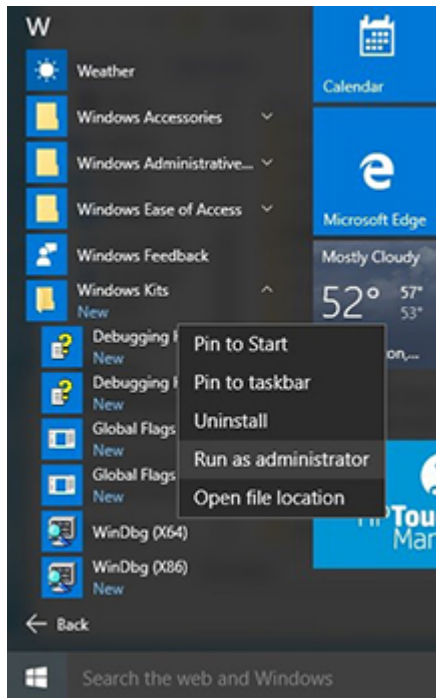

5. Set the symbol path. Select **File > Symbol File Path**.

- In the **Symbol path** box, type `SRV*C:\Windows\symbol_cache*http://msdl.microsoft.com/download/symbols`.
- Save the workspace.

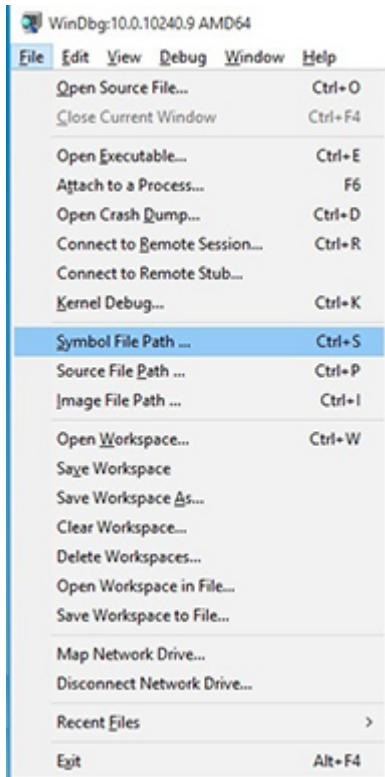

6. Open the crash dump file.

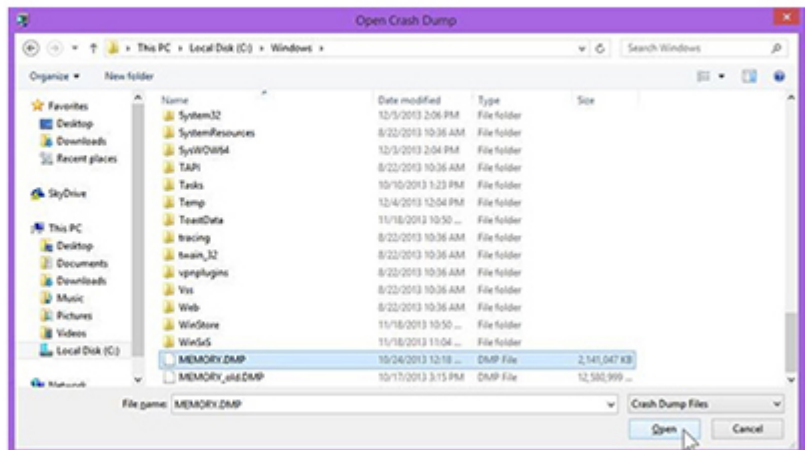
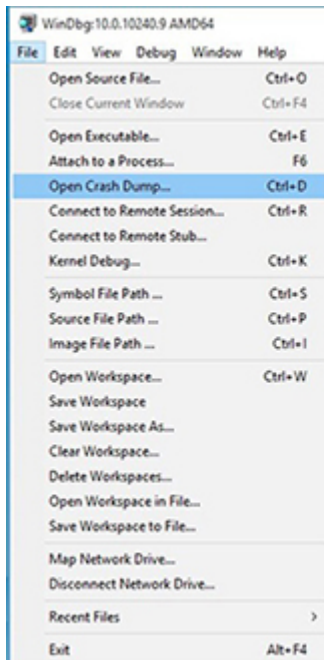

- Analyze the file. In the following memory dump sample, look for Bug Check 0x3B. The ATKMAG driver needs to be investigated for further root cause.

Lookup for Bug Check 0xC2.

```

1: kd> !analyze -v
.....
*
*                               Bugcheck Analysis
*
*
*
.....

SYSTEM_SERVICE_EXCEPTION (3b)
An exception happened while executing a system service routine.
Arguments:
Arg1: 00000000c0000005, Exception code that caused the bugcheck
Arg2: fffff8006d927acf, Address of the instruction which caused the bugcheck
Arg3: fffff80020e4e500, Address of the context record for the exception that caused the bugcheck
Arg4: 0000000000000000, zero.

Debugging Details:
-----
BUGCHECK_P1: c0000005
BUGCHECK_P2: fffff8006d927acf
BUGCHECK_P3: fffff80020e4e500
BUGCHECK_P4: 0
EXCEPTION_CODE: (NTSTATUS) 0xc0000005 - The instruction at 0x%p referenced memory at 0x%p. The memory

FAULTING_IP:
atikmpag+2facf
fffff800`6d927acf 4539bc2434030000 cmp     dword ptr [r12+334h],r15d
...

SYMBOL_STACK_INDEX: 0
SYMBOL_NAME: atikmpag+2facf
FOLLOWUP_NAME: MachineOwner
MODULE_NAME: atikmpag
IMAGE_NAME: atikmpag.sys
DEBUG_FLR_IMAGE_TIMESTAMP: 55479b42
STACK_COMMAND: .cxr 0xfffff80020e4e500 ; kb
BUCKET_ID_FUNC_OFFSET: 2facf
FAILURE_BUCKET_ID: 0x3B_atikmpag!Unknown_Function
BUCKET_ID: 0x3B_atikmpag!Unknown_Function
PRIMARY_PROBLEM_CLASS: 0x3B_atikmpag!Unknown_Function
ANALYSIS_SOURCE: KM
FAILURE_ID_HASH_STRING: km:0x3b_atikmpag!unknown_function
FAILURE_ID_HASH: {adb80875-801c-005a-68e8-645bb2f2c848}

```

```

Command - Dump C:\Windows\MEMORY.DMP - WinDbg:6.3.9600.16384 AMD64
.....
Loading User Symbols
Loading unloaded module list
.....
*
*                               Bugcheck Analysis
*
*
*
.....
Use !analyze -v to get detailed debugging information.
BugCheck C2. (7. 1205. 1159400. fffff80001137358)
*** ERROR: Module load completed but symbols could not be loaded for nldr.sys
Probably caused by : NETIO.SYS ( NETIO! ?? ::FNODOBFM::'string'+797c )
Followup: MachineOwner
.....
0: kd>

```

## Display issue: pixel anomalies

All HP notebook displays adhere to strict quality and reliability specifications. A small percentage of display panels might have minor cosmetic manufacturing anomalies or irregularities such as bright or dark dots in the viewable area. These cosmetic imperfections are common to all display panel types, not specifically HP products.

All display panel defects should be examined at the highest possible resolution using both the brightest and darkest possible backgrounds, because some subpixel failures might not be readily visible under certain conditions.

- Type 1: Bright dot on a dark background = Always On
- Type 2: Dark dot on a bright background = Always Off
- Combination = in any combination and any color that are always on or off

Use the HP PC Hardware Diagnostics (UEFI) tool to determine numbers of pixels and their distance. HP uses the following set of criteria when damaged displays are submitted for warranty coverage.

Source: <http://support.hp.com/us-en/document/c00035844>

**Table 6-56 Electrical defect criteria**

Panel resolution	Accept	Reject
<b>Subpixel faults</b>		
VGA, SVGA, SD, WSVGA, XGA, 720p, SD+, WXGA, HD	N ≤ 2 Type 1 N ≤ 2 Type 2	N ≥ 3 Type 1
WXGA+, SXGA+, HD+, SXGA+	N ≤ 3 Type 1 N ≤ 3 Type 2	N ≥ 4 Type 1
WSXGA+, UXGA, FHD, WUXGA	N ≤ 4 Type 1 N ≤ 4 Type 2	N ≥ 5 Type 1
QHD, QHD+, WQXGA, UD	N ≤ 5 Type 1 N ≤ 5 Type 2	N ≥ 6 Type 1
<b>Electrical defect clusters (defects within a 5x5 pixel block)</b>		
Minimum distance between ANY allowable defects (unless otherwise specified)	S ≥ 25 mm	S < 25 mm
Cluster with 2 or more subpixels with subpixel faults		Not allowed
Dim lines		Not allowed
Cross lines on/off		Not allowed
Horizontal lines on/off		Not allowed
Vertical lines on/off		Not allowed

 **NOTE:** Examine all LCD panel defects at the highest possible resolution using both the brightest and darkest possible backgrounds, because some subpixel failures might not be readily visible under certain conditions.

 **NOTE:** Contact support for assistance if issues are not listed.

## Cable management

Proper routing of the internal cables is critical to the operation of the computer. Follow good cable management practices when you have to remove and install components.

- Handle cables with care to avoid damage.
- Apply only the tension required to seat or unseat cables during insertion or removal from the connector.
- When possible, handle cables by the connector or pull-strap.
- Route cables in such a way that they cannot be caught or snagged by parts being removed or replaced.
- Keep cables away from direct contact with major heat sources, such as the heat sink. (Some air flow guides have a cable guide that lets you route cables safely around the heat sink.)
- Do not jam cables on top of daughterboards or memory modules (DIMMs). Circuit cards and DIMMs are not designed to take excessive pressure.
- Keep cables clear of any movable or rotating parts (such as a fan) to prevent them from being cut or crimped when the component is lowered into its normal position.
- In all cases, avoid bending or twisting the cables. Do not bend any cable sharply. A sharp bend can break the internal wires.
- Do not rely on components like the keyboard or service door to push cables down internally. Always position the cables to lie properly by themselves or in the cable guides and chassis areas designed for cable routing.



**IMPORTANT:** Always release connector latch before removing the cable. Otherwise, pulling the cable could damage the cable pins and result in a failed device.

---

## Connector types

There are several types of connectors on the system board with different requirements for cable removal or insertion.

---

 **IMPORTANT:** Do not touch connector pins and connector gold fingers directly with bare hands.

---

### Flex cable

Use this information to properly use flex cables.

When connecting flex cables to a ZIF connector, rotate the latch to 90°, push the cable completely, evenly into the connector, and then close the latch.

When removing flex cables from a ZIF connector on the system board, you must release the latch before removing the cable. Always follow these steps:

1. Flip the connector latch 90° to release the cable.
2. Grasp the cable end of the connector and pull it straight out.

---

 **IMPORTANT:** Always release connector latch before removing the cable. Otherwise, pulling the cable could damage the cable pins and result in a failed device.

---

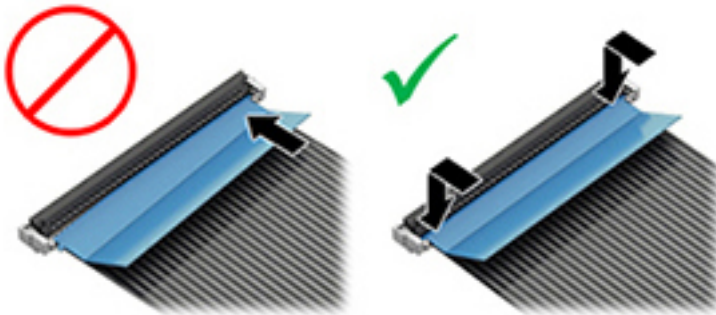

### Horizontal cable insertion

Use flat tool to pull connector evenly. Do not pull on cable to remove.

Slide connector into receptacle on same horizontal plane as board and use a flat tool to push evenly into receptacle.

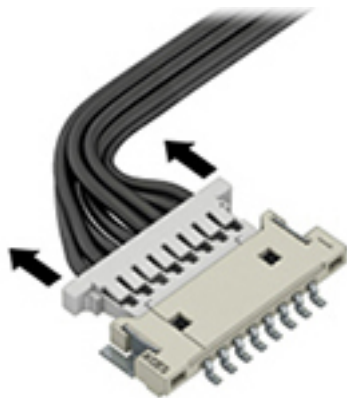

## Multiple-pin horizontal connector (LVDS cable to display panel)

Use these procedures to properly insert and remove a multiple-pin horizontal connector.

Insert procedure:

1. Slide connector evenly into receptacle on same horizontal plane as PCB connector.
2. Pull lock bar to insert and push both side connector horizontally to firmly lock.
3. Tape down lock bar over the panel to hold in position.

Reverse the previous procedure to remove the connector:

1. Remove tape.
2. Pull up bar (pull tape) and release the lock with the PCB connector.
3. Pull to the direction in parallel with PCB to withdraw the connector.

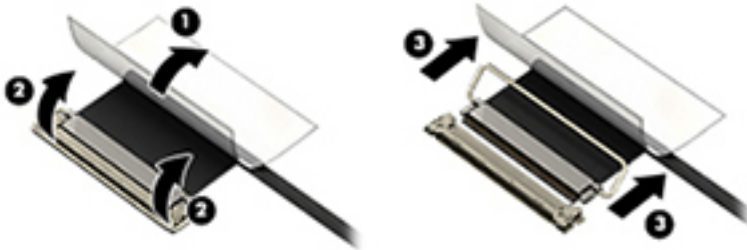

## Multiple-pin vertical connector (LVDS cable to system board)

Use this procedure to properly insert and remove a multiple-pin vertical connector.

- Remove the connector gasket before removing the connector.
- If the connector has a plastic pull tab, pull the tab to disconnect. Otherwise, use flat tool under the connector to remove evenly. Do not pull on the cable to remove.
- Press evenly when reseating, reconnecting, or installing the connector.

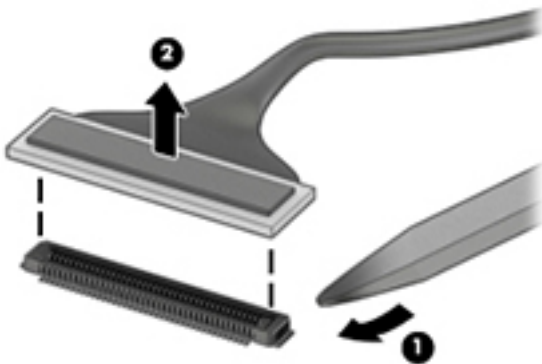

For more information about cable management, see [Cable management on page 155](#).



---

# 7 Using Setup Utility (BIOS)

Setup Utility, or Basic Input/Output System (BIOS), controls communication between all the input and output devices on the system (such as disk drives, display, keyboard, mouse, and printer). Setup Utility (BIOS) includes settings for the types of devices installed, the startup sequence of the computer, and the amount of system and extended memory.

---

 **NOTE:** To start Setup Utility on convertible computers, your computer must be in notebook mode and you must use the keyboard attached to your notebook.

---

## Starting Setup Utility (BIOS)

You have several ways to access the Setup Utility (BIOS).

---

 **IMPORTANT:** Use extreme care when making changes in Setup Utility (BIOS). Errors can prevent the computer from operating properly.

---

▲ Turn on or restart the computer and quickly press **f10**.

– or –

Turn on or restart the computer, quickly press **esc**, and then press **f10** when the Start menu is displayed.

## Updating Setup Utility (BIOS)

Updated versions of Setup Utility (BIOS) might be available on the HP website. Most BIOS updates on the HP website are packaged in compressed files called *SoftPaqs*. Some download packages contain a file named *Readme.txt*, which contains information regarding installing and troubleshooting the file.

### Determining the BIOS version

To decide whether you need to update Setup Utility (BIOS), first determine the BIOS version on your computer.

To reveal the BIOS version information (also known as *ROM date* and *System BIOS*), use one of these options.

- HP Support Assistant
  1. Type `support` in the taskbar search box, and then select the **HP Support Assistant** app.  
– or –  
Select the question mark icon in the taskbar.
  2. Select **My notebook**, and then select **Specifications**.
- Setup Utility (BIOS)
  1. Start Setup Utility (BIOS) (see [Starting Setup Utility \(BIOS\) on page 159](#)).
  2. Select **Main**, and then make note of the BIOS version.
  3. Select **Exit**, select one of the options, and then follow the on-screen instructions.
- In Windows, press `ctrl+alt+s`.

To check for later BIOS versions, see [Preparing for a BIOS update on page 161](#).

## Preparing for a BIOS update

Be sure to follow all prerequisites before downloading and installing a BIOS update.

 **IMPORTANT:** To reduce the risk of damage to the computer or an unsuccessful installation, download and install a BIOS update only when the computer is connected to reliable external power using the AC adapter. Do not download or install a BIOS update while the computer is running on battery power, docked in an optional docking device, or connected to an optional power source. During the download and installation, follow these instructions:

- Do not disconnect power from the computer by unplugging the power cord from the AC outlet.
- Do not shut down the computer or initiate Sleep.
- Do not insert, remove, connect, or disconnect any device, cable, or cord.

 **NOTE:** If your computer is connected to a network, consult the network administrator before installing any software updates, especially system BIOS updates.

## Downloading a BIOS update

After you review the prerequisites, you can check for and download BIOS updates.

1. Type `support` in the taskbar search box, and then select the **HP Support Assistant** app.  
– or –  
Select the question mark icon in the taskbar.
2. Select **Updates**, and then select **Check for updates and messages**.
3. Follow the on-screen instructions.
4. At the download area, follow these steps:
  - a. Identify the most recent BIOS update and compare it to the BIOS version currently installed on your computer. If the update is more recent than your BIOS version, make a note of the date, name, or other identifier. You might need this information to locate the update later, after it has been downloaded to your hard drive.
  - b. Follow the on-screen instructions to download your selection to the hard drive.  
  
Make a note of the path to the location on your hard drive where the BIOS update is downloaded. You will need to access this path when you are ready to install the update.

## Installing a BIOS update

BIOS installation procedures vary. Follow any instructions that appear on the screen after the download is complete. If no instructions appear, follow these steps.

1. Type `file` in the taskbar search box, and then select **File Explorer**.
2. Select your hard drive designation. The hard drive designation is typically Local Disk (C:).
3. Using the hard drive path you recorded earlier, open the folder that contains the update.

4. Double-click the file that has an .exe extension (for example, *filename.exe*).

The BIOS installation begins.

5. Complete the installation by following the on-screen instructions.



**NOTE:** After a message on the screen reports a successful installation, you can delete the downloaded file from your hard drive.

---

---

## 8 Backing up, restoring, and recovering

You can use Windows tools or HP software to back up your information, create a restore point, reset your computer, create recovery media, or restore your computer to its factory state. Performing these standard procedures can return your computer to a working state faster.

---

 **IMPORTANT:** If you will be performing recovery procedures on a tablet, the tablet battery must be at least 70% charged before you start the recovery process.

**IMPORTANT:** For a tablet with a detachable keyboard, connect the tablet to the keyboard base before beginning any recovery process.

---

## Backing up information and creating recovery media

These methods of creating recovery media and backups are available on select products only.

### Using Windows tools for backing up

HP recommends that you back up your information immediately after initial setup. You can do this task either using Windows Backup locally with an external USB drive or using online tools.

---

 **IMPORTANT:** Windows is the only option that allows you to back up your personal information. Schedule regular backups to avoid information loss.

 **NOTE:** If computer storage is 32 GB or less, Microsoft® System Restore is disabled by default.

---

### Using the HP Cloud Recovery Download Tool to create recovery media (select products only)

You can use the HP Cloud Recovery Download Tool to create HP Recovery media on a bootable USB flash drive.

For details:

▲ Go to <http://www.hp.com/support>, search for HP Cloud Recovery, and then select the result that matches the type of computer that you have.

---

 **NOTE:** If you cannot create recovery media yourself, contact support to obtain recovery discs. Go to <http://www.hp.com/support>, select your country or region, and then follow the on-screen instructions.

 **IMPORTANT:** HP recommends that you follow the [Restoring and recovery methods on page 165](#) to restore your computer before you obtain and use the HP recovery discs. Using a recent backup can return your machine to a working state sooner than using the HP recovery discs. After the system is restored, reinstalling all the operating system software released since your initial purchase can be a lengthy process.

---

# Restoring and recovering your system

You have several tools available to recover your system both within and outside of Windows if the desktop cannot load.

HP recommends that you attempt to restore your system using the [Restoring and recovery methods on page 165](#).

## Creating a system restore

System Restore is available in Windows. The System Restore software can automatically or manually create restore points, or snapshots, of the system files and settings on the computer at a particular point.

When you use System Restore, it returns your computer to its state at the time you made the restore point. Your personal files and documents should not be affected.

## Restoring and recovery methods

After you run the first method, test to see whether the issue still exists before you proceed to the next method, which might now be unnecessary.

1. Run a Microsoft System Restore.
2. Run Reset this PC.

---

 **NOTE:** The options **Remove everything** and then **Fully clean the drive** can take several hours to complete and leave no information on your computer. It is the safest way to reset your computer before you recycle it.

---

3. Recover using HP Recovery media. For more information, see [Recovering using HP Recovery media on page 165](#).

For more information about the first two methods, see the Get Help app:

Select the **Start** button, select the **Get Help** app, and then enter the task you want to perform.

---

 **NOTE:** You must be connected to the internet to access the Get Help app.

---

## Recovering using HP Recovery media

You can use HP Recovery media to recover the original operating system and software programs that were installed at the factory. On select products, it can be created on a bootable USB flash drive using the HP Cloud Recovery Download Tool.

For details, see [Using the HP Cloud Recovery Download Tool to create recovery media \(select products only\) on page 164](#).

---

 **NOTE:** If you cannot create recovery media yourself, contact support to obtain recovery discs. Go to <http://www.hp.com/support>, select your country or region, and then follow the on-screen instructions.

---

To recover your system:

- ▲ Insert the HP Recovery media, and then restart the computer.

---

 **NOTE:** HP recommends that you follow the [Restoring and recovery methods on page 165](#) to restore your computer before you obtain and use the HP recovery discs. Using a recent backup can return your machine to a working state sooner than using the HP recovery discs. After the system is restored, reinstalling all the operating system software released since your initial purchase can be a lengthy process.

---

## Changing the computer boot order

If your computer does not restart using the HP Recovery media, you can change the computer boot order, the order of devices listed in BIOS for startup information. You can select an optical drive or a USB flash drive, depending on the location of your HP Recovery media.

 **IMPORTANT:** For a tablet with a detachable keyboard, connect the tablet to the keyboard base before beginning these steps.

---

To change the boot order:

1. Insert the HP Recovery media.
2. Access the system **Startup** menu.
  - For computers or tablets with keyboards attached, turn on or restart the computer or tablet, quickly press **esc**, and then press **f9** for boot options.
  - For tablets without keyboards, turn on or restart the tablet, quickly press and hold the volume up button, and then select **f9**.

– or –

Turn on or restart the tablet, quickly press and hold the volume down button, and then select **f9**.
3. Select the optical drive or USB flash drive from which you want to boot, and then follow the on-screen instructions.

## Using HP Sure Recover (select products only)

Select computer models are configured with HP Sure Recover, a PC operating system (OS) recovery solution built into the hardware and software. HP Sure Recover can fully restore the HP OS image without installed recovery software.

Using HP Sure Recover, an administrator or user can restore the system and install:

- Latest version of the operating system
- Platform-specific device drivers
- Software applications, in the case of a custom image

To access the latest documentation for HP Sure Recover, go to <http://www.hp.com/support>. Follow the on-screen instructions to find your product and locate your documentation.



---

# 9 Using HP PC Hardware Diagnostics

You can use the HP PC Hardware Diagnostics utility to determine whether your computer hardware is running properly. The three versions are HP PC Hardware Diagnostics Windows, HP PC Hardware Diagnostics UEFI (Unified Extensible Firmware Interface), and (for select products only) Remote HP PC Hardware Diagnostics UEFI, a firmware feature.

## Downloading the HP PC Hardware Diagnostics Windows from the Microsoft Store

You can download the HP PC Hardware Diagnostics Windows from the Microsoft Store.

1. Select the Microsoft Store app on your desktop or enter `Microsoft Store` in the taskbar search box.
2. Enter `HP PC Hardware Diagnostics Windows` in the **Microsoft Store** search box.
3. Follow the on-screen directions.

The tool downloads to the selected location.

## Customizing Remote HP PC Hardware Diagnostics UEFI settings

Using the Remote HP PC Hardware Diagnostics setting in Computer Setup (BIOS), you can perform several customizations.

- Set a schedule for running diagnostics unattended. You can also start diagnostics immediately in interactive mode by selecting **Execute Remote HP PC Hardware Diagnostics**.
- Set the location for downloading the diagnostic tools. This feature provides access to the tools from the HP website or from a server that has been preconfigured for use. Your computer does not require the traditional local storage (such as a hard drive or USB flash drive) to run remote diagnostics.
- Set a location for storing the test results. You can also set the user name and password that you use for uploads.
- Display status information about the diagnostics run previously.

To customize Remote HP PC Hardware Diagnostics UEFI settings, follow these steps:

1. Turn on or restart the computer, and when the HP logo appears, press **F10** to enter Computer Setup.
2. Select **Advanced**, and then select **Settings**.

3. Make your customization selections.
4. Select **Main**, and then **Save Changes and Exit** to save your settings.

Your changes take effect when the computer restarts.

---

# 10 Specifications

This chapter provides specifications for your computer.

## Computer specifications

This section provides specifications for your computer. When traveling with your computer, the computer dimensions and weights, as well as input power ratings and operating specifications, provide helpful information.

**Table 10-1** Computer specifications

	Metric	U.S.
<b>Dimensions</b>		
Width	<b>39.84 cm</b>	15.69 in
Depth	<b>26.71 cm</b>	10.52 in
Height (front to back)	<b>2.69 cm</b>	1.06 in
<b>Weight</b> (varies by configuration and components)	<b>2.97 kg</b>	6.53 lb
<b>Input power</b>		

**Table 10-1 Computer specifications (continued)**

	Metric	U.S.
Operating voltage and current	5 V dc @ 2 A / 12 V dc @ 3 A / 15 V dc @ 3 A – 45 W USB-C	
	5 V dc @ 3 A / 9 V dc @ 3 A / 12 V dc @ 3.75 A / 15 V dc @ 3 A – 45 W USB-C	
	5 V dc @ 3 A / 9 V dc @ 3 A / 10 V dc @ 3.75 A / 12 V dc @ 3.75 A / 15 V dc @ 3 A / 20 V dc @ 2.25 A – 45 W USB-C	
	5 V dc @ 3 A / 9 V dc @ 3 A / 12 V dc @ 5 A / 15 V dc @ 4.33 A / 20 V dc @ 3.25 A – 65 W USB-C	
	5 V dc @ 3 A / 9 V dc @ 3 A / 10 V dc @ 5 A / 12 V dc @ 5 A / 15 V dc @ 4.33 A / 20 V dc @ 3.25 A – 65 W USB-C	
	5 V dc @ 3 A / 9 V dc @ 3 A / 10 V dc @ 5 A / 12 V dc @ 5 A / 15 V dc @ 5 A / 20 V dc @ 4.5 A – 90 W USB-C	
	19.5 V dc @ 2.31 A – 45 W	
	19.5 V dc @ 3.33 A – 65 W	
	19.5 V dc @ 4.62 A – 90 W	
	19.5 V dc @ 6.15 A – 120 W	
	19.5 V dc @ 6.9 A – 135 W	
	19.5 V dc @ 7.70 A – 150 W	
	19.5 V dc @ 10.3 A – 200 W	
	19.5 V dc @ 11.8 A – 230 W	
	19.5 V dc @ 16.92 A – 330 W	
<b>Temperature</b>		
Operating	<b>5°C to 35°C</b>	41°F to 95°F
Nonoperating	<b>–20°C to 60°C</b>	–4°F to 140°F
<b>Relative humidity (noncondensing)</b>		
Operating	10% to 90%	
Nonoperating	5% to 95%	
<b>Maximum altitude (unpressurized)</b>		
Operating	<b>–15 m to 3,048 m</b>	–50 ft to 10,000 ft
Nonoperating	<b>–15 m to 12,192 m</b>	–50 ft to 40,000 ft
<b>NOTE:</b> Applicable product safety standards specify thermal limits for plastic surfaces. The device operates well within this range of temperatures.		

## 39.6 cm (15.6 in) display specifications

This section provides specifications for your display.

**Table 10-2** Display specifications

	Metric	U.S.
Active diagonal size	39.6 cm	15.6 in
Resolution	1920 × 1080 (FHD) 3840 × 2160 (UHD)	
Surface treatment	Antiglare (FHD, UHD panels)	
Brightness	400 nits (UHD and FHD) 250 nits (FHD)	
Viewing angle	UWVA	
Backlight	WLED	
Display panel interface	eDP	

## Hard drive specifications

This section provides specifications for your hard drives.

**Table 10-3** Hard drive specifications

	500 GB*	750 GB*
<b>Dimensions</b>		
Height	9.5 mm	9.5 mm
Width	70 mm	70 mm
Weight	107 g max	102 g max
<b>Interface type</b>	SATA	SATA
<b>Transfer rate</b>	300 MB/s	300 MB/s
<b>Security</b>	ATA security	ATA security
<b>Seek times</b> (typical read, including setting)		
Single track	1.5 ms	1.1 ms
Average	12.0 ms	12.0 ms
Maximum	22.0 ms	21.0 ms
<b>Logical blocks</b>	976,752,240	1,465,149,168
<b>Disk rotational speed</b>	5400 rpm	5400 rpm
<b>Operating temperature</b>	0°C to 60°C (0°F to 140°F)	0°C to 60°C (0°F to 140°F)

\*Size refers to hard drive storage capacity. Actual accessible capacity is less. Actual drive specifications can differ slightly.

**NOTE:** Certain restrictions and exclusions apply. Contact support for details.

## Solid-state drive specifications

This section provides specifications for your solid-state drives.

**Table 10-4** Solid-state drive specifications

	256 GB*	512 GB*	1 TB*
<b>Dimensions</b>			
Height	1.0 mm	1.0 mm	1.0 mm
Length	50.8 mm	50.8 mm	50.8 mm
Width	28.9 mm	28.9 mm	28.9 mm
Weight	< 10 g	< 10 g	< 10 g
<b>Interface type</b>			
Ready time, maximum (to not busy)	1.0 ms	< 1.0 ms	1.0 ms
Access times, logical	0.1 ms	0.1 ms	0.1 ms
<b>Transfer rate</b>			
Sequential read	up to 2150 MB/s	up to 2150 MB/s	up to 2150 MB/s
Random read	Up to 300,000 IOPs	Up to 300,000 IOPs	Up to 300,000 IOPs
Sequential write	up to 1550 MB/s	up to 1550 MB/s	up to 1550 MB/s
Random write	Up to 100,000 IOPs	Up to 100,000 IOPs	Up to 100,000 IOPs
<b>Total logical sectors</b>	468,883,296	1,000,215,216	1,500,336,388
<b>Operating temperature</b>	<b>0°C to 70°C (32°F to 158°F)</b>		
*1 GB = 1 billion bytes when referring to hard drive storage capacity. Actual accessible capacity is less. Actual drive specifications may differ slightly.			
<b>NOTE:</b> Certain restrictions and exclusions apply. Contact support for details.			

## Solid-state drive specifications (SATA-3)

This section provides specifications for your solid-state drive.

**Table 10-5** Solid-state drive specifications

	128 GB*
<b>Dimensions</b>	
Height	1.35 mm
Weight	< 10 g
<b>Interface type</b>	
Ready time, maximum (to not busy)	1.0 ms
Access times, logical	0.1 ms
<b>Transfer rate</b>	up to 540 MB/s

**Table 10-5** Solid-state drive specifications (continued)

	<b>128 GB*</b>
<b>Total logical sectors</b>	234,441,648
<b>Operating temperature</b>	<b>0°C to 70°C</b> (32°F to 158°F)

\*1 GB = 1 billion bytes when referring to hard drive storage capacity. Actual accessible capacity is less. Actual drive specifications may differ slightly.

**NOTE:** Certain restrictions and exclusions apply. Contact support for details.





---

# 11 Statement of memory volatility

For general information regarding nonvolatile memory in HP Business computers, and to restore nonvolatile memory that can contain personal data after the system has been turned off and the hard drive has been removed, use these instructions.

HP Business computer products that use Intel®-based or AMD®-based system boards contain volatile DDR memory. The amount of nonvolatile memory present in the system depends upon the system configuration. Intel-based and AMD-based system boards contain nonvolatile memory subcomponents as originally shipped from HP, with the following assumptions:

- No subsequent modifications were made to the system.
- No applications, features, or functionality were added to or installed on the system.

Following system shutdown and removal of all power sources from an HP Business computer system, personal data can remain on volatile system memory (DIMMs) for a finite period of time and also remains in nonvolatile memory. Use the following steps to remove personal data from the computer, including the nonvolatile memory found in Intel-based and AMD-based system boards.

---

 **NOTE:** If your tablet has a keyboard base, connect to the keyboard base before beginning steps in this chapter.

---

## Current BIOS steps

Use these instructions to restore nonvolatile memory.

1. Follow these steps to restore the nonvolatile memory that can contain personal data. Restoring or reprogramming nonvolatile memory that does not store personal data is neither necessary nor recommended.

- a. Turn on or restart the computer, and then quickly press **esc**.

---

 **NOTE:** If the system has a BIOS administrator password, enter the password at the prompt.

---

- b. Select **Main**, select **Apply Factory Defaults and Exit**, and then select **Yes** to load defaults. The computer restarts.
- c. During the restart, press **esc** while the "Press the ESC key for Startup Menu" message is displayed at the bottom of the screen.

---

 **NOTE:** If the system has a BIOS administrator password, enter the password at the prompt.

---

- d. Select the **Security** menu, select **Restore Security Settings to Factory Defaults**, and then select **Yes** to restore security level defaults. The computer reboots.

- e. During the reboot, press **esc** while the "Press the ESC key for Startup Menu" message is displayed at the bottom of the screen.



---

**NOTE:** If the system has a BIOS administrator password, enter the password at the prompt.

---

- f. If an asset or ownership tag is set, select the **Security** menu and scroll down to the **Utilities** menu. Select **System IDs**, and then select **Asset Tracking Number**. Clear the tag, and then make the selection to return to the prior menu.
- g. If a DriveLock password is set, select the **Security** menu, and scroll down to **Hard Drive Utilities** under the **Utilities** menu. Select **Hard Drive Utilities**, select **DriveLock**, and then clear the check box for **DriveLock password on restart**. Select **OK** to proceed.
- h. Select the **Main** menu, and then select **Reset BIOS Security to factory default**. Select **Yes** at the warning message. The computer reboots.
- i. During the reboot, press **esc** while the "Press the ESC key for Startup Menu" message is displayed at the bottom of the screen.



---

**NOTE:** If the system has a BIOS administrator password, enter the password at the prompt.

---

- j. Select the **Main** menu, select **Apply Factory Defaults and Exit**, select **Yes** to save changes and exit, and then select **Shutdown**.
  - k. Reboot the system. If the system has a Trusted Platform Module (TPM), fingerprint reader, or both, one or two prompts will appear—one to clear the TPM and the other to Reset Fingerprint Sensor. Press or tap **f1** to accept or **f2** to reject.
  - l. Remove all power and system batteries for at least 24 hours.
2. Complete one of the following:
- Remove and retain the storage drive.  
– or –
  - Clear the drive contents by using a third-party utility designed to erase data from an SSD.  
– or –
  - Clear the contents of the drive by using the following BIOS Setup Secure Erase command option steps:

If you clear data using Secure Erase, you cannot recover it.

- a. Turn on or restart the computer, and then quickly press **esc**.
- b. Select the **Security** menu and scroll down to the **esc** menu.
- c. Select **Hard Drive Utilities**.
- d. Under **Utilities**, select **Secure Erase**, select the hard drive storing the data you want to clear, and then follow the on-screen instructions to continue.

– or –

Clear the contents of the drive using the following Disk Sanitizer commands steps:

- i. Turn on or restart the computer, and then quickly press **esc**.
- ii. Select the **Security** menu and scroll down to the **Utilities** menu.
- iii. Select **Hard Drive Utilities**.
- iv. Under **Utilities**, select **Disk Sanitizer**, select the hard drive with the data that you want to clear, and then follow the on-screen instructions to continue.

 **NOTE:** The amount of time it takes for Disk Sanitizer to run can take several hours. Plug the computer into an AC outlet before starting.

## Nonvolatile memory usage

Use this table to troubleshooting nonvolatile memory usage.

**Table 11-1** Troubleshooting steps for nonvolatile memory usage

Nonvolatile memory type	Amount (Size)	Does this memory store customer data?	Does this memory retain data when power is removed?	What is the purpose of this memory?	How is data entered into this memory?	How is this memory write-protected?
Real Time Clock (RTC) battery backed-up CMOS configuration memory	256 bytes	No	Yes	Stores system date and time and noncritical data.	RTC battery backed-up CMOS is programmed using Computer Setup (BIOS), or by changing the Windows date & time.	This memory is not write-protected.
Controller (NIC) EEPROM	64 KB (not customer accessible)	No	Yes	Stores NIC configuration and NIC firmware.	NIC EEPROM is programmed using a utility from the NIC vendor that can be run from DOS.	A utility must be used to write data to this memory and is available from the NIC vendor. Writing data to this ROM in an inappropriate manner will render the NIC non-functional.
DIMM Serial Presence Detect (SPD) configuration data	256 bytes per memory module, 128 bytes programmable (not customer accessible)	No	Yes	Stores memory module information.	DIMM SPD is programmed by the memory vendor.	Data cannot be written to this memory when the module is installed in a computer. The specific write-protection method varies by memory vendor.
System BIOS	9 MB	Yes	Yes	Stores system BIOS code and computer configuration data.	System BIOS code is programmed at the factory. Code is updated when the system BIOS is updated. Configuration data and settings are entered using the Computer Setup (BIOS) or a custom utility.	<b>NOTE:</b> Writing data to this ROM in an inappropriate manner can render the computer non-functional.  A utility must be used for writing data to this memory and is available on the HP website; go to <a href="http://www.hp.com/support">http://www.hp.com/support</a> . Select <b>Find your product</b> , and then follow the on-screen instructions.

**Table 11-1** Troubleshooting steps for nonvolatile memory usage (continued)

Nonvolatile memory type	Amount (Size)	Does this memory store customer data?	Does this memory retain data when power is removed?	What is the purpose of this memory?	How is data entered into this memory?	How is this memory write-protected?
Intel Management Engine Firmware (present only in select Elite or Z models. For more information, go to <a href="http://www.hp.com/support">http://www.hp.com/support</a> . Select <b>Identify your product for manuals and specific product information</b> , and then follow the on-screen instructions.)	1.5 MB or 7 MB	Yes	Yes	Stores Management Engine Code, Settings, Provisioning Data and iAMT third-party data store.	Management Engine Code is programmed at the factory. Code is updated via Intel secure firmware update utility. Unique Provisioning Data can be entered at the factory or by an administrator using the Management Engine (MEBx) setup utility. The third-party data store contents can be populated by a remote management console or local applications that have been registered by an administrator to have access to the space.	The Intel chipset is configured to enforce hardware protection to block all direct read-write access to this area. An Intel utility must be used for updating the firmware. Only firmware updates digitally signed by Intel can be applied using this utility.
Bluetooth flash (select products only)	2 megabits	No	Yes	Stores Bluetooth configuration and firmware.	Bluetooth flash is programmed at the factory. Tools for writing data to this memory are not publicly available but can be obtained from the silicon vendor.	A utility must be used for writing data to this memory and is made available through newer versions of the driver whenever the flash requires an upgrade.
802.11 WLAN EEPROM	4 kilobits to 8 kilobits	No	Yes	Stores configuration and calibration data.	802.11 WLAN EEPROM is programmed at the factory. Tools for writing data to this memory are not made public.	A utility must be used for writing data to this memory and is typically not made available to the public unless a firmware upgrade is necessary to address a unique issue.
Camera (select products only)	64 kilobits	No	Yes	Stores camera configuration and firmware.	Camera memory is programmed using a utility from the device manufacturer that can be run from Windows.	A utility must be used for writing data to this memory and is typically not made available to the public unless a firmware upgrade is necessary to address a unique issue.
Fingerprint reader (select products only)	512 KB flash	Yes	Yes	Stores fingerprint templates.	Fingerprint reader memory is programmed by user enrollment in HP ProtectTools Security Manager.	Only a digitally signed application can make the call to write to the flash.

## Questions and answers

Use this section to answer your questions about nonvolatile memory.

1. How can the BIOS settings be restored (returned to factory settings)?

---

 **IMPORTANT:** The restore defaults feature does not securely erase any data on your hard drive. See question and answer 6 for steps to securely erase data.

The restore defaults feature does not reset the Custom Secure Boot keys. See question and answer 7 for information about resetting the keys.

---

- a. Turn on or restart the computer, and then quickly press `esc`.
- b. Select **Main**, and then select **Apply Factory Defaults and Exit**.
- c. Follow the on-screen instructions.
- d. Select **Main**, select **Save Changes and Exit**, and then follow the on-screen instructions.

## 2. What is a UEFI BIOS, and how is it different from a legacy BIOS?

The Unified Extensible Firmware Interface (UEFI) BIOS is an industry-standard software interface between the platform firmware and an operating system (OS). It replaces the older BIOS architecture but supports much of the legacy BIOS functionality.

Like the legacy BIOS, the UEFI BIOS provides an interface to display the system information and configuration settings and to change the configuration of your computer before an OS is loaded. BIOS provides a secure runtime environment that supports a Graphic User Interface (GUI). In this environment, you can use either a pointing device (touch screen, touchpad, pointing stick, or USB mouse) or the keyboard to navigate and make menu and configuration selections. The UEFI BIOS also contains basic system diagnostics.

The UEFI BIOS provides functionality beyond that of the legacy BIOS. In addition, the UEFI BIOS works to initialize the computer's hardware before loading and executing the OS; the runtime environment allows the loading and execution of software programs from storage devices to provide more functionality, such as advanced hardware diagnostics (with the ability to display more detailed system information) and advanced firmware management and recovery software.

HP has provided options in Computer Setup (BIOS) to allow you to run in legacy BIOS, if required by the operating system. Examples of this requirement would be if you upgrade or downgrade the OS.

## 3. Where is the UEFI BIOS located?

The UEFI BIOS is located on a flash memory chip. You must use a utility to write to the chip.

## 4. What kind of configuration data is stored on the DIMM Serial Presence Detect (SPD) memory module? How would this data be written?

The DIMM SPD memory contains information about the memory module, such as size, serial number, data width, speed and timing, voltage, and thermal information. This information is written by the module manufacturer and stored on an EEPROM. You cannot write to this EEPROM when the memory module is installed in a computer. Third-party tools do exist that can write to the EEPROM when the memory module is not installed in a computer. Various third-party tools are available to read SPD memory.

## 5. What is meant by "Restore the nonvolatile memory found in Intel-based system boards"?

This message relates to clearing the Real Time Clock (RTC) CMOS memory that contains computer configuration data.

## 6. How can the BIOS security be reset to factory defaults and erase the data?

---

 **IMPORTANT:** Resetting results in the loss of information.

These steps do not reset Custom Secure Boot Keys. See question and answer 7 for information about resetting the keys.

---

- a. Turn on or restart the computer, and then quickly press `esc`.
- b. Select **Main**, and then select **Reset Security to Factory Defaults**.
- c. Follow the on-screen instructions.
- d. Select **Main**, select **Save Changes and Exit**, and then follow the on-screen instructions.

#### 7. How can the Custom Secure Boot Keys be reset?

Secure Boot is a feature to ensure that only authenticated code can start on a platform. If you enabled Secure Boot and created Custom Secure Boot Keys, disabling Secure Boot does not clear the keys. You must also select to clear the Custom Secure Boot Keys. Use the same Secure Boot access procedure that you used to create the Custom Secure Boot Keys, but select to clear or delete all Secure Boot Keys.

- a. Turn on or restart the computer, and then quickly press `esc`.
- b. Select the **Security** menu, select **Secure Boot Configuration**, and then follow the on-screen instructions.
- c. At the **Secure Boot Configuration** window, select **Secure Boot**, select **Clear Secure Boot Keys**, and then follow the on-screen instructions to continue.

# 12 Power cord set requirements

This chapter provides power cord requirements for countries and regions.

The wide-range input feature of the computer permits it to operate from any line voltage from 100 V ac to 120 V ac, or from 220 V ac to 240 V ac.

The 3-conductor power cord set included with the computer meets the requirements for use in the country or region where the equipment is purchased.

Power cord sets for use in other countries or regions must meet the requirements of the country and region where the computer is used.

## Requirements for all countries

These power cord requirements are applicable to all countries and regions.

- The length of the power cord set must be at least **1.0 m** (3.3 ft) and no more than **2.0 m** (6.5 ft).
- All power cord sets must be approved by an acceptable accredited agency responsible for evaluation in the country or region where the power cord set will be used.
- The power cord sets must have a minimum current capacity of 10 A and a nominal voltage rating of 125 V ac or 250 V ac, as required by the power system of each country or region.
- The appliance coupler must meet the mechanical configuration of an EN 60 320/IEC 320 Standard Sheet C13 connector for mating with the appliance inlet on the back of the computer.

## Requirements for specific countries and regions

To determine power cord requirements for specific countries and regions, use this table.

**Table 12-1** Power cord requirements for specific countries and regions

Country/region	Accredited agency	Applicable note number
Argentina	IRAM	1
Australia	SAA	1
Austria	OVE	1
Belgium	CEBEC	1
Brazil	ABNT	1
Canada	CSA	2

**Table 12-1** Power cord requirements for specific countries and regions (continued)

Country/region	Accredited agency	Applicable note number
Chile	IMQ	1
Denmark	DEMKO	1
Finland	FIMKO	1
France	UTE	1
Germany	VDE	1
India	BIS	1
Israel	SII	1
Italy	IMQ	1
Japan	JIS	3
The Netherlands	KEMA	1
New Zealand	SANZ	1
Norway	NEMKO	1
The People's Republic of China	CCC	4
Saudi Arabia	SASO	7
Singapore	PSB	1
South Africa	SABS	1
South Korea	KTL	5
Sweden	SEMKO	1
Switzerland	SEV	1
Taiwan	BSMI	6
Thailand	TISI	1
The United Kingdom	ASTA	1



**Table 12-1 Power cord requirements for specific countries and regions (continued)**

Country/region	Accredited agency	Applicable note number
The United States	UL	2
<ol style="list-style-type: none"> <li>1. The flexible cord must be Type H05VV-F, 3-conductor, 0.75 mm<sup>2</sup> conductor size. Power cord set fittings (appliance coupler and wall plug) must bear the certification mark of the agency responsible for evaluation in the country or region where it will be used.</li> <li>2. The flexible cord must be Type SVT/SJT or equivalent, No. 18 AWG, 3-conductor. The wall plug must be a two-pole grounding type with a NEMA 5-15P (15 A, 125 V ac) or NEMA 6-15P (15 A, 250 V ac) configuration. CSA or C-UL mark. UL file number must be on each element.</li> <li>3. The appliance coupler, flexible cord, and wall plug must bear a T mark and registration number in accordance with the Japanese Dentori Law. The flexible cord must be Type VCTF, 3-conductor, 0.75 mm<sup>2</sup> or 1.25 mm<sup>2</sup> conductor size. The wall plug must be a two-pole grounding type with a Japanese Industrial Standard C8303 (7 A, 125 V ac) configuration.</li> <li>4. The flexible cord must be Type RVV, 3-conductor, 0.75 mm<sup>2</sup> conductor size. Power cord set fittings (appliance coupler and wall plug) must bear the CCC certification mark.</li> <li>5. The flexible cord must be Type H05VV-F 3-conductor, 0.75 mm<sup>2</sup> conductor size. KTL logo and individual approval number must be on each element. Approval number and logo must be printed on a flag label.</li> <li>6. The flexible cord must be Type HVCTF 3-conductor, 1.25 mm<sup>2</sup> conductor size. Power cord set fittings (appliance coupler, cable, and wall plug) must bear the BSMI certification mark.</li> <li>7. For 127 V ac, the flexible cord must be Type SVT or SJT 3-conductor, 18 AWG, with plug NEMA 5-15P (15 A, 125 V ac), with UL and CSA or C-UL marks. For 240 V ac, the flexible cord must be Type H05VV-F 3-conductor, 0.75 mm<sup>2</sup> or 1.00 mm<sup>2</sup> conductor size, with plug BS 1363/A with BSI or ASTA marks.</li> </ol>		



---

# 13 Recycling

When a nonrechargeable or rechargeable battery has reached the end of its useful life, do not dispose of the battery in general household waste. Follow the local laws and regulations in your area for battery disposal.

HP encourages customers to recycle used electronic hardware, HP original print cartridges, and rechargeable batteries. For more information about recycling programs, see the HP website at <http://www.hp.com/recycle>.



---

# Index

## A

- antenna
  - illustrated 26
  - removal 53
  - spare part number 26, 54

## B

- backup, creating 163
- backups 163, 164
- battery
  - removal 41
  - spare part number 41
- battery support bracket
  - illustrated 24
  - removal 63
  - spare part number 24, 63
- BIOS
  - determining version 160
  - downloading an update 161
  - starting the Setup Utility 159
  - updating 160
- Bluetooth label 7
- boot order, changing 166
- bottom cover
  - removal 40
  - spare part numbers 40

## C

- Cable Kit
  - spare part number 29
- card reader board
  - removal 62
  - spare part number 62
- card reader board bracket
  - removal 63
  - spare part number 63
- card reader board cable
  - removal 61
  - spare part numbers 61

## cautions

- electrostatic discharge 31, 34

## components

- bottom 7
- display 7, 9
- left side 7, 8
- right side 7
- top 7

## computer major components 17

## computer specifications 169

## D

- display
  - specifications 169, 171
- display assembly
  - removal 46
  - spare part numbers 46
  - subcomponents 26
- display back cover
  - illustrated 26
  - spare part numbers 26
- display bezel
  - illustrated 26
  - removal 48
  - spare part numbers 26, 48
- display components 9
- display hinge
  - removal 49
  - spare part number 50
- display panel
  - illustrated 26
  - removal 50
  - spare part numbers 26, 51
- display panel cable
  - illustrated 26
  - removal 52
  - spare part number 26, 53

## E

- electrostatic discharge (ESD) 31, 34
  - preventing damage 31, 34, 35

## F

- fan
  - removal 45
  - spare part numbers 45
- fingerprint reader module
  - removal 57
  - spare part numbers 57
- fingerprint reader module bracket
  - removal 57
  - spare part number 57
- fingerprint reader module cable
  - removal 56
  - spare part numbers 56

## G

- grounding methods 31, 34, 35
- guidelines
  - packaging 31, 36
  - transporting 31, 36
  - workstation 31, 32

## H

- hard drive
  - specifications 169, 171
- heat sink
  - removal 68
  - spare part numbers 68
- hinge
  - illustrated 26
  - spare part number 26
- hinge cap
  - spare part number 49
- hinge cover
  - illustrated 26

- removal 49
- spare part number 26

- hot keys
  - break 7
  - insert 7
  - pause 7
  - programming query 7
  - scroll lock 7

- hotkeys, using 7
- HP PC Hardware Diagnostics Windows
  - downloading 167

- HP Recovery media
  - recovery 165

- HP Sure Recover 166

- HP Sure Start 175

## I

- I/O bracket
  - illustrated 24
  - removal 67
  - spare part number 24, 67

- illustrated parts catalog 17

## K

- keyboard
  - product description 4

## L

- labels
  - Bluetooth 7
  - regulatory 7
  - serial number 7
  - service 7
  - wireless certification 7
  - WLAN 7

- left side components 8

## M

- memory
  - nonvolatile 175
  - volatile 175
- memory module
  - illustrated 26
  - removal 43
  - spare part numbers 26, 43

## N

- NFC module
  - illustrated 23
  - removal 60
  - spare part number 23, 60

- NFC module cable
  - removal 59
  - spare part number 59
- nonvolatile memory 175

## P

- packaging guidelines 31, 36
- pointing device, product description 4

- power cord
  - requirements for all countries 181
  - requirements for specific countries and regions 181
  - set requirements 181

- product description
  - keyboard 4
  - pointing device 4
- product name and number, computer 7

## R

- recovery 163, 165
  - discs 165
  - media 165
  - USB flash drive 165
- recovery media 164
  - creating using HP Cloud Recovery Download Tool 164
  - creating using Windows tools 164
- regulatory information
  - regulatory label 7
  - wireless certification labels 7
- Remote HP PC Hardware Diagnostics
  - UEFI settings
    - customizing 167
- removal and replacement
  - procedures 40
- removing personal data from volatile system memory 175
- restoring 163
- restoring and recovery methods 165
- right side components 7
- RJ45 cover
  - removal 68

## S

- sensor board
  - removal 55
  - spare part number 55

- sensor board cable
  - removal 54
  - spare part number 54
- serial number, computer 7
- service labels, locating 7
- solid-state drive
  - removal 44
  - spare part numbers 28, 44
  - specifications 172
- speaker
  - removal 71
  - spare part number 71
- special keys, using 13
- specifications
  - computer 169
  - display 169, 171
  - hard drive 169, 171
  - solid-state drive 172
- static electricity 31, 34
- system board
  - removal 64
  - spare part numbers 64
- system memory, removing personal data from volatile 175
- system restore 165
- system restore point, creating 164

## T

- touchpad
  - removal 70
  - spare part numbers 70
- touchpad cable
  - removal 59
  - spare part number 59
- transporting guidelines 31, 36
- traveling with the computer 7

## W

- webcam/microphone module
  - illustrated 26
  - removal 52
  - spare part number 53
  - spare part numbers 26
- Windows
  - backup 163
  - recovery media 163
  - system restore point 164
- Windows tools, using 164
- wireless antenna
  - illustrated 26

- removal 53
- spare part number 26, 54
- wireless certification label 7
- WLAN antenna
  - removal 53
  - spare part number 54
- WLAN device 7
- WLAN label 7
- WLAN module shield
  - removal 66
  - spare part number 66
- workstation guidelines 31, 32

