

Intelli-Balance™ 100 Energy Recovery Ventilator

Intelli-Balance™
100

FV-10VEC1 (Cold Climate)
FV-10VE1 (Temperate Climate)



Powerful operation at **0.4"**
static pressure

[See PQ Curves]

- Designed for multi-family dwellings and new air tight homes built to meet energy efficiency standards
- Engineered for use in any North America Climate Zone
- Two (2) powerful ECM motors with Smart Flow™ technology ensure optimum CFM output by overcoming static pressure to effectively remove stale, moist air and replace it with fresh air
- Pick-A-Flow airflow selector (50 to 100 CFM) provides customizable airflow to create balanced, positive or negative pressure within the home
- Exclusive built-in ASHRAE 62.2 timing function helps ensure code compliance
- MERV 8 filter included; optional MERV 8 and MERV 13 replacements available
- Connect to existing ductwork or use as a standalone, whole-house ventilation solution
- Can be used to meet green building code requirements and helps minimize the impact to your HERS/ERI index

ADDITIONAL BENEFITS

- High efficiency exchange capillary core recovers heat and moisture
- Three mounting options - wall, ceiling or on a shelf
- Four integrated dual 4" or 6" duct adapters (2 exhaust, 2 supply)
- Includes static pressure access ports with balancing instructions on the ERV
- Model FV-10VEC1 meets Ontario, ENERGY STAR® and Novoclimat requirements*
- 6 Year Warranty on ECM motor, 3 Years on all other parts

*Meets strict energy efficiency guidelines set by Natural Resources Canada and is ENERGY STAR® certified for the Canadian market only

The power of performance, with exclusive smart sensing technology

Intelli-Balance™
100



FV-10VEC1* (Cold Climate)
FV-10VE1 (Temperate Climate)



*Meets strict energy efficiency guidelines set by Natural Resources Canada and is ENERGY STAR® certified for the Canadian market only.

COST EFFECTIVE, CODE COMPLIANT ERV FOR ANY CLIMATE ZONE

Intelli-Balance™ 100 is a powerful, high performance, high efficiency Energy Recovery Ventilator (ERV) that's designed to help you meet ASHRAE 62.2 requirements. This unique and cost effective ERV was engineered for total versatility and installation flexibility, in any climate zone. Built-in controls minimize the time it takes to determine desired airflow, as well as verify and maintain performance. Intelli-Balance™ 100 allows you to simply design and specify your ventilation system requirements, improve IAQ and reduce ventilation costs.

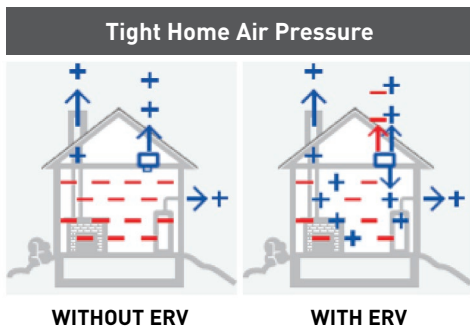
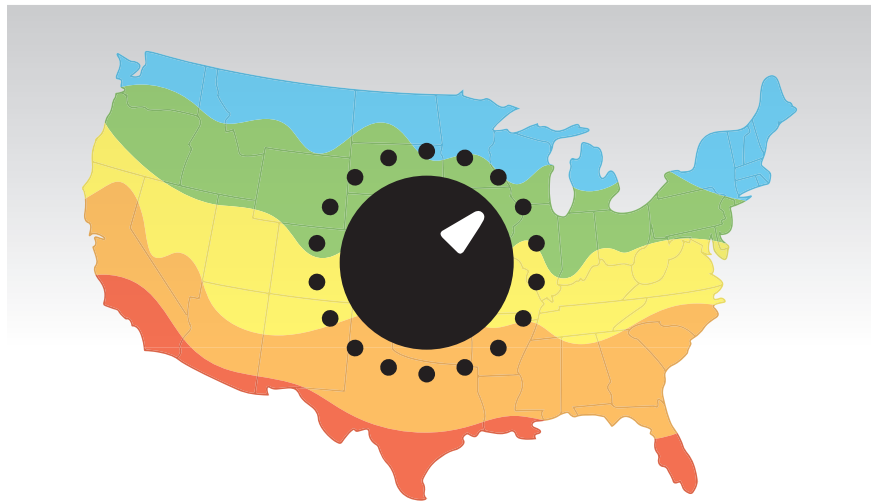

BALANCED VENTILATION

Tightly built homes and buildings utilizing exhaust only fans can create negative pressure. Intelli-Balance™ 100 solves this by supplying air to replace exhausted air, helping to balance air pressure within the home.

Panasonic Intelli-Balance™ 100 ERV uses four integrated dual 4" or 6" round duct adaptors – two to exhaust stale air and two to supply fresh. Its low, continuous run helps remove moist, stale air and replace it with fresh air.

Intelli-Balance™ 100 can be ceiling or wall mounted, does not require connection to the Central HVAC or the addition of a condensation line. This allows it to be installed in many places throughout the home to meet IAQ, health and comfort needs.



ECM MOTOR TECHNOLOGY

Intelli-Balance™ 100 uses two (2) ECM brushless motors with built-in SmartFlow™ technology for precision ventilation. When the ERV senses static pressure, its speed is automatically increased to ensure optimal CFM output; regardless of a complicated duct run. This feature provides peace of mind, as the installer doesn't have to worry about compromising the ERV's performance. Both ECM motors are rated for continuous run and are totally enclosed to ensure long-life and continuous quiet operation. Each motor also comes equipped with a thermal cutoff fuse.

Built-In Controls

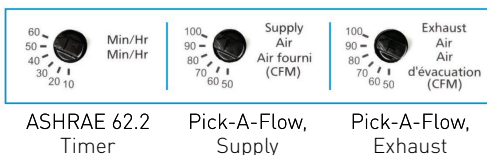

PICK-A-FLOW™ AIRFLOW TECHNOLOGY

Intelli-Balance™ 100 includes a built-in Pick-A-Flow™ airflow selector that provides the unique ability to select your required supply (50-60-70-80-90-100 CFM) and exhaust airflow (50-60-70-80-90-100 CFM), with the simple turn of a dial. This truly customizable airflow capability allows you to create balanced, positive or negative pressure within the home.

ASHRAE 62.2 TIMING FUNCTION

The adjustable Minutes Per Hour (Min/Hr) timer allows the user to set the number of minutes per hour the ERV should run. This ensures consistent and controlled ventilation throughout the day for compliance with ASHRAE 62.2. Factory default setting is 60 Min/Hr.

FILTERS & MAINTENANCE

Intelli-Balance™ 100 has two filters that clean the exhaust and supply air before passing through the ERV core, extending the life of the core. A hinged access panel allows for quick and easy product maintenance and filter checks. Convenient light indicator and unobtrusive alarm signal on the access panel will help inform the homeowner when it's time to check and clean the filters. Both filters should be vacuumed with a soft brush attachment every 2-3 months or as needed, and the supply air filter should be inspected every 90 days and replaced every 6 months to maintain the ERV's peak performance.

EXCHANGE CAPILLARY CORE

Indoor and outdoor air pass through Panasonic's patented capillary core designed to transfer heat and moisture. This process tempers supply air while transferring moisture. The core's high latent energy (moisture) transfer makes Intelli-Balance 100 ideal for use in most climate zones, as it helps expel moisture during incidences of high relative humidity (RH) and helps return moisture back inside during the winter for a healthier, more comfortable living environment.

WHOLE HOUSE ERV

Intelli-Balance™ 100 is a ceiling or wall mount Energy Recovery Ventilator (ERV) that's ideal for meeting whole house ventilation requirements under ASHRAE 62.2. Intelli-Balance™ 100 is also an ideal choice when partnered with mini-splits or VRF Heat Pumps for fresh, balanced air with energy recovery which makes it a very affordable, cost-effective IAQ solution.

Ideal for: Single Family Homes (< 3,000 sq. ft., up to 7 bedrooms) / Condominiums / Apartments / Housing Authority Properties / Hotels / Studio apartments.

ASHRAE 62.2 2010 AND 2013 STANDARD

The American Society of Heating, Refrigerating and Air Conditioning Engineers (ASHRAE) set a standard for whole house ventilation, requiring that continuous mechanical ventilation be 7.5 CFM per bedroom (master bedroom X 2) plus 1 CFM per 100 square feet, with some not to exceed 1.0. ASHRAE 62.2-2013 requires a ventilation rate of 7.5 CFM per person plus 3 CFM per 100 square feet. Please check with your local code to determine which ventilation standard you should follow. Panasonic Intelli-Balance™ 100 ERV is an affordable, efficient way to meet the ASHRAE 62.2 standard.

OPERATION

FV-10VEC1 is recommended for areas where temperatures can drop as low as -22°F (-30°C). When the outdoor temperature is < -22°F (-30°C), the defrost cycle is initiated and the product will stop operating for 47 minutes, then operate in heat exchange mode for 4 minutes in order to sample the outdoor temperature. It then operates in circulation mode for 9 minutes in order to defrost (exhaust and supply air are 50 CFM). Defrost cycle overrides the ASHRAE 62.2 timing function.

FV-10VE1 is recommended for areas where temperatures can drop as low as 14°F (-10°C). When the outdoor temperature is < 14°F (-10°C), the defrost cycle is initiated and the product will stop operating for 56 mins, then operate in heat exchange mode for 4 minutes in order to sample the outdoor temperature (exhaust and supply air are 50 CFM). Defrost cycle overrides the ASHRAE 62.2 timing function.



Supply Air Filter (MERV 8 included, MERV 13 Optional)

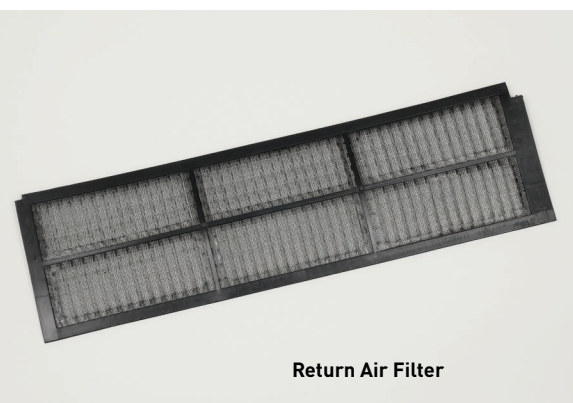

Return Air Filter

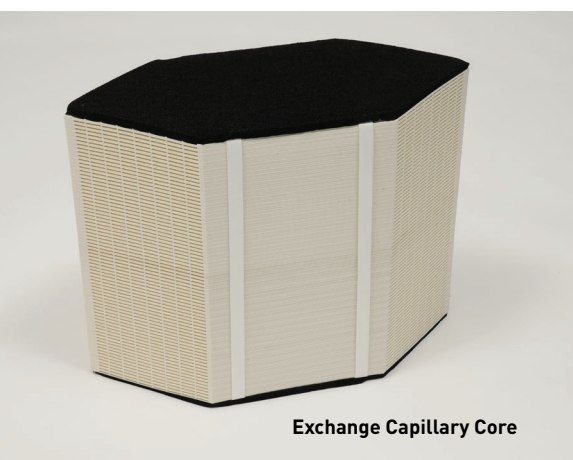

Exchange Capillary Core

Accessories (Sold Separately):

FV-FL0810VE1: MERV 8 Replacement Filter

FV-FV1310VE1: MERV 13 Optional Replacement Filter

FV-WC04VE1: Optional Exterior Wall Cap



FV-WC04VE1*

*FV-WC04VE1 is ideal for use in smaller, multi-family applications. It is not recommended for use at CFM settings higher than 50 CFM.

FV-10VEC1/FV-10VE1

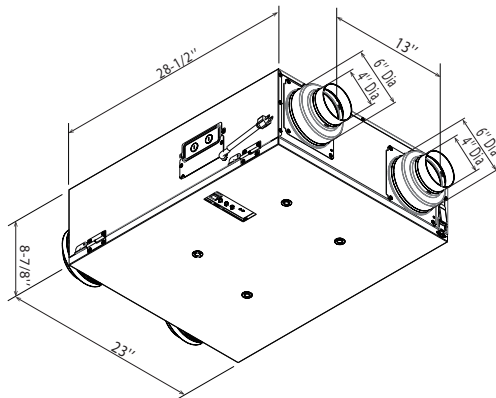

INSTALLATION

Mounting: Intelli-Balance™ 100 can easily be mounted in the ceiling or on a wall using the included cleat hanger bar. It measures 23" wide and fits between joists 16" on center. Adjustable brackets and screws are provided to secure the unit to the joist on 4 corners. Intelli-Balance™ 100 can also be chain mounted and suspended. It is recommended that you use 4 chains, 20-24" in length with a weight capacity of +66 pounds.

Wiring: Power consumption is 64 Watts on FV-10VEC1 and 62 Watts on FV-10VE1, with a power rating of 120/60 V/Hz.

Duct: Insulated 4" or 6" duct is recommended.

Static Pressure Access Ports: The unit's access panel incorporates static pressure ports for measuring the differential pressure of fresh air and exhaust air so the dampers can be adjusted for balancing airflows.

Intelli-Balance 100	FV-10VEC1		FV-10VE1	
Characteristics	COLD CLIMATE		TEMPERATE CLIMATE	
Static pressure in inches w.g.	0.1	0.4	0.1	0.4
Net Exhaust Air Volume (CFM)	96	95	95	95
Net Supply Air Volume (CFM)	98	96	99.0	101
Power Consumption (Watts)	64.0	84.0	62.0	80.0
Power Rating (V/Hz)	120/60		120/60	

FV-10VEC1

Supply Temperature		Net Air Flow		Power Consumed (Watts)	Sensible Recovery Efficiency	Apparent Sensible Effectiveness	Net Moisture Transfer
°C	°F	L/S	CFM		Efficiency	Effectiveness	Transfer
Heating							
0	32	25	53	24	81	88	0.8
0	32	31	67	34	77	86	0.76
0	32	40	86	54	75	83	0.72
-25	-13	27	57	66	65	85	0.7
-25	-13	32	68	84	64	80	0.7
Cooling							
35	95	23	48	16	Total Recovery Efficiency 65		

FV-10VE1

Supply Temperature		Net Air Flow		Power Consumed (Watts)	Sensible Recovery Efficiency	Apparent Sensible Effectiveness	Net Moisture Transfer
°C	°F	L/S	CFM		Efficiency	Effectiveness	Transfer
Heating							
0	32	25	54	20	79	90	0.76
0	32	32	67	28	79	88	0.76
0	32	41	87	46	75	85	0.72
-25	-13	-	-	-	-	-	-
-25	-13	-	-	-	-	-	-
Cooling							
35	95	25	52	22	Total Recovery Efficiency 73		

FV-10VEC1 50-80-100 CFM 4 x 4" or 6" Ducts

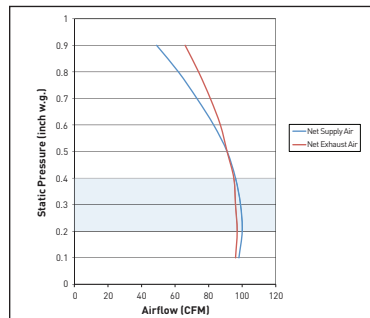

FV-10VE1 50-80-100 CFM 4 x 4" or 6" Ducts

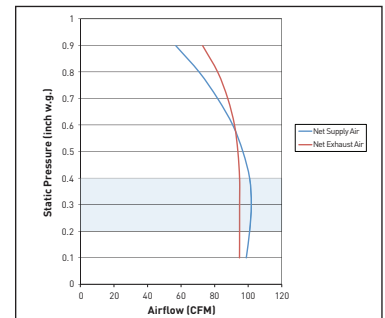

Panasonic Eco Solutions of North America
Eco Products Division
 Two Riverfront Plaza
 Newark, NJ 07102
us.panasonic.com/ventfans

For Order Information
 PHONE: 866-292-7299
 FAX: 888-553-0723
ventfans@us.panasonic.com