

# CleanMate QQ3 Model

## Quick Start Guide

If you have question or issue on the product, do not return it to store.

Please contact technical support first with live chat at:

<http://cleanmate.metapo.com>



You can register your product for one year warranty service at:

<http://cleanmate.metapo.com>

### **Step 1: Check QQ3 Unit and Accessories in the Package**

Please check and make sure the following items are inside your package.

#### **For QQ3T model without Sonic Walls**



QQ3



Rechargeable  
Battery



Self-charging base



Charger



User Manual



Remote Control



Filter(x2)

**For QQ3LT model with two Sonic Walls\***

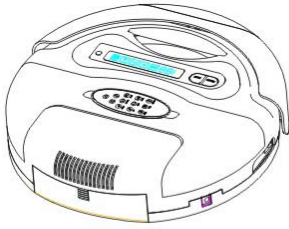

QQ3LT

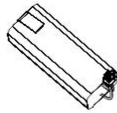

Rechargeable  
Battery

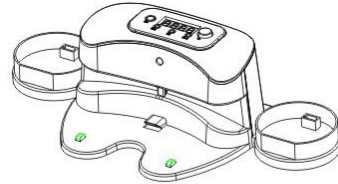

Self-charging base



Charger



Sonic Wall  
(X2)



Rechargeable Battery  
(For Sonic Wall)  
(X4)



User Manual



Remote Control



Filter(X2)

**\* Note:**

Two Sonic Walls are optional based on the model configuration.

Please check your invoice if Sonic Walls are included or not.

If Sonic Walls are not included, then the Self-charging base is shown on the previous page.

## **Step 2: Install the Battery**

Remove both bumper protection foam pads before first use of the CleanMate unit.

Remove the insulation sheet under battery before using the remote control for the 1<sup>st</sup> time.

Battery installation – open battery cover, connect the battery wire connector to the connector on QQ3 unit, put battery securely in battery compartment, and close the battery cover.

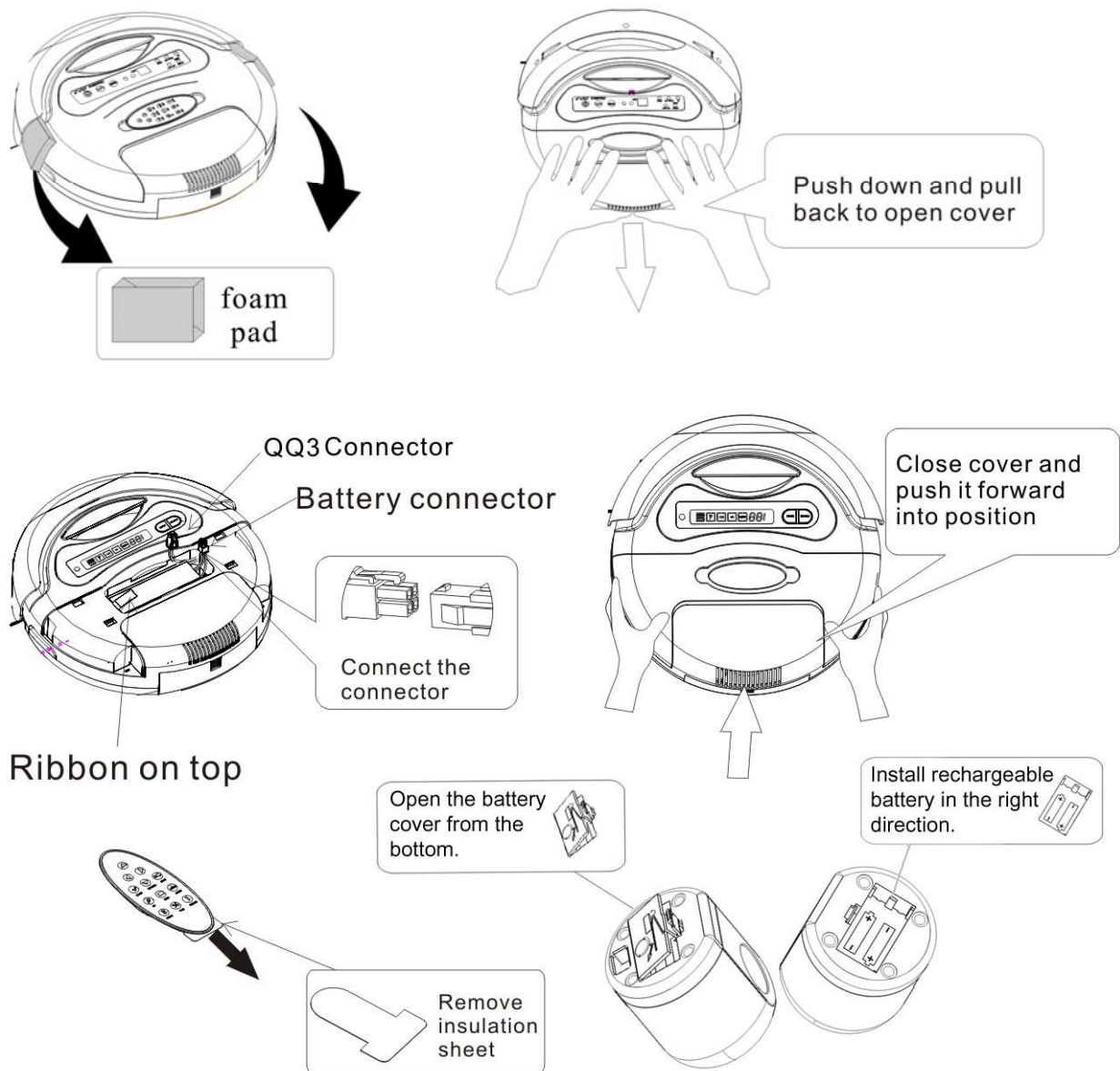

## **Step 3: Charge the Battery**

### **A. Charge the battery on self-charging base**

Make sure battery charger connector is plugged to the power socket on charging base first, and then plug the other end of charger to wall outlet.

Position charging base securely against the wall and leave enough clearance space on both sides. Also make sure there is open space in front of the charging base for QQ3 to dock onto the base. To test QQ3 self-charging base, put QQ3 unit about 2.5 ft (or less) in front of charging base, and press “HOME” button on remote control to let QQ3 automatically dock to charging base and charge the battery. Make necessary adjustment to the self-charging base if QQ3 cannot dock on the self-charging base properly.

At end of cleaning cycle or low battery condition, QQ3 unit will search for self-charging base to recharge battery.

QQ3T model blue LED light will be blinking to indicate that battery is being charged. QQ3LT model battery icon on LCD display will be blinking. It normally takes about 3 hours to have the battery fully charged. It is recommended to charge the CleanMate battery overnight before first time usage.

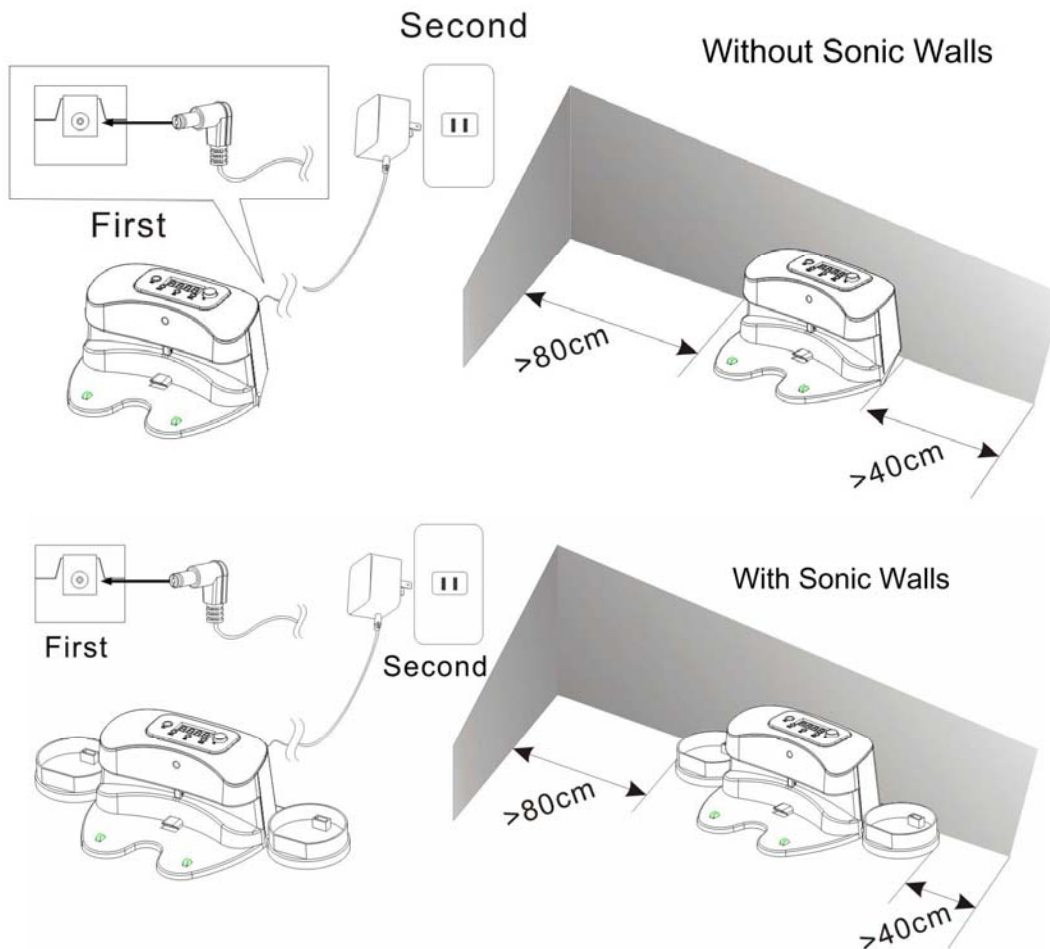

## **B. Charge battery manually**

To charge the battery manually without using self-charging base, just plug battery charger connector to the charging socket on QQ3 unit first, and then plug the other end of charger to wall outlet.

### **QQ3T model:**

Blue LED light on QQ3T unit will be blinking to indicate that battery is being charged. It normally takes about 3 hours to have the battery fully charged. It is recommended to charge the CleanMate battery overnight before first time usage.

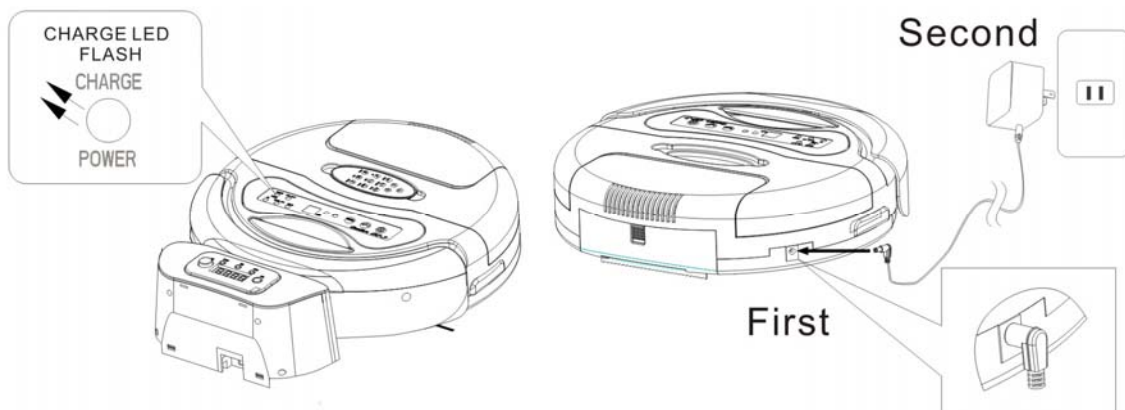

### **QQ3LT model:**

Battery icon on QQ3LT LCD display will be blinking to indicate that battery is being charged. When battery is fully charged, battery icon will be steady as shown.

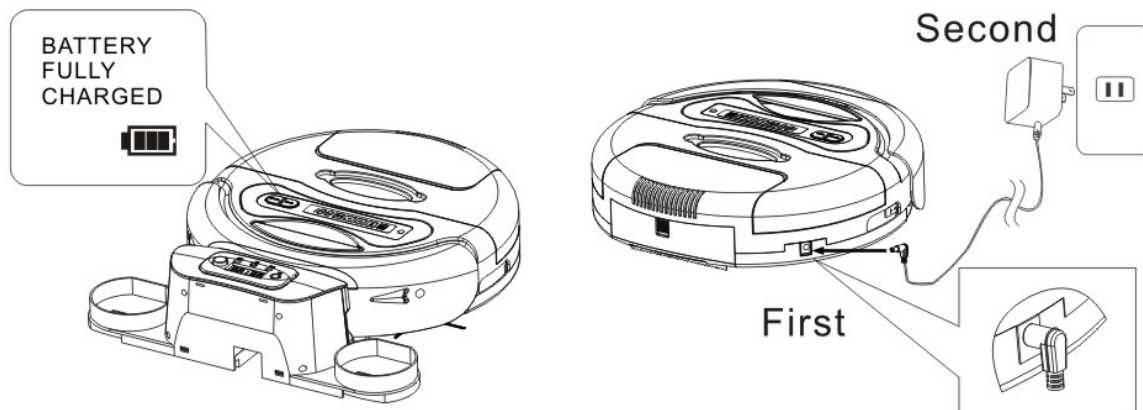

## Step 4:

### **Start / Stop Cleaning for QQ3T model**

1. Press “POWER” button on QQ3 to turn it on. The power LED (solid blue) will light up.
2. Press “Start/Stop” button once on QQ3 unit to start the cleaning. Press this button again to stop cleaning.
3. Press “TIMER” button on QQ3 unit to set the operation running time. The numerical panel on QQ3 will display the running time & cleaning mode. When QQ3 is powered on for the 1<sup>st</sup> time, default running time is set to 40 minutes. User can change running time from 10 to 90 minutes in 10-minute intervals by pressing the TIMER button.
4. Set CleanMate running time based on the size of cleaning area. Regularly remove the debris and hairs around brushes and wheels to conserve battery power and increase battery life time.
5. When the battery power is low, the LOW BATT light on QQ3 will blink in red.
6. In the following situations, ERROR light will light up: battery over charging, motor overloading, and wheel traction losing (lifted off ground, etc) for more than 3 seconds.

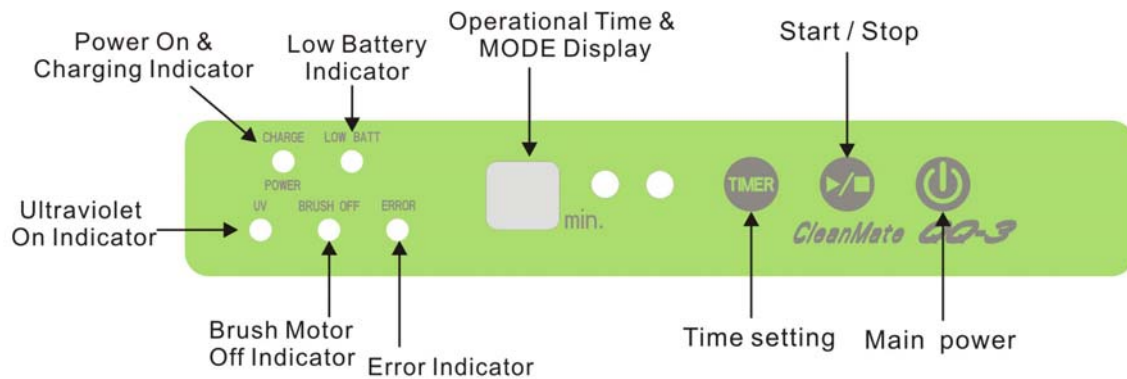

## **LED and Audible Alert Indicators**

### **Audible indicator**

<b>Status</b>	<b>Description</b>
Long Beep once followed by one Short Beep	Times up (when the cleaning timer was set)
	Battery Low, cleaning function off
Long Beep once	Error
Short Beep three times	Fully charged
Short Beep three times and One long Beep	Fully charged and start vacuuming again (when the docking station is set that after fully charged, QQ3 will go out to vacuum again)

### **LED indicator**

<b>Color of LED Lights</b>	<b>Description</b>
Green	Steady – Brush Motor Off
Red	Blinking – Battery Low
	Steady - Error
Blue	Steady – Fully Charged / Power On
	Blinking - Charging
Yellow	UV On

## Start / Stop Cleaning for QQ3LT model

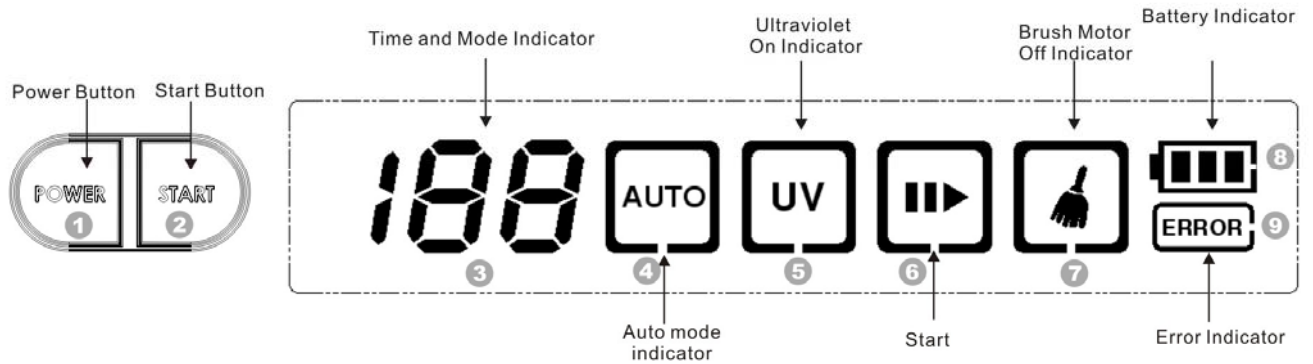

### LCD Control Panel and Functions

1. Power Button: To turn on QQ3LT
2. Start Button: To start QQ3LT
3. Time and Mode Indicator: The numerical panel on QQ3LT will display the running time & cleaning mode. When QQ3LT is powered on for the 1<sup>st</sup> time, default running time is set to 40 minutes. User can change running time from 10 to 90 minutes in 10-minute intervals by pressing the TIMER button on remote control unit.
4. Auto: Light up when the cleaning patterns are repeated automatically
5. UV: Light up when QQ3LT UV light is activated via remote control unit.
6. Start: Light up when QQ3LT started working
7. Sweep: Light up when the brush motor is turned on by starting QQ3LT; light off when brush motor is turned off via remote control unit.
8. Battery indicator:

Battery indicator	Battery Status
Three Cells	Fully Charged
One Cell	Battery Low
Blinking	Charging

9. Error: Light up when battery over charging, motor overloading, and wheel traction losing (lifted off ground, etc) for more than 3 seconds



## Remote Control Operation

Make sure to remove the insulation plastic sheet under remote battery before using the remote for the first time.

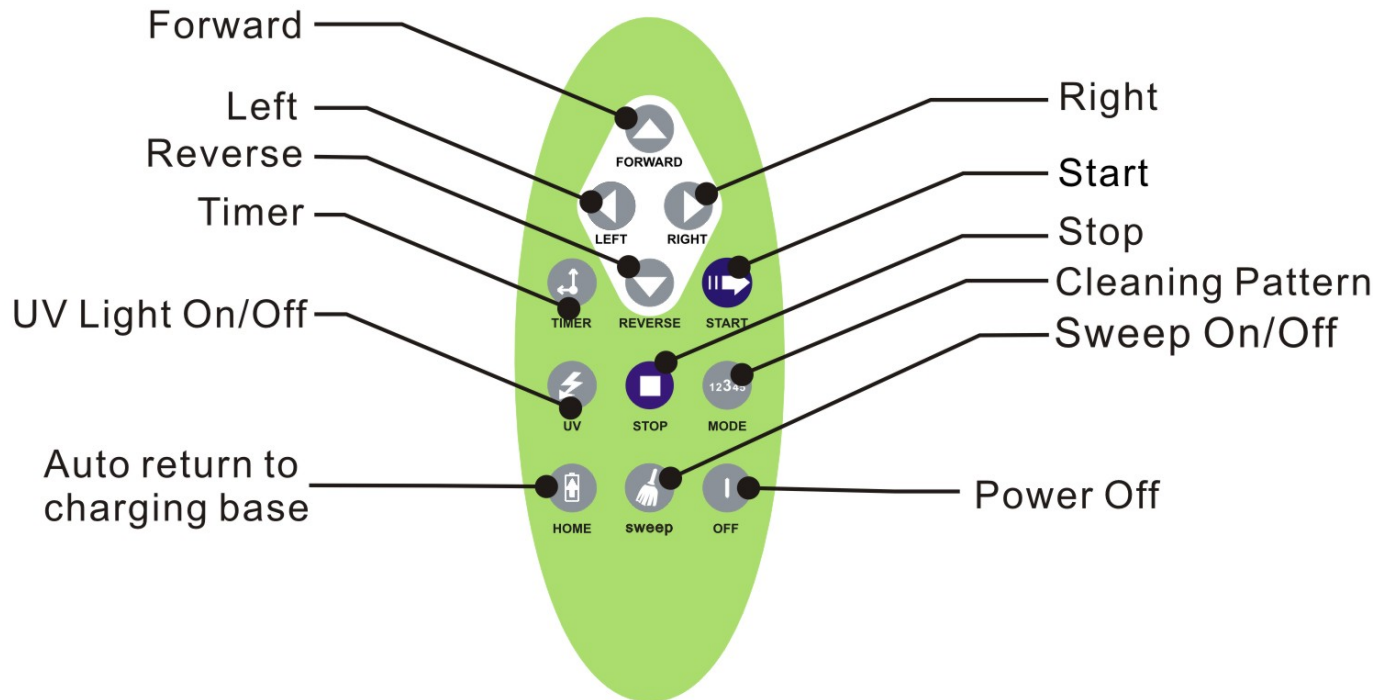

### **Remote Functions:**

1. **START** button: Press **START** to begin the automatic cleaning of your room.
2. **STOP** button: Press **STOP** to stop the operation of QQ3. You will hear a long beep sound.
3. **TIMER** button: Press **TIMER** to change the cleaning time.
4. **Direction buttons**: **FORWARD**: when you press this button, QQ3 will move forward until user press **FORWARD** again, or when it hits an obstacle. **RIGHT**, **LEFT** and **BACKWARD** buttons: press these buttons to manually drive the QQ3 unit to go to right, left or backward directions.
5. **MODE** button: Press this button to select 1 of the 5 available cleaning mode patterns. The default operation mode is Automatic mode. In this normal mode, CleanMate will go through all 5 pre-programmed cleaning patterns automatically to achieve the best cleaning effects. Presses **MODE** button one more time to select another cleaning pattern.

- a) Press “MODE” button once (1<sup>st</sup> time) to choose “Spiral” mode. The timer on QQ3 will display “1” for one minute and then show the cleaning time setting. When QQ3 hits an object while running in this mode, it will stop the movement and wait for further instruction.
  - b) Press “MODE” button again (2<sup>nd</sup> time) to choose “Special Bounce” mode. The Timer on QQ3 will display “2” for one minute.
  - c) Press “MODE” button again (3<sup>rd</sup> time) to choose “Along Wall” mode. The Timer on QQ3 will display “3” for one minute.
  - d) Press the “MODE” button again (4<sup>th</sup> time) to choose S Shape” mode. The timer on QQ3 will display “4” for one minute.
  - e) Press the “MODE” button again (5<sup>th</sup> time) to choose “Polygonal Spiral” mode. The Timer display on QQ3 will show “5” for one minute.
  - f) Press the “MODE” button again (6<sup>th</sup> time), and the QQ3 will go back to the default Automatic cleaning mode. The Timer display on QQ3 will show “A” for one minute.
6. UV button: Turn the UV light ON or OFF on QQ3.
  7. SWEEP button: Press this button to turn brush motor ON or OFF.
  8. HOME button: Press this button to direct the QQ3 to return to home charging base.
  9. OFF button: Press this button to turn OFF the QQ3.

## **Step 5: How to the Empty Dust Bin**

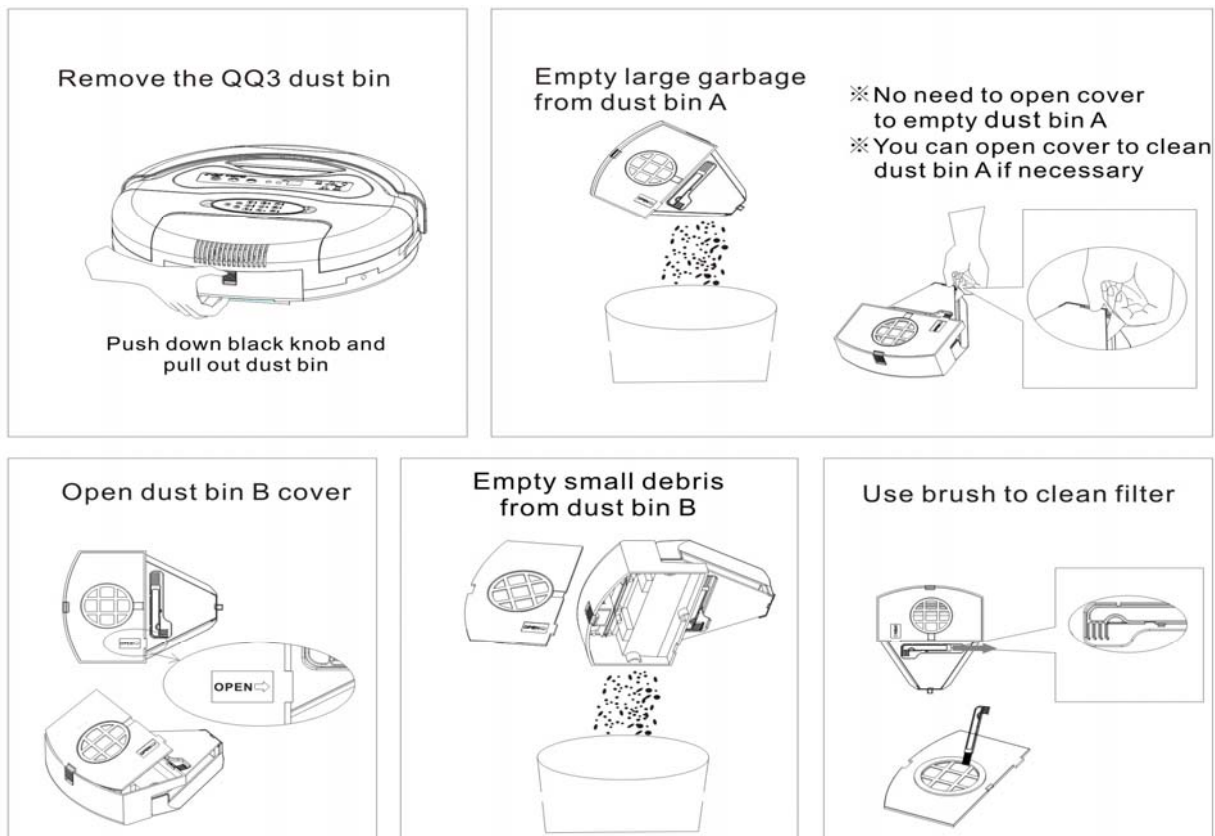

## **Step 6: How to Clean the Roller Brush**

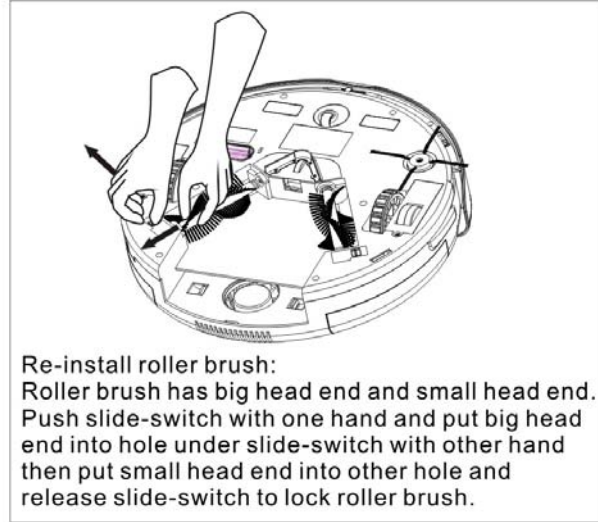

## **Step 7: How to Set Up Sonic Walls (if it is available)**

The CleanMate Sonic Walls create an invisible barrier that QQ3LT will not cross.

### **Sonic Wall**

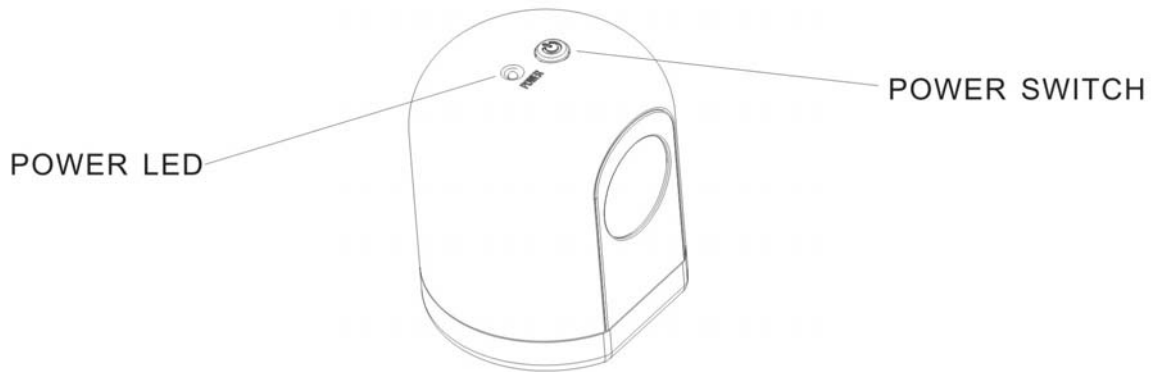

Push down the power switch, “POWER” green LED is on and Sonic Wall works. Push power switch again will power off.

Sonic Walls can be set to block an area 1.5M (5ft.) long.

Sonic Wall beam is keyhole shaped. A larger cone-shaped section blocks off areas of your home where you don't want QQ3 to go.

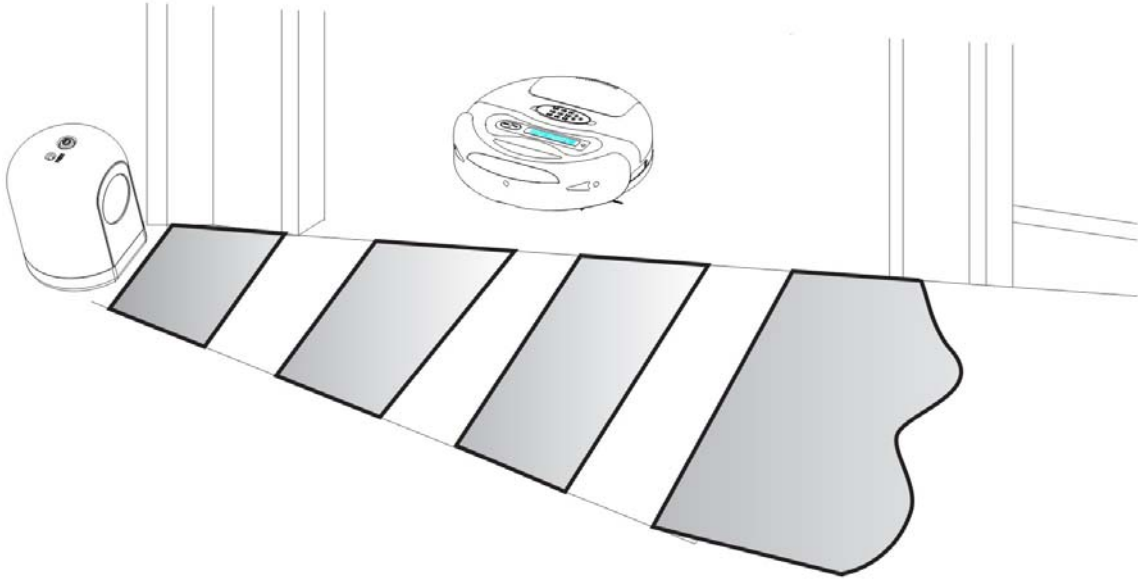

If “POWER” green LED blinks, Sonic Wall battery needs to be recharged.

TIP: Use the Sonic Wall to block doorway or keep QQ3 away from cords. Confining QQ3 to a single room will accelerate cleaning.

TIP: For best performance place the Sonic Wall on outside of the doorway you wish to block.

### Charging Sonic Walls battery

Charging Base has built in USB ports, you can dock the Sonic Walls into Charging Base to charge battery inside Sonic Walls.

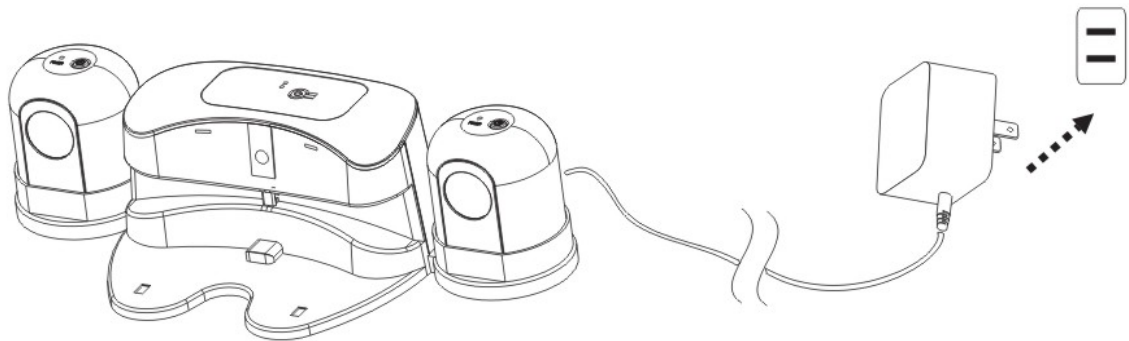

## Step 7: How to Set Up QQ3 Scheduler

With the help of scheduler on QQ3, user has the freedom to set up the cleaning time according to pre-programmed schedule. On the preset cleaning time, QQ3 will leave the charging base and start the cleaning session automatically. You can program it to start cleaning job at the same time on every day, or on any day of week you choose.

The scheduler LCD panel is located on the top of the QQ3 self-charging base unit. User needs to plug the AC adapter into QQ3 self-charging base to set up the clock and cleaning times.

### 1. Illustration of QQ3 Scheduler LCD Panel

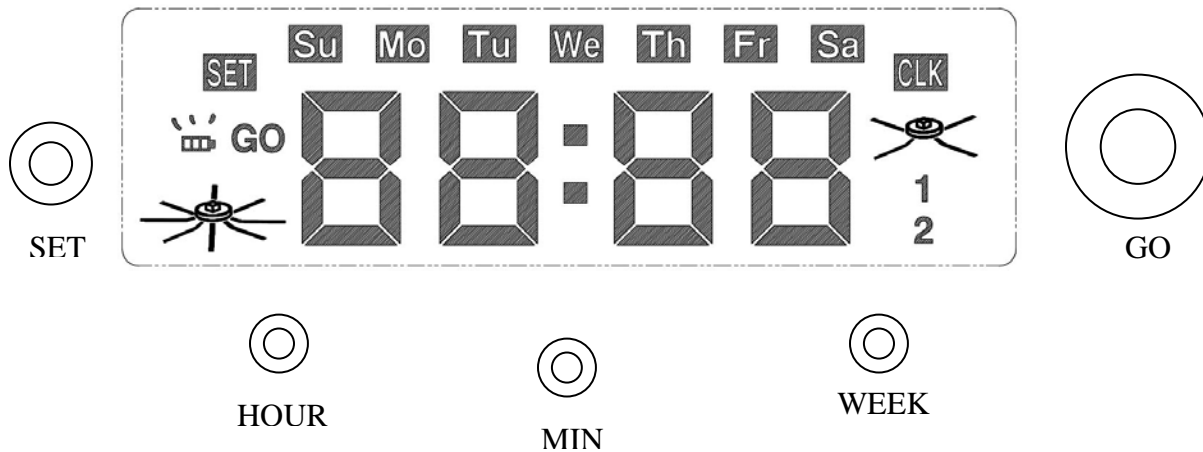

- SET (on left side of LCD panel) sign is displayed when you set clock or cleaning schedule
- Week display (top of LCD panel): Each week day display will be shown as “Su”, “Mo”, “Tu”, “We”, “Th”, “Fr” and “Sa”.
- CLK(Right side of LCD panel) is displayed in Clock-setting mode
- GO (Left side of LCD panel), Battery and Brush icon on the left panel show that the cleaning will start once the battery is fully charged.
- Brush Icon on the right side of LCD panel is displayed when scheduled cleaning time has been set up and it is ready to start cleaning based on preset schedule.
- Clock digit display is in middle of LCD panel.

## 2. Scheduler Setting Operations

### Setting the Clock

2.1 Once powered on, the scheduler will enter Clock Display Mode and display initial default setting of Sunday 00:00 (in 24 hours time format)

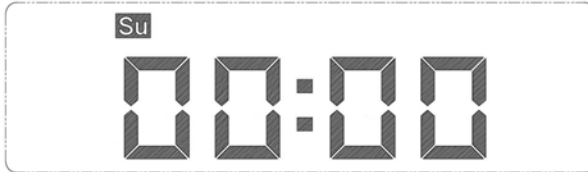

2.2 Press “SET” to set up the clock time (enter Clock-setting mode and display SET and CLK icon). Time and week will start blinking. Press “HOUR”, “MIN” or “WEEK” to set the correct time and week day. The display value will increase by “1” with each press, and the number will change rapidly if you hold the button. The clock will be set and display will become steady (SET and CLK disappear) if there is no key input for one minute (idling or no action).



### Setting the Cleaning Schedule

User can schedule the QQ3 unit to clean on any day of the week, up to 7 days per week (one cleaning time per day and same cleaning time on each day).

2.3 Press “SET” again to enter Scheduler Mode. Time and week will start blinking. Press “HOUR”, “MIN” or “WEEK” to set the cleaning schedule. The display value will increase by “1” with each press, and the number will change rapidly if you hold the button.

When you set hours and minutes, the cleaning time will not be scheduled if you select the bar (“-” sign as shown below) instead of a numeric digit.

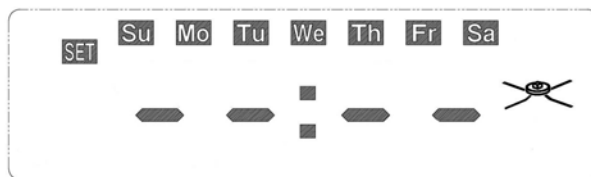

After cleaning time is set, you can choose to schedule the cleaning time on any day in a week. The initial default setting is to clean on everyday. Press “WEEK”, then the scheduler will highlight all 7 days of the week, which means the QQ3 will start automatic cleaning once a day, 7 days a week (at same cleaning time).

If you want to choose a particular day (or days) in a week to perform the cleaning job, then press “WEEK” again. You will see “Su” start blinking. Press “WEEK” one more time within 5 seconds if you want to select Sunday, and you will see “Su” turns into steady state to confirm your setting. If you want to select a day other than Sunday, just wait for more than 5 seconds and you will see “Mo”, or other days of the week. To select a particular cleaning day, just press “WEEK” within 5 seconds after you see it blinking to confirm. If you want to skip a day, wait for more than 5 seconds (without pressing “WEEK” key), and it will start display the next week day for you to choose.

2.4 When cleaning schedule set up is complete, press “SET” again and the scheduler will return to the Clock display Mode.

Example 1 (LCD display with brush icon) – Scheduler is set up to perform a preset cleaning job and current time is Monday 8:10AM.

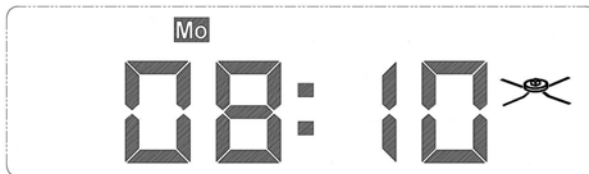

Example 2 (LCD display with no brush icon) - Scheduler has NOT been set up to do any preset cleaning job and current time is Monday 8:10AM.

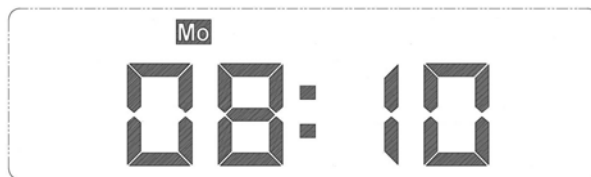

### 3. How to Delete a Preset Cleaning Schedule

When scheduler displays clock time (at Clock Display Mode), press “SET” once and it will enter Clock-setting Mode. Press “SET” again, it will enter Scheduler Mode. When you set Hours and Minutes, the cleaning will be deleted if you select the bar (“-” sign as shown below) instead of a numeric digit.

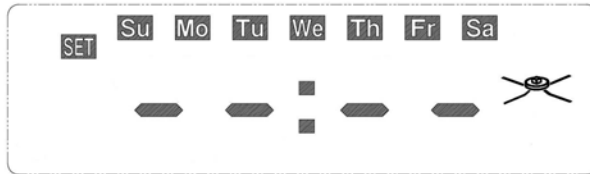

### 4. How to Display a Preset Cleaning Schedule

When scheduler displays clock time (at Clock display Mode), press “SET” once it will enter Clock-setting Mode. Press “SET” again, it enters Scheduler Mode and it also shows preset scheduling time and day.

### 5. Start Cleaning Automatically Right After Battery is Fully Charged

Press “GO” (for about 1 second) on the self-charging base, and you will see Battery, Brush and GO icons turned on (as shown below) on the left side of LCD panel. This indicates that the QQ3 vacuum will automatically start a cleaning cycle right after the battery is fully charged.

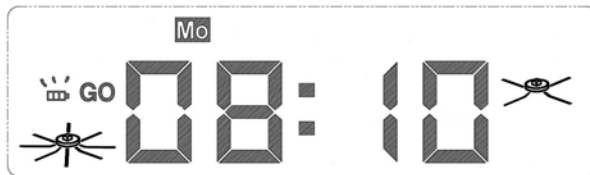

Press the “GO” button again to turn this function off. **Note: QQ3 vacuum cleaner will only run one cleaning cycle after “GO” button is selected.**

### 6. How to Start Cleaning Right Away

If you hold down “GO” button for 5 seconds, the QQ3 on the self-charging base will leave the base and begin the cleaning right away, no matter whether the battery has been charged in full or not. This function works the same way as you push “START” button on the remote control.

### 7. How to Start Cleaning with Remote Control

When the QQ3 is being charging on the self-charging base, you can direct the QQ3 to begin cleaning when you press “START” button on your remote control.