



Maintenance and Service Guide

HP ProBook 455R G6 Notebook PC

© Copyright 2019 HP Development Company, L.P.

AMD, Ryzen, and Radeon are trademarks of Advanced Micro Devices, Inc. Bluetooth is a trademark owned by its proprietor and used by HP Inc. under license. Intel, Celeron, Core, Pentium, and Thunderbolt are trademarks of Intel Corporation or its subsidiaries in the U.S. and/or other countries. SDHC, SDXC, and microSD are trademarks or registered trademarks of SD-3C LLC. Windows is either a registered trademark or trademark of Microsoft Corporation in the United States and/or other countries.

The information contained herein is subject to change without notice. The only warranties for HP products and services are set forth in the express warranty statements accompanying such products and services. Nothing herein should be construed as constituting an additional warranty. HP shall not be liable for technical or editorial errors or omissions contained herein.

First Edition: May 2019

Document Part Number: L46751-001

Product notice

This guide describes features that are common to most models. Some features may not be available on your computer.

Not all features are available in all editions or versions of Windows. Systems may require upgraded and/or separately purchased hardware, drivers, software or BIOS update to take full advantage of Windows functionality. Windows 10 is automatically updated, which is always enabled. ISP fees may apply and additional requirements may apply over time for updates. Go to <http://www.microsoft.com> for details.

To access the latest user guides, go to <http://www.hp.com/support>, and follow the instructions to find your product. Then select **User Guides**.

Software terms

By installing, copying, downloading, or otherwise using any software product preinstalled on this computer, you agree to be bound by the terms of the HP End User License Agreement (EULA). If you do not accept these license terms, your sole remedy is to return the entire unused product (hardware and software) within 14 days for a full refund subject to the refund policy of your seller.

For any further information or to request a full refund of the price of the computer, please contact your seller.

Important Notice about Customer Self-Repair Parts



IMPORTANT: Your computer includes Customer Self-Repair parts and parts that should only be accessed by an authorized service provider. See Chapter 5, "Removal and replacement procedures for Customer Self-Repair parts," for details. Accessing parts described in Chapter 6, "Removal and replacement procedures for authorized service provider only parts," can damage the computer or void your warranty.

Safety warning notice

 **WARNING!** To reduce the possibility of heat-related injuries or of overheating the device, do not place the device directly on your lap or obstruct the device air vents. Use the device only on a hard, flat surface. Do not allow another hard surface, such as an adjoining optional printer, or a soft surface, such as pillows or rugs or clothing, to block airflow. Also, do not allow the AC adapter to contact the skin or a soft surface, such as pillows or rugs or clothing, during operation. The device and the AC adapter comply with the user-accessible surface temperature limits defined by applicable safety standards.

Table of contents

1 Product description	1
2 Components	6
Right	6
Left	8
Display	9
Keyboard area	11
Touchpad	11
Lights	12
Button, speakers, and fingerprint sensor	13
Special keys	14
Hot keys (select products only)	15
Bottom	15
Labels	16
3 Illustrated parts catalog	17
Computer major components	17
Display components	20
Cable Kit	21
Bracket Kit	22
Mass storage devices	23
Miscellaneous parts	24
4 Removal and replacement procedures preliminary requirements	27
Tools required	27
Service considerations	27
Plastic parts	27
Cables and connectors	27
Drive handling	28
Workstation guidelines	28
Electrostatic discharge information	28
Generating static electricity	29
Preventing electrostatic damage to equipment	29
Personal grounding methods and equipment	30
Grounding the work area	30
Recommended materials and equipment	30

Packaging and transporting guidelines	31
5 Removal and replacement procedures for Customer Self-Repair parts	32
Component replacement procedures	32
Preparation for disassembly	32
Battery Safe mode	32
Bottom cover	33
Memory modules	34
WLAN/Bluetooth combo card	35
M.2 solid-state drive	37
Hard drive	38
6 Removal and replacement procedures for authorized service provider parts	40
Component replacement procedures	40
Battery	41
Speaker assembly	42
Fan	43
Heat sink	44
Power/USB board	46
Battery connector board	48
Touchpad assembly	49
Fingerprint sensor assembly	50
Card reader board	51
RTC battery	53
System board	54
Display assembly	57
Power connector cable	65
Keyboard/top cover	66
7 Computer Setup (BIOS), TPM, and HP Sure Start	67
Using Computer Setup	67
Starting Computer Setup	67
Navigating and selecting in Computer Setup	67
Restoring factory settings in Computer Setup	67
Updating the BIOS	68
Determining the BIOS version	68
Downloading a BIOS update	68
Changing the boot order using the f9 prompt	69
TPM BIOS settings (select products only)	69
Using HP Sure Start (select products only)	70

8 Using HP PC Hardware Diagnostics	71
Using HP PC Hardware Diagnostics Windows (select products only)	71
Downloading HP PC Hardware Diagnostics Windows	71
Downloading the latest HP PC Hardware Diagnostics Windows version	72
Downloading HP Hardware Diagnostics Windows by product name or number (select products only)	72
Installing HP PC Hardware Diagnostics Windows	72
Using HP PC Hardware Diagnostics UEFI	72
Starting HP PC Hardware Diagnostics UEFI	73
Downloading HP PC Hardware Diagnostics UEFI to a USB flash drive	73
Downloading the latest HP PC Hardware Diagnostics UEFI version	73
Downloading HP PC Hardware Diagnostics UEFI by product name or number (select products only)	73
Using Remote HP PC Hardware Diagnostics UEFI settings (select products only)	74
Downloading Remote HP PC Hardware Diagnostics UEFI	74
Downloading the latest Remote HP PC Hardware Diagnostics UEFI version	74
Downloading Remote HP PC Hardware Diagnostics UEFI by product name or number	74
Customizing Remote HP PC Hardware Diagnostics UEFI settings	74
 9 Backing up, restoring, and recovering	 76
Backing up information and creating recovery media	76
Using Windows tools	76
Using the HP Cloud Recovery Download Tool to create recovery media (select products only)	76
Restoring and recovery	77
Restoring, resetting, and refreshing using Windows tools	77
Recovering using HP Recovery media	77
Changing the computer boot order	77
 10 Specifications	 78
Computer specifications	78
39.6 cm (15.6 in) display specifications	79
Hard drive specifications	79
Solid-state drive specifications	80
 11 Statement of memory volatility	 81
Nonvolatile memory usage	83
Questions and answers	85
Using HP Sure Start (select models only)	86

12 Power cord set requirements	87
Requirements for all countries	87
Requirements for specific countries and regions	88
13 Recycling	90
Index	91

1 Product description

Table 1-1 Product components and their descriptions

Category	Description
Product Name	HP ProBook 455R G6 Notebook PC
Processors	<p>AMD Ryzen™ processors</p> <p>Ryzen 5-3500U (2.1 GHz, turbo up to 3.7 GHz), 6 MB L2 + L3 cache, 2400 MHz, quad core, 15 W; Radeon™ Vega 8 Graphics</p> <p>Ryzen 3-3200U (2.6 GHz, turbo up to 3.5 GHz), 5 MB L2 + L3 cache, DDR4-2400 MHz, dual core, 15 W; Radeon Vega 3 Graphics</p>
Graphics	<p>Integrated Intel UMA Graphics</p> <p>Integrated with shared video memory (see Processor category)</p> <p>Supports HD decode, DX12, HDMI 1.4b up to 4K @ 30 Hz</p> <p>Supports 4 independent displays when on the HP USB-C Dock G4; Max resolution = 4K @ 30 Hz (DisplayPort™ 1) or 4K @ 30 Hz (DisplayPort 2)</p> <p>Supports 4 independent displays when on the HP Thunderbolt Dock (using USB-C); Max resolution = 4K @ 30 Hz (DisplayPort 1) or 4K @ 30 Hz (DisplayPort 2)</p> <p>Supports 4 independent displays when on the HP USB-C Mini Dock; Max. resolution = 4K @ 30 Hz (HDMI) or 1920 × 1080 @ 60 Hz (VGA)</p> <p>Supports 4 independent displays when on the HP USB-C Universal Dock; Max. resolution = 4K @ 30 Hz (DisplayPort 1) or 4K @ 30 Hz (DisplayPort 2)</p>
Panel	<p>39.6 cm (15.6 in), HD (1366 × 768), LED backlight, antiglare, SVA, 220 nits, 45% CG, eDP, slim</p> <p>No camera</p> <p>HD camera, 1 WLAN antenna</p> <p>HD camera, 2 WLAN antennas</p> <p>HD+ IR camera, 2 WLAN antennas</p> <p>39.6 cm (15.6 in), FHD (1920 × 1080), LED backlight, antiglare, UWVA, 220 nits or 250 nits, 45% CG, eDP, slim, two WLAN antennas</p> <p>No camera</p> <p>HD camera, 1 WLAN antenna</p> <p>HD camera, 2 WLAN antennas</p> <p>HD+ IR camera, 2 WLAN antennas</p>
Memory	<p>Two customer-accessible memory module slots supporting up to 16 GB of RAM</p> <p>Supports dual-channel memory</p> <p>PC4-2400, DDR4 SODIMMs</p> <p>Supports the following configurations:</p>

Table 1-1 Product components and their descriptions (continued)

Category	Description
	<ul style="list-style-type: none"> • 16384 MB (8192 × 2; dual channel) • 12288 MB (8192 + 4096; dual channel) • 8192 MB (8192 × 1) • 8192 MB (4096 × 2; dual channel) • 4096 MB (4096 × 1)
Primary storage	Supports the following SATA, 7 mm, 2.5-inch hard drives: <ul style="list-style-type: none"> • 1 TB, 5400 rpm • 500 GB, 7200 rpm
Primary M.2 storage	Supports the following M.2 2280 solid-state drives: <ul style="list-style-type: none"> • 512 GB, PCIe, NVMe, TLC • 512 GB, PCIe, NVMe, value • 256 GB, PCIe, NVMe, value • 128 GB, SATA, TLC
Fixed optical drive	Supports external USB drive via power port
Audio/Visual	Audio controls Integrated mono microphone (non-camera models only) Integrated dual-array microphone Integrated camera (720p HD) (select models only) Integrated camera (720p HD + IR) (select models only) Supports WDR (Wide Dynamic Range) Headphone/microphone combo jack
RJ-45 (network)	Realtek RTL8111HSH 10/100/1000 S3/S4/S5 wake on LAN with embedded NIC The following support S3/S4/S5 wake on LAN (via out of band): HP USB-C Universal Dock, HP USB-C Dock G4, HP Thunderbolt™ Dock, and HP USB-C Mini Dock. The following support S0/S3/S4/S5 MAPT (via out of band): HP USB-C Universal Dock, HP USB-C Dock G4, HP Thunderbolt Dock, and HP USB-C Mini Dock.
Wireless network	Wireless Personal Area Network (PAN) Bluetooth® Bluetooth 4.2 supported using combo card Wireless Local Area Network (WLAN) (select models only) Integrated WLAN options with dual antennas (M.2 2230 socket PCIe/USB): <ul style="list-style-type: none"> • Realtek RTL8822BE 802.11ac 2 × 2 Wi-Fi + Bluetooth 4.2 Combo Adapter Integrated WLAN options with single antenna (M.2 2230 socket PCIe/USB): <ul style="list-style-type: none"> • Realtek RTL8821CE 802.11ac 1 × 1 Wi-Fi + Bluetooth 4.2 Combo Adapter

Table 1-1 Product components and their descriptions (continued)

Category	Description
	WLAN antennas (configured at bottom of panel on all models)
	Supports HP LAN-Wireless Protection (WLAN/LAN switching)
	Supports HP Connection Optimizer
	Support Static BIOS SAR for Intel modules and Realtek modules
	Support for Miracast
	Supports WoWLAN S3/S4 AC Mode
Media card reader	Supports microSD™, SDHC™, SDXC™
Ports (Input/output)	Hot plug/unplug and auto detect
	HDMI 1.4b
	USB 2.0 + powered port (left)
	Two USB 3.1 Gen 1 ports (right)
	USB 3.1 Gen 1 Type-C port (PD + DP)
	Headphone/microphone combo jack
	RJ-45 (network)
	Multi-pin AC port
Sensors	Combo chip/accelerometer
	Hall sensor
Docking	HP Thunderbolt Dock 120 W G2
	HP USB-C Dock G4
	HP USB-C Universal Dock
	HP USB-C Mini Dock
Keyboard/pointing devices	Keyboard
	Backlit and non-backlit, spill-resistant, with numeric keypad
	Touchpad requirements
	Microsoft Precision Touchpad Default Gestures support
	FW PTP with Filter Driver
	No Hybrid Mode Support
Power requirements	Battery
	3-cell, 45 Whr, lithium polymer, soft pack
	HP Long Life
	HP Fast Charge Technology (50% in 30 minutes with 65 W AC Adapter under S3/S4/S5)
	AC adapters
	65 W Smart AC adapter, right angle, 4.5 mm

Table 1-1 Product components and their descriptions (continued)

Category	Description
	65 W Smart AC adapter, right angle, 4.5 mm, Argentina
	65 W Smart AC adapter, right angle, 4.5 mm, EM
	65 W straight USB Type-C AC adapter
	45 W Smart AC adapter, right angle, 4.5 mm
	45 W Smart AC adapter, right angle, 4.5 mm, Argentina
	45 W Smart AC adapter, right angle, 2-prong, 4.5 mm (Japan only)
	45 W straight USB Type-C AC adapter
	Power cords
	3-wire plug (C5), 1.8 m, conventional
	3-wire plug (C5), 1.0 m, conventional
	2-wire plug (C7), 1.0 m, conventional, Japan 2-prong adapter
	Duckhead power cord (C5NS), 1.8 m
	Duckhead power cord (C5NS), 1.0 m
	Duckhead (C5NS)
Security	Security lock
	Integrated fingerprint sensor (select models only)
	TPM 2.0 (Infineon; soldered down)
	Hardware enforced firmware protection: HP Hardware Root of Trust
	Preboot authentication (password)
Operating system	Operating system version
	Windows® 10
	Preinstalled
	Windows 10 Home 64
	Windows 10 Home 64 Chinese Market CPPP
	Windows 10 Home 64 High-end Chinese Market CPPP
	Windows 10 Home 64 Plus
	Windows 10 Home 64 Plus Single Language
	Windows 10 Home 64 Plus Single Language Africa Market PPP
	Windows 10 Home 64 Plus Single Language APAC EM PPP
	Windows 10 Home 64 Plus Single Language India Market PPP
	Windows 10 Home 64 Plus Single Language Indonesia Market PPP
	Windows 10 Home 64 Single Language
	Windows 10 Home 64 Single Language Africa Market PPP

Table 1-1 Product components and their descriptions (continued)

Category	Description
	Windows 10 Home 64 Single Language APAC EM PPP
	Windows 10 Home 64 Single Language India Market PPP
	Windows 10 Home 64 Single Language Indonesia Market PPP
	Windows 10 Pro 64
	Windows 10 Pro 64 Chinese Market
	Windows 10 Pro 64 StF MSNA Plus
	Windows 10 Pro 64 StF MSNA Standard
	Windows 10 Pro 64 StF MSNA Strategic
	FreeDOS 3.0
	Restore Media
	Windows 10 Driver DVD
	Windows 10 Professional 64-bit OS DVD
	Certified
	Microsoft WHQL
	Web-only support
	Windows 10 Enterprise 64
Serviceability	End-user replaceable parts
	AC adapter
	M.2 solid-state drive
	Hard drive
	Memory module
	WLAN module

2 Components

Your computer features top-rated components. This chapter provides details about your components, where they are located, and how they work.

Right

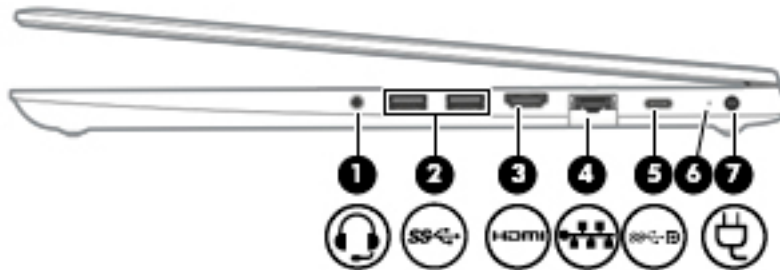

Table 2-1 Right-side components and their descriptions







Component	Description
(1)  Audio-out (headphone)/Audio-in (microphone) combo jack	Connects optional powered stereo speakers, headphones, earbuds, a headset, or a television audio cable. Also connects an optional headset microphone. This jack does not support optional standalone microphones. <p>WARNING! To reduce the risk of personal injury, adjust the volume before putting on headphones, earbuds, or a headset. For additional safety information, see the <i>Regulatory, Safety, and Environmental Notices</i>.</p> To access this guide: <ul style="list-style-type: none"> ▲ Select the Start button, select HP Help and Support, and then select HP Documentation. <p>NOTE: When a device is connected to the jack, the computer speakers are disabled.</p>
(2)  USB SuperSpeed ports	Connect a USB device, such as a cell phone, camera, activity tracker, or smartwatch, and provides high-speed data transfer.
(3)  HDMI port	Connects an optional video or audio device, such as a high-definition television, any compatible digital or audio component, or a high-speed High Definition Multimedia Interface (HDMI) device.
(4)  RJ-45 (network) jack/status lights	Connects a network cable. <ul style="list-style-type: none"> ● Green (left): The network is connected. ● Amber (right): Activity is occurring on the network.
(5)  USB Type-C power connector port, SuperSpeed port, and DisplayPort connector	Connects an AC adapter that has a USB Type-C connector, supplying power to the computer and, if needed, charging the computer battery. <p>– and –</p>

Table 2-1 Right-side components and their descriptions (continued)

Component	Description
(6) Battery light	<p>Connects a USB device that has a Type-C connector, such as a cell phone, camera, activity tracker, or smartwatch, and provides high-speed data transfer.</p> <p>– and –</p> <p>Connects a display device that has a USB Type-C connector, providing DisplayPort output.</p> <p>NOTE: Cables and/or adapters (purchased separately) may be required.</p> <p>When AC power is connected:</p> <ul style="list-style-type: none">• White: The battery charge is greater than 90 percent.• Amber: The battery charge is from 0 to 90 percent.• Off: The battery is not charging. <p>When AC power is disconnected (battery not charging):</p> <ul style="list-style-type: none">• Blinking amber: The battery has reached a low battery level. When the battery has reached a critical battery level, the battery light begins blinking rapidly.• Off: The battery is not charging.
(7)  Power connector	Connects an AC adapter.

Left

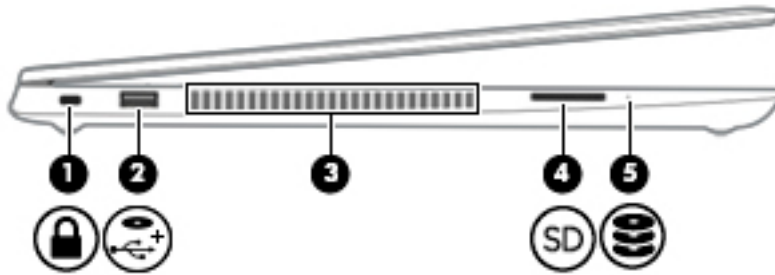







Table 2-2 Left-side components and their descriptions

Component	Description
(1)  Security cable slot	Attaches an optional security cable to the computer. NOTE: The security cable is designed to act as a deterrent, but it may not prevent the computer from being mishandled or stolen.
(2)  USB powered port	Connects and supplies power to a USB device, such as a cell phone, camera, activity tracker, optical drive, or smartwatch, and provides data transfer.
(3) Vent	Enables airflow to cool internal components. NOTE: The computer fan starts up automatically to cool internal components and prevent overheating. It is normal for the internal fan to cycle on and off during routine operation.
(4)  Memory card reader	Reads optional memory cards that store, manage, share, or access information. To insert a card: <ol style="list-style-type: none"> 1. Hold the card label-side up, with the connectors facing the computer. 2. Insert the card into the memory card reader, and then press in on the card until it is firmly seated. To remove a card: <ol style="list-style-type: none"> ▲ Press in on the card, and then remove it from the memory card reader.
(5)  Drive light	<ul style="list-style-type: none"> • Blinking white: The hard drive is being accessed. • Amber: HP 3D DriveGuard has temporarily parked the hard drive.

Display

 **NOTE:** Refer to the illustration that most closely matches your computer.

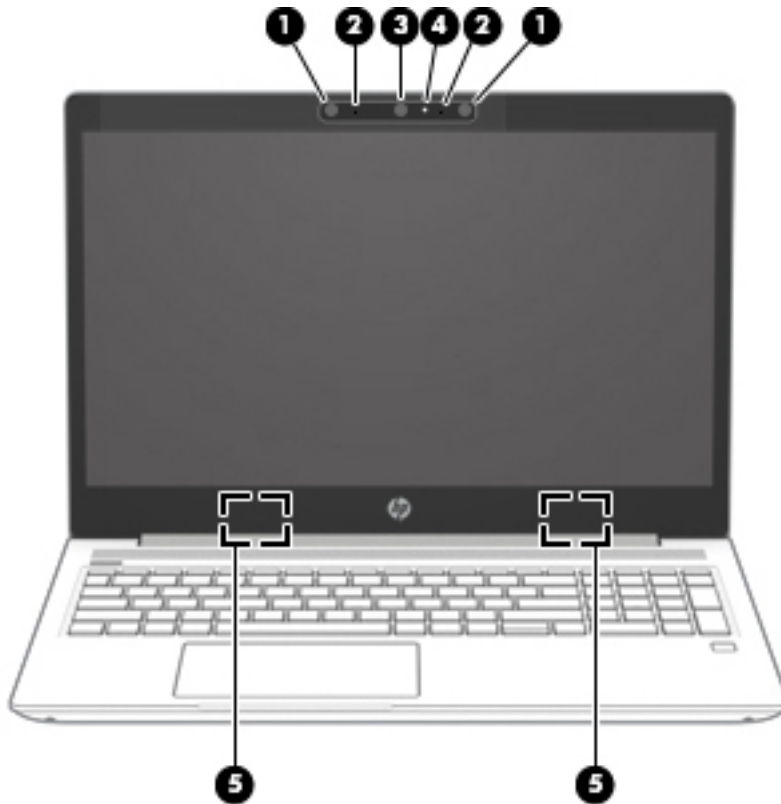

Table 2-3 Display components and their descriptions

Component	Description
(1) IR camera light (select products only)	On: The IR camera is in use.
(2) Internal microphones (1 or 2 depending on model)	Record sound.
(3) Camera(s) (select products only)	Allow(s) you to video chat, record video, and record still images. Some cameras also allow a facial recognition logon to Windows, instead of a password logon. NOTE: Camera functions vary depending on the camera hardware and software installed on your product.
(4) HD camera light (select products only)	On: The HD camera is in use.
(5) WLAN antennas* (select products only)	Send and receive wireless signals to communicate with wireless local area networks (WLANs).

*The antennas are not visible from the outside of the computer. For optimal transmission, keep the areas immediately around the antennas free from obstructions.

For wireless regulatory notices, see the section of the *Regulatory, Safety, and Environmental Notices* that applies to your country or region.

To access this guide:

- ▲ Select the **Start** button, select **HP Help and Support**, and then select **HP Documentation**.

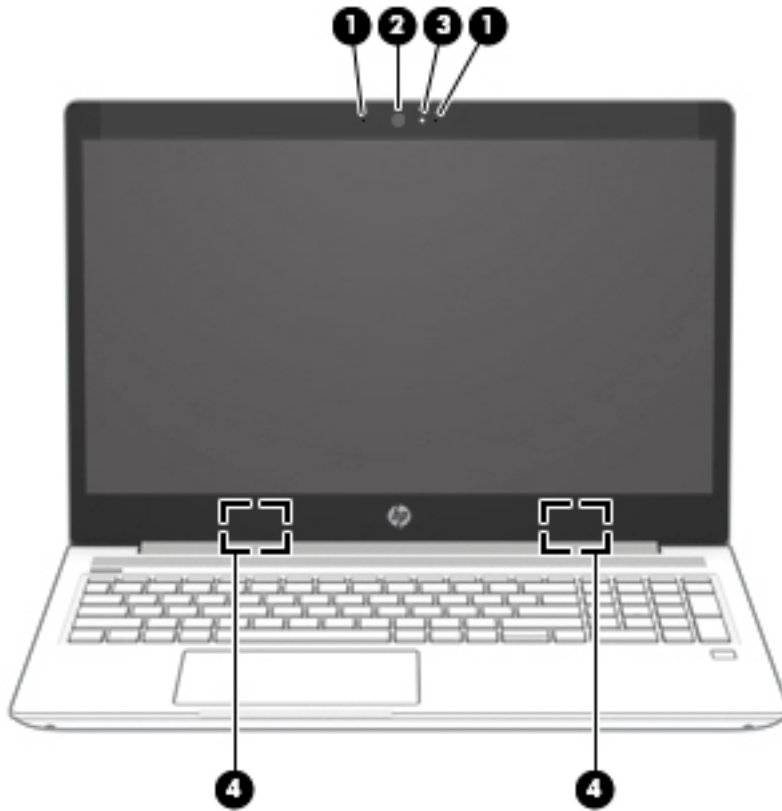

Table 2-4 Display components and their descriptions

Component	Description
(1) Internal microphones (1 or 2 depending on model)	Record sound.
(2) Camera(s) (select products only)	Allow(s) you to video chat, record video, and record still images. Some cameras also allow a facial recognition logon to Windows, instead of a password logon. NOTE: Camera functions vary depending on the camera hardware and software installed on your product.
(3) HD camera light (select products only)	On: The HD camera is in use.
(4) WLAN antennas* (select products only)	Send and receive wireless signals to communicate with wireless local area networks (WLANs).

*The antennas are not visible from the outside of the computer. For optimal transmission, keep the areas immediately around the antennas free from obstructions.

For wireless regulatory notices, see the section of the *Regulatory, Safety, and Environmental Notices* that applies to your country or region.

To access this guide:

- ▲ Select the **Start** button, select **HP Help and Support**, and then select **HP Documentation**.

Keyboard area

Touchpad

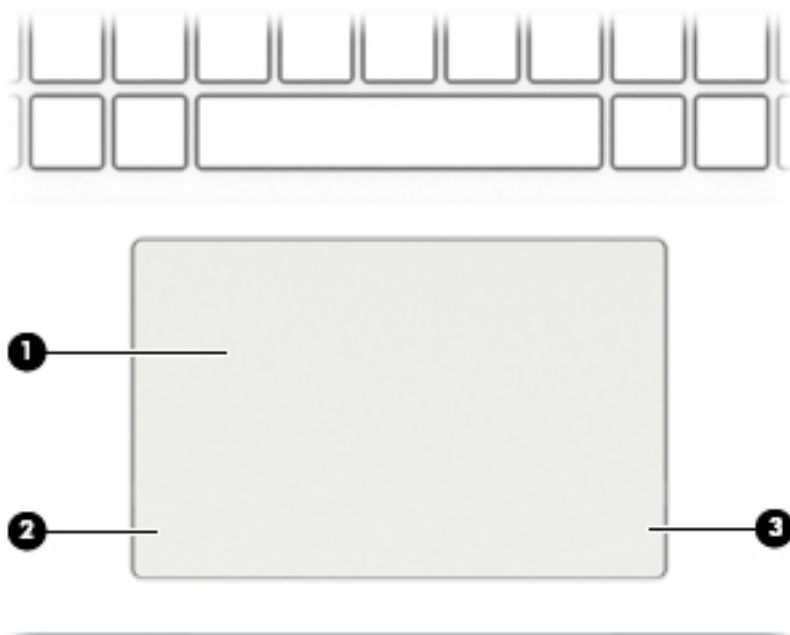

Table 2-5 Touchpad components and their descriptions

Component	Description
(1) Touchpad zone	Reads your finger gestures to move the pointer or activate items on the screen.
(2) Left touchpad button	Functions like the left button on an external mouse.
(3) Right touchpad button	Functions like the right button on an external mouse.

Lights

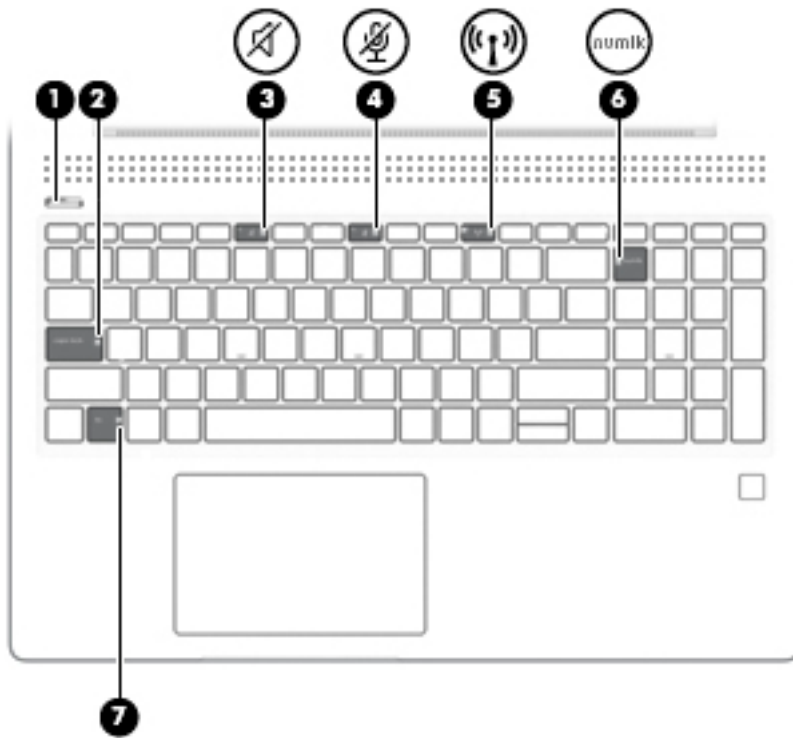







Table 2-6 Lights and their descriptions

Component	Description
(1)  Power light	<ul style="list-style-type: none"> On: The computer is on. Blinking: The computer is in the Sleep state, a power-saving state. The computer shuts off power to the display and other unneeded components. Off: The computer is off or in Hibernation. Hibernation is a power-saving state that uses the least amount of power.
(2) Caps lock light	On: Caps lock is on, which switches the key input to all capital letters.
(3)  Mute light	<ul style="list-style-type: none"> On: Computer sound is off. Off: Computer sound is on.
(4)  Microphone mute light	<ul style="list-style-type: none"> On: Microphone is off. Off: Microphone is on.
(5)  Wireless light	<p>On: An integrated wireless device, such as a wireless local area network (WLAN) device and/or a Bluetooth® device, is on.</p> <p>NOTE: On some models, the wireless light is amber when all wireless devices are off.</p>
(6)  Num lk light	On: Num lock is on.
(7) Fn lock light	On: The fn key is locked.

Button, speakers, and fingerprint sensor

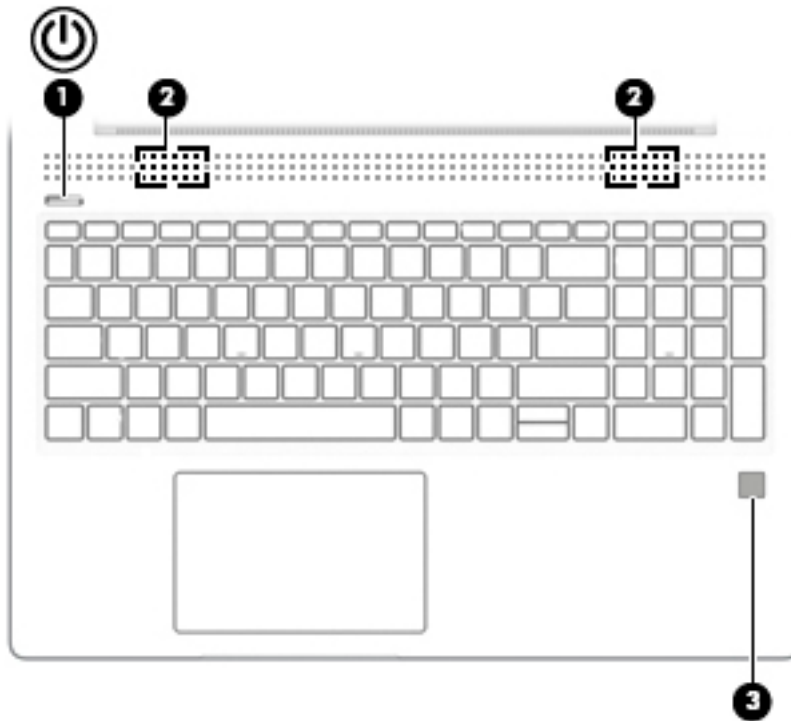



Table 2-7 Button, speakers, and fingerprint sensor and their descriptions

Component	Description
(1)  Power button	<ul style="list-style-type: none"> • When the computer is off, press the button to turn on the computer. • When the computer is on, press the button briefly to initiate Sleep. • When the computer is in the Sleep state, press the button briefly to exit Sleep (select products only). • When the computer is in Hibernation, press the button briefly to exit Hibernation. <p>IMPORTANT: Pressing and holding down the power button results in the loss of unsaved information.</p> <p>If the computer has stopped responding and shutdown procedures are ineffective, press and hold the power button for at least 5 seconds to turn off the computer.</p> <p>To learn more about your power settings, see your power options.</p> <p>▲ Right-click the Power meter icon  and then select Power Options.</p>
(2) Speakers (2)	Produce sound.
(3) Fingerprint sensor (select products only)	<p>Allows a fingerprint logon to Windows, instead of a password logon.</p> <p>▲ To use the fingerprint sensor, place your finger on the fingerprint sensor until it reads your fingerprint.</p>

Special keys

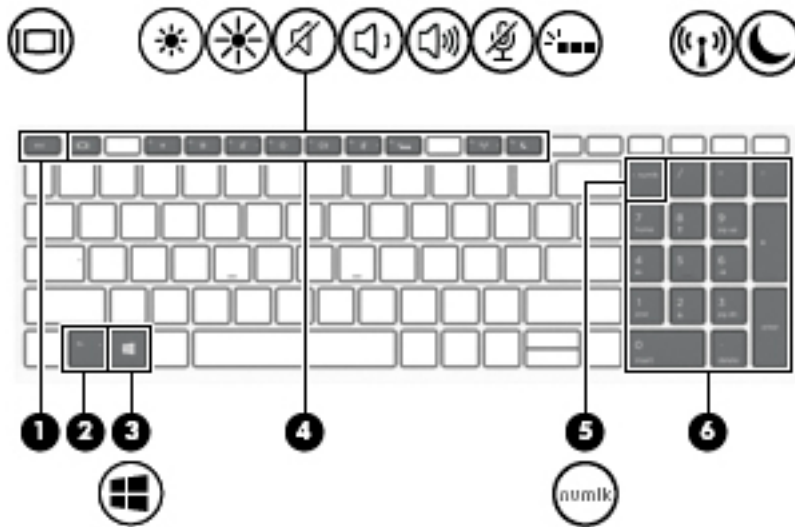



Table 2-8 Special keys and their descriptions

Component	Description
(1) <code>esc</code> key	Displays system information when pressed in combination with the <code>fn</code> key.
(2) <code>fn</code> key	Executes frequently used system functions when pressed in combination with another key. Such key combinations are called <i>hot keys</i> .
(3)  Windows key	Opens the Start menu. NOTE: Pressing the Windows key again will close the Start menu.
(4) Action keys	Execute frequently used system functions.
(5) <code>num lk</code> key	Alternates between the navigational and numeric functions on the integrated numeric keypad.
(6) Integrated numeric keypad	A separate keypad to the right of the alphabet keyboard. When <code>num lk</code> is pressed, the integrated keypad can be used like an external numeric keypad. NOTE: If the keypad function is active when the computer is turned off, that function is reinstated when the computer is turned back on.

Hot keys (select products only)

A hot key is the combination of the **fn** key and another key.

To use a hot key:

- ▲ Press the **fn** key, and then press one of the keys listed in the following table.

Table 2-9 Hot keys and their descriptions

Key	Description
C	Turns on scroll lock.
E	Turns on the insert function.
R	Breaks the operation.
S	Sends a programming query.
W	Pauses the operation.

Bottom

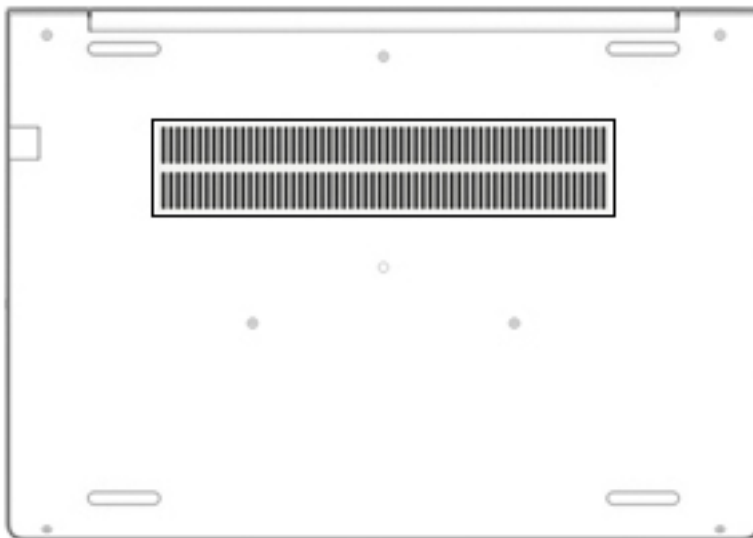

Table 2-10 Bottom components and their descriptions

Component	Description
Vent	Enables airflow to cool internal components. NOTE: The computer fan starts up automatically to cool internal components and prevent overheating. It is normal for the internal fan to cycle on and off during routine operation.

Labels

The labels affixed to the computer provide information you may need when you troubleshoot system problems or travel internationally with the computer. Labels may be in paper form or imprinted on the product.

IMPORTANT: Check the following locations for the labels described in this section: the bottom of the computer, inside the battery bay, under the service door, on the back of the display, or on the bottom of a tablet kickstand.

- Service label—Provides important information to identify your computer. When contacting support, you may be asked for the serial number, the product number, or the model number. Locate this information before you contact support.

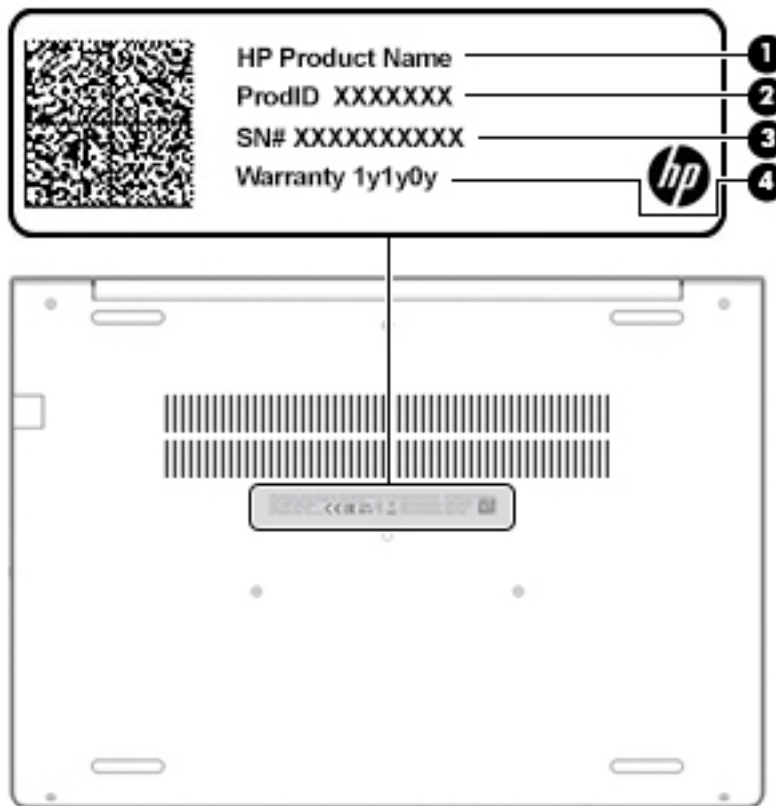

Table 2-11 Service label components

Component
(1) HP product name
(2) Product ID
(3) Serial number
(4) Warranty period

- Regulatory label(s)—Provide(s) regulatory information about the computer.
- Wireless certification label(s)—Provide(s) information about optional wireless devices and the approval markings for the countries or regions in which the devices have been approved for use.

3 Illustrated parts catalog

Computer major components

 **NOTE:** HP continually improves and changes product parts. For complete and current information on supported parts for your computer, go to <http://partsurfer.hp.com>, select your country or region, and then follow the on-screen instructions.

 **NOTE:** Details about your computer, including model, serial number, product key, and length of warranty, are on the service tag at the bottom of your computer. See [Labels on page 16](#) for details.

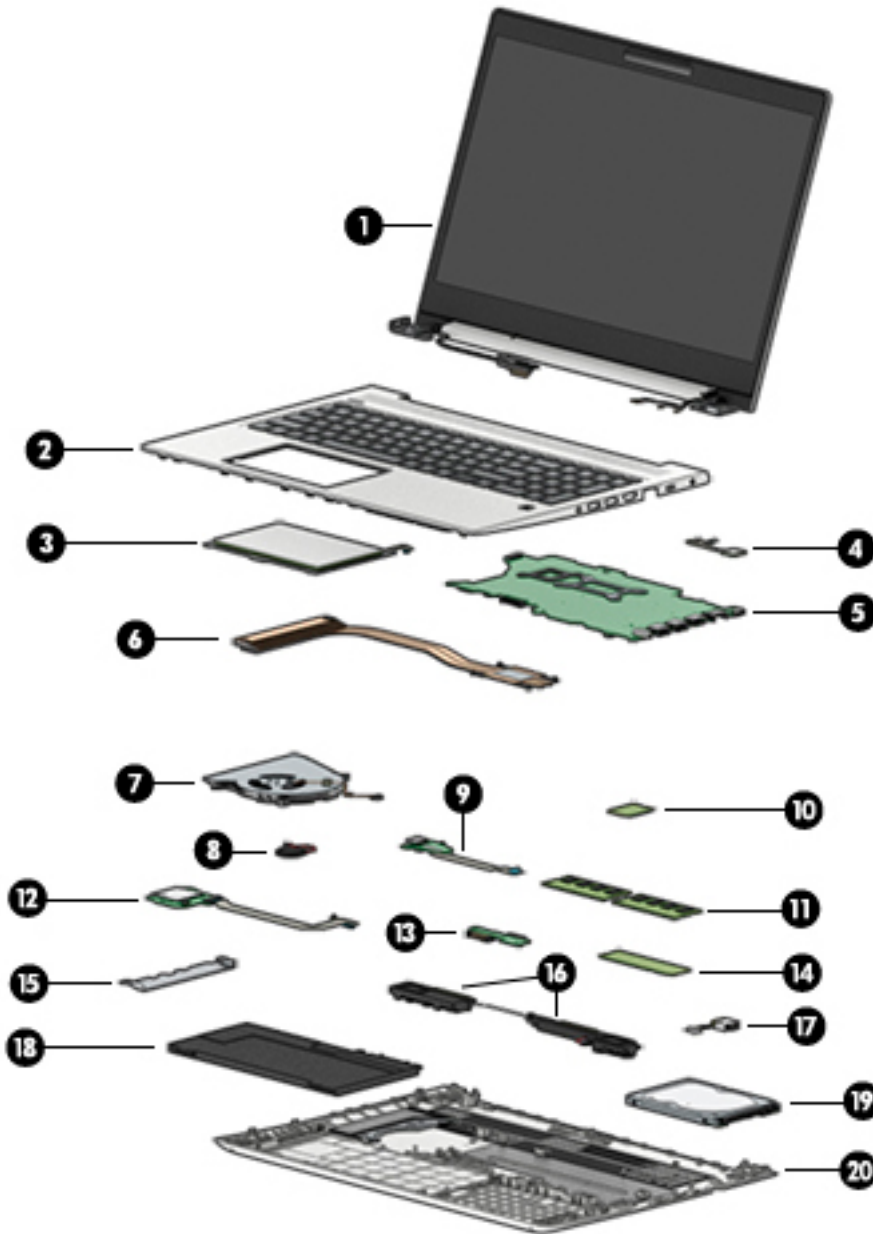

Table 3-1 Computer major components and their descriptions

Item	Description	Spare part number
(1)	Display panel assembly NOTE: Display panels are not spared as a whole assembly. They are only spared at a subcomponent level.	
(2)	Top cover/keyboard (includes cable) NOTE: For a detailed list of keyboard country codes, see Keyboard/top cover on page 66 .	
	No backlight	L45091-xxx
	Backlit	L45090-xxx
(3)	Touchpad NOTE: The touchpad cable is available in the Cable Kit as spare part number L52208-001.	L45093-001
(4)	Fingerprint sensor assembly NOTE: The fingerprint sensor cable is available in the Cable Kit as spare part number L52208-001.	L45096-001
(5)	System board (includes integrated processor and replacement thermal material) All system boards use the following part numbers: xxxxxx-001: Non-Windows operating system xxxxxx-601: Windows 10 operating system	
	AMD Ryzen 5 3500U processor	L58788-xxx
	AMD Ryzen 3 3200U processor	L58789-xxx
(6)	Heat sink (includes replacement thermal material)	L45098-001
(7)	Fan	L45100-001
(8)	RTC battery	L02772-001
(9)	Power/USB board (includes cable) NOTE: The power/USB board cable is also available in the Cable Kit as spare part number L52208-001.	L44578-001
(10)	WLAN module	
	Realtek RTL8821CE 802.11ac 1 × 1 Wi-Fi + Bluetooth 4.2 combination adapter	915621-001
	Realtek RTL8822BE 802.11ac 2 × 2 Wi-Fi + Bluetooth 4.2 combination adapter	915623-001
(11)	Memory modules (DDR4-2400)	
	8 GB	937236-850
	4 GB	L10598-850
(12)	Card reader board (includes cable) NOTE: The card reader board cable is also available in the Cable Kit as spare part number L52208-001.	L52223-001
(13)	Battery connector board	L45086-001
(14)	M.2 solid-state drive	
	512 GB, PCIe, TLC	L59049-001

Table 3-1 Computer major components and their descriptions (continued)

Item	Description	Spare part number
	512 GB, PCIe, value	L59050-001
	256 GB, PCIe	L59048-001
	128 GB, SATA-3, TLC	L59047-001
(15)	Thermal bracket (included in Bracket Kit)	L45097-001
(16)	Speaker assembly	L45092-001
(17)	Power connector cable	L01048-001
(18)	Battery	L32656-005
(19)	Hard drive	
	1 TB, 5400 rpm, 7 mm	L30422-001
	500 GB, 7200 rpm, 7 mm	703267-001
(20)	Bottom cover	L45088-001

Display components

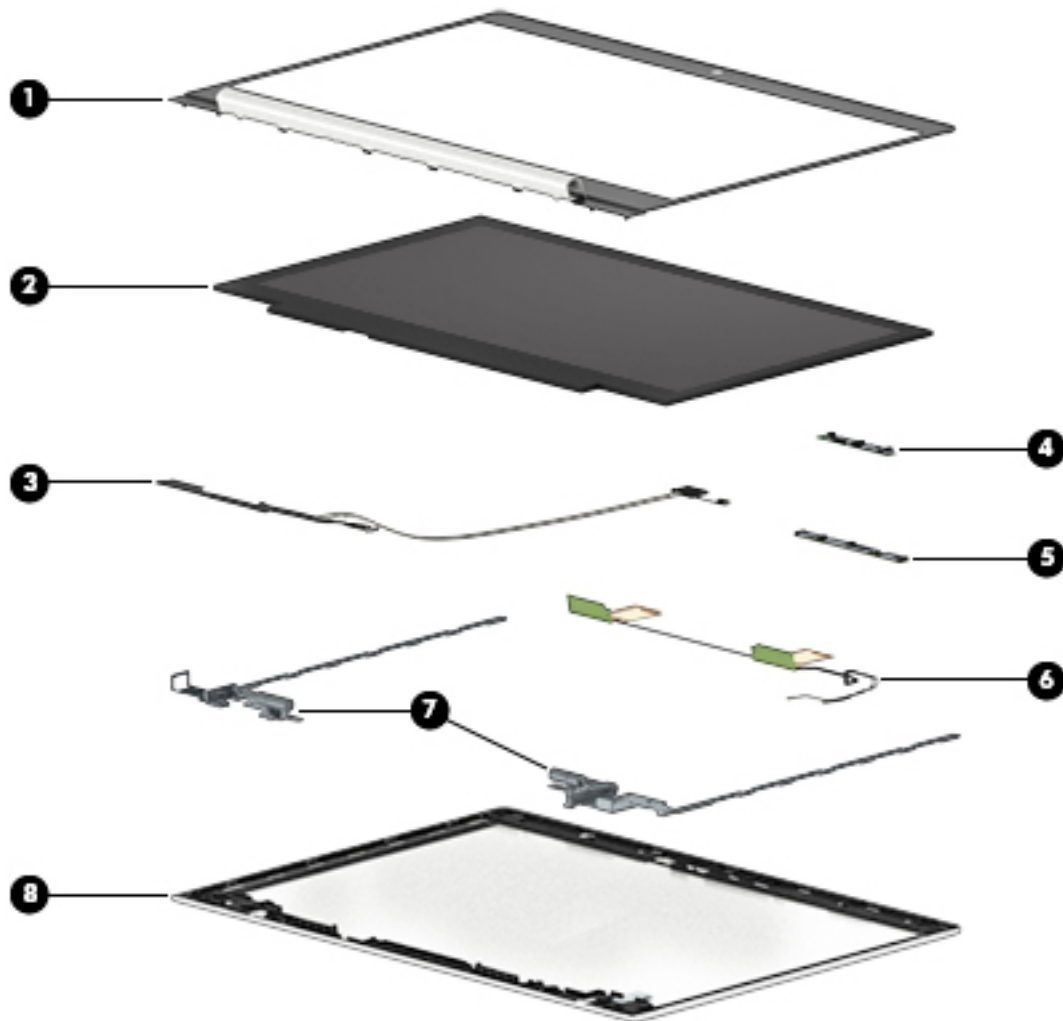

Table 3-2 Display components and their descriptions

Item	Description	Spare part number
(1)	Display bezel	
	Models without a camera	L45116-001
	Models with an HD camera	L45114-001
	Models with an HD+IR camera	L45115-001
(2)	Display panel (raw)	
	FHD, UWVA	L52212-001
	FHD, UWVA, 250 nits	L62785-001
	HD, SVA	L52213-001
(3)	Display/camera cable assembly (models with an HD camera)	L45144-001
	Display/camera cable assembly (models with an HD+IR camera; not illustrated)	L45145-001

Table 3-2 Display components and their descriptions (continued)

Item	Description	Spare part number
(4)	Camera module (HD camera)	L45118-001
(5)	Camera module (HD+IR camera)	L45119-001
	Microphone board (includes protective tape; not illustrated)	L65700-001
(6)	WLAN antennas (dual antennas)	L45112-001
	WLAN antenna (single antenna; not illustrated)	L45111-001
(7)	Hinge Kit (includes left and right hinges)	L45117-001
(8)	Display rear cover (includes wireless antennas)	
	For use in models with an HD camera	L45110-001
	For use in models with an IR camera	L51974-001

Cable Kit

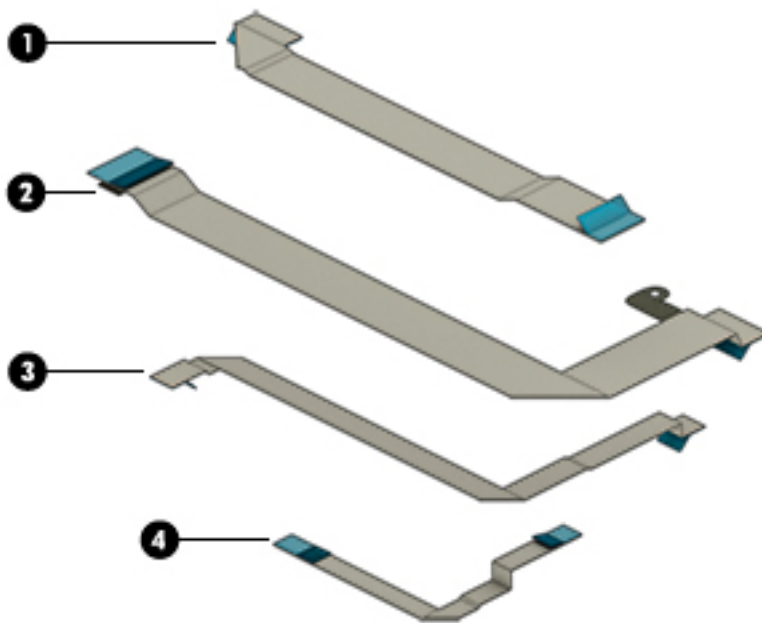
**Table 3-3 Cable Kit components and their descriptions**

Item	Description	Spare part number
	Cable Kit , includes the following parts:	L52208-001
(1)	Power/USB board cable	
(2)	Card reader board cable	
(3)	Touchpad cable	
(4)	Fingerprint sensor cable	

Bracket Kit

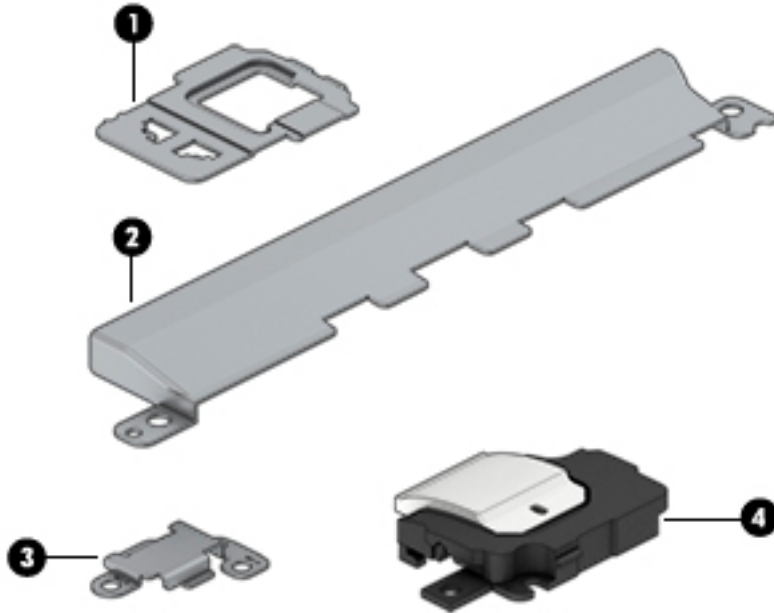

Table 3-4 Bracket Kit components and their descriptions

Item	Description	Spare part number
	Bracket Kit , includes the following parts:	L45097-001
(1)	Fingerprint sensor bracket	
(2)	Thermal bracket	
(3)	USB Type-C port bracket	
(4)	RJ-45 bracket	

Mass storage devices

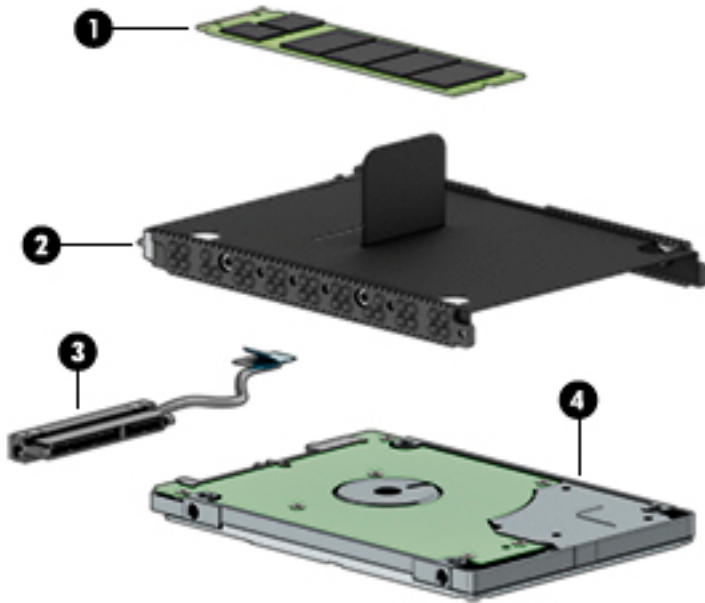

Table 3-5 Mass storage devices and their descriptions

Item	Description	Spare part number
(1)	Solid-state drive, M.2	
	512 GB, PCIe, TLC	L59049-001
	512 GB, PCIe, value	L59050-001
	256 GB, PCIe	L59048-001
	128 GB, SATA-3, TLC	L59047-001
(2)	Hard drive	
	1 TB, 5400 rpm, 7 mm	L30422-001
	500 GB, 7200 rpm, 7 mm	703267-001
	Hard Drive Hardware Kit , includes the following parts:	L45094-001
(3)	Hard drive cover	
(4)	Hard drive cable	
	Hard drive bracket (not illustrated; used to add a hard drive to models with a solid-state drive as primary storage)	L45781-001

Miscellaneous parts

Table 3-6 Miscellaneous parts and their descriptions

Description	Spare part number
AC adapters	
65 W Smart AC power adapter, 4.5 mm barrel connector, S-3P, EM	913691-850
65 W Smart AC power adapter, 4.5 mm barrel connector, S-3P, nPFC	710412-001
65 W, USB Type-C, wall mount, nPFC, 1.8 m	L32392-001
45 W Smart AC power adapter, 4.5 mm barrel connector	741727-001
45 W Smart AC power adapter, 4.5 mm barrel connector, 2 prong	742436-001
45 W, USB Type-C, wall mount, nPFC, 1.8 m	L32390-001
45 W, USB-PD, nPFC, 3 pin	934739-850
Plastics Kit (includes fingerprint sensor insert, touchpad protective tape, foil, and conductive tape)	L45095-001
Screw Kit	L45121-001
Top load case	679921-001
Messenger bag	679922-001
Backpack	679923-001
HP USB-C Universal Dock	935326-001
HP USB-C Mini Dock	935327-001
HP Thunderbolt Dock 120 W (includes cable)	L15809-001
HP USB-C Dock G4	L16133-001
HP Dock Audio Module	L15811-001
HP USB laser mouse	674318-001
HP comfort grip wireless mouse	691922-001
HP USB travel mouse	757770-001
HP smart AC adapter dongle, 7.4 mm	734734-001
Power cord (3 pin, C5, black, conventional, 1.0-m), for use in:	
Argentina	L19357-001
Australia	L19358-001
Brazil	L19359-001
Denmark	L19360-001
Europe (Austria, Belgium, Finland, France, Germany, the Netherlands, Norway and Sweden)	L19361-001
India	L19363-001
Israel	L19362-001
Italy	L19364-001
Japan	L19365-001

Table 3-6 Miscellaneous parts and their descriptions (continued)

Description	Spare part number
North America	L19367-001
People's Republic of China	L19368-001
South Africa	L19369-001
South Korea	L19366-001
Switzerland	L19370-001
Taiwan	L19372-001
Thailand	L19371-001
United Kingdom and Singapore	L19373-001
Power cord (3 pin, C5, black, conventional, 1.8-m), for use in:	
Argentina	L19357-002
Australia	L19358-002
Denmark	L19360-002
Europe (Austria, Belgium, Finland, France, Germany, the Netherlands, Norway and Sweden)	L19361-002
India	L19363-002
Israel	L19362-002
Italy	L19364-002
Japan	L19365-002
North America	L19367-002
The People's Republic of China	L19368-002
South Africa	L19369-002
South Korea	L19366-002
Switzerland	L19370-002
Taiwan	L19372-002
Thailand	L19371-002
United Kingdom and Singapore	L19373-002
Power cord (C7, black, 1.0 m), for use in:	
Japan	L19375-001
Power cord (3 pin, C5NS, black, duckhead, 1.0-m), for use in:	
Australia	L36816-001
Denmark	L36817-001
Europe (Austria, Belgium, Finland, France, Germany, the Netherlands, Norway and Sweden)	L36818-001
Israel	L36819-001
Japan	L36821-001

Table 3-6 Miscellaneous parts and their descriptions (continued)

Description	Spare part number
North America	L36822-001
The People's Republic of China	L36823-001
South Africa	L36824-001
Switzerland	L36825-001
Thailand	L36826-001
Taiwan	L36827-001
United Kingdom	L36828-001
Italy	L44788-001
Brazil	L44789-001
Power cord (3 pin, C5NS, black, duckhead, 1.8-m), for use in:	
Australia	L45264-001
Europe (Austria, Belgium, Finland, France, Germany, the Netherlands, Norway and Sweden)	L45265-001
Israel	L45266-001
Italy	L45267-001
Japan	L45268-001
North America	L45269-001
The People's Republic of China	L45270-001
South Africa	L45271-001
Switzerland	L45272-001
Taiwan	L45274-001
Thailand	L45273-001
United Kingdom	L45275-001
Power cord (duckhead, C5NS), for use in:	
Australia	L50818-004
Brazil	L48055-001
North America	L50818-002
The People's Republic of China	L50818-005
South Korea	L50818-001
The United Kingdom	L50818-003

4 Removal and replacement procedures preliminary requirements

Tools required

You will need the following tools to complete the removal and replacement procedures:

- Tweezer
- Non-conductive, non-marking plastic tool
- Magnetic Phillips P1 screwdriver
- Magnetic Torx T8 screwdriver

Service considerations

Keep these considerations in mind during disassembly and assembly procedures.

 **NOTE:** As you remove each subassembly from the computer, place the subassembly (and all accompanying screws) away from the work area to prevent damage.

Plastic parts

 **IMPORTANT:** Using excessive force during disassembly and reassembly can damage plastic parts.

Cables and connectors

 **IMPORTANT:** When servicing the computer, be sure that cables are placed in their proper locations during the reassembly process. Improper cable placement can damage the computer.

Cables must be handled with extreme care to avoid damage. Apply only the tension required to unseat or seat the cables during removal and insertion. Handle cables by the connector whenever possible. In all cases, avoid bending, twisting, or tearing cables. Be sure that cables are routed in such a way that they cannot be caught or snagged by parts being removed or replaced. Handle flex cables with extreme care; these cables tear easily.

Drive handling



IMPORTANT: Drives are fragile components that must be handled with care. To prevent damage to the computer, damage to a drive, or loss of information, observe these precautions:

Before removing or inserting a hard drive, shut down the computer. If you are unsure whether the computer is off or in Hibernation, turn the computer on, and then shut it down through the operating system.

Before handling a drive, be sure that you are discharged of static electricity. While handling a drive, avoid touching the connector.

Before removing an optical drive, be sure that a disc is not in the drive and be sure that the optical drive tray is closed.

Handle drives on surfaces covered with at least one inch of shock-proof foam.

Avoid dropping drives from any height onto any surface.

After removing a hard drive or an optical drive, place it in a static-proof bag.

Avoid exposing an internal hard drive to products that have magnetic fields, such as monitors or speakers.

Avoid exposing a drive to temperature extremes or liquids.

If a drive must be mailed, place the drive in a bubble pack mailer or other suitable form of protective packaging and label the package “FRAGILE.”

Workstation guidelines

Follow these grounding workstation guidelines:

- Cover the workstation with approved static-shielding material.
- Use a wrist strap connected to a properly grounded work surface and use properly grounded tools and equipment.
- Use conductive field service tools, such as cutters, screw drivers, and vacuums.
- When fixtures must directly contact dissipative surfaces, use fixtures made only of static-safe materials.
- Keep the work area free of nonconductive materials, such as ordinary plastic assembly aids and Styrofoam.
- Handle ESD-sensitive components, parts, and assemblies by the case or PCM laminate. Handle these items only at static-free workstations.
- Avoid contact with pins, leads, or circuitry.
- Turn off power and input signals before inserting or removing connectors or test equipment.

Electrostatic discharge information

A sudden discharge of static electricity from your finger or other conductor can destroy static-sensitive devices or microcircuitry. Often the spark is neither felt nor heard, but damage occurs. An electronic device exposed to electrostatic discharge (ESD) might not appear to be affected at all and can work perfectly throughout a normal cycle. The device might function normally for a while, but it has been degraded in the internal layers, reducing its life expectancy.

Networks built into many integrated circuits provide some protection, but in many cases, the discharge contains enough power to alter device parameters or melt silicon junctions.



IMPORTANT: To prevent damage to the device when you are removing or installing internal components, observe these precautions:

Keep components in their electrostatic-safe containers until you are ready to install them.

Before touching an electronic component, discharge static electricity by using the guidelines described in this section.

Avoid touching pins, leads, and circuitry. Handle electronic components as little as possible.

If you remove a component, place it in an electrostatic-safe container.

Generating static electricity

Note the following:

- Different activities generate different amounts of static electricity.
- Static electricity increases as humidity decreases.

Table 4-1 Static electricity occurrence based on activity and humidity

Event	Relative humidity		
	55%	40%	10%
Walking across carpet	7,500 V	15,000 V	35,000 V
Walking across vinyl floor	3,000 V	5,000 V	12,000 V
Motions of bench worker	400 V	800 V	6,000 V
Removing DIPs from plastic tube	400 V	700 V	2,000 V
Removing DIPs from vinyl tray	2,000 V	4,000 V	11,500 V
Removing DIPs from Styrofoam	3,500 V	5,000 V	14,500 V
Removing bubble pack from PCB	7,000 V	20,000 V	26,500 V
Packing PCBs in foam-lined box	5,000 V	11,000 V	21,000 V

Multiple electric components can be packaged together in plastic tubes, trays, or Styrofoam.



NOTE: As little as 700 volts can degrade a product.

Preventing electrostatic damage to equipment

Many electronic components are sensitive to ESD. Circuitry design and structure determine the degree of sensitivity. The following packaging and grounding precautions are necessary to prevent static electricity damage to electronic components.

- To avoid hand contact, transport products in static-safe containers such as tubes, bags, or boxes.
- Protect all electrostatic parts and assemblies with conductive or approved containers or packaging.
- Keep electrostatic-sensitive parts in their containers until they arrive at static-free stations.
- Place items on a grounded surface before removing them from their container.
- Always be properly grounded when touching a sensitive component or assembly.

- Avoid contact with pins, leads, or circuitry.
- Place reusable electrostatic-sensitive parts from assemblies in protective packaging or conductive foam.

Personal grounding methods and equipment

Use the following equipment to prevent static electricity damage to electronic components:

- **Wrist straps** are flexible straps with a maximum of $1\text{ M}\Omega \pm 10\%$ resistance in the ground cords. To provide proper ground, a strap must be worn snug against bare skin. The ground cord must be connected and fit snugly into the banana plug connector on the grounding mat or workstation.
- **Heel straps/Toe straps/Boot straps** can be used at standing workstations and are compatible with most types of shoes or boots. On conductive floors or dissipative floor mats, use them on both feet with a maximum of $1\text{ M}\Omega \pm 10\%$ resistance between the operator and ground.

Table 4-2 Static shielding protection levels

Static shielding protection levels	
Method	Voltage
Antistatic plastic	1,500
Carbon-loaded plastic	7,500
Metallized laminate	15,000

Grounding the work area

To prevent static damage at the work area, take the following precautions:

- Cover the work surface with approved static-dissipative material. Provide a wrist strap connected to the work surface and properly grounded tools and equipment.
- Use static-dissipative mats, foot straps, or air ionizers to give added protection.
- Handle electrostatic sensitive components, parts, and assemblies by the case or PCB laminate. Handle them only at static-free work areas.
- Turn off power and input signals before inserting and removing connectors or test equipment.
- Use fixtures made of static-safe materials when fixtures must directly contact dissipative surfaces.
- Keep work area free of nonconductive materials such as ordinary plastic assembly aids and Styrofoam.
- Use field service tools, such as cutters, screwdrivers, and vacuums, that are conductive.

Recommended materials and equipment

HP recommends the following materials and equipment to prevent static electricity:

- Antistatic tape
- Antistatic smocks, aprons, or sleeve protectors
- Conductive bins and other assembly or soldering aids
- Conductive foam
- Conductive tabletop workstations with ground cord of $1\text{ M}\Omega \pm 10\%$ resistance
- Static-dissipative table or floor mats with hard tie to ground

- Field service kits
- Static awareness labels
- Wrist straps and footwear straps providing $1\text{ M}\Omega \pm 10\%$ resistance
- Material handling packages
- Conductive plastic bags
- Conductive plastic tubes
- Conductive tote boxes
- Opaque shielding bags
- Transparent metallized shielding bags
- Transparent shielding tubes

Packaging and transporting guidelines

Follow these grounding guidelines when packaging and transporting equipment:

- To avoid hand contact, transport products in static-safe tubes, bags, or boxes.
- Protect ESD-sensitive parts and assemblies with conductive or approved containers or packaging.
- Keep ESD-sensitive parts in their containers until the parts arrive at static-free workstations.
- Place items on a grounded surface before removing items from their containers.
- Always be properly grounded when touching a component or assembly.
- Store reusable ESD-sensitive parts from assemblies in protective packaging or nonconductive foam.
- Use transporters and conveyors made of antistatic belts and roller bushings. Be sure that mechanized equipment used for moving materials is wired to ground and that proper materials are selected to avoid static charging. When grounding is not possible, use an ionizer to dissipate electric charges.

5 Removal and replacement procedures for Customer Self-Repair parts

 **IMPORTANT:** The Customer Self-Repair program is not available in all locations. Installing a part not supported by the Customer Self-Repair program may void your warranty. Check your warranty to determine if Customer Self-Repair is supported in your location.

 **NOTE:** HP continually improves and changes product parts. For complete and current information on supported parts for your computer, go to <http://partsurfer.hp.com>, select your country or region, and then follow the on-screen instructions.

Component replacement procedures

 **NOTE:** Please read and follow the procedures described here to access and replace Customer Self-Repair parts successfully.

 **NOTE:** Details about your computer, including model, serial number, product key, and length of warranty, are on the service tag at the bottom of your computer. See [Labels on page 16](#) for details.

This chapter provides removal and replacement procedures for Customer Self-Repair parts.

There are as many as 19 screws that must be removed, replaced, or loosened when servicing Customer Self-Repair parts. Make special note of each screw size and location during removal and replacement.

Preparation for disassembly

See [Removal and replacement procedures preliminary requirements on page 27](#) for initial safety procedures.

1. Turn off the computer. If you are unsure whether the computer is off or in Hibernation, turn the computer on, and then shut it down through the operating system.
2. Disconnect the power from the computer by unplugging the power cord from the computer.
3. Disconnect all external devices from the computer.

Battery Safe mode

Before removing internal components, you must place the computer in Battery Safe mode. This mode avoids short-circuits or system malfunction by removing power from internal components.

To place the computer in Battery Safe mode, follow these steps:

1. With the computer turned off and AC adapter connected, press the following key and button combination: **Windows key + Backspace key + Power button**.
2. Turn the computer on to initiate Battery Safe mode.
3. After the computer powers off, disconnect the AC adapter.

In Battery Safe mode, the power button will not turn the computer on if the AC adapter is not connected.

To disengage Battery Safe mode, plug in the AC adapter and press the power button.

Bottom cover

Table 5-1 Bottom cover description and part number

Description	Spare part number
Bottom cover	L45088-001

Before removing the bottom cover, follow these steps:

1. Prepare the computer for disassembly ([Preparation for disassembly on page 32](#)).
2. Place the computer in Battery Safe mode ([Battery Safe mode on page 32](#)).

Remove the bottom cover:

1. Loosen the five captive Phillips screws (1).
2. Remove the two Phillips M2.0 × 5.0 screws (2) that secure the bottom cover to the computer.
3. Starting under the display, use a non-conductive, non-marking tool to pry the cover up (3), and then remove the bottom cover from the computer (4).

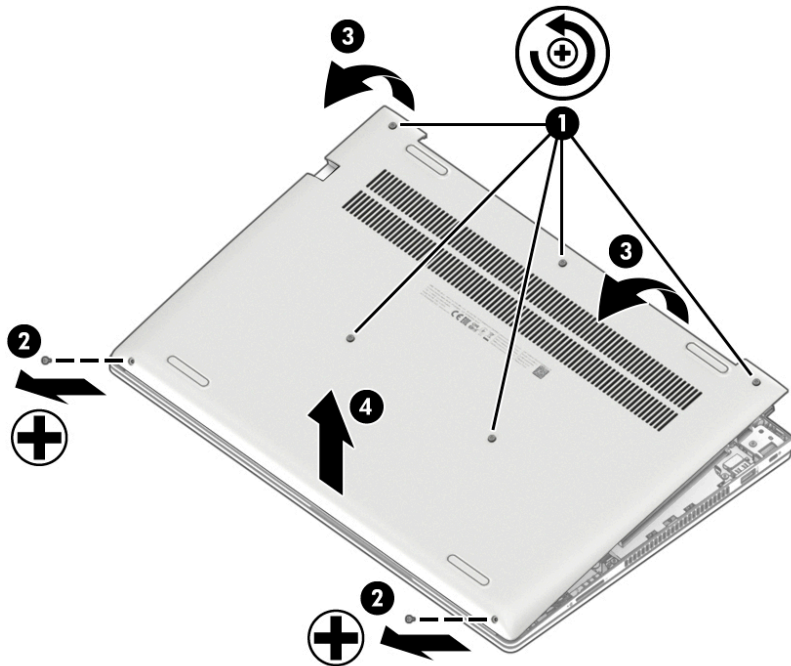

Reverse these procedures to install the bottom cover.

Memory modules

Table 5-2 Memory module descriptions and part numbers

Description	Spare part number
8 GB	937236-850
4 GB	L10598-850

 **IMPORTANT:** Before adding new memory, make sure you update the computer to the latest BIOS from www.hp.com.

Failure to update the computer to the latest BIOS prior to installing new memory may result in various system problems.

Before removing the memory module, follow these steps:

1. Prepare the computer for disassembly ([Preparation for disassembly on page 32](#)).
2. Place the computer in Battery Safe mode ([Battery Safe mode on page 32](#)).
3. Remove the bottom cover ([Bottom cover on page 33](#)).
4. Remove the battery ([Battery on page 41](#)).

Remove the memory module:

1. Spread the retaining tabs **(1)** on each side of the memory module slot to release the memory module. (The edge of the module opposite the slot rises away from the computer.)
2. Remove the memory module **(2)** by pulling the module away from the slot at an angle.

 **NOTE:** Memory modules are designed with a notch to prevent incorrect insertion into the memory module slot.

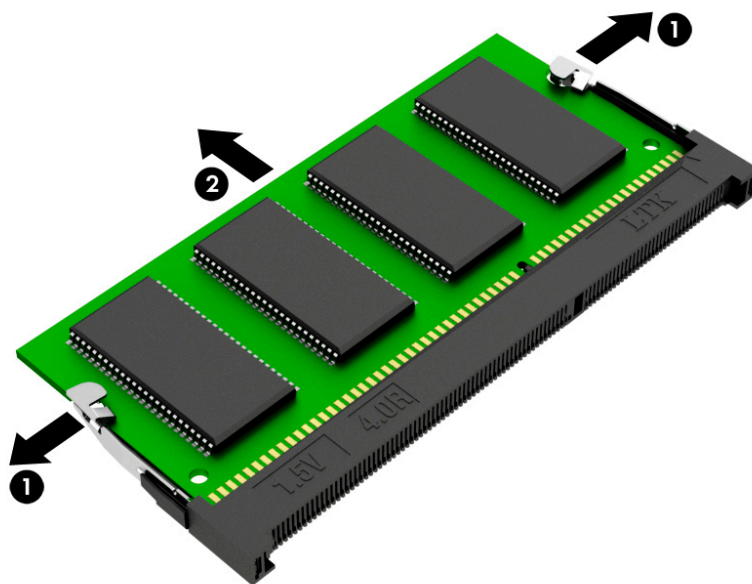

Reverse this procedure to install a memory module.

WLAN/Bluetooth combo card

The computer uses a card that provides both WLAN and Bluetooth functionality.

Table 5-3 WLAN module descriptions and part numbers

Description	Spare part number
Realtek RTL8821CE 802.11 ac 1 × 1 Wi-Fi + Bluetooth 4.2 combination adapter	915621-001
Realtek RTL8822BE 802.11 ac 2 × 2 Wi-Fi + Bluetooth 4.2 combination adapter	915623-001

 **IMPORTANT:** To prevent an unresponsive system, replace the wireless module only with a wireless module authorized for use in the computer by the governmental agency that regulates wireless devices in your country or region. If you replace the module and then receive a warning message, remove the module to restore device functionality, and then contact technical support.

Before removing the WLAN module, follow these steps:

1. Prepare the computer for disassembly ([Preparation for disassembly on page 32](#)).
2. Place the computer in Battery Safe mode ([Battery Safe mode on page 32](#)).
3. Remove the bottom cover ([Bottom cover on page 33](#)).
4. Remove the battery ([Battery on page 41](#)).

Remove the WLAN module:

1. Disconnect the WLAN antenna cables (**1**) from the terminals on the WLAN module.

 **NOTE:** The WLAN antenna cable labeled “1” connects to the WLAN module “Main” terminal labeled “1”. The WLAN antenna cable labeled “2” connects to the WLAN module “Aux” terminal labeled “2”. If the computer is equipped with an 802.11a/b/g/n WLAN module, the yellow WLAN antenna cable connects to the middle terminal on the WLAN module.

2. Remove the Phillips M2.0 × 2.5 screw (**2**) that secures the WLAN module to the computer. (The edge of the module opposite the slot rises away from the computer.)

3. Remove the WLAN module (3) by pulling the module away from the slot at an angle.

 **NOTE:** WLAN modules are designed with a notch to prevent incorrect insertion.

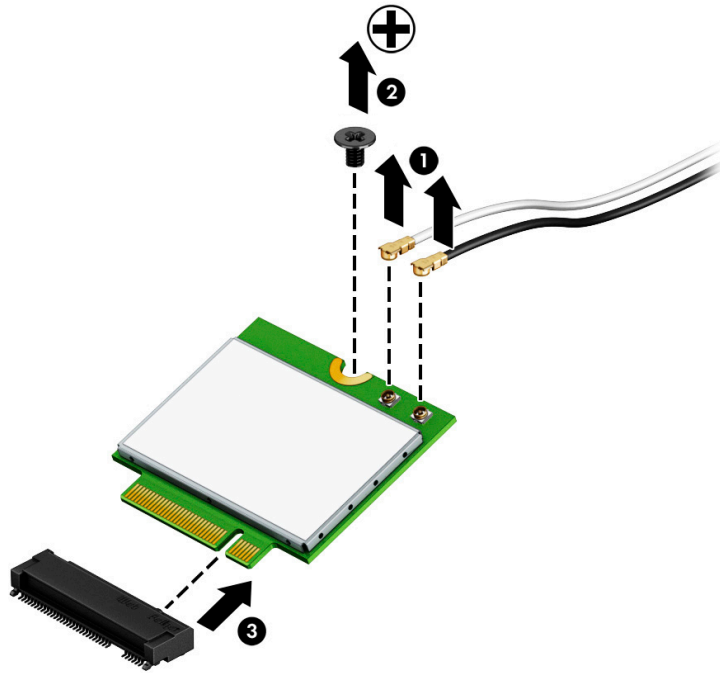

 **NOTE:** If the WLAN antennas are not connected to the terminals on the WLAN module, the protective sleeves must be installed on the antenna connectors, as shown in the following illustration.

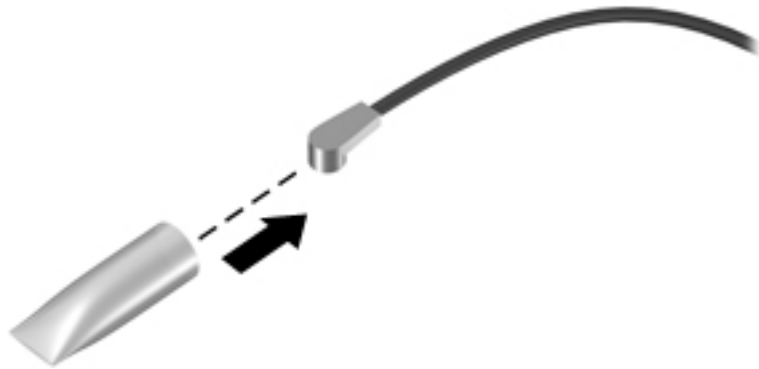

Reverse this procedure to install the WLAN module.

M.2 solid-state drive

Table 5-4 Solid-state drive descriptions and part numbers

Description	Spare part number
512 GB, PCIe, TLC	L59049-001
512 GB, PCIe, value	L59050-001
256 GB, PCIe	L59048-001
128 GB, SATA-3, TLC	L59047-001

Before removing the solid-state drive, follow these steps:

1. Prepare the computer for disassembly ([Preparation for disassembly on page 32](#)).
2. Place the computer in Battery Safe mode ([Battery Safe mode on page 32](#)).
3. Remove the bottom cover ([Bottom cover on page 33](#)).
4. Remove the battery ([Battery on page 41](#)).

Remove the solid-state drive:

1. Remove the Phillips M2.0 × 2.5 screw **(1)** that secures the solid-state drive to the computer.
2. Remove the solid-state drive **(2)** by pulling the module away from the slot at an angle.

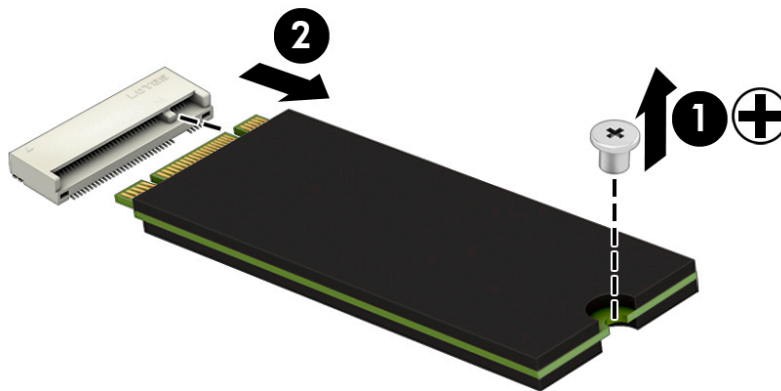

Reverse this procedure to install the solid-state drive.

Hard drive

Table 5-5 Hard drive, Hard Drive Hardware Kit, and hard drive bracket descriptions and part numbers

Description	Spare part number
Hard drive, 1 TB, 5400 rpm, 7 mm	L30422-001
Hard drive, 500 GB, 7200 rpm, 7 mm	703267-001
Hard Drive Hardware Kit (includes hard drive cover and connector)	L45094-001
Hard drive bracket (used to add a hard drive to models with a solid-state drive as primary storage)	

Before removing the hard drive, follow these steps:

1. Prepare the computer for disassembly ([Preparation for disassembly on page 32](#)).
2. Place the computer in Battery Safe mode ([Battery Safe mode on page 32](#)).
3. Remove the bottom cover ([Bottom cover on page 33](#)).
4. Remove the battery ([Battery on page 41](#)).

Remove the hard drive:

1. Release the ZIF connector **(1)**, and then disconnect the hard drive cable from the system board **(2)**.
2. Remove the two Phillips M2.0 × 4.0 screws **(3)** that secure the hard drive to the computer.
3. Lift the tab **(4)**, and then use the tab to lift the hard drive from the bay **(5)**.

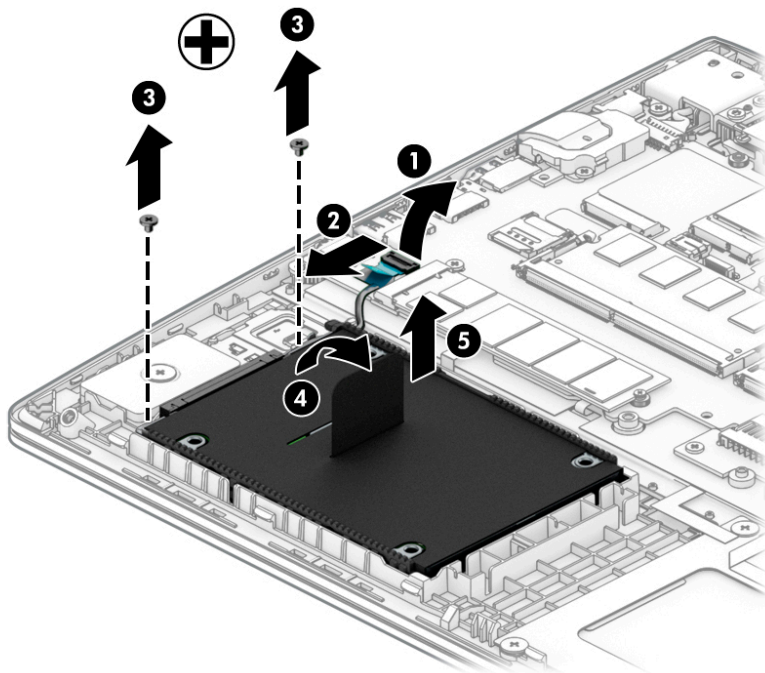

4. To disassemble the hard drive, disconnect the connector from the hard drive **(1)**, remove the four Phillips M3.0 × 3.0 screws **(2)** that secure the cover to the drive, and then lift the cover off the drive **(3)**.

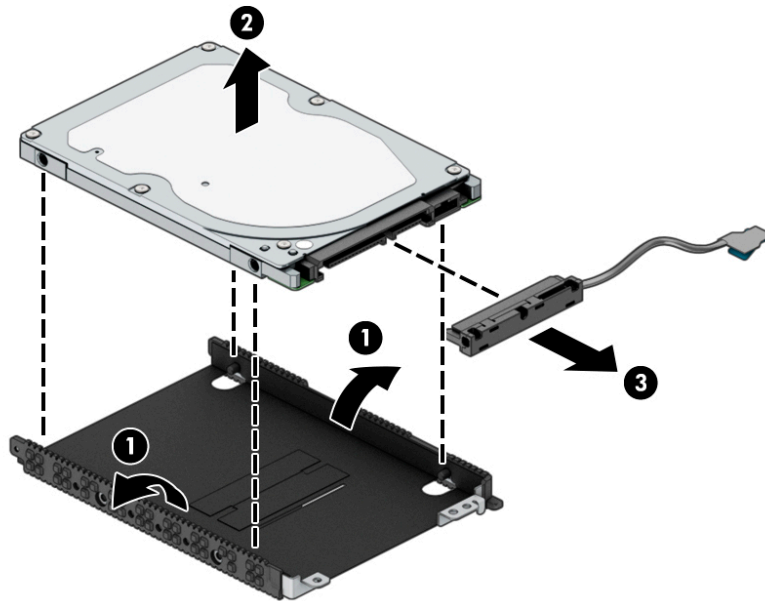

Reverse these procedures to install a hard drive.

6 Removal and replacement procedures for authorized service provider parts

 **IMPORTANT:** Components described in this chapter should only be accessed by an authorized service provider. Accessing these parts can damage the computer or void the warranty.

 **NOTE:** HP continually improves and changes product parts. For complete and current information on supported parts for your computer, go to <http://partsurfer.hp.com>, select your country or region, and then follow the on-screen instructions.

Component replacement procedures

 **NOTE:** Details about your computer, including model, serial number, product key, and length of warranty, are on the service tag at the bottom of your computer. See [Labels on page 16](#) for details.

There are as many as 43 screws that must be removed, replaced, or loosened when servicing Authorized Service Provider only parts. Make special note of each screw size and location during removal and replacement.

Battery

Table 6-1 Battery description and part number

Description	Spare part number
Battery, 3 cell, 45 Whr, 3.92 Ahr	L32656-005

Before removing the battery, follow these steps:

1. Prepare the computer for disassembly ([Preparation for disassembly on page 32](#)).
2. Place the computer in Battery Safe mode ([Battery Safe mode on page 32](#)).
3. Remove the bottom cover ([Bottom cover on page 33](#)).

Remove the battery:

1. Remove the two Phillips M2.0 × 4.0 screws (**1**) that secure the battery to the computer.
2. Remove the broadhead Phillips M2.0 × 2.0 screw (**2**) that secures the battery to the computer.
3. Rotate the top of the battery up (**3**), and then lift the battery out of the computer (**4**).

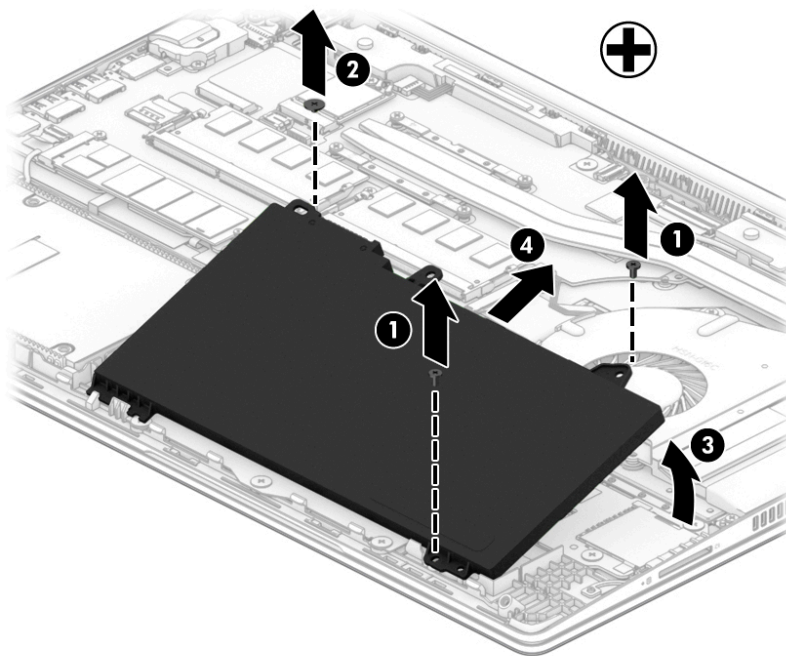

Reverse this procedure to install the battery.

Speaker assembly

Table 6-2 Speaker description and part number

Description	Spare part number
Speaker assembly	L45092-001

Before removing the speaker assembly, follow these steps:

1. Prepare the computer for disassembly ([Preparation for disassembly on page 32](#)).
2. Place the computer in Battery Safe mode ([Battery Safe mode on page 32](#)).
3. Remove the bottom cover ([Bottom cover on page 33](#)).
4. Remove the battery ([Battery on page 41](#)).

Remove the speaker assembly:

1. Disconnect the speaker cable from the system board **(1)**.
2. Remove the antenna cables from the routing channel in the right speaker **(2)**.
3. Remove the display cable from the routing channel near the left speaker **(3)**.
4. Remove the two Phillips M2.0 × 5.5 screws **(4)** that secure the speakers to the computer.
5. Remove the speakers from the computer **(5)**.

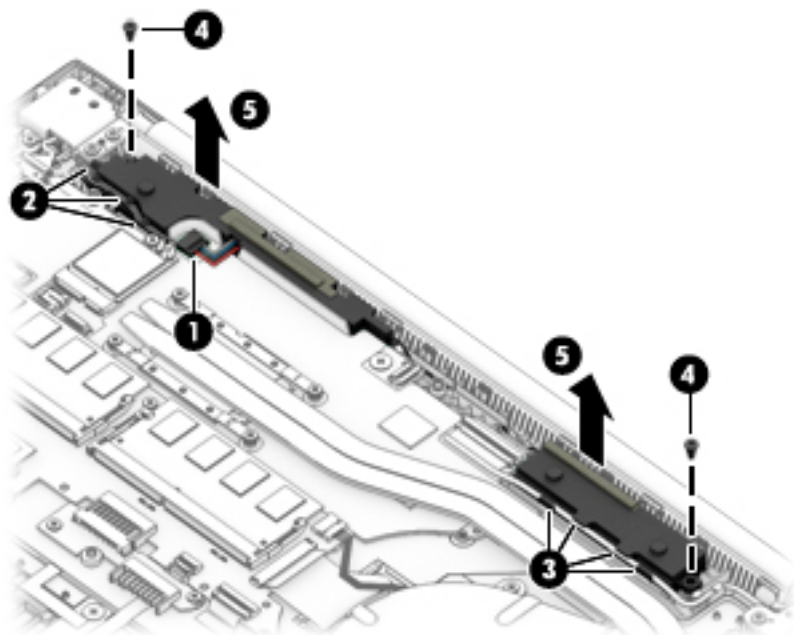

Reverse this procedure to install the speaker assembly.

Fan

Table 6-3 Fan description and part number

Description	Spare part number
Fan	L45100-001

 **NOTE:** To properly ventilate the computer, allow at least **7.6 cm (3.0 in)** of clearance on the sides of the computer. The computer uses an electric fan for ventilation. The fan is controlled by a temperature sensor and is designed to turn on automatically when high temperature conditions exist. These conditions are affected by high external temperatures, system power consumption, power management/battery conservation configurations, battery fast charging, and software requirements. Exhaust air is displaced through the ventilation grill.

Before removing the fan, follow these steps:

1. Prepare the computer for disassembly ([Preparation for disassembly on page 32](#)).
2. Place the computer in Battery Safe mode ([Battery Safe mode on page 32](#)).
3. Remove the bottom cover ([Bottom cover on page 33](#)).
4. Remove the battery ([Battery on page 41](#)).

Remove the fan:

1. Disconnect the fan cable (**1**) from the system board and remove the tape (**2**) that secures the cable.
2. Remove the Phillips M2.0 × 4.0 screw (**3**) that secures the fan to the computer.
3. Slide the fan out from under the heat sink (**4**), and then lift the fan out of the computer (**5**).

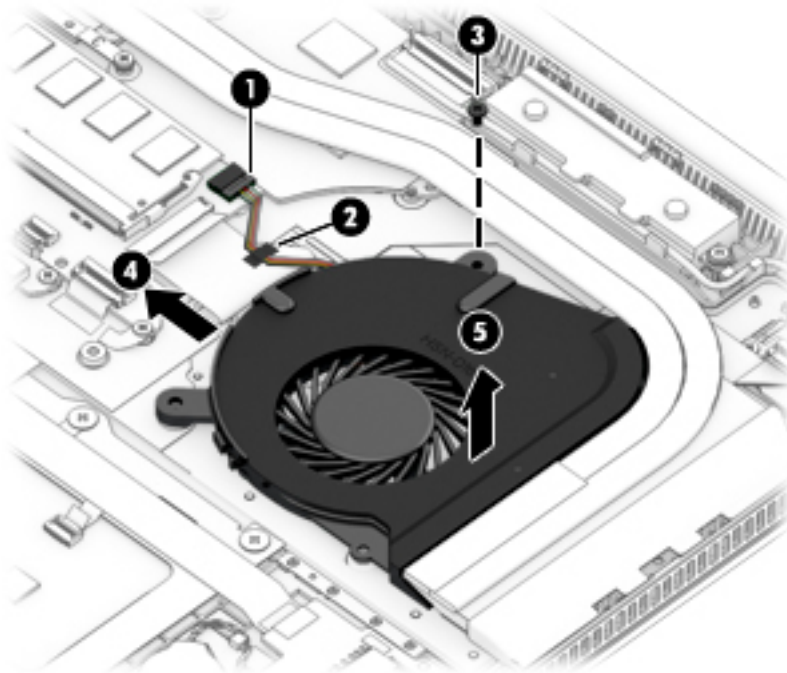

Reverse this procedure to install the fan.

Heat sink

 **NOTE:** All heat sink spare part kits include replacement thermal material.

Table 6-4 Heat sink description and part number

Description	Spare part number
Heat sink	L45098-001

Before removing the heat sink, follow these steps:

1. Prepare the computer for disassembly ([Preparation for disassembly on page 32](#)).
2. Place the computer in Battery Safe mode ([Battery Safe mode on page 32](#)).
3. Remove the bottom cover ([Bottom cover on page 33](#)).
4. Remove the battery ([Battery on page 41](#)).

Remove the heat sink:

1. In the order indicated on the heat sink, loosen the four captive Phillips screws **(1)** that secure the heat sink to the system board.
2. Lift the heat sink from the system board **(2)**, and then pull the heat sink away from the side of the chassis to remove it **(3)**.

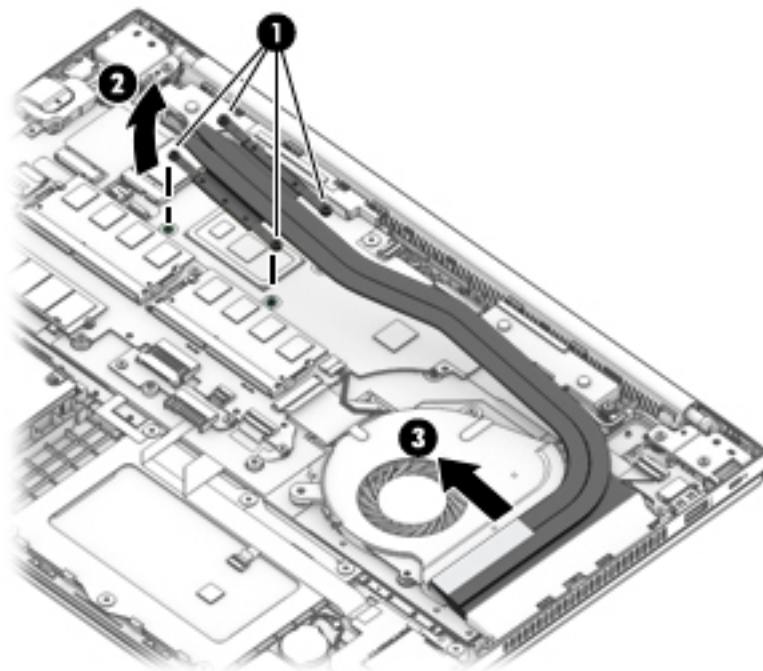

3. Thoroughly clean thermal material from the surfaces of the system board component **(1)** and the heat sink **(2)** each time you remove the heat sink. All heat sink and system board spare part kits include thermal material.

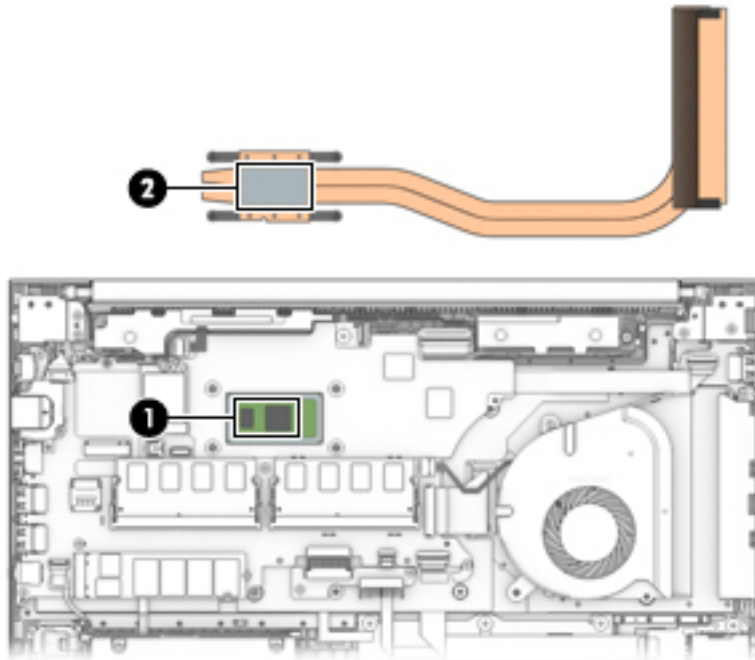

Reverse this procedure to install the heat sink.

Power/USB board

Table 6-5 Power/USB board, cable, and bracket descriptions and part numbers

Description	Spare part number
Power/USB board	L44578-001
Power/USB board cable (included in Cable Kit)	L52208-001
Thermal bracket (included in Bracket Kit)	L45097-001

Before removing the power/USB board, follow these steps:

1. Prepare the computer for disassembly ([Preparation for disassembly on page 32](#)).
2. Place the computer in Battery Safe mode ([Battery Safe mode on page 32](#)).
3. Remove the bottom cover ([Bottom cover on page 33](#)).
4. Remove the battery ([Battery on page 41](#)).

Remove the power/USB board:

1. Remove the two Phillips M2.0 × 4.0 screws **(1)** that secure the thermal bracket to the computer.
2. Lift the bracket out of the computer **(2)**.

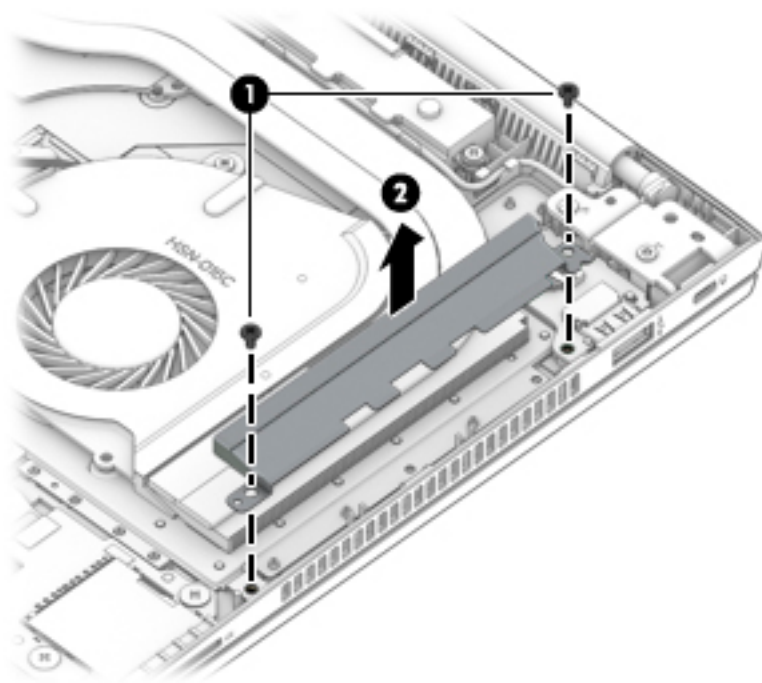

3. Disconnect the cable from the ZIF connector on the power/USB board **(1)**.
4. Remove the Phillips M2.0 × 4.0 screw **(2)** that secures the board to the computer.

5. Lift the rear of the board up, and then pull the board away from the connector and out of the computer to remove it **(3)**.

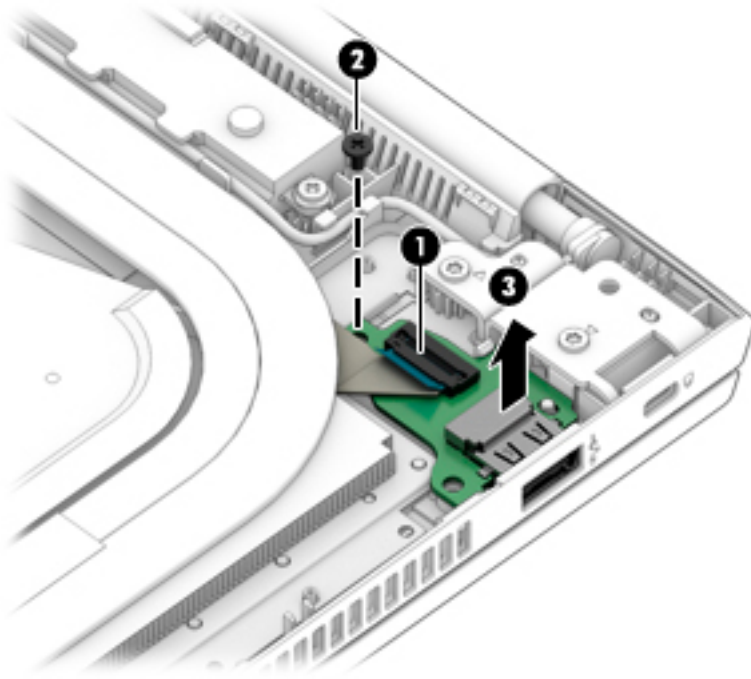

Reverse this procedure to install the power/USB board.

Battery connector board

Table 6-6 Battery connector board description and part number

Description	Spare part number
Battery connector board	L45086-001

Before removing the battery connector board, follow these steps:

1. Prepare the computer for disassembly ([Preparation for disassembly on page 32](#)).
2. Place the computer in Battery Safe mode ([Battery Safe mode on page 32](#)).
3. Remove the bottom cover ([Bottom cover on page 33](#)).
4. Remove the battery ([Battery on page 41](#)).

Remove the battery connector board:

1. Remove the two Phillips M2.0 × 2.5 screws **(1)** that secure the board to the computer.
2. Rotate the battery side of the board upward **(2)**, and then pull the board away from the connector on the system board **(3)**.

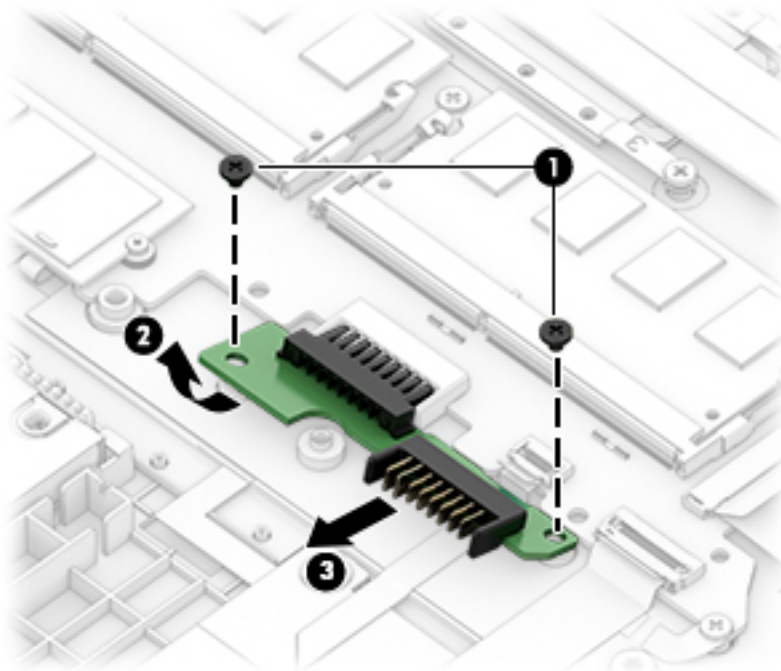

Reverse this procedure to install the battery connector board.

Touchpad assembly

Table 6-7 Touchpad assembly and cable descriptions and part numbers

Description	Spare part number
Touchpad assembly	L45093-001

NOTE: The touchpad cable is available in the Cable Kit as spare part number L52208-001.

Before removing the touchpad assembly, follow these steps:

1. Prepare the computer for disassembly ([Preparation for disassembly on page 32](#)).
2. Place the computer in Battery Safe mode ([Battery Safe mode on page 32](#)).
3. Remove the bottom cover ([Bottom cover on page 33](#)).
4. Remove the battery ([Battery on page 41](#)).

Remove the touchpad assembly:

1. Disconnect the cable from the ZIF connector on the touchpad **(1)**.
2. Lift the cable to remove it from the adhesive that secures it to the touchpad **(2)**.
3. Lift the two pieces of silver tape from the touchpad **(3)**.
4. Remove the six broadhead Phillips M2.0 × 2.0 screws **(4)** that secure the touchpad to the computer.
5. Lift the touchpad out of the computer **(5)**.

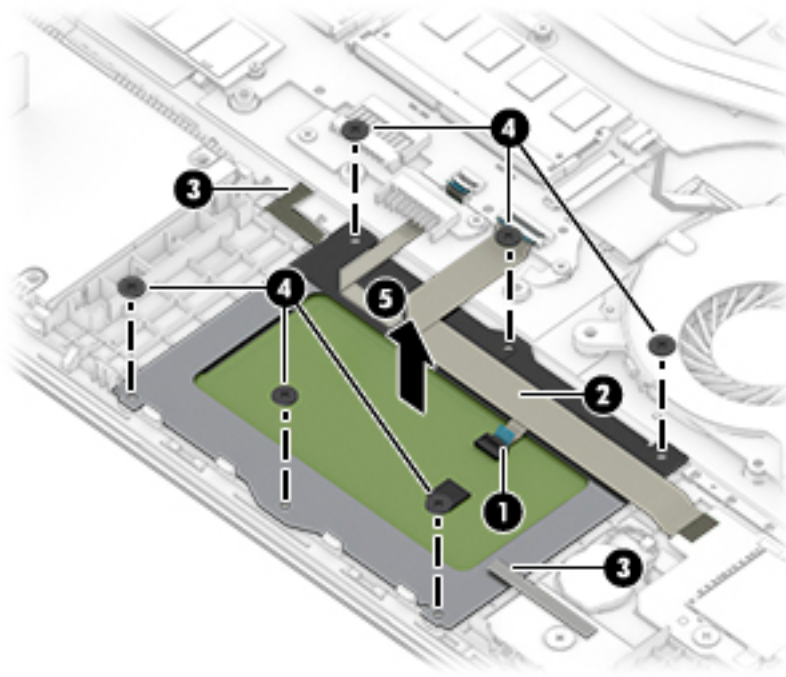

Reverse this procedure to install the touchpad assembly.

Fingerprint sensor assembly

Table 6-8 Fingerprint sensor assembly, cable, bracket, and insert descriptions and part numbers

Description	Spare part number
Fingerprint sensor assembly	L45096-001
Fingerprint sensor bracket (included in Bracket Kit)	L45097-001
Fingerprint sensor cable (included in the Cable Kit)	L52208-001
Fingerprint sensor insert (included in Plastics Kit; for use in models without a fingerprint sensor)	LL45095-001

Before removing the fingerprint sensor assembly, follow these steps:

1. Prepare the computer for disassembly ([Preparation for disassembly on page 32](#)).
2. Place the computer in Battery Safe mode ([Battery Safe mode on page 32](#)).
3. Remove the following components:
 - a. Bottom cover ([Bottom cover on page 33](#)).
 - b. Battery ([Battery on page 41](#)).
 - c. Hard drive ([Hard drive on page 38](#))

Remove the fingerprint sensor assembly:

1. Slide the bracket toward the inside of the computer, and then lift it off the fingerprint sensor board **(1)**.

 **TIP:** A tool may be required to push and disengage the bracket.

2. Disconnect the cable from the ZIF connector on the fingerprint sensor **(2)**.
3. From the top of the computer, push the fingerprint sensor up to disengage and remove it **(3)**.

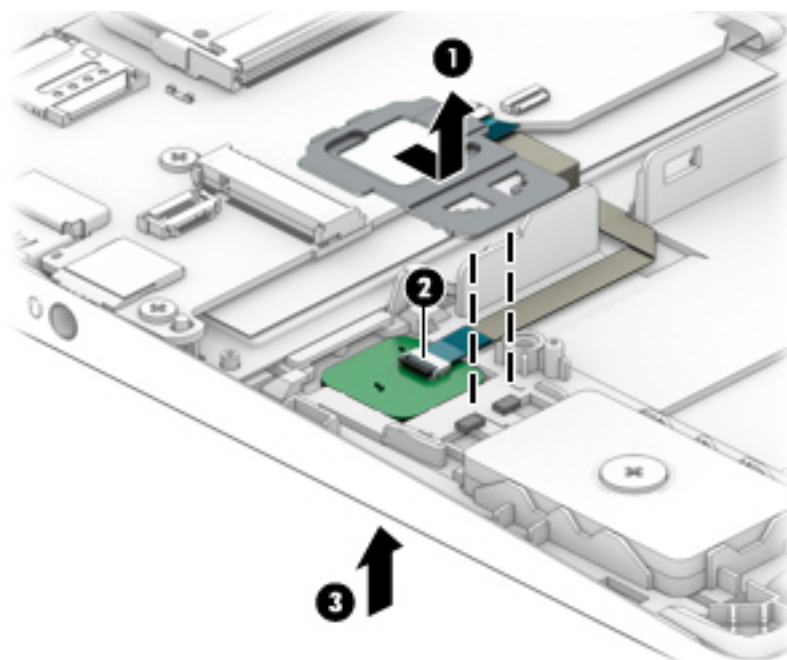

Reverse this procedure to install the fingerprint sensor assembly.

Card reader board

Table 6-9 Card reader board and cable descriptions and part numbers

Description	Spare part number
Card reader board assembly (includes cable)	L52223-001

NOTE: The card reader board cable is also available in the Cable Kit as spare part number L52208-001.

Before removing the card reader board, follow these steps:

1. Prepare the computer for disassembly ([Preparation for disassembly on page 32](#)).
2. Place the computer in Battery Safe mode ([Battery Safe mode on page 32](#)).
3. Remove the bottom cover ([Bottom cover on page 33](#)).
4. Remove the battery ([Battery on page 41](#)).

Remove the card reader board:

1. Remove the two Phillips M2.0 × 2.0 screws **(1)** that secure the card reader board to the computer.
2. Remove the tape from the cable **(2)**.
3. Position the board upside down so you can access the connectors underneath **(3)**.

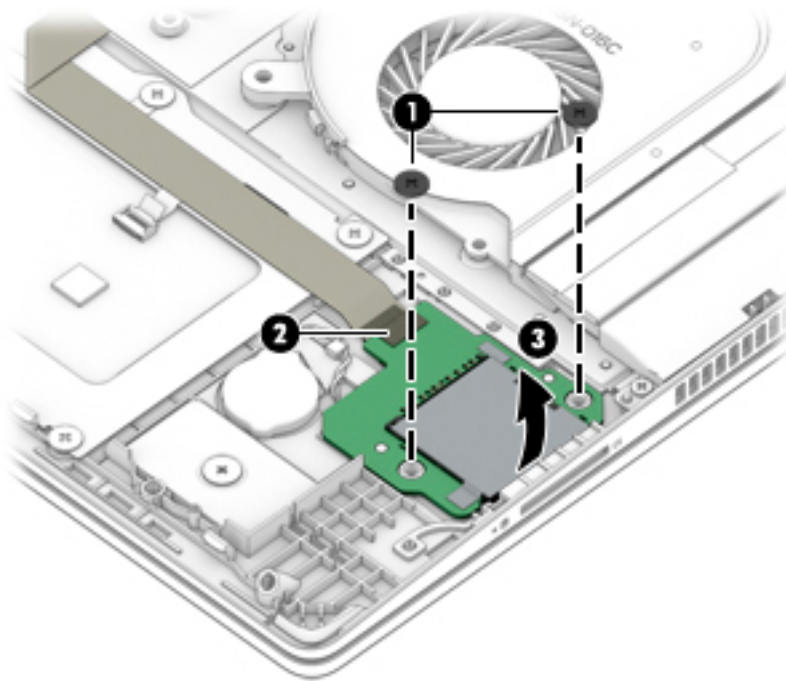

4. Disconnect the RTC battery from the card reader board **(1)**.
5. Disconnect the card reader board cable from the card reader board ZIF connector **(2)**.

6. Lift the card reader board out of the computer **(3)**.

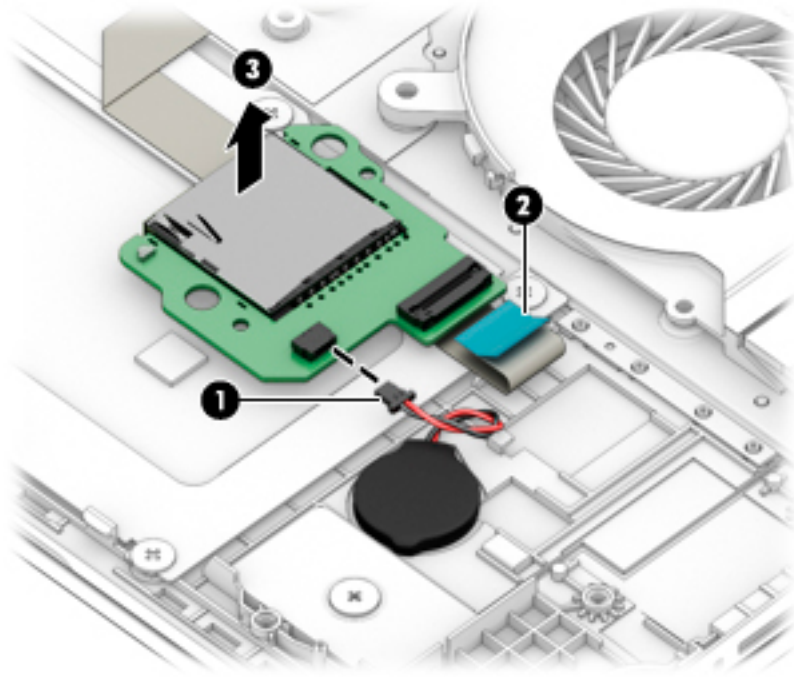

Reverse this procedure to install the card reader board.

RTC battery

Table 6-10 RTC battery description and part number

Description	Spare part number
RTC battery	L02772-001

Before removing the RTC battery, follow these steps:

1. Prepare the computer for disassembly ([Preparation for disassembly on page 32](#)).
2. Place the computer in Battery Safe mode ([Battery Safe mode on page 32](#)).
3. Remove the bottom cover ([Bottom cover on page 33](#)).
4. Remove the battery ([Battery on page 41](#)).

Remove the RTC battery:



NOTE: The RTC battery connector is located on the bottom of the card reader board.

1. Remove the screws from the card reader board, and then position the board upside down so you can access the connectors underneath (see [Card reader board on page 51](#)).
2. Disconnect the RTC battery from the card reader board **(1)**.
3. Lift the battery to disengage it from the adhesive that secures it to the computer **(2)**.

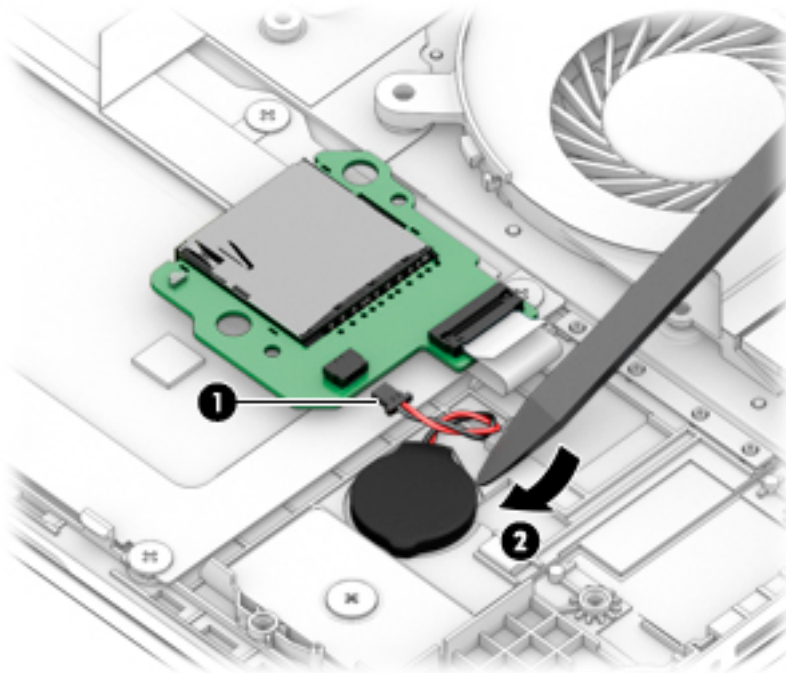

Reverse this procedure to install the RTC battery.

System board



NOTE: All system board spare part kits include replacement thermal material.

All system boards use the following part numbers:

xxxxxx-001: Non-Windows operating systems

xxxxxx-601: Windows 10 operating system

Table 6-11 System board descriptions and part numbers

Description	Spare part number
System board with integrated AMD Ryzen 5 3500U processor	L58788-xxx
System board with integrated AMD Ryzen 3 3200U processor	L58789-xxx

Before removing the system board, follow these steps:

1. Prepare the computer for disassembly ([Preparation for disassembly on page 32](#)).
2. Place the computer in Battery Safe mode ([Battery Safe mode on page 32](#)).
3. Remove the following components:
 - a. Bottom cover ([Bottom cover on page 33](#)).
 - b. Battery ([Battery on page 41](#))
 - c. Battery connector board ([Battery connector board on page 48](#))

When replacing the system board, be sure to remove the following components (as applicable) from the defective system board and install on the replacement system board:

- Memory modules ([Memory modules on page 34](#))
- WLAN/Bluetooth module ([WLAN/Bluetooth combo card on page 35](#))
- M.2 solid-state drive ([M.2 solid-state drive on page 37](#))
- Heat sink ([Heat sink on page 44](#))

Remove the system board:

1. Disconnect the following cables from the system board:
 - (1) Power connector cable
 - (2) Speaker cable
 - (3) Antennas from WLAN module (select models only)
 - (4) Display cable (ZIF)
 - (5) USB cable from USB/power board (ZIF)
 - (6) Fan cable
 - (7) Keyboard cable (ZIF)
 - (8) Card reader cable (ZIF)
 - (9) Touchpad cable (ZIF)

- (10) Backlight cable (ZIF)
- (11) Fingerprint sensor cable (ZIF)
- (12) Hard drive cable

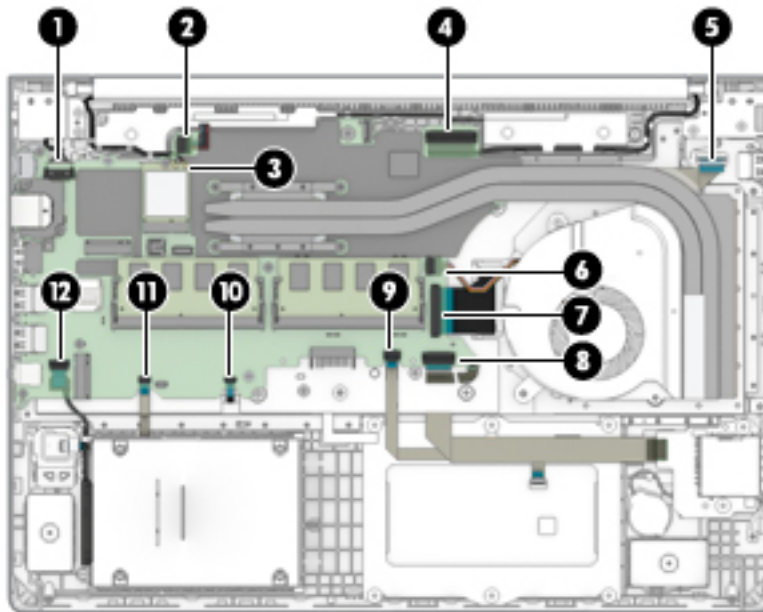

- 2. Remove the four Phillips M2.0 × 4.0 screws **(1)** that secure the system board to the computer.
- 3. Remove the two Phillips M2.0 × 2.5 screws **(2)** that secure the system board to the computer.
- 4. Remove the broad head Phillips M2.5 × 2.5 screw **(3)** that secures the system board to the computer.
- 5. Remove the RJ-45 cover from the system board **(4)**.

6. Remove the bracket from the USB-Type C port **(5)**.

The USB bracket and RJ-45 cover are available in the Bracket Kit as spare part number L45097-001.

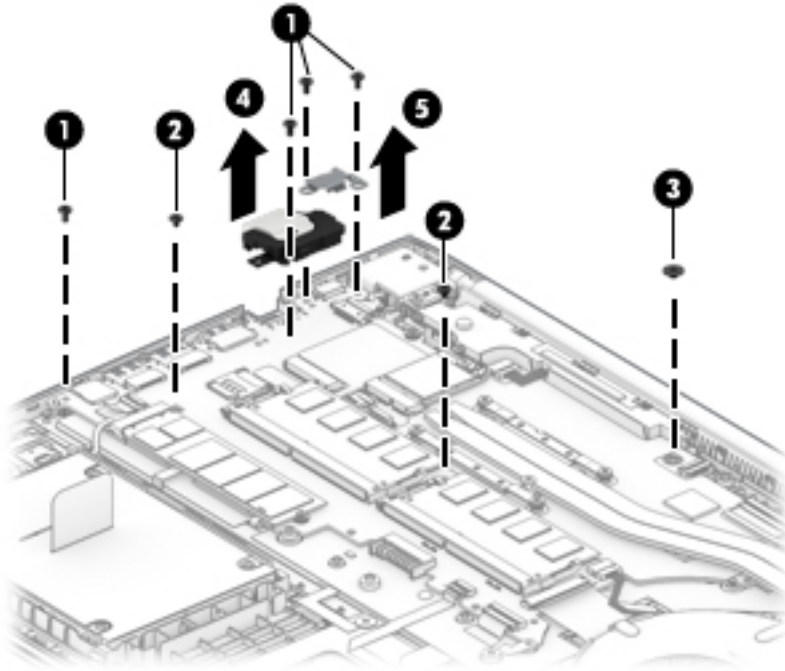

7. Rotate the right side of the system board upward **(1)**.
8. Pull the system board away from the connectors on the side of the chassis to remove it from the computer **(2)**.

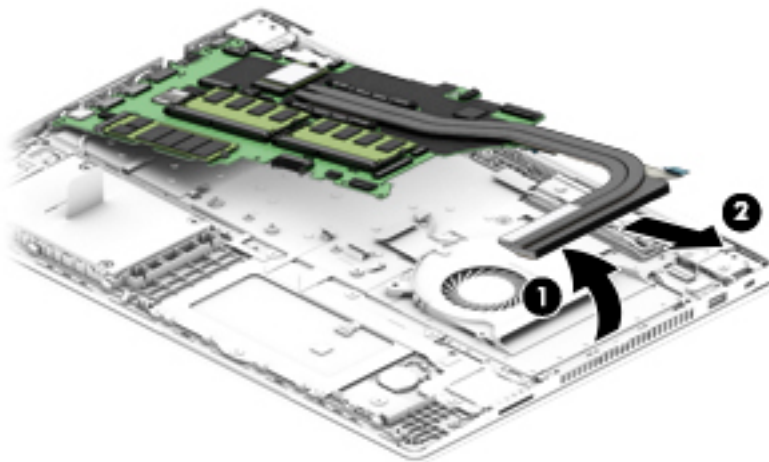

Reverse this procedure to install the system board.

Display assembly

Before disassembling the display assembly, follow these steps:

1. Prepare the computer for disassembly ([Preparation for disassembly on page 32](#)).
2. Place the computer in Battery Safe mode ([Battery Safe mode on page 32](#)).
3. Remove the bottom cover ([Bottom cover on page 33](#)).
4. Remove the battery ([Battery on page 41](#)).

Disassemble the display assembly:

 **TIP:** You can remove the bezel, display panel, and camera with or without removing the display assembly from the computer. Steps 1 - 9 show how to remove these components with the display assembly attached to the computer. Removing the remaining subcomponents requires that you remove the display assembly from the computer.

1. Flex the top **(1)** of the bezel, the inside edges of the left and right sides **(2)**, and the bottom **(3)** of the bezel until it disengages from the display enclosure.
2. Remove the display bezel **(4)**.

Bezels are available using the following spare part numbers:

L45114-001: Models with an HD camera

L45115-001: Models with an HD+IR camera

L45116-001: Models without a camera

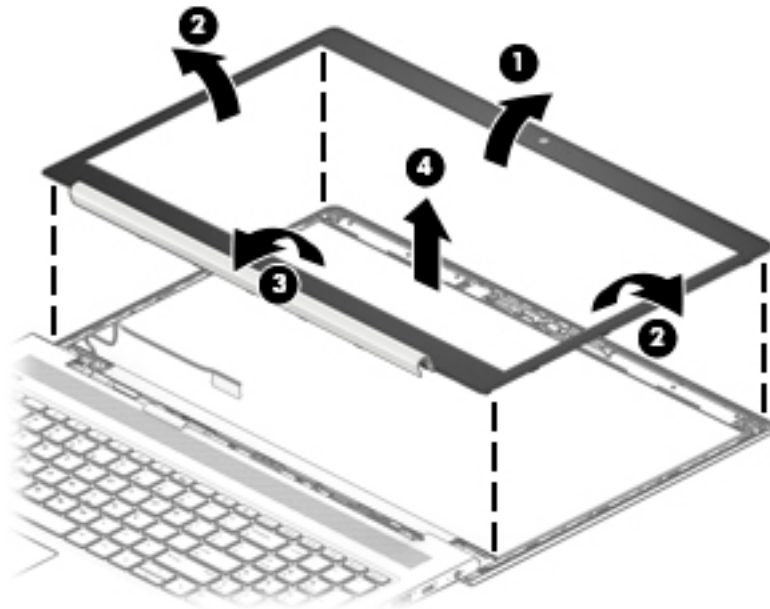

3. If it is necessary to remove or replace the display panel, use a tweezer to grasp the end of the two pieces of tape that secure the bezel to the display enclosure **(1)**. The tape is positioned under the left and right sides of the display panel.
4. Working up the side of the display panel, pull the tape out from behind both the left and right sides of the panel **(2)**. You must pull the tape multiple times before it is completely removed.

5. Rotate the top of the display panel onto the keyboard **(3)** to gain access to the display connector on the back of the panel.

Display panels are available using the following spare part numbers:

L52212-001: FHD, UWVA display

L62785-001: FHD, UWVA, 250 nit display

L52213-001: HD, SVA display

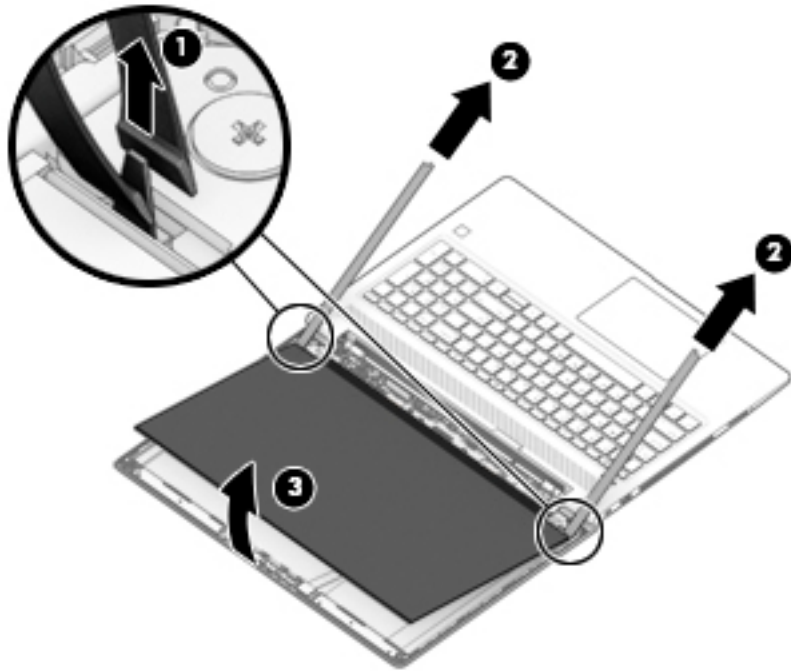

6. Lift the tape from atop the connector on the display panel (1), lift the locking latch (2), and then disconnect the cable from the panel (3).

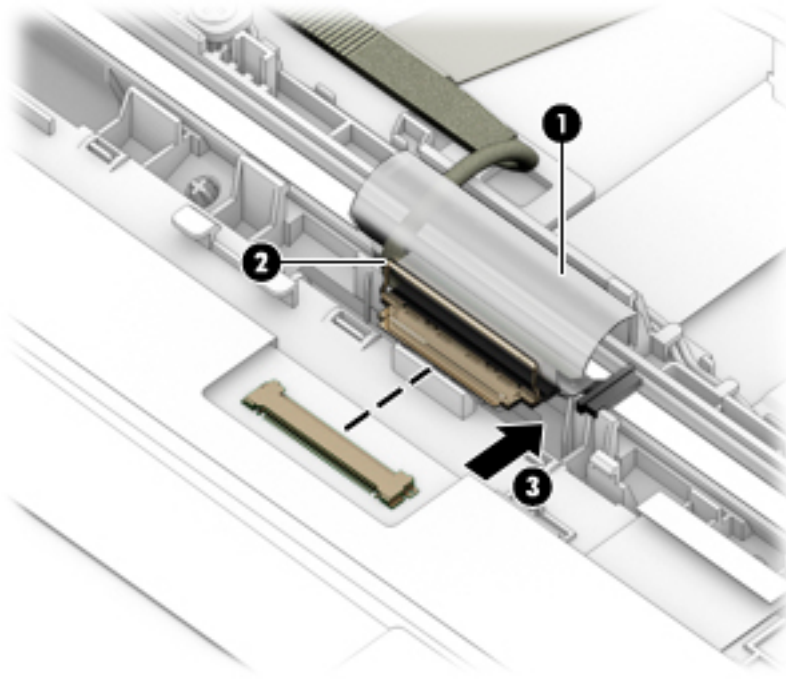

7. Use the following steps to install a display panel:
- Remove the backing from the bottom of the new tape to install in the display enclosure (1).
 - Install the tape onto the left and right sides of the enclosure from the bottom (2) to the top (3).
 - Remove the backing from the top of the installed tape (4).
 - Rotate the panel into place in the display enclosure (5).

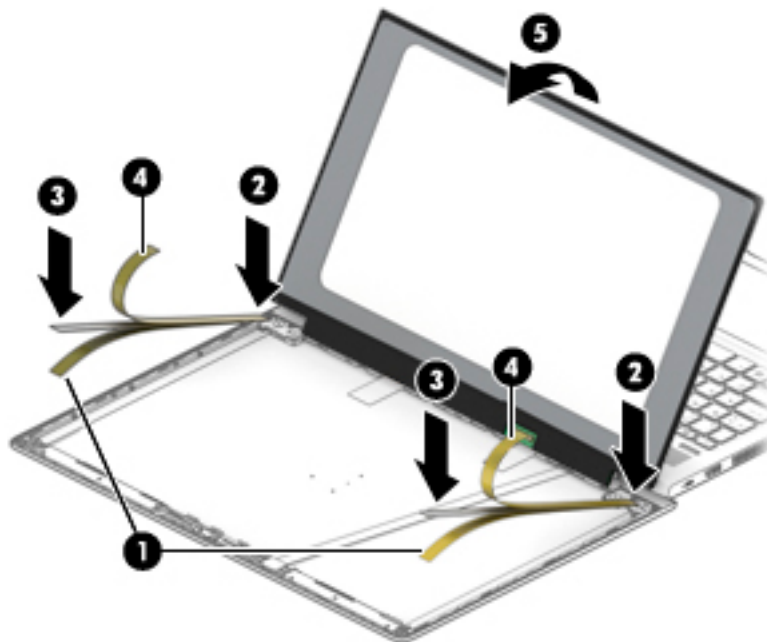

8. If it is necessary to remove or replace the HD camera, disconnect the cable from the camera (1), and then peel the silver tape up (2) and remove the module from the enclosure (3).

The HD camera is available as spare part number L45118-001.

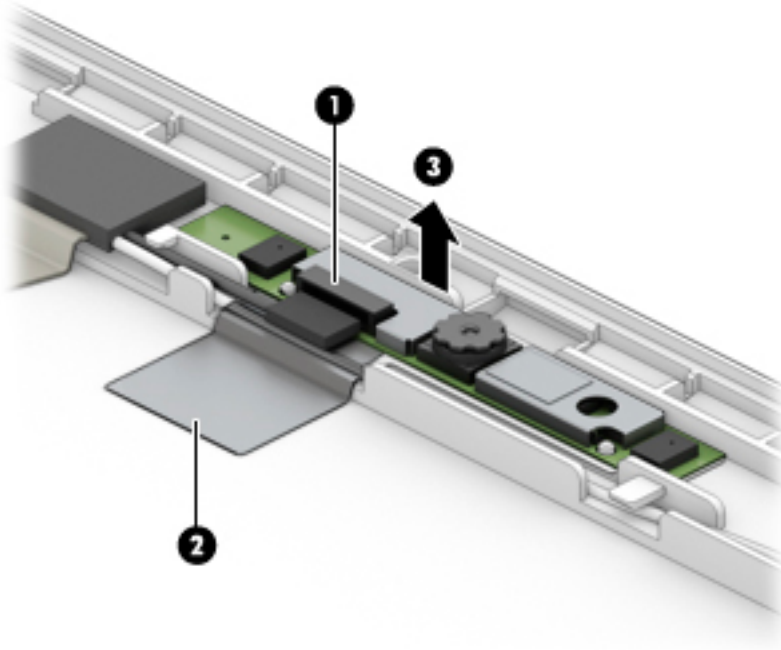

9. If it is necessary to remove or replace the IR camera, disconnect the cable from both sides of the camera (1), and then peel the camera module up to remove it from the adhesive that secures it to the enclosure (2).

The HD+IR camera is available as spare part number L45119-001.

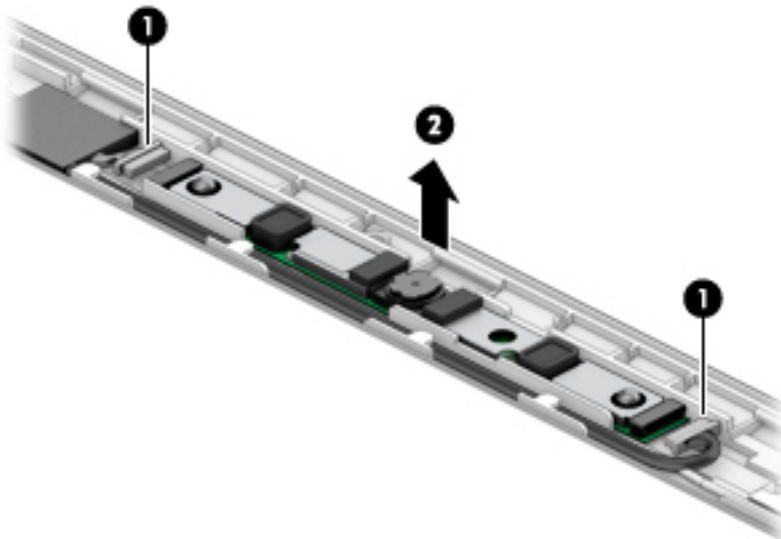

 **NOTE:** You must remove the display assembly from the computer to remove the remaining display subcomponents.

10. If it is necessary to remove the display assembly from the computer:

- a. Disconnect the antennas from the WLAN module **(1)** (select models only).
- b. Remove the antenna cables from the routing channel in the right speaker **(2)**.
- c. Disconnect the display cable from the system board ZIF connector **(3)**, and then remove the cable from the routing channel in the chassis **(4)**.
- d. Remove the four Torx T8 2.5 × 4.0 screws **(5)** that secure the display assembly to the computer.
- e. Rotate the display to open the hinges **(6)**, and then separate the display from the computer **(7)**.

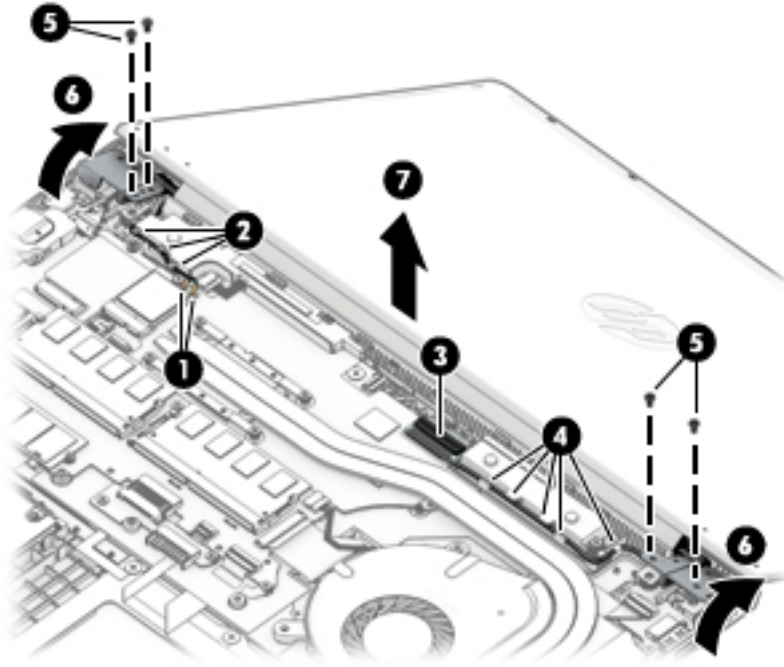

11. If it is necessary to remove the hinges from the display enclosure, remove the two Phillips broad head M2.5 × 2.5 screws **(1)** and the Phillips M2.0 × 4.0 screw **(2)** from the bottom of each hinge.

12. Slide the hinges toward the middle and then lift them from the enclosure (3).

The display hinges are available as spare part number L45117-001.

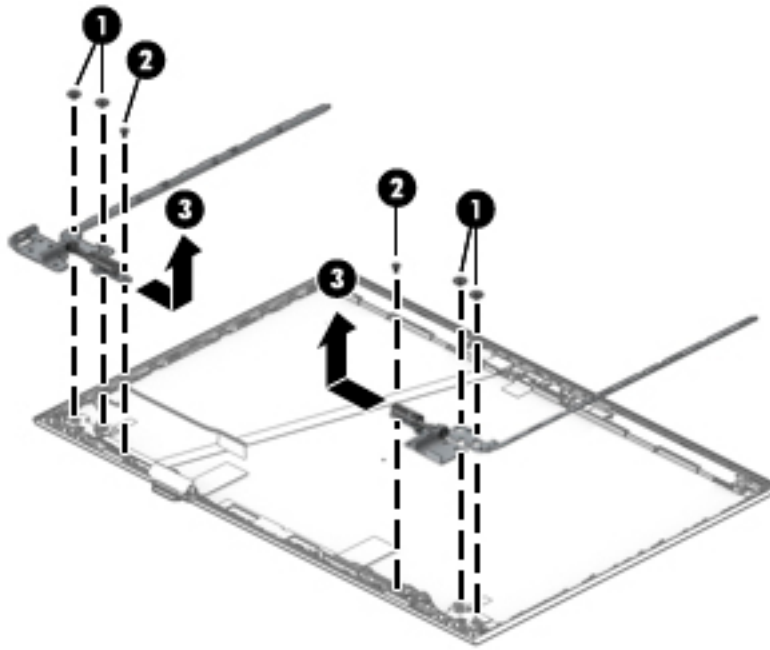

13. If it is necessary to replace the WLAN antennas, peel the antennas from the enclosure (1), remove the cables from the clips in the bottom of the enclosure (2), and then remove the antennas and cables from the enclosure (3).

 **NOTE:** Models with dual antennas shown.

WLAN antennas are available using the following spare part numbers:

L45111-001: Single antenna

L45112-001: Dual antennas

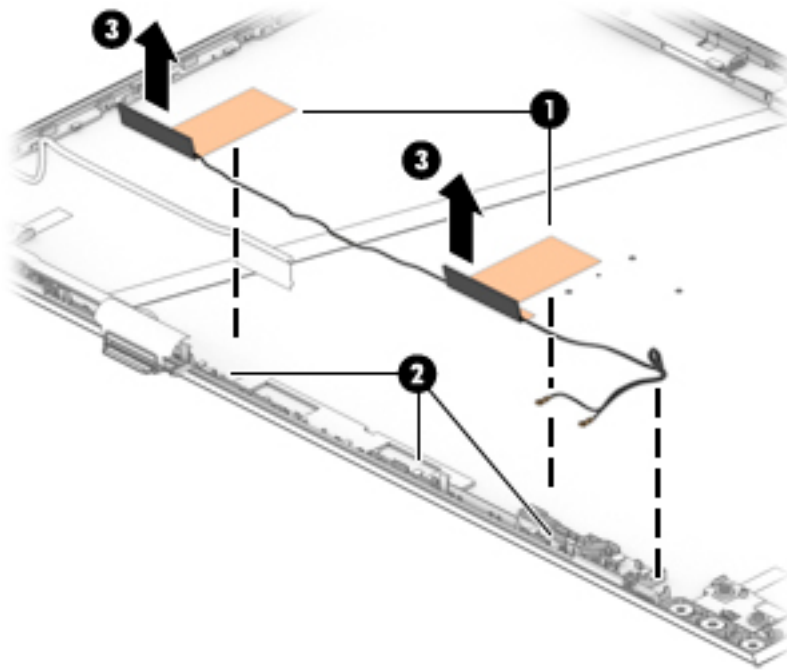

14. If it is necessary to remove or replace the display/camera cable, use the following steps:

Displays with an HD camera

- a. Disconnect the cable from the ZIF connector on the camera module (1).

- b.** Pull the cable up to disengage it from the adhesive that secures it to the inside of the enclosure **(2)**, and then remove the cable from the enclosure **(3)**.

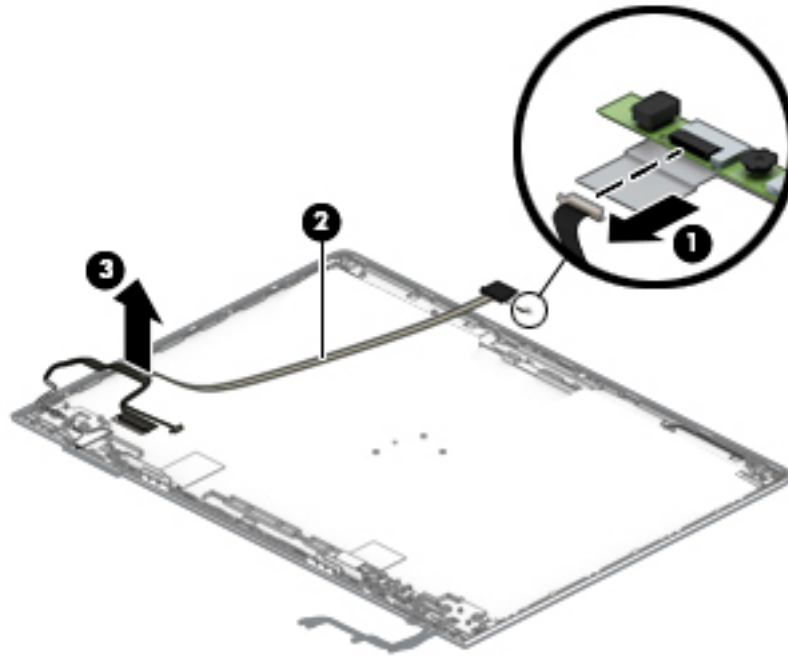

Displays with an IR camera

- a.** Disconnect the cable from the ZIF connector on both ends of the camera module **(1)**.
- b.** Pull the cable up to disengage it from the adhesive that secures it to the inside of the enclosure **(2)**, and then remove the cable from the enclosure **(3)**.

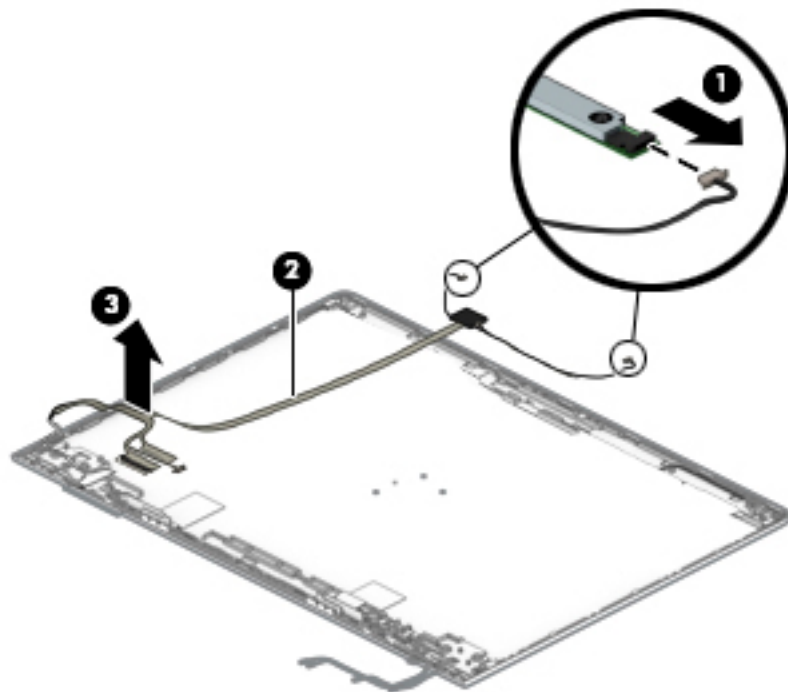

Reverse this procedure to reassemble the display assembly.

Power connector cable

Table 6-12 Power connector cable description and part number

Description	Spare part number
Power connector cable	L01048-001

Before removing the power connector cable, follow these steps:

1. Prepare the computer for disassembly ([Preparation for disassembly on page 32](#)).
2. Place the computer in Battery Safe mode ([Battery Safe mode on page 32](#)).
3. Remove the bottom cover ([Bottom cover on page 33](#)).
4. Remove the battery ([Battery on page 41](#)).
5. Remove the display ([Display assembly on page 57](#)).

Remove the power connector cable:

1. Remove the two Torx T8 2.5 × 4.0 screws from the right hinge **(1)**.
2. Rotate the hinge up from atop the power connector **(2)**.
3. Disconnect the cable from the system board **(3)**.
4. Remove the connector up and out of the computer **(4)**.

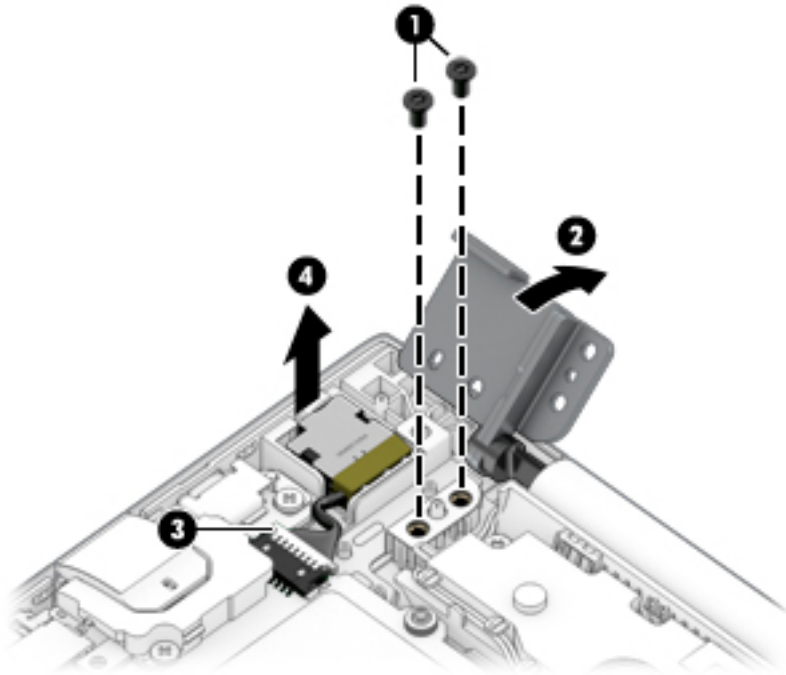

Reverse this procedure to install the power connector cable.

Keyboard/top cover

The top cover with keyboard remains after removing all other spared parts from the computer.

In this section, the first table provides the main spare part number for the keyboards. The second table provides the country codes.

Table 6-13 Keyboard/top cover descriptions and part numbers

Description	Spare part number
Keyboard/top cover, no backlight	L45091-xx1
Keyboard/top cover, backlit	L45090-xx1

Table 6-14 Spare part country codes

For use in country or region	Spare part number	For use in country or region	Spare part number	For use in country or region	Spare part number
Belgium	-A41	Iceland	-DD1	Slovenia	-BA1
Brazil	-201	India	-D61	South Korea	-AD1
Bulgaria	-261	Israel	-BB1	Spain	-071
Chile	-161	Italy	-061	Switzerland	-BG1
Czech Republic/Slovakia	-FL1	Japan	-291	Taiwan	-AB1
Denmark, Finland, and Norway	-DH1	The Netherlands	-B31	Thailand	-281
French Canada	-DB1	Northern Africa	-FP1	Turkey	-141
France	-051	Portugal	-131	Ukraine	-BD1
Germany	-041	Russia	-251	United Kingdom	-031
Greece	-151	Saudi Arabia	-171	United States	-001
Hungary	-211				

7 Computer Setup (BIOS), TPM, and HP Sure Start

Using Computer Setup

Computer Setup, or Basic Input/Output System (BIOS), controls communication between all the input and output devices on the system (such as disk drives, display, keyboard, mouse, and printer). Computer Setup includes settings for the types of devices installed, the startup sequence of the computer, and the amount of system and extended memory.

 **NOTE:** Use extreme care when making changes in Computer Setup. Errors can prevent the computer from operating properly.

Starting Computer Setup

- ▲ Turn on or restart the computer, and when the HP logo appears, press **f10** to enter Computer Setup.

Navigating and selecting in Computer Setup

- To select a menu or a menu item, use the **tab** key and the keyboard arrow keys and then press **enter**, or use a pointing device to select the item.
- To scroll up and down, select the up arrow or the down arrow in the upper-right corner of the screen, or use the up arrow key or the down arrow key on the keyboard.
- To close open dialog boxes and return to the main Computer Setup screen, press **esc**, and then follow the on-screen instructions.

To exit Computer Setup, choose one of the following methods:

- To exit Computer Setup menus without saving your changes, select **Main**, select **Ignore Changes and Exit**, and then select **Yes**.

 **NOTE:** If you are using arrow keys to highlight your choice, you must then press **enter**.

- To save your changes and exit Computer Setup menus, select **Main**, select **Save Changes and Exit**, and then select **Yes**.

 **NOTE:** If you are using arrow keys to highlight your choice, you must then press **enter**.

Your changes go into effect when the computer restarts.

Restoring factory settings in Computer Setup

 **NOTE:** Restoring defaults will not change the hard drive mode.

To return all settings in Computer Setup to the values that were set at the factory, follow these steps:

1. Start Computer Setup. See [Starting Computer Setup on page 67](#).
2. Select **Main**, select **Apply Factory Defaults and Exit**, and then select **Yes**.

 **NOTE:** If you are using arrow keys to highlight your choice, you must then press **enter**.

 **NOTE:** On select products, the selections may display **Restore Defaults** instead of **Apply Factory Defaults and Exit**.

Your changes go into effect when the computer restarts.

 **NOTE:** Your password settings and security settings are not changed when you restore the factory settings.

Updating the BIOS

Updated versions of the BIOS may be available on the HP website.

Most BIOS updates on the HP website are packaged in compressed files called *SoftPaqs*.

Some download packages contain a file named *Readme.txt*, which contains information regarding installing and troubleshooting the file.

Determining the BIOS version

To decide whether you need to update Computer Setup (BIOS), first determine the BIOS version on your computer.

BIOS version information (also known as *ROM date* and *System BIOS*) can be accessed by pressing **fn+esc** (if you are already in Windows) or by using Computer Setup.

1. Start Computer Setup. See [Starting Computer Setup on page 67](#).
2. Select **Main**, and then select **System Information**.
3. To exit Computer Setup menus without saving your changes, select **Main**, select **Ignore Changes and Exit**, and then select **Yes**.

 **NOTE:** If you are using arrow keys to highlight your choice, you must then press **enter**.

To check for later BIOS versions, see [Downloading a BIOS update on page 68](#).

Downloading a BIOS update

 **CAUTION:** To reduce the risk of damage to the computer or an unsuccessful installation, download and install a BIOS update only when the computer is connected to reliable external power using the AC adapter. Do not download or install a BIOS update while the computer is running on battery power, docked in an optional docking device, or connected to an optional power source. During the download and installation, follow these instructions:

Do not disconnect power on the computer by unplugging the power cord from the AC outlet.

Do not shut down the computer or initiate Sleep.

Do not insert, remove, connect, or disconnect any device, cable, or cord.

1. Type `support` in the taskbar search box, and then select the HP Support Assistant app.
– or –
Select the question mark icon in the taskbar.
2. Select **Updates**, and then select **Check for updates and messages**.
3. Follow the on-screen instructions.
4. At the download area, follow these steps:

- a. Identify the most recent BIOS update and compare it to the BIOS version currently installed on your computer. Make a note of the date, name, or other identifier. You may need this information to locate the update later, after it has been downloaded to your hard drive.
- b. Follow the on-screen instructions to download your selection to the hard drive.

Make a note of the path to the location on your hard drive where the BIOS update is downloaded. You will need to access this path when you are ready to install the update.

 **NOTE:** If you connect your computer to a network, consult the network administrator before installing any software updates, especially system BIOS updates.

BIOS installation procedures vary. Follow any instructions that are displayed on the screen after the download is complete. If no instructions are displayed, follow these steps:

1. Type `file` in the taskbar search box, and then select **File Explorer**.
2. Select your hard drive designation. The hard drive designation is typically Local Disk (C:).
3. Using the hard drive path you recorded earlier, open the folder that contains the update.
4. Double-click the file that has an `.exe` extension (for example, `filename.exe`).

The BIOS installation begins.

5. Complete the installation by following the on-screen instructions.

 **NOTE:** After a message on the screen reports a successful installation, you can delete the downloaded file from your hard drive.

Changing the boot order using the f9 prompt

To dynamically choose a boot device for the current startup sequence, follow these steps:

1. Access the Boot Device Options menu:
 - Turn on or restart the computer, and when the HP logo appears, press **f9** to enter the Boot Device Options menu.
2. Select a boot device, press **enter**, and then follow the on-screen instructions.

TPM BIOS settings (select products only)

 **IMPORTANT:** Before enabling Trusted Platform Module (TPM) functionality on this system, you must ensure that your intended use of TPM complies with relevant local laws, regulations and policies, and approvals or licenses must be obtained if applicable. For any compliance issues arising from your operation/usage of TPM which violates the above mentioned requirement, you shall bear all the liabilities wholly and solely. HP will not be responsible for any related liabilities.

TPM provides additional security for your computer. You can modify the TPM settings in Computer Setup (BIOS).

 **NOTE:** If you change the TPM setting to Hidden, TPM is not visible in the operating system.

To access TPM settings in Computer Setup:

1. Start Computer Setup. See [Starting Computer Setup on page 67](#).
2. Select **Security**, select **TPM Embedded Security**, and then follow the on-screen instructions.

Using HP Sure Start (select products only)

Select computer models are configured with HP Sure Start, a technology that monitors the computer's BIOS for attacks or corruption. If the BIOS becomes corrupted or is attacked, HP Sure Start automatically restores the BIOS to its previously safe state, without user intervention.

HP Sure Start is configured and already enabled so that most users can use the HP Sure Start default configuration. The default configuration can be customized by advanced users.

To access the latest documentation on HP Sure Start, go to <http://www.hp.com/support>. Select **Find your product**, and then follow the on-screen instructions.

8 Using HP PC Hardware Diagnostics

Using HP PC Hardware Diagnostics Windows (select products only)

HP PC Hardware Diagnostics Windows is a Windows-based utility that allows you to run diagnostic tests to determine whether the computer hardware is functioning properly. The tool runs within the Windows operating system in order to diagnose hardware failures.

If HP PC Hardware Diagnostics Windows is not installed on your computer, first you must download and install it. To download HP PC Hardware Diagnostics Windows, see [Downloading HP PC Hardware Diagnostics Windows on page 71](#).

After HP PC Hardware Diagnostics Windows is installed, follow these steps to access it from HP Help and Support or HP Support Assistant.

1. To access HP PC Hardware Diagnostics Windows from HP Help and Support:

- a. Select the **Start** button, and then select **HP Help and Support**.
- b. Select **HP PC Hardware Diagnostics Windows**.

– or –

To access HP PC Hardware Diagnostics Windows from HP Support Assistant:

- a. Type `support` in the taskbar search box, and then select the **HP Support Assistant** app.

– or –

Select the question mark icon in the taskbar.

- b. Select **Troubleshooting and fixes**.
- c. Select **Diagnostics**, and then select **HP PC Hardware Diagnostics Windows**.

2. When the tool opens, select the type of diagnostic test you want to run, and then follow the on-screen instructions.



NOTE: If you need to stop a diagnostic test at any time, select **Cancel**.

When HP PC Hardware Diagnostics Windows detects a failure that requires hardware replacement, a 24-digit Failure ID code is generated. The screen displays one of the following options:

- A Failure ID link is displayed. Select the link and follow the on-screen instructions.
- A Quick Response (QR) code is displayed. With a mobile device, scan the code and then follow the on-screen instructions.
- Instructions for calling support are displayed. Follow those instructions.

Downloading HP PC Hardware Diagnostics Windows

- The HP PC Hardware Diagnostics Windows download instructions are provided in English only.
- You must use a Windows computer to download this tool because only .exe files are provided.

Downloading the latest HP PC Hardware Diagnostics Windows version

To download HP PC Hardware Diagnostics Windows, follow these steps:

1. Go to <http://www.hp.com/go/techcenter/pcdiags>. The HP PC Diagnostics home page is displayed.
2. Select **Download HP Diagnostics Windows**, and then select a location on your computer or a USB flash drive.

The tool is downloaded to the selected location.

Downloading HP Hardware Diagnostics Windows by product name or number (select products only)

 **NOTE:** For some products, it may be necessary to download the software to a USB flash drive by using the product name or number.

To download HP PC Hardware Diagnostics Windows by product name or number, follow these steps:

1. Go to <http://www.hp.com/support>.
2. Select **Get software and drivers**, select your type of product, and then enter the product name or number in the search box that is displayed.
3. In the **Diagnostics** section, select **Download**, and then follow the on-screen instructions to select the specific Windows diagnostics version to be downloaded to your computer or USB flash drive.

The tool is downloaded to the selected location.

Installing HP PC Hardware Diagnostics Windows

To install HP PC Hardware Diagnostics Windows, follow these steps:

- ▲ Navigate to the folder on your computer or the USB flash drive where the .exe file was downloaded, double-click the .exe file, and then follow the on-screen instructions.

Using HP PC Hardware Diagnostics UEFI

 **NOTE:** For Windows 10 S computers, you must use a Windows computer and a USB flash drive to download and create the HP UEFI support environment because only .exe files are provided. For more information, see [Downloading HP PC Hardware Diagnostics UEFI to a USB flash drive on page 73](#).

HP PC Hardware Diagnostics UEFI (Unified Extensible Firmware Interface) allows you to run diagnostic tests to determine whether the computer hardware is functioning properly. The tool runs outside the operating system so that it can isolate hardware failures from issues that are caused by the operating system or other software components.

If your PC will not boot into Windows, you can use HP PC Hardware Diagnostics UEFI to diagnose hardware issues.

When HP PC Hardware Diagnostics Windows detects a failure that requires hardware replacement, a 24-digit Failure ID code is generated. For assistance in solving the problem:

- ▲ Select **Get Support**, and then use a mobile device to scan the QR code that displays on the next screen. The HP Customer Support - Service Center page displays, with your Failure ID and product number automatically filled in. Follow the on-screen instructions.

– or –

Contact support, and provide the Failure ID code.

 **NOTE:** To start diagnostics on a convertible computer, your computer must be in notebook mode, and you must use the attached keyboard.

 **NOTE:** If you need to stop a diagnostic test, press [esc](#).

Starting HP PC Hardware Diagnostics UEFI

To start HP PC Hardware Diagnostics UEFI, follow these steps:

1. Turn on or restart the computer, and quickly press [esc](#).
2. Press [f2](#).

The BIOS searches three places for the diagnostic tools, in the following order:

- a. Connected USB flash drive

 **NOTE:** To download the HP PC Hardware Diagnostics UEFI tool to a USB flash drive, see [Downloading the latest HP PC Hardware Diagnostics UEFI version on page 73](#).

- b. Hard drive

- c. BIOS

3. When the diagnostic tool opens, select a language, select the type of diagnostic test you want to run, and then follow the on-screen instructions.

Downloading HP PC Hardware Diagnostics UEFI to a USB flash drive

Downloading HP PC Hardware Diagnostics UEFI to a USB flash drive can be useful in the following situations:

- HP PC Hardware Diagnostics UEFI is not included in the preinstall image.
- HP PC Hardware Diagnostics UEFI is not included in the HP Tool partition.
- The hard drive is damaged.

 **NOTE:** The HP PC Hardware Diagnostics UEFI download instructions are provided in English only, and you must use a Windows computer to download and create the HP UEFI support environment because only .exe files are provided.

Downloading the latest HP PC Hardware Diagnostics UEFI version

To download the latest HP PC Hardware Diagnostics UEFI version to a USB flash drive:

1. Go to <http://www.hp.com/go/techcenter/pcdiags>. The HP PC Diagnostics home page is displayed.
2. Select **Download HP Diagnostics UEFI**, and then select **Run**.

Downloading HP PC Hardware Diagnostics UEFI by product name or number (select products only)

 **NOTE:** For some products, it may be necessary to download the software to a USB flash drive by using the product name or number.

To download HP PC Hardware Diagnostics UEFI by product name or number (select products only) to a USB flash drive:

1. Go to <http://www.hp.com/support>.
2. Enter the product name or number, select your computer, and then select your operating system.
3. In the **Diagnostics** section, follow the on-screen instructions to select and download the specific UEFI Diagnostics version for your computer.

Using Remote HP PC Hardware Diagnostics UEFI settings (select products only)

Remote HP PC Hardware Diagnostics UEFI is a firmware (BIOS) feature that downloads HP PC Hardware Diagnostics UEFI to your computer. It can then execute the diagnostics on your computer, and it may upload results to a preconfigured server. For more information about Remote HP PC Hardware Diagnostics UEFI, go to <http://www.hp.com/go/techcenter/pcdiags>, and then select **Find out more**.

Downloading Remote HP PC Hardware Diagnostics UEFI



NOTE: HP Remote PC Hardware Diagnostics UEFI is also available as a Softpaq that can be downloaded to a server.

Downloading the latest Remote HP PC Hardware Diagnostics UEFI version

To download the latest Remote HP PC Hardware Diagnostics UEFI version, follow these steps:

1. Go to <http://www.hp.com/go/techcenter/pcdiags>. The HP PC Diagnostics home page is displayed.
2. Select **Download Remote Diagnostics**, and then select **Run**.

Downloading Remote HP PC Hardware Diagnostics UEFI by product name or number



NOTE: For some products, it may be necessary to download the software by using the product name or number.

To download HP Remote PC Hardware Diagnostics UEFI by product name or number, follow these steps:

1. Go to <http://www.hp.com/support>.
2. Select **Get software and drivers**, select your type of product, enter the product name or number in the search box that is displayed, select your computer, and then select your operating system.
3. In the **Diagnostics** section, follow the on-screen instructions to select and download the **Remote UEFI** version for the product.

Customizing Remote HP PC Hardware Diagnostics UEFI settings

Using the Remote HP PC Hardware Diagnostics setting in Computer Setup (BIOS), you can perform the following customizations:

- Set a schedule for running diagnostics unattended. You can also start diagnostics immediately in interactive mode by selecting **Execute Remote HP PC Hardware Diagnostics**.
- Set the location for downloading the diagnostic tools. This feature provides access to the tools from the HP website or from a server that has been preconfigured for use. Your computer does not require the traditional local storage (such as a disk drive or USB flash drive) to run remote diagnostics.

- Set a location for storing the test results. You can also set the user name and password settings used for uploads.
- Display status information about the diagnostics run previously.

To customize Remote HP PC Hardware Diagnostics UEFI settings, follow these steps:

1. Turn on or restart the computer, and when the HP logo appears, press **f10** to enter Computer Setup.
2. Select **Advanced**, and then select **Settings**.
3. Make your customization selections.
4. Select **Main**, and then **Save Changes and Exit** to save your settings.

Your changes take effect when the computer restarts.

9 Backing up, restoring, and recovering

This chapter provides information about the following processes, which are standard procedure for most products:

- **Backing up your personal information**—You can use Windows tools to back up your personal information (see [Using Windows tools on page 76](#)).
- **Creating a restore point**—You can use Windows tools to create a restore point (see [Using Windows tools on page 76](#)).
- **Creating recovery media** (select products only)—You can use the HP Cloud Recovery Download Tool (select products only) to create recovery media (see [Using the HP Cloud Recovery Download Tool to create recovery media \(select products only\) on page 76](#)).
- **Restoring and recovery**—Windows offers several options for restoring from backup, refreshing the computer, and resetting the computer to its original state (see [Using Windows tools on page 76](#)).

 **IMPORTANT:** If you will be performing recovery procedures on a tablet, the tablet battery must be at least 70% charged before you start the recovery process.

IMPORTANT: For a tablet with a detachable keyboard, connect the tablet to the keyboard base before beginning any recovery process.

Backing up information and creating recovery media

Using Windows tools

 **IMPORTANT:** Windows is the only option that allows you to back up your personal information. Schedule regular backups to avoid information loss.

You can use Windows tools to back up personal information and create system restore points and recovery media.

 **NOTE:** If computer storage is 32 GB or less, Microsoft System Restore is disabled by default.

For more information and steps, see the Get Help app.

1. Select the **Start** button, and then select the **Get Help** app.
2. Enter the task you want to perform.

 **NOTE:** You must be connected to the Internet to access the Get Help app.

Using the HP Cloud Recovery Download Tool to create recovery media (select products only)

You can use the HP Cloud Recovery Download Tool to create HP Recovery media on a bootable USB flash drive.

To download the tool:

- ▲ Go to the Microsoft Store and search for HP Cloud Recovery.

For details, go to <http://www.hp.com/support>, search for HP Cloud Recovery, and then select "HP PCs – Using the Cloud Recovery Tool (Windows 10, 7)."



NOTE: If you cannot create recovery media yourself, contact support to obtain recovery discs. Go to <http://www.hp.com/support>, select your country or region, and then follow the on-screen instructions.

Restoring and recovery

Restoring, resetting, and refreshing using Windows tools

Windows offers several options for restoring, resetting, and refreshing the computer. For details, see [Using Windows tools on page 76](#).

Recovering using HP Recovery media

HP Recovery media is used to recover the original operating system and software programs that were installed at the factory. On select products, it can be created on a bootable USB flash drive using the HP Cloud Recovery Download Tool. For details, see [Using the HP Cloud Recovery Download Tool to create recovery media \(select products only\) on page 76](#).



NOTE: If you cannot create recovery media yourself, contact support to obtain recovery discs. Go to <http://www.hp.com/support>, select your country or region, and then follow the on-screen instructions.

To recover your system:

- ▲ Insert the HP Recovery media, and then restart the computer.

Changing the computer boot order

If your computer does not restart using the HP Recovery media, you can change the computer boot order. This is the order of devices listed in BIOS where the computer looks for startup information. You can change the selection to an optical drive or a USB flash drive, depending on the location of your HP Recovery media.

To change the boot order:



IMPORTANT: For a tablet with a detachable keyboard, connect the tablet to the keyboard base before beginning these steps.

1. Insert the HP Recovery media.
2. Access the system **Startup** menu.

For computers or tablets with keyboards attached:

- ▲ Turn on or restart the computer or tablet, quickly press **esc**, and then press **f9** for boot options.

For tablets without keyboards:

- ▲ Turn on or restart the tablet, quickly hold down the volume up button, and then select **f9**.

– or –

Turn on or restart the tablet, quickly hold down the volume down button, and then select **f9**.

3. Select the optical drive or USB flash drive from which you want to boot, and then follow the on-screen instructions.

10 Specifications

Computer specifications

Table 10-1 Computer specifications

	Metric	U.S.
Dimensions		
Depth	23.1 cm	9.09 in
Width	30.9 cm	12.15 in
Height	1.8 cm	0.71 in
Weight		
M.2 SSD,	1.49 kg	3.28 lbs
Hard drive	1.59 kg	3.50 lbs
Input power		
Operating voltage	19.0 V dc @ 4.74 A – 90 W or 18.5 V dc @ 3.5 A – 65 W	
Operating current	4.74 A or 3.5 A	
Temperature		
Operating (not writing to optical disc)	0°C to 35°C	32°F to 95°F
Operating (writing to optical disc)	5°C to 35°C	41°F to 95°F
Nonoperating	-20°C to 60°C	-4°F to 140°F
Relative humidity		
Operating	10% to 90%	
Nonoperating	5% to 95%	
Maximum altitude (unpressurized)		
Operating (14.7 to 10.1 psia)	-15 m to 3,048 m	50 ft to 10,000 ft
Nonoperating (14.7 to 4.4 psia)	-15 m to 12,192 m	-50 ft to 40,000 ft
Shock		
Operating	125 g, 2 ms, half-sine	
Nonoperating	200 g, 2 ms, half-sine	
NOTE: Applicable product safety standards specify thermal limits for plastic surfaces. The computer operates well within this range of temperatures.		

39.6 cm (15.6 in) display specifications

Table 10-2 Display specifications

	Metric	U.S.
Active diagonal size	39.6 cm	15.6 in
Resolution	1366 × 768 (HD) 1920 × 1080 (FHD)	
Surface treatment	Antiglare	
Brightness	220 nits (HD or FHD) 250 nits (FHD)	
Viewing angle	SVA (HD) UWVA (FHD)	
Backlight	LED	

Hard drive specifications

Table 10-3 Hard drive specifications

	1 TB*	500 GB*
Dimensions		
Height	7.0 mm	7.0 mm
Width	70 mm	70 mm
Weight	115 g	101 g or 95 g
Interface type	SATA	SATA
Transfer rate	100 MB/sec	100 MB/sec
Security	ATA security	ATA security
Seek times (typical read, including setting)		
Single track	1.4 ms	3 ms
Average	10 ms	13 ms
Maximum	12 ms	24 ms
Logical blocks	1,938,921,461	1,048,576,000
Disc rotational speed	5400 rpm	7200 rpm or 5400 rpm
Operating temperature	0°C to 70°C (32°F to 158°F)	
*1 GB = 1 billion bytes when referring to hard drive storage capacity. Actual accessible capacity is less. Actual drive specifications may differ slightly.		
NOTE: Certain restrictions and exclusions apply. Contact technical support for details.		

Solid-state drive specifications

Table 10-4 Solid-state drive specifications

	128 GB*	256 GB*	512 GB*
Height	1.0 mm	1.0 mm	1.0 mm
Length	50.8 mm	50.8 mm	50.8 mm
Width	28.9 mm	28.9 mm	28.9 mm
Weight	< 10 g	< 10 g	< 10 g
Transfer rate			
Sequential read	up to 2150 MB/sec	up to 2150 MB/sec	up to 2150 MB/sec
Random read	Up to 300,000 IOPs	Up to 300,000 IOPs	Up to 300,000 IOPs
Sequential write	up to 1260 MB/sec	up to 1550 MB/sec	up to 1550 MB/sec
Random write	Up to 100,000 IOPs	Up to 100,000 IOPs	Up to 100,000 IOPs
Interface type	SATA-3	PCIe	PCIe
Ready time, maximum (to not busy)	1.0 ms	< 1.0 ms	< 1.0 ms
Access times, logical	0.1 ms	0.1 ms	0.1 ms
Total logical sectors	234,441,648	468,883,296	1,000,215,216
Operating temperature	0°C to 70°C (32°F to 158°F)		
*1 GB = 1 billion bytes when referring to hard drive storage capacity. Actual accessible capacity is less. Actual drive specifications may differ slightly.			
NOTE: Certain restrictions and exclusions apply. Contact technical support for details.			

11 Statement of memory volatility

The purpose of this chapter is to provide general information regarding nonvolatile memory in HP Business computers. This chapter also provides general instructions for restoring nonvolatile memory that can contain personal data after the system has been powered off and the hard drive has been removed.

HP Business computer products that use Intel®-based or AMD®-based system boards contain volatile DDR memory. The amount of nonvolatile memory present in the system depends upon the system configuration. Intel-based and AMD-based system boards contain nonvolatile memory subcomponents as originally shipped from HP, assuming that no subsequent modifications have been made to the system and assuming that no applications, features, or functionality have been added to or installed on the system.

Following system shutdown and removal of all power sources from an HP Business computer system, personal data can remain on volatile system memory (DIMMs) for a finite period of time and will also remain in nonvolatile memory. Use the steps below to remove personal data from the computer, including the nonvolatile memory found in Intel-based and AMD-based system boards.

 **NOTE:** If your tablet has a keyboard base, connect to the keyboard base before beginning steps in this chapter.

Current BIOS steps

1. Follow steps (a) through (l) below to restore the nonvolatile memory that can contain personal data. Restoring or reprogramming nonvolatile memory that does not store personal data is neither necessary nor recommended.
 - a. Turn on or restart the computer, and then press **esc** while the “Press the ESC key for Startup Menu” message is displayed at the bottom of the screen.

 **NOTE:** If the system has a BIOS administrator password, enter the password at the prompt.
 - b. Select **Main**, select **Apply Factory Defaults and Exit**, and then select **Yes** to load defaults.
The computer will reboot.
 - c. During the reboot, press **esc** while the “Press the ESC key for Startup Menu” message is displayed at the bottom of the screen.

 **NOTE:** If the system has a BIOS administrator password, enter the password at the prompt.
 - d. Select the **Security** menu, select **Restore Security Settings to Factory Defaults**, and then select **Yes** to restore security level defaults.
The computer will reboot.
 - e. During the reboot, press **esc** while the “Press the ESC key for Startup Menu” message is displayed at the bottom of the screen.

 **NOTE:** If the system has a BIOS administrator password, enter the password at the prompt.
 - f. If an asset or ownership tag is set, select the **Security** menu and scroll down to the **Utilities** menu. Select **System IDs**, and then select **Asset Tracking Number**. Clear the tag, and then make the selection to return to the prior menu.

- g. If a DriveLock password is set, select the **Security** menu, and scroll down to **Hard Drive Utilities** under the **Utilities** menu. Select **Hard Drive Utilities**, select **DriveLock**, then uncheck the checkbox for **DriveLock password on restart**. Select **OK** to proceed.
- h. Select the **Main** menu, and then select **Reset BIOS Security to factory default**. Click **Yes** at the warning message.
The computer will reboot.
- i. During the reboot, press **esc** while the “Press the ESC key for Startup Menu” message is displayed at the bottom of the screen.



NOTE: If the system has a BIOS administrator password, enter the password at the prompt.

- j. Select the **Main** menu, select **Apply Factory Defaults and Exit**, select **Yes** to save changes and exit, and then select **Shutdown**.
 - k. Reboot the system. If the system has a Trusted Platform Module (TPM) and/or fingerprint sensor, one or two prompts will appear—one to clear the TPM and the other to Reset Fingerprint Sensor; press or tap **F1** to accept or **F2** to reject.
 - l. Remove all power and system batteries for at least 24 hours.
2. Complete one of the following:
- Remove and retain the storage drive.
 - or –
 - Clear the drive contents by using a third party utility designed to erase data from an SSD.
 - or –
 - Clear the contents of the drive by using the following BIOS Setup Secure Erase command option steps:



IMPORTANT: If you clear data using Secure Erase, it cannot be recovered.

- a. Turn on or restart the computer, and then press **esc** while the “Press the ESC key for Startup Menu” message is displayed at the bottom of the screen.
- b. Select the **Security** menu and scroll down to the **Utilities** menu.
- c. Select **Hard Drive Utilities**.
- d. Under **Utilities**, select **Secure Erase**, select the hard drive storing the data you want to clear, and then follow the on-screen instructions to continue.

Nonvolatile memory usage

Table 11-1 Nonvolatile memory usage

Nonvolatile Memory Type	Amount (Size)	Does this memory store customer data?	Does this memory retain data when power is removed?	What is the purpose of this memory?	How is data input into this memory?	How is this memory write-protected?
HP Sure Start flash (select models only)	8 MBytes	No	Yes	Provides protected backup of critical System BIOS code, EC firmware, and critical computer configuration data for select platforms that support HP Sure Start. For more information, see Using HP Sure Start (select models only) on page 86.	Data cannot be written to this device via the host processor. The content is managed solely by the HP Sure Start Embedded Controller.	This memory is protected by the HP Sure Start Embedded Controller.
Real Time Clock (RTC) battery backed-up CMOS configuration memory	256 Bytes	No	Yes	Stores system date and time and noncritical data.	RTC battery backed-up CMOS is programmed using the Computer Setup (BIOS), or changing the Microsoft Windows date & time.	This memory is not write-protected.
Controller (NIC) EEPROM	64 KBytes (not customer accessible)	No	Yes	Stores NIC configuration and NIC firmware.	NIC EEPROM is programmed using a utility from the NIC vendor that can be run from DOS.	A utility is required to write data to this memory and is available from the NIC vendor. Writing data to this ROM in an inappropriate manner will render the NIC non-functional.
DIMM Serial Presence Detect (SPD) configuration data	256 Bytes per memory module, 128 Bytes programmable (not customer accessible)	No	Yes	Stores memory module information.	DIMM SPD is programmed by the memory vendor.	Data cannot be written to this memory when the module is installed in a computer. The specific write-protection method varies by memory vendor.
System BIOS	9 MBytes	Yes	Yes	Stores system BIOS code and computer configuration data.	System BIOS code is programmed at the factory. Code is updated when the system BIOS is updated. Configuration data and settings are input using the Computer Setup (BIOS) or a custom utility.	NOTE: Writing data to this ROM in an inappropriate manner can render the computer non-functional. A utility is required for writing data to this memory and is available on the HP website; go to http://www.hp.com/

Table 11-1 Nonvolatile memory usage (continued)

Nonvolatile Memory Type	Amount (Size)	Does this memory store customer data?	Does this memory retain data when power is removed?	What is the purpose of this memory?	How is data input into this memory?	How is this memory write-protected?
Intel Management Engine Firmware (present only in select Elite or Z models. For more information, go to http://www.hp.com/support . Select Find your product , and then follow the on-screen instructions.)	1.5 MBytes or 7 MBytes	Yes	Yes	Stores Management Engine Code, Settings, Provisioning Data and iAMT third-party data store.	Management Engine Code is programmed at the factory. Code is updated via Intel secure firmware update utility. Unique Provisioning Data can be entered at the factory or by an administrator using the Management Engine (MEBx) setup utility. The third party data store contents can be populated by a remote management console or local applications that have been registered by an administrator to have access to the space.	support . Select Find your product , and then follow the on-screen instructions. The Intel chipset is configured to enforce hardware protection to block all direct read/write access to this area. An Intel utility is required for updating the firmware. Only firmware updates digitally signed by Intel can be applied using this utility.
Bluetooth flash (select products only)	2 Mbit	No	Yes	Stores Bluetooth configuration and firmware.	Bluetooth flash is programmed at the factory. Tools for writing data to this memory are not publicly available but can be obtained from the silicon vendor.	A utility is required for writing data to this memory and is made available through newer versions of the driver whenever the flash requires an upgrade.
802.11 WLAN EEPROM	4 Kbit to 8 Kbit	No	Yes	Stores configuration and calibration data.	802.11 WLAN EEPROM is programmed at the factory. Tools for writing data to this memory are not made public.	A utility is required for writing data to this memory and is typically not made available to the public unless a firmware upgrade is necessary to address a unique issue.
Camera (select products only)	64 Kbit	No	Yes	Stores camera configuration and firmware.	Camera memory is programmed using a utility from the device manufacturer that can be run from Windows.	A utility is required for writing data to this memory and is typically not made available to the public unless a firmware upgrade is necessary to address a unique issue.
Fingerprint sensor (select products only)	512 KByte flash	Yes	Yes	Stores fingerprint templates.	Fingerprint sensor memory is programmed by user enrollment in HP ProtectTools Security Manager.	Only a digitally signed application can make the call to write to the flash.

Questions and answers

1. How can the BIOS settings be restored (returned to factory settings)?



IMPORTANT: Restore defaults does not securely erase any data on your hard drive. See question and answer 6 for steps to securely erase data.

Restore defaults does not reset the Custom Secure Boot keys. See question and answer 7 for information about resetting the keys.

- a. Turn on or restart the computer, and then press **esc** while the “Press the ESC key for Startup Menu” message is displayed at the bottom of the screen.
- b. Select **Main**, and then select **Apply Factory Defaults and Exit**.
- c. Follow the on-screen instructions.
- d. Select **Main**, select **Save Changes and Exit**, and then follow the on-screen instructions.

2. What is a UEFI BIOS, and how is it different from a legacy BIOS?

The Unified Extensible Firmware Interface (UEFI) BIOS is an industry-standard software interface between the platform firmware and an operating system (OS). It is a replacement for the older BIOS architecture, but supports much of the legacy BIOS functionality.

Like the legacy BIOS, the UEFI BIOS provides an interface to display the system information and configuration settings and to change the configuration of your computer before an OS is loaded. BIOS provides a secure run-time environment that supports a Graphic User Interface (GUI). In this environment, you can use either a pointing device (touch screen, touchpad, pointing stick, or USB mouse) or the keyboard to navigate and make menu and configuration selections. The UEFI BIOS also contains basic system diagnostics.

The UEFI BIOS provides functionality beyond that of the legacy BIOS. In addition, the UEFI BIOS works to initialize the computer’s hardware before loading and executing the OS; the run-time environment allows the loading and execution of software programs from storage devices to provide more functionality, such as advanced hardware diagnostics (with the ability to display more detailed system information) and advanced firmware management and recovery software.

HP has provided options in Computer Setup (BIOS) to allow you to run in legacy BIOS, if required by the operating system. Examples of this requirement would be if you upgrade or downgrade the OS.

3. Where does the UEFI BIOS reside?

The UEFI BIOS resides on a flash memory chip. A utility is required to write to the chip.

4. What kind of configuration data is stored on the DIMM Serial Presence Detect (SPD) memory module? How would this data be written?

The DIMM SPD memory contains information about the memory module, such as size, serial number, data width, speed/timing, voltage, and thermal information. This information is written by the module manufacturer and stored on an EEPROM. This EEPROM cannot be written to when the memory module is installed in a computer. Third-party tools do exist that can write to the EEPROM when the memory module is not installed in a computer. Various third-party tools are available to read SPD memory.

5. What is meant by “Restore the nonvolatile memory found in Intel-based system boards”?

This message relates to clearing the Real Time Clock (RTC) CMOS memory that contains computer configuration data.

6. How can the BIOS security be reset to factory defaults and data erased?

 **IMPORTANT:** Resetting will result in the loss of information.

These steps will not reset Custom Secure Boot Keys. See question and answer 7 for information about resetting the keys.

- a. Turn on or restart the computer, and then press **esc** while the “Press the ESC key for Startup Menu” message is displayed at the bottom of the screen.
- b. Select **Main**, and then select **Reset Security to Factory Defaults**.
- c. Follow the on-screen instructions.
- d. Select **Main**, select **Save Changes and Exit**, and then follow the on-screen instructions.

7. How can the Custom Secure Boot Keys be reset?

Secure Boot is a feature to ensure that only authenticated code can start on a platform. If you enabled Secure Boot and created Custom Secure Boot Keys, simply disabling Secure Boot will not clear the keys. You must also select to clear the Custom Secure Boot Keys. Use the same Secure Boot access procedure you used to create the Custom Secure Boot Keys, but make the selection to clear or delete all Secure Boot Keys.

- a. Turn on or restart the computer, and then press **esc** while the “Press the ESC key for Startup Menu” message is displayed at the bottom of the screen.
- b. Select the **Security** menu, select **Secure Boot Configuration**, and then follow the on-screen instructions.
- c. At the **Secure Boot Configuration** window, select **Secure Boot**, select **Clear Secure Boot Keys**, and then follow the on-screen instructions to continue.

Using HP Sure Start (select models only)

Select computer models are configured with HP Sure Start, a technology that continuously monitors your computer's BIOS for attacks or corruption. If the BIOS becomes corrupted or is attacked, HP Sure Start restores the BIOS to its previously safe state, without user intervention. Those select computer models ship with HP Sure Start configured and enabled. HP Sure Start is configured and already enabled so that most users can use the HP Sure Start default configuration. The default configuration can be customized by advanced users.

To access the latest documentation on HP Sure Start, go to <http://www.hp.com/support>. Select **Find your product**, and then follow the on-screen instructions.

12 Power cord set requirements

The wide-range input feature of the computer permits it to operate from any line voltage from 100 to 120 V ac, or from 220 to 240 V ac.

The 3-conductor power cord set included with the computer meets the requirements for use in the country or region where the equipment is purchased.

Power cord sets for use in other countries or regions must meet the requirements of the country and region where the computer is used.

Requirements for all countries

The following requirements are applicable to all countries and regions:

- The length of the power cord set must be at least **1.0 m** (3.3 ft) and no more than **2.0 m** (6.5 ft).
- All power cord sets must be approved by an acceptable accredited agency responsible for evaluation in the country or region where the power cord set will be used.
- The power cord sets must have a minimum current capacity of 10 A and a nominal voltage rating of 125 or 250 V ac, as required by the power system of each country or region.
- The appliance coupler must meet the mechanical configuration of an EN 60 320/IEC 320 Standard Sheet C13 connector for mating with the appliance inlet on the back of the computer.

Requirements for specific countries and regions

Table 12-1 Power cord requirements for specific countries and regions

Country/region	Accredited agency	Applicable note number
Argentina	IRAM	1
Australia	SAA	1
Austria	OVE	1
Belgium	CEBEC	1
Brazil	ABNT	1
Canada	CSA	2
Chile	IMQ	1
Denmark	DEMKO	1
Finland	FIMKO	1
France	UTE	1
Germany	VDE	1
India	BIS	1
Israel	SII	1
Italy	IMQ	1
Japan	JIS	3
The Netherlands	KEMA	1
New Zealand	SANZ	1
Norway	NEMKO	1
The People's Republic of China	CCC	4
Saudi Arabia	SASO	7
Singapore	PSB	1
South Africa	SABS	1
South Korea	KTL	5
Sweden	SEMKO	1
Switzerland	SEV	1
Taiwan	BSMI	6
Thailand	TISI	1
The United Kingdom	ASTA	1
The United States	UL	2

1. The flexible cord must be Type H05VV-F, 3-conductor, 0.75 mm² conductor size. Power cord set fittings (appliance coupler and wall plug) must bear the certification mark of the agency responsible for evaluation in the country or region where it will be used.

Table 12-1 Power cord requirements for specific countries and regions (continued)

Country/region	Accredited agency	Applicable note number
		2. The flexible cord must be Type SVT/SJT or equivalent, No. 18 AWG, 3-conductor. The wall plug must be a two-pole grounding type with a NEMA 5-15P (15 A, 125 V ac) or NEMA 6-15P (15 A, 250 V ac) configuration. CSA or C-UL mark. UL file number must be on each element.
		3. The appliance coupler, flexible cord, and wall plug must bear a “T” mark and registration number in accordance with the Japanese Dentori Law. The flexible cord must be Type VCTF, 3-conductor, 0.75 mm ² or 1.25 mm ² conductor size. The wall plug must be a two-pole grounding type with a Japanese Industrial Standard C8303 (7 A, 125 V ac) configuration.
		4. The flexible cord must be Type RVV, 3-conductor, 0.75 mm ² conductor size. Power cord set fittings (appliance coupler and wall plug) must bear the CCC certification mark.
		5. The flexible cord must be Type H05VV-F 3-conductor, 0.75 mm ² conductor size. KTL logo and individual approval number must be on each element. Corset approval number and logo must be printed on a flag label.
		6. The flexible cord must be Type HVCTF 3-conductor, 1.25 mm ² conductor size. Power cord set fittings (appliance coupler, cable, and wall plug) must bear the BSMI certification mark.
		7. For 127 V ac, the flexible cord must be Type SVT or SJT 3-conductor, 18 AWG, with plug NEMA 5-15P (15 A, 125 V ac), with UL and CSA or C-UL marks. For 240 V ac, the flexible cord must be Type H05VV-F 3-conductor, 0.75 mm ² or 1.00 mm ² conductor size, with plug BS 1363/A with BSI or ASTA marks.

13 Recycling

When a non-rechargeable or rechargeable battery has reached the end of its useful life, do not dispose of the battery in general household waste. Follow the local laws and regulations in your area for battery disposal.

HP encourages customers to recycle used electronic hardware, HP original print cartridges, and rechargeable batteries. For more information about recycling programs, see the HP Web site at <http://www.hp.com/recycle>.

Index

A

- AC adapter, spare part numbers 24
- antennas
 - disconnecting 35
- audio, product description 2
- audio-out (headphone)/audio-in (microphone) combo jack, identifying 6

B

- backup, creating 76
- backups 76
- battery
 - removing 41
 - spare part number 41
- battery connector board
 - removal 48
 - spare part number 18, 48
- battery light 7
- BIOS
 - determining version 68
 - downloading an update 68
 - updating 68
- Bluetooth card
 - spare part number 35
- Bluetooth label 16
- boot order
 - changing using the f9 prompt 69
- boot order, changing 77
- bottom cover
 - removing 33
 - spare part number 19, 33
- Bracket Kit
 - contents 22
 - spare part number 22
- buttons
 - left touchpad 11
 - power 13
 - right touchpad 11

C

- Cable Kit
 - contents 21
 - spare part number 21

- camera 9, 10
 - identifying 9, 10
 - product description 2
- camera light, identifying 9, 10
- camera module
 - spare part number 21
- caps lock light, identifying 12
- card reader board
 - removal 51
 - spare part number 18, 51
- cautions
 - electrostatic discharge 28
- components
 - bottom 15
 - display 9
 - keyboard area 11
 - left side 8
 - right side 6
- Computer Setup
 - navigating and selecting 67
 - restoring factory settings 67
 - starting 67
- computer setup 67
- computer specifications 78
- connector, power 7

D

- display assembly
 - removal 57
 - spare part numbers 20, 57
- display bezel
 - spare part numbers 20
- display components 9
- display panel
 - product description 1
- display rear cover
 - spare part number 21
- display specifications 79
- docking
 - product description 3
- drive light, identifying 8

E

- electrostatic discharge (ESD) 28
 - preventing damage 29

- esc key, identifying 14

F

- fan
 - removing 43
 - spare part number 18
- fingerprint sensor assembly
 - removal 50
 - spare part number 18, 50
- fingerprint sensor, identifying 13
- fn key, identifying 14
- fn lock light, identifying 12

G

- graphics, product description 1
- grounding methods 30
- guidelines
 - packaging 31
 - transporting 31
 - workstation 28

H

- hard drive
 - product description 2
 - removing 38
 - spare part numbers 19, 23, 38
 - specifications 79
- Hard Drive Hardware Kit
 - spare part number 23, 38
- HDMI port, identifying 6
- heat sink
 - removal 44
 - spare part number 18
- Hinge Kit
 - spare part number 21
- hot keys
 - break 15
 - insert 15
 - pause 15
 - programming query 15
 - scroll lock 15
- hotkeys, using 15
- HP PC Hardware Diagnostics UEFI
 - downloading 73

- starting 73
- using 72
- HP PC Hardware Diagnostics Windows
 - downloading 71
 - installing 72
 - using 71
- HP Recovery media
 - recovery 77
- HP Sure Start 86

- I**
- integrated numeric keypad,
 - identifying 14
- internal microphones, identifying 9, 10

- J**
- jacks
 - audio-out (headphone)/audio-in (microphone) combo 6
 - network 6
 - RJ-45 (network) 6

- K**
- keyboard
 - product description 3
 - spare part numbers 18
- keyboard/top cover
 - removal 66
 - spare part numbers 66
- keypad
 - integrated numeric 14
- keys
 - esc 14
 - fn 14
 - num lock 14
 - Windows 14

- L**
- labels
 - Bluetooth 16
 - regulatory 16
 - serial number 16
 - service 16
 - wireless certification 16
 - WLAN 16
- left side components 8
- lights
 - AC adapter and battery 7
 - battery 7
 - camera 9, 10

- caps lock 12
- fn lock 12
- hard drive 8
- microphone mute 12
- num lock 12
- power 12
- RJ-45 (network) 6
- wireless 12

- M**
- mass storage devices, spare part numbers 23
- media card reader, product description 3
- memory
 - nonvolatile 81
 - volatile 81
- memory card reader, identifying 8
- memory module
 - product description 1
 - removal 34
 - spare part numbers 18, 34
- microphone (audio-in) jack
 - product description 2
- microphone mute light, identifying 12
- mini card
 - product description 2
- model name 1

- N**
- network jack, identifying 6
- nonvolatile memory 81
- num lock light 12

- O**
- operating system, product description 4
- optical drive
 - product description 2

- P**
- packaging guidelines 31
- pointing device, product description 3
- ports
 - HDMI 6
 - product description 3
 - USB powered 8
 - USB SuperSpeed 6
 - USB Type-C DisplayPort 6

- USB Type-C power connector 6
- USB Type-C SuperSpeed 6
- power button, identifying 13
- power cable
 - spare part number 19
- power connector
 - identifying 6, 7
- power connector cable
 - removal 65
 - spare part number 65
- power cord
 - requirements for all countries 87
 - requirements for specific countries and regions 88
 - set requirements 87
 - spare part numbers 24, 25, 26
- power lights 12
- power requirements, product description 3
- power/USB board
 - removal 46
 - spare part number 18, 46
- processor
 - product description 1
- product description
 - audio 2
 - camera 2
 - display panel 1
 - docking 3
 - graphics 1
 - hard drives 2
 - keyboard 3
 - media card reader 3
 - memory module 1
 - microphone 2
 - mini card 2
 - operating system 4
 - optical drive 2
 - pointing devices 3
 - ports 3
 - power requirements 3
 - processors 1
 - product name 1
 - RJ-45 (network) 2
 - security 4
 - sensors 3
 - serviceability 5
 - wireless 2
- product name 1

product name and number,
computer 16

R

recovery 76
discs 77
HP Recovery partition 77
media 77
USB flash drive 77
recovery media
creating using HP Cloud Recovery
Download Tool 76
creating using Windows tools 76
regulatory information
regulatory label 16
wireless certification labels 16
Remote HP PC Hardware Diagnostics
UEFI settings
customizing 74
using 74
removal/replacement
procedures, Authorized Service
Provider 40
procedures, Customer Self-
Repair 32
removing personal data from volatile
system memory 81
restoring 76
right side components 6
RJ-45 (network) jack, identifying 6
RJ-45 (network) lights, identifying
6
RJ-45 (network), product
description 2
RTC battery
removal 53
spare part number 18, 53

S

Screw Kit, spare part number 24
security cable slot, identifying 8
security, product description 4
sensors
product description 3
serial number, computer 16
service labels, locating 16
serviceability, product description 5
setup utility
navigating and selecting 67
restoring factory settings 67

slots
security cable 8
solid-state drive
removal 37
spare part numbers 18, 23, 37
specifications 80
speaker assembly
removal 42
spare part number 19, 42
speakers, identifying 13
special keys, using 14
specifications
computer 78
display 79
hard drive 79
solid-state drive 80
static electricity 29
Sure Start
using 70
system board
removal 54
spare part numbers 18, 54
system memory, removing personal
data from volatile 81
system restore point, creating 76

T

thermal bracket
spare part number 19
thermal material, replacement 45
touchpad
spare part number 18
touchpad assembly
removal 49
spare part number 49
touchpad buttons
identifying 11
touchpad zone
identifying 11
TPM settings 69
transporting guidelines 31
traveling with the computer 16

U

USB powered port, identifying 8
USB SuperSpeed port, identifying 6
USB Type-C power connector port,
identifying 6
USB Type-C SuperSpeed port,
identifying 6

V

vents, identifying 8, 15

W

Windows
backup 76
recovery media 76
system restore point 76
Windows key, identifying 14
Windows tools, using 76
wireless antennas
disconnecting 35
wireless certification label 16
wireless light, identifying 12
wireless, product description 2
WLAN antennas, identifying 9, 10
WLAN device 16
WLAN label 16
WLAN/Bluetooth combo card
removal 35
spare part number 18, 35
workstation guidelines 28