

FCC Test Report (BT-EDR)

Report No.: RFBWIN-WTW-P21040653-2

FCC ID: J9C-QCNFA725

Test Model: QCNFA725

Received Date: Apr. 20, 2021

Test Date: May 22 to June 16, 2021

Issued Date: July 16, 2021

Applicant: Qualcomm Technologies, Inc.

Address: 5775 Morehouse Drive, San Diego, CA 92121-1714

Issued By: Bureau Veritas Consumer Products Services (H.K.) Ltd., Taoyuan Branch
Hsin Chu Laboratory

Lab Address: E-2, No.1, Li Hsin 1st Road, Hsinchu Science Park, Hsinchu City 300,
Taiwan

Test Location: E-2, No.1, Li Hsin 1st Road, Hsinchu Science Park, Hsinchu City 300,
Taiwan

**FCC Registration /
Designation Number:** 723255 / TW2022



This report is for your exclusive use. Any copying or replication of this report to or for any other person or entity, or use of our name or trademark, is permitted only with our prior written permission. This report sets forth our findings solely with respect to the test samples identified herein. The results set forth in this report are not indicative or representative of the quality or characteristics of the lot from which a test sample was taken or any similar or identical product unless specifically and expressly noted. Our report includes all of the tests requested by you and the results thereof based upon the information that you provided to us. You have 60 days from date of issuance of this report to notify us of any material error or omission caused by our negligence, provided, however, that such notice shall be in writing and shall specifically address the issue you wish to raise. A failure to raise such issue within the prescribed time shall constitute your unqualified acceptance of the completeness of this report, the tests conducted and the correctness of the report contents. Unless specifically mentioned, the uncertainty of measurement has been explicitly taken into account to declare the compliance or non-compliance to the specification.

Table of Contents

Release Control Record	4
1 Certificate of Conformity	5
2 Summary of Test Results	6
2.1 Measurement Uncertainty	6
2.2 Modification Record	6
3 General Information	7
3.1 General Description of EUT (BT-EDR)	7
3.2 Description of Antenna	8
3.3 Description of Test Modes	9
3.3.1 Test Mode Applicability and Tested Channel Detail	10
3.4 Duty Cycle of Test Signal	12
3.5 Description of Support Units	13
3.5.1 Configuration of System under Test	14
3.6 General Description of Applied Standards and references	15
4 Test Types and Results	16
4.1 Radiated Emission and Bandedge Measurement	16
4.1.1 Limits of Radiated Emission and Bandedge Measurement	16
4.1.2 Test Instruments	17
4.1.3 Test Procedures	19
4.1.4 Deviation from Test Standard	20
4.1.5 Test Setup	21
4.1.6 EUT Operating Conditions	22
4.1.7 Test Results (Radiated Measurement)	23
4.1.8 Test Results (Conducted Measurement)	32
4.2 Conducted Emission Measurement	46
4.2.1 Limits of Conducted Emission Measurement	46
4.2.2 Test Instruments	46
4.2.3 Test Procedures	47
4.2.4 Deviation From Test Standard	47
4.2.5 Test Setup	47
4.2.6 EUT Operating Condition	47
4.2.7 Test Results	48
4.3 Number of Hopping Frequency Used	50
4.3.1 Limits of Hopping Frequency Used Measurement	50
4.3.2 Test Setup	50
4.3.3 Test Instruments	50
4.3.4 Test Procedure	50
4.3.5 Deviation from Test Standard	50
4.3.6 Test Results	51
4.4 Dwell Time on Each Channel	52
4.4.1 Limits of Dwell Time on Each Channel Measurement	52
4.4.2 Test Setup	52
4.4.3 Test Instruments	52
4.4.4 Test Procedures	52
4.4.5 Deviation from Test Standard	52
4.4.6 Test Results	53
4.5 Channel Bandwidth	57
4.5.1 Limits of Channel Bandwidth Measurement	57
4.5.2 Test Setup	57
4.5.3 Test Instruments	57
4.5.4 Test Procedure	57
4.5.5 Deviation from Test Standard	57
4.5.6 EUT Operating Condition	57

4.5.7 Test Results	58
4.6 Hopping Channel Separation.....	59
4.6.1 Limits of Hopping Channel Separation Measurement.....	59
4.6.2 Test Setup.....	59
4.6.3 Test Instruments	59
4.6.4 Test Procedure	59
4.6.5 Deviation from Test Standard	59
4.6.6 Test Results	60
4.7 Maximum Output Power	61
4.7.1 Limits of Maximum Output Power Measurement	61
4.7.2 Test Setup.....	61
4.7.3 Test Instruments	61
4.7.4 Test Procedure	61
4.7.5 Deviation from Test Standard	61
4.7.6 EUT Operating Condition	61
4.7.7 Test Results	62
4.8 Conducted Out of Band Emission Measurement	63
4.8.1 Limits of Conducted Out of Band Emission Measurement.....	63
4.8.2 Test Instruments	63
4.8.3 Test Procedure	63
4.8.4 Deviation from Test Standard	63
4.8.5 EUT Operating Condition	63
4.8.6 Test Results	63
5 Pictures of Test Arrangements.....	66
Appendix – Information of the Testing Laboratories	67

Release Control Record

Issue No.	Description	Date Issued
RFBWIN-WTW-P21040653-2	Original release.	July 16, 2021



1 Certificate of Conformity

Product: Wi-Fi 6E BT 5.2 M.2 1418 Module

Brand: Qualcomm

Test Model: QCNFA725

Sample Status: ENGINEERING SAMPLE

Applicant: Qualcomm Technologies, Inc.

Test Date: May 22 to June 16, 2021

Standards: 47 CFR FCC Part 15, Subpart C (Section 15.247)
ANSI C63.10: 2013

The above equipment has been tested by **Bureau Veritas Consumer Products Services (H.K.) Ltd., Taoyuan Branch**, and found compliance with the requirement of the above standards. The test record, data evaluation & Equipment Under Test (EUT) configurations represented herein are true and accurate accounts of the measurements of the sample's EMC characteristics under the conditions specified in this report.

Prepared by : Vivian Huang , **Date:** July 16, 2021
Vivian Huang / Specialist

Approved by : Clark Lin , **Date:** July 16, 2021
Clark Lin / Technical Manager

2 Summary of Test Results

47 CFR FCC Part 15, Subpart C (SECTION 15.247)			
FCC Clause	Test Item	Result	Remarks
15.207	AC Power Conducted Emission	PASS	Meet the requirement of limit. Minimum passing margin is -19.93dB at 3.99219 MHz.
15.247(a)(1)(iii)	Number of Hopping Frequency Used	PASS	Meet the requirement of limit.
15.247(a)(1)(iii)	Dwell Time on Each Channel	PASS	Meet the requirement of limit.
15.247(a)(1)	1. Hopping Channel Separation 2. Spectrum Bandwidth of a Frequency Hopping Sequence Spread Spectrum System	PASS	Meet the requirement of limit.
15.247(b)	Maximum Peak Output Power	PASS	Meet the requirement of limit.
15.205 & 209 & 15.247(d)	Radiated Emissions & Band Edge Measurement	PASS	Meet the requirement of limit. Minimum passing margin is -16.3dB at 900.24 MHz.
15.247(d)	Antenna Port Emission	PASS	Meet the requirement of limit.
15.203	Antenna Requirement	PASS	Antenna connector is i-pex (MHF 4L) not a standard connector.

NOTE:

1. If The Frequency Hopping System operating in 2400-2483.5MHz band and the output power less than 125mW. The hopping channel carrier frequencies separated by a minimum of 25kHz or two-thirds of the 20dB bandwidth of hopping channel whichever is greater.
2. Determining compliance based on the results of the compliance measurement, not taking into account measurement instrumentation uncertainty.

2.1 Measurement Uncertainty

Where relevant, the following measurement uncertainty levels have been estimated for tests performed on the EUT as specified in CISPR 16-4-2:

Measurement	Frequency	Expanded Uncertainty (k=2) (±)
Conducted Emissions at mains ports	150kHz ~ 30MHz	1.8 dB
Conducted Emissions	-	3.1 dB
Radiated Emissions up to 1 GHz	9kHz ~ 30MHz	3.0 dB
	30MHz ~ 1GHz	4.9 dB
Radiated Emissions above 1 GHz	1GHz ~ 6GHz	5.1 dB
	6GHz ~ 18GHz	4.9 dB
	18GHz ~ 40GHz	5.2 dB

2.2 Modification Record

There were no modifications required for compliance.

3 General Information

3.1 General Description of EUT (BT-EDR)

Product	Wi-Fi 6E BT 5.2 M.2 1418 Module
Brand	Qualcomm
Test Model	QCNFA725
Status of EUT	Engineering sample
Power Supply Rating	3.3Vdc from host equipment
Modulation Type	GFSK, $\pi/4$ -DQPSK, 8DPSK
Modulation Technology	FHSS
Transfer Rate	Up to 3Mbps
Operating Frequency	2402MHz ~ 2480MHz
Number of Channel	79
Output Power	29.785 mW
Antenna Type	Refer to section 3.2
Antenna Connector	Refer to section 3.2
Accessory Device	NA
Data Cable Supplied	NA

Note:

1. This device of WLAN (2.4GHz & 5GHz U-NII-1 Band) can support hotspot mode.
2. Simultaneously transmission condition.

Condition	Technology	
1	WLAN 2.4GHz	WLAN 6GHz
2	WLAN 2.4GHz	WLAN 5GHz
3	WLAN 6GHz	Bluetooth
4	WLAN 5GHz	Bluetooth

3. The device of WLAN (2.4GHz) and Bluetooth technology can't transmit simultaneously, it was used timely shared coexistence technology.
4. The above EUT information is declared by manufacturer and for more detailed features description, please refers to the manufacturer's specifications or user's manual.

3.2 Description of Antenna

The antenna gain was declared by client; please refer to the following table:

Antenna Set	RF Chain No.	Brand	Model	Antenna Net Gain (dBi)	Frequency Range	Cable Loss (dB)	Antenna Type	Connector Type	Cable Length
1	Chain0/1	HONGBO	260-25094	3.53	2.4~2.4835 GHz	0.76	PIFA	i-pex(MHF 4L)	300mm
				3.06	5.15~5.25 GHz	1.16			
				3.07	5.25~5.35 GHz	1.18			
				4.81	5.47~5.725 GHz	1.2			
				4.2	5.725~5.850 GHz	1.27			
2	Chain0/1	HONGBO	260-25083	5.09	5.850~5.895 GHz	1.29	PIFA	i-pex(MHF 4L)	300mm
				5.14	5.925~6.425 GHz	1.32			
				5.09	6.425~6.525 GHz	1.35			
				5.16	6.525~6.875 GHz	1.4			
				5.12	6.875~7.125 GHz	1.45			
3	Chain0/1	HONGBO	260-25084	3.22	2.4~2.4835 GHz	0.5	Monopole	i-pex(MHF 4L)	200mm
				3.35	5.150~5.250 GHz	0.76			
				3.42	5.250~5.350 GHz	0.78			
				4.77	5.470~5.725 GHz	0.81			
				4.72	5.725~5.850 GHz	0.85			
				4.71	5.850~5.895 GHz	0.86			
				4.75	5.925~6.425 GHz	0.87			
				4.29	6.425~6.525 GHz	0.91			
				4.81	6.525~6.875 GHz	0.96			
				4.74	6.875~7.125 GHz	0.98			

Note: The above Antenna information is declared by manufacturer and for more detailed features description, please refer to the manufacturer's specifications, the laboratory shall not be held responsible.

3.3 Description of Test Modes

79 channels are provided for BT-EDR mode:

Channel	Freq. (MHz)	Channel	Freq. (MHz)	Channel	Freq. (MHz)	Channel	Freq. (MHz)
0	2402	20	2422	40	2442	60	2462
1	2403	21	2423	41	2443	61	2463
2	2404	22	2424	42	2444	62	2464
3	2405	23	2425	43	2445	63	2465
4	2406	24	2426	44	2446	64	2466
5	2407	25	2427	45	2447	65	2467
6	2408	26	2428	46	2448	66	2468
7	2409	27	2429	47	2449	67	2469
8	2410	28	2430	48	2450	68	2470
9	2411	29	2431	49	2451	69	2471
10	2412	30	2432	50	2452	70	2472
11	2413	31	2433	51	2453	71	2473
12	2414	32	2434	52	2454	72	2474
13	2415	33	2435	53	2455	73	2475
14	2416	34	2436	54	2456	74	2476
15	2417	35	2437	55	2457	75	2477
16	2418	36	2438	56	2458	76	2478
17	2419	37	2439	57	2459	77	2479
18	2420	38	2440	58	2460	78	2480
19	2421	39	2441	59	2461		

3.3.1 Test Mode Applicability and Tested Channel Detail

EUT CONFIGURE MODE	APPLICABLE TO				DESCRIPTION
	RE \geq 1G	RE $<$ 1G	PLC	APCM	
-	√	√	√	√	-

RE \geq 1G: Radiated Emission above 1GHz

RE $<$ 1G: Radiated Emission below 1GHz

PLC: Power Line Conducted Emission

APCM: Antenna Port Conducted Measurement

Radiated Emission Test (Above 1GHz):

- Pre-Scan has been conducted to determine the worst-case mode from all possible combinations between available modulations, data rates and antenna ports (if EUT with antenna diversity architecture).
- Following channel(s) was (were) selected for the final test as listed below.

AVAILABLE CHANNEL	TESTED CHANNEL	MODULATION TECHNOLOGY	MODULATION TYPE	PACKET TYPE
0 to 78	0, 39, 78	FHSS	GFSK	DH5
0 to 78	0, 39, 78	FHSS	8DPSK	3DH5

Radiated Emission Test (Below 1GHz):

- Pre-Scan has been conducted to determine the worst-case mode from all possible combinations between available modulations, data rates and antenna ports (if EUT with antenna diversity architecture).
- Following channel(s) was (were) selected for the final test as listed below.

AVAILABLE CHANNEL	TESTED CHANNEL	MODULATION TECHNOLOGY	MODULATION TYPE	PACKET TYPE
0 to 78	0	FHSS	GFSK	DH5

Power Line Conducted Emission Test:

- Pre-Scan has been conducted to determine the worst-case mode from all possible combinations between available modulations, data rates and antenna ports (if EUT with antenna diversity architecture).
- Following channel(s) was (were) selected for the final test as listed below.

AVAILABLE CHANNEL	TESTED CHANNEL	MODULATION TECHNOLOGY	MODULATION TYPE	PACKET TYPE
0 to 78	0	FHSS	GFSK	DH5



Antenna Port Conducted Measurement:

- This item includes all test value of each mode, but only includes spectrum plot of worst value of each mode.
- Pre-Scan has been conducted to determine the worst-case mode from all possible combinations between available modulations, data rates and antenna ports (if EUT with antenna diversity architecture).
- Following channel(s) was (were) selected for the final test as listed below.

AVAILABLE CHANNEL	TESTED CHANNEL	MODULATION TECHNOLOGY	MODULATION TYPE	PACKET TYPE
0 to 78	0, 39, 78	FHSS	GFSK	DH5
0 to 78	0, 39, 78	FHSS	8DPSK	3DH5

Test Condition:

APPLICABLE TO	ENVIRONMENTAL CONDITIONS	INPUT POWER (System)	TESTED BY
RE \geq 1G	25deg. C, 75%RH	120Vac, 60Hz	Carter Lin
RE $<$ 1G	24deg. C, 65%RH	120Vac, 60Hz	Carter Lin
PLC	24deg. C, 75%RH	120Vac, 60Hz	Carter Lin
APCM	25deg. C, 60%RH	120Vac, 60Hz	Eric Peng

3.4 Duty Cycle of Test Signal

GFSK: Duty cycle = 2.871 ms/3.746 ms = 0.766, Duty factor = $10 * \log (1/ \text{Duty cycle}) = 1.16\text{dB}$

8DPSK: Duty cycle = 2.877 ms/3.753 ms = 0.767, Duty factor = $10 * \log (1/ \text{Duty cycle}) = 1.15\text{dB}$

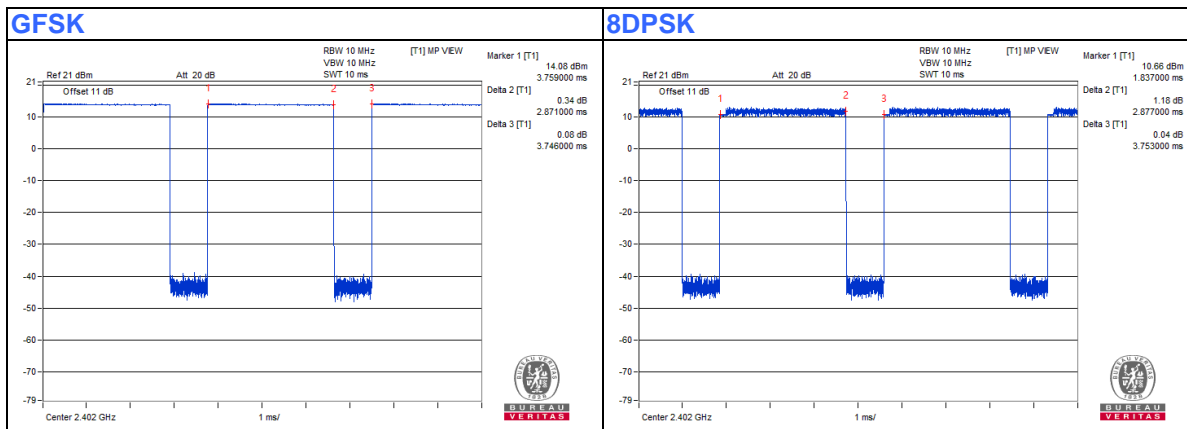



3.5 Description of Support Units

The EUT has been tested as an independent unit together with other necessary accessories or support units. The following support units or accessories were used to form a representative test configuration during the tests.

ID	Product	Brand	Model No.	Serial No.	FCC ID	Remarks
A.	Laptop	Dell	E5420	6FGHKV1	NA	Provided by Lab
B.	Test Tool	Qualcomm	Y6570	NA	NA	Supplied by client
C.	Adapter	PHIHONG	PSAA12A-120L6	NA	NA	Supplied by client

Note:

1. All power cords of the above support units are non-shielded (1.8m).

ID	Descriptions	Qty.	Length (m)	Shielding (Yes/No)	Cores (Qty.)	Remarks
1.	DC Cable	1	1.2	No	0	Supplied by client
2.	USB Cable	1	0.6	Yes	0	Provided by Lab

3.5.1 Configuration of System under Test

For Conducted Emissions test:

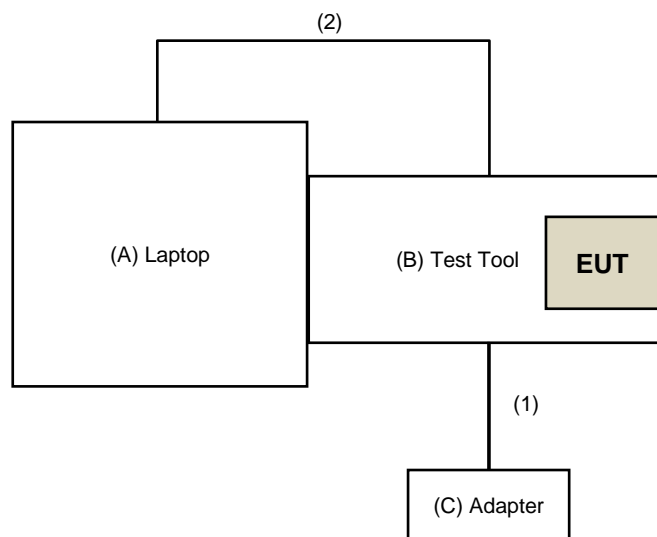

For other test:

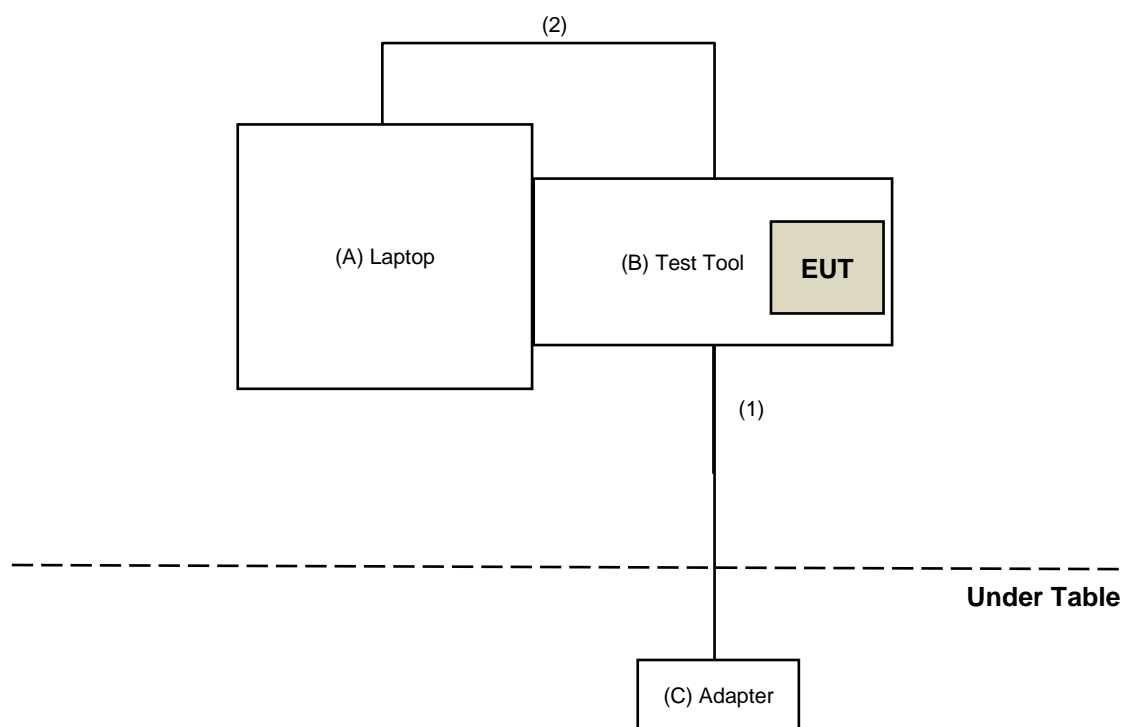

3.6 General Description of Applied Standards and references

The EUT is a RF Product. According to the specifications of the manufacturer, it must comply with the requirements of the following standards and references:

Test standard:

FCC Part 15, Subpart C (15.247)

ANSI C63.10-2013

All test items have been performed and recorded as per the above standards.

References Test Guidance:

KDB 558074 D01 15.247 Meas Guidance v05r02

All test items have been performed as a reference to the above KDB test guidance.

4 Test Types and Results

4.1 Radiated Emission and Bandedge Measurement

4.1.1 Limits of Radiated Emission and Bandedge Measurement

Radiated emissions which fall in the restricted bands must comply with the radiated emission limits specified as below table. Other emissions shall be at least 20dB below the highest level of the desired power:

Frequencies (MHz)	Field Strength (microvolts/meter)	Measurement Distance (meters)
0.009 ~ 0.490	2400/F(kHz)	300
0.490 ~ 1.705	24000/F(kHz)	30
1.705 ~ 30.0	30	30
30 ~ 88	100	3
88 ~ 216	150	3
216 ~ 960	200	3
Above 960	500	3

NOTE:

1. The lower limit shall apply at the transition frequencies.
2. Emission level (dBuV/m) = 20 log Emission level (uV/m).
3. For frequencies above 1000MHz, the field strength limits are based on average detector, however, the peak field strength of any emission shall not exceed the maximum permitted average limits, specified above by more than 20dB under any condition of modulation.



4.1.2 Test Instruments

For Radiated Emission test:

DESCRIPTION & MANUFACTURER	MODEL NO.	SERIAL NO.	CALIBRATED DATE	CALIBRATED UNTIL
Test Receiver Agilent	N9038A	MY51210202	Dec. 01, 2020	Nov. 30, 2021
Pre-Amplifier EMCI	EMC001340	980142	May 25, 2020	May 24, 2021
Loop Antenna Electro-Metrics	EM-6879	264	Mar. 05, 2021	Mar. 04, 2022
RF Cable	5D-FB	LOOPCAB-001	Jan. 07, 2021	Jan. 06, 2022
RF Cable	5D-FB	LOOPCAB-002	Jan. 07, 2021	Jan. 06, 2022
Pre-Amplifier EMCI	EMC330N	980701	Mar. 10, 2021	Mar. 09, 2022
Trilog Broadband Antenna SCHWARZBECK	VULB 9168	9168-406	Nov. 06, 2020	Nov. 05, 2021
RF Cable	8D	966-4-1	Mar. 17, 2021	Mar. 16, 2022
RF Cable	8D	966-4-2	Mar. 17, 2021	Mar. 16, 2022
RF Cable	8D	966-4-3	Mar. 17, 2021	Mar. 16, 2022
Fixed attenuator Mini-Circuits	UNAT-5+	PAD-ATT5-03	Jan. 11, 2021	Jan. 10, 2022
Horn_Antenna SCHWARZBECK	BBHA 9120D	9120D-783	Nov. 22, 2020	Nov. 21, 2021
Pre-Amplifier EMCI	EMC 12630 SE	980638	Apr. 07, 2021	Apr. 06, 2022
RF Cable	EMC104-SM-SM-1200	160922	Dec. 25, 2020	Dec. 24, 2021
RF Cable	EMC104-SM-SM-2000	180502	Apr. 26, 2021	Apr. 25, 2022
RF Cable	EMC104-SM-SM-6000	180418	Apr. 26, 2021	Apr. 25, 2022
Pre-Amplifier EMCI	EMC184045SE	980387	Jan. 11, 2021	Jan. 10, 2022
Horn_Antenna SCHWARZBECK	BBHA 9170	BBHA9170519	Nov. 22, 2020	Nov. 21, 2021
RF Cable	EMC102-KM-KM-1200	160924	Jan. 11, 2021	Jan. 10, 2022
RF Cable	EMC-KM-KM-4000	200214	Mar. 10, 2021	Mar. 09, 2022
Software	ADT_Radiated_V8.7.08	NA	NA	NA
Boresight Antenna Tower & Turn Table Max-Full	MF-7802BS	MF780208530	NA	NA

Note:

1. The calibration interval of the above test instruments is 12 months and the calibrations are traceable to NML/ROC and NIST/USA.
2. The test was performed in 966 Chamber No. 4.
3. Tested Date: May 22, 2021



For other test:

DESCRIPTION & MANUFACTURER	MODEL NO.	SERIAL NO.	CALIBRATED DATE	CALIBRATED UNTIL
Spectrum Analyzer R&S	FSV40	101516	Mar. 08, 2021	Mar. 07, 2022
Spectrum Analyzer Keysight	N9030A	MY54490679	July 13, 2020	July 12, 2021
Power meter Anritsu	ML2495A	1529002	July 22, 2020	July 21, 2021
Power sensor Anritsu	MA2411B	1339443	July 22, 2020	July 21, 2021
10dB Attenuator Woken	MDCS18N-10	MDCS18N-10-01	Apr. 13, 2021	Apr. 12, 2022
Mech Switch Absorptive Mini-Circuits	MSP4TA-18+	0140	Feb. 05, 2021	Feb. 04, 2022
FXD ATTEN Mini-Circuits	BW-S3W2+	MN71981	Feb. 05, 2021	Feb. 04, 2022
Software	ADT_RF Test Software V6.6.5.4	NA	NA	NA

- NOTE:**
1. The test was performed in Oven room 2.
 2. The calibration interval of the above test instruments is 12 months and the calibrations are traceable to NML/ROC and NIST/USA.
 3. Tested Date: June 16, 2021

4.1.3 Test Procedures

Following FCC KDB 558074 D01 DTS Meas. Guidance:

Radiated versus Conducted Measurements.

The unwanted emission limits in both the restricted and non-restricted bands are based on antenna-port conducted measurements in conjunction with cabinet emissions tests are permitted to demonstrate compliance.

The following steps was performed:

- a. Cabinet emissions measurements. Radiated measurement was performed to ensure that cabinet emissions are below the emission limits. For the cabinet-emission measurements the antenna was replaced by a termination matching the nominal impedance of the antenna.
- b. Conducted tests was performed using equipment that matches the nominal impedance of the antenna assembly used with the EUT.
- c. EIRP calculation. A value representative of an upper bound on out-of-band antenna gain (in dBi) shall be added to the measured antenna-port conducted emission power to compute EIRP within the specified measurement bandwidth. (For emissions in the restricted bands, additional calculations are required to convert EIRP to field strength at the specified distance.) The upper bound on antenna gain for a device with a single RF output shall be selected as the maximum in-band gain of the antenna across all operating bands or 2 dBi, whichever is greater.
- d. For all of Radiation emission test

For Radiated emission below 30MHz

- d-1.1. The EUT was placed on the top of a rotating table 0.8 meters above the ground at a 3 meter chamber room. The table was rotated 360 degrees to determine the position of the highest radiation.
- d-1.2. The EUT was set 3 meters away from the interference-receiving antenna, which was mounted on the top of a variable-height antenna tower.
- d-1.3. Parallel, perpendicular, and ground-parallel orientations of the antenna are set to make the measurement.
- d-1.4. For each suspected emission, the EUT was arranged to its worst case and the rotatable table was turned from 0 degrees to 360 degrees to find the maximum reading.
- d-1.5. The test-receiver system was set to Quasi-Peak Detect Function and Specified Bandwidth with Maximum Hold Mode.

Note:

1. The resolution bandwidth and video bandwidth of test receiver/spectrum analyzer is 9kHz at frequency below 30MHz.
2. KDB 414788 OATS and Chamber Correlation Justification
 - Based on FCC 15.31(f)(2) : measurements may be performed at a distance closer than that specified in the regulations; however, an attempts should be made to avoid making measurements in the near field.
 - OATs and chamber correlation testing had been performed and chamber measured test result is the worst case test result.

For Radiated emission above 30MHz

- d-2.1. The EUT was placed on the top of a rotating table 0.8 meters (for 30MHz ~ 1GHz) / 1.5 meters (for above 1GHz) above the ground at 3 meter chamber room for test. The table was rotated 360 degrees to determine the position of the highest radiation.
- d-2.2. The EUT was set 3 meters away from the interference-receiving antenna, which was mounted on the top of a variable-height antenna tower.
- d-2.3. The height of antenna is varied from one meter to four meters above the ground to determine the maximum value of the field strength. Both horizontal and vertical polarizations of the antenna are set to make the measurement.
- d-2.4. For each suspected emission, the EUT was arranged to its worst case and then the antenna was tuned to heights from 1 meter to 4 meters and the rotatable table was turned from 0 degrees to 360 degrees to find the maximum reading.
- d-2.5. The test-receiver system was set to quasi-peak detect function and specified bandwidth with maximum hold mode when the test frequency is below 1 GHz.
- d-2.6. The test-receiver system was set to peak and average detects function and specified bandwidth with maximum hold mode when the test frequency is above 1 GHz. If the peak reading value also meets average limit, measurement with the average detector is unnecessary.

Note:

1. The resolution bandwidth and video bandwidth of test receiver/spectrum analyzer is 120kHz for Quasi-peak detection (QP) at frequency below 1GHz.
2. The resolution bandwidth of test receiver/spectrum analyzer is 1 MHz and the video bandwidth is 3 MHz for Peak detection (PK) at frequency above 1GHz.
3. The resolution bandwidth of test receiver/spectrum analyzer is 1MHz and the video bandwidth is $\geq 1/T$ (Duty cycle < 98%) or 10Hz (Duty cycle $\geq 98\%$) for Average detection (AV) at frequency above 1GHz.
4. All modes of operation were investigated and the worst-case emissions are reported.

4.1.4 Deviation from Test Standard

No deviation.

4.1.5 Test Setup

For radiated configuration:

For Radiated emission below 30MHz

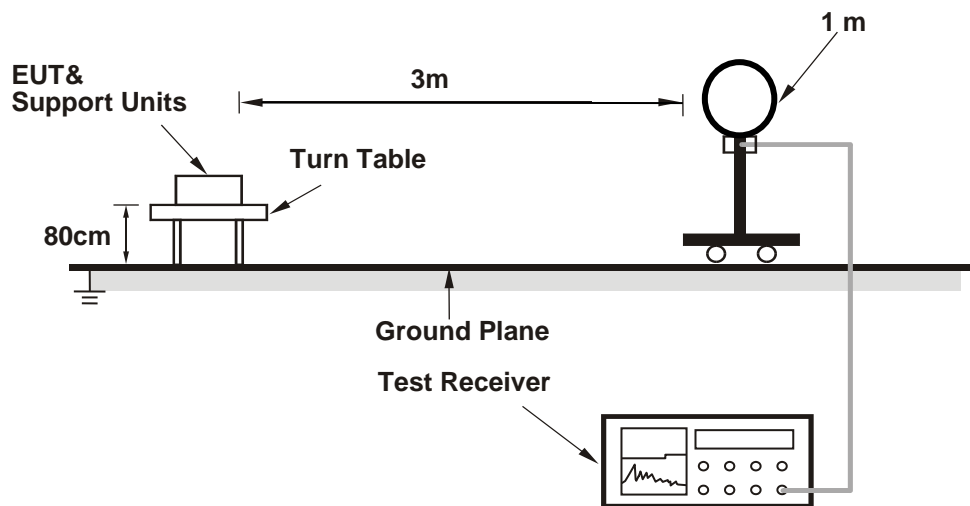

For Radiated emission 30MHz to 1GHz

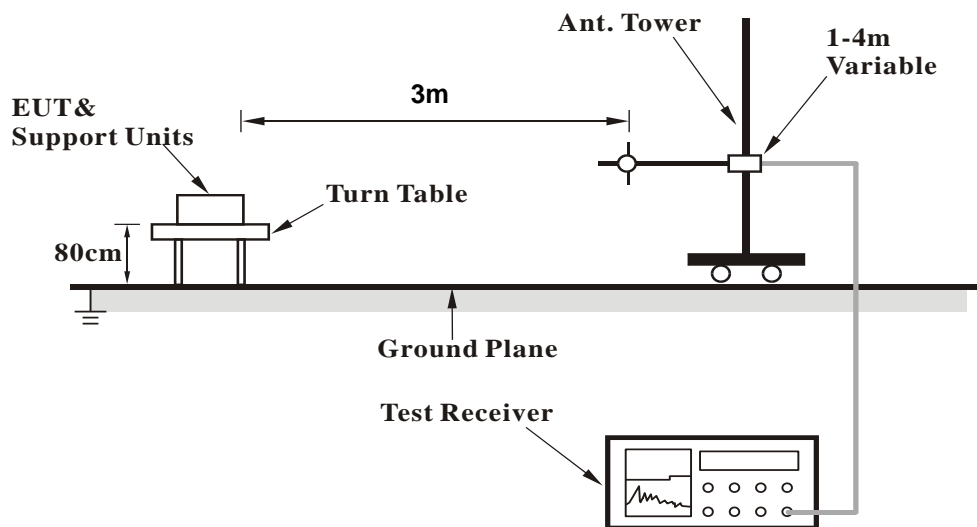

For Radiated emission above 1GHz

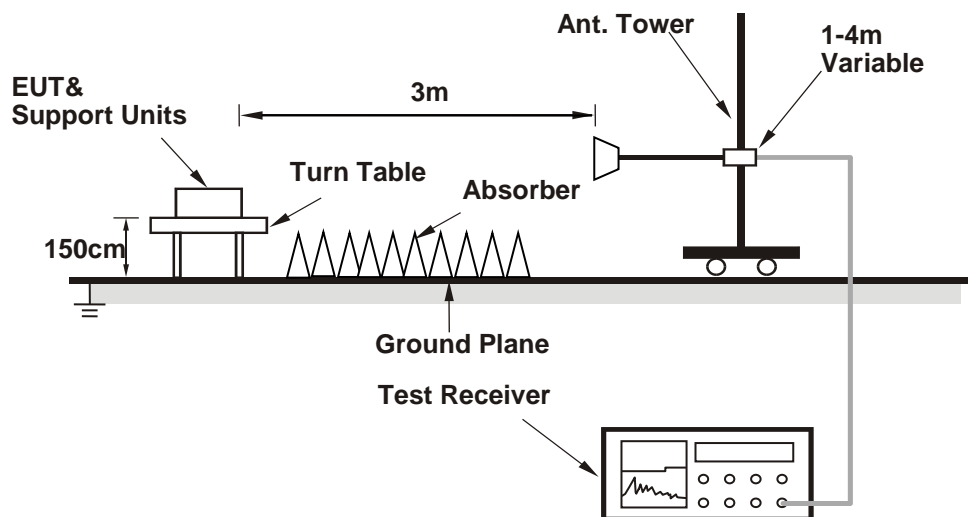

For conducted configuration:

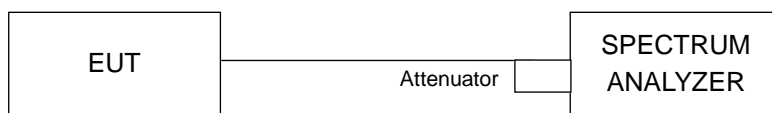

For the actual test configuration, please refer to the attached file (Test Setup Photo).

4.1.6 EUT Operating Conditions

- a. Connected the EUT with the Laptop which is placed on the testing table.
- b. Controlling software (QRCT 4.0.00177.0) has been activated to set the EUT under transmission condition continuously at specific channel frequency.

4.1.7 Test Results (Radiated Measurement)

Radiated versus Conducted Measurement	
<input type="checkbox"/> Conducted measurement	<input checked="" type="checkbox"/> Radiated measurement
<u>For Radiated measurement:</u> The level of unwanted emissions was measured when radiated by the cabinet or structure of the equipment with the antenna connector(s) terminated by a specified load (cabinet radiation)	
<u>For Conducted measurement:</u> The level of unwanted emissions was measured as their power in a specified load (conducted spurious emissions).	



Radiated test was done with 50ohm terminator on antenna port.

ABOVE 1GHz DATA

RF Mode	TX BT_GFSK	Channel	CH 0 : 2402 MHz
Frequency Range	1GHz ~ 25GHz	Detector Function	Peak (PK) Average (AV)

Antenna Polarity & Test Distance : Horizontal at 3 m

No	Frequency (MHz)	Emission Level (dBuV/m)	Limit (dBuV/m)	Margin (dB)	Antenna Height (m)	Table Angle (Degree)	Raw Value (dBuV)	Correction Factor (dB/m)
1	4804.00	42.8 PK	74.0	-31.2	1.38 H	274	42.4	0.4
2	4804.00	28.7 AV	54.0	-25.3	1.38 H	274	28.3	0.4

Antenna Polarity & Test Distance : Vertical at 3 m

No	Frequency (MHz)	Emission Level (dBuV/m)	Limit (dBuV/m)	Margin (dB)	Antenna Height (m)	Table Angle (Degree)	Raw Value (dBuV)	Correction Factor (dB/m)
1	4804.00	41.2 PK	74.0	-32.8	1.53 V	160	40.8	0.4
2	4804.00	27.6 AV	54.0	-26.4	1.53 V	160	27.2	0.4

Remarks:

1. Emission Level(dBuV/m) = Raw Value(dBuV) + Correction Factor(dB/m)
2. Correction Factor(dB/m) = Antenna Factor(dB/m) + Cable Factor(dB) – Pre-Amplifier Factor(dB)
3. Margin value = Emission Level – Limit value
4. The other emission levels were very low against the limit.



RF Mode	TX BT_GFSK	Channel	CH 39 : 2441 MHz
Frequency Range	1GHz ~ 25GHz	Detector Function	Peak (PK) Average (AV)

Antenna Polarity & Test Distance : Horizontal at 3 m								
No	Frequency (MHz)	Emission Level (dBuV/m)	Limit (dBuV/m)	Margin (dB)	Antenna Height (m)	Table Angle (Degree)	Raw Value (dBuV)	Correction Factor (dB/m)
1	4882.00	41.9 PK	74.0	-32.1	1.33 H	287	41.4	0.5
2	4882.00	28.2 AV	54.0	-25.8	1.33 H	287	27.7	0.5
3	7323.00	45.1 PK	74.0	-28.9	1.95 H	279	38.3	6.8
4	7323.00	31.2 AV	54.0	-22.8	1.95 H	279	24.4	6.8

Antenna Polarity & Test Distance : Vertical at 3 m								
No	Frequency (MHz)	Emission Level (dBuV/m)	Limit (dBuV/m)	Margin (dB)	Antenna Height (m)	Table Angle (Degree)	Raw Value (dBuV)	Correction Factor (dB/m)
1	4882.00	41.0 PK	74.0	-33.0	1.58 V	165	40.5	0.5
2	4882.00	27.6 AV	54.0	-26.4	1.58 V	165	27.1	0.5
3	7323.00	43.8 PK	74.0	-30.2	2.56 V	154	37.0	6.8
4	7323.00	30.5 AV	54.0	-23.5	2.56 V	154	23.7	6.8

Remarks:

1. Emission Level(dBuV/m) = Raw Value(dBuV) + Correction Factor(dB/m)
2. Correction Factor(dB/m) = Antenna Factor(dB/m) + Cable Factor(dB) – Pre-Amplifier Factor(dB)
3. Margin value = Emission Level – Limit value
4. The other emission levels were very low against the limit.



RF Mode	TX BT_GFSK	Channel	CH 78 : 2480 MHz
Frequency Range	1GHz ~ 25GHz	Detector Function	Peak (PK) Average (AV)

Antenna Polarity & Test Distance : Horizontal at 3 m								
No	Frequency (MHz)	Emission Level (dBuV/m)	Limit (dBuV/m)	Margin (dB)	Antenna Height (m)	Table Angle (Degree)	Raw Value (dBuV)	Correction Factor (dB/m)
1	4960.00	41.6 PK	74.0	-32.4	1.38 H	289	40.7	0.9
2	4960.00	28.1 AV	54.0	-25.9	1.38 H	289	27.2	0.9
3	7440.00	45.2 PK	74.0	-28.8	1.95 H	288	37.9	7.3
4	7440.00	31.2 AV	54.0	-22.8	1.95 H	288	23.9	7.3

Antenna Polarity & Test Distance : Vertical at 3 m								
No	Frequency (MHz)	Emission Level (dBuV/m)	Limit (dBuV/m)	Margin (dB)	Antenna Height (m)	Table Angle (Degree)	Raw Value (dBuV)	Correction Factor (dB/m)
1	4960.00	40.7 PK	74.0	-33.3	1.53 V	158	39.8	0.9
2	4960.00	27.4 AV	54.0	-26.6	1.53 V	158	26.5	0.9
3	7440.00	43.5 PK	74.0	-30.5	2.57 V	149	36.2	7.3
4	7440.00	30.4 AV	54.0	-23.6	2.57 V	149	23.1	7.3

Remarks:

1. Emission Level(dBuV/m) = Raw Value(dBuV) + Correction Factor(dB/m)
2. Correction Factor(dB/m) = Antenna Factor(dB/m) + Cable Factor(dB) – Pre-Amplifier Factor(dB)
3. Margin value = Emission Level – Limit value
4. The other emission levels were very low against the limit.



RF Mode	TX BT_8DPSK	Channel	CH 0 : 2402 MHz
Frequency Range	1GHz ~ 25GHz	Detector Function	Peak (PK) Average (AV)

Antenna Polarity & Test Distance : Horizontal at 3 m								
No	Frequency (MHz)	Emission Level (dBuV/m)	Limit (dBuV/m)	Margin (dB)	Antenna Height (m)	Table Angle (Degree)	Raw Value (dBuV)	Correction Factor (dB/m)
1	4804.00	42.5 PK	74.0	-31.5	1.29 H	275	42.1	0.4
2	4804.00	28.4 AV	54.0	-25.6	1.29 H	275	28.0	0.4

Antenna Polarity & Test Distance : Vertical at 3 m								
No	Frequency (MHz)	Emission Level (dBuV/m)	Limit (dBuV/m)	Margin (dB)	Antenna Height (m)	Table Angle (Degree)	Raw Value (dBuV)	Correction Factor (dB/m)
1	4804.00	41.5 PK	74.0	-32.5	1.58 V	154	41.1	0.4
2	4804.00	28.1 AV	54.0	-25.9	1.58 V	154	27.7	0.4

Remarks:

1. Emission Level(dBuV/m) = Raw Value(dBuV) + Correction Factor(dB/m)
2. Correction Factor(dB/m) = Antenna Factor(dB/m) + Cable Factor(dB) – Pre-Amplifier Factor(dB)
3. Margin value = Emission Level – Limit value
4. The other emission levels were very low against the limit.



RF Mode	TX BT_8DPSK	Channel	CH 39 : 2441 MHz
Frequency Range	1GHz ~ 25GHz	Detector Function	Peak (PK) Average (AV)

Antenna Polarity & Test Distance : Horizontal at 3 m								
No	Frequency (MHz)	Emission Level (dBuV/m)	Limit (dBuV/m)	Margin (dB)	Antenna Height (m)	Table Angle (Degree)	Raw Value (dBuV)	Correction Factor (dB/m)
1	4882.00	41.7 PK	74.0	-32.3	1.37 H	292	41.2	0.5
2	4882.00	27.9 AV	54.0	-26.1	1.37 H	292	27.4	0.5
3	7323.00	45.6 PK	74.0	-28.4	1.91 H	281	38.8	6.8
4	7323.00	31.5 AV	54.0	-22.5	1.91 H	281	24.7	6.8

Antenna Polarity & Test Distance : Vertical at 3 m								
No	Frequency (MHz)	Emission Level (dBuV/m)	Limit (dBuV/m)	Margin (dB)	Antenna Height (m)	Table Angle (Degree)	Raw Value (dBuV)	Correction Factor (dB/m)
1	4882.00	40.4 PK	74.0	-33.6	1.53 V	163	39.9	0.5
2	4882.00	27.3 AV	54.0	-26.7	1.53 V	163	26.8	0.5
3	7323.00	43.9 PK	74.0	-30.1	2.58 V	157	37.1	6.8
4	7323.00	30.9 AV	54.0	-23.1	2.58 V	157	24.1	6.8

Remarks:

1. Emission Level(dBuV/m) = Raw Value(dBuV) + Correction Factor(dB/m)
2. Correction Factor(dB/m) = Antenna Factor(dB/m) + Cable Factor(dB) – Pre-Amplifier Factor(dB)
3. Margin value = Emission Level – Limit value
4. The other emission levels were very low against the limit.



RF Mode	TX BT_8DPSK	Channel	CH 78 : 2480 MHz
Frequency Range	1GHz ~ 25GHz	Detector Function	Peak (PK) Average (AV)

Antenna Polarity & Test Distance : Horizontal at 3 m								
No	Frequency (MHz)	Emission Level (dBuV/m)	Limit (dBuV/m)	Margin (dB)	Antenna Height (m)	Table Angle (Degree)	Raw Value (dBuV)	Correction Factor (dB/m)
1	4960.00	42.3 PK	74.0	-31.7	1.30 H	302	41.4	0.9
2	4960.00	28.3 AV	54.0	-25.7	1.30 H	302	27.4	0.9
3	7440.00	44.5 PK	74.0	-29.5	1.99 H	281	37.2	7.3
4	7440.00	30.8 AV	54.0	-23.2	1.99 H	281	23.5	7.3

Antenna Polarity & Test Distance : Vertical at 3 m								
No	Frequency (MHz)	Emission Level (dBuV/m)	Limit (dBuV/m)	Margin (dB)	Antenna Height (m)	Table Angle (Degree)	Raw Value (dBuV)	Correction Factor (dB/m)
1	4960.00	41.0 PK	74.0	-33.0	1.55 V	170	40.1	0.9
2	4960.00	27.3 AV	54.0	-26.7	1.55 V	170	26.4	0.9
3	7440.00	43.6 PK	74.0	-30.4	2.59 V	142	36.3	7.3
4	7440.00	30.5 AV	54.0	-23.5	2.59 V	142	23.2	7.3

Remarks:

1. Emission Level(dBuV/m) = Raw Value(dBuV) + Correction Factor(dB/m)
2. Correction Factor(dB/m) = Antenna Factor(dB/m) + Cable Factor(dB) – Pre-Amplifier Factor(dB)
3. Margin value = Emission Level – Limit value
4. The other emission levels were very low against the limit.

Below 1GHz Data:

RF Mode	TX BT_GFSK	Channel	CH 0 : 2402 MHz
Frequency Range	9kHz ~ 1GHz	Detector Function	Quasi-Peak (QP)

Antenna Polarity & Test Distance : Horizontal at 3 m								
No	Frequency (MHz)	Emission Level (dBuV/m)	Limit (dBuV/m)	Margin (dB)	Antenna Height (m)	Table Angle (Degree)	Raw Value (dBuV)	Correction Factor (dB/m)
1	79.91	18.3 QP	40.0	-21.7	2.00 H	139	35.6	-17.3
2	242.89	18.9 QP	46.0	-27.1	1.00 H	360	31.9	-13.0
3	309.53	25.4 QP	46.0	-20.6	1.00 H	144	35.8	-10.4
4	492.59	23.3 QP	46.0	-22.7	2.00 H	116	28.4	-5.1
5	674.10	25.9 QP	46.0	-20.1	1.00 H	360	27.0	-1.1
6	796.91	29.1 QP	46.0	-16.9	2.00 H	194	27.7	1.4

Remarks:

1. Emission Level(dBuV/m) = Raw Value(dBuV) + Correction Factor(dB/m)
2. Correction Factor(dB/m) = Antenna Factor(dB/m) + Cable Factor(dB) – Pre-Amplifier Factor(dB)
3. Margin value = Emission Level – Limit value
4. The other emission levels were very low against the limit of frequency range 30MHz~1000MHz.
5. The emission levels were very low against the limit of frequency range 9kHz~30MHz: the amplitude of spurious emissions attenuated more than 20 dB below the permissible value to be report.

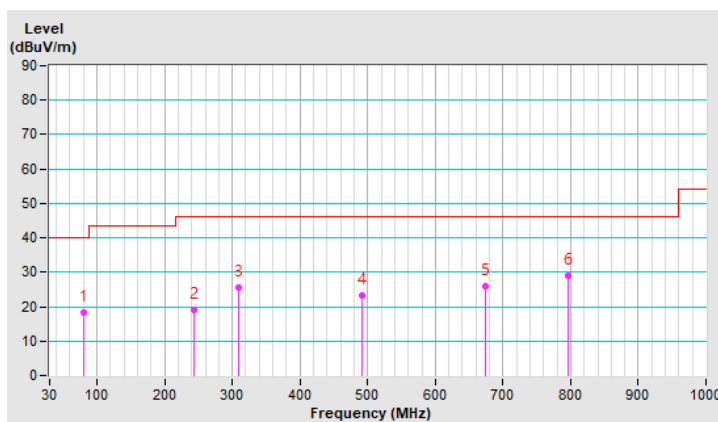

RF Mode	TX BT_GFSK	Channel	CH 0 : 2402 MHz
Frequency Range	9kHz ~ 1GHz	Detector Function	Quasi-Peak (QP)

Antenna Polarity & Test Distance : Vertical at 3 m								
No	Frequency (MHz)	Emission Level (dBuV/m)	Limit (dBuV/m)	Margin (dB)	Antenna Height (m)	Table Angle (Degree)	Raw Value (dBuV)	Correction Factor (dB/m)
1	131.70	18.7 QP	43.5	-24.8	2.00 V	204	31.8	-13.1
2	302.76	23.1 QP	46.0	-22.9	1.00 V	2	33.7	-10.6
3	412.69	23.1 QP	46.0	-22.9	2.00 V	207	30.6	-7.5
4	577.59	25.3 QP	46.0	-20.7	2.00 V	14	28.4	-3.1
5	770.33	28.9 QP	46.0	-17.1	1.00 V	338	27.6	1.3
6	900.24	29.7 QP	46.0	-16.3	1.00 V	75	26.2	3.5

Remarks:

1. Emission Level(dBuV/m) = Raw Value(dBuV) + Correction Factor(dB/m)
2. Correction Factor(dB/m) = Antenna Factor(dB/m) + Cable Factor(dB) – Pre-Amplifier Factor(dB)
3. Margin value = Emission Level – Limit value
4. The other emission levels were very low against the limit of frequency range 30MHz~1000MHz.
5. The emission levels were very low against the limit of frequency range 9kHz~30MHz: the amplitude of spurious emissions attenuated more than 20 dB below the permissible value to be report.

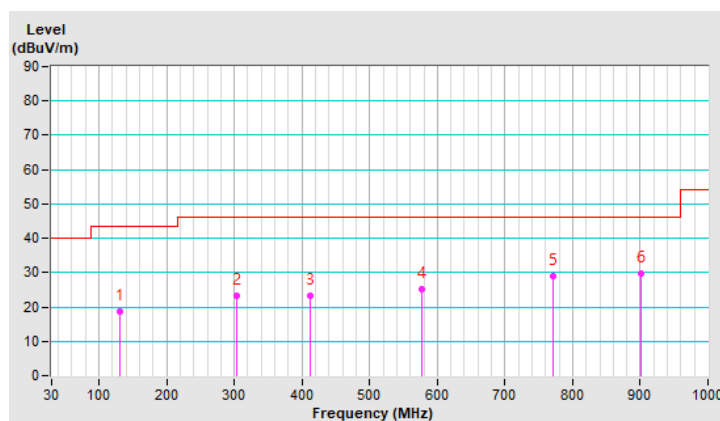

4.1.8 Test Results (Conducted Measurement)

Radiated versus Conducted Measurement	
<input checked="" type="checkbox"/> Conducted measurement	<input type="checkbox"/> Radiated measurement
<p><u>For Radiated measurement:</u> The level of unwanted emissions was measured when radiated by the cabinet or structure of the equipment with the antenna connector(s) terminated by a specified load (cabinet radiation)</p> <p><u>For Conducted measurement:</u> The level of unwanted emissions was measured as their power in a specified load (conducted spurious emissions).</p>	

Conducted Emission Convert Formula
<p>a. Emission Level (dBuV/m) = EIRP Level (dBm) – 20log(d) + 104.8 d = measurement distance in 3 meters.</p> <p>b. EIRP Level (dBm) = Raw Value(dBm) + Correction Factor(dB)</p> <p>c. Correction Factor is directional gain, and the composite gain will be used when signal support the correlated signal For the out of band spurious the gain for the specific band may have been used rather than the highest gain across all bands. For the band edge the gain for the specific band may have been used.</p> <p>Notes:</p> <ol style="list-style-type: none"> 1. In restricted bands below 1000 MHz, add upper bound on ground plane reflection: For f = 30 – 1000 MHz, add 4.7 dB. 2. The conducted emission test was considered some factor to compute test result.

GFSK - Channel 0

Conducted spurious emission table

No.	Frequency (MHz)	Emission Level (dBuV/m)	Limit (dBuV/m)	Margin (dB)	Raw Value (dBm)	Correction Factor (dB)	EIRP Level (dBm)
1	4801.56	53.06 PK	74	-20.94	-47.36	5.16	-42.20
2	4803.12	42.95 AV	54	-11.05	-57.47	5.16	-52.31

Remarks:

1. Margin value = Emission Level – Limit value
2. The other emission levels were very low against the limit.

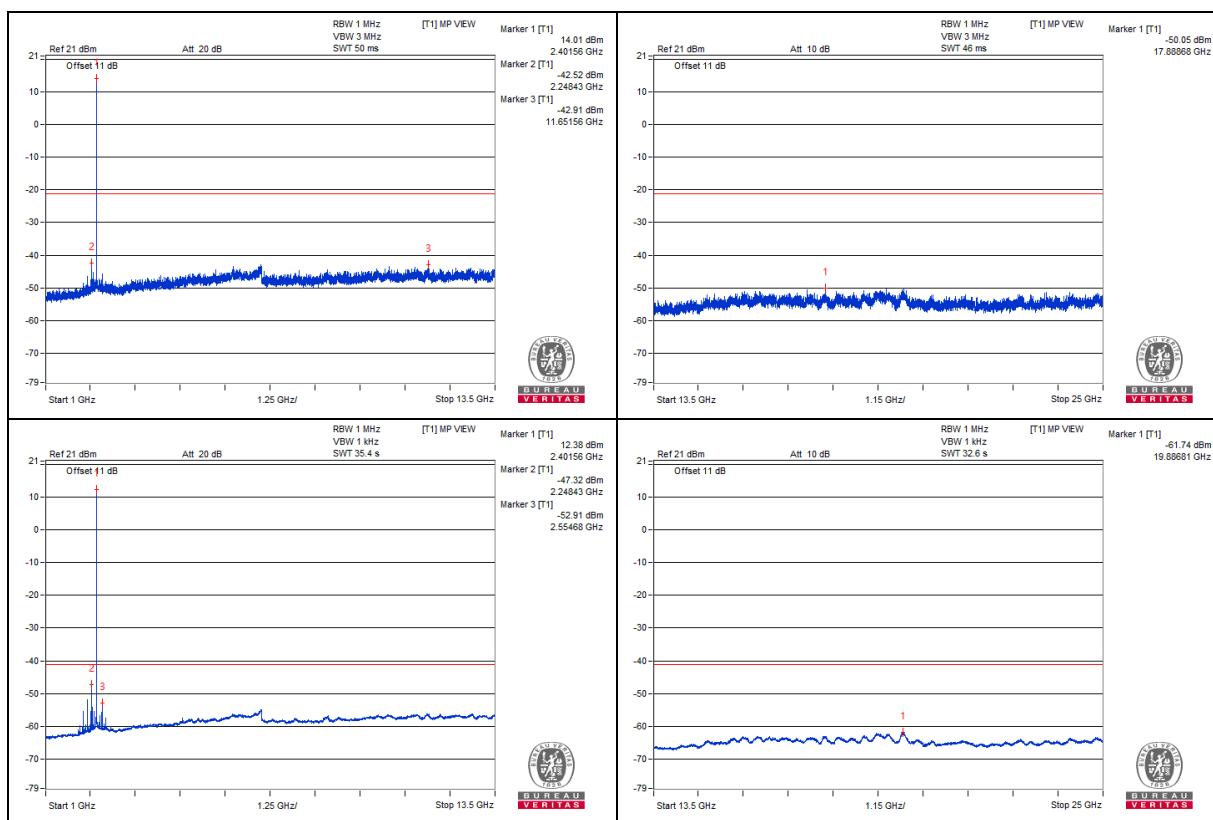

Bandedge table

No.	Frequency (MHz)	Emission Level (dBuV/m)	Limit (dBuV/m)	Margin (dB)	Raw Value (dBm)	Correction Factor (dB)	EIRP Level (dBm)
1	2325.46	53.67 PK	74	-20.33	-45.12	3.53	-41.59
2	2325.24	43.72 AV	54	-10.28	-55.07	3.53	-51.54
3	2489.47	51.91 PK	74	-22.09	-46.88	3.53	-43.35
4	2499.85	38.51 AV	54	-15.49	-60.28	3.53	-56.75

Remarks:

1. Margin value = Emission Level – Limit value
2. The other emission levels were very low against the limit.

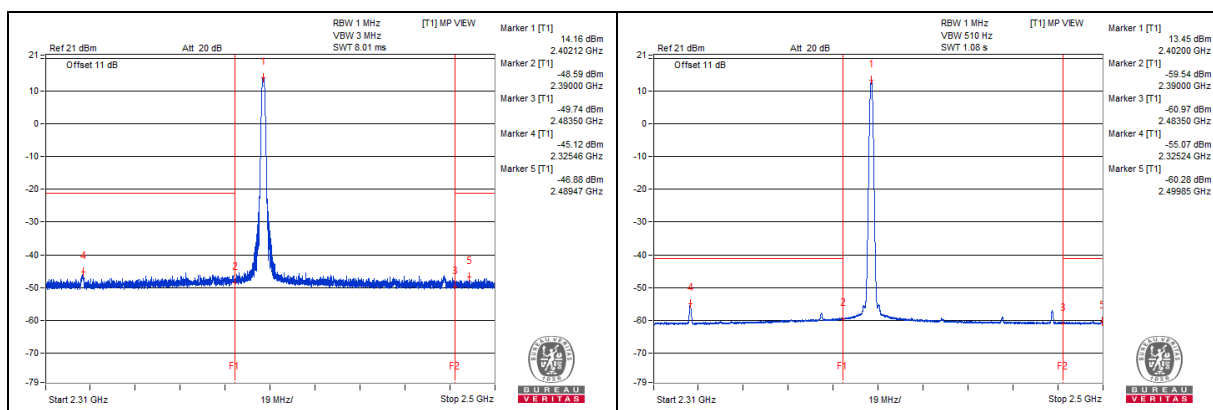

GFSK - Channel 39

Conducted spurious emission table

No.	Frequency (MHz)	Emission Level (dBuV/m)	Limit (dBuV/m)	Margin (dB)	Raw Value (dBm)	Correction Factor (dB)	EIRP Level (dBm)
1	4890.62	53.45 PK	74	-20.55	-46.97	5.16	-41.81
2	4881.25	42.58 AV	54	-11.42	-57.84	5.16	-52.68
3	7320.31	53.83 PK	74	-20.17	-46.59	5.16	-41.43
4	7320.31	42.38 AV	54	-11.62	-58.04	5.16	-52.88

Remarks:

1. Margin value = Emission Level – Limit value
2. The other emission levels were very low against the limit.

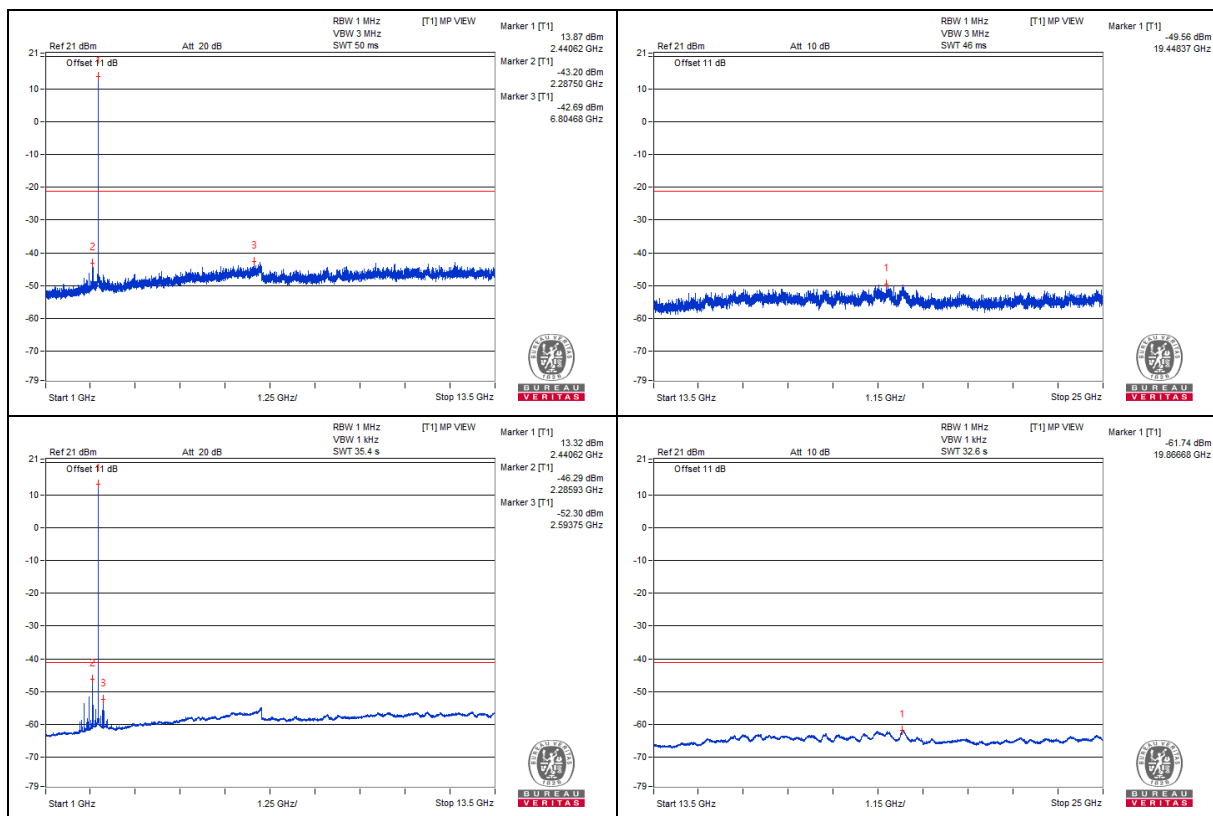

Bandedge table

No.	Frequency (MHz)	Emission Level (dBuV/m)	Limit (dBuV/m)	Margin (dB)	Raw Value (dBm)	Correction Factor (dB)	EIRP Level (dBm)
1	2363.84	52.8 PK	74	-21.2	-45.99	3.53	-42.46
2	2364.19	44.04 AV	54	-9.96	-54.75	3.53	-51.22
3	2489.66	51.41 PK	74	-22.59	-47.38	3.53	-43.85
4	2496.05	38.49 AV	54	-15.51	-60.3	3.53	-56.77

Remarks:

1. Margin value = Emission Level – Limit value
2. The other emission levels were very low against the limit.

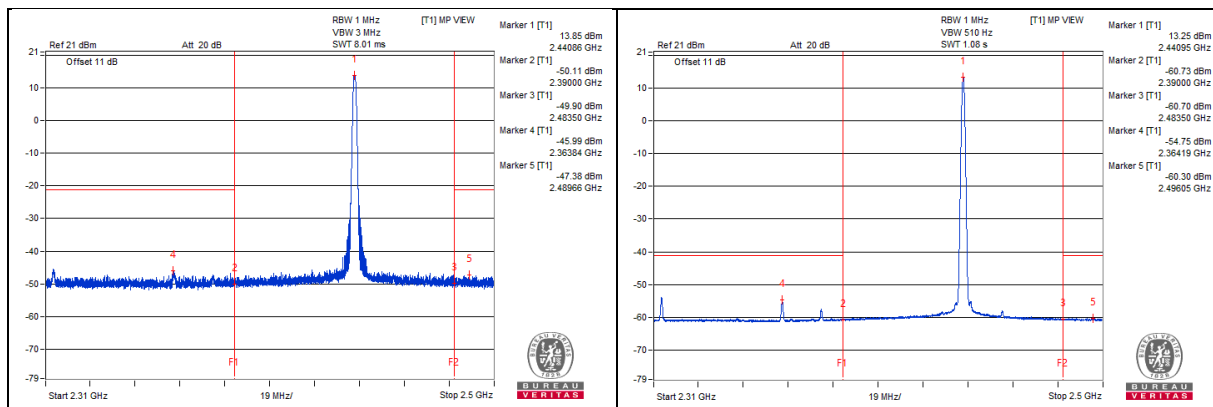

GFSK - Channel 78

Conducted spurious emission table

No.	Frequency (MHz)	Emission Level (dBuV/m)	Limit (dBuV/m)	Margin (dB)	Raw Value (dBm)	Correction Factor (dB)	EIRP Level (dBm)
1	4959.37	54.24 PK	74	-19.76	-46.18	5.16	-41.02
2	4959.37	42.8 AV	54	-11.2	-57.62	5.16	-52.46
3	7440.62	53.94 PK	74	-20.06	-46.48	5.16	-41.32
4	7434.37	42.05 AV	54	-11.95	-58.37	5.16	-53.21

Remarks:

1. Margin value = Emission Level – Limit value
2. The other emission levels were very low against the limit.

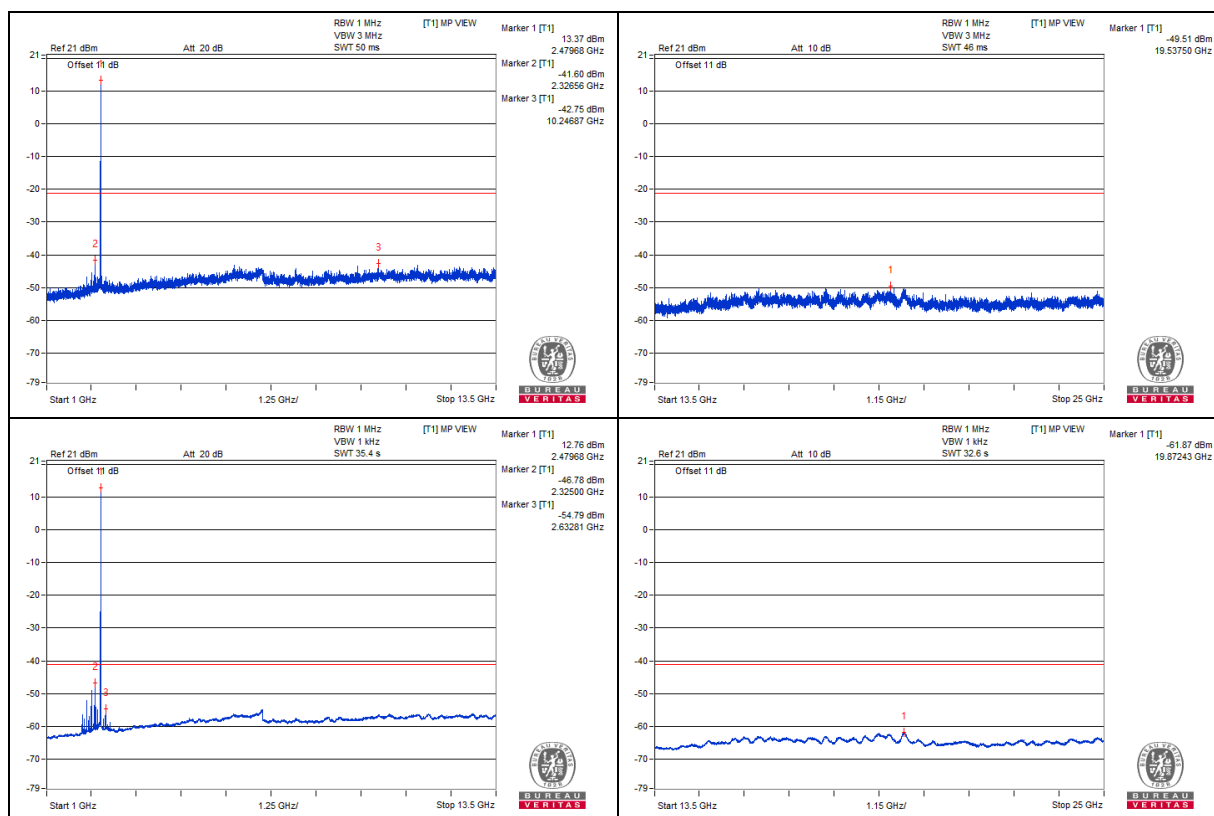

Bandedge table

No.	Frequency (MHz)	Emission Level (dBuV/m)	Limit (dBuV/m)	Margin (dB)	Raw Value (dBm)	Correction Factor (dB)	EIRP Level (dBm)
1	2326.34	57.9 PK	74	-16.1	-40.89	3.53	-37.36
2	2326.38	52.93 AV	54	-1.07	-45.86	3.53	-42.33
3	2483.85	58.18 PK	74	-15.82	-40.61	3.53	-37.08
4	2483.5	41.63 AV	54	-12.37	-57.16	3.53	-53.63

Remarks:

1. Margin value = Emission Level – Limit value
2. The other emission levels were very low against the limit.

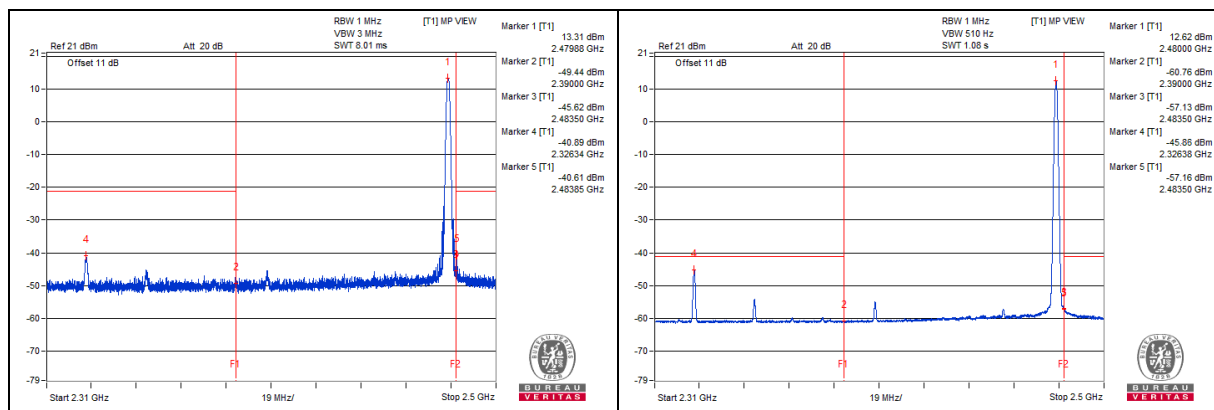

8DPSK - Channel 0

Conducted spurious emission table

No.	Frequency (MHz)	Emission Level (dBuV/m)	Limit (dBuV/m)	Margin (dB)	Raw Value (dBm)	Correction Factor (dB)	EIRP Level (dBm)
1	4806.25	53.39 PK	74	-20.61	-47.03	5.16	-41.87
2	4803.12	41.88 AV	54	-12.12	-58.54	5.16	-53.38

Remarks:

1. Margin value = Emission Level – Limit value
2. The other emission levels were very low against the limit.

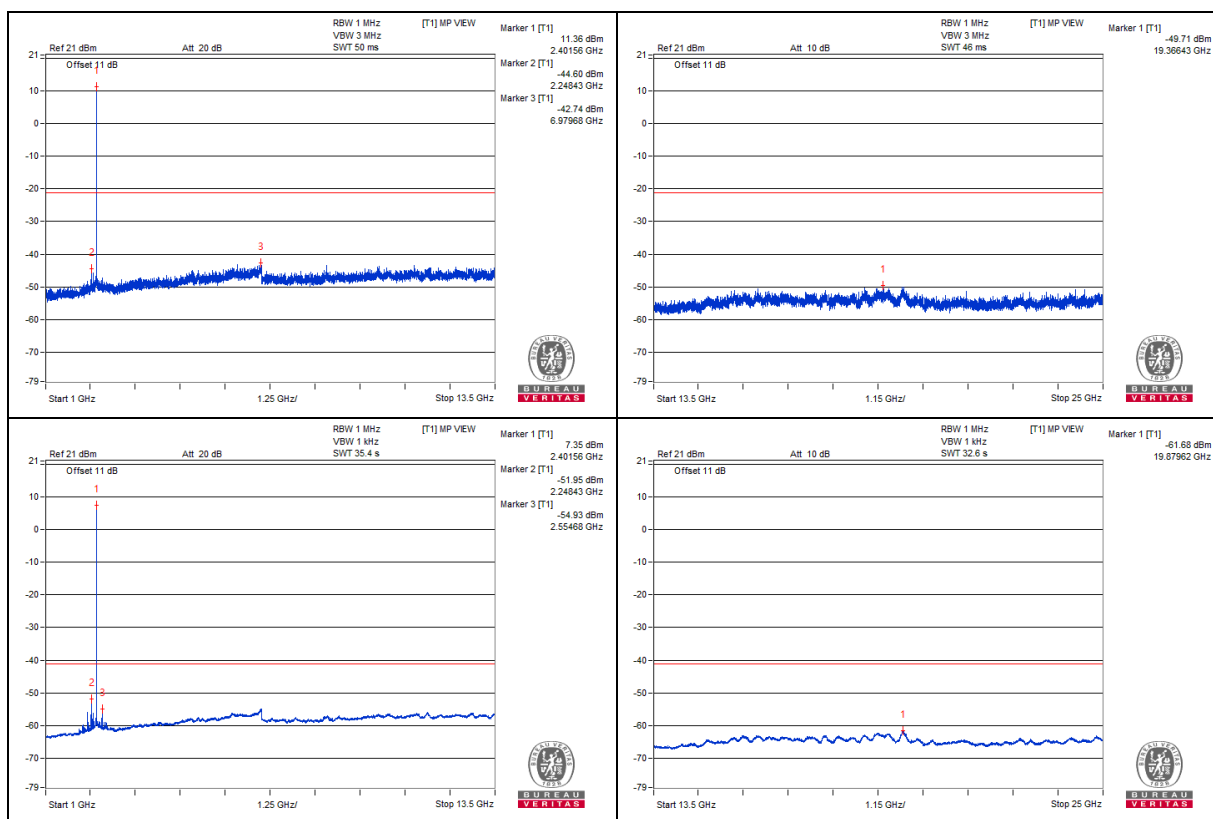

Bandedge table

No.	Frequency (MHz)	Emission Level (dBuV/m)	Limit (dBuV/m)	Margin (dB)	Raw Value (dBm)	Correction Factor (dB)	EIRP Level (dBm)
1	2388.8	52.74 PK	74	-21.26	-46.05	3.53	-42.52
2	2380.79	41.76 AV	54	-12.24	-57.03	3.53	-53.50
3	2491.56	52.3 PK	74	-21.7	-46.49	3.53	-42.96
4	2495.98	38.78 AV	54	-15.22	-60.01	3.53	-56.48

Remarks:

1. Margin value = Emission Level – Limit value
2. The other emission levels were very low against the limit.

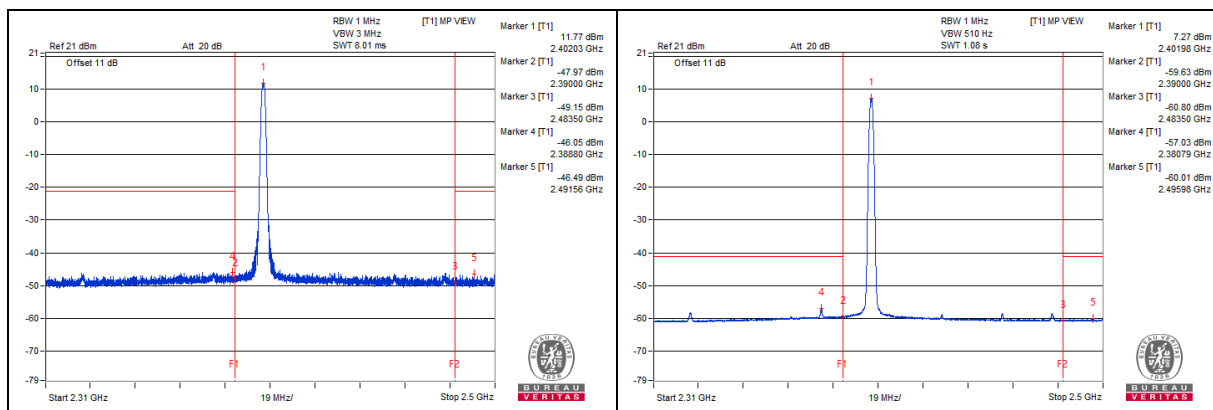

8DPSK - Channel 39

Conducted spurious emission table

No.	Frequency (MHz)	Emission Level (dBuV/m)	Limit (dBuV/m)	Margin (dB)	Raw Value (dBm)	Correction Factor (dB)	EIRP Level (dBm)
1	4885.93	53.33 PK	74	-20.67	-47.09	5.16	-41.93
2	4876.56	41.93 AV	54	-12.07	-58.49	5.16	-53.33
3	7317.18	53.59 PK	74	-20.41	-46.83	5.16	-41.67
4	7318.75	42.61 AV	54	-11.39	-57.81	5.16	-52.65

Remarks:

1. Margin value = Emission Level – Limit value
2. The other emission levels were very low against the limit.

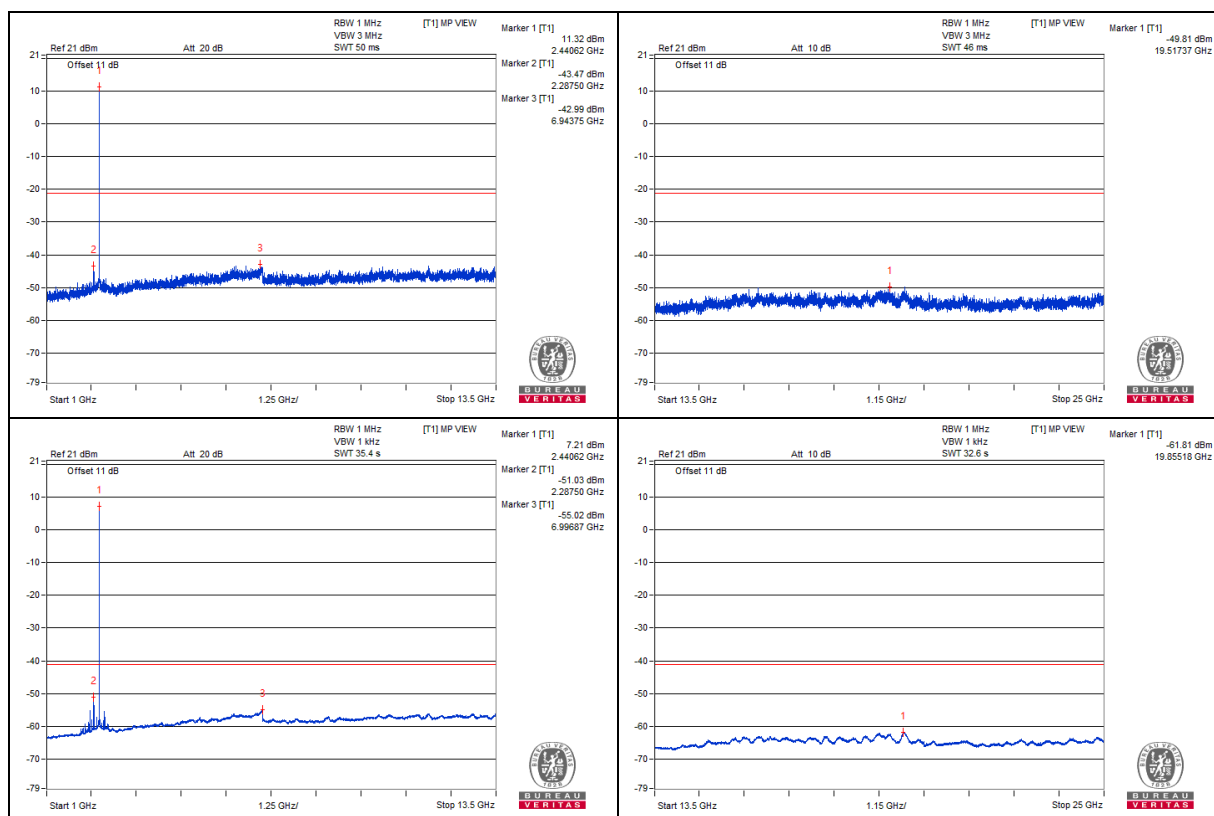

Bandedge table

No.	Frequency (MHz)	Emission Level (dBuV/m)	Limit (dBuV/m)	Margin (dB)	Raw Value (dBm)	Correction Factor (dB)	EIRP Level (dBm)
1	2364.43	52.78 PK	74	-21.22	-46.01	3.53	-42.48
2	2380.75	41.48 AV	54	-12.52	-57.31	3.53	-53.78
3	2497.93	52.42 PK	74	-21.58	-46.37	3.53	-42.84
4	2484.44	38.62 AV	54	-15.38	-60.17	3.53	-56.64

Remarks:

1. Margin value = Emission Level – Limit value
2. The other emission levels were very low against the limit.

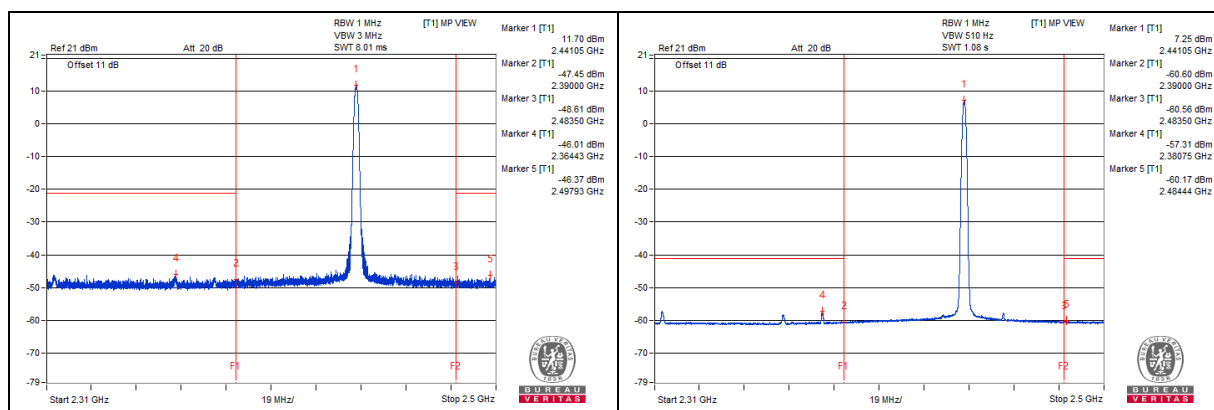

8DPSK - Channel 78

Conducted spurious emission table

No.	Frequency (MHz)	Emission Level (dBUV/m)	Limit (dBUV/m)	Margin (dB)	Raw Value (dBm)	Correction Factor (dB)	EIRP Level (dBm)
1	4954.68	53.63 PK	74	-20.37	-46.79	5.16	-41.63
2	4959.37	42.44 AV	54	-11.56	-57.98	5.16	-52.82
3	7448.43	53.41 PK	74	-20.59	-47.01	5.16	-41.85
4	7440.62	42.14 AV	54	-11.86	-58.28	5.16	-53.12

Remarks:

1. Margin value = Emission Level – Limit value
2. The other emission levels were very low against the limit.

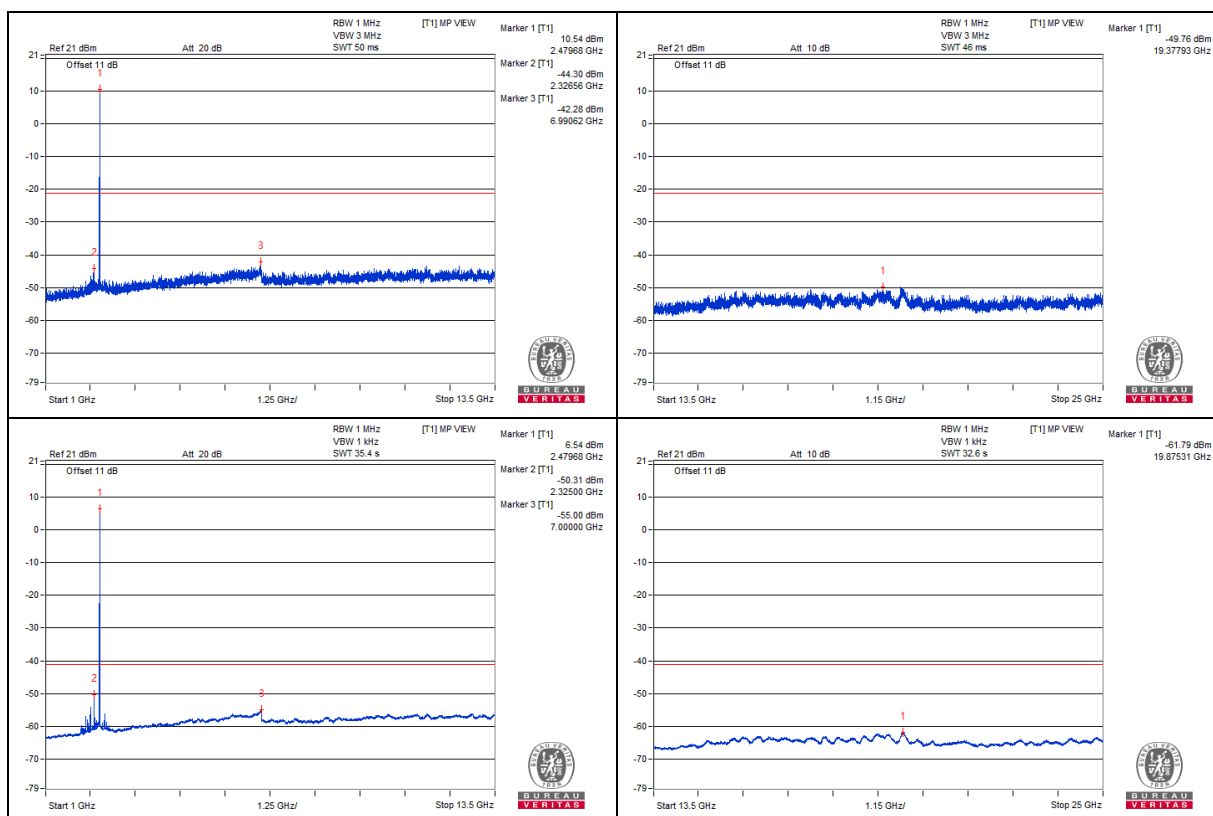

Bandedge table

No.	Frequency (MHz)	Emission Level (dBuV/m)	Limit (dBuV/m)	Margin (dB)	Raw Value (dBm)	Correction Factor (dB)	EIRP Level (dBm)
1	2326.5	56.78 PK	74	-17.22	-42.01	3.53	-38.48
2	2326.41	48.26 AV	54	-5.74	-50.53	3.53	-47.00
3	2483.51	59.21 PK	74	-14.79	-39.58	3.53	-36.05
4	2483.51	40.74 AV	54	-13.26	-58.05	3.53	-54.52

Remarks:

1. Margin value = Emission Level – Limit value
2. The other emission levels were very low against the limit.

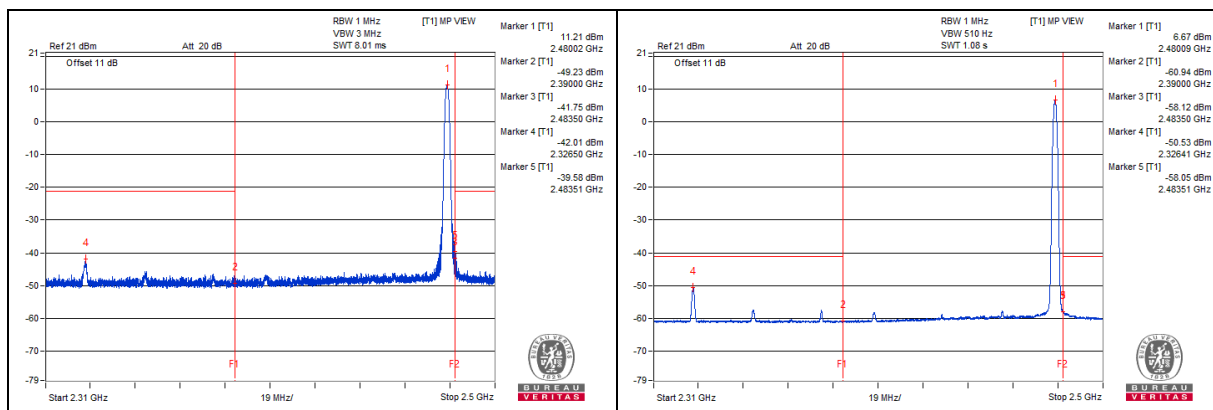

Below 1GHz Data

GFSK - Channel 0

Conducted spurious emission table

No.	Frequency (MHz)	Emission Level (dBuV/m)	Limit (dBuV/m)	Margin (dB)	Raw Value (dBm)	Correction Factor (dB)	EIRP Level (dBm)
1	86.01	34.38	40	-5.62	-66.04	5.16	-60.88
2	207.87	35.44	43.5	-8.06	-64.98	5.16	-59.82
3	397.99	35.13	46	-10.87	-65.29	5.16	-60.13
4	566.65	35.72	46	-10.28	-64.7	5.16	-59.54
5	743.55	36.42	46	-9.58	-64	5.16	-58.84
6	971.99	37.4	54	-16.6	-63.02	5.16	-57.86

Remarks:

1. Margin value = Emission Level – Limit value
2. The other emission levels were very low against the limit.

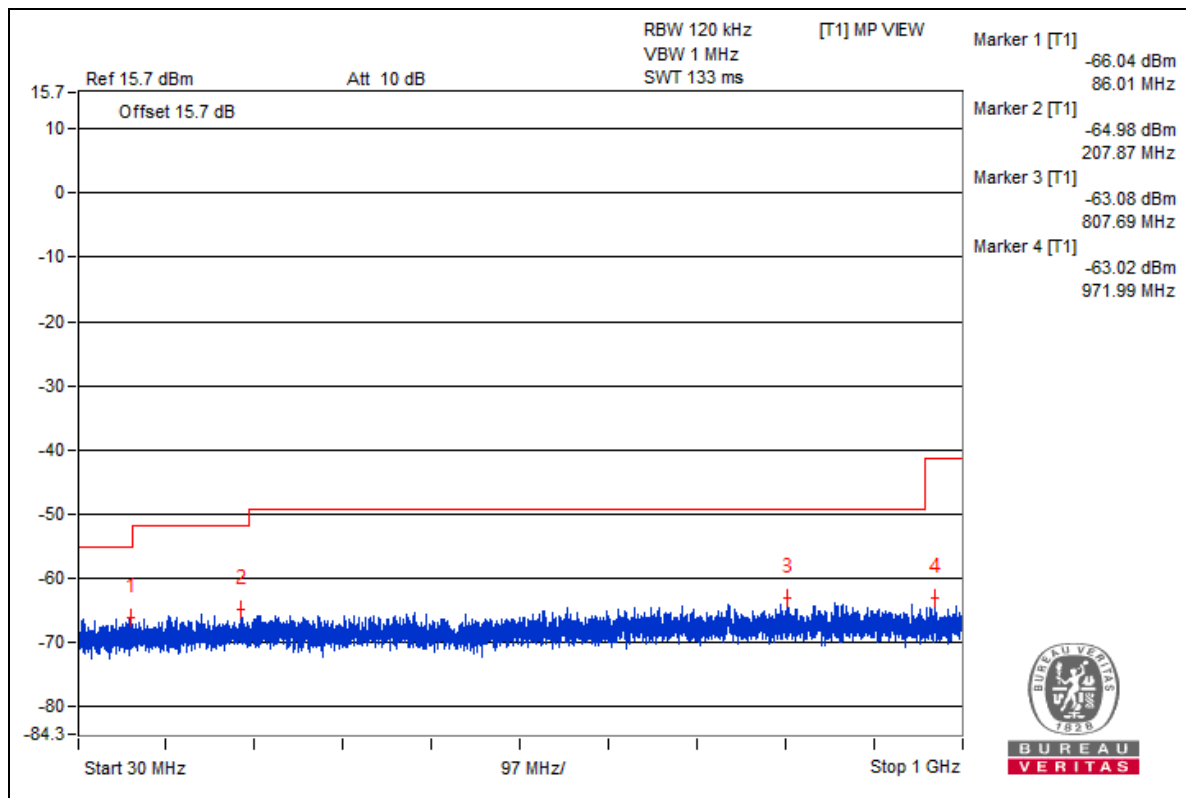



4.2 Conducted Emission Measurement

4.2.1 Limits of Conducted Emission Measurement

Frequency (MHz)	Conducted Limit (dBuV)	
	Quasi-peak	Average
0.15 - 0.5	66 - 56	56 - 46
0.50 - 5.0	56	46
5.0 - 30.0	60	50

Note: 1. The lower limit shall apply at the transition frequencies.

2. The limit decreases in line with the logarithm of the frequency in the range of 0.15 to 0.50MHz.

4.2.2 Test Instruments

DESCRIPTION & MANUFACTURER	MODEL NO.	SERIAL NO.	CALIBRATED DATE	CALIBRATED UNTIL
Test Receiver R&S	ESCS 30	847124/029	Oct. 20, 2020	Oct. 19, 2021
Line-Impedance Stabilization Network (for EUT) R&S	ESH3-Z5	848773/004	Oct. 27, 2020	Oct. 26, 2021
Line-Impedance Stabilization Network (for Peripheral) R&S	ESH3-Z5	835239/001	Mar. 26, 2021	Mar. 25, 2022
50 ohms Terminator	50	3	Oct. 26, 2020	Oct. 25, 2021
RF Cable	5D-FB	COCCAB-001	Sep. 26, 2020	Sep. 25, 2021
Fixed attenuator EMCI	STI02-2200-10	005	Aug. 29, 2020	Aug. 28, 2021
Software BVADT	BVADT_Cond_ V7.3.7.4	NA	NA	NA

Note:

1. The calibration interval of the above test instruments are 12 months and the calibrations are traceable to NML/ROC and NIST/USA.
2. The test was performed in Conduction 1.
- 3 Tested Date: May 28, 2021

4.2.3 Test Procedures

- The EUT was placed 0.4 meters from the conducting wall of the shielded room with EUT being connected to the power mains through a line impedance stabilization network (LISN). Other support units were connected to the power mains through another LISN. The two LISNs provide 50 ohm/ 50uH of coupling impedance for the measuring instrument.
- Both lines of the power mains connected to the EUT were checked for maximum conducted interference.
- The frequency range from 150kHz to 30MHz was searched. Emission levels under (Limit - 20dB) was not recorded.

NOTE: The resolution bandwidth and video bandwidth of test receiver is 9kHz for quasi-peak detection (QP) and average detection (AV) at frequency 0.15MHz-30MHz.

4.2.4 Deviation From Test Standard

No deviation.

4.2.5 Test Setup

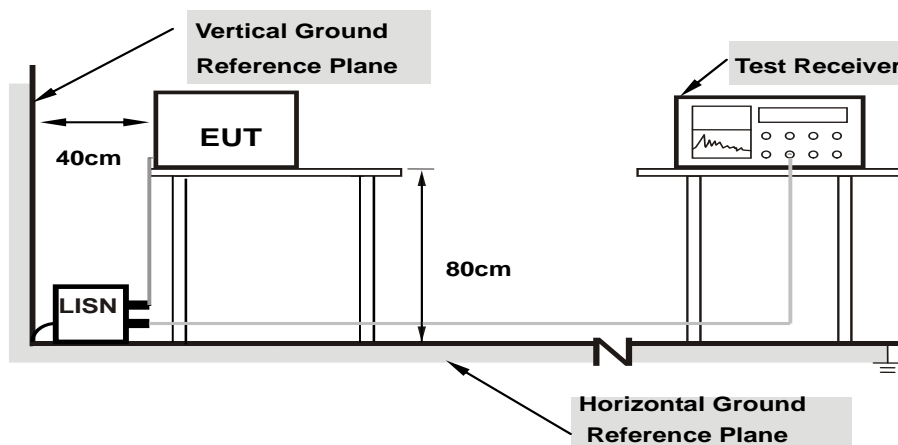

Note: 1.Support units were connected to second LISN.

For the actual test configuration, please refer to the attached file (Test Setup Photo).

4.2.6 EUT Operating Condition

Same as 4.1.6.

4.2.7 Test Results

RF Mode	TX BT_GFSK	Channel	CH 0 : 2402 MHz
Frequency Range	150kHz ~ 30MHz	Detector Function & Resolution Bandwidth	Quasi-Peak (QP) / Average (AV), 9kHz

Phase Of Power : Line (L)										
No	Frequency (MHz)	Correction Factor (dB)	Reading Value (dBuV)		Emission Level (dBuV)		Limit (dBuV)		Margin (dB)	
			Q.P.	AV.	Q.P.	AV.	Q.P.	AV.	Q.P.	AV.
1	0.15781	9.96	29.51	12.50	39.47	22.46	65.58	55.58	-26.11	-33.12
2	0.25938	10.00	28.99	17.62	38.99	27.62	61.45	51.45	-22.46	-23.83
3	0.95859	10.06	14.35	3.17	24.41	13.23	56.00	46.00	-31.59	-32.77
4	3.99219	10.28	25.79	14.05	36.07	24.33	56.00	46.00	-19.93	-21.67
5	5.16406	10.37	26.44	15.04	36.81	25.41	60.00	50.00	-23.19	-24.59
6	9.34375	10.67	22.47	10.98	33.14	21.65	60.00	50.00	-26.86	-28.35

Remarks:

1. Q.P. and AV. are abbreviations of quasi-peak and average individually.
2. The emission levels of other frequencies were very low against the limit.
3. Margin value = Emission level – Limit value
4. Correction factor = Insertion loss + Cable loss
5. Emission Level = Correction Factor + Reading Value

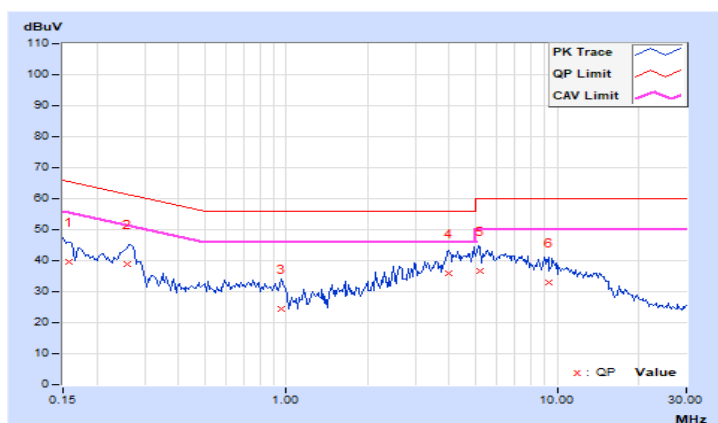

RF Mode	TX BT_GFSK	Channel	CH 0 : 2402 MHz
Frequency Range	150kHz ~ 30MHz	Detector Function & Resolution Bandwidth	Quasi-Peak (QP) / Average (AV), 9kHz

Phase Of Power : Neutral (N)										
No	Frequency (MHz)	Correction Factor (dB)	Reading Value (dBuV)		Emission Level (dBuV)		Limit (dBuV)		Margin (dB)	
			Q.P.	AV.	Q.P.	AV.	Q.P.	AV.	Q.P.	AV.
1	0.15391	9.94	29.29	12.16	39.23	22.10	65.79	55.79	-26.56	-33.69
2	0.25156	9.99	29.79	20.12	39.78	30.11	61.71	51.71	-21.93	-21.60
3	0.70469	10.04	19.38	10.13	29.42	20.17	56.00	46.00	-26.58	-25.83
4	0.97031	10.07	17.28	7.06	27.35	17.13	56.00	46.00	-28.65	-28.87
5	3.47656	10.22	22.46	12.27	32.68	22.49	56.00	46.00	-23.32	-23.51
6	5.20313	10.32	24.50	14.10	34.82	24.42	60.00	50.00	-25.18	-25.58

Remarks:

1. Q.P. and AV. are abbreviations of quasi-peak and average individually.
2. The emission levels of other frequencies were very low against the limit.
3. Margin value = Emission level – Limit value
4. Correction factor = Insertion loss + Cable loss
5. Emission Level = Correction Factor + Reading Value

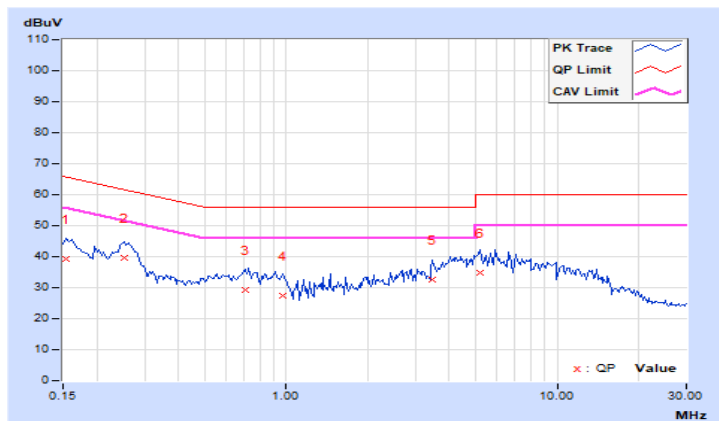

4.3 Number of Hopping Frequency Used

4.3.1 Limits of Hopping Frequency Used Measurement

At least 15 channels frequencies, and should be equally spaced.

4.3.2 Test Setup

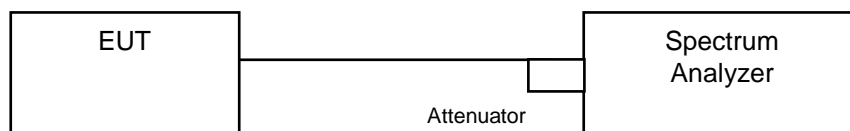

4.3.3 Test Instruments

Refer to section 4.1.2 to get information of above instrument.

4.3.4 Test Procedure

- a. Check the calibration of the measuring instrument (SA) using either an internal calibrator or a known signal from an external generator.
- b. Turn on the EUT and connect its antenna terminal to measurement via a low loss cable. Then set it to any one measured frequency within its operating range and make sure the instrument is operated in its linear range.
- c. Set the SA on MaxHold Mode, and then keep the EUT in hopping mode. Record all the signals from each channel until each one has been recorded.
- d. Set the SA on View mode and then plot the result on SA screen.
- e. Repeat above procedures until all frequencies measured were complete.

4.3.5 Deviation from Test Standard

No deviation.

4.3.6 Test Results

There are 79 hopping frequencies in the hopping mode. Please refer to next page for the test result. On the plots, it shows that the hopping frequencies are equally spaced.

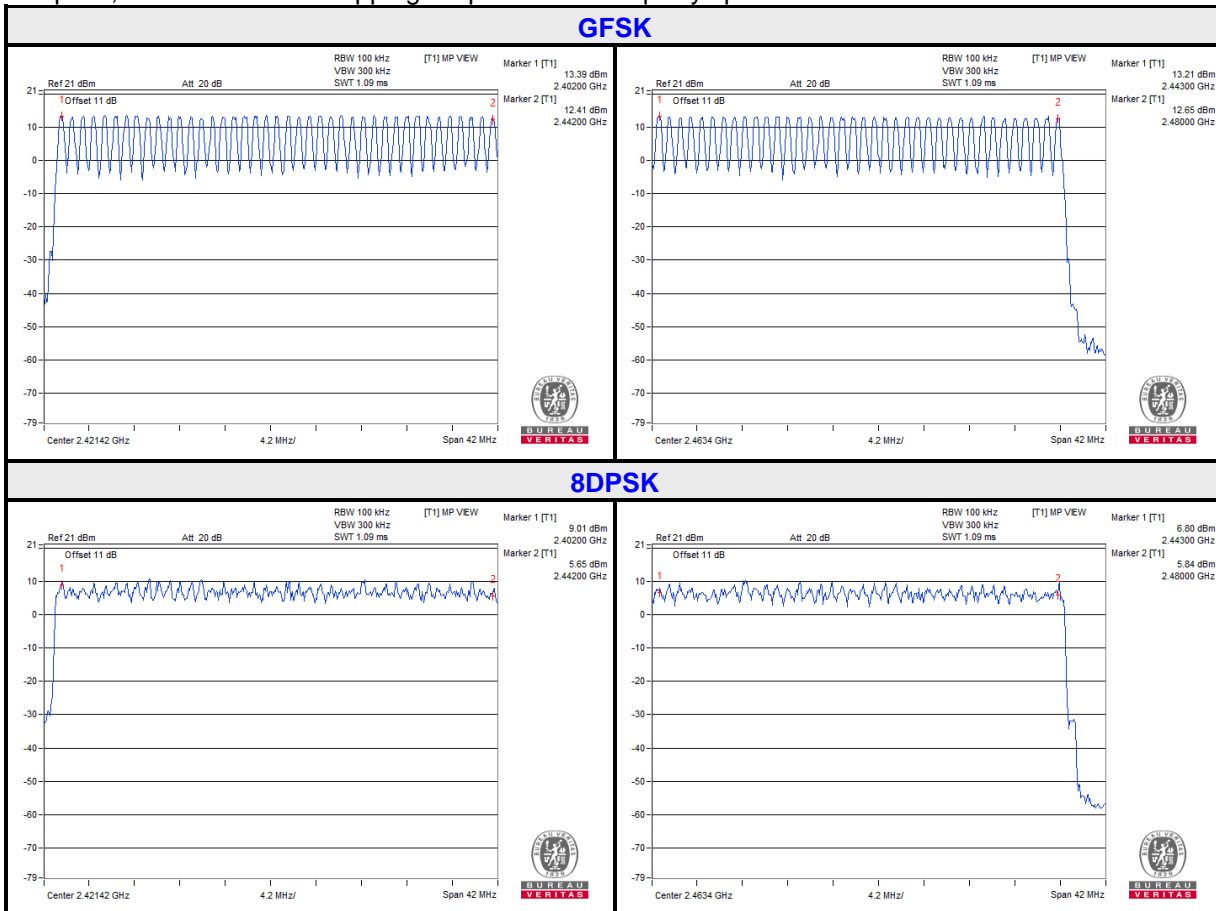

4.4 Dwell Time on Each Channel

4.4.1 Limits of Dwell Time on Each Channel Measurement

The average time of occupancy on any channel shall not be greater than 0.4 seconds within a period of 0.4 seconds multiplied by the number of hopping channels employed.

4.4.2 Test Setup

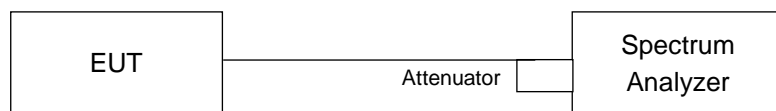

4.4.3 Test Instruments

Refer to section 4.1.2 to get information of above instrument.

4.4.4 Test Procedures

- a. Check the calibration of the measuring instrument (SA) using either an internal calibrator or a known signal from an external generator.
- b. Turn on the EUT and connect its antenna terminal to measurement via a low loss cable. Then set it to any one measured frequency within its operating range and make sure the instrument is operated in its linear range.
- c. Adjust the center frequency of SA on any frequency be measured and set SA to zero span mode. And then, set RBW and VBW of spectrum analyzer to proper value.
- d. Measure the time duration of one transmission on the measured frequency. And then plot the result with time difference of this time duration.
- e. Repeat above procedures until all different time-slot modes have been completed.

4.4.5 Deviation from Test Standard

No deviation.



4.4.6 Test Results

GFSK

Mode	Number of transmission in a 31.6 (79Hopping*0.4)	Length of transmission time (msec)	Result (msec)	Limit (msec)
DH1	50 (times / 5 sec) * 6.32 = 316 times	0.444	140.3	400
DH3	26 (times / 5 sec) * 6.32 = 165 times	1.73	285.45	400
DH5	16 (times / 5 sec) * 6.32 = 102 times	2.957	301.61	400

NOTE: Test plots of the transmitting time slot are shown on next page.



BUREAU
VERITAS

DH1

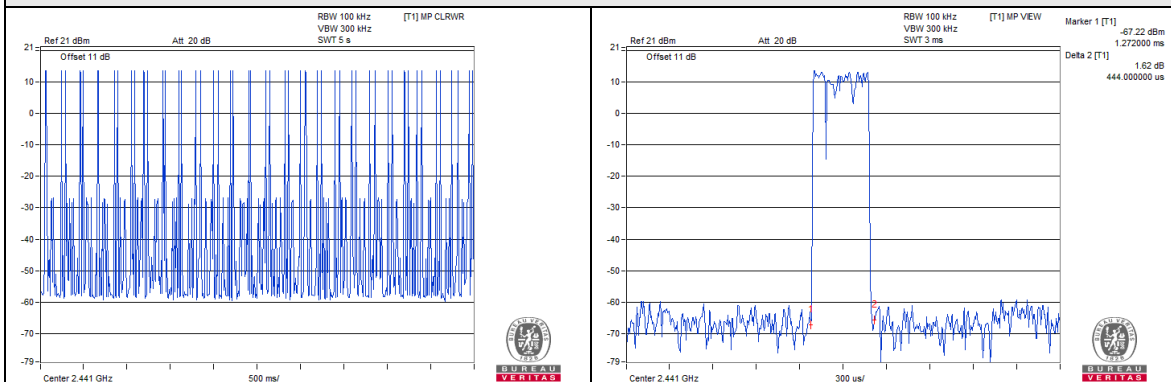

DH3

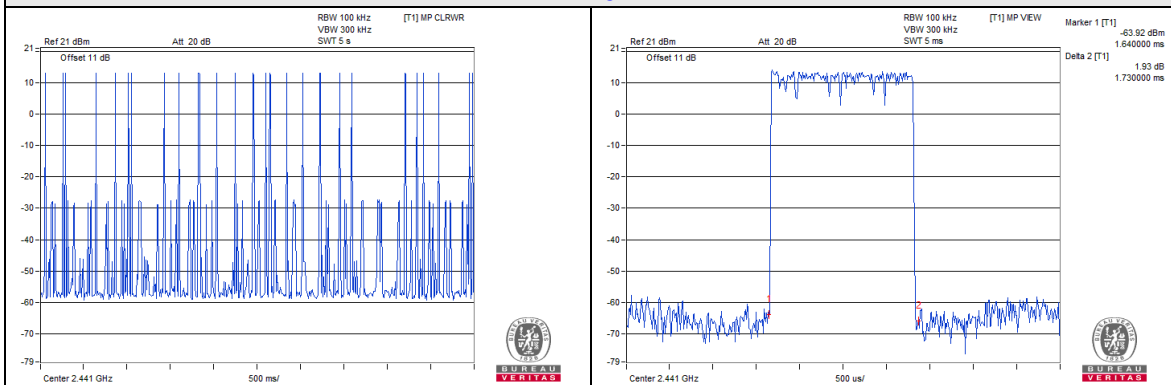

DH5

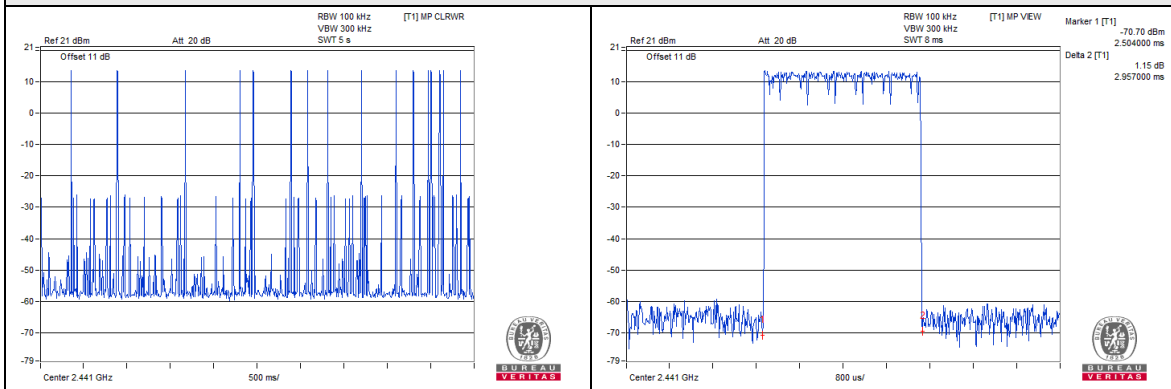

8DPSK

Mode	Number of transmission in a 31.6 (79Hopping*0.4)	Length of transmission time (msec)	Result (msec)	Limit (msec)
3DH1	50 (times / 5 sec) * 6.32 = 316 times	0.45	142.2	400
3DH3	27 (times / 5 sec) * 6.32 = 171 times	1.71	292.41	400
3DH5	18 (times / 5 sec) * 6.32 = 114 times	3.008	342.91	400

NOTE: Test plots of the transmitting time slot are shown on next page.

3DH1

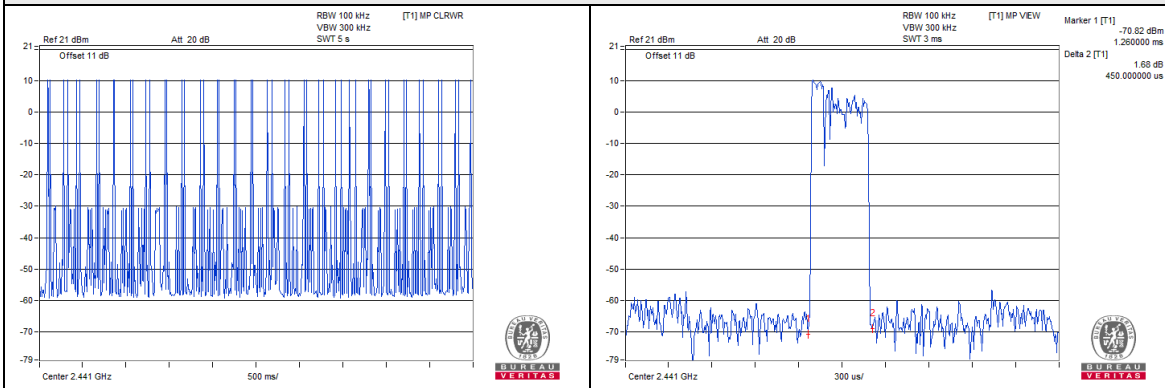

3DH3

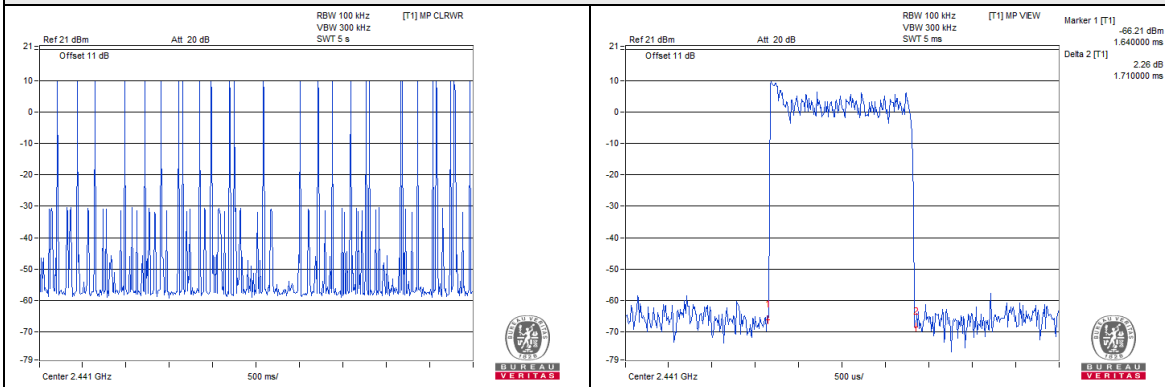

3DH5

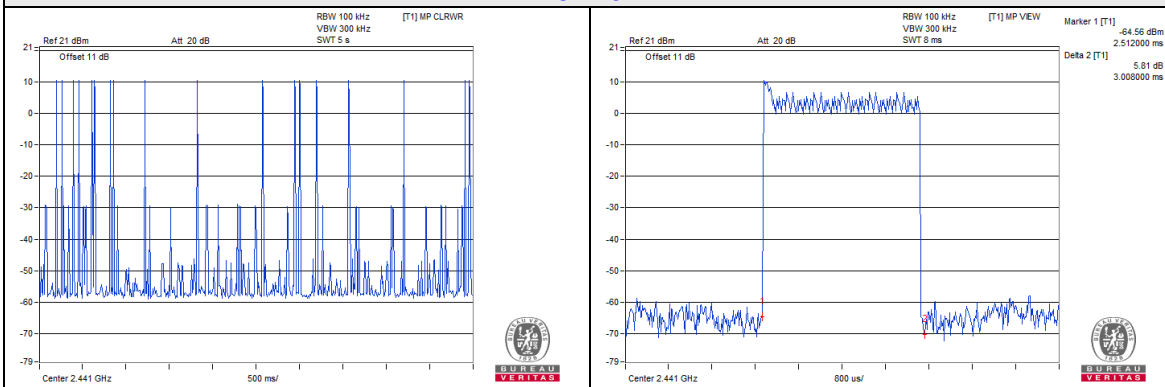

4.5 Channel Bandwidth

4.5.1 Limits of Channel Bandwidth Measurement

For frequency hopping system operating in the 2400-2483.5MHz, If the 20dB bandwidth of hopping channel is greater than 25kHz, two-thirds 20dB bandwidth of hopping channel shall be a minimum limit for the hopping channel separation.

4.5.2 Test Setup

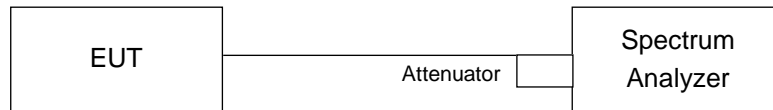

4.5.3 Test Instruments

Refer to section 4.1.2 to get information of above instrument.

4.5.4 Test Procedure

- Check the calibration of the measuring instrument using either an internal calibrator or a known signal from an external generator.
- Turn on the EUT and connect it to measurement instrument. Then set it to any one convenient frequency within its operating range. Set a reference level on the measuring instrument equal to the highest peak value.
- Measure the frequency difference of two frequencies that were attenuated 20dB from the reference level. Record the frequency difference as the emission bandwidth.
- Repeat above procedures until all frequencies measured were complete.

4.5.5 Deviation from Test Standard

No deviation.

4.5.6 EUT Operating Condition

The software provided by client enabled the EUT to transmit and receive data at lowest, middle and highest channel frequencies individually.

4.5.7 Test Results

Channel	Frequency (MHz)	20dB Bandwidth (MHz)	
		GFSK	8DPSK
0	2402	0.94	1.29
39	2441	0.94	1.29
78	2480	0.94	1.3

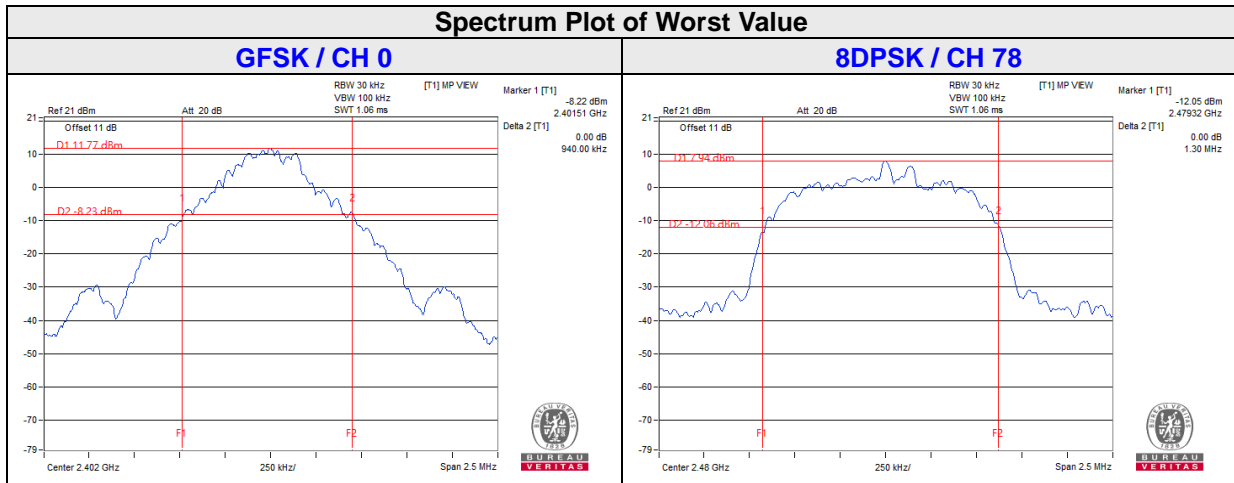

4.6 Hopping Channel Separation

4.6.1 Limits of Hopping Channel Separation Measurement

At least 25kHz or two-third of 20dB hopping channel bandwidth (whichever is greater).

4.6.2 Test Setup

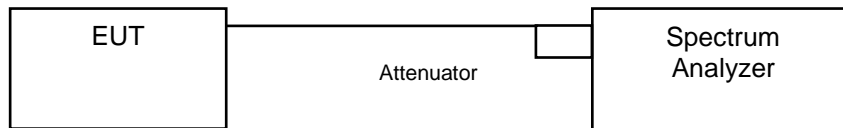

4.6.3 Test Instruments

Refer to section 4.1.2 to get information of above instrument.

4.6.4 Test Procedure

Measurement Procedure REF

- a. Check the calibration of the measuring instrument using either an internal calibrator or a known signal from an external generator.
- b. Turn on the EUT and connect it to measurement instrument. Then set it to any one convenient frequency within its operating range.
- c. By using the MaxHold function record the separation of two adjacent channels.
- d. Measure the frequency difference of these two adjacent channels by SA MARK function. And then plot the result on SA screen.
- e. Repeat above procedures until all frequencies measured were complete.

4.6.5 Deviation from Test Standard

No deviation.

4.6.6 Test Results

Channel	Frequency (MHz)	Adjacent Channel Separation (MHz)		20dB Bandwidth (MHz)		Minimum Limit (MHz)		Pass / Fail
		GFSK	8DPSK	GFSK	8DPSK	GFSK	8DPSK	
0	2402	1	1	0.94	1.29	0.63	0.86	Pass
39	2441	1	1	0.94	1.29	0.63	0.86	Pass
78	2480	1	1	0.94	1.3	0.63	0.87	Pass

NOTE: The minimum limit is two-third 20dB bandwidth.

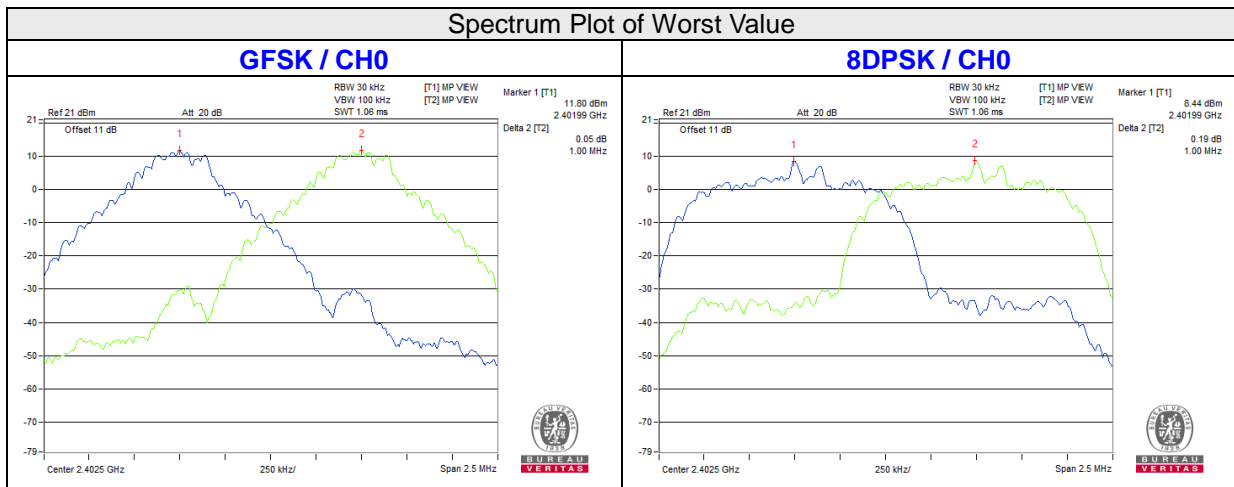

4.7 Maximum Output Power

4.7.1 Limits of Maximum Output Power Measurement

The Maximum Output Power Measurement is 125mW.

4.7.2 Test Setup

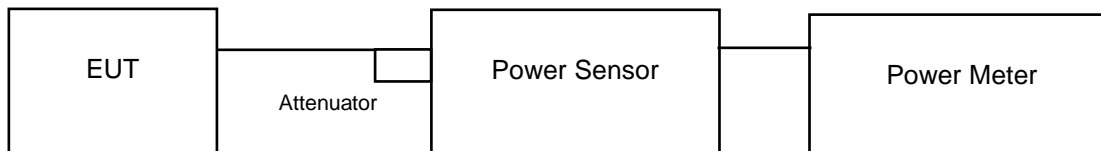

4.7.3 Test Instruments

Refer to section 4.1.2 to get information of above instrument.

4.7.4 Test Procedure

A peak power sensor was used on the output port of the EUT. A power meter was used to read the response of the peak power sensor. Record the power level.

Average power sensor was used to perform output power measurement, trigger and gating function of wide band power meter is enabled to measure max output power of TX on burst. Duty factor is not added to measured value.

4.7.5 Deviation from Test Standard

No deviation.

4.7.6 EUT Operating Condition

The software provided by client enabled the EUT to transmit and receive data at lowest, middle and highest channel frequencies individually.

4.7.7 Test Results

FOR PEAK POWER

Channel	Frequency (MHZ)	GFSK		8DPSK		Power Limit (mW)	Pass / Fail
		Output Power (mW)	Output Power (dBm)	Output Power (mW)	Output Power (dBm)		
0	2402	29.785	14.74	20.701	13.16	125	Pass
39	2441	27.925	14.46	20.091	13.03	125	Pass
78	2480	27.606	14.41	17.061	12.32	125	Pass

FOR AVERAGE POWER

Channel	Frequency (MHZ)	GFSK		8DPSK	
		Average Power (mW)	Average Power (dBm)	Average Power (mW)	Average Power (dBm)
0	2402	27.606	14.41	12.972	11.13
39	2441	26.792	14.28	12.359	10.92
78	2480	27.227	14.35	11.94	10.77

4.8 Conducted Out of Band Emission Measurement

4.8.1 Limits of Conducted Out of Band Emission Measurement

Below 20dB of the highest emission level of operating band (in 100kHz Resolution Bandwidth).

4.8.2 Test Instruments

Refer to section 4.1.2 to get information of above instrument.

4.8.3 Test Procedure

The transmitter output was connected to the spectrum analyzer via a low lose cable. Set both RBW and VBW of spectrum analyzer to 100 kHz and 300 kHz with suitable frequency span including 100 MHz bandwidth from band edge. The band edges was measured and recorded.

4.8.4 Deviation from Test Standard

No deviation.

4.8.5 EUT Operating Condition

The software provided by client enabled the EUT to transmit and receive data at lowest, middle and highest channel frequencies individually.

4.8.6 Test Results

The spectrum plots are attached on the following images. D1 line indicates the highest level, D2 line indicates the 20dB offset below D1. It shows compliance with the requirement.

GFSK

Hopping disabled_Low Channel

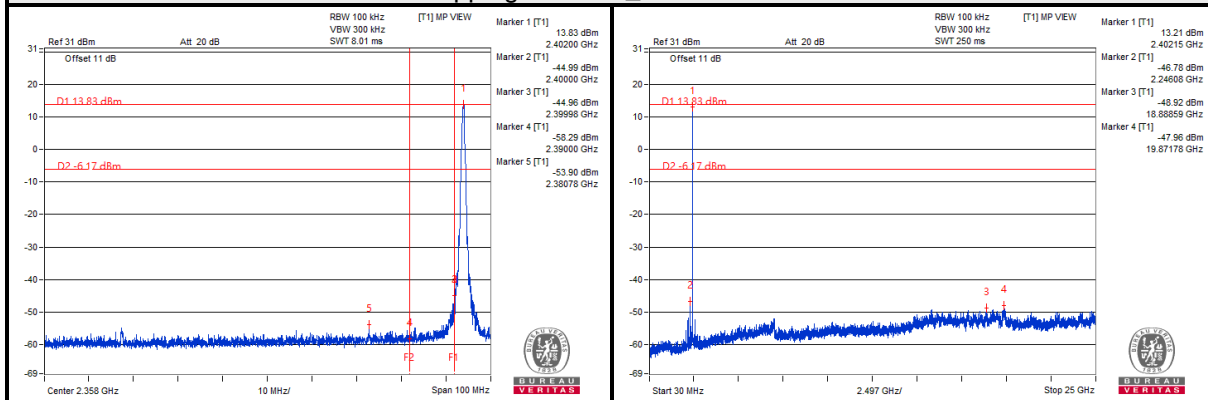

Hopping disabled_High Channel

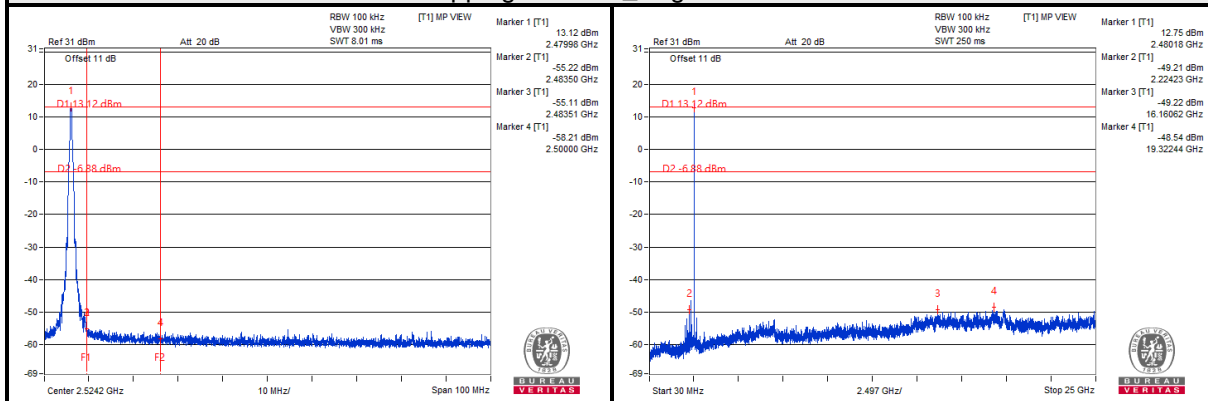

Hopping enabled_Low Channel

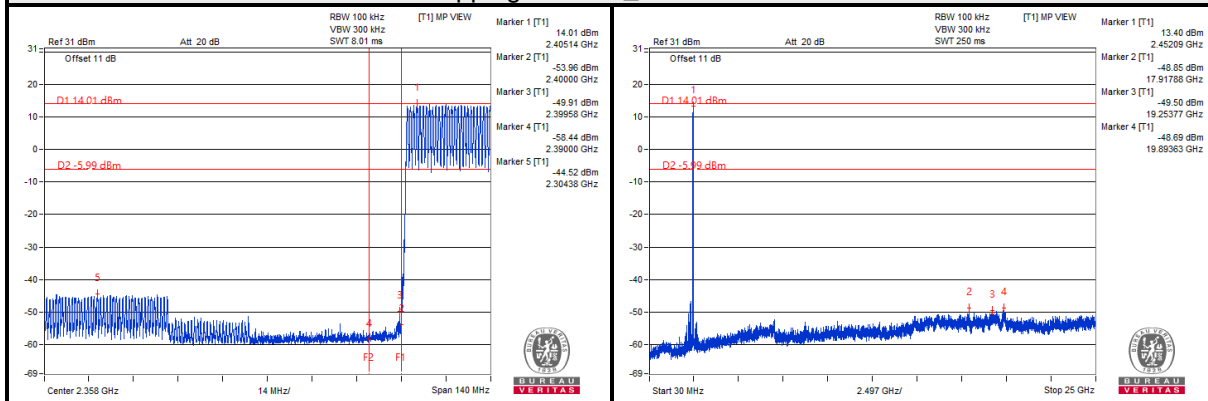

Hopping enabled_High Channel

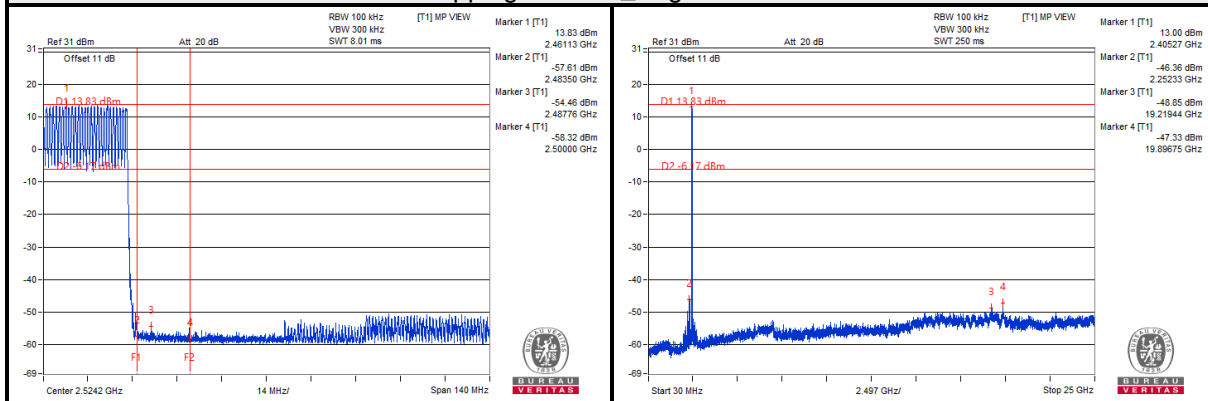

8DPSK

Hopping disabled_Low Channel

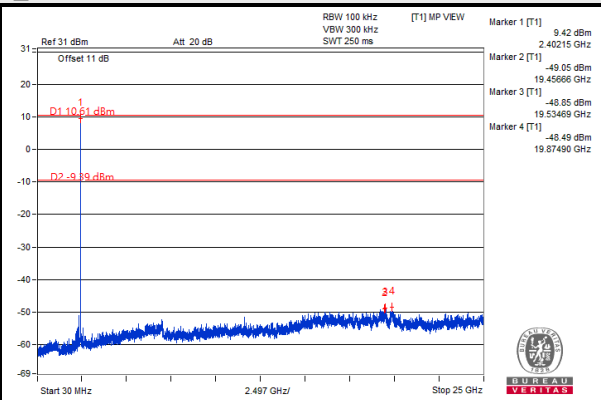
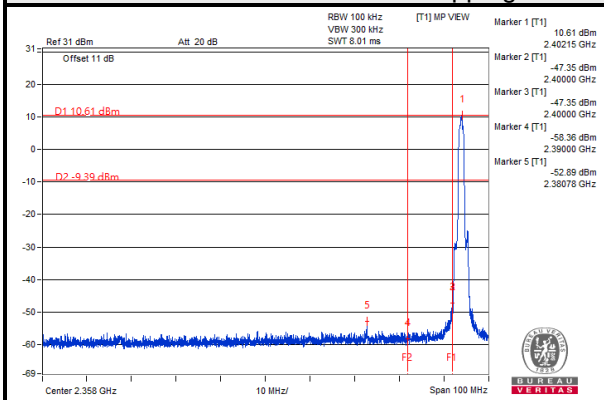

Hopping disabled_High Channel

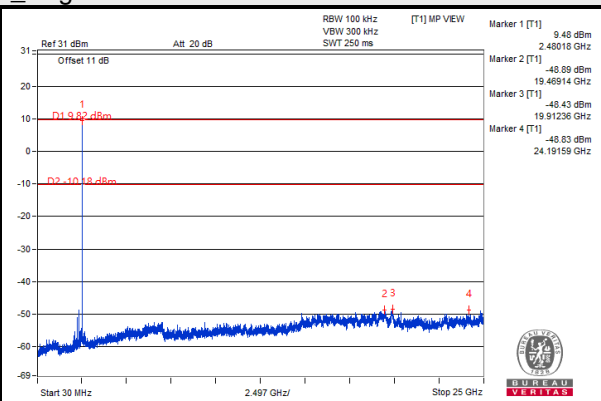
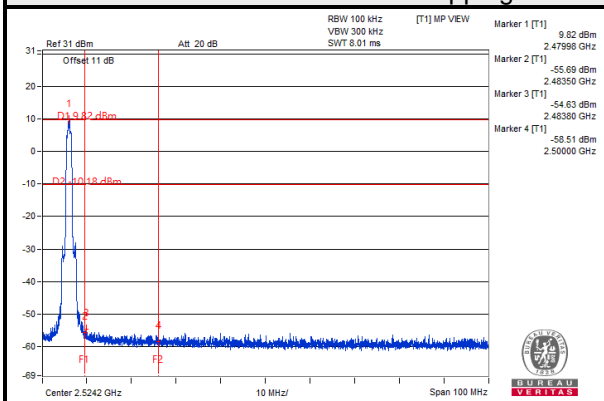

Hopping enabled_Low Channel

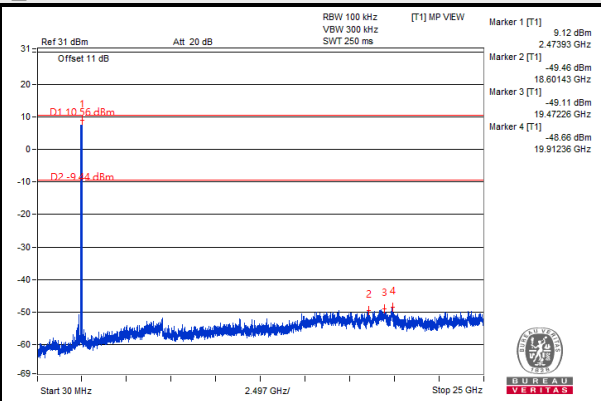
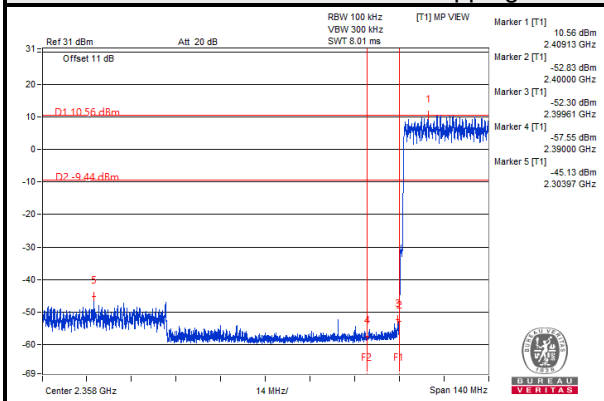

Hopping enabled_High Channel

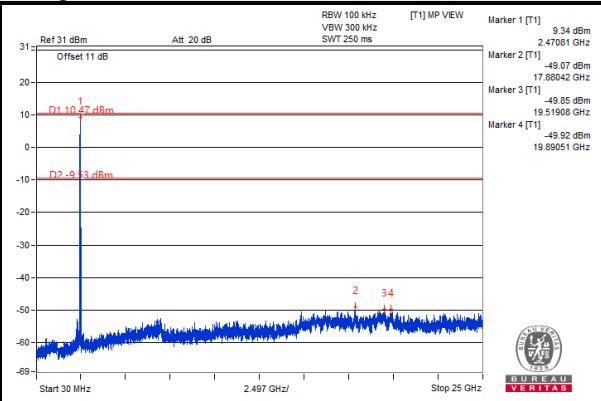
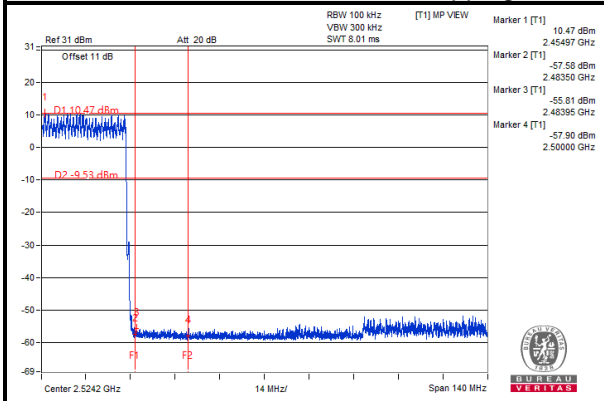

5 Pictures of Test Arrangements

Please refer to the attached file (Test Setup Photo).

Appendix – Information of the Testing Laboratories

We, Bureau Veritas Consumer Products Services (H.K.) Ltd., Taoyuan Branch, were founded in 1988 to provide our best service in EMC, Radio, Telecom and Safety consultation. Our laboratories are FCC recognized accredited test firms and accredited according to ISO/IEC 17025.

If you have any comments, please feel free to contact us at the following:

Lin Kou EMC/RF Lab

Tel: 886-2-26052180

Fax: 886-2-26051924

Hsin Chu EMC/RF/Telecom Lab

Tel: 886-3-6668565

Fax: 886-3-6668323

Hwa Ya EMC/RF/Safety Lab

Tel: 886-3-3183232

Fax: 886-3-3270892

Email: service.adt@tw.bureauveritas.com

Web Site: www.bureauveritas-adt.com

The address and road map of all our labs can be found in our web site also.

--- END ---