

General Catalogue 2022 / 2023

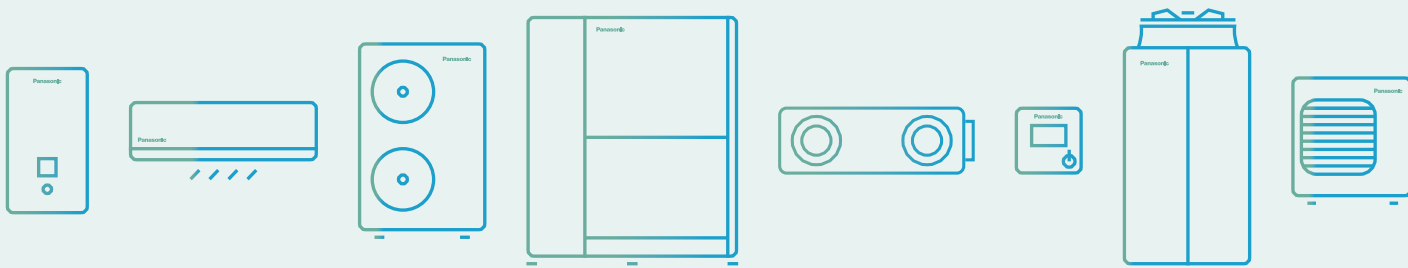

Editorial

Panasonic – leading the way in Heating and Cooling. With more than 50 years of experience, selling to more than 120 countries around the world, Panasonic is one of the leaders in the heating and cooling sector.

Bringing nature's balance indoors.

nanoe™ X, technology with the benefits of hydroxyl radicals.



PRO Club. The professional website of Panasonic.

Panasonic has an impressive range of support services for designers, specifiers, engineers and distributors working in the heating and cooling markets.



Aquarea

Aquarea is a ground breaking low energy system for heating and domestic hot water production: delivering outstanding performance, even at extreme outdoor temperatures.

New Aquarea EcoFleX.

2-in-1 - Sustainable and efficient comfort all year long. New Aquarea EcoFleX is a groundbreaking heat pump that connects an air ducted unit with nanoe™ X technology providing heat recovery hot water, space heating, space cooling and cleaner air.



Aquarea Service Cloud for professionals.

Aquarea Service Cloud will activate remote maintenance service while end user is controlling and monitoring its heating and DHW remotely.



Domestic

Panasonic has developed a range of domestic products designed for you and your clients.

Etherea: Welcome to your new home.

Designed to produce the ultimate comfort and performance for homeowners, the new Etherea is a worthy addition to any indoor environment. Now available in Matt white, Silver and Graphite grey color.



nanoe™ X: improving protection 24/7.

nanoe™ X technology brings nature's detergent – hydroxyl radicals – indoors, so that hard surfaces, soft furnishings, and the indoor environment can be a cleaner and more pleasant place to be.



Commercial

The commercial range is constantly expanding so that you can always offer your clients the optimal solutions: high performance, silent machines and a complete range of ducts, cassettes and ceiling installations.

PACi NX Series.

This series has been developed with 3 wired method and communication. It makes it simple and easy to replace old systems with 3 wire connections, which is prevalent in many systems.



CONEX. Devices and apps.

CONEX provides comfort and control for varying user needs. Accessible, flexible and scalable with different controllers and apps. Perfectly meeting requirements of modern controls for end user, installer and service.

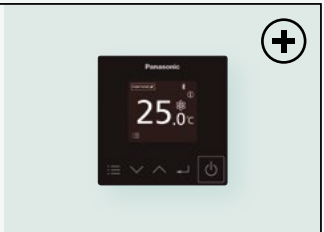

VRF Systems

The VRF industrial range considerably improves efficiency so even large buildings can benefit from a high-level of comfort with less energy consumption.

Mini ECOi LZ2 Series R32.

The Mini ECOi LZ2 Series utilizes environmentally friendly R32 refrigerant, reducing the total amount of refrigerant by 20 % and more, resulting in lower GWP, reduced by 75 %.



nanoe™ X.

Panasonic's nanoe™ X technology brings nature's detergent – hydroxyl radicals – indoors to help improve protection 24/7. Available in 4 way 90x90 cassette, floor console and adaptive ducted unit.

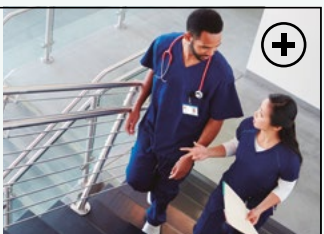

Ventilation

Panasonic ventilation solutions for maximum savings and easy integration.



AHU connection kit 3,6 to 14,0 kW for PACi NX.

The Panasonic AHU connection kits offer a wealth of connectivity possibilities so can be easily integrated into many systems.



Energy recovery ventilation.

Panasonic energy recovery ventilators help you with your comfort and energy-saving plan.



Control and connectivity

From the individual remote controller for the residential single units up to the newest technology capable of controlling your building anywhere in the world.



Panasonic AC Smart Cloud.

Panasonic AC Smart Cloud provides building mapping, remote monitoring, error notification and schedule setting for site managers.

Panasonic AC Service Cloud help maintenance companies to manage multiple sites with remote checking and advance failure prediction functions.



Panasonic AC Service Cloud.

Panasonic AC Service Cloud provides to maintenance company a unique tool to deliver advanced maintenance to increase response time, reduce sites visits and allocate better the resources.

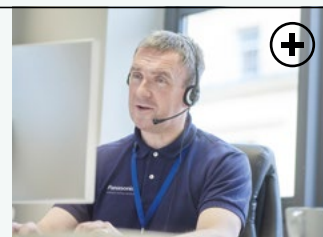

Chiller

Panasonic introduces the ECOi-W heat pumps and cooling only chiller series. These series provides a wide variety of HVAC system solutions, to meet all of your residential, commercial and industrial needs.



ECOi-W heat pump and cooling only chillers.

An extensive line up from 20 kW to 210 kW with an operating range of -17 °C (heating) to 50 °C (cooling). Offering a high quality, flexible solution for commercial applications.



Explore the range of fan coils.

Available in a wide range of designs, the fan coils are perfectly adapted to fit within almost any location.

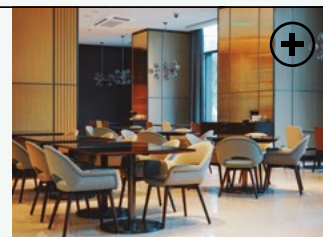

Refrigeration

Panasonic condensing units - CR Series with natural refrigerant.

Panasonic is now introducing the environmentally friendly CO₂ condensing units - CR Series for commercial refrigeration.



Refrigeration.

Offering a range of CO₂ solutions from 2 HP to 10 HP, including a new 4 HP unit. Medium or low temperature set-points available, offering a flexible installation for various applications.



CO₂ condensing units - CR Series by trusted technology.

CR Series are made in Japan with an excellent quality control established by skilled factory team.



Dimensions



Wiring diagrams



Quality Management System Certificate



ISO 9001: 2015
Panasonic Appliances Air-Conditioning
Malaysia. Sdn.Bhd.
Cert. No.: QMS 00413



GB/T 19001-2016/ISO 9001: 2015
Panasonic Appliances Air-Conditioning
(GuangZhou) Co., Ltd.
Registration Number: 01218Q30835R8L

Environmental Management System Certificate



ISO 14001: 2015
Panasonic Appliances Air-Conditioning
Malaysia Sdn.Bhd.
Cert. No.: EMS 00109



GB/T 24001-2016/ISO 14001: 2015
Panasonic Appliances Air-Conditioning
(GuangZhou) Co., Ltd.
Registration Number: 02118E10944R7M

Panasonic environmental vision 2050

To achieve “a better life” and “a sustainable global environment,” Panasonic will work towards creation and more efficient utilisation of energy which exceeds the amount of energy used, aiming for a society with clean energy and a more comfortable lifestyle.

2050

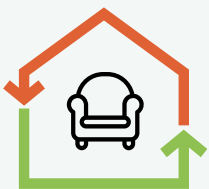

Energy used < Energy created

One initiative in the Panasonic environmental vision 2050 is offering products with greater energy efficiency. In 2018, we celebrated the 60th anniversary of our Heating & Cooling Solutions business. Our expertise gained over the years has helped us launch a range of products that contribute to a more carbon-free society.

Current status of energy used and energy created

Energy used by Panasonic business activities and products.



Clean energy created and / or made available by Panasonic products, etc.

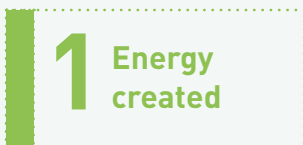

Working to realise environmental vision 2050

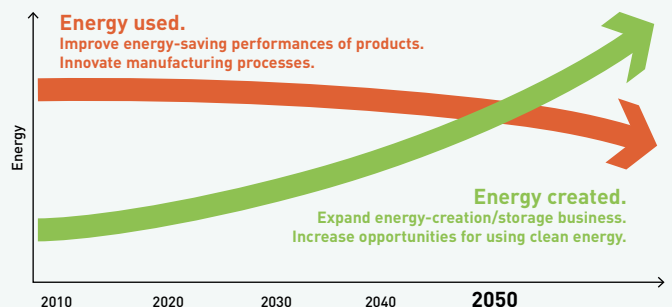

Projects and case studies of Panasonic Heating & Cooling Solutions



Panasonic, a partner with the knowledge and experience to achieve your objectives and green needs.

Integrated technology that permits better work, easy installation, high efficiency performance, and energy savings

Our main targets are the distributed services and B2B-integrated solutions.

Panasonic provides a single point of contact for the design and maintenance of your system, making things easy for you. Given our experience in processes, technologies and complex business models, we can offer you effective solutions that reduce costs, whilst also being efficient, user-friendly, reliable and innovative. Another advantage we offer to our clients is a support service for systems integration projects, which we provide through our wide range of services and solutions. As a global company, we have at our disposal the financial, logistical and technical resources to develop complex and wide-ranging solutions, both at country and international level by implementing them both on-time and on-budget.



Aquarea Heat Pumps provide heating and hot water for new rural housing development, UK.
Aquarea



The Hotel Vincci Gala with efficiency class A, up to 70 % save energy. Barcelona, Spain.
ECOi - ECO G



STEMCELL Technologies, a global biotechnology company, installed CO₂ condensing units - CR Series for cold rooms in the warehouse. France.
Refrigeration



The EDEKA store in Germany, the first supermarket providing the maintenance-free nanoe™ X technology for better indoor air quality. Germany. **ECOi and nanoe™ X**



Aquarea T-CAP provides a complete solution of heating, cooling and DHW for the refurbishment of a luxury house in Voorthuizen, Netherlands.
Aquarea



CÉDRUS LIGET, a complex facility including apartments, penthouses and showrooms etc. Hungary. **ECOi-W - ECOi - PACi**

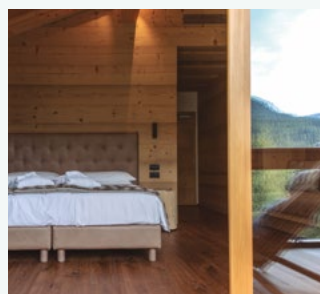

Dolomiti Lodge Alverà hotel with nice wooden furnishings, located in Cortina d'Ampezzo, Italy. **ECOi**



LIAIGRE showroom, well-known as a luxury design architect in Paris, France. **ECOi**



Marina Village Greystones. 205 apartments and 153 houses. Ireland. **Aquarea**



ITK Engineering GmbH. An innovative office building located in Germany. **ECOi - PACi**



A historic building on Amsterdam's Marineterrein. Netherlands. **ECOi-W**



Nolan's supermarket in Ireland installs the first Panasonic CO₂ condensing units - CR Series for showcases. Ireland.
Refrigeration

A desire to create things of value



"Recognising our responsibilities as industrialists, we will devote ourselves to the progress and development of society and the well-being of people through our business activities, thereby enhancing the quality of life throughout the world."

Panasonic Corporation's Basic Management Objective, formulated in 1929 by the company's founder, Konosuke Matsushita.

Panasonic becomes one of the first Japanese air conditioner manufacturers in Europe.



First room air conditioner launched for domestic installation.



1958

World's first air conditioner equipped with nanoe™



Introduces first GHP (gas heat pump) VRF air conditioner.



1985

1971

1975

1982

1989

2008

2010

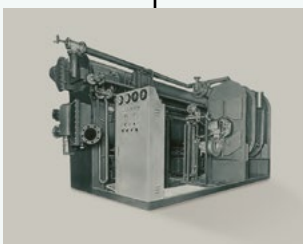

Starts production of absorption chillers.



Panasonic launches the first highly efficient air to water heat pump in Japan.



Introduces world's first simultaneous 3-Pipe heating / cooling VRF System.



New Aquarea. Panasonic introduces Aquarea, an innovative new, low-energy system in Europe.

Vitalize the future with air

These are times of exceptional challenge.
 If the world is to move forward confidently, it must overcome the serious threats of the new global pandemics and the degrading of the environment. It must find ways large and small to reduce the stresses that affect people's health and the stability of their communities. At Panasonic, we're utilizing the power of air to create positive change.
 Air that benefits body and mind.
 Air that energizes the places where people gather to work and play.
 Air that reduces our burden on the Earth.
 With more than a century of research and expertise to guide us, we're using air to open a more hopeful and vital future for all.

New Panasonic GHP units.

The gas-driven VRF Systems are ideal for projects where power restrictions apply.



New VRF Systems ECOi EX with extraordinary energy saving performance.

Panasonic introduces a new Chiller series which is named as ECOi-W.



Mini VRF R32 up to 10 HP. Outstanding efficiency in a compact body.



2012

2015

2016

2018

2019

2020

2021

Looking ahead



The first Hybrid System with VRF and GHP in Europe.



CO₂ condensing units in Europe. The ideal solution for supermarkets, shops and gas stations.



nanoe™ X, technology with the benefits of hydroxyl radicals. Improving protection 24/7.

Bringing nature's balance indoors



nanoe™ X, technology with the benefits of hydroxyl radicals.

In today's health-conscious world, we care about taking exercise, we care about what we eat and what we touch, we also care about what we breathe – and technology exists to bring good outdoor air, indoors.



Abundant in nature, hydroxyl radicals (also known as OH radicals) have the capacity to inhibit pollutants, viruses, and bacteria to clean and deodorise. nanoe™ X technology can bring these incredible benefits indoors so that hard surfaces, soft furnishings, and the indoor environment can be a cleaner and more pleasant place to be, whether at home, work, or visiting hotels, shops and restaurants etc.

A naturally occurring process

Hydroxyl radicals are unstable molecules looking to react with other elements like hydrogen, capturing it. Thanks to this reaction, hydroxyl radicals have the potential to inhibit the growth of pollutants such as bacteria, viruses, moulds, and odours, breaking them down and neutralising the unpleasant effects. This naturally occurring process has major benefits to improve indoor environments.



Hydroxyl radicals in nature.

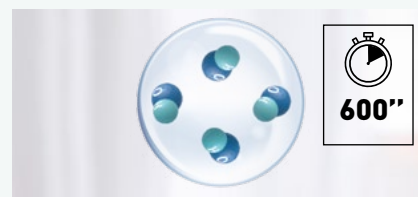

Hydroxyl radicals contained in water.



By creating hydroxyl radicals contained in water, nanoe™ X technology significantly boosts their effectiveness, increasing hydroxyl radicals lifetime from less than a second in nature, to more than 600 seconds – 10 minutes so that nanoe™ X can spread easily around the room.

Panasonic's nanoe™ X technology takes this a step further and brings nature's detergent – hydroxyl radicals – indoors to help create an ideal environment

Thanks to the nanoe™ X properties, several types of pollutants can be inhibited such as certain types of bacteria, viruses, mould, allergens, pollen and certain hazardous substances.

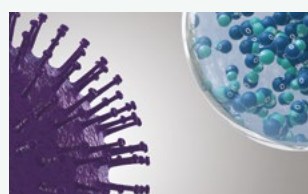

1 | nanoe™ X reliably reaches pollutants.



2 | Hydroxyl radicals denature pollutants' proteins.



3 | Pollutants activity is inhibited.

The well-being benefits of nature are well known – but do you know the power of hydroxyl radicals?

What is unique about nanoe™ X?

Hydroxyl radicals inhibit pollutants, certain types of viruses, and bacteria to clean and deodorise. Thanks to this advanced technology, even tightly woven fabrics can be treated using this solution, meaning that curtains, blinds, carpets and furniture can all benefit from this technology to inhibit hazardous substances – including on hard surfaces and, of course, the air that we breathe.



Effective on fabrics and surfaces.

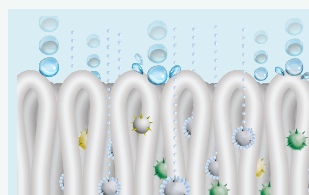

1 | At one billionth of a metre, nanoe™ X is much smaller than steam and can deeply penetrate cloth fabrics to deodorise.

Longer lifespan.



2 | Contained in tiny water particles, nanoe™ X has a longer lifespan to spread easily around the room.

Huge quantity.



3 | nanoe X Generator Mark 2 produces 9,6 trillion hydroxyl radicals per second. Greater amounts of hydroxyl radicals contained in nanoe™ X lead to higher performance on inhibition of pollutants.

Maintenance-free.



The image shows nanoe X Generator Mark 2.

4 | No maintenance, no replacement required. nanoe™ X is a filter free solution that does not require maintenance, as its atomisation electrode is enveloped with water during its generation process and it is made with Titanium.

7 effects of nanoe™ X – Panasonic unique technology

Deodorises



Odours

Capacity to inhibit 5 types of pollutants



Bacteria and viruses



Mould



Allergens



Pollen



Hazardous substances



Skin and hair

* Refer to <https://aircon.panasonic.eu> for more details and validation data.

The latest nanoe™ X device uses a “multi-leader discharge” system that focuses the discharge to 4 needle-shaped electrodes, greatly expanding the hydroxyl radicals.

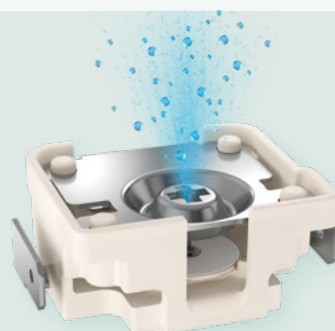

The image shows nanoe X Generator Mark 1.

How nanoe™ X is generated.

- 1 | Atomised electrode produces condensation.
- 2 | Electrical discharge is applied to the water
- 3 | nanoe™ X particles are generated

nanoe™ X, internationally-validated technology in testing facilities

The effectiveness of nanoe™ X technology has been tested by 3rd party laboratories in Germany, France, Denmark, Malaysia and Japan.

Test results conducted under controlled laboratory conditions. Performance of nanoe™ X might differ in real life environment.

Panasonic heat pump with nanoe™ X technology verified against SARS-CoV-2

Virus SARS-CoV-2: 91,4 % inhibited. Test conducted by TEXCELL (France), using a gauze saturated with SARS-CoV-2 virus solution exposed to Panasonic heat pump with nanoe™ X in a space of 6,7 m³ over 8 hours. Test report: 1140-01 C3. Performance of nanoe™ X might differ in real life environment.

	Tested contents		Result	Capacity	Time	Testing organisation	Report No.
Airborne	Virus	Bacteriophage ΦX174	99,7 % inhibited	Approx. 25 m³	6 h	Kitasato Research Center for Environmental Science	24_0300_1
	Bacteria	Staphylococcus aureus	99,9 % inhibited	Approx. 25 m³	4 h	Kitasato Research Center for Environmental Science	2016_0279
Adhered	Virus	SARS-CoV-2	91,4 % inhibited	6,7 m³	8 h	Texcell (France)	1140-01 C3
		SARS-CoV-2	99,9 % inhibited	45 L	2 h	Texcell (France)	1140-01 A1
		Feline Coronavirus	99,3 % inhibited	45 L	2 h	Yamaguchi University Faculty of Agriculture	—
		Xenotropic murine leukemia virus	99,999 % inhibited	45 L	6 h	Charles River Biopharmaceutical Services GmbH	—
		Influenza (H1N1 subtype)	99,9 % inhibited	1 m³	2 h	Kitasato Research Center for Environmental Science	21_0084_1
		Bacteriophage ΦX174	99,80% inhibited	25 m³	8 h	Japan Food Research Laboratories	13001265005-01
	Bacteria	Staphylococcus aureus	99,9 % inhibited	20 m³	8 h	Danish Technological Institute	868988
	Pollen	Ambrosia pollen	99,4 % inhibited	20 m³	8 h	Danish Technological Institute	868988
		Cedar	97 % inhibited	Approx. 23 m³	8 h	Panasonic Product Analysis Center	4AA33-151001-F01
	Odours	Cigarette smoke odour	Odour intensity reduced by 2,4 levels	Approx. 23 m³	0,2 h	Panasonic Product Analysis Center	4AA33-160615-N04

The nanoe™ X performance varies depending on the room size, environment and usage and it may take several hours to reach the full effect. nanoe™ X is not medical device, local regulations on building design and sanitary recommendations must be followed.

First nanoe™ device was developed by Panasonic in 2003

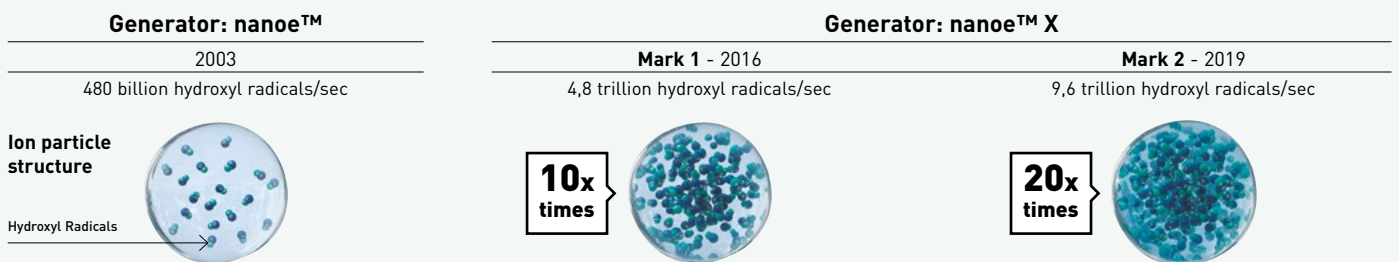

nanoe X Generator Mark 1 can reduce cigarette smoke odour intensity by 2,4 levels in 12 minutes

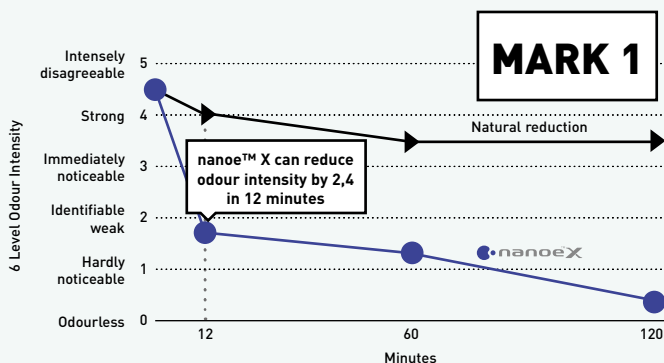

Deodorisation effect for adhering odour (cigarette smoke). Deodorisation test.
 Testing organisation: Panasonic Product Analysis Center. Testing method: Verified using the six-level odour intensity scale method in an approximately 23 m³ sized test room. Deodorisation method: nanoe™ released. Test substance: Surface-attached cigarette smoke odour. Test result: Odour intensity reduced by 2,4 levels in 12 minutes. (4AA33-160615-N04).

nanoe X Generator Mark 2 can reduce the aged-related body odour in half of the time

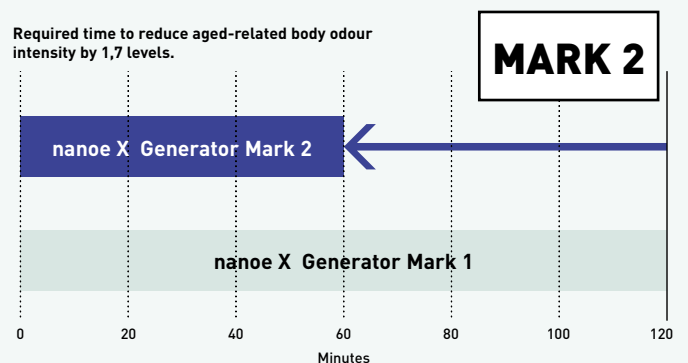

Deodorisation test.
 Testing organization: Panasonic Product Analysis Center. Testing method: Verified using the six-level odour intensity scale method in an approximately 23 m³ sized test room. Deodorisation method: nanoe™ released. Test substance: Surface-attached aged related body odour. Test result: Odour intensity reduced by 1.7 levels in 1 hour (Y18HM059).

Where is nanoe™ X technology used?

Since 2003, nanoe™ has become a part of people's lives in Japan and other regions.

Such technology can be found in diverse applications for cleaning air and surfaces, inside trains, elevators, cars, home appliances and personal beauty ... as well as in air conditioning.

Panasonic Heating & Cooling Solutions is incorporating nanoe™ technology in a wide range of equipment for residential applications as well as for commercial spaces and, it is a solution that does not require filters or maintenance and can work independently from heating or cooling.

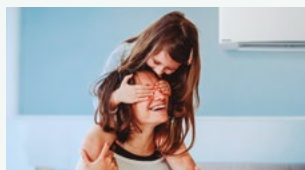

Home



Shop

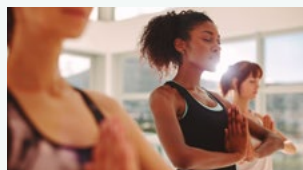

Gym



Hotel



Office



Clinic

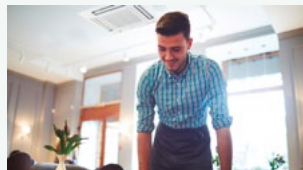

Restaurant



Hospital

It has been adopted in people's homes as well as in public facilities where improved air quality is desired, such as offices, hospitals, healthcare centres and hotels etc.

nanoe™ X: improving protection 24/7

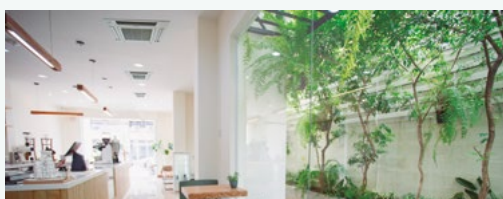

Panasonic Heating & Cooling Solutions is incorporating nanoe™ technology in a wide range of equipment

Home.

Built-in nanoe X Generator Mark 2.

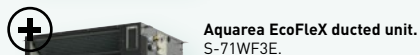
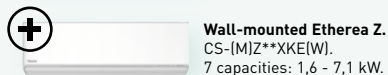
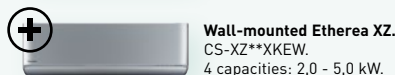
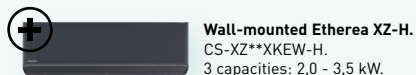

Built-in nanoe X Generator Mark 1.



Built-in nanoe™.



Commercial.

PACi NX. Built-in nanoe X Generator Mark 1.

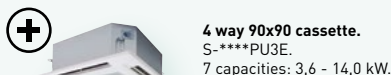

PACi NX. Built-in nanoe X Generator Mark 2.

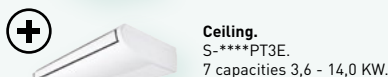
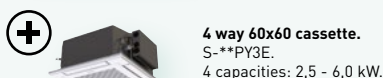
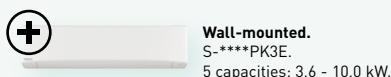

VRF. **NEW** Built-in nanoe X Generator (TBC).

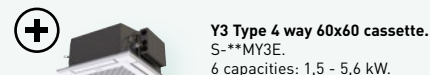

VRF. Built-in nanoe X Generator Mark 2.

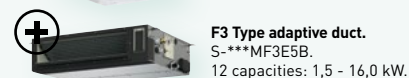
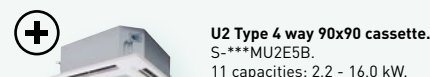

VRF. Built-in nanoe X Generator Mark 1.



nanoe™ X: improving protection 24/7

100 % Panasonic, the DNA of Japanese craftsmanship

Applying advanced technologies that truly make life better, we live by an unparalleled commitment to product quality.

Panasonic is building on the Japanese tradition of uncompromising quality control worldwide, developing and manufacturing fine products and delivering them to customers everywhere.

**JAPAN
QUALITY**



At Panasonic, we believe that the best air conditioner is one that works quietly and effectively in the background whilst minimising its impact on the environment

People who use our products can look forward to long years of high-quality performance without the need for constant service. As part of our rigorous design and development process, Panasonic air conditioners undergo a variety of stringent tests to ensure their effectiveness and long-term reliability. Tests for durability, waterproofing, shock resistance, and noise are conducted on component parts or on the finished products themselves.

As a result of all of these time consuming efforts, Panasonic air conditioners meet industrial standards and regulations in every country where they are sold.

International Standard Quality

To uphold the company's reputation around the world, Panasonic strives continuously to offer quality with minimized environmental impact.



Reliable parts that meet or exceed industrial standards.

In every country where they are sold, Panasonic air conditioners comply with all required industrial standards and regulations. In addition, Panasonic conducts stringent testing to ensure the reliability of parts and materials. The strength of the resin material used in a propeller fan is confirmed by a tension test.



Compliance with RoHS / REACH substance restrictions.

Panasonic products and used materials strictly comply with chemical substance restrictions as defined by RoHS or REACH. During the development and production of parts, stringent inspections are conducted on over 100 materials to ensure that no hazardous substances are included.



Sophisticated production process.

Panasonic's air conditioner production lines employ state-of-the-art factory automation technologies to ensure products are manufactured with high attention to quality to meet expectations of reliability and trustworthiness.

Durability

At Panasonic we know the importance of a long service life with minimal maintenance. That's why we subject our air conditioners to a wide range of stringent durability tests.



Long-term durability test.

To ensure durability and stable operation for many years, we conduct a long-term continuous operation test under conditions that are much more severe than actual operating conditions.



Compressor reliability test.

After the continuous operation test, we remove the compressor from a selected outdoor unit, disassemble it, and examine the internal mechanisms and parts for potential failure. This helps ensure reliable long-term performance under harsh conditions.

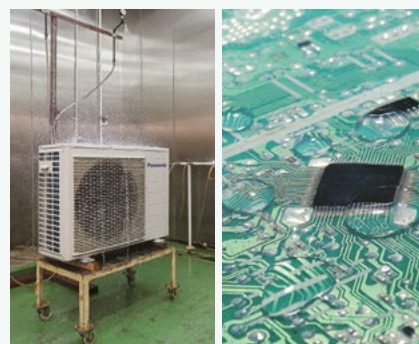

Waterproofing test.

The unit - which is subject to rain and wind - complies with IPX4 waterproof specifications. Contact sections on printed circuit boards are resin-potted to prevent adverse effects caused by exposure to water (an unlikely occurrence).

A globally trusted air conditioning brand

Panasonic – leading the way in Heating and Cooling.

With more than 50 years of experience, selling to more than 120 countries around the world, Panasonic is one of the leaders in the heating and cooling sector.

With a diverse network of production and R&D facilities, Panasonic delivers innovative products incorporating cutting-edge technologies that set the standard for air conditioners worldwide.



From, for and by Europe

In 2018 Panasonic initiated the production of air to water heat pumps in its factory in Pilsen, Czech Republic. Keeping an excellent combination of highly skilled human resources and production automation the big demand growth foreseen in Europe can be met with outstanding quality standards.



Factory in Pilsen, Czech Republic.



More than 40 years of experienced organization in Europe.

At Panasonic, we know that the best is always yet to come. This is why our air conditioning and heat pump solutions are constantly upgraded. Panasonic is committed to offering our customers innovative products in the heating and cooling market across Europe, and has the ambition to not only meet but also exceed their requirements. Our Technology and Design teams anticipate the needs of tomorrow. We look to produce smaller, quieter, efficient solutions - with better technological features - that can reduce energy consumption while providing suitable temperature conditions for the user.

Panasonic R&D Center Germany GmbH.

The European Research and Development Center of Panasonic focusing on technology development for intelligent and environmentally friendly future products, such as audio video, communication and energy solutions.



Panasonic R&D Center Germany GmbH.

37 Training Center in 19 countries in Europe

The Panasonic PRO Academy.

Heating and Cooling business is changing rapidly, new technologies, new regulations, new solutions that require continuous update for professionals. Panasonic takes its responsibility to its distributors, specifiers and installers seriously and has developed a comprehensive training programme with 37 Training Center in 19 countries in Europe.



PRO Club. The professional website of Panasonic

Panasonic has an impressive range of support services for designers, specifiers, engineers and distributors working in the heating and cooling markets.



Panasonic PRO Club (www.panasonicproclub.com) is the online tool which makes your life easier! You just have to register and a lot of functionalities are freely available to you, where ever you are, from your computer or smartphone!

- Print catalogues with your logo and contact details
- Access to the extensive library of professional design, selection and calculation tools (Aquarea Designer, VRF software, chiller selector, etc.)
- Get documents of conformity and all other documents you may need
- Download all the service manuals, end user manuals and installation manuals
- Download energy labels in PDF format using the energy label generators
- Download Revit and CAD files and specification texts
- Know what to do with error codes (error code search by error code or unit ref.)
- PRO Academy: register for training
- Download product images in high resolutions, advertisements, deco guidelines
- Get to know special offers and promotions
- Find out about the latest news first

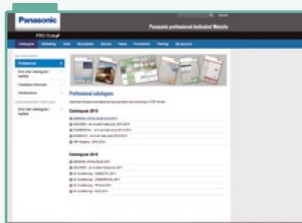

Easy download Panasonic service documentation and brochures

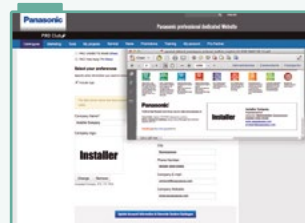

Customise leaflets with your logo and contact details. Save and print the PDF



Energy label generator. Download Energy labels of any device in PDF format

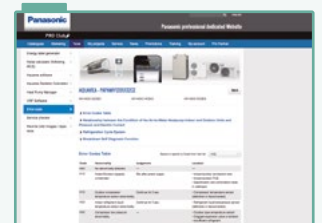

Error Code on your smartphone and your PC: Search by error code or model reference. Online version + downloadable version for offline use

Panasonic PRO Club is fully compatible with tablet computer and smartphone.

Visit www.panasonicproclub.com or connect simply with your smartphone to the PRO Club using this QR.



Panasonic provides bespoke software and tools helping system designers, installers and dealers to very quickly select, design and size systems or create wiring or hydraulic diagrams at the push of a button.

Aquarea Designer - online tool

With Panasonic's online tool, projects can be developed simply and easily. The newly developed tool is optimised to help HVAC professionals easily identify the most appropriate Aquarea air to water heat pump for a particular application.

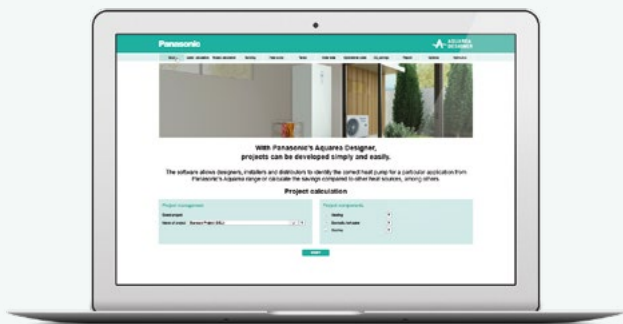

Domestic AirCon Quick Selector

This user-friendly online tool for our domestic range allows to choose the best split or multi-split system for each project needs and get the specifications of that particular application.

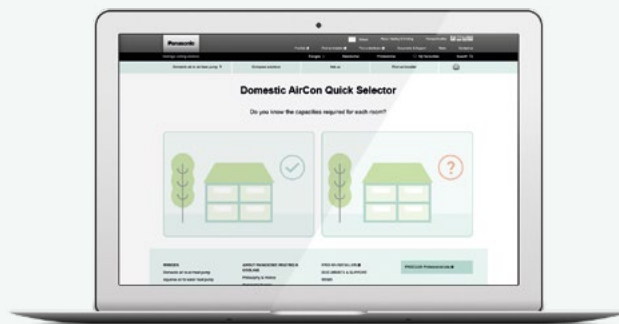

VRF Designer

Building on the success of the ECOi VRF Designer software, this package provides air conditioning system designers, installers and dealers with a program to design and size projects for Panasonic's VRF ranges.



Open BIM

Design, analysis and BIM modeling of Panasonic VRF and Air to Water heat pump systems. Generates documents, 3D model, schematics and drawings. This application is integrated into the Open BIM workflow via the BIMserver.center platform.

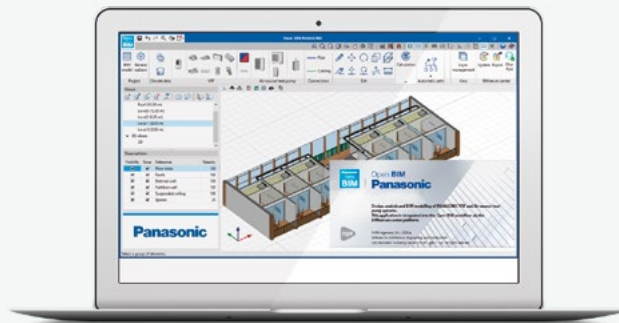

Chiller configurator

This online software solution offers a complete tool to allow the user to accurately calculate the performance at specified conditions, select and configure our range of commercial chillers, heat pumps and fan coils. It also provides a comprehensive report to share with customers and clients alike.



Refrigeration tool

Panasonic has launched a new online calculator to support engineers, installers, and technicians to quickly make calculations when specifying solutions for commercial refrigeration systems.

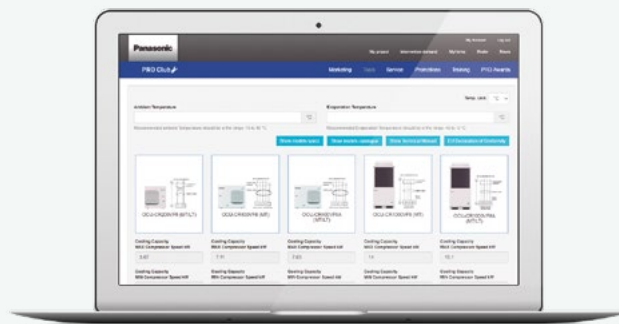

AQUAREA



Welcome to Aquarea air to water heat pump

Aquarea's air to water Heat Pump for residential and commercial applications.

Offering capacities from 3 kW all the way through to 16 kW, the Aquarea Heat Pump Range is the widest on the market, ensuring a system is available whatever your heating and cooling needs. Suitable for new build and refurbishment projects, the solutions are cost-effective with minimised environmental impact.

Highlighted features	→ 20
Introducing the Panasonic Aquarea – air source heat pump	→ 22
Aquarea Heat Pump line-up	→ 24
New Aquarea EcoFlex	→ 26
All in One Compact	→ 30
Aquarea High Performance	→ 32
Aquarea T-CAP	→ 34
Aquarea HT	→ 36
Aquarea commercial	→ 38
Aquarea Smart and Service Cloud	→ 40
Control and Connectivity	→ 42
Aquarea + PV Panels	→ 45
Panasonic PRO Club	→ 46
Aquarea Designer - online tool	→ 47
Aquarea Heat Pump range	→ 48
Aquarea, top-level efficiency across the board	→ 50

Aquarea EcoFlex

Aquarea EcoFlex	→ 51
-----------------	------

Aquarea High Performance

All in One J Generation 1 or 2 zones · R32	→ 52
All in One H Generation · R410A	→ 53
All in One Compact J Generation · R32	→ 54
All in One Compact H Generation · R410A	→ 55
Bi-bloc J Generation · R32	→ 56
Bi-bloc H Generation · R410A	→ 57
Mono-bloc J Generation · R32	→ 58
Mono-bloc H Generation · R410A	→ 59

Aquarea T-CAP

All in One H Generation · R410A	→ 60
All in One H Generation · R410A	→ 61
All in One Compact H Generation · R410A	→ 62
Bi-bloc H Generation · R410A	→ 63
Bi-bloc H Generation · R410A	→ 64
Mono-bloc J Generation · R32	→ 65

Aquarea HT

Bi-bloc F Generation · R407C	→ 66
Mono-bloc G Generation · R407C	→ 67

Fan coils highlighted features	→ 68
Smart fan coils	→ 69
Fan coils - ducted	→ 70
Fan coils - wall-mounted	→ 72
Wired controllers for AC and EC fan coils	→ 73
Sanitary Tanks	→ 74
Heat recovery ventilation unit	→ 76
DHW Stand Alone	→ 78
Accessories and control	→ 80
Heating and cooling capacity tables	→ 84

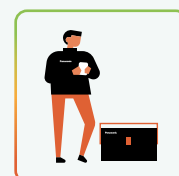
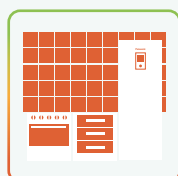
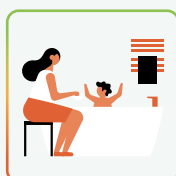
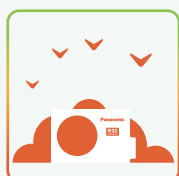

Highlighted features

Panasonic's Aquarea range of heat pumps deliver major energy savings thanks to its incredible efficiency even at $-20\text{ }^{\circ}\text{C}$. The Panasonic Aquarea Heat Pumps are designed and produced by Panasonic and not by other companies.

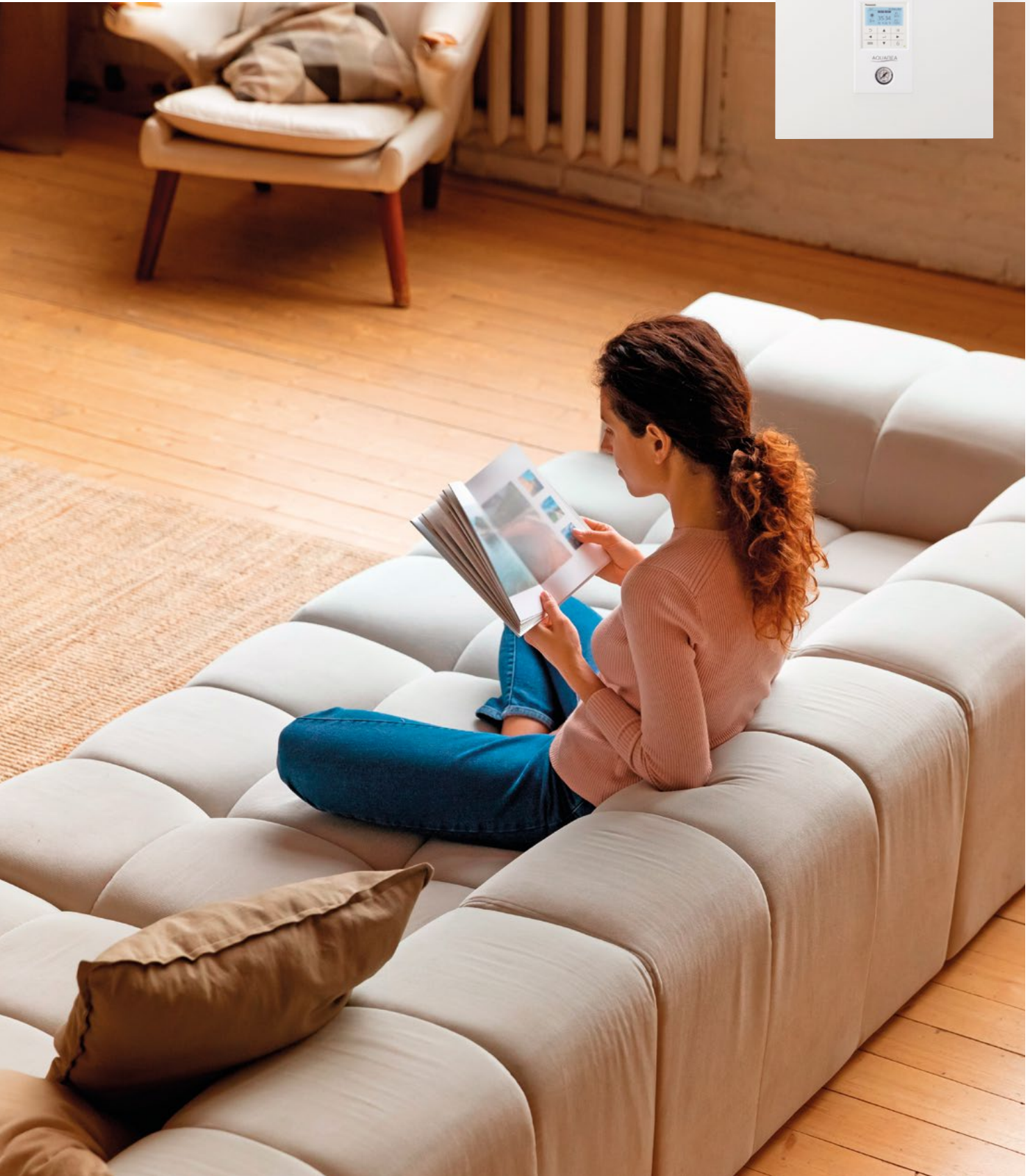

The Aquarea Heat Pump is a system that generates the perfect temperature and produces hot water, in an easy, cheap and environmentally conscious way, by transferring heat instead of generating it. It is among the Technologies listed on the International Energy Agency (IEA) Blue Map, whose goal is to reduce CO₂ emissions to half the levels emitted in 2005, by the year 2050. Aquarea is part of a new generation of heating solutions that use a renewable, free energy source (the air) to heat or cool the home and to produce hot water.

AQUAREA

The Good Design Award is among the most prestigious awards for product design excellence. Winning this award has underscored the outstanding performance and energy savings of the Panasonic indoor units All in One and Bi-bloc. In addition, these units' clean, tidy design and functionality make the Aquarea line the ideal system for household applications.



Energy saving



Refrigerant gas R32
Our heat pumps containing the refrigerant R32 show a drastic reduction in the value of Global Warming Potential (GWP).

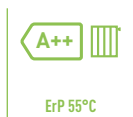

Better efficiency and value for medium temperature applications.
Energy efficiency class up to A++ in a scale from A+++ to D.



Better efficiency and value for low temperature applications.
Energy efficiency class up to A+++ in a scale from A+++ to D.



Better efficiency and value for domestic hot water.
Energy efficiency class up to A+ in a scale from A+ to F.



Inverter Plus.
Panasonic Inverter Plus compressors are designed to achieve outstanding level of performance.



A class water pump.
Aquarea are built-in with A class energy efficiency water pump. High efficiency circulating the water in the heating installation.

High Performance



Aquarea High Performance for low consumption houses.
From 3 to 16 kW. For a house with low temperature radiators or under-floor heating, our high performance Aquarea HP is a good solution. *COP of 5,33 for J Generation 3 kW.



Aquarea T-CAP for extremely low temperatures.
From 9 to 16 kW. If the most important aspect is to maintain nominal heating capacities even at temperatures as low as -7 °C or -20 °C, select the Aquarea T-CAP.

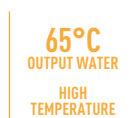

Aquarea HT ideal for retrofit. From 9 to 12 kW.
For a house with traditional high-temperature radiators, the Aquarea HT solution is the most appropriate, can work in output water temperatures of 65 °C even at outdoor temperatures as low as -20 °C.



DHW.
With Aquarea you can also heat your domestic hot water at a very low cost with the optional hot water cylinder.

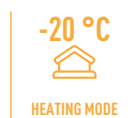

Down to -20 °C in heating mode.
The heat pumps work in heating mode with an outdoor temperature is as low as -20 °C.



Water filter with magnet.
Easy access and fast clip technology for J Generation. Water filter only for H Generation.

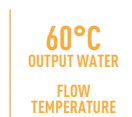

60 °C output water.
Reaches water outlet temperature up to 60 °C.

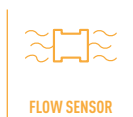

Water flow sensor.
Included on J and H Generation.



5 years compressor warranty.
We guarantee the outdoor unit compressors in the entire range for five years.



Aquarea J and H Generation heat pumps in combination with the optional PCB CZ-NSP4 hold the SG Ready Label (Smart Grid Ready Label), given by Bundesverband Wärmepumpe (German Heat Pump Association). This Label shows the real capacity of Aquarea to be connected in an intelligent grid control. MCS Certificate number: MCS HP0086.*
Keypmark: Check all our certified heat pumps on: www.heatpumpkeymark.com.
Passive House Institute: Certified models can be checked in <https://database.passivehouse.com>.



High connectivity

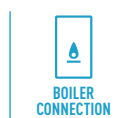

Renovation.
Our Aquarea Heat Pumps can be connected to an existing or new boiler for optimum comfort even at very low outdoor temperatures.



Solar kit.
For even greater efficiency, our Aquarea Heat Pumps can be connected to photovoltaic solar panels with an optional kit.



Advanced control.
Remote controller with full dotted 3,5" wide back light screen. Menu with 17 available languages easy to use for installer and user. Included on J and H Generation.



Internet control.
A next generation system providing user-friendly remote control of air conditioning or heat pump units from everywhere, using a simple Android™ or iOS smartphone, tablet or PC via the internet.



Connectivity.
The communication port can be integrated into the indoor unit and provides easy connection to, and control of, your Panasonic heat pump to your home or building management system.

Warning on quality of water and groundwater use:

This product is designed to comply with the European Water Quality Directive 98/83/EC amended by 2015/1787/EU. The lifespan of the product is not guaranteed in the case of the use of groundwater, such as spring water or well water, the use of tap water when salt or other impurities are contained, nor in areas of acidic water quality. Maintenance and warranty costs related to these cases are the customer's responsibility.

* Not all products certified. As the certification process is on-going and the list of certified products constantly changing, please check for latest details on the official websites.

Introducing the Panasonic Aquarea – air source heat pump

At the forefront of energy innovation, Aquarea is resolutely positioned as a “green” heating and air conditioning solution.



Introducing the Panasonic Aquarea – air source heat pump

In European households, 79 %* of energy consumption comes from heating and producing domestic hot water. By converting heat energy in the air into household warmth, highly efficient Aquarea technology reduces CO₂ emissions and environmental impact, compared to conventional boilers and electric heaters. Compared to an electric heater, the Aquarea Heat Pumps offer up to five times the output in kilowatts per every input in kilowatts.

* ec.europa.eu/eurostat

Comparison: 1 kW input versus output in kW.

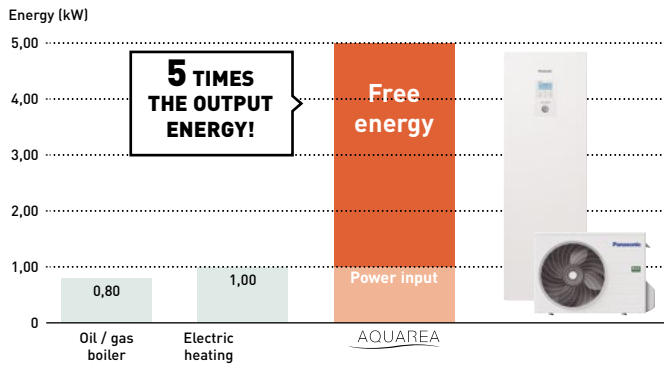

* 35 °C flow temperature.



Why Panasonic Aquarea air source heat pumps?



Optimum solutions for premium comfort.

Panasonic Aquarea Heat Pumps warm your home effectively and efficiently, to optimise the comfort.

- Precise control the indoor temperature thanks to reliable Panasonic Inverter Compressors
- Aquarea can cool space in summer and brings hot water all year round
- Night mode to reduce the noise when it's needed
- Aquarea T-CAP heat pumps can work in outdoor temperatures as low as -28 °C (for All in One and Bi-bloc)
- Energy savings, comfort and convenient control from any location thanks to Aquarea Smart Cloud
- Aquarea Service Cloud enables remote maintenance of the system



Energy saving means money savings.

Panasonic Aquarea Heat Pumps are a smart choice for saving in heating, all leading to large savings in electricity bills.

- Savings of up to 80 % on heating expenses, compared to electrical heaters
- Up to A+++ in heating, within the range of A+++ to D, and A+ in domestic hot water, in the range of A+ to F
- Energy consumption can be further reduced by connecting photovoltaic panels to the system
- In combination with a ventilation solution, the indoor air becomes cleaner and the heating requirements of the building are reduced



Adapts to your needs.

Panasonic Aquarea Heat Pumps produce heating, cooling and domestic hot water with a single system.

- From 3 kW to 16 kW, there is always an option for lower initial investment and lower operational cost
- Aquarea can be connected to floor heating, radiators or fan coil units
- In refurbishment projects, Aquarea can be integrated in existing heating systems
- Able to reach up to 65 °C water outlet¹⁾
- Large piping length of up to 50 m between indoor and outdoor
- Aquarea T-CAP heat pumps guarantee the capacity without back-up heating down to -20 °C²⁾

1) Aquarea T-CAP Mono-bloc J Generation and Aquarea HT.
2) At 35 °C flow temperature.



Contributing to a decarbonised society.

The heat pump is considered a 'green' choice as the heat energy is taken from the environment, making it a sustainable option.

- It maintains a comfortable indoor temperature while significantly reducing environmental burden
- All Aquarea Heat Pumps can also be connected to a solar thermal or PV system in order to increase efficiency and minimise environmental impact

Aquarea Heat Pump line-up

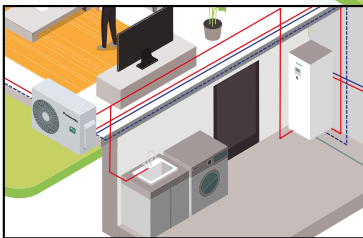

A

B

C

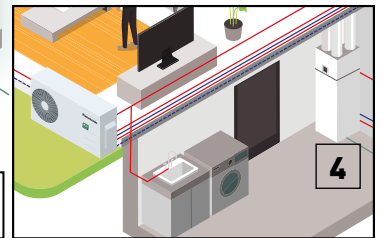

4



All in One system.

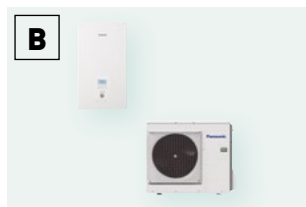

Bi-bloc system.

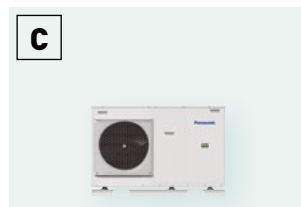

Mono-bloc system.



Aquarea EcoFlex.

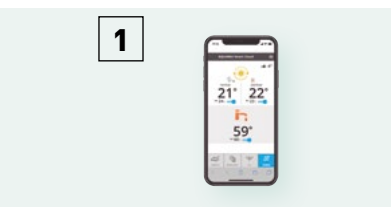

Control through smartphone, tablet or computer (optional).



Super high efficiency cylinder (optional).

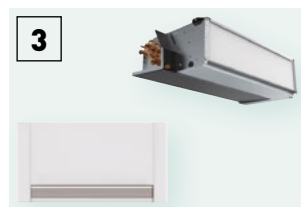

Fan coils for heating and cooling (optional).



Heat recovery Ventilation + DHW Tank (optional).

Panasonic Aquarea offers you solutions, helping to make the home more efficient and the installation cheaper and easier.

Aquarea EcoFleX

For new installations, specially those with limited spaces.
New Aquarea EcoFleX is a groundbreaking heat pump that connects an air ducted unit with nanoe™ X technology providing heat recovery hot water, space heating, space cooling and cleaner air. Outstanding efficiency and energy savings with low CO₂ emissions.

Aquarea High Performance

For new installations and low consumption homes.
Outstanding efficiency and energy savings with minimised CO₂ emissions and minimum space. Improved performance with COPs up to 5,33 for J Generation 3 kW.

















Aquarea T-CAP

For extremely low temperatures, refurbishment and innovation.
Ideal to ensure that the heating capacity is maintained even at very low temperatures. This line-up is able to maintain the heat pump output capacity until -20 °C¹⁾ outdoor temperature without the help of an electrical booster heater.

1) At 35 °C flow temperature.

Aquarea HT

For a house with old high-temperature radiators.
Ideal for retrofit: green energy source works with existing radiators. Aquarea HT Solution is the most appropriate, providing output water temperatures of 65 °C even at outdoor temperatures as low as -15 °C.

Aquarea EcoFleX	Aquarea High Performance	Aquarea T-CAP	Aquarea HT
			
Heating - Cooling - DHW	Heating - Cooling - DHW	Heating - Cooling - DHW	Heating - DHW
Single phase 8 kW	Single phase from 3 to 16 kW Three phase from 9 to 16 kW	Single phase from 9 to 12 kW Three phase from 9 to 16 kW	Single phase from 9 to 12 kW Three phase from 9 to 12 kW
Connectable to			
			
Radiators - Underfloor heating - DHW - Air conditioning	Radiators - Fan coil - Underfloor heating - DHW	Radiators - Fan coil - Underfloor heating - DHW	Traditional high-temperature radiators - DHW
Application			
			
New buildings	Normal installation	For extreme cold ambient	Retrofit for old radiators
Energy efficiency			
			
Heating 35 °C / 55 °C ¹⁾	Heating 35 °C / 55 °C ¹⁾	Heating 35 °C / 55 °C ¹⁾	Heating 35 °C / 55 °C ¹⁾
Minimum outdoor temperature			
-15 °C	-20 °C	-28 °C (All in One and Bi-bloc) -20 °C (Mono-bloc) ²⁾	-20 °C
Minimum outdoor temperature to provide constant capacity at 35 °C supply water temperature			
—	-7 °C (not for all units)	-20 °C ²⁾	-15 °C
Supply temperature for heating. Maximum / Heat pump only			
65 °C / 55 °C	75 °C ³⁾ / 55 °C ⁴⁾ (or 60 °C for Aquarea J Generation)	75 °C ³⁾ / 60 °C ⁴⁾ (65 °C ⁵⁾ for Aquarea J generation)	75 °C ³⁾ / 65 °C
Control and connectivity			
Smart Grid Contact ⁶⁾ Wi-Fi included	Smart Grid Contact ⁶⁾ Wireless LAN Ready	Smart Grid Contact ⁶⁾ Wireless LAN Ready	—
Range			
Aquarea EcoFleX 8 kW (185 L)	All in One from 3 to 16 kW (185 L) Bi-bloc from 3 to 16 kW Mono-bloc from 5 to 16 kW	All in One from 9 to 16 kW (185 L) Bi-bloc from 9 to 16 kW Mono-bloc from 9 to 16 kW	Bi-bloc from 9 to 12 kW Mono-bloc from 9 to 12 kW

All data in this chart is applicable in most of models in each line up, check product specs to confirm. 1) Scale from A+++ to D. 2) 9 and 12 kW. 3) DHW maximum temperature with heater. 4) In case of outdoor temperature over -10 °C. 5) It is possible to set temperature by 65 °C on remote controller. Normally, outlet water temperature is 60 °C or lower. In case of ΔT setting with remote controller is 15 °C and the outdoor ambient temperature is 5 to 20 °C, outlet water temperature 65 °C is possible. 6) J and H Generation with CZ-NS4P.

New Aquarea EcoFlex

2-in-1 - Sustainable and efficient comfort all year long.

New Aquarea EcoFlex is a groundbreaking heat pump that connects an air ducted unit with nanoe™ X technology providing heat recovery hot water, space heating, space cooling and cleaner air. Outstanding efficiency and energy savings with low CO₂ emissions.

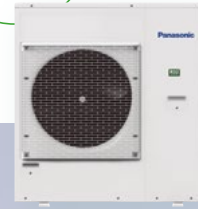

1 Multi solution

Trendy air to water + DX value added solution, featuring bi-heating and heat recovery function.

- Bi-heating: Simultaneous air heating and DHW or heating
- Heat recovery: Re-use wasted heat from the outdoor unit for DHW production
- Non-stop heating: Air heating runs continuously even in defrost operation

2 Compact design

Aquarea EcoFlex offers outstanding design and efficiency, ideal for installations with limited spaces such as apartments or housing complexes. The compact outdoor unit can supply both air conditioning and hot water at the same time. The Tank fits beautifully in any kitchen, small laundry space, or any other desired area. No need for gas supply.

3 Smart convenience

Energy savings, comfort and control from anywhere. Aquarea EcoFlex is equipped standard with Wi-Fi to enable smart control and energy consumption monitoring, using Aquarea Smart Cloud.



4 nanoe™ X technology to improve protection 24/7

This advanced technology utilises hydroxyl radicals (also known as OH radicals), which inhibit the growth of certain pollutants such as allergens, bacteria, viruses, moulds, odours, and certain hazardous substances. This naturally occurring process has major benefits indoors and improves the protection inside a room 24/7.

The nanoe™ X performance varies depending on the room size, environment and usage and it may take several hours to reach the full effect (see page 10 for more detail). nanoe™ X is not medical device, local regulations on building design and sanitary recommendations must be followed.



Unique technology that drives the system

Heat recovery.

Cooling (air to air) + DHW (air to water).

Heat exchange that took place in outdoor unit now is carried out in the water heater.

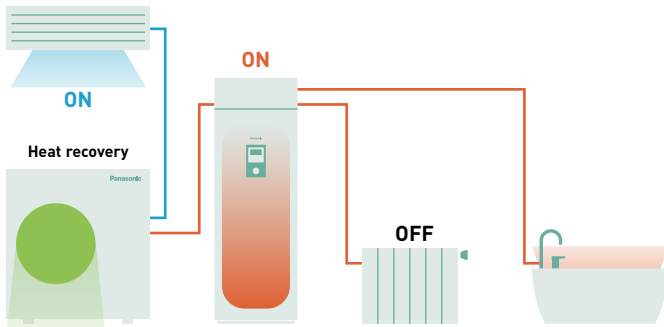

Bi-heating.

Heating (air to air) + Heating (air to water) or DHW.

Heat from the compressor is supplied for heating and DHW simultaneously.

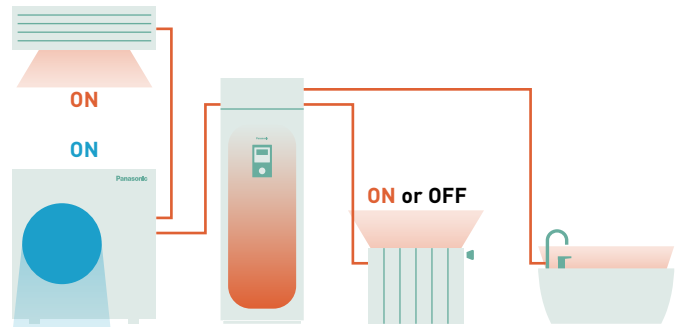

Non-stop heating.

Heating (air to air) continuous operation.

Use heat from tank to defrost and heat simultaneously.

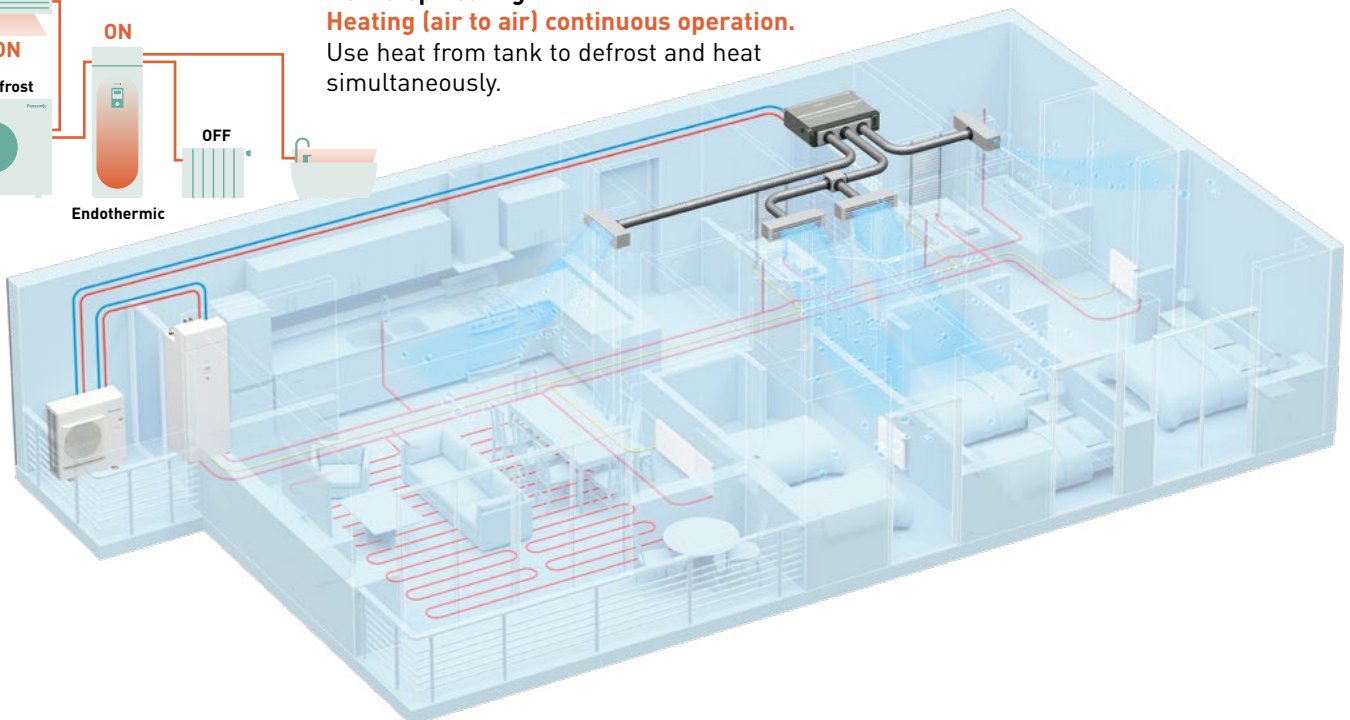
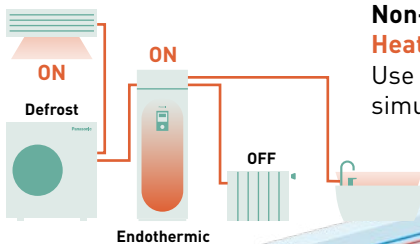

New Aquarea EcoFleX.

Air to water

Tank unit + heat exchanger box to produce domestic hot water and space heating using radiators or floor heating.



Fits beautifully in any kitchen, small laundry space, or any other desired area

Kitchen.



Laundry space.



The same depth as a regular refrigerator/washing machine.



Deep: 600 mm
Wide: 598 mm

Deep: 600 mm
Wide: 600 mm

Deep: 600 mm
Wide: 600 mm

Compact, yet easy to maintain



- Heat exchanger box structure to mitigate R32 refrigerant restrictions, flexible installation.**
Water heat exchanger is designed above the top plate to comply with installation area regulation for products using large amounts of R32 refrigerant.



- Maintained serviceability.**
 - Easy maintenance concept
 - Access to hydraulic parts thanks to door opening mechanism
 - No buffer tank required, reducing space, cost and installation time



Width:
116 mm
Height:
250 mm

- Improved water filter for less maintenance.**
Superior dust removal capacity of the water filter. Less frequent filter cleaning means more convenience.



Deep:
600 mm
Wide:
598 mm

185 L

- Slim indoor unit with big tank capacity.**
Built-in 185 L water tank in a slim W 598 x D 600 mm indoor unit housing.

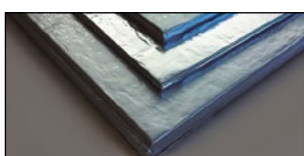

- U-Vacua insulation technology.**
Panasonic U-Vacua™ is a high performance vacuum insulation panel with very low thermal conductivity, that performs about 19 times better than standard urethane foam.

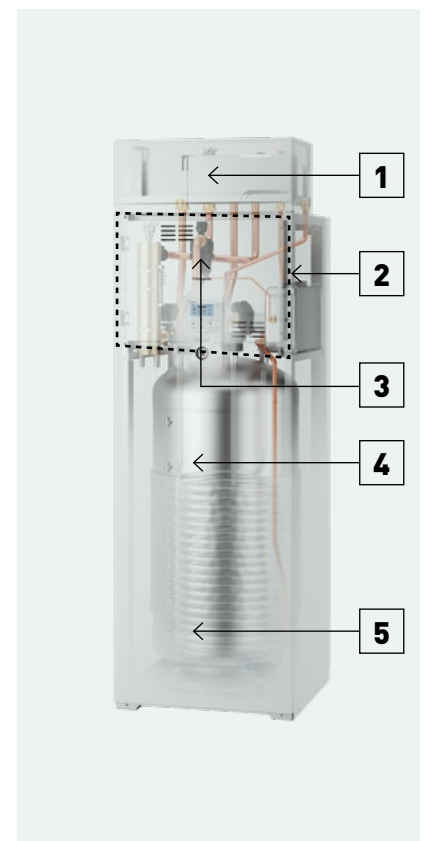

New Aquarea EcoFlex. Air heating or cooling and cleaner air



Aquarea EcoFlex ducted unit has been designed to provide better comfort and flexibility.

[+ SEE PRODUCT SPECIFICATIONS](#)

1 Superior air quality

Standard equipped with nanoe™ X, a unique technology that cleans indoor air.

2 Ideal for living spaces

- Static pressure level: 10 - 150 Pa
- Compact body: Only 250 mm high
- Smart control ready via CONEX
- Rated up to SEER / SCOP class A++
- Low noise operation (22 ~ 29 dB(A)) using an improved fan casing
- DC fan motor, built-in drain pump

Panasonic's nanoe™ X technology takes this a step further and brings nature's detergent – hydroxyl radicals – indoors to help create an ideal environment



Thanks to the nanoe™ X properties, several types of pollutants can be inhibited such as certain types of bacteria, viruses, mould, allergens, pollen and certain hazardous substances.

Deodorises



Odours

Capacity to inhibit 5 types of pollutants



Bacteria and viruses



Mould



Allergens



Pollen



Hazardous substances



Skin and hair

The nanoe™ X performance varies depending on the room size, environment and usage and it may take several hours to reach the full effect. nanoe™ X is not medical device, local regulations on building design and sanitary recommendations must be followed.

[+ REFER TO PAGE 10 FOR MORE DETAILS AND VALIDATION DATA](#)

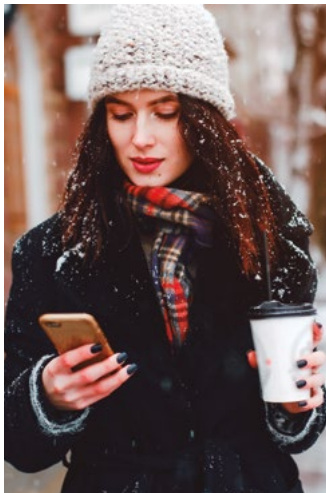

nanoe™ X: improving protection 24/7.

Acts to clean your air, so that the indoor environment can be a cleaner and more pleasant place to be all day long. nanoe™ X works together with heating or cooling function when you are at home and can work independently when you are away.

Give the air conditioning the strength to increase the protection at home with nanoe™ X technology and convenient control via the Panasonic Comfort Cloud App.

Cleans the air when you are away.

Leave the nanoe™ mode ON to inhibit certain pollutants and deodorise before you return home.

Improves your environment when you are at home.

Enjoy a cleaner, comfortable space with loved ones.



Selectable inlet air position

Inlet air position may be adjusted by means of a removable panel, to allow rear or bottom entry, depending on the duct installation.

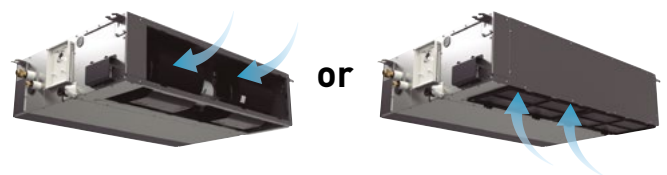

Compact body

- Only 250 mm high
- Light units from 25 to 39 kg

Conventional model	33 kg	290 mm
Ducted unit	30 kg	250 mm

Ducted unit



All in One Compact

The Aquarea All in One Compact unit is the ultimate space-saving solution. Its 598 x 600 mm footprint, standard size of other big appliances, reduces the space required for the installation



Aquarea All in One: the best Panasonic technology for your home

High quality components inside:

- Maintenance free Inox stainless 185 l tank
- Variable speed water pump (class A)
- Less frequent maintenance with pre-installed improved magnet filter
- Expansion vessel
- Vortex flow sensor
- Back up heater
- Safety valve
- Air purge valves
- 3 way valve inside

The ultimate space-saving solution.

- 598 x 600 mm footprint reduces required installation space
- Low height leaves space for a ventilation unit
- No buffer tank required, reducing space, cost and installation time

Further flexibility.

- Easy access to hydraulic parts
- Less frequent maintenance with pre-installed improved magnet filter
- Operation without back-up heating at -20 °C
- Can supply 60 °C hot water even at -10 °C outside temperature
- Piping length up to 50 m (for J Generation 7 and 9 kW)
- Modern remote controller can be installed up to 50 m from the indoor unit
- Can connect additional room temperature sensor, solar kit, 2 zones control, swimming pool and circulating pump (need optional PCB: CZ-NS4P)

Aquarea All in One Compact: Made compact but maintenance is still easy



1 | Maintained serviceability.

- Easy maintenance concept
- Access to hydraulic parts thanks to door opening mechanism

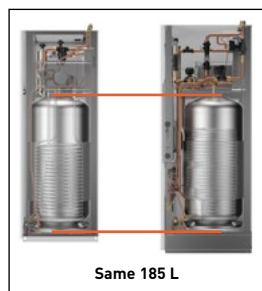

2 | Slimmer, yet same tank capacity.

- Piping layout at the top in order to maintain large 185 L tank capacity.

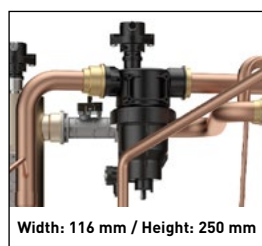

3 | Advanced magnetic water filter for less maintenance.

- Superior dust removal capacity of the water filter.
- Less frequent filter cleaning means more convenience.



4 | Robust body for top ventilation unit.

- Strengthening the body and top surface with a frame enables installation of a top ventilation unit. For safety, it's secured with bolts to prevent it falling.

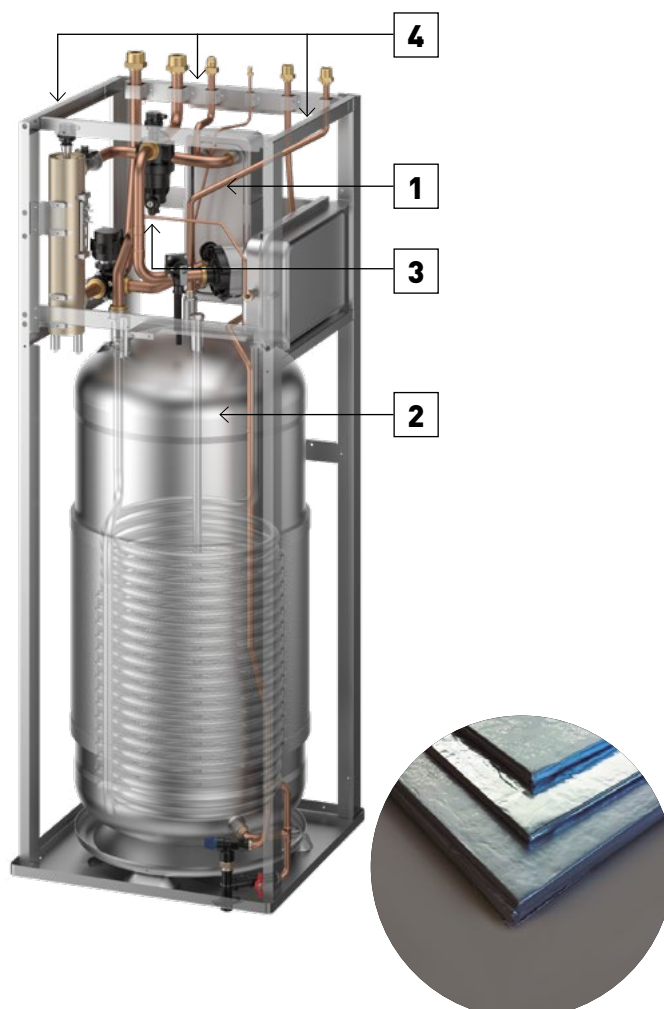

U-Vacua™ VIPs consist of a unique fiberglass core encased in a laminate film made up of several layers that include nylon, aluminium, and a protective layer. Interior pressure is reduced to a vacuum of 1-20 Pa, thereby minimising thermal conductivity.

Aquarea All in One with 2 zone control: The optimal solution for an installation with 2 heating zones.

- 2 heating circuits, with 2 different water temperatures
- 2 water pumps and 2 water filters
- Floor heating water control with mixing valve

Aquarea High Performance

For new installations and low consumption homes. Outstanding efficiency and energy savings with minimised CO₂ emissions and minimum space.



High Performance helps you to meet strict building requirements and reduce building costs

The heating and production of domestic hot water have a very important impact on the energy consumption of a house. Efficient Panasonic heat pumps can help to significantly reduce the energy consumption of the house.

Key points of the line-up

- Improved performance with COPs up to 5,33 for J Generation 3kW
- Reduced energy consumption through our circulating pump with energy efficiency class "A"
- Remote controller functions added: Auto mode, holiday mode, power consumption display

Panasonic has designed the Aquarea All in One, Bi-bloc and Mono-bloc heat pumps for homes which have high performance requirements. Whatever the weather, Aquarea can work even at -20 °C! The Aquarea is easy to install on new or existing installations, in all types of properties.

High Performance Heat Pumps are highly efficient (KIT-ADC03JE5 for example)

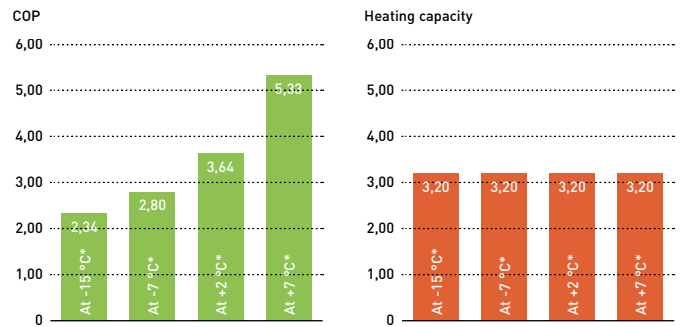

* Heating water at 35 °C.

Standard circulating pumps vs our circulating pump with energy efficiency class "A"

Comparison of energy consumption of circulation pumps. Circulating pump with energy efficiency class "A" with Dynamic flow control for 5 kW Mono-bloc.

* Based on German market: Assuming Standard pump may vary depending on consumption and energy cost.

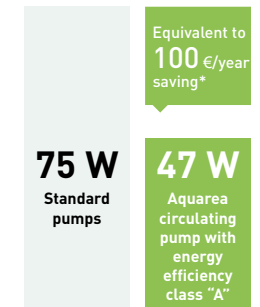

Panasonic created a night mode to reduce the noise when it's needed

Special attention has been given to noise levels.

- 1) Sound pressure measured at 1 m from the outdoor unit and at 1,5 m height.
- 2) At standard condition working at heating capacity at +7 °C (heating water at 35 °C) for two fans outdoor units. For one fan outdoor units, night mode reduction is 3 dB(A).

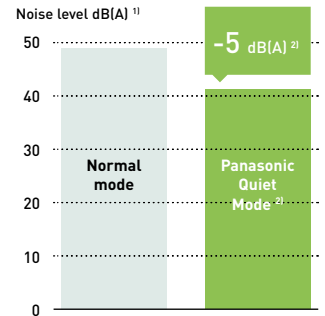

High Performance J Generation keeps 60 °C water outlet temperature even at very low temperatures

Aquarea High performance J Generation is able to keep 60 °C water outlet temperature in outdoor temperatures down to -10 °C, keeping high comfort in the room even at low temperatures. With other heat pumps, water temperature dramatically drops at low outdoor temperatures, making the heat pump to work out of the design conditions and creating discomfort inside the room.

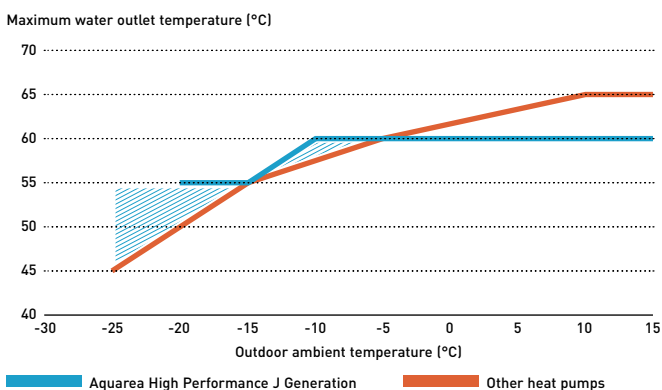

Aquarea T-CAP

For retrofit and new builds, Aquarea T-CAP is the ideal solution for those installations where the output capacity is demanding.

The entire Aquarea T-CAP line-up is excellent for replacing gas or oil boilers and for connecting to new underfloor heating, radiators or fan coil units. Aquarea T-CAP can maintain the heat pump output capacity until $-20\text{ }^{\circ}\text{C}$ ¹⁾ outdoor temperature without the help of an electrical booster heater, offering high heating capacity even at low ambient temperatures.

1) At $35\text{ }^{\circ}\text{C}$ flow temperature.



Aquarea T-CAP Mono-bloc J Generation R32

R32 Refrigerant: A 'small' change that changes everything.

With Mono-bloc, the refrigerant circuit is sealed inside the outdoor unit, so there is no need to worry about the amount of refrigerant per room.

65 °C¹⁾ water temperature possible.

By optimising the system and the refrigerant cycle, the unit can work under higher pressure and realise a water temperature of 65°C.

1) In case of ΔT setting with remote controller is 15 °C and outdoor ambient temperature is 5 to 20 °C, 65 °C hot water temperature is possible. Even with the T-CAP series, capacity will drop when water temperature reaches 65 °C.



How Aquarea T-CAP maintains performance even at -20 °C outdoors

A patent has been obtained for technology that can maintain heating capacity even in low outdoor temperatures through optimal control that comes from incorporating dual-piped heat exchanger into the refrigeration cycle.

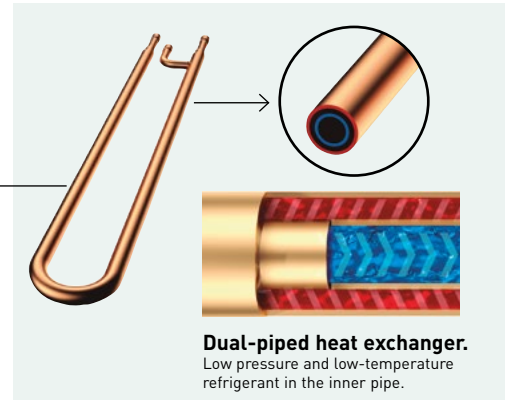

Higher efficiency compared to other heating systems

Panasonic heat pumps have a maximum COP of 5,08 at +7 °C which makes them much more efficient than others heating systems.

T-CAP is also able to provide extremely high efficiencies, whatever the outside or the water temperature.

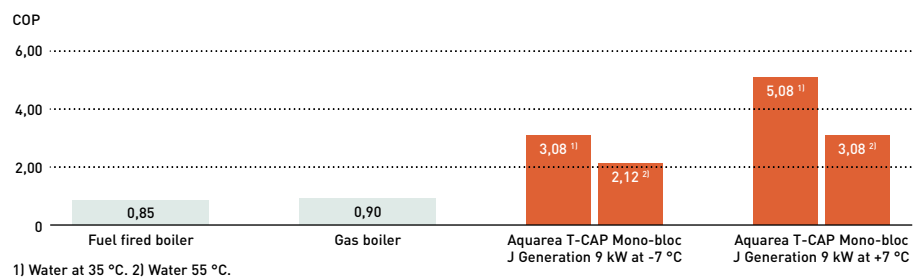

No need to oversize to reach required capacity at low temperatures

With Aquarea T-CAP technology, Panasonic heat pumps can work in outdoor temperatures as low as -20 °C and maintain capacity without back-up heating at -20 °C¹⁾. With other heat pumps, a larger capacity is required to achieve the same level of comfort at low temperatures.

1) 35 °C flow temperature.

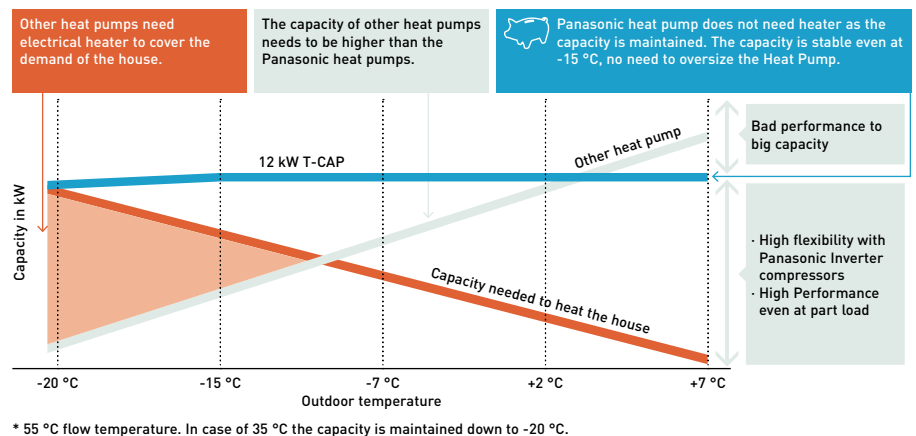

Aquarea Super Quiet T-CAP Bi-bloc

The special outdoor chassis notably reduces operation sound by up to 15 dB.^{1) 2)}

1) When comparing WH-UQ12HE8 at quiet mode level 3 operation with WH-UX12HE8 at full load operation. 2) Heating capacity may drop.

Aquarea HT

Aquarea HT can produce a flow temperature of 65 °C making it the ideal high efficiency replacement for oil/gas boilers connected to high temperature radiators.



Green energy source works with existing radiators

The Aquarea HT (9 kW and 12 kW) allows you to replace your traditional heating source (such as oil or gas) while keeping the existing old style radiators for minimum disruption to the home.

Yearly savings with Aquarea HT

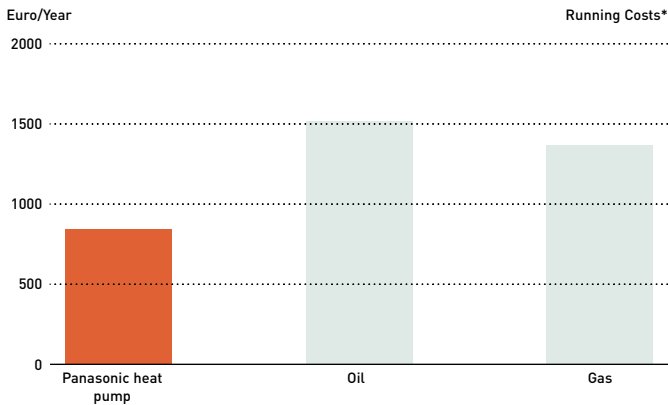

* For a 170 m² house and 40 W/m² energy losses in central Europe Conditions, outside minimum conditions -10 °C.

Aquarea HT: High savings and low CO₂

The benefit of replacing a traditional heating systems with Aquarea HT are clear: Reduced CO₂ emissions, future proofing running costs. Panasonic heat pumps are much more efficient than fossil fueled boilers and help you to reach your house energy targets.

Easy installation

Air source heat pumps are simple to install. They do not require a chimney, gas connection or oil / lpg tank. All that is required is a power supply connection.

Panasonic Aquarea HT is highly efficient even at low outdoor temperatures

Heating Capacity of a 9 kW HT (WH-SHF09F3E5).

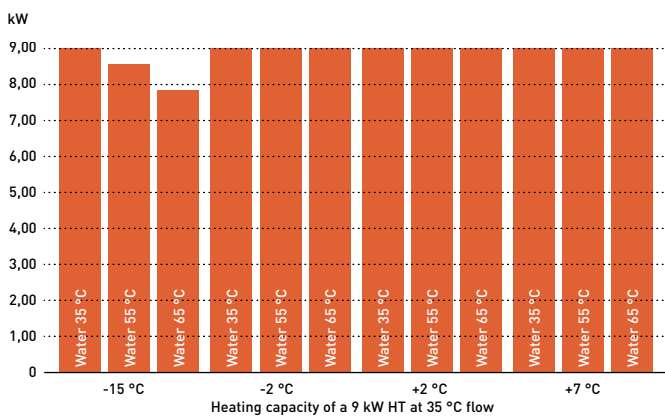

COP (Coefficient of Performance) of a 9 kW HT (WH-MHF09G3E5).

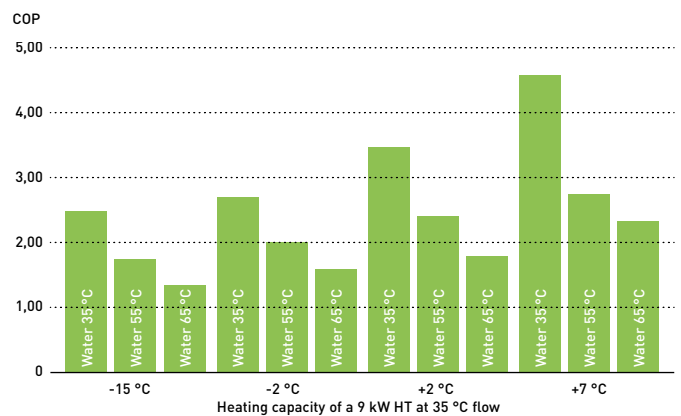

The Aquarea HT range is easy to install and is available with nominal heat outputs of 9 kW or 12 kW. These can be either single or three phase, in both Bi-bloc and Mono-bloc versions.



Aquarea commercial

Solutions for best savings. Efficient Panasonic heat pumps can help to significantly reduce the energy consumption of your business.

Restaurant with Aquarea.

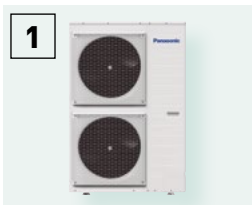
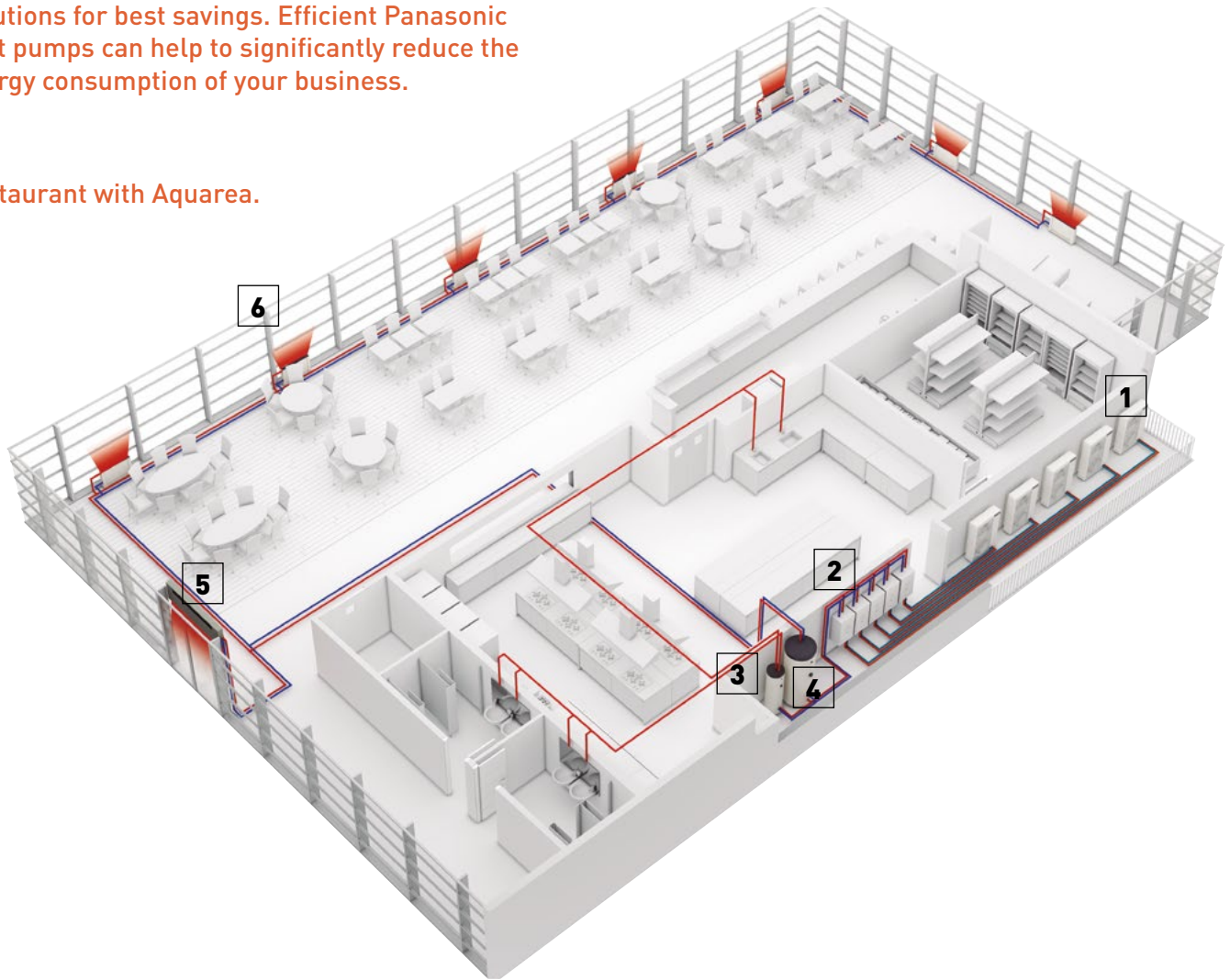

1
Aquarea T-CAP.
16 kW heat pumps on cascade mode. T-CAP line-up is an ideal replacement for old gas/oil boilers.



2
High efficiency Aquarea T-CAP hydromodule.
Indoor unit of Aquarea Bi-bloc systems. When a Mono-bloc system is used, the hydromodule is integrated in the outdoor unit.



3
Super high efficiency Tanks.
Combining Panasonic Aquarea with a high efficiency tank ensures the desired volume of hot water, at the correct temperature while reduced energy costs.

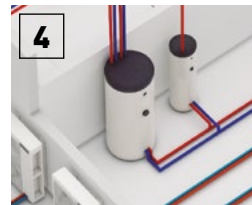

4
Buffer Tank.
Panasonic Aquarea can be combined with the hydraulic elements of the new or existing water system.



5
Air Curtain with water Coil.
Water coil air curtains can be used in the hydraulic system to have efficient performance of the water system.

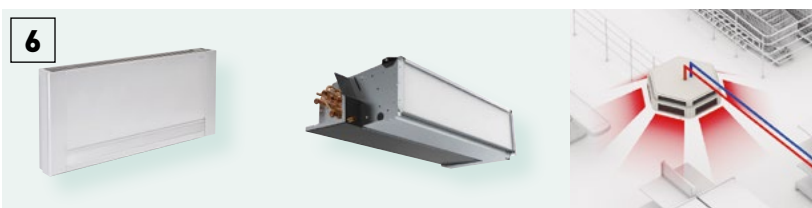

6
Fan coils for heating and cooling.
Aquarea Heat Pumps can be easily connected to the existing water system: 2 way and 4 way fan coils, floor heating, DHW tanks...

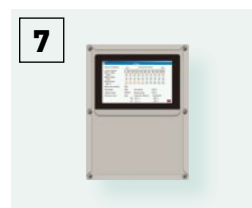

7
Cascade manager.
The cascade manager enables the control of up to 10 Aquarea Heat Pumps (balancing the working hours and making the operation more efficient) and up to 2 buffer tanks.

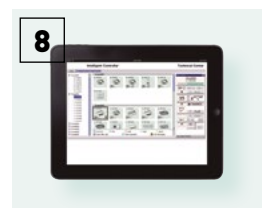

8
BMS integration.
The cascade system can be easily integrated in a Modbus project thanks to the cascade manager.



Panasonic Aquarea Heat Pumps offer space saving, energy-efficient heating and can be easily adapted for installation in flats, houses and commercial premises. Businesses producing heating, cooling and big quantities of hot water at 65 °C, such as restaurants or supermarkets, installing an Aquarea Heat Pump system can also use this wasted heat to improve energy efficiency further. Heat pump technology is scalable, meaning that it can be installed in buildings of varying sizes, offering both small and large-scale heating solutions. The technology is also environmentally friendly when compared to traditional

heating systems alternatives based on fossil fuel energy and in addition it is more energy efficient.

Key points:

- Efficient hot water production
- Fast return of investment
- Easy control
- Easy integration in the existing water system: fan coils, floor heating, domestic hot water tanks, etc
- Very good part load management
- High efficiency

Supermarket with Aquarea.

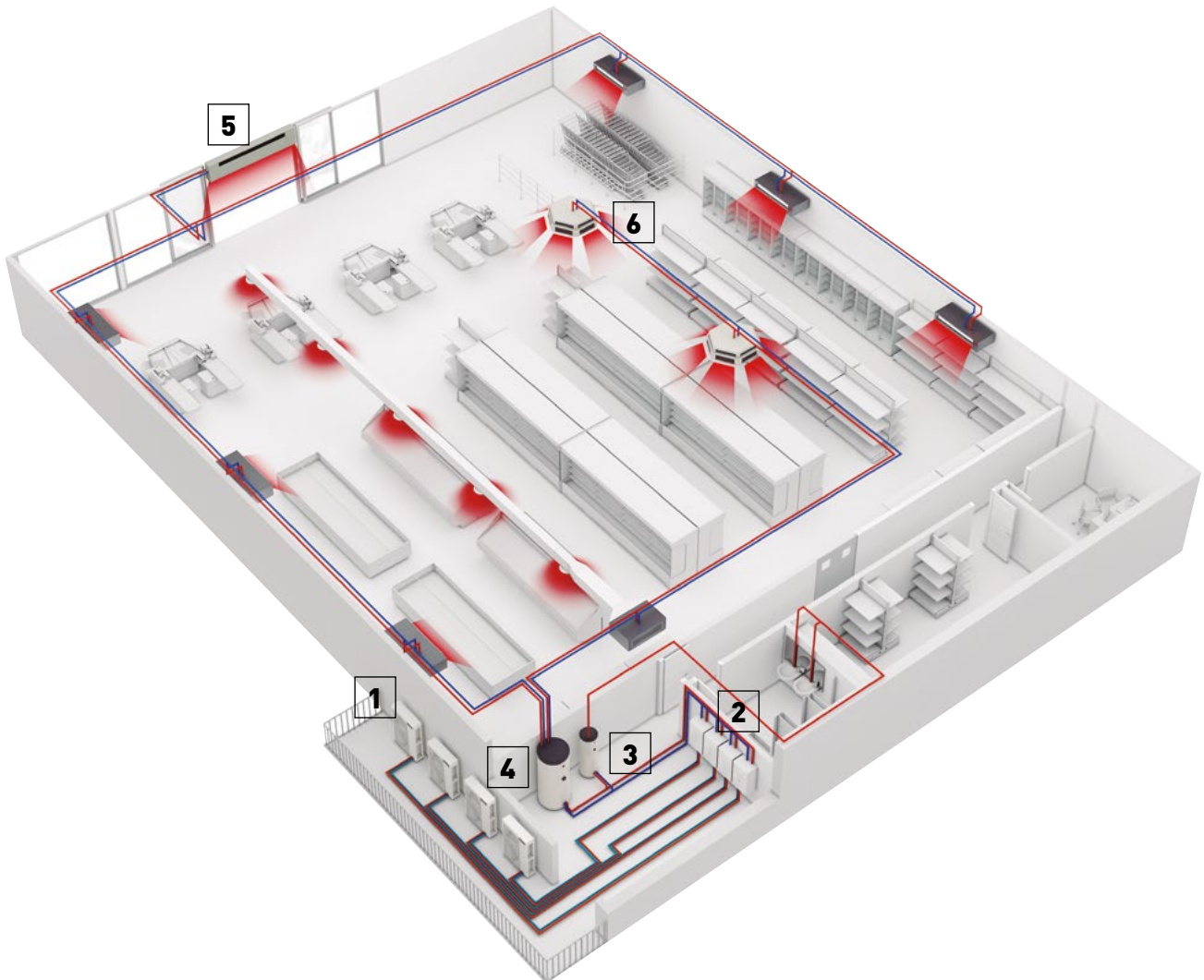

Burger & Lobster restaurant. Bath, UK.

Panasonic's air to water Aquarea system has been installed in the latest glamorous Burger & Lobster restaurant in Bath. The Octagon Chapel, a large listed building in the city centre, was converted to accommodate the restaurant, and Panasonic's Aquarea system provided an extensive, energy efficient and unobtrusive heating and cooling solution.



Carluccio's restaurant. UK.

One of UK's leading Italian restaurant, Carluccio's, wanted to install a system which would provide the desired volume of hot water, at the correct temperature while at the same time reduced energy costs. FWP installed a 12 kW Aquarea T-CAP mono bloc unit which would allow for the free air from the kitchen roof space to be transferred through condensing unit providing hot water at the optimum temperature.

Aquarea Smart Cloud for the users

The most advanced heating control for today and for the future. Aquarea can be connected to the Cloud with the accessory CZ-TAW1, enabling both user control and remote maintenance by service partners.

WATCH DEMO



* User interface image may change without notification.

Easy and powerful energy management

The Aquarea Smart Cloud is much more than a simple thermostat for switching a heating device ON or OFF. It is a powerful and intuitive service for remotely controlling the full range of heating and hot water functions, including monitoring energy consumption.

How does it work?

After connecting an Aquarea J or H generation to the cloud by wireless LAN or by wired LAN, the user accesses the Cloud portal to remotely operate all functions of his units. He can also permit service partners to access customised functions for remote maintenance and monitoring.

Requirements

1. Aquarea J or H Generation
2. In-house internet connection with router wireless LAN or wired LAN
3. Get a Panasonic ID in <https://aquarea-smart.panasonic.com/>

Functions:

- Visualization and Control
- Scheduling
- Energy Statistics
- Malfunction notification



More possibilities with IFTTT.

IF This Then That: IFTTT service enables user to automatically trigger actions for Aquarea system based on other apps, web services or devices.

Connect your Aquarea to your voice assistant, get an e-mail if your Aquarea gets an error or automatically turn on your Aquarea on Heat Mode when outdoor temperature drops below specified level.

Advantages

Energy savings, comfort and control from anywhere. Increased efficiency and resources management, operating costs savings and owner satisfaction. The Aquarea Smart Cloud services are focused on enabling full remote maintenance of the Aquarea system. This allows maintenance specialists to engage in predictive maintenance and system fine-tuning, as well as fixing malfunctions when they occur.

Aquarea compatibility	J and H Generation
Connection point	CN-CNT Aquarea port
Home router connection	Wireless or Wired LAN
Temperature sensor	Can use remote controller sensor
Tablet or PC browser compatibility*	Yes
Operation from remote — ON / OFF — Temperature setting Mode selection — DHW setting — Error codes — Scheduling	Yes
Heating areas	Up to 2 zones
Power consumption estimation — Operation log history	Yes — Yes

* Check browsers and version compatibility.

Get the most out of your Aquarea Heat Pump.

Aquarea+ offers end user useful information to operate a Panasonic Aquarea Heat Pump to provide heating, cooling and hot water in the most efficient and cost effective way.



AQUAREA+



Aquarea Service Cloud for installers or maintenance companies

WATCH DEMO



The Aquarea Service Cloud allows installers to take care of their customers' heating systems remotely. It saves time and money and shortens the response time, thus increasing the customers' satisfaction.



The real remote maintenance made simple

Advanced functions for remote maintenance with professional screens:

- Global view at a glance
- Error log history
- Full unit information
- Statistics always available
- Most settings available

Home page.

Status of connected users at a glance. 2 view options: map view or list view.

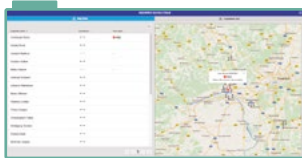

Status tab.

Current status of unit with a maximum 28 parameters.



Statistics tab.

Customisable statistics of a maximum of 71 parameters. Available anytime with the information of the last 7 days.

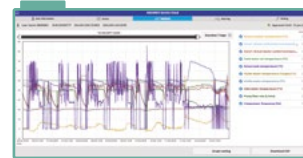

Settings tab.

Most of the user and installer settings can be done remotely.



Activation of the Aquarea Service Cloud

Requirements.

Hardware and connection	End user registration	Installer / maintenance registration
J or H Generation Aquarea connected to CZ-TAW1	Get Panasonic ID	Get Service ID
In-house internet connection with Wireless LAN or Wired LAN	Aquarea Smart Cloud	Aquarea Service Cloud

Connecting the unit to the Aquarea Service Cloud.

The process can be initiated by the end user or by the installer. The end user can select and change the installer's level of control anytime (4 levels).

Installer registration: <https://aquarea-service.panasonic.com/>

End user registration: <https://aquarea-smart.panasonic.com/>

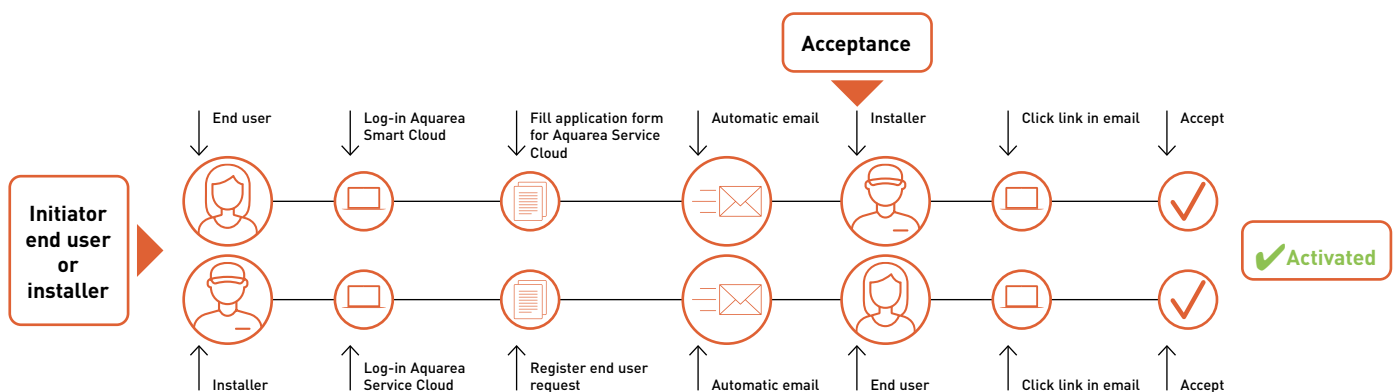

Control and connectivity

Home connectivity and Home Managements Systems integration is becoming more and more popular. These integrations helps to control all house devices from centralised platform and helps to optimise the operation and running costs. Panasonic interfaces are made to work with both KNX and Modbus, the most populars protocols. Also for non integrated control, Panasonic developed a simple connection to Wireless LAN, with this end user can control remotely its own heat pump from wherever.



Connectivity. Control by BMS

Great flexibility for integration into your KNX / Modbus projects allows fully bi-directional monitoring and control of all the functioning parameters.

Reference	 PAW-AW-KNX-1i / PAW-AW-KNX-H	Modbus® PAW-AW-MBS-1 / PAW-AW-MBS-H
Small dimensions	✓	✓
Quick installation and possibility of hidden installation	✓	✓
External power not required	✓	✓
Direct connection to the unit	✓	✓
Control and monitoring, from sensors or gateways, of the internal variables of the indoor unit and error codes and indication	✓ Fully interoperable	
Control and monitoring, from any BMS or PLC Modbus Master, of internal variables of the indoor unit and error codes and indication		✓ Fully interoperable
Aquarea unit can be controlled simultaneously by its remote controller and by KNX / Modbus Master devices	✓	✓

These interfaces allows full monitoring and control, bi-directional, of most of the functioning parameters of Aquarea control from KNX / Modbus installations.

Advanced controller for J and H Generation

Improved visibility and easy operation with large full dot LCD display and large touch panel!

Remote controller can be removed from indoor unit and installed in living room.

Key Points:

Full large dot LCD screen (3,5 inch): High resolution screen with backlight, easy set up, check conditions easily, flat, innovative design, temperature sensor included in controller.

Function for installer:

- Floor heating concrete dry mode: Allows for a slow increase in temperature of underfloor heating via software.
- Heating and Cooling Mode: Authorised PRO Partners can enable the cooling mode through a special operation via the remote controller on site
- Installer can select delta T. Water pump speed is selected automatically due to this setting

Function for End User:

- Auto Mode: Automatically changes from heating to cooling depending on outdoor temperature.
- Energy Consumption Display: Displays the heat pump's energy consumption, split by heating, cooling and domestic hot water, showing the total consumption figure.
- Holiday Mode: Enables the system to resume at the preset temperature after your holiday



PCB for additional functions

CZ-NS4P. Optional PCB for advanced functions.

The optional PCB CZ-NS4P enable advanced control functions for Aquarea Heat Pumps J and H Generation.

The optional PCB is connected to the main.

These functions are available through the connection of the optional PCB (CZ-NS4P) to the main PCB:

- Control of 2 zones with 2 mixing valves, 2 pumps and 2 room thermostats or sensors
- Control of swimming pool
- 0-10 V signal for heat pump demand control
- Buffer tank temperature sensor
- Solar thermal control
- External heating / cooling mode switch
- Stop compressor by external compressor switch
- Error output signal
- SG ready*

* Aquarea H and J Generation heat pumps in combination with the optional PCB CZ-NSP4 hold the SG Ready Label (Smart Grid Ready Label), given by Bundesverband Wärmepumpe (German Heat Pump Association). This Label shows the real capacity of Aquarea to be connected in an intelligent grid control.

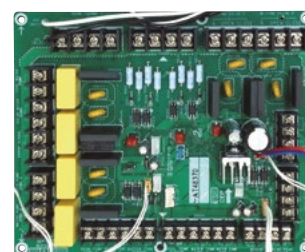

Cascade controller

PAW-A2W-CMH-1. Cascade manager.

- Cascade up to 10 heat pumps, getting up to 160 kW
- Manages the heat demand based on a PID logic, balancing working hours
- Can control 3 way valves for cooling (2 buffer tanks)
- Modbus IP for BMS communication
- High flexibility for external demand control, though an Analog Input 0-10 V or Modbus IP
- DHW control logic
- Large, easy-to- use touch screen display, with information about the heat pump
- All components in one case
- Compatible with Aquarea Heat Pumps, J or H Generation*

* Requires 1 PAW-AW-MBS-H per each Aquarea.



Model name	Interface
PAW-AW-KNX-H	KNX Interface for J and H Generation
PAW-AW-MBS-H	Modbus Interface for J and H Generation
PAW-AW-KNX-1i	KNX interface (not compatible with J and H Generation)
PAW-AW-MBS-1	Modbus interface (not compatible with J and H Generation)

Model name	Interface
PAW-A2W-CMH-1	Cascade controller
CZ-TAW1	Aquarea Smart Cloud, internet control through wireless or wired LAN for Aquarea J and H generation
CZ-NS4P	PCB for advanced functions in J and H Generation

How Panasonic contributes to Nearly Zero Energy Buildings (nZEB)

Our expertise gained over the years has helped to launch a range of products that contribute to a more carbon-free society.

Panasonic is committed to develop products with greater energy efficiency.

Highly efficient Panasonic solutions can help to significantly reduce the energy consumption of the house, at the same time a high level of comfort and good indoor air quality are kept.

- Aquarea High performance heat pump for heating, cooling and domestic hot water production
- Aquarea Smart Cloud, for energy monitoring
- Heat recovery ventilation system
- PV panels to produce renewable energy on-site



Aquarea Heat Pumps and the ventilation unit with heat recovery certified as Passive House Component

Aquarea High Performance All in One Compact and Bi-bloc J Generation heat pumps¹⁾ and the ventilation unit with heat recovery PAW-A2W-VENTA have been certified by the Passive House Institute (PHI) as Passive House Component. This certification ensures highly energy efficient components according to international criteria for respective thermal performance, comfort and indoor air quality.

1) 3, 5 and 7 kW models.

Certified models can be checked under the certification section of <https://database.passivehouse.com>.

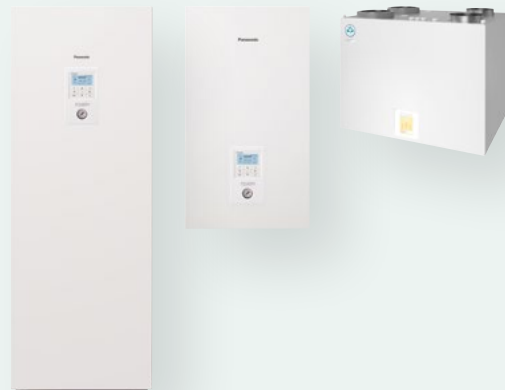
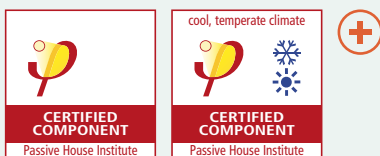

H3 Grande Passive House, Poland.

When looking for a energy-efficient heating solution, Polish construction company Procyon selected a 5 kW Panasonic Aquarea High Performance heat pump for its passive house project, H3 Grande. Procyon found this solution reduced annual heating expenses by almost half compared to an oil-based system, or by 10 % in comparison to natural gas.

H3 Grande is a 175 m² detached house certified by the Passive House Institute (PHI) in Darmstadt. It is designed to minimise energy losses while incorporating an attractive, yet simple aesthetic. The building's shape, interior design and pitched roof contribute to the energy balance of the house, while large south-facing windows and wall insulation provide passive thermal comfort by retaining heat. The building has very low heating demand of approximately 15 kW/m² and is designed to minimise energy.

Aquarea + PV panels

Aquarea Heat Pumps are designed with the future in mind. They can synchronise with PV panels with simple CZ-NS4P PCB. Thanks to this feature, demand of heating, cooling and domestic hot water production is adapted to the PV panel production.

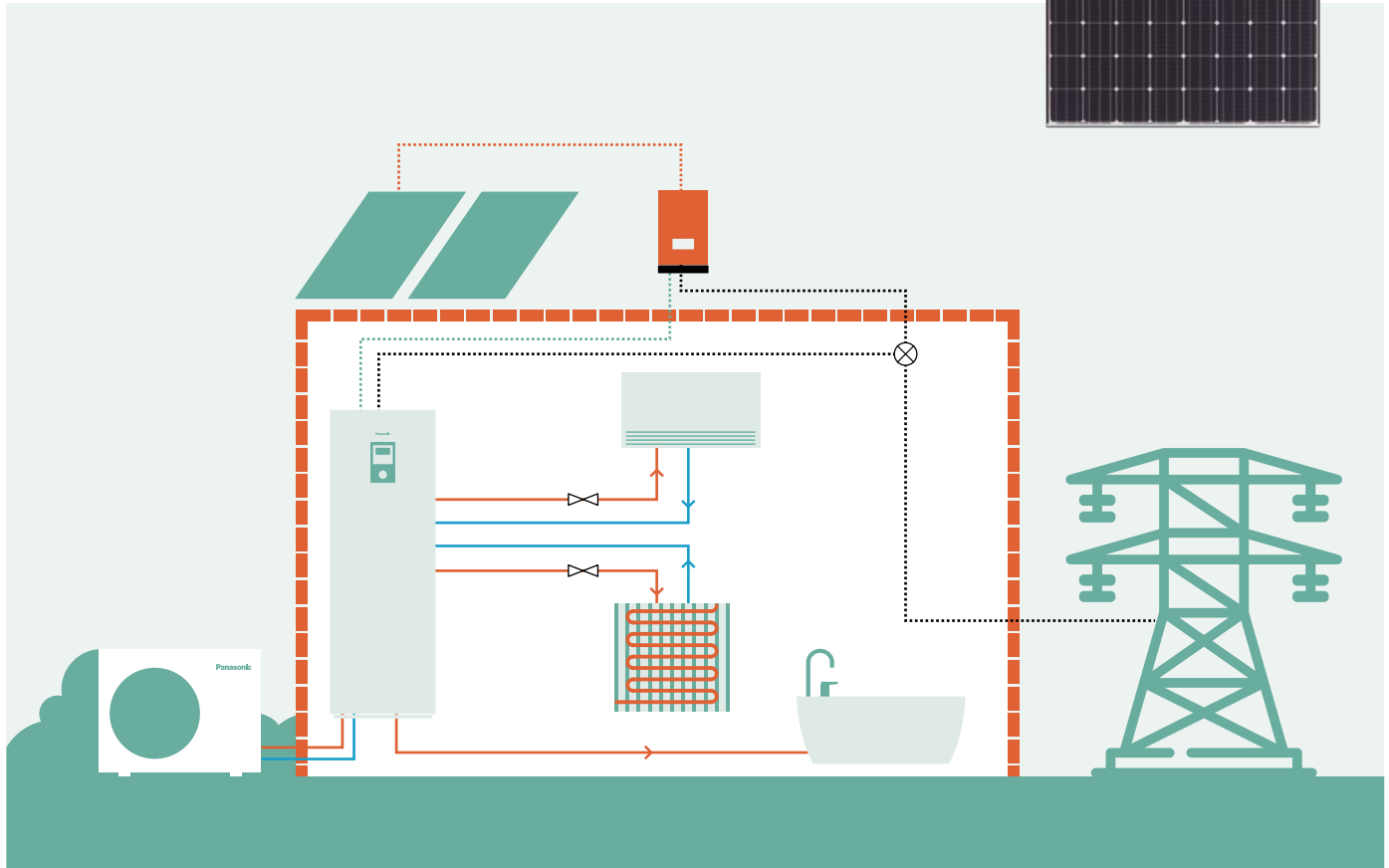

A part of converting Aquarea in Smart Grid ready, the additional PCB allows 0-10 V control, for and advanced energy management.



Turning a family home into an energy-neutral home with Panasonic air to water.

Sinne Technyk, installer, opts for Aquarea T-CAP heat pump combined with HIT KURO photovoltaic panels for a house in Oudemirdum in Friesland, the Netherlands. With this combination, the household enjoys energy-neutral and free heating, as well as domestic hot water, and benefit for a more comfortable indoor climate. The house had an annual gas consumption of 1800 to 2200 cubic meters per year. "The aim was to realize an energy-neutral home and reduce the usage of gas to zero," explains Leo van der Molen of Sinne Technyk. "That makes a heat pump an interesting option." With the comfort of the customers and neighbours in mind, a silent Aquarea T-CAP heat pump was chosen, powered by solar panels. A total of 24 Panasonic HIT KURO solar panels of 325 Wp each were installed. "The products of Panasonic are high end but offer a higher quality than other solutions. The price-quality ratio is, therefore, considerably better," says Van der Molen.

Panasonic PRO Club makes your life easier. All Aquarea Designer - online tool can be found there

Panasonic has an impressive range of support services for designers, specifiers, engineers and distributors working in air to water heat pump projects.



Energy Label

Fridges, dishwashers, washing machines, ovens – it all started with white goods in the 1990s. Today, other energy-consuming appliances also carry the European energy efficiency label, such as televisions and lighting. From 2013, the regulations applied to air conditioners and heat pumps but since September 2015, it has also been applicable to room heaters, water heaters and storage water heaters.

Minimum energy efficiency requirements are also specified for manufacturers of system and combi boilers, water heaters and DHW cylinders.

The purpose of Energy Labels are to assist consumers in their purchasing decisions, as well as ecodesign requirements on products which help reduce private energy demand and help to reduce global warming.

Panasonic helps you to calculate the system label.

From 26th September 2015, installers can be assured that all products manufactured after this date will be sold with the required energy efficiency labels which will aid installers with their paperwork. While it is the manufacturer's responsibility to issue their products with the required labels, the installers will need to calculate and issue an energy efficiency label for the entire heating system. Whether installing a new heating system or installing new boilers, controls or renewables into an existing system, it is, and will continue to be, the installer's responsibility to calculate and issue energy efficiency labels. Calculators which assist installers with this process are available on www.panasonicproclub.com.

Information on the energy efficiency label.

The rating system for heat pumps classifies them into seven efficiency categories. From 26th September 2019, the best energy efficiency category is A+++, least energy efficient is D. The energy efficiency label for system boilers shows its efficiency category on a scale from A+++ to D, and from A+ to F for hot water cylinders.

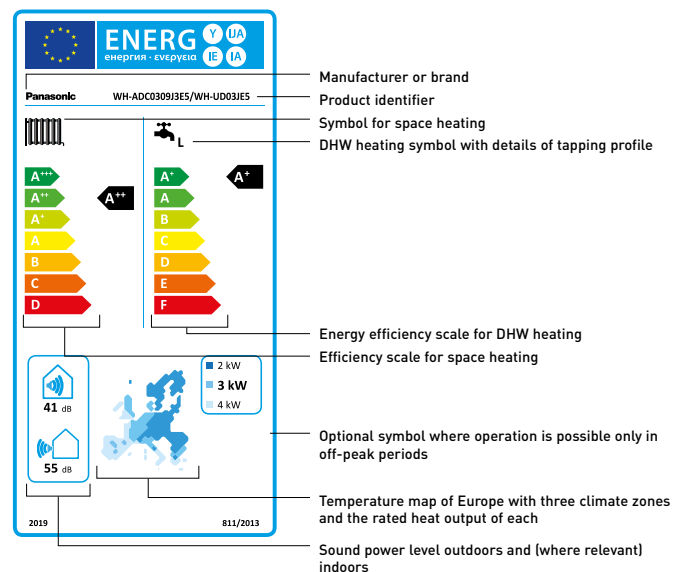



Aquarea Designer - online tool

With Panasonic's online tool, projects can be developed simply and easily. The newly developed tool is optimised to help HVAC professionals easily identify the most appropriate Aquarea air to water heat pump for a particular application.



Aquarea Designer

This program allows HVAC designers, installers and distributors to identify the correct heat pump for a particular application from Panasonic's Aquarea range, calculate the savings compared to other heat sources and very quickly calculate CO₂ emissions. Using Panasonic's Aquarea Designer, projects can be developed simply and easily, by either using the Quick Design or Expert Design options. Each allows the user to build up the project data in a simple step-by-step process and choose to output reports (project data input includes: either Quick or Large formats) as HTML files or as print-outs. To create these useful reports, project data is input, including:

- Heated area
- Heating requirement
- Heating flow and return temperatures
- Climate data (from a simple drop-down menu) including outdoor temperature
- Type of hot water tank, storage capacity and hot water target temperature



Aquarea Designer also means saving

Aquarea Designer will calculate the project's energy costs in terms of hot water, heating and pumping. It will show the equipment running times and calculate the COP (coefficient of performance). It then allows the designer to show clients a comparison with other equipment options such as heating by conventional gas-fired boilers, oil systems, wood, standard electric heating and electric night storage heaters. This compares running costs, initial investment costs and maintenance costs. The comparison can also be made for CO₂ emissions and savings.

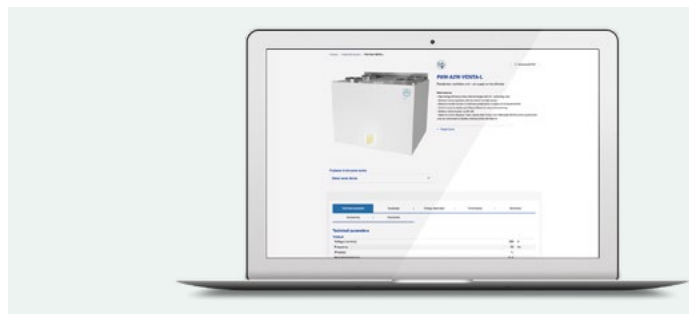

Residential ventilation selection tool.

The tool contains all the information the HVAC professionals need for their residential ventilation projects (specifications, technical manuals, etc.) as well as a calculator of the performance curves.

Heating demand calculator

This software can quickly and easily determine the heating requirements for the rooms in a project. The Heating demand calculator will help determine approximately how much power is needed to heat each room individually. The result in kilowatts will help you choose the space heater best suited to your needs.

CAD images and spec texts

In order to add value in the design of projects, Panasonic has a wide library of 2D CAD, BIM objects (Building Information Modeling) and Spec texts to be used in Revit.

All the support tools are available in Panasonic PRO Club (www.panasonicproclub.com).

Among many others, these are the main tools for the design of Aquarea projects.

Hydraulic scheme generator

This tool allows costumers to select the scheme between more than 110 different type according to their installation requirements in a simple way. It possible to download hydraulic and electric part in pdf and in cad file. Moreover it is available a list, one for each scheme type, with the Panasonic codes and third party codes that the costumers need to realize the installation in a proper way.

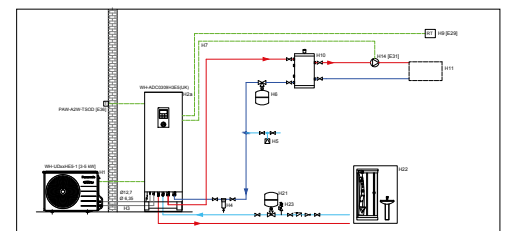

Panasonic helps you to calculate the system label www.panasonicproclub.com or connect simply with your smartphone to the PRO Club using this QR.

PRO Club  



Aquarea Heat Pump range

	3 kW	5 kW	7 kW
Aquarea EcoFleX	1 Phase		
P. 51			
Aquarea High Performance	All in One		
P. 52, 53, 54, 55	1 Phase 3 Phase		
	WH-ADC0309J3E5 WH-ADC0309J3E5B WH-ADC0309J3E5C WH-UD03JE5	WH-ADC0309J3E5 WH-ADC0309J3E5B WH-ADC0309J3E5C WH-UD05JE5	WH-ADC0309J3E5 WH-ADC0309J3E5B WH-ADC0309J3E5C WH-UD07JE5
P. 56, 57	Bi-bloc 1 Phase 3 Phase		
	WH-SDC0305J3E5 WH-UD03JE5	WH-SDC0305J3E5 WH-UD05JE5	WH-SDC0709J3E5 WH-UD07JE5
P. 58, 59	Mono-bloc 1 Phase		
		WH-MDC05J3E5	WH-MDC07J3E5
Aquarea T-CAP	All in One		
P. 60, 61, 62	1 Phase 3 Phase		
P. 63, 64	Bi-bloc 1 Phase 3 Phase		
P. 65	Mono-bloc 1 Phase 3 Phase		
Aquarea HT	Bi-bloc		
P. 66	1 Phase 3 Phase		
P. 67	Mono-bloc		
	1 Phase		



 Check all our certified heat pumps on: www.heatpumpkeymark.com

9 kW

12 kW

16 kW



8 kW
 WH-ADF0309J3E5CM
 S-71WF3E
 CU-2WZ71YBE5



WH-ADC0309J3E5
 WH-ADC0309J3E5B
 WH-ADC0309J3E5C
 WH-UD09JE5-1
 WH-ADC0916H9E8
 WH-UD09HE8



WH-ADC1216H6E5
 WH-ADC1216H6E5C
 WH-UD12HE5
 WH-ADC0916H9E8
 WH-UD12HE8



WH-ADC1216H6E5
 WH-ADC1216H6E5C
 WH-UD16HE5
 WH-ADC0916H9E8
 WH-UD16HE8



WH-SDC0709J3E5
 WH-UD09JE5-1
 WH-SDC09H3E8
 WH-UD09HE8



WH-SDC12H6E5
 WH-UD12HE5
 WH-SDC12H9E8
 WH-UD12HE8



WH-SDC16H6E5
 WH-UD16HE5
 WH-SDC16H9E8
 WH-UD16HE8



WH-MDC09J3E5



WH-MDC12H6E5



WH-MDC16H6E5



WH-ADC1216H6E5
 WH-ADC1216H6E5C
 WH-UX09HE5
 WH-ADC0916H9E8
 WH-UX09HE8
 WH-ADC0916H9E8
 WH-UQ09HE8



WH-ADC1216H6E5
 WH-ADC1216H6E5C
 WH-UX12HE5
 WH-ADC0916H9E8
 WH-UX12HE8
 WH-ADC0916H9E8
 WH-UQ12HE8



WH-ADC0916H9E8
 WH-UX16HE8
 WH-ADC0916H9E8
 WH-UQ16HE8



WH-SXC09H3E5
 WH-UX09HE5
 WH-SXC09H3E8
 WH-UX09HE8
 WH-SQC09H3E8
 WH-UQ09HE8



WH-SXC12H6E5
 WH-UX12HE5
 WH-SXC12H9E8
 WH-UX12HE8
 WH-SQC12H9E8
 WH-UQ12HE8



WH-SXC16H9E8
 WH-UX16HE8
 WH-SQC16H9E8
 WH-UQ16HE8



WH-MXC09J3E5
 WH-MXC09J3E8



WH-MXC12J6E5
 WH-MXC12J9E8



WH-MXC16J9E8



WH-SHF09F3E5
 WH-UH09FE5
 WH-SHF09F3E8
 WH-UH09FE8



WH-SHF12F6E5
 WH-UH12FE5
 WH-SHF12F9E8
 WH-UH12FE8

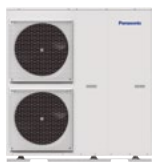

WH-MHF09G3E5



WH-MHF12G6E5

Aquarea, top-level efficiency across the board

Aquarea J Generation: much more than Aquarea in R32. Available in 3/5/7/9 kW All in One / Bi-bloc and 5/7/9/12/16 kW Mono-bloc.



1 Keeping Aquarea essence

- A+++ in heating mode at 35 °C (scale from A+++ to D)
- Optional Aquarea Smart and Service Cloud

2 Higher efficiency

- SCOP up to + 5 % vs H Generation
- DHW COP up to 3,30 (for 3 kW All in One and 5 kW models)

3 More flexibility in design

- 60 °C water temperature (up to 65 °C in T-CAP Mono-bloc)
- Piping length between indoor and outdoor units improved: 7/9 kW: 50/30 m (up to 40 m without minimum floor area*) - 3/5 kW: 25/20 m
- Chiller function: cooling down to 10 °C outdoor temperature

* With a 5 % decrease of the capacity.

4 Smart functions

- SG ready for heating, cooling and DHW modes
- Utility remote bivalent control: By dry contacts*
- Stop external device when defrost by Dry contact (for fan coil fan stop)*

* Can not be used at same time.

5 More comfort

- Better comfort in extreme low temperature: Heating curve can be set up down to -20 °C
- Efficient or comfort mode for DHW: Part load for better efficiency or full load to reduce the heat up time
- DHW two sensor position selectable for All in One: Efficient position (best DHW COP) or bigger volume of hot water

Other improvements: More silent outdoor units / Magnet filter for water cycle.

Aquarea H Generation.

The beauty of comfort. The H Generation is available from 3 to 16 kW. The small capacities are specially designed for low energy homes and achieve an impressive COP of 5 (on the 3 kW).

Better efficiency and value A++ / A+++.

- A++ for medium temperature applications (radiators. ErP 55 °C in the scale from A+++ to D)
- A+++ for low temperature applications (floor heating. ErP 35 °C in the scale from A+++ to D)

Aquarea, a generation of energy efficient heating and hot water.

Thanks to the system's high degree of technology and advanced control, it is able to maintain a high output capacity and efficiency even at -7 °C and -15 °C. The Aquarea's software can be set for the requirements of low consumption homes in order to maximise energy efficiency. Whatever the weather, Aquarea can work even at -28 °C (for T-CAP All in One and Bi-bloc) lower limit. The compact design of the outdoor unit makes installation very easy.



NEW Aquarea EcoFlex. Single phase. Heating and Cooling · R32

Energy efficiency: Heat recovery function, to re-use wasted heat of outdoor unit for DHW production.

Flexibility: Small foot print outdoor unit, tank unit with a standard size of appliances.

Comfort: Non-stop heating operation / nanoe™ X technology to improve protection 24/7 (nanoe X Generator Mark 2).

Connectivity: Wi-Fi adapters included for instant connectivity via Aquarea Smart Cloud or Panasonic Comfort Cloud App.

WH-ADF0309J3E5CM

Air to water	Heating capacity / COP [A +7 °C, W 35 °C]	kW / COP	8,00/4,21	
	Heating capacity / COP [A +7 °C, W 55 °C]	kW / COP	8,00/2,81	
	Heating capacity / COP [A +2 °C, W 35 °C]	kW / COP	6,70/3,25	
	Heating capacity / COP [A +2 °C, W 55 °C]	kW / COP	6,00/2,08	
	Heating capacity / COP [A -7 °C, W 35 °C]	kW / COP	5,60/2,84	
	Heating capacity / COP [A -7 °C, W 55 °C]	kW / COP	5,30/1,91	
	Cooling capacity / EER [A 35 °C, W 7 °C]	kW / EER	—	
	Cooling capacity / EER [A 35 °C, W 18 °C]	kW / EER	—	
	Heating average climate (W 35 °C / W 55 °C)	Seasonal energy efficiency	SCOP (η _s %)	4,00/3,20(157/125)
		Energy class ¹⁾	A+++ to D	A++/A++
	Heating warm climate (W 35 °C / W 55 °C)	Seasonal energy efficiency	SCOP (η _s %)	5,69/3,69(224/145)
		Energy class ¹⁾	A+++ to D	A+++/A+++
	Heating cold climate (W 35 °C / W 55 °C)	Seasonal energy efficiency	SCOP (η _s %)	3,61/2,80(141/109)
		Energy class ¹⁾	A+++ to D	A+/A+
	Sound pressure	Heat / Cool	dB(A)	28/—
	Dimension / Net weight	HxWxD	mm / kg	1880x598x600/108
	Capacity of integrated electric heater		kW	3,00
	Water volume		L	185
	Maximum DHW temperature		°C	65
	Heating water flow [ΔT=5 K, 35 °C]		L/min	22,90
Tapping profile according EN16147			L	
DHW tank ERP efficiency average / warm / cold ²⁾		A+ to F	A/A+/A	
DHW tank ERP average climate η / COPdhw		η _{wh} % / COPdhw	104/2,60	
DHW tank ERP warm climate η / COPdhw		η _{wh} % / COPdhw	134/3,35	
DHW tank ERP cold climate η / COPdhw		η _{wh} % / COPdhw	92/2,30	
Heat recovery capacity (DHW 55 °C)		kW	7,10+9,00	
Heat recovery input power (DHW 55 °C)		kW	3,15	
Heat recovery COP (DHW 55 °C)			5,11	
Water outlet		°C	20 - 55	

S-71WF3E

Air to air	Cooling capacity	Nominal	kW	7,10
	EER ³⁾	Nominal	W/W	3,40
	SEER ⁴⁾			5,60 A+
	Pdesign (cooling)			7,10
	Heating capacity	Nominal	kW	7,10
	COP ³⁾	Nominal	W/W	3,90
	SCOP ⁴⁾			3,90 A
	Pdesign at -10 °C		kW	4,80
	External static pressure ⁵⁾		Pa	30(10 - 150)
	Air flow		m ³ /min	22,7
	Sound pressure ⁶⁾	Cool / Heat (Hi)	dB(A)	34/34
	Sound power ⁷⁾	Cool / Heat (Hi)	dB(A)	57/57
	Dimension / Net weight	HxWxD	mm / kg	250x1000x730/30
	nanoe X Generator			Mark2

CU-2WZ71YBE5

Outdoor unit	Sound pressure	Cool / Heat (air to air)	dB(A)	49/49
	Sound power ⁷⁾	Cool / Heat (air to air)	dB(A)	68/67
	Sound pressure	Heat (air to water)	dB(A)	51
	Sound power ⁸⁾	Heat (air to water)	dB(A)	61
	Dimension / Net weight	HxWxD	mm / kg	999x940x340/82
	Refrigerant (R32) / CO ₂ Eq.		kg / T	2,40/1,62
	Piping diameter	Liquid / Gas	Inch (mm)	1/4(6,35)/1/2(12,70)
	Pipe length range / Elevation difference (in / out)		m / m	35/30
	Pipe length for additional gas / Additional gas amount		m / g/m	30/20
	Operating range - outdoor ambient	Heat (air to air)	°C	-15 ~ +24
Cool (air to air)		°C	-10 ~ +46	
Heat (air to water)		°C	-15 ~ +35	
Heat recovery (floor / DHW)		°C	+10 ~ +35 / +10 ~ +46	

1) Scale from A+++ to D. 2) Scale from A+ to F. 3) EER and COP calculation is based in accordance to EN14511. 4) SEER and SCOP is calculated based on values of EU/626/2011. 5) Medium external static pressure setting from factory. 6) The sound pressure of the units shows the value measured of the position 1,5 m below the unit. The sound pressure is measured in accordance with Eurovent 6/C/006-97 specification. 7) Sound power is measured in accordance with EN14511 and EN12102-1:2017 at +7 °C. 8) Sound power in accordance to 811/2013, 813/2013 and EN12102-1:2017 at +7 °C.



INTERNET CONTROL: Included Wi-Fi adapter.



GOOD DESIGN AWARD 2017

011-1W0515

A++
ErP 55 °C
Scale from A+++ to D

A+++
ErP 35 °C
Scale from A+++ to D

A+
DHW
Scale from A+ to F

Aquarea High Performance All in One H Generation Single phase / Three phase. Heating and Cooling · R410A

Energy efficiency: A+++ in heating at 35 °C and A+ in DHW / "A" water pump with variable speed / Stainless steel DHW tank with U-Vacua™ insulation panel / Built-in flow meter.

Flexibility: Optional magnet for the water filter.

Comfort: Operating range down to -20 °C.

Control: Additional functions with optional PCB (2 zone control, bivalent control, Smart Grid contact and more).

Connectivity: Optional Aquarea Smart and Service Cloud and integration into BMS projects.

Kit	Single phase (Power to indoor)			Three phase (Power to indoor)		
		KIT-ADC12HE5	KIT-ADC16HE5	KIT-ADC09HE8	KIT-ADC12HE8	KIT-ADC16HE8
Heating capacity / COP (A +7 °C, W 35 °C)	kW / COP	12,00/4,74	16,00/4,28	9,00/4,84	12,00/4,74	16,00/4,28
Heating capacity / COP (A +7 °C, W 55 °C)	kW / COP	12,00/2,93	14,50/2,72	9,00/2,94	12,00/2,93	14,50/2,72
Heating capacity / COP (A +2 °C, W 35 °C)	kW / COP	11,40/3,44	13,00/3,28	9,00/3,59	11,40/3,44	13,00/3,28
Heating capacity / COP (A +2 °C, W 55 °C)	kW / COP	9,10/2,23	9,80/2,21	8,80/2,23	9,10/2,23	9,80/2,21
Heating capacity / COP (A -7 °C, W 35 °C)	kW / COP	10,00/2,73	11,40/2,57	9,00/2,85	10,00/2,73	11,40/2,57
Heating capacity / COP (A -7 °C, W 55 °C)	kW / COP	8,20/1,95	9,00/1,85	7,90/2,05	8,20/1,95	9,00/1,85
Cooling capacity / EER (A 35 °C, W 7 °C)	kW / EER	10,00/2,81	12,20/2,56	7,00/3,17	10,00/2,85	12,20/2,56
Cooling capacity / EER (A 35 °C, W 18 °C)	kW / EER	10,00/4,17	12,20/4,12	7,00/4,67	10,00/4,26	12,20/4,12
Heating average climate (W 35 °C / W 55 °C)	Seasonal energy efficiency	ηs %	190/134	190/130	190/133	190/134
	SCOP		4,82/3,42	4,82/3,33	4,81/3,41	4,82/3,42
Heating warm climate (W 35 °C / W 55 °C)	Seasonal energy efficiency	ηs %	245/159	245/169	245/159	245/159
	SCOP		6,21/4,05	6,21/4,30	6,21/4,05	6,21/4,05
Heating cold climate (W 35 °C / W 55 °C)	Seasonal energy efficiency	ηs %	168/121	168/121	168/121	168/121
	SCOP		4,29/3,10	4,28/3,10	4,28/3,10	4,29/3,10
Energy class ¹⁾		A+++ to D	A+++ / A++	A+++ / A++	A+++ / A++	A+++ / A++
Energy class ¹⁾		A+++ to D	A+++ / A+++	A+++ / A+++	A+++ / A+++	A+++ / A+++
Energy class ¹⁾		A+++ to D	A++ / A+	A++ / A+	A++ / A+	A++ / A+
Indoor unit		WH-ADC1216HE5	WH-ADC1216HE5	WH-ADC0916HE8	WH-ADC0916HE8	WH-ADC0916HE8
Sound pressure	Heat / Cool	dB(A)	33/33	33/33	33/33	33/33
Dimension	HxWxD	mm	1800x598x717	1800x598x717	1800x598x717	1800x598x717
Net weight		kg	124	124	126	126
Water pipe connector		Inch	R 1½	R 1½	R 1½	R 1½
A class pump	Number of speeds	Variable Speed	Variable Speed	Variable Speed	Variable Speed	Variable Speed
	Input power (Min/Max)	W	36/152	36/152	36/152	36/152
Heating water flow (ΔT=5 K, 35 °C)		L/min	34,4	45,9	25,8	34,4
Capacity of integrated electric heater		kW	6,00	6,00	9,00	9,00
Recommended fuse		A	30/30	30/30	16/16	16/16
Recommended cable size, supply 1 / 2		mm ²	3x4,0/3x4,0	3x4,0/3x4,0	5x1,5/5x1,5	5x1,5/5x1,5
Water volume		L	185	185	185	185
Maximum DHW temperature		°C	65	65	65	65
Material inside tank			Stainless steel	Stainless steel	Stainless steel	Stainless steel
Tapping profile according EN16147			L	L	L	L
DHW tank ERP efficiency average / warm / cold ²⁾		A+ to F	A/A/A	A/A/B	A/A/A	A/A/B
DHW tank ERP average climate η / COPdHW		ηwh % / COPdHW	95/2,37	91/2,28	95/2,37	91/2,27
DHW tank ERP warm climate η / COPdHW		ηwh % / COPdHW	110/2,75	107/2,67	110/2,75	107/2,67
DHW tank ERP cold climate η / COPdHW		ηwh % / COPdHW	75/1,87	72/1,80	75/1,87	72/1,80
Outdoor unit		WH-UD12HE5	WH-UD16HE5	WH-UD09HE8	WH-UD12HE8	WH-UD16HE8
Sound power ³⁾	Heat	dB(A)	65	65	65	65
Dimension / Net weight	HxWxD	mm / kg	1340x900x320/101	1340x900x320/101	1340x900x320/107	1340x900x320/107
Refrigerant (R410A) / CO ₂ Eq.		kg / T	2,55/5,324	2,55/5,324	2,55/5,324	2,55/5,324
Piping diameter	Liquid / Gas	Inch (mm)	3/8(9,52)/5/8(15,88)	3/8(9,52)/5/8(15,88)	3/8(9,52)/5/8(15,88)	3/8(9,52)/5/8(15,88)
Pipe length range / Elevation difference (in / out)		m / m	3-50/30	3-50/30	3-30/20	3-30/20
Pipe length for additional gas / Additional gas amount		m / g/m	10/50	10/50	10/50	10/50
Operating range - outdoor ambient	Heat	°C	-20 ~ +35	-20 ~ +35	-20 ~ +35	-20 ~ +35
	Cool	°C	+16 ~ +43	+16 ~ +43	+16 ~ +43	+16 ~ +43
Water outlet	Heat / Cool	°C	20-55/5-20	20-55/5-20	20-55/5-20	20-55/5-20

1) Scale from A+++ to D. 2) Scale from A+ to F. 3) Sound power in accordance to 811/2013, 813/2013 and EN12102-1:2017 at +7 °C. * EER and COP calculation is based in accordance to EN14511. ** This product is designed to comply with the European Water Quality Directive 98/83/EC amended by 2015/1787/EU. The lifespan of the product is not guaranteed in the case of the use of groundwater, such as spring water or well water, the use of tap water when salt or other impurities are contained, nor in areas of acidic water quality. Maintenance and warranty costs related to these cases are the customer's responsibility.

Accessories	
PAW-ADC-PREKIT-1	Piping pre installation kit for J Generation
CZ-TAW1	Aquarea Smart Cloud for remote control and maintenance through wireless or wired LAN
CZ-TAW1-CBL	10 m extension cable for CZ-TAW1

Accessories	
CZ-NS4P	Additional functions PCB
PAW-A2W-RTWIRED	Room thermostat
PAW-A2W-RTWIRELESS	Wireless LCD room thermostat

INTERNET CONTROL: Optional. GOOD DESIGN AWARD 2017: Indoor units All in One and Bi-bloc J and H Generation awarded with the prestigious Good Design Award 2017.



**GOOD DESIGN
AWARD 2017**

011-1W0207
011-1W0208
011-1W0209



3, 5 and 7 kW
models.



Aquarea High Performance All in One Compact J Generation Single phase. Heating and Cooling - R32

Energy efficiency: COP up to 5,33 / A+++ in heating at 35 °C and A+ in DHW / "A" water pump with variable speed / Stainless steel DHW tank with U-Vacua™ insulation panel / Built-in flow meter.

Flexibility: 598 x 600 footprint / Long piping lengths / Built-in magnetic water filter.

Comfort: Heating curve down to -20 °C / 60 °C water outlet temperature.

Control: Additional functions with optional PCB (2 zone control, bivalent control, Smart Grid contact and more).

Connectivity: Optional Aquarea Smart and Service Cloud and integration into BMS projects.

				Single phase (Power to indoor)			
Kit			KIT-ADC03JE5C	KIT-ADC05JE5C	KIT-ADC07JE5C	KIT-ADC09JE5C-1	
Heating capacity / COP (A +7 °C, W 35 °C)	kW / COP		3,20/5,33	5,00/5,00	7,00/4,76	9,00/4,48	
Heating capacity / COP (A +7 °C, W 55 °C)	kW / COP		3,20/2,81	5,00/2,72	7,00/2,82	8,95/2,78	
Heating capacity / COP (A +2 °C, W 35 °C)	kW / COP		3,20/3,64	4,20/3,18	6,85/3,41	7,00/3,40	
Heating capacity / COP (A +2 °C, W 55 °C)	kW / COP		3,20/2,19	4,10/1,99	6,20/2,21	6,30/2,16	
Heating capacity / COP (A -7 °C, W 35 °C)	kW / COP		3,30/2,80	4,20/2,59	5,60/2,87	6,12/2,78	
Heating capacity / COP (A -7 °C, W 55 °C)	kW / COP		3,20/1,79	3,55/1,71	5,25/1,94	5,90/1,93	
Cooling capacity / EER (A 35 °C, W 7 °C)	kW / EER		3,20/3,52	4,50/3,00	6,70/3,03	8,20/2,72	
Cooling capacity / EER (A 35 °C, W 18 °C)	kW / EER		3,20/4,71	4,80/4,29	6,70/4,72	9,00/4,18	
Heating average climate (W 35 °C / W 55 °C)	Seasonal energy efficiency	ηs %	200/136	200/136	193/130	193/130	
		SCOP	5,07/3,47	5,07/3,47	4,90/3,32	4,90/3,32	
Heating warm climate (W 35 °C / W 55 °C)	Seasonal energy efficiency	ηs %	245/165	245/165	227/160	227/160	
		SCOP	6,20/4,20	6,20/4,20	5,75/4,07	5,75/4,07	
Heating cold climate (W 35 °C / W 55 °C)	Seasonal energy efficiency	ηs %	157/110	157/110	164/116	164/116	
		SCOP	4,00/2,83	4,00/2,83	4,18/2,98	4,18/2,98	
	Energy class ¹⁾	A+++ to D	A+++ / A++	A+++ / A++	A+++ / A++	A+++ / A++	
Indoor unit			WH-ADC0309J3E5C	WH-ADC0309J3E5C	WH-ADC0309J3E5C	WH-ADC0309J3E5C	
Sound pressure	Heat / Cool	dB(A)	28/28	28/28	28/28	28/28	
Dimension	H x W x D	mm	1640 x 598 x 600	1640 x 598 x 600	1640 x 598 x 600	1640 x 598 x 600	
Net weight		kg	101	101	101	101	
Water pipe connector		Inch	R 1½	R 1½	R 1½	R 1½	
A class pump	Number of speeds		Variable Speed	Variable Speed	Variable Speed	Variable Speed	
	Input power (Min/Max)	W	30/120	30/120	30/120	30/120	
Heating water flow (ΔT=5 K, 35 °C)		L/min	9,20	14,30	20,10	25,80	
Capacity of integrated electric heater		kW	3,00	3,00	3,00	3,00	
Recommended fuse		A	16/16	16/16	25/16	25/16	
Recommended cable size, supply 1 / 2		mm²	3 x 1,5 / 3 x 1,5	3 x 1,5 / 3 x 1,5	3 x 2,5 / 3 x 1,5	3 x 2,5 / 3 x 1,5	
Water volume		L	185	185	185	185	
Maximum DHW temperature		°C	65	65	65	65	
Material inside tank			Stainless steel	Stainless steel	Stainless steel	Stainless steel	
Tapping profile according EN16147			L	L	L	L	
DHW tank ERP efficiency average / warm / cold ²⁾		A+ to F	A+ / A+ / A	A+ / A+ / A	A+ / A+ / A	A+ / A+ / A	
DHW tank ERP average climate η / COPdHW		ηwh % / COPdHW	128/3,20	128/3,20	116/2,90	116/2,90	
DHW tank ERP warm climate η / COPdHW		ηwh % / COPdHW	154/3,86	154/3,86	134/3,35	134/3,35	
DHW tank ERP cold climate η / COPdHW		ηwh % / COPdHW	99/2,48	99/2,48	98/2,45	98/2,45	
Outdoor unit			WH-UD03JE5	WH-UD05JE5	WH-UD07JE5	WH-UD09JE5-1	
Sound power ³⁾	Heat	dB(A)	55	55	59	59	
Dimension / Net weight	H x W x D	mm / kg	622 x 824 x 298 / 37	622 x 824 x 298 / 37	795 x 875 x 320 / 61	795 x 875 x 320 / 61	
Refrigerant (R32) / CO ₂ Eq.		kg / T	0,9/0,608	0,9/0,608	1,27/0,857	1,27/0,857	
Piping diameter	Liquid / Gas	Inch (mm)	1/4 (6,35) / 1/2 (12,70)	1/4 (6,35) / 1/2 (12,70)	1/4 (6,35) / 5/8 (15,88)	1/4 (6,35) / 5/8 (15,88)	
Pipe length range / Elevation difference (in / out)		m / m	3 ~ 25 / 20	3 ~ 25 / 20	3 ~ 50 / 30	3 ~ 50 / 30	
Pipe length for additional gas / Additional gas amount		m / g/m	10 / 20	10 / 20	10 / 25	10 / 25	
Operating range - outdoor ambient	Heat	°C	-20 ~ +35	-20 ~ +35	-20 ~ +35	-20 ~ +35	
	Cool	°C	+10 ~ +43	+10 ~ +43	+10 ~ +43	+10 ~ +43	
Water outlet	Heat / Cool	°C	20 ~ 60 / 5 ~ 20	20 ~ 60 / 5 ~ 20	20 ~ 60 / 5 ~ 20	20 ~ 60 / 5 ~ 20	

1) Scale from A+++ to D. 2) Scale from A+ to F. 3) Sound power in accordance to 811/2013, 813/2013 and EN12102-1:2017 at +7 °C. * EER and COP calculation is based in accordance to EN14511. ** This product is designed to comply with the European Water Quality Directive 98/83/EC amended by 2015/1787/EU. The lifespan of the product is not guaranteed in the case of the use of groundwater, such as spring water or well water, the use of tap water when salt or other impurities are contained, nor in areas of acidic water quality. Maintenance and warranty costs related to these cases are the customer's responsibility.

Accessories	
CZ-TAW1	Aquarea Smart Cloud for remote control and maintenance through wireless or wired LAN
CZ-TAW1-CBL	10 m extension cable for CZ-TAW1

Accessories	
CZ-NS4P	Additional functions PCB
PAW-A2W-RTWIRED	Room thermostat
PAW-A2W-RTWIRELESS	Wireless LCD room thermostat



INTERNET CONTROL: Optional. GOOD DESIGN AWARD 2017: Indoor units All in One and Bi-bloc J and H Generation awarded with the prestigious Good Design Award 2017.

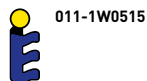

Aquarea High Performance All in One Compact H Generation Single phase. Heating and Cooling - R410A

Energy efficiency: A+++ in heating at 35 °C and A in DHW / "A" water pump with variable speed / Stainless steel DHW tank with U-Vacua™ insulation panel / Built-in flow meter.

Flexibility: 598 x 600 footprint / Built-in magnetic water filter.

Comfort: Operating range down to -20 °C.

Control: Additional functions with optional PCB (2 zone control, bivalent control, Smart Grid contact and more).

Connectivity: Optional Aquarea Smart and Service Cloud and integration into BMS projects.

Single phase (Power to indoor)

Kit			KIT-ADC12HE5C	KIT-ADC16HE5C
Heating capacity / COP (A +7 °C, W 35 °C)		kW / COP	12,00/4,74	16,00/4,28
Heating capacity / COP (A +7 °C, W 55 °C)		kW / COP	-/-	-/-
Heating capacity / COP (A +2 °C, W 35 °C)		kW / COP	11,40/3,44	13,00/3,28
Heating capacity / COP (A +2 °C, W 55 °C)		kW / COP	-/-	-/-
Heating capacity / COP (A -7 °C, W 35 °C)		kW / COP	-/-	-/-
Heating capacity / COP (A -7 °C, W 55 °C)		kW / COP	-/-	-/-
Cooling capacity / EER (A 35 °C, W 7 °C)		kW / EER	10,00/2,81	12,20/2,56
Cooling capacity / EER (A 35 °C, W 18 °C)		kW / EER	-/-	-/-
Heating average climate (W 35 °C / W 55 °C)	Seasonal energy efficiency	ηs %	190/134	190/130
	SCOP		4,82/3,42	4,82/3,33
Heating warm climate (W 35 °C / W 55 °C)	Seasonal energy efficiency	ηs %	245/159	245/169
	SCOP		6,21/4,05	6,20/4,30
Heating cold climate (W 35 °C / W 55 °C)	Seasonal energy efficiency	ηs %	168/121	168/121
	SCOP		4,29/3,10	4,28/3,10
Energy class ¹⁾			A+++ / A++	A+++ / A++
Indoor unit			WH-ADC1216H6E5C	WH-ADC1216H6E5C
Sound pressure	Heat / Cool	dB(A)	33/33	33/33
Dimension	HxWxD	mm	1640x598x600	1640x598x600
Net weight		kg	101	101
Water pipe connector		Inch	R 1½	R 1½
A class pump	Number of speeds		Variable Speed	Variable Speed
	Input power (Min/Max)	W	-/-	-/-
Heating water flow (ΔT=5 K, 35 °C)		L/min	34,40	45,90
Capacity of integrated electric heater		kW	6,00	6,00
Recommended fuse		A	-/-	-/-
Recommended cable size, supply 1 / 2		mm ²	-/-	-/-
Water volume		L	185	185
Maximum DHW temperature		°C	65	65
Material inside tank			Stainless steel	Stainless steel
Tapping profile according EN16147			-	-
DHW tank ERP efficiency average / warm / cold ²⁾		A+ to F	-/-/-	-/-/-
DHW tank ERP average climate η / COPdHW		ηwh %/COPdHW	92/2,30	88/2,20
DHW tank ERP warm climate η / COPdHW		ηwh %/COPdHW	107/2,67	104/2,59
DHW tank ERP cold climate η / COPdHW		ηwh %/COPdHW	72/1,81	70/1,74
Outdoor unit			WH-UD12HE5	WH-UD16HE5
Sound power ³⁾	Heat	dB(A)	65	65
Dimension / Net weight	HxWxD	mm / kg	1340x900x320/101	1340x900x320/101
Refrigerant (R410A) / CO ₂ Eq.		kg / T	2,55/5,324	2,55/5,324
Piping diameter	Liquid / Gas	Inch (mm)	3/8(9,52)/5/8(15,88)	3/8(9,52)/5/8(15,88)
Pipe length range / Elevation difference (in / out)		m / m	3~50/30	3~50/30
Pipe length for additional gas / Additional gas amount		m / g/m	10/50	10/50
Operating range - outdoor ambient	Heat	°C	-20~+35	-20~+35
	Cool	°C	+16~+43	+16~+43
Water outlet	Heat / Cool	°C	20~55/5~20	20~55/5~20

1) Scale from A+++ to D. 2) Scale from A+ to F. 3) Sound power in accordance to 811/2013, 813/2013 and EN12102-1:2017 at +7 °C. * EER and COP calculation is based in accordance to EN14511. ** This product is designed to comply with the European Water Quality Directive 98/83/EC amended by 2015/1787/EU. The lifespan of the product is not guaranteed in the case of the use of groundwater, such as spring water or well water, the use of tap water when salt or other impurities are contained, nor in areas of acidic water quality. Maintenance and warranty costs related to these cases are the customer's responsibility.

Accessories

CZ-TAW1	Aquarea Smart Cloud for remote control and maintenance through wireless or wired LAN
CZ-TAW1-CBL	10 m extension cable for CZ-TAW1

Accessories

CZ-NS4P	Additional functions PCB
PAW-A2W-RTWIRED	Room thermostat
PAW-A2W-RTWIRELESS	Wireless LCD room thermostat



INTERNET CONTROL: Optional. GOOD DESIGN AWARD 2017: Indoor units All in One and Bi-bloc J and H Generation awarded with the prestigious Good Design Award 2017.



**GOOD DESIGN
AWARD 2017**



011-1W0207
011-1W0208
011-1W0209



3, 5 and 7 kW
models.



Aquarea High Performance Bi-bloc J Generation Single phase. Heating and Cooling - SDC - R32

Energy efficiency: COP up to 5,33 / A+++ in heating at 35 °C / "A" water pump with variable speed / Built-in flow meter.

Flexibility: Long piping lengths / Built-in magnetic water filter.

Comfort: Operating range and heating curve down to -20 °C / 60 °C water outlet temperature.

Control: Additional functions with optional PCB (2 zone control, bivalent control, Smart Grid contact and more).

Connectivity: Optional Aquarea Smart and Service Cloud and integration into BMS projects.



			Single phase (Power to indoor)			
Kit			KIT-WC03J3E5	KIT-WC05J3E5	KIT-WC07J3E5	KIT-WC09J3E5
Heating capacity / COP (A +7 °C, W 35 °C)	kW / COP		3,20/5,33	5,00/5,00	7,00/4,76	9,00/4,48
Heating capacity / COP (A +7 °C, W 55 °C)	kW / COP		3,20/2,81	5,00/2,72	7,00/2,82	8,95/2,78
Heating capacity / COP (A +2 °C, W 35 °C)	kW / COP		3,20/3,64	4,20/3,18	6,85/3,41	7,00/3,40
Heating capacity / COP (A +2 °C, W 55 °C)	kW / COP		3,20/2,19	4,10/1,99	6,20/2,21	6,30/2,16
Heating capacity / COP (A -7 °C, W 35 °C)	kW / COP		3,30/2,80	4,20/2,59	5,60/2,87	6,12/2,78
Heating capacity / COP (A -7 °C, W 55 °C)	kW / COP		3,20/1,79	3,55/1,71	5,25/1,94	5,90/1,93
Cooling capacity / EER (A 35 °C, W 7 °C)	kW / EER		3,20/3,52	4,50/3,00	6,70/3,03	8,20/2,72
Cooling capacity / EER (A 35 °C, W 18 °C)	kW / EER		3,20/4,71	4,80/4,29	6,70/4,72	9,00/4,18
Heating average climate (W 35 °C / W 55 °C)	Seasonal energy efficiency	ηs %	200/136	200/136	193/130	193/130
	SCOP		5,07/3,47	5,07/3,47	4,90/3,32	4,90/3,32
Heating warm climate (W 35 °C / W 55 °C)	Seasonal energy efficiency	ηs %	245/165	245/165	227/160	227/160
	SCOP		6,20/4,20	6,20/4,20	5,75/4,07	5,75/4,07
Heating cold climate (W 35 °C / W 55 °C)	Seasonal energy efficiency	ηs %	157/110	157/110	164/116	164/116
	SCOP		4,00/2,83	4,00/2,83	4,18/2,98	4,18/2,98
Energy class			A+++ to D	A+++ to D	A+++ to D	A+++ to D
			A+++ / A++	A+++ / A++	A+++ / A++	A+++ / A++
Indoor unit			WH-SDC0305J3E5	WH-SDC0305J3E5	WH-SDC0709J3E5	WH-SDC0709J3E5
	Sound pressure	Heat / Cool	28/28	28/28	30/30	30/31
Dimension	H x W x D	mm	892 x 500 x 340	892 x 500 x 340	892 x 500 x 340	892 x 500 x 340
Net weight		kg	42	42	42	42
Water pipe connector		Inch	R 1½	R 1½	R 1½	R 1½
A class pump	Number of speeds		Variable Speed	Variable Speed	Variable Speed	Variable Speed
	Input power (Min/Max)	W	30/100	33/106	34/114	40/120
Heating water flow (ΔT=5 K, 35 °C)		L/min	9,2	14,3	20,1	25,8
Capacity of integrated electric heater		kW	3,00	3,00	3,00	3,00
Recommended fuse		A	15/30	15/30	15/30	15/30
Recommended cable size, supply 1 / 2		mm²	3 x 1,5 / 3 x 1,5	3 x 1,5 / 3 x 1,5	3 x 2,5 / 3 x 1,5	3 x 2,5 / 3 x 1,5
Outdoor unit			WH-UD03JE5	WH-UD05JE5	WH-UD07JE5	WH-UD09JE5-1
	Sound power ¹⁾	Heat	55	55	59	59
Dimension	H x W x D	mm	622 x 824 x 298	622 x 824 x 298	795 x 875 x 320	795 x 875 x 320
Net weight		kg	37	37	61	61
Refrigerant (R32) / CO ₂ Eq.		kg / T	0,9/0,608	0,9/0,608	1,27/0,857	1,27/0,857
Piping diameter	Liquid / Gas	Inch (mm)	1/4 (6,35) / 1/2 (12,70)	1/4 (6,35) / 1/2 (12,70)	1/4 (6,35) / 5/8 (15,88)	1/4 (6,35) / 5/8 (15,88)
Pipe length range		m	3 - 25	3 - 25	3 - 50	3 - 50
Elevation difference (in / out)		m	20	20	30	30
Pipe length for additional gas		m	10	10	10	10
Additional gas amount		g/m	20	20	25	25
Operating range - outdoor ambient	Heat	°C	-20 ~ +35	-20 ~ +35	-20 ~ +35	-20 ~ +35
	Cool	°C	+10 ~ +43	+10 ~ +43	+10 ~ +43	+10 ~ +43
Water outlet	Heat / Cool	°C	20 - 60 / 5 - 20	20 - 60 / 5 - 20	20 - 60 / 5 - 20	20 - 60 / 5 - 20

1) Sound power in accordance to 811/2013, 813/2013 and EN12102-1:2017 at +7 °C. * EER and COP calculation is based in accordance to EN14511.

Accessories	
PAW-TD20C1E5	Tank 200 L - Stainless steel
PAW-TD30C1E5	Tank 300 L - Stainless steel
PAW-TA20C1E5STD	Tank 200 L - Enamelled
PAW-TA30C1E5STD	Tank 300 L - Enamelled
PAW-3WYVLV-HW	3 way valve for DHW Tanks
CZ-NV1	3 way valve kit for inside of hydrokit
PAW-BTANK50L-2	Buffer tank 50 L

Accessories	
CZ-TAW1	Aquarea Smart Cloud for remote control and maintenance through wireless or wired LAN
CZ-TAW1-CBL	10 m extension cable for CZ-TAW1
CZ-NS4P	Additional functions PCB
PAW-A2W-RTWIRED	Room thermostat
PAW-A2W-RTWIRELESS	Wireless LCD room thermostat



INTERNET CONTROL: Optional. GOOD DESIGN AWARD 2017: Indoor units All in One and Bi-bloc J and H Generation awarded with the prestigious Good Design Award 2017.



GOOD DESIGN AWARD 2017



011-1W0515

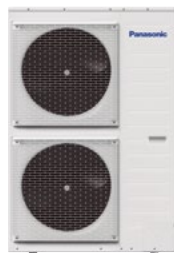

Aquaarea High Performance Bi-bloc H Generation Single phase / Three phase. Heating and Cooling - SDC · R410A

Energy efficiency: A+++ in heating at 35 °C / "A" water pump with variable speed / Built-in flow meter.

Flexibility: Optional magnet for the water filter.

Comfort: Operating range down to -20 °C.

Control: Additional functions with optional PCB (2 zone control, bivalent control, Smart Grid contact and more).

Connectivity: Optional Aquaarea Smart and Service Cloud and integration into BMS projects.

Kit	Single phase		Three phase (Power to indoor)				
	KIT-WC12H6E5	KIT-WC16H6E5	KIT-WC09H3E8	KIT-WC12H9E8	KIT-WC16H9E8		
Heating capacity / COP (A +7 °C, W 35 °C)	kW / COP	12,00/4,74	16,00/4,28	9,00/4,84	12,00/4,74	16,00/4,28	
Heating capacity / COP (A +7 °C, W 55 °C)	kW / COP	12,00/2,93	14,50/2,72	9,00/2,94	12,00/2,93	14,50/2,72	
Heating capacity / COP (A +2 °C, W 35 °C)	kW / COP	11,40/3,44	13,00/3,28	9,00/3,59	11,40/3,44	13,00/3,28	
Heating capacity / COP (A +2 °C, W 55 °C)	kW / COP	9,10/2,23	9,80/2,21	8,80/2,23	9,10/2,23	9,80/2,21	
Heating capacity / COP (A -7 °C, W 35 °C)	kW / COP	10,00/2,73	11,40/2,57	9,00/2,85	10,00/2,73	11,40/2,57	
Heating capacity / COP (A -7 °C, W 55 °C)	kW / COP	8,20/1,95	9,00/1,85	7,90/2,05	8,20/1,95	9,00/1,85	
Cooling capacity / EER (A 35 °C, W 7 °C)	kW / EER	10,00/2,81	12,20/2,56	7,00/3,17	10,00/2,85	12,20/2,56	
Cooling capacity / EER (A 35 °C, W 18 °C)	kW / EER	10,00/4,17	12,20/4,12	7,00/4,67	10,00/4,26	12,20/4,12	
Heating average climate (W 35 °C / W 55 °C)	Seasonal energy efficiency	ηs %	190/134	190/130	190/133	190/134	190/130
	SCOP		4,82/3,42	4,82/3,33	4,81/3,41	4,82/3,42	4,82/3,33
Heating warm climate (W 35 °C / W 55 °C)	Seasonal energy efficiency	ηs %	245/159	245/169	245/159	245/159	245/169
	SCOP		6,21/4,05	6,21/4,30	6,21/4,05	6,21/4,05	6,20/4,30
Heating cold climate (W 35 °C / W 55 °C)	Seasonal energy efficiency	ηs %	168/121	168/121	168/121	168/121	168/121
	SCOP		4,29/3,10	4,28/3,10	4,28/3,10	4,29/3,10	4,28/3,10
Energy class			A+++ to D	A+++ / A++	A+++ / A++	A+++ / A++	A+++ / A++
			A+++ to D	A+++ / A+++	A+++ / A+++	A+++ / A+++	A+++ / A+++
Energy class			A+++ to D	A++ / A+	A++ / A+	A++ / A+	A++ / A+
			A+++ to D	A++ / A+	A++ / A+	A++ / A+	A++ / A+
Indoor unit		WH-SDC12H6E5	WH-SDC16H6E5	WH-SDC09H3E8	WH-SDC12H9E8	WH-SDC16H9E8	
Sound pressure	Heat / Cool	dB(A)	33/33	33/33	33/33	33/33	
Dimension	HxWxD	mm	892x500x340	892x500x340	892x500x340	892x500x340	
Net weight		kg	43	44	43	45	
Water pipe connector		Inch	R 1½	R 1½	R 1½	R 1½	
A class pump	Number of speeds		Variable Speed	Variable Speed	Variable Speed	Variable Speed	Variable Speed
	Input power (Min/Max)	W	34/110	30/105	32/102	34/110	30/105
Heating water flow (ΔT=5 K, 35 °C)		L/min	34,4	45,9	25,8	34,4	45,9
Capacity of integrated electric heater		kW	6,00	6,00	3,00	9,00	9,00
Recommended fuse		A	30/30	30/30	15/30	15/30	15/30
Recommended cable size, supply 1 / 2		mm²	3x4,0 or 6,0/3x4,0	3x4,0 or 6,0/3x4,0	5x1,5/5x1,5	5x1,5/5x1,5	5x1,5/5x1,5
Outdoor unit		WH-UD12HE5	WH-UD16HE5	WH-UD09HE8	WH-UD12HE8	WH-UD16HE8	
Sound power ¹⁾	Heat	dB(A)	65	65	65	65	
Dimension	HxWxD	mm	1340x900x320	1340x900x320	1340x900x320	1340x900x320	
Net weight		kg	101	101	107	107	
Refrigerant (R410A) / CO ₂ , Eq.		kg / T	2,55/5,324	2,55/5,324	2,55/5,324	2,55/5,324	
Piping diameter	Liquid / Gas	Inch (mm)	3/8(9,52)/5/8(15,88)	3/8(9,52)/5/8(15,88)	3/8(9,52)/5/8(15,88)	3/8(9,52)/5/8(15,88)	
Pipe length range		m	3-50	3-50	3-30	3-30	
Elevation difference (in / out)		m	30	30	20	20	
Pipe length for additional gas		m	10	10	10	10	
Additional gas amount		g/m	50	50	50	50	
Operating range - outdoor ambient	Heat	°C	-20 ~ +35	-20 ~ +35	-20 ~ +35	-20 ~ +35	
	Cool	°C	+16 ~ +43	+16 ~ +43	+16 ~ +43	+16 ~ +43	
Water outlet	Heat / Cool	°C	20-55/5-20	20-55/5-20	20-55/5-20	20-55/5-20	

1) Sound power in accordance to 811/2013, 813/2013 and EN12102-1:2017 at +7 °C. * EER and COP calculation is based in accordance to EN14511.

Accessories	
PAW-TD20C1E5	Tank 200 L - Stainless steel
PAW-TD30C1E5	Tank 300 L - Stainless steel
PAW-TA20C1E5STD	Tank 200 L - Enamelled
PAW-TA30C1E5STD	Tank 300 L - Enamelled
PAW-3WYVLV-HW	3 way valve for DHW Tanks
CZ-NV1	3 way valve kit for inside of hydrokit
PAW-BTANK50L-2	Buffer tank 50 L

Accessories	
CZ-TAW1	Aquaarea Smart Cloud for remote control and maintenance through wireless or wired LAN
CZ-TAW1-CBL	10 m extension cable for CZ-TAW1
CZ-NS4P	Additional functions PCB
PAW-A2W-MGTFILTER	Magnet for the water filter
PAW-A2W-RTWIRED	Room thermostat
PAW-A2W-RTWIRELESS	Wireless LCD room thermostat



INTERNET CONTROL: Optional. GOOD DESIGN AWARD 2017: Indoor units All in One and Bi-bloc J and H Generation awarded with the prestigious Good Design Award 2017.

011-1W0398
011-1W0399
011-1W0400



Aquarea High Performance Mono-bloc J Generation Single phase. Heating and Cooling - MDC - R32

Energy efficiency: A+++ in heating at 35 °C / "A" water pump with variable speed / Built-in flow meter.

Flexibility: Built-in magnetic water filter / Built-in 6L expansion vessel.

Comfort: Operating range and heating curve down to -20 °C / 60 °C water outlet temperature / Cooling mode down to +10 °C.

Control: Additional functions with optional PCB (2 zone control, bivalent control, Smart Grid contact and more).

Connectivity: Optional Aquarea Smart and Service Cloud and integration into BMS projects.

Outdoor unit		Single phase			
		WH-MDC05J3E5	WH-MDC07J3E5	WH-MDC09J3E5	
Heating capacity / COP (A +7 °C, W 35 °C)	kW / COP	5,00/5,08	7,00/4,76	9,00/4,48	
Heating capacity / COP (A +7 °C, W 55 °C)	kW / COP	5,00/3,01	7,00/2,82	8,95/2,78	
Heating capacity / COP (A +2 °C, W 35 °C)	kW / COP	5,00/3,57	7,00/3,40	7,45/3,13	
Heating capacity / COP (A +2 °C, W 55 °C)	kW / COP	5,00/2,27	6,30/2,16	7,00/2,12	
Heating capacity / COP (A -7 °C, W 35 °C)	kW / COP	5,00/2,78	6,80/2,81	7,50/2,63	
Heating capacity / COP (A -7 °C, W 55 °C)	kW / COP	5,00/1,85	6,30/1,86	7,00/1,80	
Cooling capacity / EER (A 35 °C, W 7 °C)	kW / EER	5,00/3,31	7,00/3,06	9,00/2,71	
Cooling capacity / EER (A 35 °C, W 18 °C)	kW / EER	5,00/5,05	7,00/4,73	9,00/4,25	
Heating average climate (W 35 °C / W 55 °C)	Seasonal energy efficiency	ηs %	202/142	193/130	193/130
	SCOP		5,12/3,63	4,90/3,32	4,90/3,32
Heating warm climate (W 35 °C / W 55 °C)	Seasonal energy efficiency	ηs %	237/165	227/160	227/160
	SCOP		6,00/4,20	5,75/4,07	5,75/4,07
Heating cold climate (W 35 °C / W 55 °C)	Seasonal energy efficiency	ηs %	160/115	164/116	164/116
	SCOP		4,08/2,95	4,18/2,98	4,18/2,98
Sound power ¹⁾	Heat	dB(A)	59	59	59
	Cool				
Dimension	H x W x D	mm	865 x 1283 x 320	865 x 1283 x 320	865 x 1283 x 320
Net weight		kg	99	104	104
Refrigerant (R32) / CO ₂ Eq. ²⁾		kg / T	1,3/0,878	1,3/0,878	1,3/0,878
Water pipe connector		Inch	R 1½	R 1½	R 1½
Pump	Number of speeds		Variable Speed	Variable Speed	Variable Speed
	Input power (Min/Max)	W	34/96	36/100	39/108
Heating water flow (ΔT=5 K, 35 °C)		L/min	14,3	20,1	25,8
Capacity of integrated electric heater		kW	3,00	3,00	3,00
Input power	Heat	kW	0,985	1,47	2,01
	Cool	kW	1,51	2,29	3,32
Running and starting current	Heat	A	4,7	7,0	9,3
	Cool	A	7,0	10,5	14,7
Current 1		A	12	17	17
Current 2		A	13	13	13
Recommended fuse		A	30/15	30/15	30/16
Recommended cable size, supply 1 / 2		mm ²	3x1,5/3x1,5	3x2,5/3x1,5	3x2,5/3x1,5
Operating range - outdoor ambient	Heat	°C	-20 ~ 35	-20 ~ 35	-20 ~ 35
	Cool	°C	+10 ~ +43	+10 ~ +43	+10 ~ +43
Water outlet	Heat	°C	20 ~ 60	20 ~ 60	20 ~ 60
	Cool	°C	5 ~ 20	5 ~ 20	5 ~ 20

1) Sound power in accordance to 811/2013, 813/2013 and EN12102-1:2017 at +7 °C. 2) WH-MDC models are hermetically sealed. * EER and COP calculation is based in accordance to EN14511.

Accessories	
PAW-TD20C1E5	Tank 200 L - Stainless steel
PAW-TD30C1E5	Tank 300 L - Stainless steel
PAW-TA20C1E5STD	Tank 200 L - Enamelled
PAW-TA30C1E5STD	Tank 300 L - Enamelled
PAW-TD20B8E3-2	Combo Tank 185 L + 80 L - Enamelled
PAW-TD23B6E5	Combo Tank 230 L + 60 L - Stainless Steel
PAW-3WYVLV-HW	3 way valve for DHW Tanks
PAW-BTANK50L-2	Buffer tank 50 L

Accessories	
CZ-TAW1	Aquarea Smart Cloud for remote control and maintenance through wireless or wired LAN
CZ-TAW1-CBL	10 m extension cable for CZ-TAW1
PAW-A2W-AFVLV	1 anti-freeze valve. It is required to order 2 valves per system
PAW-A2W-RTWIRED	Room thermostat
PAW-A2W-RTWIRELESS	Wireless LCD room thermostat



INTERNET CONTROL: Optional.

011-1W0509

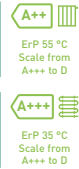
**Aquarea High Performance Mono-bloc H Generation Single phase. Heating and Cooling - MDC - R410A****Energy efficiency:** A+++ in heating at 35 °C / "A" water pump with variable speed / Built-in flow meter.**Flexibility:** Optional magnet for the water filter.**Comfort:** Operating range and heating curve down to -20 °C / 55 °C water outlet temperature.**Control:** Additional functions with optional PCB (2 zone control, bivalent control, Smart Grid contact and more).**Connectivity:** Optional Aquarea Smart and Service Cloud and integration into BMS projects.

Single phase

Outdoor unit			WH-MDC12H6E5	WH-MDC16H6E5
Heating capacity / COP (A +7 °C, W 35 °C)		kW / COP	12,00/4,74	16,00/4,28
Heating capacity / COP (A +7 °C, W 55 °C)		kW / COP	12,00/2,93	14,50/2,72
Heating capacity / COP (A +2 °C, W 35 °C)		kW / COP	11,40/3,44	13,00/3,28
Heating capacity / COP (A +2 °C, W 55 °C)		kW / COP	9,10/2,23	9,80/2,21
Heating capacity / COP (A -7 °C, W 35 °C)		kW / COP	10,00/2,73	11,40/2,57
Heating capacity / COP (A -7 °C, W 55 °C)		kW / COP	8,20/1,95	9,00/1,84
Cooling capacity / EER (A 35 °C, W 7 °C)		kW / EER	10,00/2,81	12,20/2,56
Cooling capacity / EER (A 35 °C, W 18 °C)		kW / EER	9,39/4,65	11,40/4,10
Heating average climate (W 35 °C / W 55 °C)	Seasonal energy efficiency	ηs %	190/134	190/130
	SCOP		4,82/3,42	4,82/3,33
Heating warm climate (W 35 °C / W 55 °C)	Seasonal energy efficiency	ηs %	245/159	245/169
	SCOP		6,20/4,05	6,20/4,30
Heating cold climate (W 35 °C / W 55 °C)	Seasonal energy efficiency	ηs %	168/121	168/121
	SCOP		4,28/3,10	4,28/3,10
Sound power ¹⁾	Heat	dB(A)	65	65
	Dimension	HxWxD	1410x1283x320	1410x1283x320
Net weight		kg	140	140
Refrigerant (R410A) / CO ₂ Eq. ²⁾		kg / T	2,10/4,385	2,10/4,385
Water pipe connector		Inch	R 1½	R 1½
Pump	Number of speeds		Variable Speed	Variable Speed
	Input power (Min/Max)	W	34/110	38/120
Heating water flow (ΔT=5 K, 35 °C)		L/min	34,4	45,9
Capacity of integrated electric heater		kW	6,00	6,00
Input power	Heat	kW	2,53	3,74
	Cool	kW	3,56	4,76
Running and starting current	Heat	A	11,7	16,9
	Cool	A	16,2	21,5
Current 1		A	24,0	26,0
Current 2		A	26,0	26,0
Recommended fuse		A	30/30	30/30
Recommended cable size, supply 1 / 2		mm ²	3x4,0 or 6,0/3x4,0	3x4,0 or 6,0/3x4,0
	Operating range - outdoor ambient	Heat	°C	-20 ~ +35
	Cool	°C	+16 ~ +43	+16 ~ +43
Water outlet	Heat	°C	25 ~ 55	25 ~ 55
	Cool	°C	5 ~ 20	5 ~ 20

1) Sound power in accordance to 811/2013, 813/2013 and EN12102-1:2017 at +7 °C. 2) WH-MDC models are hermetically sealed. * EER and COP calculation is based in accordance to EN14511.

Accessories

PAW-TD20C1E5	Tank 200 L - Stainless steel
PAW-TD30C1E5	Tank 300 L - Stainless steel
PAW-TA20C1E5STD	Tank 200 L - Enamelled
PAW-TA30C1E5STD	Tank 300 L - Enamelled
PAW-TD20B8E3-2	Combo Tank 185 L + 80 L - Enamelled
PAW-TD23B6E5	Combo Tank 230 L + 60 L - Stainless Steel
PAW-3WYVLV-HW	3 way valve for DHW Tanks
PAW-BTANK50L-2	Buffer tank 50 L

Accessories

CZ-TAW1	Aquarea Smart Cloud for remote control and maintenance through wireless or wired LAN
CZ-TAW1-CBL	10 m extension cable for CZ-TAW1
PAW-A2W-MGTFILTER	Magnet for the water filter
PAW-A2W-AFVLV	1 anti-freeze valve. It is required to order 2 valves per system
PAW-A2W-RTWIRED	Room thermostat
PAW-A2W-RTWIRELESS	Wireless LCD room thermostat



INTERNET CONTROL: Optional.



GOOD DESIGN AWARD 2017

011-1W0510
011-1W0511



Aquarea T-CAP All in One H Generation Single phase / Three phase. Heating and Cooling - R410A

Energy efficiency: A+++ in heating at 35 °C and A+ in DHW / "A" water pump with variable speed / Stainless steel DHW tank with U-Vacuum™ insulation panel / Built-in flow meter.

Flexibility: Optional magnet for the water filter.

Comfort: Constant capacity down to -20 °C / Operating range down to -28 °C / 60 °C water outlet temperature.

Control: Additional functions with optional PCB (2 zone control, bivalent control, Smart Grid contact and more).

Connectivity: Optional Aquarea Smart and Service Cloud and integration into BMS projects.

Kit	Single phase (Power to indoor)			Three phase (Power to indoor)			
	KIT-AXC09HE5	KIT-AXC12HE5	KIT-AXC09HE8	KIT-AXC12HE8	KIT-AXC16HE8		
Heating capacity / COP (A +7 °C, W 35 °C)	kW / COP	9,00/4,84	12,00/4,74	9,00/4,84	12,00/4,74	16,00/4,28	
Heating capacity / COP (A +7 °C, W 55 °C)	kW / COP	9,00/2,94	12,00/2,88	9,00/2,94	12,00/2,88	16,00/2,71	
Heating capacity / COP (A +2 °C, W 35 °C)	kW / COP	9,00/3,59	12,00/3,44	9,00/3,59	12,00/3,44	16,00/3,10	
Heating capacity / COP (A +2 °C, W 55 °C)	kW / COP	9,00/2,21	12,00/2,19	9,00/2,21	12,00/2,19	16,00/2,13	
Heating capacity / COP (A -7 °C, W 35 °C)	kW / COP	9,00/2,85	12,00/2,72	9,00/2,85	12,00/2,72	16,00/2,49	
Heating capacity / COP (A -7 °C, W 55 °C)	kW / COP	9,00/2,02	12,00/1,92	9,00/2,02	12,00/1,92	16,00/1,86	
Cooling capacity / EER (A 35 °C, W 7 °C)	kW / EER	7,00/3,17	10,00/2,81	7,00/3,17	10,00/2,81	12,20/2,57	
Cooling capacity / EER (A 35 °C, W 18 °C)	kW / EER	7,00/5,19	10,00/5,13	7,00/5,19	10,00/5,13	12,20/3,49	
Heating average climate (W 35 °C / W 55 °C)	Seasonal energy efficiency	ηs %	181/130	170/130	181/130	170/130	160/125
	SCOP	4,59/3,32	4,32/3,32	4,59/3,32	4,32/3,32	4,08/3,20	
Heating warm climate (W 35 °C / W 55 °C)	Seasonal energy efficiency	ηs %	235/158	231/158	235/158	231/158	231/159
	SCOP	5,95/4,02	5,86/4,02	5,95/4,02	5,86/4,02	5,86/4,05	
Heating cold climate (W 35 °C / W 55 °C)	Seasonal energy efficiency	ηs %	160/125	160/125	160/125	160/125	150/125
	SCOP	4,08/3,20	4,08/3,20	4,08/3,20	4,08/3,20	3,83/3,20	
Indoor unit		WH-ADC1216H6E5	WH-ADC1216H6E5	WH-ADC0916H9E8	WH-ADC0916H9E8	WH-ADC0916H9E8	
Sound pressure	Heat / Cool	dB(A)	33/33	33/33	33/33	33/33	
Dimension	HxWxD	mm	1800x598x717	1800x598x717	1800x598x717	1800x598x717	
Net weight		kg	124	124	126	126	
Water pipe connector		Inch	R1¼	R1¼	R1¼	R1¼	
A class pump	Number of speeds	Variable Speed	Variable Speed	Variable Speed	Variable Speed	Variable Speed	
	Input power (Min/Max)	W	36/152	36/152	36/152	36/152	36/152
Heating water flow (ΔT=5 K, 35 °C)		L/min	25,8	34,4	25,8	34,4	45,9
Capacity of integrated electric heater		kW	6,00	6,00	9,00	9,00	9,00
Recommended fuse		A	30/30	30/30	16/16	16/16	16/16
Recommended cable size, supply 1 / 2		mm²	3x4,0/3x4,0	3x4,0/3x4,0	5x1,5/5x1,5	5x1,5/5x1,5	5x1,5/5x1,5
Water volume		L	185	185	185	185	185
Maximum DHW temperature		°C	65	65	65	65	65
Material inside tank			Stainless steel	Stainless steel	Stainless steel	Stainless steel	Stainless steel
Tapping profile according EN16147			L	L	L	L	L
DHW tank ERP efficiency average / warm / cold ²⁾		A+ to F	A/A/A	A/A/A	A/A/A	A/A/A	A/A/B
DHW tank ERP average climate η / COPdHW		ηwh %/COPdHW	95/2,37	95/2,37	95/2,37	95/2,37	91/2,27
DHW tank ERP warm climate η / COPdHW		ηwh %/COPdHW	110/2,75	110/2,75	110/2,75	110/2,75	107/2,67
DHW tank ERP cold climate η / COPdHW		ηwh %/COPdHW	75/1,87	75/1,87	75/1,87	75/1,87	72/1,80
Outdoor unit			WH-UX09HE5	WH-UX12HE5	WH-UX09HE8	WH-UX12HE8	WH-UX16HE8
Sound power ³⁾	Heat	dB(A)	66	66	65	65	67
Dimension / Net weight	HxWxD	mm / kg	1340x900x320/101	1340x900x320/101	1340x900x320/108	1340x900x320/108	1340x900x320/118
Refrigerant (R410A) / CO ₂ Eq.		kg / T	2,85/5,951	2,85/5,951	2,85/5,951	2,85/5,951	2,90/6,055
Piping diameter	Liquid / Gas	Inch (mm)	3/8(9,52)/5/8(15,88)	3/8(9,52)/5/8(15,88)	3/8(9,52)/5/8(15,88)	3/8(9,52)/5/8(15,88)	3/8(9,52)/5/8(15,88)
Pipe length range / Elevation difference (in / out)		m / m	3~30/20	3~30/20	3~30/20	3~30/20	3~30/20
Pipe length for additional gas / Additional gas amount		m / g/m	10/50	10/50	10/50	10/50	10/50
Operating range - outdoor ambient	Heat	°C	-28~+35	-28~+35	-28~+35	-28~+35	-28~+35
	Cool	°C	+16~+43	+16~+43	+16~+43	+16~+43	+16~+43
Water outlet	Heat / Cool	°C	20~60/5~20	20~60/5~20	20~60/5~20	20~60/5~20	20~60/5~20

1) Scale from A+++ to D. 2) Scale from A+ to F. 3) Sound power in accordance to 811/2013, 813/2013 and EN12102-1:2017 at +7 °C. * EER and COP calculation is based in accordance to EN14511. ** This product is designed to comply with the European Water Quality Directive 98/83/EC amended by 2015/1787/EU. The lifespan of the product is not guaranteed in the case of the use of groundwater, such as spring water or well water, the use of tap water when salt or other impurities are contained, nor in areas of acidic water quality. Maintenance and warranty costs related to these cases are the customer's responsibility.

Accessories

PAW-ADC-PREKIT-1	Piping pre installation kit for J Generation
CZ-TAW1	Aquarea Smart Cloud for remote control and maintenance through wireless or wired LAN
CZ-TAW1-CBL	10 m extension cable for CZ-TAW1

Accessories

CZ-NS4P	Additional functions PCB
PAW-A2W-MGTFILTER	Magnet for the water filter
PAW-A2W-RTWIRED	Room thermostat
PAW-A2W-RTWIRELESS	Wireless LCD room thermostat

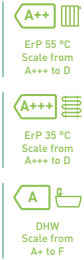

INTERNET CONTROL: Optional. GOOD DESIGN AWARD 2017: Indoor units All in One and Bi-Bloc J and H Generation awarded with the prestigious Good Design Award 2017.

011-1W0510
011-1W0511

Aquarea T-CAP All in One H Generation Three phase. Super Quiet outdoor unit. Heating and Cooling · R410A

Energy efficiency: A+++ in heating at 35 °C and A+ in DHW / "A" water pump with variable speed / Stainless steel DHW tank with U-Vacua™ insulation panel / Built-in flow meter.

Flexibility: Optional magnet for the water filter.

Comfort: Low noise level / Constant capacity down to -20 °C / Operating range down to -28 °C / 60 °C water outlet temperature.

Control: Additional functions with optional PCB (2 zone control, bivalent control, Smart Grid contact and more).

Connectivity: Optional Aquarea Smart and Service Cloud and integration into BMS projects.

Three phase (Power to indoor)

Kit			KIT-AQC09HE8	KIT-AQC12HE8	KIT-AQC16HE8
Heating capacity / COP (A +7 °C, W 35 °C)		kW / COP	9,00/4,84	12,00/4,74	16,00/4,28
Heating capacity / COP (A +7 °C, W 55 °C)		kW / COP	9,00/2,94	12,00/2,88	16,00/2,71
Heating capacity / COP (A +2 °C, W 35 °C)		kW / COP	9,00/3,59	12,00/3,44	16,00/3,10
Heating capacity / COP (A +2 °C, W 55 °C)		kW / COP	9,00/2,21	12,00/2,19	16,00/2,13
Heating capacity / COP (A -7 °C, W 35 °C)		kW / COP	9,00/2,85	12,00/2,72	16,00/2,49
Heating capacity / COP (A -7 °C, W 55 °C)		kW / COP	9,00/2,02	12,00/1,92	16,00/1,86
Cooling capacity / EER (A 35 °C, W 7 °C)		kW / EER	7,00/3,17	10,00/2,81	12,20/2,57
Cooling capacity / EER (A 35 °C, W 18 °C)		kW / EER	7,00/5,19	10,00/5,13	12,20/3,49
Heating average climate (W 35 °C / W 55 °C)	Seasonal energy efficiency	ηs %	181/130	170/130	160/125
	SCOP		4,59/3,32	4,32/3,32	4,08/3,20
Heating warm climate (W 35 °C / W 55 °C)	Seasonal energy efficiency	ηs %	235/158	231/158	231/159
	SCOP		5,95/4,02	5,86/4,02	5,86/4,05
Heating cold climate (W 35 °C / W 55 °C)	Seasonal energy efficiency	ηs %	160/125	160/125	150/125
	SCOP		4,08/3,20	4,08/3,20	3,83/3,20
Energy class ¹⁾			A+++ to D	A++/A++	A++/A++
			A+++ to D	A+++/A+++	A+++/A+++
Energy class ¹⁾			A+++ to D	A++/A++	A++/A++
			A+++ to D	A++/A++	A++/A++
Indoor unit			WH-ADC0916H9E8	WH-ADC0916H9E8	WH-ADC0916H9E8
Sound pressure	Heat / Cool	dB(A)	33/33	33/33	33/33
Dimension	HxWxD	mm	1800x598x717	1800x598x717	1800x598x717
Net weight		kg	126	126	126
Water pipe connector		Inch	R 1¼	R 1¼	R 1¼
A class pump	Number of speeds		Variable Speed	Variable Speed	Variable Speed
	Input power (Min/Max)	W	36/152	36/152	36/152
Heating water flow (ΔT=5 K, 35 °C)		L/min	25,8	34,4	45,9
Capacity of integrated electric heater		kW	9,00	9,00	9,00
Recommended fuse		A	16/16	16/16	16/16
Recommended cable size, supply 1 / 2		mm ²	5x1,5/5x1,5	5x1,5/5x1,5	5x1,5/5x1,5
Water volume		L	185	185	185
Maximum DHW temperature		°C	65	65	65
Material inside tank			Stainless steel	Stainless steel	Stainless steel
Tapping profile according EN16147			L	L	L
DHW tank ERP efficiency average / warm / cold ²⁾		A+ to F	A/A/A	A/A/A	A/A/B
DHW tank ERP average climate η / COPdHWH		ηwh%/COPdHWH	95/2,37	95/2,37	91/2,27
DHW tank ERP warm climate η / COPdHWH		ηwh%/COPdHWH	110/2,75	110/2,75	107/2,67
DHW tank ERP cold climate η / COPdHWH		ηwh%/COPdHWH	75/1,87	75/1,87	72/1,80
Outdoor unit			WH-UQ09HE8	WH-UQ12HE8	WH-UQ16HE8
Sound power ³⁾	Heat	dB(A)	58	58	62
Dimension / Net weight	HxWxD	mm / kg	1410x1283x320/151	1410x1283x320/151	1410x1283x320/161
Refrigerant (R410A) / CO ₂ Eq.		kg / T	2,85/5,951	2,85/5,951	2,99/6,243
Piping diameter	Liquid / Gas	Inch (mm)	3/8(9,52)/5/8(15,88)	3/8(9,52)/5/8(15,88)	3/8(9,52)/5/8(15,88)
Pipe length range / Elevation difference (in / out)		m / m	3-30/20	3-30/20	3-30/20
Pipe length for additional gas / Additional gas amount		m / g/m	10/50	10/50	10/50
Operating range - outdoor ambient	Heat	°C	-28 ~ +35	-28 ~ +35	-28 ~ +35
	Cool	°C	+16 ~ +43	+16 ~ +43	+16 ~ +43
Water outlet	Heat / Cool	°C	20 ~ 60/5 ~ 20	20 ~ 60/5 ~ 20	20 ~ 60/5 ~ 20

1) Scale from A+++ to D. 2) Scale from A+ to F. 3) Sound power in accordance to 811/2013, 813/2013 and EN12102-1:2017 at +7 °C. * EER and COP calculation is based in accordance to EN14511. ** This product is designed to comply with the European Water Quality Directive 98/83/EC amended by 2015/1787/EU. The lifespan of the product is not guaranteed in the case of the use of groundwater, such as spring water or well water, the use of tap water when salt or other impurities are contained, nor in areas of acidic water quality. Maintenance and warranty costs related to these cases are the customer's responsibility.

Accessories

PAW-ADC-PREKIT-1	Piping pre installation kit for J Generation
CZ-TAW1	Aquarea Smart Cloud for remote control and maintenance through wireless or wired LAN
CZ-TAW1-CBL	10 m extension cable for CZ-TAW1

Accessories

CZ-NS4P	Additional functions PCB
PAW-A2W-MGTFILTER	Magnet for the water filter
PAW-A2W-RTWIRED	Room thermostat
PAW-A2W-RTWIRELESS	Wireless LCD room thermostat



INTERNET CONTROL: Optional. GOOD DESIGN AWARD 2017: Indoor units All in One and Bi-bloc J and H Generation awarded with the prestigious Good Design Award 2017.



GOOD DESIGN AWARD 2017

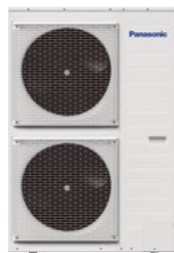

011-1W0510
011-1W0511



Aquarea T-CAP Bi-bloc H Generation Single phase / Three phase. Heating and Cooling - SXC - R410A

Energy efficiency: A+++ in heating at 35 °C / "A" water pump with variable speed / Built-in flow meter.

Flexibility: Optional magnet for the water filter.

Comfort: Constant capacity down to -20 °C / Operating range down to -28 °C / 60 °C water outlet temperature.

Control: Additional functions with optional PCB (2 zone control, bivalent control, Smart Grid contact and more).

Connectivity: Optional Aquarea Smart and Service Cloud and integration into BMS projects.

Kit	Single phase (Power to indoor)			Three phase (Power to indoor)		
	KIT-WXC09H3E5	KIT-WXC12H6E5	KIT-WXC09H3E8	KIT-WXC12H9E8	KIT-WXC16H9E8	
Heating capacity / COP (A +7 °C, W 35 °C)	kW / COP	9,00/4,84	12,00/4,74	9,00/4,84	12,00/4,74	16,00/4,28
Heating capacity / COP (A +7 °C, W 55 °C)	kW / COP	9,00/2,94	12,00/2,88	9,00/2,94	12,00/2,88	16,00/2,71
Heating capacity / COP (A +2 °C, W 35 °C)	kW / COP	9,00/3,59	12,00/3,44	9,00/3,59	12,00/3,44	16,00/3,10
Heating capacity / COP (A +2 °C, W 55 °C)	kW / COP	9,00/2,21	12,00/2,19	9,00/2,21	12,00/2,19	16,00/2,13
Heating capacity / COP (A -7 °C, W 35 °C)	kW / COP	9,00/2,85	12,00/2,72	9,00/2,85	12,00/2,72	16,00/2,49
Heating capacity / COP (A -7 °C, W 55 °C)	kW / COP	9,00/2,02	12,00/1,92	9,00/2,02	12,00/1,92	16,00/1,86
Cooling capacity / EER (A 35 °C, W 7 °C)	kW / EER	7,00/3,17	10,00/2,81	7,00/3,17	10,00/2,81	12,20/2,57
Cooling capacity / EER (A 35 °C, W 18 °C)	kW / EER	7,00/5,19	10,00/5,13	7,00/5,19	10,00/5,13	12,20/3,49
Heating average climate (W 35 °C / W 55 °C)	Seasonal energy efficiency	ηs %	181/130	170/130	181/130	170/130
	SCOP	4,59/3,32	4,32/3,32	4,59/3,32	4,32/3,32	4,08/3,20
Heating warm climate (W 35 °C / W 55 °C)	Seasonal energy efficiency	ηs %	235/158	231/158	235/158	231/159
	SCOP	5,95/4,02	5,86/4,02	5,95/4,02	5,86/4,02	5,86/4,05
Heating cold climate (W 35 °C / W 55 °C)	Seasonal energy efficiency	ηs %	160/125	160/125	160/125	150/125
	SCOP	4,08/3,20	4,08/3,20	4,08/3,20	4,08/3,20	3,83/3,20
Energy class	A+++ to D	A+++ / A+++	A+++ / A+++	A+++ / A+++	A+++ / A+++	A+++ / A+++
	A+++ to D	A+++ / A+++	A+++ / A+++	A+++ / A+++	A+++ / A+++	A+++ / A+++
Indoor unit		WH-SXC09H3E5	WH-SXC12H6E5	WH-SXC09H3E8	WH-SXC12H9E8	WH-SXC16H9E8
Sound pressure	Heat / Cool	dB(A)	33/33	33/33	33/33	33/33
Dimension	HxWxD	mm	892x500x340	892x500x340	892x500x340	892x500x340
Net weight		kg	43	43	43	44
Water pipe connector		Inch	R 1½	R 1½	R 1½	R 1½
A class pump	Number of speeds	Variable Speed	Variable Speed	Variable Speed	Variable Speed	Variable Speed
	Input power (Min/Max)	W	32/102	34/110	32/102	34/110
Heating water flow (ΔT=5 K, 35 °C)		L/min	25,8	34,4	25,8	34,4
Capacity of integrated electric heater		kW	3,00	6,00	3,00	9,00
Recommended fuse		A	30/30	30/30	16/16	16/16
Recommended cable size, supply 1 / 2		mm²	3x4,0or6,0/3x4,0	3x4,0or6,0/3x4,0	5x1,5/3x1,5	5x1,5/5x1,5
Outdoor unit		WH-UX09HE5	WH-UX12HE5	WH-UX09HE8	WH-UX12HE8	WH-UX16HE8
Sound power ¹⁾	Heat	dB(A)	66	66	65	65
Dimension	HxWxD	mm	1340x900x320	1340x900x320	1340x900x320	1340x900x320
Net weight		kg	101	101	108	108
Refrigerant (R410A) / CO ₂ , Eq.		kg / T	2,85/5,951	2,85/5,951	2,85/5,951	2,85/5,951
Piping diameter	Liquid / Gas	Inch (mm)	3/8(9,52)/5/8(15,88)	3/8(9,52)/5/8(15,88)	3/8(9,52)/5/8(15,88)	3/8(9,52)/5/8(15,88)
Pipe length range		m	3-30	3-30	3-30	3-30
Elevation difference (in / out)		m	20	20	20	20
Pipe length for additional gas		m	10	10	10	10
Additional gas amount		g/m	50	50	50	50
Operating range - outdoor ambient	Heat	°C	-28 ~ +35	-28 ~ +35	-28 ~ +35	-28 ~ +35
	Cool	°C	+16 ~ +43	+16 ~ +43	+16 ~ +43	+16 ~ +43
Water outlet	Heat / Cool	°C	20-60/5-20	20-60/5-20	20-60/5-20	20-60/5-20

1) Sound power in accordance to 811/2013, 813/2013 and EN12102-1:2017 at +7 °C. * EER and COP calculation is based in accordance to EN14511.

Accessories

PAW-TD20C1E5	Tank 200 L - Stainless steel
PAW-TD30C1E5	Tank 300 L - Stainless steel
PAW-TA20C1E5STD	Tank 200 L - Enamelled
PAW-TA30C1E5STD	Tank 300 L - Enamelled
PAW-3WYVLV-HW	3 way valve for DHW Tanks
CZ-NV1	3 way valve kit for inside of hydrokit
PAW-BTANK50L-2	Buffer tank 50 L

Accessories

CZ-TAW1	Aquarea Smart Cloud for remote control and maintenance through wireless or wired LAN
CZ-TAW1-CBL	10 m extension cable for CZ-TAW1
CZ-NS4P	Additional functions PCB
PAW-A2W-MGTFILTER	Magnet for the water filter
PAW-A2W-RTWIRED	Room thermostat
PAW-A2W-RTWIRELESS	Wireless LCD room thermostat



INTERNET CONTROL: Optional. GOOD DESIGN AWARD 2017: Indoor units All in One and Bi-bloc J and H Generation awarded with the prestigious Good Design Award 2017.



**GOOD DESIGN
AWARD 2017**

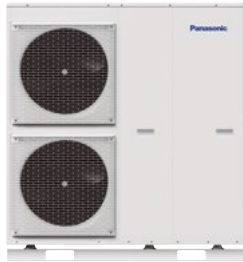

011-1W0510
011-1W0511



Aquarea T-CAP Bi-bloc H Generation Three phase. Super Quiet outdoor unit. Heating and Cooling - SQC · R410A

Energy efficiency: A+++ in heating at 35 °C / "A" water pump with variable speed / Built-in flow meter.

Flexibility: Optional magnet for the water filter.

Comfort: Low noise level / Constant capacity down to -20 °C / Operating range down to -28 °C / 60 °C water outlet temperature.

Control: Additional functions with optional PCB (2 zone control, bivalent control, Smart Grid contact and more).

Connectivity: Optional Aquarea Smart and Service Cloud and integration into BMS projects.

			Three phase (Power to indoor)		
Kit			KIT-WQC09H3E8	KIT-WQC12H9E8	KIT-WQC16H9E8
Heating capacity / COP (A +7 °C, W 35 °C)		kW / COP	9,00/4,84	12,00/4,74	16,00/4,28
Heating capacity / COP (A +7 °C, W 55 °C)		kW / COP	9,00/2,94	12,00/2,88	16,00/2,71
Heating capacity / COP (A +2 °C, W 35 °C)		kW / COP	9,00/3,59	12,00/3,44	16,00/3,10
Heating capacity / COP (A +2 °C, W 55 °C)		kW / COP	9,00/2,21	12,00/2,19	16,00/2,13
Heating capacity / COP (A -7 °C, W 35 °C)		kW / COP	9,00/2,85	12,00/2,72	16,00/2,49
Heating capacity / COP (A -7 °C, W 55 °C)		kW / COP	9,00/2,02	12,00/1,92	16,00/1,86
Cooling capacity / EER (A 35 °C, W 7 °C)		kW / EER	7,00/3,17	10,00/2,81	12,20/2,57
Cooling capacity / EER (A 35 °C, W 18 °C)		kW / EER	7,00/5,19	10,00/5,13	12,20/3,49
Heating average climate (W 35 °C / W 55 °C)	Seasonal energy efficiency	ηs %	181/130	170/130	160/125
	SCOP		4,59/3,32	4,32/3,32	4,08/3,20
Heating warm climate (W 35 °C / W 55 °C)	Seasonal energy efficiency	ηs %	235/158	231/158	231/159
	SCOP		5,95/4,02	5,86/4,02	5,86/4,05
Heating cold climate (W 35 °C / W 55 °C)	Seasonal energy efficiency	ηs %	160/125	160/125	150/125
	SCOP		4,08/3,20	4,08/3,20	3,83/3,20
Energy class		A+++ to D	A+++ / A+++	A++ / A++	A+++ / A+++
			A+++ / A+++	A++ / A++	A+++ / A+++
Indoor unit			WH-SQC09H3E8	WH-SQC12H9E8	WH-SQC16H9E8
Sound pressure	Heat / Cool	dB(A)	33/33	33/33	33/33
Dimension	HxWxD	mm	892x500x340	892x500x340	892x500x340
Net weight		kg	43	44	45
Water pipe connector		Inch	R 1½	R 1½	R 1½
A class pump	Number of speeds		Variable Speed	Variable Speed	Variable Speed
	Input power (Min/Max)	W	32/102	34/110	30/105
Heating water flow (ΔT=5 K, 35 °C)		L/min	25,8	34,4	45,9
Capacity of integrated electric heater		kW	3,00	9,00	9,00
Recommended fuse		A	15/30	15/30	15/30
Recommended cable size, supply 1 / 2		mm²	5x1,5/3x1,5	5x1,5/5x1,5	5x1,5/5x1,5
Outdoor unit			WH-UQ09HE8	WH-UQ12HE8	WH-UQ16HE8
Sound power ¹⁾	Heat	dB(A)	58	58	62
Dimension	HxWxD	mm	1410x1283x320	1410x1283x320	1410x1283x320
Net weight		kg	151	151	161
Refrigerant (R410A) / CO ₂ Eq.		kg / T	2,85/5,951	2,85/5,951	2,99/6,243
Piping diameter	Liquid / Gas	Inch (mm)	3/8(9,52)/5/8(15,88)	3/8(9,52)/5/8(15,88)	3/8(9,52)/5/8(15,88)
Pipe length range		m	3~30	3~30	3~30
Elevation difference (in / out)		m	20	20	20
Pipe length for additional gas		m	10	10	10
Additional gas amount		g/m	50	50	50
Operating range - outdoor ambient	Heat	°C	-28 ~ +35	-28 ~ +35	-28 ~ +35
	Cool	°C	+16 ~ +43	+16 ~ +43	+16 ~ +43
Water outlet	Heat / Cool	°C	20~60/5~20	20~60/5~20	20~60/5~20

1) Sound power in accordance to 811/2013, 813/2013 and EN12102-1:2017 at +7 °C. * EER and COP calculation is based in accordance to EN14511.

Accessories	
PAW-TD20C1E5	Tank 200 L - Stainless steel
PAW-TD30C1E5	Tank 300 L - Stainless steel
PAW-TA20C1E5STD	Tank 200 L - Enamelled
PAW-TA30C1E5STD	Tank 300 L - Enamelled
PAW-3WYVLV-HW	3 way valve for DHW Tanks
CZ-NV1	3 way valve kit for inside of hydrokit
PAW-BTANK50L-2	Buffer tank 50 L

Accessories	
CZ-TAW1	Aquarea Smart Cloud for remote control and maintenance through wireless or wired LAN
CZ-TAW1-CBL	10 m extension cable for CZ-TAW1
CZ-NS4P	Additional functions PCB
PAW-A2W-MGTFILTER	Magnet for the water filter
PAW-A2W-RTWIRED	Room thermostat
PAW-A2W-RTWIRELESS	Wireless LCD room thermostat



INTERNET CONTROL: Optional. GOOD DESIGN AWARD 2017: Indoor units All in One and Bi-bloc J and H Generation awarded with the prestigious Good Design Award 2017.



011-1W0463
011-1W0464
For 9 and 12 kW
single and three
phase.



Aquarea T-CAP Mono-bloc J Generation Single phase / Three phase. Heating and Cooling - MXC · R32

Energy efficiency: A+++ in heating at 35 °C / "A" water pump with variable speed / Built-in flow meter.

Flexibility: Built-in magnetic water filter.

Comfort: Constant capacity and operating range down to -20 °C / 65 °C water outlet temperature.

Control: Additional functions with optional PCB (2 zone control, bivalent control, Smart Grid contact and more).

Connectivity: Optional Aquarea Smart and Service Cloud and integration into BMS projects.

Outdoor unit	Single phase			Three phase			
	WH-MXC09J3E5	WH-MXC12J6E5	WH-MXC09J3E8	WH-MXC12J9E8	WH-MXC16J9E8		
Heating capacity / COP (A +7 °C, W 35 °C)	kW / COP	9,00/5,08	12,00/4,80	9,00/5,08	12,00/4,80	16,00/4,52	
Heating capacity / COP (A +7 °C, W 55 °C)	kW / COP	9,00/3,08	12,00/3,05	9,00/3,08	12,00/3,05	16,00/2,86	
Heating capacity / COP (A +2 °C, W 35 °C)	kW / COP	9,00/3,81	12,00/3,53	9,00/3,81	12,00/3,53	16,00/3,10	
Heating capacity / COP (A +2 °C, W 55 °C)	kW / COP	9,00/2,54	12,00/2,42	9,00/2,54	12,00/2,42	16,00/2,07	
Heating capacity / COP (A -7 °C, W 35 °C)	kW / COP	9,00/3,08	12,00/2,82	9,00/3,08	12,00/2,82	16,00/2,39	
Heating capacity / COP (A -7 °C, W 55 °C)	kW / COP	9,00/2,12	12,00/2,00	9,00/2,12	12,00/2,00	16,00/1,71	
Cooling capacity / EER (A 35 °C, W 7 °C)	kW / EER	9,00/3,18	12,00/2,90	9,00/3,09	12,00/2,84	14,50/2,84	
Cooling capacity / EER (A 35 °C, W 18 °C)	kW / EER	9,00/4,62	12,00/3,95	9,00/4,46	12,00/3,79	16,00/3,75	
Heating average climate (W 35 °C / W 55 °C)	Seasonal energy efficiency	ηs %	195/140	195/140	195/140	176/129	
	SCOP		4,96/3,57	4,96/3,57	4,96/3,57	4,46/3,31	
Heating warm climate (W 35 °C / W 55 °C)	Seasonal energy efficiency	ηs %	256/171	256/171	256/171	232/160	
	SCOP		6,47/4,34	6,47/4,34	6,47/4,34	5,88/4,09	
Heating cold climate (W 35 °C / W 55 °C)	Seasonal energy efficiency	ηs %	169/127	169/127	169/127	150/125	
	SCOP		4,31/3,26	4,31/3,26	4,31/3,26	3,83/3,20	
Sound power ¹⁾	Heat	dB(A)	65	65	65	66	
	HxWxD	mm	1410x1283x320	1410x1283x320	1410x1283x320	1410x1283x320	
Net weight	kg	140	140	140	140	150	
Refrigerant (R32) / CO ₂ Eq. ²⁾	kg / T	1,60/1,080	1,60/1,080	1,60/1,080	1,60/1,080	1,80/1,215	
Water pipe connector	Inch	R 1½	R 1½	R 1½	R 1½	R 1½	
Pump	Number of speeds	Variable Speed	Variable Speed	Variable Speed	Variable Speed	Variable Speed	
	Input power (Min/Max)	W	32/173	34/173	32/173	34/173	38/173
Heating water flow (ΔT=5 K, 35 °C)	L/min	25,8	34,4	25,8	34,4	45,9	
Capacity of integrated electric heater	kW	3,00	6,00	3,00	9,00	9,00	
Input power	Heat	kW	1,77	2,50	1,77	2,50	3,54
	Cool	kW	2,83	4,14	2,91	4,23	5,11
Running and starting current	Heat	A	8,3	11,6	2,6	3,7	5,3
	Cool	A	13,1	19,1	4,3	6,3	7,6
Current 1	A	29,0	29,0	14,7	11,8	16,4	
Current 2	A	13,0	26,0	13,0	13,0	13,0	
Recommended fuse, supply 1 / 2	A	30/30	30/30	20/16	20/20	20/20	
Recommended cable size, supply 1 / 2	mm ²	3x4,0 or 6,0/3x4,0	3x4,0 or 6,0/3x4,0	5x1,5/3x1,5	5x1,5/5x1,5	5x2,5/5x1,5	
Operating range - outdoor ambient	Heat	°C	-20 ~ +35	-20 ~ +35	-20 ~ +35	-20 ~ +35	
	Cool	°C	10 ~ +43	10 ~ +43	10 ~ +43	10 ~ +43	
Water outlet ³⁾	Heat	°C	20 ~ 65	20 ~ 65	20 ~ 65	20 ~ 65	
	Cool	°C	5 ~ 20	5 ~ 20	5 ~ 20	5 ~ 20	

1) Sound power in accordance to 811/2013, 813/2013 and EN12102-1:2017 at +7 °C. 2) WH-MXC models are hermetically sealed. 3) It is possible to set temperature by 65 °C on remote controller. Normally, outlet water temperature is 60 °C or lower. In case of AT setting with remote controller is 15 °C and the outdoor ambient temperature is 5 to 20 °C, outlet water temperature 65 °C is possible. * EER and COP calculation is based in accordance to EN14511.

Accessories

PAW-TD20C1E5	Tank 200 L - Stainless steel
PAW-TD30C1E5	Tank 300 L - Stainless steel
PAW-TA20C1E5STD	Tank 200 L - Enamelled
PAW-TA30C1E5STD	Tank 300 L - Enamelled
PAW-TD20B8E3-2	Combo Tank 185 L + 80 L - Enamelled
PAW-TD23B6E5	Combo Tank 230 L + 60 L - Stainless Steel
PAW-3WYVLV-HW	3 way valve for DHW Tanks
PAW-BTANK50L-2	Buffer tank 50 L

Accessories

CZ-TAW1	Aquarea Smart Cloud for remote control and maintenance through wireless or wired LAN
CZ-TAW1-CBL	10 m extension cable for CZ-TAW1
PAW-A2W-AFVLV	1 anti-freeze valve. It is required to order 2 valves per system
PAW-A2W-RTWIRED	Room thermostat
PAW-A2W-RTWIRELESS	Wireless LCD room thermostat

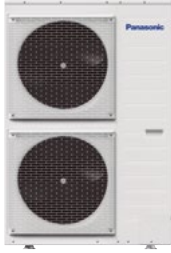

INTERNET CONTROL: Optional.

**Aquarea HT Bi-bloc F Generation Single phase / Three phase. Heating Only - SHF · R407C****Energy efficiency:** "A" water pump with variable speed.**Comfort:** Operating range down to -20 °C outdoor temperature / 65 °C water outlet temperature

Kit	Single phase (Power to indoor)		Three phase (Power to indoor)			
	KIT-WHF09F3E5	KIT-WHF12F6E5	KIT-WHF09F3E8	KIT-WHF12F9E8		
Heating capacity / COP (A +7 °C, W 35 °C)	kW / COP	9,00/4,64	12,00/4,46	9,00/4,64	12,00/4,46	
Heating capacity / COP (A +7 °C, W 65 °C)	kW / COP	9,00/2,48	12,00/2,41	9,00/2,48	12,00/2,41	
Heating capacity / COP (A +2 °C, W 35 °C)	kW / COP	9,00/3,45	12,00/3,26	9,00/3,45	12,00/3,26	
Heating capacity / COP (A +2 °C, W 65 °C)	kW / COP	9,00/2,06	10,30/2,01	9,00/2,06	10,30/2,01	
Heating capacity / COP (A -7 °C, W 35 °C)	kW / COP	9,00/2,74	12,00/2,52	9,00/2,74	12,00/2,52	
Heating capacity / COP (A -7 °C, W 65 °C)	kW / COP	9,00/1,79	9,60/1,77	9,00/1,79	9,60/1,77	
Heating average climate (W 35 °C / W 55 °C)	Seasonal energy efficiency	ηs %	153/125	150/125	153/125	150/125
	SCOP	3,90/3,20	3,82/3,21	3,90/3,20	3,82/3,21	
Heating warm climate (W 35 °C / W 55 °C)	Seasonal energy efficiency	ηs %	191/156	188/156	191/156	188/156
	SCOP	4,84/3,97	4,77/3,97	4,84/3,97	4,77/3,97	
Heating cold climate (W 35 °C / W 55 °C)	Seasonal energy efficiency	ηs %	137/116	134/113	137/116	134/113
	SCOP	3,50/2,97	3,42/2,90	3,50/2,97	3,42/2,90	
Energy class	A+++ to D	A++/A++	A++/A++	A++/A++	A++/A++	
	A+++ to D	A+++/A+++	A+++/A+++	A+++/A+++	A+++/A+++	
Energy class	A+++ to D	A+/A+	A+/A+	A+/A+	A+/A+	
	A+++ to D	A+/A+	A+/A+	A+/A+	A+/A+	
Indoor unit		WH-SHF09F3E5	WH-SHF12F6E5	WH-SHF09F3E8	WH-SHF12F9E8	
Sound pressure	dB(A)	33	33	33	33	
Dimension	H x W x D	892 x 502 x 353	892 x 502 x 353	892 x 502 x 353	892 x 502 x 353	
Net weight	kg	46	47	47	48	
Water pipe connector	Inch	R 1½	R 1½	R 1½	R 1½	
A class pump	Number of speeds	7	7	7	7	
	Input power (Min/Max)	W	38/100	40/106	38/100	40/106
Heating water flow (ΔT=5 K, 35 °C)	L/min	25,8	34,4	25,8	34,4	
Capacity of integrated electric heater	kW	3,00	6,00	3,00	9,00	
Recommended fuse	A	30/30	30/30	30/16	30/16	
Recommended cable size, supply 1 / 2	mm²	3 x 4,0 or 6,0 / 3 x 4,0	3 x 4,0 or 6,0 / 3 x 4,0	5 x 1,5 / 3 x 1,5	5 x 1,5 / 5 x 1,5	
Outdoor unit		WH-UH09FE5	WH-UH12FE5	WH-UH09FE8	WH-UH12FE8	
Sound power ¹⁾	dB(A)	—	—	—	—	
Dimension	H x W x D	1340 x 900 x 320	1340 x 900 x 320	1340 x 900 x 320	1340 x 900 x 320	
Net weight	kg	104	104	110	110	
Refrigerant (R407C) / CO ₂ Eq.	kg / T	2,90/5,145	2,90/5,145	2,90/5,145	2,90/5,145	
Piping diameter	Liquid / Gas	Inch (mm)	3/8 (9,52) / 5/8 (15,88)	3/8 (9,52) / 5/8 (15,88)	3/8 (9,52) / 5/8 (15,88)	3/8 (9,52) / 5/8 (15,88)
Pipe length range	m	3-30	3-30	3-30	3-30	
Elevation difference (in / out)	m	20	20	20	20	
Pipe length for additional gas	m	10	10	10	10	
Additional gas amount	g/m	70	70	70	70	
Operating range	Outdoor ambient (Heat)	°C	-20 ~ +35	-20 ~ +35	-20 ~ +35	-20 ~ +35
Water outlet	Heat	°C	25 ~ 65	25 ~ 65	25 ~ 65	25 ~ 65

1) Sound power in accordance to 811/2013, 813/2013 and EN12102-1:2017 at +7 °C. * EER and COP calculation is based in accordance to EN14511.

Accessories

PAW-TD20C1E5	Tank 200 L - Stainless steel
PAW-TD30C1E5	Tank 300 L - Stainless steel
PAW-TA20C1E5STD	Tank 200 L - Enamelled
PAW-TA30C1E5STD	Tank 300 L - Enamelled

Accessories

PAW-3WYVLV-HW	3 way valve for DHW Tanks
PAW-BTANK50L-2	Buffer tank 50 L
PAW-A2W-RTWIRED	Room thermostat
PAW-A2W-RTWIRELESS	Wireless LCD room thermostat





Aquarea HT Mono-bloc G Generation Single phase. Heating Only - MHF - R407C

Energy efficiency: "A" water pump with variable speed.

Comfort: Operating range down to -20 °C outdoor temperature / 65 °C water outlet temperature

Single phase

Outdoor unit			WH-MHF09G3E5	WH-MHF12G6E5
Heating capacity / COP [A +7 °C, W 35 °C]		kW / COP	9,00/4,64	12,00/4,46
Heating capacity / COP [A +7 °C, W 65 °C]		kW / COP	9,00/2,48	12,00/2,41
Heating capacity / COP [A +2 °C, W 35 °C]		kW / COP	9,00/3,45	12,00/3,26
Heating capacity / COP [A +2 °C, W 65 °C]		kW / COP	9,00/2,06	10,30/2,01
Heating capacity / COP [A -7 °C, W 35 °C]		kW / COP	9,00/2,74	12,00/2,52
Heating capacity / COP [A -7 °C, W 65 °C]		kW / COP	9,00/1,79	9,60/1,77
Heating average climate (W 35 °C / W 55 °C)	Seasonal energy efficiency	η_s %	153/125	150/125
		SCOP	3,90/3,20	3,82/3,21
Heating warm climate (W 35 °C / W 55 °C)	Seasonal energy efficiency	η_s %	191/156	188/156
		SCOP	4,84/3,97	4,77/3,97
Heating cold climate (W 35 °C / W 55 °C)	Seasonal energy efficiency	η_s %	137/116	134/113
		SCOP	3,50/2,97	3,42/2,90
Sound power ¹⁾		dB(A)	—	—
Dimension	H x W x D	mm	1410 x 1283 x 320	1410 x 1283 x 320
Net weight		kg	151	151
Refrigerant (R407C) / CO ₂ Eq. ²⁾		kg / T	1,92/3,406	1,92/3,406
Water pipe connector		Inch	R1½	R1½
Pump	Number of speeds		7	7
	Input power (Min/Max)	W	—	—
Heating water flow [$\Delta T=5$ K, 35 °C]		L/min	25,8	34,4
Capacity of integrated electric heater		kW	3,00	6,00
Input power		kW	1,94	2,69
Running and starting current		A	9,3	12,8
Current 1		A	28,5	29,0
Current 2		A	13,0	26,0
Recommended fuse		A	30/30	30/30
Recommended cable size, supply 1 / 2		mm ²	3 x 4,0 or 6,0 / 3 x 4,0	3 x 4,0 or 6,0 / 3 x 4,0
Operating range	Outdoor ambient (Heat)	°C	-20 ~ +35	-20 ~ +35
Water outlet	Heat	°C	25 ~ 65	25 ~ 65

1) Sound power in accordance to 811/2013, 813/2013 and EN12102-1:2017 at +7 °C. 2) WH-MHF models are hermetically sealed. * EER and COP calculation is based in accordance to EN14511.

Accessories

PAW-TD20C1E5	Tank 200 L - Stainless steel
PAW-TD30C1E5	Tank 300 L - Stainless steel
PAW-TA20C1E5STD	Tank 200 L - Enamelled
PAW-TA30C1E5STD	Tank 300 L - Enamelled
PAW-TD20B8E3-2	Combo Tank 185 L + 80 L - Enamelled
PAW-TD23B6E5	Combo Tank 230 L + 60 L - Stainless Steel

Accessories

PAW-3WYVLV-HW	3 way valve for DHW Tanks
PAW-BTANK50L-2	Buffer tank 50 L
PAW-A2W-AFVLV	1 anti-freeze valve. It is required to order 2 valves per system
PAW-A2W-RTWIRED	Room thermostat
PAW-A2W-RTWIRELESS	Wireless LCD room thermostat



Fan coils highlighted features

Available in a wide range of designs, the fan coils are perfectly adapted to fit within almost any location.



MORE FAN COIL OPTIONS
IN CHILLERS SECTION



1 Innovation for optimum comfort

Range of fan coil for heating and cooling with capacities from 0,2 to 9,6 kW in cooling and from 0,2 to 13,6 kW in heating. Bring full year comfort with water based systems.

2 Energy efficient and low noise fan

Dynamically balanced and specially designed fans, reinforced acoustic insulation and optimised fan speed staging for lower noise levels. Improved efficiency with optional EC fan motor.

3 Quality and efficient coil

Constructed from staggered copper tubes, mechanically expanded into aluminium fins, providing maximum heat transfer efficiency, durability and hygiene.

4 Flexible installation

Various types of unit to fit your needs with flexible installation options. A choice of service side for hydraulic connections, piping configuration and horizontal or vertical installation for ducted units.

Offering a great range of capacities and performance, available in a wide range of designs, the fan coils are perfectly adapted to fit within almost any location. Whether the requirements are for cooling only, or for both heating and cooling, there is a fan coil to suit. With a variety of piping and fan configuration, the range is capable of meeting the most stringent of requirements. Line up available in AC and EC fans, it is possible to achieve both powerful performance, but with sustainability in mind.

Controllers with sophisticated designs, provide a user friendly interface while enabling an easy and low cost integration to building management systems.



PAW-FC-RC1

Optional wired remote controller for AC fan, 2-pipe and 4-pipe application.



PAW-FC-TC903

Optional wired remote controller for AC fan 2-pipe application.



PAW-FC-907TC

Optional wired remote controller for EC fan, 2-pipe and 4-pipe application.

Smart fan coils

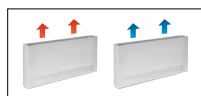

Built-in advanced thermostat.

			PAW-AAIR-200-2	PAW-AAIR-700-2	PAW-AAIR-900-2
Total cooling capacity	Lo/Med/Hi	kW	0,2/0,3/0,6	0,8/1,0/1,2	1,2/1,5/1,7
Sensible cooling capacity	Lo/Med/Hi	kW	0,2/0,3/0,5	0,6/0,9/1,1	1,1/1,4/1,6
Water flow	Lo/Med/Hi	kg/h	40,0/59,0/95,0	129,0/178,0/207,0	198,0/261,0/300,0
Water pressure drop	Lo/Med/Hi	kPa	0,4/2,0/2,9	1,0/2,0/2,0	6,0/9,0/12,0
Inlet water temperature		°C	10	10	10
Outlet water temperature		°C	15	15	15
Inlet air temperature		°C	27,0	27,0	27,0
Outlet air temperature	Lo/Med/Hi	°C	15,0/17,0/18,0	14,0/16,0/17,0	16,0/17,0/18,0
Relative humidity of inlet air		%	47	47	47
Total heating capacity	Lo/Med/Hi	kW	0,2/0,5/0,6	0,7/1,0/1,2	0,9/1,4/1,7
Water flow	Lo/Med/Hi	kg/h	37,3/80,8/98,0	121,8/177,5/204,3	152,4/244,2/292,9
Water pressure drop	Lo/Med/Hi	kPa	0,4/2,0/2,9	0,3/0,8/1,0	0,5/1,6/2,2
Inlet water temperature		°C	35	35	35
Outlet water temperature		°C	30	30	30
Inlet air temperature		°C	19,0	19,0	19,0
Outlet air temperature	Lo/Med/Hi	°C	38,9/32,0/30,0	33,3/31,8/30,6	30,2/31,1/30,6
Air flow	Lo/Med/Hi	m ³ /min	0,9/1,9/2,7	2,6/4,2/5,3	4,1/6,1/7,7
Maximum input power	Lo/Med/Hi	W	7,0/9,0/13,0	14,0/18,0/22,0	16,0/20,0/24,0
Sound pressure	Lo/Med/Hi	dB(A)	23/33/40	24/36/42	25/36/44
Dimension (HxWxD)		mm	735x579x129	935x579x129	1135x579x129
Net weight		kg	17	20	23
3 Ways valve included			Yes	Yes	Yes
Touch screen thermostat			Yes	Yes	Yes

* Smart fan coils is produced by Innova.

Accessories

PAW-AAIR-LEGS-1 Kits of 2 legs to protect the water pipings

Accessories

PAW-AAIR-RHCABLE Motor connection cable for units with hydraulic connections on the right

Stylish floor-standing fan coils with advanced controller

The slimline of Smart fan coils delivers high efficiency climate control.

With a depth of just under 130 mm they are at the cutting edge of the market. Blending easily into the home, Smart fan coil's elegant design and product refinements are clear to see in every detail.

Exceptional ventilation efficiency means the motor uses considerably less energy (low wattage). The fan speed is continuously modulated by the temperature controller with proportional integral logic, with undoubted advantages for regulating the temperature and humidity in summer mode.

Technical focus

- 4 operation modes (auto, silent, night-time and maximum ventilation speed)
- Exclusive design
- Extremely compact (only 129 mm deep)
- Cooling and dehumidification functions possible (drain is needed)
- 3-way valve included (no overflow valve needed on the installation if more than 3 units installed)
- Touch screen thermostat

With standard cast radiators.

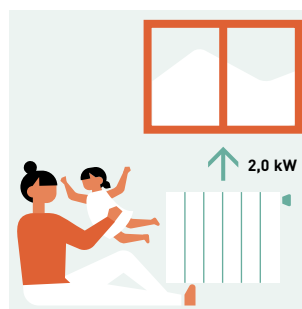

Water at 65 °C needed.

With Smart fan coil.

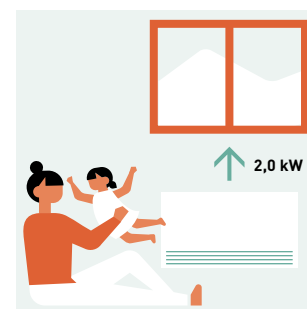

Water at 35 °C needed.

All temperature curves and capacity are available on www.panasonicproclub.com

PRO Club





Fan coils - ducted (AC)



Optional controller.
Wired remote controller.
PAW-FC-903TC



Optional controller.
Advanced wired remote controller.
PAW-FC-RC1

Left connection (PAW-)			FC2A-D010L	FC2A-D020L	FC2A-D030L	FC2A-D040L	FC2A-D050L	FC2A-D060L	FC2A-D070L	FC2A-D080L
Right connection (PAW-)			FC2A-D010R	FC2A-D020R	FC2A-D030R	FC2A-D040R	FC2A-D050R	FC2A-D060R	FC2A-D070R	FC2A-D080R
Total cooling capacity ¹⁾	Lo/Med/Hi	kW	0,7/1,0/1,5	0,7/1,2/1,7	1,0/2,0/2,5	1,2/2,4/3,2	1,7/3,2/4,6	2,7/4,6/5,8	3,4/6,1/7,3	4,6/6,1/8,1
Sensible cooling capacity ¹⁾	Lo/Med/Hi	kW	0,5/0,8/1,1	0,6/0,9/1,3	0,8/1,5/1,9	0,9/1,8/2,3	1,2/2,2/3,3	1,9/3,3/4,5	2,4/4,3/5,1	3,4/4,6/6,3
Water flow	Lo/Med/Hi	l/h	124/172/250	127/213/289	172/341/430	206/413/547	296/544/798	466/784/1003	587/1058/1252	798/1048/1400
Water pressure drop	Lo/Med/Hi	kPa	10,7/19,5/39,2	1,9/3,9/6,3	6,3/19,3/28,8	5,4/17,1/28,0	7,5/22,8/46,9	13,9/37,4/60,2	4,8/15,4/21,5	11,9/19,3/32,5
Heating capacity ²⁾	Lo/Med/Hi	kW	0,9/1,4/2,0	0,9/1,5/2,2	1,3/2,4/3,1	1,4/2,9/4,0	2,1/4,1/5,7	3,1/5,3/7,1	4,3/7,9/9,3	5,9/8,1/11,6
Sound levels										
Global sound power	Lo/Med/Hi	dB(A)	33/40/49	31/43/50	30/45/52	30/44/51	34/46/56	38/51/58	43/56/61	50/55/64
Global sound pressure ³⁾	Lo/Med/Hi	dB(A)	24/31/40	22/34/41	21/36/43	21/35/42	25/37/47	29/42/49	34/47/52	41/46/55
Fan										
Number			1	1	1	2	2	2	2	3
Air flow	Lo/Med/Hi	m ³ /h	111/190/283	105/179/265	138/274/390	173/357/499	253/486/716	350/640/933	480/893/1064	660/936/1397
Maximum external pressure		Pa	55	55	65	85	85	115	125	70
Filter			G2	G2	G2	G2	G2	G2	G2	G2
Electrical data										
Power supply	Voltage	V	230	230	230	230	230	230	230	230
	Phase		Single phase	Single phase	Single phase	Single phase	Single phase	Single phase	Single phase	Single phase
	Frequency	Hz	50/60	50/60	50/60	50/60	50/60	50/60	50/60	50/60
Power consumption	Lo/Med/Hi	W	13/24/36	10/18/29	16/37/45	15/37/56	28/55/72	37/75/105	53/100/147	90/112/188
Water connections										
Type			Female gas threaded	Female gas threaded	Female gas threaded	Female gas threaded	Female gas threaded	Female gas threaded	Female gas threaded	Female gas threaded
Water connections		Inch	1/2	1/2	1/2	1/2	1/2	1/2	3/4	3/4
Dimension and weight										
Dimension	H x W x D	mm	220 x 570 x 430	220 x 570 x 430	220 x 730 x 430	220 x 938 x 430	220 x 1122 x 430	220 x 1307 x 430	220 x 1121 x 530	220 x 1316 x 530
Weight		kg	13	13	15	20	22	26	27	38

1) According to Eurovent standard. Air: 27 °C DB / 19 °C WB. Water in / out: 7 °C / 12 °C. 2) Air: 20 °C. Water in / out: 50 °C / 45 °C. 3) The sound pressure levels are based on (NR) characteristics of a room having volume of 100 m³ with reverberation of 0,5 seconds.

Values indicated are for 0 Pa external static pressure, for additional pressure characteristics, please refer the selection software. * Fan coil units are produced by Systemair.

Accessories

PAW-FC-RC1	Advanced wired remote controller for fan coil
PAW-FC-903TC	Wired remote controller for fan coil
PAW-FC-2WY-11/55-1	2 way valve + drain pan for models 010-060

Accessories

PAW-FC-2WY-65/90-1	2 way valve + drain pan for models 070-080
PAW-FC-3WY-11/55-1	3 way valve + drain pan for models 010-060
PAW-FC-3WY-65/90-1	3 way valve + drain pan for models 070-080

Technical focus

- Cooling capacity from 0,7 to 8,1 kW
- Heating capacity from 0,7 to 10,3 kW
- 5-speed AC fan motor(s)

Main features and accessories

- Left or right hand arrangements
- Ease of installation
- Very low acoustic levels
- 2 way or 3 way ON / OFF valves
- Auxiliary drain pan
- Air intake with removable grid
- G2 filter

Operating limits

Entering water temperature	From 5 to 90 °C
Indoor air temperature	From 5 to 32 °C



Fan coils - ducted (EC)

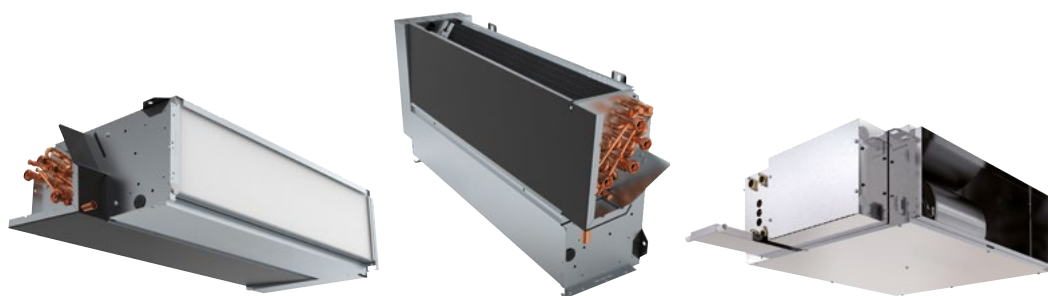

Optional controller.
Wired remote
controller for EC fans.
PAW-FC-907TC

Left connection (PAW-)			FC2E-D010L	FC2E-D020L	FC2E-D030L	FC2E-D040L	FC2E-D050L	FC2E-D060L	FC2E-D070L	FC2E-D080L	FC2E-F040L
Right connection (PAW-)			FC2E-D010R	FC2E-D020R	FC2E-D030R	FC2E-D040R	FC2E-D050R	FC2E-D060R	FC2E-D070R	FC2E-D080R	FC2E-F040R
Total cooling capacity ¹⁾	Lo/Med/Hi	kW	0,6/1,2/2,1	0,6/1,4/2,4	0,9/2,1/3,1	1,3/2,9/4,2	1,3/4,0/5,0	2,0/4,5/5,2	2,7/5,9/6,9	5,1/6,5/8,8	3,6/6,6/9,2
Sensible cooling capacity ¹⁾	Lo/Med/Hi	kW	0,5/1,1/1,9	0,5/1,1/1,9	0,6/1,6/2,4	1,0/2,1/3,0	1,1/3,0/3,7	1,4/3,5/4,0	2,0/4,3/5,2	3,7/4,8/6,6	2,9/6,1/9,1
Water flow	Lo/Med/Hi	l/h	107/210/356	110/237/406	148/354/532	230/506/722	231/685/743	341/767/800	463/1008/1098	879/1111/1254	627/1142/1575
Water pressure drop	Lo/Med/Hi	kPa	8,2/28,2/76,9	1,5/4,6/11,0	5,0/20,5/42,1	6,4/24,4/46,3	4,9/35,1/41,0	7,8/35,8/38,8	3,0/14,0/16,6	14,1/21,4/26,6	10,6/51,2/93,8
Heating capacity ²⁾	Lo/Med/Hi	kW	0,8/1,6/2,9	0,9/1,9/3,3	1,0/2,2/3,4	1,4/3,0/5,3	1,7/5,2/5,5	2,3/5,9/6,1	3,8/7,3/8,2	6,2/8,0/9,3	4,4/8,3/11,8
Sound levels											
Global sound power	Lo/Med/Hi	dB(A)	34/47/60	34/47/60	31/50/59	29/44/52	30/51/57	32/54/58	40/54/59	51/56/64	42/58/68 ³⁾
Global sound pressure ⁴⁾	Lo/Med/Hi	dB(A)	25/38/51	25/38/51	22/41/50	20/35/43	21/42/48	23/45/49	31/45/50	42/47/55	23/39/52
Fan											
Number			1	1	1	2	2	2	2	3	1
Air flow	Lo/Med/Hi	m ³ /h	108/228/417	98/234/413	145/380/585	170/412/678	203/645/816	245/737/912	350/850/1050	685/927/1398	592/1284/1935
Maximum external pressure		Pa	75	75	75	105	70	105	115	115	190
Filter			G2	G2	G2	G2	G2	G2	G2	G2	G2
Electrical data											
Power supply	Voltage	V	230	230	230	230	230	230	230	230	230
	Phase		Single phase	Single phase	Single phase	Single phase	Single phase	Single phase	Single phase	Single phase	Single phase
	Frequency	Hz	50/60	50/60	50/60	50/60	50/60	50/60	50/60	50/60	50/60
Power consumption	Lo/Med/Hi	W	5/11/41	5/13/41	4/16/42	2/13/43	4/24/46	2/30/54	11/44/77	23/42/108	11/62/197
Water connections											
Type			Female gas threaded	Female gas threaded	Female gas threaded	Female gas threaded	Female gas threaded	Female gas threaded	Female gas threaded	Female gas threaded	Female gas threaded
Water connections	Inch		1/2	1/2	1/2	1/2	1/2	1/2	3/4	3/4	3/4
Dimension and weight											
Dimension	HxWxD	mm	220 x 570 x 430	220 x 570 x 430	220 x 730 x 430	220 x 938 x 430	220 x 1122 x 430	220 x 1307 x 430	220 x 1121 x 530	220 x 1316 x 530	223 x 1233 x 653
Weight		kg	13	13	15	20	22	26	27	38	19

1) According to Eurovent standard. Air: 27 °C DB / 19 °C WB. Water in / out: 7 °C / 12 °C. 2) Air: 20 °C. Water in / out: 50 °C / 45 °C. 3) The sound power levels indicated are from return and radiated measurements. 4) The sound pressure levels are based on (NR) characteristics of a room having volume of 100 m³ with reverberation of 0,5 seconds.

Values indicated are for 0 Pa external static pressure, for additional pressure characteristics, please refer the selection software. * Fan coil units are produced by Systemair.

Accessories

PAW-FC-907TC	Wired remote controller for fan coil
PAW-FC-2WY-11/55-1	2 way valve + drain pan for models 010-060
PAW-FC-2WY-65/90-1	2 way valve + drain pan for models 070-080
PAW-FC-2WY-F040	2 way valve + drain pan for model F040

Accessories

PAW-FC-3WY-11/55-1	3 way valve + drain pan for models 010-060
PAW-FC-3WY-65/90-1	3 way valve + drain pan for models 070-080
PAW-FC-3WY-F040	3 way valve + drain pan for model F040

Technical focus

- Cooling capacity from 0,5 to 9,6 kW
- Heating capacity from 0,6 to 13,6 kW
- Low energy consumption EC fan(s)

Main features and accessories

- Left or right hand arrangements
- Can be installed both horizontally and vertically*
- Ease of installation
- Very low acoustic levels
- 2 way or 3 way ON / OFF valves
- Auxiliary drain pan
- Air intake with removable grid
- G2 filter

Operating limits

Entering water temperature	From 5 to 90 °C
Indoor air temperature	From 5 to 32 °C

* PAW-FC2E-F040 may only be installed horizontally.



Fan coils - wall-mounted (AC)



Optional controller.
Wired remote
controller.
PAW-FC-903TC



Optional controller.
Advanced wired
remote controller.
PAW-FC-RC1



Infrared remote
supplied with IR
versions.
IR Controller

2-pipe			PAW-FC2A-K007	PAW-FC2A-K009	PAW-FC2A-K018	PAW-FC2A-K022
			PAW-FC2A-K007IR	PAW-FC2A-K009IR	PAW-FC2A-K018IR	PAW-FC2A-K022IR
Total cooling capacity ¹⁾	Lo/Med/Hi	kW	1,0/1,3/1,7	1,6/1,7/2,4	2,8/3,0/3,5	2,9/3,1/3,9
Sensible cooling capacity ¹⁾	Lo/Med/Hi	kW	0,7/1,0/1,2	1,2/1,3/1,9	2,1/2,3/2,7	2,3/2,5/3,1
Water flow	Lo/Med/Hi	l/h	172/231/287	270/291/418	483/508/609	502/535/669
Water pressure drop	Lo/Med/Hi	kPa	18,6/24,9/30,9	18,5/27,0/40,0	34,6/41,3/55,6	37,2/33,7/45,2
Heating capacity ²⁾	Lo/Med/Hi	kW	1,4/1,7/2,0	1,7/2,0/2,7	2,9/3,2/4,0	3,1/3,7/4,4
Sound levels						
Sound power	Lo/Med/Hi	dB(A)	45/49/51	47/52/57	49/53/59	56/59/63
Sound pressure ³⁾	Lo/Med/Hi	dB(A)	32/36/38	34/39/44	40/43/46	43/46/50
Fan						
Number			1	1	1	1
Air flow	Lo/Med/Hi	m ³ /h	282/321/360	367/413/551	532/592/680	617/709/850
Filter			G1	G1	G1	G1
Electrical data						
Power supply	Voltage	V	230	230	230	230
	Phase		Single phase	Single phase	Single phase	Single phase
	Frequency	Hz	50	50	50	50
Fuse rating		A	3	3	3	3
Power consumption	Lo/Med/Hi	W	39/42/62	30/47/59	44/50/55	50/55/70
Water connections						
Type			Female gas threaded	Female gas threaded	Female gas threaded	Female gas threaded
Water connections		Inch	1/2	1/2	1/2	1/2
Dimension and weight						
Dimension	HxWxD	mm	275 x 180 x 845	275 x 180 x 845	298 x 200 x 940	298 x 200 x 940
Weight		kg	11	11	13	13

1) According to Eurovent standard. Air: 27 °C DB / 19 °C WB. Water in / out: 7 °C / 12 °C. 2) According to Eurovent standard. Air: 20 °C. Water in / out: 45 °C / 40 °C. 3) Sound pressure considering a local of 100 m³ a reverberation time of 0,5 seconds and a distance of 1 m.

Accessories	
PAW-FC-RC1	Advanced wired remote controller for fan coil
PAW-FC-903TC	Wired remote controller for fan coil

Accessories	
PAW-FC2-2WY-K007	2 way valve
PAW-FC2-3WY-K007	3 way valve

Technical focus

- 4 sizes
- Cooling capacity from 1,0 to 3,9 kW
- Heating capacity from 1,4 to 4,1 kW
- Version: 2-pipes, AC fan

Main features and accessories

- 2 way or 3 way valve ON / OFF
- 3-speed AC fan motor
- Silent unit for optimum customer comfort
- Aesthetic design suitable for residential and hotel applications
- Compatible with IR controller (supplied with IR versions)
- Coil with hydrophilic fins to improve the condensate flow

Operating limits	
Entering water temperature	From 5 to 60 °C
Indoor air temperature	From 6 to 40 °C



Wired controllers for AC and EC fan coils

Advanced wired remote controller (AC)

PAW-FC-RC1

This advanced controller provides a higher level of comfort in heating. The sensor can be used as a water flow sensor, stopping the fan when the water temperature is low, avoiding cold drafts in winter.

Features:

- For 2-pipe and 4-pipe, AC fan
- Change Over function (cold draft prevention)
- Room thermostat
- 3 outputs, 230 V relays for fan control
- 2 outputs, 230 V relays for heating / cooling control
- Connection to BMS - Modbus RTU slave
- 1 DI for presence detection (key card switch)
- 1 AI for sensor



Wired remote controller (EC)

PAW-FC-907TC

Stylish and sophisticated design with backlit LCD display, is suitable for installation within a wide variety of locations such as office, hotel and residential applications. By connecting the controller to the range of EC fan coils, the user can take advantage of the improved performance, higher levels of efficiency and thus improved energy savings.

Features:

- For 2-pipe and 4-pipe, EC fan
- Back lit LCD screen with touch control
- Adjustable range EC fan control
- Economiser
- Connection to BMS via Modbus
- 1 DI for presence detection (key card switch)



Wired remote controller (AC)

PAW-FC-903TC

Feature rich and perfectly adapted to control AC fan coils, the PAW-FC-903TC is the ideal addition for any fan coil. With intuitive user interface provided by the push button control and large LCD display, it will fit seamlessly with almost any location.

Features:

- For 2-pipe, AC fan
- Back lit LCD screen
- 3 speed control relay, for fan
- Economizer



Sanitary Tanks

Combo tanks.

The best option to combine with Mono-bloc units. DHW tank with buffer tank. Designed for retrofit applications, the DHW tank with a buffer tank is particularly suitable for fast integration on an existing installation. Easy to install, nice looking, high efficiency for DHW production and for heating.

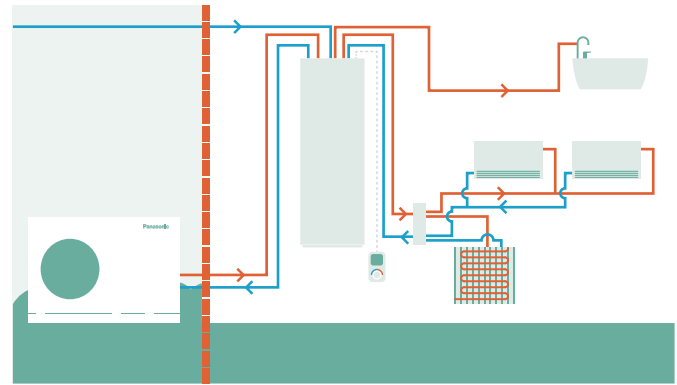

Type		Enamelled		Stainless steel	
Reference		PAW-TD20B8E3-2		PAW-TD23B6E5	
Dimension HxWxD	mm	1770 x 640 x 690		1750 x 600 x 646	
Weight (empty)	kg	150		111	
Volume	L	185 + 80		230 + 60	
Power supply	V, Phase, Hz	230, 1, 50		230, 1, 50	
		Hot water tank	Buffer tank	Hot water tank	Buffer tank
Volume	L	185	80	230	60
Max working pressure	MPa (bar)	0,8 (8)	0,6 (6)	1,0 (10)	0,3 (3,0)
Pressure test	MPa (bar)	1,2 (12)	0,9 (9)	1,5 (15)	0,39 (3,9)
Max working temp	°C	90	90	80	80
Connections	mm	Ø22	Ø22	Ø22	Ø22, copper
Material		S 275 JR vitrified		EN 14521	
Insulation	Material, t=mm	PUR, 50	PUR 40	PUR, 50	PUR, 50
Heating coil surface	m ²	2,1	—	1,8	—
Electrical heater	W	3000	—	2800	—
Energy loss at 65 °C ¹⁾	kWh/24h	1,3	—	1,25	—
Energy efficiency class (from A+ to F) ²⁾		B	B	B	A
Standing loss	W	53	46	52	29

1) Tested pursuant to EN 12897:2006. 2) EU Regulation 812/2013. * Enamelled Combo Tank is produced by Lapesa. Stainless Steel Combo Tank is produced by OSO.



Buffer tanks.

Reference		PAW-BTANK50L-2	PAW-BTANK100L	PAW-BTANK200L	PAW-BTANK300L
Capacity	L	48	100	199	289
Energy losses	W	35	55	50	66
Energy Efficiency Class (from A+ to F)		B	C	B	B
Material		Stainless Steel		Stainless Steel	Stainless Steel
Dimension (Height / Diameter)	mm	636 / 430		1275 / 595	1755 / 595
Net weight	kg	17	28	47	57

* Automatic air vent and drain cock are included. Built-in pocket sensor (sensor not included). ** Buffer Tank are produced by OSO.



Enamelled tanks.

Type	Enamelled Tank				Enamelled 2 coils Tank (for bivalent Solar + HP)	Square Tank	
	PAW-TA15C1E5STD	PAW-TA20C1E5STD	PAW-TA30C1E5STD	PAW-TA40C1E5STD	PAW-TA30C2E5STD	PAW-TA20C1E5C	
Reference							
Water volume	L	150	200	290	380	350	200
Maximum water temperature	°C	95	95	95	95	95	95
Dimension (Height / Diameter)	mm	1210/520	1340/610	1800/610	1835/670	1835/670	1550 x 600 x 600
Weight / filled with water	kg	109/254	90/280	120/389	191/572	169/519	134 / 327
Electric heater	kW	—	3,00	3,00	3,00	3,00	—
Power supply	V	—	230	230	230	230	—
Material inside tank		Enamelled	Enamelled	Enamelled	Enamelled	Enamelled	Enamelled
Exchange surface	m ²	1,2	1,8	2,6	3,8	3,5 / 1,2	1,83
Energy loss at 65 °C ¹⁾	kWh/24h	1,45	1,37	1,61	1,76	1,76	1,37
3 way valve accessory PAW-3WYVLV-HW or CZ-NV1		Optional	Optional	Optional	Optional	Optional	Built-in 3 way valve
20 m temperature sensor cable included		Yes	Yes	Yes	Yes	Yes	Yes
Energy losses	W	60	57	67	73	73	57
Energy Efficiency Class (from A+ to F)		C	B	B	B	B	B
Warranty of the inner vessel		5 Years	5 Years	5 Years	5 Years	5 Years	5 Years
Maintenance required		Every 2 years	Every 2 years	Every 2 years	Every 2 years	Every 2 years	Every 2 years

1) Insulated tested under EN12897. * Enamelled Tanks and Square Tank are produced by AEmail.



Stainless steel tanks.

Reference		PAW-TD20C1E5	PAW-TD30C1E5	PAW-TD30C1E5-HI
Water volume	L	192	284	280
Maximum water temperature	°C	75	75	75
Dimension (Height / Diameter)	mm	1270/595	1750/595	1750 / 595
Weight / filled with water	kg	50/—	61/—	65 / -
Electric heater	kW	1,5	1,5	1,5
Power supply	V	230	230	230
Material inside tank		Stainless steel	Stainless steel	Stainless steel
Exchange surface	m ²	1,8	1,8	2,35
Energy loss at 65 °C ¹⁾	kWh/24h	1,01	1,18	1,18
3 way valve accessory PAW-3WYVLV-HW or CZ-NV1		Optional	Optional	Optional
20 m temperature sensor cable included		Yes	Yes	Yes
Energy losses	W	42	49	49
Energy Efficiency Class (from A+ to F)		A	A	A
Warranty		2 Years	2 Years	2 Years
Maintenance required		No	No	No

1) Insulated tested under EN12897. * Stainless Steel Tanks are produced by OSO.

Accessories for sanitary tanks

PAW-3WYVLV-HW 3 way valve for DHW Tanks

Accessories for sanitary tanks

CZ-NV1 3 way valve kit for inside of hydrokit

Heat recovery ventilation unit

The heat recovery ventilation unit is design not only to provide a good indoor air quality, but it is also designed to recover heat that would otherwise be lost throughout ventilation. These heat recovery ventilation systems are used to assist in the retention of heat.

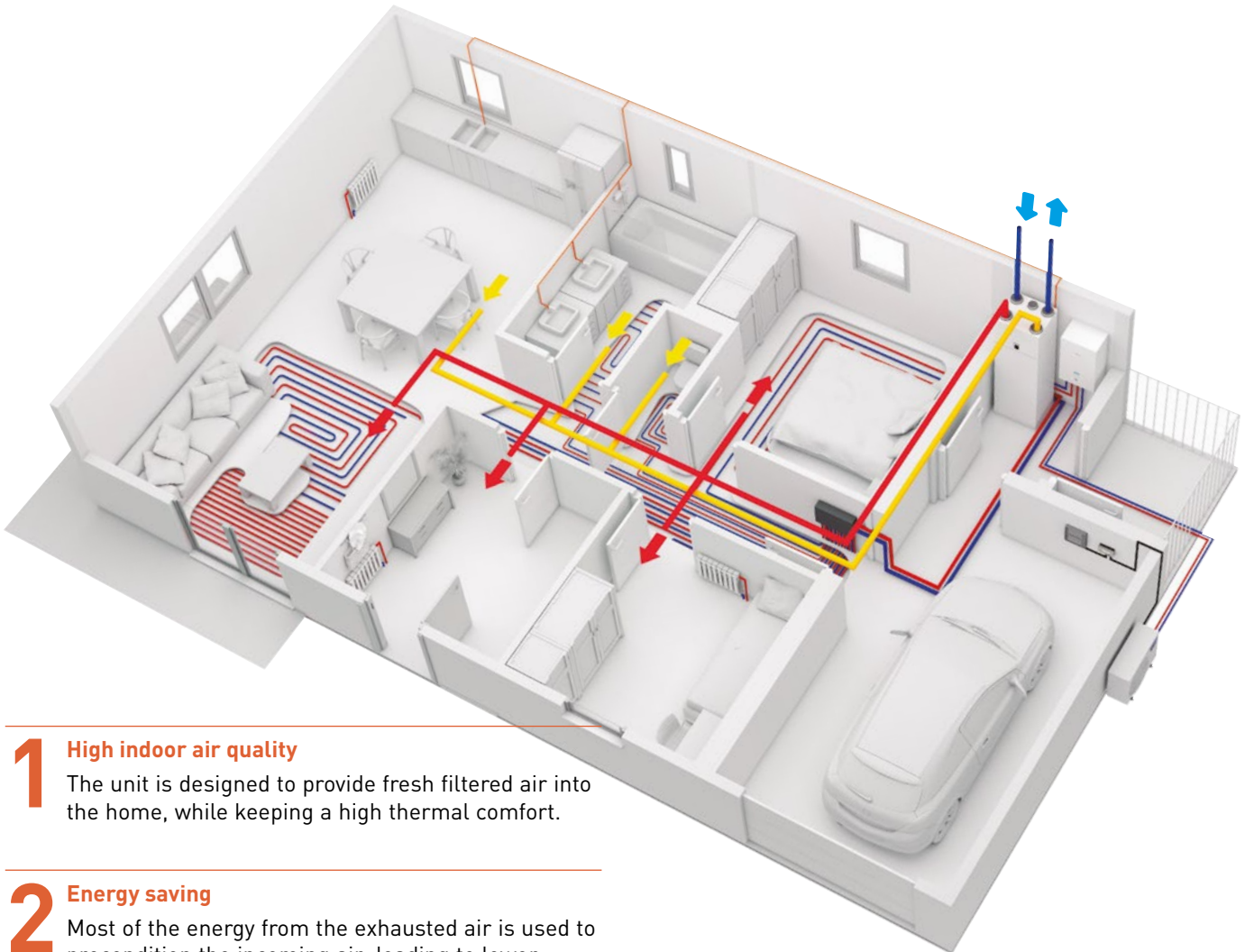

1 High indoor air quality
The unit is designed to provide fresh filtered air into the home, while keeping a high thermal comfort.

2 Energy saving
Most of the energy from the exhausted air is used to precondition the incoming air, leading to lower heating requirements in the building.

3 Space saving
The compact ventilation unit can be installed over the DHW square tank or the Aquarea All in One Compact indoor unit for an space-saving solution.

4 Better user interface
The Residential ventilation unit and the Aquarea Heat Pump can be controlled with one single user-friendly controller.

AQUAREA

Combine the Residential ventilation unit with Panasonic Aquarea for an space saving and highly efficient solution for heating, cooling, ventilation and DHW.



Heat Recovery Ventilation + Aquarea All in One Compact



Heat Recovery Ventilation + DHW Square Tank + Aquarea Mono-bloc



Heat Recovery Ventilation + DHW Square Tank + Aquarea Bi-bloc

* The unit can be mounted on a PAW-TA20C1E5C, on a WH-ADC0309J3E5C or installed on the wall (PAW-VEN-WBRK is needed).



PAW-A2W-VENTA-R



PAW-A2W-VENTA-L



Heat recovery Ventilation unit		PAW-A2W-VENTA-R	PAW-A2W-VENTA-L
Nominal air flow rate	m ³ /h	204 @ 50 Pa	
Maximum air flow rate	m ³ /h	292 @ 100 Pa	
SPF		1,24 @ 204 m ³ /h	
Heat exchanger rotor drive type		Variable speed	
Exchanger type		Rotating	
Heat recovery efficiency		84 %	
Power supply	V / Hz	230 / 50 / 1 phase	
Power consumption	W	176	
Energy Class, basic unit		A	
Energy Class, unit with local control on demand		A	
Noise level	dB(A)	40	
Dimension (W x H x D)	mm	598 x 450 x 500	
Weight	kg	46	
Mounting position		Vertical	
Supply side		Right	Left
Duct connections	mm	DN125	
Filter class, supply air		F7/ePM1 60 %	
Filter class, extract air		M5/ePM10 50 %	
Minimum outdoor temperature	°C	-20	

* Heat recovery efficiency according to EN 13141-7. ** Heat recovery Ventilation unit is produced by Systemair.

Accessories	
PAW-VEN-FLTKIT	Supply and extract filters kit
PAW-VEN-ACCPCB	Optional PCB for additional functions
PAW-VEN-DPL	HRV touch control panel. White frame (cable must be ordered separately)
PAW-VEN-CBLEXT12	Cable with plug for electrical connection between unit and control panel, type CE and CD (12 m)
PAW-VEN-DIVPLG	Twin plugs for installation of several control panels type CD or CE for one unit

Accessories	
PAW-VEN-DPLBOX	HRV touch control panel wall-mounted kit
PAW-VEN-S-CO2RH-W	CO ₂ RH wall-mounted sensor
PAW-VEN-S-CO2-W	CO ₂ wall-mounted sensor
PAW-VEN-S-CO2-D	CO ₂ duct sensor
PAW-VEN-WBRK	Wall bracket kit for stand-alone installation on the wall
PAW-VEN-HTR06	Electrical duct heater 0,6 kW (includes relay)
PAW-VEN-HTR12	Electrical duct heater 1,2 kW (includes relay)

Main features of the residential ventilation unit

- Designed for areas up to approximately 140 m²
- High energy-efficiency rotary heat exchanger with EC - technology fans
- Moisture transfer function to minimize condensation in supply air during wintertime
- The built in humidity sensor in extract air can be used for demand control

- Control via touch display and Startup Wizard for easy commissioning
- Modbus communication via RS-485
- Option to control an Aquarea H or J Generation heat pump from PAW-A2W-VENTA control panel (PAW-AW-MBS-H and PAW-VEN-ACCPCB required)

Control user-friendly interface

All settings and features accessible via a control panel, integrated into the front cover. The option for connecting one or more external control panels is available.

- Color touch screen with a user-friendly interface
- MANUAL and AUTO mode or choose preferred settings from the pre-configured user modes

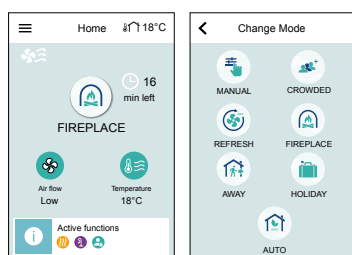

- If Aquarea J and H Generations heat pumps are connected with PAW-A2W-VENTA, the heat pump control options appear on the home screen in a separate tab

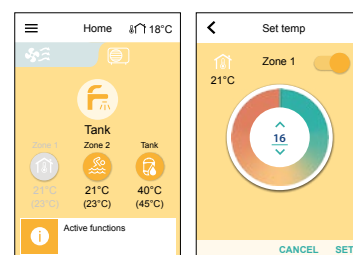

DHW Stand Alone

The wide range of DHW Stand Alone heat pump is a great solution to adapt to any type of family house.



DHW Stand Alone: highly efficient heat pump water heater.

The wall type is available in 100 and 150 L capacities, and the floor-standing in 200 and 270 L. For reaching even more efficient use the 270 L is available in additional coil, it is able to connect solar water production.

- A+ Highly efficient domestic hot water heat pump
- Provides reduced power consumption up to 72 % compared with traditional electric water heater
- Easy to install
- Being CFC-free, this water heater is environmentally friendly

1 Energy saving

- Digital control panel with energy consumption monitoring
- Photovoltaic function
- Compatible with ducted fresh air intake installations
- Boiler / Solar Coil (only PAW-DHW270C1F)

2 Comfort

- Different modes of operation based on user needs
- Mode AUTO: Intelligent Temperature Set Point, thanks to monitoring hot water usage
- Mode BOOST, Mode ECO and Mode ABSENCE

3 Durability

- Diamond-quality enamel lining the inner tank
- Pressure relief valve which provides safety if any malfunctions or pressure rise
- Dielectric union preventing corrosion
- Specific lip gasket preventing rust around the flange



Type	Wall-mounted			Floor-standing		
	Reference	PAW-DHW100W-1	PAW-DHW150W-1	PAW-DHW200F	PAW-DHW270F	PAW-DHW270C1F
Nominal capacity	L	100	150	200	270	263
Dimension (HxWxD)	mm	1209 x 522 x 538	1527 x 522 x 538	1617 x 620 x 665	1957 x 620 x 665	1957 x 620 x 665
Empty weight	kg	57	66	80	92	111
Hot and cold connection		¾" M	¾" M	¾" M	¾" M	¾" M
Anticorrosion system	Anode	Magnesium	Magnesium	Magnesium	Magnesium	Magnesium
Rated water pressure	Mpa (bar)	0,8 (8)	0,8 (8)	0,8 (8)	0,8 (8)	0,8 (8)
Electrical connection	V / Hz	230/50	230/50	230/50	230/50	230/50
Total maximum power	W	1550	1950	2300	2300	2300
Maximal power heat pump	W	350	350	700	700	700
Power electric heating element	W	1200	1600	1600	1600	1600
Heat pump water temperature range	°C	50 ~ 62	50 ~ 62	50 ~ 62	50 ~ 62	50 ~ 62
Heat pump air temperature range	°C	-5 ~ +43	-5 ~ +43	-5 ~ +43	-5 ~ +43	-5 ~ +43
Duct diameter	mm	125	125	160	160	160
Air flow (without duct)	m³/h	160	160	310/390	310/390	310/390
Load losses acceptable on ventilation circuit, without affecting performance	Pa	70	70	25	25	25
Sound power ¹⁾	dB(A)	45	45	53	53	53
Refrigerant R134a (wall-mounted) / R513A (floor-standing)	kg	0,52	0,58	0,80	0,86	0,86
Refrigerant volume in tons of CO ₂ equivalent	TCO ₂ Eq.	0,74	0,83	0,50	0,54	0,54
Refrigerant weight per liter	kg/L	0,0052	0,0039	0,0040	0,0032	0,0032
Hot water quantity at 40 °C: V40td	L	151,0	182,0	265,5	361,2	357,9
Acoustic power ErP ²⁾	dB(A)	45	45	53	53	53
Energy Efficiency Class (from A+ to F)		A+	A+	A+	A+	A+
Connectable to PV		Yes	Yes	Yes	Yes	Yes
Additional coil exchanger connection		—	—	—	—	1" M
Additional coil surface	m²	—	—	—	—	1,2
Warranty of the inner vessel		5 Years	5 Years	5 Years	5 Years	5 Years
Performance at 7 °C air temperature		[EN 16147] ducted at 25 Pa		[CDC LCIE 103-15/C] ducted at 30 Pa ³⁾		
Coefficient of performance [COP] according load profile		2,66 - M	3,05 - L	2,81 - L	3,16 - XL	3,05 - XL
Standby input power [P _{std}]	W	18	24	32	29	33
Heating up time (t _h)	h. Min	6h47	10h25	07h11	10h39	11h04
Reference hot water temperature [T _{ref}]	°C	52,7	53,2	52,7	53,1	52,9
Flow rate (air)	m³/h	140	110	320	320	320
Performance at 15 °C air temperature [EN 16147]						
Coefficient of performance [COP] according load profile		2,88 - M	3,28 - L	3,05 - L	3,61 - XL	3,44 - XL
Standby input power [P _{std}]	W	19	25	30	30	33
Heating up time (t _h)	h. Min	6h07	9h29	6h24	8h34	8h40
Reference hot water temperature [T _{ref}]	°C	52,6	53,4	52,8	53,0	53,1
Flow rate (air)	m³/h	140	110	320	320	320

1) According to ISO3744. 2) Compliant with EN 16147 conditions. 3) Performance measured for a water heater from 10 °C to T_{ref} according to the protocol of the NF Electricity Performance Mark specifications No.LCIE 103-15C, selfheating thermodynamic water heaters (based on standard EN 16147). * DHW Stand Alone is produced by S.A.T.E.

Accessories







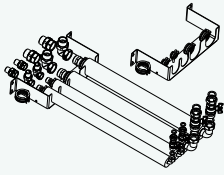

PAW-DHW-STAND Rack for suspended device for 100 and 150 liters models

Ideal for small surfaces

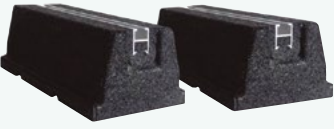
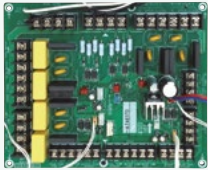
Suitable for all installations (adapted to small surfaces, low ceiling, corner).

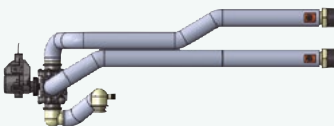

Accessories and control

All in One accessories	Special outdoor supports		
 <p>Flexible pipings and wall mounting plate for All in One J Generation (not compatible with WH-ADC0309J3E5C).</p> <p>-----</p> <p>PAW-ADC-PREKIT-1</p>	 <p>Tray for condenser water compatible with outdoor elevation platform.</p> <p>-----</p> <p>PAW-WTRAY</p>	 <p>Outdoor elevation platform. Dimension (HxWxD): 400 x 900 x 400 mm</p> <p>-----</p> <p>PAW-GRDSTD40</p>	 <p>Outdoor base ground support for noise and vibration absorption. Dimension (HxWxD): 600 x 95 x 130 mm Safe working load: 500 kg</p> <p>-----</p> <p>PAW-GRDBSE20</p>
PCB's for additional functions	Deice accessories		
 <p>PCB for advanced functions in J and H Generation.</p> <p>-----</p> <p>CZ-NS4P</p>	 <p>Base pan heater (for all old Bi-bloc and Mono-bloc, not for the 3 and 5 kW).</p> <p>-----</p> <p>CZ-NE1P</p>	<p>Base pan heater (for Bi-bloc 3 and 5 kW).</p> <p>-----</p> <p>CZ-NE2P</p>	<p>Base pan heater for J and H Generation.</p> <p>-----</p> <p>CZ-NE3P</p>
Hydraulic accessories			
 <p>3 way valve kit for inside of hydrokit.</p> <p>-----</p> <p>CZ-NV1</p>	 <p>3 way valve for DHW Tanks.</p> <p>-----</p> <p>PAW-3WYVLV-HW</p>	 <p>1 anti-freeze valve. It is required to order 2 valves per system.</p> <p>-----</p> <p>PAW-A2W-AFVLV</p>	 <p>Optional magnet for the water filter in H Generation models.</p> <p>-----</p> <p>PAW-A2W-MGTFILTER</p>



Connectivity Solutions



Aquaarea Smart Cloud for remote control and maintenance through wireless or wired LAN.

CZ-TAW1

10 m extension cable for CZ-TAW1.

CZ-TAW1-CBL



KNX Interface for J and H Generation.

PAW-AW-KNX-H



Modbus Interface for J and H Generation.

PAW-AW-MBS-H

Cascade manager



Cascade manager for Aquaarea Heat Pumps.

PAW-A2W-CMH-1

Room thermostats



Wired LCD room thermostat with weekly timer.

PAW-A2W-RTWIRED



Wireless LCD room thermostat with weekly timer.

PAW-A2W-RTWIRELESS

Sensors for Aquaarea J and H Generation



Outdoor ambient sensor.

PAW-A2W-TSOD



Zone room sensor.

PAW-A2W-TSRT



Zone water sensor.

PAW-A2W-TSHC



Solar sensor.

PAW-A2W-TSSO



Buffer tank sensor.

Zone water sensor PAW-A2W-TSHC is also required to operate buffer tank sensor.





PAW-A2W-TSBU

Accessories and control

Smart fan coil accessories



<p>Kits of 2 legs to protect the water pipings.</p> <p>-----</p> <p>PAW-AAIR-LEGS-1</p>	<p>Motor connection cable for units with hydraulic connections on the right.</p> <p>-----</p> <p>PAW-AAIR-RHCABLE</p>
--	--

Fan coil accessories

 <p>Wired remote controller for fan coil.</p> <p>-----</p> <p>PAW-FC-903TC</p>	 <p>Advanced wired remote controller for fan coil.</p> <p>-----</p> <p>PAW-FC-RC1</p>	 <p>Wired remote controller for EC fan coil.</p> <p>-----</p> <p>PAW-FC-907TC</p>	 <p>Infrared remote supplied with IR versions.</p> <p>-----</p> <p>IR Controller</p>
<p>2 way valve + drain pan for ducted models 010-060.</p> <p>-----</p> <p>PAW-FC-2WY-11/55-1</p>	<p>2 way valve + drain pan for ducted models 070-080.</p> <p>-----</p> <p>PAW-FC-2WY-65/90-1</p>	<p>2 way valve + drain pan for ducted model F040.</p> <p>-----</p> <p>PAW-FC-2WY-F040</p>	<p>2 way valve for wall-mounted.</p> <p>-----</p> <p>PAW-FC2-2WY-K007</p>
<p>3 way valve + drain pan for ducted models 010-060.</p> <p>-----</p> <p>PAW-FC-3WY-11/55-1</p>	<p>3 way valve + drain pan for ducted models 070-080.</p> <p>-----</p> <p>PAW-FC-3WY-65/90-1</p>	<p>3 way valve + drain pan for ducted model F040.</p> <p>-----</p> <p>PAW-FC-3WY-F040</p>	<p>3 way valve for wall-mounted.</p> <p>-----</p> <p>PAW-FC2-3WY-K007</p>

Sanitary Tank accessories

DHW Stand Alone accessories

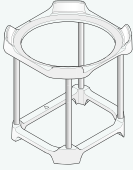
 <p>Tank sensor with 6 m cable length.</p> <p>-----</p> <p>PAW-TS1</p> <p>Tank sensor with 20 m cable length.</p> <p>-----</p> <p>PAW-TS2</p> <p>Tank sensor with 6 m cable length and only 6 mm diameter.</p> <p>-----</p> <p>PAW-TS4</p>	 <p>Temperature sensor kit for third party tank (with copper pocket and 6 m length sensor cable).</p> <p>-----</p> <p>CZ-TK1</p>	 <p>Rack for suspended device for 100 and 150 liters models.</p> <p>-----</p> <p>PAW-DHW-STAND</p>
--	--	--



Heat recovery Ventilation accessories



Supply and extract filters kit.

PAW-VEN-FLTKit



Optional PCB for additional functions.

PAW-VEN-ACCPCB



HRV touch control panel. White frame (cable must be ordered separately).

PAW-VEN-DPL



Cable with plug for electrical connection between unit and control panel, type CE and CD (12 m).

PAW-VEN-CBLEXT12



Twin plugs for installation of several control panels type CD or CE for one unit.

PAW-VEN-DIVPLG



HRV touch control panel wall-mounted kit.

PAW-VEN-DPLBOX



CO₂ RH wall-mounted sensor.

PAW-VEN-S-CO2RH-W



CO₂ wall-mounted sensor.

PAW-VEN-S-CO2-W



CO₂ duct sensor.

PAW-VEN-S-CO2-D

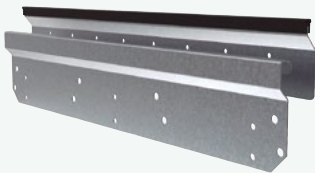

Wall bracket kit for stand-alone installation on the wall.

PAW-VEN-WBRK



Electrical duct heater 0,6 kW (includes relay).

PAW-VEN-HTR06



Electrical duct heater 1,2 kW (includes relay).

PAW-VEN-HTR12



Heating and cooling capacity tables

Based on outlet temperature and outside temperature.

Aquarea High Performance Bi-bloc J Generation Single phase. Heating and Cooling - R32

WH-UD03JE5

Tamb	HC	IP	COP	HC	IP	COP	HC	IP	COP	HC	IP	COP	HC	IP	COP
LWC	25	25	25	35	35	35	45	45	45	55	55	55	60	60	60
-20	2,50	1,11	2,25	2,52	1,31	1,92	2,24	1,59	1,41	2,12	1,80	1,18	—	—	—
-15	3,00	1,14	2,63	3,20	1,37	2,34	3,00	1,62	1,85	2,75	1,92	1,43	—	—	—
-7	2,99	0,91	3,29	3,30	1,18	2,80	3,25	1,47	2,21	3,20	1,79	1,79	3,00	1,88	1,60
2	2,92	0,69	4,23	3,20	0,88	3,64	3,20	1,13	2,83	3,20	1,46	2,19	3,15	1,67	1,89
7	3,09	0,49	6,31	3,20	0,60	5,33	3,20	0,84	3,81	3,20	1,14	2,81	2,95	1,22	2,42
25	3,27	0,23	14,22	3,27	0,38	8,61	3,61	0,63	5,73	4,06	1,11	3,66	4,03	1,14	3,54

WH-UD05JE5

Tamb	HC	IP	COP	HC	IP	COP	HC	IP	COP	HC	IP	COP	HC	IP	COP
LWC	25	25	25	35	35	35	45	45	45	55	55	55	60	60	60
-20	3,60	1,57	2,29	3,51	1,81	1,94	3,16	1,99	1,59	2,46	2,11	1,17	—	—	—
-15	4,46	1,72	2,59	4,20	1,93	2,18	3,75	2,18	1,72	3,00	2,12	1,42	—	—	—
-7	4,18	1,33	3,14	4,20	1,62	2,59	3,80	1,82	2,09	3,55	2,08	1,71	3,25	2,15	1,51
2	4,07	1,01	4,03	4,20	1,32	3,18	4,20	1,64	2,56	4,10	2,06	1,99	4,10	2,21	1,86
7	5,20	0,83	6,27	5,00	1,00	5,00	5,00	1,41	3,55	5,00	1,84	2,72	4,25	2,10	2,02
25	5,00	0,52	9,62	5,00	0,72	6,94	5,30	0,98	5,41	5,60	1,27	4,41	4,80	1,27	3,78

WH-UD07JE5

Tamb	HC	IP	COP	HC	IP	COP	HC	IP	COP	HC	IP	COP	HC	IP	COP
LWC	25	25	25	35	35	35	45	45	45	55	55	55	60	60	60
-20	4,33	1,64	2,64	3,98	1,88	2,12	3,83	2,26	1,69	3,30	2,77	1,19	—	—	—
-15	5,16	1,69	3,05	4,75	2,00	2,38	4,65	2,40	1,94	4,50	2,96	1,52	—	—	—
-7	5,64	1,56	3,62	5,60	1,95	2,87	5,50	2,30	2,39	5,25	2,70	1,94	4,98	2,90	1,72
2	6,80	1,57	4,33	6,85	2,01	3,41	6,75	2,40	2,81	6,20	2,80	2,21	6,18	2,91	2,12
7	7,55	1,15	6,57	7,00	1,47	4,76	7,00	1,96	3,57	7,00	2,48	2,82	6,86	2,75	2,49
25	7,00	0,62	11,29	6,88	0,90	7,64	7,00	1,33	5,26	6,92	1,75	3,95	6,83	1,90	3,59

WH-UD09JE5-1

Tamb	HC	IP	COP	HC	IP	COP	HC	IP	COP	HC	IP	COP	HC	IP	COP
LWC	25	25	25	35	35	35	45	45	45	55	55	55	60	60	60
-20	4,95	1,93	2,56	6,20	3,00	2,07	5,28	3,09	1,71	4,23	3,33	1,27	—	—	—
-15	7,58	2,70	2,81	7,40	3,20	2,31	6,29	3,26	1,93	5,20	3,42	1,52	—	—	—
-7	6,39	1,81	3,53	6,12	2,20	2,78	5,88	2,61	2,25	5,90	3,06	1,93	5,65	3,24	1,74
2	6,96	1,61	4,32	7,00	2,06	3,40	6,85	2,50	2,74	6,30	2,92	2,16	7,26	3,33	2,18
7	9,44	1,55	6,09	9,00	2,01	4,48	9,00	2,61	3,45	8,95	3,22	2,78	8,62	3,47	2,48
25	8,27	0,95	8,71	8,12	1,29	6,29	8,71	1,80	4,84	7,83	1,97	3,97	6,08	1,72	3,53

Aquarea High Performance Bi-bloc J Generation Single phase. Heating and Cooling - R32

Outdoor		WH-UD03JE5									WH-UD05JE5								
Tamb	CC	IP	EER	CC	IP	EER	CC	IP	EER	CC	IP	EER	CC	IP	EER	CC	IP	EER	
LWC	7	7	7	14	14	14	18	18	18	7	7	7	14	14	14	18	18	18	
16	3,56	0,57	6,25	4,32	0,55	7,85	3,47	0,41	8,46	3,59	0,56	6,41	4,23	0,54	7,83	4,79	0,52	9,21	
25	3,29	0,73	4,51	4,06	0,72	5,64	3,27	0,52	6,29	4,61	1,18	3,91	5,54	1,21	4,58	5,23	0,90	5,81	
35	3,20	0,91	3,52	3,56	0,93	3,83	3,20	0,68	4,71	4,50	1,50	3,00	5,08	1,51	3,36	4,80	1,12	4,29	
43	2,68	1,06	2,53	3,34	1,09	3,06	2,79	0,82	3,40	3,77	1,71	2,20	4,94	1,80	2,74	4,30	1,35	3,19	
Outdoor		WH-UD07JE5									WH-UD09JE5-1								
Tamb	CC	IP	EER	CC	IP	EER	CC	IP	EER	CC	IP	EER	CC	IP	EER	CC	IP	EER	
LWC	7	7	7	14	14	14	18	18	18	7	7	7	14	14	14	18	18	18	
16	5,20	0,81	6,42	6,62	0,73	9,07	7,04	0,72	9,78	6,85	1,18	5,81	8,80	1,15	7,65	9,11	1,15	7,92	
25	7,40	1,73	4,28	9,30	1,78	5,22	7,65	1,10	6,95	9,00	2,35	3,83	10,40	2,48	4,19	9,10	1,58	5,76	
35	6,70	2,21	3,03	8,10	2,23	3,63	6,70	1,42	4,72	8,20	3,02	2,72	9,90	3,02	3,28	9,00	2,15	4,19	
43	4,50	1,99	2,26	5,44	2,00	2,72	5,10	1,71	2,98	3,80	1,99	1,91	4,70	1,97	2,39	5,35	1,99	2,69	

Tamb: Ambient Temperature (°C). LWC: Leaving Water Condenser Temperature (°C). HC: Heating Capacity (kW). CC: Cooling Capacity (kW). IP: Input Power (kW). This data is measured by Panasonic in accordance with EN14511-2 standard. This data is for reference purpose only, and does not guarantee the performance.

Aquarea High Performance Bi-bloc H Generation Single phase. Heating and Cooling · R410A

WH-UD12HE5

Tamb	HC	IP	COP	HC	IP	COP	HC	IP	COP	HC	IP	COP	HC	IP	COP	HC	IP	COP
LWC	30	30	30	35	35	35	40	40	40	45	45	45	50	50	50	55	55	55
-15	9,30	3,46	2,69	8,90	3,62	2,46	8,50	3,79	2,24	8,10	3,95	2,05	7,50	4,05	1,85	7,00	4,16	1,68
-7	10,40	3,37	3,09	10,00	3,66	2,73	9,60	3,95	2,43	9,20	4,24	2,17	8,70	4,26	2,04	8,20	4,27	1,92
2	11,80	3,10	3,81	11,40	3,31	3,44	11,00	3,53	3,12	10,60	3,74	2,83	9,80	3,94	2,49	9,10	4,14	2,20
7	12,00	2,10	5,71	12,00	2,53	4,74	12,00	2,96	4,05	12,00	3,39	3,54	12,00	3,78	3,17	12,00	4,16	2,88
25	12,00	1,38	8,70	12,00	1,66	7,23	11,80	1,94	6,08	11,70	2,23	5,25	11,50	2,49	4,62	11,40	2,74	4,16

WH-UD16HE5

Tamb	HC	IP	COP	HC	IP	COP	HC	IP	COP	HC	IP	COP	HC	IP	COP	HC	IP	COP
LWC	30	30	30	35	35	35	40	40	40	45	45	45	50	50	50	55	55	55
-15	10,60	4,09	2,59	10,30	4,38	2,35	10,00	4,67	2,14	9,70	4,96	1,96	8,80	4,94	1,78	7,90	4,91	1,61
-7	11,90	4,03	2,95	11,40	4,43	2,57	10,80	4,83	2,24	10,30	5,22	1,97	9,60	5,09	1,89	9,00	4,95	1,82
2	13,50	3,74	3,61	13,00	3,96	3,28	12,40	4,18	2,97	11,90	4,40	2,70	10,80	4,46	2,42	9,80	4,51	2,17
7	16,00	3,21	4,98	16,00	3,74	4,28	16,00	4,27	3,75	16,00	4,80	3,33	15,20	5,11	2,97	14,50	5,41	2,68
25	16,00	2,31	6,93	16,00	2,69	5,95	16,00	3,07	5,21	16,00	3,45	4,64	16,00	3,67	4,36	15,90	3,89	4,09

Aquarea High Performance Bi-bloc H Generation Single phase. Heating and Cooling · R410A

WH-UD12HE5

Tamb	CC	IP	EER	CC	IP	EER	CC	IP	EER
LWC	7	7	7	14	14	14	18	18	18
16	7,86	1,18	6,66	13,15	1,40	9,39	10,00	1,73	5,78
25	12,08	2,90	4,17	15,70	2,05	7,66	10,00	1,97	5,08
35	10,00	2,56	3,91	12,00	2,67	4,49	10,00	2,40	4,17
43	7,80	3,80	2,05	11,10	3,19	3,48	8,00	2,85	2,81

WH-UD16HE5

Tamb	CC	IP	EER	CC	IP	EER	CC	IP	EER
LWC	7	7	7	14	14	14	18	18	18
16	9,20	1,62	5,68	16,40	2,58	6,36	12,20	2,45	4,98
25	14,40	3,92	3,67	19,20	3,83	5,01	12,20	2,79	4,37
35	12,20	4,76	2,56	15,00	4,98	3,01	12,20	2,96	4,12
43	7,75	3,40	2,28	13,80	5,95	2,32	9,70	4,00	2,43

Tamb: Ambient Temperature [°C]. LWC: Leaving Water Condenser Temperature [°C]. HC: Heating Capacity (kW). CC: Cooling Capacity (kW). IP: Input Power (kW). This data is measured by Panasonic in accordance with EN14511-2 standard. This data is for reference purpose only, and does not guarantee the performance.



Heating and cooling capacity tables

Based on outlet temperature and outside temperature.

Aquarea High Performance Bi-bloc H Generation Three phase. Heating and Cooling - R410A

WH-UD09HE8

Tamb	HC	IP	COP	HC	IP	COP	HC	IP	COP	HC	IP	COP	HC	IP	COP	HC	IP	COP
LWC	30	30	30	35	35	35	40	40	40	45	45	45	50	50	50	55	55	55
-15	8,65	3,06	2,83	8,30	3,21	2,59	7,95	3,41	2,33	7,60	3,61	2,11	7,15	3,71	1,93	6,70	3,81	1,76
-7	9,35	2,91	3,21	9,00	3,16	2,85	8,85	3,54	2,50	8,70	3,92	2,22	8,30	3,89	2,13	7,90	3,86	2,05
2	9,31	2,35	3,96	9,00	2,51	3,59	9,00	2,78	3,24	9,00	3,05	2,95	8,90	3,49	2,55	8,80	3,94	2,23
7	9,00	1,54	5,84	9,00	1,86	4,84	9,00	2,16	4,17	9,00	2,46	3,66	9,00	2,76	3,26	9,00	3,06	2,94
25	9,00	1,05	8,57	9,00	1,24	7,26	8,73	1,44	6,06	8,46	1,64	5,16	8,28	1,82	4,55	8,10	2,00	4,05

WH-UD12HE8

Tamb	HC	IP	COP	HC	IP	COP	HC	IP	COP	HC	IP	COP	HC	IP	COP	HC	IP	COP
LWC	30	30	30	35	35	35	40	40	40	45	45	45	50	50	50	55	55	55
-15	9,30	3,46	2,69	8,90	3,62	2,46	8,50	3,79	2,24	8,10	3,95	2,05	7,50	4,05	1,85	7,00	4,16	1,68
-7	10,40	3,37	3,09	10,00	3,66	2,73	9,60	3,95	2,43	9,20	4,24	2,17	8,70	4,26	2,04	8,20	4,27	1,92
2	11,80	3,10	3,81	11,40	3,31	3,44	11,00	3,53	3,12	10,60	3,74	2,83	9,80	3,94	2,49	9,10	4,14	2,20
7	12,00	2,10	5,71	12,00	2,53	4,74	12,00	2,96	4,05	12,00	3,39	3,54	12,00	3,78	3,17	12,00	4,16	2,88
25	12,00	1,38	8,70	12,00	1,66	7,23	11,80	1,94	6,08	11,70	2,23	5,25	11,50	2,49	4,62	11,40	2,74	4,16

WH-UD16HE8

Tamb	HC	IP	COP	HC	IP	COP	HC	IP	COP	HC	IP	COP	HC	IP	COP	HC	IP	COP
LWC	30	30	30	35	35	35	40	40	40	45	45	45	50	50	50	55	55	55
-15	10,60	4,09	2,59	10,30	4,38	2,35	10,00	4,67	2,14	9,70	4,96	1,96	8,80	4,94	1,78	7,90	4,91	1,61
-7	11,90	4,03	2,95	11,40	4,43	2,57	10,80	4,83	2,24	10,30	5,22	1,97	9,60	5,09	1,89	9,00	4,95	1,82
2	13,50	3,74	3,61	13,00	3,96	3,28	12,40	4,18	2,97	11,90	4,40	2,70	10,80	4,46	2,42	9,80	4,51	2,17
7	16,00	3,21	4,98	16,00	3,74	4,28	16,00	4,27	3,75	16,00	4,80	3,33	15,20	5,11	2,97	14,50	5,41	2,68
25	16,00	2,31	6,93	16,00	2,69	5,95	16,00	3,07	5,21	16,00	3,45	4,64	16,00	3,67	4,36	15,90	3,89	4,09

Aquarea High Performance Bi-bloc H Generation Three phase. Heating and Cooling - R410A

WH-UD09HE8

Tamb	CC	IP	EER	CC	IP	EER	CC	IP	EER
LWC	7	7	7	14	14	14	18	18	18
16	7,50	1,15	6,52	9,10	1,20	7,58	7,00	1,13	6,19
25	8,35	1,77	4,72	10,90	1,78	6,12	7,00	1,24	5,65
35	7,00	2,23	3,14	8,30	2,32	3,58	7,00	1,52	4,61
43	5,52	2,54	2,17	7,69	2,77	2,78	5,60	1,80	3,11

WH-UD12HE8

Tamb	CC	IP	EER	CC	IP	EER	CC	IP	EER
LWC	7	7	7	14	14	14	18	18	18
16	7,86	1,18	6,66	13,15	1,40	9,39	10,00	1,73	5,78
25	12,08	2,90	4,17	15,70	2,05	7,66	10,00	1,97	5,08
35	10,00	2,56	3,91	12,00	2,67	4,49	10,00	2,40	4,17
43	7,80	3,80	2,05	11,10	3,19	3,48	8,00	2,85	2,81

WH-UD16HE8

Tamb	CC	IP	EER	CC	IP	EER	CC	IP	EER
LWC	7	7	7	14	14	14	18	18	18
16	9,20	1,62	5,68	16,40	2,58	6,36	12,20	2,45	4,98
25	14,40	3,92	3,67	19,20	3,83	5,01	12,20	2,79	4,37
35	12,20	4,76	2,56	15,00	4,98	3,01	12,20	2,96	4,12
43	7,75	3,40	2,28	13,80	5,95	2,32	9,70	4,00	2,43

Tamb: Ambient Temperature (°C). LWC: Leaving Water Condenser Temperature (°C). HC: Heating Capacity (kW). CC: Cooling Capacity (kW). IP: Input Power (kW). This data is measured by Panasonic in accordance with EN14511-2 standard. This data is for reference purpose only, and does not guarantee the performance.

Aquarea High Performance Mono-bloc J Generation Single phase. Heating and Cooling - MDC - R32

WH-MDC05J3E5																
Tamb	HC	IP	COP	HC	IP	COP	HC	IP	COP	HC	IP	COP	HC	IP	COP	
LWC	25	25	25	35	35	35	45	45	45	55	55	55	60	60	60	
-20	4,37	1,73	2,53	4,16	2,03	2,05	3,84	2,37	1,62	3,43	2,64	1,30	—	—	—	
-15	5,13	1,78	2,88	5,00	2,17	2,30	4,75	2,51	1,89	3,70	2,45	1,51	—	—	—	
-7	5,17	1,49	3,47	5,00	1,80	2,78	4,80	2,16	2,22	5,00	2,70	1,85	4,68	2,71	1,73	
2	5,00	1,11	4,50	5,00	1,40	3,57	5,00	1,81	2,76	5,00	2,20	2,27	4,80	2,40	2,00	
7	5,09	0,78	6,53	5,00	0,99	5,05	5,00	1,31	3,82	5,00	1,66	3,01	4,58	1,90	2,41	
25	4,96	0,77	6,44	5,04	0,90	5,60	5,31	1,16	4,58	5,61	1,34	4,19	5,15	1,33	3,87	
WH-MDC07J3E5																
Tamb	HC	IP	COP	HC	IP	COP	HC	IP	COP	HC	IP	COP	HC	IP	COP	
LWC	25	25	25	35	35	35	45	45	45	55	55	55	60	60	60	
-20	4,86	2,03	2,39	4,66	2,35	1,98	4,44	2,75	1,61	4,23	3,13	1,35	—	—	—	
-15	5,80	2,11	2,75	5,60	2,40	2,33	5,30	2,84	1,87	5,00	3,32	1,51	—	—	—	
-7	6,76	2,07	3,27	6,80	2,42	2,81	6,30	2,82	2,23	6,30	3,39	1,86	4,74	2,76	1,72	
2	6,83	1,66	4,11	7,00	2,06	3,40	6,85	2,50	2,74	6,30	2,92	2,16	4,80	2,40	2,00	
7	7,32	1,19	6,15	7,00	1,47	4,76	7,00	1,96	3,57	7,00	2,48	2,82	6,18	2,44	2,53	
25	6,80	0,64	10,63	6,67	0,93	7,17	6,79	1,38	4,92	6,70	1,80	3,72	6,22	1,78	3,49	
WH-MDC09J3E5																
Tamb	HC	IP	COP	HC	IP	COP	HC	IP	COP	HC	IP	COP	HC	IP	COP	
LWC	25	25	25	35	35	35	45	45	45	55	55	55	60	60	60	
-20	5,33	2,36	2,26	6,43	3,60	1,79	5,78	3,83	1,51	4,83	3,64	1,33	—	—	—	
-15	7,76	3,20	2,43	7,60	3,41	2,23	7,00	3,71	1,89	5,60	3,80	1,47	—	—	—	
-7	7,39	2,45	3,02	7,50	2,85	2,63	7,30	3,37	2,17	7,00	3,89	1,80	6,44	3,67	1,75	
2	7,38	1,89	3,90	7,45	2,38	3,13	7,00	2,85	2,46	7,00	3,30	2,12	5,46	2,72	2,01	
7	9,15	1,59	5,75	9,00	2,01	4,48	9,00	2,61	3,45	8,95	3,22	2,78	7,25	2,87	2,53	
25	8,02	0,98	8,18	7,88	1,32	5,97	8,46	1,86	4,55	7,60	2,03	3,74	6,30	1,87	3,37	

Aquarea High Performance Mono-bloc J Generation Single phase. Heating and Cooling - MDC - R32

WH-MDC05J3E5										
Tamb	CC	IP	EER	CC	IP	EER	CC	IP	EER	
LWC	7	7	7	14	14	14	18	18	18	
16	5,18	0,82	6,32	6,17	0,84	7,35	5,78	0,60	9,63	
25	5,38	1,22	4,41	6,64	1,25	5,31	5,55	0,78	7,12	
35	5,00	1,54	3,25	5,86	1,61	3,64	5,00	0,99	5,05	
43	4,19	1,85	2,26	5,36	1,92	2,79	4,37	1,30	3,36	
WH-MDC07J3E5										
Tamb	CC	IP	EER	CC	IP	EER	CC	IP	EER	
LWC	7	7	7	14	14	14	18	18	18	
16	5,38	0,83	6,48	6,69	0,85	7,87	7,65	0,76	10,07	
25	6,96	1,82	3,82	9,06	1,98	4,58	7,58	1,23	6,16	
35	7,00	2,29	3,06	8,37	2,47	3,39	7,00	1,48	4,73	
43	5,60	2,55	2,20	6,87	2,58	2,66	6,10	1,88	3,24	
WH-MDC09J3E5										
Tamb	CC	IP	EER	CC	IP	EER	CC	IP	EER	
LWC	7	7	7	14	14	14	18	18	18	
16	6,89	1,21	5,69	8,65	1,23	7,03	9,82	1,19	8,25	
25	9,50	2,84	3,35	11,55	3,06	3,77	9,68	1,82	5,32	
35	9,00	3,32	2,71	10,10	3,51	2,88	9,00	2,12	4,25	
43	5,42	2,56	2,12	6,56	2,56	2,56	7,40	2,56	2,89	

Tamb: Ambient Temperature [°C]. LWC: Leaving Water Condenser Temperature [°C]. HC: Heating Capacity (kW). CC: Cooling Capacity (kW). IP: Input Power (kW). This data is measured by Panasonic in accordance with EN14511-2 standard. This data is for reference purpose only, and does not guarantee the performance.



Heating and cooling capacity tables

Based on outlet temperature and outside temperature.

Aquarea High Performance Mono-bloc H Generation Single phase. Heating and Cooling - MDC · R410A

WH-MDC12H6E5

Tamb	HC	IP	COP	HC	IP	COP	HC	IP	COP	HC	IP	COP	HC	IP	COP	HC	IP	COP
LWC	30	30	30	35	35	35	40	40	40	45	45	45	50	50	50	55	55	55
-15	9,30	3,46	2,69	8,90	3,62	2,46	8,50	3,79	2,24	8,10	3,95	2,05	—	—	—	7,00	4,10	1,71
-7	10,40	3,37	3,09	10,00	3,66	2,73	9,60	3,95	2,43	9,20	4,24	2,17	—	—	—	8,20	4,21	1,95
2	11,80	3,10	3,81	11,40	3,31	3,44	11,00	3,53	3,12	10,60	3,74	2,83	—	—	—	9,10	4,08	2,23
7	12,00	2,10	5,71	12,00	2,53	4,74	12,00	2,96	4,05	12,00	3,39	3,54	—	—	—	12,00	4,10	2,93
12	12,00	1,38	8,70	12,00	1,66	7,23	11,80	1,94	6,08	11,70	2,23	5,25	—	—	—	11,40	2,74	4,16

WH-MDC16H6E5

Tamb	HC	IP	COP	HC	IP	COP	HC	IP	COP	HC	IP	COP	HC	IP	COP	HC	IP	COP
LWC	30	30	30	35	35	35	40	40	40	45	45	45	50	50	50	55	55	55
-15	10,60	4,09	2,59	10,30	4,38	2,35	10,00	4,67	2,14	9,70	4,96	1,96	7,90	4,84	1,63	—	—	—
-7	11,90	4,03	2,95	11,40	4,43	2,57	10,80	4,83	2,24	10,30	5,22	1,97	9,00	4,88	1,84	—	—	—
2	13,50	13,74	0,98	13,00	3,96	3,28	12,40	4,18	2,97	11,90	4,40	2,70	9,80	4,44	2,21	—	—	—
7	16,00	3,21	4,98	16,00	3,74	4,28	16,00	4,27	3,75	16,00	4,80	3,33	14,50	5,33	2,72	—	—	—
12	16,00	2,31	6,93	16,00	2,69	5,95	16,00	3,07	5,21	16,00	3,45	4,64	15,90	3,89	4,09	—	—	—

Aquarea High Performance Mono-bloc H Generation Single phase. Heating and Cooling - MDC · R410A

WH-MDC12H6E5

Tamb	CC	IP	EER	CC	IP	EER	CC	IP	EER
LWC	7	7	7	14	14	14	18	18	18
16	7,86	1,18	6,66	13,15	2,05	6,41	10,00	1,73	5,78
25	12,08	2,90	4,17	15,70	3,05	5,15	10,00	1,97	5,08
35	10,00	3,56	2,81	12,00	3,67	3,27	10,00	2,15	4,65
43	7,80	3,80	2,05	11,10	3,19	3,48	8,00	2,85	2,81

WH-MDC16H6E5

Tamb	CC	IP	EER	CC	IP	EER	CC	IP	EER
LWC	7	7	7	14	14	14	18	18	18
16	9,20	1,62	5,68	16,40	2,58	6,36	12,20	2,45	4,98
25	14,40	3,92	3,67	19,20	3,83	5,01	12,20	2,79	4,37
35	12,20	4,76	2,56	15,00	4,98	3,01	12,20	2,96	4,12
43	7,75	3,40	2,28	13,80	5,95	2,32	9,70	4,00	2,43

Tamb: Ambient Temperature (°C). LWC: Leaving Water Condenser Temperature (°C). HC: Heating Capacity (kW). CC: Cooling Capacity (kW). IP: Input Power (kW). This data is measured by Panasonic in accordance with EN14511-2 standard. This data is for reference purpose only, and does not guarantee the performance.

Aquarea T-CAP Bi-bloc H Generation Single phase / Three phase. Heating and Cooling · R410A

WH-UX09HE5

Tamb	HC	IP	COP	HC	IP	COP	HC	IP	COP	HC	IP	COP	HC	IP	COP	HC	IP	COP
LWC	30	30	30	35	35	35	40	40	40	45	45	45	50	50	50	55	55	55
-15	9,00	3,24	2,78	9,00	3,51	2,56	9,00	3,91	2,30	9,00	4,30	2,09	9,00	4,73	1,90	9,00	5,16	1,74
-7	9,00	2,71	3,32	9,00	3,16	2,85	9,00	3,62	2,49	9,00	4,07	2,21	9,00	4,27	2,11	9,00	4,46	2,02
2	9,00	2,36	3,81	9,00	2,51	3,59	9,00	2,78	3,24	9,00	3,05	2,95	9,00	3,56	2,53	9,00	4,07	2,21
7	9,00	1,64	5,49	9,00	1,86	4,84	9,00	2,16	4,17	9,00	2,46	3,66	9,00	2,76	3,26	9,00	3,06	2,94
25	13,60	1,50	9,07	13,60	1,71	7,95	13,20	1,93	6,84	12,80	2,14	5,98	12,00	2,41	4,98	11,20	2,67	4,19

WH-UX12HE5

Tamb	HC	IP	COP	HC	IP	COP	HC	IP	COP	HC	IP	COP	HC	IP	COP	HC	IP	COP
LWC	30	30	30	35	35	35	40	40	40	45	45	45	50	50	50	55	55	55
-15	12,00	4,75	2,53	12,00	4,96	2,42	12,00	5,41	2,22	11,00	5,38	2,04	10,80	5,82	1,86	10,50	6,26	1,68
-7	12,00	3,85	3,12	12,00	4,41	2,72	12,00	4,98	2,41	12,00	5,54	2,17	12,00	5,90	2,03	12,00	6,26	1,92
2	12,00	3,19	3,76	12,00	3,49	3,44	12,00	3,87	3,10	12,00	4,25	2,82	12,00	4,86	2,47	12,00	5,47	2,19
7	12,00	2,18	5,50	12,00	2,53	4,74	12,00	2,96	4,05	12,00	3,39	3,54	12,00	3,78	3,17	12,00	4,16	2,88
25	13,60	1,55	8,77	13,60	1,76	7,73	13,40	2,10	6,38	13,20	2,43	5,43	12,60	2,66	4,74	12,00	2,89	4,15

WH-UX09HE8

Tamb	HC	IP	COP	HC	IP	COP	HC	IP	COP	HC	IP	COP	HC	IP	COP	HC	IP	COP
LWC	30	30	30	35	35	35	40	40	40	45	45	45	50	50	50	55	55	55
-15	9,00	3,24	2,78	9,00	3,51	2,56	9,00	3,91	2,30	9,00	4,30	2,09	9,00	4,73	1,90	9,00	5,16	1,74
-7	9,00	2,71	3,32	9,00	3,16	2,85	9,00	3,62	2,49	9,00	4,07	2,21	9,00	4,27	2,11	9,00	4,46	2,02
2	9,00	2,36	3,81	9,00	2,51	3,59	9,00	2,78	3,24	9,00	3,05	2,95	9,00	3,56	2,53	9,00	4,07	2,21
7	9,00	1,64	5,49	9,00	1,86	4,84	9,00	2,16	4,17	9,00	2,46	3,66	9,00	2,76	3,26	9,00	3,06	2,94
25	13,60	1,50	9,07	13,60	1,71	7,95	13,20	1,93	6,84	12,80	2,14	5,98	12,00	2,41	4,98	11,20	2,67	4,19

WH-UX12HE8

Tamb	HC	IP	COP	HC	IP	COP	HC	IP	COP	HC	IP	COP	HC	IP	COP	HC	IP	COP
LWC	30	30	30	35	35	35	40	40	40	45	45	45	50	50	50	55	55	55
-15	12,00	4,75	2,53	12,00	4,96	2,42	12,00	5,41	2,22	12,00	5,86	2,05	11,80	6,24	1,89	11,60	6,62	1,75
-7	12,00	3,85	3,12	12,00	4,41	2,72	12,00	4,98	2,41	12,00	5,54	2,17	12,00	5,90	2,03	12,00	6,26	1,92
2	12,00	3,19	3,76	12,00	3,49	3,44	12,00	3,87	3,10	12,00	4,25	2,82	12,00	4,86	2,47	12,00	5,47	2,19
7	12,00	2,18	5,50	12,00	2,53	4,74	12,00	2,96	4,05	12,00	3,39	3,54	12,00	3,78	3,17	12,00	4,16	2,88
25	13,60	1,55	8,77	13,60	1,76	7,73	13,40	2,10	6,38	13,20	2,43	5,43	12,60	2,66	4,74	12,00	2,89	4,15

WH-UX16HE8

Tamb	HC	IP	COP	HC	IP	COP	HC	IP	COP	HC	IP	COP	HC	IP	COP	HC	IP	COP
LWC	30	30	30	35	35	35	40	40	40	45	45	45	50	50	50	55	55	55
-15	16,00	6,30	2,54	16,00	6,89	2,32	16,00	7,45	2,15	16,00	8,10	1,98	16,00	8,48	1,89	15,20	8,96	1,70
-7	16,00	5,85	2,74	16,00	6,42	2,49	16,00	7,00	2,29	16,00	7,57	2,11	16,00	8,10	1,98	16,00	8,62	1,86
2	16,00	4,67	3,43	16,00	5,21	3,07	16,00	5,74	2,79	16,00	6,31	2,54	16,00	6,90	2,32	16,00	7,50	2,13
7	16,00	3,35	4,78	16,00	3,74	4,28	16,00	4,30	3,72	16,00	4,80	3,33	16,00	5,43	2,95	16,00	5,91	2,71
16	16,00	2,59	6,18	16,00	3,18	5,03	16,00	3,71	4,31	16,00	4,27	3,75	16,00	4,86	3,29	16,00	5,22	3,07
25	16,00	2,02	7,92	16,00	2,58	6,20	16,00	2,91	5,50	16,00	3,36	4,76	16,00	3,74	4,28	16,00	4,00	4,00

Aquarea T-CAP Bi-bloc H Generation Single phase / Three phase. Heating and Cooling · R410A

Outdoor			WH-UX09HE5							WH-UX12HE5										
Tamb	CC	IP	EER	CC	IP	EER	CC	IP	EER	CC	IP	EER	CC	IP	EER	CC	IP	EER		
LWC	7	7	7	14	14	14	18	18	18	7	7	7	14	14	14	18	18	18		
18	7,00	1,36	5,15	8,55	1,41	6,06	7,00	1,00	7,00	10,00	1,75	5,71	13,20	1,96	6,73	10,00	1,40	7,14		
25	7,65	1,91	4,01	11,10	1,98	5,61	7,00	1,10	6,36	11,20	2,67	4,19	16,50	3,01	5,48	10,00	1,60	6,25		
35	7,00	2,21	3,17	9,23	2,37	3,89	7,00	1,35	5,19	10,00	3,56	2,81	12,55	3,63	3,46	10,00	1,95	5,13		
43	6,25	2,66	2,35	8,55	2,71	3,15	5,60	1,60	3,50	8,00	3,35	2,39	10,00	3,46	2,89	8,00	2,30	3,48		
Outdoor			WH-UX09HE8						WH-UX12HE8						WH-UX16HE8					
Tamb	CC	IP	EER	CC	IP	EER	CC	IP	EER	CC	IP	EER	CC	IP	EER	CC	IP	EER		
LWC	7	7	7	18	18	18	7	7	7	18	18	18	7	7	7	18	18	18		
18	7,00	1,36	5,15	—	—	—	7,50	1,41	5,32	—	—	—	8,50	1,70	5,00	10,00	1,70	5,88		
25	7,65	1,91	4,01	—	—	—	8,90	2,16	4,12	—	—	—	14,00	4,00	3,50	14,00	2,94	4,76		
35	7,00	2,21	3,17	—	—	—	10,00	3,56	2,81	—	—	—	12,20	4,76	2,56	12,20	3,50	3,49		
43	6,25	2,66	2,35	—	—	—	8,00	3,01	2,66	—	—	—	7,10	3,31	2,15	9,80	3,31	2,96		

Tamb: Ambient Temperature [°C]. LWC: Leaving Water Condenser Temperature [°C]. HC: Heating Capacity (kW). CC: Cooling Capacity (kW). IP: Input Power (kW). This data is measured by Panasonic in accordance with EN14511-2 standard. This data is for reference purpose only, and does not guarantee the performance.



Heating and cooling capacity tables

Based on outlet temperature and outside temperature.

Aquarea T-CAP Bi-bloc H Generation Three phase. Super Quiet outdoor unit. Heating and Cooling - SQC · R410A

WH-UQ09HE8

Tamb	HC	IP	COP	HC	IP	COP	HC	IP	COP	HC	IP	COP	HC	IP	COP	HC	IP	COP
LWC	30	30	30	35	35	35	40	40	40	45	45	45	50	50	50	55	55	55
-15	9,00	3,24	2,78	9,00	3,51	2,56	9,00	3,91	2,30	9,00	4,30	2,09	9,00	4,73	1,90	9,00	5,16	1,74
-7	9,00	2,71	3,32	9,00	3,16	2,85	9,00	3,62	2,49	9,00	4,07	2,21	9,00	4,27	2,11	9,00	4,46	2,02
2	9,00	2,36	3,81	9,00	2,51	3,59	9,00	2,78	3,24	9,00	3,05	2,95	9,00	3,56	2,53	9,00	4,07	2,21
7	9,00	1,64	5,49	9,00	1,86	4,84	9,00	2,16	4,17	9,00	2,46	3,66	9,00	2,76	3,26	9,00	3,06	2,94
25	13,60	1,50	9,07	13,60	1,71	7,95	13,20	1,93	6,84	12,80	2,14	5,98	12,00	2,41	4,98	11,20	2,67	4,19

WH-UQ12HE8

Tamb	HC	IP	COP	HC	IP	COP	HC	IP	COP	HC	IP	COP	HC	IP	COP	HC	IP	COP
LWC	30	30	30	35	35	35	40	40	40	45	45	45	50	50	50	55	55	55
-15	12,00	4,75	2,53	12,00	4,96	2,42	12,00	5,41	2,22	12,00	5,86	2,05	11,80	6,24	1,89	11,60	6,62	1,75
-7	12,00	3,85	3,12	12,00	4,41	2,72	12,00	4,98	2,41	12,00	5,54	2,17	12,00	5,90	2,03	12,00	6,26	1,92
2	12,00	3,19	3,76	12,00	3,49	3,44	12,00	3,87	3,10	12,00	4,25	2,82	12,00	4,86	2,47	12,00	5,47	2,19
7	12,00	2,18	5,50	12,00	2,53	4,74	12,00	2,96	4,05	12,00	3,39	3,54	12,00	3,78	3,17	12,00	4,16	2,88
25	13,60	1,55	8,77	13,60	1,76	7,73	13,40	2,10	6,38	13,20	2,43	5,43	12,60	2,66	4,74	12,00	2,89	4,15

WH-UQ16HE8

Tamb	HC	IP	COP	HC	IP	COP	HC	IP	COP	HC	IP	COP	HC	IP	COP	HC	IP	COP
LWC	30	30	30	35	35	35	40	40	40	45	45	45	50	50	50	55	55	55
-15	16,00	6,30	2,54	16,00	6,89	2,32	16,00	7,45	2,15	16,00	8,10	1,98	16,00	8,48	1,89	15,20	8,96	1,70
-7	16,00	5,85	2,74	16,00	6,42	2,49	16,00	7,00	2,29	16,00	7,57	2,11	16,00	8,10	1,98	16,00	8,62	1,86
2	16,00	4,67	3,43	16,00	5,21	3,07	16,00	5,74	2,79	16,00	6,31	2,54	16,00	6,90	2,32	16,00	7,50	2,13
7	16,00	3,35	4,78	16,00	3,74	4,28	16,00	4,30	3,72	16,00	4,80	3,33	16,00	5,43	2,95	16,00	5,91	2,71
16	16,00	2,59	6,18	16,00	3,18	5,03	16,00	3,71	4,31	16,00	4,27	3,75	16,00	4,86	3,29	16,00	5,22	3,07
25	16,00	2,02	7,92	16,00	2,58	6,20	16,00	2,91	5,50	16,00	3,36	4,76	16,00	3,74	4,28	16,00	4,00	4,00

Aquarea T-CAP Bi-bloc H Generation Three phase. Super Quiet outdoor unit. Heating and Cooling - SQC · R410A

WH-UQ09HE8

Tamb	CC	IP	EER	CC	IP	EER
LWC	7	7	7	18	18	18
18	7,00	1,36	5,15	—	—	—
25	7,65	1,91	4,01	—	—	—
35	7,00	2,21	3,17	—	—	—
43	6,25	2,66	2,35	—	—	—

WH-UQ12HE8

Tamb	CC	IP	EER	CC	IP	EER
LWC	7	7	7	18	18	18
18	7,50	1,41	5,32	—	—	—
25	8,90	2,16	4,12	—	—	—
35	10,00	3,56	2,81	—	—	—
43	8,00	3,01	2,66	—	—	—

WH-UQ16HE8

Tamb	CC	IP	EER	CC	IP	EER
LWC	7	7	7	18	18	18
18	8,50	1,70	5,00	10,00	1,70	5,88
25	14,00	4,00	3,50	14,00	2,94	4,76
35	12,20	4,76	2,56	12,20	3,50	3,49
43	7,10	3,31	2,15	9,80	3,31	2,96

Tamb: Ambient Temperature (°C). LWC: Leaving Water Condenser Temperature (°C). HC: Heating Capacity (kW). CC: Cooling Capacity (kW). IP: Input Power (kW). This data is measured by Panasonic in accordance with EN14511-2 standard. This data is for reference purpose only, and does not guarantee the performance.

Aquarea T-CAP Mono-bloc J Generation Single phase. Heating and Cooling - MXC · R32

WH-MXC09J3E5																
Tamb	HC	IP	COP	HC	IP	COP	HC	IP	COP	HC	IP	COP	HC	IP	COP	
LWC	25	25	25	35	35	35	45	45	45	55	55	55	60	60	60	
-20	9,00	3,44	2,62	9,00	3,95	2,28	9,00	4,65	1,94	7,90	5,58	1,42	—	—	—	
-15	9,00	2,98	3,02	9,00	3,41	2,64	9,00	4,04	2,23	9,00	4,83	1,86	8,70	5,37	1,62	
-7	10,50	2,72	3,86	9,00	2,92	3,08	9,00	3,54	2,54	9,00	4,24	2,12	9,00	4,62	1,95	
2	10,80	2,14	5,05	9,00	2,36	3,81	9,00	2,91	3,09	9,00	3,55	2,54	9,00	4,05	2,22	
7	9,00	1,38	6,52	9,00	1,77	5,08	9,00	2,37	3,80	9,00	2,92	3,08	9,00	3,29	2,74	
25	9,00	0,77	11,69	9,00	1,00	9,00	10,00	1,67	5,99	10,00	2,28	4,39	11,00	2,86	3,85	
WH-MXC12J6E5																
Tamb	HC	IP	COP	HC	IP	COP	HC	IP	COP	HC	IP	COP	HC	IP	COP	
LWC	25	25	25	35	35	35	45	45	45	55	55	55	60	60	60	
-20	12,00	5,02	2,39	12,00	5,80	2,07	11,00	5,95	1,85	10,00	6,50	1,54	—	—	—	
-15	12,00	4,14	2,90	12,00	4,83	2,48	11,00	5,20	2,12	10,50	6,00	1,75	8,90	6,30	1,41	
-7	13,50	4,30	3,14	12,00	4,25	2,82	12,00	5,02	2,39	12,00	6,00	2,00	11,00	6,30	1,75	
2	14,50	3,23	4,49	12,00	3,40	3,53	12,00	4,20	2,86	12,00	4,95	2,42	12,00	5,77	2,08	
7	12,00	2,00	6,00	12,00	2,50	4,80	12,00	3,24	3,70	12,00	3,94	3,05	12,00	4,52	2,65	
25	12,00	1,20	10,00	12,00	1,49	8,05	12,00	2,10	5,71	12,00	2,75	4,36	12,00	3,11	3,86	

Aquarea T-CAP Mono-bloc J Generation Single phase. Heating and Cooling - MXC · R32

WH-MXC09J3E5									
Tamb	CC	IP	EER	CC	IP	EER	CC	IP	EER
LWC	7	7	7	14	14	14	18	18	18
16	9,00	1,61	5,59	11,00	1,49	7,38	11,40	1,30	8,77
25	9,00	2,00	4,50	12,60	2,38	5,29	10,50	1,54	6,82
35	9,00	2,83	3,18	10,90	2,98	3,66	9,00	1,95	4,62
43	7,20	3,26	2,21	8,70	3,23	2,69	7,30	2,43	3,00
WH-MXC12J6E5									
Tamb	CC	IP	EER	CC	IP	EER	CC	IP	EER
LWC	7	7	7	14	14	14	18	18	18
16	11,40	2,10	5,43	13,60	2,09	6,51	15,00	2,06	7,28
25	12,00	2,87	4,18	15,70	3,60	4,36	14,00	2,56	5,47
35	12,00	4,14	2,90	13,60	4,35	3,13	12,00	3,04	3,95
43	10,30	4,89	2,11	11,80	4,98	2,37	10,40	3,72	2,80

Tamb: Ambient Temperature [°C]. LWC: Leaving Water Condenser Temperature [°C]. HC: Heating Capacity (kW). CC: Cooling Capacity (kW). IP: Input Power (kW). This data is measured by Panasonic in accordance with EN14511-2 standard. This data is for reference purpose only, and does not guarantee the performance.

Heating and cooling capacity tables

Based on outlet temperature and outside temperature.

Aquarea HT Bi-bloc F Generation Single phase / Three phase. Heating Only - R407C

WH-UH09FE5

Tamb	HC	IP	COP	HC	IP	COP	HC	IP	COP	HC	IP	COP	HC	IP	COP	HC	IP	COP	HC	IP	COP	HC	IP	COP
LWC	30	30	30	35	35	35	40	40	40	45	45	45	50	50	50	55	55	55	60	60	60	65	65	65
-15	9,00	3,46	2,60	9,00	3,71	2,43	9,00	4,01	2,24	8,80	4,26	2,07	8,60	4,61	1,87	8,50	4,91	1,73	8,00	5,06	1,58	7,80	5,86	1,33
-7	9,00	3,06	2,94	9,00	3,29	2,74	9,00	3,56	2,53	8,90	3,83	2,32	8,90	4,11	2,17	8,90	4,46	2,00	8,90	4,96	1,79	8,90	5,46	1,63
2	9,00	2,43	3,70	9,00	2,61	3,45	9,00	2,91	3,09	9,00	3,21	2,80	9,00	3,55	2,54	9,00	3,88	2,32	9,00	4,35	2,07	9,00	4,76	1,89
7	9,00	1,82	4,95	9,00	1,94	4,64	9,00	2,21	4,07	9,00	2,46	3,66	9,00	2,76	3,26	9,00	3,06	2,94	9,00	3,46	2,60	9,00	3,96	2,27
16	9,00	1,46	6,16	9,00	1,56	5,77	9,00	1,81	4,97	8,90	2,02	4,41	8,80	2,31	3,81	8,60	2,52	3,41	8,20	2,77	2,96	8,20	3,18	2,58
25	12,00	1,66	7,23	12,00	1,76	6,82	12,00	2,01	5,97	10,80	2,14	5,05	10,60	2,46	4,31	10,20	2,66	3,83	9,80	2,89	3,39	9,60	3,31	2,90

WH-UH12FE5

Tamb	HC	IP	COP	HC	IP	COP	HC	IP	COP	HC	IP	COP	HC	IP	COP	HC	IP	COP	HC	IP	COP	HC	IP	COP
LWC	30	30	30	35	35	35	40	40	40	45	45	45	50	50	50	55	55	55	60	60	60	65	65	65
-15	12,00	5,16	2,33	12,00	5,53	2,17	11,00	5,51	2,00	10,60	5,53	1,92	10,30	5,63	1,83	9,70	5,76	1,68	9,00	6,01	1,50	8,00	6,11	1,31
-7	12,00	4,43	2,71	12,00	4,76	2,52	11,50	4,91	2,34	11,20	5,06	2,21	10,80	5,16	2,09	10,10	5,28	1,91	10,00	5,66	1,77	9,60	5,91	1,62
2	12,00	3,42	3,51	12,00	3,68	3,26	11,50	3,86	2,98	11,30	4,14	2,73	11,00	4,51	2,44	10,80	4,86	2,22	10,65	5,31	2,01	10,30	5,59	1,84
7	12,00	2,52	4,76	12,00	2,69	4,46	12,00	3,06	3,92	12,00	3,44	3,49	12,00	3,81	3,15	12,00	4,28	2,80	12,00	4,76	2,52	12,00	5,41	2,22
16	12,00	2,03	5,91	12,00	2,17	5,53	12,00	2,52	4,76	12,00	2,86	4,20	11,50	3,19	3,61	11,50	3,48	3,30	11,00	3,82	2,88	11,00	4,37	2,52
25	12,00	1,66	7,23	12,00	1,76	6,82	12,00	2,01	5,97	11,80	2,41	4,90	11,20	2,64	4,24	10,80	2,86	3,78	10,50	3,11	3,38	10,30	3,62	2,85

WH-UH09FE8

Tamb	HC	IP	COP	HC	IP	COP	HC	IP	COP	HC	IP	COP	HC	IP	COP	HC	IP	COP	HC	IP	COP	HC	IP	COP
LWC	30	30	30	35	35	35	40	40	40	45	45	45	50	50	50	55	55	55	60	60	60	65	65	65
-15	9,00	3,46	2,60	9,00	3,71	2,43	9,00	4,01	2,24	8,80	4,26	2,07	8,60	4,61	1,87	8,50	4,91	1,73	8,00	5,06	1,58	7,80	5,86	1,33
-7	9,00	3,06	2,94	9,00	3,29	2,74	9,00	3,56	2,53	8,90	3,83	2,32	8,90	4,11	2,17	8,90	4,46	2,00	8,90	4,96	1,79	8,90	5,46	1,63
2	9,00	2,43	3,70	9,00	2,61	3,45	9,00	2,91	3,09	9,00	3,21	2,80	9,00	3,55	2,54	9,00	3,88	2,32	9,00	4,35	2,07	9,00	4,76	1,89
7	9,00	1,82	4,95	9,00	1,94	4,64	9,00	2,21	4,07	9,00	2,46	3,66	9,00	2,76	3,26	9,00	3,06	2,94	9,00	3,46	2,60	9,00	3,96	2,27
16	9,00	1,46	6,16	9,00	1,56	5,77	9,00	1,81	4,97	8,90	2,02	4,41	8,80	2,31	3,81	8,60	2,52	3,41	8,20	2,77	2,96	8,20	3,18	2,58
25	12,00	1,66	7,23	12,00	1,76	6,82	12,00	2,01	5,97	10,80	2,14	5,05	10,60	2,46	4,31	10,20	2,66	3,83	9,80	2,89	3,39	9,60	3,31	2,90

WH-UH12FE8

Tamb	HC	IP	COP	HC	IP	COP	HC	IP	COP	HC	IP	COP	HC	IP	COP	HC	IP	COP	HC	IP	COP	HC	IP	COP
LWC	30	30	30	35	35	35	40	40	40	45	45	45	50	50	50	55	55	55	60	60	60	65	65	65
-15	12,00	5,16	2,33	12,00	5,53	2,17	11,00	5,51	2,00	10,60	5,53	1,92	10,30	5,63	1,83	9,70	5,76	1,68	9,00	6,01	1,50	8,00	6,11	1,31
-7	12,00	4,43	2,71	12,00	4,76	2,52	11,50	4,91	2,34	11,20	5,06	2,21	10,80	5,16	2,09	10,10	5,28	1,91	10,00	5,66	1,77	9,60	5,91	1,62
2	12,00	3,42	3,51	12,00	3,68	3,26	11,50	3,86	2,98	11,30	4,14	2,73	11,00	4,51	2,44	10,80	4,86	2,22	10,65	5,31	2,01	10,30	5,59	1,84
7	12,00	2,52	4,76	12,00	2,69	4,46	12,00	3,06	3,92	12,00	3,44	3,49	12,00	3,81	3,15	12,00	4,28	2,80	12,00	4,76	2,52	12,00	5,41	2,22
16	12,00	2,03	5,91	12,00	2,17	5,53	12,00	2,52	4,76	12,00	2,86	4,20	11,50	3,19	3,61	11,50	3,48	3,30	11,00	3,82	2,88	11,00	4,37	2,52
25	12,00	1,66	7,23	12,00	1,76	6,82	12,00	2,01	5,97	11,80	2,41	4,90	11,20	2,64	4,24	10,80	2,86	3,78	10,50	3,11	3,38	10,30	3,62	2,85

Aquarea HT Mono-bloc G Generation Single phase. Heating Only - MHF - R407C

WH-MHF09G3E5

Tamb	HC	IP	COP	HC	IP	COP	HC	IP	COP	HC	IP	COP	HC	IP	COP	HC	IP	COP	HC	IP	COP
LWC	30	30	30	35	35	35	40	40	40	45	45	45	50	50	50	55	55	55	55	55	55
-15	9,00	3,46	2,60	9,00	3,71	2,43	9,00	4,01	2,24	8,80	4,26	2,07	8,50	4,71	1,80	7,80	5,38	1,45			
-7	9,00	3,06	2,94	9,00	3,29	2,74	9,00	3,56	2,53	8,90	3,83	2,32	8,90	4,28	2,08	9,00	5,02	1,79			
2	9,00	2,43	3,70	9,00	2,61	3,45	9,00	2,91	3,09	9,00	3,21	2,80	9,00	3,72	2,42	9,00	4,37	2,06			
7	9,00	1,82	4,95	9,00	1,94	4,64	9,00	2,21	4,07	9,00	2,46	3,66	9,00	2,99	3,01	9,00	3,64	2,47			
25	9,00	1,52	5,92	9,00	1,70	5,29	9,00	1,88	4,79	9,00	2,16	4,17	9,00	2,63	3,42	9,00	3,20	2,81			

WH-MHF12G6E5

Tamb	HC	IP	COP	HC	IP	COP	HC	IP	COP	HC	IP	COP	HC	IP	COP	HC	IP	COP	HC	IP	COP
LWC	30	30	30	35	35	35	40	40	40	45	45	45	50	50	50	55	55	55	55	55	55
-15	12,00	5,16	2,33	12,00	5,53	2,17	11,00	5,51	2,00	10,80	5,49	1,97	9,70	5,52	1,76	8,00	5,61	1,43			
-7	12,00	4,43	2,71	12,00	4,76	2,52	11,50	4,91	2,34	11,20	5,06	2,21	10,10	5,06	2,00	9,60	5,43	1,77			
2	12,00	3,42	3,51	12,00	3,68	3,26	11,50	3,86	2,98	11,30	4,14	2,73	10,80	4,66	2,32	10,30	5,13	2,01			
7	12,00	2,52	4,76	12,00	2,69	4,46	12,00	3,06	3,92	12,00	3,44	3,49	12,00	4,10	2,93	12,00	4,97	2,41			
25	12,00	2,03	5,91	12,00	2,36	5,08	12,00	2,69	4,46	12,00	3,02	3,97	12,00	3,61	3,32	12,00	4,37	2,75			

Tamb: Ambient Temperature (°C). LWC: Leaving Water Condenser Temperature (°C). HC: Heating Capacity (kW). CC: Cooling Capacity (kW). IP: Input Power (kW).
This data is measured by Panasonic in accordance with EN14511-2 standard. This data is for reference purpose only, and does not guarantee the performance.

Examples of installations

Aquarea J and H Generation:
Bivalent with buffer tank and mixing valve

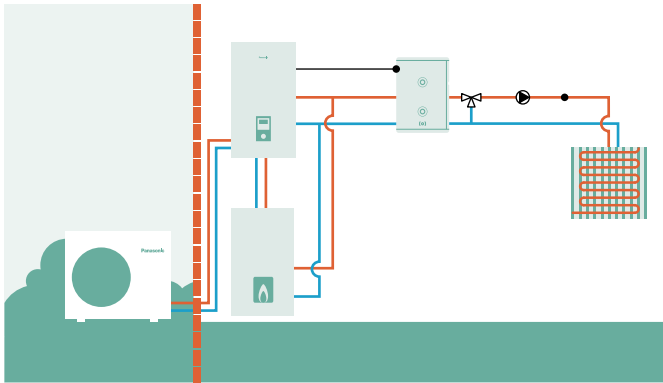

Aquarea J and H Generation:
Buffer tank with solar and mixing valve

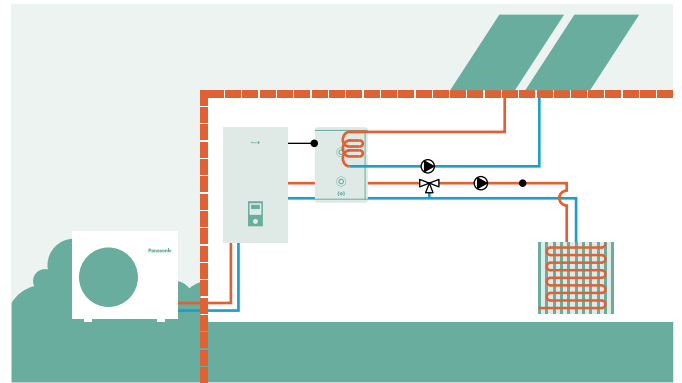

Aquarea J and H Generation:
2 zones with external kit without buffer tank

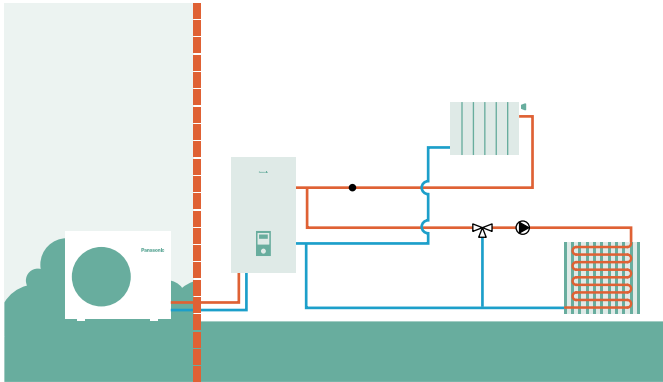

Aquarea J and H Generation:
2 zones with external kit, buffer tank and swimming pool

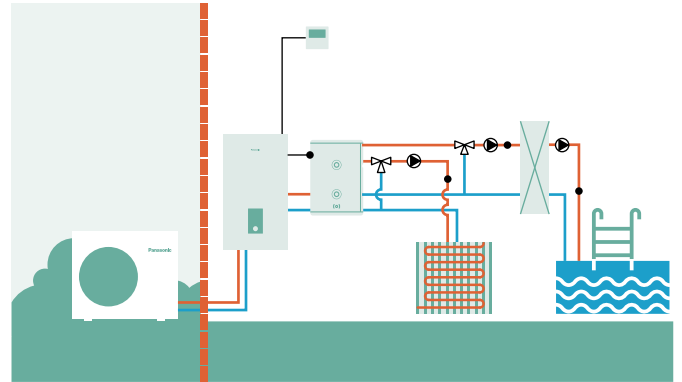

Aquarea All in One J and H Generation:
2 zones with external kit, without buffer tank

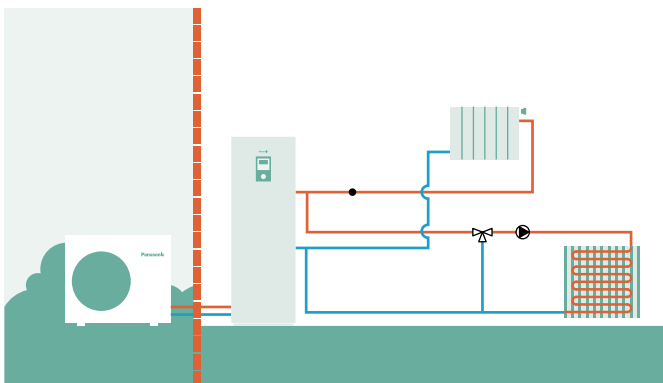

Aquarea All in One 2 zones J and H Generation:
2 zones built-in, without buffer tank

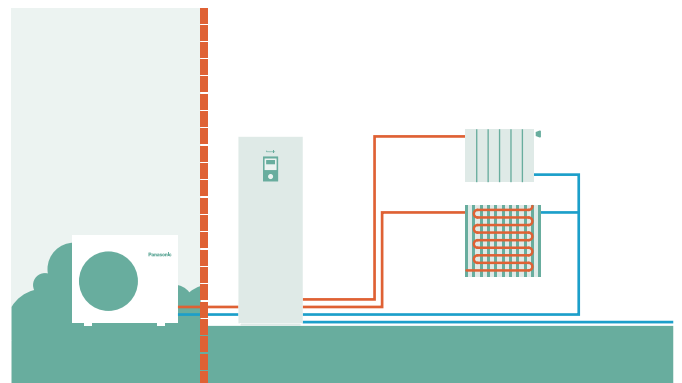

ETHEREA

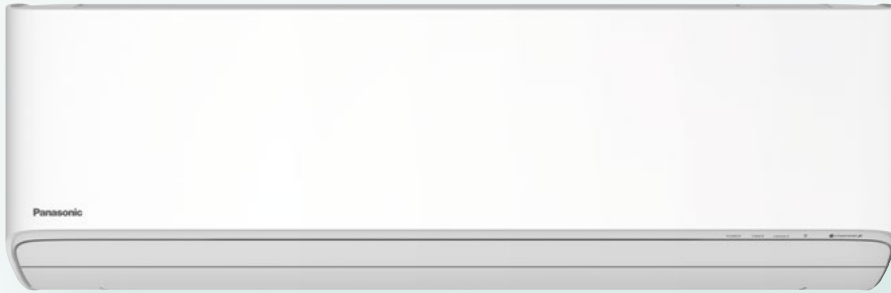

Panasonic domestic air to air heat pump

Panasonic has developed a range of products designed for you, better than ever before. Above all, it is also a range for air conditioning professionals, such as yourself, thanks to its broad range of products which are capable of conditioning rooms of all sizes – always with optimal efficiency and incomparable ease of installation.

Highlighted features	→ 96
Bringing nature's balance indoors	→ 98
Etherea with nanoe™ X technology	→ 100
Heatcharge. Energy Charge System	→ 102
Wall-mounted TZ super-compact	→ 104
Super-compact units	→ 106
Floor console	→ 108
Panasonic R2 rotary compressor	→ 110
R22 Renewal	→ 112
Welcome to the connected world of Panasonic Comfort Cloud App	→ 114
Voice Control	→ 118
Control and Connectivity	→ 120
Domestic air conditioner R32 range	→ 122

Wall-mounted

Heatcharge VZ · R32	→ 124
Etherea · R32	→ 125
TZ super-compact · R32	→ 126
BZ super-compact · R32	→ 127
UZ super-compact · R32	→ 128
PZ super-compact · R32	→ 129

More options for your home

Floor console · R32	→ 130
Low static pressure hide-away · R32	→ 131
Free Multi system	→ 132
Multi TZ system	→ 136
Compare solutions	→ 137
Feature comparison	→ 138
Features explained	→ 140
Accessories and control	→ 141
Free Multi R32 combinations table	→ 142
Multi TZ combinations table	→ 160

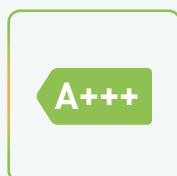
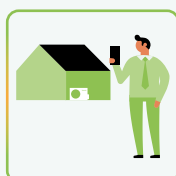

Highlighted features

Panasonic has developed a range of products designed for you, better than ever before.

With innovative design, high efficiency and advanced technologies, such as Panasonic Comfort Cloud App for smart control and nanoe™ X for indoor air quality improvement, the residential range has been designed with you and your clients in mind.

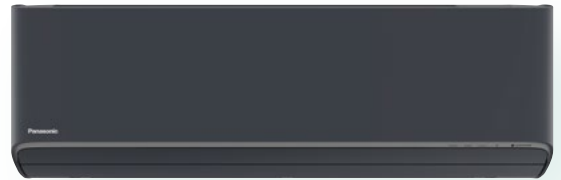

Panasonic air conditioners provide more savings and more comfort

We believe that going green shouldn't compromise on comfort.

Our super silent air conditioners guarantee clean indoor air to take care of you and your family. For a cleaner living environment, the nanoe™ X helps improve the quality of the indoor air as well as your surroundings. Together, these breakthrough technologies embody Panasonic's Eco Clean Life Innovation - innovations that improve our environment whilst making life as comfortable as possible.

The Good Design Award is among the most prestigious awards for product design excellence. An "excellent design" indicated by Good Design Award is a design which focusses on humanity, honesty, innovation, aesthetics and ethics. Panasonic's award-winning TZ proves to be a worthy addition to any home.



Energy saving

<p>R32</p>	<p>A+++ 10,50 SEER</p>	<p>A+++ 6,20 SCOP</p>	<p>38% ECONAVI</p>	<p>INVERTER+</p>	<p>INVERTER</p>	<p>R2 ROTARY COMPRESSOR</p>
<p>Refrigerant gas R32. Our heat pumps containing the refrigerant R32 show a drastic reduction in the value of Global Warming Potential (GWP). An important step to reduce greenhouse gases. R32 is also a component refrigerant, making it easy to recycle.</p>	<p>Exceptional seasonal cooling efficiency based on the ErP regulation. Higher SEER ratings mean greater efficiency - year-round cooling savings!</p>	<p>Exceptional seasonal heating efficiency based on the ErP regulation. Higher SCOP ratings mean greater efficiency - year-round heating savings!</p>	<p>Econavi. Sunlight Sensor technology can detect and reduce the waste of energy by optimising air conditioner operation according to room conditions. With just one touch of a button, you can save energy.</p>	<p>Inverter Plus. Inverter Plus System classification highlights Panasonic's highest performing systems.</p>	<p>Inverter. The Inverter range provides greater efficiency and comfort. Provides more precise temperature control, without highs and lows, and keeps the ambient temperature constant with lower energy consumption and a significant reduction in noise and vibration levels.</p>	<p>Panasonic R2 rotary compressor. Designed to withstand extreme conditions, it delivers high performance and efficiency.</p>

High performance and indoor air quality

<p>nanoe™ X</p>	<p>PM2,5 FILTER</p>	<p>DUST COLLECTION FILTER</p>	<p>18 dB(A)</p>	<p>HUMIDITY CONTROL MILD DRY</p>	<p>AEROWINGS</p>	<p>STATIC PRESSURE UP TO 7 mmAq</p>
<p>nanoe™ X. Technology with the benefits of hydroxyl radicals has the capacity to inhibit pollutants, viruses, and bacteria to clean and deodorise.</p>	<p>PM2,5 filter. Particulate matter (PM2,5) can be found suspended in the air, including dust, dirt, smoke and liquid droplets. This filter can catch PM2,5 particles including hazardous pollutants as well as house dust and pollen.</p>	<p>Dust Collection Filter. This filter collects and retains particles suspended in the air, resulting in cleaner air in the room.</p>	<p>Super Quiet. With Super Quiet technology our devices are quieter than a library (30 dB(A)).</p>	<p>Mild dry. The humidity controls level the air to prevent over-dryness.</p>	<p>More comfort with Aerowings. Direct air flow to the ceiling, creating a shower cooling effect with built-in twin flap.</p>	<p>Static pressure up to 7 mmAq. Low static pressure Hide Away RAC with selectable static pressure up to 7 mmAq.</p>
<p>FILTER INCLUDED</p>	<p>-10 °C COOLING MODE</p>	<p>-15 °C HEATING MODE</p>	<p>SUMMER HOUSE</p>	<p>R22 / R410A RENEWAL</p>	<p>5 YEARS COMPRESSOR WARRANTY</p>	
<p>Filter included. Low static pressure Hide Away RAC with filter included.</p>	<p>Down to -10 °C in cooling mode. The air conditioner works in cooling mode when the outdoor temperature of -10 °C.</p>	<p>Down to -15 °C in heating mode. The air conditioner works in heat pump mode when the outdoor temperature is as low as -15 °C.</p>	<p>Summer House. This innovative function keeps the house at 8/10 or 8/15 °C to avoid freezing pipes during the winter. This function is beneficial for summer or weekend homes.</p>	<p>R410A / R22 renewal. The Panasonic renewal system allows good quality existing R410A or R22 pipe work to be re-used whilst installing new high efficiency R32 systems.</p>	<p>5 Years compressor warranty. We guarantee the outdoor unit compressors in the entire range for five years.</p>	

High connectivity

<p>INTEGRATION TO P-LINK</p>	<p>Domestic integration to P-Link - CZ-CAPRA1. Can connect RAC range to P-Link. Full control is now possible.</p>	<p>WI-FI CONTROL</p>	<p>Wi-Fi control. A next generation system providing user-friendly control of air conditioning or heat pump units from everywhere, using a simple Android™ or iOS smartphone or tablet via Wi-Fi.</p>	<p>BMS CONNECTIVITY</p>	<p>BMS connectivity. The communication port can be integrated into the indoor unit and provides easy connection to, and control of, your Panasonic heat pump to your home or building management system.</p>
-------------------------------------	--	-----------------------------	--	--------------------------------	---

Bringing nature's balance indoors



nanoe™ X, technology with the benefits of hydroxyl radicals.

Abundant in nature, hydroxyl radicals (also known as OH radicals) have the capacity to inhibit pollutants, viruses, and bacteria to clean and deodorise. nanoe™ X technology can bring these incredible benefits indoors so that hard surfaces, soft furnishings, and the indoor environment can be a cleaner and more pleasant place to be.



Panasonic's nanoe™ X technology takes this a step further and brings nature's detergent – hydroxyl radicals – indoors to help create an ideal environment

Thanks to the nanoe™ X properties, several types of pollutants can be inhibited such as certain types of bacteria, viruses, mould, allergens, pollen and certain hazardous substances.

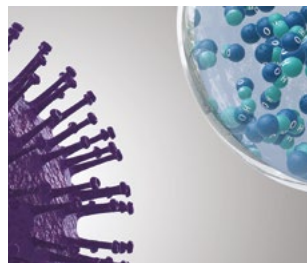

1 | nanoe™ X reliably reaches pollutants.

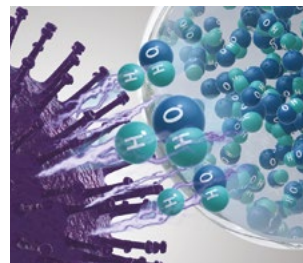

2 | Hydroxyl radicals denature pollutants' proteins.

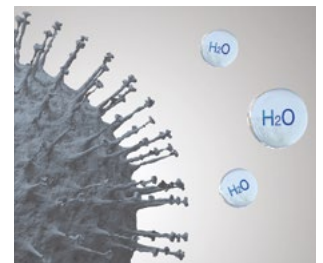

3 | Pollutants activity is inhibited.

What is unique about nanoe™ X?

Effective on fabrics and surfaces.

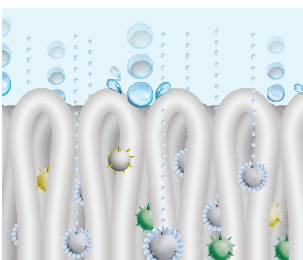

1 | At one billionth of a metre, nanoe™ X is much smaller than steam and can deeply penetrate cloth fabrics to deodorise.

Longer lifespan.



2 | Contained in tiny water particles, nanoe™ X has a longer lifespan to spread easily around the room.

Huge quantity.



3 | nanoe™ X Generator Mark 2 produces 9,6 trillion hydroxyl radicals per second. Greater amounts of hydroxyl radicals contained in nanoe™ X lead to higher performance on inhibition of pollutants.

Maintenance-free.



The image shows nanoe™ X Generator Mark 2.

4 | No maintenance, no replacement required. nanoe™ X is a filter free solution that does not require maintenance, as its atomisation electrode is enveloped with water during its generation process and it is made with Titanium.

7 effects of nanoe™ X – Panasonic unique technology

Deodorises



Odours

Capacity to inhibit 5 types of pollutants



Bacteria and viruses



Mould



Allergens



Pollen



Hazardous substances



Skin and hair

* Refer to <https://aircon.panasonic.eu> for more details and validation data.

nanoe™ X, internationally-validated technology in testing facilities

The effectiveness of nanoe™ X technology has been tested by 3rd party laboratories in Germany, France, Denmark, Malaysia and Japan.

The nanoe™ X performance varies depending on the room size, environment and usage and it may take several hours to reach the full effect. nanoe™ X is not medical device, local regulations on building design and sanitary recommendations must be followed.

Test results conducted under controlled laboratory conditions. Performance of nanoe™ X might differ in real life environment.

	Tested contents		Result	Capacity	Time	Testing organisation	Report No.
Airborne	Virus	Bacteriophage ΦX174	99,7 % inhibited	Approx. 25 m³	6 h	Kitasato Research Center for Environmental Science	24_0300_1
	Bacteria	Staphylococcus aureus	99,9 % inhibited	Approx. 25 m³	4 h	Kitasato Research Center for Environmental Science	2016_0279
Adhered	Virus	SARS-CoV-2	91,4 % inhibited	6,7 m³	8 h	Texcell (France)	1140-01 C3
		SARS-CoV-2	99,9 % inhibited	45 L	2 h	Texcell (France)	1140-01 A1
		Xenotropic murine leukemia virus	99,999 % inhibited	45 L	6 h	Charles River Biopharmaceutical Services GmbH	—
		Influenza (H1N1 subtype)	99,9 % inhibited	1 m³	2 h	Kitasato Research Center for Environmental Science	21_0084_1
		Bacteriophage ΦX174	99,80% inhibited	25 m³	8 h	Japan Food Research Laboratories	13001265005-01
	Bacteria	Staphylococcus aureus	99,9 % inhibited	20 m³	8 h	Danish Technological Institute	868988
	Pollen	Ambrosia pollen	99,4 % inhibited	20 m³	8 h	Danish Technological Institute	868988
	Odours	Cigarette smoke odour	Odour intensity reduced by 2,4 levels	Approx. 23 m³	0,2 h	Panasonic Product Analysis Center	4AA33-160615-N04

First nanoe™ device was developed by Panasonic in 2003

Generator	nanoe™	nanoe™ X	
	2003	Mark 1 - 2016	Mark 2 - 2019
	480 billion hydroxyl radicals/sec	4,8 trillion hydroxyl radicals/sec	9,6 trillion hydroxyl radicals/sec
Ion particle structure	 Hydroxyl Radicals	10x times	20x times

nanoe™ X: improving protection 24/7



Acts to clean your air, so that the indoor environment can be a cleaner and more pleasant place to be all day long. nanoe™ X works together with heating or cooling function when you are at home and can work independently when you are away.

Give the air conditioning the strength to increase the protection at home with nanoe™ X technology and convenient control via the Panasonic Comfort Cloud App.



Cleans the air when you are away.

Leave the nanoe™ mode ON to inhibit certain pollutants and deodorise before you return home.

Improves your environment when you are at home.

Enjoy a cleaner, comfortable space with loved ones.

Panasonic Heating & Cooling Solutions is incorporating nanoe™ technology in a wide range of equipment

Etherea.
Built-in nanoe X Generator Mark 2.

Floor console.
Built-in nanoe X Generator Mark 1.

Heatcharge VZ.
Built-in nanoe™.

Etherea with nanoe™ X technology

A smart solution to keep your home clean, comfortable and welcoming
The smart, new Etherea comes with nanoe™ X technology with the benefits of hydroxyl radicals. With advanced control options, class-leading performance, a stylish design and intelligent features, Etherea is designed to make your home comfortable, clean and the ideal place to be.





Available in 3 colors.

Graphite grey

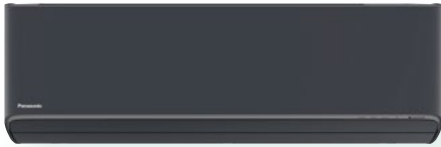

Silver

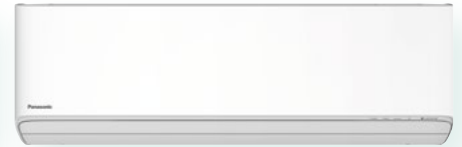

Matt white

**NEW
COLOR**[SEE PRODUCT SPECIFICATIONS](#)

1 Air quality

- nanoe™ X technology with the benefits of hydroxyl radicals
- Acts to clean your air, so that the indoor environment can be a cleaner and more pleasant place to be all day long

2 Smart control

- Built-in Wi-Fi
- Advanced control via smartphone
- Compatible with Google Assistant and Amazon Alexa

3 High efficiency

- Top class energy efficiency up to A+++ in heating and cooling

4 Ultimate comfort

- Aerowings 2.0, end-to-end vanes enhance comfortable air flow
- Super quiet ambient

5 New design

- **NEW!** Available in Matt white, Silver and Graphite grey color
- Stylish, monolithic design
- Chassis and parts designed for easier installation and servicing
- High class, easy-to-use remote control with backlight

nanoe™ X: Improving protection 24/7

Acts to clean your air, so that the indoor environment can be a cleaner and more pleasant place to be all day long. nanoe™ X works together with heating or cooling function when you are at home and can work independently when you are away. Give the air conditioning the strength to increase the protection at home with nanoe™ X technology and convenient control via the Panasonic Comfort Cloud App.



Cleans the air when you are away.

Leave the nanoe™ mode ON to inhibit certain pollutants and deodorise before you return home.

Improves your environment when you are at home.

Enjoy a cleaner, comfortable space with loved ones.

Technology for the ultimate comfort

Introducing the Aerowings 2.0 to the Etheria range.

Panasonic's Aerowings technology consists of two independent flexible vanes that concentrate air flow to heat or cool a room in the shortest time possible and helps distribute air evenly throughout a room. Thanks to the larger sub vane (72 mm), which is more than doubled in size than other conventional designs, the ability to lift air flow has been further improved.



Aerowings 2.0 has a new shower cooling feature which allows air flow to be concentrated evenly towards the ceiling to achieve comfortable cooling across a room, showering gently down into a room rather than one area subject to a continuous icy blast.



For heating, Aerowings 2.0 releases a concentrated air flow downwards to achieve an effect similar to floor heating the air, which rises and fills the room.

Sleek design with easy-to-use remote controller

Panasonic has meticulously designed a new Etheria for a sleek and stylish solution to blend with any interior. Its elegant monolithic design is robust and allows for a high-performance air conditioner, with a large air discharge area to optimise performance.

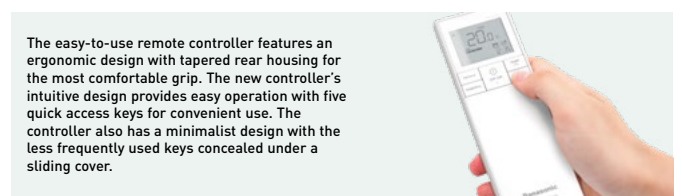

The easy-to-use remote controller features an ergonomic design with tapered rear housing for the most comfortable grip. The new controller's intuitive design provides easy operation with five quick access keys for convenient use. The controller also has a minimalist design with the less frequently used keys concealed under a sliding cover.



Heatcharge. Energy Charge System

Energy class A+++ and offers maximum comfort and energy savings. This powerful air heat pump is designed for commercial and residential climate that places extremely high demands on the heating system.





heatcharge



[+ SEE PRODUCT SPECIFICATIONS](#)

1 Powerful, reliable heating even at low ambient winter temperatures

When the air conditioner is operating, the compressor, which is the power supply of the unit, generates heat. Until now, this heat was released into the atmosphere. Panasonic has utilised this waste heat!

Constant heating.

Using stored heat provides stable heating with less drop in temperature. Even when heating operation stops during defrost operation, stored heat continues to constantly warm the room. This eliminates the previous discomfort due to the temperature dropping when heating temporarily stops to ensure stable air conditioner heating.

2 Panasonic's full line-up of A+++ heat pumps

In response to the Kyoto Protocol, the European Union set some challenging targets for the reduction in greenhouse-gas emissions. By the year 2020, across the member states, the EU wants to have achieved the following objectives:

- A 20 % cut in greenhouse gas emissions (from 1990 base levels)
- The share of renewables in the energy mix to increase by 20 %
- An overall reduction of 20 % in energy consumption

3 Comfort and efficiency

- nanoe™ technology with the benefits of hydroxyl radicals
- Higher efficiency and comfort with Econavi sunlight detection and human activity detection
- Powerful air flow to quickly reach the desired temperature

Conventional. The room gradually becomes cold.

Defrost operation: About 11 to 15 min. Fall in room temperature: About 5 to 6 °C.

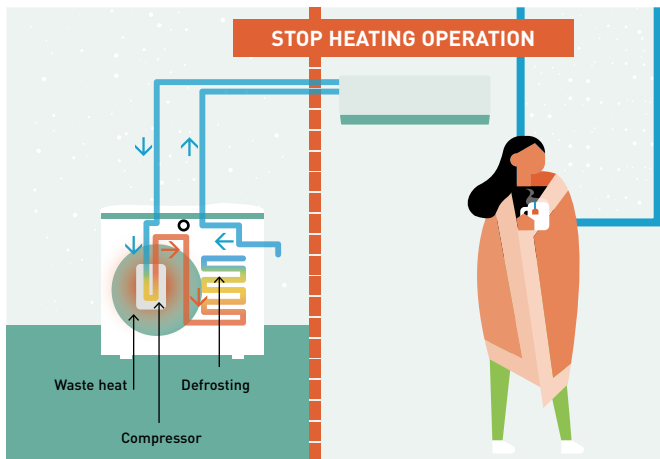

Heatcharge. The room is thoroughly warmed.

Defrost operation: About 5 to 6 min. Fall in room temperature: About 1 to 2 °C.

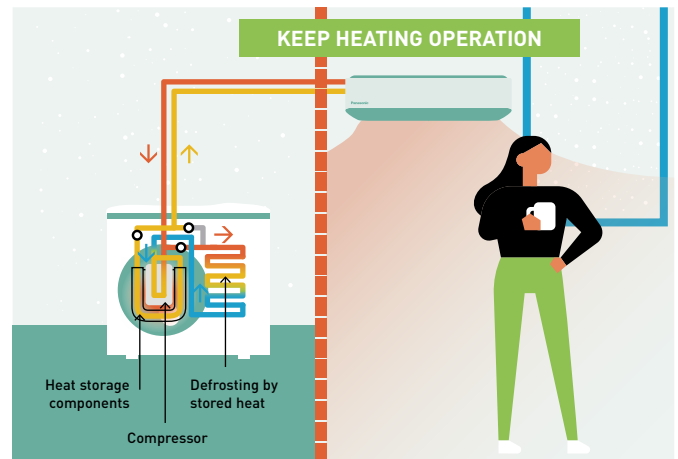

Conventional.

During operation, heat is generated inside the compressor.

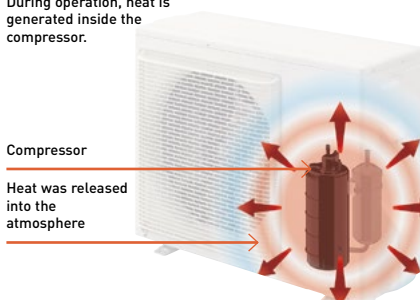

Heatcharge.

Heat generated by the compressor is stored inside and used to warm the refrigerant to efficiently increase heating power.

Waste heat is "charged" and used effectively



Heatcharge.

The compressor is wrapped and exhaust heat is used for charging.

Heatcharge tank. Waste heat from the compressor is stored.

Finless heat exchanger. Stored heat is converted to energy.

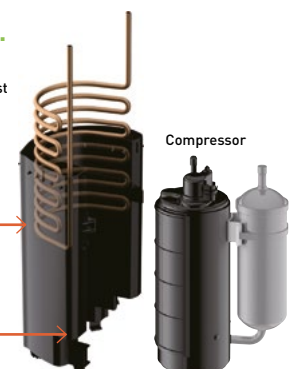

* Defrost operation time and how low room temperature falls differ depending on the environment in which the unit is being used (how insulated and airtight the room is), operation conditions, and temperature conditions. Output air temperature falls during defrost operation. How low room temperature falls differs depending on the environment in which the unit is being used (how insulated and airtight the room is), operation conditions, and temperature conditions. In environments where a lot of frost accumulates, heating may stop during defrost operation.

Wall-mounted TZ super-compact

The perfect air conditioner for the smallest spaces in your home.
TZ with R32 refrigerant powerful and efficient.



**GOOD DESIGN
AWARD 2020**

An "excellent design" indicated by Good Design Award is a design which focusses on humanity, honesty, innovation, aesthetics and ethics. Panasonic's award-winning TZ proves to be a worthy addition to any home.

[SEE PRODUCT SPECIFICATIONS](#)

1 Super-compact design

The compact design of the indoor units have a width of just 779 mm. This allows for more installation possibilities, including the limited space above a door.

Meticulously designed for both installer and user benefit, installation time of the TZ has been dramatically decreased.

The inner workings of the unit have also been redesigned to make maintenance quicker and easier. Electronics and wiring components are now on just one side of the unit to simplify maintenance.

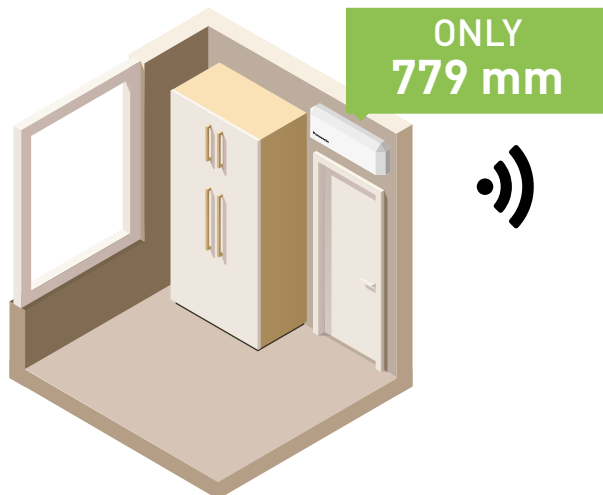

2 Built-in Wi-Fi and compatible with Voice Assistant

The unit is ready to connect to the internet and to be controlled by smartphone with Panasonic Comfort Cloud App. Control, monitor, and schedule with easy interface.

By connecting Panasonic Comfort Cloud App the unit can be managed by the Google Assistant or Amazon Alexa*.

* Amazon, Alexa and all related logos are trademarks of Amazon.com, Inc. or its affiliates. Google, Android, Google Play and Google Home are trademarks of Google LLC.

3 PM2,5

Particulate matter (PM2,5) can be found suspended in the air, including dust, dirt, smoke and liquid droplets. The filter can catch PM2,5 particles including hazardous pollutants as well as house dust and pollen and is able to maintain the air quality of the room.

4 Stylish infrared control

Enjoy innovative design at your fingertips with the stylish and sleek Backlit Sky Controller. Bigger screen and easier to use.



Silent ambient and relaxing atmosphere 20 dB(A)

We have succeeded in making one of the most silent air conditioners on the market. Panasonic Inverter air conditioner's indoor operating noise has been reduced as the Inverter constantly varies its output power to enable more precise temperature control.

* 2,5 and 3,5 kW models: In the Quiet Mode during cooling operation with low fan speed.

Aerowings

Panasonic's Aerowings feature incorporates two independent blades that concentrate air flow to cool you down in the shortest time possible. This also helps distribute cool air evenly throughout the room.

Superior air flow control.

Aerowings features two independent blades that give you more control over the direction of the air flow. Without Aerowings, with direct air flow, the target never changes, so you can easily begin to feel too cold as you are subjected to the continuous icy blast.

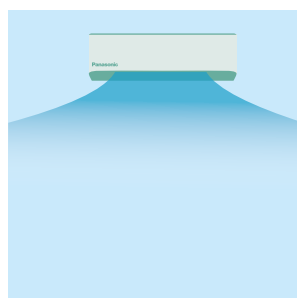

Comfort that goes on and on with Shower Cooling.

When the Aerowings twin blades direct air towards the ceiling they create the Shower Cooling effect.

Panasonic Air Conditioners with Aerowings feature an indoor design with wider intake grille and super-high fan speed to produce bigger air flow.

For Shower Cooling.
This ensures cool air is evenly distributed throughout the room and you can stay comfortable without experiencing continuous direct cooling.

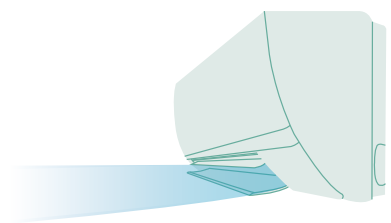

Wall-mounted indoor units, designed for simple installation and maintenance

The full range of wall-mounted indoor units has been carefully designed for simple, stress-free installation and ongoing maintenance.

* Not applicable to VZ.



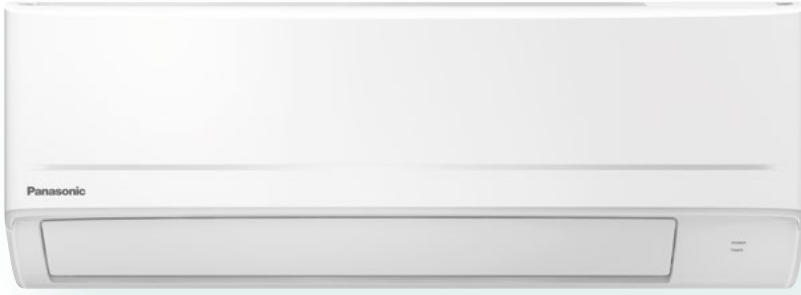

FEATURE AVAILABLE IN ETHEREA, TZ, BZ, UZ AND PZ



SEE PRODUCT SPECIFICATIONS

1 Simple installation

Thanks to advanced improvements, installation time has been dramatically decreased. The models have been designed to provide more stability and strength for neat installation, with newly built-in support and convenient access to the drain hose, cabling inserts and larger space for secure installation.



2 Easy maintenance

Meticulously designed for both installer and user benefit, the unit features an easy to remove front grille for convenient access to the interior. The inner workings of the unit have also been redesigned to make maintenance quicker and easier. Electronics and wiring components are now on just one side of the unit to simplify maintenance.

1. Stronger installation plate.

The models feature a stronger, solid installation plate that provides more stability and strength. For uneven surfaces, there are 2 additional screws to ensure a neat and secure installation.

Installation plate: Strong and solid.

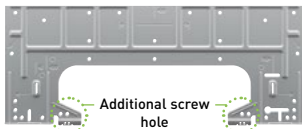

Screw holder for uneven surface (screws not provided).



2. One-piece front grille.

The model comes with a one-piece front grille design to make servicing easier. First, open the intake grille and remove the screws. Next, slide the three slider locks and remove the front grille.

One-piece front grille: Easy removal.



Slider locks: Easy to unlock / lock.

3. Built-in support holder.

The model features a built-in support holder, making installation easier and providing convenience and workspace improvements.

Convenient installation and serviceability.



4. Easy access to drain hose and piping connection.

With larger piping space, pipes and insulations are securely and neatly hidden.

With the visible piping storage, pipes can easily be inspected for leaks without lifting the unit.

Piping storage: up to 15 % larger (for TZ-WKE).

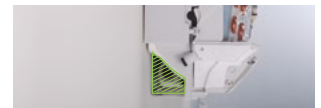

Bigger working space.

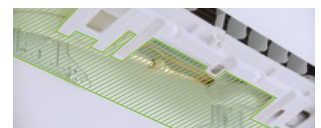

5. Easy wire insertion and tightening.

The models have combined 2 wire inserts into 1, ensuring front visibility and convenience while inserting wires from the back.

Single tunnel: easy wire insert.



Bigger working space for wiring connection.



6. Easy removal of PCB.

PCB removal is achieved in just 4 easy steps. Simply remove the control board cover, disconnect all connectors from the indicator, disconnect all connectors and pull out the main PCB.

Simple steps for PCB removal.

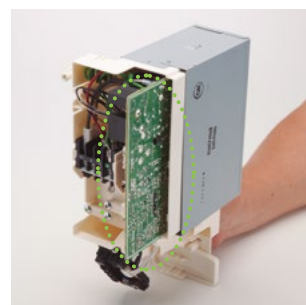

7. Easy / hidden installation of the Wi-Fi adapter.

The latest model features a dedicated space for a network adapter. Easy to plug in, the guided wire slots allow for clear, easy installation and can be neatly tucked away - simple and out of sight!

* Only for models without built-in network adapter.



8. Cross flow fan removal.

The models are carefully designed to make removal of cross flow fans easier compared to the previous models, saving valuable time.

Bigger diameter: up to Ø105 (for Z-XKE).



Floor console. Efficient comfort and clean air all year round

Floor console with new nanoe™ X technology: outstanding efficiency A++, comfort (Super Quiet technology only 20 dB(A)) and better air quality combined in a breakthrough design.



nanoe™ X: Improving protection 24/7. Acts to clean your air, so that the indoor environment can be a cleaner and more pleasant place to be all day long. nanoe™ X works together with heating or cooling function when you are at home and can work independently when you are away.





The iF Product Design Awards are among the most prestigious awards for product design excellence. Winning the award thanks to its highly intelligent functionality, the Panasonic Floor console is the ideal air-conditioning system for domestic and commercial applications.

[SEE PRODUCT SPECIFICATIONS](#)

1 nanoe™ X: Bringing nature's balance indoors

Panasonic's nanoe™ X technology brings nature's detergent – hydroxyl radicals – indoors to help improve protection 24/7 against several types of pollutants can be inhibited such as certain types of bacteria, viruses, mould, allergens, pollen or hazardous substances.

The nanoe™ X performance varies depending on the room size, environment and usage and it may take several hours to reach the full effect (see page 99 for more detail). nanoe™ X is not medical device, local regulations on building design and sanitary recommendations must be followed.

2 Superquiet operation

When the system reaches its set temperature, the unit will operate at only 20 dB(A). Creating a comfortable home is not only by temperature - a quiet atmosphere is also important.

3 Designed to follow the high European demands

Super quiet operation, highly efficient and technology to help clean the air.

Double air flow for improved comfort and temperature dispersion: through the top for an efficient operation



Stylish infrared control

Enjoy innovative design at your fingertips with the stylish and sleek Backlit Sky Controller. Bigger screen and easier to use.



Easy to integrate into your home

A breakthrough design that integrates perfectly with any style. We have carefully selected materials and processes to create an elegant design. Compact in size and with a stylish design, the floor console will easily integrate into your home's interior decoration. There are four options available:



High energy efficiency class A++

The floor console brings the outdoor heat energy inside. Can provide heat inside even when it is -15 °C outside.

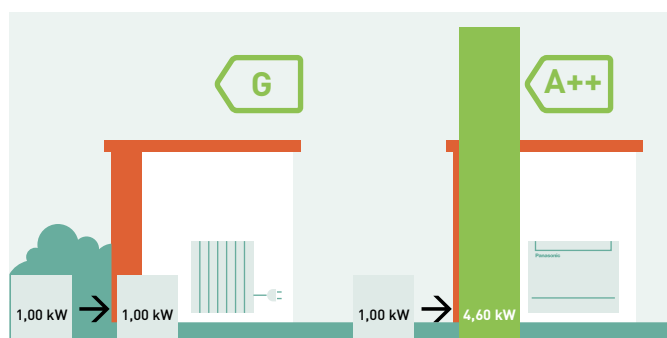

* SCOP on heating mode for Floor console Type KIT-Z25-UFE and KIT-Z35-UFE compared with electrical heaters at +7 °C.

The perfect solution for the replacement of old boiler heating systems



Panasonic R2 rotary compressor

The secret is flexibility. Panasonic Inverter air conditioners have the flexibility to vary the rotation speed of the compressor. This allows it to use less energy to maintain the set temperature while also being able to cool the room quicker at start up.

So you can enjoy better savings on your electricity bills while maintaining cooling comfort.



R2 rotary compressors utilize rolling piston technology.

The R2 compressor has been tested in extreme conditions: higher efficiency, single and dual piston, R32 / R410A refrigerant, compact size.



Making the world a cooler place since 1978

Panasonic rotary compressors for room air conditioners have been installed in the most demanding environments around the world. Designed to withstand extreme conditions, Panasonic Rotary delivers high performance, efficiency and reliable service, no matter where you are. Panasonic, the world's largest manufacturer of rotary compressors.

Why is the Panasonic R2 rotary compressor so efficient?

1. High efficiency motor. The premium silicon steel motor meets industry efficiency requirements.
2. Improved lubrication of high volume oil pump. The extended, high volume oil pump in conjunction with a larger capacity oil reservoir provides superior lubrication.
3. Accumulator has larger refrigerant capacity. The larger accumulator accommodates generous refrigerant amounts needed in longer line length installations.

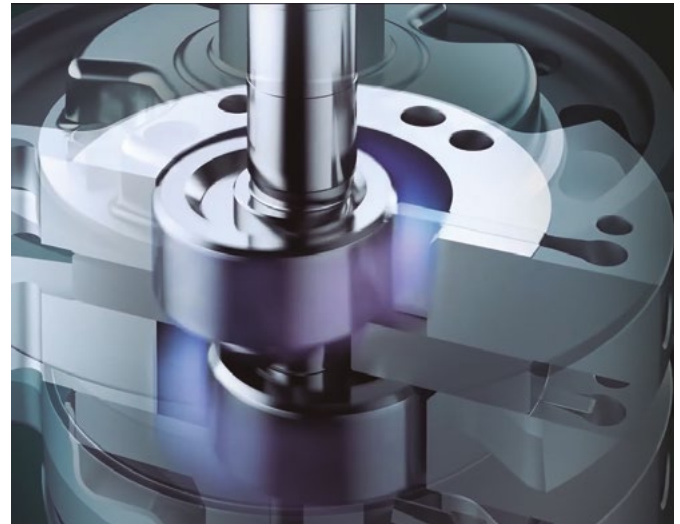

* This image is for 5,0 / 7,1 kW.

R2 compressor value

About R2 compressor.

Built upon 36 years of compressor design and production experience, R2 is the next generation of rotary compressors for residential central air conditioning. The technology improvements, enhanced materials and simple design ensure R2 compressors are reliable, efficient and quiet. The R2 compressor delivers quality, comfort and peace of mind in homes around the world. Panasonic's Rotary Compressors have been life tested in some of the world's most demanding environments and the R2 design is the compressor of choice by contractors and homeowners in these challenging climates. For the high performance that home-owners demand, R2 rotary compressors are considered by the industry experts.

Leading technology.

Used in over 80 % of cooling solutions globally, rotary is the world's dominant residential air conditioning compression technology. Panasonic is the leading rotary and residential AC compressor manufacturer in the world, with over 200 million compressors produced.

Benefits.

Central air conditioning delivered with a Panasonic R2 rotary compressor ensures a superior level of comfort at an economical cost.

Inverter technology

Great energy-saving performance. Reduces electricity consumption.

Panasonic Inverter air conditioners are designed to give you exceptional energy savings and performance. At the start up of an air conditioner's operation, a boost in power is required to reach the set temperature. After the set temperature is reached, less power is required to maintain it. The Panasonic Inverter air conditioner varies the rotation speed of the compressor. This provides a highly precise method of maintaining the set temperature.

Constant comfort.

Precise temperature control with a wide power output range enables an inverter air conditioner to meet different room occupancy levels – thus ensuring constant comfort.

Quick comfort.

Panasonic Inverter air conditioners can operate with higher power during the start up period to cool the room 1,5 times faster and heat the room 4 times faster than non-Inverter models.

Comparison of cooling speed.

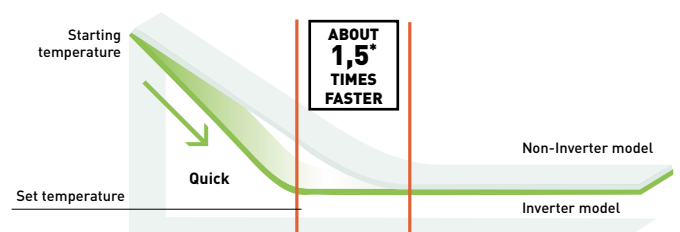

* 3,5 kW Inverter vs. non-Inverter. Outside room temperature: 35 °C; setting temperature: 25 °C.

Comparison of heating speed.

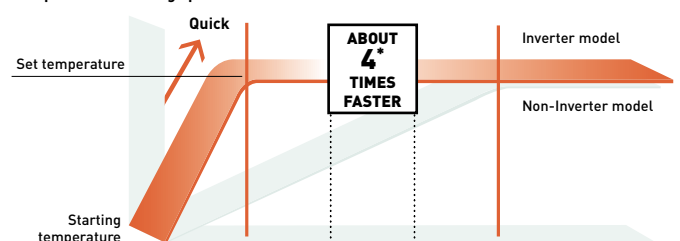

* Comparison of 2,5 kW Inverter and Non-Inverter. Outside room temperature: 2 °C ; Setting temperature: 25 °C.

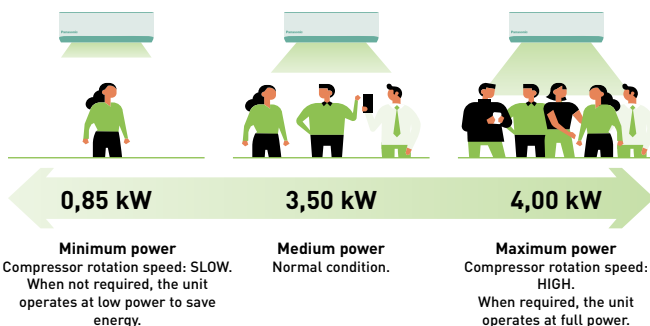

* Graph shows the 3,5 kW Inverter model's wide power output range during cooling.

R22 Renewal. Panasonic standard units can be installed on existing R22 pipings

Change your old air conditioning system to a more efficient system!





An important drive to further reduce the potential damage to our ozone

- All Panasonic standard SKE, TKE and UKE units can be installed on existing R22 pipings
- No need for additional accessories (only pipe reductions)
- Approximately 30 % energy savings compared to R22 units

Panasonic is doing its part

We at Panasonic are also doing our part – recognising that all finances are under pressure at the moment. Panasonic has developed a clean and cost effective solution to enable this latest legislation to be introduced with as minimum an effect on businesses and cash reserves as possible.

The Panasonic renewal system allows good quality existing R22 pipe work to be re-used whilst installing new high efficiency R410A / R32 systems.

By bringing a simple solution to the problem Panasonic can renew all Split Systems and PACi systems; and depending upon certain restrictions we don't even limit the manufacturer's equipment we are replacing.

By installing a new high efficiency Panasonic R410A / R32 system you can benefit from around 30 % running cost saving compared to the R22 system.

Yes...

1. Check the capacity of the system you wish to replace
2. Select from the Panasonic range the best system to replace it with
3. Follow the procedure detailed in the brochure and technical data

Simple...

R22 - The reduction of Chlorine critical for a cleaner future.

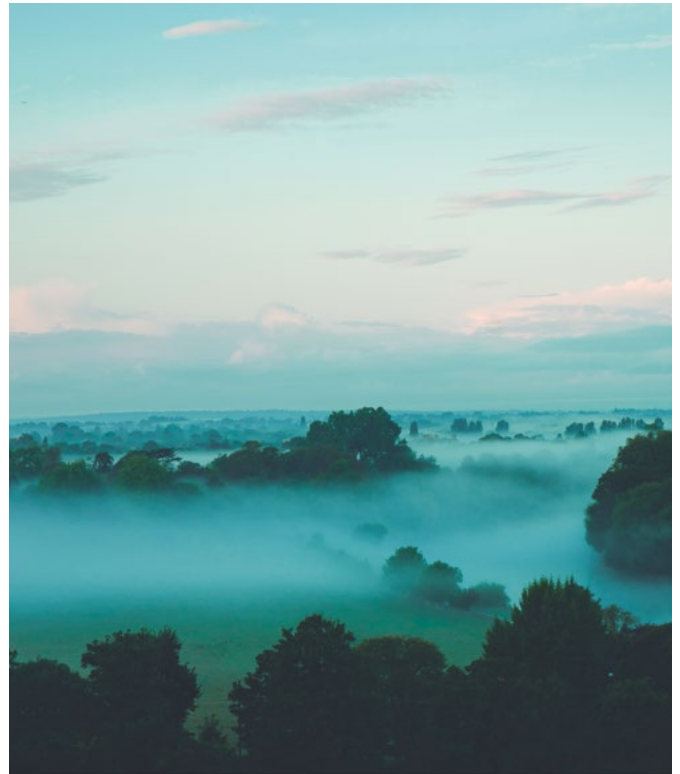

Guidance on re-using existing R22 piping for a new R410A / R32 installation

1. Precaution.

The existing R22 piping can be re-used for a R410A / R32 system installation if the following conditions are met and the piping are finally verified to be:

- Dry (no moisture remaining in the piping)
- Clean (no dust remaining in the piping)
- Tight (no refrigerant leak at the joining and piping)

2. Conditions.

- Recover the refrigerant and oil.
Operate "force cooling" according to the recommended operation time, regardless of the piping length. Single split: 10 min. Multi split: 30 min. After that, carry out "pump down" to recover the refrigerant and oil from the existing R22 system

* Note: If pump down operation is not possible due to the malfunction of the system, flush and wash the existing piping to collect back the oil and dirt inside the system.

- Check the oil condition. If the oil contains dirt, wash the existing pipes
- Check the oil colour. After pump down, use a cotton bud to wipe the oil from the existing pipe. If the oil colour is higher than ASTM3, use a new pipe as re-use of old piping is not allowed
- Check pipe thickness. Make sure that the pipe thickness is more than 0,8 mm. If the thickness is less than 0,8 mm, use a new pipe
- Rework the flare for R410A / R32 connection. Do not reuse the old flare nuts

Deterioration Criteria for Refrigerant Oil

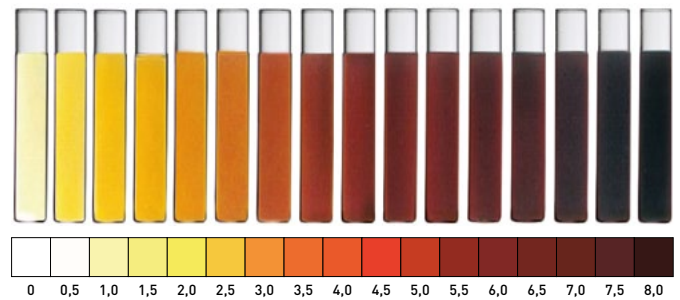

Make sure to use the new flare nuts attached to the R410A / R32 system.

* Note: If the existing piping size is 1/4" (6,35 mm) and 1/2" (12,7 mm), and the new R410A / R32 system is 1/4" (6,35 mm) and 3/8" (9,52 mm), use a pipe reducer connected at indoor and outdoor unit.

3. Applicable Model.

Panasonic single split room air conditioner from CS/ CU-RE/UE/YE/XE/CE/NE/E*NKE and PKE series onwards.
Panasonic multi split room air conditioner from CU-2E/3E/4E/5PBE series onwards.

		Liquid		
		Gas	3/8 [9,52]	1/4 [6,35] 1/2 [12,70] 5/8 [15,88]
Split	16 / 20 / 25 / 35	1,6 - 3,5 kW	✓	▲ ✗
	42 / 50 / 60	4,2 - 6,0 kW	✗	✓ ▲
	71	6,8 - 7,5 kW	✗	✗ ✓

✓ Standard piping connection with current piping length and refrigerant charge rules.

▲ This combinations is allowed respecting maximum piping length and refrigerant charged declared in model installed as new.

✗ This combinations is not allowed as it is out of piping diameter.

Welcome to the connected world of Panasonic Comfort Cloud App

Whether you are at home, at the office or running a business, Panasonic Comfort Cloud put total control of your indoor air quality at your fingertips.





The Panasonic Comfort Cloud Application enables you to conveniently manage and monitor multiple air conditioning units for homes from just one mobile device. Also, energy monitoring is possible allowing opportunity to learn how to reduce the operating cost even more.

- Connectable up to 200 units* with just 1 device
- Compatible for both residential and commercial applications

Download on the
App StoreGET IT ON
Google Play

* 10 different groups, with up to 20 units / per group.



1 Smart control

In control of cooling comfort anytime, anywhere.

- Control multiple units in 1 group (up to 20 units per group and up to 10 different groups)
- Control multiple units in multiple locations

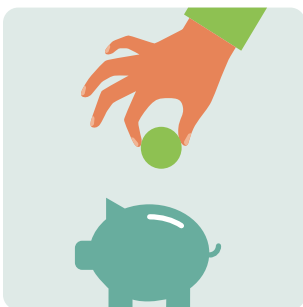

3 Smart efficiency

More comfort with less wasted energy.

- Analyze energy usage patterns ²⁾
- Compare usage history for better budget planning

2) Estimated energy consumption data accuracy depends on power supply quantity.

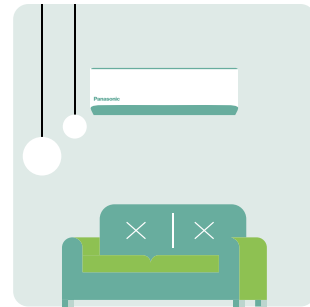

2 Smart comfort

Easily manage your comfort and air quality.

- Remotely access all AC features
- Activate 24-hour nanoe™ X ¹⁾
- Pre-heat or cool spaces

1) nanoe™ X is available in certain series.

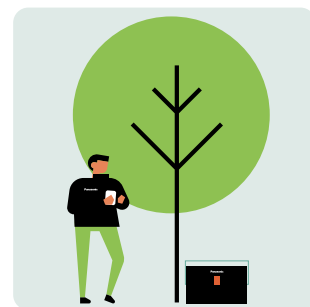

4 Smart assist

Be informed of breakdowns.

- Assign other users while you are away
- Effortless troubleshooting ³⁾

3) Contact trained technicians to perform any repairing / service.

Panasonic Comfort Cloud App connectable up to 200 units. 20 units per group.



The smartest way to bring convenience to your living space (living room, bedroom, study room...) and business (spa, schools, restaurants...).



New possibilities, new applications.

Families.

Different users can be set up, such as each child can manage their own room. In second homes, rooms can be remotely pre-cooled or pre-warmed, or turned off if needed.

Multi tenant owner.

The ability to manage up to 200 units with just one smartphone. It allows for quick and efficient maintenance through remote error codes and the knowledge of consumption.

Small and medium sized offices.

Owner can control different rooms of the office easily and give unit by unit access to their staff. Also provides information to know where energy might be wasted for heating and cooling and promoting best comfort practices.

Experience what Panasonic Comfort Cloud App can do for you and for your commercial spaces

Quick access to preset operations.

Panasonic Comfort Cloud App comes with many different preset modes (auto, heat, cool, dry, nanoe)*. Choose the best mode that suits your lifestyle or your business space.

* Available mode depends on your model.

Pre-heat your home before arriving.

After a hectic day outside, when you depart for home, pre-cool or pre-heat it before arriving and be greeted with a welcoming home.

Conveniently turn ALL ON / OFF.

Never have to worry about individually switching ON / OFF your air conditioner units. You can now do it with a single tap of a button.

Monitor your energy consumption.

Monitor and compare your air conditioner energy consumption across different time intervals such as daily, weekly, monthly and yearly.



Clean the air of your home all day long with nanoe™ X.
Activate nanoe™ X technology with the with the benefits of hydroxyl radicals.



Smart control at your fingertips

With Panasonic Comfort Cloud App, the user can manage all functions of the heat pump such as nanoe™ X, air flow direction, speed, temperature setting, mode, plus more.

Energy monitor and statistics

Knowing the energy each unit uses when operating is key to see opportunities to reduce the energy bill. Panasonic Comfort Cloud App stores the energy consumption* of each unit, which can then be shown in easy and powerful statistics graphs. With the weekly timer the operation can be adjusted to optimise the usage of the energy.

* Estimated energy consumption data accuracy depends on power supply quality.
** This function is available from XKE, WKE, VKE, TKE and UKE generation.

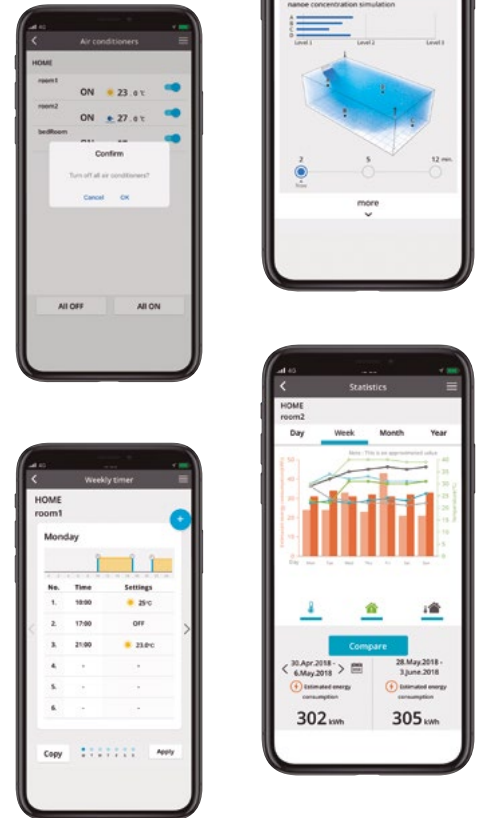

nanoe™ X: improving protection 24/7

Improve the protection of your living spaces at all hours of the day. Turn nanoe™ X on or off easily with "One-touch nanoe™ button" on the main screen. Panasonic Comfort Cloud App includes a nanoe™ X Concentration Simulator to see how the nanoe™ X particles fulfill the room.

* Only for units compatible with nanoe™ X function. The Concentration Simulator is beta version covering limited patterns of simulation results.

Connection diagram



Download free app: Panasonic Comfort Cloud App.

Other hardware requirements: Router and Internet (purchase and subscribe separately).

Built-in Wi-Fi in certain models or with optional adaptor CZ-TACG1 connected to port CN-CNT. Panasonic Cloud Server is designed, operated and managed by Panasonic.



Built-in Wi-Fi.

CS-XZ**XKEW-H, CS-Z**YKEA, CS-Z**XKEW, CS-MZ16XKE, CS-XZ**XKEW, CS-Z**VKEW, CS-MZ16VKE, CS-XZ**VKEW, CS-TZ**WKEW and CS-RZ**WKEW.

Optional CZ-TACG1 Wi-Fi accessory required.

CS-BZ**XKE, CS-FZ**WKE, CZ-UZ**WKE, CS-PZ**WKE, CS-UZ**VKE, CS-PZ**VKE, CS-FZ**UKE, CS-MZ20UFEA, CS-Z**UFEAW, CS-Z**UB4EAW, CS-MZ20UD3EA, CS-Z**UD3EAW and CS-VZ**SKE.

Optional CZ-CAPWFC1 Wi-Fi accessory or CONEX CZ-RTC6BLW remote controller required.

S-**PY3E and S-M20PY3E,

Remark: indoor temperature display and some special functions are not available through the app for all models. Languages: Available in 19 European languages: Bulgarian, Croatian, Czech, Danish, Deutsch, English, Estonian, Finnish, French, Greek, Hungarian, Italian, Norwegian, Polish, Portuguese, Slovenian, Spanish, Swedish and Turkish.

Voice Control. Words do more than actions

Control without boundaries and get hands-free help to fully access the features of your air conditioners. Maximising your cooling comfort is now a breeze with our Network-Enabled air conditioners with Panasonic Comfort Cloud App and Voice Control.

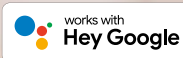

1 Turn ON / OFF air conditioner

Convenient control for blissful rest.

Turn ON / OFF AC with ease when preparing a comfortable space for your little ones.

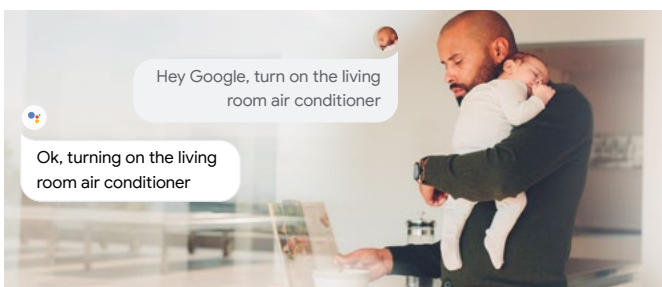

3 Adjust temperature

Easy control for uninterrupted quality time.

Adjust AC temperature to your comfort with a simple voice command.

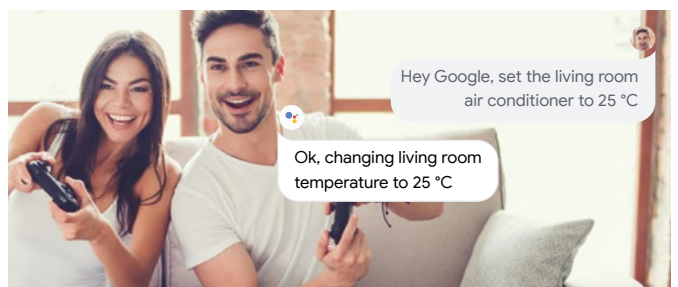

2 Change mode

Extra help when you have a hectic day.

Conveniently change your AC operation mode to cool / heat / auto when your hands are full.



4 Check current status

Hands-free comfort for the whole family.

Easy access for the elderly to check current AC operation status and adjust AC settings.





Get multiple things done with your voice

Simplify your day with your personalised routine by grouping individual actions.

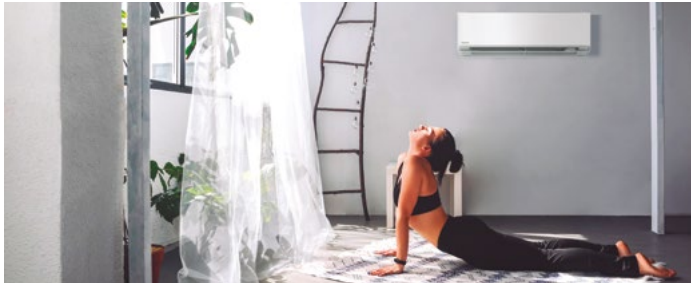

Schedule your routine with your voice.

With the routine function, you can customise voice commands and control multiple voice-controlled devices including our network-enabled air conditioners to help you with your personalised routine.

Example of morning routine.

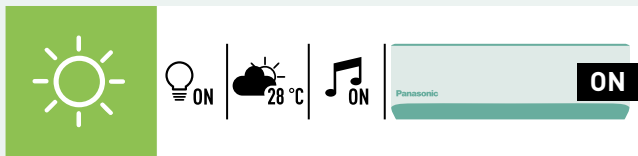

Example of night routine.

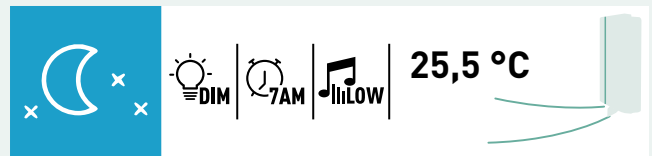

Find out more: [Amazon] <https://www.techhive.com/article/3327501/how-to-use-alexa-routines.html>

Voice Control with Network-Enabled air conditioners

Functions	When you are home		When away from home
	Remote Control	Voice Control	Comfort Cloud App
Smart control	Power ON / OFF	✓	✓
	Control multiple units in 1 location	—	✓
	Control multiple units in multiple locations	—	✓
Smart comfort	Set up and manage routines	—	—
	Cooling mode	✓	✓
	Heating mode	✓	✓
	Auto mode	✓	✓
	nanoe™ X mode	✓	—
	Summer House mode	✓	✓
	Pre-cool	—	✓
	Change temperature	✓	✓
Smart efficiency	Analyse energy usage patterns	—	✓
	Compare historical usage	—	✓
Smart assist	Receive error notifications	—	✓
	Assign multiple users	—	✓
	Check power ON / OFF	✓	✓
	Check current mode	✓	✓
	Check temperature settings	✓	✓
	Check room temperature	✓	✓

Seamless set up in 3 simple steps

Set up your Panasonic Comfort Cloud App.



Set up your Google Nest Mini or Amazon Echo devices and app.



Link your Google Nest Mini or Amazon Echo with Panasonic Comfort Cloud App.



Compatible device and browsers as of June 2020

1. Android™ 5.0 Lollipop or above
2. iOS 9.0 or above

Please note:

- This is not a definitive list of all compatible devices, other similar devices which use supported Operating Systems should also work either via dedicated apps. Please note that user experience may vary slightly depending on hardware and software combination
- Google, Android, Google Play and Google Home are trademarks of Google LLC.
- Google Assistant is not available in certain languages and countries
- Amazon, Alexa and all related logos are trademarks of Amazon.com, Inc. or its affiliates
- Availability of Voice Assistant services varies depending on country and language
- More information about set up procedures: <https://aircon.panasonic.com/connectivity/application.html>
- Google Assistant and Alexa are compatible with the models shown in pages 122, 123



Control and connectivity

Panasonic offers its customers cutting-edge technology, specially designed to ensure our air conditioning systems deliver even higher performance.



CZ-TACG1 network adaptor (optional)*

- Optional RAC network adaptor
- Compact size for easy installation
- Available for built-in or exposed installation depending on model type.

* Functionality varies depending on models. Please contact your local dealers for compatible models.

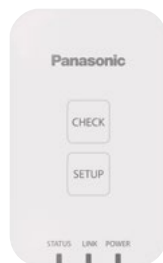

Specifications

Input Voltage	DC 12V
Power Consumption	Max. 660 mW
Size (HxWxD)	66 x 36 x 12 mm
Mass	Approx. 85g
Interface	1 x Wireless LAN
Wireless LAN Standard	IEEE 802,11 b/g/n
Frequency Range	2,4GHz band
Encryption	WPA2-PSK (TKIP/AES)

Domestic integration to P-Link - CZ-CAPRA1

Can connect RAC range to P-Link. Full control is now possible.

Integrates any unit in big system control.

- YKEA server room integration ¹⁾
- Small offices with domestic indoors
- Tender for refurbishment (old system Domestic and VRF in one installation)

¹⁾ When duty rotation using the remote controller is set up, CZ-CAPRA1 cannot be connected.

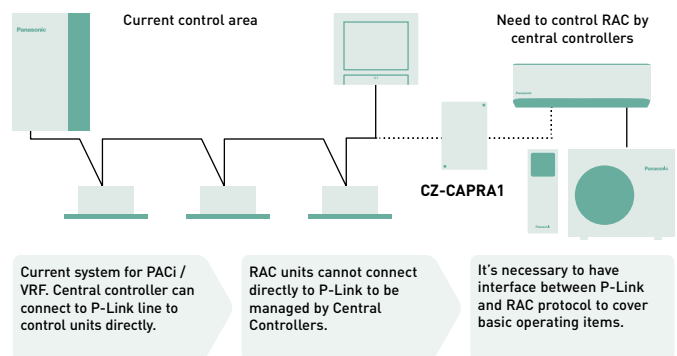

Current system for PACi / VRF. Central controller can connect to P-Link line to control units directly.

RAC units cannot connect directly to P-Link to be managed by Central Controllers.

It's necessary to have interface between P-Link and RAC protocol to cover basic operating items.

Centralized Control Systems: 64 indoor units

Intelligent controller / Web Server: 256 indoor units

Panasonic AC Smart Cloud

Basic operation items: ON / OFF, Mode select, Temperature setting, Fan speed, Flap setting, Remote control prohibit.

External input: ON / OFF control signal, Abnormal stop signal.

External output for Relay ¹⁾: Operation status (ON / OFF), Alarm status output.



¹⁾ Because current CN-CNT connector can not provide the power for external output relay, additional Input power for external relay is necessary.



You can properly manage the air conditioning and perform comprehensive monitoring and control, with all of the features the remote controller provides at home, from anywhere in the world thanks to the internet applications Panasonic has created for you.

Connectivity. Control by BMS

Great flexibility for integration into your KNX, Modbus and BACnet projects allows fully bi-directional monitoring and control of all the functioning parameters.

Reference	 PAW-AC-KNX-1i	Modbus® PAW-AC-MBS-1	 PAW-AC-BAC-1 ¹⁾
Quick installation and possibility of hidden installation	✓	✓	✓
External power not required	✓	✓	✓
Direct connection to the AC indoor unit	✓ (Split or multi split)	✓ (Split or multi split)	✓ (Split or multi split)
Control and monitoring of the internal variables of the indoor unit and error codes and indication	✓ Fully compatible	✓ Fully compatible	✓ Fully compatible
Use the AC ambient temperature or the one measured by external sensor	✓	✓	Only internal temperature
AC unit can be controlled simultaneously by the remote controller of the AC unit and interface devices	✓	✓	✓
Advanced control functions	✓	✓	✓
4 binary inputs. They work as standard interface binary inputs as well as being used to control the AC directly	✓	✗	✗
Total Control and Supervision. Real states of the AC unit's internal variables	✓	✓	✓

1) This interface allows a complete and natural integration of Panasonic air conditioners into either BACnet IP or MS/TP networks. Is a BTL certified device.

PAW-AC-DIO

Dry contact ON / OFF Interface. Panasonic has developed for hotels applications a dry contact PCB which works with Etherea, RE, UE and YE indoor units in order to control simply the unit centrally.

- ON / OFF signal by 3rd party BMS
- PCB connected to CN-RMT port on indoor unit PCB

Easy connectivity









CN-CNT port easy to access in all indoor units, without dismantling the unit to reach the connector. Can easier connect: Wireless accessory / KNX / Modbus / CZ-TACG1 / CZ-CAPRA1 to integrate to PACi control.

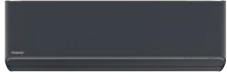

Model name	Interface
CZ-TACG1	Wi-Fi adapter for smart control via Panasonic Comfort Cloud App
CZ-CAPRA1	RAC interface adapter for integration into P-Link, plus external input and alarm/status output
PAW-AC-KNX-1i	This interface can be used with all models which have a CN-CNT connector
PAW-AC-MBS-1	This interface can be used with all models which have a CN-CNT connector

Model name	Interface
PAW-AC-BAC-1	This interface can be used with all models which have a CN-CNT connector
PAW-AC-HEAT-1	Heating only PCB for Etherea and low static pressure hide-away
PAW-AC-DIO	This interface can be used with all models which have a CN-RMT connector
PAW-SMCONTROL	Control of the Etherea, Flagship and Heatcharge by SMS (need additional SIM card)







Domestic air conditioner R32 range





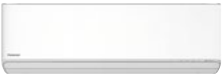

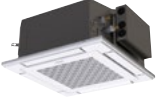

Page	Single split units	2,0 kW	2,5 kW	3,5 kW	4,2 kW	5,0 kW	6,0 kW	7,1 kW
P. 124	Wall-mounted Heatcharge VZ Inverter+ · R32							
			CS-VZ9SKE CU-VZ9SKE	CS-VZ12SKE CU-VZ12SKE				
P. 125	Wall-mounted Etherea Inverter+ · R32							
		CS-XZ20XKEW-H CU-Z20XKE	CS-XZ25XKEW-H CU-Z25XKE	CS-XZ35XKEW-H CU-Z35XKE				
		CS-XZ20XKEW CU-Z20XKE	CS-XZ25XKEW CU-Z25XKE	CS-XZ35XKEW CU-Z35XKE		CS-XZ50XKEW CU-Z50XKE		
P. 126	Wall-mounted TZ super-compact Inverter · R32							
		CS-TZ20WKEW CU-TZ20WKE	CS-TZ25WKEW CU-TZ25WKE	CS-TZ35WKEW CU-TZ35WKE	CS-TZ42WKEW CU-TZ42WKE	CS-TZ50WKEW CU-TZ50WKE	CS-TZ60WKEW CU-TZ60WKE	CS-TZ71WKEW CU-TZ71WKE
P. 127	NEW Wall-mounted BZ super-compact Inverter · R32							
			CS-BZ25XKE CU-BZ25XKE	CS-BZ35XKE CU-BZ35XKE		CS-BZ50XKE CU-BZ50XKE	CS-BZ60XKE CU-BZ60XKE	
P. 128	Wall-mounted UZ super-compact Inverter · R32							
			CS-UZ25WKE CU-UZ25WKE	CS-UZ35WKE CU-UZ35WKE		CS-UZ50WKE CU-UZ50WKE		
P. 129	Wall-mounted PZ super-compact Inverter · R32							
			CS-PZ25WKE CU-PZ25WKE	CS-PZ35WKE CU-PZ35WKE		CS-PZ50WKE CU-PZ50WKE		
P. 130	Floor console Inverter+ · R32							
			CS-Z25UFEAW CU-Z25UBEAW	CS-Z35UFEAW CU-Z35UBEAW		CS-Z50UFEAW CU-Z50UBEAW		
P. 131	Low static pressure hide-away Inverter · R32							
			CS-Z25UD3EAW CU-Z25UBEAW	CS-Z35UD3EAW CU-Z35UBEAW		CS-Z50UD3EAW CU-Z50UBEAW	CS-Z60UD3EAW CU-Z60UBEAW	



* Available in Spring 22.



Configure in a few steps your multi split system with our online tool.

Page	Free Multi indoors	1,6 kW	2,0 kW	2,5 kW	3,5 kW	4,2 kW	5,0 kW	6,0 kW	7,1 kW
P. 135	Wall-mounted Etherea Inverter+	 * CS-XZ20XKEW-H CS-XZ25XKEW-H CS-XZ35XKEW-H							
		 CS-XZ20XKEW CS-XZ25XKEW CS-XZ35XKEW			CS-XZ50XKEW				
		 CS-MZ16XKE CS-Z20XKEW CS-Z25XKEW CS-Z35XKEW CS-Z42XKEW CS-Z50XKEW	CS-Z71XKEW						
P. 135	Wall-mounted TZ super-compact Inverter	 CS-MTZ16WKE CS-TZ20WKEW CS-TZ25WKEW CS-TZ35WKEW CS-TZ42WKEW CS-TZ50WKEW CS-TZ60WKEW CS-TZ71WKEW							
P. 135	Floor console Inverter+	 CS-MZ20UFEA CS-Z25UFEAW CS-Z35UFEAW							
		CS-Z50UFEAW							
P. 135	NEW 4 Way 60x60 cassette Inverter	 S-M20PY3E CZ-KPY4 S-25PY3E CZ-KPY4 S-36PY3E CZ-KPY4 S-50PY3E CZ-KPY4 S-60PY3E CZ-KPY4							
P. 135	Low static pressure hide-away Inverter	 CS-MZ20UD3EA CS-Z25UD3EAW CS-Z35UD3EAW							
		CS-Z50UD3EAW CS-Z60UD3EAW							

Page	Free Multi outdoors	3,2 ~ 6,0 kW	3,2 ~ 6,0 kW	3,2 ~ 7,7 kW	4,5 ~ 9,5 kW	4,5 ~ 11,2 kW	4,5 ~ 11,5 kW	4,5 ~ 14,7 kW	4,5 ~ 18,3 kW
P. 134	Outdoor unit Free Multi System Z · R32	 CU-2Z35TBE	 CU-2Z41TBE	 CU-2Z50TBE	 CU-3Z52TBE	 CU-3Z68TBE	 CU-4Z68TBE	 CU-4Z80TBE	 CU-5Z90TBE

Page	Multi Wall TZ outdoors	3,2 ~ 6,0 kW	3,2 ~ 7,7 kW	4,5 ~ 9,5 kW
P. 136	Outdoor unit Multi TZ for wall TZ indoors · R32	 CU-2TZ41TBE	 CU-2TZ50TBE	 CU-3TZ52TBE

**Wall-mounted Heatcharge VZ Inverter+ · R32**

- Energy Charge System. Heat storage unit which utilizes non-stop heating and fast heating function
- Econavi Sunlight Detection sensor: Even higher efficiency and great comfort
- nanoe™ technology to improve protection 24/7
- Super Quiet! Only 18 dB(A), equivalent to night-time in the countryside
- Performance tested at -35 °C outdoor temperature

Kit			KIT-VZ9-SKE	KIT-VZ12-SKE
Cooling capacity	Nominal (Min - Max)	kW	2,50 (0,60 - 3,00)	3,50 (0,60 - 4,00)
SEER ¹⁾			10,50 A+++	10,00 A+++
Pdesign (cooling)		kW	2,50	3,50
Input power	Nominal (Min - Max)	kW	0,43 (0,14 - 0,61)	0,80 (0,14 - 0,98)
Annual energy consumption ³⁾		kWh/a	83	122
Heating capacity	Nominal (Min - Max)	kW	3,60 (0,60 - 7,80)	4,20 (0,60 - 9,20)
COP ²⁾		W/W	5,63	5,04
Heating capacity at -7 °C		kW	5,00	5,60
COP at -7 °C ²⁾		W/W	2,07	2,00
SCOP ¹⁾			6,20 A+++	5,90 A+++
Pdesign at -10 °C		kW	3,60	4,20
Input power	Nominal (Min - Max)	kW	0,64 (0,14 - 2,72)	0,83 (0,14 - 3,16)
Annual energy consumption ³⁾		kWh/a	812	995
Indoor unit			CS-VZ9SKE	CS-VZ12SKE
Power supply		V	230	230
Recommended fuse		A	16	16
Connection indoor / outdoor		mm ²	4 x 1,5	4 x 1,5
Air flow	Cool / Heat (Hi)	m ³ /min	12,5 / 15,5	12,9 / 15,9
Sound pressure ⁴⁾	Cool (Hi / Lo / Q-Lo)	dB(A)	44 / 27 / 18	45 / 33 / 18
	Heat (Hi / Lo / Q-Lo)	dB(A)	44 / 26 / 18	45 / 29 / 18
Dimension	H x W x D	mm	295 x 798 x 375	295 x 798 x 375
Net weight		kg	14,5	14,5
Outdoor unit			CU-VZ9SKE	CU-VZ12SKE
Air flow	Cool / Heat (Hi)	m ³ /min	33,1 / 33,1	35,4 / 33,9
Sound pressure ⁴⁾	Cool / Heat (Hi)	dB(A)	49 / 49	50 / 50
Dimension ⁵⁾	H x W x D	mm	630 x 799 x 299	630 x 799 x 299
Net weight		kg	39,5	39,5
Piping diameter	Liquid pipe	Inch (mm)	1/4 (6,35)	1/4 (6,35)
	Gas pipe	Inch (mm)	3/8 (9,52)	3/8 (9,52)
Pipe length range		m	3 - 15	3 - 15
Elevation difference (in / out)		m	12	12
Pipe length for additional gas		m	7,5	7,5
Additional gas amount		g/m	20	20
Refrigerant (R32) / CO ₂ Eq.		kg / T	1,05 / 0,70875	1,10 / 0,7425
Operating range	Cool Min ~ Max	°C	-10 ~ +43	-10 ~ +43
	Heat Min ~ Max	°C	-30 ~ +24	-30 ~ +24
Lowest outdoor temperature tested by 3rd party laboratory ⁶⁾		°C	-35	-35

1) Energy Label Scale from A+++ to D. 2) EER and COP calculation is based in accordance to EN14511. 3) The annual energy consumption is calculated in accordance to EU/626/2011. 4) The sound pressure of the indoor unit shows the value measured of a position of 1 m in front of the main body and 0,8 m below the unit. For outdoor unit 1 m in front and 1 m in rear side of main body. The sound pressure is measured in accordance with JIS C 9612. Q-Lo: Quiet mode. Lo: The lowest set fan speed. 5) Add 70 mm for piping port. 6) Tested by 3rd party laboratory, SP, according to EN14511:2013 and SP Method 1721, this temperature is not guaranteed by Factory.

Accessories	
CZ-TACG1	Wi-Fi adapter for smart control via Panasonic Comfort Cloud App

Accessories	
CZ-CAPRA1	RAC interface adapter for integration into P-Link
PAW-SMSCONTROL	Control by SMS (need additional SIM card)



SEER and SCOP: For KIT-VZ9-SKE. -35 °C HEATING MODE: Heating performance tested at -35 °C by SP, European third party laboratory. INTERNET CONTROL: Optional.



Wall-mounted Etherea Inverter+ · R32

- nanoe™ X technology to improve protection 24/7
- New sleek and stylish design, in Matt white, Silver and Graphite grey color
- Improved SEER / SCOP to achieve top class energy efficiency
- Aerowings 2.0 for the ultimate comfort
- New easy-to-use remote controller
- Built-in Wi-Fi for instant connectivity via Panasonic Comfort Cloud App
- Compatible with Google Assistant and Amazon Alexa
- Chassis and parts designed for easier installation

New Kit Graphite grey*			KIT-XZ20-XKE-H	KIT-XZ25-XKE-H	KIT-XZ35-XKE-H	—	—	—
Kit Silver			KIT-XZ20-XKE	KIT-XZ25-XKE	KIT-XZ35-XKE	—	KIT-XZ50-XKE	—
Kit Matt white			KIT-Z20-XKE	KIT-Z25-XKE	KIT-Z35-XKE	KIT-Z42-XKE	KIT-Z50-XKE	KIT-Z71-XKE
Cooling capacity	Nominal (Min - Max)	kW	2,05 (0,75 - 2,65)	2,50 (0,85 - 3,50)	3,50 (0,85 - 4,20)	4,20 (0,85 - 5,00)	5,00 (0,98 - 6,00)	7,10 (0,98 - 8,50)
EER ¹⁾	Nominal (Min - Max)	W/W	4,56 (4,69 - 3,96)	4,90 (5,00 - 3,89)	4,12 (4,25 - 3,62)	3,39 (3,62 - 3,18)	3,68 (3,92 - 3,16)	3,17 (2,33 - 2,83)
SEER ²⁾			8,10 A++	9,40 A+++	9,50 A+++	7,00 A++	8,50 A+++	6,50 A++
Pdesign (cooling)		kW	2,1	2,5	3,5	4,2	5,0	7,1
Input power	Nominal (Min - Max)	kW	0,45 (0,16 - 0,67)	0,51 (0,17 - 0,90)	0,85 (0,20 - 1,16)	1,24 (0,24 - 1,57)	1,36 (0,25 - 1,90)	2,24 (0,42 - 3,00)
Annual energy consumption ³⁾		kWh/a	91	93	129	210	206	382
Heating capacity	Nominal (Min - Max)	kW	2,80 (0,75 - 4,00)	3,40 (0,80 - 4,80)	4,00 (0,80 - 5,50)	5,30 (0,80 - 6,80)	5,80 (0,98 - 8,00)	8,20 (0,98 - 10,20)
Heating capacity at -7 °C		kW	2,38	2,80	3,20	4,11	4,80	6,31
COP ¹⁾	Nominal (Min - Max)	W/W	4,52 (4,69 - 4,26)	4,86 (5,00 - 4,07)	4,44 (4,44 - 3,77)	3,68 (4,21 - 3,66)	4,14 (4,26 - 3,35)	3,69 (2,45 - 3,29)
SCOP ²⁾			4,80 A++	5,20 A+++	5,20 A+++	4,20 A+	4,80 A++	4,20 A+
Pdesign at -10 °C		kW	2,1	2,4	2,8	3,6	4,2	5,5
Input power	Nominal (Min - Max)	kW	0,62 (0,16 - 0,94)	0,70 (0,16 - 1,18)	0,90 (0,18 - 1,46)	1,44 (0,19 - 1,86)	1,40 (0,23 - 2,39)	2,22 (0,40 - 3,10)
Annual energy consumption ³⁾		kWh/a	613	646	754	1200	1225	1833
Indoor unit Graphite grey			CS-XZ20XKEW-H	CS-XZ25XKEW-H	CS-XZ35XKEW-H	—	—	—
Indoor unit Silver			CS-XZ20XKEW	CS-XZ25XKEW	CS-XZ35XKEW	—	CS-XZ50XKEW	—
Indoor unit Matt white			CS-Z20XKEW	CS-Z25XKEW	CS-Z35XKEW	CS-Z42XKEW	CS-Z50XKEW	CS-Z71XKEW
Power supply	V		230	230	230	230	230	230
Recommended fuse	A		16	16	16	16	16	20
Connection indoor / outdoor	mm ²		4 x 1,5	4 x 1,5	4 x 1,5	4 x 1,5	4 x 2,5	4 x 2,5
Air flow	Cool / Heat	m ³ /min	11,7/13,0	12,7/14,1	12,7/14,7	14,4/15,4	17,4/19,1	19,0/19,9
Moisture removal volume	L/h		1,3	1,5	2,0	2,4	2,8	4,1
Sound pressure ⁴⁾	Cool (Hi / Lo / Q-Lo)	dB(A)	37/24/19	39/25/19	42/28/19	43/31/25	44/37/30	47/38/30
	Heat (Hi / Lo / Q-Lo)	dB(A)	38/25/19	41/27/19	43/33/19	43/35/29	44/37/30	47/38/30
Dimension	H x W x D	mm	295 x 870 x 229	295 x 870 x 229	295 x 870 x 229	295 x 870 x 229	295 x 1040 x 244	295 x 1040 x 244
Net weight	kg		10	10	11	10	12	14
nanoe X Generator			Mark 2	Mark 2	Mark 2	Mark 2	Mark 2	Mark 2
Outdoor unit			CU-Z20XKE	CU-Z25XKE	CU-Z35XKE	CU-Z42XKE	CU-Z50XKE	CU-Z71XKE
Air flow	Cool / Heat	m ³ /min	27,4/26,7	28,7/27,2	29,8/30,6	29,8/30,9	39,8/36,9	44,7/45,8
Sound pressure ⁴⁾	Cool / Heat (Hi)	dB(A)	45/46	46/47	48/50	49/51	47/47	52/54
Dimension ⁵⁾	H x W x D	mm	542 x 780 x 289	542 x 780 x 289	542 x 780 x 289	542 x 780 x 289	695 x 875 x 320	695 x 875 x 320
Net weight	kg		25	27	30	30	40	50
Piping diameter	Liquid pipe	Inch (mm)	1/4 (6,35)	1/4 (6,35)	1/4 (6,35)	1/4 (6,35)	1/4 (6,35)	1/4 (6,35)
	Gas pipe	Inch (mm)	3/8 (9,52)	3/8 (9,52)	3/8 (9,52)	1/2 (12,70)	1/2 (12,70)	5/8 (15,88)
Pipe length range	m		3 - 15	3 - 15	3 - 15	3 - 15	3 - 30	3 - 30
Elevation difference (in / out)	m		15	15	15	15	15	20
Pipe length for additional gas	m		7,5	7,5	7,5	7,5	7,5	10
Additional gas amount	g/m		10	10	10	10	15	25
Refrigerant (R32) / CO ₂ Eq.	kg / T		0,67/0,45	0,80/0,54	0,89/0,60	0,95/0,64	1,13/0,76	1,35/0,91
Operating range	Cool Min ~ Max	°C	-10 ~ +43	-10 ~ +43	-10 ~ +43	-10 ~ +43	-10 ~ +43	-10 ~ +43
	Heat Min ~ Max	°C	-15 ~ +24	-15 ~ +24	-15 ~ +24	-15 ~ +24	-15 ~ +24	-15 ~ +24

1) EER and COP calculation is based in accordance to EN14511. 2) Energy Label Scale from A+++ to D. 3) The annual energy consumption is calculated in accordance to EU/626/2011. 4) The sound pressure of the indoor unit shows the value measured at a position of 1 m in front of the main body and 0,8 m below the unit. For outdoor unit 1 m in front and 1 m in rear side of main body. The sound pressure is measured in accordance with JIS C 9612. Q-Lo: Quiet mode. Lo: The lowest set fan speed. 5) Add 70 mm for piping port. * Available in Spring 22.

Accessories

CZ-CAPRA1	RAC interface adapter for integration into P-Link
PAW-SMSCONTROL	Control by SMS (need additional SIM card)

Accessories

CZ-RD517C	Wired remote controller for wall-mounted and floor console
------------------	--



SEER and SCOP: For KIT-**35-XKE. SUPER QUIET: For KIT-**20-XKE, KIT-**25-XKE, KIT-**35-XKE. INTERNET CONTROL: Built-in Wi-Fi.

Rating Conditions: Cooling Indoor 27 °C DB / 19 °C WB. Cooling Outdoor 35 °C DB / 24 °C WB. Heating Indoor 20 °C DB. Heating Outdoor 7 °C DB / 6 °C WB. (DB: Dry Bulb; WB: Wet Bulb). Specifications subject to change without notice. For detailed information about ErP / Energy Labelling, please visit our websites www.aircon.panasonic.eu or www.ptc.panasonic.eu.

**GOOD DESIGN
AWARD 2020****Wall-mounted TZ super-compact - R32**

- Compact and elegant design with only 779 mm wide
- Built-in Wi-Fi for instant connectivity via Panasonic Comfort Cloud App
- Compatible with Google Assistant and Amazon Alexa
- Stylish Sky remote controller
- Cleaner air with PM2,5 filter
- Super Quiet! Only 20 dB(A)
- Aerowings to control air draft direction
- High energy savings

Kit			KIT-TZ20-WKE	KIT-TZ25-WKE	KIT-TZ35-WKE	KIT-TZ42-WKE	KIT-TZ50-WKE	KIT-TZ60-WKE	KIT-TZ71-WKE
Cooling capacity	Nominal (Min - Max)	kW	2,00(0,75-2,40)	2,50(0,85-3,00)	3,50(0,85-3,90)	4,20(0,85-4,60)	5,00(0,98-5,60)	6,00(0,98-6,60)	7,10(0,98-8,20)
EER ¹⁾	Nominal (Min - Max)	W/W	4,08(4,17-4,00)	3,85(4,05-3,41)	3,57(3,62-3,36)	3,36(3,62-2,80)	3,13(3,92-2,95)	3,24(3,92-2,87)	3,17(2,33-2,98)
SEER ²⁾			7,00 A++	7,00 A++	6,80 A++	6,40 A++	6,90 A++	6,80 A++	6,20 A++
Pdesign (cooling)		kW	2,00	2,50	3,50	4,20	5,00	6,00	7,10
Input power	Nominal (Min - Max)	kW	0,49(0,18-0,60)	0,65(0,21-0,88)	0,98(0,24-1,16)	1,25(0,24-1,64)	1,60(0,25-1,90)	1,85(0,25-2,30)	2,24(0,42-2,75)
Annual energy consumption ³⁾		kWh/a	100	125	180	230	254	309	401
Heating capacity	Nominal (Min - Max)	kW	2,70(0,70-3,60)	3,30(0,80-4,10)	4,00(0,80-5,10)	5,00(0,80-6,80)	5,80(0,98-7,50)	7,00(0,98-8,20)	8,60(0,98-9,90)
Heating capacity at -7 °C		kW	2,14	2,70	3,30	3,90	4,62	4,90	6,13
COP ¹⁾	Nominal (Min - Max)	W/W	4,15(4,24-3,53)	4,18(4,21-3,66)	4,04(4,10-3,70)	3,73(4,10-3,33)	3,41(4,67-3,26)	3,68(4,67-3,57)	3,51(2,45-3,47)
SCOP ²⁾			4,60 A++	4,60 A++	4,60 A++	4,00 A+	4,50 A+	4,30 A+	4,00 A+
Pdesign at -10 °C		kW	1,90	2,40	2,80	3,60	4,00	4,40	5,50
Input power	Nominal (Min - Max)	kW	0,65(0,17-1,02)	0,79(0,19-1,12)	0,99(0,20-1,38)	1,34(0,20-2,04)	1,70(0,21-2,30)	1,90(0,21-2,30)	2,45(0,40-2,85)
Annual energy consumption ³⁾		kWh/a	578	730	852	1260	1244	1433	1925
Indoor unit			CS-TZ20WKEW	CS-TZ25WKEW	CS-TZ35WKEW	CS-TZ42WKEW	CS-TZ50WKEW	CS-TZ60WKEW	CS-TZ71WKEW
Power supply		V	230	230	230	230	230	230	230
Recommended fuse		A	16	16	16	16	16	20	20
Connection indoor / outdoor		mm ²	4x1,5	4x1,5	4x1,5	4x1,5	4x2,5	4x2,5	4x2,5
Air flow	Cool / Heat	m ³ /min	10,3/10,8	11,0/11,5	11,8/12,3	12,5/13,2	12,5/13,2	20,9/21,9	22,1/22,9
Moisture removal volume		L/h	1,3	1,5	2,0	2,4	2,8	3,3	4,1
Sound pressure ⁴⁾	Cool (Hi / Lo / Q-Lo)	dB(A)	37/25/20	40/26/20	42/30/20	44/31/29	44/37/33	45/37/34	47/38/35
	Heat (Hi / Lo / Q-Lo)	dB(A)	38/26/22	40/27/22	42/33/22	44/35/28	44/37/33	45/37/34	47/38/35
Dimension	HxWxD	mm	290x779x209	290x779x209	290x779x209	290x779x209	290x779x209	302x1102x244	302x1102x244
Net weight		kg	8	8	8	8	8	13	13
Outdoor unit			CU-TZ20WKE	CU-TZ25WKE	CU-TZ35WKE	CU-TZ42WKE	CU-TZ50WKE	CU-TZ60WKE	CU-TZ71WKE
Air flow	Cool / Heat	m ³ /min	29,7/29,7	30,0/28,9	28,7/29,7	30,4/30,8	32,7/32,7	34,0/34,0	44,7/45,9
Sound pressure ⁴⁾	Cool / Heat (Hi)	dB(A)	46/47	47/48	48/50	49/51	48/49	49/51	52/54
Dimension ⁵⁾	HxWxD	mm	542x780x289	542x780x289	542x780x289	542x780x289	619x824x299	619x824x299	695x875x320
Net weight		kg	24	25	31	31	36	36	50
Piping diameter	Liquid pipe	Inch (mm)	1/4(6,35)	1/4(6,35)	1/4(6,35)	1/4(6,35)	1/4(6,35)	1/4(6,35)	1/4(6,35)
	Gas pipe	Inch (mm)	3/8(9,52)	3/8(9,52)	3/8(9,52)	1/2(12,70)	1/2(12,70)	1/2(12,70)	5/8(15,88)
Pipe length range		m	3~15	3~15	3~15	3~15	3~20	3~30	3~30
Elevation difference (in / out)		m	15	15	15	15	15	15	20
Pipe length for additional gas		m	7,5	7,5	7,5	7,5	7,5	10	10
Additional gas amount		g/m	10	10	10	10	15	15	25
Refrigerant (R32) / CO ₂ Eq.		kg / T	0,54/0,365	0,67/0,452	0,77/0,520	0,79/0,533	1,14/0,770	1,22/0,824	1,32/0,891
Operating range	Cool Min - Max	°C	-10~+43	-10~+43	-10~+43	-10~+43	-10~+43	-10~+43	-10~+43
	Heat Min - Max	°C	-15~+24	-15~+24	-15~+24	-15~+24	-15~+24	-15~+24	-15~+24

1) EER and COP calculation is based in accordance to EN14511. 2) Energy Label Scale from A+++ to D. 3) The annual energy consumption is calculated in accordance to EU/626/2011. 4) The sound pressure of the indoor unit shows the value measured of a position of 1 m in front of the main body and 0,8 m below the unit. For outdoor unit 1 m in front and 1 m in rear side of main body. The sound pressure is measured in accordance with JIS C 9612. Q-Lo: Quiet mode. Lo: The lowest set fan speed. 5) Add 70 mm for piping port.

Accessories**CZ-CAPRA1** RAC interface adapter for integration into P-Link**Accessories****CZ-RD517C** Wired remote controller for wall-mounted and floor console

SEER and SCOP: For KIT-TZ20-WKE and KIT-TZ25-WKE. SUPER QUIET: For KIT-TZ20-WKE, KIT-TZ25-WKE and KIT-TZ35-WKE. INTERNET CONTROL: Built-in Wi-Fi.



NEW Wall-mounted BZ super-compact Inverter · R32

- Compact design with only 779 mm wide
- Cleaner air with PM2,5 Filter
- Super Quiet! Only 20 dB(A)
- Aerowings to control air draft direction
- High energy savings
- Cooling even at -10 °C
- Optional internet and voice control

Kit			KIT-BZ25-XKE	KIT-BZ35-XKE	KIT-BZ50-XKE	KIT-BZ60-XKE
Cooling capacity	Nominal (Min - Max)	kW	2,50 [0,85 - 3,00]	3,40 [0,85 - 3,90]	5,00 [0,98 - 5,40]	6,00 [0,98 - 6,50]
EER ¹⁾	Nominal (Min - Max)	W/W	3,68 [4,05 - 3,33]	3,18 [3,54 - 3,05]	3,03 [3,92 - 2,90]	3,03 [3,92 - 2,83]
SEER ²⁾			6,20 A++	6,10 A++	6,50 A++	6,30 A++
Pdesign (cooling)		kW	2,50	3,40	5,00	6,00
Input power	Nominal (Min - Max)	kW	0,68 [0,21 - 0,90]	1,07 [0,24 - 1,28]	1,65 [0,25 - 1,86]	1,98 [0,25 - 2,30]
Annual energy consumption ³⁾		kWh/a	141	195	269	333
Heating capacity	Nominal (Min - Max)	kW	3,15 [0,80 - 3,60]	3,84 [0,80 - 4,40]	5,40 [0,98 - 7,50]	6,80 [0,98 - 8,00]
Heating capacity at -7 °C		kW	2,14	2,60	4,58	5,10
COP ¹⁾	Nominal (Min - Max)	W/W	4,06 [4,21 - 3,46]	3,69 [4,10 - 3,41]	3,42 [4,67 - 3,06]	3,16 [4,26 - 3,02]
SCOP ²⁾			4,20 A+	4,20 A+	4,10 A+	4,00 A+
Pdesign at -10 °C		kW	1,90	2,40	4,00	4,40
Input power	Nominal (Min - Max)	kW	0,78 [0,19 - 1,04]	1,04 [0,20 - 1,29]	1,58 [0,21 - 2,45]	2,15 [0,23 - 2,65]
Annual energy consumption ³⁾		kWh/a	633	800	1366	1540
Indoor unit			CS-BZ25XKE	CS-BZ35XKE	CS-BZ50XKE	CS-BZ60XKE
Power supply		V	230	230	230	230
Recommended fuse		A	16	16	16	20
Connection indoor / outdoor		mm ²	4 x 1,5	4 x 1,5	4 x 2,5	4 x 2,5
Air flow	Cool / Heat	m ³ /min	10,5/11,1	10,8/11,3	12,5/13,2	12,7/13,6
Moisture removal volume		L/h	1,5	2,0	2,8	3,3
Sound pressure ⁴⁾	Cool (Hi / Lo / Q-Lo)	dB(A)	37/26/20	38/30/20	44/37/34	45/37/34
	Heat (Hi / Lo / Q-Lo)	dB(A)	37/27/24	38/33/25	44/37/34	45/37/34
Dimension	H x W x D	mm	290 x 779 x 209	290 x 779 x 209	290 x 779 x 209	290 x 779 x 209
Net weight		kg	8	8	8	9
Outdoor unit			CU-BZ25XKE	CU-BZ35XKE	CU-BZ50XKE	CU-BZ60XKE
Air flow	Cool / Heat	m ³ /min	30,4/30,4	31,1/31,1	32,7/32,7	42,6/41,5
Sound pressure ⁴⁾	Cool / Heat (Hi)	dB(A)	48/49	48/50	48/49	50/50
Dimension ⁵⁾	H x W x D	mm	542 x 780 x 289	542 x 780 x 289	619 x 824 x 299	695 x 875 x 320
Net weight		kg	24	25	36	43
Piping diameter	Liquid pipe	Inch (mm)	1/4 (6,35)	1/4 (6,35)	1/4 (6,35)	1/4 (6,35)
	Gas pipe	Inch (mm)	3/8 (9,52)	3/8 (9,52)	1/2 (12,70)	1/2 (12,70)
Pipe length range		m	3 ~ 15	3 ~ 15	3 ~ 15	3 ~ 30
Elevation difference (in / out)		m	15	15	15	15
Pipe length for additional gas		m	7,5	7,5	7,5	7,5
Additional gas amount		g/m	10	10	15	15
Refrigerant (R32) / CO ₂ Eq.		kg / T	0,54/0,36	0,67/0,45	1,14/0,77	1,11/0,75
Operating range	Cool Min ~ Max	°C	-10 ~ +43	-10 ~ +43	-10 ~ +43	-10 ~ +43
	Heat Min ~ Max	°C	-15 ~ +24	-15 ~ +24	-15 ~ +24	-15 ~ +24

1) EER and COP calculation is based in accordance to EN14511. 2) Energy Label Scale from A+++ to D. 3) The annual energy consumption is calculated in accordance to EU/626/2011. 4) The sound pressure of the indoor unit shows the value measured of a position of 1 m in front of the main body and 0,8 m below the unit. For outdoor unit 1 m in front and 1 m in rear side of main body. The sound pressure is measured in accordance with JIS C 9612. Q-Lo: Quiet mode. Lo: The lowest set fan speed. 5) Add 70 mm for piping port.

Accessories

CZ-TACG1	Wi-Fi adapter for smart control via Panasonic Comfort Cloud App
CZ-CAPRA1	RAC interface adapter for integration into P-Link

Accessories

CZ-RD517C	Wired remote controller for wall-mounted and floor console
------------------	--



SEER and SCOP: For KIT-BZ50-XKE. SUPER QUIET: For KIT-BZ25-XKE and KIT-BZ35-XKE. INTERNET CONTROL: Optional.

Rating Conditions: Cooling Indoor 27 °C DB / 19 °C WB. Cooling Outdoor 35 °C DB / 24 °C WB. Heating Indoor 20 °C DB. Heating Outdoor 7 °C DB / 6 °C WB. [DB: Dry Bulb; WB: Wet Bulb]. Specifications subject to change without notice. For detailed information about ErP / Energy Labelling, please visit our websites www.aircon.panasonic.eu or www.ptc.panasonic.eu.

**Wall-mounted UZ super-compact Inverter · R32**

- Compact design with only 779 mm wide
- Dust Collection Filter
- Super Quiet! Only 20 dB(A)
- Aerowings to control air draft direction
- High energy savings
- Cooling even at -10 °C
- Optional internet and voice control

Kit			KIT-UZ25-WKE	KIT-UZ35-WKE	KIT-UZ50-WKE
Cooling capacity	Nominal (Min - Max)	kW	2,50 (0,85 - 3,00)	3,30 (0,85 - 3,80)	5,00 (0,98 - 5,30)
EER ¹⁾	Nominal (Min - Max)	W/W	3,68 (4,05 - 3,33)	3,20 (3,54 - 3,06)	3,03 (3,92 - 2,93)
SEER ²⁾			6,20 A++	6,10 A++	6,50 A++
Pdesign (cooling)		kW	2,50	3,30	5,00
Input power	Nominal (Min - Max)	kW	0,68 (0,21 - 0,90)	1,03 (0,24 - 1,24)	1,65 (0,25 - 1,81)
Annual energy consumption ³⁾		kWh/a	141	189	269
Heating capacity	Nominal (Min - Max)	kW	3,00 (0,80 - 3,50)	3,70 (0,80 - 4,30)	5,40 (0,98 - 7,40)
Heating capacity at -7 °C		kW	2,08	2,54	4,52
COP ¹⁾	Nominal (Min - Max)	W/W	4,05 (4,21 - 3,47)	3,70 (4,10 - 3,44)	3,42 (4,67 - 3,08)
SCOP ²⁾			4,10 A+	4,10 A+	4,10 A+
Pdesign at -10 °C		kW	1,90	2,40	4,00
Input power	Nominal (Min - Max)	kW	0,74 (0,19 - 1,01)	1,00 (0,20 - 1,25)	1,58 (0,21 - 2,40)
Annual energy consumption ³⁾		kWh/a	649	820	1366
Indoor unit			CS-UZ25WKE	CS-UZ35WKE	CS-UZ50WKE
Power supply		V	230	230	230
Recommended fuse		A	16	16	16
Connection indoor / outdoor		mm ²	4 x 1,5	4 x 1,5	4 x 2,5
Air flow	Cool / Heat	m ³ /min	10,5/11,1	10,8/11,3	12,5/13,2
Moisture removal volume		L/h	1,5	1,9	2,8
Sound pressure ⁴⁾	Cool (Hi / Lo / Q-Lo)	dB(A)	37/26/20	38/30/20	44/37/34
	Heat (Hi / Lo / Q-Lo)	dB(A)	37/27/24	38/33/25	44/37/34
Dimension	H x W x D	mm	290 x 779 x 209	290 x 779 x 209	290 x 779 x 209
Net weight		kg	8	8	8
Outdoor unit			CU-UZ25WKE	CU-UZ35WKE	CU-UZ50WKE
Air flow	Cool / Heat	m ³ /min	30,4/30,4	31,1/31,1	32,7/32,7
Sound pressure ⁴⁾	Cool / Heat (Hi)	dB(A)	48/49	48/50	48/49
Dimension ⁵⁾	H x W x D	mm	542 x 780 x 289	542 x 780 x 289	619 x 824 x 299
Net weight		kg	24	25	36
Piping diameter	Liquid pipe	Inch (mm)	1/4 (6,35)	1/4 (6,35)	1/4 (6,35)
	Gas pipe	Inch (mm)	3/8 (9,52)	3/8 (9,52)	1/2 (12,70)
Pipe length range		m	3 ~ 15	3 ~ 15	3 ~ 15
Elevation difference (in / out)		m	15	15	15
Pipe length for additional gas		m	7,5	7,5	7,5
Additional gas amount		g/m	10	10	15
Refrigerant (R32) / CO ₂ Eq.		kg / T	0,54/0,365	0,67/0,452	1,14/0,770
Operating range	Cool Min ~ Max	°C	-10 ~ +43	-10 ~ +43	-10 ~ +43
	Heat Min ~ Max	°C	-15 ~ +24	-15 ~ +24	-15 ~ +24

1) EER and COP calculation is based in accordance to EN14511. 2) Energy Label Scale from A+++ to D. 3) The annual energy consumption is calculated in accordance to EU/626/2011. 4) The sound pressure of the indoor unit shows the value measured of a position of 1 m in front of the main body and 0,8 m below the unit. For outdoor unit 1 m in front and 1 m in rear side of main body. The sound pressure is measured in accordance with JIS C 9612. Q-Lo: Quiet mode. Lo: The lowest set fan speed. 5) Add 70 mm for piping port.

Accessories

CZ-TACG1	Wi-Fi adapter for smart control via Panasonic Comfort Cloud App
CZ-CAPRA1	RAC interface adapter for integration into P-Link

Accessories

CZ-RD517C	Wired remote controller for wall-mounted and floor console
------------------	--



SEER and SCOP: For KIT-UZ50-WKE. SUPER QUIET: For KIT-UZ25-WKE and KIT-UZ35-WKE. INTERNET CONTROL: Optional.



Wall-mounted PZ super-compact Inverter · R32

- Compact design with only 779 mm wide
- Super Quiet! Only 20 dB(A)
- Aerowings to control air draft direction
- High energy savings
- Optional internet and voice control



Kit			KIT-PZ25-WKE	KIT-PZ35-WKE	KIT-PZ50-WKE
Cooling capacity	Nominal (Min - Max)	kW	2,50 (0,85 - 3,00)	3,40 (0,85 - 3,90)	5,00 (0,98 - 5,40)
EER ¹⁾	Nominal (Min - Max)	W/W	3,62 (4,05 - 3,30)	3,09 (3,54 - 3,00)	2,98 (3,92 - 2,86)
SEER ²⁾			6,00 A+	6,00 A+	6,00 A+
Pdesign (cooling)		kW	2,50	3,40	5,00
Input power	Nominal (Min - Max)	kW	0,69 (0,21 - 0,91)	1,10 (0,24 - 1,30)	1,68 (0,25 - 1,89)
Annual energy consumption ³⁾		kWh/a	146	198	292
Heating capacity	Nominal (Min - Max)	kW	3,15 (0,80 - 3,60)	3,84 (0,80 - 4,40)	5,40 (0,98 - 7,50)
Heating capacity at -7 °C		kW	2,14	2,60	4,58
COP ¹⁾	Nominal (Min - Max)	W/W	4,09 (4,21 - 3,50)	3,69 (4,10 - 3,46)	3,44 (4,67 - 3,07)
SCOP ²⁾			4,10 A+	4,10 A+	4,10 A+
Pdesign at -10 °C		kW	1,90	2,40	4,00
Input power	Nominal (Min - Max)	kW	0,77 (0,19 - 1,03)	1,04 (0,20 - 1,27)	1,57 (0,21 - 2,44)
Annual energy consumption ³⁾		kWh/a	649	820	1366
Indoor unit			CS-PZ25WKE	CS-PZ35WKE	CS-PZ50WKE
Power supply		V	230	230	230
Recommended fuse		A	16	16	16
Connection indoor / outdoor		mm ²	4 x 1,5	4 x 1,5	4 x 2,5
Air flow	Cool / Heat	m ³ /min	10,5 / 11,1	10,8 / 11,3	12,5 / 13,2
Moisture removal volume		L/h	1,5	2,0	2,8
Sound pressure ⁴⁾	Cool (Hi / Lo / Q-Lo)	dB(A)	37 / 26 / 20	38 / 30 / 20	44 / 37 / 34
	Heat (Hi / Lo / Q-Lo)	dB(A)	37 / 27 / 24	38 / 33 / 25	44 / 37 / 34
Dimension	H x W x D	mm	290 x 779 x 209	290 x 779 x 209	290 x 779 x 209
Net weight		kg	8	8	8
Outdoor unit			CU-PZ25WKE	CU-PZ35WKE	CU-PZ50WKE
Air flow	Cool / Heat	m ³ /min	30,4 / 30,4	31,1 / 31,1	32,7 / 32,7
Sound pressure ⁴⁾	Cool / Heat (Hi)	dB(A)	48 / 49	48 / 50	48 / 49
Dimension ⁵⁾	H x W x D	mm	542 x 780 x 289	542 x 780 x 289	619 x 824 x 299
Net weight		kg	24	25	36
Piping diameter	Liquid pipe	Inch (mm)	1/4 (6,35)	1/4 (6,35)	1/4 (6,35)
	Gas pipe	Inch (mm)	3/8 (9,52)	3/8 (9,52)	1/2 (12,70)
Pipe length range		m	3 ~ 15	3 ~ 15	3 ~ 15
Elevation difference (in / out)		m	15	15	15
Pipe length for additional gas		m	7,5	7,5	7,5
Additional gas amount		g/m	10	10	15
Refrigerant (R32) / CO ₂ Eq.		kg / T	0,54 / 0,365	0,67 / 0,452	1,14 / 0,770
Operating range	Cool Min ~ Max	°C	5 ~ +43	5 ~ +43	5 ~ +43
	Heat Min ~ Max	°C	-15 ~ +24	-15 ~ +24	-15 ~ +24

1) EER and COP calculation is based in accordance to EN14511. 2) Energy Label Scale from A+++ to D. 3) The annual energy consumption is calculated in accordance to EU/626/2011. 4) The sound pressure of the indoor unit shows the value measured of a position of 1 m in front of the main body and 0,8 m below the unit. For outdoor unit 1 m in front and 1 m in rear side of main body. The sound pressure is measured in accordance with JIS C 9612. Q-Lo: Quiet mode. Lo: The lowest set fan speed. 5) Add 70 mm for piping port.

Accessories

CZ-TACG1	Wi-Fi adapter for smart control via Panasonic Comfort Cloud App
CZ-CAPRA1	RAC interface adapter for integration into P-Link

Accessories

CZ-RD517C	Wired remote controller for wall-mounted and floor console
------------------	--



SUPER QUIET: For KIT-PZ25-WKE and KIT-PZ35-WKE. **INTERNET CONTROL:** Optional.

Rating Conditions: Cooling Indoor 27 °C DB / 19 °C WB. Cooling Outdoor 35 °C DB / 24 °C WB. Heating Indoor 20 °C DB. Heating Outdoor 7 °C DB / 6 °C WB. (DB: Dry Bulb; WB: Wet Bulb). Specifications subject to change without notice. For detailed information about ErP / Energy Labelling, please visit our websites www.aircon.panasonic.eu or www.ptc.panasonic.eu.



Floor console Inverter+ · R32

- nanoe™ X technology to improve protection 24/7 (nanoe X Generator Mark 1)
- Stylish Sky remote controller
- A breakthrough design that integrates perfectly with the most modern environments
- High energy efficiency class A++ SEER and A++ SCOP
- Optional internet and voice control

Kit			KIT-Z25-UFE	KIT-Z35-UFE	KIT-Z50-UFE
Cooling capacity	Nominal (Min - Max)	kW	2,50 (0,85 - 3,40)	3,50 (0,85 - 3,80)	5,00 (0,90 - 5,70)
EER ¹⁾	Nominal (Min - Max)	W/W	4,81 (3,54 - 3,78)	4,07 (3,54 - 3,73)	3,60 (3,53 - 3,15)
SEER ²⁾			7,90 A++	8,10 A++	6,70 A++
Pdesign (cooling)		kW	2,50	3,50	5,00
Input power	Nominal (Min - Max)	kW	0,52 (0,24 - 0,90)	0,86 (0,24 - 1,02)	1,39 (0,26 - 1,81)
Annual energy consumption ³⁾		kWh/a	111	151	261
Heating capacity	Nominal (Min - Max)	kW	3,40 (0,85 - 5,00)	4,30 (0,85 - 6,00)	5,80 (0,90 - 8,10)
Heating capacity at -7 °C		kW	2,88	3,37	5,03
COP ¹⁾	Nominal (Min - Max)	W/W	4,47 (3,54 - 3,70)	3,98 (3,54 - 3,43)	3,74 (3,46 - 3,12)
SCOP ²⁾			4,60 A++	4,60 A++	4,30 A+
Pdesign at -10 °C		kW	2,70	3,20	4,40
Input power	Nominal (Min - Max)	kW	0,76 (0,24 - 1,35)	1,08 (0,24 - 1,75)	1,55 (0,26 - 2,60)
Annual energy consumption ³⁾		kWh/a	822	974	1433
Indoor unit			CS-Z25UFEAW	CS-Z35UFEAW	CS-Z50UFEAW
Air flow	Cool / Heat	m ³ /min	9,6/9,9	9,9/10,1	11,6/13,2
Moisture removal volume		L/h	1,5	2,0	2,8
Sound pressure ⁴⁾	Cool (Hi / Lo / Q-Lo)	dB(A)	38/25/20	39/26/20	44/31/27
	Heat (Hi / Lo / Q-Lo)	dB(A)	38/25/19	39/26/19	46/33/29
Dimension	HxWxD	mm	600x750x207	600x750x207	600x750x207
Net weight		kg	13	13	13
nanoe X Generator			Mark 1	Mark 1	Mark 1
Outdoor unit			CU-Z25UBEA	CU-Z35UBEA	CU-Z50UBEA
Power supply		V	230	230	230
Recommended fuse		A	16	16	16
Connection indoor / outdoor		mm ²	—	—	—
Air flow	Cool / Heat	m ³ /min	28,7/27,2	34,3/33,5	39,7/38,6
Sound pressure ⁴⁾	Cool / Heat (Hi)	dB(A)	46/47	48/48	48/48
Dimension ⁵⁾	HxWxD	mm	542x780x289	619x824x299	695x875x320
Net weight		kg	33	35	43
Piping diameter	Liquid pipe	Inch (mm)	1/4 (6,35)	1/4 (6,35)	1/4 (6,35)
	Gas pipe	Inch (mm)	3/8 (9,52)	3/8 (9,52)	1/2 (12,70)
Pipe length range		m	3 - 20	3 - 20	3 - 30
Elevation difference (in / out)		m	15	15	20
Pipe length for additional gas		m	7,5	7,5	7,5
Additional gas amount		g/m	10	10	15
Refrigerant (R32) / CO ₂ Eq.		kg / T	0,88/0,594	0,93/0,628	1,13/0,763
Operating range	Cool Min ~ Max	°C	-10 ~ +43	-10 ~ +43	-10 ~ +43
	Heat Min ~ Max	°C	-15 ~ +24	-15 ~ +24	-15 ~ +24

1) EER and COP calculation is based in accordance to EN14511. 2) Energy Label Scale from A+++ to D. 3) The annual energy consumption is calculated in accordance to EU/626/2011. 4) The sound pressure of the units shows the value measured of a position 1 m in front of the main body and 1 m above floor. The sound pressure is measured in accordance with JIS C 9612. Q-Lo: Quiet mode. Lo: The lowest set fan speed. 5) Add 70 mm for piping port.

Accessories

CZ-TACG1	Wi-Fi adapter for smart control via Panasonic Comfort Cloud App
CZ-CAPRA1	RAC interface adapter for integration into P-Link

Accessories

CZ-RD517C	Wired remote controller for wall-mounted and floor console
------------------	--



SEER and SCOP: For KIT-Z35-UFE. SUPER QUIET: For KIT-Z25-UFE and KIT-Z35-UFE. INTERNET CONTROL: Optional. IF DESIGN AWARD 2019: Floor console awarded with the prestigious IF Design Award 2019.



MORE DUCT TYPE SOLUTIONS IN PACI SECTION



Optional wireless control kit.
CZ-RL511D



Low static pressure hide-away Inverter - R32

- Duct type can be controlled by KNX and Modbus
- Eco mode for 20 % energy saving
- Extremely compact indoor units without losing static pressure (only 200 mm high)
- Weekly timer, 42 settings per week
- Easy check mode for failure detection
- Drain pump included

Kit			KIT-Z25-UD3	KIT-Z35-UD3	KIT-Z50-UD3	KIT-Z60-UD3
Cooling capacity	Nominal (Min - Max)	kW	2,50 [0,85 - 3,20]	3,50 [0,85 - 4,00]	5,10 [0,90 - 5,70]	6,00 [0,90 - 6,50]
EER ¹⁾	Nominal (Min - Max)	W/W	4,31 [3,54 - 3,76]	3,85 [3,54 - 3,36]	3,27 [3,53 - 3,20]	2,94 [3,53 - 2,83]
SEER ²⁾			5,90 A+	5,80 A+	5,90 A+	5,60 A+
P _{design} (cooling)		kW	2,50	3,50	5,10	6,00
Input power	Nominal (Min - Max)	kW	0,58 [0,24 - 0,85]	0,91 [0,24 - 1,19]	1,56 [0,26 - 1,78]	2,04 [0,26 - 2,30]
Annual energy consumption ³⁾		kWh/a	148	211	303	375
Heating capacity	Nominal (Min - Max)	kW	3,20 [0,85 - 4,60]	4,20 [0,85 - 5,10]	6,10 [0,90 - 7,20]	7,00 [0,90 - 8,00]
Heating capacity at -7 °C		kW	2,60	3,00	4,50	5,10
COP ¹⁾	Nominal (Min - Max)	W/W	4,00 [3,70 - 3,68]	3,82 [3,70 - 3,59]	3,35 [3,46 - 3,27]	3,24 [3,46 - 3,08]
SCOP ²⁾			4,20 A+	4,10 A+	4,10 A+	4,10 A+
P _{design} at -10 °C		kW	2,60	2,80	4,00	4,60
Input power	Nominal (Min - Max)	kW	0,80 [0,23 - 1,25]	1,10 [0,23 - 1,42]	1,82 [0,26 - 2,20]	2,16 [0,26 - 2,60]
Annual energy consumption ³⁾		kWh/a	867	956	1366	1571
Indoor unit			CS-Z25UD3EAW	CS-Z35UD3EAW	CS-Z50UD3EAW	CS-Z60UD3EAW
External static pressure ⁴⁾	Min - Max	Pa	15 - 45	15 - 45	15 - 50	15 - 50
Air flow	Cool / Heat	m ³ /min	10,5/10,5	11,2/11,2	15,3/15,3	15,7/15,7
Moisture removal volume		L/h	1,5	2,0	2,8	3,3
Sound pressure ⁵⁾	Cool (Hi / Lo / Q-Lo)	dB(A)	33/27/24	33/27/24	39/29/26	41/30/27
	Heat (Hi / Lo / Q-Lo)	dB(A)	35/27/24	35/27/24	39/30/27	41/32/29
Dimension	H x W x D	mm	200 x 750 x 640	200 x 750 x 640	200 x 750 x 640	200 x 750 x 640
Net weight		kg	19	19	19	19
Outdoor unit			CU-Z25UBEA	CU-Z35UBEA	CU-Z50UBEA	CU-Z60UBEA
Power supply		V	230	230	230	230
Recommended fuse		A	16	16	16	—
Connection indoor / outdoor		mm ²	4 x 1,5 - 2,5	4 x 1,5 - 2,5	4 x 1,5 - 2,5	—
Air flow	Cool / Heat	m ³ /min	28,7/27,2	34,3/33,5	39,7/38,6	42,6/41,5
Sound pressure ⁵⁾	Cool / Heat (Hi)	dB(A)	46/47	48/48	48/48	49/50
Dimension ⁶⁾	H x W x D	mm	542 x 780 x 289	619 x 824 x 299	695 x 875 x 320	695 x 875 x 320
Net weight		kg	33	35	43	43
Piping diameter	Liquid pipe	Inch (mm)	1/4 (6,35)	1/4 (6,35)	1/4 (6,35)	1/4 (6,35)
	Gas pipe	Inch (mm)	3/8 (9,52)	3/8 (9,52)	1/2 (12,70)	1/2 (12,70)
Pipe length range		m	3 - 20	3 - 20	3 - 30	3 - 30
Elevation difference (in / out)		m	15	15	20	20
Pipe length for additional gas		m	7,5	7,5	7,5	7,5
Additional gas amount		g/m	10	10	15	15
Refrigerant (R32) / CO ₂ Eq.		kg / T	0,88 / 0,594	0,93 / 0,628	1,13 / 0,763	1,13 / 0,763
Operating range	Cool Min ~ Max	°C	-10 ~ +43	-10 ~ +43	-10 ~ +43	-10 ~ +43
	Heat Min ~ Max	°C	-15 ~ +24	-15 ~ +24	-15 ~ +24	-15 ~ +24

1) EER and COP calculation is based in accordance to EN14511. 2) Energy Label Scale from A+++ to D. 3) The annual energy consumption is calculated in accordance to EU/626/2011. 4) The specification listed on the table indicates values under the condition of 25 Pa (2,5 mmAq) which are applied for factory default setting. Change switch on PCB from Hi to S-Hi to have more than 6,0 mmAq. 5) The sound pressure of the indoor unit shows the value measured at a position of 1,5 m below the unit with 1 m duct on the suction side and 2 m duct on the discharge side. For outdoor unit 1 m in front and 1 m in rear side of main body. The sound pressure is measured in accordance with JIS C 9612. 6) Add 100 mm for indoor unit or 70 mm for outdoor unit for piping port.

Accessories

CZ-TACG1 Wi-Fi adapter for smart control via Panasonic Comfort Cloud App

Accessories

CZ-CAPRA1 RAC interface adapter for integration into P-Link
CZ-RL511D Optional wireless control kit



SEER and SCOP: For KIT-Z25-UD3. INTERNET CONTROL: Optional.

Rating Conditions: Cooling Indoor 27 °C DB / 19 °C WB. Cooling Outdoor 35 °C DB / 24 °C WB. Heating Indoor 20 °C DB. Heating Outdoor 7 °C DB / 6 °C WB. (DB: Dry Bulb; WB: Wet Bulb). Specifications subject to change without notice. For detailed information about ErP / Energy Labelling, please visit our websites www.aircon.panasonic.eu or www.ptc.panasonic.eu.

Free Multi system

If air conditioning requirements exceed the scope of a single room, Panasonic offers an extensive range of possibilities with a multi split solution.

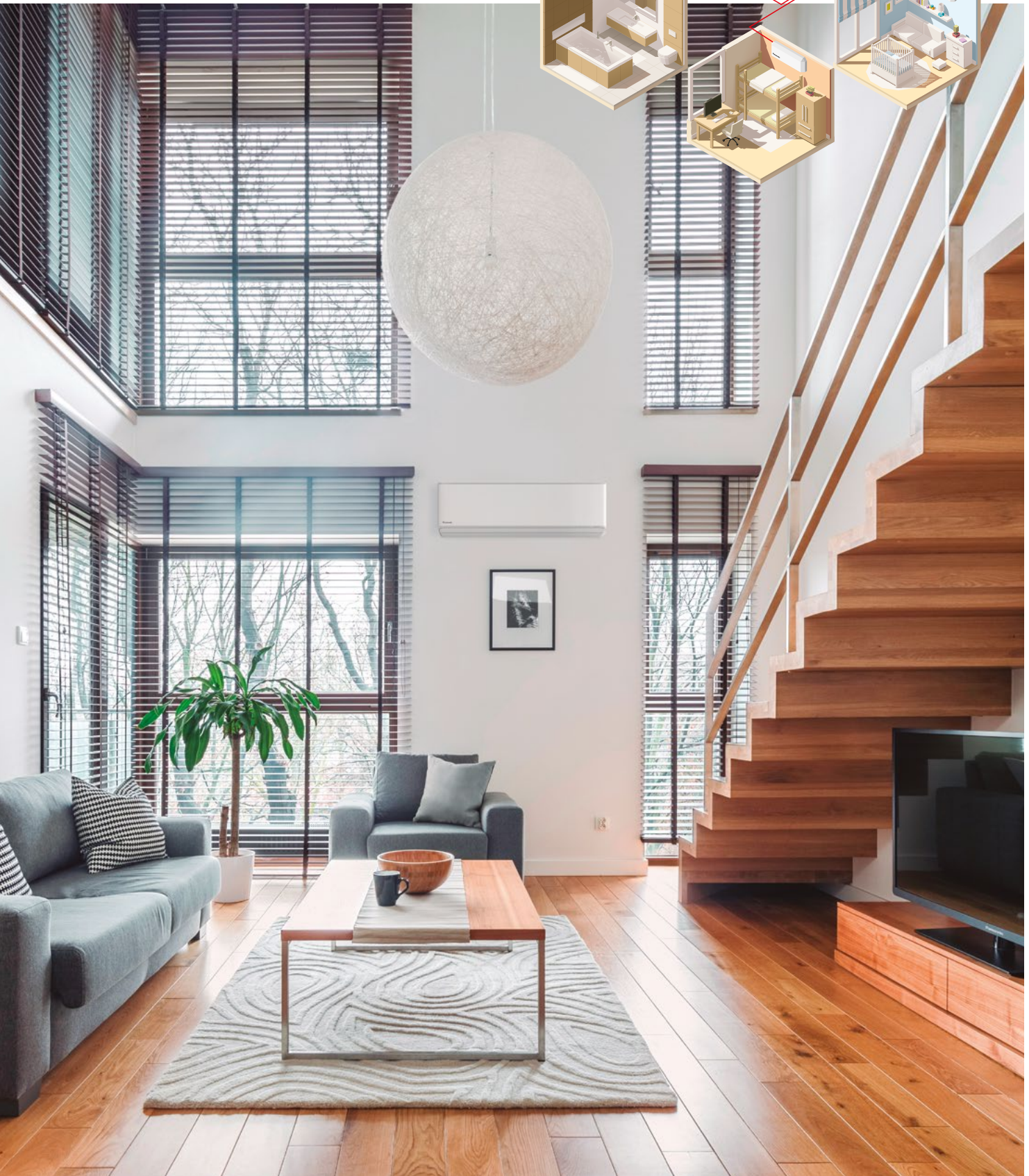
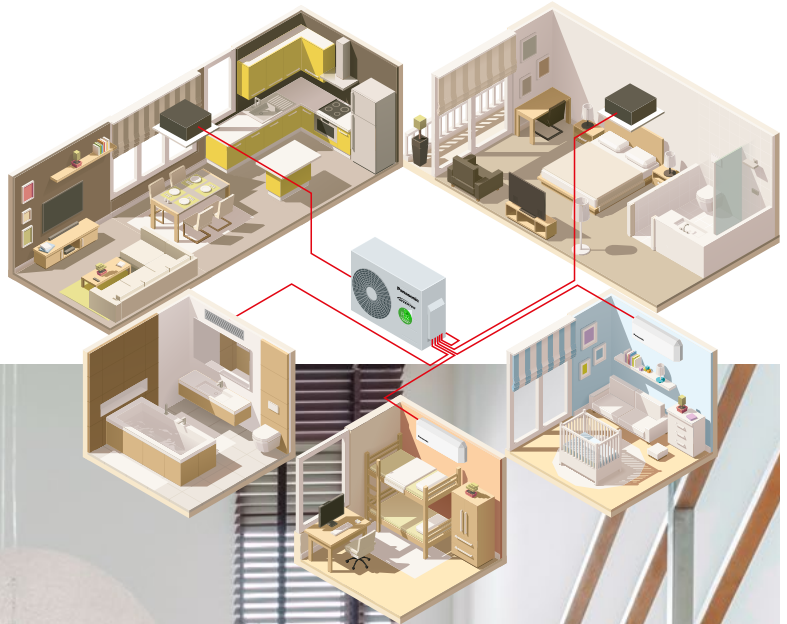

Panasonic offers widest range in multi split systems

The multi split solution offers high flexibility, as 2 to 5 indoor units can be connected to a single outdoor unit. The wide range of compatible indoor units includes Etherea and TZ wall-mounted units, floor console, 4 way 60x60 cassette and low static pressure hide-away.

Full flexibility up to 9,0 kW and up to 5 ports with wide range of indoor units including high performance Etherea indoor units, reaching up to A+++ / A++.

Line up	Multi Z	
Capacities	8 units (3,5 ~ 9,0 kW)	
Indoor unit ports	2~5	
Efficiency up to	A+++ / A++	
Indoor units	Etherea	Yes
	TZ super-compact	Yes
	Floor console	Yes
	Cassette	Yes
	Hide-away	Yes

Why a multi split is better than several separate split units

Up to 5 indoor units with a single outdoor unit.

- Just one compact outdoor unit
- Increased comfort in the house since every room has its own indoor unit for heating or cooling
- Much more powerful than a single split

- More efficient since the units are always operating at full capacity
- You can connect all types of indoor units, such as wall types and consoles, depending on what suits your house best

Solution with single split.

One indoor unit is connected to one outdoor unit. The indoor unit is placed in the main hallway and heats the entire house. Certain rooms may not be perfectly heated, which causes inadequate comfort.

1. Laundry room. 2. Entrance. 3. Kitchen / dining area. 4. Bathroom. 5. Living room. 6. Bedroom.

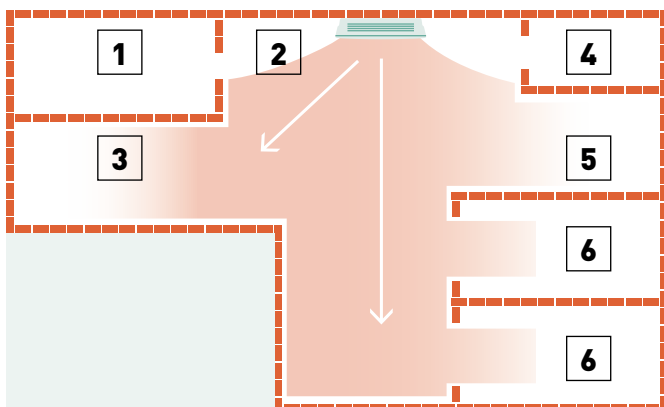

Solution with multi split.

With one outdoor unit, you can connect up to five indoor units. There is one indoor unit per room or area. It gives an extreme increase in comfort levels. On the roof, there is only one outdoor unit.

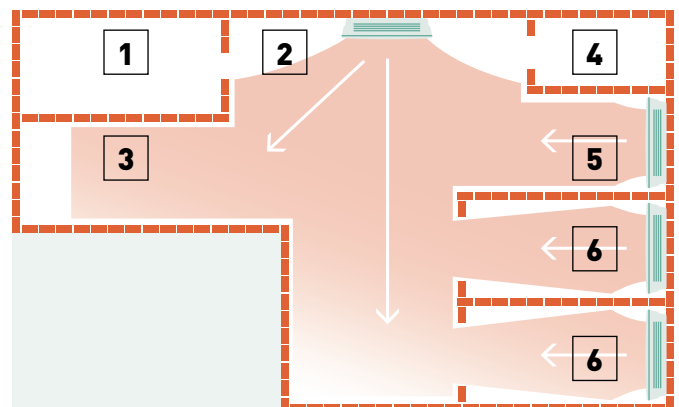

Configure in a few steps your multi split system with our online tool.

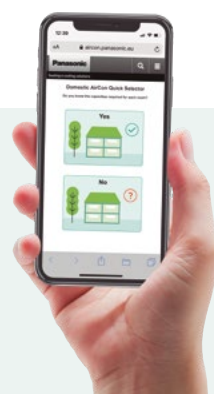



Optional wired remote controller. CZ-RD517C

INTERNET CONTROL: Built-in Wi-Fi.



NEW Wall-mounted Etherea	Indoor unit Graphite grey*	Indoor unit Silver	Indoor unit Matt white	Cooling capacity kW	Heating capacity kW	Connection in. / out. mm ²	Sound pressure ¹⁾ dB(A)		Dimension / Net weight mm / kg	Piping diameter Liquid / Gas pipe Inch / mm
							Cool	Heat (Hi/Lo/S-Lo)		
1,6 kW	—	—	CS-MZ16XKE	1,60	2,60	4x1,5	38/26/21	— 39/27/21	295x870x229/10	1/4(6,35)/3/8(9,52)
2,0 kW	CS-XZ20XKEW-H	CS-XZ20XKEW	CS-Z20XKEW	2,00	3,20	4x1,5	39/26/21	— 40/27/21	295x870x229/10	1/4(6,35)/3/8(9,52)
2,5 kW	CS-XZ25XKEW-H	CS-XZ25XKEW	CS-Z25XKEW	2,50	3,60	4x1,5	41/27/21	— 43/29/21	295x870x229/10	1/4(6,35)/3/8(9,52)
3,5 kW ²⁾	CS-XZ35XKEW-H	CS-XZ35XKEW	CS-Z35XKEW	3,50	4,50	4x1,5	44/30/21	— 45/35/21	295x870x229/11	1/4(6,35)/3/8(9,52)
4,2 kW ³⁾	—	—	CS-Z42XKEW	4,20	5,60	4x1,5	44/33/27	— 45/37/31	295x870x229/10	1/4(6,35)/1/2(12,70)
5,0 kW ⁴⁾	—	CS-XZ50XKEW	CS-Z50XKEW	5,00	6,80	4x2,5	44/39/32	— 46/39/32	295x1040x244/12	1/4(6,35)/1/2(12,70)
7,1 kW	—	—	CS-Z71XKEW	7,10	8,70	4x2,5	49/40/32	— 49/40/32	295x1040x244/14	1/4(6,35)/5/8(15,88)



Optional wired remote controller. CZ-RD517C

INTERNET CONTROL: Built-in Wi-Fi.



Wall-mounted TZ super-compact	Indoor unit	Cooling capacity kW	Heating capacity kW	Connection in. / out. mm ²	Sound pressure ¹⁾ dB(A)		Dimension / Net weight mm / kg	Piping diameter Liquid / Gas pipe Inch / mm
					Cool	Heat (Hi/Lo/S-Lo)		
1,6 kW	CS-MTZ16WKE	1,60	2,60	4x1,5	38/27/22	— 39/28/24	290x779x209/8	1/4(6,35)/3/8(9,52)
2,0 kW	CS-TZ20WKEW	2,00	2,70	4x1,5	37/25/20	— 38/26/22	290x779x209/8	1/4(6,35)/3/8(9,52)
2,5 kW	CS-TZ25WKEW	2,50	3,30	4x1,5	40/26/20	— 40/27/22	290x779x209/8	1/4(6,35)/3/8(9,52)
3,5 kW ²⁾	CS-TZ35WKEW	3,50	4,00	4x1,5	42/30/20	— 42/33/22	290x779x209/8	1/4(6,35)/3/8(9,52)
4,2 kW	CS-TZ42WKEW	4,20	5,00	4x1,5	44/31/29	— 44/35/34	290x779x209/8	1/4(6,35)/1/2(12,70)
5,0 kW	CS-TZ50WKEW	5,00	5,80	4x2,5	44/37/33	— 44/37/33	290x779x209/8	1/4(6,35)/1/2(12,70)
6,0 kW	CS-TZ60WKEW	6,00	7,00	4x2,5	45/37/34	— 45/37/34	302x1102x244/13	1/4(6,35)/1/2(12,70)
7,1 kW	CS-TZ71WKEW	7,10	8,60	4x2,5	47/38/35	— 47/38/35	302x1102x244/13	1/4(6,35)/5/8(15,88)



Optional wired remote controller. CZ-RD517C

INTERNET CONTROL: Optional.



Floor console ⁵⁾	Indoor unit	Cooling capacity kW	Heating capacity kW	Connection in. / out. mm ²	Sound pressure ⁶⁾ dB(A)		Dimension / Net weight mm / kg	Piping diameter Liquid / Gas pipe Inch / mm
					Cool	Heat (Hi/Lo/S-Lo)		
2,0 kW	CS-MZ20UFEA	2,00	3,20	4x1,5	39/27/22	— 39/27/21	600x750x207/13	1/4(6,35)/3/8(9,52)
2,5 kW	CS-Z25UFEAW	2,50	3,60	4x1,5	40/27/22	— 40/27/21	600x750x207/13	1/4(6,35)/3/8(9,52)
3,5 kW ²⁾	CS-Z35UFEAW	3,50	4,50	4x1,5	41/28/22	— 41/28/21	600x750x207/13	1/4(6,35)/3/8(9,52)
5,0 kW	CS-Z50UFEAW	5,00	5,30	4x1,5	44/33/29	— 48/35/31	600x750x207/13	1/4(6,35)/1/2(12,70)



NEW 2022

Optional wired remote controller. CZ-RTC6



Panel (sold separately). CZ-KPY4

INTERNET CONTROL and BMS CONNECTIVITY: Optional.



NEW 4 Way 60x60 cassette*	Indoor unit (Panel CZ-KPY4)	Cooling capacity kW	Heating capacity kW	Connection in. / out. mm ²	Sound pressure ⁷⁾ dB(A)		Dimension / Net weight		Piping diameter Liquid / Gas pipe Inch / mm
					Cool	Heat (Hi/Lo/S-Lo)	Indoor HxWxD	Panel HxWxD	
2,0 kW	S-M20PY3E	2,00	3,20	4x1,5	33/30/27	— 33/30/27	243x575x575/15	30x625x625/2,8	1/4(6,35)/1/2(12,70)
2,5 kW	S-25PY3E	2,50	3,60	4x1,5	33/30/27	— 33/30/27	243x575x575/15	30x625x625/2,8	1/4(6,35)/1/2(12,70)
3,5 kW ²⁾	S-36PY3E	3,50	3,60	4x1,5	36/32/27	— 36/32/27	243x575x575/15	30x625x625/2,8	1/4(6,35)/1/2(12,70)
5,0 kW ⁴⁾	S-50PY3E	5,00	6,80	4x1,5	41/36/29	— 41/36/29	243x575x575/15	30x625x625/2,8	1/4(6,35)/1/2(12,70)
6,0 kW	S-60PY3E	6,00	8,50	4x1,5	45/39/33	— 45/39/33	243x575x575/15	30x625x625/2,8	3/8(9,52)/5/8(15,88)

* Compatible with Commercial control and connectivity accessories only. For detailed information go to the control systems section.



Optional wireless control kit. CZ-RL511D

INTERNET CONTROL and BMS CONNECTIVITY: Optional.



Low static pressure hide-away	Indoor unit	Cooling capacity kW	Heating capacity kW	Connection in. / out. mm ²	Sound pressure ⁸⁾ dB(A)		Dimension / Net weight mm / kg	Piping diameter Liquid / Gas pipe Inch / mm
					Cool	Heat (Hi/Lo/S-Lo)		
2,0 kW	CS-MZ20UD3EA	2,00	3,20	4x1,5	34/29/26	— 36/29/26	200x750x640/19	1/4(6,35)/3/8(9,52)
2,5 kW	CS-Z25UD3EAW	2,50	3,60	4x1,5	35/29/26	— 37/29/26	200x750x640/19	1/4(6,35)/3/8(9,52)
3,5 kW ²⁾	CS-Z35UD3EAW	3,50	4,50	4x1,5	35/29/26	— 37/29/26	200x750x640/19	1/4(6,35)/3/8(9,52)
5,0 kW ⁴⁾	CS-Z50UD3EAW	5,00	6,80	4x1,5	41/31/28	— 41/32/29	200x750x640/19	1/4(6,35)/1/2(12,70)
6,0 kW	CS-Z60UD3EAW	6,00	8,50	4x1,5	43/32/29	— 43/34/31	200x750x640/19	1/4(6,35)/1/2(12,70)

1) The sound pressure of the indoor unit shows the value measured at a position of 1 m in front of the main body and 0,8 m below the unit. The sound pressure is measured in accordance with JIS C 9612. Q-Lo: Quiet mode. Lo: The lowest set fan speed. 2) Heating capacity in combination with Free Multi outdoor units except with CU-Z235TBE. In this case, the heating capacity is 4,20 kW. 3) Heating capacity in combination with Free Multi outdoor units except with CU-Z250TBE. In this case, the heating capacity is 5,00 kW. 4) Heating capacity in combination with Free Multi outdoor units except with CU-Z235TBE. In this case, the heating capacity is 5,30 kW. 5) Compatible only with 2 ports R32 outdoor CU-Z235TBE / CU-Z241TBE / CU-Z250TBE. Minimum quantity of connection: 2 indoor units. 6) The sound pressure of the units shows the value measured at a position 1 m in front of the main body and 1 m above floor. The sound pressure is measured in accordance with JIS C 9612. Q-Lo: Quiet mode. Lo: The lowest set fan speed. 7) The sound pressure of the indoor unit shows the value measured at a position of 1,5 m below the unit. The sound pressure is measured in accordance with JIS C 9612. Q-Lo: Quiet mode. Lo: The lowest set fan speed. 8) The sound pressure of the indoor unit shows the value measured at a position of 1,5 m below the unit with 1 m duct on the suction side and 2 m duct on the discharge side. The sound pressure is measured in accordance with JIS C 9612. * Available in Spring 22.

Rating Conditions: Cooling Indoor 27 °C DB / 19 °C WB. Cooling Outdoor 35 °C DB / 24 °C WB. Heating Indoor 20 °C DB. Heating Outdoor 7 °C DB / 6 °C WB. [DB: Dry Bulb; WB: Wet Bulb]. Specifications subject to change without notice. For detailed information about ErP / Energy Labelling, please visit our websites www.aircon.panasonic.eu or www.ptc.panasonic.eu.



Multi TZ system



Outdoor units Multi TZ - R32

- Up to 3 indoor units with a single outdoor unit
- Up to 3 rooms with individual control
- High energy efficiency class A++ SEER
- Flexible installation, compact units and large connection distance
- Indoor units compatible with internet and voice control



SEE THE COMBINATIONS TABLES

Outdoor unit			CU-2TZ41TBE	CU-2TZ50TBE	CU-3TZ52TBE
Indoor nominal capacity (Min - Max)			3,2 ~ 6,0 kW	3,2 ~ 7,7 kW	4,5 ~ 9,5 kW
Cooling capacity	Nominal (Min - Max)	kW	4,10 (1,50 - 4,70)	5,00 (1,50 - 5,40)	5,20 (1,80 - 6,60)
EER ¹⁾	Nominal (Min - Max)	W/W	4,14 (5,56 - 3,41)	3,85 (5,56 - 3,33)	4,52 (3,67 - 5,00)
SEER ²⁾			7,10 A++	7,00 A++	7,60 A++
Pdesign (cooling)		kW	4,10	5,00	5,20
Input power	Nominal (Min - Max)	kW	0,99 (0,27 - 1,38)	1,30 (0,27 - 1,62)	1,15 (0,36 - 1,80)
Annual energy consumption ³⁾		kWh/a	202	250	239
Heating capacity	Nominal (Min - Max)	kW	4,40 (1,10 - 6,30)	5,70 (1,10 - 6,40)	6,80 (1,60 - 7,50)
Heating capacity at -7 °C		kW	—	—	—
COP ¹⁾	Nominal (Min - Max)	W/W	4,44 (5,00 - 3,54)	4,35 (5,00 - 3,62)	4,28 (3,87 - 5,00)
SCOP ²⁾			4,30 A+	4,20 A+	4,20 A+
Pdesign at -10 °C		kW	3,50	4,50	5,00
Input power	Nominal (Min - Max)	kW	0,99 (0,22 - 1,78)	1,31 (0,22 - 1,77)	1,59 (0,32 - 1,94)
Annual energy consumption ³⁾		kWh/a	1139	1500	1667
Current	Cool / Heat	A	4,60 / 4,60	6,00 / 6,00	5,30 / 7,30
Power supply		V	230	230	230
Sound pressure ⁴⁾	Cool / Heat (Hi)	dB(A)	48 / 50	50 / 52	48 / 48
Dimension ⁵⁾	H x W x D	mm	542 x 780 x 289	542 x 780 x 289	795 x 875 x 320
Net weight		kg	35	35	71
Piping diameter	Liquid pipe	Inch (mm)	1/4 (6,35)	1/4 (6,35)	1/4 (6,35)
	Gas pipe	Inch (mm)	3/8 (9,52)	3/8 (9,52)	3/8 (9,52)
Pipe length range total		m	6 ~ 30	6 ~ 30	6 ~ 50
Pipe length range to one unit		m	3 ~ 20	3 ~ 20	3 ~ 25
Elevation difference (in / out)		m	10	10	15
Pipe length for additional gas		m	20	20	30
Additional gas amount		g/m	15	15	20
Refrigerant (R32) / CO ₂ Eq.		kg / T	0,9 / 0,6075	0,9 / 0,6075	2,1 / 1,4175
Operating range	Cool Min ~ Max	°C	-10 ~ +46	-10 ~ +46	-10 ~ +46
	Heat Min ~ Max	°C	-15 ~ +24	-15 ~ +24	-15 ~ +24

1) EER and COP calculation is based in accordance to EN14511. 2) Energy Label Scale from A+++ to D. 3) The annual energy consumption is calculated in accordance to EU/626/2011. 4) The sound pressure of the units shows the value measured of a position 1 m in front and 1 m in rear side of the main body. The sound pressure is measured in accordance with JIS C 9612. 5) Add 70 or 95 mm for piping port.



Possible outdoor / indoor units combinations

Rooms	Outdoor unit	Indoor capacity connected (Min - Max)	Wall-mounted TZ super-compact					
			16	20	25	35	42	50
2	CU-2TZ41TBE	3,2 ~ 6,0 kW	✓	✓	✓	✓		
	CU-2TZ50TBE	3,2 ~ 7,7 kW	✓	✓	✓	✓	✓	✓
3	CU-3TZ52TBE	4,5 ~ 9,5 kW	✓	✓	✓	✓	✓	✓

Minimum quantity of connection: 2 indoor units.



Optional wired remote controller.
CZ-RD517C



Wall-mounted TZ super-compact	Indoor unit	Cooling capacity	Heating capacity	Connection in. / out.	Sound pressure ¹⁾	Dimension / Net weight	Piping diameter
					Cool — Heat (Hi/Lo/S-Lo)	H x W x D	Liquid / Gas pipe
		kW	kW	mm ²	dB(A)	mm / kg	Inch (mm)
1,6 kW	CS-MTZ16WKE	1,60	2,60	4 x 1,5	38 / 27 / 22 — 39 / 28 / 24	290 x 779 x 209 / 8	1/4 (6,35) / 3/8 (9,52)
2,0 kW	CS-TZ20WKEW	2,00	2,70	4 x 1,5	37 / 25 / 20 — 38 / 26 / 22	290 x 779 x 209 / 8	1/4 (6,35) / 3/8 (9,52)
2,5 kW	CS-TZ25WKEW	2,50	3,30	4 x 1,5	40 / 26 / 20 — 40 / 27 / 22	290 x 779 x 209 / 8	1/4 (6,35) / 3/8 (9,52)
3,5 kW	CS-TZ35WKEW	3,50	4,00	4 x 1,5	42 / 30 / 20 — 42 / 33 / 22	290 x 779 x 209 / 8	1/4 (6,35) / 3/8 (9,52)
4,2 kW	CS-TZ42WKEW	4,20	5,00	4 x 1,5	44 / 31 / 29 — 44 / 35 / 34	290 x 779 x 209 / 8	1/4 (6,35) / 1/2 (12,70)
5,0 kW	CS-TZ50WKEW	5,00	5,80	4 x 2,5	44 / 37 / 33 — 44 / 37 / 33	290 x 779 x 209 / 8	1/4 (6,35) / 1/2 (12,70)

1) The sound pressure of the indoor unit shows the value measured of a position of 1 m in front of the main body and 0,8 m below the unit. The sound pressure is measured in accordance with JIS C 9612. Q-L: Quiet mode. Lo: The lowest set fan speed.



Compare solutions

			Indoor unit dimension	Efficiency ¹⁾	Indoor air quality		Comfort	Connectivity
Wall-mounted Heatcharge VZ	White	2,5 to 3,5 kW	295 x 798 x 375	A+++ A+++	nanoe	-10 °C in cooling mode -30 °C in heating mode	18 dB(A)	Optional Wi-Fi CZ-TACG1
Wall-mounted Etherea	Graphite grey / Silver / Matt white	2,0 to 7,1 kW	295 x 870 x 229 (295 x 1040 x 244 wide model)	A+++ A+++	nanoe X Generator Mark 2	-10 °C in cooling mode -15 °C in heating mode	Aerowings 2.0 19 dB(A)	Built-in Wi-Fi
Wall-mounted TZ super-compact	Matte white	2,0 to 7,1 kW	290 x 779 x 209 (295 x 1040 x 244 wide model)	A++ A++	PM2,5 Filter	-10 °C in cooling mode -15 °C in heating mode	Aerowings 20 dB(A)	Built-in Wi-Fi
Wall-mounted BZ super-compact	Matte white	2,5 to 6,0 kW	290 x 779 x 209	A++ A+	PM2,5 Filter	-10 °C in cooling mode -15 °C in heating mode	Aerowings 20 dB(A)	Optional Wi-Fi CZ-TACG1
Wall-mounted UZ super-compact	Matte white	2,5 to 5,0 kW	290 x 779 x 209	A++ A+	Dust collection filter	-10 °C in cooling mode -15 °C in heating mode	Aerowings 20 dB(A)	Optional Wi-Fi CZ-TACG1
Wall-mounted PZ super-compact	Matte white	2,5 to 5,0 kW	290 x 779 x 209	A+ A+	Air filter	+5 °C in cooling mode -15 °C in heating mode	Aerowings 20 dB(A)	Optional Wi-Fi CZ-TACG1
Floor console	White	2,5 to 5,0 kW	600 x 750 x 207	A++ A+++	nanoe X Generator Mark 1	-10 °C in cooling mode -15 °C in heating mode	Double air flow 20 dB(A)	Optional Wi-Fi CZ-TACG1
Low static pressure hide-away		2,5 to 6,0 kW	200 x 750 x 640	A+ A+	Air filter	-10 °C in cooling mode -15 °C in heating mode	24 dB(A)	Optional Wi-Fi CZ-TACG1

1) Energy efficiency class in 2,5 kW references. * All data in this chart is applicable in most of the models in each line up, check product specifications to confirm.

Rating Conditions: Cooling Indoor 27 °C DB / 19 °C WB. Cooling Outdoor 35 °C DB / 24 °C WB. Heating Indoor 20 °C DB. Heating Outdoor 7 °C DB / 6 °C WB. (DB: Dry Bulb; WB: Wet Bulb). Specifications subject to change without notice. For detailed information about ErP / Energy Labelling, please visit our websites www.aircon.panasonic.eu or www.ptc.panasonic.eu.

Feature comparison

Models	Wall-mounted Heatcharge VZ · R32	Wall-mounted Etherea · R32	Wall-mounted TZ super-compact · R32
Refrigerant R32	✓	✓	✓
Econavi. Sunlight Sensor	✓		
Inverter+ system	✓	✓	
Inverter system			✓
R2 rotary compressor	✓	✓	✓
nanoe X Generator Mark 1	✓ nanoe™	✓	
PM2,5 Filter			✓
Dust collection filter			✓
Antiallergy properties	✓	✓	
Super Quiet ¹⁾	✓	✓ 19 dB(A) for XZ/Z20, XZ/Z25 and XZ/Z35	✓ 20 dB(A) for TZ20, TZ25 and TZ35
Mild Dry Cooling		✓	
Aerowings		✓	✓
Down to -10 °C in cooling only	✓	✓	✓
Down to -15 °C in heating mode	✓ -35 °C ²⁾	✓	✓
Summer House	✓		
R410A/R22 Renewal	✓	✓	✓
Odour-removing function	✓	✓	✓
Removable, washable panel	✓	✓	✓
Powerful mode	✓	✓	✓
Soft dry operation mode	✓	✓	✓
Personal air flow creation	✓	✓	✓ For TZ50, TZ60 and TZ71
Automatic vertical air flow control			✓ For TZ20, TZ25, TZ35 and TZ42
Manual horizontal air flow control			✓ For TZ20, TZ25, TZ35 and TZ42
Auto mode	✓	✓	✓
Hot start mode	✓	✓	✓
Real time clock with dual ON / OFF timer	✓	✓	✓
Weekly timer			
LCD infrared remote controller	✓	✓	✓
Automatic restart	✓	✓	✓
Long piping	✓ 15 m	✓ 15 m, 30 m (XZ/Z50, XZ/Z71)	✓ 15 m, 20 m (TZ50), 30 m (TZ71 and TZ60)
Top-Panel maintenance access	✓	✓	✓
Self-diagnosis function	✓	✓	✓
CZ-CAPRA1: RAC interface adapter for integration into P-Link	✓	✓	✓
Wi-Fi control	✓	✓ Built-in	✓ Built-in
Easy control by BMS	✓	✓	✓
Warranty on the compressor	✓	✓	✓

1) At the lowest fan speed. 2) Tested by 3rd party laboratory, SP, according to EN14511:2013 and SP Method 1721, this temperature is not guaranteed by Factory.



NEW Wall-mounted BZ super-compact · R32	Wall-mounted UZ super-compact · R32	Wall-mounted PZ super-compact · R32	Floor console · R32	Low static pressure hide away · R32
✓	✓	✓	✓	✓
			✓	
✓	✓	✓		✓
✓	✓	✓	✓	✓
			✓	
✓				
	✓			
			✓	
✓ 20 dB(A) for BZ25 and BZ35 ✓ 20 dB(A) for UZ25 and UZ35 ✓ 20 dB(A) for PZ25 and PZ35 ✓ 20 dB(A) for Z25 and Z35				
✓	✓	✓		
✓	✓		✓	✓
✓	✓	✓	✓	✓
✓	✓	✓	✓	✓
✓	✓	✓	✓	✓
✓	✓	✓	✓	
✓	✓	✓	✓	✓
✓	✓	✓	✓	✓
✓	✓	✓	✓	✓
✓	✓	✓	✓	✓
✓	✓	✓	✓	✓
✓	✓	✓	✓	✓
✓	✓	✓	✓	✓
✓	✓	✓	✓	✓
✓	✓	✓	✓	✓
✓	✓	✓	✓	✓
✓	✓	✓	✓	✓
✓	✓	✓	✓	✓
✓	✓	✓	✓	✓
✓	✓	✓	✓	✓
✓	✓	✓	✓	✓
✓	✓	✓	✓	✓
✓ 15 m, 30 m [BZ60]	✓ 15 m	✓ 15 m	✓ 20 m, 30 m [Z50]	✓ 20 m, 30 m [Z50 and Z60]
✓	✓	✓	✓	✓
✓	✓	✓	✓	✓
✓	✓	✓	✓	✓
✓	✓	✓	✓	✓
✓	✓	✓	✓	✓
✓	✓	✓	✓	✓

Features explained

Energy saving

Domestic Econavi.
Sunlight Sensor technology can detect and reduce the waste of energy by optimising air conditioner operation according to room conditions. With just one touch of a button, you can save energy.

Inverter Plus system.
This classification highlights Panasonic's highest performing systems.

Inverter system.
The Inverter range provides greater efficiency and comfort. Provides more precise temperature control, without highs and lows, and keeps the ambient temperature constant with lower energy consumption and a significant reduction in noise and vibration levels.

R2 Rotary compressor.
Panasonic R2 rotary compressor. Designed to withstand extreme conditions, it delivers high performance and efficiency.

Refrigerant R32.
Our heat pumps containing the refrigerant R32 show a drastic reduction in the value of Global Warming Potential (GWP). An important step to reduce greenhouse gases. R32 is also a component refrigerant, making it easy to recycle.

High performance and indoor air quality

nanoe™ X.
Technology with the benefits of hydroxyl radicals has the capacity to inhibit pollutants, viruses, and bacteria to clean and deodorise.

PM2.5 filter.
Particulate matter (PM2.5) can be found suspended in the air, including dust, dirt, smoke and liquid droplets. Sized at 2.5µm, these particles are said to pose health problems as they can easily enter our lungs.

Dust collection filter.
This filter collects and retains particles suspended in the air, resulting in cleaner air in the room.

Antiallergy properties.
System is equipped with antiallergy properties filter.

Super Quiet.
Thanks to its latest generation compressor and its twin blade fan, our outdoor unit is one of the most silent on the market. The indoor unit emits an almost imperceptible 18 dB(A).

Mild Dry cooling.
Fine control helps prevent a rapid decrease in room humidity while maintaining the set temperature. Maintains an RH* up to 10 % higher than cooling operation (*RH: Relative Humidity). Ideal when sleeping with the air conditioner on.

Aerowings.
More comfort with Aerowings. Direct air flow to the ceiling, creating a shower cooling effect with built-in twin flap.

Down to -10 °C in cooling only mode.
The air conditioner works in cooling mode when the outdoor temperature of -10 °C.

-15 °C Down to -15 °C in heating mode.
The air conditioner works in heat pump mode when the outdoor temperature is as low as -15 °C.

Summer House.
This innovative function keeps the house at 7/8 °C to avoid freezing pipes during the winter. This function is beneficial for summer or weekend homes.

R22/R410A Renewal.
The Panasonic renewal system allows good quality existing R410A or R22 pipe work to be re-used whilst installing new high efficiency R32 systems.

Odour-removing function.
Allows the exchanger to be cleaned, preventing possible odours. While this function is connected, the fan also remains OFF momentarily to avoid unpleasant odours while the exchanger is being cleaned.

Removable, washable panel.
The front panel is easy to keep clean. It can be removed quickly in one single step and can be washed in water. A clean front panel ensures smoother, more efficient operation, which can save energy.

Powerful mode.
The rapid and effective powerful mode is ideal for when you come home on the hottest or coldest days. It works at maximum power to reach the desired temperature in just 15 minutes.

Soft Dry operation mode.
The soft dry mode eliminates excess moisture with a soft breeze and provides a sense of wellbeing without much change in temperature.

Personal air flow creation.
Permits the air direction to be adjusted vertically and horizontally. This feature can be conveniently selected by remote controller.

Automatic vertical air flow control.
The flap swings up and down automatically. The flow can also be set at a fixed angle with the remote controller.

Manual horizontal air flow control.

Auto mode.
Automatically switches the current operation mode to heating or cooling mode necessary to keep the temperature at a constantly comfortable level based on the temperature of the room. In case of multi split installation the function is limited to first unit working and logic of switching is different considering also the outdoor temperature.

Hot Start mode.
At the start of heating cycle and after defrost cycle, the indoor fan will start up once the indoor heat exchanger is warm.

Real time clock with dual ON / OFF timer.
This feature enables you to preset two different sets of start/stop operation timer (hour and minute) within a 24-hour time frame.

Weekly timer.
Allow to fix per each day of the week up to 6 operations per day.

LCD infrared remote controller.

Automatic restart.
This function permits automatic restarting if safe mode operation has stopped for some unusual reason, such as after a power cut. As soon as the power is back, the unit restarts with the parameters selected before it stopped.

Long piping.
Indicates the maximum length of pipe between the outdoor unit and the indoor unit(s). The distances permitted, demonstrate the installations possible.

Top-panel maintenance access.
Maintenance of an outdoor unit used to be quite a tedious task. Now, with the possibility of removing the top cover, maintenance is quick and easy.

Self-diagnosis function.
With this function the unit carries out a process self-diagnosis when a particular function does not work correctly. This allows faster servicing.

High connectivity

RAC interface adapter for integration into P-Link.
CZ-CNT port integration to PACi and ECOi. Domestic integration to P-Link. Can connect ranges to P-Link. Full control is now possible.

Wi-Fi control.
A next generation system providing user-friendly control of air conditioning or heat pump units from everywhere, using a simple Android™ or iOS smartphone or tablet via Wi-Fi.









Easy control by BMS.
The communication port can be integrated into the indoor unit and provides easy connection to, and control of, your Panasonic heat pump to your home or building management system.

5 Years warranty.
Panasonic guarantees the compressors in the entire range for five years.







Accessories and control

Connectivity





 <p>Wi-Fi adapter for smart control via Panasonic Comfort Cloud App.</p> <p>-----</p> <p>CZ-TACG1</p>	 <p>RAC interface adapter for integration into P-Link, plus external input and alarm/status output.</p> <p>-----</p> <p>CZ-CAPRA1</p>	 <p>This interface can be used with all models which have a CN-CNT connector.</p> <p>-----</p> <p>PAW-AC-KNX-1i</p>	 <p>This interface can be used with all models which have a CN-CNT connector.</p> <p>-----</p> <p>PAW-AC-MBS-1</p>
 <p>This interface can be used with all models which have a CN-CNT connector.</p> <p>-----</p> <p>PAW-AC-BAC-1</p>	 <p>This interface can be used with all models which have a CN-RMT connector.</p> <p>-----</p> <p>PAW-AC-DIO</p>	 <p>Heating only PCB for Etherea and low static pressure hide-away.</p> <p>-----</p> <p>PAW-AC-HEAT-1</p>	 <p>Control of the Etherea, Flagship and Heatcharge by SMS (need additional SIM card).</p> <p>-----</p> <p>PAW-SMSCONTROL</p>

Individual controls

 <p>NEW wired remote controller for wall-mounted and floor console.</p> <p>* Available in Winter 22.</p> <p>-----</p> <p>CZ-RD517C</p>	 <p>Wired remote controller for wall-mounted and floor console.</p> <p>-----</p> <p>CZ-RD514C</p>	 <p>Infrared remote controller Sky Remote. 2 m cable length of infrared receiver for hide-away.</p> <p>-----</p> <p>CZ-RL511D</p>	 <p>CONEX wired remote controller (non-wireless) for 4 way 60x60 cassette PY3.</p> <p>-----</p> <p>CZ-RTC6</p>
--	---	--	--

Panel

Pipe reducer

 <p>Panel for 4 way 60x60 cassette - PY3.</p> <p>-----</p> <p>CZ-KPY4</p>	 <p>Reduces the connection size on the indoor unit from 1/2" to 3/8".</p> <p>-----</p> <p>CZ-MA1PA</p>	 <p>Increases the connection size on the outdoor unit from 3/8" to 1/2".</p> <p>-----</p> <p>CZ-MA2PA</p>	 <p>Reduces the connection size on the indoor unit from 5/8" to 1/2".</p> <p>-----</p> <p>CZ-MA3PA</p>
---	--	--	--



Free Multi R32 combinations table

Free Multi 2x1 CU-2Z35TBE. Minimum capacity connected: 3,2 kW. Maximum capacity connected: 6,0 kW · R32

Indoor unit capacity	Cooling capacity (kW). Rooms			EER	SEER ¹⁾	Input power rating			A.E.C.	Current	Heating capacity (kW). Rooms			COP	SCOP ¹⁾	Input power rating			A.E.C.	Current	
	A	B	Total (Min - Max)			W/W	kW	kWh			230V	A	B			Total (Min - Max)	W/W	kW			kWh
1 Room																					
16	1,60		1,60 (1,10 - 2,30)	3,90		0,41 (0,22 - 0,60)	205	1,95	2,60		2,60 (0,70 - 3,80)	3,77		0,69 (0,17 - 1,11)	345	3,20					
20	2,00		2,00 (1,10 - 2,90)	3,85		0,52 (0,22 - 0,77)	260	2,45	3,20		3,20 (0,70 - 4,80)	3,76		0,85 (0,17 - 1,41)	425	3,95					
25	2,50		2,50 (1,10 - 3,50)	3,73		0,67 (0,22 - 1,00)	335	3,15	3,60		3,60 (0,70 - 5,50)	3,50		1,03 (0,17 - 1,70)	515	4,75					
35	3,50		3,50 (1,10 - 4,00)	3,47		1,01 (0,22 - 1,22)	505	4,70	4,20		4,20 (0,70 - 5,60)	3,44		1,22 (0,17 - 1,68)	610	5,65					
2 Rooms																					
16+16	1,60	1,60	3,20 (1,50 - 4,00)	4,92	8,50 A+++	0,65 (0,25 - 1,00)	325	3,05	2,10	2,10	4,20 (1,10 - 5,60)	4,88	4,60 A+++	0,86 (0,21 - 1,34)	430	4,00					
16+20	1,55	1,95	3,50 (1,50 - 4,50)	4,86	8,50 A+++	0,72 (0,25 - 1,10)	360	3,35	1,85	2,35	4,20 (1,10 - 5,60)	4,88	4,60 A+++	0,86 (0,21 - 1,34)	430	4,00					
16+25	1,35	2,15	3,50 (1,50 - 4,50)	4,86	8,50 A+++	0,72 (0,25 - 1,10)	360	3,35	1,65	2,55	4,20 (1,10 - 5,60)	4,88	4,60 A+++	0,86 (0,21 - 1,34)	430	4,00					
16+35	1,10	2,40	3,50 (1,50 - 4,50)	4,86	8,50 A+++	0,72 (0,25 - 1,10)	360	3,35	1,30	2,90	4,20 (1,10 - 5,60)	4,88	4,60 A+++	0,86 (0,21 - 1,34)	430	4,00					
20+20	1,75	1,75	3,50 (1,50 - 4,50)	4,86	8,50 A+++	0,72 (0,25 - 1,10)	360	3,35	2,10	2,10	4,20 (1,10 - 5,60)	4,88	4,60 A+++	0,86 (0,21 - 1,34)	430	4,00					
20+25	1,55	1,95	3,50 (1,50 - 4,50)	4,86	8,50 A+++	0,72 (0,25 - 1,10)	360	3,35	1,85	2,35	4,20 (1,10 - 5,60)	4,88	4,60 A+++	0,86 (0,21 - 1,34)	430	4,00					
20+35	1,25	2,25	3,50 (1,50 - 4,50)	5,07	8,50 A+++	0,69 (0,25 - 1,05)	345	3,25	1,55	2,65	4,20 (1,10 - 5,60)	5,00	4,60 A+++	0,84 (0,21 - 1,29)	420	3,90					
25+25	1,75	1,75	3,50 (1,50 - 4,50)	5,07	8,50 A+++	0,69 (0,25 - 1,05)	345	3,25	2,10	2,10	4,20 (1,10 - 5,60)	5,00	4,60 A+++	0,84 (0,21 - 1,29)	420	3,90					
25+35	1,45	2,05	3,50 (1,50 - 4,50)	5,07	8,50 A+++	0,69 (0,25 - 1,05)	345	3,25	1,75	2,45	4,20 (1,10 - 5,60)	5,00	4,60 A+++	0,84 (0,21 - 1,29)	420	3,90					

Free Multi 2x1 CU-2Z41TBE. Minimum capacity connected: 3,2 kW. Maximum capacity connected: 6,0 kW · R32

Indoor unit capacity	Cooling capacity (kW). Rooms			EER	SEER ¹⁾	Input power rating			A.E.C.	Current	Heating capacity (kW). Rooms			COP	SCOP ¹⁾	Input power rating			A.E.C.	Current	
	A	B	Total (Min - Max)			W/W	kW	kWh			230V	A	B			Total (Min - Max)	W/W	kW			kWh
1 Room																					
16	1,60		1,60 (1,10 - 2,30)	3,90		0,41 (0,22 - 0,60)	205	1,95	2,60		2,60 (0,70 - 3,80)	3,77		0,69 (0,17 - 1,11)	345	3,20					
20	2,00		2,00 (1,10 - 2,90)	3,85		0,52 (0,22 - 0,77)	260	2,45	3,20		3,20 (0,70 - 4,80)	3,76		0,85 (0,17 - 1,41)	425	3,95					
25	2,50		2,50 (1,10 - 3,50)	3,73		0,67 (0,22 - 1,00)	335	3,15	3,60		3,60 (0,70 - 5,50)	3,50		1,03 (0,17 - 1,70)	515	4,75					
35	3,50		3,50 (1,10 - 4,00)	3,47		1,01 (0,22 - 1,22)	505	4,70	4,50		4,50 (0,70 - 6,20)	3,60		1,25 (0,17 - 1,81)	625	5,80					
2 Rooms																					
16+16	1,60	1,60	3,20 (1,50 - 4,00)	4,71	8,50 A+++	0,68 (0,25 - 0,99)	340	3,15	2,20	2,20	4,40 (1,10 - 7,00)	4,68	4,60 A+++	0,94 (0,21 - 1,81)	470	4,35					
16+20	1,60	2,00	3,60 (1,50 - 4,50)	4,62	8,50 A+++	0,78 (0,25 - 1,15)	390	3,60	2,05	2,55	4,60 (1,10 - 7,00)	4,79	4,60 A+++	0,96 (0,21 - 1,79)	480	4,45					
16+25	1,60	2,50	4,10 (1,50 - 5,20)	4,56	8,50 A+++	0,90 (0,25 - 1,37)	450	4,15	1,80	2,80	4,60 (1,10 - 7,00)	4,79	4,60 A+++	0,96 (0,21 - 1,79)	480	4,45					
16+35	1,30	2,80	4,10 (1,50 - 5,20)	4,56	8,50 A+++	0,90 (0,25 - 1,37)	450	4,15	1,45	3,15	4,60 (1,10 - 7,00)	4,79	4,60 A+++	0,96 (0,21 - 1,79)	480	4,45					
20+20	2,00	2,00	4,00 (1,50 - 5,00)	4,49	8,50 A+++	0,89 (0,25 - 1,31)	445	4,10	2,30	2,30	4,60 (1,10 - 7,00)	4,84	4,60 A+++	0,95 (0,21 - 1,77)	475	4,40					
20+25	1,80	2,30	4,10 (1,50 - 5,20)	4,56	8,50 A+++	0,90 (0,25 - 1,37)	450	4,15	2,05	2,55	4,60 (1,10 - 7,00)	4,84	4,60 A+++	0,95 (0,21 - 1,77)	475	4,40					
20+35	1,50	2,60	4,10 (1,50 - 5,20)	4,56	8,50 A+++	0,90 (0,25 - 1,37)	450	4,15	1,65	2,95	4,60 (1,10 - 7,00)	4,84	4,60 A+++	0,95 (0,21 - 1,77)	475	4,40					
25+25	2,05	2,05	4,10 (1,50 - 5,20)	4,56	8,50 A+++	0,90 (0,25 - 1,37)	450	4,15	2,30	2,30	4,60 (1,10 - 7,00)	4,84	4,60 A+++	0,95 (0,21 - 1,77)	475	4,40					
25+35	1,70	2,40	4,10 (1,50 - 5,20)	4,56	8,50 A+++	0,90 (0,25 - 1,37)	450	4,15	1,90	2,70	4,60 (1,10 - 7,00)	4,84	4,60 A+++	0,95 (0,21 - 1,77)	475	4,40					

Free Multi 2x1 CU-2Z50TBE. Minimum capacity connected: 3,2 kW. Maximum capacity connected: 7,7 kW · R32

Indoor unit capacity	Cooling capacity (kW). Rooms			EER	SEER ¹⁾	Input power rating			A.E.C.	Current	Heating capacity (kW). Rooms			COP	SCOP ¹⁾	Input power rating			A.E.C.	Current	
	A	B	Total (Min - Max)			W/W	kW	kWh			230V	A	B			Total (Min - Max)	W/W	kW			kWh
1 Room																					
16	1,60		1,60 (1,10 - 2,30)	3,90		0,41 (0,22 - 0,60)	205	1,95	2,60		2,60 (0,70 - 3,80)	3,77		0,69 (0,17 - 1,11)	345	3,20					
20	2,00		2,00 (1,10 - 2,90)	3,85		0,52 (0,22 - 0,77)	260	2,45	3,20		3,20 (0,70 - 4,80)	3,76		0,85 (0,17 - 1,41)	425	3,95					
25	2,50		2,50 (1,10 - 3,50)	3,73		0,67 (0,22 - 1,00)	335	3,15	3,60		3,60 (0,70 - 5,50)	3,50		1,03 (0,17 - 1,70)	515	4,75					
35	3,50		3,50 (1,10 - 4,00)	3,47		1,01 (0,22 - 1,22)	505	4,70	4,50		4,50 (0,70 - 6,20)	3,60		1,25 (0,17 - 1,81)	625	5,80					
42	4,20		4,20 (1,10 - 5,40)	3,09		1,36 (0,22 - 1,50)	680	6,35	5,00		5,00 (1,10 - 6,40)	3,23		1,55 (0,21 - 2,18)	775	7,15					
50	5,00		5,00 (1,20 - 5,10)	2,96		1,69 (0,23 - 1,79)	845	7,80	5,30		5,30 (1,10 - 6,80)	3,23		1,64 (0,21 - 2,29)	820	7,60					
2 Rooms																					
16+16	1,60	1,60	3,20 (1,50 - 4,00)	4,71	8,50 A+++	0,68 (0,25 - 0,99)	340	3,15	2,60	2,60	5,20 (1,10 - 7,00)	4,60	4,60 A+++	1,13 (0,21 - 1,81)	565	5,10					
16+20	1,60	2,00	3,60 (1,50 - 4,50)	4,62	8,50 A+++	0,78 (0,25 - 1,15)	390	3,60	2,40	3,00	5,40 (1,10 - 7,00)	4,58	4,60 A+++	1,18 (0,21 - 1,79)	590	5,35					
16+25	1,60	2,50	4,10 (1,50 - 5,20)	4,56	8,50 A+++	0,90 (0,25 - 1,37)	450	4,15	2,10	3,30	5,40 (1,10 - 7,00)	4,58	4,60 A+++	1,18 (0,21 - 1,79)	590	5,35					
16+35	1,55	3,45	5,00 (1,50 - 5,20)	4,24	8,50 A+++	1,18 (0,25 - 1,37)	590	5,35	1,70	3,70	5,40 (1,10 - 7,00)	4,58	4,60 A+++	1,18 (0,21 - 1,79)	590	5,35					
16+42	1,40	3,60	5,00 (1,50 - 5,40)	4,24	8,50 A+++	1,18 (0,25 - 1,49)	590	5,35	1,55	4,05	5,60 (1,10 - 7,20)	4,63	4,60 A+++	1,21 (0,21 - 1,80)	605	5,50					
16+50	1,20	3,80	5,00 (1,50 - 5,40)	4,24	8,50 A+++	1,18 (0,25 - 1,49)	590	5,35	1,35	4,25	5,60 (1,10 - 7,20)	4,63	4,60 A+++	1,21 (0,21 - 1,80)	605	5,50					
20+20	2,00	2,00	4,00 (1,50 - 5,00)	4,49	8,50 A+++	0,89 (0,25 - 1,31)	445	4,10	2,70	2,70	5,40 (1,10 - 7,00)	4,62	4,60 A+++	1,17 (0,21 - 1,77)	585	5,30					
20+25	2,00	2,50	4,50 (1,50 - 5,20)	4,37	8,50 A+++	1,03 (0,25 - 1,37)	515	4,65	2,40	3,00	5,40 (1,10 - 7,00)	4,62	4,60 A+++	1,17 (0,21 - 1,77)	585	5,30					
20+35	1,80	3,20	5,00 (1,50 - 5,40)	4,24	8,50 A+++	1,18 (0,25 - 1,49)	590	5,35	2,05	3,55	5,60 (1,10 - 7,20)	4,63	4,60 A+++	1,21 (0,21 - 1,80)	605	5,50					
20+42	1,60	3,40	5,00 (1,50 - 5,40)	4,24	8,50 A+++	1,18 (0,25 - 1,49)	590	5,35	1,80	3,80	5,60 (1,10 - 7,20)	4,63	4,60 A+++	1,21 (0,21 - 1,80)	605	5,50					
20+50	1,45	3,55	5,00 (1,50 - 5,40)	4,24	8,50 A+++	1,18 (0,25 - 1,49)	590	5,35	1,60	4,00	5,60 (1,10 - 7,20)	4,63	4,60 A+++	1,21 (0,21 - 1,80)	605	5,50					
25+25	2,50	2,50	5,00 (1,50 - 5,40)	4,24	8,50 A+++	1,18 (0,25 - 1,49)	590	5,35	2,80	2,80	5,60 (1,10 - 7,20)	4,63	4,60 A+++	1,21 (0,21 - 1,80)	605	5,50					
25+35	2,10	2,90	5,00 (1,50 - 5,40)	4,24	8,50 A+++	1,18 (0,25 - 1,49)	590	5,35	2,35	3,25	5,60 (1,10 - 7,20)	4,63	4,60 A+++	1,21 (0,21 - 1,80)	605	5,50					
25+42	1,85	3,15	5,00 (1,50 - 5,40)	4,24	8,50 A+++	1,18 (0,25 - 1,49)	590	5,35	2,10	3,50	5,60 (1,10 - 7,20)	4,63	4,60 A+++	1,21 (0,21 - 1,80)	605	5,50					
25+50	1,65	3,35	5,00 (1,50 - 5,40)	4,24	8,50 A+++	1,18 (0,25 - 1,49)	590	5,35	1,85	3,75	5,60 (1,10 - 7,20)	4,63	4,60 A+++	1,21 (0,21 - 1,80)	605	5,50					
35+35	2,50	2,50	5,00 (1,50 - 5,40)	4,24	8,50 A+++	1,18 (0,25 - 1,49)	590	5,35	2,80	2,80	5,60 (1,10 - 7,20)	4,63	4,60 A+++	1,21 (0,21 - 1,80)	605	5,50					
35+42	2,25	2,75	5,00 (1,50 - 5,40)	4,24	8,50 A+++	1,18 (0,25 - 1,49)	590	5,35	2,55	3,05	5,60 (1,10 - 7,20)	4,63	4,60 A+++	1,21 (0,21 - 1							

Configure in a few steps your multi split system with our online tool.



Free Multi 3x1 CU-3Z52TBE. Minimum capacity connected: 4,5 kW. Maximum capacity connected: 9,5 kW - R32

Indoor unit capacity	Cooling capacity (kW). Rooms				EER	SEER ¹⁾	Input power rating			A.E.C.	Current	Heating capacity (kW). Rooms					COP	SCOP ¹⁾	Input power rating			A.E.C.	Current	
	A	B	C	Total (Min - Max)			W/W	kW	kWh			230V	A	B	C	Total (Min - Max)			W/W	kW	kWh			230V
1 Room																								
16	1,60			1,60(1,30-2,30)	4,00		0,40(0,25-0,64)			200	2,00	2,60				2,60(1,20-3,20)	4,33					0,60(0,30-0,96)	300	3,00
20	2,00			2,00(1,80-2,90)	4,00		0,50(0,34-0,81)			250	2,50	3,20				3,20(1,20-4,10)	4,32				0,74(0,30-1,23)	370	3,70	
25	2,50			2,50(1,80-2,90)	3,97		0,63(0,34-0,81)			315	3,00	3,60				3,60(1,20-4,30)	3,83				0,94(0,30-1,23)	470	4,50	
35	3,50			3,50(1,80-3,80)	3,72		0,94(0,34-1,36)			470	4,30	4,50				4,50(1,20-5,80)	3,66				1,23(0,30-2,10)	615	5,80	
42	4,20			4,20(1,80-4,30)	3,07		1,37(0,34-1,99)			685	6,10	5,60				5,60(1,20-6,80)	3,26				1,72(0,30-2,93)	860	7,70	
50	5,00			5,00(1,90-5,70)	3,23		1,55(0,34-2,13)			775	6,80	6,80				6,80(1,20-6,90)	3,24				2,10(0,30-2,52)	1050	9,20	
2 Rooms																								
16+16	1,60	1,60		3,20(1,80-6,20)	5,42	7,00 A++	0,59(0,33-2,09)			295	2,90	2,60	2,60			5,20(1,40-7,00)	4,13	3,80 A			1,26(0,34-1,99)	630	5,80	
16+20	1,60	2,00		3,60(1,80-6,20)	4,93	7,00 A++	0,73(0,33-2,05)			365	3,50	2,58	3,22			5,80(1,40-7,00)	4,03	3,80 A			1,44(0,33-1,95)	720	6,60	
16+25	1,60	2,50		4,10(1,80-6,20)	4,66	7,00 A++	0,88(0,33-2,05)			440	4,10	2,42	3,78			6,20(1,40-7,00)	3,95	3,80 A			1,57(0,33-1,95)	785	7,20	
16+35	1,60	3,50		5,10(1,80-6,30)	3,89	7,00 A++	1,31(0,33-2,06)			655	6,00	2,13	4,67			6,80(1,40-7,30)	3,89	3,80 A			1,75(0,29-2,05)	875	7,90	
16+42	1,63	3,77		5,20(1,90-6,40)	3,85	7,00 A++	1,35(0,35-2,10)			675	6,20	1,88	4,92			6,80(1,40-7,30)	3,98	3,80 A			1,71(0,31-2,04)	855	7,80	
16+50	1,26	3,94		5,20(1,90-6,80)	4,44	7,20 A++	1,17(0,34-2,04)			585	5,40	1,65	5,15			6,80(1,40-8,00)	4,36	4,00 A+			1,56(0,27-2,15)	780	7,10	
20+20	2,00	2,00		4,00(1,80-6,20)	4,71	7,00 A++	0,85(0,33-2,01)			425	4,00	3,20	3,20			6,40(1,40-7,00)	3,93	3,80 A			1,63(0,32-1,95)	815	7,40	
20+25	2,00	2,50		4,50(1,80-6,20)	4,33	7,00 A++	1,04(0,33-2,01)			520	4,80	3,02	3,78			6,80(1,40-7,00)	3,86	3,80 A			1,76(0,29-1,95)	880	8,00	
20+35	1,89	3,31		5,20(1,80-6,30)	3,85	7,00 A++	1,35(0,33-2,02)			675	6,20	2,47	4,33			6,80(1,40-7,30)	3,98	3,80 A			1,71(0,28-2,04)	855	7,80	
20+42	1,68	3,52		5,20(1,90-6,40)	3,94	7,00 A++	1,32(0,35-2,06)			660	6,00	2,19	4,61			6,80(1,40-7,30)	4,00	3,80 A			1,70(0,30-2,00)	850	7,80	
20+50	1,49	3,71		5,20(1,90-6,80)	4,44	7,20 A++	1,17(0,34-2,04)			585	5,40	1,94	4,86			6,80(1,40-8,00)	4,36	4,00 A+			1,56(0,27-2,15)	780	7,10	
25+25	2,50	2,50		5,00(1,80-6,20)	3,91	7,00 A++	1,28(0,33-2,01)			640	5,80	3,40	3,40			6,80(1,40-7,00)	3,86	3,80 A			1,76(0,29-1,95)	880	8,00	
25+35	2,17	3,03		5,20(1,90-6,30)	3,85	7,00 A++	1,35(0,35-2,02)			675	6,20	2,83	3,97			6,80(1,40-7,30)	3,98	3,80 A			1,71(0,28-2,04)	855	7,80	
25+42	1,94	3,26		5,20(1,90-6,40)	3,94	7,00 A++	1,32(0,35-2,06)			660	6,00	2,54	4,26			6,80(1,40-7,30)	4,00	3,80 A			1,70(0,28-2,00)	850	7,80	
25+50	1,73	3,47		5,20(1,90-6,80)	4,44	7,20 A++	1,17(0,34-2,04)			585	5,40	2,27	4,53			6,80(1,40-8,00)	4,36	4,00 A+			1,56(0,24-2,15)	780	7,10	
35+35	2,60	2,60		5,20(1,90-6,40)	4,06	7,00 A++	1,28(0,35-2,02)			640	5,80	3,40	3,40			6,80(1,40-7,50)	4,02	3,80 A			1,69(0,27-2,06)	845	7,70	
35+42	2,36	2,84		5,20(1,90-6,50)	4,06	7,00 A++	1,28(0,35-2,07)			640	5,80	3,09	3,71			6,80(1,40-7,50)	4,02	3,80 A			1,69(0,26-2,06)	845	7,70	
35+50	2,14	3,06		5,20(1,90-6,90)	4,60	7,20 A++	1,13(0,36-2,04)			565	5,20	2,80	4,00			6,80(1,40-8,00)	4,42	4,00 A+			1,54(0,24-2,08)	770	7,50	
42+42	2,60	2,60		5,20(1,90-6,50)	4,06	7,00 A++	1,28(0,35-2,07)			640	5,80	3,40	3,40			6,80(1,40-7,60)	4,12	3,80 A			1,65(0,26-2,09)	825	7,80	
42+50	2,37	2,83		5,20(1,90-6,90)	4,60	7,20 A++	1,13(0,36-2,04)			565	5,20	3,10	3,70			6,80(1,40-8,00)	4,44	4,00 A+			1,53(0,24-2,08)	765	7,00	
3 Rooms																								
16+16+16	1,60	1,60	1,60	4,80(1,80-7,20)	5,05	8,50 A+++	0,95(0,36-2,13)			475	4,40	2,26	2,26	2,26		6,78(1,50-8,10)	4,58	4,20 A+			1,48(0,29-2,10)	740	6,80	
16+16+20	1,60	1,60	2,00	5,20(1,80-7,30)	4,77	8,50 A+++	1,09(0,36-2,18)			545	5,00	2,09	2,09	2,62		6,80(1,60-8,30)	4,63	4,20 A+			1,47(0,32-2,17)	735	6,70	
16+16+25	1,46	1,46	2,28	5,20(1,90-7,20)	4,77	8,50 A+++	1,09(0,39-2,09)			545	5,00	1,91	1,91	2,98		6,80(1,60-8,30)	4,63	4,20 A+			1,47(0,32-2,17)	735	6,70	
16+16+35	1,24	1,24	2,72	5,20(1,90-7,20)	4,77	8,50 A+++	1,09(0,39-2,04)			545	5,00	1,62	1,62	3,56		6,80(1,60-8,30)	4,69	4,20 A+			1,45(0,34-2,10)	725	6,60	
16+16+42	1,12	1,12	2,96	5,20(1,80-7,30)	4,77	8,50 A+++	1,09(0,39-2,09)			545	5,00	1,47	1,47	3,86		6,80(1,60-8,30)	4,69	4,20 A+			1,45(0,31-2,10)	725	6,60	
16+16+50	1,01	1,01	3,18	5,20(1,80-7,30)	5,15	8,50 A+++	1,01(0,42-1,91)			505	4,70	1,33	1,33	4,14		6,80(1,60-8,30)	5,07	4,20 A+			1,34(0,33-1,96)	670	6,10	
16+20+20	1,48	1,86	1,86	5,20(1,90-7,20)	4,77	8,50 A+++	1,09(0,39-2,09)			545	5,00	1,94	2,43	2,43		6,80(1,60-8,30)	4,66	4,20 A+			1,46(0,31-2,12)	730	6,70	
16+20+25	1,36	1,70	2,14	5,20(1,90-7,20)	4,77	8,50 A+++	1,09(0,39-2,09)			545	5,00	1,78	2,23	2,79		6,80(1,60-8,30)	4,66	4,20 A+			1,46(0,31-2,12)	730	6,70	
16+20+35	1,17	1,46	2,57	5,20(1,90-7,20)	4,77	8,50 A+++	1,09(0,39-2,00)			545	5,00	1,53	1,92	3,35		6,80(1,60-8,30)	4,69	4,20 A+			1,45(0,34-2,10)	725	6,60	
16+20+42	1,07	1,33	2,80	5,20(1,80-7,30)	4,77	8,50 A+++	1,09(0,39-2,09)			545	5,00	1,39	1,74	3,67		6,80(1,60-8,30)	4,72	4,20 A+			1,44(0,31-2,09)	720	6,60	
16+20+50	0,97	1,21	3,02	5,20(1,80-7,30)	5,15	8,50 A+++	1,01(0,42-1,86)			505	4,70	1,27	1,58	3,95		6,80(1,60-8,30)	5,11	4,20 A+			1,33(0,34-1,95)	665	6,10	
16+25+25	1,26	1,97	1,97	5,20(1,90-7,20)	4,77	8,50 A+++	1,09(0,39-2,09)			545	5,00	1,64	2,58	2,58		6,80(1,60-8,30)	4,66	4,20 A+			1,46(0,31-2,12)	730	6,70	
16+25+35	1,09	1,71	2,40	5,20(1,80-7,30)	4,77	8,50 A+++	1,09(0,39-2,09)			545	5,00	1,43	2,24	3,13		6,80(1,60-8,30)	4,69	4,20 A+			1,45(0,34-2,10)	725	6,60	
16+25+42	1,00	1,57	2,63	5,20(1,80-7,30)	4,77	8,50 A+++	1,09(0,39-2,09)			545	5,00	1,31	2,05	3,44		6,80(1,60-8,30)	4,72	4,20 A+			1,44(0,31-2,09)	720	6,60	
16+25+50	0,91	1,43	2,86	5,20(1,80-7,30)	5,15	8,50 A+++	1,01(0,42-1,86)			505	4,70	1,19	1,87	3,74		6,80(1,60-8,30)	5,11	4,20 A+			1,33(0,34-1,95)	665	6,10	
16+35+35	0,96	2,12	2,12	5,20(1,80-7,30)	4,95	8,50 A+++	1,05(0,39-2,04)			525	4,80	1,26	2,77	2,77		6,80(1,60-8,30)	4,76	4,20 A+			1,43(0,32-2,07)	715	6,50	
16+35+42	0,89	1,96	2,35	5,20(1,80-7,30)	4,95	8,50 A+++	1,05(0,39-2,04)			525	4,80	1,17	2,56	3,07		6,80(1,60-8,30)	4,79	4,20 A+			1,42(0,32-2,06)	710	6,50	
20+20+20	1,73	1,73	1,73	5,19(1,90-7,20)	4,76	8,50 A+++	1,09(0,39-2,04)			545	5,00	2,26	2,26	2,26		6,78(1,60-8,30)	4,64	4,20 A+			1,46(0,31-2,11)	730	6,70	
20+20+25	1,60	1,60	2,00	5,20(1,90-7																				



Free Multi R32 combinations table

Free Multi 3x1 CU-3Z68TBE. Minimum capacity connected: 4,5 kW. Maximum capacity connected: 11,2 kW - R32

Indoor unit capacity	Cooling capacity (kW). Rooms				EER	SEER ¹⁾	Input power rating			A.E.C.	Current	Heating capacity (kW). Rooms				COP	SCOP ¹⁾	Input power rating			A.E.C.	Current	
	A	B	C	Total (Min - Max)			W/W	kW	kWh			230V	A	B	C			Total (Min - Max)	W/W	kW			kWh
1 Room																							
16	1,60			1,60(1,30-2,30)	4,00		0,40(0,25-0,64)	200	2,00	2,60				2,60(1,20-3,20)	4,33		0,60(0,30-0,96)	300	3,00				
20	2,00			2,00(1,80-2,90)	4,00		0,50(0,34-0,81)	250	2,50	3,20				3,20(1,20-4,10)	4,32		0,74(0,30-1,23)	370	3,70				
25	2,50			2,50(1,80-2,90)	3,97		0,63(0,34-0,81)	315	3,20	3,60				3,60(1,20-4,30)	3,83		0,94(0,30-1,23)	470	4,70				
35	3,50			3,50(1,80-3,80)	3,72		0,94(0,34-1,36)	470	4,50	4,50				4,50(1,20-5,80)	3,66		1,23(0,30-2,10)	615	6,00				
42	4,20			4,20(1,80-4,30)	3,07		1,37(0,34-1,99)	685	6,40	5,60				5,60(1,20-6,80)	3,26		1,72(0,30-2,93)	860	8,00				
50	5,00			5,00(1,90-5,70)	3,23		1,55(0,34-2,13)	775	7,20	6,80				6,80(1,20-6,90)	3,24		2,10(0,30-2,52)	1050	9,70				
60	6,00			6,00(1,90-6,20)	2,96		2,03(0,34-2,33)	1015	9,20	8,50				8,50(1,30-9,00)	3,54		2,40(0,62-2,55)	1200	11,10				
2 Rooms																							
16+16	1,60	1,60		3,20(1,90-6,40)	5,71	6,10 A++	0,56(0,27-2,12)	280	2,80	2,60	2,60			5,20(2,70-9,80)	4,00	3,80 A	1,30(0,66-3,01)	650	5,90				
16+20	1,60	2,00		3,60(1,90-6,40)	5,22	6,10 A++	0,69(0,27-2,08)	345	3,40	2,58	3,22			5,80(2,70-9,80)	3,92	3,80 A	1,48(0,65-3,02)	740	6,80				
16+25	1,60	2,50		4,10(1,90-6,40)	4,94	6,10 A++	0,83(0,27-2,08)	415	3,90	2,42	3,78			6,20(2,70-9,80)	3,85	3,80 A	1,61(0,65-3,02)	805	7,40				
16+35	1,60	3,50		5,10(1,90-6,90)	4,08	6,10 A++	1,25(0,27-2,48)	625	5,70	2,23	4,87			7,10(2,70-9,90)	3,74	3,80 A	1,90(0,63-3,02)	950	8,60				
16+42	1,60	4,20		5,80(1,90-6,90)	3,60	6,10 A++	1,61(0,27-2,44)	805	7,40	2,26	5,94			8,20(2,70-9,90)	3,52	3,80 A	2,33(0,63-3,02)	1165	10,50				
16+50	1,60	5,00		6,60(2,00-7,50)	3,63	6,50 A++	1,82(0,28-2,52)	910	8,20	2,06	6,44			8,50(2,80-10,20)	3,76	3,80 A	2,26(0,56-2,99)	1130	10,20				
16+60	1,43	5,37		6,80(2,00-7,50)	3,49	6,50 A++	1,95(0,28-2,52)	975	8,80	1,79	6,71			8,50(2,80-10,20)	3,76	3,80 A	2,26(0,56-2,99)	1130	10,20				
20+20	2,00	2,00		4,00(1,90-6,40)	5,00	6,10 A++	0,80(0,27-2,04)	400	3,80	3,20	3,20			6,40(2,70-9,80)	3,83	3,80 A	1,67(0,64-3,02)	835	7,60				
20+25	2,00	2,50		4,50(1,90-6,40)	4,59	6,10 A++	0,98(0,27-2,04)	490	4,60	3,02	3,78			6,80(2,70-9,80)	3,78	3,80 A	1,80(0,64-3,02)	900	8,10				
20+35	2,00	3,50		5,50(1,90-6,90)	3,85	6,10 A++	1,43(0,27-2,44)	715	6,50	2,80	4,90			7,70(2,70-9,90)	3,65	3,80 A	2,11(0,63-3,02)	1055	9,50				
20+42	2,00	4,20		6,20(1,90-6,90)	3,35	6,10 A++	1,85(0,27-2,40)	925	8,40	2,74	5,76			8,50(2,70-9,90)	3,48	3,80 A	2,44(0,62-3,03)	1220	11,00				
20+50	1,94	4,86		6,80(2,00-7,50)	3,49	6,50 A++	1,95(0,28-2,48)	975	8,80	2,43	6,07			8,50(2,80-10,20)	3,76	3,80 A	2,26(0,56-2,99)	1130	10,20				
20+60	1,70	5,10		6,80(2,00-7,50)	3,49	6,50 A++	1,95(0,28-2,48)	975	8,80	2,12	6,38			8,50(2,80-10,20)	3,76	3,80 A	2,26(0,56-2,99)	1130	10,20				
25+25	2,50	2,50		5,00(1,90-6,80)	4,13	6,10 A++	1,21(0,27-2,43)	605	5,60	3,60	3,60			7,20(2,70-9,80)	3,71	3,80 A	1,94(0,64-3,02)	970	8,80				
25+35	2,50	3,50		6,00(1,90-6,90)	3,47	6,10 A++	1,73(0,27-2,44)	865	7,90	3,37	4,73			8,10(2,70-9,90)	3,60	3,80 A	2,25(0,63-3,02)	1125	10,20				
25+42	2,50	4,20		6,70(1,90-6,90)	2,94	6,10 A++	2,28(0,27-2,40)	1140	10,30	3,17	5,33			8,50(2,70-9,90)	3,48	3,80 A	2,44(0,62-3,03)	1220	11,00				
25+50	2,27	4,53		6,80(1,90-7,50)	3,49	6,50 A++	1,95(0,26-2,48)	975	8,80	2,83	5,67			8,50(2,80-10,20)	3,76	3,80 A	2,26(0,56-2,99)	1130	10,20				
25+60	2,00	4,80		6,80(1,90-7,50)	3,49	6,50 A++	1,95(0,26-2,48)	975	8,80	2,50	6,00			8,50(2,80-10,20)	3,76	3,80 A	2,26(0,56-2,99)	1130	10,20				
35+35	3,40	3,40		6,80(1,90-7,00)	2,97	6,10 A++	2,29(0,27-2,40)	1145	10,40	4,25	4,25			8,50(2,80-10,00)	3,56	3,80 A	2,39(0,64-3,02)	1195	10,80				
35+42	3,09	3,71		6,80(1,90-7,10)	3,04	6,10 A++	2,24(0,27-2,50)	1120	10,10	3,86	4,64			8,50(2,80-10,00)	3,56	3,80 A	2,39(0,60-3,02)	1195	10,80				
35+60	2,80	4,00		6,80(2,00-7,60)	3,64	6,50 A++	1,87(0,28-2,48)	935	8,50	3,50	5,00			8,50(2,80-10,30)	3,86	3,80 A	2,20(0,54-2,97)	1100	10,00				
35+60	2,51	4,29		6,80(2,00-7,60)	3,64	6,50 A++	1,87(0,28-2,48)	935	8,50	3,13	5,37			8,50(2,80-10,30)	3,86	3,80 A	2,20(0,54-2,97)	1100	10,00				
42+42	3,40	3,40		6,80(1,90-7,10)	3,02	6,10 A++	2,25(0,26-2,45)	1125	10,20	4,25	4,25			8,50(2,80-10,00)	3,57	3,80 A	2,38(0,60-2,98)	1190	10,80				
42+50	3,10	3,70		6,80(2,00-7,60)	3,64	6,50 A++	1,87(0,28-2,44)	935	8,50	3,88	4,62			8,50(2,80-10,30)	3,88	3,80 A	2,19(0,54-2,96)	1095	9,90				
42+60	2,80	4,00		6,80(2,00-7,60)	3,64	6,50 A++	1,87(0,28-2,44)	935	8,50	3,50	5,00			8,50(2,80-10,30)	3,88	3,80 A	2,19(0,54-2,96)	1095	9,90				
50+50	3,40	3,40		6,80(2,10-8,10)	4,10	6,50 A++	1,66(0,32-2,50)	830	7,60	4,25	4,25			8,50(2,80-10,50)	4,15	3,80 A	2,05(0,51-2,87)	1025	9,30				
50+60	3,09	3,71		6,80(2,10-8,10)	4,10	6,50 A++	1,66(0,32-2,50)	830	7,60	3,86	4,64			8,50(2,80-10,50)	4,15	3,80 A	2,05(0,51-2,87)	1025	9,30				
3 Rooms																							
16+16+16	1,60	1,60	1,60	4,80(1,90-8,00)	4,85	8,00 A++	0,99(0,27-2,50)	495	4,60	2,60	2,60	2,60	7,80(3,30-10,40)	3,98	4,20 A+	1,96(0,64-2,95)	980	8,90					
16+16+20	1,60	1,60	2,00	5,20(1,90-8,00)	4,60	8,00 A++	1,13(0,27-2,46)	565	5,20	2,58	2,58	3,24	8,40(3,30-10,40)	3,84	4,20 A+	2,19(0,64-2,94)	1095	9,90					
16+16+25	1,60	1,60	2,50	5,70(1,90-8,00)	4,19	8,00 A++	1,36(0,27-2,46)	680	6,20	2,39	2,39	3,72	8,50(3,30-10,40)	3,81	4,20 A+	2,23(0,64-2,94)	1115	10,10					
16+16+35	1,60	1,60	3,50	6,70(1,90-8,00)	3,68	8,00 A++	1,82(0,27-2,37)	910	8,20	2,03	2,03	4,44	8,50(3,30-10,40)	3,94	4,20 A+	2,16(0,63-2,92)	1080	9,80					
16+16+42	1,47	1,47	3,86	6,80(1,90-8,10)	3,66	8,00 A++	1,86(0,27-2,46)	930	8,40	1,84	1,84	4,82	8,50(3,30-10,50)	3,95	4,20 A+	2,15(0,62-2,95)	1075	9,70					
16+16+50	1,33	1,33	4,14	6,80(2,00-8,50)	3,93	8,00 A++	1,73(0,32-2,42)	865	7,90	1,66	1,66	5,18	8,50(3,20-10,60)	4,21	4,20 A+	2,02(0,60-2,80)	1010	9,10					
16+16+60	1,18	1,18	4,44	6,80(2,00-8,50)	3,93	8,00 A++	1,73(0,32-2,42)	865	7,90	1,48	1,48	5,54	8,50(3,20-10,60)	4,21	4,20 A+	2,02(0,60-2,80)	1010	9,10					
16+20+20	1,60	2,00	2,00	5,60(1,90-8,00)	4,38	8,00 A++	1,28(0,27-2,46)	640	5,80	2,42	3,04	3,04	8,50(3,30-10,40)	3,83	4,20 A+	2,22(0,63-2,93)	1110	10,00					
16+20+25	1,60	2,00	2,50	6,10(1,90-8,00)	4,01	8,00 A++	1,52(0,27-2,46)	760	6,90	2,23	2,79	3,48	8,50(3,30-10,40)	3,83	4,20 A+	2,22(0,63-2,93)	1110	10,00					
16+20+35	1,53	1,92	3,35	6,80(1,90-8,00)	3,66	8,00 A++	1,86(0,27-2,37)	930	8,40	1,92	2,39	4,19	8,50(3,30-10,40)	3,95	4,20 A+	2,15(0,62-2,86)	1075	9,70					
16+20+42	1,39	1,74	3,67	6,80(1,90-8,10)	3,66	8,00 A++	1,86(0,27-2,42)	930	8,40	1,74	2,18	4,58	8,50(3,30-10,50)	3,95	4,20 A+	2,15(0,62-2,90)	1075	9,70					

Configure in a few steps your multi split system with our online tool.



Free Multi 3x1 CU-3Z68TBE. Minimum capacity connected: 4,5 kW. Maximum capacity connected: 11,2 kW · R32

Indoor unit capacity	Cooling capacity (kW). Rooms					EER	SEER ¹⁾	Input power rating			A.E.C.	Current	Heating capacity (kW). Rooms					COP	SCOP ¹⁾	Input power rating			A.E.C.	Current
	A	B	C	Total (Min - Max)	W/W			kW	kWh	230V			A	B	C	Total (Min - Max)	W/W			kW	kWh	230V		
25+25+25	2,26	2,26	2,26	6,78(1,90-8,00)	3,65	8,00 A++	1,86(0,27-2,41)	930	8,40	2,83	2,83	2,83	8,49(3,30-10,40)	3,91	4,20 A+	2,17(0,63-2,92)	1085	9,80						
25+25+35	2,00	2,00	2,80	6,80(1,90-8,00)	3,66	8,00 A++	1,86(0,27-2,32)	930	8,40	2,50	2,50	3,50	8,50(3,30-10,40)	3,95	4,20 A+	2,15(0,62-2,89)	1075	9,70						
25+25+42	1,85	1,85	3,10	6,80(1,90-8,10)	3,74	8,00 A++	1,82(0,29-2,42)	910	8,20	2,31	2,31	3,88	8,50(3,30-10,50)	3,97	4,20 A+	2,14(0,62-2,85)	1070	9,70						
25+25+50	1,70	1,70	3,40	6,80(2,00-8,50)	4,05	8,00 A++	1,68(0,34-2,38)	840	7,70	2,13	2,13	4,24	8,50(3,20-10,60)	4,25	4,20 A+	2,00(0,60-2,78)	1000	9,00						
25+25+60	1,55	1,55	3,70	6,80(2,00-8,50)	4,05	8,00 A++	1,68(0,34-2,38)	840	7,70	1,93	1,93	4,64	8,50(3,20-10,60)	4,25	4,20 A+	2,00(0,60-2,78)	1000	9,00						
25+35+35	1,78	2,51	2,51	6,80(1,90-8,10)	3,74	8,00 A++	1,82(0,29-2,33)	910	8,20	2,24	3,13	3,13	8,50(3,30-10,50)	4,01	4,20 A+	2,12(0,64-2,87)	1060	9,60						
25+35+42	1,67	2,33	2,80	6,80(1,90-8,20)	3,74	8,00 A++	1,82(0,29-2,42)	910	8,20	2,08	2,92	3,50	8,50(3,30-10,50)	4,03	4,20 A+	2,11(0,64-2,86)	1055	9,50						
25+35+50	1,55	2,16	3,09	6,80(2,00-8,50)	4,05	8,00 A++	1,68(0,34-2,33)	840	7,70	1,93	2,70	3,87	8,50(3,20-10,60)	4,29	4,20 A+	1,98(0,60-2,76)	990	9,00						
25+42+42	1,56	2,62	2,62	6,80(1,90-8,20)	3,84	8,00 A++	1,77(0,29-2,37)	885	8,00	1,94	3,28	3,28	8,50(3,30-10,50)	4,05	4,20 A+	2,10(0,63-2,86)	1050	9,50						
35+35+35	2,26	2,26	2,26	6,78(1,90-8,20)	3,83	8,00 A++	1,77(0,29-2,33)	885	8,00	2,83	2,83	2,83	8,49(3,30-10,50)	4,12	4,20 A+	2,06(0,63-2,85)	1030	9,30						
35+35+42	2,13	2,13	2,54	6,80(1,90-8,20)	3,84	8,00 A++	1,77(0,29-2,33)	885	8,00	2,66	2,66	3,18	8,50(3,30-10,50)	4,15	4,20 A+	2,05(0,63-2,80)	1025	9,30						

1) Energy Label Scale from A+++ to D.

Free Multi 4x1 CU-4Z68TBE. Minimum capacity connected: 4,5 kW. Maximum capacity connected: 11,5 kW · R32

Indoor unit capacity	Cooling capacity (kW). Rooms					EER	SEER ¹⁾	Input power rating			A.E.C.	Current	Heating capacity (kW). Rooms					COP	SCOP ¹⁾	Input power rating			A.E.C.	Current		
	A	B	C	D	Total (Min - Max)			W/W	kW	kWh			230V	A	B	C	D			Total (Min - Max)	W/W	kW			kWh	230V
1 Room																										
16	1,60				1,60(1,30-2,30)	4,00	6,10 A++	0,40(0,25-0,64)	200	2,00	2,60		2,60(1,20-3,20)	4,33				0,60(0,30-0,96)	300	3,00						
20	2,00				2,00(1,80-2,90)	4,00	6,10 A++	0,50(0,34-0,81)	250	2,50	3,20		3,20(1,20-4,10)	4,32				0,74(0,30-1,23)	370	3,70						
25	2,50				2,50(1,80-2,90)	3,97	6,10 A++	0,63(0,34-0,81)	315	3,20	3,60		3,60(1,20-4,30)	3,83				0,94(0,30-1,23)	470	4,70						
35	3,50				3,50(1,80-3,80)	3,72	6,10 A++	0,94(0,34-1,36)	470	4,50	4,50		4,50(1,20-5,80)	3,66				1,23(0,30-2,10)	615	6,00						
42	4,20				4,20(1,80-4,30)	3,07	6,10 A++	1,37(0,34-1,99)	685	6,40	5,60		5,60(1,20-6,80)	3,26				1,72(0,30-2,93)	860	8,00						
50	5,00				5,00(1,90-5,70)	3,23	6,10 A++	1,55(0,34-2,13)	775	7,20	6,80		6,80(1,20-6,90)	3,24				2,10(0,30-2,52)	1050	9,70						
60	6,00				6,00(1,90-6,20)	2,96	6,10 A++	2,03(0,34-2,33)	1015	9,20	8,50		8,50(1,30-9,00)	3,54				2,40(0,62-2,55)	1200	11,10						
2 Rooms																										
16+16	1,60	1,60			3,20(1,90-6,40)	5,71	6,10 A++	0,56(0,27-2,12)	280	2,80	2,60	2,60	5,20(2,70-9,80)	4,00	3,80 A			1,30(0,66-3,01)	650	5,90						
16+20	1,60	2,00			3,60(1,90-6,40)	5,22	6,10 A++	0,69(0,27-2,08)	345	3,40	2,58	3,22	5,80(2,70-9,80)	3,92	3,80 A			1,48(0,65-3,02)	740	6,80						
16+25	1,60	2,50			4,10(1,90-6,40)	4,94	6,10 A++	0,83(0,27-2,08)	415	3,90	2,42	3,78	6,20(2,70-9,80)	3,85	3,80 A			1,61(0,65-3,02)	805	7,40						
16+35	1,60	3,50			5,10(1,90-6,90)	4,08	6,10 A++	1,25(0,27-2,48)	625	5,70	2,23	4,87	7,10(2,70-9,90)	3,74	3,80 A			1,90(0,63-3,02)	950	8,60						
16+42	1,60	4,20			5,80(1,90-6,90)	3,60	6,10 A++	1,61(0,27-2,44)	805	7,40	2,26	5,94	8,20(2,70-9,90)	3,52	3,80 A			2,33(0,63-3,02)	1165	10,50						
16+50	1,60	5,00			6,60(2,00-7,50)	3,63	6,50 A++	1,82(0,28-2,52)	910	8,20	2,06	6,44	8,50(2,80-10,20)	3,76	3,80 A			2,26(0,56-2,99)	1130	10,20						
16+60	1,43	5,37			6,80(2,00-7,50)	3,49	6,50 A++	1,95(0,28-2,52)	975	8,80	1,79	6,71	8,50(2,80-10,20)	3,76	3,80 A			2,26(0,56-2,99)	1130	10,20						
20+20	2,00	2,00			4,00(1,90-6,40)	5,00	6,10 A++	0,80(0,27-2,04)	400	3,80	3,20	3,20	6,40(2,70-9,80)	3,83	3,80 A			1,67(0,64-3,02)	835	7,60						
20+25	2,00	2,50			4,50(1,90-6,40)	4,59	6,10 A++	0,98(0,27-2,04)	490	4,60	3,02	3,78	6,80(2,70-9,80)	3,78	3,80 A			1,80(0,64-3,02)	900	8,10						
20+35	2,00	3,50			5,50(1,90-6,90)	3,85	6,10 A++	1,43(0,27-2,44)	715	6,50	2,80	4,90	7,70(2,70-9,90)	3,65	3,80 A			2,11(0,63-3,02)	1055	9,50						
20+42	2,00	4,20			6,20(1,90-6,90)	3,35	6,10 A++	1,85(0,27-2,40)	925	8,40	2,74	5,76	8,50(2,70-9,90)	3,48	3,80 A			2,44(0,62-3,03)	1220	11,00						
20+50	1,94	4,86			6,80(2,00-7,50)	3,49	6,50 A++	1,95(0,28-2,48)	975	8,80	2,43	6,07	8,50(2,80-10,20)	3,76	3,80 A			2,26(0,56-2,99)	1130	10,20						
20+60	1,70	5,10			6,80(2,00-7,50)	3,49	6,50 A++	1,95(0,28-2,48)	975	8,80	2,12	6,38	8,50(2,80-10,20)	3,76	3,80 A			2,26(0,56-2,99)	1130	10,20						
25+25	2,50	2,50			5,00(1,90-6,80)	4,13	6,10 A++	1,21(0,27-2,43)	605	5,60	3,60	3,60	7,20(2,70-9,80)	3,71	3,80 A			1,94(0,64-3,02)	970	8,80						
25+35	2,50	3,50			6,00(1,90-6,90)	3,47	6,10 A++	1,73(0,27-2,44)	865	7,90	3,37	4,73	8,10(2,70-9,90)	3,60	3,80 A			2,25(0,63-3,02)	1125	10,20						
25+42	2,50	4,20			6,70(1,90-6,90)	2,94	6,10 A++	2,28(0,27-2,40)	1140	10,30	3,17	5,33	8,50(2,70-9,90)	3,48	3,80 A			2,44(0,62-3,03)	1220	11,00						
25+50	2,27	4,53			6,80(1,90-7,50)	3,49	6,50 A++	1,95(0,26-2,48)	975	8,80	2,83	5,67	8,50(2,80-10,20)	3,76	3,80 A			2,26(0,56-2,99)	1130	10,20						
25+60	2,00	4,80			6,80(1,90-7,50)	3,49	6,50 A++	1,95(0,26-2,48)	975	8,80	2,50	6,00	8,50(2,80-10,20)	3,76	3,80 A			2,26(0,56-2,99)	1130	10,20						
35+35	3,40	3,40			6,80(1,90-7,00)	2,97	6,10 A++	2,29(0,27-2,40)	1145	10,40	4,25	4,25	8,50(2,80-10,20)	3,56	3,80 A			2,39(0,64-3,02)	1195	10,80						
35+42	3,09	3,71			6,80(1,90-7,10)	3,04	6,10 A++	2,24(0,27-2,50)	1120	10,10	3,86	4,64	8,50(2,80-10,00)	3,56	3,80 A			2,39(0,60-3,02)	1195	10,80						
35+50	2,80	4,00			6,80(2,00-7,60)	3,64	6,50 A++	1,87(0,28-2,48)	935	8,50	3,50	5,00	8,50(2,80-10,30)	3,86	3,80 A			2,20(0,54-2,97)	1100	10,00						
35+60	2,51	4,29			6,80(2,00-7,60)	3,64	6,50 A++	1,87(0,28-2,48)	935	8,50	3,13	5,37	8,50(2,80-10,30)	3,86	3,80 A			2,20(0,54-2,97)	1100	10,00						
42+42	3,40	3,40			6,80(1,90-7,10)	3,02	6,10 A++	2,25(0,26-2,45)	1125	10,20	4,25	4,25	8,50(2,80-10,00)	3,57	3,80 A			2,38(0,60-2,98)	1190	10,80						
42+50	3,10	3,70			6,80(2,00-7,60)	3,64	6,50 A++	1,87(0,28-2,44)	935	8,50	3,88	4,62	8,50(2,80-10,30)	3,88	3,80 A			2,19(0,54-2,96)	1095	9,90						
42+60	2,80	4,00			6,80(2,00-7,60)	3,64	6,50 A++	1,87(0,28-2,44)	935	8,50	3,50	5,00	8,50(2,80-10,30)	3,88	3,80 A			2,19(0,54-2,96)	1095	9,90						
50+50	3,40	3,40			6,80(2,10-8,10)	4,10	6,50 A++	1,66(0,32-2,50)	830	7,60	4,25	4,25	8,50(2,80-10,50)	4,15	3,80 A			2,05(0,51-2,87)	1025	9,30						
50+60	3,09	3,71			6,80(2,10-8,10)	4,10	6,50 A++	1,66(0,32-2,50)	830	7,60	3,86	4,64	8,50(2,80-10,50)	4,15	3,80 A			2,05(0,51-2,87)	1025	9,30						
3 Rooms																										
16+16+16	1,60	1,60	1,60																							



Free Multi R32 combinations table

Free Multi 4x1 CU-4Z68TBE. Minimum capacity connected: 4,5 kW. Maximum capacity connected: 11,5 kW - R32

Indoor unit capacity	Cooling capacity (kW). Rooms				EER	SEER ¹⁾	Input power rating			A.E.C.	Current			Heating capacity (kW). Rooms				COP	SCOP ¹⁾	Input power rating			A.E.C.	Current		
	A	B	C	D			Total (Min - Max)	W/W	kW			230V	A	B	C	D	Total (Min - Max)			W/W	kW			230V		
16+42+42	1,08	2,86	2,86		6,80(1,90-8,20)	3,74	8,00 A++	1,82(0,29-2,42)	910	8,20	1,36	3,57	3,57		8,50(3,30-10,50)	4,03	4,00 A+	2,11(0,64-2,86)	1055	9,50						
16+42+50	1,01	2,64	3,15		6,80(2,00-8,50)	4,05	8,00 A++	1,68(0,34-2,33)	840	7,70	1,25	3,31	3,94		8,50(3,20-10,60)	4,29	4,00 A+	1,98(0,60-2,76)	990	9,00						
20+20+20	2,00	2,00	2,00		6,00(1,90-8,00)	4,05	8,00 A++	1,48(0,27-2,41)	740	6,80	2,83	2,83	2,83		8,49(3,30-10,40)	3,91	4,00 A+	2,17(0,63-2,92)	1085	9,80						
20+20+25	2,00	2,00	2,50		6,50(1,90-8,00)	3,76	8,00 A++	1,73(0,27-2,41)	865	7,90	2,62	2,62	3,26		8,50(3,30-10,40)	3,92	4,00 A+	2,17(0,63-2,92)	1085	9,80						
20+20+35	1,81	1,81	3,18		6,80(1,90-8,00)	3,66	8,00 A++	1,86(0,27-2,32)	930	8,40	2,27	2,27	3,96		8,50(3,30-10,40)	3,95	4,00 A+	2,15(0,62-2,85)	1075	9,70						
20+20+42	1,66	1,66	3,48		6,80(1,90-8,10)	3,74	8,00 A++	1,82(0,29-2,42)	910	8,20	2,07	2,07	4,36		8,50(3,30-10,50)	3,97	4,00 A+	2,14(0,62-2,89)	1070	9,70						
20+20+50	1,51	1,51	3,78		6,80(2,00-8,50)	4,05	8,00 A++	1,68(0,34-2,38)	840	7,70	1,89	1,89	4,72		8,50(3,20-10,60)	4,25	4,00 A+	2,00(0,60-2,78)	1000	9,00						
20+20+60	1,36	1,36	4,08		6,80(2,00-8,50)	4,05	8,00 A++	1,68(0,34-2,38)	840	7,70	1,70	1,70	5,10		8,50(3,20-10,60)	4,25	4,00 A+	2,00(0,60-2,78)	1000	9,00						
20+25+25	1,94	2,43	2,43		6,80(1,90-8,00)	3,66	8,00 A++	1,86(0,27-2,41)	930	8,40	2,42	3,04	3,04		8,50(3,30-10,40)	3,92	4,00 A+	2,17(0,63-2,92)	1085	9,80						
20+25+35	1,69	2,13	2,98		6,80(1,90-8,00)	3,66	8,00 A++	1,86(0,27-2,32)	930	8,40	2,12	2,66	3,72		8,50(3,30-10,40)	3,95	4,00 A+	2,15(0,62-2,85)	1075	9,70						
20+25+42	1,56	1,95	3,29		6,80(1,90-8,10)	3,74	8,00 A++	1,82(0,29-2,42)	910	8,20	1,95	2,44	4,11		8,50(3,30-10,50)	3,97	4,00 A+	2,14(0,62-2,89)	1070	9,70						
20+25+50	1,43	1,79	3,58		6,80(2,00-8,50)	4,05	8,00 A++	1,68(0,34-2,38)	840	7,70	1,79	2,24	4,47		8,50(3,20-10,60)	4,25	4,00 A+	2,00(0,60-2,78)	1000	9,00						
20+25+60	1,29	1,62	3,89		6,80(2,00-8,50)	4,05	8,00 A++	1,68(0,34-2,38)	840	7,70	1,62	2,02	4,86		8,50(3,20-10,60)	4,25	4,00 A+	2,00(0,60-2,78)	1000	9,00						
20+35+35	1,52	2,64	2,64		6,80(1,90-8,10)	3,74	8,00 A++	1,82(0,29-2,33)	910	8,20	1,88	3,31	3,31		8,50(3,30-10,50)	4,01	4,00 A+	2,12(0,64-2,87)	1060	9,60						
20+35+42	1,40	2,45	2,95		6,80(1,90-8,20)	3,74	8,00 A++	1,82(0,29-2,42)	910	8,20	1,75	3,07	3,68		8,50(3,30-10,50)	4,03	4,00 A+	2,11(0,64-2,86)	1055	9,50						
20+35+50	1,29	2,27	3,24		6,80(2,00-8,50)	4,05	8,00 A++	1,68(0,34-2,33)	840	7,70	1,62	2,83	4,05		8,50(3,20-10,60)	4,29	4,00 A+	1,98(0,60-2,76)	990	9,00						
20+35+60	1,18	2,07	3,55		6,80(2,00-8,50)	4,05	8,00 A++	1,68(0,34-2,33)	840	7,70	1,48	2,59	4,43		8,50(3,20-10,60)	4,29	4,00 A+	1,98(0,60-2,76)	990	9,00						
20+42+42	1,30	2,75	2,75		6,80(1,90-8,20)	3,84	8,00 A++	1,77(0,29-2,37)	885	8,00	1,64	3,43	3,43		8,50(3,30-10,50)	4,05	4,00 A+	2,10(0,63-2,86)	1050	9,50						
20+42+50	1,21	2,55	3,04		6,80(2,00-8,50)	4,05	8,00 A++	1,68(0,34-2,33)	840	7,70	1,52	3,19	3,79		8,50(3,20-10,60)	4,31	4,00 A+	1,97(0,62-2,75)	985	8,90						
25+25+25	2,26	2,26	2,26		6,78(1,90-8,00)	3,65	8,00 A++	1,86(0,27-2,41)	930	8,40	2,83	2,83	2,83		8,49(3,30-10,40)	3,91	4,00 A+	2,17(0,63-2,92)	1085	9,80						
25+25+35	2,00	2,00	2,80		6,80(1,90-8,00)	3,66	8,00 A++	1,86(0,27-2,32)	930	8,40	2,50	2,50	3,50		8,50(3,30-10,40)	3,95	4,00 A+	2,15(0,62-2,85)	1075	9,70						
25+25+42	1,85	1,85	3,10		6,80(1,90-8,10)	3,74	8,00 A++	1,82(0,29-2,42)	910	8,20	2,31	2,31	3,88		8,50(3,30-10,50)	3,97	4,00 A+	2,14(0,62-2,89)	1070	9,70						
25+25+50	1,70	1,70	3,40		6,80(2,00-8,50)	4,05	8,00 A++	1,68(0,34-2,38)	840	7,70	2,13	2,13	4,24		8,50(3,20-10,60)	4,25	4,00 A+	2,00(0,60-2,78)	1000	9,00						
25+25+60	1,55	1,55	3,70		6,80(2,00-8,50)	4,05	8,00 A++	1,68(0,34-2,38)	840	7,70	1,93	1,93	4,64		8,50(3,20-10,60)	4,25	4,00 A+	2,00(0,60-2,78)	1000	9,00						
25+35+35	1,78	2,51	2,51		6,80(1,90-8,10)	3,74	8,00 A++	1,82(0,29-2,33)	910	8,20	2,24	3,13	3,13		8,50(3,30-10,50)	4,01	4,00 A+	2,12(0,64-2,87)	1060	9,60						
25+35+42	1,67	2,33	2,80		6,80(1,90-8,20)	3,74	8,00 A++	1,82(0,29-2,42)	910	8,20	2,08	2,92	3,50		8,50(3,30-10,50)	4,03	4,00 A+	2,11(0,64-2,86)	1055	9,50						
25+35+50	1,55	2,16	3,09		6,80(2,00-8,50)	4,05	8,00 A++	1,68(0,34-2,33)	840	7,70	1,93	2,70	3,87		8,50(3,20-10,60)	4,29	4,00 A+	1,98(0,60-2,76)	990	9,00						
25+42+42	1,56	2,62	2,62		6,80(1,90-8,20)	3,84	8,00 A++	1,77(0,29-2,37)	885	8,00	1,94	3,28	3,28		8,50(3,30-10,50)	4,05	4,00 A+	2,10(0,63-2,86)	1050	9,50						
35+35+35	2,26	2,26	2,26		6,78(1,90-8,20)	3,83	8,00 A++	1,77(0,29-2,33)	885	8,00	2,83	2,83	2,83		8,49(3,30-10,50)	4,12	4,00 A+	2,06(0,63-2,85)	1030	9,30						
35+35+42	2,13	2,13	2,54		6,80(1,90-8,20)	3,84	8,00 A++	1,77(0,29-2,33)	885	8,00	2,66	2,66	3,18		8,50(3,30-10,50)	4,15	4,00 A+	2,05(0,63-2,80)	1025	9,30						
4 Rooms																										
16+16+16+16	1,65	1,65	1,65	1,65	6,60(1,90-8,70)	4,49	8,50 A+++	1,47(0,34-2,38)	735	6,70	2,12	2,12	2,12	2,12	8,48(3,00-10,60)	4,44	4,20 A+	1,91(0,58-2,69)	955	8,60						
16+16+16+20	1,60	1,60	1,60	2,00	6,80(1,90-8,80)	4,39	8,00 A++	1,55(0,34-2,47)	775	7,00	2,00	2,00	2,50		8,50(3,00-10,60)	4,47	4,20 A+	1,90(0,58-2,68)	950	8,60						
16+16+16+25	1,49	1,49	1,49	2,33	6,80(1,90-8,80)	4,39	8,00 A++	1,55(0,34-2,47)	775	7,00	1,86	1,86	2,92		8,50(3,00-10,60)	4,47	4,20 A+	1,90(0,58-2,68)	950	8,60						
16+16+16+35	1,31	1,31	1,31	2,87	6,80(1,90-8,80)	4,39	8,00 A++	1,55(0,34-2,38)	775	7,00	1,64	1,64	3,58		8,50(3,00-10,60)	4,52	4,20 A+	1,88(0,58-2,66)	940	8,50						
16+16+16+42	1,21	1,21	1,21	3,17	6,80(1,90-8,80)	4,50	8,00 A++	1,51(0,34-2,38)	755	6,80	1,51	1,51	3,97		8,50(3,00-10,60)	4,55	4,20 A+	1,87(0,58-2,65)	935	8,50						
16+16+16+50	1,11	1,11	1,11	3,47	6,80(1,90-8,80)	4,50	8,00 A++	1,51(0,40-2,24)	755	6,80	1,39	1,39	4,33		8,50(3,00-10,60)	4,64	4,20 A+	1,83(0,65-2,55)	915	8,30						
16+16+16+60	1,01	1,01	1,01	3,77	6,80(1,90-8,80)	4,50	8,00 A++	1,51(0,40-2,24)	755	6,80	1,26	1,26	4,72		8,50(3,00-10,60)	4,64	4,20 A+	1,83(0,65-2,55)	915	8,30						
16+16+20+20	1,51	1,51	1,89	1,89	6,80(1,90-8,80)	4,39	8,00 A++	1,55(0,34-2,43)	775	7,00	1,89	1,89	2,36	2,36	8,50(3,10-10,60)	4,50	4,20 A+	1,89(0,60-2,67)	945	8,50						
16+16+20+25	1,41	1,41	1,77	2,21	6,80(1,90-8,80)	4,39	8,00 A++	1,55(0,34-2,43)	775	7,00	1,77	1,77	2,20	2,76	8,50(3,10-10,60)	4,50	4,20 A+	1,89(0,60-2,67)	945	8,50						
16+16+20+35	1,25	1,25	1,56	2,74	6,80(1,90-8,80)	4,50	8,00 A++	1,51(0,40-2,38)	755	6,80	1,56	1,56	1,95	3,43	8,50(3,00-10,60)	4,55	4,20 A+	1,87(0,58-2,65)	935	8,50						
16+16+20+42	1,16	1,16	1,44	3,04	6,80(1,90-8,80)	4,50	8,00 A++	1,51(0,37-2,38)	755	6,80	1,45	1,45	1,80	3,80	8,50(3,00-10,60)	4,57	4,20 A+	1,86(0,60-2,64)	930	8,40						
16+16+20+50	1,07	1,07	1,33	3,33	6,80(1,90-8,80)	4,50	8,00 A++	1,51(0,40-2,20)	755	6,80	1,33	1,33	1,67	4,17	8,50(3,00-10,60)	4,64	4,20 A+	1,83(0,66-2,54)	915	8,30						
16+16+20+60	0,97	0,97	1,21	3,65	6,80(1,90-8,80)	4,50	8,00 A++	1,51(0,40-2,20)	755	6,80	1,21	1,21	1,52	4,56	8,50(3,00-10,60)	4,64	4,20 A+	1,83(0,66-2,54)	915	8,30						
16+16+25+25	1,33	1,33	2,07	2,07	6,80(1,90-8,80)	4,39	8,00 A++	1,55(0,34-2,43)	775	7,00	1,66	1,66	2,59	2,59	8,50(3,10-10,60)	4,50	4,20 A+	1,89(0,60-2,67)	945	8,50						
16+16+25+35	1,18	1,18	1,85	2,59	6,80(1,90-8,80)	4,50	8,00 A++	1,51(0,34-2,38)	755	6,80	1,48	1,48	2,31	3,23	8,50(3,00-10,60)	4,55	4,20 A+	1,87(0,58-2,65)	935	8,50						
16+16+25+42	1,10	1,10	1,72	2,88	6,80(1,90-8,80)	4,50	8,00 A++	1,51(0,37-2,38)	755	6,80	1,37	1,37	2,15	3,61	8,50(3,00-10,60)	4,57	4,20 A+	1,86(0,60-2,64)	930	8,40						
16+16+25+50	1,02	1,02	1,58	3,18	6,80(1,90-8,80)	4,50	8,00 A++	1,51(0,40-2,20)	755	6,80	1,27	1,27	1,99	3,97	8,50(3,00-10,60)	4,64	4,20 A+	1,83(0,66-2,54)	915	8,30						
16+16+35+35	1,07	1,07	2,33	2,33	6,80(1,90-8,80)	4,50	8,00 A++	1,51(0,37-2,33)	755	6,80	1,33	1,33	2,92	2,92	8,50(3,00-10,60)	4,59	4,20 A+	1,85(0,61-2,62)	925	8,40						
16+16+35+42	1,00																									

Free Multi R32 combinations table

Free Multi 4x1 CU-4Z80TBE. Minimum capacity connected: 4,5 kW. Maximum capacity connected: 14,7 kW - R32

Indoor unit capacity	Cooling capacity (kW). Rooms				EER	SEER ¹⁾	Input power rating			A.E.C.	Current			Heating capacity (kW). Rooms				COP	SCOP ¹⁾	Input power rating			A.E.C.	Current		
	A	B	C	D			Total (Min - Max)	W/W	kW			230V			A	B	C			D	Total (Min - Max)	W/W		kW		
16+50+50	1,10	3,45	3,45		8,00(3,00-8,80)	4,17	7,40 A++	1,92(0,57-2,58)	960	9,20	1,30	4,05	4,05	9,40(3,20-10,60)	4,70	4,40 A+	2,00(0,57-2,93)	1000	9,40							
16+50+60	1,02	3,17	3,81		8,00(3,00-9,00)	4,17	7,40 A++	1,92(0,57-2,65)	960	9,20	1,19	3,73	4,48	9,40(3,20-10,60)	4,70	4,40 A+	2,00(0,57-2,93)	1000	9,40							
16+50+71	0,93	2,92	4,15		8,00(3,00-9,00)	4,17	7,40 A++	1,92(0,57-2,65)	960	9,20	1,10	3,43	4,87	9,40(3,20-10,60)	4,72	4,40 A+	1,99(0,59-2,92)	995	9,40							
16+60+60	0,94	3,53	3,53		8,00(3,00-9,00)	4,17	7,40 A++	1,92(0,57-2,65)	960	9,20	1,10	4,15	4,15	9,40(3,20-10,60)	4,70	4,40 A+	2,00(0,57-2,93)	1000	9,40							
16+60+71	0,87	3,27	3,86		8,00(3,00-9,00)	4,17	7,40 A++	1,92(0,57-2,65)	960	9,20	1,02	3,84	4,54	9,40(3,20-10,60)	4,72	4,40 A+	1,99(0,59-2,92)	995	9,40							
20+20+20	2,00	2,00	2,00		6,00(3,00-8,50)	4,00	7,40 A++	1,50(0,48-3,03)	750	7,30	3,13	3,13	3,13	9,39(3,20-10,60)	4,15	4,30 A+	2,26(0,49-3,24)	1130	10,60							
20+20+25	2,00	2,00	2,50		6,50(3,00-8,50)	3,76	7,40 A++	1,73(0,48-3,03)	865	8,40	2,89	2,89	3,62	9,40(3,20-10,60)	4,16	4,30 A+	2,26(0,49-3,24)	1130	10,60							
20+20+35	2,00	2,00	3,50		7,50(3,00-8,50)	3,64	7,40 A++	2,06(0,48-2,95)	1030	9,90	2,51	2,51	4,38	9,40(3,20-10,60)	4,22	4,30 A+	2,23(0,49-3,20)	1115	10,50							
20+20+42	1,95	1,95	4,10		8,00(3,00-8,60)	3,49	7,40 A++	2,29(0,48-3,03)	1145	11,00	2,29	2,29	4,82	9,40(3,20-10,60)	4,23	4,40 A+	2,22(0,48-3,19)	1110	10,40							
20+20+50	1,78	1,78	4,44		8,00(3,00-8,60)	3,92	7,40 A++	2,04(0,52-2,65)	1020	9,80	2,09	2,09	5,22	9,40(3,20-10,50)	4,45	4,40 A+	2,11(0,51-3,03)	1055	9,90							
20+20+60	1,60	1,60	4,80		8,00(3,00-8,80)	3,92	7,40 A++	2,04(0,52-2,80)	1020	9,80	1,88	1,88	5,64	9,40(3,20-10,50)	4,45	4,40 A+	2,11(0,51-3,03)	1055	9,90							
20+20+71	1,44	1,44	5,12		8,00(3,00-8,80)	3,92	7,40 A++	2,04(0,52-2,72)	1020	9,80	1,69	1,69	6,02	9,40(3,20-10,60)	4,48	4,40 A+	2,10(0,51-3,08)	1050	9,90							
20+25+25	2,00	2,50	2,50		8,00(3,00-8,50)	3,70	7,40 A++	1,98(0,48-3,03)	945	9,00	2,68	3,36	3,36	9,40(3,20-10,60)	4,16	4,30 A+	2,26(0,49-3,24)	1130	10,60							
20+25+35	2,00	2,50	3,50		8,00(3,00-8,60)	3,49	7,40 A++	2,29(0,48-3,03)	1145	11,00	2,35	2,94	4,11	9,40(3,20-10,60)	4,22	4,40 A+	2,23(0,49-3,20)	1115	10,50							
20+25+42	1,84	2,30	3,86		8,00(3,00-8,60)	3,49	7,40 A++	2,29(0,48-3,03)	1145	11,00	2,16	2,70	4,54	9,40(3,20-10,50)	4,23	4,40 A+	2,22(0,48-3,25)	1110	10,40							
20+25+50	1,68	2,11	4,21		8,00(3,00-8,60)	3,92	7,40 A++	2,04(0,52-2,65)	1020	9,80	1,98	2,47	4,95	9,40(3,20-10,50)	4,45	4,40 A+	2,11(0,51-3,03)	1055	9,90							
20+25+60	1,52	1,90	4,58		8,00(3,00-8,80)	3,92	7,40 A++	2,04(0,52-2,80)	1020	9,80	1,79	2,24	5,37	9,40(3,20-10,50)	4,45	4,40 A+	2,11(0,51-3,03)	1055	9,90							
20+25+71	1,38	1,72	4,90		8,00(3,00-8,80)	3,92	7,40 A++	2,04(0,52-2,72)	1020	9,80	1,62	2,03	5,75	9,40(3,20-10,60)	4,48	4,40 A+	2,10(0,51-3,08)	1050	9,90							
20+35+35	1,78	3,11	3,11		8,00(3,00-8,60)	3,59	7,40 A++	2,23(0,48-2,95)	1115	10,70	2,08	3,66	3,66	9,40(3,20-10,50)	4,27	4,40 A+	2,20(0,48-3,16)	1100	10,30							
20+35+42	1,65	2,89	3,46		8,00(3,00-8,60)	3,59	7,40 A++	2,23(0,48-2,95)	1115	10,70	1,94	3,39	4,07	9,40(3,20-10,50)	4,29	4,40 A+	2,19(0,48-3,15)	1095	10,30							
20+35+50	1,52	2,67	3,81		8,00(3,00-8,80)	3,92	7,40 A++	2,04(0,52-2,80)	1020	9,80	1,79	3,13	4,48	9,40(3,20-10,50)	4,50	4,40 A+	2,09(0,51-3,00)	1045	9,80							
20+35+60	1,39	2,43	4,18		8,00(3,00-8,80)	3,92	7,40 A++	2,04(0,52-2,80)	1020	9,80	1,63	2,86	4,91	9,40(3,20-10,60)	4,50	4,40 A+	2,09(0,51-3,06)	1045	9,80							
20+35+71	1,27	2,22	4,04		8,00(3,00-9,00)	4,04	7,40 A++	1,98(0,52-2,80)	990	9,50	1,49	2,61	5,30	9,40(3,20-10,60)	4,54	4,40 A+	2,07(0,51-3,04)	1035	9,70							
20+42+42	1,54	3,23	3,23		8,00(3,00-8,80)	3,59	7,40 A++	2,23(0,48-3,03)	1115	10,70	1,80	3,80	3,80	9,40(3,20-10,50)	4,31	4,40 A+	2,18(0,48-3,14)	1090	10,20							
20+42+50	1,43	3,00	3,57		8,00(3,00-8,80)	3,92	7,40 A++	2,04(0,52-2,72)	1020	9,80	1,68	3,53	4,19	9,40(3,20-10,60)	4,52	4,40 A+	2,08(0,51-3,05)	1040	9,80							
20+42+60	1,31	2,75	3,94		8,00(3,00-9,00)	3,92	7,40 A++	2,04(0,52-2,87)	1020	9,80	1,54	3,24	4,62	9,40(3,20-10,60)	4,52	4,40 A+	2,08(0,51-3,05)	1040	9,80							
20+42+71	1,20	2,53	4,27		8,00(3,00-8,60)	4,04	7,40 A++	2,04(0,52-2,80)	990	9,50	1,41	2,97	5,02	9,40(3,20-10,60)	4,54	4,40 A+	2,07(0,52-3,03)	1035	9,70							
20+50+50	1,33	3,33	3,33		7,99(3,00-9,00)	4,16	7,40 A++	1,92(0,57-2,65)	960	9,20	1,56	3,92	3,92	9,40(3,20-10,60)	4,72	4,40 A+	1,99(0,59-2,92)	995	9,40							
20+50+60	1,23	3,08	3,69		8,00(3,00-9,00)	4,17	7,40 A++	1,92(0,57-2,65)	960	9,20	1,45	3,62	4,33	9,40(3,20-10,60)	4,72	4,40 A+	1,99(0,59-2,92)	995	9,40							
20+50+71	1,13	2,84	4,03		8,00(3,00-9,00)	4,17	7,40 A++	1,92(0,57-2,65)	960	9,20	1,33	3,33	4,74	9,40(3,20-10,60)	4,75	4,40 A+	1,98(0,60-2,91)	990	9,30							
20+60+60	1,14	3,43	3,43		8,00(3,00-9,00)	4,17	7,40 A++	1,92(0,57-2,65)	960	9,20	1,34	4,03	4,03	9,40(3,20-10,60)	4,72	4,40 A+	1,99(0,59-2,92)	995	9,40							
25+25+25	2,50	2,50	2,50		7,50(3,00-8,50)	3,52	7,40 A++	2,13(0,48-3,03)	1065	10,20	3,13	3,13	3,13	9,39(3,20-10,60)	4,15	4,30 A+	2,26(0,49-3,24)	1130	10,60							
25+25+35	2,35	2,35	3,30		8,00(3,00-8,60)	3,49	7,40 A++	2,29(0,48-3,03)	1145	11,00	2,76	2,76	3,88	9,40(3,20-10,60)	4,22	4,40 A+	2,23(0,49-3,20)	1115	10,50							
25+25+42	2,17	2,17	3,66		8,00(3,00-8,60)	3,49	7,40 A++	2,29(0,48-3,03)	1145	11,00	2,55	2,55	4,30	9,40(3,20-10,50)	4,23	4,40 A+	2,22(0,48-3,25)	1110	10,40							
25+25+50	2,00	2,00	4,00		8,00(3,00-8,80)	3,92	7,40 A++	2,04(0,52-2,80)	1020	9,80	2,35	2,35	4,70	9,40(3,20-10,50)	4,45	4,40 A+	2,11(0,51-3,03)	1055	9,90							
25+25+60	1,82	1,82	4,36		8,00(3,00-8,80)	3,92	7,40 A++	2,04(0,52-2,80)	1020	9,80	2,14	2,14	5,12	9,40(3,20-10,50)	4,45	4,40 A+	2,11(0,51-3,03)	1055	9,90							
25+25+71	1,65	1,65	4,70		8,00(3,00-9,00)	3,92	7,40 A++	2,04(0,52-2,87)	1020	9,80	1,94	1,94	5,52	9,40(3,20-10,60)	4,48	4,40 A+	2,10(0,51-3,08)	1050	9,90							
25+35+35	2,10	2,95	2,95		8,00(3,00-8,60)	3,59	7,40 A++	2,23(0,48-2,95)	1115	10,70	2,48	3,46	3,46	9,40(3,20-10,50)	4,27	4,40 A+	2,20(0,48-3,16)	1100	10,30							
25+35+42	1,96	2,75	3,29		8,00(3,00-8,80)	3,59	7,40 A++	2,23(0,48-3,10)	1115	10,70	2,30	3,23	3,87	9,40(3,20-10,50)	4,29	4,40 A+	2,19(0,48-3,15)	1095	10,30							
25+35+50	1,82	2,55	3,63		8,00(3,00-8,80)	3,92	7,40 A++	2,04(0,52-2,80)	1020	9,80	2,14	2,99	4,27	9,40(3,20-10,50)	4,50	4,40 A+	2,09(0,51-3,00)	1045	9,80							
25+35+60	1,67	2,33	4,00		8,00(3,00-9,00)	3,92	7,40 A++	2,04(0,52-2,87)	1020	9,80	1,96	2,74	4,70	9,40(3,20-10,60)	4,50	4,40 A+	2,09(0,51-3,06)	1045	9,80							
25+35+71	1,53	2,14	4,33		8,00(3,00-9,00)	4,04	7,40 A++	1,98(0,52-2,80)	990	9,50	1,79	2,51	5,10	9,40(3,20-10,60)	4,54	4,40 A+	2,07(0,51-3,04)	1035	9,70							
25+42+42	1,84	3,08	3,08		8,00(3,00-8,80)	3,59	7,40 A++	2,23(0,48-3,03)	1115	10,70	2,16	3,62	3,62	9,40(3,20-10,50)	4,31	4,40 A+	2,18(0,48-3,14)	1090	10,20							
25+42+50	1,71	2,87	3,42		8,00(3,00-8,80)	3,92	7,40 A++	2,04(0,52-2,72)	1020	9,80	2,01	3,37	4,02	9,40(3,20-10,60)	4,52	4,40 A+	2,08(0,51-3,05)	1040	9,80							
25+42+60	1,57	2,65	3,78		8,00(3,00-9,00)	3,92	7,40 A++	2,04(0,52-2,87)	1020	9,80	1,85	3,11	4,44	9,40(3,20-10,60)	4,52	4,40 A+	2,08(0,51-3,05)	1040	9,80							
25+42+71	1,45	2,43	4,12		8,00(3,00-9,00)	4,04	7,40 A++	1,98(0,52-2,80)	990	9,50	1,70	2,86	4,84	9,40(3,20-10,60)	4,54	4,40 A+	2,07(0,52-3,03)	1035	9,70							
25+50+50	1,60	3,20	3,20		8,00(3,00-9,00)	4,17	7,40 A++	1,92(0,57-2,65)	960	9,20	1,88	3,76	3,76	9,40(3,20-10,60)	4,72	4,40 A+	1,99(0,59-2,92)	995	9,40							
25+50+60	1,48	2,96	3,56		8,00(3,00-9,00)	4,17	7,40 A++	1,92(0,57-2,65)	960	9,20	1,74	3,48	4,18	9,40(3,20-10,60)	4,72	4,40 A+	1,99(0,59-2,92)	995	9,40							
25+50+71	1,37	2,74	3,89		8,00(3,00-9,00)	4,17	7,40 A++	1,92(0,57-2,65)	960	9,20	1,61	3,22	4,57	9,40(3,20-10,60)	4,75	4,40 A+	1,98(0,60-2,91)	990	9,30							
25+60+60	1,38	3,31	3,31		8,00(3,00-9,00)	4,17	7,40 A++	1,92(0,57-2,65)	960	9,20	1,62	3,89	3,89	9,40(3,20-10,60)	4,72	4,40 A+	1,99(0,59-2,92)	995	9,40							
35+35+35	2,66																									



Configure in a few steps your multi split system with our online tool.

Free Multi 4x1 CU-4Z80TBE. Minimum capacity connected: 4,5 kW. Maximum capacity connected: 14,7 kW · R32

Indoor unit capacity	Cooling capacity (kW). Rooms					EER	SEER ¹⁾	Input power rating	A.E.C.	Current	Heating capacity (kW). Rooms					COP	SCOP ¹⁾	Input power rating	A.E.C.	Current
	A	B	C	D	Total (Min - Max)						W/W	kW	kWh	230V	A					
16+16+20+50	1,25	1,25	1,57	3,93	8,00(3,00-9,20)	4,28	7,90 A++	1,87(0,62-2,65)	935	9,00	1,47	1,47	1,84	4,62	9,40(4,20-10,60)	4,72	4,70 A++	1,99(0,77-2,85)	995	9,40
16+16+20+60	1,14	1,14	1,43	4,29	8,00(3,00-9,20)	4,28	7,90 A++	1,87(0,62-2,65)	935	9,00	1,34	1,34	1,68	5,04	9,40(4,20-10,60)	4,72	4,70 A++	1,99(0,77-2,85)	995	9,40
16+16+20+71	1,04	1,04	1,30	4,62	8,00(3,00-9,20)	4,28	7,90 A++	1,87(0,62-2,66)	935	9,00	1,22	1,22	1,53	5,43	9,40(4,20-10,60)	4,75	4,70 A++	1,98(0,79-2,90)	990	9,30
16+16+25+25	1,56	1,56	2,44	2,44	8,00(3,00-9,20)	4,04	7,90 A++	1,98(0,53-2,87)	990	9,50	1,83	1,83	2,87	2,87	9,40(4,20-10,60)	4,59	4,70 A++	2,05(0,68-3,01)	1025	9,60
16+16+25+35	1,39	1,39	2,17	3,05	8,00(3,00-9,20)	4,17	7,90 A++	1,92(0,53-2,87)	960	9,20	1,63	1,63	2,55	3,59	9,40(4,20-10,60)	4,63	4,70 A++	2,03(0,69-2,98)	1015	9,50
16+16+25+42	1,29	1,29	2,02	3,40	8,00(3,00-9,20)	4,17	7,90 A++	1,92(0,56-2,87)	960	9,20	1,52	1,52	2,37	3,99	9,40(4,20-10,60)	4,65	4,70 A++	2,02(0,71-2,97)	1010	9,50
16+16+25+50	1,20	1,20	1,87	3,73	8,00(3,00-9,20)	4,28	7,90 A++	1,87(0,62-2,65)	935	9,00	1,41	1,41	2,20	4,38	9,40(4,20-10,60)	4,72	4,70 A++	1,99(0,77-2,85)	995	9,40
16+16+25+60	1,09	1,09	1,71	4,11	8,00(3,00-9,20)	4,28	7,90 A++	1,87(0,62-2,65)	935	9,00	1,29	1,29	2,01	4,81	9,40(4,20-10,60)	4,72	4,70 A++	1,99(0,77-2,85)	995	9,40
16+16+25+71	1,00	1,00	1,56	4,44	8,00(3,00-9,20)	4,28	7,90 A++	1,87(0,62-2,66)	935	9,00	1,18	1,18	1,84	5,20	9,40(4,20-10,60)	4,75	4,70 A++	1,98(0,79-2,90)	990	9,30
16+16+35+35	1,25	1,25	2,75	2,75	8,00(3,00-9,20)	4,17	7,90 A++	1,92(0,57-2,80)	960	9,20	1,47	1,47	3,23	3,23	9,40(4,20-10,60)	4,68	4,70 A++	2,01(0,72-2,95)	1005	9,40
16+16+35+42	1,17	1,17	2,57	3,09	8,00(3,00-9,20)	4,17	7,90 A++	1,92(0,57-2,80)	960	9,20	1,38	1,38	3,02	3,62	9,40(4,20-10,60)	4,70	4,70 A++	2,00(0,72-2,94)	1000	9,40
16+16+35+50	1,09	1,09	2,39	3,43	8,00(3,00-9,20)	4,28	7,90 A++	1,87(0,62-2,66)	935	9,00	1,29	1,29	2,81	4,01	9,40(4,20-10,60)	4,75	4,70 A++	1,98(0,80-2,89)	990	9,30
16+16+35+60	1,01	1,01	2,20	3,78	8,00(3,00-9,20)	4,28	7,90 A++	1,87(0,62-2,66)	935	9,00	1,18	1,18	2,59	4,45	9,40(4,20-10,60)	4,75	4,70 A++	1,98(0,80-2,89)	990	9,30
16+16+35+71	0,93	0,93	2,03	4,11	8,00(3,00-9,20)	4,28	7,90 A++	1,87(0,63-2,66)	935	9,00	1,09	1,09	2,38	4,84	9,40(4,20-10,60)	4,77	4,70 A++	1,97(0,80-2,87)	985	9,30
16+16+42+42	1,10	1,10	2,90	2,90	8,00(3,00-9,20)	4,17	7,90 A++	1,92(0,57-2,80)	960	9,20	1,30	1,30	3,40	3,40	9,40(4,20-10,60)	4,70	4,70 A++	2,00(0,72-2,93)	1000	9,40
16+16+42+50	1,03	1,03	2,71	3,23	8,00(3,00-9,20)	4,28	7,90 A++	1,87(0,62-2,66)	960	9,00	1,21	1,21	3,18	3,80	9,40(4,20-10,60)	4,77	4,70 A++	1,97(0,80-2,88)	985	9,30
16+16+42+60	0,96	0,96	2,51	3,57	8,00(3,00-9,20)	4,28	7,90 A++	1,87(0,62-2,66)	935	9,00	1,12	1,12	2,95	4,21	9,40(4,20-10,60)	4,77	4,70 A++	1,97(0,80-2,88)	985	9,30
16+16+42+71	0,88	0,88	2,32	3,92	8,00(3,00-9,20)	4,28	7,90 A++	1,87(0,63-2,66)	935	9,00	1,04	1,04	2,72	4,60	9,40(4,20-10,60)	4,77	4,70 A++	1,97(0,81-2,87)	985	9,30
16+16+50+50	0,97	0,97	3,03	3,03	8,00(3,00-9,20)	4,26	7,90 A++	1,88(0,69-2,60)	940	9,00	1,14	1,14	3,56	3,56	9,40(4,20-10,60)	4,68	4,70 A++	2,01(0,92-2,85)	1005	9,40
16+16+50+60	0,90	0,90	2,82	3,38	8,00(3,00-9,20)	4,26	7,90 A++	1,88(0,69-2,60)	940	9,00	1,06	1,06	3,31	3,97	9,40(4,20-10,60)	4,68	4,70 A++	2,01(0,92-2,85)	1005	9,40
16+20+20+20	1,60	2,00	2,00	2,00	7,60(3,00-9,20)	4,06	7,90 A++	1,87(0,53-2,87)	935	9,00	1,99	2,47	2,47	2,47	9,40(4,20-10,60)	4,61	4,60 A++	2,04(0,69-3,00)	1020	9,60
16+20+20+25	1,58	1,98	1,98	2,46	8,00(3,00-9,20)	4,04	7,90 A++	1,98(0,53-2,87)	990	9,50	1,86	2,32	2,32	2,90	9,40(4,20-10,60)	4,61	4,70 A++	2,04(0,69-3,00)	1020	9,60
16+20+20+35	1,41	1,76	1,76	3,07	8,00(3,00-9,20)	4,17	7,90 A++	1,92(0,57-2,80)	960	9,20	1,65	2,07	2,07	3,61	9,40(4,20-10,60)	4,65	4,70 A++	2,02(0,71-2,97)	1010	9,50
16+20+20+42	1,31	1,63	1,63	3,43	8,00(3,00-9,20)	4,17	7,90 A++	1,92(0,57-2,80)	960	9,20	1,53	1,92	1,92	4,03	9,40(4,20-10,60)	4,68	4,70 A++	2,01(0,71-2,96)	1005	9,40
16+20+20+50	1,21	1,51	1,51	3,77	8,00(3,00-9,20)	4,28	7,90 A++	1,87(0,62-2,65)	935	9,00	1,42	1,77	1,77	4,44	9,40(4,20-10,60)	4,72	4,70 A++	1,99(0,79-2,90)	995	9,40
16+20+20+60	1,10	1,38	1,38	4,14	8,00(3,00-9,20)	4,28	7,90 A++	1,87(0,62-2,65)	935	9,00	1,30	1,62	1,62	4,86	9,40(4,20-10,60)	4,72	4,70 A++	1,99(0,79-2,90)	995	9,40
16+20+20+71	1,01	1,26	1,26	4,47	8,00(3,00-9,20)	4,28	7,90 A++	1,87(0,63-2,66)	935	9,00	1,18	1,48	1,48	5,26	9,40(4,20-10,60)	4,75	4,70 A++	1,98(0,80-2,89)	990	9,30
16+20+25+25	1,48	1,86	2,33	2,33	8,00(3,00-9,20)	4,04	7,90 A++	1,98(0,53-2,87)	990	9,50	1,75	2,19	2,73	2,73	9,40(4,20-10,60)	4,61	4,70 A++	2,04(0,69-3,00)	1020	9,60
16+20+25+35	1,33	1,67	2,08	2,92	8,00(3,00-9,20)	4,17	7,90 A++	1,92(0,57-2,80)	960	9,20	1,57	1,96	2,45	3,42	9,40(4,20-10,60)	4,65	4,70 A++	2,02(0,71-2,97)	1010	9,50
16+20+25+42	1,24	1,55	1,94	3,27	8,00(3,00-9,20)	4,17	7,90 A++	1,92(0,57-2,80)	960	9,20	1,46	1,83	2,28	3,83	9,40(4,20-10,60)	4,68	4,70 A++	2,01(0,71-2,96)	1005	9,40
16+20+25+50	1,15	1,44	1,80	3,61	8,00(3,00-9,20)	4,28	7,90 A++	1,87(0,62-2,65)	935	9,00	1,35	1,69	2,12	4,24	9,40(4,20-10,60)	4,72	4,70 A++	1,99(0,79-2,90)	995	9,40
16+20+25+60	1,06	1,32	1,65	4,30	8,00(3,00-9,20)	4,28	7,90 A++	1,87(0,62-2,65)	935	9,00	1,24	1,55	1,94	4,67	9,40(4,20-10,60)	4,72	4,70 A++	1,99(0,79-2,90)	995	9,40
16+20+25+71	0,97	1,21	1,52	4,30	8,00(3,00-9,20)	4,28	7,90 A++	1,87(0,63-2,66)	935	9,00	1,14	1,42	1,78	5,06	9,40(4,20-10,60)	4,75	4,70 A++	1,98(0,80-2,89)	990	9,30
16+20+35+35	1,21	1,51	2,64	2,64	8,00(3,00-9,20)	4,17	7,90 A++	1,92(0,57-2,80)	960	9,20	1,42	1,78	3,10	3,10	9,40(4,20-10,60)	4,70	4,70 A++	2,00(0,72-2,94)	1000	9,40
16+20+35+42	1,13	1,42	2,48	2,97	8,00(3,00-9,20)	4,17	7,90 A++	1,92(0,57-2,80)	960	9,20	1,33	1,66	2,91	3,50	9,40(4,20-10,60)	4,70	4,70 A++	2,00(0,72-2,93)	1000	9,40
16+20+35+50	1,06	1,32	2,14	3,31	8,00(3,00-9,20)	4,28	7,90 A++	1,87(0,63-2,66)	935	9,00	1,24	1,55	2,72	3,89	9,40(4,20-10,60)	4,77	4,70 A++	1,97(0,80-2,88)	985	9,30
16+20+35+60	0,98	1,22	2,16	3,66	8,00(3,00-9,20)	4,28	7,90 A++	1,87(0,63-2,66)	935	9,00	1,15	1,44	2,51	4,30	9,40(4,20-10,60)	4,77	4,70 A++	1,97(0,80-2,88)	985	9,30
16+20+35+71	0,90	1,13	1,97	4,00	8,00(3,00-9,20)	4,28	7,90 A++	1,87(0,63-2,66)	935	9,00	1,06	1,32	2,32	4,70	9,40(4,20-10,60)	4,77	4,70 A++	1,97(0,81-2,87)	985	9,30
16+20+42+42	1,07	1,33	2,80	2,80	8,00(3,00-9,20)	4,17	7,90 A++	1,92(0,57-2,80)	960	9,20	1,25	1,57	3,29	3,29	9,40(4,20-10,60)	4,72	4,70 A++	1,99(0,72-2,92)	995	9,40
16+20+42+50	1,00	1,25	2,63	3,12	8,00(3,00-9,20)	4,28	7,90 A++	1,87(0,63-2,66)	960	9,00	1,18	1,47	3,08	3,67	9,40(4,20-10,60)	4,77	4,70 A++	1,97(0,81-2,87)	985	9,30
16+20+42+60	0,93	1,16	2,43	3,48	8,00(3,00-9,20)	4,28	7,90 A++	1,87(0,63-2,66)	935	9,00	1,09	1,36	2,86	4,09	9,40(4,20-10,60)	4,77	4,70 A++	1,97(0,81-2,87)	985	9,30
16+20+50+50	0,94	1,18	2,94	2,94	8,00(3,00-9,20)	4,23	7,90 A++	1,89(0,69-2,60)	945	9,00	1,10	1,38	3,46	3,46	9,40(4,20-10,60)	4,68	4,70 A++	2,01(0,93-2,90)	1005	9,40
16+20+50+60	0,88	1,10	2,74	3,28	8,00(3,00-9,20)	4,23	7,90 A++	1,89(0,69-2,60)	945	9,00	1,03	1,29	3,22	3,86	9,40(4,20-10,60)	4,68	4,70 A++	2,01(0,93-2,90)	1005	9,40
16+25+25+25	1,40	2,20	2,20	2,20	8,00(3,00-9,20)	4,04	7,90 A++	1,98(0,53-2,87)	990	9,50	1,66	2,58	2,58	2,58	9,40(4,20-10,60)	4,61	4,70 A++	2,04(0,69-3,00)	1020	9,60
16+25+25+35	1,27	1,98	1,98	2,77	8,00(3,00-9,20)	4,17	7,90 A++	1,92(0,57-2,80)	960	9,20	1,49	2,33	2,33	3,25	9,40(4,20-10,60)	4,65	4,70 A++	2,02(0,71-2,97)	1010	9,50
16+25+25+42	1,19	1,85	1,85	3,11	8,00(3,00-9,20)	4,17	7,90 A++	1,92(0,57-2,80)	960	9,20	1,39	2,18	2,18	3,65	9,40(4,20-10,60)	4,68	4,70 A++	2,01(0,71-2,96)	1005	9,40
16+25+25+50	1,10	1,72	1,72	3,46	8,00(3,00-9,20)	4,28	7,90 A++	1,87(0,62-2,65)	935	9,00	1,30	2,03	2,03	4,04	9,40(4,20-10,60)	4,72	4,70 A++	1,99(0,79-2,90)	995	9,40
16+25+25+60	1,02	1,59	1,59	3,80	8,00(3,00-9,20)	4,28	7,90 A++	1,87(0,62-2,65)	935	9,00	1,19	1,87	1							



Free Multi R32 combinations table

Free Multi 4x1 CU-4Z80TBE. Minimum capacity connected: 4,5 kW. Maximum capacity connected: 14,7 kW - R32

Indoor unit capacity	Cooling capacity (kW). Rooms						EER	SEER ¹⁾	Input power rating			A.E.C.	Current	Heating capacity (kW). Rooms						COP	SCOP ¹⁾	Input power rating			A.E.C.	Current						
	A	B	C	D	Total (Min - Max)	W/W			kW					kWh			A	B	C			D	Total (Min - Max)	W/W			kW			kWh		
									230V					230V									230V									
20+20+25+71	1,18	1,18	1,47	4,17	8,00(3,00-9,20)	4,28	7,90 A++	1,87(0,63-2,66)	935	9,00	1,38	1,38	1,73	4,91	9,40(4,20-10,60)	4,77	4,70 A++	1,97(0,80-2,88)	985	9,30												
20+20+35+35	1,45	1,45	2,55	2,55	8,00(3,00-9,20)	4,17	7,90 A++	1,92(0,57-2,80)	960	9,20	1,71	1,71	2,99	2,99	9,40(4,20-10,60)	4,70	4,70 A++	2,00(0,72-2,93)	1000	9,40												
20+20+35+42	1,37	1,37	2,39	2,87	8,00(3,00-9,20)	4,17	7,90 A++	1,92(0,57-2,80)	960	9,20	1,61	1,61	2,81	3,37	9,40(4,20-10,60)	4,72	4,70 A++	1,99(0,72-2,92)	995	9,40												
20+20+35+50	1,28	1,28	2,24	3,20	8,00(3,00-9,20)	4,28	7,90 A++	1,87(0,63-2,66)	935	9,00	1,50	1,50	2,63	3,77	9,40(4,20-10,60)	4,77	4,70 A++	1,97(0,81-2,87)	985	9,30												
20+20+35+60	1,19	1,19	2,07	3,55	8,00(3,00-9,20)	4,28	7,90 A++	1,87(0,63-2,66)	935	9,00	1,39	1,39	2,44	4,18	9,40(4,20-10,60)	4,77	4,70 A++	1,97(0,81-2,87)	985	9,30												
20+20+35+71	1,10	1,10	1,92	3,88	8,00(3,00-9,20)	4,28	7,90 A++	1,87(0,63-2,66)	935	9,00	1,29	1,29	2,25	4,57	9,40(4,20-10,60)	4,70	4,70 A++	2,00(0,83-2,86)	1000	9,40												
20+20+42+42	1,29	1,29	2,71	2,71	8,00(3,00-9,20)	4,17	7,90 A++	1,92(0,57-2,80)	960	9,20	1,52	1,52	3,18	3,18	9,40(4,20-10,60)	4,75	4,70 A++	1,98(0,72-2,91)	990	9,30												
20+20+42+50	1,21	1,21	2,55	3,03	8,00(3,00-9,20)	4,28	7,90 A++	1,87(0,63-2,66)	935	9,00	1,42	1,42	2,99	3,57	9,40(4,20-10,60)	4,70	4,70 A++	2,00(0,81-2,86)	1000	9,40												
20+20+42+60	1,13	1,13	2,37	3,37	8,00(3,00-9,20)	4,28	7,90 A++	1,87(0,63-2,66)	935	9,00	1,32	1,32	2,78	3,98	9,40(4,20-10,60)	4,70	4,70 A++	2,00(0,81-2,86)	1000	9,40												
20+20+50+50	1,14	1,14	2,86	2,86	8,00(3,00-9,20)	4,23	7,90 A++	1,89(0,70-2,60)	945	9,00	1,34	1,34	3,36	3,36	9,40(4,20-10,60)	4,68	4,70 A++	2,01(0,94-2,89)	1005	9,40												
20+25+25+25	1,67	2,11	2,11	2,11	8,00(3,00-9,20)	4,04	7,90 A++	1,98(0,53-2,87)	990	9,50	1,99	2,47	2,47	2,47	9,40(4,20-10,60)	4,63	4,70 A++	2,03(0,69-2,99)	1015	9,50												
20+25+25+35	1,52	1,90	1,90	2,68	8,00(3,00-9,20)	4,17	7,90 A++	1,92(0,57-2,80)	960	9,20	1,79	2,24	2,24	3,13	9,40(4,20-10,60)	4,68	4,70 A++	2,01(0,71-2,96)	1005	9,40												
20+25+25+42	1,43	1,79	1,79	2,99	8,00(3,00-9,20)	4,17	7,90 A++	1,92(0,57-2,80)	960	9,20	1,68	2,10	2,10	3,52	9,40(4,20-10,60)	4,68	4,70 A++	2,01(0,72-2,95)	1005	9,40												
20+25+25+50	1,33	1,67	1,67	3,33	8,00(3,00-9,20)	4,28	7,90 A++	1,87(0,62-2,65)	935	9,00	1,57	1,96	1,96	3,91	9,40(4,20-10,60)	4,75	4,70 A++	1,98(0,80-2,89)	990	9,30												
20+25+25+60	1,23	1,54	1,54	3,69	8,00(3,00-9,20)	4,28	7,90 A++	1,87(0,62-2,65)	935	9,00	1,45	1,81	1,81	4,33	9,40(4,20-10,60)	4,75	4,70 A++	1,98(0,80-2,89)	990	9,30												
20+25+25+71	1,13	1,42	1,42	4,03	8,00(3,00-9,20)	4,28	7,90 A++	1,87(0,63-2,66)	935	9,00	1,33	1,67	1,67	4,73	9,40(4,20-10,60)	4,77	4,70 A++	1,97(0,80-2,88)	985	9,30												
20+25+35+35	1,39	1,75	2,43	2,43	8,00(3,00-9,20)	4,17	7,90 A++	1,92(0,57-2,80)	960	9,20	1,63	2,05	2,86	2,86	9,40(4,20-10,60)	4,70	4,70 A++	2,00(0,72-2,93)	1000	9,40												
20+25+35+42	1,31	1,64	2,30	2,75	8,00(3,00-9,20)	4,17	7,90 A++	1,92(0,57-2,80)	960	9,20	1,54	1,93	2,70	3,23	9,40(4,20-10,60)	4,72	4,70 A++	1,99(0,72-2,92)	995	9,40												
20+25+35+50	1,23	1,54	2,15	3,08	8,00(3,00-9,20)	4,28	7,90 A++	1,87(0,63-2,66)	935	9,00	1,45	1,81	2,53	3,61	9,40(4,20-10,60)	4,77	4,70 A++	1,97(0,81-2,87)	985	9,30												
20+25+35+60	1,14	1,43	2,00	3,43	8,00(3,00-9,20)	4,28	7,90 A++	1,87(0,63-2,66)	935	9,00	1,34	1,68	2,35	4,03	9,40(4,20-10,60)	4,77	4,70 A++	1,97(0,81-2,87)	985	9,30												
20+25+42+42	1,24	1,56	2,60	2,60	8,00(3,00-9,20)	4,17	7,90 A++	1,92(0,57-2,80)	960	9,20	1,46	1,82	3,06	3,06	9,40(4,20-10,60)	4,75	4,70 A++	1,98(0,72-2,91)	990	9,30												
20+25+42+50	1,17	1,46	2,45	2,92	8,00(3,00-9,20)	4,28	7,90 A++	1,87(0,63-2,66)	935	9,00	1,37	1,72	2,88	3,43	9,40(4,20-10,60)	4,70	4,70 A++	2,00(0,81-2,86)	1000	9,40												
20+25+42+60	1,09	1,36	2,29	3,26	8,00(3,00-9,20)	4,28	7,90 A++	1,87(0,63-2,66)	935	9,00	1,28	1,60	2,69	3,83	9,40(4,20-10,60)	4,70	4,70 A++	2,00(0,81-2,86)	1000	9,40												
20+25+50+50	1,10	1,38	2,76	2,76	8,00(3,00-9,20)	4,23	7,90 A++	1,89(0,70-2,60)	945	9,00	1,30	1,62	3,24	3,24	9,40(4,20-10,60)	4,68	4,70 A++	2,01(0,94-2,89)	1005	9,40												
20+35+35+35	1,28	2,24	2,24	2,24	8,00(3,00-9,20)	4,17	7,90 A++	1,92(0,57-2,72)	960	9,20	1,51	2,63	2,63	2,63	9,40(4,20-10,60)	4,75	4,70 A++	1,98(0,75-2,90)	990	9,30												
20+35+35+42	1,21	2,12	2,12	2,55	8,00(3,00-9,20)	4,17	7,90 A++	1,92(0,57-2,72)	960	9,20	1,42	2,49	2,49	3,00	9,40(4,20-10,60)	4,77	4,70 A++	1,97(0,75-2,89)	985	9,30												
20+35+35+50	1,14	2,00	2,00	2,86	8,00(3,00-9,20)	4,28	7,90 A++	1,87(0,63-2,66)	935	9,00	1,34	2,35	2,35	3,36	9,40(4,20-10,60)	4,70	4,70 A++	2,00(0,84-2,85)	1000	9,40												
20+35+42+42	1,15	2,01	2,42	2,42	8,00(3,00-9,20)	4,17	7,90 A++	1,92(0,57-2,72)	960	9,20	1,35	2,37	2,84	2,84	9,40(4,20-10,60)	4,77	4,70 A++	1,97(0,76-2,88)	985	9,30												
20+35+42+50	1,09	1,90	2,29	2,72	8,00(3,00-9,20)	4,28	7,90 A++	1,87(0,63-2,66)	935	9,00	1,28	2,24	2,69	3,19	9,40(4,20-10,60)	4,72	4,70 A++	1,99(0,85-2,84)	995	9,40												
20+42+42+42	1,10	2,30	2,30	2,30	8,00(3,00-9,20)	4,28	7,90 A++	1,87(0,58-2,72)	935	9,00	1,30	2,70	2,70	2,70	9,40(4,20-10,60)	4,70	4,70 A++	2,00(0,76-2,87)	1000	9,40												
25+25+25+25	2,00	2,00	2,00	2,00	8,00(3,00-9,20)	4,04	7,90 A++	1,98(0,53-2,87)	990	9,50	2,35	2,35	2,35	2,35	9,40(4,20-10,60)	4,63	4,70 A++	2,03(0,69-2,99)	1015	9,50												
25+25+25+35	1,82	1,82	1,82	2,54	8,00(3,00-9,20)	4,17	7,90 A++	1,92(0,57-2,80)	960	9,20	2,14	2,14	2,14	2,98	9,40(4,20-10,60)	4,68	4,70 A++	2,01(0,71-2,96)	1005	9,40												
25+25+25+42	1,71	1,71	1,71	2,87	8,00(3,00-9,20)	4,17	7,90 A++	1,92(0,57-2,80)	960	9,20	2,01	2,01	2,01	3,37	9,40(4,20-10,60)	4,68	4,70 A++	2,01(0,72-2,95)	1005	9,40												
25+25+25+50	1,60	1,60	1,60	3,20	8,00(3,00-9,20)	4,28	7,90 A++	1,87(0,62-2,65)	935	9,00	1,88	1,88	1,88	3,76	9,40(4,20-10,60)	4,75	4,70 A++	1,98(0,80-2,89)	990	9,30												
25+25+25+60	1,48	1,48	1,48	3,56	8,00(3,00-9,20)	4,28	7,90 A++	1,87(0,62-2,65)	935	9,00	1,74	1,74	1,74	4,18	9,40(4,20-10,60)	4,75	4,70 A++	1,98(0,80-2,89)	990	9,30												
25+25+25+71	1,37	1,37	1,37	3,89	8,00(3,00-9,20)	4,28	7,90 A++	1,87(0,63-2,66)	935	9,00	1,61	1,61	1,61	4,57	9,40(4,20-10,60)	4,77	4,70 A++	1,97(0,80-2,88)	985	9,30												
25+25+35+35	1,67	1,67	2,33	2,33	8,00(3,00-9,20)	4,17	7,90 A++	1,92(0,57-2,80)	960	9,20	1,96	1,96	2,74	2,74	9,40(4,20-10,60)	4,70	4,70 A++	2,00(0,72-2,93)	1000	9,40												
25+25+35+42	1,57	1,57	2,20	2,66	8,00(3,00-9,20)	4,17	7,90 A++	1,92(0,57-2,80)	960	9,20	1,85	1,85	2,59	3,11	9,40(4,20-10,60)	4,72	4,70 A++	1,99(0,72-2,92)	995	9,40												
25+25+35+50	1,48	1,48	2,07	2,97	8,00(3,00-9,20)	4,28	7,90 A++	1,87(0,63-2,66)	935	9,00	1,74	1,74	2,44	3,48	9,40(4,20-10,60)	4,77	4,70 A++	1,97(0,81-2,87)	985	9,30												
25+25+35+60	1,38	1,38	1,93	3,31	8,00(3,00-9,20)	4,28	7,90 A++	1,87(0,63-2,66)	935	9,00	1,62	1,62	2,27	3,89	9,40(4,20-10,60)	4,77	4,70 A++	1,97(0,81-2,87)	985	9,30												
25+25+42+42	1,49	1,49	2,51	2,51	8,00(3,00-9,20)	4,17	7,90 A++	1,92(0,57-2,80)	960	9,20	1,75	1,75	2,95	2,95	9,40(4,20-10,60)	4,75	4,70 A++	1,98(0,72-2,91)	990	9,30												
25+25+42+50	1,41	1,41	2,37	2,81	8,00(3,00-9,20)	4,28	7,90 A++	1,87(0,63-2,66)	935	9,00	1,65	1,65	2,78	3,32	9,40(4,20-10,60)	4,70	4,70 A++	2,00(0,81-2,86)	1000	9,40												
25+35+35+35	1,55	2,15	2,15	2,15	8,00(3,00-9,20)	4,17	7,90 A++	1,92(0,57-2,72)	960	9,20	1,81	2,53	2,53	2,53	9,40(4,20-10,60)	4,75	4,70 A++	1,98(0,75-2,90)	990	9,30												
25+35+35+42	1,46	2,04	2,04	2,46	8,00(3,00-9,20)	4,17	7,90 A++	1,92(0,57-2,72)	960	9,20	1,72	2,40	2,40	2,88	9,40(4,20-10,60)	4,77	4,70 A++	1,97(0,75-2,89)	985	9,30												
25+35+35+50	1,38	1,93	1,93	2,76	8,00(3,00-9,20)	4,28	7,90 A++	1,87(0,63-2,66)	935	9,00	1,62	2,27	2,27	3,24	9,40(4,20-10,60)	4,70	4,70 A++	2,00(0,84-2,85)	1000	9,40												
25+35+42+42	1,39	1,95	2,33	2,33	8,00(3,00-9,20)	4,17	7,90 A++	1,92(0,57-2,72)	960	9,20	1,63	2,29	2,74	2,74	9,40(4,20-10,60)	4,77	4,70 A++	1,97(0,76-2,88)	985	9,30												
35+35+35+35	2,00	2,00	2,00	2,00	8,00(3,00-9,20)	4,28	7,90 A++	1,87(0,58-2,72)	935																							

Free Multi R32 combinations table

Free Multi 5x1 CU-5Z90TBE. Minimum capacity connected: 4,5 kW. Maximum capacity connected: 18,3 kW - R32

Indoor unit capacity	Cooling capacity (kW). Rooms										EER	SEER ¹⁾	Input power rating			A.E.C.	Current	Heating capacity (kW). Rooms										COP	SCOP ¹⁾	Input power rating			A.E.C.	Current
	A					B							kW	kWh	230V			A					B							kW	kWh	230V		
	A	B	C	D	E	Total (Min - Max)	W/W	A	B	C								D	E	Total (Min - Max)	W/W	A	B	C	D	E	Total (Min - Max)							
16+60+60	1,06	3,97	3,97			9,00(3,00-10,70)	4,17	7,20 A++	2,16(0,40-2,94)	1080	10,30	1,22	4,59	4,59	10,40(2,70-14,10)	4,79	4,20 A+	2,17(0,30-3,67)	1085	10,20														
16+60+71	0,98	3,67	4,35			9,00(3,00-10,70)	4,15	7,20 A++	2,17(0,40-2,87)	1085	10,40	1,13	4,24	5,03	10,40(2,70-14,10)	4,81	4,20 A+	2,16(0,31-3,65)	1080	10,20														
16+71+71	0,92	4,04	4,04			9,00(3,00-10,70)	4,27	7,20 A++	2,11(0,40-2,81)	1055	10,10	1,06	4,67	4,67	10,40(2,70-14,40)	4,75	4,20 A+	2,19(0,32-3,75)	1095	10,30														
20+20+20	2,00	2,00	2,00			6,00(2,90-8,50)	4,32	7,20 A++	1,39(0,31-2,55)	695	6,70	2,86	2,86	2,86	8,58(2,70-12,30)	4,33	4,10 A+	1,98(0,23-3,35)	990	9,30														
20+20+25	2,00	2,00	2,50			6,50(2,90-8,50)	4,06	7,20 A++	1,60(0,31-2,55)	800	7,70	2,77	2,77	3,46	9,00(2,70-12,30)	4,25	4,10 A+	2,12(0,23-3,35)	1060	10,00														
20+20+35	2,00	2,00	3,50			7,50(2,90-8,50)	3,85	7,20 A++	1,95(0,34-2,49)	975	9,30	2,61	2,61	4,58	9,80(2,70-12,30)	4,12	4,10 A+	2,38(0,23-3,26)	1190	11,20														
20+20+42	2,00	2,00	4,20			8,20(2,90-8,70)	3,57	7,20 A++	2,30(0,34-2,54)	1150	11,00	2,54	2,54	5,32	10,40(2,70-12,90)	4,24	4,10 A+	2,45(0,23-3,53)	1225	11,50														
20+20+50	2,00	2,00	5,00			9,00(2,90-9,60)	3,73	7,20 A++	2,41(0,34-2,62)	1205	11,50	2,31	2,31	5,78	10,40(2,70-13,60)	4,54	4,20 A+	2,29(0,25-3,62)	1145	10,80														
20+20+60	1,80	1,80	5,40			9,00(2,90-10,70)	3,73	7,20 A++	2,41(0,34-3,41)	1205	11,50	2,08	2,08	6,24	10,40(2,70-13,60)	4,54	4,20 A+	2,29(0,25-3,62)	1145	10,80														
20+20+71	1,62	1,62	5,76			9,00(2,90-10,70)	3,83	7,20 A++	2,35(0,34-3,27)	1175	11,20	1,87	1,87	6,66	10,40(2,70-13,80)	4,56	4,20 A+	2,28(0,25-3,71)	1140	10,70														
20+25+25	2,00	2,50	2,50			7,00(2,90-8,50)	3,93	7,20 A++	1,78(0,31-2,55)	890	8,50	2,68	3,36	3,36	9,40(2,70-12,30)	4,16	4,10 A+	2,26(0,23-3,35)	1130	10,60														
20+25+35	2,00	2,50	3,50			8,00(2,90-8,50)	3,67	7,20 A++	2,18(0,34-2,49)	1090	10,40	2,55	3,19	4,46	10,20(2,70-12,90)	4,16	4,10 A+	2,45(0,23-3,54)	1225	11,50														
20+25+42	2,00	2,50	4,20			8,70(2,90-9,60)	3,43	7,20 A++	2,54(0,34-3,00)	1270	12,20	2,39	2,99	5,02	10,40(2,70-13,60)	4,24	4,20 A+	2,45(0,23-3,87)	1225	11,50														
20+25+50	1,89	2,37	4,74			9,00(2,90-10,10)	3,73	7,20 A++	2,41(0,34-2,94)	1205	11,50	2,19	2,74	5,47	10,40(2,70-13,60)	4,54	4,20 A+	2,29(0,25-3,62)	1145	10,80														
20+25+60	1,71	2,14	5,15			9,00(2,90-10,70)	3,73	7,20 A++	2,41(0,34-3,41)	1205	11,50	1,98	2,48	5,94	10,40(2,70-13,80)	4,54	4,20 A+	2,29(0,25-3,73)	1145	10,80														
20+25+71	1,55	1,94	5,51			9,00(2,90-10,70)	3,83	7,20 A++	2,35(0,34-3,27)	1175	11,20	1,79	2,24	6,37	10,40(2,70-13,80)	4,56	4,20 A+	2,28(0,25-3,71)	1140	10,70														
20+35+35	2,00	3,50	3,50			9,00(2,90-9,60)	3,38	7,20 A++	2,66(0,34-2,93)	1330	12,70	2,32	4,04	4,04	10,40(2,70-13,60)	4,28	4,20 A+	2,43(0,24-3,85)	1215	11,40														
20+35+42	1,85	3,25	3,90			9,00(2,90-10,70)	3,38	7,20 A++	2,66(0,34-3,91)	1330	12,70	2,14	3,75	4,51	10,40(2,70-13,60)	4,30	4,20 A+	2,42(0,24-3,78)	1210	11,40														
20+35+50	1,71	3,00	4,29			9,00(2,90-10,70)	3,83	7,20 A++	2,35(0,34-3,34)	1175	11,20	1,98	3,47	4,95	10,40(2,70-13,80)	4,60	4,20 A+	2,26(0,23-3,70)	1130	10,60														
20+35+60	1,56	2,74	4,70			9,00(2,90-10,70)	3,83	7,20 A++	2,35(0,34-3,34)	1175	11,20	1,81	3,17	5,42	10,40(2,70-13,80)	4,60	4,20 A+	2,26(0,27-3,70)	1130	10,60														
20+35+71	1,43	2,50	5,07			9,00(2,90-10,70)	3,95	7,20 A++	2,28(0,37-3,20)	1140	10,90	1,65	2,89	5,86	10,40(2,70-13,80)	4,62	4,20 A+	2,25(0,27-3,68)	1125	10,60														
20+42+42	1,74	3,63	3,63			9,00(2,90-10,70)	3,46	7,20 A++	2,28(0,34-3,91)	1300	12,40	2,00	4,20	4,20	10,40(2,70-13,60)	4,32	4,20 A+	2,41(0,24-3,77)	1205	11,30														
20+42+50	1,60	3,38	4,02			9,00(2,90-10,70)	3,83	7,20 A++	2,35(0,34-3,27)	1175	11,20	1,86	3,90	4,64	10,40(2,70-13,80)	4,60	4,20 A+	2,26(0,27-3,68)	1130	10,60														
20+42+60	1,47	3,10	4,43			9,00(2,90-10,70)	3,83	7,20 A++	2,35(0,34-3,27)	1175	11,20	1,70	3,58	5,12	10,40(2,70-13,80)	4,60	4,20 A+	2,26(0,27-3,68)	1130	10,60														
20+42+71	1,35	2,84	4,81			9,00(2,90-10,70)	3,95	7,20 A++	2,28(0,37-3,20)	1140	10,90	1,56	3,28	5,56	10,40(2,70-14,10)	4,64	4,20 A+	2,24(0,27-3,78)	1120	10,50														
20+50+50	1,50	3,75	3,75			9,00(2,90-10,70)	4,17	7,20 A++	2,16(0,37-2,94)	1080	10,30	1,74	4,33	4,33	10,40(2,70-13,80)	4,81	4,20 A+	2,16(0,31-3,48)	1080	10,20														
20+50+60	1,38	3,46	4,16			9,00(2,90-10,70)	4,17	7,20 A++	2,16(0,37-2,94)	1080	10,30	1,60	4,00	4,80	10,40(2,70-14,10)	4,81	4,20 A+	2,16(0,31-3,65)	1080	10,20														
20+50+71	1,28	3,19	4,53			9,00(3,00-10,70)	4,15	7,20 A++	2,17(0,40-2,87)	1085	10,40	1,48	3,69	5,23	10,40(2,70-14,10)	4,75	4,20 A+	2,19(0,32-3,64)	1095	10,30														
20+60+60	1,28	3,86	3,86			9,00(3,00-10,70)	4,17	7,20 A++	2,16(0,40-2,94)	1080	10,30	1,48	4,46	4,46	10,40(2,70-14,10)	4,81	4,20 A+	2,16(0,31-3,65)	1080	10,20														
20+60+71	1,19	3,58	4,23			9,00(3,00-10,70)	4,15	7,20 A++	2,17(0,40-2,87)	1085	10,40	1,38	4,13	4,89	10,40(2,70-14,40)	4,75	4,20 A+	2,19(0,32-3,75)	1095	10,30														
20+71+71	1,12	3,94	3,94			9,00(3,00-10,70)	4,27	7,20 A++	2,11(0,41-2,81)	1055	10,10	1,28	4,56	4,56	10,40(2,70-14,40)	4,77	4,20 A+	2,18(0,33-3,74)	1090	10,20														
25+25+25	2,50	2,50	2,50			7,50(2,90-8,50)	3,73	7,20 A++	2,01(0,31-2,55)	1005	9,60	3,23	3,23	3,23	9,69(2,70-12,30)	4,02	4,10 A+	2,41(0,23-3,35)	1205	11,30														
25+25+35	2,50	2,50	3,50			8,50(2,90-9,60)	3,41	7,20 A++	2,49(0,34-3,00)	1245	11,90	3,06	3,06	4,28	10,40(2,70-13,60)	4,23	4,20 A+	2,46(0,23-3,89)	1230	11,60														
25+25+42	2,45	2,45	4,10			9,00(2,90-10,10)	3,30	7,20 A++	2,73(0,34-3,40)	1365	13,10	2,83	2,83	4,74	10,40(2,70-13,60)	4,24	4,20 A+	2,45(0,23-3,87)	1225	11,50														
25+25+50	2,25	2,25	4,50			9,00(2,90-10,70)	3,73	7,20 A++	2,41(0,34-3,41)	1205	11,50	2,60	2,60	5,20	10,40(2,70-13,60)	4,54	4,20 A+	2,29(0,25-3,62)	1145	10,80														
25+25+60	2,05	2,05	4,90			9,00(2,90-10,70)	3,73	7,20 A++	2,41(0,34-3,41)	1205	11,50	2,36	3,26	5,68	10,40(2,70-13,80)	4,54	4,20 A+	2,29(0,25-3,73)	1145	10,80														
25+25+71	1,86	1,86	5,28			9,00(2,90-10,70)	3,83	7,20 A++	2,35(0,34-3,27)	1175	11,20	2,15	2,15	6,10	10,40(2,70-13,80)	4,56	4,20 A+	2,28(0,25-3,71)	1140	10,70														
25+35+35	2,36	3,32	3,32			9,00(2,90-10,10)	3,38	7,20 A++	2,66(0,34-3,33)	1330	12,70	2,74	3,83	3,83	10,40(2,70-13,60)	4,28	4,20 A+	2,43(0,24-3,85)	1215	11,40														
25+35+42	2,20	3,09	3,71			9,00(2,90-10,70)	3,38	7,20 A++	2,66(0,34-3,91)	1330	12,70	2,55	3,57	4,28	10,40(2,70-13,60)	4,30	4,20 A+	2,42(0,24-3,78)	1210	11,40														
25+35+50	2,05	2,86	4,09			9,00(2,90-10,70)	3,83	7,20 A++	2,35(0,34-3,34)	1175	11,20	2,36	3,31	4,73	10,40(2,70-13,80)	4,60	4,20 A+	2,26(0,27-3,70)	1130	10,60														
25+35+60	1,87	2,63	4,50			9,00(2,90-10,70)	3,83	7,20 A++	2,35(0,34-3,34)	1175	11,20	2,17	3,03	5,20	10,40(2,70-13,80)	4,60	4,20 A+	2,26(0,27-3,70)	1130	10,60														
25+35+71	1,72	2,40	4,88			9,00(2,90-10,70)	3,95	7,20 A++	2,28(0,37-3,20)	1140	10,90	1,98	2,78	5,64	10,40(2,70-14,10)	4,62	4,20 A+	2,25(0,27-3,80)	1125	10,60														
25+42+42	2,06	3,47	3,47			9,00(2,90-10,70)	3,46	7,20 A++	2,60(0,34-3,91)	1300	12,40	2,38	4,01	4,01	10,40(2,70-13,80)	4,32	4,20 A+	2,41(0,24-3,89)	1205	11,30														
25+42+50	1,92	3,23	3,85			9,00(2,90-10,70)	3,83	7,20 A++	2,35(0,34-3,27)	1175	11,20	2,22	3,73	4,45	10,40(2,70-13,80)	4,60	4,20 A+	2,26(0,27-3,68)	1130	10,60														
25+42+60	1,77	2,98	4,25			9,00(2,90-10,70)	3,83	7,20 A++	2,35(0,34-3,27)	1175	11,20	2,05	3,44	4,91	10,40(2,70-14,10)	4,60	4,20 A+	2,26(0,27-3,80)	1130	10,60														
25+42+71	1,63	2,74	4,63			9,00(3,00-10,70)	3,95	7,20 A++	2,28(0,37-3,20)	1140	10,90	1,88	3,17	5,35	10,40(2,70-14,10)	4,64	4,20 A+	2,24(0,27-3,78)	1120	10,50														
25+50+50	1,80	3,60	3,60			9,00(2,90-10,70)	4,17	7,20 A++	2,16(0,37-2,94)	1080	10,30	2,08	4,16	4,16	10,40(2,70-13,80)	4,81	4,20 A+	2,16(0,31-3,48)	1080	10,20														
25+50+60	1,67	3,33	4,00			9,00(3,00-10,70)	4,17	7,20 A++	2,16(0,40-2,94)	1080	10,30	1,93	3,85	4,62	10,40(2,70-14,10)	4,81	4,20 A+	2,16(0,31-3,65)	1080	10,20														
25+50+71	1,5																																	

Free Multi R32 combinations table

Free Multi 5x1 CU-5Z90TBE. Minimum capacity connected: 4,5 kW. Maximum capacity connected: 18,3 kW - R32

Indoor unit capacity	Cooling capacity (kW). Rooms										EER	SEER ¹⁾	Input power rating			A.E.C.	Current	Heating capacity (kW). Rooms										COP	SCOP ¹⁾	Input power rating			A.E.C.	Current
	A					B							kW	kWh	230V			A					B							kW	kWh	230V		
	A	B	C	D	E	Total (Min-Max)	W/W	A	B	C								D	E	Total (Min-Max)	W/W	A	B	C	D	E	Total (Min-Max)							
16+25+42+60	1,01	1,57	2,64	3,78	9,00	(3,00-11,00)	3,98	8,00	+++	2,26	(0,44-3,26)	1130	10,80	1,16	1,82	3,05	4,37	10,40	(3,40-14,40)	4,91	4,40	A+	2,12	(0,42-3,63)	1060	10,00								
16+25+42+71	0,94	1,46	2,45	4,15	9,00	(3,00-11,00)	4,09	8,00	+++	2,20	(0,44-3,19)	1100	10,50	1,08	1,69	2,84	4,79	10,40	(3,40-14,40)	4,81	4,40	A+	2,16	(0,43-3,61)	1080	10,20								
16+25+50+50	1,02	1,60	3,19	3,19	9,00	(2,90-10,80)	4,07	8,00	+++	2,21	(0,49-2,98)	1105	10,60	1,18	1,84	3,69	3,69	10,40	(3,40-14,40)	4,84	4,40	A+	2,15	(0,50-3,56)	1075	10,10								
16+25+50+60	0,95	1,49	2,98	3,58	9,00	(3,00-11,00)	4,07	8,00	+++	2,21	(0,49-3,12)	1105	10,60	1,10	1,72	3,44	4,14	10,40	(3,40-14,40)	4,84	4,40	A+	2,15	(0,50-3,56)	1075	10,10								
16+25+50+71	0,89	1,39	2,78	3,94	9,00	(3,00-11,20)	4,07	8,00	+++	2,21	(0,52-3,20)	1105	10,60	1,03	1,60	3,21	4,56	10,40	(3,40-14,40)	4,84	4,40	A+	2,15	(0,51-3,60)	1075	10,10								
16+25+60+60	0,89	1,41	3,35	3,35	9,00	(3,00-11,20)	4,07	8,00	+++	2,21	(0,49-3,19)	1105	10,60	1,03	1,61	3,88	3,88	10,40	(3,40-14,40)	4,84	4,40	A+	2,15	(0,50-3,56)	1075	10,10								
16+25+60+71	0,83	1,31	3,14	3,72	9,00	(3,00-11,20)	4,07	8,00	+++	2,21	(0,52-3,20)	1105	10,60	0,97	1,51	3,63	4,29	10,40	(3,40-14,40)	4,84	4,40	A+	2,15	(0,51-3,60)	1075	10,10								
16+25+71+71	0,79	1,23	3,49	3,49	9,00	(3,00-11,20)	4,17	8,00	+++	2,16	(0,53-3,20)	1080	10,30	0,91	1,43	4,03	4,03	10,40	(3,40-14,40)	4,77	4,40	A+	2,18	(0,52-3,59)	1090	10,20								
16+35+35+35	1,20	2,60	2,60	2,60	9,00	(2,90-10,80)	3,90	8,00	+++	2,31	(0,38-3,33)	1155	11,10	1,37	3,01	3,01	3,01	10,40	(3,40-14,20)	4,84	4,40	A+	2,15	(0,37-3,64)	1075	10,10								
16+35+35+42	1,13	2,46	2,46	2,95	9,00	(2,90-10,80)	3,90	8,00	+++	2,31	(0,40-3,33)	1155	11,10	1,30	2,84	2,84	3,42	10,40	(3,40-14,40)	4,75	4,40	A+	2,19	(0,37-3,75)	1095	10,30								
16+35+35+50	1,05	2,32	2,32	3,31	9,00	(2,90-10,80)	4,09	8,00	+++	2,20	(0,44-3,11)	1100	10,50	1,22	2,68	2,68	3,82	10,40	(3,40-14,40)	4,81	4,40	A+	2,16	(0,43-3,61)	1080	10,20								
16+35+35+60	0,98	2,16	2,16	3,70	9,00	(3,00-11,00)	4,09	8,00	+++	2,20	(0,44-3,26)	1100	10,50	1,14	2,49	4,49	4,28	10,40	(3,40-14,40)	4,81	4,40	A+	2,16	(0,43-3,61)	1080	10,20								
16+35+35+71	0,91	2,01	2,01	4,07	9,00	(3,00-11,00)	4,09	8,00	+++	2,20	(0,47-3,19)	1100	10,50	1,06	2,32	2,32	4,70	10,40	(3,40-14,40)	4,84	4,40	A+	2,15	(0,45-3,65)	1075	10,10								
16+35+42+42	1,07	2,33	2,80	2,80	9,00	(2,90-10,80)	3,90	8,00	+++	2,21	(0,40-3,33)	1155	11,10	1,22	2,70	3,24	3,24	10,40	(3,40-14,40)	4,77	4,40	A+	2,18	(0,37-3,73)	1090	10,20								
16+35+42+50	1,01	2,20	2,64	3,15	9,00	(3,00-11,00)	4,09	8,00	+++	2,20	(0,44-3,26)	1100	10,50	1,16	2,55	3,05	3,64	10,40	(3,40-14,40)	4,84	4,40	A+	2,15	(0,45-3,65)	1075	10,10								
16+35+42+60	0,94	2,06	2,47	3,53	9,00	(3,00-11,00)	4,09	8,00	+++	2,20	(0,44-3,26)	1100	10,50	1,09	2,38	2,85	4,08	10,40	(3,40-14,40)	4,84	4,40	A+	2,15	(0,45-3,65)	1075	10,10								
16+35+42+71	0,88	1,92	2,30	3,90	9,00	(3,00-11,20)	4,09	8,00	+++	2,20	(0,47-3,33)	1100	10,50	1,01	2,22	2,66	4,51	10,40	(3,40-14,40)	4,86	4,40	A+	2,14	(0,45-3,64)	1070	10,10								
16+35+50+50	0,95	2,09	2,98	2,98	9,00	(3,00-11,00)	4,07	8,00	+++	2,21	(0,52-3,05)	1105	10,60	1,10	2,42	3,44	3,44	10,40	(3,40-14,40)	4,77	4,40	A+	2,18	(0,52-3,59)	1090	10,20								
16+35+50+60	0,89	1,96	2,80	3,35	9,00	(3,00-11,20)	4,07	8,00	+++	2,21	(0,52-3,20)	1105	10,60	1,03	2,26	3,23	3,88	10,40	(3,40-14,40)	4,77	4,40	A+	2,18	(0,52-3,59)	1090	10,20								
16+35+50+71	0,83	1,83	2,62	3,72	9,00	(3,00-11,20)	4,19	8,00	+++	2,15	(0,52-3,20)	1075	10,30	0,97	2,12	3,02	4,29	10,40	(3,40-14,40)	4,77	4,40	A+	2,18	(0,54-3,57)	1090	10,20								
16+35+60+60	0,84	1,84	3,16	3,16	9,00	(3,00-11,20)	4,07	8,00	+++	2,21	(0,52-3,20)	1105	10,60	0,97	2,13	3,65	3,65	10,40	(3,40-14,40)	4,77	4,40	A+	2,18	(0,52-3,59)	1090	10,20								
16+35+60+71	0,79	1,73	2,97	3,51	9,00	(3,00-11,20)	4,19	8,00	+++	2,21	(0,52-3,20)	1075	10,30	0,91	2,03	3,43	4,06	10,40	(3,40-14,40)	4,77	4,40	A+	2,18	(0,54-3,57)	1090	10,20								
16+42+42+42	1,02	2,66	2,66	2,66	9,00	(3,00-11,00)	3,90	8,00	+++	2,31	(0,40-3,48)	1155	11,10	1,16	3,08	3,08	3,08	10,40	(3,40-14,40)	4,79	4,40	A+	2,17	(0,39-3,72)	1085	10,20								
16+42+42+50	0,96	2,52	2,52	3,00	9,00	(3,00-11,00)	4,09	8,00	+++	2,20	(0,44-3,19)	1100	10,50	1,11	2,91	2,91	3,47	10,40	(3,40-14,40)	4,84	4,40	A+	2,15	(0,45-3,64)	1075	10,10								
16+42+42+60	0,90	2,36	2,36	3,38	9,00	(3,00-11,20)	4,09	8,00	+++	2,20	(0,44-3,33)	1100	10,50	1,04	2,73	2,73	3,90	10,40	(3,40-14,40)	4,84	4,40	A+	2,15	(0,45-3,64)	1075	10,10								
16+42+42+71	0,84	2,21	2,21	3,74	9,00	(3,00-11,20)	4,09	8,00	+++	2,20	(0,48-3,34)	1100	10,50	0,97	2,55	2,55	4,33	10,40	(3,40-14,40)	4,86	4,40	A+	2,14	(0,46-3,63)	1070	10,10								
16+42+50+50	0,91	2,39	2,85	2,85	9,00	(3,00-11,20)	4,07	8,00	+++	2,21	(0,52-3,20)	1105	10,60	1,05	2,77	3,29	3,29	10,40	(3,40-14,40)	4,77	4,40	A+	2,18	(0,53-3,58)	1090	10,20								
16+42+50+60	0,86	2,25	2,68	3,21	9,00	(3,00-11,20)	4,07	8,00	+++	2,21	(0,52-3,20)	1105	10,60	0,99	2,60	3,10	3,71	10,40	(3,40-14,40)	4,77	4,40	A+	2,18	(0,53-3,58)	1090	10,20								
16+42+50+71	0,80	2,11	2,51	3,58	9,00	(3,00-11,20)	4,17	8,00	+++	2,16	(0,53-3,20)	1080	10,30	0,93	2,44	2,91	4,12	10,40	(3,40-14,40)	4,79	4,40	A+	2,17	(0,54-3,56)	1085	10,20								
16+42+60+60	0,81	2,13	3,03	3,03	9,00	(3,00-11,20)	4,07	8,00	+++	2,21	(0,52-3,20)	1105	10,60	0,93	2,45	3,51	3,51	10,40	(3,40-14,40)	4,77	4,40	A+	2,18	(0,53-3,58)	1090	10,20								
16+50+50+50	0,87	2,17	2,71	2,71	9,00	(3,00-11,20)	4,15	8,00	+++	2,17	(0,57-3,14)	1085	10,40	1,01	3,13	3,13	3,13	10,40	(3,40-14,40)	4,66	4,40	A+	2,23	(0,63-3,58)	1115	10,50								
16+50+50+60	0,81	2,56	2,56	3,07	9,00	(3,00-11,20)	4,15	8,00	+++	2,17	(0,57-3,14)	1085	10,40	0,95	2,95	2,95	3,55	10,40	(3,40-14,40)	4,66	4,40	A+	2,23	(0,63-3,58)	1115	10,50								
20+20+20+20	2,00	2,00	2,00	2,00	8,00	(2,90-10,60)	4,06	8,00	+++	1,97	(0,37-3,40)	985	9,40	2,60	2,60	2,60	2,60	10,40	(3,40-14,20)	4,71	4,20	A+	2,21	(0,34-3,79)	1105	10,40								
20+20+20+25	2,00	2,00	2,00	2,50	8,50	(2,90-10,60)	3,95	8,00	+++	2,15	(0,37-3,40)	1075	10,30	2,45	2,45	2,45	3,05	10,40	(3,40-14,20)	4,71	4,20	A+	2,21	(0,34-3,79)	1105	10,40								
20+20+20+35	1,89	1,89	1,89	3,33	9,00	(2,90-10,60)	3,78	8,00	+++	2,38	(0,37-3,33)	1190	11,40	2,19	2,19	2,19	3,83	10,40	(3,40-14,20)	4,75	4,40	A+	2,19	(0,35-3,76)	1095	10,30								
20+20+20+42	1,76	1,76	1,76	3,72	9,00	(2,90-10,60)	3,78	8,00	+++	2,38	(0,37-3,33)	1190	11,40	2,04	2,04	2,04	4,28	10,40	(3,40-14,20)	4,77	4,40	A+	2,18	(0,36-3,74)	1090	10,20								
20+20+20+50	1,64	1,64	1,64	4,08	9,00	(2,90-10,60)	4,00	8,00	+++	2,25	(0,41-3,04)	1125	10,80	1,89	1,89	1,89	4,73	10,40	(3,40-14,20)	4,86	4,40	A+	2,14	(0,42-3,60)	1070	10,10								
20+20+20+60	1,50	1,50	1,50	4,50	9,00	(2,90-10,60)	4,00	8,00	+++	2,25	(0,41-3,04)	1125	10,80	1,73	1,73	1,73	5,21	10,40	(3,40-14,20)	4,86	4,40	A+	2,14	(0,42-3,60)	1070	10,10								
20+20+20+71	1,37	1,37	1,37	4,89	9,00	(2,90-10,80)	4,09	8,00	+++	2,20	(0,44-3,11)	1100	10,50	1,59	1,59	1,59	5,63	10,40	(3,40-14,40)	4,88	4,40	A+	2,13	(0,42-3,64)	1065	10,00								
20+20+25+25	2,00	2,00	2,50	2,50	9,00	(2,90-10,60)	3,78	8,00	+++	2,38	(0,37-3,40)	1190	11,40	2,31	2,31	2,89	2,89	10,40	(3,40-14,20)	4,71	4,40	A+	2,21	(0,34-3,79)	1105	10,40								
20+20+25+35	1,80	1,80	2,25	3,15	9,00	(2,90-10,60)	3,78	8,00	+++	2,38	(0,37-3,33)	1190	11,40	2,08	2,08	2,60	3,64	10,40	(3,40-14,20)	4,75	4,40	A+	2,19	(0,35-3,76)	1095	10,30								
20+20+25+42	1,68	1,68	2,10	3,54	9,00	(2,90-10,60)	3,78	8,00	+++	2,38	(0,37-3,33)	1190	11,40	1,94	1,94	2,43	4,09	10,40	(3,40-14,20)	4,77	4,40	A+	2,18	(0,36-3,74)	1090	10,20								
20+20+25+50	1,57	1,57	1,95	3,91	9,00	(2,90-10,60)	4,00	8,00	+++	2,25	(0,41-3,04)	1125	10,80	1,81	1,81	2,26	4,52	10,40	(3,40-14,20)	4,86	4,40	A+	2,14	(0,										

Configure in a few steps your multi split system with our online tool.



Free Multi 5x1 CU-5Z90TBE. Minimum capacity connected: 4,5 kW. Maximum capacity connected: 18,3 kW · R32

Indoor unit capacity	Cooling capacity (kW). Rooms										EER	SEER ¹⁾	Input power rating			A.E.C.	Current	Heating capacity (kW). Rooms										COP	SCOP ¹⁾	Input power rating			A.E.C.	Current
	A	B	C	D	E	Total (Min - Max)	W/W	kW	kWh	230V			A	B	C			D	E	Total (Min - Max)	W/W	kW	kWh	230V										
20+35+35+35	1,44	2,52	2,52	2,52		9,00(2,90-10,80)	3,90	8,00 A++	2,31(0,40-3,33)	1155	11,10	1,67	2,91	2,91	2,91	10,40(3,40-14,20)	4,75	4,40 A+	2,19(0,37-3,63)	1095	10,30													
20+35+35+42	1,36	2,39	2,39	2,86		9,00(2,90-10,80)	3,90	8,00 A++	2,31(0,40-3,33)	1155	11,10	1,58	2,76	2,76	3,30	10,40(3,40-14,40)	4,77	4,40 A+	2,18(0,37-3,73)	1090	10,20													
20+35+35+50	1,29	2,25	2,25	3,21		9,00(2,90-10,80)	4,09	8,00 A++	2,20(0,44-3,11)	1100	10,50	1,49	2,60	2,60	3,71	10,40(3,40-14,40)	4,84	4,40 A+	2,15(0,45-3,65)	1075	10,10													
20+35+35+60	1,20	2,10	2,10	3,60		9,00(3,00-11,00)	4,09	8,00 A++	2,20(0,44-3,26)	1100	10,50	1,39	2,43	2,43	4,15	10,40(3,40-14,40)	4,84	4,40 A+	2,15(0,45-3,65)	1075	10,10													
20+35+35+71	1,11	1,96	1,96	3,97		9,00(3,00-11,20)	4,09	8,00 A++	2,20(0,47-3,33)	1100	10,50	1,29	2,26	2,26	4,59	10,40(3,40-14,40)	4,86	4,40 A+	2,14(0,45-3,64)	1070	10,10													
20+35+42+42	1,29	2,27	2,72	2,72		9,00(2,90-10,80)	3,90	8,00 A++	2,31(0,40-3,33)	1155	11,10	1,50	2,62	3,14	3,14	10,40(3,40-14,40)	4,79	4,40 A+	2,17(0,39-3,72)	1085	10,20													
20+35+42+50	1,22	2,14	2,57	3,07		9,00(3,00-11,00)	4,09	8,00 A++	2,20(0,44-3,19)	1100	10,50	1,41	2,48	2,97	3,54	10,40(3,40-14,40)	4,84	4,40 A+	2,15(0,45-3,64)	1075	10,10													
20+35+42+60	1,14	2,01	2,41	3,44		9,00(3,00-11,00)	4,09	8,00 A++	2,20(0,44-3,19)	1100	10,50	1,32	2,32	2,78	3,98	10,40(3,40-14,40)	4,84	4,40 A+	2,15(0,45-3,64)	1075	10,10													
20+35+42+71	1,07	1,88	2,25	3,80		9,00(3,00-11,20)	4,09	8,00 A++	2,20(0,48-3,34)	1100	10,50	1,24	2,17	2,60	4,39	10,40(3,40-14,40)	4,86	4,40 A+	2,14(0,46-3,63)	1070	10,10													
20+35+50+50	1,16	2,04	2,90	2,90		9,00(3,00-11,00)	4,07	8,00 A++	2,21(0,52-3,05)	1105	10,60	1,34	2,36	3,35	3,35	10,40(3,40-14,40)	4,77	4,40 A+	2,18(0,53-3,58)	1090	10,20													
20+35+50+60	1,09	1,91	2,73	3,27		9,00(3,00-11,20)	4,07	8,00 A++	2,21(0,52-3,20)	1105	10,60	1,26	2,21	3,15	3,78	10,40(3,40-14,40)	4,77	4,40 A+	2,18(0,53-3,58)	1090	10,20													
20+35+50+71	1,02	1,79	2,56	3,63		9,00(3,00-11,20)	4,17	8,00 A++	2,16(0,53-3,20)	1080	10,30	1,18	2,07	2,95	4,20	10,40(3,40-14,40)	4,79	4,40 A+	2,17(0,54-3,56)	1085	10,20													
20+35+60+60	1,02	1,80	3,09	3,09		9,00(3,00-11,20)	4,07	8,00 A++	2,21(0,52-3,20)	1105	10,60	1,19	2,07	3,57	3,57	10,40(3,40-14,40)	4,77	4,40 A+	2,18(0,53-3,58)	1090	10,20													
20+42+42+42	1,23	2,59	2,59	2,59		9,00(3,00-11,00)	3,90	8,00 A++	2,31(0,40-3,40)	1155	11,10	1,43	2,99	2,99	2,99	10,40(3,40-14,40)	4,79	4,40 A+	2,17(0,39-3,71)	1085	10,20													
20+42+42+50	1,17	2,45	2,45	2,93		9,00(3,00-11,00)	4,09	8,00 A++	2,20(0,45-3,19)	1100	10,50	1,35	2,84	2,84	3,37	10,40(3,40-14,40)	4,86	4,40 A+	2,14(0,45-3,63)	1070	10,10													
20+42+42+60	1,10	2,30	2,30	3,30		9,00(3,00-11,20)	4,09	8,00 A++	2,20(0,45-3,33)	1100	10,50	1,27	2,66	2,66	3,81	10,40(3,40-14,40)	4,86	4,40 A+	2,14(0,45-3,63)	1070	10,10													
20+42+42+71	1,03	2,16	2,16	3,65		9,00(3,00-11,20)	4,09	8,00 A++	2,20(0,48-3,26)	1100	10,50	1,19	2,50	3,50	4,21	10,40(3,40-14,40)	4,88	4,40 A+	2,13(0,46-3,61)	1065	10,00													
20+42+50+50	1,11	2,33	2,78	2,78		9,00(3,00-11,20)	4,19	8,00 A++	2,15(0,52-3,20)	1075	10,30	1,28	2,70	3,21	3,21	10,40(3,40-14,40)	4,79	4,40 A+	2,17(0,54-3,57)	1085	10,20													
20+42+50+60	1,04	2,20	2,62	3,14		9,00(3,00-11,20)	4,19	8,00 A++	2,15(0,52-3,20)	1075	10,30	1,21	2,54	3,02	3,63	10,40(3,40-14,40)	4,79	4,40 A+	2,17(0,54-3,57)	1085	10,20													
20+42+50+71	0,98	2,07	2,46	3,49		9,00(3,00-11,20)	4,17	8,00 A++	2,16(0,53-3,13)	1080	10,30	1,14	2,39	2,84	4,03	10,40(3,40-14,40)	4,79	4,40 A+	2,17(0,55-3,55)	1085	10,20													
20+42+60+60	0,98	2,08	2,97	2,97		9,00(3,00-11,20)	4,19	8,00 A++	2,15(0,52-3,20)	1075	10,30	1,14	2,40	3,43	4,43	10,40(3,40-14,40)	4,79	4,40 A+	2,17(0,54-3,57)	1085	10,20													
20+50+50+50	1,05	2,65	2,65	2,65		9,00(3,00-11,20)	4,15	8,00 A++	2,17(0,58-3,14)	1085	10,40	1,22	3,06	3,06	3,06	10,40(3,40-14,40)	4,60	4,40 A+	2,26(0,63-3,57)	1130	10,60													
20+50+50+60	1,00	2,50	2,50	3,00		9,00(3,00-11,20)	4,15	8,00 A++	2,17(0,58-3,14)	1085	10,40	1,16	2,89	2,89	3,66	10,40(3,40-14,40)	4,60	4,40 A+	2,26(0,63-3,57)	1130	10,60													
25+25+25+25	2,25	2,25	2,25	2,25		9,00(2,90-10,60)	3,78	8,00 A++	2,38(0,37-3,40)	1190	11,40	2,60	2,60	2,60	2,60	10,40(3,40-14,20)	4,71	4,40 A+	2,21(0,34-3,79)	1105	10,40													
25+25+25+35	2,05	2,05	2,05	2,85		9,00(2,90-10,60)	3,78	8,00 A++	2,38(0,37-3,33)	1190	11,40	2,36	2,36	2,36	3,32	10,40(3,40-14,20)	4,75	4,40 A+	2,19(0,35-3,76)	1095	10,30													
25+25+25+42	1,92	1,92	1,92	3,24		9,00(2,90-10,60)	3,78	8,00 A++	2,38(0,37-3,33)	1190	11,40	2,22	2,22	2,22	3,74	10,40(3,40-14,20)	4,77	4,40 A+	2,18(0,36-3,74)	1090	10,20													
25+25+25+50	1,80	1,80	1,80	3,60		9,00(2,90-10,80)	4,00	8,00 A++	2,25(0,41-3,18)	1125	10,80	2,08	2,08	2,08	4,16	10,40(3,40-14,20)	4,86	4,40 A+	2,14(0,42-3,60)	1070	10,10													
25+25+25+60	1,67	1,67	1,67	3,99		9,00(2,90-10,80)	4,00	8,00 A++	2,25(0,41-3,18)	1125	10,80	1,93	1,93	1,93	4,61	10,40(3,40-14,40)	4,86	4,40 A+	2,14(0,42-3,66)	1070	10,10													
25+25+25+71	1,54	1,54	1,54	4,38		9,00(3,00-11,00)	4,09	8,00 A++	2,20(0,44-3,26)	1100	10,50	1,78	1,78	1,78	5,06	10,40(3,40-14,40)	4,88	4,40 A+	2,13(0,42-3,64)	1065	10,00													
25+25+35+35	1,87	1,87	2,63	2,63		9,00(2,90-10,60)	3,90	8,00 A++	2,31(0,37-3,25)	1155	11,10	2,17	2,17	3,03	3,03	10,40(3,40-14,20)	4,79	4,40 A+	2,17(0,37-3,66)	1085	10,20													
25+25+35+42	1,77	1,77	2,48	2,98		9,00(2,90-10,80)	3,90	8,00 A++	2,31(0,37-3,40)	1155	11,10	2,05	2,05	2,87	3,43	10,40(3,40-14,20)	4,81	4,40 A+	2,16(0,37-3,65)	1080	10,20													
25+25+35+50	1,67	1,67	2,33	3,33		9,00(2,90-10,80)	3,98	8,00 A++	2,26(0,44-3,11)	1130	10,80	1,93	1,93	2,70	3,84	10,40(3,40-14,40)	4,91	4,40 A+	2,12(0,42-3,63)	1060	10,00													
25+25+35+60	1,55	1,55	2,17	3,73		9,00(3,00-11,00)	3,98	8,00 A++	2,26(0,44-3,26)	1130	10,80	1,79	1,79	2,51	4,31	10,40(3,40-14,40)	4,91	4,40 A+	2,12(0,42-3,63)	1060	10,00													
25+25+35+71	1,44	1,44	2,02	4,10		9,00(3,00-11,00)	4,09	8,00 A++	2,20(0,44-3,19)	1100	10,50	1,67	1,67	2,33	4,73	10,40(3,40-14,40)	4,81	4,40 A+	2,16(0,43-3,61)	1080	10,20													
25+25+42+42	1,68	1,68	2,82	2,82		9,00(2,90-10,80)	3,90	8,00 A++	2,31(0,37-3,40)	1155	11,10	1,94	1,94	3,26	3,26	10,40(3,40-14,40)	4,75	4,40 A+	2,19(0,37-3,76)	1095	10,30													
25+25+42+50	1,58	1,58	2,66	3,18		9,00(3,00-11,00)	4,09	8,00 A++	2,20(0,44-3,26)	1100	10,50	1,83	1,83	3,08	3,66	10,40(3,40-14,40)	4,81	4,40 A+	2,16(0,43-3,62)	1080	10,20													
25+25+42+60	1,48	1,48	2,49	3,55		9,00(3,00-11,00)	4,09	8,00 A++	2,20(0,44-3,26)	1100	10,50	1,71	1,71	2,87	4,11	10,40(3,40-14,40)	4,81	4,40 A+	2,16(0,43-3,62)	1080	10,20													
25+25+42+71	1,38	1,38	2,32	3,92		9,00(3,00-11,20)	4,09	8,00 A++	2,20(0,45-3,33)	1100	10,50	1,60	1,60	2,68	4,52	10,40(3,40-14,40)	4,84	4,40 A+	2,15(0,44-3,66)	1075	10,10													
25+25+50+50	1,50	1,50	3,00	3,00		9,00(3,00-11,00)	4,07	8,00 A++	2,21(0,49-3,12)	1105	10,60	1,73	1,73	3,47	3,47	10,40(3,40-14,40)	4,84	4,40 A+	2,15(0,51-3,60)	1075	10,10													
25+25+50+60	1,41	1,41	2,80	3,38		9,00(3,00-11,20)	4,07	8,00 A++	2,21(0,49-3,19)	1105	10,60	1,63	1,63	3,25	3,89	10,40(3,40-14,40)	4,84	4,40 A+	2,15(0,51-3,60)	1075	10,10													
25+25+50+71	1,32	1,32	2,62	3,74		9,00(3,00-11,20)	4,19	8,00 A++	2,15(0,52-3,20)	1075	10,30	1,52	1,52	3,04	4,32	10,40(3,40-14,40)	4,77	4,40 A+	2,18(0,52-3,59)	1090	10,20													
25+25+60+60	1,32	1,32	3,18	3,18		9,00(3,00-11,20)	4,07	8,00 A++	2,21(0,49-3,19)	1105	10,60	1,53	1,53	3,67	3,67	10,40(3,40-14,40)	4,84	4,40 A+	2,15(0,51-3,60)	1075	10,10													



Free Multi R32 combinations table

Free Multi 5x1 CU-5Z90TBE. Minimum capacity connected: 4,5 kW. Maximum capacity connected: 18,3 kW - R32

Indoor unit capacity	Cooling capacity (kW). Rooms						EER	SEER ¹⁾	Input power rating	A.E.C.	Current	Heating capacity (kW). Rooms						COP	SCOP ¹⁾	Input power rating	A.E.C.	Current
	A	B	C	D	E	Total (Min-Max)						W/W	kW	kWh	230V	A	B					
5 Rooms																						
16+16+16+16+16	1,60	1,60	1,60	1,60	1,60	8,00(2,90-11,50)	4,28	8,50 A+++	1,87(0,45-3,56)	935	9,00	2,08	2,08	2,08	2,08	2,08	10,40(3,40-14,50)	4,81	4,60 A+	2,16(0,43-3,67)	1080	10,20
16+16+16+16+20	1,60	1,60	1,60	1,60	2,00	8,40(2,90-11,50)	4,24	8,50 A+++	1,98(0,45-3,56)	990	9,50	1,98	1,98	1,98	1,98	2,48	10,40(3,40-14,50)	4,84	4,50 A+	2,15(0,44-3,66)	1075	10,10
16+16+16+16+25	1,62	1,62	1,62	1,62	2,52	9,00(2,90-11,50)	4,09	8,50 A+++	2,20(0,45-3,56)	1100	10,50	1,87	1,87	1,87	1,87	2,92	10,40(3,40-14,50)	4,84	4,68 A++	2,15(0,44-3,66)	1075	10,10
16+16+16+16+35	1,45	1,45	1,45	1,45	3,20	9,00(2,90-11,50)	4,09	8,50 A+++	2,20(0,45-3,49)	1100	10,50	1,68	1,68	1,68	1,68	3,68	10,40(3,40-14,50)	4,86	4,68 A++	2,14(0,45-3,63)	1070	10,10
16+16+16+16+42	1,36	1,36	1,36	1,36	3,56	9,00(2,90-11,50)	4,09	8,50 A+++	2,20(0,45-3,49)	1100	10,50	1,57	1,57	1,57	1,57	4,12	10,40(3,40-14,50)	4,86	4,68 A++	2,14(0,46-3,67)	1070	10,10
16+16+16+16+50	1,26	1,26	1,26	1,26	3,96	9,00(2,90-11,50)	4,17	8,50 A+++	2,16(0,53-3,35)	1080	10,30	1,46	1,46	1,46	1,46	4,56	10,40(3,40-14,50)	4,79	4,68 A++	2,17(0,54-3,61)	1085	10,20
16+16+16+16+60	1,16	1,16	1,16	1,16	4,36	9,00(2,90-11,50)	4,17	8,50 A+++	2,16(0,53-3,35)	1080	10,30	1,34	1,34	1,34	1,34	5,04	10,40(3,40-14,50)	4,79	4,68 A++	2,17(0,54-3,61)	1085	10,20
16+16+16+16+71	1,07	1,07	1,07	1,07	4,72	9,00(2,90-11,50)	4,17	8,50 A+++	2,16(0,54-3,28)	1080	10,30	1,23	1,23	1,23	1,23	5,48	10,40(3,40-14,50)	4,71	4,68 A++	2,21(0,56-3,60)	1105	10,40
16+16+16+20+20	1,60	1,60	1,60	2,00	2,00	8,80(2,90-11,50)	4,11	8,50 A+++	2,14(0,45-3,48)	1070	10,20	1,89	1,89	1,89	2,36	2,36	10,39(3,40-14,50)	4,83	4,60 A++	2,15(0,45-3,65)	1075	10,10
16+16+16+20+25	1,55	1,55	1,55	1,94	2,41	9,00(2,90-11,50)	4,09	8,50 A+++	2,20(0,45-3,48)	1100	10,50	1,79	1,79	1,79	2,24	2,79	10,40(3,40-14,50)	4,84	4,68 A++	2,15(0,45-3,65)	1075	10,10
16+16+16+20+35	1,40	1,40	1,40	1,75	3,05	9,00(2,90-11,50)	4,09	8,50 A+++	2,20(0,45-3,49)	1100	10,50	1,62	1,62	1,62	2,02	3,52	10,40(3,40-14,50)	4,86	4,68 A++	2,14(0,46-3,67)	1070	10,10
16+16+16+20+42	1,31	1,31	1,31	1,64	3,43	9,00(2,90-11,50)	4,09	8,50 A+++	2,20(0,48-3,49)	1100	10,50	1,51	1,51	1,51	1,89	3,98	10,40(3,40-14,50)	4,88	4,68 A++	2,13(0,47-3,66)	1065	10,00
16+16+16+20+50	1,22	1,22	1,22	1,53	3,81	9,00(2,90-11,50)	4,17	8,50 A+++	2,16(0,53-3,35)	1080	10,30	1,41	1,41	1,41	1,76	4,41	10,40(3,40-14,50)	4,79	4,68 A++	2,17(0,56-3,60)	1085	10,20
16+16+16+20+60	1,13	1,13	1,13	1,41	4,20	9,00(2,90-11,50)	4,17	8,50 A+++	2,16(0,53-3,35)	1080	10,30	1,30	1,30	1,30	1,63	4,87	10,40(3,40-14,50)	4,79	4,68 A++	2,17(0,56-3,60)	1085	10,20
16+16+16+20+71	1,04	1,04	1,04	1,29	4,59	9,00(2,90-11,50)	4,15	8,50 A+++	2,17(0,54-3,28)	1085	10,40	1,20	1,20	1,20	1,50	5,30	10,40(3,40-14,50)	4,73	4,68 A++	2,20(0,57-3,59)	1100	10,30
16+16+16+25+25	1,47	1,47	1,47	2,29	2,29	8,99(2,90-11,50)	4,09	8,50 A+++	2,20(0,45-3,48)	1100	10,50	1,70	1,70	1,70	2,65	2,65	10,40(3,40-14,50)	4,84	4,68 A++	2,15(0,45-3,65)	1075	10,10
16+16+16+25+35	1,33	1,33	1,33	2,08	2,93	9,00(2,90-11,50)	4,09	8,50 A+++	2,20(0,45-3,49)	1100	10,50	1,54	1,54	1,54	2,41	3,37	10,40(3,40-14,50)	4,86	4,68 A++	2,14(0,46-3,67)	1070	10,10
16+16+16+25+42	1,25	1,25	1,25	1,96	3,29	9,00(2,90-11,50)	4,09	8,50 A+++	2,20(0,48-3,49)	1100	10,50	1,45	1,45	1,45	2,26	3,79	10,40(3,40-14,50)	4,88	4,68 A++	2,13(0,47-3,66)	1065	10,00
16+16+16+25+50	1,17	1,17	1,17	1,83	3,66	9,00(2,90-11,50)	4,17	8,50 A+++	2,16(0,53-3,35)	1080	10,30	1,35	1,35	1,35	2,11	4,24	10,40(3,40-14,50)	4,79	4,68 A++	2,17(0,56-3,60)	1085	10,20
16+16+16+25+60	1,08	1,08	1,08	1,69	4,07	9,00(2,90-11,50)	4,17	8,50 A+++	2,16(0,53-3,35)	1080	10,30	1,25	1,25	1,25	1,95	4,70	10,40(3,40-14,50)	4,79	4,68 A++	2,17(0,56-3,60)	1085	10,20
16+16+16+25+71	1,00	1,00	1,00	1,56	4,44	9,00(2,90-11,50)	4,15	8,50 A+++	2,17(0,54-3,28)	1085	10,40	1,16	1,16	1,16	1,81	5,11	10,40(3,40-14,50)	4,73	4,68 A++	2,20(0,57-3,59)	1100	10,30
16+16+16+35+35	1,22	1,22	1,22	2,67	2,67	9,00(2,90-11,50)	4,07	8,50 A+++	2,21(0,48-3,41)	1105	10,60	1,41	1,41	1,41	3,08	3,08	10,39(3,40-14,50)	4,81	4,68 A++	2,16(0,48-3,64)	1080	10,20
16+16+16+35+42	1,15	1,15	1,15	2,52	3,03	9,00(2,90-11,50)	4,07	8,50 A+++	2,21(0,48-3,41)	1105	10,60	1,33	1,33	1,33	2,91	3,50	10,40(3,40-14,50)	4,81	4,68 A++	2,16(0,49-3,63)	1080	10,20
16+16+16+35+50	1,08	1,08	1,08	2,37	3,39	9,00(2,90-11,50)	4,15	8,50 A+++	2,17(0,54-3,28)	1085	10,40	1,25	1,25	1,25	2,74	3,91	10,40(3,40-14,50)	4,73	4,68 A++	2,20(0,57-3,63)	1100	10,30
16+16+16+35+60	1,01	1,01	1,01	2,20	3,77	9,00(2,90-11,50)	4,15	8,50 A+++	2,17(0,54-3,28)	1085	10,40	1,16	1,16	1,16	2,55	4,37	10,40(3,40-14,50)	4,73	4,68 A++	2,20(0,57-3,63)	1100	10,30
16+16+16+35+71	0,94	0,94	0,94	2,05	4,13	9,00(2,90-11,50)	4,15	8,50 A+++	2,17(0,57-3,28)	1085	10,40	1,08	1,08	1,08	2,36	4,80	10,40(3,40-14,50)	4,73	4,68 A++	2,20(0,59-3,62)	1100	10,30
16+16+16+42+42	1,09	1,09	1,09	2,86	2,86	8,99(2,90-11,50)	4,07	8,50 A+++	2,21(0,49-3,41)	1105	10,60	1,26	1,26	1,26	3,31	3,31	10,40(3,40-14,50)	4,84	4,68 A++	2,15(0,50-3,62)	1075	10,10
16+16+16+42+50	1,03	1,03	1,03	2,70	3,21	9,00(2,90-11,50)	4,15	8,50 A+++	2,17(0,54-3,28)	1085	10,40	1,19	1,19	1,19	3,12	3,71	10,40(3,40-14,50)	4,73	4,68 A++	2,20(0,59-3,62)	1100	10,30
16+16+16+42+60	0,96	0,96	0,96	2,52	3,60	9,00(2,90-11,50)	4,15	8,50 A+++	2,17(0,54-3,28)	1085	10,40	1,11	1,11	1,11	2,91	4,16	10,40(3,40-14,50)	4,73	4,68 A++	2,20(0,59-3,62)	1100	10,30
16+16+16+42+71	0,89	0,89	0,89	2,35	3,98	9,00(2,90-11,50)	4,15	8,50 A+++	2,17(0,57-3,29)	1085	10,40	1,03	1,03	1,03	2,71	4,60	10,40(3,40-14,50)	4,66	4,68 A++	2,23(0,60-3,61)	1115	10,50
16+16+16+50+50	0,97	0,97	0,97	3,04	3,05	9,00(2,90-11,50)	4,11	8,50 A+++	2,19(0,62-3,23)	1095	10,50	1,12	1,12	1,12	3,52	3,52	10,40(3,40-14,50)	4,54	4,68 A++	2,29(0,69-3,63)	1145	10,80
16+16+16+50+60	0,91	0,91	0,91	2,85	3,42	9,00(2,90-11,50)	4,11	8,50 A+++	2,19(0,62-3,23)	1095	10,50	1,05	1,05	1,05	3,29	3,96	10,40(3,40-14,50)	4,54	4,68 A++	2,29(0,69-3,63)	1145	10,80
16+16+16+50+71	0,85	0,85	0,85	2,66	3,79	9,00(2,90-11,50)	3,98	8,50 A+++	2,26(0,66-3,24)	1130	10,80	0,98	0,98	0,98	3,08	3,38	10,40(3,40-14,50)	4,54	4,68 A++	2,29(0,71-3,62)	1145	10,80
16+16+16+60+60	0,86	0,86	0,86	3,21	3,21	9,00(2,90-11,50)	4,11	8,50 A+++	2,19(0,62-3,23)	1095	10,50	0,99	0,99	0,99	3,71	3,71	10,39(3,40-14,50)	4,54	4,68 A++	2,29(0,69-3,63)	1145	10,80
16+16+16+60+71	0,80	0,80	0,80	3,02	3,58	9,00(2,90-11,50)	3,98	8,50 A+++	2,26(0,66-3,24)	1130	10,80	0,93	0,93	0,93	3,49	4,12	10,40(3,40-14,50)	4,54	4,68 A++	2,29(0,71-3,62)	1145	10,80
16+16+20+20+20	1,56	1,56	1,56	1,96	1,96	9,00(2,90-11,50)	4,09	8,50 A+++	2,20(0,45-3,49)	1100	10,50	1,81	1,81	2,26	2,26	2,26	10,40(3,40-14,50)	4,86	4,68 A++	2,14(0,45-3,64)	1070	10,10
16+16+20+20+25	1,48	1,48	1,48	1,86	2,32	9,00(2,90-11,50)	4,09	8,50 A+++	2,20(0,45-3,49)	1100	10,50	1,72	1,72	2,14	2,14	2,68	10,40(3,40-14,50)	4,86	4,68 A++	2,14(0,45-3,64)	1070	10,10
16+16+20+20+35	1,35	1,35	1,35	1,68	2,94	9,00(2,90-11,50)	4,09	8,50 A+++	2,20(0,48-3,49)	1100	10,50	1,56	1,56	1,94	1,94	3,40	10,40(3,40-14,50)	4,88	4,68 A++	2,13(0,47-3,66)	1065	10,00
16+16+20+20+42	1,26	1,26	1,26	1,58	3,32	9,00(2,90-11,50)	4,09	8,50 A+++	2,20(0,48-3,41)	1100	10,50	1,46	1,46	1,82	1,82	3,84	10,40(3,40-14,50)	4,79	4,68 A++	2,17(0,48-3,65)	1085	10,20
16+16+20+20+50	1,18	1,18	1,18	1,48	3,68	9,00(2,90-11,50)	4,17	8,50 A+++	2,16(0,53-3,28)	1080	10,30	1,36	1,36	1,70	1,70	4,28						

Configure in a few steps your multi split system with our online tool.



Free Multi 5x1 CU-5Z90TBE. Minimum capacity connected: 4,5 kW. Maximum capacity connected: 18,3 kW · R32

Indoor unit capacity	Cooling capacity (kW). Rooms										EER	SEER ¹⁾	Input power rating			A.E.C.	Current	Heating capacity (kW). Rooms										COP	SCOP ¹⁾	Input power rating			A.E.C.	Current
	A	B	C	D	E	Total (Min - Max)	W/W	kW	kWh	230V			A	B	C			D	E	Total (Min - Max)	W/W	kW	kWh	230V										
16+16+25+50+71	0,81	0,81	1,26	2,53	3,59	9,00(2,90-11,50)	3,96	8,50	A+++	2,27(0,66-3,24)	1135	10,90	0,93	0,93	1,46	2,92	4,16	10,40(3,40-14,50)	4,66	4,68	A++	2,33(0,71-3,66)	1165	10,90										
16+16+25+60+60	0,81	0,81	1,28	3,05	3,05	9,00(2,90-11,50)	3,98	8,50	A+++	2,26(0,63-3,23)	1130	10,80	0,94	0,94	1,46	3,53	3,53	10,40(3,40-14,50)	4,54	4,68	A++	2,29(0,70-3,62)	1145	10,80										
16+16+35+35+35	1,05	1,05	2,30	2,30	2,30	9,00(2,90-11,50)	4,07	8,50	A+++	2,21(0,49-3,42)	1105	10,60	1,21	1,21	2,66	2,66	2,66	10,40(3,40-14,50)	4,84	4,68	A++	2,15(0,51-3,60)	1075	10,10										
16+16+35+35+42	1,00	1,00	2,19	2,19	2,62	9,00(2,90-11,50)	4,07	8,50	A+++	2,21(0,49-3,42)	1105	10,60	1,16	1,16	2,53	2,53	3,02	10,40(3,40-14,50)	4,77	4,68	A++	2,18(0,51-3,59)	1090	10,20										
16+16+35+35+50	0,95	0,95	2,07	2,07	2,96	9,00(2,90-11,50)	4,15	8,50	A+++	2,17(0,57-3,28)	1085	10,40	1,09	1,09	2,39	2,39	3,44	10,40(3,40-14,50)	4,66	4,68	A++	2,23(0,61-3,59)	1115	10,50										
16+16+35+35+60	0,89	0,89	1,94	1,94	3,34	9,00(2,90-11,50)	4,15	8,50	A+++	2,17(0,57-3,28)	1085	10,40	1,03	1,03	2,25	2,25	3,84	10,40(3,40-14,50)	4,66	4,68	A++	2,23(0,61-3,59)	1115	10,50										
16+16+35+35+71	0,83	0,83	1,82	1,82	3,70	9,00(2,90-11,50)	4,13	8,50	A+++	2,18(0,58-3,29)	1090	10,40	0,96	0,96	2,10	2,10	4,28	10,40(3,40-14,50)	4,66	4,68	A++	2,23(0,62-3,58)	1115	10,50										
16+16+35+42+42	0,95	0,95	2,10	2,50	2,50	9,00(2,90-11,50)	4,07	8,50	A+++	2,21(0,49-3,34)	1105	10,60	1,10	1,10	2,42	2,89	2,89	10,40(3,40-14,50)	4,77	4,68	A++	2,18(0,52-3,64)	1090	10,20										
16+16+35+42+50	0,91	0,91	1,98	2,38	2,82	9,00(2,90-11,50)	4,15	8,50	A+++	2,17(0,57-3,29)	1085	10,40	1,05	1,05	2,29	2,75	3,26	10,40(3,40-14,50)	4,66	4,68	A++	2,23(0,62-3,59)	1115	10,50										
16+16+35+42+60	0,85	0,85	1,86	2,24	3,20	9,00(2,90-11,50)	4,15	8,50	A+++	2,17(0,57-3,29)	1085	10,40	0,98	0,98	2,15	2,58	3,71	10,40(3,40-14,50)	4,66	4,68	A++	2,23(0,62-3,59)	1115	10,50										
16+16+35+42+71	0,80	0,80	1,75	2,10	3,55	9,00(2,90-11,50)	4,13	8,50	A+++	2,18(0,58-3,29)	1090	10,40	0,92	0,92	2,02	2,43	4,11	10,40(3,40-14,50)	4,66	4,68	A++	2,22(0,63-3,63)	1110	10,40										
16+16+35+50+50	0,86	0,86	1,90	2,69	2,69	9,00(2,90-11,50)	3,98	8,50	A+++	2,26(0,66-3,24)	1130	10,80	1,00	1,00	2,18	3,11	3,11	10,40(3,40-14,50)	4,66	4,68	A++	2,33(0,72-3,65)	1165	10,90										
16+16+35+50+60	0,81	0,81	1,78	2,54	3,06	9,00(2,90-11,50)	3,98	8,50	A+++	2,26(0,66-3,24)	1130	10,80	0,94	0,94	2,06	2,94	3,52	10,40(3,40-14,50)	4,46	4,68	A++	2,33(0,72-3,65)	1165	10,90										
16+16+42+42+42	0,91	0,91	2,39	2,39	2,39	9,00(2,90-11,50)	4,18	8,50	A+++	2,15(0,49-3,34)	1075	10,30	1,06	1,06	2,76	2,76	2,76	10,40(3,40-14,50)	4,77	4,68	A++	2,18(0,53-3,63)	1090	10,20										
16+16+42+42+50	0,87	0,87	2,28	2,28	2,70	9,00(2,90-11,50)	4,15	8,50	A+++	2,17(0,57-3,29)	1085	10,40	1,00	1,00	2,63	2,63	3,14	10,40(3,40-14,50)	4,66	4,68	A++	2,23(0,63-3,63)	1115	10,50										
16+16+42+42+60	0,82	0,82	2,15	2,15	3,06	9,00(2,90-11,50)	4,15	8,50	A+++	2,17(0,57-3,29)	1085	10,40	0,95	0,95	2,48	2,48	3,54	10,40(3,40-14,50)	4,66	4,68	A++	2,23(0,63-3,63)	1115	10,50										
16+16+42+50+50	0,83	0,83	2,16	2,59	2,59	9,00(2,90-11,50)	3,96	8,50	A+++	2,27(0,66-3,24)	1135	10,90	0,96	0,96	2,50	2,99	2,99	10,40(3,40-14,50)	4,46	4,68	A++	2,33(0,74-3,65)	1165	10,90										
16+16+50+50+50	0,79	0,79	2,47	2,47	2,47	8,99(2,90-11,50)	3,91	8,50	A+++	2,30(0,76-3,27)	1150	11,00	0,91	0,91	2,86	2,86	2,86	10,40(3,40-14,50)	4,19	4,68	A++	2,48(0,86-3,73)	1240	11,70										
16+20+20+20+20	1,48	1,88	1,88	1,88	1,88	9,00(2,90-11,50)	4,09	8,50	A+++	2,20(0,45-3,49)	1100	10,50	1,72	1,72	1,72	1,72	1,72	10,40(3,40-14,50)	4,86	4,68	A++	2,14(0,46-3,68)	1070	10,10										
16+20+20+20+25	1,43	1,78	1,78	1,78	2,23	9,00(2,90-11,50)	4,09	8,50	A+++	2,20(0,45-3,49)	1100	10,50	1,65	2,06	2,06	2,06	2,57	10,40(3,40-14,50)	4,86	4,68	A++	2,14(0,46-3,68)	1070	10,10										
16+20+20+20+35	1,30	1,62	1,62	1,62	2,84	9,00(2,90-11,50)	4,09	8,50	A+++	2,20(0,48-3,41)	1100	10,50	1,50	1,87	1,87	1,87	3,29	10,40(3,40-14,50)	4,79	4,68	A++	2,17(0,48-3,65)	1085	10,20										
16+20+20+20+42	1,22	1,53	1,53	1,53	3,19	9,00(2,90-11,50)	4,07	8,50	A+++	2,21(0,48-3,41)	1105	10,60	1,41	1,76	1,76	1,76	3,71	10,40(3,40-14,50)	4,71	4,68	A++	2,16(0,48-3,64)	1080	10,20										
16+20+20+20+50	1,14	1,43	1,43	1,43	3,57	9,00(2,90-11,50)	4,17	8,50	A+++	2,16(0,54-3,28)	1080	10,30	1,32	1,65	1,65	1,65	4,13	10,40(3,40-14,50)	4,73	4,68	A++	2,20(0,57-3,58)	1100	10,30										
16+20+20+20+60	1,06	1,32	1,32	1,32	3,98	9,00(2,90-11,50)	4,17	8,50	A+++	2,16(0,54-3,28)	1080	10,30	1,22	1,53	1,53	1,53	4,59	10,40(3,40-14,50)	4,73	4,68	A++	2,20(0,57-3,58)	1100	10,30										
16+20+20+20+71	0,98	1,22	1,22	1,22	4,36	9,00(2,90-11,50)	4,15	8,50	A+++	2,17(0,57-3,28)	1085	10,40	1,13	1,41	1,41	1,41	5,04	10,40(3,40-14,50)	4,73	4,68	A++	2,20(0,58-3,62)	1100	10,30										
16+20+20+25+25	1,36	1,70	1,70	2,12	2,12	9,00(2,90-11,50)	4,09	8,50	A+++	2,20(0,45-3,49)	1100	10,50	1,58	1,96	1,96	2,45	2,45	10,40(3,40-14,50)	4,86	4,68	A++	2,14(0,46-3,68)	1070	10,10										
16+20+20+25+35	1,24	1,55	1,55	1,94	2,72	9,00(2,90-11,50)	4,09	8,50	A+++	2,20(0,48-3,41)	1100	10,50	1,43	1,79	1,79	2,24	3,15	10,40(3,40-14,50)	4,79	4,68	A++	2,17(0,48-3,65)	1085	10,20										
16+20+20+25+42	1,17	1,46	1,46	1,83	3,08	9,00(2,90-11,50)	4,07	8,50	A+++	2,21(0,48-3,41)	1105	10,60	1,35	1,69	1,69	2,11	3,56	10,40(3,40-14,50)	4,81	4,68	A++	2,16(0,48-3,64)	1080	10,20										
16+20+20+25+50	1,10	1,37	1,37	1,72	3,44	9,00(2,90-11,50)	4,17	8,50	A+++	2,16(0,54-3,28)	1080	10,30	1,27	1,59	1,59	1,98	3,97	10,40(3,40-14,50)	4,73	4,68	A++	2,20(0,57-3,58)	1100	10,30										
16+20+20+25+60	1,02	1,28	1,28	1,60	3,82	9,00(2,90-11,50)	4,17	8,50	A+++	2,16(0,54-3,28)	1080	10,30	1,18	1,48	1,48	1,84	4,42	10,40(3,40-14,50)	4,73	4,68	A++	2,20(0,58-3,58)	1100	10,30										
16+20+20+25+71	0,95	1,18	1,18	1,48	4,21	9,00(2,90-11,50)	4,15	8,50	A+++	2,17(0,57-3,28)	1085	10,40	1,09	1,37	1,37	1,71	4,86	10,40(3,40-14,50)	4,73	4,68	A++	2,20(0,57-3,58)	1100	10,30										
16+20+20+35+35	1,14	1,43	1,43	2,50	2,50	9,00(2,90-11,50)	4,07	8,50	A+++	2,21(0,49-3,41)	1105	10,60	1,32	1,65	1,65	2,89	2,89	10,40(3,40-14,50)	4,84	4,68	A++	2,15(0,50-3,62)	1075	10,10										
16+20+20+35+42	1,08	1,35	1,35	2,37	2,85	9,00(2,90-11,50)	4,07	8,50	A+++	2,21(0,49-3,42)	1105	10,60	1,25	1,56	1,56	2,74	3,29	10,40(3,40-14,50)	4,84	4,68	A++	2,15(0,51-3,61)	1075	10,10										
16+20+20+35+50	1,02	1,28	1,28	2,33	3,19	9,00(2,90-11,50)	4,15	8,50	A+++	2,17(0,57-3,28)	1085	10,40	1,18	1,48	1,48	2,58	3,68	10,40(3,40-14,50)	4,75	4,68	A++	2,19(0,60-3,61)	1095	10,30										
16+20+20+35+60	0,95	1,19	1,19	2,09	3,58	9,00(2,90-11,50)	4,15	8,50	A+++	2,17(0,57-3,28)	1085	10,40	1,10	1,38	1,38	2,41	4,13	10,40(3,40-14,50)	4,75	4,68	A++	2,19(0,60-3,61)	1095	10,30										
16+20+20+35+71	0,89	1,11	1,11	1,94	3,95	9,00(2,90-11,50)	4,13	8,50	A+++	2,18(0,58-3,29)	1090	10,40	1,03	1,28	1,28	2,25	4,56	10,40(3,40-14,50)	4,66	4,68	A++	2,23(0,61-3,60)	1115	10,50										
16+20+20+42+42	1,02	1,29	1,29	2,70	2,70	9,00(2,90-11,50)	4,07	8,50	A+++	2,21(0,49-3,42)	1105	10,60	1,18	1,49	1,49	3,12	3,12	10,40(3,40-14,50)	4,84	4,68	A++	2,15(0,51-3,60)	1075	10,10										
16+20+20+42+50	0,97	1,22	1,22	2,55	3,04	9,00(2,90-11,50)	4,15	8,50	A+++	2,17(0,57-3,28)	1085	10,40	1,12	1,41	1,41	2,95	3,51	10,40(3,40-14,50)	4,66	4,68	A++	2,23(0,60-3,60)	1115	10,50										
16+20+20+42+60	0,91	1,14	1,14	2,39	3,42	9,00(2,90-11,50)	4,15	8,50	A+++	2,17(0,57-3,28)	1085	10,40	1,05	1,32	1,32	2,76	3,95	10,40(3,40-14,50)	4,66	4,68	A++	2,23(0,60-3,60)	1115	10,50										
16+20+20+42+71	0,85	1,07	1,07	2,24	3,77	9,00(2,90-11,50)	4,13	8,50	A+++	2,18(0,58-3,29)	1090	10,40	0,98	1,23	1,23	2,58	4,38	10,40(3,40-14,50)	4,66	4,68	A++	2,23(0,62-3,59)	1115	10,50										
16+20+20+50+50	0,94	1,15	1,15	2,88	2,88	9,00(2,90-11,50)	3,98	8,50	A+++	2,26(0,63-3,23)	1130	10,80	1,08	1,33	1,33	3,33	3,33	10,40(3,40-14,50)	4,46	4,68	A++	2,33(0,71-3,61)	1165	10,90										
16+20+20+50+60	0,87	1,08	1,08	2,71	3,26	9,00(2,90-11,50)	3,98	8,50	A+++	2,26(0,63-3,23)	1130	10,80	1,00	1,25	1,25	3,13	3,77	10,40(3,40-14,50)	4,46	4,68	A++	2,33(0,71-3,61)	1165	10,90										



Free Multi R32 combinations table

Free Multi 5x1 CU-5Z90TBE. Minimum capacity connected: 4,5 kW. Maximum capacity connected: 18,3 kW - R32

Indoor unit capacity	Cooling capacity (kW). Rooms										EER	SEER ¹⁾	Input power rating			A.E.C.	Current	Heating capacity (kW). Rooms										COP	SCOP ¹⁾	Input power rating			A.E.C.	Current
	A	B	C	D	E	Total (Min-Max)	W/W	kW	kWh	230V			A	B	C			D	E	Total (Min-Max)	W/W	kW	kWh	230V										
16+25+25+25+50	1,02	1,60	1,60	1,60	3,18	9,00(2,90-11,50)	4,17	8,50 A+++	2,16(0,54-3,28)	1080	10,30	1,18	1,84	1,84	1,84	3,70	10,40(3,40-14,50)	4,73	4,68 A++	2,20(0,57-3,58)	1100	10,30												
16+25+25+25+60	0,95	1,49	1,49	1,49	3,58	9,00(2,90-11,50)	4,17	8,50 A+++	2,16(0,54-3,28)	1080	10,30	1,10	1,72	1,72	1,72	4,14	10,40(3,40-14,50)	4,73	4,68 A++	2,20(0,57-3,58)	1100	10,30												
16+25+25+25+71	0,89	1,39	1,39	1,39	3,94	9,00(2,90-11,50)	4,15	8,50 A+++	2,17(0,57-3,28)	1085	10,40	1,03	1,60	1,60	1,60	4,57	10,40(3,40-14,50)	4,73	4,68 A++	2,20(0,58-3,62)	1100	10,30												
16+25+25+35+35	1,06	1,65	1,65	2,32	2,32	9,00(2,90-11,50)	4,07	8,50 A+++	2,21(0,49-3,41)	1105	10,60	1,22	1,91	1,91	2,68	2,68	10,40(3,40-14,50)	4,84	4,68 A++	2,15(0,50-3,62)	1075	10,10												
16+25+25+35+42	1,01	1,57	1,57	2,20	2,65	9,00(2,90-11,50)	4,07	8,50 A+++	2,21(0,49-3,42)	1105	10,60	1,16	1,82	1,82	2,55	3,05	10,40(3,40-14,50)	4,84	4,68 A++	2,15(0,51-3,61)	1075	10,10												
16+25+25+35+50	0,95	1,49	1,49	2,09	2,98	9,00(2,90-11,50)	4,15	8,50 A+++	2,17(0,57-3,28)	1085	10,40	1,10	1,72	1,72	2,41	3,45	10,40(3,40-14,50)	4,75	4,68 A++	2,19(0,60-3,61)	1095	10,30												
16+25+25+35+60	0,89	1,40	1,40	1,96	3,35	9,00(2,90-11,50)	4,15	8,50 A+++	2,17(0,57-3,28)	1085	10,40	1,03	1,61	1,61	2,26	3,89	10,40(3,40-14,50)	4,75	4,68 A++	2,19(0,60-3,61)	1095	10,30												
16+25+25+35+71	0,84	1,31	1,31	1,83	3,71	9,00(2,90-11,50)	4,13	8,50 A+++	2,18(0,58-3,29)	1090	10,40	0,97	1,51	1,51	2,12	4,29	10,40(3,40-14,50)	4,66	4,68 A++	2,23(0,60-3,60)	1115	10,50												
16+25+25+42+42	0,96	1,50	1,50	2,52	2,52	9,00(2,90-11,50)	4,07	8,50 A+++	2,21(0,49-3,42)	1105	10,60	1,12	1,73	1,73	2,91	2,91	10,40(3,40-14,50)	4,84	4,68 A++	2,15(0,51-3,60)	1075	10,10												
16+25+25+42+50	0,91	1,42	1,42	2,39	2,86	9,00(2,90-11,50)	4,15	8,50 A+++	2,17(0,57-3,28)	1085	10,40	1,05	1,65	1,65	2,76	3,29	10,40(3,40-14,50)	4,66	4,68 A++	2,23(0,60-3,60)	1115	10,50												
16+25+25+42+60	0,86	1,34	1,34	2,25	3,21	9,00(2,90-11,50)	4,15	8,50 A+++	2,17(0,57-3,28)	1085	10,40	0,99	1,55	1,55	2,60	3,71	10,40(3,40-14,50)	4,66	4,68 A++	2,23(0,60-3,60)	1115	10,50												
16+25+25+42+71	0,80	1,26	1,26	2,11	3,57	9,00(2,90-11,50)	4,13	8,50 A+++	2,18(0,58-3,29)	1090	10,40	0,93	1,45	1,45	2,44	4,13	10,40(3,40-14,50)	4,66	4,68 A++	2,23(0,62-3,59)	1115	10,50												
16+25+25+50+50	0,86	1,36	1,36	2,71	2,71	9,00(2,90-11,50)	3,98	8,50 A+++	2,26(0,63-3,23)	1130	10,80	1,00	1,57	1,57	3,13	3,13	10,40(3,40-14,50)	4,46	4,68 A++	2,33(0,71-3,61)	1165	10,90												
16+25+25+50+60	0,82	1,28	1,28	2,56	3,06	9,00(2,90-11,50)	3,98	8,50 A+++	2,26(0,63-3,23)	1130	10,80	0,95	1,48	1,48	2,95	3,54	10,40(3,40-14,50)	4,46	4,68 A++	2,33(0,71-3,61)	1165	10,90												
16+25+35+35+35	0,99	1,53	2,16	2,16	2,16	9,00(2,90-11,50)	4,07	8,50 A+++	2,21(0,49-3,34)	1105	10,60	1,14	1,79	2,49	2,49	2,49	10,40(3,40-14,50)	4,77	4,68 A++	2,18(0,51-3,59)	1090	10,20												
16+25+35+35+42	0,94	1,47	2,06	2,06	2,47	9,00(2,90-11,50)	4,19	8,50 A+++	2,15(0,49-3,34)	1075	10,30	1,09	1,70	2,38	2,38	2,85	10,40(3,40-14,50)	4,77	4,68 A++	2,18(0,52-3,64)	1090	10,20												
16+25+35+35+50	0,89	1,40	1,96	1,96	2,79	9,00(2,90-11,50)	4,15	8,50 A+++	2,17(0,57-3,29)	1085	10,40	1,03	1,61	2,26	2,26	3,24	10,40(3,40-14,50)	4,66	4,68 A++	2,23(0,62-3,59)	1115	10,50												
16+25+35+35+60	0,84	1,32	1,84	1,84	3,16	9,00(2,90-11,50)	4,15	8,50 A+++	2,17(0,57-3,29)	1085	10,40	0,97	1,52	2,13	2,13	3,65	10,40(3,40-14,50)	4,66	4,68 A++	2,23(0,62-3,59)	1115	10,50												
16+25+35+35+71	0,79	1,24	1,73	1,73	3,51	9,00(2,90-11,50)	4,13	8,50 A+++	2,18(0,58-3,29)	1090	10,40	0,91	1,43	2,00	2,00	4,06	10,40(3,40-14,50)	4,68	4,68 A++	2,22(0,63-3,63)	1110	10,40												
16+25+35+42+42	0,90	1,41	1,97	2,36	2,36	9,00(2,90-11,50)	4,19	8,50 A+++	2,15(0,49-3,34)	1075	10,30	1,03	1,63	2,28	2,73	2,73	10,40(3,40-14,50)	4,77	4,68 A++	2,18(0,53-3,63)	1090	10,20												
16+25+35+42+50	0,86	1,34	1,88	2,25	2,67	9,00(2,90-11,50)	4,13	8,50 A+++	2,18(0,58-3,29)	1090	10,40	0,99	1,55	2,17	2,60	3,09	10,40(3,40-14,50)	4,66	4,68 A++	2,23(0,63-3,63)	1115	10,50												
16+25+35+42+60	0,81	1,26	1,77	2,12	3,04	9,00(2,90-11,50)	4,13	8,50 A+++	2,18(0,58-3,29)	1090	10,40	0,93	1,46	2,04	2,45	3,52	10,40(3,40-14,50)	4,66	4,68 A++	2,23(0,63-3,63)	1115	10,50												
16+25+35+50+50	0,82	1,28	1,78	2,56	2,56	9,00(2,90-11,50)	3,96	8,50 A+++	2,27(0,66-3,24)	1135	10,90	0,95	1,48	2,07	2,95	2,95	10,40(3,40-14,50)	4,46	4,68 A++	2,33(0,74-3,65)	1165	10,90												
16+25+42+42+42	0,86	1,36	2,26	2,26	2,26	9,00(2,90-11,50)	4,19	8,50 A+++	2,15(0,52-3,34)	1075	10,30	0,98	1,56	2,62	2,62	2,62	10,40(3,40-14,50)	4,79	4,68 A++	2,17(0,54-3,62)	1085	10,20												
16+25+42+42+50	0,82	1,29	2,16	2,16	2,57	9,00(2,90-11,50)	4,13	8,50 A+++	2,18(0,58-3,29)	1090	10,40	0,95	1,49	2,50	2,50	2,96	10,40(3,40-14,50)	4,60	4,68 A++	2,26(0,63-3,62)	1130	10,60												
16+25+42+50+50	0,79	1,23	2,04	2,46	2,46	9,00(2,90-11,50)	3,96	8,50 A+++	2,27(0,67-3,24)	1135	10,90	0,91	1,42	2,39	2,84	2,84	10,40(3,40-14,50)	4,41	4,68 A++	2,36(0,75-3,64)	1180	11,10												
16+35+35+35+35	0,92	2,02	2,02	2,02	2,02	9,00(2,90-11,50)	4,19	8,50 A+++	2,15(0,52-3,35)	1075	10,30	1,08	2,33	2,33	2,33	2,33	10,40(3,40-14,50)	4,79	4,68 A++	2,17(0,54-3,62)	1085	10,20												
16+35+35+35+42	0,88	1,93	1,93	1,93	2,33	9,00(2,90-11,50)	4,17	8,50 A+++	2,16(0,52-3,35)	1080	10,30	1,02	2,23	2,23	2,23	2,69	10,40(3,40-14,50)	4,79	4,68 A++	2,17(0,54-3,61)	1085	10,20												
16+35+35+35+50	0,84	1,84	1,84	1,84	2,64	9,00(2,90-11,50)	4,13	8,50 A+++	2,18(0,58-3,29)	1090	10,40	0,97	2,13	2,13	2,13	3,04	10,40(3,40-14,50)	4,60	4,68 A++	2,26(0,65-3,62)	1130	10,60												
16+35+35+35+60	0,80	1,74	1,74	1,74	2,98	9,00(2,90-11,50)	4,13	8,50 A+++	2,18(0,58-3,29)	1090	10,40	0,92	2,01	2,01	2,01	3,45	10,40(3,40-14,50)	4,60	4,68 A++	2,26(0,65-3,62)	1130	10,60												
16+35+35+42+42	0,86	1,85	2,22	2,22	2,22	9,00(2,90-11,50)	4,17	8,50 A+++	2,16(0,53-3,35)	1080	10,30	0,98	2,14	2,14	2,57	2,57	10,40(3,40-14,50)	4,79	4,68 A++	2,17(0,55-3,60)	1085	10,20												
16+35+35+42+50	0,81	1,77	1,77	2,12	2,53	9,00(2,90-11,50)	4,13	8,50 A+++	2,18(0,58-3,29)	1090	10,40	0,93	2,04	2,04	2,45	2,94	10,40(3,40-14,50)	4,60	4,68 A++	2,26(0,65-3,61)	1130	10,60												
16+35+42+42+42	0,81	1,77	2,14	2,14	2,14	9,00(2,90-11,50)	4,17	8,50 A+++	2,16(0,53-3,35)	1080	10,30	0,93	2,06	2,47	2,47	2,47	10,40(3,40-14,50)	4,73	4,68 A++	2,20(0,56-3,59)	1100	10,30												
20+20+20+20+20	1,80	1,80	1,80	1,80	1,80	9,00(2,90-11,50)	4,09	8,50 A+++	2,20(0,48-3,49)	1100	10,50	2,08	2,08	2,08	2,08	2,08	10,40(3,40-14,50)	4,88	4,68 A++	2,13(0,46-3,67)	1065	10,00												
20+20+20+20+25	1,71	1,71	1,71	1,71	2,16	9,00(2,90-11,50)	4,09	8,50 A+++	2,20(0,48-3,49)	1100	10,50	1,98	1,98	1,98	1,98	2,48	10,40(3,40-14,50)	4,88	4,68 A++	2,13(0,46-3,67)	1065	10,00												
20+20+20+20+35	1,57	1,57	1,57	1,57	2,72	9,00(2,90-11,50)	4,07	8,50 A+++	2,21(0,48-3,41)	1105	10,60	1,81	1,81	1,81	1,81	3,16	10,40(3,40-14,50)	4,81	4,68 A++	2,16(0,48-3,64)	1080	10,20												
20+20+20+20+42	1,48	1,48	1,48	1,48	3,08	9,00(2,90-11,50)	4,07	8,50 A+++	2,21(0,49-3,41)	1105	10,60	1,70	1,70	1,70	1,70	3,60	10,40(3,40-14,50)	4,81	4,68 A++	2,16(0,49-3,63)	1080	10,20												
20+20+20+20+50	1,38	1,38	1,38	1,38	3,48	9,00(2,90-11,50)	4,15	8,50 A+++	2,17(0,54-3,28)	1085	10,40	1,60	1,60	1,60	1,60	4,00	10,40(3,40-14,50)	4,73	4,68 A++	2,20(0,58-3,63)	1100	10,30												
20+20+20+20+60	1,29	1,29	1,29	1,29	3,84	9,00(2,90-11,50)	4,15	8,50 A+++	2,17(0,54-3,28)	1085	10,40	1,49	1,49	1,49	1,49	4,44	10,40(3,40-14,50)	4,73	4,68 A++	2,20(0,58-3,63)	1100	10,30												
20+20+20+20+71	1,19	1,19	1,19	1,19	4,24	9,00(2,90-11,50)	4,15	8,50 A+++	2,17(0,57-3,28)	1085	10,40	1,38	1,38	1,38	1,38	4,88	10,40(3,40-14,50)	4,75	4,68 A++	2,19(0,59-3,61)	1095	10,30												
20+20+20+25+25	1,64	1,64	1,64	2,04	2,04	9,00(2,90-11,50)	4,09	8,50 A+++	2,20(0,48-3,49)	1100	10,50	1,89	1,89	1,89	2,36	2,36	10,40(3,40-14,50)	4,88	4,68 A++	2,13(0,46-3,67)	1065	10,00												
20+20+20+25+35	1,50	1,50	1,50	1,88	2,62	9,00(2,90-11,50)	4,07	8,50 A+++	2,21(0,48-3,41)	1105	10,60	1,73	1,73	1,73	2,17	3,04	10,40(3,40-14,50)	4,81	4,68 A++	2,16(0,48-3,64)	1080	10,20												
20+20+20+25+42	1,42	1,42	1,42	1,77	2,97	9,00(2,90-11,50)	4,07	8,50 A+++	2,21(0,49-3,41)	1105	10,60	1,64	1,64	1,64	2,05	3,43	10,40(3,40-14,50)	4,81	4,68 A++	2,16(0,49-3,63)	1080	10,20												
20+20+20+25+50	1,33	1,33	1,33	1,67	3,34	9,00(2,90-11,50)	4,15																											

Configure in a few steps your multi split system with our online tool.



Free Multi 5x1 CU-5Z90TBE. Minimum capacity connected: 4,5 kW. Maximum capacity connected: 18,3 kW · R32

Indoor unit capacity	Cooling capacity (kW). Rooms										EER	SEER ¹⁾	Input power rating			A.E.C.	Current	Heating capacity (kW). Rooms										COP	SCOP ¹⁾	Input power rating			A.E.C.	Current
	A	B	C	D	E	Total (Min - Max)	W/W	kW	kWh	230V			A	B	C			D	E	Total (Min - Max)	W/W	kW	kWh	230V										
20+20+35+35+71	0,99	0,99	1,74	1,74	3,54	9,00(2,90-11,50)	4,13	8,50 A+++	2,18(0,61-3,29)	1090	10,40	1,15	1,15	2,01	2,01	4,08	10,40(3,40-14,50)	4,60	4,68 A++	2,26(0,64-3,62)	1130	10,60												
20+20+35+42+42	1,13	1,13	1,98	2,38	2,38	9,00(2,90-11,50)	4,19	8,50 A+++	2,15(0,52-3,35)	1075	10,30	1,31	1,31	2,28	2,75	10,40(3,40-14,50)	4,79	4,68 A++	2,17(0,54-3,62)	1085	10,20													
20+20+35+42+50	1,08	1,08	1,89	2,26	2,69	9,00(2,90-11,50)	4,13	8,50 A+++	2,18(0,58-3,29)	1090	10,40	1,25	1,25	2,18	2,62	10,40(3,40-14,50)	4,60	4,68 A++	2,26(0,63-3,62)	1130	10,60													
20+20+35+42+60	1,02	1,02	1,78	2,14	3,04	9,00(2,90-11,50)	4,13	8,50 A+++	2,18(0,58-3,29)	1090	10,40	1,18	1,18	2,06	2,47	10,40(3,40-14,50)	4,60	4,68 A++	2,26(0,63-3,62)	1130	10,60													
20+20+35+50+50	1,03	1,03	1,80	2,57	2,57	9,00(2,90-11,50)	3,96	8,50 A+++	2,27(0,67-3,24)	1135	10,90	1,19	1,19	2,08	2,97	10,40(3,40-14,50)	4,41	4,68 A++	2,36(0,75-3,64)	1180	11,10													
20+20+42+42+42	1,08	1,08	2,28	2,28	2,28	9,00(2,90-11,50)	4,19	8,50 A+++	2,15(0,52-3,35)	1075	10,30	1,25	1,25	2,63	2,63	10,39(3,40-14,50)	4,79	4,68 A++	2,17(0,54-3,61)	1085	10,20													
20+20+42+42+50	1,03	1,03	2,17	2,17	2,60	9,00(2,90-11,50)	4,13	8,50 A+++	2,18(0,58-3,29)	1090	10,40	1,20	1,20	2,51	2,51	10,40(3,40-14,50)	4,60	4,68 A++	2,26(0,65-3,61)	1130	10,60													
20+20+42+50+50	0,99	0,99	2,08	2,47	2,47	9,00(2,90-11,50)	3,96	8,50 A+++	2,27(0,67-3,24)	1135	10,90	1,14	1,14	2,40	2,86	10,40(3,40-14,50)	4,39	4,68 A++	2,37(0,75-3,69)	1185	11,10													
20+25+25+25+25	1,48	1,88	1,88	1,88	1,88	9,00(2,90-11,50)	4,09	8,50 A+++	2,20(0,48-3,49)	1100	10,50	1,72	1,72	2,17	2,17	10,40(3,40-14,50)	4,88	4,68 A++	2,13(0,46-3,67)	1065	10,00													
20+25+25+25+35	1,38	1,73	1,73	1,73	2,43	9,00(2,90-11,50)	4,07	8,50 A+++	2,21(0,48-3,41)	1105	10,60	1,60	2,00	2,00	2,00	10,40(3,40-14,50)	4,81	4,68 A++	2,16(0,48-3,64)	1080	10,20													
20+25+25+25+42	1,31	1,64	1,64	1,64	2,77	9,00(2,90-11,50)	4,07	8,50 A+++	2,21(0,49-3,41)	1105	10,60	1,52	1,90	1,90	3,18	10,40(3,40-14,50)	4,81	4,68 A++	2,16(0,49-3,63)	1080	10,20													
20+25+25+25+50	1,24	1,55	1,55	1,55	3,11	9,00(2,90-11,50)	4,15	8,50 A+++	2,17(0,54-3,28)	1085	10,40	1,43	1,79	1,79	3,60	10,40(3,40-14,50)	4,73	4,68 A++	2,20(0,58-3,63)	1100	10,30													
20+25+25+25+60	1,16	1,45	1,45	1,45	3,49	9,00(2,90-11,50)	4,15	8,50 A+++	2,17(0,54-3,28)	1085	10,40	1,34	1,68	1,68	4,02	10,40(3,40-14,50)	4,73	4,68 A++	2,20(0,58-3,63)	1100	10,30													
20+25+25+25+71	1,08	1,36	1,36	1,36	3,84	9,00(2,90-11,50)	4,15	8,50 A+++	2,17(0,57-3,28)	1085	10,40	1,25	1,57	1,57	4,44	10,40(3,40-14,50)	4,75	4,68 A++	2,19(0,59-3,61)	1095	10,30													
20+25+25+35+35	1,28	1,61	1,61	2,25	2,25	9,00(2,90-11,50)	4,07	8,50 A+++	2,21(0,49-3,42)	1105	10,60	1,48	1,86	1,86	2,60	10,40(3,40-14,50)	4,84	4,68 A++	2,15(0,51-3,61)	1075	10,10													
20+25+25+35+42	1,22	1,53	1,53	2,14	2,58	9,00(2,90-11,50)	4,07	8,50 A+++	2,21(0,49-3,42)	1105	10,60	1,41	1,77	1,77	2,48	10,40(3,40-14,50)	4,84	4,68 A++	2,15(0,51-3,60)	1075	10,10													
20+25+25+35+50	1,16	1,45	1,45	2,03	2,91	9,00(2,90-11,50)	4,15	8,50 A+++	2,17(0,57-3,28)	1085	10,40	1,34	1,68	1,68	2,35	10,40(3,40-14,50)	4,66	4,68 A++	2,23(0,60-3,60)	1115	10,50													
20+25+25+35+60	1,09	1,36	1,36	1,91	3,28	9,00(2,90-11,50)	4,15	8,50 A+++	2,17(0,57-3,28)	1085	10,40	1,26	1,58	1,58	2,21	10,40(3,40-14,50)	4,66	4,68 A++	2,23(0,60-3,60)	1115	10,50													
20+25+25+35+71	1,02	1,28	1,28	1,79	3,63	9,00(2,90-11,50)	4,13	8,50 A+++	2,18(0,58-3,29)	1090	10,40	1,18	1,48	1,48	2,07	4,19	10,40(3,40-14,50)	4,66	4,68 A++	2,23(0,62-3,59)	1115	10,50												
20+25+25+42+42	1,18	1,46	1,46	2,45	2,45	9,00(2,90-11,50)	4,07	8,50 A+++	2,21(0,49-3,42)	1105	10,60	1,34	1,69	1,69	2,84	10,40(3,40-14,50)	4,77	4,68 A++	2,18(0,52-3,59)	1090	10,20													
20+25+25+42+50	1,11	1,39	1,39	2,33	2,78	9,00(2,90-11,50)	4,15	8,50 A+++	2,17(0,57-3,28)	1085	10,40	1,28	1,60	1,60	2,70	10,40(3,40-14,50)	4,66	4,68 A++	2,23(0,61-3,59)	1115	10,50													
20+25+25+42+60	1,05	1,31	1,31	2,20	3,13	9,00(2,90-11,50)	4,15	8,50 A+++	2,17(0,57-3,28)	1085	10,40	1,21	1,51	1,51	2,54	10,40(3,40-14,50)	4,66	4,68 A++	2,23(0,61-3,59)	1115	10,50													
20+25+25+42+71	0,98	1,23	1,23	2,07	3,49	9,00(2,90-11,50)	4,13	8,50 A+++	2,18(0,58-3,29)	1090	10,40	1,14	1,42	1,42	2,39	4,03	10,40(3,40-14,50)	4,66	4,68 A++	2,23(0,63-3,63)	1115	10,50												
20+25+25+50+50	1,06	1,32	1,32	2,65	2,65	9,00(2,90-11,50)	3,98	8,50 A+++	2,26(0,66-3,23)	1130	10,80	1,22	1,53	1,53	3,06	3,06	10,40(3,40-14,50)	4,46	4,68 A++	2,33(0,72-3,66)	1165	10,90												
20+25+25+50+60	1,00	1,25	1,25	2,50	3,00	9,00(2,90-11,50)	3,98	8,50 A+++	2,26(0,66-3,23)	1130	10,80	1,16	1,44	1,44	2,89	3,47	10,40(3,40-14,50)	4,46	4,68 A++	2,33(0,72-3,66)	1165	10,90												
20+25+35+35+35	1,20	1,50	2,10	2,10	2,10	9,00(2,90-11,50)	4,19	8,50 A+++	2,15(0,49-3,34)	1075	10,30	1,38	1,73	2,43	2,43	2,43	10,40(3,40-14,50)	4,77	4,68 A++	2,18(0,52-3,64)	1090	10,20												
20+25+35+35+42	1,15	1,43	2,01	2,01	2,40	9,00(2,90-11,50)	4,19	8,50 A+++	2,15(0,50-3,34)	1075	10,30	1,32	1,66	2,32	2,32	2,78	10,40(3,40-14,50)	4,77	4,68 A++	2,18(0,53-3,63)	1090	10,20												
20+25+35+35+50	1,09	1,36	1,91	1,91	2,73	9,00(2,90-11,50)	4,13	8,50 A+++	2,18(0,58-3,29)	1090	10,40	1,26	1,58	2,21	2,21	3,14	10,40(3,40-14,50)	4,66	4,68 A++	2,23(0,63-3,63)	1115	10,50												
20+25+35+35+60	1,03	1,29	1,80	1,80	3,08	9,00(2,90-11,50)	4,13	8,50 A+++	2,18(0,58-3,29)	1090	10,40	1,19	1,49	2,08	2,08	3,56	10,40(3,40-14,50)	4,66	4,68 A++	2,23(0,63-3,63)	1115	10,50												
20+25+35+42+42	1,10	1,37	1,93	2,30	2,30	9,00(2,90-11,50)	4,19	8,50 A+++	2,15(0,52-3,35)	1075	10,30	1,27	1,59	2,22	2,66	2,66	10,40(3,40-14,50)	4,79	4,68 A++	2,17(0,54-3,62)	1085	10,20												
20+25+35+42+50	1,05	1,31	1,83	2,20	2,61	9,00(2,90-11,50)	4,13	8,50 A+++	2,18(0,58-3,29)	1090	10,40	1,21	1,51	2,12	2,54	3,02	10,40(3,40-14,50)	4,60	4,68 A++	2,26(0,63-3,62)	1130	10,60												
20+25+35+42+60	0,99	1,24	1,73	2,08	2,96	9,00(2,90-11,50)	4,13	8,50 A+++	2,18(0,58-3,29)	1090	10,40	1,14	1,43	2,00	2,40	3,43	10,40(3,40-14,50)	4,60	4,68 A++	2,26(0,63-3,62)	1130	10,60												
20+25+35+50+50	1,00	1,25	1,75	2,50	2,50	9,00(2,90-11,50)	3,96	8,50 A+++	2,27(0,67-3,24)	1135	10,90	1,16	1,44	2,02	2,89	2,89	10,40(3,40-14,50)	4,41	4,68 A++	2,36(0,75-3,64)	1180	11,10												
20+25+42+42+42	1,05	1,32	2,21	2,21	2,21	9,00(2,90-11,50)	4,19	8,50 A+++	2,15(0,52-3,35)	1075	10,30	1,23	1,52	2,05	2,55	2,55	10,40(3,40-14,50)	4,79	4,68 A++	2,17(0,54-3,61)	1085	10,20												
20+25+42+42+50	1,01	1,26	2,11	2,11	2,51	9,00(2,90-11,50)	4,13	8,50 A+++	2,18(0,58-3,29)	1090	10,40	1,16	1,45	2,44	2,44	2,91	10,40(3,40-14,50)	4,60	4,68 A++	2,26(0,65-3,61)	1130	10,60												
20+35+35+35+35	1,12	1,97	1,97	1,97	1,97	9,00(2,90-11,50)	4,17	8,50 A+++	2,16(0,53-3,35)	1080	10,30	1,28	2,28	2,28	2,28	2,28	10,40(3,40-14,50)	4,79	4,68 A++	2,17(0,54-3,61)	1085	10,20												
20+35+35+35+42	1,08	1,89	1,89	1,89	2,25	9,00(2,90-11,50)	4,17	8,50 A+++	2,16(0,53-3,35)	1080	10,30	1,25	2,18	2,18	2,18	2,61	10,40(3,40-14,50)	4,79	4,68 A++	2,17(0,55-3,60)	1085	10,20												
20+35+35+35+50	1,03	1,80	1,80	1,80	2,57	9,00(2,90-11,50)	4,13	8,50 A+++	2,18(0,58-3,29)	1090	10,40	1,19	2,08	2,08	2,08	2,97	10,40(3,40-14,50)	4,60	4,68 A++	2,26(0,65-3,61)	1130	10,60												
20+35+35+42+42	1,04	1,81	1,81	2,17	2,17	9,00(2,90-11,50)	4,17	8,50 A+++	2,16(0,53-3,35)	1080	10,30	1,20	2,09	2,09	2,51	2,51	10,40(3,40-14,50)	4,73	4,68 A++	2,20(0,56-3,59)	1100	10,30												
20+35+35+42+50	0,99																																	



Multi TZ combinations table

Multi TZ 2x1 CU-2TZ41TBE. Minimum capacity connected: 3,2 kW. Maximum capacity connected: 6,0 kW - R32

Indoor unit capacity	Cooling capacity (kW). Rooms			EER	SEER ¹⁾	Input power rating			A.E.C.	Current	Heating capacity (kW). Rooms			COP	SCOP ¹⁾	Input power rating			A.E.C.	Current	
	A	B	Total (Min - Max)			W/W	kW	kWh			230V	A	B			Total (Min - Max)	W/W	kW			kWh
1 Room																					
16	1,60		1,60 (1,10 - 2,30)	3,56		0,45 (0,24 - 0,65)	225	2,15	2,60		2,60 (0,70 - 3,80)	3,42		0,76 (0,18 - 1,24)	380	3,50					
20	2,00		2,00 (1,10 - 2,90)	3,51		0,57 (0,24 - 0,83)	285	2,70	3,20		3,20 (0,70 - 4,80)	3,44		0,93 (0,18 - 1,57)	465	4,30					
25	2,50		2,50 (1,10 - 3,50)	3,47		0,72 (0,24 - 1,07)	360	3,40	3,60		3,60 (0,70 - 5,50)	3,24		1,11 (0,18 - 1,88)	555	5,15					
35	3,50		3,50 (1,10 - 4,00)	3,24		1,08 (0,24 - 1,30)	540	5,05	4,30		4,30 (0,70 - 6,20)	3,41		1,26 (0,18 - 2,00)	630	5,85					
2 Rooms																					
16+16	1,60	1,60	3,20 (1,50 - 4,00)	4,21	7,10 A++	0,76 (0,27 - 1,08)	380	3,50	2,20	2,20	4,40 (1,10 - 6,30)	4,27	4,30 A+	1,03 (0,22 - 1,80)	515	4,75					
16+20	1,60	2,00	3,60 (1,50 - 4,50)	4,19	7,10 A++	0,86 (0,27 - 1,25)	430	4,00	1,95	2,45	4,40 (1,10 - 6,30)	4,44	4,30 A+	0,99 (0,22 - 1,78)	495	4,60					
16+25	1,60	2,50	4,10 (1,50 - 4,70)	4,14	7,10 A++	0,99 (0,27 - 1,38)	495	4,60	1,70	2,70	4,40 (1,10 - 6,30)	4,44	4,30 A+	0,99 (0,22 - 1,78)	495	4,60					
16+35	1,30	2,80	4,10 (1,50 - 4,70)	4,14	7,10 A++	0,99 (0,27 - 1,38)	495	4,60	1,40	3,00	4,40 (1,10 - 6,30)	4,44	4,30 A+	0,99 (0,22 - 1,78)	495	4,60					
20+20	2,00	2,00	4,00 (1,50 - 4,70)	4,08	7,10 A++	0,98 (0,27 - 1,38)	490	4,55	2,20	2,20	4,40 (1,10 - 6,30)	4,49	4,30 A+	0,98 (0,22 - 1,76)	490	4,55					
20+25	1,80	2,30	4,10 (1,50 - 4,70)	4,14	7,10 A++	0,99 (0,27 - 1,38)	495	4,60	1,95	2,45	4,40 (1,10 - 6,30)	4,49	4,30 A+	0,98 (0,22 - 1,76)	490	4,55					
20+35	1,50	2,60	4,10 (1,50 - 4,70)	4,14	7,10 A++	0,99 (0,27 - 1,38)	495	4,60	1,60	2,80	4,40 (1,10 - 6,30)	4,49	4,30 A+	0,98 (0,22 - 1,76)	490	4,55					
25+25	2,05	2,05	4,10 (1,50 - 4,70)	4,14	7,10 A++	0,99 (0,27 - 1,38)	495	4,60	2,20	2,20	4,40 (1,10 - 6,30)	4,49	4,30 A+	0,98 (0,22 - 1,76)	490	4,55					
25+35	1,70	2,40	4,10 (1,50 - 4,70)	4,14	7,10 A++	0,99 (0,27 - 1,38)	495	4,60	1,85	2,55	4,40 (1,10 - 6,30)	4,49	4,30 A+	0,98 (0,22 - 1,76)	490	4,55					

Multi TZ 2x1 CU-2TZ50TBE. Minimum capacity connected: 3,2 kW. Maximum capacity connected: 7,7 kW - R32

Indoor unit capacity	Cooling capacity (kW). Rooms			EER	SEER ¹⁾	Input power rating			A.E.C.	Current	Heating capacity (kW). Rooms			COP	SCOP ¹⁾	Input power rating			A.E.C.	Current	
	A	B	Total (Min - Max)			W/W	kW	kWh			230V	A	B			Total (Min - Max)	W/W	kW			kWh
1 Room																					
16	1,60		1,60 (1,10 - 2,30)	3,56		0,45 (0,24 - 0,65)	225	2,15	2,60		2,60 (0,70 - 3,80)	3,42		0,76 (0,18 - 1,24)	380	3,50					
20	2,00		2,00 (1,10 - 2,90)	3,51		0,57 (0,24 - 0,83)	285	2,70	3,20		3,20 (0,70 - 4,80)	3,44		0,93 (0,18 - 1,57)	465	4,30					
25	2,50		2,50 (1,10 - 3,50)	3,47		0,72 (0,24 - 1,07)	360	3,40	3,60		3,60 (0,70 - 5,50)	3,24		1,11 (0,18 - 1,88)	555	5,15					
35	3,50		3,50 (1,10 - 4,00)	3,24		1,08 (0,24 - 1,30)	540	5,05	4,50		4,50 (0,70 - 6,20)	3,36		1,34 (0,18 - 2,00)	670	6,20					
42	4,20		4,20 (1,10 - 4,50)	2,90		1,45 (0,24 - 1,60)	725	6,80	5,00		5,00 (1,10 - 6,30)	2,91		1,72 (0,22 - 2,35)	860	7,95					
50	5,00		5,00 (1,20 - 5,10)	2,78		1,80 (0,25 - 1,90)	900	8,30	5,30		5,30 (1,10 - 6,30)	2,93		1,81 (0,22 - 2,33)	905	8,35					
2 Rooms																					
16+16	1,60	1,60	3,20 (1,50 - 4,00)	4,21	7,00 A++	0,76 (0,27 - 1,08)	380	3,50	2,65	2,65	5,30 (1,10 - 6,30)	4,31	4,20 A+	1,23 (0,22 - 1,80)	615	5,65					
16+20	1,60	2,00	3,60 (1,50 - 4,50)	4,19	7,00 A++	0,86 (0,27 - 1,25)	430	4,00	2,45	3,05	5,50 (1,10 - 6,30)	4,30	4,20 A+	1,28 (0,22 - 1,78)	640	5,85					
16+25	1,60	2,50	4,10 (1,50 - 5,20)	4,14	7,00 A++	0,99 (0,27 - 1,48)	495	4,60	2,15	3,35	5,50 (1,10 - 6,30)	4,30	4,20 A+	1,28 (0,22 - 1,78)	640	5,85					
16+35	1,55	3,45	5,00 (1,50 - 5,20)	3,85	7,00 A++	1,30 (0,27 - 1,48)	650	6,00	1,75	3,75	5,50 (1,10 - 6,30)	4,30	4,20 A+	1,28 (0,22 - 1,78)	640	5,85					
16+42	1,40	3,60	5,00 (1,50 - 5,40)	3,85	7,00 A++	1,30 (0,27 - 1,62)	650	6,00	1,55	4,15	5,70 (1,10 - 6,40)	4,35	4,20 A+	1,31 (0,22 - 1,77)	655	6,00					
16+50	1,20	3,80	5,00 (1,50 - 5,40)	3,85	7,00 A++	1,30 (0,27 - 1,62)	650	6,00	1,40	4,30	5,70 (1,10 - 6,40)	4,35	4,20 A+	1,31 (0,22 - 1,77)	655	6,00					
20+20	2,00	2,00	4,00 (1,50 - 5,00)	4,08	7,00 A++	0,98 (0,27 - 1,42)	490	4,55	2,75	2,75	5,50 (1,10 - 6,30)	4,33	4,20 A+	1,27 (0,22 - 1,76)	635	5,80					
20+25	2,00	2,50	4,50 (1,50 - 5,20)	3,95	7,00 A++	1,14 (0,27 - 1,48)	570	5,25	2,45	3,05	5,50 (1,10 - 6,30)	4,33	4,20 A+	1,27 (0,22 - 1,76)	635	5,80					
20+35	1,80	3,20	5,00 (1,50 - 5,40)	3,85	7,00 A++	1,30 (0,27 - 1,62)	650	6,00	2,05	3,65	5,70 (1,10 - 6,40)	4,35	4,20 A+	1,31 (0,22 - 1,77)	655	6,00					
20+42	1,60	3,40	5,00 (1,50 - 5,40)	3,85	7,00 A++	1,30 (0,27 - 1,62)	650	6,00	1,85	3,85	5,70 (1,10 - 6,40)	4,35	4,20 A+	1,31 (0,22 - 1,77)	655	6,00					
20+50	1,45	3,55	5,00 (1,50 - 5,40)	3,85	7,00 A++	1,30 (0,27 - 1,62)	650	6,00	1,65	4,05	5,70 (1,10 - 6,40)	4,35	4,20 A+	1,31 (0,22 - 1,77)	655	6,00					
25+25	2,50	2,50	5,00 (1,50 - 5,40)	3,85	7,00 A++	1,30 (0,27 - 1,62)	650	6,00	2,85	2,85	5,70 (1,10 - 6,40)	4,35	4,20 A+	1,31 (0,22 - 1,77)	655	6,00					
25+35	2,10	2,90	5,00 (1,50 - 5,40)	3,85	7,00 A++	1,30 (0,27 - 1,62)	650	6,00	2,35	3,35	5,70 (1,10 - 6,40)	4,35	4,20 A+	1,31 (0,22 - 1,77)	655	6,00					
25+42	1,85	3,15	5,00 (1,50 - 5,40)	3,85	7,00 A++	1,30 (0,27 - 1,62)	650	6,00	2,15	3,55	5,70 (1,10 - 6,40)	4,35	4,20 A+	1,31 (0,22 - 1,77)	655	6,00					
25+50	1,65	3,35	5,00 (1,50 - 5,40)	3,85	7,00 A++	1,30 (0,27 - 1,62)	650	6,00	1,90	3,80	5,70 (1,10 - 6,40)	4,35	4,20 A+	1,31 (0,22 - 1,77)	655	6,00					
35+35	2,50	2,50	5,00 (1,50 - 5,40)	3,85	7,00 A++	1,30 (0,27 - 1,62)	650	6,00	2,85	2,85	5,70 (1,10 - 6,40)	4,35	4,20 A+	1,31 (0,22 - 1,77)	655	6,00					
35+42	2,25	2,75	5,00 (1,50 - 5,40)	3,85	7,00 A++	1,30 (0,27 - 1,62)	650	6,00	2,60	3,10	5,70 (1,10 - 6,40)	4,35	4,20 A+	1,31 (0,22 - 1,77)	655	6,00					

1) Energy Label Scale from A+++ to D.

Configure in a few steps your multi split system with our online tool.



Multi TZ 3x1 CU-3TZ52TBE. Minimum capacity connected: 4,5 kW. Maximum capacity connected: 9,5 kW - R32

Indoor unit capacity	Cooling capacity (kW). Rooms				EER	SEER ¹⁾	Input power rating			A.E.C.	Current	Heating capacity (kW). Rooms				COP	SCOP ¹⁾	Input power rating			A.E.C.	Current	
	A	B	C	Total (Min - Max)			W/W	kW	kWh			230V	A	B	C			Total (Min - Max)	W/W	kW			kWh
1 Room																							
16	1,60			1,60(1,30 - 2,30)	3,81		0,42(0,25 - 0,66)	210	2,10	2,60			2,60(1,20 - 3,20)	4,06			0,64(0,30 - 1,00)	320	3,10				
20	2,00			2,00(1,80 - 2,90)	3,85		0,52(0,34 - 0,83)	260	2,60	3,20			3,20(1,20 - 4,10)	4,10			0,78(0,30 - 1,27)	390	3,80				
25	2,50			2,50(1,80 - 2,90)	3,85		0,65(0,34 - 0,83)	325	3,10	3,60			3,60(1,20 - 4,30)	3,67			0,98(0,30 - 1,27)	490	4,70				
35	3,50			3,50(1,80 - 3,80)	3,65		0,96(0,34 - 1,38)	480	4,30	4,50			4,50(1,20 - 5,80)	3,54			1,27(0,30 - 2,14)	635	6,00				
42	4,20			4,20(1,80 - 4,30)	3,02		1,39(0,34 - 2,01)	695	6,20	5,60			5,60(1,20 - 6,80)	3,18			1,76(0,30 - 2,97)	880	7,80				
50	5,00			5,00(1,90 - 5,40)	3,07		1,63(0,34 - 2,15)	815	7,60	6,80			6,80(1,20 - 6,90)	2,89			2,35(0,30 - 2,84)	1175	10,80				
2 Rooms																							
16+16	1,60	1,60		3,20(1,80 - 6,20)	5,08	6,10 A+	0,63(0,33 - 2,13)	315	3,10	2,60	2,60		5,20(1,40 - 7,00)	3,88	3,80 A		1,34(0,34 - 2,07)	670	6,10				
16+20	1,60	2,00		3,60(1,80 - 6,20)	4,68	6,10 A+	0,77(0,33 - 2,09)	385	3,70	2,58	3,22		5,80(1,40 - 7,00)	3,82	3,80 A		1,52(0,33 - 2,03)	760	6,90				
16+25	1,60	2,50		4,10(1,80 - 6,20)	4,46	6,10 A+	0,92(0,33 - 2,09)	460	4,30	2,42	3,78		6,20(1,40 - 7,00)	3,76	3,80 A		1,65(0,33 - 2,03)	825	7,50				
16+35	1,60	3,50		5,10(1,80 - 6,30)	3,78	6,10 A+	1,35(0,33 - 2,10)	675	6,20	2,13	4,67		6,80(1,40 - 7,30)	3,72	3,80 A		1,83(0,29 - 2,13)	915	8,30				
16+42	1,63	3,77		5,20(1,90 - 6,40)	3,74	6,10 A+	1,39(0,35 - 2,14)	695	6,40	1,88	4,92		6,80(1,40 - 7,30)	3,80	3,80 A		1,79(0,31 - 2,12)	895	8,10				
16+50	1,26	3,94		5,20(1,90 - 6,40)	4,30	6,50 A+	1,21(0,34 - 1,82)	605	5,60	1,65	5,15		6,80(1,40 - 7,50)	4,15	4,00 A++		1,64(0,27 - 2,00)	820	7,50				
20+20	2,00	2,00		4,00(1,80 - 6,20)	4,49	6,10 A+	0,89(0,33 - 2,05)	445	4,20	3,20	3,20		6,40(1,40 - 7,00)	3,74	3,80 A		1,71(0,32 - 2,03)	855	7,80				
20+25	2,00	2,50		4,50(1,80 - 6,20)	4,17	6,10 A+	1,08(0,33 - 2,05)	540	5,00	3,02	3,78		6,80(1,40 - 7,00)	3,70	3,80 A		1,84(0,29 - 2,03)	920	8,30				
20+35	1,89	3,31		5,20(1,80 - 6,30)	3,74	6,10 A+	1,39(0,33 - 2,06)	695	6,40	2,47	4,33		6,80(1,40 - 7,30)	3,80	3,80 A		1,79(0,28 - 2,12)	895	8,10				
20+42	1,68	3,52		5,20(1,90 - 6,40)	3,82	6,10 A+	1,36(0,35 - 2,10)	680	6,20	2,19	4,61		6,80(1,40 - 7,30)	3,82	3,80 A		1,78(0,30 - 2,08)	890	8,10				
20+50	1,49	3,71		5,20(1,90 - 6,40)	4,30	6,50 A+	1,21(0,34 - 1,82)	605	5,60	1,94	4,86		6,80(1,40 - 7,50)	4,15	4,00 A++		1,64(0,27 - 2,00)	820	7,50				
25+25	2,50	2,50		5,00(1,80 - 6,20)	3,79	6,10 A+	1,32(0,33 - 2,05)	660	6,00	3,40	3,40		6,80(1,40 - 7,00)	3,70	3,80 A		1,84(0,29 - 2,03)	920	8,30				
25+35	2,17	3,03		5,20(1,90 - 6,30)	3,74	6,10 A+	1,39(0,35 - 2,06)	695	6,40	2,83	3,97		6,80(1,40 - 7,30)	3,80	3,80 A		1,79(0,28 - 2,12)	895	8,10				
25+42	1,94	3,26		5,20(1,90 - 6,40)	3,82	6,10 A+	1,36(0,35 - 2,10)	680	6,20	2,54	4,26		6,80(1,40 - 7,30)	3,82	3,80 A		1,78(0,28 - 2,08)	890	8,10				
25+50	1,73	3,47		5,20(1,90 - 6,40)	4,30	6,50 A+	1,21(0,34 - 1,82)	605	5,60	2,27	4,53		6,80(1,40 - 7,50)	4,15	4,00 A++		1,64(0,24 - 2,00)	820	7,50				
35+35	2,60	2,60		5,20(1,90 - 6,40)	3,94	6,10 A+	1,32(0,35 - 2,06)	660	6,00	3,40	3,40		6,80(1,40 - 7,50)	3,84	3,80 A		1,77(0,27 - 2,14)	885	8,00				
35+42	2,36	2,84		5,20(1,90 - 6,40)	3,94	6,10 A+	1,32(0,35 - 2,06)	660	6,00	3,09	3,71		6,80(1,40 - 7,50)	3,84	3,80 A		1,77(0,26 - 2,14)	885	8,00				
35+50	2,14	3,06		5,20(1,90 - 6,40)	4,44	6,50 A+	1,17(0,36 - 1,73)	585	5,40	2,80	4,00		6,80(1,40 - 7,50)	4,20	4,00 A++		1,62(0,24 - 1,97)	810	7,40				
42+42	2,60	2,60		5,20(1,90 - 6,40)	3,94	6,10 A+	1,32(0,35 - 2,02)	660	6,00	3,40	3,40		6,80(1,40 - 7,50)	3,93	3,80 A		1,73(0,26 - 2,13)	865	7,90				
42+50	2,37	2,83		5,20(1,90 - 6,40)	4,44	6,50 A+	1,17(0,36 - 1,73)	585	5,40	3,10	3,70		6,80(1,40 - 7,50)	4,22	4,00 A++		1,61(0,24 - 1,97)	805	7,40				
3 Rooms																							
16+16+16	1,60	1,60	1,60	4,80(1,80 - 6,60)	4,75	7,60 A+	1,01(0,36 - 1,79)	505	4,70	2,26	2,26	2,26	6,78(1,50 - 7,50)	4,24	4,20 A++		1,60(0,29 - 1,95)	800	7,30				
16+16+20	1,60	1,60	2,00	5,20(1,80 - 6,60)	4,52	7,60 A+	1,15(0,36 - 1,80)	575	5,30	2,09	2,09	2,62	6,80(1,60 - 7,50)	4,28	4,20 A++		1,59(0,32 - 1,94)	795	7,30				
16+16+25	1,46	1,46	2,28	5,20(1,90 - 6,60)	4,52	7,60 A+	1,15(0,39 - 1,80)	575	5,30	1,91	1,91	2,98	6,80(1,60 - 7,50)	4,28	4,20 A++		1,59(0,32 - 1,94)	795	7,30				
16+16+35	1,24	1,24	2,72	5,20(1,90 - 6,60)	4,52	7,60 A+	1,15(0,39 - 1,75)	575	5,30	1,62	1,62	3,56	6,80(1,60 - 7,50)	4,33	4,20 A++		1,57(0,34 - 1,92)	785	7,20				
16+16+42	1,12	1,12	2,96	5,20(1,80 - 6,60)	4,52	7,60 A+	1,15(0,39 - 1,71)	575	5,30	1,47	1,47	3,86	6,80(1,60 - 7,50)	4,33	4,20 A++		1,57(0,31 - 1,91)	785	7,20				
16+16+50	1,01	1,01	3,18	5,20(1,80 - 6,60)	4,86	7,60 A+	1,07(0,42 - 1,59)	535	4,90	1,33	1,33	4,14	6,80(1,60 - 7,50)	4,66	4,20 A++		1,46(0,33 - 1,79)	730	6,70				
16+20+20	1,48	1,86	1,86	5,20(1,90 - 6,60)	4,52	7,60 A+	1,15(0,39 - 1,75)	575	5,30	1,94	2,43	2,43	6,80(1,60 - 7,50)	4,30	4,20 A++		1,58(0,31 - 1,93)	790	7,20				
16+20+25	1,36	1,70	2,14	5,20(1,90 - 6,60)	4,52	7,60 A+	1,15(0,39 - 1,75)	575	5,30	1,78	2,23	2,79	6,80(1,60 - 7,50)	4,30	4,20 A++		1,58(0,31 - 1,93)	790	7,20				
16+20+35	1,17	1,46	2,57	5,20(1,90 - 6,60)	4,52	7,60 A+	1,15(0,39 - 1,71)	575	5,30	1,53	1,92	3,35	6,80(1,60 - 7,50)	4,33	4,20 A++		1,57(0,34 - 1,91)	785	7,20				
16+20+42	1,07	1,33	2,80	5,20(1,80 - 6,60)	4,52	7,60 A+	1,15(0,39 - 1,71)	575	5,30	1,39	1,74	3,67	6,80(1,60 - 7,50)	4,36	4,20 A++		1,56(0,31 - 1,90)	780	7,10				
16+20+50	0,97	1,21	3,02	5,20(1,80 - 6,60)	4,86	7,60 A+	1,07(0,42 - 1,59)	535	4,90	1,27	1,58	3,95	6,80(1,60 - 7,50)	4,69	4,20 A++		1,45(0,34 - 1,78)	725	6,60				
16+25+25	1,26	1,97	1,97	5,20(1,90 - 6,60)	4,52	7,60 A+	1,15(0,39 - 1,75)	575	5,30	1,64	2,58	2,58	6,80(1,60 - 7,50)	4,30	4,20 A++		1,58(0,31 - 1,93)	790	7,20				
16+25+35	1,09	1,71	2,40	5,20(1,80 - 6,60)	4,52	7,60 A+	1,15(0,39 - 1,71)	575	5,30	1,43	2,24	3,13	6,80(1,60 - 7,50)	4,33	4,20 A++		1,57(0,34 - 1,91)	785	7,20				
16+25+42	1,00	1,57	2,63	5,20(1,80 - 6,60)	4,52	7,60 A+	1,15(0,39 - 1,71)	575	5,30	1,31	2,05	3,44	6,80(1,60 - 7,50)	4,36	4,20 A++		1,56(0,31 - 1,90)	780	7,10				
16+25+50	0,91	1,43	2,86	5,20(1,80 - 6,60)	4,86	7,60 A+	1,07(0,42 - 1,59)	535	4,90	1,19	1,87	3,74	6,80(1,60 - 7,50)	4,69	4,20 A++		1,45(0,34 - 1,78)	725	6,60				
16+35+35	0,96	2,12	2,12	5,20(1,80 - 6,60)	4,68	7,60 A+	1,11(0,39 - 1,71)	555	5,10	1,26	2,77	2,77	6,80(1,60 - 7,50)	4,39	4,20 A++		1,55(0,32 - 1,89)	775	7,10				
16+35+42	0,89	1,96	2,35	5,20(1,80 - 6,60)	4,68	7,60 A+	1,11(0,39 - 1,67)	555	5,10	1,17	2,56	3,07	6,80(1,60 - 7,50)	4,42	4,20 A++		1,54(0,32 - 1,88)	770	7,00				
20+20+20	1,73	1,73	1,73	5,19(1,90 - 6,60)	4,51	7,60 A+	1,15(0,39 - 1,75)	575	5,30	2,26	2,26	2,26	6,78(1,60 -										

PACi

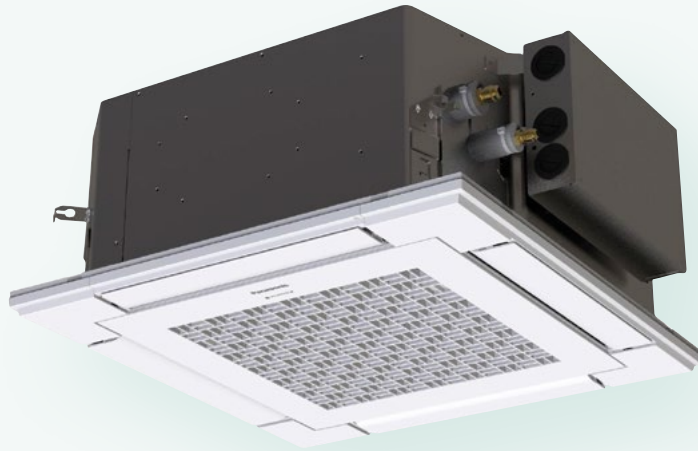

Panasonic Commercial air to air

Panasonic has developed an impressive range of highly efficient Commercial Air Conditioners. This range confirms our commitment to the environment, with our highly efficient inverter compressor technology to optimise performance.

Highlighted features → 164

Product quality and safety → 166

PACi NX Series → 168

CONEX. Devices and apps → 170

Commercial Wi-Fi Adaptor → 171

Bringing nature's balance indoors → 172

PACi NX: Excellent SEER and SCOP → 174

PACi NX 4 way 90x90 cassette - PU3 → 176

PACi NX adaptive ducted unit - PF3 → 178

PACi NX wall-mounted, 4 way 60x60 cassette and ceiling → 180

Solutions for 24/7/365 applications → 182

Commercial units range → 184

Wall-mounted Professional Inverter -25 °C → 186

Elite - Standard wall-mounted · R32 → 188

Elite - Standard 4 way 60x60 cassette · R32 → 192

Elite - Standard 4 way 90x90 cassette · R32 → 194

Elite - Standard ceiling · R32 → 198

Elite - Standard adaptive ducted unit · R32 → 202

High static pressure hide-away 20,0-25,0 kW · R32 → 206

Elite 4 way 60x60 cassette · R32 → 208

Commercial PACi NX Multi → 210

Commercial twin, triple and double-twin systems · R32 → 212

Hydronic PACi

PRO-HT Tank Series for PACi → 216

PACi with Water Heat Exchanger → 220

R22 Renewal. Fast, easy to install and cost effective → 224

Accessories and control → 228

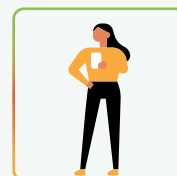
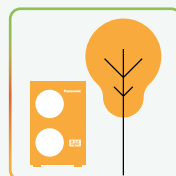
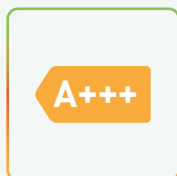

Highlighted features

PACi: Commercial air to air. The compact and high efficiency solution for shops, restaurants, offices or residential applications.





Great savings and improved comfort. Panasonic has developed an impressive range of highly efficient Commercial air conditioners, with our highly efficient inverter compressor technology to optimise performance.

A wide range for industry, office or residential application. With configuration from 1:1 to 4:1, Panasonic can offer the most comfortable climate with solutions designed for every environment. The diverse array of connectivity and control systems allows you to manage your units from various locations. Receive real-time status updates and maintenance alerts, while optimising costs and energy usage.

Energy saving

 R32	 28% ECONAVI	 8,50 SEER	 5,1 SCOP	 INVERTER+
<p>R32 refrigerant. Our heat pumps containing the refrigerant R32 show a drastic reduction in the value of Global Warming Potential (GWP). An important step to reduce greenhouse gases. R32 is also a component refrigerant, making it easy to recycle.</p>	<p>Econavi. Intelligent Human Activity Sensor and Sunlight Sensor technologies that can detect and reduce waste energy, by optimising air conditioner operation according to room conditions. With just one touch of a button, you can save energy.</p>	<p>Exceptional seasonal cooling efficiency based on the ErP regulation. Higher SEER ratings mean greater efficiency - year-round cooling savings!</p>	<p>Exceptional seasonal heating efficiency based on the ErP regulation. Higher SCOP ratings mean greater efficiency - year-round heating savings!</p>	<p>Inverter Plus System. Inverter Plus System classification highlights Panasonic's highest performing systems.</p>
 INVERTER	 HIGH EFFICIENCY COMPRESSOR	 R2 ROTARY COMPRESSOR	 DHW	 ErP 35°C
<p>Inverter. The Inverter range provides greater efficiency and comfort. Provides more precise temperature control, without highs and lows, and keeps the ambient temperature constant with lower energy consumption and a significant reduction in noise and vibration levels.</p>	<p>High efficiency compressor. Compressors that operate with a wider Hz range realize a more efficient operation throughout the year. For Big PACi Series.</p>	<p>Panasonic R2 rotary compressor. Designed to withstand extreme conditions, it delivers high performance and efficiency.</p>	<p>Better efficiency and value for domestic hot water. Energy efficiency class up to A+ in a scale from A+ to F. For PRO-HT tank.</p>	<p>Better efficiency and value for low temperature applications. On an energy efficiency scale from D to A+++ , both the PACi Water Heat Exchanger and the PRO-HT provide A++ rated heating.</p>

High performance

 -15°C COOLING MODE	 -20°C HEATING MODE	 46°C COOLING MODE	 nanoeX	 BLUEFIN	 LARGE FAN	 DC FAN	 FILTER INCLUDED
<p>Down to -15 °C in cooling mode. The air conditioner works in cooling mode when the outdoor temperature of -15 °C.</p>	<p>Down to -20 °C in heating mode. All our commercial systems operate in heating to -15 °C, with models capable of up to -20 °C.</p>	<p>Up to 46 °C in cooling mode. System works in cooling mode at outdoor temperature up to 46 °C. For PACi with Water Heat Exchanger</p>	<p>nanoe™ X. Technology with the benefits of hydroxyl radicals has the capacity to inhibit pollutants, viruses, and bacteria to clean and deodorise.</p>	<p>Bluefin. Panasonic has extended the life of its condensers with an original anti-rust coating. For Big PACi Series.</p>	<p>Large fan. Large fan provides larger air flow rate and very quiet operation at low speed. For Big PACi Series.</p>	<p>DC fan. Safe and precise.</p>	<p>Filter included. Adaptive ducted with filter included.</p>
 22 dB(A)	 AEROWINGS	 DHW	 65°C OUTPUT WATER HIGH TEMPERATURE	 R22 RENEWAL	 R410A / R22 RENEWAL	 5 YEARS COMPRESSOR WARRANTY	
<p>Super Quiet. With Super Quiet technology our devices are quieter than a library (30 dB(A)).</p>	<p>More comfort with Aerowings. Direct air flow to the ceiling, creating a shower cooling effect with built-in twin flap.</p>	<p>DHW. With PRO-HT Tank you can also heat your domestic hot water at a very low cost with the optional hot water cylinder.</p>	<p>High temperature. With PRO-HT Tank, maximum water outlet temperature up to 65 °C.</p>	<p>R22 renewal. The Panasonic renewal system allows good quality existing R22 pipe work to be re-used whilst installing new high efficiency R410A systems.</p>	<p>R410A / R22 renewal. The Panasonic renewal system allows good quality existing R410A or R22 pipe work to be re-used whilst installing new high efficiency R32 systems.</p>	<p>5 Years compressor warranty. We guarantee the outdoor unit compressors in the entire range for five years.</p>	

High connectivity

 PANASONIC AC SMART CLOUD	 OPTIONAL WI-FI	 BMS CONNECTIVITY	 INTEGRATION TO P-LINK
<p>Panasonic AC Smart Cloud. The AC Smart Cloud from Panasonic allows you to have complete control of all your installations. In a simple click, receive status updates from all your units in real-time, preventing breakdowns and optimising costs.</p>	<p>Internet control. A next generation system providing user-friendly remote control of air conditioning or heat pump units from everywhere, using a simple Android™ or iOS smartphone, tablet or PC via the internet.</p>	<p>BMS connectivity. The communication port can be integrated into the indoor unit and provides easy connection to, building management system, providing control of your Panasonic heat pump.</p>	<p>Domestic integration to P-Link - CZ-CAPRA1. Can connect RAC range to P-Link. Full control is now possible.</p>
 ADVANCED CONTROL			
<p>Advanced control. A touch screen remote controller is included as a standard. Clean design, easy operation and quick access to all menus.</p>			

Product quality and safety

All Panasonic air conditioners undergo strict quality and safety tests before sale. This rigorous process includes obtaining all necessary safety approvals, to ensure that all air conditioners we sell are not only built to the highest market standards, but are also completely safe.



Professional air conditioners with R32 refrigerant

Panasonic recommends R32, with lower Global Warming Potential (GWP). Compared to R22 and R410A, R32 has a low potential impact on global warming.

Panasonic takes action in helping to protect the environment. In line with the European countries participating in the Montreal Protocol, protecting the ozone layer and preventing global warming, Panasonic is leading the switch to R32.

1 Installation innovation

- Extremely easy to install, practically the same as R410A
- Single substance refrigerant, which makes it easier to recycle and reuse

2 Environmental innovation

- Zero impact on the ozone layer
- 75 % less impact on global warming

3 Economic and energy consumption innovation

- Lower cost and greater savings
- Higher energy efficiency than R410A



PACi NX Elite: Top-tier commercial air conditioning

Outstanding performance at extreme ambient temperatures with very high energy efficiency both in heating and cooling. Fans, fan motors, compressors and heat exchangers engineered for maximum savings result in higher seasonal efficiencies, which ranks as one of the best in the industry, ensuring reduced CO₂ emissions, energy consumption and operating costs.

From 3,6 to 14,0 kW.

- Meeting all necessary approvals to ensure quality and safety
- Top class SEER: A+++ / SCOP: A+++ at 3,6 kW (in 90x90 cassette)

- Cooling operation is possible with outdoor temperature as high as 48 °C (for 7,1 kW and higher capacities)
- Precise control with DC inverter technology for even more energy saving
- Cooling operation at -20 °C (10,0 kW to 14,0 kW with 30 m maximum pipe length)
- Heating operation at ambient temperature as low as -20 °C
- Compact outdoor units
- Auto restart after power outage
- Twin, triple and double-twin connections

PACi NX Standard: For economy and value

With high quality design and engineering, the PACi NX Standard are the perfect solutions for projects which demand quality on a limited budget. In addition, compact and lightweight design makes them ideal for installations with limited space including small commercial and residential applications. The slim and lightweight outdoor unit design enables installation even in very challenging locations.

From 2,5 to 14,0 kW.

- Extended range of outdoor units starting from 2,5 kW

- Great balance of system cost and performance
- Top class SEER / SCOP in the standard inverter category SEER: A++ / SCOP: A++ up to 7,1 kW (in 90x90 cassette)
- Variety of individual and central controllers which provides full flexibility
- Compact outdoor units, small footprint and lightweight
- Twin connection possible
- Cooling operation down to -10 °C and heating operation down to -15 °C

Big PACi Elite R32

20,0 – 25,0 kW is ideally suited for small and mid retail applications.

In addition to its lightweight, split-able, compact body, the newly designed hide-away unit enables easy installation and pipe work within a narrow void.

Panasonic Big PACi : Environmental friendly, strong and flexible.

- High efficiency with Panasonic compressor as the driving force

- Compact and light indoor body
- Easy pipe work with split-able hide-away indoor design
- Separable indoor unit allows for flexible installation to fit in narrow void
- Water heat exchanger and AHU connection compatibility
- Bluefin anti-corrosion coating of the heat exchanger as standard
- Wide range of controls including Cloud Control compatibility

PACi NX Series.

The next generation is here

NX Series with R32 refrigerant has been developed to meet the demand of easy refurbishment with 3 wired method.

Integrated with IoT solutions and includes nanoe™ X function as standard.



1 PACi NX Series for absolute ease of refurbishment

This series have been developed with 3 wired power and communication. It makes it simple and easy to replace old systems with 3 wire connections, which is prevalent in many systems.

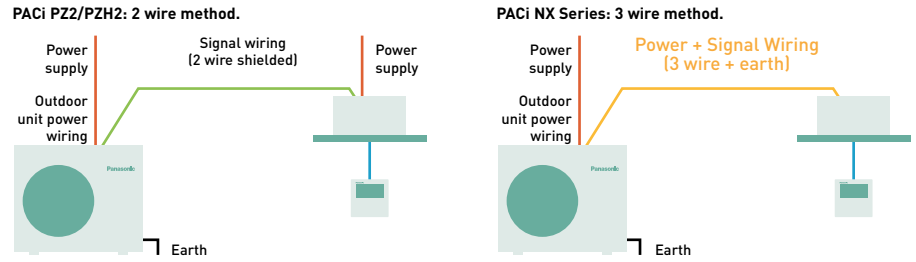

2 CONEX with IoT integration

The wired remote controller series is fully integrated with IoT solutions developed by Panasonic. Detailed operation, maintenance setting and service operation are all possible with smartphone or tablet.

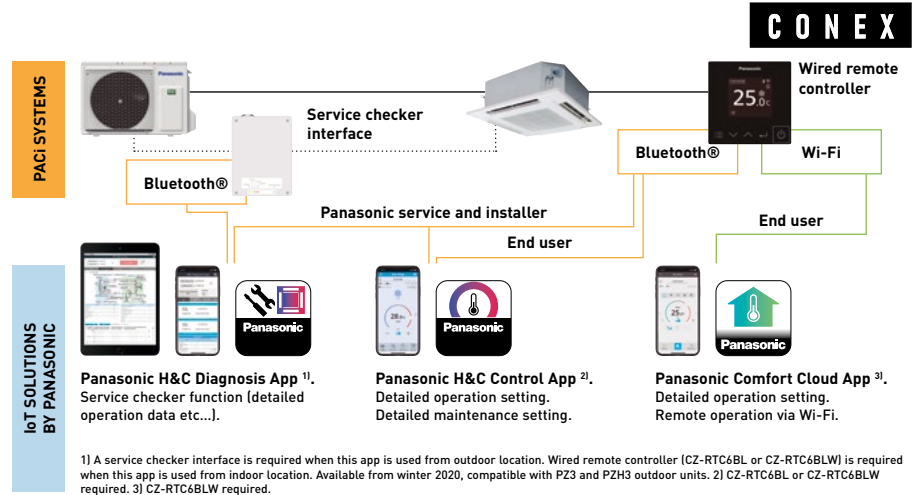

3 Let Panasonic take care of indoor air quality

Thanks to the nanoe™ X properties, several types of pollutants can be inhibited such as certain types of bacteria, viruses, mould, allergens, pollen and certain hazardous substances. This unique technology is equipped to provide better air quality whether residential or commercial.



7 effects of nanoe™ X – Panasonic unique technology.

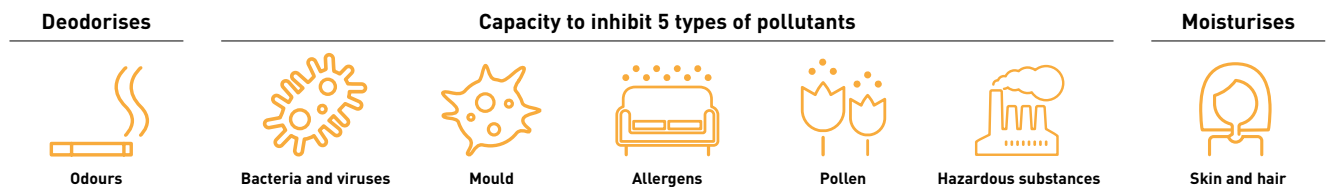

The nanoe™ X performance varies depending on the room size, environment and usage and it may take several hours to reach the full effect. nanoe™ X is not medical device, local regulations on building design and sanitary recommendations must be followed.

REFER TO PAGE 10 FOR MORE DETAILS AND VALIDATION DATA

4 Increasing the efficiency

The PACi NX Series have improved seasonal efficiencies in both heating and cooling versus the previous generation.

kW	Wall-mounted - PK3				4 way cassette - PY3				4 way cassette - PU3				Ceiling - PT3				Adaptive ducted - PF3			
	Elite		Standard		Elite		Standard		Elite		Standard		Elite		Standard		Elite		Standard	
	SEER / η _{s,c}	SCOP / η _{s,h}	SEER / η _{s,c}	SCOP / η _{s,h}	SEER / η _{s,c}	SCOP / η _{s,h}	SEER / η _{s,c}	SCOP / η _{s,h}	SEER / η _{s,c}	SCOP / η _{s,h}	SEER / η _{s,c}	SCOP / η _{s,h}	SEER / η _{s,c}	SCOP / η _{s,h}	SEER / η _{s,c}	SCOP / η _{s,h}	SEER / η _{s,c}	SCOP / η _{s,h}	SEER / η _{s,c}	SCOP / η _{s,h}
2,5							A++	A++												
3,6	A++	A++	A++	A+	A++	A++	A++	A+	A+++	A+++	A++	A++	A++	A++	A++	A+	A++	A+	A+	A+
5,0	A++	A++	A++	A+	A++	A++	A++	A+	A++	A++	A++	A++	A++	A++	A++	A+	A++	A+	A++	A+
6,0	A++	A++	A++	A++	A++	A+	A++	A+	A++	A++	A++	A++	A++	A++	A++	A++	A++	A++	A++	A++
7,1	A++	A++	A+	A+					A++	A++	A++	A++	A++	A++	A+	A+	A++	A++	A++	A+
10,0	A++	A+	A++	A					A++	A++	A++	A+	A++	A++	A++	A+	A++	A+	A++	A
12,5									304,3 %	186,0 %	267,0 %	157,0 %	278,4 %	181,0 %	241,7 %	147,4 %	281,7 %	170,0 %	257,4 %	142,6 %
14,0									286,6 %	181,2 %	257,0 %	152,2 %	263,3 %	178,0 %	228,8 %	145,3 %	275,9 %	171,0 %	252,2 %	140,6 %

* Energy label scale from A+++ to D for models below 12,0 kW (EU regulation 626/2011).
 * η_{s,c} / η_{s,h} values for models above 12,0 kW (EN 14825).

CONEX. Devices and apps

CONEX provides comfort and control for varying user needs. Accessible, flexible and scalable with different controllers and apps. Perfectly meeting requirements of modern controls for end user, installer and service. With nanoe™ X function, technology with the benefits of hydroxyl radicals.



1 Intuitive control with stylish design

- Simple operation at a glance
- Clean face with full flat and black LCD display
- Compact body, only 86x86 mm

2 Control comfort with your smartphone

- Flexible control options with IoT integration
- Panasonic H&C Control App for daily remote control operation
- Panasonic Comfort Cloud App for remote operation 24/7/365

3 Easy maintenance with service support app

- Quick and easy app set-up for system setting
- Panasonic H&C Diagnosis App enables the user to obtain detailed system operation data

* The use of apps depends on the remote controller model.

CONEX with IoT integration



The wired remote controller series is fully integrated with IoT solutions developed by Panasonic. Detailed operation, maintenance setting and service operation are all possible with smartphone or tablet.

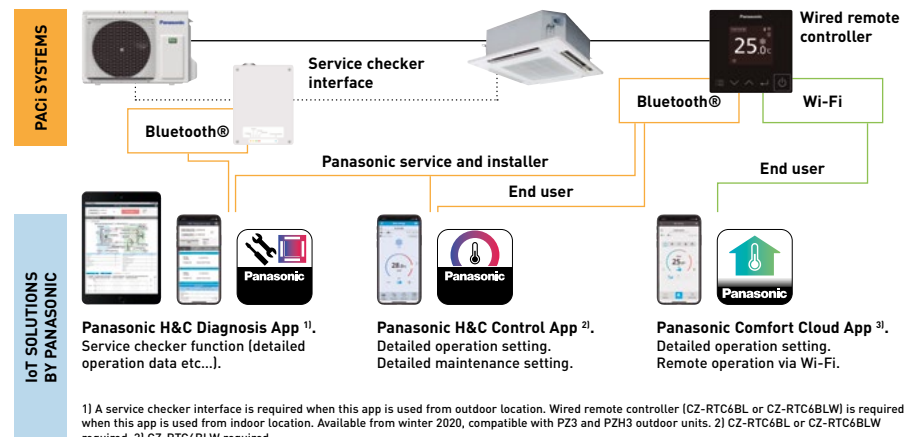

Model	CZ-RTC6	CZ-RTC6BL	CZ-RTC6BLW
Wired connection compatible with	PACi, PACi NX, ECOi, GHP	PACi, PACi NX, ECOi, GHP	PACi NX only
Wireless functions	No wireless capability	Bluetooth®	Bluetooth® + Wi-Fi
App compatibility			
Panasonic Comfort Cloud App	—	—	✓
Panasonic H&C Control App	—	✓ PACi, PACi NX, ECOi, GHP	✓ PACi NX only
Panasonic H&C Diagnosis App ¹⁾	—	✓ PACi NX only ²⁾	✓ PACi NX only ²⁾
Outdoor unit settings (remote controller connected to indoor unit)	✓ PACi NX only ²⁾	✓ PACi NX only ²⁾	✓ PACi NX only ²⁾

1) Compatible with U-71/100/125/140PZH3E5/8 and U-100/125/140PZ3E5/8. 2) When connected to PACi NX indoor and outdoor unit combination.



Commercial Wi-Fi Adaptor

Panasonic CZ-CAPWFC1 interface adaptor, allows connection of one or a group of indoor units to Panasonic Comfort Cloud App, which provides control, monitoring, scheduling and error alerts.

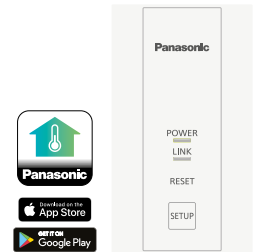

Advanced smartphone control

Control PACi, ECOi and ECO G indoor units with your smartphone from wherever and whenever you are, by using Panasonic Comfort Cloud App and Commercial Wi-Fi Adaptor. This scalable solution is ideal for one system, one site or multiple locations. Coupling the adaptor with the already feature rich systems, makes it an ideal solution for residential and commercial applications.

1 From 1 to 200 units
User can control up to 10 different sites, with up to 20 units / groups per site. Additionally, one adaptor can be connected to 1 indoor or to a group of up to 8 indoors.

2 Voice control compatible
When registering the unit to Panasonic Comfort Cloud App it makes compatible with most popular voice assistants.

3 Multi user
The Panasonic Comfort Cloud App allows multi-user access control. Restrict user access to specific units.

4 Easy scheduling
Complex weekly scheduling made simple. Not only for one unit, but across multiple sites and from a smartphone.

5 Energy monitor
See the estimated power consumption and compare with other periods, to see how energy consumption can be reduced even more. Check list of units that provides consumption*.

6 Error codes
Error code notification through the App, provides early notification and allows for faster repair.

* Function available depending on the model.

Connection Diagram

Commercial Wi-Fi Adaptor wiring length is 1,9 m and connects to indoor unit thru T10 connector and R1/R2 terminal connectors.

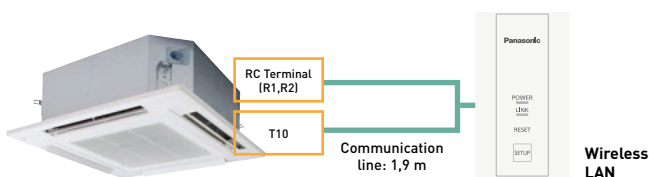

Input Voltage	DC 12 V (supplied from T10 connector)
Power Consumption	Maximum 2,4 W
Size (HxWxD)	120 x 70 x 25 mm
Weight	190 g (including communications lines)
Interface	1 x Wireless LAN
Wireless LAN Standard	IEEE 802,11 b/g/n
Frequency Range	2,4 GHz band
Operating range	0 ~ 55 °C, 20 ~ 80 RH%
Connectable indoor unit	1 unit
Length of communication line	1,9 m (included in the shipment)

Download free app: Panasonic Comfort Cloud App.

Other hardware requirements: Router and Internet (purchase and subscribe separately).

Panasonic Cloud Server is designed, operated and managed by Panasonic.

Bringing nature's balance indoors



nanoe™ X, technology with the benefits of hydroxyl radicals.

Abundant in nature, hydroxyl radicals (also known as OH radicals) have the capacity to inhibit pollutants, viruses, and bacteria to clean and deodorise. nanoe™ X technology can bring these incredible benefits indoors so that hard surfaces, soft furnishings, and the indoor environment can be a cleaner and more pleasant place to be, whether at home, work, or visiting hotels, shops and restaurants etc.



Panasonic's nanoe™ X technology takes this a step further and brings nature's detergent – hydroxyl radicals – indoors to help create an ideal environment

Thanks to the nanoe™ X properties, several types of pollutants can be inhibited such as certain types of bacteria, viruses, mould, allergens, pollen and certain hazardous substances.

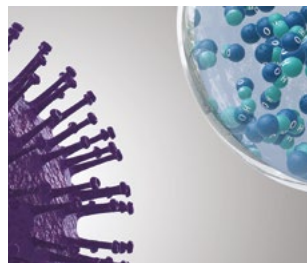

1 | nanoe™ X reliably reaches pollutants.

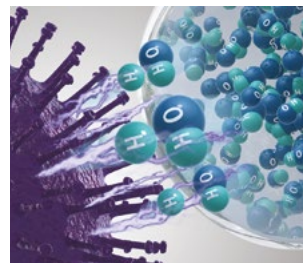

2 | Hydroxyl radicals denature pollutants' proteins.

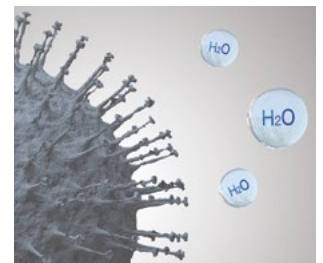

3 | Pollutants activity is inhibited.

What is unique about nanoe™ X?

Effective on fabrics and surfaces.

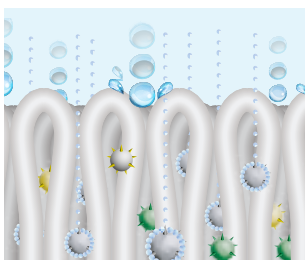

1 | At one billionth of a metre, nanoe™ X is much smaller than steam and can deeply penetrate cloth fabrics to deodorise.

Longer lifespan.



2 | Contained in tiny water particles, nanoe™ X has a longer lifespan to spread easily around the room.

Huge quantity.



3 | nanoe™ X Generator Mark 2 produces 9,6 trillion hydroxyl radicals per second. Greater amounts of hydroxyl radicals contained in nanoe™ X lead to higher performance on inhibition of pollutants.

Maintenance-free.



The image shows nanoe™ X Generator Mark 2.

4 | No maintenance, no replacement required. nanoe™ X is a filter free solution that does not require maintenance, as its atomisation electrode is enveloped with water during its generation process and it is made with Titanium.

7 effects of nanoe™ X – Panasonic unique technology

Deodorises



Odours

Capacity to inhibit 5 types of pollutants



Bacteria and viruses



Mould



Allergens



Pollen



Hazardous substances



Skin and hair

* Refer to <https://aircon.panasonic.eu> for more details and validation data.

nanoe™ X, internationally-validated technology in testing facilities

The effectiveness of nanoe™ X technology has been tested by 3rd party laboratories in Germany, France, Denmark, Malaysia and Japan.

The nanoe™ X performance varies depending on the room size, environment and usage and it may take several hours to reach the full effect. nanoe™ X is not medical device, local regulations on building design and sanitary recommendations must be followed.

Test results conducted under controlled laboratory conditions. Performance of nanoe™ X might differ in real life environment.

	Tested contents		Result	Capacity	Time	Testing organisation	Report No.
Airborne	Virus	Bacteriophage ΦX174	99,7 % inhibited	Approx. 25 m³	6 h	Kitasato Research Center for Environmental Science	24_0300_1
	Bacteria	Staphylococcus aureus	99,9 % inhibited	Approx. 25 m³	4 h	Kitasato Research Center for Environmental Science	2016_0279
Adhered	Virus	SARS-CoV-2	91,4 % inhibited	6,7 m³	8 h	Texcell (France)	1140-01 C3
		SARS-CoV-2	99,9 % inhibited	45 L	2 h	Texcell (France)	1140-01 A1
	Virus	Xenotropic murine leukemia virus	99,999 % inhibited	45 L	6 h	Charles River Biopharmaceutical Services GmbH	—
		Influenza (H1N1 subtype)	99,9 % inhibited	1 m³	2 h	Kitasato Research Center for Environmental Science	21_0084_1
		Bacteriophage ΦX174	99,80% inhibited	25 m³	8 h	Japan Food Research Laboratories	13001265005-01
	Bacteria	Staphylococcus aureus	99,9 % inhibited	20 m³	8 h	Danish Technological Institute	868988
	Pollen	Ambrosia pollen	99,4 % inhibited	20 m³	8 h	Danish Technological Institute	868988
	Odours	Cigarette smoke odour	Odour intensity reduced by 2,4 levels	Approx. 23 m³	0,2 h	Panasonic Product Analysis Center	4AA33-160615-N04

First nanoe™ device was developed by Panasonic in 2003

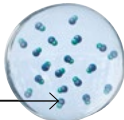
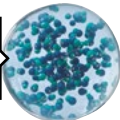
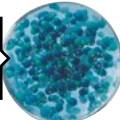
	nanoe™	nanoe™ X	
Generator	2003	Mark 1 - 2016	Mark 2 - 2019
	480 billion hydroxyl radicals/sec	4,8 trillion hydroxyl radicals/sec	9,6 trillion hydroxyl radicals/sec
Ion particle structure			

nanoe™ X: improving protection 24/7

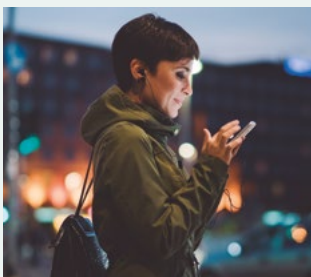

Acts to clean your air, so that the indoor environment can be a cleaner and more pleasant place to be all day long. nanoe™ X works together with heating or cooling function when the during the day and can work independently when the area is not occupied. Give the air conditioning the strength to increase the protection of your indoor spaces with nanoe™ X technology and convenient control via the Panasonic Comfort Cloud App.



Cleans the air when you are away.

Leave the nanoe™ mode ON to inhibit certain pollutants and deodorise before you return home.

Improves your environment when you are at home.

Enjoy a cleaner, comfortable space with loved ones.

Panasonic Heating & Cooling Solutions is incorporating nanoe™ technology in a wide range of equipment

-  **Wall-mounted.**
Built-in nanoe X Generator Mark 2.
-  **Ceiling.**
Built-in nanoe X Generator Mark 2.
-  **4 Way 90x90 cassette.**
Built-in nanoe X Generator Mark 1.
-  **Adaptive ducted unit.**
Built-in nanoe X Generator Mark 2.
-  **4 Way 60x60 cassette.**
Built-in nanoe X Generator Mark 2.

PACi NX: Excellent SEER and SCOP values

High operating efficiency using DC inverter compressor, DC motor and a heat exchanger design.



PACi NX R32 seasonal efficiency for daily energy saving

SEER / SCOP

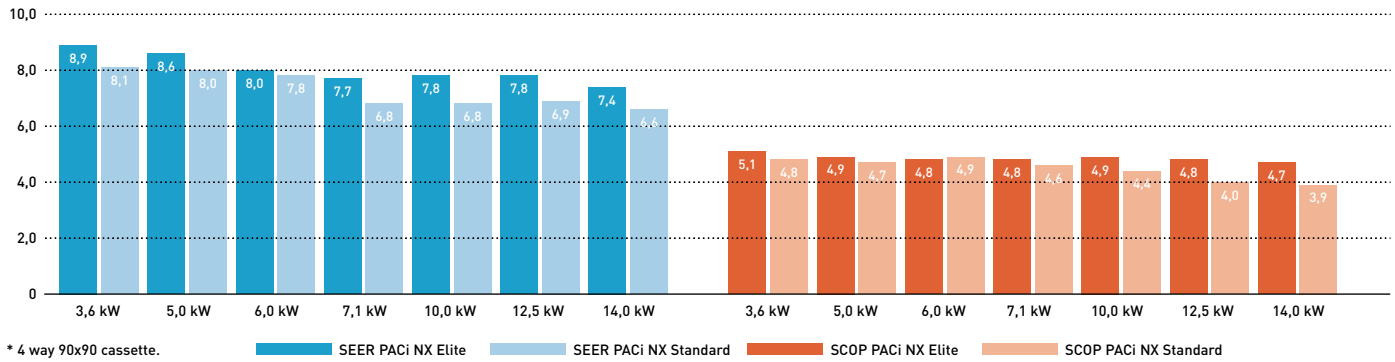

Increased piping length for greater design flexibility

Adaptable to various building types and sizes. Maximum piping length: 85 m (10,0, 12,5, 14,0 kW). 50 m (7,1 kW).

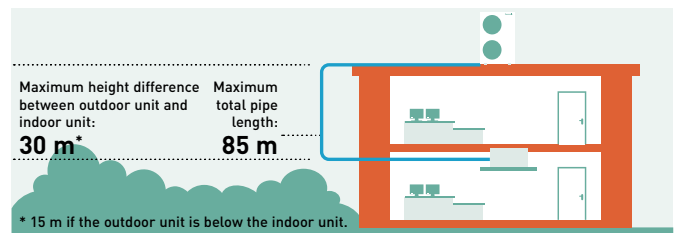

PACi NX Elite design operation conditions

PACi NX elite series are capable of working even in the most difficult ambient conditions. Cooling operation is possible when outdoor temperature is as low as -20 °C¹⁾ or as high as 48 °C²⁾. Heating operation can also be utilized at outdoor temperatures down to -20 °C when outdoor temperature is as low as -20 °C.

1) It is possible to operate at -20 °C only computer rooms with the piping length of 30 m or less.
2) Please check technical tables for further details on operating temperature.

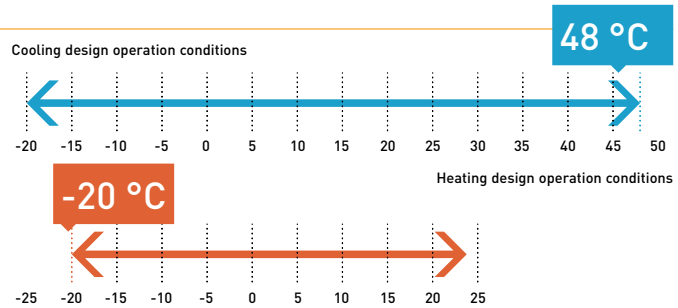

Compact and flexible-design

The slim and lightweight design means the PACi outdoor unit can be installed in a number of compact situations. As the unit only weighs 99kg, it is easy to carry and easy to install.

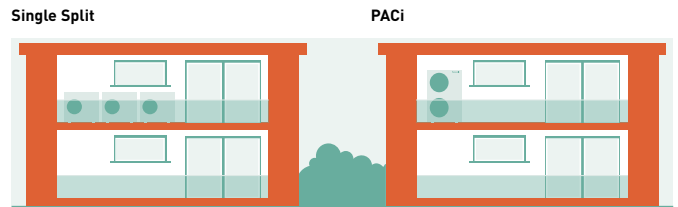

Energy consumption monitoring display with the CZ-RTC5B

Power consumption 20:30 (THU)

Select consumption interval

- 1 day
- 1 week
- 1 year

Sel. [←] Confirm

Menu selection: 3 types (Day/Week/Year) of display are available.

Consump. (1 day) 20:30 (THU)

YD: 61.2 kWh TO: 49.2 kWh

Approx power consumption

Daily Energy consumption: Data is shown with Yesterday's record. (Graph starts from 0 o'clock to 24 o'clock only.)

Consump. (1 week) 20:30 (THU)

THU, DEC 27 49.2 kWh

Approx power consumption

Weekly Energy consumption: Power consumption of each day of the week can be checked.

Consump. (1 year) 20:30 (THU)

DEC 2018 4481 kWh

Approx power consumption

Annual Energy consumption: Power consumption of each month can be checked.

Datanavi, a new way to connect.
Simple and easy support tool with your smartphone.

PACi → Panasonic unique Light ID technology → Datanavi App → Panasonic Cloud Server

- Scan and save AC system info
- Easy access to manual database
- Commissioning, F gas check data history

Demand response compliant (CZ-CAPDC3) as a standard function for 20,0 - 25,0 kW outdoor units

This terminal allows demand control of the outdoor unit. Several setting levels are available:

- Level-1, 2, 3: 75 / 50 / 0 %
- Level-1, 2 can be set in 40 - 100 % (40, 45, 50...95, 100: each 5 %)

CZ-CAPDC3 also allows for forced stop which can be used for fire-alarm connection on LV3.

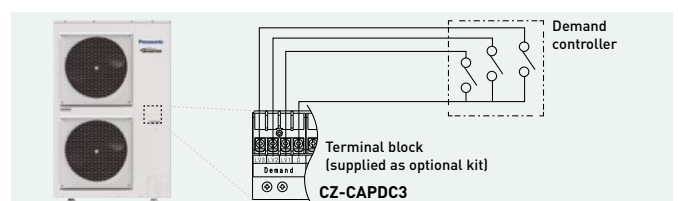

PACi NX 4 way 90x90 cassette - PU3



These cassettes offer upgraded nanoe™ X and Econavi technologies to make the room air more comfortable and healthy and to increase the energy efficiency.





+ SEE PRODUCT SPECIFICATIONS

1 Improved indoor air quality with nanoe™ X and fresh air intake

- nanoe™ X technology equipped as standard for improved indoor air quality
- Internal cleaning function for the unit with nanoe™ X
- High external fresh air intake volume with optional kit (CZ-FDU3 + CZ-ATU2)

2 Superior energy efficiency and comfort

- High seasonal efficiency both in heating and cooling, maximum SEER / SCOP = A+++ / A+++
- Econavi: Intelligent sensors to increase energy savings and comfort
- Super quiet operation down to 27 dB(A)

3 Easy installation

- Light weight, easy piping and integrated drain pump for quick installation
- Wired remote controller CZ-RTC6BL allows easy system setting via Bluetooth®

Always fresh and clean air with nanoe™ X

The 4 way 90x90 cassette with nanoe™ X, when tested, has shown to inhibit hazardous substances by 92 %, when compared to natural reduction*. In addition to the 7 effects of nanoe™ X, the indoor unit can also be cleaned with a short operation of nanoe™ X + dry mode.

* Controllers (CZ-RTC5B or CZ-RTC6/BL/BLW) are required.

After cooling / drying operation, the inside of the indoor unit is automatically dried and nanoe™ X is activated to suppress mould growth and to reduce odour.

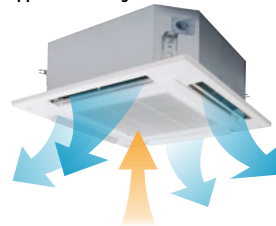

Operates the fan to discharge internal humidity.

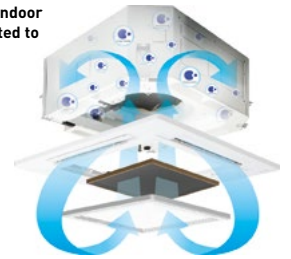

Operate the fan to circulate nanoe™ X internally.

nanoe™ X effect against odour proven in large space

92 % of hexadecane²⁾ is inhibited after 8-hours exposure in room side 267 m².

Hexadecane inhabitation ratio.

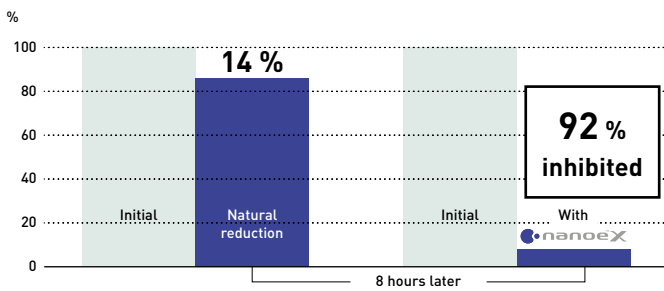

Test ambient.

3rd party certification organization SIRIM³⁾ conducted the performance experiment of 4 way cassette equipped with nanoe X Generator Mark 1 device in inhibiting hexadecane, a chemical contaminant.

2) Hexadecane is a hazardous substance contained in gasoline and diesel exhaust gas, and considered to be one cause of oil odour. 3) SIRIM Berhad (SIRIM), a premier industrial research and technology organization in Malaysia, wholly-owned by the Ministry of Finance Incorporated.

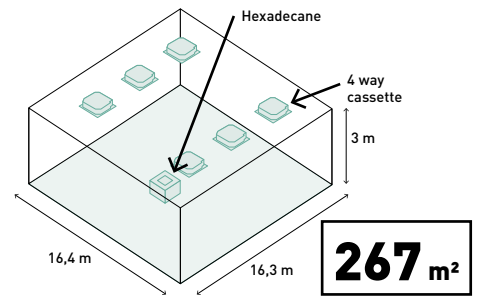

Optional Econavi intelligent sensor

Human activity sensor and floor temperature sensor can reduce waste energy, by optimising air conditioner operation.

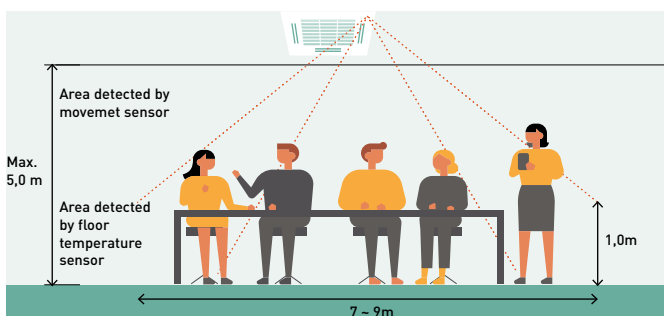

Advanced Econavi functions.

2 sensors (movement and floor temperature) can provide a reduction in wasted energy by means of effective control. The floor temperature can be detected with a ceiling height of 5 m.



Econavi exclusive panel. Optional (CZ-KPU3AW)



Floor temperature sensor.
This sensor detects average floor temperature and operates circulation if floor temperature is low.

Movement sensor.
This sensor detects the amount of human activity, and operates effectively.



Wired remote controller CZ-RTC5B or CZ-RTC6/BL/BLW is required.

PACi NX adaptive ducted unit - PF3



Adaptive ducted - PF3 has been completely re-designed to provide better flexibility. The vertical installation is newly available with powerful external static pressure (maximum 150 Pa).





<https://youtu.be/LBiRrs0aqXo>



SEE PRODUCT SPECIFICATIONS

1 Highly flexible installation
2 installation possibilities (horizontal / vertical).

2 High seasonal performance with slim body
Maximum SEER / SCOP: A++ / A++.

3 Comfort operation
Super quiet operation, minimum 22 dB(A)*.

* 3,6 kW model and when operating with external static pressure 50 Pa in low fan mode.

2 installation possibilities (horizontal / vertical)

Vertical installation is newly available.
External static pressure 150 Pa, sufficient for remotely installing units away from the rooms.



Improved drain pan design

Just one drain pan for both horizontal and vertical installations. No need to modify the unit.

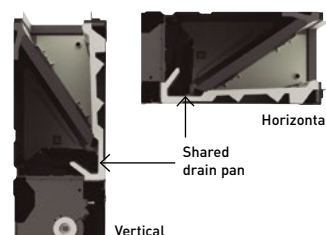

Selectable inlet air position

Inlet air position may be adjusted by means of a removable panel, to allow rear or bottom entry, depending on the duct installation.

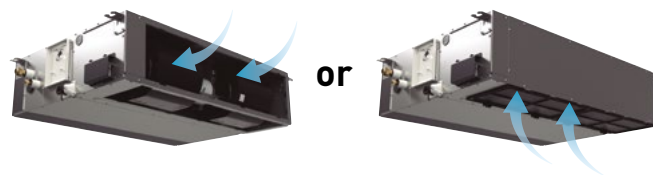

Maximum efficiency

	kW	3,6	5,0	6,0	7,1	10,0		12,5	14,0
Elite	SEER	A++	A++	A++	A++	A++	$\eta_{s,c}$	281,7%	275,9%
	SCOP	A+	A+	A++	A++	A+	$\eta_{s,h}$	170,0%	171,0%
Standard	SEER	—	—	A++	A++	A++	$\eta_{s,c}$	257,4%	252,2%
	SCOP	—	—	A++	A+	A	$\eta_{s,h}$	142,6%	140,6%

Compact body

- Only 250 mm high
- Light units from 25 to 39 kg

Conventional model	Adaptive ducted
33 kg	30 kg
290 mm	250 mm

Adaptive ducted



Better indoor air quality with nanoe™ X



The performance of nanoe™ X technology is maintained, even with 10 m long ducts*.
The effect of improved air quality is sufficient to allow for numerous duct shapes to fit the application.

* Panasonic internal survey.

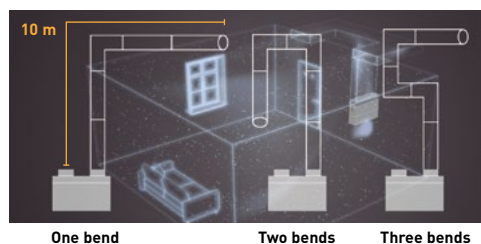

As the experiments demonstrate, up to a duct length of 10 m, effectiveness of nanoe™ X is maintained even if the duct is bended 3 times.

nanoe™ X effect against odour proven in large space

In a room of 139 m², tobacco odour is reduced by a factor of 0,7 when compared to natural reduction over a period of 2 hours.

Tobacco deodorisation ratio.

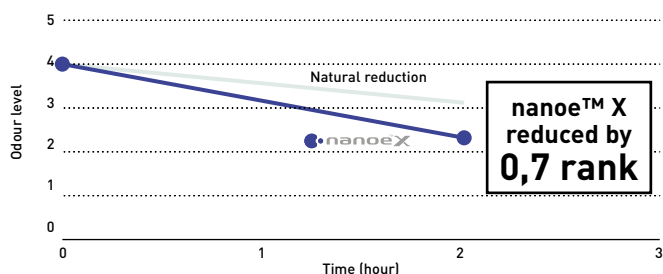

Test ambient.

3rd party international testing institute KAKEN¹⁾ conducted the performance experiment of Adaptive ducted equipped with nanoe X Generator Mark 2 device removing tobacco odour.

1) KAKEN TEST CENTER General Incorporated Foundation in Japan, international testing institute.

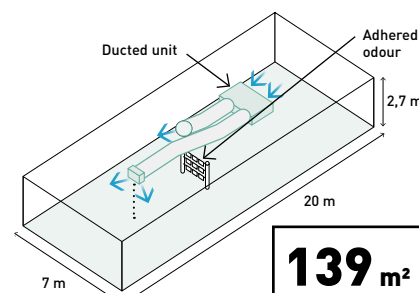

PACi NX wall-mounted, 4 way 60x60 cassette and ceiling

A new era of air conditioning solutions are here, with built-in nanoe™ X technology.



**PACi NX wall-mounted - PK3.**

Providing a small, lightweight and low noise level design, it is ideal for small offices and other commercial applications. It also has a stylish smooth design with a washable front panel.

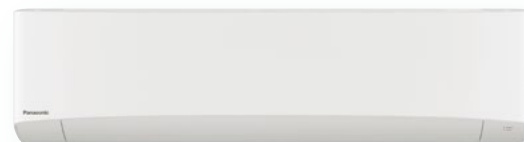

Air distribution is automatically altered depending on the operational mode of the unit

Air outlet angle is automatically adjusted for cooling and heating operation.

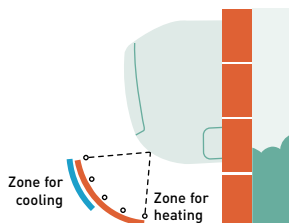
**Closed discharge port**

When the unit is turned OFF, the flap closes completely to prevent dust getting into the unit and to keep the equipment clean.

Piping outlet in six directions

Piping outlet is possible in six directions of; right, right rear, right bottom, left, left rear and left bottom, making installation flexible.



[+ SEE PRODUCT SPECIFICATIONS](#)

PACi NX 4 way 60x60 cassette - PY3.

The PY3 not only perfectly matches with 600 x 600 mm ceiling grids but also provides an additional benefit for better indoor quality, with nanoe™ X built-in.

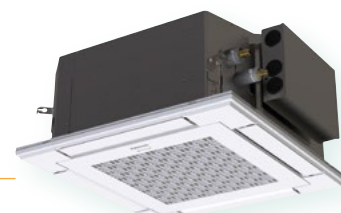
**Industry-leading energy efficiency**

- SEER / SCOP class A++* with Elite outdoor range
- SEER / SCOP class A++ with Standard outdoor range 2,5 kW model

* Except for 6,0 kW.

Compact and stylish design

- Ceiling depth is only 250 mm
- Exposed area is only 30 mm

Internal cleaning function

When cooling or dry operation stopped, internal drying and nanoe™ X circulation airflow is activated in order to suppress the mould proliferation inside the unit (airflow passage, fan, heat exchanger)*.

* Depending on the installation environment or operating hours, mould proliferation or inhabitation of mould growth will be changed.

Individual flap control

Better control of the air flow with 4 motors, providing individual flap control. Perfect air distribution without direct airflow, to reduce the feeling of cold drafts.

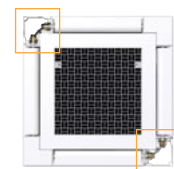

[+ SEE PRODUCT SPECIFICATIONS](#)

PACi NX ceiling - PT3.

Providing outstanding energy-saving performance, comfort and long-distance airflow distribution, these units are perfect for retail stores and schools.

**Comfortable, long-distance airflow distribution**

The shape of the outlet has been optimised to provide long-distance air flow distribution. Even in long rooms, air flow reaches every corner for exceptionally comfortable air conditioning.

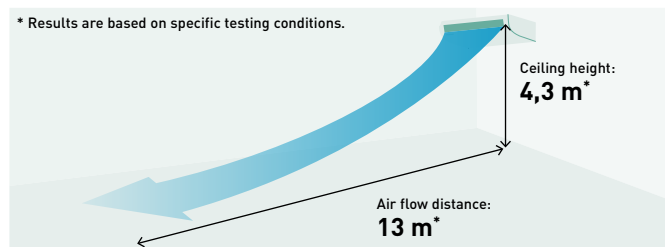
**Compact looking, stylish, one-motion design**

With its streamlined, one-motion form, the unit looks thin and compact when installed for a neat appearance in any room. When not operating, the louver closes to provide an elegant look while also keeping the unit clean.

Energy-saving technology delivering top-class efficiency

Optimisation of the shape of the casing and fan assures bigger air flow and higher efficiency. Energy-saving performance is top class in the industry. Thanks to new DC fan motor and large diagonal air flow fan.

[+ SEE PRODUCT SPECIFICATIONS](#)

Solutions for 24/7/365 applications

High efficiency products for 24/7 applications.

Panasonic has developed a complete range of solutions for server rooms which efficiently protect your servers, keeping them at an appropriate temperature even when the outdoor temperature is below -25 °C.



High efficiency all year

Key points:

- From 2,5 to 7,1 kW with YKEA units A+++ in cooling
- PACi NX units from 2,5 to 14,0 kW
- Back-up function
- Duty rotation mode
- Error information by dry contact
- Operation even at -25 °C outdoor temperature*
- High seasonal performance
- Designed for 24h/7d a week operation

* For YKEA units.

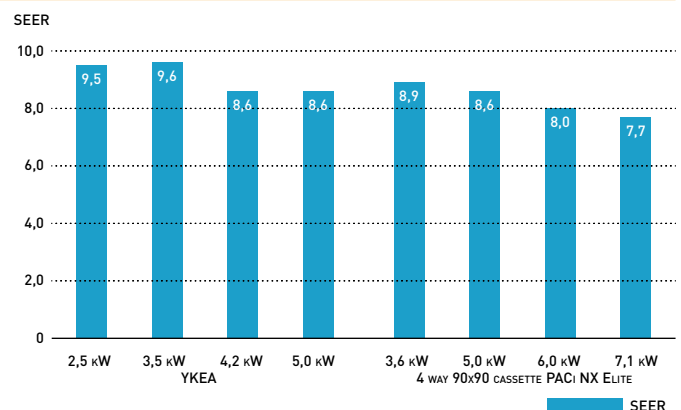



Control solutions for PACi

Interface to run 2 or 3 PACi and VRF indoor units. PAW-PACR3.

In combination with one PAW-T10 on each indoor unit, allows the redundant operation of 2 (or 3) PACi or VRF indoor units.

All units will be operated sequentially in order to achieve the same operating time (example turn every 8 hours within a 24 hour period).

If the room temperature exceeds a freely set value, the 2nd (or 3rd) unit will be switched ON and an alarm will be activated.

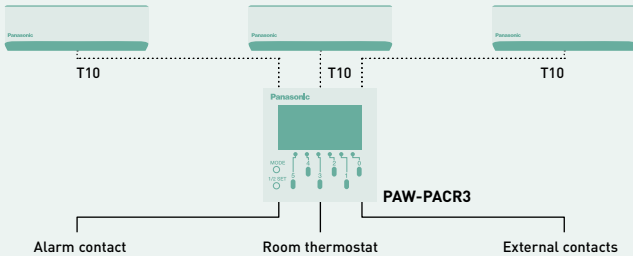

Display and Settings:

- Possible to select next unit manually
- Possible to reset operation
- LED display shows operation status of the 2 or 3 units
- Operation status output
- Alarm LED and alarm output
- Temperature limit can be set
- Temperature hysteresis can be set
- Room temperature is displayed
- Time counter displayed



Back-up control by using CZ-RTC5B.

Group wiring of 2 systems of PACi can do auto individual control.

- Rotation operation
- Back-up operation
- Support operation

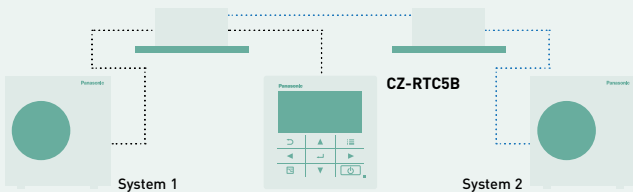

Control solutions with wall-mounted YKEA

YKEA Duty rotation mode (requires optional CZ-RCC5).

Two indoor units operate alternately to maintain the room temperature, reducing the load on the air conditioners and providing stable operation.

Even if one of the units breaks down, the other unit supports stable operation.

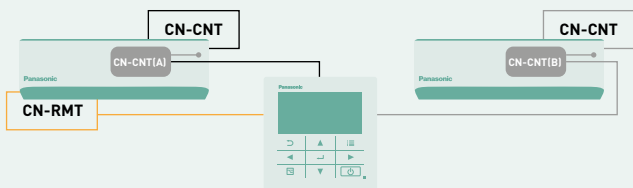

Domestic integration to P-Link - CZ-CAPRA1.

Can connect RAC range to P-Link. Full control is now possible.

Integrates any unit in big system control.

- YKEA server room integration ¹⁾
- Small offices with domestic indoors
- Tender for refurbishment (old system Domestic and VRF in one installation)



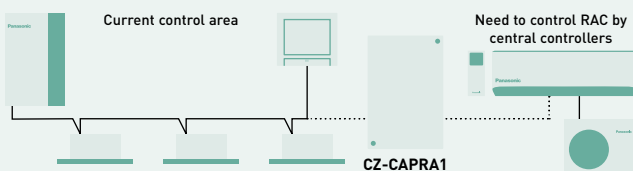







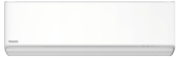
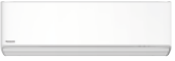
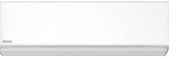
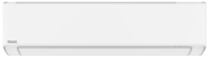





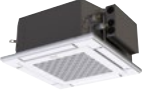

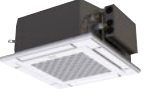











1) When redundancy control using the remote controller is set up, CZ-CAPRA1 cannot be connected.



- Current system for PACi / VRF. Central controller can connect to P-Link line to control units directly
- RAC units cannot connect directly to P-Link to be managed by Central Controllers
- It's necessary to have interface between P-Link and RAC protocol to cover basic operating items



Commercial units range

Page	Indoor units	2,5 kW	3,6 kW	4,5 kW ¹⁾	5,0 kW	6,0 kW
P. 186	NEW wall-mounted Professional Inverter · R32 ²⁾	 CS-Z25YKEA	 CS-Z35YKEA	 CS-Z42YKEA	 CS-Z50YKEA	
P. 188	PACi NX wall-mounted Inverter+ · R32		 S-3650PK3E	 S-3650PK3E	 S-3650PK3E	 S-6010PK3E
P. 192	PACi NX 4 way 60x60 cassette Inverter+ · R32	 S-25PY3E	 S-36PY3E		 S-50PY3E	 S-60PY3E
P. 194	PACi NX 4 way 90x90 cassette Inverter+ · R32		 S-3650PU3E	 S-3650PU3E	 S-3650PU3E	 S-6071PU3E
P. 198	PACi NX ceiling Inverter+ · R32		 S-3650PT3E	 S-3650PT3E	 S-3650PT3E	 S-6071PT3E
P. 202	PACi NX adaptive ducted Inverter+ · R32		 S-3650PF3E	 S-3650PF3E	 S-3650PF3E	 S-6071PF3E
P. 206	High static pressure hide-away 20-25 kW Inverter+ · R32					
P. 208	4 Way 60x60 cassette Inverter+ · R32		 S-36PY2E5B	 S-45PY2E5B	 S-50PY2E5B	
Outdoor units						
		2,5 kW	3,6 kW		5,0 kW	6,0 kW
	PACi NX Elite · R32		 U-36PZH3E5 / U-36PZH2E5 ³⁾		 U-50PZH3E5 / U-50PZH2E5 ³⁾	 U-60PZH3E5
	PACi NX Standard · R32	 U-25PZ3E5	 U-36PZ3E5		 U-50PZ3E5	 U-60PZ3E5A

1) The 4,5 kW indoor capacity options are only available only for twin, triple and double-twin combinations. 2) Not compatible with PACi NX outdoors and accessories. Domestic range sales conditions may apply. Check with your sales representative. 3) PZH2 models only for PY2 models. 4) These two units are not in PACi NX range but part of Big PACi range. * U-__E5 Single phase / U-__E8 Three phase.



OPTIONAL UNITS ON VENTILATION SECTION

7,1 kW

10,0 kW

12,5 kW

14,0 kW

20,0 kW

25,0 kW

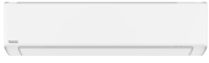

CS-Z71YKEA



S-6010PK3E



S-6010PK3E



S-6071PU3E



S-1014PU3E



S-1014PU3E



S-1014PU3E



S-6071PT3E



S-1014PT3E



S-1014PT3E



S-1014PT3E



S-6071PF3E



S-1014PF3E



S-1014PF3E



S-1014PF3E



S-200PE3E5B



S-250PE3E5B

7,1 kW

10,0 kW

12,5 kW

14,0 kW

20,0 kW

25,0 kW



U-71PZH3E5 / U-71PZH3E8



U-100PZH3E5 / U-100PZH3E8



U-125PZH3E5 / U-125PZH3E8



U-140PZH3E5 / U-140PZH3E8



U-200PZH2E8 ⁴⁾



U-250PZH2E8 ⁴⁾



U-71PZ3E5A



U-100PZ3E5 / U-100PZ3E8



U-125PZ3E5 / U-125PZ3E8



U-140PZ3E5 / U-140PZ3E8

Solutions for server rooms

High efficiency products for 24/7 applications. Panasonic has developed a complete range of solutions for server rooms which efficiently protect your servers, keeping them at an appropriate temperature even when the outdoor temperature is below -25°C .



Not compatible with PACI NX outdoors and accessories. Domestic range sales conditions may apply. Check with your sales representative.



1 Designed for 24h/7d a week operation

High efficiency all year round. This wall-mounted air conditioner is designed for professional, critical applications such as computer rooms where reliable cooling inside the room is necessary even with extreme ambient conditions.

2 New remote controller for better usability

New wired remote controller, which can assure the operation 24/7 of two server room units, thanks to the integrated duty rotation mode. This function manages rotation and back-up of two units and it is available when connecting an optional CN-CNT cable (CZ-RCC5) between the controller and each of the two indoor units.

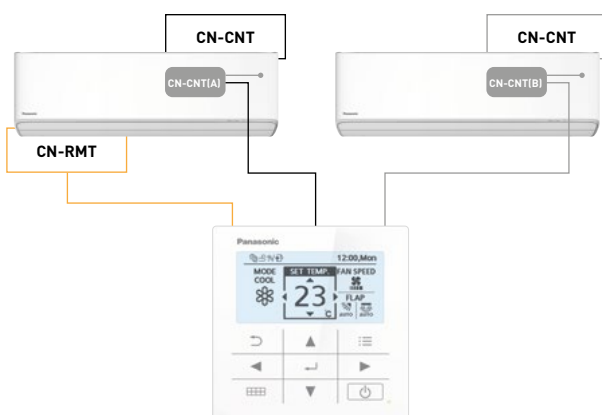

3 Highest energy rating in cooling

The SEER and SCOP of the Server room unit has been further improved to achieve top class energy efficiency. The 3,5 kW unit reaches now the SEER value of 9,6 (A+++).

4 Built-in Wi-Fi and compatible with Voice Assistant

The unit is ready to connect to the internet and to be controlled by smartphone with Panasonic Comfort Cloud App. Control, monitor energy consumption statistics and easily identify errors in case of failure.

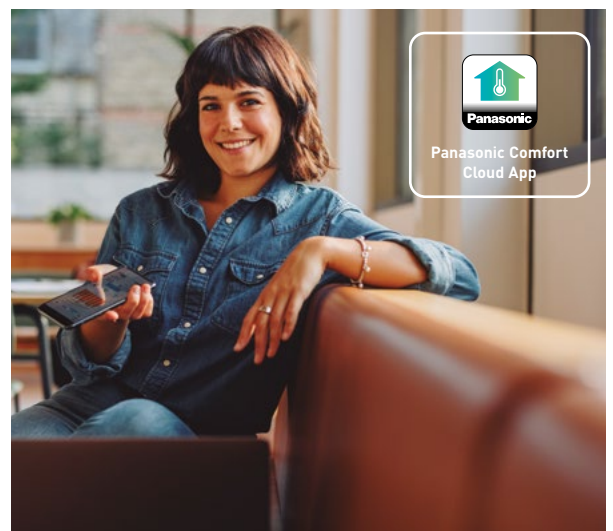

NEW 2022

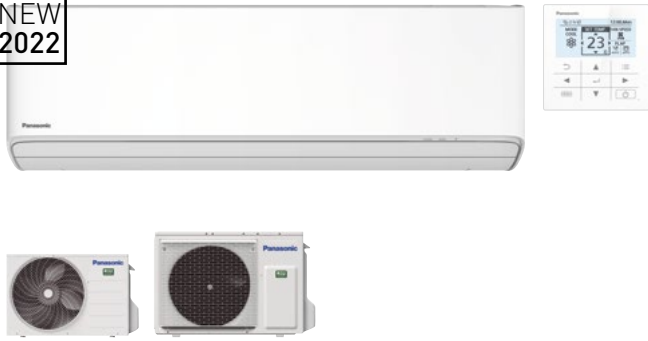

NEW wall-mounted Professional Inverter -25 °C · R32

- Designed for 24h/7d a week operation
- New wired remote controller, with optional duty rotation mode
- Improved SEER / SCOP to achieve top class energy efficiency
- Aerowings 2.0, for a better control of the airflow
- Built-in Wi-Fi for instant connectivity via Panasonic Comfort Cloud App
- Compatible with Google Assistant and Amazon Alexa
- Chassis and parts designed for easier installation

Kit			KIT-Z25-YKEA	KIT-Z35-YKEA	KIT-Z42-YKEA	KIT-Z50-YKEA	KIT-Z71-YKEA
Cooling capacity	Nominal (Min - Max)	kW	2,50 (0,85 - 3,50)	3,50 (0,85 - 4,20)	4,20 (0,85 - 5,00)	5,00 (0,98 - 6,00)	7,10 (0,98 - 8,50)
EER ¹⁾	Nominal (Min - Max)	W/W	4,90 (4,72 - 3,98)	4,12 (4,72 - 3,68)	3,82 (4,72 - 3,25)	3,68 (3,92 - 3,16)	3,23 (2,33 - 2,83)
SEER ²⁾			9,5 A+++	9,6 A+++	8,6 A+++	8,6 A+++	6,5 A++
Pdesign		kW	2,50	3,50	4,20	5,00	7,10
Input power	Nominal (Min - Max)	kW	0,51 (0,18 - 0,88)	0,85 (0,18 - 1,14)	1,10 (0,18 - 1,54)	1,36 (0,25 - 1,90)	2,20 (0,42 - 3,00)
Annual energy consumption ³⁾		kWh/a	92	128	171	203	382
Heating capacity	Nominal (Min - Max)	kW	3,40 (0,85 - 5,00)	4,00 (0,85 - 5,80)	5,30 (0,85 - 6,80)	5,80 (0,98 - 8,00)	8,20 (0,98 - 10,20)
Heating capacity at -7 °C		kW	3,05	3,40	4,11	4,80	6,31
COP ¹⁾	Nominal (Min - Max)	W/W	4,86 (4,72 - 3,97)	4,44 (4,72 - 3,87)	3,93 (4,72 - 3,66)	4,08 (4,26 - 3,35)	3,71 (2,45 - 3,29)
SCOP ²⁾			4,6 A++	4,6 A++	4,5 A+	4,6 A++	4,1 A+
Pdesign at -10 °C		kW	2,70	3,20	3,60	4,20	5,50
Input power	Nominal (Min - Max)	kW	0,70 (0,18 - 1,26)	0,90 (0,18 - 1,50)	1,35 (0,18 - 1,86)	1,42 (0,23 - 2,39)	2,21 (0,40 - 3,10)
Annual energy consumption ³⁾		kWh/a	822	974	1120	1278	1878
Indoor unit			CS-Z25YKEA	CS-Z35YKEA	CS-Z42YKEA	CS-Z50YKEA	CS-Z71YKEA
Power supply		V	230	230	230	230	230
Recommended fuse		A	16	16	16	16	20
Connection indoor / outdoor		mm ²	4 x 1,5	4 x 1,5	4 x 1,5	4 x 2,5	4 x 2,5
Air flow	Cool / Heat	m ³ /min	11,4 / 13,8	12,7 / 14,8	13,2 / 15,2	17,4 / 19,1	19,0 / 19,9
Moisture removal volume		L/h	1,5	2,0	2,4	2,8	4,1
Sound pressure ⁴⁾	Cool (Hi / Lo / Q-Lo)	dB(A)	39 / 25 / 21	42 / 28 / 21	43 / 32 / 29	44 / 37 / 30	47 / 38 / 35
	Heat (Hi / Lo / Q-Lo)	dB(A)	41 / 27 / 22	43 / 30 / 22	44 / 35 / 29	44 / 37 / 30	47 / 38 / 35
Sound power	Cool / Heat (Hi)	dB(A)	55 / 57	58 / 59	59 / 60	60 / 60	63 / 63
Dimension	H x W x D	mm	295 x 870 x 229	295 x 870 x 229	295 x 870 x 229	295 x 1040 x 244	295 x 1040 x 244
Net weight		kg	11	11	11	12	13
Outdoor unit			CU-Z25YKEA	CU-Z35YKEA	CU-Z42YKEA	CU-Z50YKEA	CU-Z71YKEA
Air flow	Cool / Heat	m ³ /min	27,6 / 27,6	29,8 / 29,8	29,8 / 31,0	39,8 / 36,9	44,7 / 45,8
Sound pressure ⁴⁾	Cool / Heat (Hi)	dB(A)	46 / 48	48 / 50	48 / 51	48 / 50	52 / 54
Sound power	Cool / Heat (Hi)	dB(A)	61 / 63	63 / 65	63 / 66	63 / 65	66 / 68
Dimension ⁵⁾	H x W x D	mm	542 x 780 x 289	542 x 780 x 289	542 x 780 x 289	695 x 875 x 320	695 x 875 x 320
Net weight		kg	30	30	30	40	45
Piping diameter	Liquid pipe	Inch (mm)	1/4 (6,35)	1/4 (6,35)	1/4 (6,35)	1/4 (6,35)	1/4 (6,35)
	Gas pipe	Inch (mm)	3/8 (9,52)	3/8 (9,52)	1/2 (12,70)	1/2 (12,70)	5/8 (15,88)
Pipe length range		m	3 - 20	3 - 20	3 - 20	3 - 30	3 - 30
Elevation difference (in / out)		m	15	15	15	15	20
Pipe length for additional gas		m	7,5	7,5	7,5	7,5	10
Additional gas amount		g/m	10	10	10	15	25
Refrigerant (R32) / CO ₂ Eq.		kg / T	0,89 / 0,60	0,89 / 0,60	0,97 / 0,65	1,13 / 0,76	1,35 / 0,91
Operating range	Cool Min ~ Max	°C	-25 ~ +43	-25 ~ +43	-25 ~ +43	-25 ~ +43	-25 ~ +43
	Heat Min ~ Max	°C	-15 ~ +24	-15 ~ +24	-15 ~ +24	-15 ~ +24	-15 ~ +24

1) EER and COP calculation is based in accordance to EN14511. 2) Energy Label Scale from A+++ to D. 3) The annual energy consumption is calculated in accordance to EU/626/2011. 4) The sound pressure of the indoor unit shows the value measured at a position 1 m in front of the main body and 0,8 m below the unit. For outdoor unit 1 m in front and 1 m in rear side of main body. The sound pressure is measured in accordance with JIS C 9612. Q-Lo: Quiet mode. Lo: The lowest set fan speed. 5) Add 70 mm for piping port. * Available in February 2022. ** Not compatible with PACi NX outdoors and accessories. Domestic range sales conditions may apply. Check with your sales representative.

Accessories

CZ-RCC5	CN-CNT cables x2 for server room application, control of 2 units, rotation, back-up, etc.
PAW-WTRAY	Tray for condenser water compatible with outdoor elevation platform

Accessories

PAW-GRDBSE20	Outdoor base ground support for noise and vibration absorption
PAW-GRDSTD40	Outdoor elevation platform 400x900x400 mm



SEER: For KIT-Z35-YKEA. SCOP: For KIT-Z25-YKEA, KIT-Z35-YKEA and KIT-Z50-YKEA. SUPER QUIET: For KIT-Z25-YKEA. INTERNET CONTROL: Built-in Wi-Fi.

Rating Conditions: Cooling Indoor 27 °C DB / 19 °C WB. Cooling Outdoor 35 °C DB / 24 °C WB. Heating Indoor 20 °C DB. Heating Outdoor 7 °C DB / 6 °C WB. [DB: Dry Bulb; WB: Wet Bulb]. Specifications subject to change without notice. For detailed information about ErP / Energy Labelling, please visit our websites www.aircon.panasonic.eu or www.ptc.panasonic.eu.



PACi NX Series Elite wall-mounted Inverter+ · R32

The wall-mounted units with stylish matt color can be offered for many applications such as studios, gyms, high ceiling areas and even computer server rooms.

The compact design and flat face ensure discreet installation, even in a small space.



			Single phase				
			3,6 kW	5,0 kW	6,0 kW	7,1 kW	10,0 kW
Kit			KIT-36PK3ZH5	KIT-50PK3ZH5	KIT-60PK3ZH5	KIT-71PK3ZH5	KIT-100PK3ZH5
Remote controller			CZ-RTC5B	CZ-RTC5B	CZ-RTC5B	CZ-RTC5B	CZ-RTC5B
Cooling capacity	Nominal (Min - Max)	kW	3,6 (1,2 - 4,0)	5,0 (1,2 - 5,6)	6,1 (1,2 - 7,1)	7,1 (2,2 - 9,0)	9,5 (3,1 - 10,5)
EER ¹⁾	Nominal (Min - Max)	W/W	4,93 (4,49 - 5,45)	4,24 (3,61 - 5,45)	3,86 (3,02 - 5,45)	3,50 (2,69 - 5,79)	3,26 (3,09 - 5,34)
SEER ²⁾			8,4 A++	8,0 A++	7,2 A++	6,8 A++	6,4 A++
Pdesign		kW	3,6	5,0	6,1	7,1	9,5
Input power	Nominal (Min - Max)	kW	0,73 (0,22 - 0,89)	1,18 (0,22 - 1,55)	1,58 (0,22 - 2,35)	2,03 (0,38 - 3,35)	2,91 (0,58 - 3,40)
Annual energy consumption ³⁾		kWh/a	150	219	297	365	520
Heating capacity	Nominal (Min - Max)	kW	4,0 (1,2 - 5,0)	5,6 (1,2 - 6,5)	7,0 (1,2 - 8,0)	8,0 (2,0 - 9,0)	9,5 (3,1 - 11,5)
COP ¹⁾	Nominal (Min - Max)	W/W	4,82 (4,17 - 5,45)	4,15 (3,55 - 5,45)	4,19 (3,40 - 5,45)	4,00 (3,16 - 5,56)	3,97 (3,43 - 5,54)
SCOP ²⁾			4,9 A++	4,7 A++	4,8 A++	4,7 A++	4,1 A+
Pdesign at -10 °C		kW	3,6	4,5	4,6	5,2	8,0
Input power	Nominal (Min - Max)	kW	0,83 (0,22 - 1,20)	1,35 (0,22 - 1,83)	1,67 (0,22 - 2,35)	2,00 (0,36 - 2,85)	2,39 (0,56 - 3,35)
Annual energy consumption ³⁾		kWh/a	1029	1341	1342	1549	2732
Indoor unit			S-3650PK3E	S-3650PK3E	S-6010PK3E	S-6010PK3E	S-6010PK3E
Air flow	Hi / Med / Lo	m ³ /min	13,0/11,0/9,0	16,0/13,5/11,0	20,0/17,5/14,5	20,0/17,5/14,5	22,0/18,5/15,0
Moisture removal volume		L/h	0,9	1,8	2,0	3,0	4,8
Sound pressure ⁴⁾	Hi / Med / Lo	dB(A)	35/31/27	40/36/32	47/44/40	47/44/40	49/45/41
Sound power	Hi / Med / Lo	dB(A)	51/47/43	56/52/48	63/60/56	63/60/56	65/61/57
Dimension	H x W x D	mm	302 x 1120 x 236	302 x 1120 x 236	302 x 1120 x 236	302 x 1120 x 236	302 x 1120 x 236
Net weight		kg	13	13	14	14	14
nanoe X Generator			Mark 2	Mark 2	Mark 2	Mark 2	Mark 2
Outdoor unit			U-36PZH3E5	U-50PZH3E5	U-60PZH3E5	U-71PZH3E5	U-100PZH3E5
Power supply		V	220 - 230 - 240	220 - 230 - 240	220 - 230 - 240	220 - 230 - 240	220 - 230 - 240
Current	Cool	A	3,60 - 3,45 - 3,30	5,60 - 5,35 - 5,10	7,40 - 7,10 - 6,80	10,0 - 9,60 - 9,20	14,40 - 13,80 - 13,20
	Heat	A	4,05 - 3,90 - 3,70	6,40 - 6,10 - 5,85	7,75 - 7,40 - 7,10	9,65 - 9,35 - 8,95	11,70 - 11,30 - 10,80
Air flow	Cool / Heat	m ³ /min	34,1/36,4	42,0/42,0	42,0/42,0	61,0/60,0	118,0/108,0
Sound pressure	Cool / Heat (Hi)	dB(A)	43/44	46/48	47/50	48/50	52/52
Sound power	Cool / Heat (Hi)	dB(A)	62/64	64/67	65/69	65/67	69/69
Dimension	H x W x D	mm	695 x 875 x 320	695 x 875 x 320	695 x 875 x 320	996 x 940 x 340	1416 x 940 x 340
Net weight		kg	42	42	43	65	98
Piping diameter	Liquid pipe	Inch (mm)	1/4 (6,35)	1/4 (6,35)	1/4 (6,35) ⁵⁾	3/8 (9,52)	3/8 (9,52)
	Gas pipe	Inch (mm)	1/2 (12,70)	1/2 (12,70)	1/2 (12,70) ⁶⁾	5/8 (15,88)	5/8 (15,88)
Pipe length range		m	3 - 40	3 - 40	3 - 40	5 - 50	5 - 85
Elevation difference (in / out) ⁷⁾		m	15/30	15/30	15/30	15/30	15/30
Pipe length for additional gas		m	30	30	30	30	30
Additional gas amount		g/m	15	15	15	45	45
Refrigerant (R32) / CO ₂ Eq.		kg / T	1,13/0,76	1,13/0,76	1,15/0,78	1,95/1,32	3,05/2,06
Operating range	Cool Min ~ Max	°C	-15 ~ +46	-15 ~ +46	-15 ~ +46	-15 ~ +48	-20 ~ +48 ⁸⁾
	Heat Min ~ Max	°C	-20 ~ +24	-20 ~ +24	-20 ~ +24	-20 ~ +24	-20 ~ +24

Technical focus

- Modern design with flat face and compact size
- DC fan for better efficiency and control
- Six directional piping outlet
- nanoe™ X (Generator Mark 2= 9,6 trillion hydroxyl radicals/sec) as standard for better indoor air quality
- Wired remote control CZ-RTC6BL allows easy system setting via Bluetooth®
- Easy connection and control of external fan or ERV using the connector PAW-FDC on the indoor unit PCB. The external device can be controlled by the remote control of the Panasonic indoor unit

Closed discharge port

When the unit is turned OFF, the flap closes completely to prevent dust getting into the unit and to keep the equipment clean.

Quiet operation

These units are among the quietest in the industry, making them ideal for hotels and hospitals.

Piping outlet in six directions

Piping outlet is possible in six directions of; right, right rear, right bottom, left, left rear and left bottom, making installation flexible.



CZ-RTC5B



Optional controller. CONEX wired remote controller.
CZ-RTC6 - CZ-RTC6BL
- CZ-RTC6BLW



Optional controller. Infrared remote controller.
CZ-RWS3



Optional Econavi sensor.
CZ-CENSC1

COMPATIBLE WITH ALL PANASONIC CONNECTIVITY SOLUTIONS. FOR DETAILED INFORMATION GO TO THE CONTROL SYSTEMS SECTION

Three phase

			7,1 kW	10,0 kW
Kit			KIT-71PK3ZH8	KIT-100PK3ZH8
Remote controller			CZ-RTC5B	CZ-RTC5B
Cooling capacity	Nominal (Min - Max)	kW	7,1 (2,2 - 9,0)	9,5 (3,1 - 10,5)
EER ¹⁾	Nominal (Min - Max)	W/W	3,50 (2,69 - 5,79)	3,26 (3,09 - 5,34)
SEER ²⁾			6,7 A++	6,3 A++
Pdesign		kW	7,1	9,5
Input power	Nominal (Min - Max)	kW	2,03 (0,38 - 3,35)	2,91 (0,58 - 3,40)
Annual energy consumption ³⁾		kWh/a	370	526
Heating capacity	Nominal (Min - Max)	kW	8,0 (2,0 - 9,0)	9,5 (3,1 - 11,5)
COP ¹⁾	Nominal (Min - Max)	W/W	4,00 (3,16 - 5,56)	3,97 (3,43 - 5,54)
SCOP ²⁾			4,7 A++	4,1 A+
Pdesign at -10 °C		kW	5,2	8,0
Input power	Nominal (Min - Max)	kW	2,00 (0,36 - 2,85)	2,39 (0,56 - 3,35)
Annual energy consumption ³⁾		kWh/a	1549	2732
Indoor unit			S-6010PK3E	S-6010PK3E
Air flow	Hi / Med / Lo	m ³ /min	20,0/17,5/14,5	22,0/18,5/15,0
Moisture removal volume		L/h	3,0	4,8
Sound pressure ⁴⁾	Hi / Med / Lo	dB(A)	47/44/40	49/45/41
Sound power	Hi / Med / Lo	dB(A)	63/60/56	65/61/57
Dimension	HxWxD	mm	302x1120x236	302x1120x236
Net weight		kg	14	14
nanoe X Generator			Mark 2	Mark 2
Outdoor unit			U-71PZH3E8	U-100PZH3E8
Power supply		V	380 - 400 - 415	380 - 400 - 415
Current	Cool	A	3,40 - 3,25 - 3,15	4,85 - 4,60 - 4,40
	Heat	A	3,30 - 3,15 - 3,05	4,00 - 3,80 - 3,60
Air flow	Cool / Heat	m ³ /min	61,0/60,0	118,0/108,0
Sound pressure	Cool / Heat (Hi)	dB(A)	48/50	52/52
Sound power	Cool / Heat (Hi)	dB(A)	65/67	69/69
Dimension	HxWxD	mm	996 x 940 x 340	1416 x 940 x 340
Net weight		kg	65	98
Piping diameter	Liquid pipe	Inch (mm)	3/8 (9,52)	3/8 (9,52)
	Gas pipe	Inch (mm)	5/8 (15,88)	5/8 (15,88)
Pipe length range		m	5 - 50	5 - 85
Elevation difference (in / out) ⁷⁾		m	15/30	15/30
Pipe length for additional gas		m	30	30
Additional gas amount		g/m	45	45
Refrigerant (R32) / CO ₂ Eq.		kg / T	1,95/1,32	3,05/2,06
Operating range	Cool Min ~ Max	°C	-15 ~ +48	-20 ~ +48 ⁸⁾
	Heat Min ~ Max	°C	-20 ~ +24	-20 ~ +24

1) EER and COP calculation is based in accordance to EN14511. 2) For models below 12 kW, the SEER and SCOP is calculated based on values of EU/626/2011. For models above 12 kW, the η_{he}/η_{hc} values is calculated based on EN 14825. 3) Factory setting. 4) The sound pressure of the units shows the value measured of the position 1 m in front of the main body and 1 m below the unit. The sound pressure is measured in accordance with Eurovent 6/C/006-97 specification. 5) Connect the liquid socket tube (Ø6,35-Ø9,52) to the liquid tubing side indoor unit. 6) Connect the gas socket tube (Ø12,70-Ø15,88) to the gas tubing side indoor unit. 7) Outdoor unit located lower / outdoor unit located higher. 8) For models 100 ~ 140PZH3E5(8), it is possible to operate the lowest -20 °C in the computer rooms with the piping length of 30 m or less. * Recommended fuse for the indoor 3 A. ** Above values are in the case of nanoe™ X OFF.

Accessories

CZ-RTC6	CONEX wired remote controller (non-wireless)
CZ-RTC6BL	CONEX wired remote controller with Bluetooth®
CZ-RTC6BLW	CONEX wired remote controller with Wi-Fi and Bluetooth®
CZ-RTC5B	Wired remote controller with Econavi function and datanavi
CZ-RWS3	Infrared remote controller
CZ-CAPWFC1	Commercial Wi-Fi Adaptor

Accessories

PAW-PACR3	Interfaces to run 3 units on back-up and alternative run
PAW-WTRAY	Tray for condenser water compatible with outdoor elevation platform
PAW-GRDBSE20	Outdoor base ground support for noise and vibration absorption
PAW-GRDSTD40	Outdoor elevation platform 400 x 900 x 400 mm
CZ-CENSC1	Econavi energy savings sensor



SEER and SCOP: For S-3650PK3E + U-36PZH3E5. INTERNET CONTROL: Optional.

Rating Conditions: Cooling Indoor 27 °C DB / 19 °C WB. Cooling Outdoor 35 °C DB / 24 °C WB. Heating Indoor 20 °C DB. Heating Outdoor 7 °C DB / 6 °C WB. (DB: Dry Bulb; WB: Wet Bulb). Specifications subject to change without notice. For detailed information about ErP / Energy Labelling, please visit our websites www.aircon.panasonic.eu or www.ptc.panasonic.eu.



PACi NX Series Standard wall-mounted Inverter+ · R32

The wall-mounted units with stylish matt color can be offered for many applications such as studios, gyms, high ceiling areas and even computer server rooms.

The compact design and flat face ensure discreet installation, even in a small space.



			Single phase				
			3,6 kW	5,0 kW	6,0 kW	7,1 kW	10,0 kW
Kit			KIT-36PK3Z5	KIT-50PK3Z5	KIT-60PK3Z5	KIT-71PK3Z5	KIT-100PK3Z5
Remote controller			CZ-RTC5B	CZ-RTC5B	CZ-RTC5B	CZ-RTC5B	CZ-RTC5B
Cooling capacity	Nominal (Min - Max)	kW	3,6(1,5 - 4,0)	5,0(1,5 - 5,6)	6,1(2,0 - 7,1)	7,1(2,6 - 7,7)	9,0(3,0 - 9,7)
EER ¹⁾	Nominal (Min - Max)	W/W	4,14(3,74 - 5,88)	3,52(3,03 - 6,25)	3,67(3,01 - 6,90)	3,16(2,77 - 5,00)	3,47(3,13 - 5,36)
SEER ²⁾			7,6 A++	7,4 A++	7,0 A++	5,8 A+	6,5 A++
Pdesign		kW	3,6	5,0	6,1	7,1	9,0
Input power	Nominal (Min - Max)	kW	0,87(0,26 - 1,07)	1,42(0,24 - 1,85)	1,66(0,29 - 2,36)	2,25(0,52 - 2,78)	2,59(0,56 - 3,10)
Annual energy consumption ³⁾		kWh/a	166	237	3,05	429	485
Heating capacity	Nominal (Min - Max)	kW	3,6(1,5 - 4,6)	5,0(1,5 - 6,4)	6,1(1,8 - 7,0)	7,1(2,1 - 8,1)	9,0(3,0 - 10,5)
COP ¹⁾	Nominal (Min - Max)	W/W	4,62(4,11 - 6,52)	4,20(3,17 - 7,50)	4,39(3,18 - 7,50)	4,23(3,38 - 6,36)	3,93(3,56 - 5,36)
SCOP ²⁾			4,5 A+	4,4 A+	4,7 A++	4,4 A+	3,9 A
Pdesign at -10 °C		kW	2,8	4,0	4,6	5,2	9,0
Input power	Nominal (Min - Max)	kW	0,78(0,23 - 1,12)	1,19(0,20 - 2,02)	1,39(0,24 - 2,20)	1,68(0,33 - 2,40)	2,29(0,56 - 2,95)
Annual energy consumption ³⁾		kWh/a	872	1273	1370	1653	3231
Indoor unit			S-3650PK3E	S-3650PK3E	S-6010PK3E	S-6010PK3E	S-6010PK3E
Air flow	Hi / Med / Lo	m ³ /min	13,0/11,0/9,0	16,0/13,5/11,0	20,0/17,5/14,5	20,0/17,5/14,5	22,0/18,5/15,0
Moisture removal volume		L/h	0,9	1,8	2,0	3,0	4,3
Sound pressure ⁴⁾	Hi / Med / Lo	dB(A)	35/31/27	40/36/32	47/44/40	47/44/40	49/45/41
Sound power	Hi / Med / Lo	dB(A)	51/47/43	56/52/48	63/60/56	63/60/56	65/61/57
Dimension	HxWxD	mm	302x1120x236	302x1120x236	302x1120x236	302x1120x236	302x1120x236
Net weight		kg	13	13	14	14	14
nanoe X Generator			Mark 2	Mark 2	Mark 2	Mark 2	Mark 2
Outdoor unit			U-36PZ3E5	U-50PZ3E5	U-60PZ3E5A	U-71PZ3E5A	U-100PZ3E5
Power supply		V	220 - 230 - 240	220 - 230 - 240	220 - 230 - 240	220 - 230 - 240	220 - 230 - 240
Current	Cool	A	4,05 - 3,85 - 3,70	6,60 - 6,30 - 6,05	7,70 - 7,35 - 7,05	10,4 - 10,00 - 9,55	12,9 - 12,4 - 11,9
	Heat	A	3,65 - 3,50 - 3,35	5,60 - 5,35 - 5,10	6,45 - 6,15 - 5,90	7,80 - 7,45 - 7,15	11,4 - 10,9 - 10,5
Air flow	Cool / Heat	m ³ /min	33,6/34,0	32,7/31,9	42,6/41,5	44,7/45,9	73,0/73,0
Sound pressure	Cool / Heat (Hi)	dB(A)	46/47	46/46	47/48	48/49	52/52
Sound power	Cool / Heat (Hi)	dB(A)	64/66	64/64	64/65	66/68	70/70
Dimension	HxWxD	mm	619x824x299	619x824x299	695x875x320	695x875x320	996x980x370
Net weight		kg	32	35	42	50	83
Piping diameter	Liquid pipe	Inch (mm)	1/4 (6,35)	1/4 (6,35)	1/4 (6,35) ⁵⁾	1/4 (6,35) ⁵⁾	3/8(9,52)
	Gas pipe	Inch (mm)	1/2 (12,70)	1/2 (12,70)	1/2 (12,70) ⁶⁾	5/8(15,88) ⁶⁾	5/8(15,88)
Pipe length range		m	3 - 15	3 - 20	3 - 40	3 - 40	5 - 50
Elevation difference (in / out) ⁷⁾		m	15/15	15/15	15/30	20/30	15/30
Pipe length for additional gas		m	7,5	7,5	30	30	30
Additional gas amount		g/m	10	15	15	17	45
Refrigerant (R32) / CO ₂ Eq.		kg / T	0,87/0,59	1,14/0,77	1,15/0,78	1,32/0,89	2,4/1,62
Operating range	Cool Min ~ Max	°C	-10 ~ +43	-10 ~ +43	-10 ~ +43	-10 ~ +43	-10 ~ +43
	Heat Min ~ Max	°C	-15 ~ +24	-15 ~ +24	-15 ~ +24	-15 ~ +24	-15 ~ +24

Technical focus

- Modern design with flat face and compact size
- DC fan for better efficiency and control
- Six directional piping outlet
- nanoe™ X (Generator Mark 2= 9,6 trillion hydroxyl radicals/sec) as standard for better indoor air quality
- Wired remote control CZ-RTC6BL allows easy system setting via Bluetooth®
- Easy connection and control of external fan or ERV using the connector PAW-FDC on the indoor unit PCB. The external device can be controlled by the remote control of the Panasonic indoor unit

Closed discharge port

When the unit is turned OFF, the flap closes completely to prevent dust getting into the unit and to keep the equipment clean.

Quiet operation

These units are among the quietest in the industry, making them ideal for hotels and hospitals.

Piping outlet in six directions

Piping outlet is possible in six directions of; right, right rear, right bottom, left, left rear and left bottom, making installation flexible.



CZ-RTC5B



COMPATIBLE WITH ALL PANASONIC CONNECTIVITY SOLUTIONS. FOR DETAILED INFORMATION GO TO THE CONTROL SYSTEMS SECTION



CONEX



Optional controller. CONEX wired remote controller. CZ-RTC6 - CZ-RTC6BL - CZ-RTC6BLW



Optional controller. Infrared remote controller. CZ-RWS3



Optional Econavi sensor. CZ-CENSC1

			Three phase
			10,0 kW
Kit			KIT-100PK3Z8
Remote controller			CZ-RTC5B
Cooling capacity	Nominal (Min - Max)	kW	9,0 (3,0 - 9,7)
EER ¹⁾	Nominal (Min - Max)	W/W	3,47 (5,36 - 3,13)
SEER ²⁾			6,5 A++
Pdesign		kW	9,0
Input power	Nominal (Min - Max)	kW	2,59 (0,56 - 3,10)
Annual energy consumption ³⁾		kWh/a	485
Heating capacity	Nominal (Min - Max)	kW	9,0 (3,0 - 10,5)
COP ¹⁾	Nominal (Min - Max)	W/W	3,93 (5,36 - 3,56)
SCOP ²⁾			3,9 A
Pdesign at -10 °C		kW	9,0
Input power	Nominal (Min - Max)	kW	2,29 (0,56 - 2,95)
Annual energy consumption ³⁾		kWh/a	3231
Indoor unit			S-6010PK3E
Air flow	Hi / Med / Lo	m ³ /min	22,0 / 18,5 / 15,0
Moisture removal volume		L/h	4,3
Sound pressure ⁴⁾	Hi / Med / Lo	dB(A)	49 / 45 / 41
Sound power	Hi / Med / Lo	dB(A)	65 / 61 / 57
Dimension	H x W x D	mm	302 x 1120 x 236
Net weight		kg	14
nanoe X Generator			Mark 2
Outdoor unit			U-100PZ3E8
Power supply		V	380 - 400 - 415
Current	Cool	A	4,30 - 4,10 - 3,95
	Heat	A	3,80 - 3,65 - 3,50
Air flow	Cool / Heat	m ³ /min	73,0 / 73,0
Sound pressure	Cool / Heat (Hi)	dB(A)	52 / 52
Sound power	Cool / Heat (Hi)	dB(A)	70 / 70
Dimension	H x W x D	mm	996 x 980 x 370
Net weight		kg	83
Piping diameter	Liquid pipe	Inch (mm)	3/8 (9,52)
	Gas pipe	Inch (mm)	5/8 (15,88)
Pipe length range		m	5 - 50
Elevation difference (in / out) ⁷⁾		m	15 / 30
Pipe length for additional gas		m	30
Additional gas amount		g/m	45
Refrigerant (R32) / CO ₂ Eq.		kg / T	2,4 / 1,62
Operating range	Cool Min ~ Max	°C	-10 ~ +43
	Heat Min ~ Max	°C	-15 ~ +24

1) EER and COP calculation is based in accordance to EN14511. 2) For models below 12 kW, the SEER and SCOP is calculated based on values of EU/626/2011. For models above 12 kW, the $\eta_{h,c} / \eta_{h,h}$ values is calculated based on EN 14825. 3) Factory setting. 4) The sound pressure of the units shows the value measured of the position 1 m in front of the main body and 1 m below the unit. The sound pressure is measured in accordance with Eurovent 6/C/006-97 specification. 5) Connect the liquid socket tube (Ø6,35-Ø9,52) to the liquid tubing side indoor unit. 6) Connect the gas socket tube (Ø12,70-Ø15,88) to the gas tubing side indoor unit. 7) Outdoor unit located lower / outdoor unit located higher. * Recommended fuse for the indoor 3 A. ** Above values are in the case of nanoe™ X OFF.

Accessories

CZ-RTC6	CONEX wired remote controller (non-wireless)
CZ-RTC6BL	CONEX wired remote controller with Bluetooth®
CZ-RTC6BLW	CONEX wired remote controller with Wi-Fi and Bluetooth®
CZ-RTC5B	Wired remote controller with Econavi function and datanavi
CZ-RWS3	Infrared remote controller
CZ-CAPWFC1	Commercial Wi-Fi Adaptor

Accessories

PAW-PACR3	Interfaces to run 3 units on back-up and alternative run
PAW-WTRAY	Tray for condenser water compatible with outdoor elevation platform
PAW-GRDBSE20	Outdoor base ground support for noise and vibration absorption
PAW-GRDSTD40	Outdoor elevation platform 400 x 900 x 400 mm
CZ-CENSC1	Econavi energy savings sensor



SEER: For S-3650PK3E + U-36PZ3E5. SCOP: For S-6010PK3E + U-60PZ3E5A. INTERNET CONTROL: Optional.

Rating Conditions: Cooling Indoor 27 °C DB / 19 °C WB. Cooling Outdoor 35 °C DB / 24 °C WB. Heating Indoor 20 °C DB. Heating Outdoor 7 °C DB / 6 °C WB. (DB: Dry Bulb; WB: Wet Bulb). Specifications subject to change without notice. For detailed information about ErP / Energy Labelling, please visit our websites www.aircon.panasonic.eu or www.ptc.panasonic.eu.

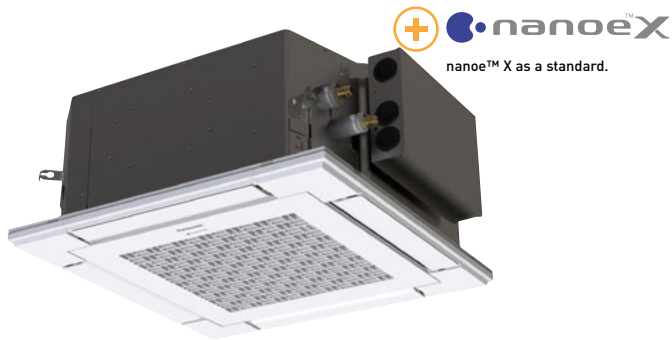

nanoe™ X
nanoe™ X as a standard.

PACi NX Series Elite and Standard 4 way 60x60 cassette Inverter+ · R32

4 way 60x60 cassette - PY3.

- From 2,5 to 6,0 kW (4 capacity sizes)
- SEER / SCOP class A++*
- Built-in drain pump
- DC drain pump and float switch to reduce the noise
- nanoe™ X (Generator Mark 2= 9,6 trillion hydroxyl radicals/sec) as standard for better indoor air quality

* SCOP class A+ in case of 2,5 / 6,0 kW.

Elite			Single phase		
			3,6 kW	5,0 kW	6,0 kW
Kit			KIT-36PY3ZH5	KIT-50PY3ZH5	KIT-60PY3ZH5
Remote controller			CZ-RTC5B	CZ-RTC5B	CZ-RTC5B
Cooling capacity	Nominal (Min - Max)	kW	3,6(1,2 - 4,0)	5,0(1,2 - 5,6)	6,0(1,2 - 6,5)
EER ¹⁾	Nominal (Min - Max)	W/W	4,50(4,04 - 5,45)	3,76(3,41 - 5,45)	3,43(2,77 - 5,45)
SEER²⁾			7,3 A++	7,0 A++	6,7 A++
Pdesign		kW	3,6	5,0	6,0
Input power	Nominal (Min - Max)	kW	0,80(0,22 - 0,99)	1,33(0,22 - 1,64)	1,75(0,22 - 2,35)
Annual energy consumption ³⁾		kWh/a	400	685	875
Heating capacity	Nominal (Min - Max)	kW	4,0(1,2 - 5,0)	5,6(1,2 - 6,5)	7,0(1,2 - 7,5)
COP ¹⁾	Nominal (Min - Max)	W/W	4,12(3,45 - 5,45)	3,37(2,95 - 5,45)	3,35(3,38 - 5,45)
SCOP²⁾			4,7 A++	4,6 A++	4,3 A+
Pdesign at -10 °C		kW	3,6	4,5	4,6
Input power	Nominal (Min - Max)	kW	0,97(0,22 - 1,45)	1,66(0,22 - 2,20)	2,09(0,22 - 2,22)
Annual energy consumption ³⁾		kWh/a	1073	1370	1495
Indoor unit			S-36PY3E	S-50PY3E	S-60PY3E
Air flow	Hi / Med / Lo	m ³ /min	9,5/7,5/6,0	12,0/9,5/6,5	14,0/10,5/8,0
Moisture removal volume		L/h	1,5	2,5	2,8
Sound pressure ⁴⁾	Hi / Med / Lo	dB(A)	34/30/25	39/34/27	43/37/31
Sound power	Hi / Med / Lo	dB(A)	49/45/40	54/49/42	58/52/46
Dimension	Indoor (HxWxD)	mm	243x575x575	243x575x575	243x575x575
	Panel (HxWxD)	mm	30x625x625	30x625x625	30x625x625
Net weight	Indoor / Panel	kg	15/2,8	15/2,8	15/2,8
nanoe X Generator			Mark 2	Mark 2	Mark 2
Outdoor unit			U-36PZH3E5	U-50PZH3E5	U-60PZH3E5
Power supply		V	220 - 230 - 240	220 - 230 - 240	220 - 230 - 240
Current	Cool	A	3,95 - 3,60 - 3,60	5,30 - 5,00 - 5,75	8,20 - 7,85 - 7,60
	Heat	A	4,75 - 4,55 - 4,35	7,85 - 7,50 - 7,20	9,70 - 9,25 - 8,90
Air flow	Cool / Heat	m ³ /min	34,1/36,4	42,0/42,0	42,0/42,0
Sound pressure	Cool / Heat (Hi)	dB(A)	43/44	46/48	47/50
Sound power	Cool / Heat (Hi)	dB(A)	62/64	64/67	65/69
Dimension	HxWxD	mm	695x875x320	695x875x320	695x875x320
Net weight		kg	42	42	43
Piping diameter	Liquid pipe	Inch (mm)	1/4 (6,35)	1/4 (6,35)	1/4 (6,35) ⁵⁾
	Gas pipe	Inch (mm)	1/2 (12,70)	1/2 (12,70)	1/2 (12,70) ⁶⁾
Pipe length range		m	3 - 40	3 - 40	3 - 40
Elevation difference (in / out) ⁷⁾		m	15/30	15/30	15/30
Pipe length for additional gas		m	30	30	30
Additional gas amount		g/m	15	15	15
Refrigerant (R32) / CO ₂ Eq.		kg / T	1,13/0,76	1,13/0,76	1,15/0,78
Operating range	Cool Min ~ Max	°C	-15 ~ +46	-15 ~ +46	-15 ~ +46
	Heat Min ~ Max	°C	-20 ~ +24	-20 ~ +24	-20 ~ +24

Compact and stylish design

- Ceiling depth is only 250 mm
- Exposed area is only 30 mm

Industry-leading energy efficiency

Achieved SEER / SCOP class A++*.

* SCOP class A+ in case of 2,5 / 6,0 kW.

Individual flap control

Better control of the air flow with 4 motors, providing individual flap control.
Perfect air distribution without direct airflow, to reduce the feeling of cold drafts.

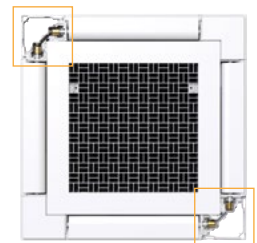

SEER and SCOP: For S-36PY3E + U-36PZH3E5. ECONAVI and INTERNET CONTROL: Optional.



CZ-RTC5B



Panel.
CZ-KPY4



COMPATIBLE WITH ALL PANASONIC CONNECTIVITY SOLUTIONS. FOR DETAILED INFORMATION GO TO THE CONTROL SYSTEMS SECTION



CONEX



Optional controller.
CONEX wired remote controller.
CZ-RTC6 - CZ-RTC6BL
- CZ-RTC6BLW



Optional controller.
Infrared remote controller.
CZ-RWS3 + CZ-RWRV3



Optional Econavi sensor.
CZ-CENSC1

Standard

Single phase

Kit	Single phase					
	2,5 kW	3,6 kW	5,0 kW	6,0 kW		
Remote controller	KIT-25PY3Z5	KIT-35PY3Z5	KIT-50PY3Z5	KIT-60PY3Z5		
Remote controller	CZ-RTC5B	CZ-RTC5B	CZ-RTC5B	CZ-RTC5B		
Cooling capacity	Nominal (Min - Max) kW	2,5(1,5 - 3,9)	3,6(1,5 - 4,0)	5,0(1,5 - 5,6)	6,0(2,0 - 7,0)	
EER ¹⁾	Nominal (Min - Max) W/W	4,46(3,55 - 5,88)	3,96(3,57 - 5,88)	3,50(3,03 - 6,25)	3,39(2,77 - 6,90)	
SEER ²⁾		6,5 A++	6,7 A++	7,3 A++	6,8 A++	
Pdesign	kW	2,5	3,6	5,0	6,0	
Input power	Nominal (Min - Max) kW	0,56(0,26 - 1,10)	0,91(0,26 - 1,12)	1,43(0,24 - 1,85)	1,77(0,29 - 2,53)	
Annual energy consumption ³⁾	kWh/a	134	188	238	3,05	
Heating capacity	Nominal (Min - Max) kW	3,2(1,5 - 4,6)	3,6(1,5 - 4,6)	5,0(1,5 - 6,4)	6,0(1,8 - 7,0)	
COP ¹⁾	Nominal (Min - Max) W/W	4,44(3,41 - 6,52)	4,29(3,38 - 6,52)	3,94(2,91 - 7,50)	3,61(2,86 - 7,60)	
SCOP ²⁾		4,6 A++	4,3 A+	4,4 A+	4,2 A+	
Pdesign at -10 °C	kW	2,8	2,8	4,0	4,6	
Input power	Nominal (Min - Max) kW	0,72(0,23 - 1,35)	0,84(0,23 - 1,36)	1,27(0,20 - 2,20)	1,66(0,24 - 2,45)	
Annual energy consumption ³⁾	kWh/a	850	912	1264	1500	
Indoor unit		S-25PY3E	S-36PY3E	S-50PY3E	S-60PY3E	
Air flow	Hi / Med / Lo	m ³ /min	8,5/7,0/6,0	9,5/7,0/6,0	12,0/9,5/6,5	14,0/10,5/8,0
Moisture removal volume		L/h	0,7	1,5	2,3	2,8
Sound pressure ⁴⁾	Hi / Med / Lo	dB(A)	31/28/25	34/30/25	39/34/27	43/37/31
Sound power	Hi / Med / Lo	dB(A)	46/43/40	49/45/40	54/49/42	58/52/46
Dimension	Indoor (HxWxD)	mm	243x575x575	243x575x575	243x575x575	243x575x575
	Panel (HxWxD)	mm	30x625x625	30x625x625	30x625x625	30x625x625
Net weight	Indoor / Panel	kg	15/2,8	15/2,8	15/2,8	15/2,8
nanoe X Generator			Mark 2	Mark 2	Mark 2	Mark 2
Outdoor unit		U-25PZ3E5	U-36PZ3E5	U-50PZ3E5	U-60PZ3E5A	
Power supply		V	220 - 230 - 240	220 - 230 - 240	220 - 230 - 240	220 - 230 - 240
Current	Cool	A	2,65 - 2,55 - 2,45	4,20 - 4,05 - 3,85	6,65 - 6,35 - 6,10	8,20 - 7,85 - 7,55
	Heat	A	3,40 - 3,25 - 3,10	3,95 - 3,75 - 3,60	5,695 - 5,70 - 5,45	7,70 - 7,35 - 7,05
Air flow	Cool / Heat	m ³ /min	33,6/34,0	32,6/34,0	32,7/31,9	42,6/41,5
Sound pressure	Cool / Heat (Hi)	dB(A)	46/47	46/47	46/48	47/48
Sound power	Cool / Heat (Hi)	dB(A)	64/66	64/66	64/64	64/65
Dimension	H x W x D	mm	619 x 824 x 299	619 x 824 x 299	619 x 824 x 299	695 x 875 x 320
Net weight		kg	32	32	35	46
Piping diameter	Liquid pipe	Inch (mm)	1/4 (6,35)	1/4 (6,35)	1/4 (6,35)	1/4 (6,35) ⁵⁾
	Gas pipe	Inch (mm)	1/2 (12,70)	1/2 (12,70)	1/2 (12,70)	1/2 (12,70) ⁶⁾
Pipe length range		m	3 - 15	3 - 15	3 - 20	3 - 40
Elevation difference (in / out) ⁷⁾		m	15/15	15/15	15/15	15/30
Pipe length for additional gas		m	7,5	7,5	7,5	30
Additional gas amount		g/m	10	10	15	15
Refrigerant (R32) / CO ₂ Eq.		kg / T	0,87/0,59	0,87/0,59	1,14/0,77	1,15/0,78
Operating range	Cool Min ~ Max	°C	-10 ~ +43	-10 ~ +43	-10 ~ +43	-10 ~ +43
	Heat Min ~ Max	°C	-15 ~ +24	-15 ~ +24	-15 ~ +24	-15 ~ +24

1) EER and COP calculation is based in accordance to EN14511. 2) For models below 12 kW, the SEER and SCOP is calculated based on values of EU/626/2011. For models above 12 kW, the η_{h,c} / η_{h,h} values is calculated based on EN 14825. 3) Factory setting. 4) The sound pressure of the units shows the value measured of the position 1,5 m below the unit. The sound pressure is measured in accordance with Eurovent 6/C/006-97 specification. 5) Connect the liquid socket tube (Ø6,35-Ø9,52) to the liquid tubing side indoor unit. 6) Connect the gas socket tube (Ø12,70-Ø15,88) to the gas tubing side indoor unit. 7) Outdoor unit located lower / outdoor unit located higher. * Recommended fuse for the indoor 3 A. ** Above values are in the case of nanoe™ X OFF.

Accessories

CZ-RTC6	CONEX wired remote controller (non-wireless)
CZ-RTC6BL	CONEX wired remote controller with Bluetooth®
CZ-RTC6BLW	CONEX wired remote controller with Wi-Fi and Bluetooth®
CZ-RTC5B	Wired remote controller with Econavi function and datanavi
CZ-RWS3 + CZ-RWRV3	Infrared remote controller and receiver
CZ-CAPWFC1	Commercial Wi-Fi Adaptor

Accessories

PAW-PACR3	Interfaces to run 3 units on back-up and alternative run
PAW-WTRAY	Tray for condenser water compatible with outdoor elevation platform
PAW-GRDBSE20	Outdoor base ground support for noise and vibration absorption
PAW-GRDSTD40	Outdoor elevation platform 400x900x400 mm
CZ-CENSC1	Econavi energy savings sensor



SEER: For S-50PY3E + U-50PZ3E5. SCOP: For S-25PY3E + U-25PZ3E5. ECONAVI and INTERNET CONTROL: Optional.

Rating Conditions: Cooling Indoor 27 °C DB / 19 °C WB. Cooling Outdoor 35 °C DB / 24 °C WB. Heating Indoor 20 °C DB. Heating Outdoor 7 °C DB / 6 °C WB. (DB: Dry Bulb; WB: Wet Bulb). Specifications subject to change without notice. For detailed information about ErP / Energy Labelling, please visit our websites www.aircon.panasonic.eu or www.ptc.panasonic.eu.



nanoe™ X
nanoe™ X as a standard.

PACi NX Series Elite 4 way 90x90 cassette Inverter+ · R32

4 way 90x90 cassette - PU3.

Powerful turbo fan and intelligent Econavi sensor ensure high energy efficiency, and nanoe™ X, which is equipped as standard, provides an exceptional level of indoor air quality.

		Single phase							
		3,6 kW	5,0 kW	6,0 kW	7,1 kW	10,0 kW	12,5 kW	14,0 kW	
Kit		KIT-36PU3ZH5	KIT-50PU3ZH5	KIT-60PU3ZH5	KIT-71PU3ZH5	KIT-100PU3ZH5	KIT-125PU3ZH5	KIT-140PU3ZH5	
Remote controller		CZ-RTC5B	CZ-RTC5B	CZ-RTC5B	CZ-RTC5B	CZ-RTC5B	CZ-RTC5B	CZ-RTC5B	
Cooling capacity	Nominal (Min - Max)	kW	3,6(1,2 - 4,0)	5,0(1,2 - 5,6)	6,0(1,2 - 7,1)	7,1(2,2 - 9,0)	10,0(3,1 - 12,5)	12,5(3,2 - 14,0)	14,0(3,3 - 16,0)
EER ¹⁾	Nominal (Min - Max)	W/W	5,45(4,60 - 5,45)	4,31(3,86 - 5,45)	4,05(3,02 - 5,45)	4,06(2,69 - 5,79)	4,41(3,42 - 5,34)	3,80(3,08 - 5,33)	3,41(2,74 - 5,32)
SEER / η_{sc} ²⁾			8,9 A+++	8,6 A+++	8,0 A++	7,7 A++	7,8 A++	304,3 %	286,6 %
Pdesign		kW	3,6	5,0	6,0	7,1	10,0	12,5	14,0
Input power	Nominal (Min - Max)	kW	0,66(0,22 - 0,87)	1,16(0,22 - 1,45)	1,48(0,22 - 2,35)	1,75(0,38 - 3,35)	2,27(0,58 - 3,66)	3,29(6,00 - 4,55)	4,11(0,62 - 5,85)
Annual energy consumption ³⁾		kWh/a	122	203	263	323	449	—	—
Heating capacity	Nominal (Min - Max)	kW	4,0(1,2 - 5,0)	5,6(1,2 - 6,5)	7,0(1,2 - 8,0)	8,0(2,0 - 9,0)	11,2(3,1 - 14,0)	14,0(3,2 - 16,0)	16,0(3,3 - 18,0)
COP ¹⁾	Nominal (Min - Max)	W/W	5,41(4,55 - 5,45)	4,24(4,19 - 5,45)	4,02(3,40 - 5,45)	4,30(3,16 - 5,56)	5,00(3,64 - 5,54)	4,61(3,37 - 5,52)	4,30(3,27 - 5,50)
SCOP / η_{sh} ²⁾			5,1 A+++	4,9 A++	4,8 A++	4,8 A++	4,9 A++	186,0 %	181,2 %
Pdesign at -10 °C		kW	3,6	4,5	4,7	5,2	8,0	9,5	10,6
Input power	Nominal (Min - Max)	kW	0,74(0,22 - 1,10)	1,32(0,22 - 1,55)	1,74(0,22 - 2,35)	1,86(0,36 - 2,85)	2,24(0,56 - 3,85)	3,04(0,58 - 4,75)	3,72(0,60 - 5,50)
Annual energy consumption ³⁾		kWh/a	988	1286	1371	1517	2286	—	—
Indoor unit			S-3650PU3E	S-3650PU3E	S-6071PU3E	S-6071PU3E	S-1014PU3E	S-1014PU3E	S-1014PU3E
Air flow	Hi / Med / Lo	m ³ /min	14,5/13,0/11,5	16,5/13,5/11,5	21,0/16,0/13,0	22,0/16,0/13,0	36,0/26,0/18,0	37,0/27,0/19,0	38,0/29,0/20,0
Moisture removal volume		L/h	0,7	1,6	1,7	2,5	2,7	4,8	6,0
Sound pressure ⁴⁾	Hi / Med / Lo	dB(A)	30/28/27	32/29/27	36/31/28	37/31/28	45/38/32	46/39/33	47/40/34
Sound power	Hi / Med / Lo	dB(A)	45/43/42	47/44/42	51/46/43	52/46/43	60/53/47	61/54/48	62/55/49
Dimension	Indoor (HxWxD)	mm	256x840x840	256x840x840	256x840x840	256x840x840	319x840x840	319x840x840	319x840x840
	Panel (HxWxD)	mm	33,5x950x950	33,5x950x950	33,5x950x950	33,5x950x950	33,5x950x950	33,5x950x950	33,5x950x950
Net weight	Indoor / Panel	kg	19/5	19/5	20/5	20/5	25/5	25/5	25/5
nanoe X Generator			Mark 1	Mark 1	Mark 1	Mark 1	Mark 1	Mark 1	Mark 1
Outdoor unit			U-36PZH3E5	U-50PZH3E5	U-60PZH3E5	U-71PZH3E5	U-100PZH3E5	U-125PZH3E5	U-140PZH3E5
Power supply		V	220 - 230 - 240	220 - 230 - 240	220 - 230 - 240	220 - 230 - 240	220 - 230 - 240	220 - 230 - 240	220 - 230 - 240
Current	Cool	A	3,25 - 3,10 - 3,00	5,50 - 5,25 - 5,05	6,95 - 6,65 - 6,35	8,65 - 8,25 - 7,95	11,20 - 10,70 - 10,30	16,10 - 15,40 - 14,70	20,10 - 19,20 - 18,40
	Heat	A	3,60 - 3,45 - 3,30	6,25 - 6,00 - 5,75	8,05 - 7,70 - 7,40	9,00 - 8,70 - 8,35	10,90 - 10,60 - 10,10	14,90 - 14,20 - 13,60	18,20 - 17,40 - 16,70
Air flow	Cool / Heat	m ³ /min	34,1/36,4	42,0/42,0	42,0/42,0	61,0/60,0	118,0/108,0	125,0/112,0	129,0/116,0
Sound pressure	Cool / Heat (Hi)	dB(A)	43/44	46/48	47/50	48/50	52/52	53/53	54/54
Sound power	Cool / Heat (Hi)	dB(A)	62/64	64/67	65/69	65/67	69/69	70/70	71/71
Dimension	HxWxD	mm	695x875x320	695x875x320	695x875x320	996x940x340	1416x940x340	1416x940x340	1416x940x340
Net weight		kg	42	42	43	65	98	98	98
Piping diameter	Liquid pipe	Inch (mm)	1/4 (6,35)	1/4 (6,35)	1/4 (6,35) ⁵⁾	3/8 (9,52)	3/8 (9,52)	3/8 (9,52)	3/8 (9,52)
	Gas pipe	Inch (mm)	1/2 (12,70)	1/2 (12,70)	1/2 (12,70) ⁶⁾	5/8 (15,88)	5/8 (15,88)	5/8 (15,88)	5/8 (15,88)
Pipe length range		m	3~40	3~40	3~40	5~50	5~85	5~85	5~85
Elevation difference (in / out) ⁷⁾		m	15/30	15/30	15/30	15/30	15/30	15/30	15/30
Pipe length for additional gas		m	30	30	30	30	30	30	30
Additional gas amount		g/m	15	15	15	45	45	45	45
Refrigerant (R32) / CO ₂ Eq.		kg / T	1,13/0,76	1,13/0,76	1,15/0,78	1,95/1,32	3,05/2,06	3,05/2,06	3,05/2,06
Operating range	Cool Min - Max	°C	-15 ~ +46	-15 ~ +46	-15 ~ +46	-15 ~ +48	-20 ~ +48 ⁸⁾	-20 ~ +48 ⁸⁾	-20 ~ +48 ⁸⁾
	Heat Min - Max	°C	-20 ~ +24	-20 ~ +24	-20 ~ +24	-20 ~ +24	-20 ~ +24	-20 ~ +24	-20 ~ +24

Technical focus

- High performance turbo fan
- Econavi: An optional intelligent sensor to reduce waste of energy
- nanoe™ X (Generator Mark 1= 4,8 trillion hydroxyl radicals/sec) as standard for better indoor air quality, indoor unit internal cleaning with nanoe™ X and dry operation
- Lower noise in slow fan operation
- Light weight, easy piping and integrated drain pump for quick installation
- Wired remote control CZ-RTC6BL allows easy system setting via Bluetooth®
- High volume fresh air input with optional air-intake plenum and chamber (CZ-FDU3+CZ-ATU2)



Standard panel.
CZ-KPU3W

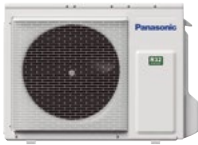

CZ-RTC5B



Optional Econavi panel (CZ-RTC5B is required).
CZ-KPU3AW



Optional controller. CONEX wired remote controller.
CZ-RTC6 - CZ-RTC6BL - CZ-RTC6BLW



Optional controller. Infrared remote controller.
CZ-RWS3 + CZ-RWRU3W

COMPATIBLE WITH ALL PANASONIC CONNECTIVITY SOLUTIONS. FOR DETAILED INFORMATION GO TO THE CONTROL SYSTEMS SECTION

Three phase

Kit			7,1 kW	10,0 kW	12,5 kW	14,0 kW
			KIT-71PU3ZH8	KIT-100PU3ZH8	KIT-125PU3ZH8	KIT-140PU3ZH8
Remote controller			CZ-RTC5B	CZ-RTC5B	CZ-RTC5B	CZ-RTC5B
Cooling capacity	Nominal (Min - Max)	kW	7,1 [2,2 - 9,0]	10,0 [3,1 - 12,5]	12,5 [3,2 - 14,0]	14,0 [3,3 - 16,0]
EER ¹⁾	Nominal (Min - Max)	W/W	4,06 [2,69 - 5,79]	4,41 [3,42 - 5,34]	3,80 [3,08 - 5,33]	3,41 [2,74 - 5,82]
SEER / η _{sc} ²⁾			7,6 A++	7,7 A++	303,3 %	285,6 %
Pdesign			7,1	10,0	12,5	14,0
Input power	Nominal (Min - Max)	kW	1,75 [0,38 - 3,35]	2,27 [0,58 - 3,65]	3,29 [0,60 - 4,55]	4,11 [0,62 - 5,85]
Annual energy consumption ³⁾			327	455	—	—
Heating capacity	Nominal (Min - Max)	kW	8,0 [2,0 - 9,0]	11,2 [3,1 - 14,0]	14,0 [3,2 - 16,0]	16,0 [3,3 - 18,0]
COP ¹⁾	Nominal (Min - Max)	W/W	4,30 [3,16 - 5,56]	5,00 [3,64 - 5,54]	4,61 [3,37 - 5,52]	4,30 [3,27 - 5,50]
SCOP / η _{sh} ²⁾			4,8 A++	4,9 A++	186,0 %	181,1 %
Pdesign at -10 °C			5,2	8,0	9,5	10,6
Input power	Nominal (Min - Max)	kW	1,86 [0,36 - 2,85]	2,24 [0,56 - 3,85]	3,04 [0,58 - 4,75]	3,72 [0,60 - 5,50]
Annual energy consumption ³⁾			1517	2286	—	—
Indoor unit			S-6071PU3E	S-1014PU3E	S-1014PU3E	S-1014PU3E
Air flow	Hi / Med / Lo	m ³ /min	22,0 / 16,0 / 13,0	36,0 / 26,0 / 18,0	37,0 / 27,0 / 19,0	38,0 / 29,0 / 20,0
Moisture removal volume			2,5	2,7	4,8	6,0
Sound pressure ⁴⁾	Hi / Med / Lo	dB(A)	37 / 31 / 28	45 / 38 / 32	46 / 39 / 33	47 / 40 / 34
Sound power	Hi / Med / Lo	dB(A)	52 / 46 / 43	60 / 53 / 47	61 / 54 / 48	62 / 55 / 49
Dimension	Indoor (H x W x D)	mm	256 x 840 x 840	319 x 840 x 840	319 x 840 x 840	319 x 840 x 840
	Panel (H x W x D)	mm	33,5 x 950 x 950	33,5 x 950 x 950	33,5 x 950 x 950	33,5 x 950 x 950
Net weight	Indoor / Panel	kg	20 / 5	25 / 5	25 / 5	25 / 5
nanoe X Generator			Mark 1	Mark 1	Mark 1	Mark 1
Outdoor unit			U-71PZH3E8	U-100PZH3E8	U-125PZH3E8	U-140PZH3E8
Power supply			380 - 400 - 415	380 - 400 - 415	380 - 400 - 415	380 - 400 - 415
Current	Cool	A	2,90 - 2,80 - 2,70	3,80 - 3,60 - 3,45	5,45 - 5,15 - 5,00	6,80 - 6,45 - 6,20
	Heat	A	3,05 - 2,95 - 2,85	3,75 - 3,55 - 3,40	5,10 - 4,80 - 4,65	6,20 - 5,90 - 5,65
Air flow	Cool / Heat	m ³ /min	61,0 / 60,0	118,0 / 108,0	125,0 / 112,0	129,0 / 116,0
Sound pressure	Cool / Heat (Hi)	dB(A)	48 / 50	52 / 52	53 / 53	54 / 54
Sound power	Cool / Heat (Hi)	dB(A)	65 / 67	69 / 69	70 / 70	71 / 71
Dimension	H x W x D	mm	996 x 940 x 340	1416 x 940 x 340	1416 x 940 x 340	1416 x 940 x 340
Net weight			65	98	98	98
Piping diameter	Liquid pipe	Inch (mm)	3/8 (9,52)	3/8 (9,52)	3/8 (9,52)	3/8 (9,52)
	Gas pipe	Inch (mm)	5/8 (15,88)	5/8 (15,88)	5/8 (15,88)	5/8 (15,88)
Pipe length range			5 - 50	5 - 85	5 - 85	5 - 85
Elevation difference (in / out) ⁷⁾			15 / 30	15 / 30	15 / 30	15 / 30
Pipe length for additional gas			30	30	30	30
Additional gas amount			45	45	45	45
Refrigerant (R32) / CO ₂ Eq.			1,95 / 1,32	3,05 / 2,06	3,05 / 2,06	3,05 / 2,06
Operating range	Cool Min ~ Max	°C	-15 ~ +48	-20 ~ +48 ⁸⁾	-20 ~ +48 ⁸⁾	-20 ~ +48 ⁸⁾
	Heat Min ~ Max	°C	-20 ~ +24	-20 ~ +24	-20 ~ +24	-20 ~ +24

1) EER and COP calculation is based in accordance to EN14511. 2) For models below 12 kW, the SEER and SCOP is calculated based on values of EU/626/2011. For models above 12 kW, the η_{sc} / η_{sh} values is calculated based on EN 14825. 3) Factory setting. 4) The sound pressure of the units shows the value measured of the position 1,5 m below the unit. The sound pressure is measured in accordance with Eurovent 6/C/006-97 specification. 5) Connect the liquid socket tube (Ø6,35-Ø9,52) to the liquid tubing side indoor unit. 6) Connect the gas socket tube (Ø12,70-Ø15,88) to the gas tubing side indoor unit. 7) Outdoor unit located lower / outdoor unit located higher. 8) For models 100 ~ 140PZH3E8, it is possible to operate the lowest -20 °C in the computer rooms with the piping length of 30 m or less. * Recommended fuse for the indoor 3 A. ** Above values are in the case of nanoe™ X OFF.

Accessories

CZ-RTC6	CONEX wired remote controller (non-wireless)
CZ-RTC6BL	CONEX wired remote controller with Bluetooth®
CZ-RTC6BLW	CONEX wired remote controller with Wi-Fi and Bluetooth®
CZ-RTC5B	Wired remote controller with Econavi function and datanavi
CZ-RWS3 + CZ-RWRU3W	Infrared remote controller and receiver
CZ-CAPWFC1	Commercial Wi-Fi Adaptor

Accessories

CZ-KPU3AW	Econavi exclusive panel
PAW-PACR3	Interfaces to run 3 units on back-up and alternative run
PAW-WTRAY	Tray for condenser water compatible with outdoor elevation platform
PAW-GRDBSE20	Outdoor base ground support for noise and vibration absorption
PAW-GRDSTD40	Outdoor elevation platform 400 x 900 x 400 mm
CZ-FDU3+CZ-ATU2	Fresh air-intake kit



SEER and SCOP: For S-3650PU3E + U-36PZH3E5. ECONAVI and INTERNET CONTROL: Optional.

Rating Conditions: Cooling Indoor 27 °C DB / 19 °C WB. Cooling Outdoor 35 °C DB / 24 °C WB. Heating Indoor 20 °C DB. Heating Outdoor 7 °C DB / 6 °C WB. (DB: Dry Bulb; WB: Wet Bulb). Specifications subject to change without notice. For detailed information about ErP / Energy Labelling, please visit our websites www.aircon.panasonic.eu or www.ptc.panasonic.eu.



PACi NX Series Standard 4 way 90x90 cassette Inverter+ - R32

4 way 90x90 cassette - PU3.

Powerful turbo fan and intelligent Econavi sensor ensure high energy efficiency, and nanoe™ X, which is equipped as standard, provides an exceptional level of indoor air quality.

		Single phase							
		3,6 kW	5,0 kW	6,0 kW	7,1 kW	10,0 kW	12,5 kW	14,0 kW	
Kit		KIT-36PU3Z5	KIT-50PU3Z5	KIT-60PU3Z5	KIT-71PU3Z5	KIT-100PU3Z5	KIT-125PU3Z5	KIT-140PU3Z5	
Remote controller		CZ-RTC5B	CZ-RTC5B	CZ-RTC5B	CZ-RTC5B	CZ-RTC5B	CZ-RTC5B	CZ-RTC5B	
Cooling capacity	Nominal (Min - Max)	kW	3,6(1,5 - 4,0)	5,0(1,5 - 5,6)	6,0(2,0 - 7,1)	7,1(2,6 - 7,7)	10,0(3,0 - 11,5)	12,5(3,2 - 13,5)	14,0(3,3 - 15,0)
EER ¹⁾	Nominal (Min - Max)	W/W	4,34(5,88-3,81)	3,91(6,25-3,20)	3,73(6,90-3,01)	3,27(5,00-2,77)	3,82(2,88-5,36)	3,58(2,81-5,33)	3,23(2,73-5,32)
SEER / η_{sc} ²⁾			8,1 A++	8,0 A++	7,8 A++	6,8 A++	6,8 A++	267,0 %	257,0 %
Pdesign		kW	3,6	5,0	6,0	7,1	10,0	12,5	14,0
Input power	Nominal (Min - Max)	kW	0,83(0,25-1,05)	1,28(0,24-1,75)	1,61(0,29-2,36)	2,17(0,52-2,78)	2,62(0,56-4,00)	3,49(0,60-4,80)	4,34(0,62-5,50)
Annual energy consumption ³⁾		kWh/a	156	219	269	365	515	—	—
Heating capacity	Nominal (Min - Max)	kW	3,6(1,5 - 4,6)	5,0(1,5 - 6,4)	6,0(1,8 - 7,0)	7,1(2,1 - 8,1)	10,0(3,0 - 14,0)	12,5(3,3 - 15,0)	14,0(3,4 - 16,0)
COP ¹⁾	Nominal (Min - Max)	W/W	5,07(4,32 - 6,52)	4,63(3,48 - 7,50)	4,48(3,18 - 7,50)	4,23(3,38 - 6,36)	4,93(3,59 - 5,36)	4,43(3,57 - 5,50)	4,18(3,33 - 5,48)
SCOP / η_{sh} ²⁾			4,8 A++	4,7 A++	4,9 A++	4,6 A++	4,4 A+	157,0 %	152,2 %
Pdesign at -10 °C		kW	2,8	4,0	4,6	5,2	10,0	12,5	14,0 (at -7 °C)
Input power	Nominal (Min - Max)	kW	0,71(0,23-1,06)	1,08(0,20-1,84)	1,34(0,24-2,20)	1,68(0,33-2,40)	2,03(0,56-3,90)	2,82(0,60-4,20)	3,35(0,62-4,80)
Annual energy consumption ³⁾		kWh/a	817	1191	1314	1583	3182	—	—
Indoor unit			S-3650PU3E	S-3650PU3E	S-6071PU3E	S-6071PU3E	S-1014PU3E	S-1014PU3E	S-1014PU3E
Air flow	Hi / Med / Lo	m ³ /min	14,5/13,0/11,5	16,5/13,5/11,5	21,0/16,0/13,0	22,0/16,0/13,0	36,0/26,0/18,0	37,0/27,0/19,0	38,0/29,0/20,0
Moisture removal volume		L/h	0,7	1,6	1,7	2,5	2,7	4,8	6,0
Sound pressure ⁴⁾	Hi / Med / Lo	dB(A)	30/28/27	32/29/27	36/31/28	37/31/28	45/38/32	46/39/33	47/40/34
Sound power	Hi / Med / Lo	dB(A)	45/43/42	47/44/42	51/46/43	52/46/43	60/53/47	61/54/48	62/55/49
Dimension	Indoor (HxWxD)	mm	256x840x840	256x840x840	256x840x840	256x840x840	319x840x840	319x840x840	319x840x840
	Panel (HxWxD)	mm	33,5x950x950	33,5x950x950	33,5x950x950	33,5x950x950	33,5x950x950	33,5x950x950	33,5x950x950
Net weight	Indoor / Panel	kg	19/5	19/5	20/5	20/5	25/5	25/5	25/5
nanoe X Generator			Mark 1	Mark 1	Mark 1	Mark 1	Mark 1	Mark 1	Mark 1
Outdoor unit			U-36PZ3E5	U-50PZ3E5	U-60PZ3E5A	U-71PZ3E5A	U-100PZ3E5	U-125PZ3E5	U-140PZ3E5
Power supply		V	220 - 230 - 240	220 - 230 - 240	220 - 230 - 240	220 - 230 - 240	220 - 230 - 240	220 - 230 - 240	220 - 230 - 240
Current	Cool	A	3,85 - 3,70 - 3,55	5,95 - 5,70 - 5,45	7,45 - 7,15 - 6,85	10,00 - 9,65 - 9,25	13,10 - 12,50 - 12,00	16,90 - 16,10 - 15,40	21,00 - 20,00 - 19,20
	Heat	A	3,35 - 3,20 - 3,05	5,05 - 4,85 - 4,65	6,20 - 5,95 - 5,70	7,80 - 7,45 - 7,15	10,10 - 9,70 - 9,30	13,60 - 13,00 - 12,50	16,20 - 15,50 - 14,80
Air flow	Cool / Heat	m ³ /min	33,6/34,0	32,7/31,9	42,6/41,5	44,7/45,9	73,0/73,0	82,0/80,0	84,0/82,0
Sound pressure	Cool / Heat (Hi)	dB(A)	46/47	46/46	47/48	48/49	52/52	55/55	56/56
Sound power	Cool / Heat (Hi)	dB(A)	64/66	64/64	64/65	66/68	70/70	73/73	74/74
Dimension	HxWxD	mm	619x824x299	619x824x299	695x875x320	695x875x320	996x980x370	996x980x370	996x980x370
Net weight		kg	32	35	42	50	83	87	87
Piping diameter	Liquid pipe	Inch (mm)	1/4 (6,35)	1/4 (6,35)	1/4 (6,35) ⁵⁾	1/4 (6,35) ⁵⁾	3/8(9,52)	3/8(9,52)	3/8(9,52)
	Gas pipe	Inch (mm)	1/2 (12,70)	1/2 (12,70)	1/2 (12,70) ⁴⁾	5/8(15,88)	5/8(15,88)	5/8(15,88)	5/8(15,88)
Pipe length range		m	3~15	3~20	3~40	3~40	5~50	5~50	5~50
Elevation difference (in / out) ⁷⁾		m	15/15	15/15	15/30	20/30	15/30	15/30	15/30
Pipe length for additional gas		m	7,5	7,5	30	30	30	30	30
Additional gas amount		g/m	10	15	15	17	45	45	45
Refrigerant (R32) / CO ₂ Eq.		kg / T	0,87/0,59	1,14/0,77	1,15/0,78	1,32/0,89	2,40/1,62	2,80/1,89	2,80/1,89
Operating range	Cool Min - Max	°C	-10~+43	-10~+43	-10~+43	-10~+43	-10~+43	-10~+43	-10~+43
	Heat Min - Max	°C	-15~+24	-15~+24	-15~+24	-15~+24	-15~+24	-15~+24	-15~+24

Technical focus

- High performance turbo fan
- Econavi: An optional intelligent sensor to reduce waste of energy
- nanoe™ X (Generator Mark 1= 4,8 trillion hydroxyl radicals/sec) as standard for better indoor air quality, indoor unit internal cleaning with nanoe™ X and dry operation
- Lower noise in slow fan operation
- Light weight, easy piping and integrated drain pump for quick installation
- Wired remote control CZ-RTC6BL allows easy system setting via Bluetooth®
- High volume fresh air input with optional air-intake plenum and chamber (CZ-FDU3+CZ-ATU2)



CZ-RTC5B

COMPATIBLE WITH ALL PANASONIC CONNECTIVITY SOLUTIONS. FOR DETAILED INFORMATION GO TO THE CONTROL SYSTEMS SECTION

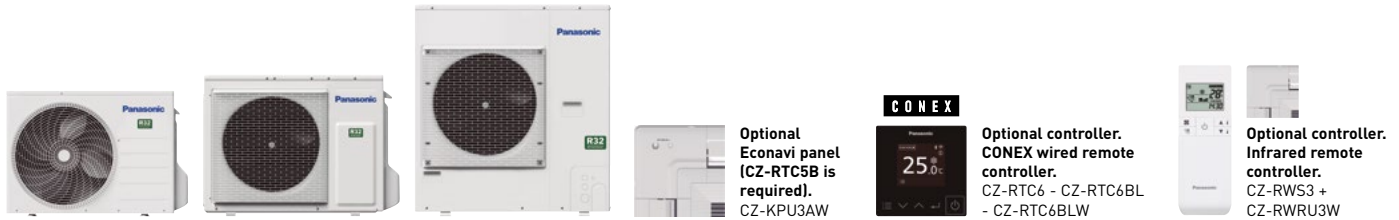

Optional Econavi panel (CZ-RTC5B is required). CZ-KPU3AW



Optional controller. CONEX wired remote controller. CZ-RTC6 - CZ-RTC6BL - CZ-RTC6BLW



Optional controller. Infrared remote controller. CZ-RWS3 + CZ-RWRU3W

			Three phase		
			10,0 kW	12,5 kW	14,0 kW
Kit			KIT-100PU3Z8	KIT-125PU3Z8	KIT-140PU3Z8
Remote controller			CZ-RTC5B	CZ-RTC5B	CZ-RTC5B
Cooling capacity	Nominal (Min - Max)	kW	10,0(3,0 - 11,5)	12,5(3,2 - 13,5)	14,0(3,3 - 15,0)
EER ¹⁾	Nominal (Min - Max)	W/W	3,82(2,88 - 5,36)	3,58(2,81 - 5,33)	3,23(2,73 - 5,32)
SEER / η_{sc} ²⁾			6,7 A++	265,8 %	256,2 %
P _{design}			10,0	12,5	14,0
Input power	Nominal (Min - Max)	kW	2,62(0,56 - 4,00)	3,49(0,60 - 4,80)	4,34(0,62 - 5,50)
Annual energy consumption ³⁾			521	—	—
Heating capacity	Nominal (Min - Max)	kW	10,0(3,0 - 14,0)	12,5(3,3 - 15,0)	14,0(3,4 - 16,0)
COP ¹⁾	Nominal (Min - Max)	W/W	4,93(3,59 - 5,36)	4,43(3,57 - 5,50)	4,18(3,33 - 5,48)
SCOP / η_{sh} ²⁾			4,4 A+	157,0 %	152,2 %
P _{design} at -10 °C			10,0	12,5	14,0 (at -7 °C)
Input power	Nominal (Min - Max)	kW	2,03(0,56 - 3,90)	2,82(0,60 - 4,20)	3,35(0,62 - 4,80)
Annual energy consumption ³⁾			3182	—	—
Indoor unit			S-1014PU3E	S-1014PU3E	S-1014PU3E
Air flow	Hi / Med / Lo	m ³ /min	36,0/26,0/18,0	37,0/27,0/19,0	38,0/29,0/20,0
Moisture removal volume			2,7	4,8	6,0
Sound pressure ⁴⁾	Hi / Med / Lo	dB(A)	45/38/32	46/39/33	47/40/34
Sound power	Hi / Med / Lo	dB(A)	60/53/47	61/54/48	62/55/49
Dimension	Indoor (HxWxD)	mm	319 x 840 x 840	319 x 840 x 840	319 x 840 x 840
	Panel (HxWxD)	mm	33,5 x 950 x 950	33,5 x 950 x 950	33,5 x 950 x 950
Net weight	Indoor / Panel	kg	25/5	25/5	25/5
nanoe X Generator			Mark 1	Mark 1	Mark 1
Outdoor unit			U-100PZ3E8	U-125PZ3E8	U-140PZ3E8
Power supply			380 - 400 - 415	380 - 400 - 415	380 - 400 - 415
Current	Cool	A	4,35 - 4,15 - 4,00	5,65 - 5,35 - 5,15	7,00 - 6,65 - 6,40
	Heat	A	3,40 - 3,20 - 3,10	4,55 - 4,35 - 4,15	5,40 - 5,15 - 4,95
Air flow	Cool / Heat	m ³ /min	73,0/73,0	82,0/80,0	84,0/82,0
Sound pressure	Cool / Heat (Hi)	dB(A)	52/52	55/55	56/56
Sound power	Cool / Heat (Hi)	dB(A)	70/70	73/73	74/74
Dimension	H x W x D	mm	996 x 980 x 370	996 x 980 x 370	996 x 980 x 370
Net weight			83	87	87
Piping diameter	Liquid pipe	Inch (mm)	3/8(9,52)	3/8(9,52)	3/8(9,52)
	Gas pipe	Inch (mm)	5/8(15,88)	5/8(15,88)	5/8(15,88)
Pipe length range			5 - 50	5 - 50	5 - 50
Elevation difference (in / out) ⁷⁾			15/30	15/30	15/30
Pipe length for additional gas			30	30	30
Additional gas amount			45	45	45
Refrigerant (R32) / CO ₂ Eq.			2,40/1,62	2,80/1,89	2,80/1,89
Operating range	Cool Min ~ Max	°C	-10 ~ +24	-10 ~ +24	-10 ~ +24
	Heat Min ~ Max	°C	-15 ~ +43	-15 ~ +24	-15 ~ +24

1) EER and COP calculation is based in accordance to EN14511. 2) For models below 12 kW, the SEER and SCOP is calculated based on values of EU/626/2011. For models above 12 kW, the η_{sc} / η_{sh} values is calculated based on EN 14825. 3) Factory setting. 4) The sound pressure of the units shows the value measured of the position 1,5 m below the unit. The sound pressure is measured in accordance with Eurovent 6/C/006-97 specification. 5) Connect the liquid socket tube (Ø6,35-Ø9,52) to the liquid tubing side indoor unit. 6) Connect the gas socket tube (Ø12,70-Ø15,88) to the gas tubing side indoor unit. 7) Outdoor unit located lower / outdoor unit located higher. * Recommended fuse for the indoor 3 A. ** Above values are in the case of nanoe™ X OFF.

Accessories	
CZ-RTC6	CONEX wired remote controller (non-wireless)
CZ-RTC6BL	CONEX wired remote controller with Bluetooth®
CZ-RTC6BLW	CONEX wired remote controller with Wi-Fi and Bluetooth®
CZ-RTC5B	Wired remote controller with Econavi function and datanavi
CZ-RWS3 + CZ-RWRU3W	Infrared remote controller and receiver
CZ-CAPWFC1	Commercial Wi-Fi Adaptor

Accessories	
CZ-KPU3AW	Econavi exclusive panel
PAW-PACR3	Interfaces to run 3 units on back-up and alternative run
PAW-WTRAY	Tray for condenser water compatible with outdoor elevation platform
PAW-GRDBSE20	Outdoor base ground support for noise and vibration absorption
PAW-GRDSTD40	Outdoor elevation platform 400 x 900 x 400 mm
CZ-FDU3+CZ-ATU2	Fresh air-intake kit



SEER: For S-3650PU3E + U-36PZ3E5. SCOP: For S-6071PU3E + U-60PZ3E5A. ECONAVI and INTERNET CONTROL: Optional.

Rating Conditions: Cooling Indoor 27 °C DB / 19 °C WB. Cooling Outdoor 35 °C DB / 24 °C WB. Heating Indoor 20 °C DB. Heating Outdoor 7 °C DB / 6 °C WB. (DB: Dry Bulb; WB: Wet Bulb). Specifications subject to change without notice. For detailed information about ErP / Energy Labelling, please visit our websites www.aircon.panasonic.eu or www.ptc.panasonic.eu.



PACi NX Series Elite ceiling Inverter+ · R32

Ceiling mounted units provide large and wide air distribution which is good for big rooms.

The height and depth of all capacities are the same for unified appearance in mixed installations.

		Single phase							
		3,6 kW	5,0 kW	6,0 kW	7,1 kW	10,0 kW	12,5 kW	14,0 kW	
Kit		KIT-36PT3ZH5	KIT-50PT3ZH5	KIT-60PT3ZH5	KIT-71PT3ZH5	KIT-100PT3ZH5	KIT-125PT3ZH5	KIT-140PT3ZH5	
Remote controller		CZ-RTC5B	CZ-RTC5B	CZ-RTC5B	CZ-RTC5B	CZ-RTC5B	CZ-RTC5B	CZ-RTC5B	
Cooling capacity	Nominal (Min - Max)	kW	3,5(1,2 - 4,0)	5,0(1,2 - 5,6)	6,0(1,2 - 7,1)	6,8(2,2 - 9,0)	9,5(3,1 - 12,5)	12,1(3,2 - 14,0)	13,4(3,3 - 16,0)
EER ¹⁾	Nominal (Min - Max)	W/W	4,86(4,55 - 5,45)	4,03(3,57 - 5,45)	3,82(3,02 - 5,45)	3,91(2,69 - 5,79)	4,15(3,29 - 5,54)	3,51(3,01 - 5,33)	3,21(2,67 - 5,32)
SEER / η_{sc} ²⁾			7,7 A++	7,4 A++	7,5 A++	7,3 A++	7,3 A++	278,4 %	263,3 %
Pdesign		kW	3,5	5,0	6,0	6,8	9,5	12,1	13,4
Input power	Nominal (Min - Max)	kW	0,72(0,22 - 0,88)	1,24(0,22 - 1,57)	1,57(0,22 - 2,35)	1,74(0,38 - 3,35)	2,29(0,58 - 3,80)	3,45(0,60 - 4,65)	4,17(0,62 - 6,00)
Annual energy consumption ³⁾		kWh/a	160	237	280	326	456	—	—
Heating capacity	Nominal (Min - Max)	kW	4,0(1,2 - 5,0)	5,6(1,2 - 6,5)	7,0(1,2 - 8,0)	8,0(2,0 - 9,0)	11,2(3,1 - 14,0)	14,0(3,2 - 16,0)	16,0(3,3 - 18,0)
COP ¹⁾	Nominal (Min - Max)	W/W	5,00(4,17 - 5,45)	4,03(3,94 - 5,45)	4,14(3,40 - 5,45)	3,96(3,16 - 5,56)	4,09(3,54 - 5,54)	3,78(3,20 - 5,52)	3,48(3,10 - 5,50)
SCOP / η_{sh} ²⁾			4,9 A++	4,8 A++	4,8 A++	4,7 A++	4,7 A++	181,0 %	178,0 %
Pdesign at -10 °C		kW	3,1	4,0	4,6	4,7	7,8	9,5	10,2
Input power	Nominal (Min - Max)	kW	0,80(0,21 - 1,20)	1,39(0,22 - 1,65)	1,69(0,22 - 2,35)	2,02(0,36 - 2,85)	2,74(0,56 - 3,95)	3,70(0,58 - 5,00)	4,60(0,62 - 5,80)
Annual energy consumption ³⁾		kWh/a	886	1167	1342	1400	2323	—	—
Indoor unit			S-3650PT3E	S-3650PT3E	S-6071PT3E	S-6071PT3E	S-1014PT3E	S-1014PT3E	S-1014PT3E
Air flow	Hi / Med / Lo	m ³ /min	14,0/12,0/10,5	15,0/12,5/10,5	20,0/17,0/14,5	21,0/18,0/15,5	30,0/25,0/23,0	34,0/28,0/24,0	35,0/29,0/25,0
Moisture removal volume		L/h	0,8	2,0	2,1	2,7	3,6	5,4	6,4
Sound pressure ⁴⁾	Hi / Med / Lo	dB(A)	36/32/28	37/33/28	38/34/29	39/35/30	42/37/34	46/40/35	47/41/36
Sound power	Hi / Med / Lo	dB(A)	54/50/46	55/51/46	56/52/47	57/53/48	60/55/52	64/58/53	65/59/54
Dimension	HxWxD	mm	235x960x690	235x960x690	235x1275x690	235x1275x690	235x1590x690	235x1590x690	235x1590x690
Net weight		kg	26	26	34	34	40	40	40
nanoe X Generator			Mark 2	Mark 2	Mark 2	Mark 2	Mark 2	Mark 2	Mark 2
Outdoor unit			U-36PZH3E5	U-50PZH3E5	U-60PZH3E5	U-71PZH3E5	U-100PZH3E5	U-125PZH3E5	U-140PZH3E5
Power supply		V	220 - 230 - 240	220 - 230 - 240	220 - 230 - 240	220 - 230 - 240	220 - 230 - 240	220 - 230 - 240	220 - 230 - 240
Current	Cool	A	3,55 - 3,40 - 3,25	5,85 - 5,60 - 5,40	7,35 - 7,05 - 6,75	8,60 - 8,20 - 7,90	11,30 - 10,80 - 10,40	16,90 - 16,10 - 15,50	20,40 - 19,50 - 18,70
	Heat	A	3,90 - 3,75 - 3,60	6,60 - 6,30 - 6,05	7,85 - 7,50 - 7,20	9,75 - 9,45 - 9,05	13,40 - 12,90 - 12,40	18,10 - 17,30 - 16,60	22,50 - 21,50 - 20,60
Air flow	Cool / Heat	m ³ /min	34,1/36,4	42,0/42,0	42,0/42,0	61,0/60,0	118,0/108,0	125,0/112,0	129,0/116,0
Sound pressure	Cool / Heat (Hi)	dB(A)	43/44	46/48	47/50	48/50	52/52	53/53	54/54
Sound power	Cool / Heat (Hi)	dB(A)	62/64	64/67	65/69	65/67	69/69	70/70	71/71
Dimension	HxWxD	mm	695x875x320	695x875x320	695x875x320	996x940x340	1416x940x340	1416x940x340	1416x940x340
Net weight		kg	42	42	43	65	98	98	98
Piping diameter	Liquid pipe	Inch (mm)	1/4 (6,35)	1/4 (6,35)	1/4 (6,35) ⁵⁾	3/8 (9,52)	3/8 (9,52)	3/8 (9,52)	3/8 (9,52)
	Gas pipe	Inch (mm)	1/2 (12,70)	1/2 (12,70)	1/2 (12,70) ⁶⁾	5/8 (15,88)	5/8 (15,88)	5/8 (15,88)	5/8 (15,88)
Pipe length range		m	3 - 40	3 - 40	3 - 40	5 - 50	5 - 85	5 - 85	5 - 85
Elevation difference (in / out) ⁷⁾		m	15/30	15/30	15/30	15/30	15/30	15/30	15/30
Pipe length for additional gas		m	30	30	30	30	30	30	30
Additional gas amount		g/m	15	15	15	45	45	45	45
Refrigerant (R32) / CO ₂ Eq.		kg / T	1,13/0,76	1,13/0,76	1,15/0,78	1,95/1,32	3,05/2,06	3,05/2,06	3,05/2,06
Operating range	Cool Min - Max	°C	-15 ~ +46	-15 ~ +46	-15 ~ +46	-15 ~ +48	-20 ~ +48 ⁸⁾	-20 ~ +48 ⁸⁾	-20 ~ +48 ⁸⁾
	Heat Min - Max	°C	-20 ~ +24	-20 ~ +24	-20 ~ +24	-20 ~ +24	-20 ~ +24	-20 ~ +24	-20 ~ +24

Technical focus

- Wide air distribution for large rooms
- Horizontal air flow reaches maximum 9,5 m
- Fresh air connection available on the unit
- Slim design with 235 mm height fits narrow space
- Silent operation
- nanoe™ X (Generator Mark 2= 9,6 trillion hydroxyl radicals/sec) as standard for better indoor air quality
- Wired remote control CZ-RTC6BL allows easy system setting via Bluetooth®
- Twin, Triple and Double-twin split options
- Easy connection and control of external fan or ERV using the connector PAW-FDC on the indoor unit PCB. The external device can be controlled by the remote control of the Panasonic indoor unit

Further comfort improvement with air flow distribution

Horizontal air flow reaches maximum 9,5 m. This is ideal for wide rooms.

The wide air discharge opening expands the air flow to the left and right. The unpleasant feeling caused when the air flow directly hits the human body is prevented by the "Draft prevention position", which changes the swing width, so that the degree of comfort is increased.



PACi NX Series Standard ceiling Inverter+ · R32

Ceiling mounted units provide large and wide air distribution which is good for big rooms.

The height and depth of all capacities are the same for unified appearance in mixed installations.

		Single phase							
Kit		3,6 kW	5,0 kW	6,0 kW	7,1 kW	10,0 kW	12,5 kW	14,0 kW	
Remote controller		KIT-36PT3Z5	KIT-50PT3Z5	KIT-60PT3Z5	KIT-71PT3Z5	KIT-100PT3Z5	KIT-125PT3Z5	KIT-140PT3Z5	
		CZ-RTC5B	CZ-RTC5B	CZ-RTC5B	CZ-RTC5B	CZ-RTC5B	CZ-RTC5B	CZ-RTC5B	
Cooling capacity	Nominal (Min - Max)	kW	3,5(1,5 - 4,0)	5,0(1,5 - 5,2)	6,0(2,0 - 7,1)	6,8(2,6 - 7,7)	10,0(3,0 - 11,5)	12,5(3,2 - 13,5)	14,0(3,3 - 15,0)
EER ¹⁾	Nominal (Min - Max)	W/W	4,14(3,69 - 5,17)	3,03(2,86 - 5,00)	3,59(2,90 - 6,90)	3,24(2,75 - 4,91)	3,64(2,80 - 5,36)	3,32(2,77 - 5,33)	2,98(2,73 - 5,32)
SEER / η _{sc} ²⁾			7,2 A++	6,7 A++	7,3 A++	5,9 A+	6,6 A++	241,7 %	228,8 %
Pdesign		kW	3,5	5,0	6,0	6,8	10,0	12,5	14,0
Input power	Nominal (Min - Max)	kW	0,85(0,29 - 1,10)	1,65(0,30 - 1,82)	1,67(0,29 - 2,45)	2,10(0,53 - 2,80)	2,75(0,56 - 4,10)	3,76(0,60 - 4,88)	4,70(0,62 - 5,50)
Annual energy consumption ³⁾		kWh/a	179	262	288	404	531	—	—
Heating capacity	Nominal (Min - Max)	kW	3,5(1,5 - 4,6)	5,0(1,5 - 6,4)	6,0(1,8 - 7,0)	6,8(2,1 - 8,1)	10,0(3,0 - 14,0)	12,5(3,3 - 15,0)	14,0(3,4 - 16,0)
COP ¹⁾	Nominal (Min - Max)	W/W	4,61(3,51 - 5,70)	3,73(3,12 - 6,25)	4,11(2,92 - 6,67)	4,20(3,06 - 5,68)	4,24(3,30 - 5,36)	3,89(3,41 - 4,52)	3,70(3,08 - 5,48)
SCOP / η _{sh} ²⁾			4,4 A+	4,1 A+	4,6 A++	4,3 A+	4,2 A+	147,4 %	145,3 %
Pdesign at -10 °C		kW	2,8	4,0	4,6	4,7	10,0	12,5	13,6
Input power	Nominal (Min - Max)	kW	0,76(0,26 - 1,31)	1,34(0,24 - 2,05)	1,46(0,27 - 2,40)	1,62(0,37 - 2,65)	2,36(0,56 - 4,00)	3,21(0,73 - 4,40)	3,78(0,62 - 5,20)
Annual energy consumption ³⁾		kWh/a	891	1365	1399	1529	3331	—	—
Indoor unit			S-3650PT3E	S-3650PT3E	S-6071PT3E	S-6071PT3E	S-1014PT3E	S-1014PT3E	S-1014PT3E
Air flow	Hi / Med / Lo	m ³ /min	14,0/12,0/10,5	15,0/12,5/10,5	20,0/17,0/14,5	21,0/18,0/15,5	30,0/25,0/23,0	34,0/28,0/24,0	35,0/29,0/25,0
Moisture removal volume		L/h	0,8	2,0	2,1	2,7	4,1	5,7	6,9
Sound pressure ⁴⁾	Hi / Med / Lo	dB(A)	36/32/28	37/33/28	38/34/29	39/35/30	42/37/34	46/40/35	47/41/36
Sound power	Hi / Med / Lo	dB(A)	54/50/46	55/51/46	56/52/47	57/53/48	60/55/52	64/58/53	65/59/54
Dimension	HxWxD	mm	235x960x690	235x960x690	235x1275x690	235x1275x690	235x1590x690	235x1590x690	235x1590x690
Net weight		kg	26	26	34	34	40	40	40
nanoe X Generator			Mark 2	Mark 2	Mark 2	Mark 2	Mark 2	Mark 2	Mark 2
Outdoor unit			U-36PZ3E5	U-50PZ3E5	U-60PZ3E5A	U-71PZ3E5A	U-100PZ3E5	U-125PZ3E5	U-140PZ3E5
Power supply		V	220 - 230 - 240	220 - 230 - 240	220 - 230 - 240	220 - 230 - 240	220 - 230 - 240	220 - 230 - 240	220 - 230 - 240
Current	Cool	A	3,90 - 3,75 - 3,60	7,65 - 7,30 - 7,00	7,75 - 7,40 - 7,10	9,75 - 9,30 - 8,95	13,70 - 13,10 - 12,60	18,20 - 17,40 - 16,70	22,70 - 21,70 - 20,80
	Heat	A	3,55 - 3,40 - 3,25	6,30 - 6,00 - 5,75	6,75 - 6,50 - 6,20	7,50 - 7,20 - 6,90	11,80 - 11,30 - 10,80	15,50 - 14,80 - 14,20	18,30 - 17,50 - 16,80
Air flow	Cool / Heat	m ³ /min	33,6/34,0	32,7/31,9	42,6/41,5	44,7/45,9	73,0/73,0	82,0/80,0	84,0/82,0
Sound pressure	Cool / Heat (Hi)	dB(A)	46/47	46/46	47/48	48/49	52/52	55/55	56/56
Sound power	Cool / Heat (Hi)	dB(A)	64/66	64/64	64/65	66/68	70/70	73/73	74/74
Dimension	HxWxD	mm	619x824x299	619x824x299	695x875x320	695x875x320	996x980x370	996x980x370	996x980x370
Net weight		kg	32	35	42	50	83	87	87
Piping diameter	Liquid pipe	Inch (mm)	1/4 (6,35)	1/4 (6,35)	1/4 (6,35) ⁵⁾	1/4 (6,35) ⁵⁾	3/8 (9,52)	3/8 (9,52)	3/8 (9,52)
	Gas pipe	Inch (mm)	1/2 (12,70)	1/2 (12,70)	1/2 (12,70) ⁴⁾	5/8 (15,88)	5/8 (15,88)	5/8 (15,88)	5/8 (15,88)
Pipe length range		m	3 - 15	3 - 20	3 - 40	3 - 40	5 - 50	5 - 50	5 - 50
Elevation difference (in / out) ⁷⁾		m	15/15	15/15	15/30	20/30	15/30	15/30	15/30
Pipe length for additional gas		m	7,5	7,5	30	30	30	30	30
Additional gas amount		g/m	10	15	15	17	45	45	45
Refrigerant (R32) / CO ₂ Eq.		kg / T	0,87/0,59	1,14/0,77	1,15/0,78	1,32/0,89	2,40/1,62	2,80/1,89	2,80/1,89
Operating range	Cool Min - Max	°C	-10 ~ +43	-10 ~ +43	-10 ~ +43	-10 ~ +43	-10 ~ +43	-10 ~ +43	-10 ~ +43
	Heat Min - Max	°C	-15 ~ +24	-15 ~ +24	-15 ~ +24	-15 ~ +24	-15 ~ +24	-15 ~ +24	-15 ~ +24

Technical focus

- Wide air distribution for large rooms
- Horizontal air flow reaches maximum 9,5 m
- Fresh air connection available on the unit
- Slim design with 235 mm height fits narrow space
- Silent operation
- nanoe™ X (Generator Mark 2= 9,6 trillion hydroxyl radicals/sec) as standard for better indoor air quality
- Wired remote control CZ-RTC6BL allows easy system setting via Bluetooth®
- Single and twin options
- Easy connection and control of external fan or ERV using the connector PAW-FDC on the indoor unit PCB. The external device can be controlled by the remote control of the Panasonic indoor unit

Further comfort improvement with air flow distribution

Horizontal air flow reaches maximum 9,5 m. This is ideal for wide rooms.

The wide air discharge opening expands the air flow to the left and right. The unpleasant feeling caused when the air flow directly hits the human body is prevented by the "Draft prevention position", which changes the swing width, so that the degree of comfort is increased.



PACi NX Series Elite adaptive ducted unit Inverter+ · R32

Adaptive ducted unit - PF3.

2 installation possibilities (horizontal / vertical) with high ESP 150Pa allows flexible installation.

		Single phase							
		3,6 kW	5,0 kW	6,0 kW	7,1 kW	10,0 kW	12,5 kW	14,0 kW	
Kit		KIT-36PFH3Z5	KIT-50PFH3Z5	KIT-60PFH3Z5	KIT-71PFH3Z5	KIT-100PFH3Z5	KIT-125PFH3Z5	KIT-140PFH3Z5	
Remote controller		CZ-RTC5B	CZ-RTC5B	CZ-RTC5B	CZ-RTC5B	CZ-RTC5B	CZ-RTC5B	CZ-RTC5B	
Cooling capacity	Nominal (Min - Max)	kW	3,6(1,2 - 4,0)	5,0(1,2 - 5,6)	5,7(1,2 - 6,3)	6,8(2,2 - 7,8)	9,5(3,1 - 11,4)	12,1(3,2 - 13,6)	13,4(3,3 - 15,3)
EER ¹⁾	Nominal (Min - Max)	W/W	4,24(3,57 - 5,45)	3,42(3,11 - 5,45)	3,68(3,15 - 5,45)	3,74(2,41 - 5,64)	4,17(2,82 - 5,08)	3,58(3,00 - 5,00)	3,38(2,59 - 4,18)
SEER / η _{sc} ²⁾			6,8 A++	6,1 A++	7,1 A++	7,1 A++	7,4 A++	281,7 %	275,9 %
Pdesign		kW	3,6	5,0	5,7	6,8	9,5	12,1	13,4
Input power	Nominal (Min - Max)	kW	0,85(0,22 - 1,12)	1,46(0,22 - 1,80)	1,55(0,22 - 2,00)	1,82(0,39 - 3,24)	2,28(0,61 - 4,04)	3,38(0,64 - 4,54)	3,96(0,79 - 5,90)
Annual energy consumption ³⁾		kWh/a	185	287	281	332	447	—	—
Heating capacity	Nominal (Min - Max)	kW	4,0(1,2 - 5,0)	5,6(1,2 - 6,5)	7,0(1,2 - 8,0)	7,5(2,0 - 9,0)	10,8(3,1 - 13,5)	13,5(3,2 - 15,4)	15,5(3,3 - 17,4)
COP ¹⁾	Nominal (Min - Max)	W/W	4,17(3,23 - 5,45)	3,61(2,97 - 5,45)	3,74(3,33 - 5,45)	4,03(3,16 - 5,41)	3,97(3,07 - 5,25)	3,46(3,06 - 5,16)	3,44(3,14 - 4,29)
SCOP / η _{sh} ²⁾			4,5 A+	4,2 A+	4,4 A+	4,7 A++	4,5 A+	170,0 %	171,0 %
Pdesign at -10 °C		kW	3,6	4,0	4,7	4,7	7,8	9,3	9,5
Input power	Nominal (Min - Max)	kW	0,96(0,22 - 1,55)	1,55(0,22 - 2,19)	1,87(0,22 - 2,40)	1,86(0,37 - 2,85)	2,72(0,59 - 4,40)	3,90(0,62 - 5,04)	4,51(0,77 - 5,55)
Annual energy consumption ³⁾		kWh/a	1120	1333	1495	1393	2424	—	—
Indoor unit			S-3650PF3E	S-3650PF3E	S-6071PF3E	S-6071PF3E	S-1014PF3E	S-1014PF3E	S-1014PF3E
External static pressure ⁴⁾	Nominal (Min - Max)	Pa	30(10 - 150)	30(10 - 150)	30(10 - 150)	30(10 - 150)	40(10 - 150)	50(10 - 150)	50(10 - 150)
Air flow	Hi / Med / Lo	m ³ /min	14,0/13,0/10,0	16,0/15,0/12,0	21,0/19,0/15,0	21,0/19,0/15,0	32,0/26,0/21,0	34,0/29,0/23,0	36,0/32,0/25,0
Moisture removal volume		L/h	0,9	1,9	1,7	2,7	3,2	4,1	4,9
Sound pressure ⁵⁾	Hi / Med / Lo	dB(A)	30/27/22	34/30/25	30/26/23	30/26/23	33/29/25	35/31/27	39/35/29
Sound power	Hi / Med / Lo	dB(A)	53/50/45	57/53/48	53/49/46	53/49/46	56/52/48	58/54/50	62/58/52
Dimension	HxWxD	mm	250x800x730	250x800x730	250x1000x730	250x1000x730	250x1400x730	250x1400x730	250x1400x730
Net weight		kg	25	25	30	30	39	39	39
nanoe X Generator			Mark 2	Mark 2	Mark 2	Mark 2	Mark 2	Mark 2	Mark 2
Outdoor unit			U-36PZH3E5	U-50PZH3E5	U-60PZH3E5	U-71PZH3E5	U-100PZH3E5	U-125PZH3E5	U-140PZH3E5
Power supply		V	220 - 230 - 240	220 - 230 - 240	220 - 230 - 240	220 - 230 - 240	220 - 230 - 240	220 - 230 - 240	220 - 230 - 240
Current	Cool	A	4,20 - 4,00 - 3,85	6,90 - 6,60 - 6,35	7,25 - 6,95 - 6,65	9,00 - 8,60 - 8,25	11,10 - 10,80 - 10,30	16,50 - 15,80 - 15,10	19,60 - 18,70 - 17,90
	Heat	A	4,70 - 4,50 - 4,30	7,35 - 7,00 - 6,75	8,65 - 8,30 - 7,95	9,00 - 8,60 - 8,35	13,30 - 12,70 - 12,20	19,10 - 18,20 - 17,50	22,00 - 21,10 - 20,20
Air flow	Cool / Heat	m ³ /min	34,1/36,4	42,0/42,0	42,0/42,0	61,0/60,0	118,0/108,0	125,0/112,0	129,0/116,0
Sound pressure	Cool / Heat (Hi)	dB(A)	43/44	46/48	47/50	48/50	52/52	53/53	54/54
Sound power	Cool / Heat (Hi)	dB(A)	62/64	64/67	65/69	65/67	69/69	70/70	71/71
Dimension	HxWxD	mm	695x875x320	695x875x320	695x875x320	996x940x340	1416x940x340	1416x940x340	1416x940x340
Net weight		kg	42	42	43	65	98	98	98
Piping diameter	Liquid pipe	Inch (mm)	1/4 (6,35)	1/4 (6,35)	1/4 (6,35) ⁶⁾	3/8 (9,52)	3/8 (9,52)	3/8 (9,52)	3/8 (9,52)
	Gas pipe	Inch (mm)	1/2 (12,70)	1/2 (12,70)	1/2 (12,70) ⁷⁾	5/8 (15,88)	5/8 (15,88)	5/8 (15,88)	5/8 (15,88)
Pipe length range		m	3 - 40	3 - 40	3 - 40	5 - 50	5 - 85	5 - 85	5 - 85
Elevation difference (in / out) ⁸⁾		m	15/30	15/30	15/30	15/30	15/30	15/30	15/30
Pipe length for additional gas		m	30	30	30	30	30	30	30
Additional gas amount		g/m	15	15	15	45	45	45	45
Refrigerant (R32) / CO ₂ Eq.		kg / T	1,13/0,76	1,13/0,76	1,15/0,78	1,95/1,32	3,05/2,06	3,05/2,06	3,05/2,06
Operating range	Cool Min - Max	°C	-15 ~ +46	-15 ~ +46	-15 ~ +46	-15 ~ +48	-20 ~ +48 ⁹⁾	-20 ~ +48 ⁹⁾	-20 ~ +48 ⁹⁾
	Heat Min - Max	°C	-20 ~ +24	-20 ~ +24	-20 ~ +24	-20 ~ +24	-20 ~ +24	-20 ~ +24	-20 ~ +24

Technical focus

- 2 installation possibilities (horizontal / vertical)
- Maximum external static pressure: 150 Pa
- Selectable inlet air position (rear / bottom entry)
- Improved drain pan suitable for both horizontal / vertical installation
- Drain pump included
- nanoe™ X (Generator Mark 2= 9,6 trillion hydroxyl radicals/sec) as standard for the long duct piping case*
- Wired remote control CZ-RTC6BL allows easy system setting via Bluetooth®

* The performance of nanoe™ X air can be expected even by 10 m long duct by Panasonic internal survey.

2 installation possibilities (horizontal / vertical)

Vertical installation is newly available. ESP 150Pa, sufficient for remotely installing units away from the rooms.



Improved drain pan design

Drain pan is shared in both cases horizontal and vertical installation. No need to modify the unit.

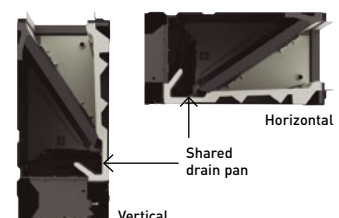



CZ-RTC5B



Optional controller. CONEX wired remote controller.
CZ-RTC6 - CZ-RTC6BL
- CZ-RTC6BLW



Optional Econavi sensor.
CZ-CENSC1



COMPATIBLE WITH ALL PANASONIC CONNECTIVITY SOLUTIONS. FOR DETAILED INFORMATION GO TO THE CONTROL SYSTEMS SECTION

		Three phase				
		7,1 kW	10,0 kW	12,5 kW	14,0 kW	
Kit		KIT-71PFH3Z8	KIT-100PFH3Z8	KIT-125PFH3Z8	KIT-140PFH3Z8	
Remote controller		CZ-RTC5B	CZ-RTC5B	CZ-RTC5B	CZ-RTC5B	
Cooling capacity	Nominal (Min - Max)	kW	6,8[2,2 - 7,8]	9,5[3,1 - 11,4]	12,1[3,2 - 13,6]	13,4[3,3 - 15,3]
EER ¹⁾	Nominal (Min - Max)	W/W	3,74[5,64 - 2,41]	4,17[5,08 - 2,82]	3,58[5,00 - 3,00]	3,38[4,18 - 2,59]
SEER / η_{sc} ²⁾			7,0 A++	7,3 A++	281,0 %	275,2 %
Pdesign		kW	6,8	9,5	12,1	13,4
Input power	Nominal (Min - Max)	kW	1,82[0,39 - 3,24]	2,28[0,61 - 4,04]	3,38[0,64 - 4,54]	3,96[0,79 - 5,90]
Annual energy consumption ³⁾		kWh/a	338	451	—	—
Heating capacity	Nominal (Min - Max)	kW	7,5[2,0 - 9,0]	10,8[3,1 - 13,5]	13,5[3,2 - 15,4]	15,5[3,3 - 17,4]
COP ¹⁾	Nominal (Min - Max)	W/W	4,03[5,41 - 3,16]	3,97[5,25 - 3,07]	3,46[5,16 - 3,06]	3,44[4,29 - 3,14]
SCOP / η_{sh} ²⁾			4,7 A++	4,5 A+	170,0 %	171,0 %
Pdesign at -10 °C		kW	4,7	7,8	9,3	9,5
Input power	Nominal (Min - Max)	kW	1,86[0,37 - 2,85]	2,72[0,59 - 4,40]	3,9[0,62 - 5,04]	4,51[0,77 - 5,55]
Annual energy consumption ³⁾		kWh/a	1394	2424	—	—
Indoor unit			S-6071PF3E	S-1014PF3E	S-1014PF3E	S-1014PF3E
External static pressure ⁴⁾	Nominal (Min - Max)	Pa	30[10 - 150]	40[10 - 150]	50[10 - 150]	50[10 - 150]
Air flow	Hi / Med / Lo	m ³ /min	21,0/19,0/15,0	32,0/26,0/21,0	34,0/29,0/23,0	36,0/32,0/25,0
Moisture removal volume		L/h	2,7	3,2	4,1	4,9
Sound pressure ⁵⁾	Hi / Med / Lo	dB(A)	30/26/23	33/29/25	35/31/27	39/35/29
Sound power	Hi / Med / Lo	dB(A)	53/49/46	56/52/48	58/54/50	62/58/52
Dimension	HxWxD	mm	250x1000x730	250x1400x730	250x1400x730	250x1400x730
Net weight		kg	30	39	39	39
nanoe X Generator			Mark 2	Mark 2	Mark 2	Mark 2
Outdoor unit			U-71PZH3E8	U-100PZH3E8	U-125PZH3E8	U-140PZH3E8
Power supply		V	380 - 400 - 415	380 - 400 - 415	380 - 400 - 415	380 - 400 - 415
Current	Cool	A	3,00 - 2,90 - 2,80	3,80 - 3,60 - 3,50	5,60 - 5,30 - 5,15	6,60 - 6,30 - 6,05
	Heat	A	3,05 - 2,95 - 2,85	4,50 - 4,30 - 4,15	6,45 - 6,10 - 5,90	7,55 - 7,15 - 6,90
Air flow	Cool / Heat	m ³ /min	61,0/60,0	118,0/108,0	125,0/112,0	129,0/116,0
Sound pressure	Cool / Heat (Hi)	dB(A)	48/50	52/52	53/53	54/54
Sound power	Cool / Heat (Hi)	dB(A)	65/67	69/69	70/70	71/71
Dimension	HxWxD	mm	996x940x340	1416x940x340	1416x940x340	1416x940x340
Net weight		kg	65	98	98	98
Piping diameter	Liquid pipe	Inch (mm)	3/8(9,52)	3/8(9,52)	3/8(9,52)	3/8(9,52)
	Gas pipe	Inch (mm)	5/8(15,88)	5/8(15,88)	5/8(15,88)	5/8(15,88)
Pipe length range		m	5 - 50	5 - 85	5 - 85	5 - 85
Elevation difference (in / out) ⁶⁾		m	15/30	15/30	15/30	15/30
Pipe length for additional gas		m	30	30	30	30
Additional gas amount		g/m	45	45	45	45
Refrigerant (R32) / CO ₂ Eq.		kg / T	1,95/1,32	3,05/2,06	3,05/2,06	3,05/2,06
Operating range	Cool Min ~ Max	°C	-15 ~ +48	-20 ~ +48 ¹⁰⁾	-20 ~ +48 ⁹⁾	-20 ~ +48 ⁹⁾
	Heat Min ~ Max	°C	-20 ~ +24	-20 ~ +24	-20 ~ +24	-20 ~ +24

1) EER and COP calculation is based in accordance to EN14511. 2) For models below 12 kW, the SEER and SCOP is calculated based on values of EU/626/2011. For models above 12 kW, the η_{sc} / η_{sh} values is calculated based on EN 14825. 3) Factory setting. 4) Medium external static pressure setting from factory. 5) The sound pressure of the units shows the value measured of the position 1,5 m below the unit. The sound pressure is measured in accordance with Eurovent 6/C/006-97 specification. 6) Connect the liquid socket tube (Ø6,35-Ø9,52) to the liquid tubing side indoor unit. 7) Connect the gas socket tube (Ø12,70-Ø15,88) to the gas tubing side indoor unit. 8) Outdoor unit located lower / outdoor unit located higher. 9) For models 100 - 140PZH3E5[8], it is possible to operate the lowest -20 °C in the computer rooms with the piping length of 30 m or less. * Recommended fuse for the indoor 3 A. ** Above values are in the case of standard installation(horizontal installation in the ceiling, rear side air intake) and nanoe™ X OFF.

Accessories	
CZ-RTC6	CONEX wired remote controller (non-wireless)
CZ-RTC6BL	CONEX wired remote controller with Bluetooth®
CZ-RTC6BLW	CONEX wired remote controller with Wi-Fi and Bluetooth®
CZ-RTC5B	Wired remote controller with Econavi function and datanavi
CZ-RWS3 + CZ-RWRC3	Infrared remote controller and receiver
CZ-CAPWFC1	Commercial Wi-Fi Adaptor
PAW-PACR3	Interfaces to run 3 units on back-up and alternative run

Accessories	
PAW-WTRAY	Tray for condenser water compatible with outdoor elevation platform
PAW-GRDBSE20	Outdoor base ground support for noise and vibration absorption
PAW-GRDSTD40	Outdoor elevation platform 400x900x400 mm
CZ-CENSC1	Econavi energy savings sensor
CZ-56DAF2	Air outlet plenum for S-3650PF3E
CZ-90DAF2	Air outlet plenum for S-6071PF3E
CZ-160DAF2	Air outlet plenum for S-1014PF3E



SEER and SCOP: For S-6071PF3E + U-71PZH3E5. SUPER QUIET: For S-3650PF3E + U-36PZH3E5. INTERNET CONTROL: Optional.

Rating Conditions: Cooling Indoor 27 °C DB / 19 °C WB. Cooling Outdoor 35 °C DB / 24 °C WB. Heating Indoor 20 °C DB. Heating Outdoor 7 °C DB / 6 °C WB. [DB: Dry Bulb; WB: Wet Bulb]. Specifications subject to change without notice. For detailed information about ErP / Energy Labelling, please visit our websites www.aircon.panasonic.eu or www.ptc.panasonic.eu.



PACi NX Series Standard adaptive ducted unit Inverter+ R32

Adaptive ducted unit - PF3.

2 installation possibilities (horizontal / vertical) with high ESP 150Pa allows flexible installation.

		Single phase							
		3,6 kW	5,0 kW	6,0 kW	7,1 kW	10,0 kW	12,5 kW	14,0 kW	
Kit		KIT-36PF3Z5	KIT-50PF3Z5	KIT-60PF3Z5	KIT-71PF3Z5	KIT-100PF3Z5	KIT-125PF3Z5	KIT-140PF3Z5	
Remote controller		CZ-RTC5B	CZ-RTC5B	CZ-RTC5B	CZ-RTC5B	CZ-RTC5B	CZ-RTC5B	CZ-RTC5B	
Cooling capacity	Nominal (Min - Max)	kW	3,4(1,5 - 4,0)	5,0(1,5 - 5,3)	5,7(2,0 - 6,3)	6,8(2,6 - 7,7)	9,5(3,0 - 11,4)	12,1(3,2 - 13,5)	13,4(3,3 - 15,0)
EER ¹⁾	Nominal (Min - Max)	W/W	3,78(3,51 - 5,00)	2,78(2,76 - 4,63)	3,54(2,63 - 5,88)	3,18(2,69 - 4,56)	3,57(2,36 - 5,08)	3,40(2,76 - 5,08)	3,16(2,56 - 5,08)
SEER / η_{sc}²⁾			6,0 A+	6,5 A++	6,4 A++	6,0 A+	6,6 A++	257,4 %	252,2 %
Pdesign		kW	3,4	5,0	5,7	6,8	9,5	12,1	13,4
Input power	Nominal (Min - Max)	kW	0,90(0,30 - 1,14)	1,80(0,32 - 1,92)	1,61(0,34 - 2,40)	2,14(0,57 - 2,86)	2,66(0,59 - 4,84)	3,56(0,63 - 4,90)	4,24(0,65 - 5,86)
Annual energy consumption ³⁾		kWh/a	198	267	310	391	502	—	—
Heating capacity	Nominal (Min - Max)	kW	3,4(1,5 - 4,6)	5,0(1,5 - 5,9)	5,7(1,8 - 7,0)	6,8(2,1 - 8,1)	9,5(3,0 - 13,5)	12,1(3,3 - 15,0)	13,4(3,4 - 16,0)
COP ¹⁾	Nominal (Min - Max)	W/W	4,15(3,51 - 5,36)	3,62(3,06 - 5,36)	4,04(2,82 - 6,21)	4,00(3,03 - 5,68)	4,09(3,00 - 5,08)	3,56(3,16 - 5,24)	3,76(3,03 - 5,23)
SCOP / η_{sh}²⁾			4,0 A+	4,0 A+	4,4 A+	4,1 A+	3,9 A	142,6 %	140,6 %
Pdesign at -10 °C		kW	2,4	3,8	4,4	4,7	7,8	9,3	9,5
Input power	Nominal (Min - Max)	kW	0,82(0,28 - 1,31)	1,38(0,28 - 1,73)	1,41(0,29 - 2,48)	1,70(0,37 - 2,67)	2,32(0,59 - 4,50)	3,40(0,63 - 4,74)	3,56(0,65 - 5,28)
Annual energy consumption ³⁾		kWh/a	839	1303	1376	1591	2795	—	—
Indoor unit			S-3650PF3E	S-3650PF3E	S-6071PF3E	S-6071PF3E	S-1014PF3E	S-1014PF3E	S-1014PF3E
External static pressure ⁴⁾	Nominal (Min - Max)	Pa	30(10 - 150)	30(10 - 150)	30(10 - 150)	30(10 - 150)	40(10 - 150)	50(10 - 150)	50(10 - 150)
Air flow	Hi / Med / Lo	m ³ /min	14,0/13,0/10,0	16,0/15,0/12,0	21,0/19,0/15,0	21,0/19,0/15,0	32,0/26,0/21,0	34,0/29,0/23,0	36,0/32,0/25,0
Moisture removal volume		L/h	0,9	1,9	1,7	2,7	3,2	4,1	4,9
Sound pressure ⁵⁾	Hi / Med / Lo	dB(A)	30/27/22	34/30/25	30/26/23	30/26/23	33/29/25	35/31/27	39/35/29
Sound power	Hi / Med / Lo	dB(A)	53/50/45	57/53/48	53/49/46	53/49/46	56/52/48	58/54/50	62/58/52
Dimension	HxWxD	mm	250x800x730	250x800x730	250x1000x730	250x1000x730	250x1400x730	250x1400x730	250x1400x730
Net weight		kg	25	25	30	30	39	39	39
nanoe X Generator			Mark 2	Mark 2	Mark 2	Mark 2	Mark 2	Mark 2	Mark 2
Outdoor unit			U-36PZ3E5	U-50PZ3E5	U-60PZ3E5A	U-71PZ3E5A	U-100PZ3E5	U-125PZ3E5	U-140PZ3E5
Power supply		V	220 - 230 - 240	220 - 230 - 240	220 - 230 - 240	220 - 230 - 240	220 - 230 - 240	220 - 230 - 240	220 - 230 - 240
Current	Cool	A	4,15 - 4,00 - 3,85	8,35 - 8,00 - 7,65	7,45 - 7,15 - 6,85	9,95 - 9,50 - 9,10	13,30 - 12,70 - 12,20	17,20 - 16,40 - 15,80	20,50 - 19,60 - 18,8
	Heat	A	3,85 - 3,70 - 3,50	6,45 - 6,20 - 5,95	6,55 - 6,25 - 6,00	7,90 - 7,55 - 7,25	11,60 - 11,10 - 10,60	16,40 - 15,70 - 15,00	17,20 - 16,40 - 15,80
Air flow	Cool / Heat	m ³ /min	33,6/34,0	32,7/31,9	42,6/41,5	44,7/45,9	73,0/73,0	82,0/80,0	84,0/82,0
Sound pressure	Cool / Heat (Hi)	dB(A)	46/47	46/46	47/48	48/49	52/52	55/55	56/56
Sound power	Cool / Heat (Hi)	dB(A)	64/66	64/64	64/65	66/68	70/70	73/73	74/74
Dimension	HxWxD	mm	619x824x299	619x824x299	695x875x320	695x875x320	996x980x370	996x980x370	996x980x370
Net weight		kg	32	35	42	50	83	87	87
Piping diameter	Liquid pipe	Inch (mm)	1/4(Ø6,35)	1/4(Ø6,35)	1/4(Ø6,35) ⁶⁾	1/4(Ø6,35) ⁶⁾	3/8(9,52)	3/8(9,52)	3/8(9,52)
	Gas pipe	Inch (mm)	1/2(Ø12,7)	1/2(Ø12,7)	1/2(Ø12,7) ⁷⁾	5/8(Ø15,88)	5/8(15,88)	5/8(15,88)	5/8(15,88)
Pipe length range		m	3 - 15	3 - 20	3 - 40	3 - 40	5 - 50	5 - 50	5 - 50
Elevation difference (in / out) ⁸⁾		m	15/15	15/15	15/30	20/30	15/30	15/30	15/30
Pipe length for additional gas		m	7,5	7,5	30	30	30	30	30
Additional gas amount		g/m	10	15	15	17	45	45	45
Refrigerant (R32) / CO ₂ Eq.		kg / T	0,87/0,59	1,14/0,77	1,15/0,78	1,32/0,89	2,40/1,62	2,80/1,89	2,80/1,89
Operating range	Cool Min - Max	°C	-10 ~ +43	-10 ~ +43	-10 ~ +43	-10 ~ +43	-10 ~ +43	-10 ~ +43	-10 ~ +43
	Heat Min - Max	°C	-15 ~ +24	-15 ~ +24	-15 ~ +24	-15 ~ +24	-15 ~ +24	-15 ~ +24	-15 ~ +24

Technical focus

- 2 installation possibilities (horizontal / vertical)
- Maximum external static pressure: 150 Pa
- Selectable inlet air position (rear / bottom entry)
- Improved drain pan suitable for both horizontal / vertical installation
- Drain pump included
- nanoe™ X (Generator Mark 2= 9,6 trillion hydroxyl radicals/sec) as standard for the long duct piping case*
- Wired remote control CZ-RTC6BL allows easy system setting via Bluetooth®

* The performance of nanoe™ X air can be expected even by 10 m long duct by Panasonic internal survey.

2 installation possibilities (horizontal / vertical)

Vertical installation is newly available. ESP 150Pa, sufficient for remotely installing units away from the rooms.



Improved drain pan design

Drain pan is shared in both cases horizontal and vertical installation. No need to modify the unit.

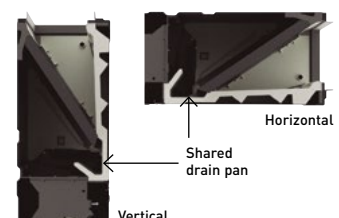



CZ-RTC5B



COMPATIBLE WITH ALL PANASONIC CONNECTIVITY SOLUTIONS. FOR DETAILED INFORMATION GO TO THE CONTROL SYSTEMS SECTION



Optional controller. CONEX wired remote controller.
CZ-RTC6 - CZ-RTC6BL
- CZ-RTC6BLW



Optional controller. Infrared remote controller.
CZ-RWS3 + CZ-RWRC3

Optional Econavi sensor.
CZ-CENSC1

Kit	10,0 kW			Three phase		
	KIT-100PF3Z8			KIT-125PF3Z8		
Remote controller	CZ-RTC5B			CZ-RTC5B		
Cooling capacity	Nominal (Min - Max)	kW	9,5(3,0 - 11,4)	12,1(3,2 - 13,5)	13,4(3,3 - 15,0)	
EER ¹⁾	Nominal (Min - Max)	W/W	3,57(2,36 - 5,08)	3,40(2,76 - 5,08)	3,16(2,56 - 5,08)	
SEER / η _{sc} ²⁾	6,5 A++			256,2 %		
Pdesign		kW	9,5	12,1	13,4	
Input power	Nominal (Min - Max)	kW	2,66(0,59 - 4,84)	3,56(0,63 - 4,90)	4,24(0,65 - 5,86)	
Annual energy consumption ³⁾		kWh/a	508	—	—	
Heating capacity	Nominal (Min - Max)	kW	9,5(3,0 - 13,5)	12,1(3,3 - 15,0)	13,4(3,4 - 16,0)	
COP ¹⁾	Nominal (Min - Max)	W/W	4,09(3,00 - 5,08)	3,56(3,16 - 5,24)	3,76(3,03 - 5,23)	
SCOP / η _{sh} ²⁾	3,9 A			142,6 %		
Pdesign at -10 °C		kW	7,8	9,3	9,5	
Input power	Nominal (Min - Max)	kW	2,32(0,59 - 4,50)	3,40(0,63 - 4,74)	3,56(0,65 - 5,28)	
Annual energy consumption ³⁾		kWh/a	2795	—	—	
Indoor unit	S-1014PF3E			S-1014PF3E		
External static pressure ⁴⁾	Nominal (Min - Max)	Pa	40(10 - 150)	50(10 - 150)	50(10 - 150)	
Air flow	Hi / Med / Lo	m ³ /min	32,0/26,0/21,0	34,0/29,0/23,0	36,0/32,0/25,0	
Moisture removal volume		L/h	3,2	4,1	4,9	
Sound pressure ⁵⁾	Hi / Med / Lo	dB(A)	33/29/25	35/31/27	39/35/29	
Sound power	Hi / Med / Lo	dB(A)	56/52/48	58/54/50	62/58/52	
Dimension	H x W x D	mm	250 x 1400 x 730	250 x 1400 x 730	250 x 1400 x 730	
Net weight		kg	39	39	39	
nanoe X Generator			Mark 2	Mark 2	Mark 2	
Outdoor unit	U-100PZ3E8			U-125PZ3E8		
Power supply		V	380 - 400 - 415	380 - 400 - 415	380 - 400 - 415	
Current	Cool	A	4,45 - 4,20 - 4,05	5,75 - 5,45 - 5,25	6,85 - 6,50 - 6,30	
	Heat	A	3,85 - 3,70 - 3,55	5,50 - 5,20 - 5,05	5,75 - 5,45 - 5,25	
Air flow	Cool / Heat	m ³ /min	73,0/73,0	82,0/80,0	84,0/82,0	
Sound pressure	Cool / Heat (Hi)	dB(A)	52/52	55/55	56/56	
Sound power	Cool / Heat (Hi)	dB(A)	70/70	73/73	74/74	
Dimension	H x W x D	mm	996 x 980 x 370	996 x 980 x 370	996 x 980 x 370	
Net weight		kg	83	87	87	
Piping diameter	Liquid pipe	Inch (mm)	3/8(9,52)	3/8(9,52)	3/8(9,52)	
	Gas pipe	Inch (mm)	5/8(15,88)	5/8(15,88)	5/8(15,88)	
Pipe length range		m	5 - 50	5 - 50	5 - 50	
Elevation difference (in / out) ⁶⁾		m	15/30	15/30	15/30	
Pipe length for additional gas		m	30	30	30	
Additional gas amount		g/m	45	45	45	
Refrigerant (R32) / CO ₂ Eq.		kg / T	2,40/1,62	2,80/1,89	2,80/1,89	
Operating range	Cool Min ~ Max	°C	-10 ~ +43	-10 ~ +43	-10 ~ +43	
	Heat Min ~ Max	°C	-15 ~ +24	-15 ~ +24	-15 ~ +24	

1) EER and COP calculation is based in accordance to EN14511. 2) For models below 12 kW, the SEER and SCOP is calculated based on values of EU/626/2011. For models above 12 kW, the η_{sc} / η_{sh} values is calculated based on EN 14825. 3) Factory setting. 4) Medium external static pressure setting from factory. 5) The sound pressure of the units shows the value measured of the position 1,5 m below the unit. The sound pressure is measured in accordance with Eurovent 6/C/006-97 specification. 6) Connect the liquid socket tube (Ø6,35-Ø9,52) to the liquid tubing side indoor unit. 7) Connect the gas socket tube (Ø12,70-Ø15,88) to the gas tubing side indoor unit. 8) Outdoor unit located lower / outdoor unit located higher. * Recommended fuse for the indoor 3 A. ** Above values are in the case of standard installation(horizontal installation in the ceiling, rear side air intake) and nanoe™ X OFF.

Accessories	
CZ-RTC6	CONEX wired remote controller (non-wireless)
CZ-RTC6BL	CONEX wired remote controller with Bluetooth®
CZ-RTC6BLW	CONEX wired remote controller with Wi-Fi and Bluetooth®
CZ-RTC5B	Wired remote controller with Econavi function and datanavi
CZ-RWS3 + CZ-RWRC3	Infrared remote controller and receiver
CZ-CAPWFC1	Commercial Wi-Fi Adaptor
PAW-PACR3	Interfaces to run 3 units on back-up and alternative run

Accessories	
PAW-WTRAY	Tray for condenser water compatible with outdoor elevation platform
PAW-GRDBSE20	Outdoor base ground support for noise and vibration absorption
PAW-GRDSTD40	Outdoor elevation platform 400 x 900 x 400 mm
CZ-CENSC1	Econavi energy savings sensor
CZ-56DAF2	Air outlet plenum for S-3650PF3E
CZ-90DAF2	Air outlet plenum for S-6071PF3E
CZ-160DAF2	Air outlet plenum for S-1014PF3E



SEER: For S-1014PF3E + U-100PZ3E5. SCOP: For S-6071PF3E + U-60PZ3E5A. SUPER QUIET: For S-3650PF3E + U-36PZ3E5. INTERNET CONTROL: Optional.

Rating Conditions: Cooling Indoor 27 °C DB / 19 °C WB. Cooling Outdoor 35 °C DB / 24 °C WB. Heating Indoor 20 °C DB. Heating Outdoor 7 °C DB / 6 °C WB. [DB: Dry Bulb; WB: Wet Bulb]. Specifications subject to change without notice. For detailed information about ErP / Energy Labelling, please visit our websites www.aircon.panasonic.eu or www.ptc.panasonic.eu.



Panasonic Big PACi high static pressure hide-away 20,0-25,0 kW Inverter+ · R32

Panasonic Big PACi, not only environmental friendly but also a groundbreaking product.

Big PACi with R32 has been introduced with full renewal of its indoor unit, also offering hydronic application by PACi Water heat exchanger.

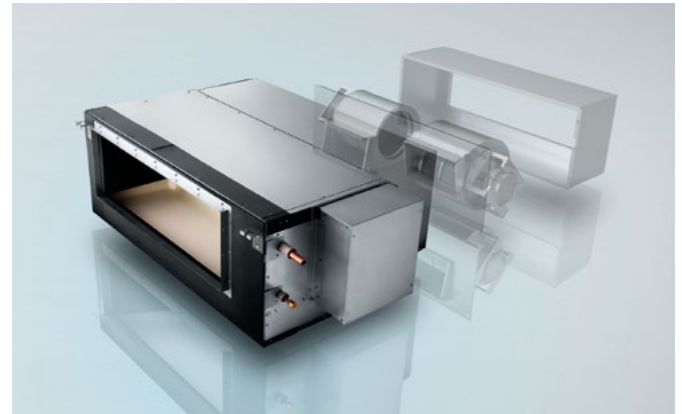

1 Compact and light indoor body

Compact and light indoor body, keeping the high efficiency, has a split-able design for easy installation within a limited narrow space. Plus ease of maintenance due to the simplified disassembly design.

2 Easy pipe work with split-able hide-away indoor design

Heat exchanger and fan elements (fan + casing) can be separated during installation. The hide-away indoor unit is easily reassembled and will fit through a narrow space.

3 High external static pressure, maximum 200 Pa* setting

A high static pressure enables the use of long ducts for installation in a wide range of spaces.

* S-250PE3E5B.

4 Panasonic Comfort Cloud App control

Smartphone ready to control of PACi systems with Panasonic Comfort Cloud App*.

* Panasonic Wi-Fi Adaptor CZ-CAPWFC1 is required.

Compact and light indoor body, keeping high efficiency

15 % lighter weight vs conventional model drastically improves installation work.

	Conventional model	Panasonic model
20,0 kW	100 kg	86 kg
25,0 kW	104 kg	88 kg

DEPTH WAS REDUCED BY 230 mm



Maximum 200 Pa* static pressure setting

A high static pressure enables the use of long ducts for installation in a wide range of spaces.

3-step static pressure set up.

Selectable of static pressure modes can change 200 Pa / 130 Pa / 75 Pa for extra installation flexibility.

* In case of S-250PE3E5B.



Easy installation with light components

Indoor unit can easily be split into 3 components, the heaviest of which weighs only 48 kg.

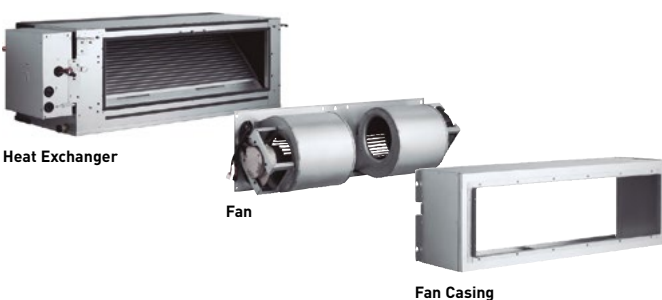

Dimensions of each component (lightweight design for easy disassembly).

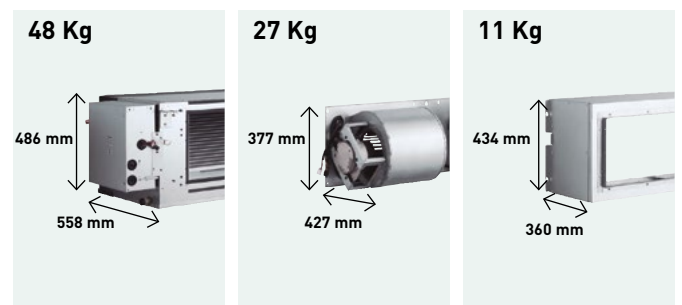

The weight is for S-200PE3E5B model.



CZ-RTC5B



COMPATIBLE WITH ALL PANASONIC CONNECTIVITY SOLUTIONS. FOR DETAILED INFORMATION GO TO THE CONTROL SYSTEMS SECTION

CONEX



Optional controller. CONEX wired remote controller. CZ-RTC6 - CZ-RTC6BL



Optional controller. Infrared remote controller. CZ-RWS3 + CZ-RWRC3



Optional Econavi sensor. CZ-CENSC1

Three phase

Kit			20,0 kW	25,0 kW
			KIT-200PE3ZH8	KIT-250PE3ZH8
Remote controller			CZ-RTC5B	CZ-RTC5B
Cooling capacity	Nominal (Min - Max)	kW	19,5 (5,7 - 21,0)	23,2 (6,1 - 27,0)
EER ¹⁾	Nominal (Min - Max)	W/W	3,22 (3,09 - 4,52)	3,11 (2,93 - 4,59)
SEER / η _{sc} ²⁾			207,0 %	190,6 %
P _{design}			19,5	23,2
Input power	Nominal (Min - Max)	kW	6,06 (1,26 - 6,80)	7,46 (1,33 - 9,20)
Heating capacity	Nominal (Min - Max)	kW	22,4 (5,0 - 25,0)	28,0 (5,5 - 29,0)
COP ¹⁾	Nominal (Min - Max)	W/W	3,61 (3,16 - 4,76)	3,41 (3,05 - 5,00)
SCOP / η _{s,h} ²⁾			141,3 %	142,7 %
P _{design} at -10 °C			17,0	20,0
Input power	Nominal (Min - Max)	kW	6,21 (1,05 - 7,90)	8,21 (1,10 - 9,50)
Indoor unit			S-200PE3E5B	S-250PE3E5B
Power supply	V / ph / Hz		220 - 230 - 240 / 1 / 50	220 - 230 - 240 / 1 / 50
External static pressure at shipment (adjustable)	Pa		75 ³⁾ - 120 - 180	75 ³⁾ - 130 - 200
Air flow	Hi / Med / Lo	m ³ /min	72 / 63 / 53	84 / 72 / 59
Sound pressure ⁴⁾	Hi / Med / Lo	dB(A)	46 / 44 / 41	47 / 45 / 42
Dimension	H x W x D	mm	486 x 1456 x 916	486 x 1456 x 916
Net weight	kg		86	88
Outdoor unit			U-200PZH2E8	U-250PZH2E8
Power supply	V / ph / Hz		380 - 400 - 415 / 3 / 50	380 - 400 - 415 / 3 / 50
Recommended fuse	A		30	30
Air flow	Cool / Heat	m ³ /min	164 / 164	160 / 160
Sound pressure	Cool / Heat (Hi)	dB(A)	59 / 61	59 / 63
Sound power	Cool / Heat (Hi)	dB(A)	77 / 79	78 / 82
Dimension ⁵⁾	H x W x D	mm	1500 x 980 x 370	1500 x 980 x 370
Net weight	kg		117	128
Piping diameter	Liquid pipe	Inch (mm)	3/8 (9,52)	1/2 (12,70)
	Gas pipe	Inch (mm)	1 (25,40)	1 (25,40)
Pipe length range	m		5 - 90	5 - 60
Elevation difference (in / out)	m		30	30
Pipe length for additional gas	m		30	30
Additional gas amount	g/m		60	80
Refrigerant (R32) / CO ₂ Eq.	kg / T		4,20 / 2,835	5,20 / 3,51
Operating range	Cool Min - Max	°C	-15 - +46	-15 - +46
	Heat Min - Max	°C	-20 - +24	-20 - +24

1) EER and COP calculation is based in accordance to EN14511. 2) For models below 12 kW, the SEER and SCOP is calculated based on values of EU/626/2011. For models above 12 kW, the η_{sc} / η_{s,h} values is calculated based on EN 14825. 3) Factory setting. 4) The sound pressure of the units shows the value measured of the position 1,5 m below the unit. The sound pressure is measured in accordance with Eurovent 6/C/006-97 specification. 5) Add 100 mm for indoor unit or 70 mm for outdoor unit for piping port. * No filter included.

Accessories

CZ-RTC6	CONEX wired remote controller (non-wireless)
CZ-RTC6BL	CONEX wired remote controller with Bluetooth®
CZ-RTC5B	Wired remote controller with Econavi function and datanavi
CZ-RWS3 + CZ-RWRC3	Infrared remote controller and receiver

Accessories

CZ-CAPWFC1	Commercial Wi-Fi Adaptor
PAW-PACR3	Interfaces to run 3 units on back-up and alternative run
PAW-GRDBSE20	Outdoor base ground support for noise and vibration absorption
PAW-GRDSTD40	Outdoor elevation platform 400x900x400 mm
CZ-CENSC1	Econavi energy savings sensor

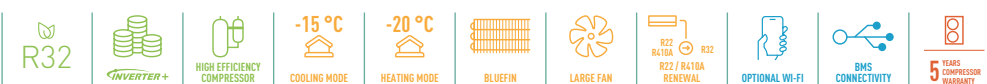

INTERNET CONTROL: Optional.

Rating Conditions: Cooling Indoor 27 °C DB / 19 °C WB. Cooling Outdoor 35 °C DB / 24 °C WB. Heating Indoor 20 °C DB. Heating Outdoor 7 °C DB / 6 °C WB. (DB: Dry Bulb; WB: Wet Bulb). Specifications subject to change without notice. For detailed information about ErP / Energy Labelling, please visit our websites www.aircon.panasonic.eu or www.ptc.panasonic.eu.

PACi Elite 4 way 60x60 cassette Inverter+ · R32

Small and powerful, ideal for offices and restaurants.



Technical focus

- Fresh air distribution
- Multidirectional air flow
- Integrated drain pump gives 850 mm lift
- 3 speed centrifugal fan
- DC fan for better efficiency and control
- Easy connection and control of external fan or ERV using the connector PAW-FDC on the indoor unit PCB. The external device can be controlled by the remote control of the Panasonic indoor unit

Lighter and slimmer, easier installation

Lightweight and very slim which makes installation possible even in narrow ceilings. Designed to fit exactly into a 600x600 mm ceiling grid without the need to alter the bar configuration.

A drain height of approximately 850 mm from the ceiling surface

The drain height can be increased by approx. 350 mm over the conventional value by using a high-lift drain pump, and long horizontal piping is possible.

Lightweight at 18kg, the unit is also very slim with a height of only 288 mm, making installation possible even in narrow ceilings.

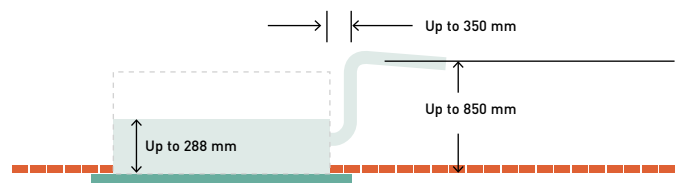

Significant reduction of power consumption by using highly developed DC fan motors with variable speed, special heat exchangers, etc.



CZ-RTC5B



COMPATIBLE WITH ALL PANASONIC CONNECTIVITY SOLUTIONS. FOR DETAILED INFORMATION GO TO THE CONTROL SYSTEMS SECTION



Panel 700x700 mm.
CZ-KPY3AW

Panel 625x625 mm.
CZ-KPY3BW



Optional controller.
CONEX wired remote controller.
CZ-RTC6 - CZ-RTC6BL



Optional controller.
Infrared remote controller.
CZ-RWS3

Single phase

			3,6 kW	5,0 kW
Kit			KIT-36PY2ZH5	KIT-50PY2ZH5
Remote controller			CZ-RTC5B	CZ-RTC5B
Cooling capacity	Nominal (Min - Max)	kW	3,6 [1,5 - 4,0]	5,0 [1,5 - 5,6]
EER ¹⁾		W/W	4,68	3,68
SEER / η_{sc} ²⁾			6,6 A++	6,4 A++
Pdesign		kW	3,6	5,0
Input power		kW	0,77	1,36
Annual energy consumption ³⁾		kWh/a	191	273
Heating capacity	Nominal (Min - Max)	kW	4,0 [1,5 - 5,0]	5,6 [1,5 - 6,5]
COP ¹⁾		W/W	4,26	3,46
SCOP / η_{sh} ²⁾			4,6 A++	4,3 A+
Pdesign at -10 °C		kW	3,6	4,5
Input power		kW	0,94	1,62
Annual energy consumption ³⁾		kWh/a	1096	1465
Indoor unit			S-36PY2E5B	S-50PY2E5B
Air flow	Hi / Med / Lo	m ³ /min	9,7/8,0/6,0	11,1/9,8/8,5
Moisture removal volume		L/h	1,5	2,4
Sound pressure ⁴⁾	Hi / Med / Lo	dB(A)	36/32/26	40/37/33
Sound power	Hi / Med / Lo	dB(A)	51/47/41	55/52/48
Dimension (HxWxD) / Net weight	Indoor	mm / kg	288x583x583/18	288x583x583/18
	CZ-KPY3AW Panel	mm / kg	31x700x700/2,4	31x700x700/2,4
	CZ-KPY3BW Panel	mm / kg	31x625x625/2,4	31x625x625/2,4
Outdoor unit			U-36PZH2E5	U-50PZH2E5
Power supply		V	220 - 230 - 240	220 - 230 - 240
Current	Cool	A	3,65 - 3,50 - 3,35	6,35 - 6,10 - 5,85
	Heat	A	4,50 - 4,30 - 4,15	7,70 - 8,40 - 8,10
Air flow	Cool / Heat	m ³ /min	40/40	40/45
Sound pressure	Cool / Heat (Hi)	dB(A)	43/44	45/48
Sound power	Cool / Heat (Hi)	dB(A)	62/64	64/68
Dimension / Net weight	HxWxD	mm / kg	695x875x320/43	695x875x320/43
Piping diameter	Liquid pipe	Inch (mm)	1/4 (6,35)	1/4 (6,35)
	Gas pipe	Inch (mm)	1/2 (12,70)	1/2 (12,70)
Pipe length range		m	3 - 40	3 - 40
Elevation difference (in / out) ⁵⁾		m	15/30	15/30
Pipe length for additional gas		m	30	30
Additional gas amount		g/m	20	20
Refrigerant (R32) / CO ₂ Eq.		kg / T	1,15/0,776	1,15/0,776
Operating range	Cool Min ~ Max	°C	-15 ~ +46	-15 ~ +46
	Heat Min ~ Max	°C	-20 ~ +24	-20 ~ +24

1) EER and COP calculation is based in accordance to EN14511. 2) Energy Label Scale from A+++ to D. For models below 12 kW, the SEER and SCOP is calculated based on values of EU/626/2011. For models above 12 kW, the η_{sc} / η_{sh} values is calculated based on EN 14825. 3) The annual energy consumption is calculated in accordance to EU/626/2011. 4) The sound pressure of the units shows the value measured of the position 1,5 m below the unit. The sound pressure is measured in accordance with Eurovent 6/C/006-97 specification. 5) Outdoor unit located lower / outdoor unit located higher. * Recommended fuse for the indoor 3 A.

Accessories

CZ-RTC6	CONEX wired remote controller (non-wireless)
CZ-RTC6BL	CONEX wired remote controller with Bluetooth®
CZ-RTC5B	Wired remote controller with Econavi function and datanavi
CZ-RWS3	Infrared remote controller
CZ-CAPWFC1	Commercial Wi-Fi Adaptor
PAW-PACR3	Interfaces to run 3 units on back-up and alternative run

Accessories

PAW-WTRAY	Tray for condenser water compatible with outdoor elevation platform
PAW-GRDBSE20	Outdoor base ground support for noise and vibration absorption
PAW-GRDSTD40	Outdoor elevation platform 400x900x400 mm
CZ-CENSC1	Econavi energy savings sensor



SEER and SCOP: For KIT-36PY2ZH5. INTERNET CONTROL: Optional.

Rating Conditions: Cooling Indoor 27 °C DB / 19 °C WB. Cooling Outdoor 35 °C DB / 24 °C WB. Heating Indoor 20 °C DB. Heating Outdoor 7 °C DB / 6 °C WB. (DB: Dry Bulb; WB: Wet Bulb). Specifications subject to change without notice. For detailed information about ErP / Energy Labelling, please visit our websites www.aircon.panasonic.eu or www.ptc.panasonic.eu.

Commercial twin, triple and double-twin systems - R32

With this system, a single outdoor unit can split its capacity simultaneously across up to 4 indoor units, for better distribution within the space. This makes the system particularly apt for common areas. It reduces noise concentration and enables the same temperature to be reached around the room. A wide variety of the same type of indoor units can be connected in multi combinations (including wall-mounted, cassette, hide-away and ceiling).



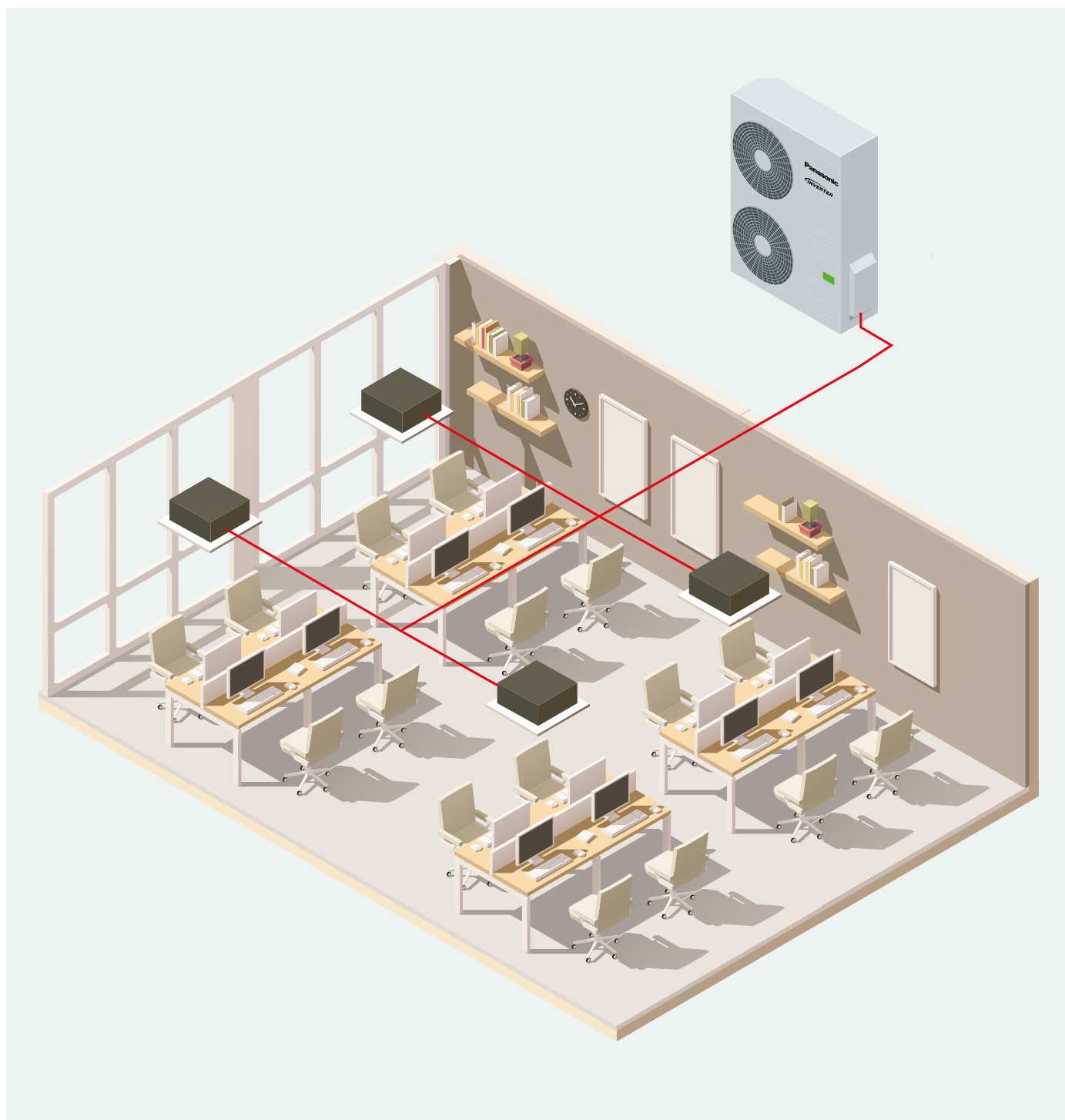

1 PACi NX Elite from 7,1 to 14,0 kW

Up to 4 indoor units can be connected to the same outdoor unit. Panasonic's Elite units 7,1, 10,0, 12,0 and 14,0 can be installed as twin, triple and double-twin systems. The indoor units can be combined as per the selection table. The operation will always be simultaneous. All the indoor units will work with the same settings.

2 PACi NX Standard from 10,0 to 14,0 kW

Up to 2 indoor units connectable on the same outdoor. Panasonic's Standard units can be installed as single and twin systems. The indoor units can be combined following the selection table. The operation will always be simultaneous. All the indoor units will work with the same settings.

3 Big PACi Elite from 20,0 to 25,0 kW

Up to 4 indoor units can be connected to the same outdoor unit. Panasonic's PACi units 20,0 and 25,0 can be installed as twin, triple and double-twin systems. The indoor units can be combined as per the selection table. The operation will always be simultaneous. All the indoor units will work with the same settings.



Commercial twin, triple and double-twin systems - R32



PACi Elite Outdoor units - R32

			PACi NX				Big PACi	
			7,1 kW	10,0 kW	12,5 kW	14,0 kW	20,0 kW	25,0 kW
Outdoor unit single phase			U-71PZH3E5	U-100PZH3E5	U-125PZH3E5	U-140PZH3E5	—	—
Outdoor unit three phase			U-71PZH3E8	U-100PZH3E8	U-125PZH3E8	U-140PZH3E8	U-200PZH2E8	U-250PZH2E8
Cooling capacity	Nominal (Min - Max)	kW	6,8(2,2 - 9,0)	9,5(3,1 - 12,5)	12,1(3,2 - 14,0)	13,4(3,3 - 16,0)	20,0(5,7 - 22,4)	25,0(6,1 - 28,0)
Heating capacity	Nominal (Min - Max)	kW	8,0(2,0 - 9,0)	11,2(3,1 - 14,0)	14,0(3,2 - 16,0)	16,0(3,3 - 18,0)	22,4(5,0 - 25,0)	28,0(5,5 - 31,5)
Power supply	Single phase	V	220 - 230 - 240	220 - 230 - 240	220 - 230 - 240	220 - 230 - 240	—	—
	Three phase	V	380 - 400 - 415	380 - 400 - 415	380 - 400 - 415	380 - 400 - 415	380 - 400 - 415	380 - 400 - 415
Connection indoor / outdoor		mm ²	2x1,5 or 2,5	2x1,5 or 2,5	2x1,5 or 2,5	2x1,5 or 2,5	—	—
Air flow	Cool / Heat	m ³ /min	61,0/60,0	118,0/108,0	125,0/112,0	129,0/116,0	164/164	160/160
Sound pressure	Cool / Heat (Hi)	dB(A)	48/50	52/52	53/53	54/54	59/61	59/63
Sound power	Cool / Heat (Hi)	dB(A)	65/67	69/69	70/70	71/71	77/79	78/82
Dimension	H x W x D	mm	996 x 940 x 340	1416 x 940 x 340	1416 x 940 x 340	1416 x 940 x 340	1500 x 980 x 370	1500 x 980 x 370
Net weight		kg	65	98	98	98	117	128
Piping diameter	Liquid pipe	Inch (mm)	3/8 (9,52)	3/8 (9,52)	3/8 (9,52)	3/8 (9,52)	3/8 (9,52)	1/2 (12,70)
	Gas pipe	Inch (mm)	5/8 (15,88)	5/8 (15,88)	5/8 (15,88)	5/8 (15,88)	1 (25,40)	1 (25,40)
Pipe length range	Min ~ Max	m	5 ~ 50	5 ~ 85	5 ~ 85	5 ~ 85	5 ~ 80	5 ~ 60
Elevation difference (in / out)	Max	m	15/30 ¹⁾	15/30 ¹⁾	15/30 ¹⁾	15/30 ¹⁾	30	30
Pipe length for additional gas		m	30	30	30	30	30	30
Additional gas amount		g/m	45	45	45	45	60	80
Refrigerant (R32) / CO ₂ Eq.		kg / T	1,95/1,32	3,05/2,06	3,05/2,06	3,05/2,06	4,20/2,835	5,20/3,51
Operating range	Cool Min ~ Max	°C	-15 ~ 48	-20 ~ +48 ²⁾	-20 ~ +48 ²⁾	-20 ~ +48 ²⁾	-15 ~ +46	-15 ~ +46
	Heat Min ~ Max	°C	-20 ~ 24	-20 ~ 24	-20 ~ 24	-20 ~ 24	-20 ~ +24	-20 ~ +24

1) Outdoor unit located lower / outdoor unit located higher. 2) For models 100 ~ 140PZH3E5(8), it is possible to operate the lowest -20 °C in the computer rooms with the piping length of 30 m or less.

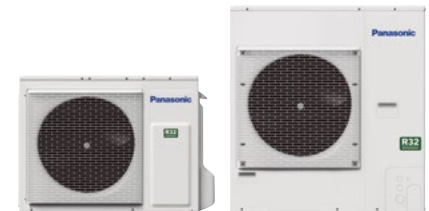

PACi NX Standard Outdoor units - R32

			10,0 kW	12,5 kW	14,0 kW
Outdoor unit single phase			U-100PZ3E5	U-125PZ3E5	U-140PZ3E5
Outdoor unit three phase			U-100PZ3E8	U-125PZ3E8	U-140PZ3E8
Cooling capacity	Nominal (Min - Max)	kW	10,0(3,0 - 11,5)	12,5(3,2 - 13,5)	14,0(3,3 - 15,0)
Heating capacity	Nominal (Min - Max)	kW	10,0(3,0 - 14,0)	12,5(3,3 - 15,0)	14,0(3,4 - 16,0)
Power supply	Single phase	V	220-230-240	220-230-240	220-230-240
	Three phase	V	380-400-415	380-400-415	380-400-415
Connection indoor / outdoor		mm ²	2x1,5 or 2,5	2x1,5 or 2,5	2x1,5 or 2,5
Air flow	Cool / Heat	m ³ /min	73,0/73,0	82,0/80,0	84,0/82,0
Sound pressure	Cool / Heat (Hi)	dB(A)	52/52	55/55	56/56
Sound power	Cool / Heat (Hi)	dB(A)	70/70	73/73	74/74
Dimension	H x W x D	mm	996 x 980 x 370	996 x 980 x 370	996 x 980 x 370
Net weight		kg	83	87	87
Piping diameter	Liquid pipe	Inch (mm)	3/8 (9,52)	3/8 (9,52)	3/8 (9,52)
	Gas pipe	Inch (mm)	5/8 (15,88)	5/8 (15,88)	5/8 (15,88)
Pipe length range	Min ~ Max	m	5 ~ 50	5 ~ 50	5 ~ 50
Elevation difference (in / out) ¹⁾	Max	m	15/30	15/30	15/30
Pipe length for additional gas		m	30	30	30
Additional gas amount		g/m	45	45	45
Refrigerant (R32) / CO ₂ Eq.		kg / T	2,4/1,62	2,8/1,89	2,8/1,89
Operating range	Cool Min ~ Max	°C	-10 ~ +43	-10 ~ +43	-10 ~ +43
	Heat Min ~ Max	°C	-15 ~ 24	-15 ~ 24	-15 ~ 24

1) Outdoor unit located lower / outdoor unit located higher.



Compatible indoor units for multi combinations

CONEX



Optional controller.
CONEX wired remote controller.
CZ-RTC6 - CZ-RTC6BL
- CZ-RTC6BLW



Optional controller.
Wired remote controller.
CZ-RTC5B



Optional Econavi sensor.
CZ-CENSC1



INTERNET CONTROL: Optional.



Wall-mounted	Indoor unit	Cooling capacity	Heating capacity	Dimension	Sound pressure	Air flow
		kW	kW	H x W x D mm	Hi / Med / Lo dB(A)	Hi / Med / Lo m ³ /min
3,6 / 4,5 / 5,0 kW	S-3650PK3E	3,6 - 5,0	4,0 - 5,6	302 x 1120 x 236	35/31/27 ¹⁾	13,0/11,0/9,0 ¹⁾
6,0 / 7,1 kW	S-6010PK3E	6,1 - 10,0	7,0 - 8,0	302 x 1120 x 236	47/44/40 ¹⁾	20,0/17,5/14,5 ¹⁾

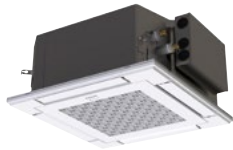

INTERNET CONTROL: Optional.



4 way 60x60 cassette	Indoor unit (panel CZ-KPY4)	Cooling capacity	Heating capacity	Dimension indoor	Dimension panel	Sound pressure	Air flow
		kW	kW	H x W x D mm	H x W x D mm	Hi / Med / Lo dB(A)	Hi / Med / Lo m ³ /min
3,6 kW	S-36PY3E	3,60	3,60	243 x 575 x 575	30 x 625 x 625	34/30/25	9,5/7,0/6,0
5,0 kW	S-50PY3E	5,00	5,00	243 x 575 x 575	30 x 625 x 625	39/34/27	12,0/9,5/6,5
6,0 kW	S-60PY3E	6,00	6,00	243 x 575 x 575	30 x 625 x 625	43/37/31	14,0/10,5/8,0



INTERNET CONTROL: Optional.



4 way 90x90 cassette	Indoor unit (panels CZ-KPU3W / CZ-KPU3AW)	Cooling capacity	Heating capacity	Dimension indoor	Dimension panel	Sound pressure	Air flow
		kW	kW	H x W x D mm	H x W x D mm	Hi / Med / Lo dB(A)	Hi / Med / Lo m ³ /min
3,6 / 4,5 / 5,0 kW	S-3650PU3E	3,6 - 5,0	4,0 - 5,6	256 x 840 x 840	33,5 x 950 x 950	30/28/27 ¹⁾	14,5/13,0/11,5 ¹⁾
6,0 / 7,1 kW	S-6071PU3E	6,0 - 7,1	7,0 - 8,0	256 x 840 x 840	33,5 x 950 x 950	36/31/28 ¹⁾	21,0/16,0/13,0 ¹⁾
10,0 / 12,5 / 14,0 kW	S-1014PU3E	10,0 - 14,0	11,2 - 16,0	319 x 840 x 840	33,5 x 950 x 950	45/38/32 ¹⁾	36,0/26,0/18,0 ¹⁾



INTERNET CONTROL: Optional.



Ceiling	Indoor unit	Cooling capacity	Heating capacity	Dimension	Sound pressure	Air flow
		kW	kW	H x W x D mm	Hi / Med / Lo dB(A)	Hi / Med / Lo m ³ /min
3,6 / 4,5 / 5,0 kW	S-3650PT3E	3,5 - 5,0	4,0 - 5,6	235 x 960 x 690	36/32/28 ¹⁾	14,0/12,0/10,5 ¹⁾
6,0 / 7,1 kW	S-6071PT3E	6,0 - 6,8	7,0 - 8,0	235 x 1275 x 690	38/34/29 ¹⁾	20,0/17,0/14,5 ¹⁾
10,0 / 12,5 / 14,0 kW	S-1014PT3E	9,5 - 13,4	11,2 - 16,0	235 x 1590 x 690	42/37/34 ¹⁾	30,0/25,0/23,0 ¹⁾



INTERNET CONTROL: Optional.



Adaptive ducted unit	Indoor unit	Cooling capacity	Heating capacity	Dimension	External static pressure	Sound pressure	Air flow
		kW	kW	H x W x D mm	Nominal (Min - Max) Pa	Hi / Med / Lo dB(A)	Hi / Med / Lo m ³ /min
3,6 / 4,5 / 5,0 kW	S-3650PF3E	3,6 - 5,0	4,0 - 5,6	250 x 800 x 730	30(10 - 150)	30/27/22 ¹⁾	14,0/13,0/10,0 ¹⁾
6,0 / 7,1 kW	S-6071PF3E	5,7 - 6,8	7,0 - 7,5	250 x 1000 x 730	30(10 - 150)	30/26/23 ¹⁾	21,0/19,0/15,0 ¹⁾
10,0 / 12,5 / 14,0 kW	S-1014PF3E	9,5 - 13,4	10,8 - 13,5	250 x 1400 x 730	30(10 - 150)	33/29/25 ¹⁾	32,0/26,0/21,0 ¹⁾

1) 36/60/10 types of indoor units value.

Rating Conditions: Cooling Indoor 27 °C DB / 19 °C WB. Cooling Outdoor 35 °C DB / 24 °C WB. Heating Indoor 20 °C DB. Heating Outdoor 7 °C DB / 6 °C WB. (DB: Dry Bulb; WB: Wet Bulb). Specifications subject to change without notice. For detailed information about ErP / Energy Labelling, please visit our websites www.aircon.panasonic.eu or www.ptc.panasonic.eu.

Simultaneous operation system combinations

PACi NX Elite from 7,1 to 14,0 kW simultaneous operation system combinations - R32

Capacity	Indoor	Outdoor			
		7,1 kW	10,0 kW	12,5 kW	14,0 kW
3,6 kW	S-36PY3E				
	S-3650PF3E				
	S-3650PK3E				
	S-3650PT3E S-3650PU3E				
4,5 kW	S-3650PF3E				
	S-3650PK3E				
	S-3650PT3E S-3650PU3E				
5,0 kW	S-50PY3E				
	S-3650PF3E				
	S-3650PK3E				
	S-3650PT3E				
	S-3650PU3E				
6,0 kW	S-60PY3E				
	S-6071PF3E				
	S-6010PK3E				
	S-6071PT3E				
	S-6071PU3E				
7,1 kW	S-6071PF3E				
	S-6010PK3E				
	S-6071PT3E				
	S-6071PU3E				

PACi NX Standard from 10,0 to 14,0 kW simultaneous operation system combinations - R32

Capacity	Indoor	Outdoor		
		10,0 kW	12,5 kW	14,0 kW
5,0 kW	S-50PY3E			
	S-3650PF3E			
	S-3650PK3E			
	S-3650PT3E			
	S-3650PU3E			
6,0 kW	S-60PY3E			
	S-6071PF3E			
	S-6010PK3E			
	S-6071PT3E			
	S-6071PU3E			
7,1 kW	S-6071PF3E			
	S-6010PK3E			
	S-6071PT3E			
	S-6071PU3E			

Big PACi Elite from 20,0 to 25,0 kW simultaneous operation system combinations - R32

Capacity	Indoor	Outdoor	
		20,0 kW	25,0 kW
5,0 kW	S-50PY3E		
	S-3650PF3E		
	S-3650PK3E		
	S-3650PT3E		
	S-3650PU3E		
6,0 kW	S-60PY3E		
	S-6071PF3E		
	S-6010PK3E		
	S-6071PT3E		
	S-6071PU3E		
7,1 kW	S-6071PF3E		
	S-6010PK3E		
	S-6071PT3E		
	S-6071PU3E		
10,0 kW	S-1014PF3E		
	S-6010PK3E		
	S-1014PT3E		
	S-1014PU3E		
12,5 kW	S-1014PF3E		
	S-1014PT3E		
	S-1014PU3E		

Refrigerant piping arrangements for single, twin, triple and double-twin

Single

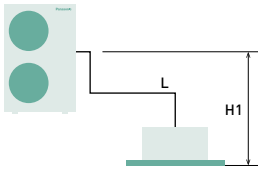

Twin

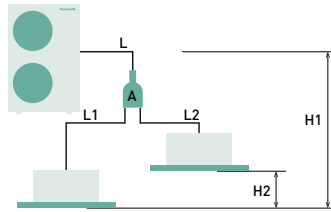

Triple

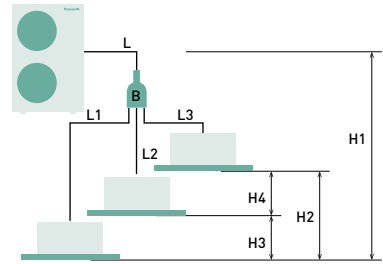

Double-twin

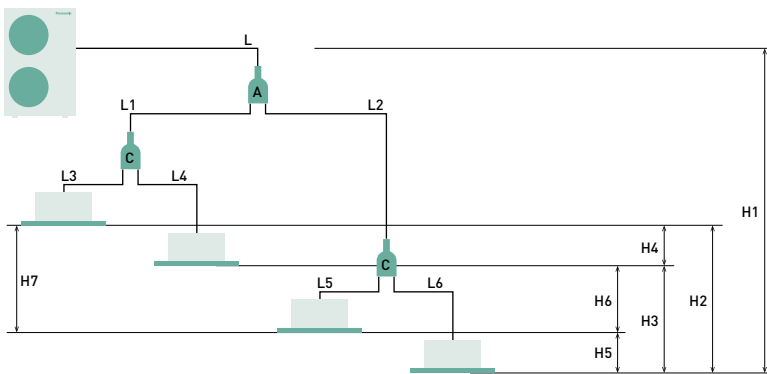

PACi NX Elite twin, triple and double-twin system from 7,1 to 14,0 kW

Joint distribution (sold separately)
 A= CZ-P224BK2BM
 B= CZ-P3 HPC2BM
 C= CZ-P224BK2BM

PACi NX Standard twin system from 10,0 to 14,0 kW

Joint distribution (sold separately)
 A= CZ-P224BK2BM

PACi Elite twin, triple and double-twin system from 20,0 to 25,0 kW

Joint distribution (sold separately)
 A= CZ-P680BK2BM
 B= CZ-P3 HPC2BM
 C= CZ-P224BK2BM

Twin System	PACi NX Standard single and twin system from 7,1 to 14,0 kW				PACi NX Elite and PACi Elite twin, triple and double-twin system from 7,1 to 25 kW							
	Indoor unit combinations (see examples above)		Equivalent lengths and height differences (m) for outdoor unit sizes...		Indoor unit combinations (see examples above)				Equivalent lengths and height differences (m) for outdoor unit sizes from 7,1 to 14,0 kW		Equivalent lengths and height differences (m) for outdoor unit sizes from 20,0 to 25,0 kW	
	Single	Twin	Single	Twin	Single	Twin	Triple	Double-Twin	Single	Twin	Triple	Double-Twin
Total pipe length	L	L + L1 + L2	≤ 50 m	L	L + L1 + L2	L + L1 + L2 + L3	L + L1 + L2 + L3 + L4 + L5 + L6	U-60/U-71: ≤ 50 m U-100/125/140: ≤ 75 m	U-200: ≤ 100 m U-250: ≤ 80 m			
Maximum pipe length from outdoor unit to most distant indoor unit	-	-	-	-	L + L1 or L + L2	L + L1 or L + L2 or L + L3	L + L1 + L3 or L + L1 + L4 or L + L2 + L5 or L + L2 + L6	-	U-200: 90 m U-250: 60 m			
Maximum branch pipe length	-	L1 L2	≤ 15	-	L1 or L2	L1 or L2 or L3	L1 + L3 or L1 + L4 or L2 + L5 or L2 + L6	≤ 15 m	≤ 20 m			
Maximum branch pipe length differences	-	L1 > L2 L1 - L2	≤ 10	-	L1 > L2; L1 - L2	L1 > L2 > L3: L1 - L2 L2 - L3 L1 - L3	L2 + L6 (Max.) L1 + L3 (Min.): (L2 + L6) - (L1 + L3)	≤ 10 m	≤ 10 m			
Maximum pipe length differences after first branch (Double-Twin)	-	-	-	-	-	-	L2 > L1: L2 - L1	≤ 10 m	≤ 10 m			
Maximum pipe length differences after second branch (Double-Twin)	-	-	-	-	-	-	L4 > L3: L4 - L3 L6 > L5: L6 - L5	≤ 10 m	≤ 10 m			
Height difference (outdoor unit located higher)	H1	H1	≤ 30	H1	H1	H1	H1	≤ 30 m	≤ 30 m			
Height difference (outdoor unit located lower)	H1	H1	≤ 15	H1	H1	H1	H1	≤ 15 m	≤ 15 m			
Height difference between indoor units	-	H2	≤ 0,5	-	H2	H2 or H3 or H4	H2 or H3 or H4 or H5 or H6	≤ 0,5 m	≤ 0,5 m			

Twin System	PACi NX Standard single and twin system from 7,1 to 14,0 kW				PACi NX Elite twin, triple and double-twin system from 7,1 to 14,0 kW						PACi Elite twin, triple and double-twin system from 20,0 to 25,0 kW					
	Outdoor unit main piping diameter (L)		Indoor unit connection tube (L1, L2)		Outdoor unit main piping diameter (L)	Indoor unit connection piping diameter (L1, L2, L3, L4) (mm)					Outdoor unit main piping diameter (L) (mm)	Double-Twin distribution pipe (L1, L2) ¹⁾		Indoor unit connection piping diameter ²⁾		
Unit type capacity	100	125	50	60	71 - 140	36	45	50	60	71	200	250	100 - 125	50	60 - 125	
Liquid pipe (mm)	Ø 9,52	Ø 12,70	Ø 6,35	Ø 9,52	Ø 9,52	Ø 6,35	Ø 6,35	Ø 6,35	Ø 9,52	Ø 9,52	Ø 9,52	Ø 12,70	Ø 9,52	Ø 6,35	Ø 9,52	
Gas pipe (mm)	Ø 15,88	Ø 15,88	Ø 12,70	Ø 15,88	Ø 15,88	Ø 12,70	Ø 12,70	Ø 12,70	Ø 15,88	Ø 15,88	Ø 25,40	Ø 25,40	Ø 15,88	Ø 12,70	Ø 15,88	
Additional gas amount (g/m)	50	50	20	50	50	20	20	20	50	50	60	80	45	20	45	

1) Total capacity of indoor unit connected after the branch. 2) 4 way cassette type.

Make additional charges by adding up tube length in an order of main tube (L) → branch tube (L1 → L2 → L3 wide diameter) and then selecting the amount of refrigerant corresponding to the remaining (after charge-less tube length: 30 m) liquid tube diameter and tube length from the above table.

PRO-HT Tank Series for PACi

Enjoy an efficient DHW / heating and cooling tank.
Panasonic commercial PRO-HT Tank solutions meet all
needs of your hot water applications providing 65 °C water.

PRO-HT TANK

MAXIMUM
65 °C
WATER OUTLET
TEMPERATURE





PRO-HT Tank DHW: PAW-VP750DHW and PAW-VP1000LDHW.
 Big volume and high temperature tank for commercial application.

1 High performance and high saving

- Energy Efficiency Class for energy label: A+ (from A+ to F)
- High temperature hot water without booster
- Save installation time and cost by skipping additional accessories

2 Sufficient hot water production

- Maximum water outlet temperature up to 65 °C
- Big volume tanks with 750 L and 1000 L capacity
- Heat exchanger design inhibits limescale

3 Trusted quality

- Double tube heat exchanger following drinking-water regulation
- Tank and heat exchanger made with stainless steel
- Internal and external pickling

Solution example DHW tank 1000 L + PACi

- Ideal for small hotels and high-end residential
- Hot water temperature up to 65 °C

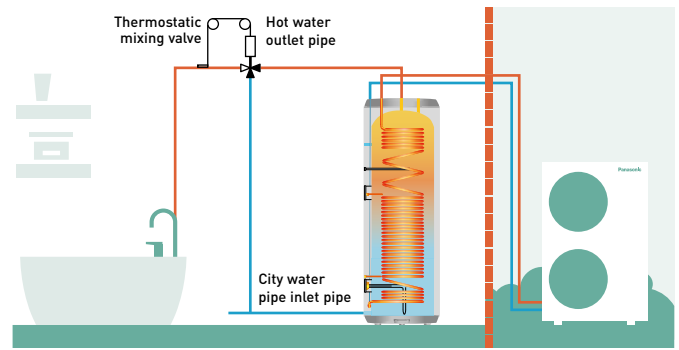

One by one system compatible list with PACi Elite

Model	Tank type	Product compatibility	Hot water outlet temperature without an electric heater
PAW-VP750LDHW-1	DHW	U-250PE2E8A	65 °C
PAW-VP1000LDHW-1	DHW	U-250PE2E8A	65 °C

PRO-HT Tank heating and cooling: PAW-VP380L. Waterborne heating and cooling for floor heating, radiators or fan coils

1 High performance and high saving

- A7 COP 3,26, heating water temperature at 45 °C
- Maximum 45 °C water outlet temperature
- Energy efficiency class: A+++ (from A+++ to D)

2 Simple waterborne heating and cooling solution

- High temperature water without any boosters
- Installation cost can be saved without additional boosters and buffer tanks

3 Trusted quality

- Tank and heat exchanger made with stainless steel
- Internal and external pickling

Heating and cooling tank 380L + PACi 20,0 kW

- Ideal offer for small offices
- Cost saving solution with simple waterborne heating and cooling
- Hot water up to 45 °C

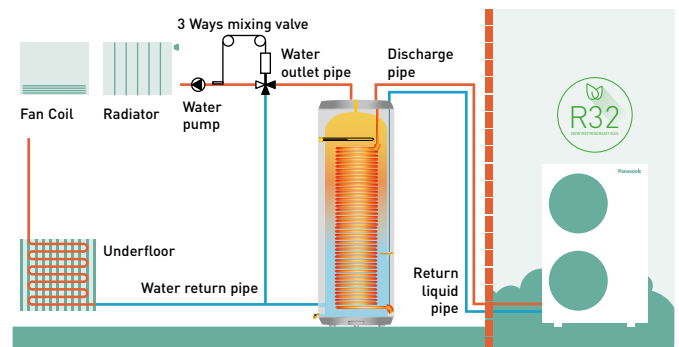

One by one system compatible list with PACi Elite

Model	Tank type	Product compatibility	Water outlet temperature range
PAW-VP380L	Heating and cooling	U-200PZH2E8	5 °C ~ 45 °C



PRO-HT TANK

PRO-HT Tank DHW

High temperature hot water is efficiently produced without any boosters.

Panasonic commercial PRO-HT Tank solutions can be adapted to various projects from high-end residential to gyms, and hotels.

PRO-HT Tank			PAW-VP750LDHW-1	PAW-VP1000LDHW-1
COP DHW (A +7 °C, W 10-55 °C) EN 16147 ¹⁾			4,10	3,86
COP DHW (A +15 °C, W 10-55 °C) EN 16147 ²⁾			4,79	4,79
Energy Efficiency Class (from A+ to F) ³⁾			A+	A+
Volume (net)	L		726	933
Reference tapping cycle			2XL	2XL
Standby heat loss according to EN16147	W/h		77	80
Maximum water temperature	Heat pump	°C	65	65
	Electrical heater	°C	85	85
Dimension	H x Ø	mm	1855 x 990	2210 x 990
Net weight / with water	kg		179 / 905	191 / 1124
Stainless steel 316 L tank			Yes	Yes
Connections to the water supply network			RP 1¼	RP 1¼
Average insulation thickness	mm		100	100
Number of electrical heaters x power	W		1 x 6000	1 x 6000
Electric protection	A		16	16
Moisture protection (PAW-VP-RTC5B-PAC)			IP24	IP24
Heat exchanger connection	Inlet	Inch (mm)	1/2 (12,70)	1/2 (12,70)
	Outlet	Inch (mm)	3/4 (19,05)	3/4 (19,05)
Outdoor unit			U-250PE2E8A	U-250PE2E8A
Nominal electrical power - related to rated heat output	W		6670	6670
Energy consumption by chosen cycle (A +7 °C, W 10-55 °C)	kWh		6,00	6,36
Energy consumption by chosen cycle (A +15 °C, W 10-55 °C)	kWh		5,12	5,12
Power supply	Voltage	V	400	400
	Phase		Three phase	Three phase
	Frequency	Hz	50	50
Maximum power consumption	Without heater	W	12900	12900
	With heater	W	18900	18900
Dimension	HxWxD	mm	1642 x 1 095 x 529	1642 x 1 095 x 529
Net weight	kg		138	138
Sound pressure at 1 m from outdoor unit	dB(A)		57	57
Refrigerant (R410A) / CO ₂ Eq.	kg / T		6,4 / 13,363	6,4 / 13,363
Piping diameter	Liquid pipe	Inch (mm)	1/2 (12,70)	1/2 (12,70)
	Gas pipe	Inch (mm)	1 (25,40)	1 (25,40)
Pipe length range ⁴⁾	m		30	30
Elevation difference (in/out)	m		30 (OD above) 30 (OD below)	30 (OD above) 30 (OD below)
Pipe length for nominal capacity	m		7,5	7,5
Pipe length for additional gas	m		> 7,5	> 7,5
Additional gas amount	g/m		Refer to manual	Refer to manual
Operating range - outdoor ambient	Heat Min ~ Max	°C	-20 ~ +24	-20 ~ +24

1) Heating of sanitary water up to 55 °C with inlet air temperature at 7 °C, humidity at 89 % and inlet water temperature at 10 °C. According to EN16147. 2) Heating of sanitary water up to 55 °C with inlet air temperature at 15 °C, humidity at 74 % and inlet water temperature at 10 °C. According to EN16147. 3) Scale from A+ to F following COMMISSION DELEGATED REGULATION (EU) No. 812/2013. 4) The pipe length range is between indoor and outdoor, but does not include additional length for coil.

This product is designed to comply with the European Water Quality Directive 98/83/EC amended by 2015/1787/EU. The lifespan of the product is not guaranteed in the case of the use of groundwater, such as spring water or well water, the use of tap water when salt or other impurities are contained, nor in areas of acidic water quality. Maintenance and warranty costs related to these cases are the customer's responsibility.

* When connected as pressurised, safety valve is mandatory.

Accessories

PAW-VP-RTC5B-PAC Tank controller for PACi system

Technical focus

- Water volume 750 L and 1000 L
- Maximum hot water production 65 °C without boosters
- Heating coil 52 m (750 L) and 63 m (1000 L)
- Tank material 3 mm
- ABS external case



**PRO-HT TANK****PRO-HT Tank heating and cooling**

High temperature hot water is efficiently produced without any boosters.

Panasonic commercial PRO-HT Tank solutions can be combined with PACi to adapt various projects from high-end residential to small offices.

PRO-HT Tank			PAW-VP380L
Cooling capacity at 35 °C, water outlet 7 °C		kW	12,8
Heating capacity		kW	25
Heating capacity at +7 °C, heating water temperature at 45 °C		kW	23
COP at +7 °C with heating water temperature at 45 °C		W/W	3,26
Heating Energy Efficiency class at 35 °C (from A+++ to D)			A+++
$\eta_{s,h}$ (LOT1) ¹⁾		%	193
Dimension	H x Ø	mm	1820 x 690
Volume (net)		L	380
Shipping weight		kg	99
Connections to the water supply network			RP 1½
Heating water flow (ΔT=5 K, 35 °C)		m³/h	3,9
Water outlet	Cool Min ~ Max	°C	5 ~ 15
	Heat Min ~ Max	°C	25 ~ 50
Piping diameter	Liquid pipe	Inch (mm)	1/2 (12,70)
	Gas pipe	Inch (mm)	3/4 (19,05)
Outdoor unit			U-200PZH2E8
Dimension	HxWxD	mm	1500x980x370
Net weight		kg	117
Sound pressure at 1 m from outdoor unit		dB(A)	57
Refrigerant (R32) / CO ₂ Eq.		kg	4,20 / 3 510
Piping diameter	Liquid pipe	Inch (mm)	3/8 (9,52)
	Gas pipe	Inch (mm)	1 (25,40) + adapter
Pipe length range ²⁾		m	30
Elevation difference (in / out)		m	30 (OD above) 30 (OD below)
Pipe length for nominal capacity		m	7,5
Pipe length for additional gas		m	> 7,5
Additional gas amount		g/m	Refer to manual
Operating range - outdoor ambient	Cool Min ~ Max	°C	-15 ~ +46
	Heat Min ~ Max	°C	-20 ~ +24

1) Seasonal space cooling / heating energy efficiency following COMMISSION REGULATION (EU) 811/2013. 2) The pipe length range is between indoor and outdoor, but does not include additional length for coil.

This product is designed to comply with the European Water Quality Directive 98/83/EC amended by 2015/1787/EU. The lifespan of the product is not guaranteed in the case of the use of groundwater, such as spring water or well water, the use of tap water when salt or other impurities are contained, nor in areas of acidic water quality. Maintenance and warranty costs related to these cases are the customer's responsibility.

Performance calculation in agreement with Eurovent. Sound pressure measured at 1 m from the outdoor unit and at 1,5 m height.

* Flow switch and water filter are not equipped.

Accessories	
PAW-VP-RTC5B-PAC	Tank controller for PACi system
PAW-IU29	Additional heater
PAW-IU39	Additional heater

Technical focus

- Water volume 380 L
- Maximum hot water production 45 °C
- Tank and heat exchanger made with stainless steel
- Heating coil 52 m 316 L
- Internal and external pickling
- Foam insulation 70 mm
- Tank material 2 mm 316 L
- ABS external case



PACi with Water Heat Exchanger

Panasonic introduces a highly-efficient Water Heat Exchanger for PACi Series. This ground-breaking product offers further possibilities of PACi solutions by adding hydronic options.

**WATER OUTLET
TEMPERATURE**
Cooling: 5 ~ 15 °C
Heating: 30 ~ 55 °C





Highly-efficient Water Heat Exchanger for PACi Series.

System example.

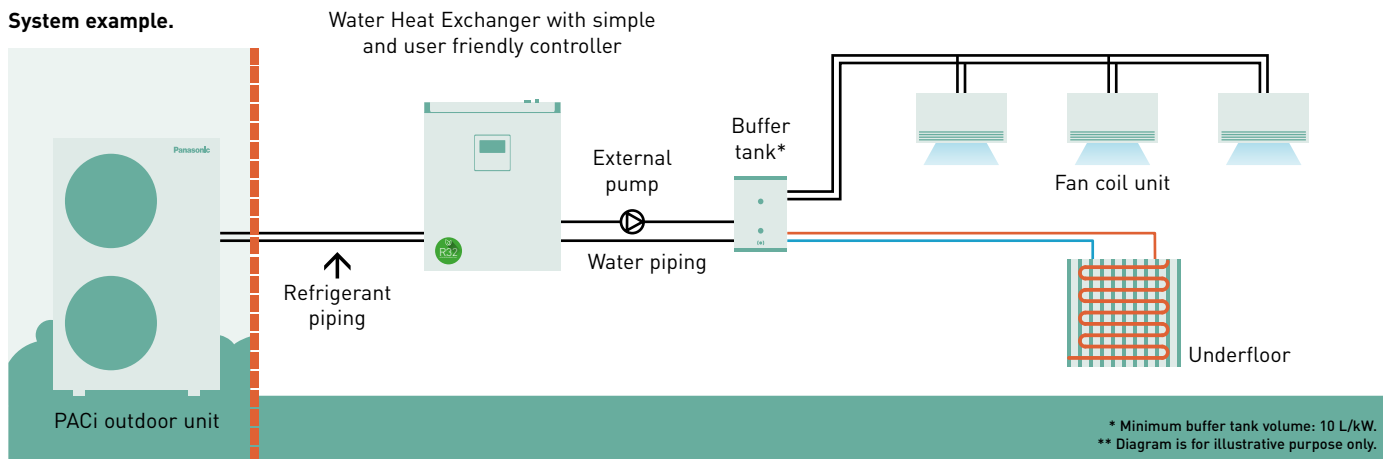

1 Cost saving solution

- A+++ Energy efficiency class (scale from A+++ to D)
- Cost effective water projects thanks to lower cost for PACi compared to VRF

2 Space saving and flexible positioning

- 2 installation possibilities (wall-mounted / floor-standing)
- Compact, lightweight unit design, only 27 kg

3 Easy installation, maintenance

- Quick mounting process
- Flow switch kit is included as a standard
- Direct access to electrical box

Space saving and flexible positioning

Compact and light unit.

- Only 205 mm depth fits within a limited space
- Lightweight design at only 27 kg, makes it easy to maneuver and position
- Maximum total refrigerant piping length: 90 m*

* 90 m for PAW-200W5APAC.

2 installation options.

- Wall-mounted and floor-standing installation options are available. Free-up floor space by using the wall-mounted installation
 - Quick mounting process with its lightweight compact design
- Make fixing holes → Fix 2 screws → Hang the unit → Finish

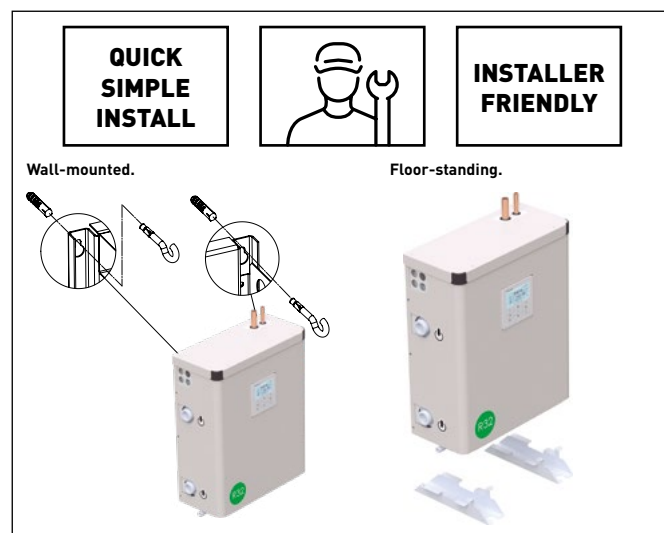
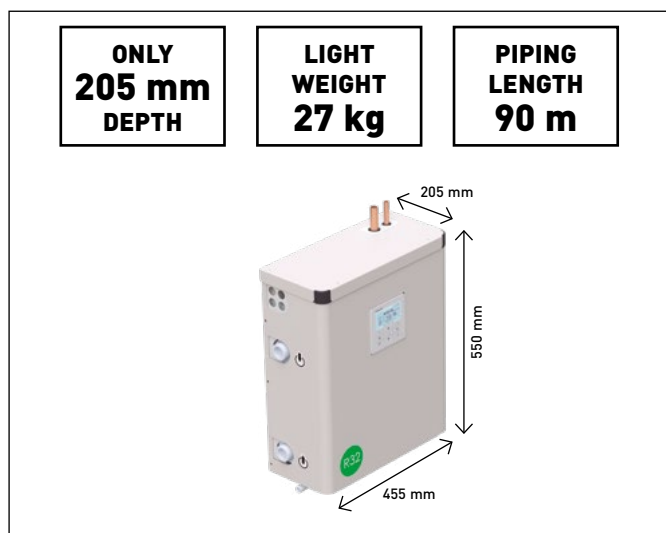

Application example

- Fulfilling R32 refrigerant needs to follow environmental perspective, Company policy
- Water solution to substitute existing boiler system
- Hydraulic system to reduce total amount of HFC refrigeration

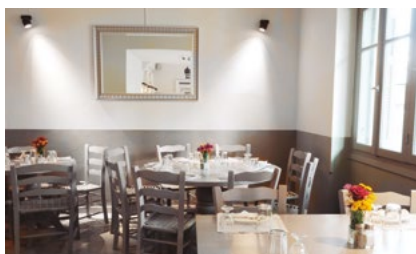

Foodchain.



Small office.

PACi Water Heat Exchanger (WHE) is the ideal solution for small retails and offices. This is the first PACi connected WHE system. The investment costs can be amortised in a short period.

Easy maintenance operation from two points of access

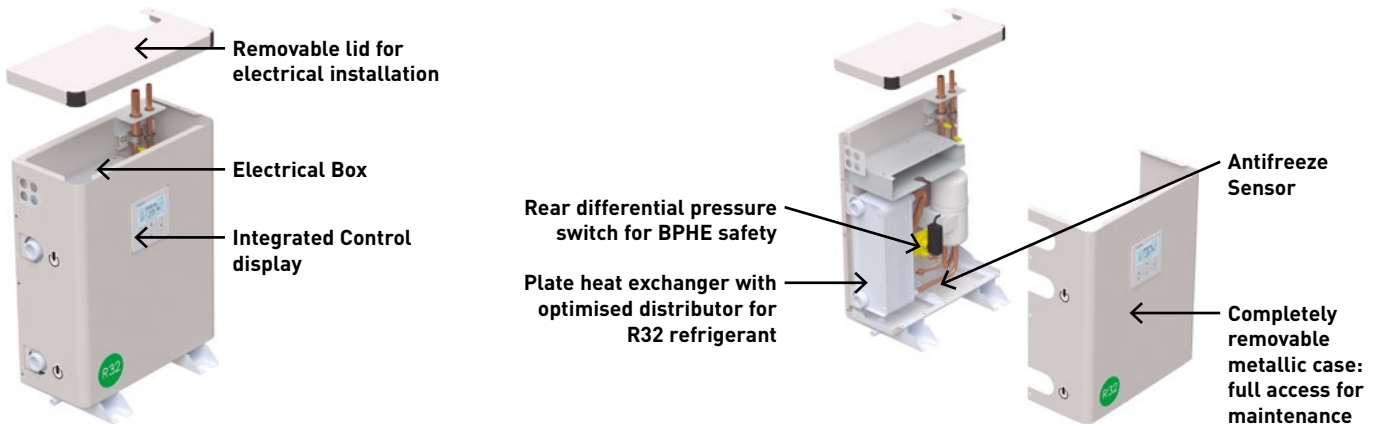

PACi Water Heat Exchanger can be connected as cascade up to 3 groups of 8 units each reaching up to 600 kW

Built-in cascade control for 2 units.

2 refrigerant systems can be connected together in a cascade. This option is included in the standard scope of delivery on the WHE. It is activated using the one of the CZ-RTC5B remote controllers on the units as master. Rotation and Back-up operation modes can be selected.

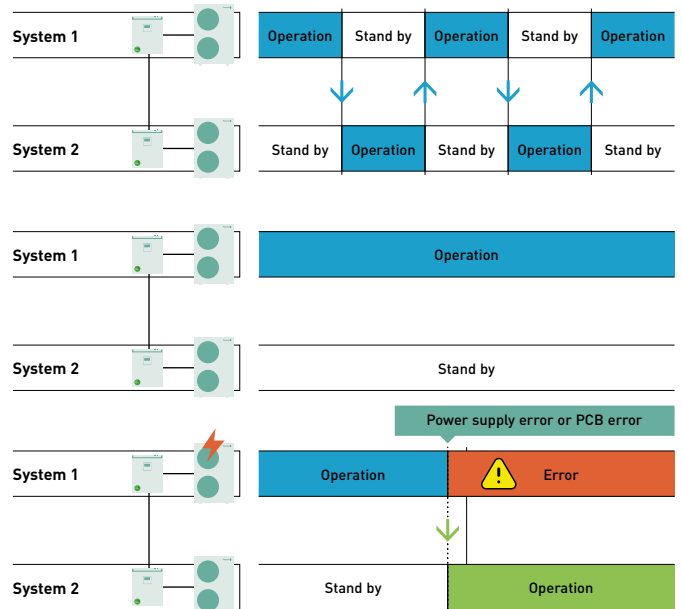
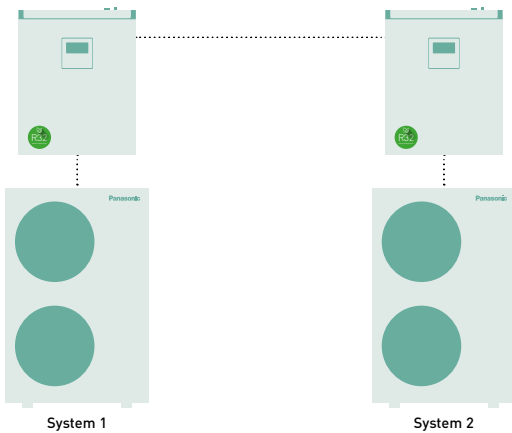

* One of built-in controllers should be deactivated.

Cascade controller PAW-PACR3 allows control from 3 units to 3 groups of 8 units each.

Up to three groups can be combined into a cascade by using optional PAW-PACR3 for failure substitution or temperature assist.

- Maximum 3 groups (up to 8 units per group)
- Rotation
- Failure substitution
- Temperature
- Operation output signal
- Alarm output signal

Example: 3 x groups.

Maximum available capacity per group: 8 x 25 kW = 200 kW.
Total maximum available capacity: 3 x 200 kW = 600 kW.

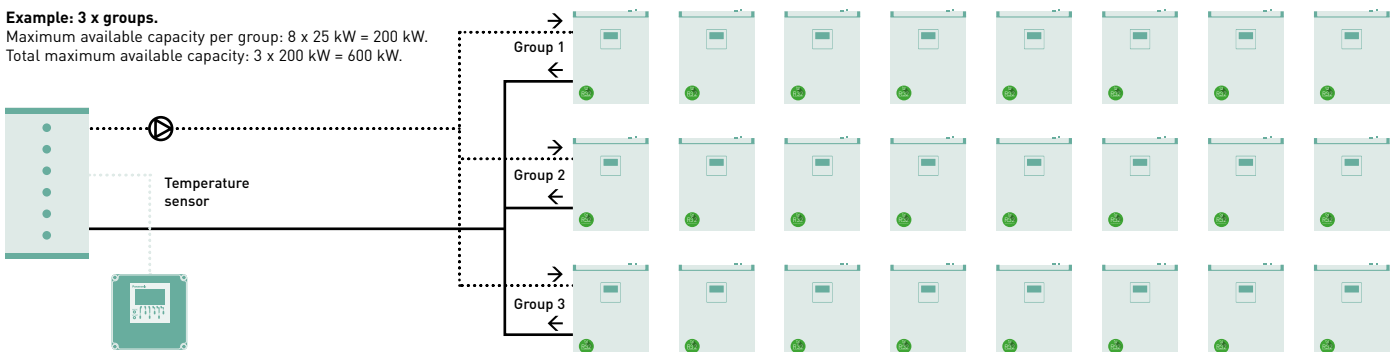

**PACi with Water Heat Exchanger for chilled and hot water production****Constant 55 °C flow available.****Short-term investment recovery.**

PACi Water Heat Exchanger is ideal for small offices and retails. The investment costs can be amortised within a very short period. This solution allows investors and operators to save money.

			PAW-200W5APAC	PAW-250W5APAC
Cooling capacity ¹⁾		kW	20,00	25,00
EER ¹⁾		W/W	3,03	2,89
Heating capacity ²⁾		kW	23,00	28,00
COP ²⁾		W/W	2,98	2,95
$\eta_{s,h}$ (LOT1) ³⁾		%	178	178
Energy efficiency class (Scale A+++ to D) ⁴⁾			A+++	A+++
Dimension	H x W x D	mm	550 x 455 x 205	550 x 455 x 205
Net weight		kg	27	27
Water pipe connector		Inch	Male Thread 1 1/4	Male Thread 1 1/4
Cooling water flow ($\Delta T=5$ K, 35 °C)		m ³ /h	3,45	4,30
Heating water flow ($\Delta T=5$ K, 35 °C)		m ³ /h	4,15	4,85
Flow switch			Included	Included
Water filter			Included	Included
Outdoor unit			U-200PZH2E8	U-250PZH2E8
Sound pressure	Cool / Heat (Hi)	dB(A)	59/61	59/63
Dimension	H x W x D	mm	1500 x 980 x 370	1500 x 980 x 370
Net weight		kg	117	128
Piping diameter	Liquid pipe	Inch (mm)	3/8 (9,52)	1/2 (12,70)
	Gas pipe	Inch (mm)	1 (25,40)	1 (25,40)
Pipe length range		m	5 - 90	5 - 60
Elevation difference (in / out)		m	30	30
Pipe length for additional gas		m	30	30
Additional gas amount		g/m	60	80
Water outlet temperature range	Cool Min ~ Max	°C	+5 ~ +15	+5 ~ +15
	Heat Min ~ Max	°C	+30 ~ +50	+30 ~ +50
Operating range	Cool Min ~ Max	°C	-15 ~ +46	-15 ~ +46
	Heat Min ~ Max	°C	-20 ~ +24	-20 ~ +24

1) Data refers to 7 °C leaving chilled water temperature and 35 °C ambient air temperature, according to EN14511 standard. 2) Data refers to 45 °C leaving warm water temperature and 7 °C ambient air temperature according to EN14511 standard. 3) Following COMMISSION REGULATION (EU) No 813/2013 for low-temperature heat pumps. 4) Following COMMISSION REGULATION (EU) No 811/2013 for low-temperature heat pumps. Scale from A+++ to D.

Professional solution

Water heat exchanger is compatible with R32 PACi.

Many air conditioning manufacturers are selling R32 systems and it is becoming the standard refrigerant for split type air conditioning, because R32 has a much lower global warming potential than R410A, and can also provide higher efficiency.

Quick installation with pre-assembled flow switch

The flow switches come pre-assembled with pipe fittings for ease of installation.

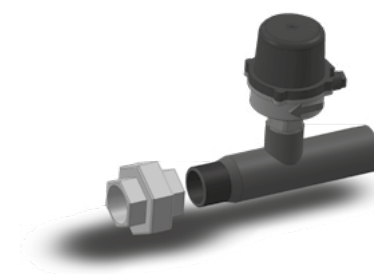

R22 Renewal. Fast, easy to install and cost effective

An important drive to further reduce the potential damage to our ozone.

It is often said that legislation is ruling our lives but sometimes it is there to help save lives. R22 phase out can be described as one of these and from Jan 1st 2010 the use of Virgin (new) R22 refrigerant was banned within the European Union.



Panasonic is doing its part

We at Panasonic are also doing our part – recognising that all finances are under pressure at the moment. Panasonic has developed a clean and cost effective solution to enable this latest legislation to offer less financial impact on your business.

The Panasonic renewal system allows good quality existing R22 or R410A pipe work to be re-used whilst installing new high efficiency R32 systems.

By bringing a simple solution to the problem Panasonic can renew all Split Systems and PACi systems; and depending upon certain restrictions we don't even limit the manufacturer's equipment we are replacing.

By installing a new high efficiency Panasonic R32 system you can benefit from around 30 % running cost saving compared to the R22 system.

Yes...

1. Check the capacity of the system you wish to replace
2. Select from the Panasonic range the best system to replace it with
3. Follow the procedure detailed in the brochure and technical data

Simple...

Why renewal?

Unique R22 Renewal from Panasonic: Fast, easy to install and cost effective.

- Panasonic refrigerant oil doesn't react to the most common oil types used in air-conditioning systems. This ensures the mix of oil does not damage the units. Therefore installations are easier

- All Panasonic PACi units can be installed in R22 pipings, no specific models are available
- Up to 33 Bar! When there is any doubt about the strength of the piping, the maximum working pressure can be reduced to 33 Bar with a setting in the software of the outdoor unit

Reuse of existing piping (renewal design and installation)

Notes on reuse of existing refrigerant piping.

It is possible for each series of PZH and PZ series outdoor unit to reuse the existing refrigerant piping without cleaning when obtained under certain conditions. Make sure that the requirements under the section "Notes on reuse of existing refrigerant piping", "Measurement procedure for renewal" and "Refrigerant piping size and allowable piping length" will be satisfied in order to carry out.

Also, check the items with regard to section "Safety" and "Cleaning".

1. Prerequisite

- If the refrigerant used for the existing unit is other than R22, R407C and R410A / R32, the existing refrigerant piping cannot be used.
- If the existing unit has another use than air conditioning, then existing refrigerant piping cannot be used.

2. Safety

- If there is a hollow, crack or corrosion on the piping, make sure to install new piping.
- If the existing piping is other than capable of reuse of piping as shown in the flowchart, make sure to install new piping.
- In case of multiple operation, use our genuine branch piping for refrigerant R32.

A local supplier shall assume responsibility for the defects and hollows on the reuse of existing piping surface and recognition of reliability of the piping strength. There is no guarantee that we take responsibility for such damages.

The operational pressure of the refrigerant R32 becomes higher compared to R22 or R410A. In the worst case, a lack of compressive strength may lead to piping explosion.

3. Cleaning

- When the refrigerant oil used for the existing unit is other than the listed below, make sure to install new piping or wash it thoroughly before reusing it.
[Mineral Oil] SUNISO, FIORE S, MS
[Synthesized oil] alkyl benzene oil (HAB, parallel freeze), ester oil, ether oil (PVE only)

If the existing unit is GHP type, it is necessary to wash the piping thoroughly.

- If the existing pipes in the outdoor and indoor units remain disconnected, make sure to install a new piping or wash it thoroughly before reusing it.
- If the discoloured oil or residue remains in the existing piping, make sure to install a new piping or wash it thoroughly before reusing it. See "Deterioration Criteria for Refrigerant Oil" in table 3.
- If the compressor of the existing air conditioner has a failure history, make sure to install a new piping or wash it through thoroughly before reusing it.

When reusing the existing piping as it is without removing dirt and dust, inadequate piping could result a renewal appliance in failure.



Notes on renewal for simultaneous operation of multiple units

Only main pipe is applicable for using the different diameter size.

In case of different diameter size for the branch pipes, a new installation work for a standard size is necessary. Be sure to use our genuine branch piping for refrigerant R32.

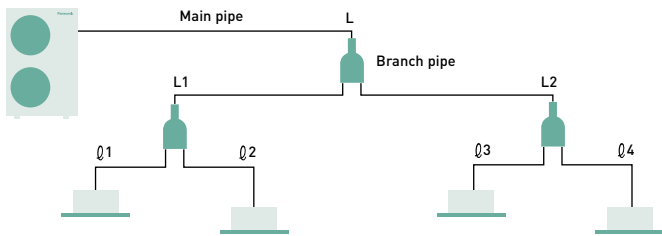

Notes on renewal for simultaneous operation of multiple units

Capacity class	Standard liquid pipe size	Standard gas pipe size
Type 50	∅ 6,35	∅ 12,70
Type from 60 to 140	∅ 9,52	∅ 15,88
Type 200	∅ 9,52	∅ 25,40
Type 250	∅ 12,70	∅ 25,40

- Only the main pipe L can be used among different diameter's existing piping
- Installation work as a standard size is capable for L1, L2, Q1 - Q4 piping
- Be sure to use our genuine branch piping for refrigerant R32

- In case of single unit:
It is not necessary to charge with additional refrigerant until the chargeless pipe length in the table 2. If the pipe length is exceeding the charge less pipe length, charge with additional refrigerant amount per 1 m according to the equivalent length.
- In case of simultaneous operation of multiple units:
Calculate the refrigerant charging amount according to the calculating method of the standard piping diameter. As to the additional refrigerant charging amount per 1 m, refer to the additional amount in the table 2.

Measurement procedure for Renewal

Observe the following procedure when reusing the existing piping or carrying out renewal installation work. Flowchart of existing piping measures criteria for PZH and PZ series outdoor unit.

Flare nut size (mm)					
Piping size	∅6,35	∅9,52	∅12,70	∅15,88	∅19,05
For R32 / R410A	17	22	26	29	36
For R22 / R407C	17	22	24	27	36

See Table 3. Level "3 Over" according to colour scale level

- Use our genuine branch piping for refrigerant R32
 - Re-process the flare of existing piping for R410A and use the flare nut attached to the service valve of the outdoor unit (for R32)
- * Please do not reuse the existing flare to prevent gas leak.
* Please make sure to install new flare.

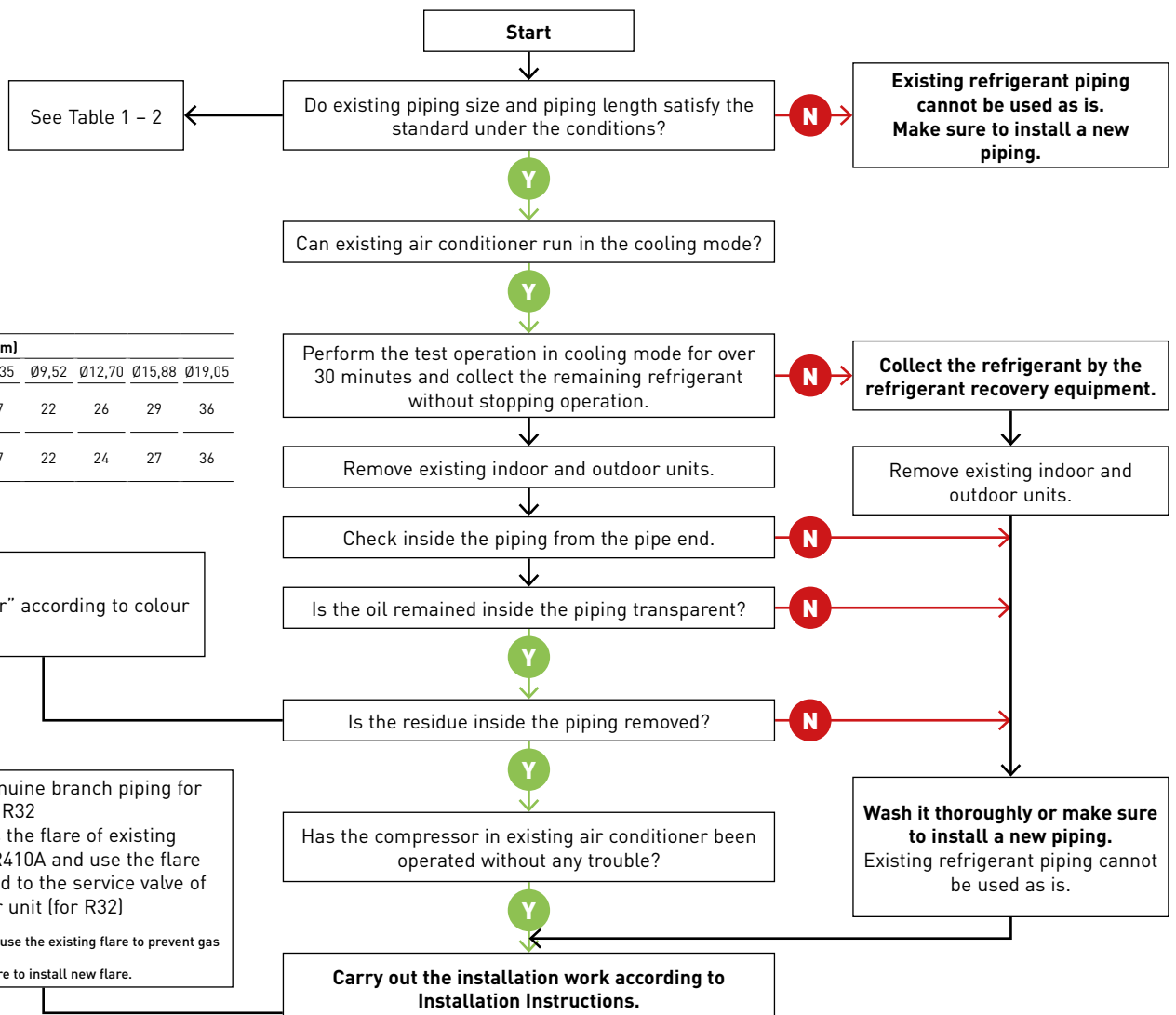



Refrigerant piping size and allowable piping length

Check if reuse of existing refrigerant piping is possible based on the following chart.

The standards other than this one (difference of elevation, etc.) are identical to the requirements of ordinary refrigerant piping.

Table 1 - Reusable existing piping (mm)

Material	O					1/2 H, H*			
External diameter	Ø6,35	Ø9,52	Ø12,70	Ø15,88	Ø19,05	Ø22,22	Ø25,40	Ø28,58	
Thickness	0,80	0,80	0,80	1,00	1,00	1,00	1,00	1,00	

* It is impossible to reuse the size of Ø19.05, Ø22.22, Ø25.4 and Ø28.58 for material O. Change to material 1/2H or material H.

Table 2 - 1 Refrigerant piping size: 2,5 - 14,0 kW type (mm)

Liquid pipe			Ø6,35		Ø9,52		Ø12,70			
Gas pipe			Ø9,52	Ø12,70	Ø15,88	Ø12,70	Ø15,88	Ø19,05	Ø15,88	Ø19,05
PZH3	Type 36 - 60	Additional gas 15 g/m	×	Standard 40 m (30 m)	×	×	×	×	×	×
	Type 25		Tentative data							
PZ3	Type 36	Additional gas 10 g/m	×	Standard 15 m (7,5 m)	×	×	×	×	×	×
	Type 50	Additional gas 15 g/m	×	Standard 20 m (7,5 m)	×	×	×	×	×	×
	Type 60	Additional gas 15 g/m	×	Standard 30 m (7,5 m)	×	×	×	×	×	×
	Type 71	Additional gas 17 g/m	×	×	Standard 40 m (10 m)	×	×	×	×	×

Liquid pipe			Ø6,35		Ø9,52		Ø12,70			
Gas pipe			Ø9,52	Ø12,70	Ø15,88	Ø12,70	Ø15,88	Ø19,05	Ø15,88	Ø19,05
PZH3	Type 71		×	□ 10 m (10 m)	□ 10 m (10 m)	▽ 30 m (30 m)	Standard 50 m (30 m)	×	□ 25 m (15 m)	×
	Type 100 - 140		×	×	×	×	Standard 85 m (30 m)	⊙ 85 m (30 m)	□ 35 m (15 m)	□ 35 m (15 m)
Additional gas			20 g/m			45 g/m		80 g/m		
PZ3	Type 100 - 140		×	×	×	×	Standard 50 m (30 m)	⊙ 50 m (30 m)	□ 25 m (15 m)	□ 25 m (15 m)
Additional gas			20 g/m			45 g/m		80 g/m		
PZH2	Type 50		×	Standard 40 m (30 m)	⊙ 40 m (30 m)	□ 20 m (15 m)	□ 20 m (15 m)	×	×	×
PZ2	Type 60 - 71		×	▽ 10 m (10 m)	□ 10 m (10 m)	▽ 30 m (20 m)	Standard 50 m (20 m)	×	□ 25 m (10 m)	×
Additional refrigerant charging amount per 1 m			20 g/m			40 g/m		80 g/m		
PZH2	Type 60 - 71		×	▽ 10 m (10 m)	□ 10 m (10 m)	▽ 30 m (30 m)	Standard 50 m (30 m)	×	□ 25 m (15 m)	×
	Type 100 - 140		×	×	×	×	Standard 75 m (30 m)	⊙ 75 m (30 m)	□ 35 m (15 m)	□ 35 m (15 m)
PZ2	Type 100 - 140		×	×	×	×	Standard 50 m (30 m)	⊙ 50 m (30 m)	□ 25 m (15 m)	□ 25 m (15 m)
Additional refrigerant charging amount per 1 m			20 g/m			50 g/m		80 g/m		

How to see table definition (example):

In case of type 71, standard size is liquid pipe Ø9,52 / gas pipe Ø15,88.

There is a limitation to liquid pipe Ø9,52 / gas pipe Ø12,70 and to liquid pipe Ø12,70 / gas pipe Ø15,88.

However, they are applicable for different diameter's pipes.

Table 2 - 2 Refrigerant piping size: 20,0 - 25,0 kW type (mm)

Liquid pipe			Ø9,52		Ø12,70		Ø15,88				
Gas pipe			Ø22,22	Ø25,40	Ø28,58	Ø22,22	Ø25,40	Ø28,58	Ø22,22	Ø25,40	Ø28,58
PZH	Type 200		▽ 80 m (30 m)	Standard 100 m (30 m)	⊙ 100 m (30 m)	▽ 50 m (15 m)	□ 50 m (15 m)	□ 50 m (15 m)	×	×	×
	Type 250		×	×	×	▽ 80 m (30 m)	Standard 100 m (30 m)	⊙ 100 m (30 m)	▽ 65 m (20 m)	□ 65 m (20 m)	□ 65 m (20 m)
Additional refrigerant charging amount per 1 m			40 g/m			80 g/m		120 g/m			

- ⊙ Allowable
- ▽ Cooling capacity down
- Limited piping length
- ×
- Unallowable
- 50 m Maximum piping length
- (50 m) Charge less piping length in a single connection

Table 3 - Deterioration Criteria for Refrigerant Oil

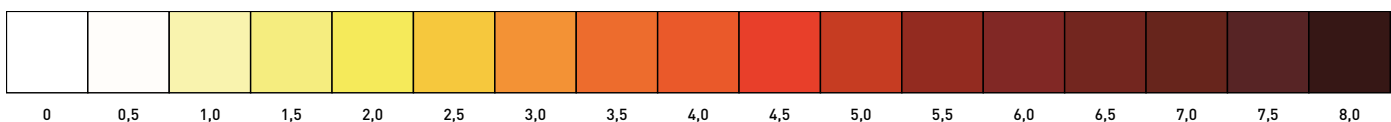

Accessories and control

Drain kits

Drain kit to suit outdoor units from 5,0 to 7,1 kW.

CZ-50DRS1

Drain kit to suit outdoor units from 10,0 to 25 kW.

CZ-140DRS1

Branch Pipes, Header



Branch pipe.

CZ-P224BK2BM



Branch pipe (from 22,4 kW to 68 kW).

CZ-P680BK2BM

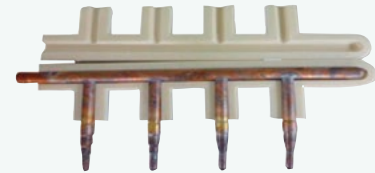

Header.

CZ-P3HPC2BM

Outdoor accessories



Tray for condenser water compatible with outdoor elevation platform.

PAW-WTRAY



Outdoor elevation platform.
Dimension (H x W x D): 400 x 900 x 400 mm

PAW-GRDSTD40



Outdoor base ground support for noise and vibration absorption.

Dimension (H x W x D): 600 x 95 x 130 mm
Safe working load: 500 kg

PAW-GRDBSE20

Panels



Panel for 4 way 60x60 cassette - PY3.

CZ-KPY4



Standard panel for 4 way 90x90 cassette.

CZ-KPU3W



Econavi panel for 4 way 90x90 cassette.

CZ-KPU3AW



Panel for 60x60 cassette - PY2 size 700x700 mm.

CZ-KPY3AW

Panel for 60x60 cassette - PY2 size 625x625 mm.

CZ-KPY3BW

Sensors



Econavi energy savings sensor.

CZ-CENSC1



Remote temperature sensor.

CZ-CSRC3



Plenums

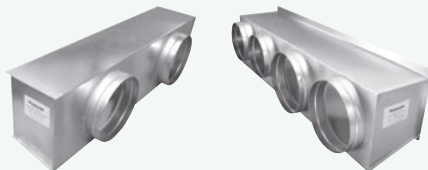

Air outlet plenum for S-3650PF3E.

CZ-56DAF2

Air outlet plenum for S-6071PF3E.

CZ-90DAF2

Air outlet plenum for S-1014PF3E.

CZ-160DAF2

Air outlet plenum for S-200PE2E5.

CZ-TREMIESPW705

Air outlet plenum for S-250PE2E5.

CZ-TREMIESPW706

VRF Smart Connectivity+



Remote controller Panasonic Net Con, RH, No PIR, R1/R2.

SER8150R0B1194

Remote controller Panasonic Net Con, RH, PIR, R1/R2.

SER8150R5B1194



Wireless ZigBee® Pro module / Green Com card.

VCM8000V5094P



Hotel Room Expansion Module 14 indoor units.

HRCEP14R

Hotel Room Controller w/ Display 42 indoor units.

HRCPDG42R



Door / window wireless sensor.

SED-WDC-G-5045



Wall / ceiling (motion) wireless sensor.

SED-MTH-G-5045



CO₂ sensor.

SED-C02-G-5045



Sensor with room temperature and humidity.

SED-TRH-G-5045



Water leakage sensor.

SED-WLS-G-5045

Accessories and control



Cover frame. Silver.

FAS-00

Cover frame. Glossy translucent white.

FAS-03

Cover frame. Dark brown wood.

FAS-06

Cover frame. Brushed steel finish.

FAS-10

Cover frame. White.

FAS-01

Cover frame. Light tan wood.

FAS-05

Cover frame. Dark black wood.

FAS-07

Controller and touch controllers for hotels with dry contacts

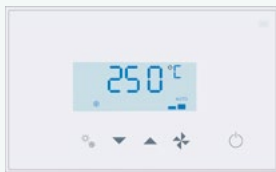

Modbus RS-485 touch room controller with I/O, White.

PAW-RE2C4-MOD-WH

Touch display control with 2 digital inputs, White.

PAW-RE2D4-WH

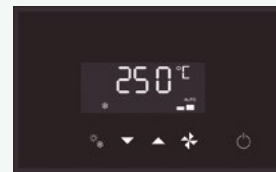

Modbus RS-485 touch room controller with I/O, Black.

PAW-RE2C4-MOD-BK

Touch display control with 2 digital inputs, Black.

PAW-RE2D4-BK

Hotel sensors for dry contacts



Wall motion sensor 24 V.

PAW-WMS-DC

Wall motion sensor 240 V AC.

PAW-WMS-AC



Ceiling motion sensor 24 V.

PAW-CMS-DC

Ceiling motion sensor 240 V AC.

PAW-CMS-AC



Power supply 24 V.

PAW-24DC



Door or window contact.

PAW-DWC

Centralised controls



System controller for 64 indoor units with weekly timer.

CZ-64ESMC3



Central ON / OFF controller, up to 16 groups, 64 indoor units.

CZ-ANC3



Intelligent controller (touch screen/web server) to control up to 256 indoors with included load distribution ratio (LDR).

CZ-256ESMC3



Panasonic AC Smart Cloud



Panasonic AC Smart Cloud. Cloud internet control. Up to 128 groups. Controls 128 units.

CZ-CFUSCC1

Accessories interfaces



Modbus RTU and TCP interface for 16 indoor units.

PAW-AC2-MBS-16P

Modbus RTU and TCP interface for 64 indoor units.

PAW-AC2-MBS-64P

Modbus RTU and TCP interface for 128 indoor units.

PAW-AC2-MBS-128P



KNX interface for 16 indoor units.

PAW-AC2-KNX-16P

KNX interface for 64 indoor units.

PAW-AC2-KNX-64P



BACnet IP and MSTP interface for 16 indoor units.

PAW-AC2-BAC-16P

BACnet IP and MSTP interface for 64 indoor units.

PAW-AC2-BAC-64P

BACnet IP and MSTP interface for 128 indoor units.

PAW-AC2-BAC-128P



Commercial Wi-Fi Adaptor.

CZ-CAPWFC1



KNX interface.

PAW-RC2-KNX-1i



Modbus RTU interface.

PAW-RC2-MBS-1



Modbus RTU interface to control 4 indoor/ groups.

PAW-RC2-MBS-4

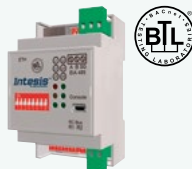

BACnet IP and MSTP.

PAW-RC2-BAC-1



RAC interface adapter for integration into P-Link, plus external input and alarm/status output (for YKEA units).

CZ-CAPRA1

Accessories and control

Centralised controls. Connection with general equipment



Adaptor for ON / OFF control of external devices.

CZ-CAPC3



Mini series parallel device controlling indoor units, maximum 1 group and 8 indoor unit.

CZ-CAPBC2



Communication Adaptor. Up to 128 groups. Controls 128 units.

CZ-CFUNC2

Individual controls



CONEX wired remote controller (non-wireless).

CZ-RTC6



CONEX wired remote controller with Bluetooth®.

CZ-RTC6BL



CONEX wired remote controller with Wi-Fi and Bluetooth®.

CZ-RTC6BLW*



Design wired remote controller with Econavi function and datanavi.

CZ-RTC5B



Infrared remote controller and receiver for 4 way 90x90 cassette.

CZ-RWS3 + CZ-RWRU3W



Infrared remote controller and receiver for 4 way 60x60 cassette PY3 with panel.

CZ-RWS3 + CZ-RWRY3



Infrared remote controller for wall-mounted and 4 way 60x60 cassette with panel.

CZ-RWS3



Infrared remote controller and receiver for ceiling.

CZ-RWS3 + CZ-RWRT3



Infrared remote controller and receiver for all indoor units.

CZ-RWS3 + CZ-RWRC3



Accessories PCB

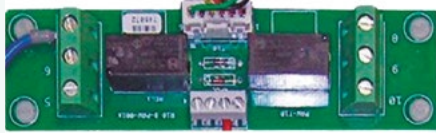

T10 interface PCB with digital and relay connections.

PAW-T10



PCB for server room application, control of 3 PACi units, redundancy, back-up, etc.

PAW-PACR3

Connector to PACi NX indoor unit's PCB to provide OPT functions.

PAW-OPT-NX

Accessories cables



Cable for all the T10 functions.

CZ-T10



Cable to operate external EC fan.

PAW-FDC



Cable for all option monitoring signals.

PAW-OCT

Cable with force thermo OFF/leakage detection.

PAW-EXCT

PRO-HT Tank accessories

Tank controller for PACi system.

PAW-VP-RTC5B-PAC

Additional heater.

PAW-IU29

Additional heater.

PAW-IU39

* Only compatible with PACi NX Series.

ECO i EX

ECO i

ECO G



Commercial VRF Systems

Professional solutions for commercial projects.

Panasonic VRF Systems are specifically designed for energy saving, easy installation and high efficiency performance. A wide range of outdoor and indoor unit models offer unique features which are designed for the most demanding offices and large buildings.



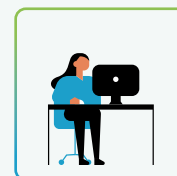
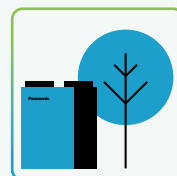
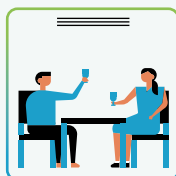



VRF highlighted features	→ 236	Design support software for VRF	→ 310
Panasonic: delivering TOP energy efficiencies for many years	→ 238	R22 Renewal	→ 311
Bringing nature's balance indoors	→ 240	ECOi and ECO G indoor units range	→ 314
Panasonic VRF: TOP in comfort	→ 242	U2 Type 4 way 90x90 cassette · R32 / R410A	→ 317
Solutions for Restaurants	→ 244	Y3 Type 4 way 60x60 cassette · R32 / R410A	→ 318
Your entire hotel with superior comfort, control and savings too	→ 246	Y2 Type 4 way 60x60 cassette · R32 / R410A	→ 319
Innovative solutions for retail	→ 248	L1 Type 2 way cassette · R410A	→ 320
Best efficiency ECOi Series from Panasonic	→ 252	D1 Type 1 way cassette · R410A	→ 321
Mini ECOi LZ2 Series R32	→ 254	F3 Type variable static pressure adaptive duct · R32 / R410A	→ 322
Mini ECOi LE Series for light commercial and residential use	→ 260	F2 Type variable static pressure hide-away · R410A	→ 323
ECOi EX. The Game Changer	→ 266	M1 Type slim variable static pressure hide-away concealed duct · R32 / R410A	→ 324
Slim 3-Pipe control box kit	→ 283	E2 Type high static pressure hide-away · R410A	→ 325
Eurovent certified technical data	→ 288	Heat recovery with DX coil · R410A	→ 326
ECO G, the gas driven VRF	→ 290	T2 Type ceiling · R410A	→ 327
Panasonic GHP/EHP Hybrid System	→ 300	K2 Type wall-mounted · R32 / R410A	→ 328
Water heat exchanger for hydronic applications	→ 304	G1 Type floor console · R410A	→ 329
Leak detection and automatic refrigerant Pump Down for R410A refrigerant	→ 308	P1 Type floor-standing · R410A	→ 330
VRF outdoor units range	→ 250	R1 Type concealed floor-standing · R410A	→ 330
Mini ECOi LZ2 Series 4 to 6 HP · R32	→ 258	Hydrokit for ECOi, water at 45 °C · R410A	→ 331
Mini ECOi LZ2 Series 8 and 10 HP · R32	→ 259	PRO-HT Tank Series for ECOi	→ 332
Mini ECOi LE2 Series 4 to 6 HP · R410A	→ 264	Fan coils highlighted features	→ 334
Mini ECOi LE1 Series 8 and 10 HP · R410A	→ 265	Smart fan coils	→ 335
2-Pipe ECOi EX ME2 Series	→ 277	Fan coils - ducted	→ 336
3-Pipe ECOi EX MF3 Series	→ 286	Fan coils - wall-mounted	→ 337
2-Pipe ECO G GE3 Series	→ 296	Accessories and control	→ 338
3-Pipe ECO G GF3 Series	→ 299	Dimensions and tube sizes of branches and headers for 2-Pipe ECOi EX ME2 and Mini ECOi Series	→ 346
2-Pipe Hybrid GHP/EHP	→ 303	Dimensions and tube sizes of branches and headers for 3-Pipe ECOi EX MF3 Series	→ 348
ECOi 2-Pipe with water heat exchanger	→ 306		
ECO G with water heat exchanger	→ 307		



VRF highlighted features

Panasonic provides an extensive range of solutions for medium and large sized buildings, combining the best options to satisfy all needs and site restrictions.



ECOi. Electrical VRF				ECO G. Gas Powered VRF	
2-Pipe Mini ECOi LZ2 · R32	2-Pipe Mini ECOi LE2 / LE1 · R410A	2-Pipe ECOi EX	3-Pipe ECOi EX	2-Pipe ECO G GE3	3-Pipe ECO G GF3
					
Capacity range					
4 - 10 HP	4 - 10 HP	8 - 80 HP	8 - 48 HP	16 - 60 HP	16 - 25 HP
Extreme temperatures operation					
-20 °C (heating) / 52 °C (cooling)	-20 °C	-25 °C	-20 °C	-21 °C	-21 °C
Number of indoor units					
15	15	64	52	64	24
Simultaneity ratio					
50 ~ 150 %	50 ~ 130 %	200 %	150 %	50 ~ 200 % ¹⁾	50 ~ 200 %
Indoor units					
All (check restrictions)					
Controls					
All					
Other ranges integration					
PACi full control integration + Domestic integration by accessory					

¹⁾ 50 ~ 200 % only when one outdoor unit is installed. In other cases 50 ~ 130 %.



Uniquely, you can choose from both Electrical VRF and Gas-powered VRF systems from Panasonic, delivering the best choice that really makes a difference to our customers

Providing a large choice of indoor units, you can also connect water heat exchangers, air handling units and ventilation units with or without a heat exchanger. And all managed from a simple and powerful stand-alone remote control, new centralised controls or cloud connection with 3G embedded.

This cutting edge control technology is called VRF Smart Connectivity, combining the expertise of VRF communication and a leading BEMS company to maximise comfort and efficiency while also reducing installation costs.



ECO i







ECO G

Panasonic ECOi is Eurovent certified. Panasonic's VRF systems - ECOi range is now certified by Eurovent*. The Eurovent certification verifies the performance ratings of heating and cooling systems following European standards. Those data provides products efficiency with full transparency for the benefit of customers and professionals.





















* Reference website: <https://www.eurovent-certification.com/en>.

Energy saving



 <p>INVERTER+</p>	 <p>R2 ROTARY COMPRESSOR</p>	 <p>ALL INVERTER COMPRESSORS</p>	 <p>28% ECONAVI</p>	 <p>HIGH COP</p>	 <p>GAS POWERED ECO G</p>
<p>Inverter Plus System. Inverter Plus System classification highlights Panasonic's highest performing systems.</p>	<p>Panasonic R2 rotary compressor. Designed to withstand extreme conditions, it delivers high performance and efficiency.</p>	<p>All inverter compressors. Multiple large-capacity all inverter compressors (more than 14 HP). Two independently controlled inverter compressors achieve high efficiency. Redesigned components in the body provide performance improvement especially in the rated cooling condition and EER performance.</p>	<p>Econavi. Intelligent Human Activity Sensor and Sunlight Sensor technologies that can detect and reduce waste of energy by optimising air conditioner operation according to room conditions. With just one touch of a button, you can save energy.</p>	<p>High COP. High efficiency models performs higher COP than standard units and standard combinations.</p>	<p>Gas powered. ECO G technology offers the best in energy efficiency. ECO G gas VRF is specially designed for buildings where the electricity is restricted or CO₂ emissions must be reduced.</p>

High performance

 <p>-25 °C HEATING MODE</p>	 <p>-20 °C OPERATION RANGE</p>	 <p>52 °C COOLING MODE</p>	 <p>BLUEFIN</p>	 <p>nanoe™ X</p>	 <p>FILTER INCLUDED</p>	 <p>SELF-DIAGNOSING</p>	 <p>AUTOMATIC FAN</p>	 <p>HUMIDITY CONTROL DRY</p>
<p>Down to -25 °C in heating mode. The ECOi EX system works in heating mode with performance data at outdoor temperature down to -25 °C.</p>	<p>Operating range. The PRO-HT Tanks work with an outdoor temperature is as low as -20 °C.</p>	<p>Cooling with outdoor temperature up to 52 °C. The ECOi EX system works in cooling mode with performance data at outdoor temperature up to 52 °C.</p>	<p>Bluefin. Panasonic has extended the life of its condensers with an original anti-rust coating.</p>	<p>nanoe™ X. Technology with the benefits of hydroxyl radicals has the capacity to inhibit pollutants, viruses, and bacteria to clean and deodorize.</p>	<p>Filter included. Hide-away with filter included.</p>	<p>Self-diagnosing function. By using electronic control valves past warnings are stored. This makes it easier to diagnose malfunctions, reducing service labour and therefore costs.</p>	<p>Automatic fan operation. Convenient microprocessor control automatically adjusts fan speed to high, medium or low, corresponding to room sensor and maintains comfortable air flow throughout the room.</p>	<p>Mild Dry. By intermittent control of compressor and indoor unit's fan, "Mild Dry" gives you comfort. It realizes efficient dehumidification according to room temperature.</p>

 <p>AUTO-FLAP CONTROL</p>	 <p>AUTOMATIC RESTART</p>	 <p>AIR SWEEP</p>	 <p>BUILT-IN DRAIN PUMP</p>	 <p>6,70 COP HIGH PERFORMANCE</p>	 <p>DHW</p>	 <p>65 °C OUTPUT WATER HIGH TEMPERATURE</p>	 <p>R22 RENEWAL</p>	 <p>5 YEARS COMPRESSOR WARRANTY</p>
<p>Comfortable auto-flap control. When the unit is first turned on, flap position is automatically adjusted in accordance with the cooling or heating operation.</p>	<p>Automatic restart. Automatic restart function for power failure. Even when power failure occurs, preset programmed operation can be reactivated once power is resumed.</p>	<p>Air Sweep. The air sweep function moves the flap up and down in the air outlet, directing air in a "sweeping" motion around the room and providing comfort in every corner.</p>	<p>Built-in drain pump. Maximum head 50cm (or 75cm for U type) from the bottom of the unit.</p>	<p>High performance. A7 COP 6,70 for ECOi 3-Pipe in case of heat recovery. For PRO-HT Tank.</p>	<p>DHW. With PRO-HT Tank you can also heat your domestic hot water at a very low cost with the optional hot water cylinder.</p>	<p>High temperature. With PRO-HT Tank, maximum water outlet temperature up to 65 °C.</p>	<p>R22 renewal. The Panasonic renewal system allows good quality existing R22 pipe work to be re-used whilst installing new high efficiency R410A systems.</p>	<p>5 Years Warranty. We guarantee the outdoor unit compressors for five years.</p>

High connectivity

 <p>PANASONIC AC SMART CLOUD</p> <p>Panasonic AC Smart Cloud. The AC Smart Cloud from Panasonic allows you to have complete control of all your installations. In a simple click, receive status updates from all your units in real-time, preventing breakdowns and optimising costs.</p>	 <p>OPTIONAL WI-FI</p> <p>Internet control. A next generation system providing user-friendly remote control of air conditioning or heat pump units from everywhere, using a simple Android™ or iOS smartphone, tablet or PC via the internet.</p>	 <p>BMS CONNECTIVITY</p> <p>BMS connectivity. The communication port can be integrated into the indoor unit and provides easy connection to, building management system, providing control of your Panasonic heat pump.</p>
---	--	--

Panasonic: delivering TOP energy efficiencies for many years



Particularly suitable for retail, hotels and office applications

Outstanding efficiency at part load conditions:

Panasonic ECOi EX model covers up to 30 % part load with extremely high efficiency.

EER comparison of Panasonic 2-Pipe ECOi EX ME2 at different partial load

Load %	100 %	80 %	60 %	50 %	40 %	30 %
18 HP High Efficiency model	4,54	5,30	6,37	7,12	8,23	6,93
18 HP Space saving model	3,38	3,97	4,75	5,25	5,13	4,97

Conditions: Outdoor temperature 35 °C DB, Room temperature 19 °C WB.

COP comparison of Panasonic 2-Pipe ECOi EX ME2 at different partial load

Load %	100 %	80 %	60 %	50 %	40 %	30 %
18 HP High Efficiency model	3,89	5,42	6,90	6,94	6,59	6,11
18 HP Space saving model	3,43	4,90	6,36	6,59	6,33	5,92

Conditions: Outdoor temperature 0 °C WB, Room temperature 20 °C DB.

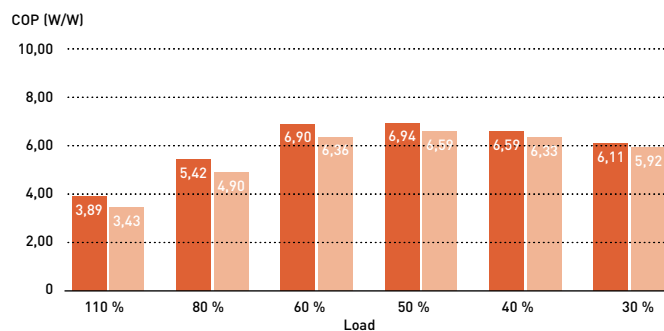
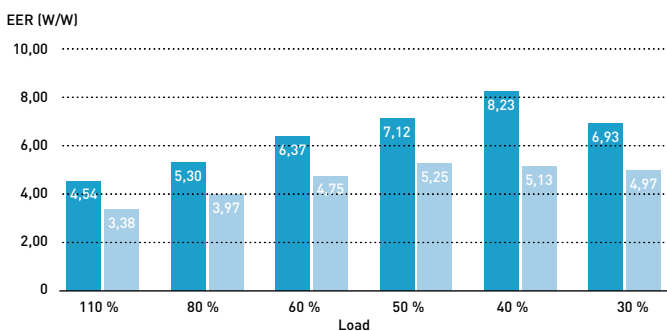

* Data from Panasonic official technical data book.

Excellent SEER and SCOP values for VRF 2 and 3-Pipe

Panasonic have a extremely high SEER and SCOP values following LOT21 (seasonal space cooling / heating energy efficiency by COMMISSION REGULATION (EU) 2016/2281).

	Mini ECOi (LE)					2-Pipe							3-Pipe				
	4 HP	5 HP	6 HP	8 HP	10 HP	8 HP	10 HP	12 HP	14 HP	16 HP	18 HP	20 HP	8 HP	10 HP	12 HP	14 HP	16 HP
SEER	7,9	7,5	7,3	6,3	6,4	7,58	7,09	6,86	7,36	6,55	7,70	7,16	7,15	7,18	6,51	6,81	6,12
SCOP	4,9	4,4	4,2	4,2	4,3	4,85	4,32	4,78	4,33	4,09	4,34	4,13	4,92	4,30	4,32	4,17	3,84

Efficient defrost operation

Panasonic uses the second unit to defrost the first unit. This makes the system more efficient during defrost and does not affect comfort.

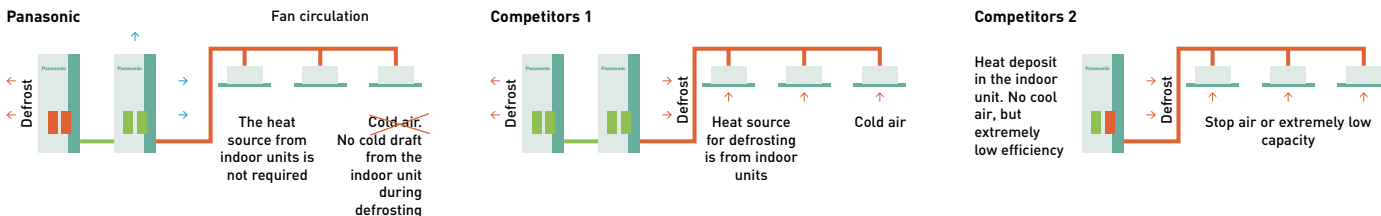

Panasonic ECOi operates at as low as -25 °C

This unique feature demonstrate the supremacy of Panasonic ECOi EX Series.

Panasonic use the second unit to defrost the first unit. This makes the system more efficient during defrost and does not affect the comfort.

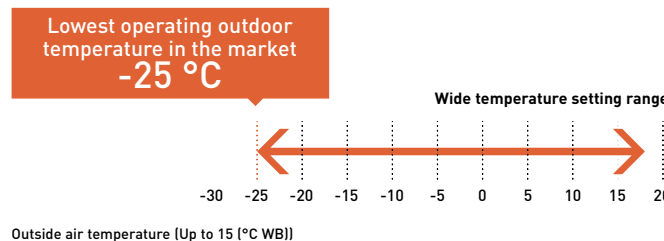

Bringing nature's balance indoors



nanoe™ X, technology with the benefits of hydroxyl radicals.

Abundant in nature, hydroxyl radicals (also known as OH radicals) have the capacity to inhibit pollutants, viruses, and bacteria to clean and deodorise. nanoe™ X technology can bring these incredible benefits indoors so that hard surfaces, soft furnishings, and the indoor environment can be a cleaner and more pleasant place to be, whether at home, work, or visiting hotels, shops and restaurants etc.



Panasonic's nanoe™ X technology takes this a step further and brings nature's detergent – hydroxyl radicals – indoors to help create an ideal environment

Thanks to the nanoe™ X properties, several types of pollutants can be inhibited such as certain types of bacteria, viruses, mould, allergens, pollen and certain hazardous substances.

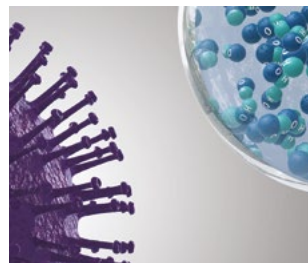

1 | nanoe™ X reliably reaches pollutants.

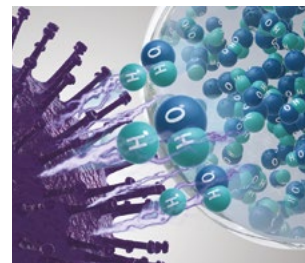

2 | Hydroxyl radicals denature pollutants' proteins.

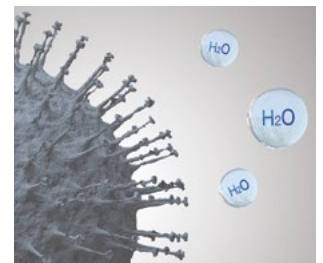

3 | Pollutants activity is inhibited.

What is unique about nanoe™ X?

Effective on fabrics and surfaces.

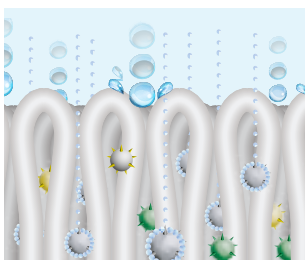

1 | At one billionth of a metre, nanoe™ X is much smaller than steam and can deeply penetrate cloth fabrics to deodorise.

Longer lifespan.



2 | Contained in tiny water particles, nanoe™ X has a longer lifespan to spread easily around the room.

Huge quantity.



3 | nanoe X Generator Mark 2 produces 9,6 trillion hydroxyl radicals per second. Greater amounts of hydroxyl radicals contained in nanoe™ X lead to higher performance on inhibition of pollutants.

Maintenance-free.



The image shows nanoe X Generator Mark 2.

4 | No maintenance, no replacement required. nanoe™ X is a filter free solution that does not require maintenance, as its atomisation electrode is enveloped with water during its generation process and it is made with Titanium.

7 effects of nanoe™ X – Panasonic unique technology

Deodorises



Odours

Capacity to inhibit 5 types of pollutants



Bacteria and viruses



Mould



Allergens



Pollen



Hazardous substances



Skin and hair

* Refer to <https://aircon.panasonic.eu> for more details and validation data.

nanoe™ X, internationally-validated technology in testing facilities

The effectiveness of nanoe™ X technology has been tested by 3rd party laboratories in Germany, France, Denmark, Malaysia and Japan.

The nanoe™ X performance varies depending on the room size, environment and usage and it may take several hours to reach the full effect. nanoe™ X is not medical device, local regulations on building design and sanitary recommendations must be followed.

Test results conducted under controlled laboratory conditions. Performance of nanoe™ X might differ in real life environment.

		Tested contents	Result	Capacity	Time	Testing organisation	Report No.
Airborne	Virus	Bacteriophage ΦX174	99,7 % inhibited	Approx. 25 m³	6 h	Kitasato Research Center for Environmental Science	24_0300_1
	Bacteria	Staphylococcus aureus	99,9 % inhibited	Approx. 25 m³	4 h	Kitasato Research Center for Environmental Science	2016_0279
Adhered	Virus	SARS-CoV-2	91,4 % inhibited	6,7 m³	8 h	Texcell (France)	1140-01 C3
		SARS-CoV-2	99,9 % inhibited	45 L	2 h	Texcell (France)	1140-01 A1
	Virus	Xenotropic murine leukemia virus	99,999 % inhibited	45 L	6 h	Charles River Biopharmaceutical Services GmbH	—
		Influenza (H1N1 subtype)	99,9 % inhibited	1 m³	2 h	Kitasato Research Center for Environmental Science	21_0084_1
		Bacteriophage ΦX174	99,80% inhibited	25 m³	8 h	Japan Food Research Laboratories	13001265005-01
	Bacteria	Staphylococcus aureus	99,9 % inhibited	20 m³	8 h	Danish Technological Institute	868988
	Pollen	Ambrosia pollen	99,4 % inhibited	20 m³	8 h	Danish Technological Institute	868988
	Odours	Cigarette smoke odour	Odour intensity reduced by 2,4 levels	Approx. 23 m³	0,2 h	Panasonic Product Analysis Center	4AA33-160615-N04

First nanoe™ device was developed by Panasonic in 2003

Generator	nanoe™	nanoe™ X	
	2003	Mark 1 - 2016	Mark 2 - 2019
	480 billion hydroxyl radicals/sec	4,8 trillion hydroxyl radicals/sec	9,6 trillion hydroxyl radicals/sec
Ion particle structure	 Hydroxyl Radicals	10x times	20x times

nanoe™ X: improving protection 24/7

Acts to clean your air, so that the indoor environment can be a cleaner and more pleasant place to be all day long. nanoe™ X works together with heating or cooling function when the during the day and can work independently when the area is not occupied. Give the air conditioning the strength to increase the protection of your indoor spaces with nanoe™ X technology and convenient control via the Panasonic Comfort Cloud App.



Cleans the air when you are away.

Leave the nanoe™ mode ON to inhibit certain pollutants and deodorise before you return home.

Improves your environment when you are at home.

Enjoy a cleaner, comfortable space with loved ones.

Panasonic Heating & Cooling Solutions is incorporating nanoe™ technology in a wide range of equipment

NEW Built-in nanoe X Generator (TBC).



Y3 Type 4 way 60x60 cassette.
S-**MY3E.
6 capacities: 1,5 - 5,6 kW.

Built-in nanoe X Generator Mark 2.



U2 Type 4 way 90x90 cassette.
S-***MU2E5B.
11 capacities: 2,2 - 16,0 kW.



F3 Type adaptive duct.
S-***MF3E5B.
12 capacities: 1,5 - 16,0 kW.

Built-in nanoe X Generator Mark 1.



G1 Type floor console.
S-**MG1E5N.
5 capacities: 2,2 - 5,6 kW.

Panasonic VRF: TOP in comfort

Since 2006, all Panasonic VRF systems have included special VET technology, with variable refrigerant temperature, as standard.

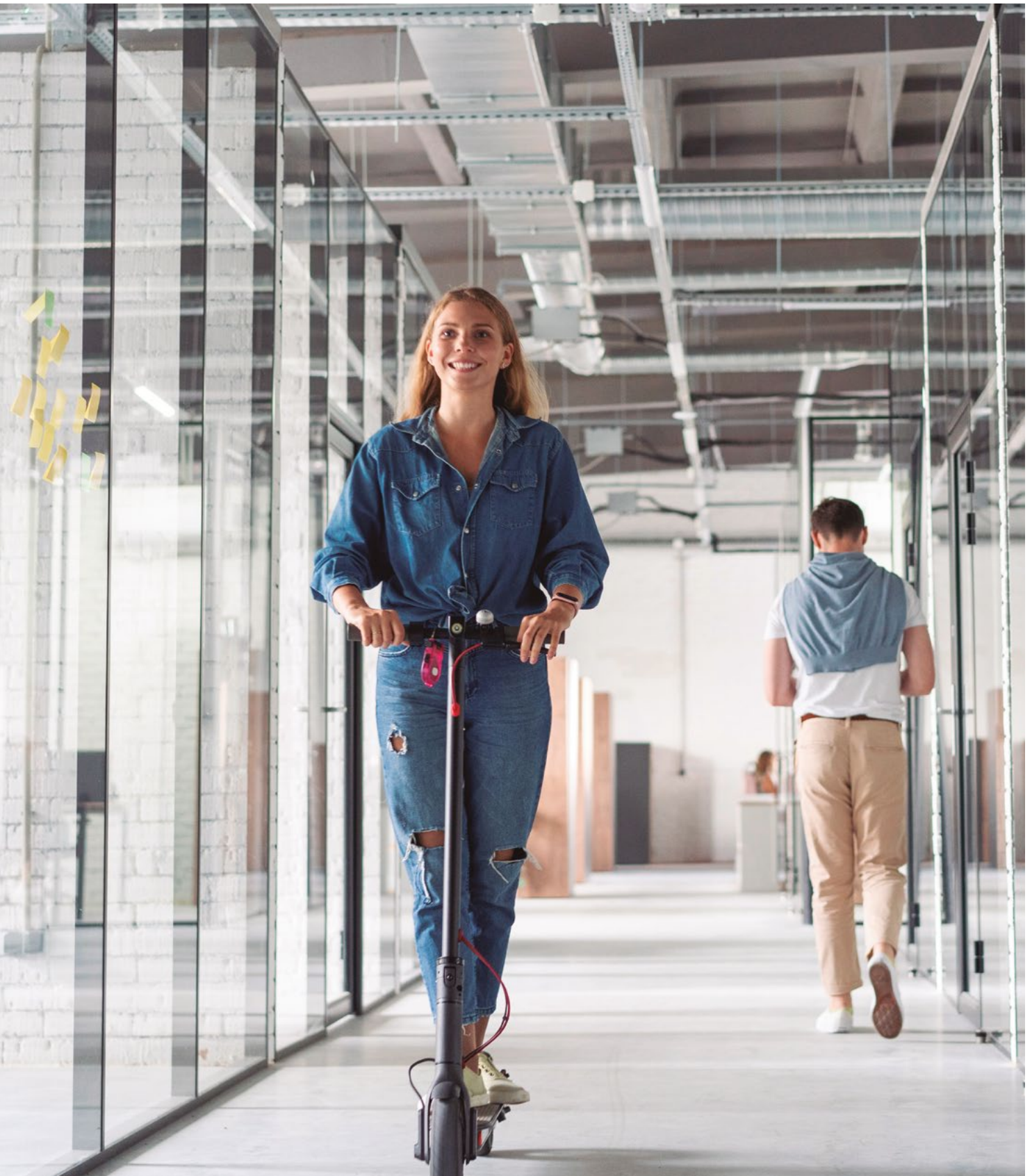

Variable Evaporation and Condensation Temperature

Our 'smart logic' system checks the temperature every 30 seconds, automatically adjusting the refrigerant temperature according to actual demand and outdoor conditions. This ensures better energy performance at all times.

Temperature varies from 16 °C to 3 °C.

Similarly, the condensation temperature is also variable and is adjusted to the room thermal load, within a range of 33 - 55 °C.

Refrigerant evaporation temperature (°C)

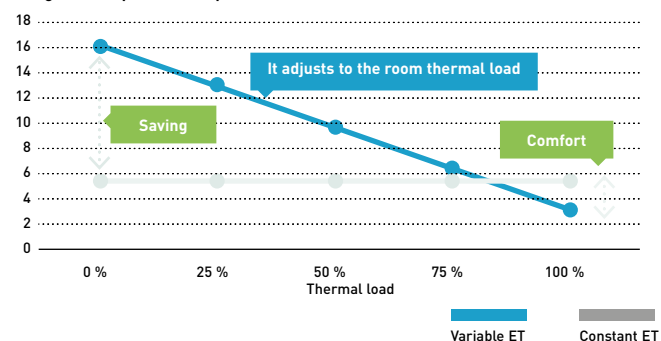

Refrigerant condensation temperature (°C)

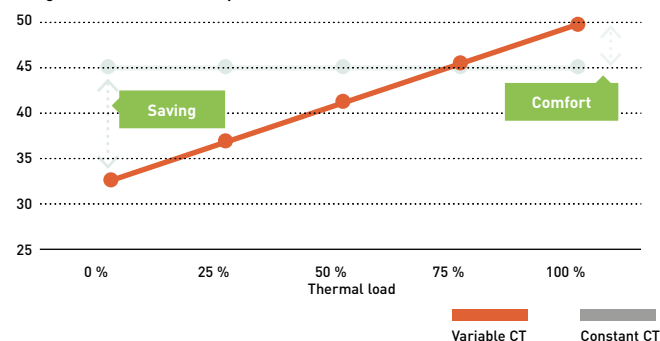

Example of cooling mode (similarly applicable to heating mode).



Technical focus on variable temperatures

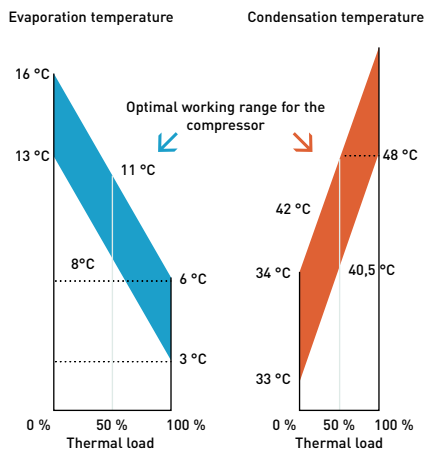

Control of the discharge temperature

This special function is available in all of Panasonic VRF systems' indoor units to guarantee maximum comfort for the end user. For example, in cooling mode, if the temperature of the discharged air was below 10 °C, the user may feel discomfort, just as he would do in heating mode if the temperature was far too high. With the Panasonic control of the discharge temperature, this can be adjusted within a cooling range of 7 - 22 °C.

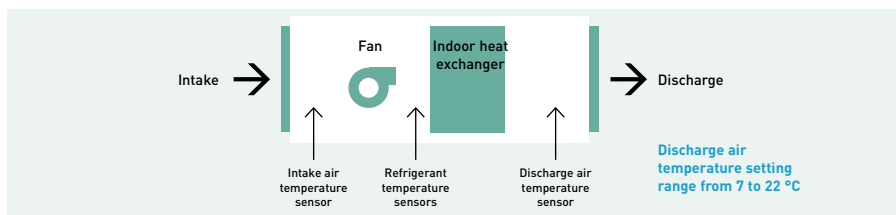

Benefits:

- The air will never be too cold or too warm
- Available in cooling and in heating
- Higher comfort
- Energy saving
- It prevents the formation of condensation within ducts and vents, improving levels of hygiene

Solutions for Restaurants

Full heating, cooling and DHW solutions for Restaurants.



1a Gas VRF. ECO G.

ECO G gas VRF is designed for buildings where the electricity is restricted or CO₂ emissions must be reduced. Sanitary hot water is produced for free, all year round.



1b Electric VRF. ECOi EX and Mini ECOi.

ECOi electrical VRF is specifically designed for the most demanding hotels. High efficiency system. Extended operating range to provide heating at outdoor temperature as low as -25 °C (2-Pipe ECOi EX). Suitable for refurbishment projects.

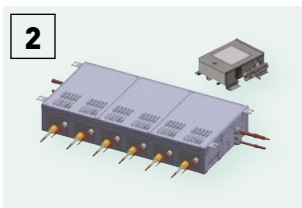

2 3-Pipe control box kit.

Heat Recovery box to connect multiple indoor units with just one box, 4, 6 and up to 8 indoor units or groups. This is good advantage in the restaurants, where space for connecting several boxes is limited.



3 Aquarea T-CAP.

Ideal for heating, cooling and for production of big quantities of hot water at 65 °C, Aquarea have a extremely quick return on investment and a low CO₂ footprint.



4 Water heat exchanger for ECOi. Water at 55 °C.

Producing MT hot water, compatible with both ECOi, heat pump and heat recovery outdoors.

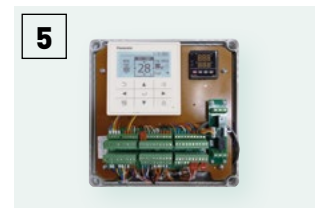

5 Air handling unit kits for efficient ventilation.

The AHU kit is specially designed to improve the efficiency of the pre-heating or pre-cooling process of the ventilation.

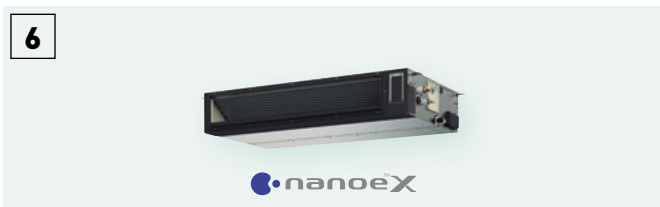

6 Adaptive ducted with nanoe™ X.

Super silent units deliver the ideal air supply. Units available from 1,5 kW providing precise temperature control even in small rooms. 2 installation possibilities (horizontal / vertical) with high ESP 150 Pa allows for flexible installation. nanoe™ X is built-in as standard.

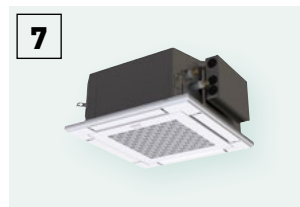

7 Mini Cassette.

The Y3 type 4 way 60x60 cassette unit has modern and stylish panel design which matches with any type of the building design.



8 Control your way.

Wide variety of controls, from simple user control to full system control via remote access functionality. Touch panel and consumption control.

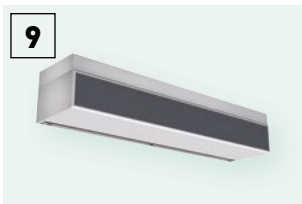

9 Air curtain with DX coil.

The Panasonic range of air curtains is designed for smooth operation and efficient performance.



10 Protocol friendly.

Great flexibility for integration into your KNX / Modbus / LonWorks / BACnet projects allows fully bi-directional monitoring and control of all the functioning parameters. Range of solutions to control locally or remotely the full system in bi-directional mode.



11 Panasonic AC Smart Cloud / Service Cloud.

Taking your business under control. New service function makes maintenance works simpler.



12 Condensing unit with natural refrigerant.

Panasonic CO₂ unit is the natural choice for showcases and cold rooms in restaurants. Always fresh foods from a future-proof refrigeration technology, without any contamination risk.



Highly efficient at part load conditions

Panasonic has solutions for optimising the installation of cooling, heating and DHW production in restaurants. While the kitchen needs cooling, heating is needed for DHW and also for heating the public area, with the advantage of 100 % fresh air that removes odours. Combining all these needs smartly with Panasonic technology results in a simple and flexible system adaptable to any restaurant requests, with lower utility bills. Additionally, Panasonic is the unique offering solution for areas where electric power is limited, using ECO G, VRF units powered mainly by Natural Gas or Propane, bringing comfort and DHW anywhere.

For chiller options, please check chiller section.

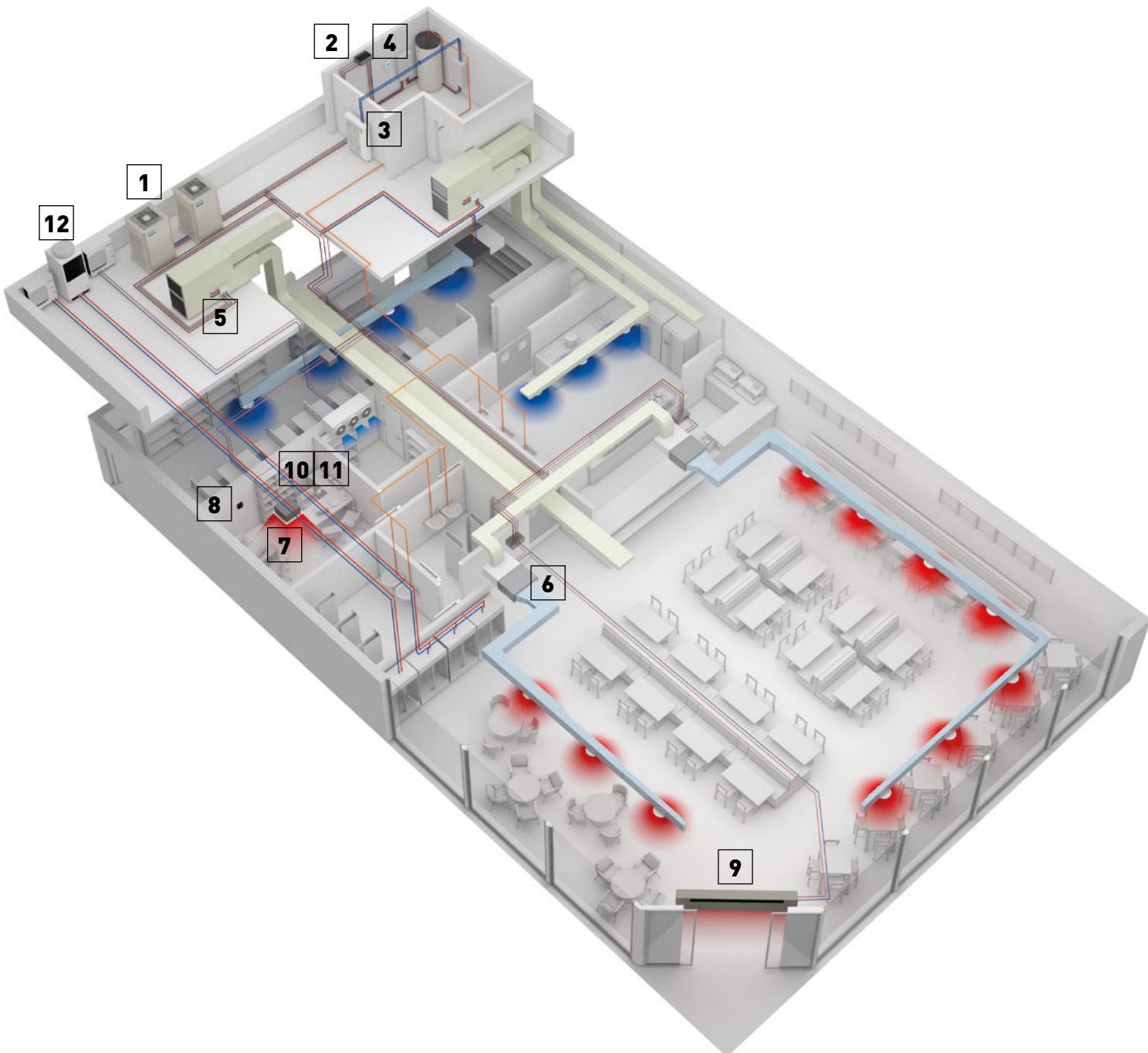

Your entire hotel with superior comfort, control and savings too



1a Hybrid system.

Gas + Electricity Hybrid system. Taking advantage of Gas and Electricity to achieve the most efficient performance and maximum energy savings.



1b Gas VRF. ECO G.

ECO G gas VRF is designed for buildings where the electricity is restricted or CO₂ emissions must be reduced. Sanitary hot water is produced for free, all year round.



2 Hydronic units.

For obtaining hot and cold water for heating and refrigeration [Aquarea Air radiators, underfloor heating, radiators...]

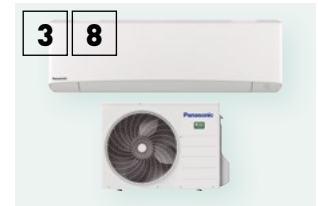

3 8 YKEA unit for server room.

Steady cooling, nonstop, even at -20 °C and still with high efficiency. Ready for continuous operation and easy to connect 2 systems to automatically alternate and ensure server rooms are kept cool.

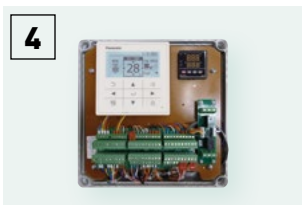

4 Air handling unit kits for efficient ventilation.

The AHU kit is specially designed to improve the efficiency of the pre-heating or pre-cooling process of the ventilation.



5 PRO-HT Tank DHW.

DHW tank with maximum outlet temperature 65 °C. Ideal solution for high demand of hot water such as shower, spa, swimming pool.



6 Electric VRF. ECOi EX.

ECOi electrical VRF is specifically designed for the most demanding hotels. High efficiency system. Extended operating range to provide heating at outdoor temperature as low as -25 °C (2-Pipe ECOi EX). Suitable for refurbishment projects.



7 Control your way.

Wide variety of controls, from simple user control to full system control via remote access functionality. Touch panel, web server, consumption control, smartphone control... everything is possible.

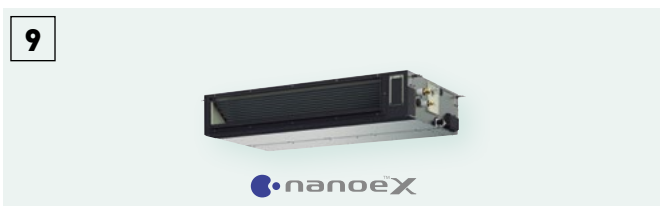

9 Wide range of indoor units.

All units provided with supply air temperature sensor and low operation sound level to guarantee maximum guests comfort. Some units with nanoe™ X equipped (available in specific models) provide better air quality in public spaces in the hotel.



10 Panasonic AC Smart Cloud / Service Cloud.

Taking your business under control. New service function makes maintenance works simpler.



11 Protocol friendly.

Great flexibility for integration into your KNX / Modbus / LonWorks / BACnet projects allows fully bi-directional monitoring and control of all the functioning parameters.

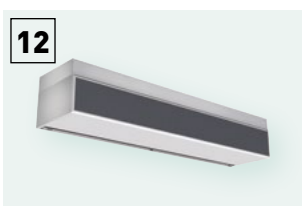

12 Air curtain with DX coil.

The Panasonic range of air curtains is designed for smooth operation and efficient performance.



13a Condensing unit with natural refrigerant.

Panasonic CO₂ unit is the natural choice for an energy saving and environmentally friendly solution.



13b PACi NX Elite Series for cooling rooms.

High quality and efficient solution for high temperature refrigeration applications.



14 Maximum savings on hot water production.

Hot water for swimming pool, spa and laundry for free thanks to the residual heat generated by the ECO G units.



Panasonic offers the widest range in HVAC, DHW and ventilation available. That enables us to offer the most suitable solution 24 hours a day, 365 days a year. Panasonic Solutions ensure not only a higher customer satisfaction but also a lower energy bill.

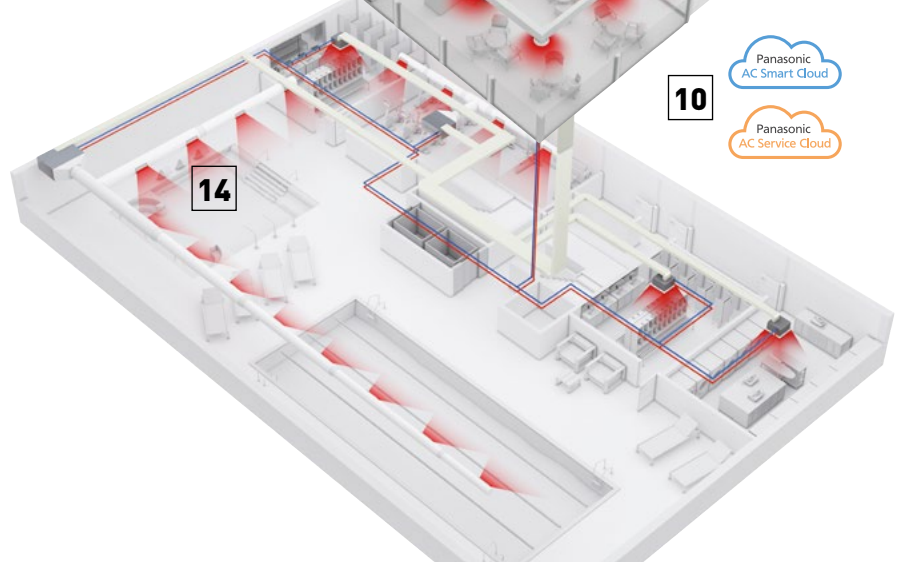
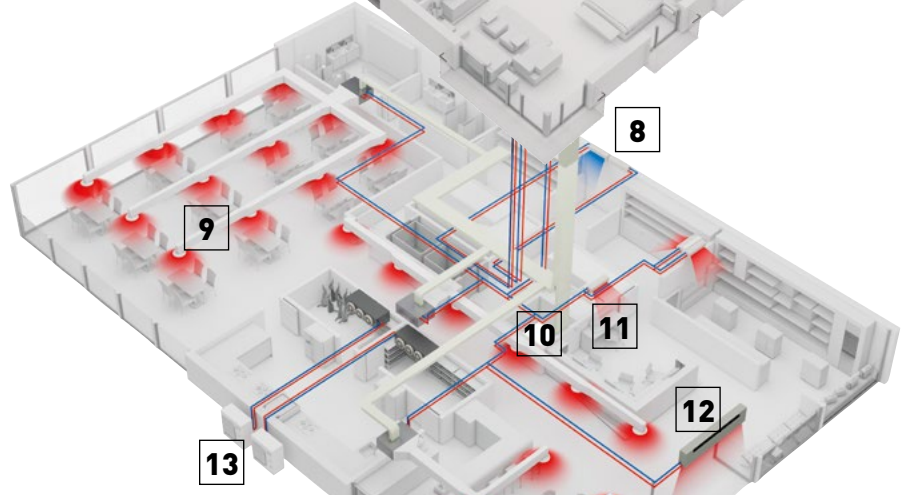
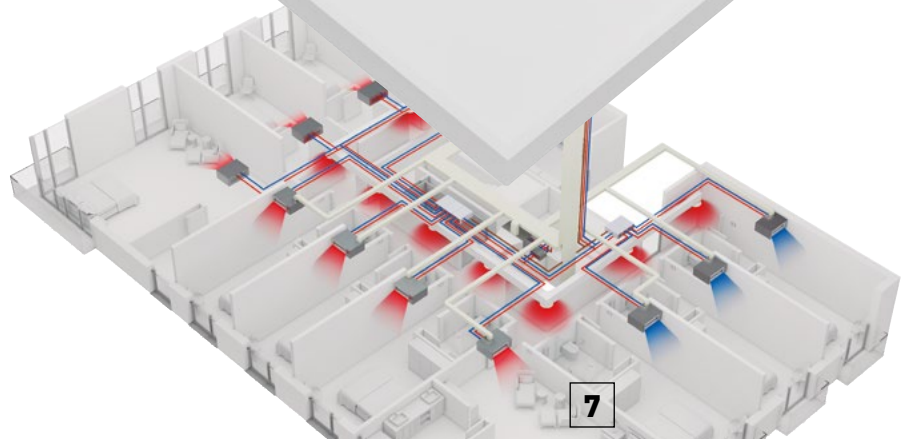
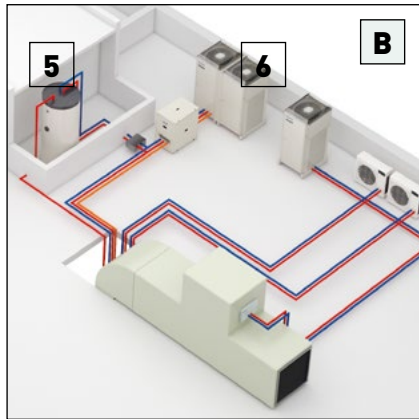
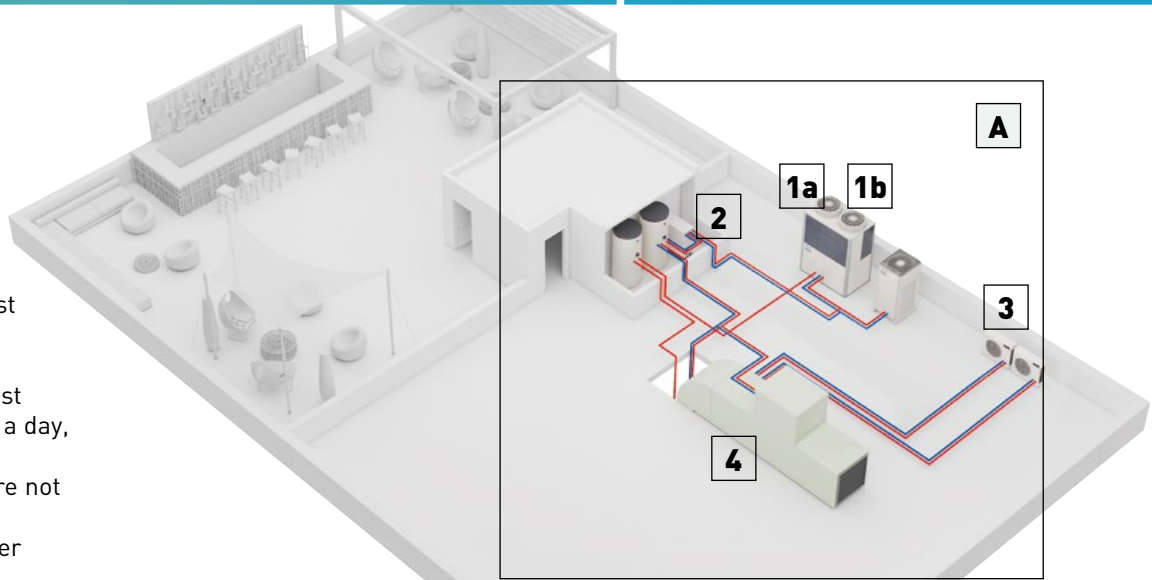

- A**
- Option A: Hybrid solution. Gas + electric:**
When large quantities of hot/cold water is needed.
- ECO G (gas heat pump)
 - Water heat exchanger
 - Aquarea HT to produce hot water up to 65 °C
 - Air handling unit kit to connect the ECO G to the AHU
 - YKEA wall-mounted to cool the server rooms efficiently

- B**
- Option B: Full Electric solution 2 and 3-Pipe.**
When flexibility is needed and electricity power availability is not an issue.
- ECOi (electric VRF)
 - Direct expansion indoor units
 - Air handling unit (AHU) kit to connect the ECOi to the AHU
 - YKEA wall-mounted to cool the server rooms efficiently
 - Panasonic Pump Down system

Innovative solutions for retail

Heating and cooling solutions for retail applications

Panasonic has developed solutions for retail and office applications where return on investment is a key factor! The comfort inside the shop is key for a good customer experience.

From local control or Panasonic's new cloud control system, a detailed status of the heating and cooling system can be displayed, analysed and optimised in order to improve the efficiency, reduce the running time and increase the life time of the units.

8 reason why Panasonic is the best solution for your retail:

- Complete solution
- Flexibility and adaptation
- Go green retail: low CO₂ emissions
- Comfort - high customer satisfaction
- Future expansion
- Panasonic offers efficient systems meeting expectations over the years
- High quality of service with Panasonic pro-partner installation team
- The system will still operate up to 25 % of the connected indoor units. System will not stop when up to 25 % of indoor units have power supply breakdown when they are on mode

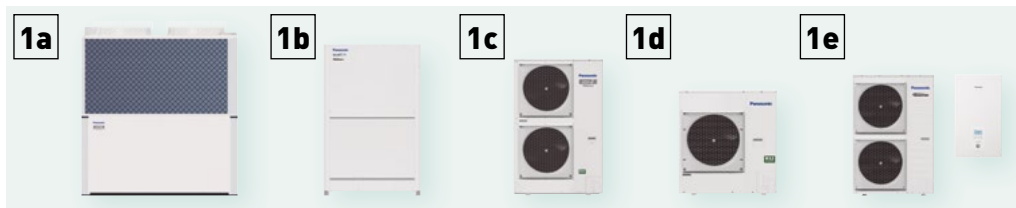

Multi energy solutions, gas or electric.

The Multi energy solution (Gas and Electric) from Panasonic provides the best choice in energy saving and on the flexibility of the installation. Panasonic solutions can be connect to direct expansion systems, water chiller installations and ventilation systems as air handling units.

1a: Gas VRF. ECO G

1b: Electric VRF. ECOi

1c: Electric VRF. Mini ECOi

1d: Electric 1x1. PACi NX

1e: Electric A2W. Aquarea



YKEA unit for server room.

Steady cooling, nonstop, even at -20 °C and still with high efficiency. Ready for continuous operation and easy to connect 2 systems to automatically alternate and ensure server rooms are kept cool.



3

Control your way.

Wide variety of controls, from simple user control to full system control via remote access functionality. Touch panel and consumption control.



4

Econavi Sensor.

The Econavi Sensor detects presence in the room, and quietly adapts the PACi or VRF air conditioning system in order to improve comfort and energy savings.

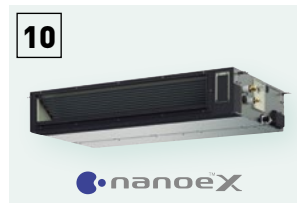

10

Wide range of indoor units.

All units provided with supply air temperature sensor and low operation sound level to guarantee maximum guests comfort. Some units with nanoe™ X equipped (available in specific models) provide better air quality in public spaces in the hotel.



6

Hide-away, for power and efficiency.

Super silent units deliver the ideal air supply. Units available from 1,5 kW providing precise temperature control even in small rooms. Two models available: slim unit for height restricted areas (MM unit only 200 mm deep), another which allows 100 % fresh air (MF).

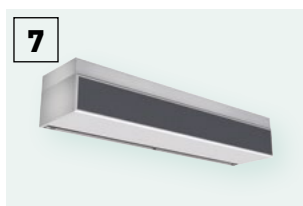

7

Air curtain with DX coil.

The Panasonic range of air curtains is designed for smooth operation and efficient performance.



Protocol friendly.

Great flexibility for integration into your KNX / Modbus / LonWorks / BACnet projects allows fully bi-directional monitoring and control of all the functioning parameters. Range of solutions to control locally or remotely the full system in bi-directional mode.



Air handling unit kits for efficient ventilation.

The AHU kit is specially designed to improve the efficiency of the pre-heating or pre-cooling process of the ventilation.

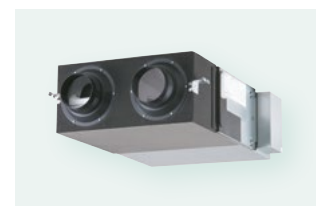





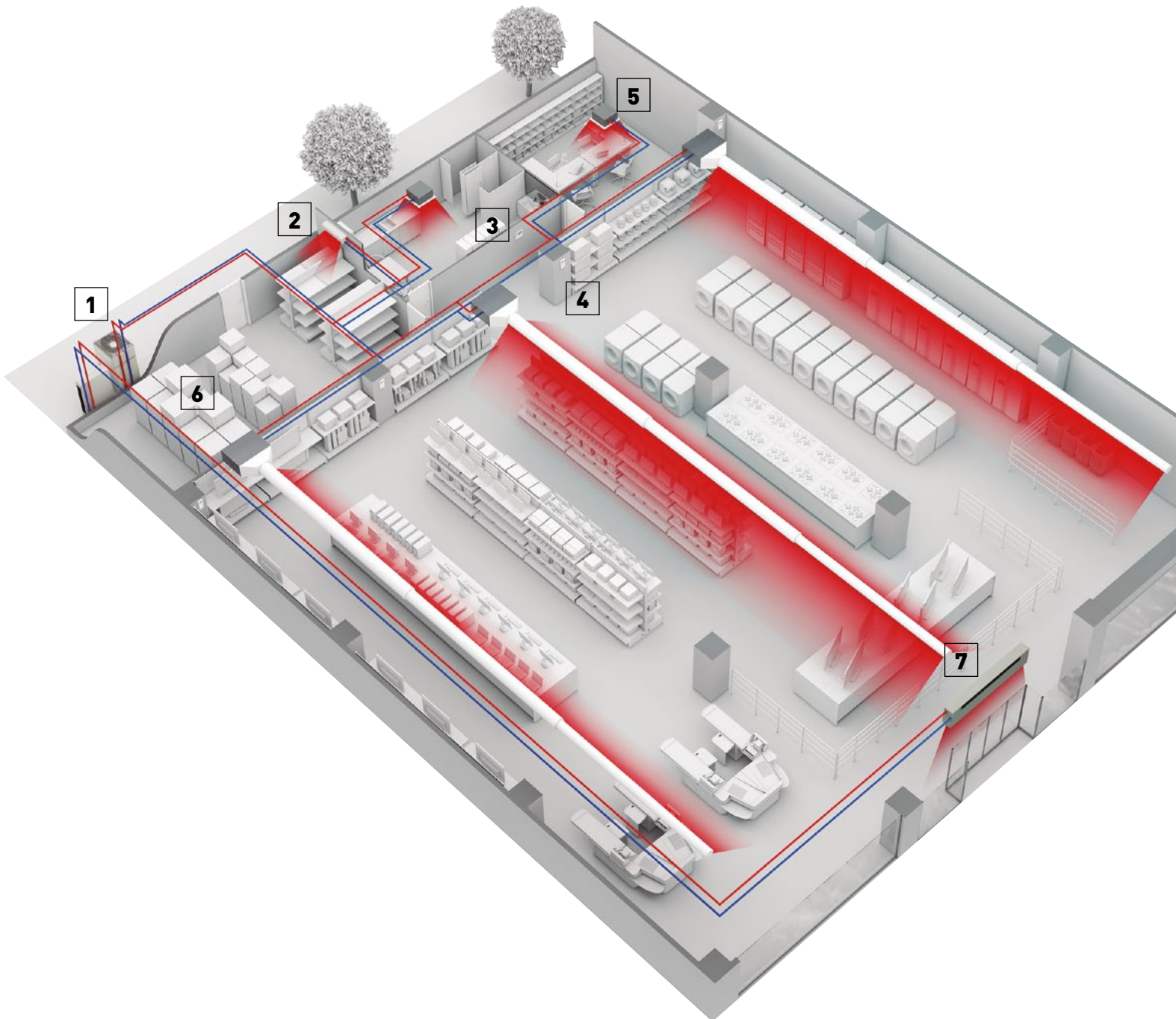











Energy Recovery unit for high efficiency of the system.

Panasonic Energy Recovery Ventilators can reduce the outside air load because they efficiently recover the heat lost by ventilation during the heat recovery process.



VRF outdoor units range

Page	Outdoor units	4 HP	5 HP	6 HP	8 HP	10 HP	12 HP
P. 254	 Mini ECOi LZ2 Series · R32						
		U-4LZ2E5 / U-4LZ2E8	U-5LZ2E5 / U-5LZ2E8	U-6LZ2E5 / U-6LZ2E8	U-8LZ2E8	U-10LZ2E8	
P. 260	Mini ECOi LE2 / LE1 Series · R410A						
		U-4LE2E5 / U-4LE2E8	U-5LE2E5 / U-5LE2E8	U-6LE2E5 / U-6LE2E8	U-8LE1E8	U-10LE1E8	
P. 272	2-Pipe ECOi EX ME2 Series · R410A						
					U-8ME2E8	U-10ME2E8	U-12ME2E8
P. 282	3-Pipe ECOi EX MF3 Series · R410A						
					U-8MF3E8	U-10MF3E8	U-12MF3E8
P. 294	2-Pipe ECO G GE3 Series · R410A						
P. 298	3-Pipe ECO G GF3 Series · R410A						
P. 300	GHP/EHP Hybrid System · R410A						



14 HP

16 HP

18 HP

20 HP

25 HP

30 HP



U-14ME2E8



U-16ME2E8



U-18ME2E8



U-20ME2E8



U-14MF3E8



U-16MF3E8



U-16GE3E5



U-20GE3E5



U-25GE3E5



U-30GE3E5



U-16GF3E5



U-20GF3E5



U-25GF3E5



U-20GES3E5 / U-10MES2E8

Best efficiency ECOi Series from Panasonic

ECOi

The ECOi Series is designed for energy savings, easy installation, and high efficiency. Always continuing to evolve, Panasonic uses advanced technologies to meet the requirements of diverse situations and contribute to the creation of comfortable living spaces.



**HIGH PERFORMANCE OF
PANASONIC'S ECOi SERIES IS
VERIFIED BY EUROVENT NOW*!**

*DETAILED DATA IN PAGES 288, 289.



**Mini ECOi LZ2 Series · R32**

The Mini ECOi LZ2 Series utilizes environmentally friendly R32 refrigerant, reducing the total amount of refrigerant by 20 % and more, resulting in lower GWP, reduced by 75 %*.

* As a result of applying R32 while at the same time reducing the total refrigerant amount.

Mini ECOi LE Series · R410A

The 2-Pipe heat pump small VRF system specifically designed for the European market.

2-Pipe ECOi EX ME2 Series · R410A

The VRF system delivering energy-saving performance, powerful operation, reliability and comfort surpassing anything previously possible.

3-Pipe ECOi EX MF3 Series · R410A

The VRF system that offers high-efficiency and performance for simultaneous heating and cooling.

Lower running and life cycle costs.

Panasonic ECOi systems are highly efficient VRF systems on the market, offering COPs in excess of 4,0 at full load conditions. The system is also designed to make sure that we reduce the running cost of each system by using our unique road map control routine to ensure that the efficient combination of compressors are running at any one time. Improved defrost sequencing also reduces running costs by defrosting each outdoor coil in turn when conditions allow.

Up to 64 indoor units can be connected up to a capacity of 200 % indexed indoor unit loads, enabling the system to be used effectively on highly diversified building loads: this

large connectability feature makes it an easy-to-design solution for schools, hotels, hospitals and other large buildings. Up to 1000 m in pipe length enables the VRF ECOi Series to be used in very large buildings, with maximum design flexibility. The ECOi system is also easy to control. It has more than 8 types of control from standard wired remote controls to touch screen panels or web access interfaces.

DC-inverter control technology for rapid and powerful cooling and heating. The ever-evolving Panasonic ECOi Series.**ECOi Series benefits****Ease of installation.**

R410A has a higher operating pressure with a lower pressure loss than previous refrigerants. This enables smaller pipe sizes to be used and allows reduced refrigerant charges.

Simple to design.

Panasonic recognise that designing, selecting and preparing a professional VRF quotation can be a time consuming and costly process, especially as it is often also a speculative exercise. So we have designed proprietary software which is quick and easy to use and produces a full schematic layout of pipework and controls, as well as a full materials list and performance data.

Easy to control.

A wide variety of control options are available to ensure that the ECOi system provides the user with the degree of control that they desire, from simple room controllers through to state of the art BMS controls.

Simple to commission.

Simple set-up procedure including automatic addressing of connected indoor units. Configuration settings can be made from an outdoor unit or via a remote controller.

Easy to position.

The compact design of the ECOi outdoor units means that sizes 4 HP to 10 HP fit into a standard lift and are easy to handle and position when on site. The small footprint and modular appearance of the units ensure a cohesive appearance to an installation.

Wide selection and connectability.

With 17 indoor model styles available, ECOi systems are the ideal choice for multiple small capacity indoor unit installations, with the ability to connect up to 40 indoor units to systems of 24 HP or greater for 3-Pipe ECOi EX MF3 Series.

Easy to maintain.

Each system allows the use of prognostic and diagnostic controls routines, to manage system operation and identifying faults, all designed to reduce the speed of maintenance calls and unit down time.

Lower running and life cycle costs.

Panasonic ECOi system are also designed to make sure that we reduce the running cost of each system by using our unique road map control routine to ensure that the most efficient combination of compressors are running at any one time. Improved defrost sequencing also reduces running costs by defrosting each outdoor coil in turn when conditions allow.

Mini ECOi LZ2 Series R32

Outstanding efficiency in a compact body and continuous operation even at extreme ambient temperatures.





**INDUSTRY 1ST
8 HP AND
10 HP MINI
VRF UNITS
WITH R32**



1 Low GWP and less refrigerant

The Mini ECOi LZ2 Series utilizes environmentally friendly R32 refrigerant, reducing the total amount of refrigerant by 20 % and more, resulting in lower GWP, reduced by 75 %*.

* As a result of applying R32 while at the same time reducing the total refrigerant amount.

2 Outstanding efficiency at the most challenging ambient conditions

Re-engineered for better performance, the LZ2 series produces extraordinary savings with SEER levels up to 8,50 and SCOP levels up to 5,05 (for 4 HP model). The large range of outdoor units from 12 kW to 28 kW can also work at extreme ambient temperatures, down to -20 °C in heating and up to 52 °C in cooling, providing a very wide range of operating ability.

3 More flexibility for your project

The ECOi LZ2 series provides ease of installation with long piping lengths and small footprints in a lightweight body. A variety of indoor units, supporting Panasonic's optional R32 refrigerant leak detector, increases the flexibility for installers. A wide range of individual and central controllers, the new generation Smart and Service Cloud, as well as apps for end users and installers, provide a fully customizable monitoring and controlling solution.

Minimum environmental impact

Panasonic has designed the LZ2 series in order to minimize the environmental impact of the system. Low GWP refrigerant R32 and highest efficiency levels ensure this through the total operational lifetime.



VRF with outstanding energy-saving performance and superior SEER and SCOP

Mini ECOi LZ2 provides the optimal performance in any climatic condition.

WIDE OPERATING RANGE

-20 °C in heating to
52 °C in cooling

8,50 | **5,05**
SEER | **SCOP**
EXTRAORDINARY SAVINGS

ECOi LZ2 mini VRF series from 12 to 28 kW

- Improving protection 24/7. Unique indoors with nanoe™ X, hydroxyl radicals contained in water
- SEER levels up to 8,50 and SCOP levels up to 5,05 (for 4 HP model)
- Low GWP and highly reduced refrigerant volume
- Improved connectivity with CONEX remote controllers and app support, Smart and Service Cloud applications and support for communication protocols for BMS integration
- Wide range of connectable units allowing wide range of installations with and without refrigerant mitigation
- Increased indoor / outdoor capacity ratio up to 150 %
- Quiet mode operation with low capacity drop
- Same Panasonic DNA with Panasonic compressors and precise temperature control thanks to discharge temperature sensors in the indoor units
- Continuous operation at extreme ambient temperatures: -20 °C (heating) to 52 °C (cooling)
- Flexible mitigation measures, with Panasonic R32 refrigerant leak detector / alarm to be installed only when required
- 35 Pa static pressure

For the most challenging spaces

The Mini ECOi LZ2 R32 VRF system is the ideal solution to fit into any application thanks to its compact design and long piping length support.

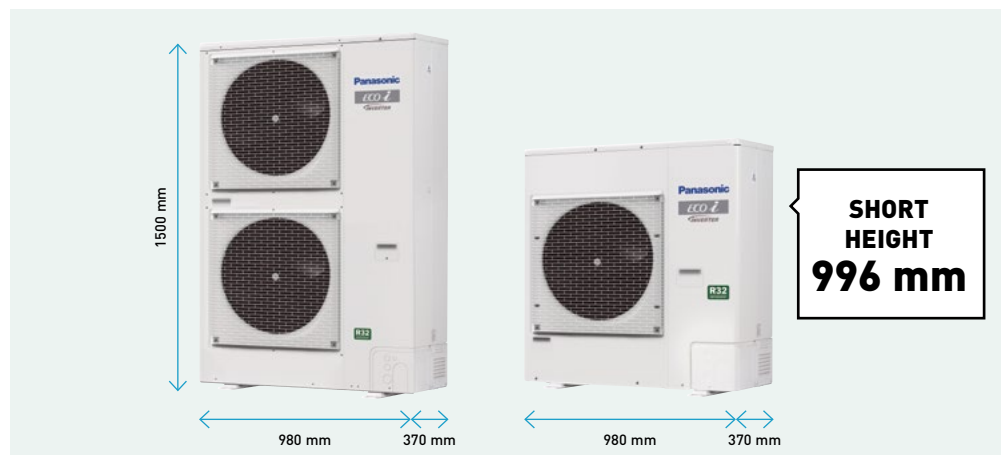

Extended design operation conditions

LZ2 mini VRF is extremely reliable even under the most difficult conditions. The units can operate in cooling mode at extreme temperatures, 52 °C in cooling and -20 °C in heating mode.

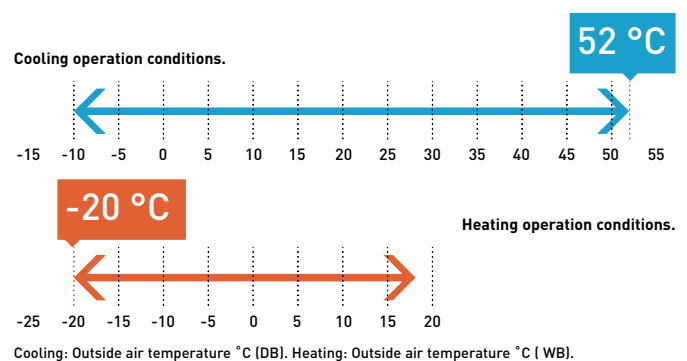
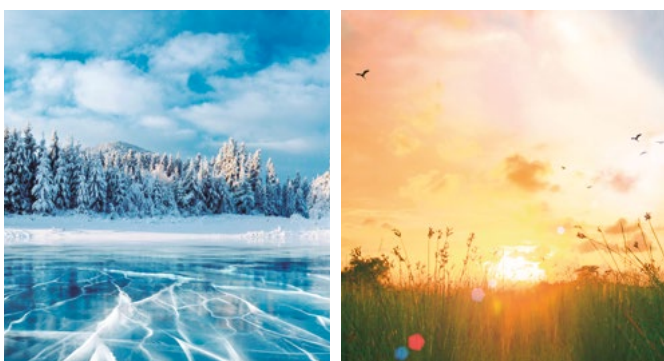

Compatible with a large range of indoor units and controls

An expansion of Panasonic VRF line up, the Mini ECOi R32 is compatible with a large range of indoor units and can utilize all Panasonic's scalable control and monitoring solutions.

Wide range of indoor units, either supporting Panasonic's optional R32 refrigerant leak detector alarm or having built-in detectors provide a great flexibility for all types of installation.

Scaling your control options from a single zone to geographically distributed facilities.

LZ2 series are fully compatible with all control and connectivity solutions from Panasonic. With a wide range of individual controllers, hotel room controllers, optional wireless adapters, VRF Smart Connectivity+, easy BMS connection with P-link and Panasonic AC Smart Cloud compatibility. LZ2 series, the most flexible control and monitoring R32 solution in the market.

	4 way 90x90 cassette		Connects to Panasonic R32 sensor
	4 way 60x60 cassette		Connects to Panasonic R32 sensor
	Variable static pressure adaptive duct		Built-in R32 sensors
	Wall-mounted		Connects to Panasonic R32 sensor
	Slim variable static pressure hide-away		Connects to Panasonic R32 sensor

Panasonic R32 refrigerant leak detector/alarm (optional)

For compatible indoor unit models, Panasonic offers its optional external Panasonic R32 refrigerant leak detector (CZ-CGLSC1). This enables the customer to decide if a Panasonic R32 refrigerant leak detector is required to comply with the restrictions, or if the indoor unit may be safely installed in this room without it. This optional leakage detection sensor has an integrated alarm buzzer and can output a signal to a central alarm system in the building. The device is connected to the remote control terminals of the indoor unit and can be used in combination with any of the Panasonic VRF remote controllers, either wired or wireless.

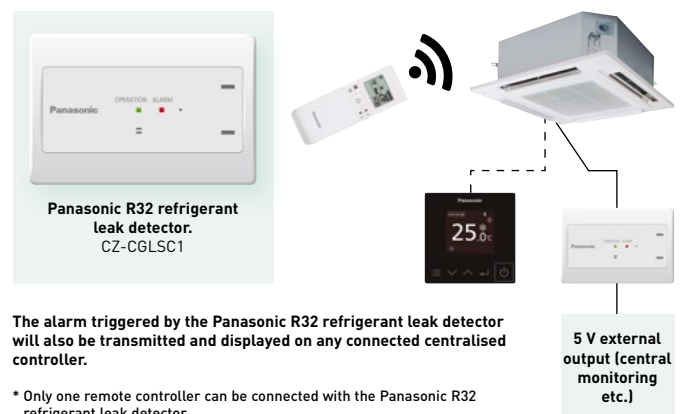

R32 Pump Down solution

New R32 Pump Down solution which offers the assurance of additional safety protection, whilst expanding the potential installation cases, allowing for installation within smaller rooms.

Suitable for the Mini ECOi LZ2 range up to 10 HP, compatible indoor units connected to CZ-CGLSC1 or integrated Panasonic R32 refrigerant leak detector.

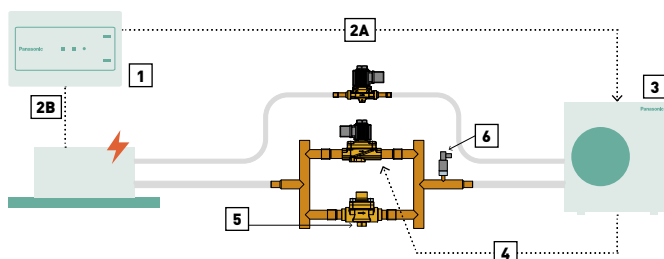

Operation steps: 1 | A leak is detected by the leak detection sensor. 2A | Leak alarm signal is sent to the outdoor unit. 2B | Indoor unit fan activated and runs at maximum speed. 3 | Pump Down procedure is activated. 4 | Solenoid valves are closed preventing refrigerant returning to indoor units. 5 | Outdoor unit is operating in Pump Down mode and check valve only allows flow to the outdoor unit. 6 | Low pressure switch threshold is reached. Error signal isolates the outdoor unit, preventing restart.

Technical Focus

- Simplified design and installation
- Complies with IEC 60335-2-40 ed.6.0
- Recovers base charge within outdoor unit
- Expands potential installation cases
- IP rated connections for outdoor installation

Model reference	Description
PAW-PUD2WB-1	Basic Pump Down system (2 way) for one R32 Mini ECOi outdoor unit

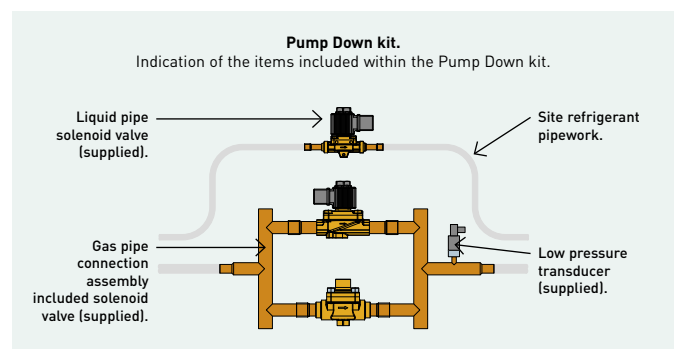

**SHORT
HEIGHT
996 mm**



Mini ECOi LZ2 Series 4 to 6 HP - R32

Outstanding efficiency in a compact body and continuous operation even at extreme ambient temperatures.

HP		4 HP	5 HP	6 HP	4 HP	5 HP	6 HP	
Outdoor unit		U-4LZ2E5	U-5LZ2E5	U-6LZ2E5	U-4LZ2E8	U-5LZ2E8	U-6LZ2E8	
Power supply	Voltage	V	220-230-240	220-230-240	220-230-240	380-400-415	380-400-415	
	Phase		Single phase	Single phase	Single phase	Three phase	Three phase	
	Frequency	Hz	50	50	50	50	50	
Cooling capacity	kW	12,1	14,0	15,5	12,1	14,0	15,5	
EER ¹⁾	W/W	4,53	4,12	3,88	4,53	4,12	3,88	
Recommended combination		2 x S-60MU2E5B	4 x S-36MU2E5B	2 x S-36MU2E5B + 2 x S-45MU2E5B	2 x S-60MU2E5B	4 x S-36MU2E5B	2 x S-36MU2E5B + 2 x S-45MU2E5B	
SEER ²⁾		8,50	8,12	7,71	8,50	8,12	7,71	
$\eta_{s,c}$	%	337,0	321,8	305,4	337,0	321,8	305,4	
Current	A	13,30-12,80-12,20	16,90-16,20-15,50	19,60-18,70-18,00	4,37-4,15-4,00	5,50-5,23-5,04	6,44-6,12-5,89	
Input power	kW	2,67	3,40	4,00	2,67	3,40	4,00	
Heating capacity	kW	12,5	16,0	16,5	12,5	16,0	16,5	
COP ¹⁾	W/W	5,27	4,71	4,42	5,27	4,71	4,42	
SCOP ²⁾		5,05	4,61	4,59	5,05	4,61	4,59	
$\eta_{s,h}$	%	199,0	181,4	180,6	199,0	181,4	180,6	
Current	A	12,00-11,40-11,00	16,90-16,20-15,50	18,50-17,70-17,00	3,91-3,71-3,58	5,50-5,22-5,03	6,02-5,72-5,51	
Input power	kW	2,37	3,40	3,73	2,37	3,40	3,73	
Starting current	A	1,0	1,0	1,0	1,0	1,0	1,0	
Maximum current	A	19,6	23,7	26,5	7,2	9,2	9,9	
Maximum input power	kW	3,92-4,10-4,28	4,76-4,98-5,19	5,41-5,66-5,90	4,40-4,63-4,80	5,69-5,99-6,22	6,15-6,47-6,72	
Maximum number of connectable indoor units ³⁾		7(10)	8(12)	9(12)	7(10)	8(12)	9(12)	
External static pressure	Pa	0-35	0-35	0-35	0-35	0-35	0-35	
Air flow	m ³ /min	69	72	74	69	72	74	
Sound pressure	Cool	dB(A)	52	53	54	52	53	
	Cool (Silent 1/2/3/4)	dB(A)	49/47/45/45	50/48/46/45	51/49/47/45	49/47/45/45	50/48/46/45	51/49/47/45
	Heat	dB(A)	54	56	56	54	56	56
Sound power	Cool / Heat	dB(A)	69/72	70/74	72/75	69/72	70/74	72/75
Dimension	HxWxD	mm	996x980x370	996x980x370	996x980x370	996x980x370	996x980x370	
Net weight		kg	94	94	94	94	94	
Piping diameter	Liquid pipe	Inch (mm)	3/8(9,52)	3/8(9,52)	3/8(9,52)	3/8(9,52)	3/8(9,52)	
	Gas pipe	Inch (mm)	5/8(15,88)	5/8(15,88)	5/8(15,88)	5/8(15,88)	5/8(15,88)	
Maximum piping length (total)	m	90(180)	90(180)	90(180)	90(180)	90(180)	90(180)	
Elevation difference (in / out)	m	50(OD above)/ 40(OD below)	50(OD above)/ 40(OD below)	50(OD above)/ 40(OD below)	50(OD above)/ 40(OD below)	50(OD above)/ 40(OD below)	50(OD above)/ 40(OD below)	
Refrigerant (R32)	kg	2,7	2,7	2,7	2,7	2,7	2,7	
Maximum allowable indoor / outdoor capacity ratio ⁴⁾	%	50-150(130)	50-150(130)	50-150(130)	50-150(130)	50-150(130)	50-150(130)	
Operating range	Cool Min - Max	°C	-10-52	-10-52	-10-52	-10-52	-10-52	
	Heat Min - Max	°C	-20-18	-20-18	-20-18	-20-18	-20-18	

1) EER and COP calculation is based on EN 14511. 2) SEER / SCOP is calculated based on the seasonal space cooling / heating efficiency "η" values of the COMMISSION REGULATION (EU) 2016/2281. SEER, SCOP = (η + Correction) × PEF. 3) The number in parenthesis indicates maximum number of connectable indoor unit in case of 1,5kW indoor units connection. 4) The number in parenthesis indicates maximum allowed indoor / outdoor capacity ratio in case of 1,5 kW indoor units connection.

Minimum environmental impact

Panasonic has designed the LZ2 series in order to minimize the environmental impact of the system. Low GWP refrigerant R32 and highest efficiency levels ensure this through the total operational lifetime.

For the most challenging spaces

The Mini ECOi LZ2 R32 VRF system is the ideal solution to fit into any application thanks to its compact design and long piping lengths.

Technical focus

- SEER levels up to 8,50 and SCOP levels up to 5,05 (for 4 HP model)
- Continuous operation at extreme ambient temperatures: -20 °C (heating) to 52 °C (cooling)
- Wide range of connectable units
- Unique indoors with nanoe™ X, hydroxyl radicals contained in water
- Allowing wide range of installations with and without mitigation measures
- Flexible mitigation measures, with Panasonic R32 refrigerant leak detector / alarm to be installed only when required



INTERNET CONTROL: Optional.



**INDUSTRY 1ST
8 HP AND 10 HP
MINI VRF UNITS
WITH R32**

Mini ECOi LZ2 Series 8 and 10 HP - R32

Introducing widest range of R32 Mini VRF.

HP			8 HP	10 HP
Outdoor unit			U-8LZ2E8	U-10LZ2E8
Power supply	Voltage	V	380-400-415	380-400-415
	Phase		Three phase	Three phase
	Frequency	Hz	50	50
Cooling capacity		kW	22,4	28,0
EER ¹⁾		W/W	3,84	3,47
Recommended combination			4 x S-56MU2E5B	4 x S-73MU2E5B
SEER ²⁾			7,56	7,08
$\eta_{s,c}$		%	293,3	274,7
Current		A	9,73 - 9,25 - 8,91	13,2 - 12,5 - 12,1
Input power		kW	5,83	8,07
Heating capacity		kW	25,0	28,0
COP ¹⁾		W/W	4,30	4,47
SCOP ²⁾			4,59	4,60
$\eta_{s,h}$		%	170,3	178,5
Current		A	9,81 - 9,32 - 8,98	10,5 - 9,93 - 9,57
Input power		kW	5,81	6,26
Starting current		A	1,0	1,0
Maximum current		A	13,7	19,5
Maximum input power		kW	8,21 - 8,64 - 8,96	11,9 - 12,6 - 13,0
Maximum number of connectable indoor units ³⁾			16	16
External static pressure		Pa	0-35	0-35
Air flow		m ³ /min	158	167
Sound pressure	Cool	dB(A)	59,0	60,0
	Cool (Silent 1/2/3/4)	dB(A)	56/54/52/50	57/55/53/50
Sound power	Cool	dB(A)	72	74
Dimension	H x W x D	mm	1500 x 980 x 370	1500 x 980 x 370
Net weight		kg	125	126
Piping diameter	Liquid pipe	Inch (mm)	3/8(9,52)	3/8(9,52)
	Gas pipe	Inch (mm)	3/4(19,05)	7/8(22,22)
Maximum piping length (total)		m	100(300)	100(300)
Elevation difference (in / out)		m	50(OD above)/40(OD below)	50(OD above)/40(OD below)
Refrigerant (R32)		kg	4,9	5,1
Maximum allowable indoor / outdoor capacity ratio ⁴⁾		%	50-150(130)	50-150(130)
Operating range	Cool Min ~ Max	°C	-10-52	-10-52
	Heat Min ~ Max	°C	-20-18	-20-18

1) EER and COP calculation is based on EN 14511. 2) SEER / SCOP is calculated based on the seasonal space cooling / heating efficiency "η" values of the COMMISSION REGULATION (EU) 2016/2281. SEER, SCOP = (η + Correction) × PEF. 3) The number in parenthesis indicates maximum number of connectable indoor unit in case of 1,5kW indoor units connection. 4) The number in parenthesis indicates maximum allowed indoor / outdoor capacity ratio in case of 1,5 kW indoor units connection.

Perfect fit for small to medium size projects

8 and 10 HP LZ2 Mini VRF units bring in the total benefits of a VRF system in a smaller application. You can enjoy advanced individual and central VRF control options including the revolutionary Panasonic AC Smart Cloud and AC Service Cloud.

For the most difficult conditions

The Mini ECOi LZ2 series are able to operate at the hardest conditions from -20 °C up to +52 °C providing continuous and efficient, heating and cooling for your space all year long.

Technical focus

- SEER levels up to 7,56 and SCOP levels up to 4,59 (for 8 HP model)
- Continuous operation at extreme ambient temperatures: -20 °C (heating) to 52 °C (cooling)
- Widest range of connectable units in R32 VRF
- Unique indoors with nanoe™ X, hydroxyl radicals contained in water
- Allowing wide range of installations with and without refrigerant mitigation
- Flexible mitigation measures, with Panasonic R32 refrigerant leak detector / alarm to be installed only when required



INTERNET CONTROL: Optional.

Rating Conditions: Cooling Indoor 27 °C DB / 19 °C WB. Cooling Outdoor 35 °C DB / 24 °C WB. Heating Indoor 20 °C DB. Heating Outdoor 7 °C DB / 6 °C WB. (DB: Dry Bulb; WB: Wet Bulb). Specifications subject to change without notice. For detailed information about ErP / Energy Labelling, please visit our websites www.aircon.panasonic.eu or www.ptc.panasonic.eu.

Mini ECOi LE Series for light commercial and residential use

Mini ECOi with extraordinary energy-saving performance and high external static pressure (35Pa).

**COMPACT
DESIGN**



ECO*i*

7,9
SEER | **4,9***
SCOP
INDUSTRY LEADING
EFFICIENCY



6,4*
SEER
4,3
SCOP

Advantages of Mini ECOi LE Series used for medium sized buildings.

1 Efficiency energy control

Upgraded outdoor units deliver high efficiency rating and reduced energy costs.

2 Space saving

Ideal for commercial locations with limited space such as banks and shops. Compact units integrate easily and discreetly into building design.

3 Flexible installation

Reduced installation time thanks to compact units and extra long piping without additional refrigeration charge. High external static pressure 35 Pa and small chassis increase installation options.

Compact design: LE2 Series - 4 / 5 / 6 HP

- Extraordinary energy saving: 7,9 SEER and 4,9 SCOP (4 HP)*
- 50 m piping length without additional refrigerant charge
- Quiet operation mode with 4 levels
- High COP mode option

* SEER / SCOP is calculated based on the seasonal space cooling / heating efficiency "η" values of the COMMISSION REGULATION (EU) 2016/2281. SEER, SCOP = (η + Correction) × PEF.

LE1 Series - 8 / 10 HP

- 60 % smaller than ECOi ME2 8 / 10 HP with vertical flow type
- Flexible piping length (Total: 300 m, Furthest: 150 m)
- Maximum number of connectable indoor units: 15

Key features for LE2 / LE1.

- High external static pressure 35 Pa
- Full range of ECOi indoor units and controllers
- Variable evaporation temperature control as standard
- Connectable maximum indoor / outdoor capacity ratio up to 130 %
- Auto restart from outdoor units
- Demand response (Peak cut) by optional parts
- Suitable for R22 renewable projects

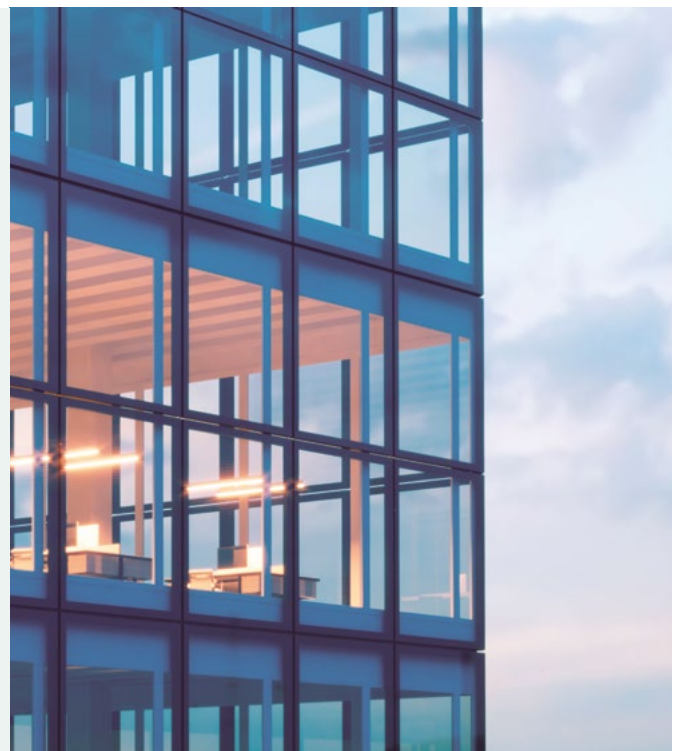

Flexible, easy and hassle free installation

- Compact space-saving design
- High external static pressure 35 Pa
- Long piping length for flexible installation
- No refrigeration charge up to 50 m
- 130 % ratio for connectable indoor capacity units

High external static pressure 35 Pa

- High air pressure
- New blade shape
- Good for high class condominiums

When unit is installed on a narrow balcony and exposed to the sun, the barrier at the front side would restrict hot air from being discharged. Heat accumulated in an enclosure can cause over-heating. This could potentially result in damage or shorten the product's life span. A high external static pressure sends the air further away from the outdoor unit and through the barrier. This provides better air circulation and distribution. And a high air pressure of 35 Pa discharges the hot air a sufficient distance.

Previous model - low pressure

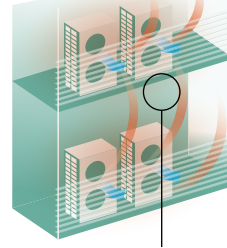

Heat accumulated.
When the pressure is low, hot air will accumulate in the unit thus affecting its work performance and that of unit above it as well.



LE Series - high pressure



Heat discharged.
But with a high pressure of 35 Pa, hot air is sent further away preventing overheating inside the outdoor unit enclosure.



Long piping design length for greater design flexibility

LE1: Maximum total piping length: 300 m.
LE2: Maximum total piping length: 180 m.

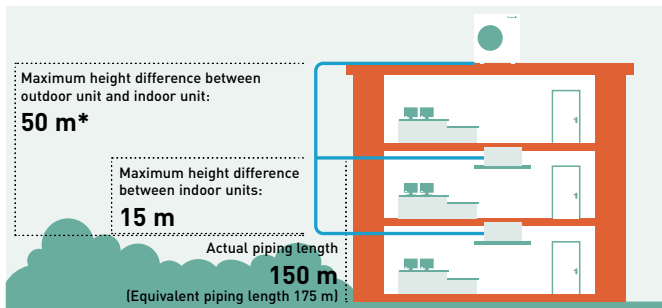

* 40 m if the outdoor unit is below the indoor unit.

Plug and Play concept

- 50 m piping length free of charge
- A 50 m pipe length is sufficient for most residential and small business buildings

FREE OF CHARGE
50 m

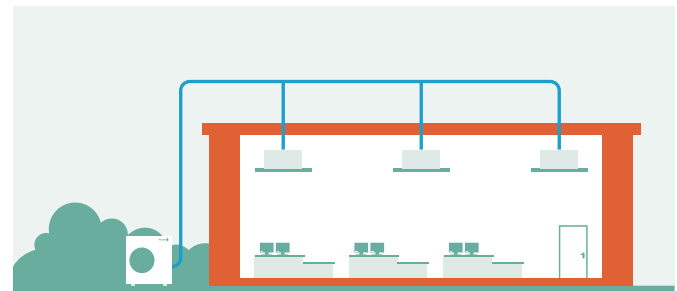

Connection of up to 15 indoor units

An expansion from Panasonic VRF line up, the mini ECOi is compatible with the same indoor units and controls as the rest of the ECOi range.

Compact design

Mini ECOi LE Series is a single unit.

Perfect for installations with limited space and easy to hide within a modern building. Flexible space-saving options compared to single split system.

LE2 short height of 996 mm.

LE2 Series is 25 % smaller in height than conventional model.

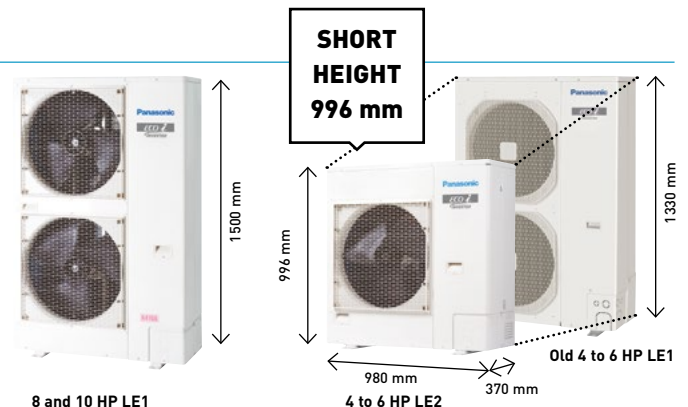



Energy control and reliability

The Mini ECOi system delivering energy-saving performance, powerful operation, reliability and comfort surpassing anything previously possible.

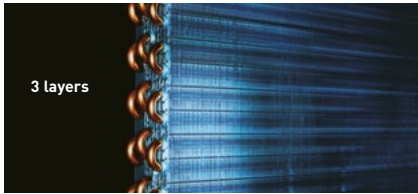

Powerful heat exchanger.
3 layers of heat exchanger for all LE Series. LE Series features the same heat exchange volume as conventional model even though it is 15 % smaller in size.

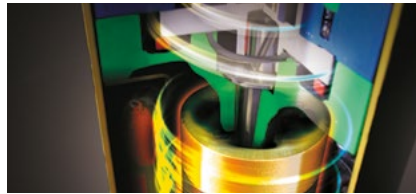

Panasonic twin rotary compressor.
A large capacity inverter compressor has been adopted. This compressor features wider and 0,1 Hz step inverter control.



Design fan.
Fan blades have been redesigned to inhibit air resistance and to increase efficiency. The larger fan increases air flow while maintaining low noise levels.

Energy savings design

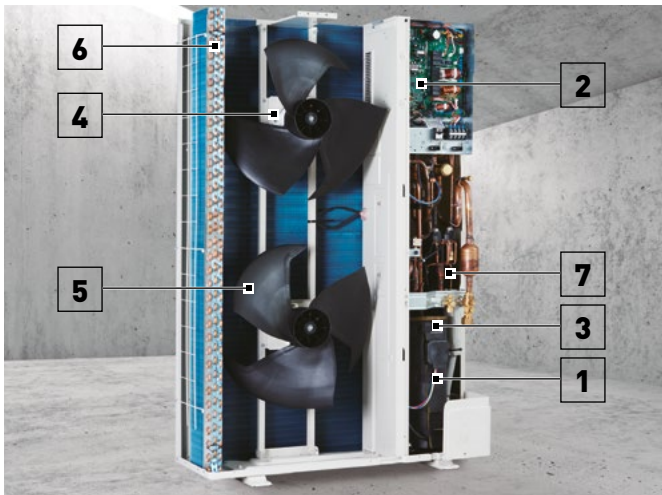

- 1 | **Panasonic Inverter compressor.** A large-capacity inverter compressor has been adopted. The inverter compressor is superior in performance with improved partial-load capacity.
- 2 | **Printed circuit board.** The number of PCB is 2 pieces for making maintenance easier.
- 3 | **Accumulator.** A large accumulator has been adopted to maintain compressor reliability because of the increased refrigerant quantity, which allows an extended maximum piping length.
- 4 | **DC fan motor.** Checking load and outside temperature, the DC motor is controlled for optimum air flow.
- 5 | **Newly designed fan.** The newly designed fan blades have been developed to inhibit air turbulence and to increase efficiency. As fan diameter has been increased its size, the air flow has been increased whilst maintaining a same sound level.
- 6 | **Heat exchanger and copper tubes.** The heat exchanger size and the copper tube sizes in the heat exchanger have been redesigned to increase efficiency.
- 7 | **Oil separator.** A centrifugal separator has been adopted to improve oil separation efficiency and reduce refrigerant pressure loss.

Bluefin condenser: high durability outdoor unit

The anti-corrosion Bluefin treatment of the heat exchanger provides greater resistance against corrosion. All models are equipped with Bluefin condenser and corrosion-resistance treated for high resistance to rust and salty air to assure long-lasting performance.

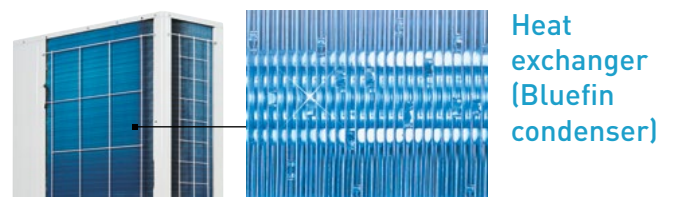

Heat exchanger (Bluefin condenser)

Maximum comfort with quiet operation mode

- Quiet operation mode reduces outdoor unit operating sound by 7dB(A)
- 4-step set point is available
- Silent mode 1 maintains rated cooling capacity

* Timer setting of quiet operation mode is available in High-spec remote controller.

Silent mode options	Sound pressure level
Silent mode 1	-1,5dB(A)
Silent mode 2	-3dB(A)
Silent mode 3	-5dB(A)
Silent mode 4	-7dB(A)

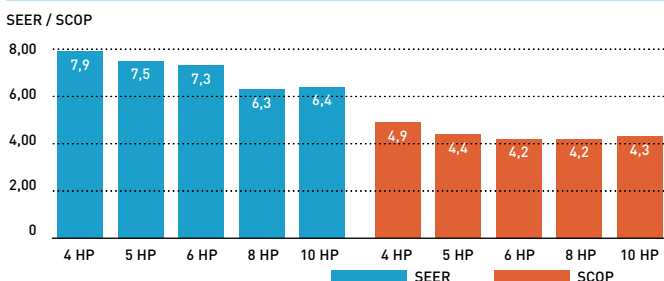

Superior seasonal energy efficiency (SEER / SCOP follows LOT21*)

The operation efficiency has been improved using highly efficient R410A refrigerant, a DC Inverter compressor, DC motor and a heat exchanger design.

* SEER / SCOP is calculated based on the seasonal space cooling / heating efficiency "η" values of the COMMISSION REGULATION (EU) 2016/2281. SEER, SCOP = [η + Correction] × PEF.

Mini ECOi LE2 Series high efficiency 4 to 6 HP - R410A

Panasonic Mini ECOi. Extraordinary energy-saving.
The most compact ECOi system ever.



HP		4 HP	5 HP	6 HP	4 HP	5 HP	6 HP	
Outdoor unit		U-4LE2E5	U-5LE2E5	U-6LE2E5	U-4LE2E8	U-5LE2E8	U-6LE2E8	
Power supply	Voltage	V	220 - 230 - 240	220 - 230 - 240	220 - 230 - 240	380 - 400 - 415	380 - 400 - 415	
	Phase		Single phase	Single phase	Single phase	Three phase	Three phase	
	Frequency	Hz	50	50	50	50	50	
Cooling capacity	kW	12,1	14,0	15,5	12,1	14,0	15,5	
EER¹⁾	W/W	4,50	4,06	3,73	4,50	4,06	3,73	
Recommended combination		3 x S-28MF2E5A + 1 x S-36MF2E5A	4 x S-36MF2E5A	2 x S-36MF2E5A + 2 x S-45MF2E5A	3 x S-28MF2E5A + 1 x S-36MF2E5A	4 x S-36MF2E5A	2 x S-36MF2E5A + 2 x S-45MF2E5A	
SEER²⁾		7,9	7,5	7,3	7,9	7,5	7,3	
$\eta_{s,c}$	%	311,0	296,2	286,8	311,0	296,2	286,8	
Current	A	13,30 - 12,70 - 12,20	16,30 - 15,60 - 17,00	20,30 - 19,40 - 18,60	4,39 - 4,17 - 4,02	5,58 - 5,30 - 5,11	6,71 - 6,37 - 6,14	
Input power	kW	2,69	3,45	4,15	2,69	3,45	4,15	
Heating capacity	kW	12,5	16,0	16,5	12,5	16,0	16,5	
COP¹⁾	W/W	5,19	4,60	4,27	5,19	4,60	4,27	
SCOP²⁾		4,9	4,4	4,2	4,9	4,4	4,2	
$\eta_{s,h}$	%	191,8	172,9	166,7	191,8	172,9	166,7	
Current	A	12,20 - 11,60 - 11,20	17,60 - 16,80 - 16,10	19,10 - 18,20 - 17,50	3,98 - 3,78 - 3,64	5,62 - 5,34 - 5,14	6,24 - 5,93 - 5,71	
Input power	kW	2,41	3,48	3,86	2,41	3,48	3,86	
Starting current	A	1,00	1,00	1,00	1,00	1,00	1,00	
Maximum current	A	17,30	24,30	27,40	7,90	10,10	10,70	
Maximum input power	kW	3,50 - 3,66 - 3,82	4,92 - 5,14 - 5,37	5,61 - 5,86 - 6,12	4,34 - 5,09 - 5,28	6,25 - 6,55 - 6,82	6,62 - 6,97 - 7,23	
Maximum number of connectable indoor units ³⁾		7(10)	8(10)	9(12)	7(10)	8(10)	9(12)	
External static pressure	Pa	0 - 35	0 - 35	0 - 35	0 - 35	0 - 35	0 - 35	
Air flow	m ³ /min	69	72	74	69	72	74	
Sound pressure	Cool	dB(A)	52	53	54	52	53	
	Cool (Silent 1/2/3/4)	dB(A)	50,5/49/47/45	51,5/50/48/46	52,5/51/48/46	50,5/49/49/47	48,5/50/48/46	48,5/50/48/46
	Heat	dB(A)	54	56	56	54	56	56
Sound power	Cool / Heat	dB(A)	69/72	71/75	73/75	69/72	71/75	
Dimension	HxWxD	mm	996x980x370	996x980x370	996x980x370	996x980x370	996x980x370	
Net weight	kg	106	106	106	106	106	106	
Piping diameter	Liquid pipe	Inch (mm)	3/8(9,52)	3/8(9,52)	3/8(9,52)	3/8(9,52)	3/8(9,52)	
	Gas pipe	Inch (mm)	5/8(15,88)	5/8(15,88)	5/8(15,88)	5/8(15,88)	5/8(15,88)	
Maximum piping length (total)	m	150(180)	150(180)	150(180)	150(180)	150(180)	150(180)	
Elevation difference (in / out)	m	50(OD above)/ 40(OD below)	50(OD above)/ 40(OD below)	50(OD above)/ 40(OD below)	50(OD above)/ 40(OD below)	50(OD above)/ 40(OD below)	50(OD above)/ 40(OD below)	
Refrigerant (R410A) / CO ₂ Eq.	kg / T	6,70(14,40)/ 13,9896	6,70(14,40)/ 13,9896	6,70(14,40)/ 13,9896	6,70(14,40)/ 13,9896	6,70(14,40)/ 13,9896	6,70(14,40)/ 13,9896	
Maximum allowable indoor / outdoor capacity ratio	%	50 - 130	50 - 130	50 - 130	50 - 130	50 - 130	50 - 130	
Operating range	Cool Min - Max	°C	-10 ~ +46	-10 ~ +46	-10 ~ +46	-10 ~ +46	-10 ~ +46	
	Heat Min - Max	°C	-20 ~ +18	-20 ~ +18	-20 ~ +18	-20 ~ +18	-20 ~ +18	

1) EER and COP calculation is based in accordance to EN14511. 2) SEER / SCOP is calculated based on the seasonal space cooling / heating efficiency "η" values of the COMMISSION REGULATION (EU) 2016/2281. SEER, SCOP = (η + Correction) × PEF. 3) In case of 1,5 kW indoor units connection, able to connect maximum 12 indoor units.

For light commercial use

Mini ECOi allows easier installation in condominiums and medium sized buildings with limited spaces. Utilising R410A and DC inverter technology, Panasonic offers VRF to a new and growing market.

Reduced height of 996 mm

In addition to raising efficiency, the outdoor unit has been designed to be as compact as possible. It can now be installed in places that were previously too small.

Technical focus

- Outstanding SEER and SCOP
- Better efficiency even compared to 2 fan outdoor units
- 50 m piping without additional refrigeration charge
- High static pressure 35 Pa
- High COP mode selectable with maintenance remote controller
- Selectable silent mode



INTERNET CONTROL: Optional.



**Mini ECOi LE1 Series high efficiency 8 and 10 HP · R410A****Prepare to be blown away by Panasonic's Mini VRF system.**

The Mini VRF compact system is the ideal solution for minimum outdoor space. Panasonic extends the Mini VRF range by 8 and 10 HP units.



HP			8 HP	10 HP
Outdoor unit			U-8LE1E8	U-10LE1E8
Power supply	Voltage	V	380-400-415	380-400-415
	Phase		Three phase	Three phase
	Frequency	Hz	50	50
Cooling capacity		kW	22,4	28,0
EER ¹⁾		W/W	3,80	3,11
Recommended combination			4 x S-56MF2E5A	4 x S-73MF2E5A
SEER ²⁾			6,3	6,4
η_{s,c}		%	247,9	251,8
Current		A	9,60 - 9,15 - 8,80	14,70 - 14,00 - 13,50
Input power		kW	5,89	9,00
Heating capacity		kW	25,0	28,0
COP ¹⁾		W/W	4,02	3,93
SCOP ²⁾			4,2	4,3
η_{s,h}		%	166,4	169,5
Current		A	10,20 - 9,65 - 9,30	11,60 - 11,10 - 10,70
Input power		kW	6,22	7,13
Starting current		A	1,00	1,00
Maximum current		A	13,70	19,60
Maximum input power		kW	9,16	13,10
Maximum number of connectable indoor units ³⁾			15	15
External static pressure		Pa	0-35	0-35
Air flow		m ³ /min	150	160
Sound pressure	Cool	dB(A)	60	63
	Cool (Silent 1/2/3)	dB(A)	57/55/53	60/58/56
	Heat	dB(A)	64	65
Sound power	Cool / Heat	dB(A)	81/85	84/86
Dimension	H x W x D	mm	1500 x 980 x 370	1500 x 980 x 370
Net weight		kg	132	133
Piping diameter	Liquid pipe	Inch (mm)	3/8(9,52) ⁴⁾ / 1/2(12,70) ⁵⁾	3/8(9,52) ⁴⁾ / 1/2(12,70) ⁵⁾
	Gas pipe	Inch (mm)	3/4(19,05) ⁴⁾ / 7/8(22,22) ⁵⁾	7/8(22,22) ⁴⁾ / 1(25,40) ⁵⁾
Maximum piping length (total)		m	7,5 - 150(7,5 - 300)	7,5 - 150(7,5 - 300)
Elevation difference (in / out)		m	50(OD above) / 40(OD below)	50(OD above) / 40(OD below)
Refrigerant (R410A) / CO ₂ Eq.		kg / T	6,30(24,00) / 13,1544	6,60(24,00) / 13,7808
Maximum allowable indoor / outdoor capacity ratio		%	50 - 130	50 - 130
Operating range	Cool Min ~ Max	°C	-10 ~ +46	-10 ~ +46
	Heat Min ~ Max	°C	-20 ~ +18	-20 ~ +18

1) EER and COP calculation is based in accordance to EN14511. 2) SEER / SCOP is calculated based on the seasonal space cooling / heating efficiency "η" values of the COMMISSION REGULATION (EU) 2016/2281. SEER, SCOP = (η + Correction) × PEF. 3) If the heating utilized, it is necessary to increase 1 size with respect to the main liquid pipe, depending on the combination of the indoor unit. 4) Under 90 m for ultimate indoor unit. 5) Over 90 m for ultimate indoor unit. If the longest piping equivalent length exceeds 90 m, increase the sizes of the main tubes by 1 rank for gas and liquid pipes.

Increase external static pressure

When unit is installed on a narrow balcony, the fence at front side will be the obstacle. High external static pressure will overcome this obstacle and maintain operation capacity.

High ambient temperature performance

Cooling operating range up to 46 °C. The system can maintain the rated (100 %) capacity up to 40 °C by 8 HP model and up to 37 °C by 10 HP model.

Technical focus

- Piping flexibility with 150 m maximum length
- High efficiency
- Connection of up to 15 indoor units
- Quiet operation mode (one of the lowest in the market)
- High ambient temp performance
- High static pressure 35 Pa



INTERNET CONTROL: Optional.

Rating Conditions: Cooling Indoor 27 °C DB / 19 °C WB. Cooling Outdoor 35 °C DB / 24 °C WB. Heating Indoor 20 °C DB. Heating Outdoor 7 °C DB / 6 °C WB. [DB: Dry Bulb; WB: Wet Bulb]. Specifications subject to change without notice. For detailed information about ErP / Energy Labelling, please visit our websites www.aircon.panasonic.eu or www.ptc.panasonic.eu.



ECOi EX. The Game Changer



VRF with outstanding energy-saving performance and powerful operation SEER 7,70 (2-Pipe 18 HP model).



A game-changing VRF system delivering energy-saving performance, powerful operation, reliability and comfort surpassing anything previously possible.

It represents a true paradigm shift in air conditioning solutions. Taking quality to the extreme — that's the Panasonic challenge.

1 High performance at extreme conditions

ECOi EX is highly reliable, with strong cooling and heating power, even when operating at extreme ambient temperatures. The units can operate at 100 % of capacity at 43 °C, reaching a great cooling operation up to 52 °C and in heating to -25 °C*.

Also, the ECOi EX features include Bluefin in newly designed heat exchanger, improving efficiency in marine ambient. A silicone coated PCB (Printed Circuit Board) protects the unit from being damaged by environmental factors such as moisture and dust.

2 Outstanding efficiency and comfort

The ECOi EX system is designed to increase energy efficiency by delivering high SEER rating, as well as high efficiency for part-load operation.

The system has reduced energy costs thanks to "All-Inverter Compressors" with independent control, to deliver highly flexible performance. Also, the ECOi EX features an enlarged heat exchanger with triple surfaces that allow for improved heat transfer and a newly designed curved air discharge bell-mouth, for better aerodynamics. The three-stage oil recovery design makes it able to minimise the frequency of forced oil recovery, leading to reduced energy costs and sustained comfort.

3 Superior flexibility

With up to 1000* meters of pipeline, 30 meters maximum height difference between indoor units and maximum 90 meters between outdoor unit and indoor unit, the design possibilities have grown exponentially, making the ECOi EX the ideal air conditioning option for expansive buildings, such as train stations, airports, schools or hospitals. These advantages are enhanced with the wide range of indoor unit models and capacities, facilitating the perfect adaptation to all kind of projects. The careful selection of controls and peripherals such as the Pump Down, the AHU and / or the chiller, enables an optimised system selection. Maximum allowable indoor / outdoor connected capacity ratio of up to 200 %.

* Conditions of 2-Pipe ECOi EX ME2 Series.



TOP efficiency and comfort

Remarkable improvement on key components: extraordinary energy-saving performance and redesigned for smooth and better air discharge.

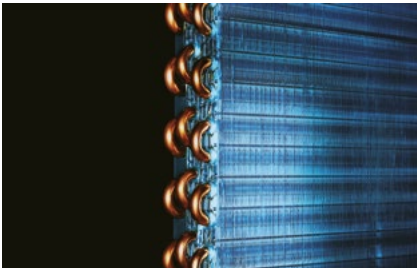

Enlarged heat exchanger surface area with triple surface.

* For 8 and 10 HP unit, the heat exchanger is 2 row design.



Multiple large-capacity all inverter compressors (from 14 HP).



Designed curved air discharge bell mouth for better aerodynamics.

Improvements on refrigerant circuit

Compressor.

Redesigned components in the body provide performance improvement especially in the rated cooling condition and AEER performance.



Accumulator.

Oil returning circuit with control valve makes efficient oil recovery to compressor.

Oil separator.

Modified tank design makes efficient oil separation with less pressure drop.



Receiver tank less design

Improved refrigerant control program recovers the remaining refrigerant gas in the system back to the accumulator tank effectively.



Smooth exhaust flow by bell-mouth

The curved shape with integrated top and bottom assure smooth exhaust flow. This gives more air-volume with same sound level, less input power at same air flow.

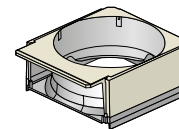

Conventional model (ME1)

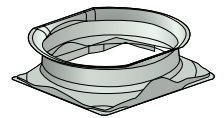

ME2 model

Sound pressure dB(A)

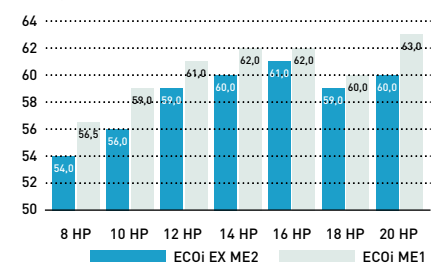

Combined 3 surface heat exchanger

The highly efficient piping pattern increases heat exchange performance by 5%. The heat exchanger features a 3 surface construction. Compared to the divided dual-surface construction in current models, there is no divided space and the face area of heat exchanger becomes larger.



Conventional model (ME1)



ME2 model

Oil recovery intelligent control

Oil recovery intelligent control advantages:

1. Higher efficiency
2. Durability
3. Comfort: continuous operation, low noise and low vibration

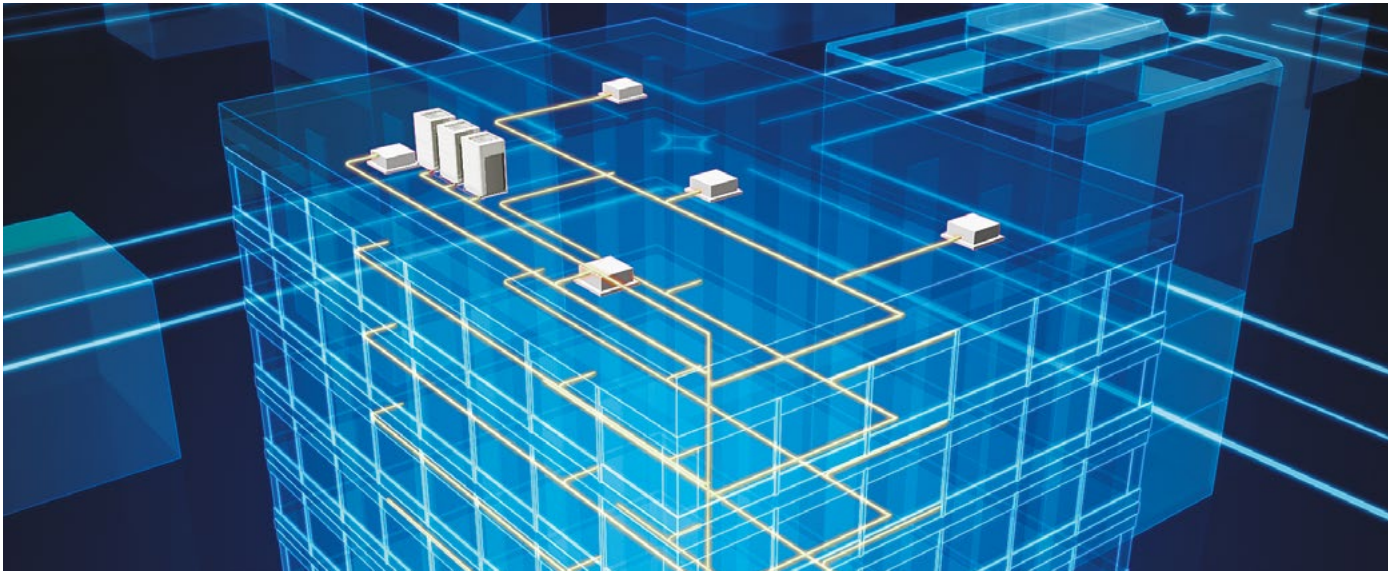

Intelligent 3-stage oil management system

In a VRF system, where lengthy piping and a large number of indoor units need to be controlled collectively, the key to maintaining the system's reliability is to ensure an appropriate amount of oil is secured in the compressors. In order to avoid oil shortage in the compressor, maximum operation is normally forcibly conducted at regular intervals to recover oil from indoor units. This method, typically employed in a standard VRF, causes the system to overheat or overcool and thus waste energy. In Panasonic VRF systems, a sensor for detecting oil levels is mounted in each compressor. In installations with multiple outdoor units, a shortage of oil in one compressor can be compensated for by recovering oil either from another compressor in the same unit, from a compressor in an adjacent outdoor unit, or from a connected indoor unit. Panasonic VRF systems provide users with a comfortable environment whilst saving energy.

The Panasonic system efficiently manages oil recovery in three stages; minimising the frequency of forced oil recovery while reducing energy cost and maintaining comfort.

STAGE-1: Panasonic compressors are equipped with sensors which monitor oil levels precisely at all times. If oil levels fall, oil can be transferred from other compressors within the same outdoor unit.

STAGE-2: If oil levels in all compressors within the outdoor unit fall, oil can be replenished from adjacent outdoor units.

STAGE-3: Forced oil recovery is implemented only if oil levels become insufficient in spite of above measures. The Panasonic system's design concept is radically different from conventional oil systems.

Features of oil recovery design

Oil sensors installed in each compressor.

Oil sensors installed in each Panasonic compressor precisely monitor oil levels, eliminating unnecessary oil recovery.

Highly functional oil separator.

Thanks to extended separate piping, oil recovery efficiency reaches 90 %, minimising the oil to be discharged from the compressor.

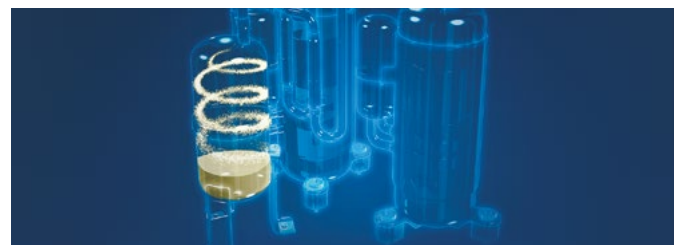

Twin rotary Inverter compressor

Two independently controlled inverter compressors achieve high efficiency. Redesigned components in the body provide performance improvement especially in the rated cooling condition and EER performance.

- Wider and flexible control on Inverter compressor
- Better oil lubrication
- Smooth start up

Extraordinary energy-saving performance

Designed for Actual Operation Performance. Panasonic builds air conditioning systems not only with a high EER for rated operation, but also with Seasonal-EER appropriate to the customer's actual environment of use. For instance, with rated operation, outdoor temperature is constant at 35 °C, but in reality the outdoor temperature is continuously changing. Consequently, required air conditioning performance also changes. That's why Panasonic implements the following kind of proprietary control.

- 1 | Set temperature is rapidly attained; full-load operating time is kept to a minimum.
- 2 | The frequency of forced oil recovery is minimised. The volume of oil within the compressors is monitored precisely by sensors, so forced oil recovery under full-load operation is conducted only when necessary. Since this suppresses noise due to oil recovery, comfort is maintained.
- 3 | Panasonic pursues a high EER, of course, as well as high EER in part load, for energy saving performance under a broad range of loads.

Panasonic's design concept contributes to substantial energy cost reductions.

Compressor efficiency electric system VRF.

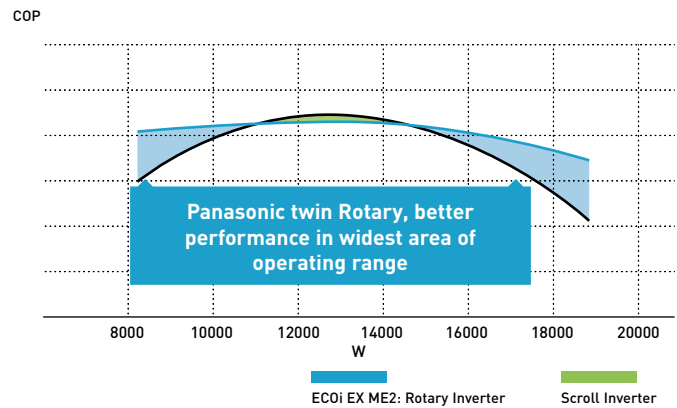

Number of Inverter compressors.

	2-Pipe ECOi EX ME2						3-Pipe ECOi EX MF3					
Size	Small		Medium		Large		Medium					
HP	8	10	12	14	16	18	20	8	10	12	14	16
Number	1 pc.		1 pc.		2 pcs.		2 pcs.		1 pc.		2 pcs.	

Actual operation data graph of Panasonic VRF

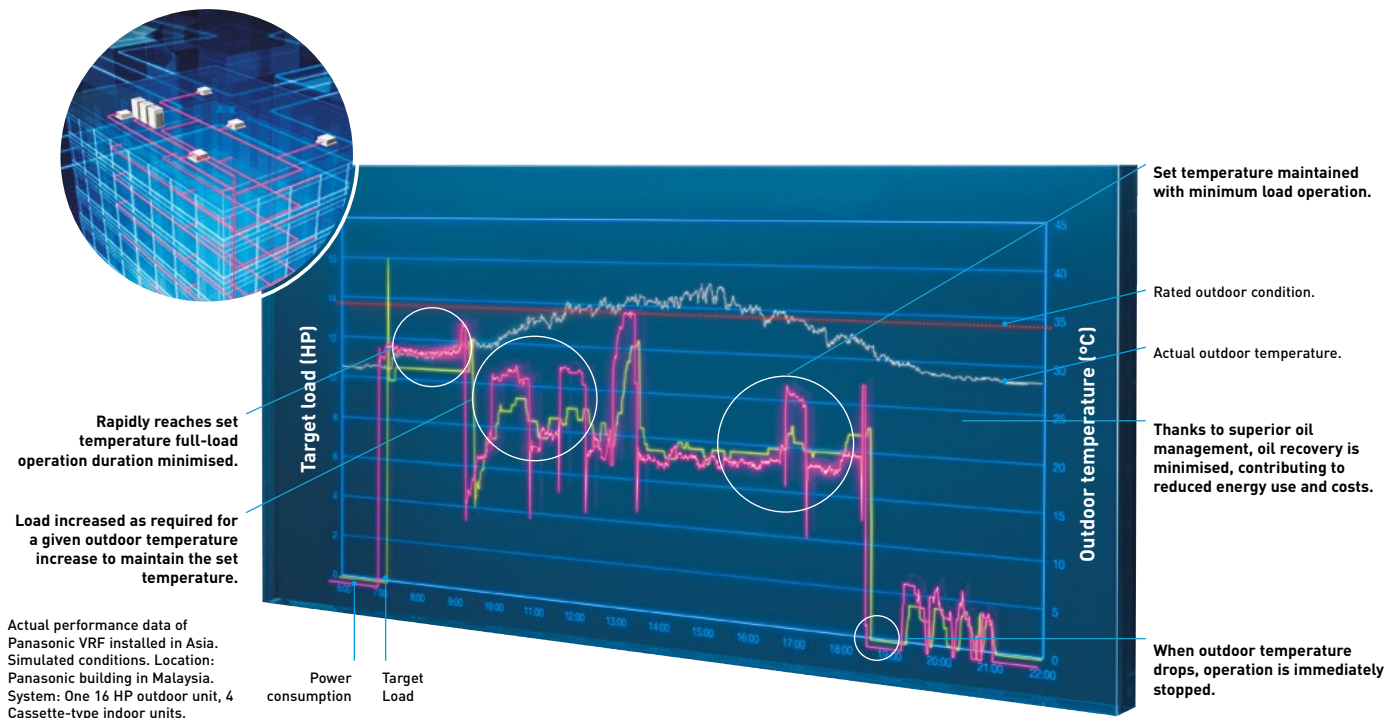

Superior quality, reliability and durability

High safety operation in case of breakdown!

Automatic Back-Up operation. Ensures heating and cooling.

It is possible for the system to keep working, even if the compressors, fan motor and the temperature sensor are damaged (even when a compressor fails in single unit with 2 compressors inside).

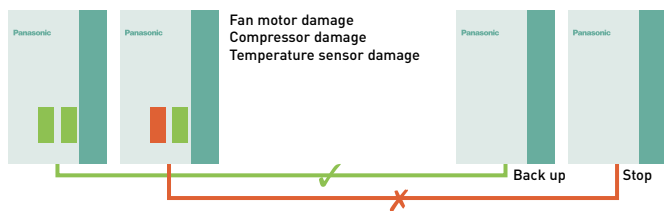

The system will still operate up to 25 % of the connected indoor units.

System will not stop when up to 25 % of indoor units have power supply breakdown when they are ON Mode.

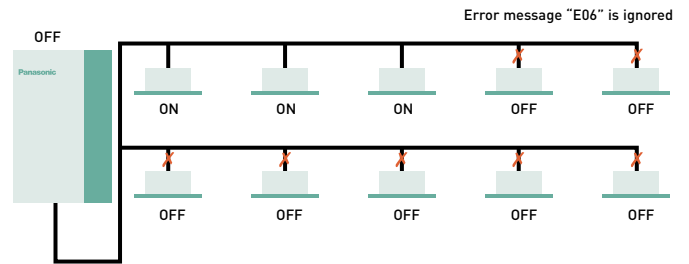

Hi-durability outdoor unit

Treated for high resistance to corrosion (rust and salty air) to ensure long-lasting performance.

Note: Selecting this unit does not completely eliminate the possibility of rust developing. For details concerning unit installation and maintenance, please consult an authorised dealer.

Specially protected parts.

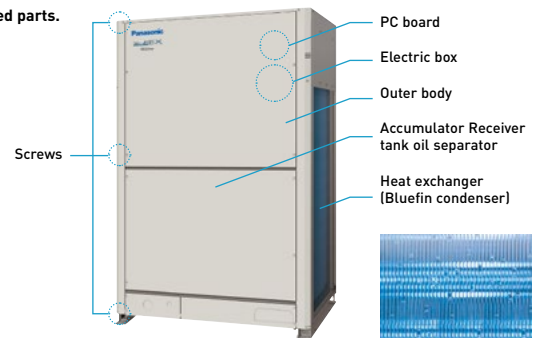

Extended compressor life by uniform compressor operation time

The total run-time of compressors are monitored by a built-in microcomputer, which ensures that operation times of all compressors within the same refrigerant circuit are balanced.

Compressors with histories showing shorter run times are selected first, ensuring equal wear and tear across all units and extending the working life of the system.

System example.

A,C: DC inverter compressor

B,D: Constant speed compressor

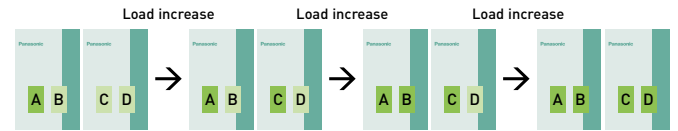

50 h 30 h 60 h 10 h

* Depend on accumulated operation time of each compressors.

* Compressor priority has possibility to be changed.

[e.g] Case 1: A→C→B→D, Case 2: C→A→D→B, Case 3: A→C→D→B, Case 4: C→A→B→D

* Also other cases available.

A large number of indoor unit models can be connected.



2-Pipe ECOi EX ME2 Series Extraordinary partial load, SEER and SCOP

Efficiency in VRF systems

The only way to compare so far, was the nominal efficiency at outdoor ambient temperature of 35 °C (EER) in Cooling and at 7 °C in heating (COP). With EN-14825 seasonal efficiency will be shown, the result will be SEER and SCOP. ECOi EX is reaching excellent performance without using any additional saving functions.

The highest EER / COP rating in most capacities

Compared to conventional model ECOi (ME1)

The ECOi EX marks a revolutionary step forward in VRF efficiency. A look at the incredible EER / COP value clearly indicates that. What's more, this high EER / COP value is achieved even during part load operation. This shows the extraordinary energy-saving performance the ECOi EX is capable of providing.

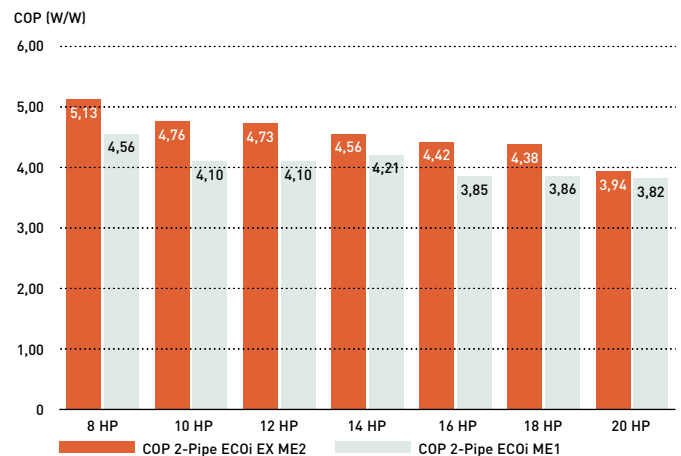
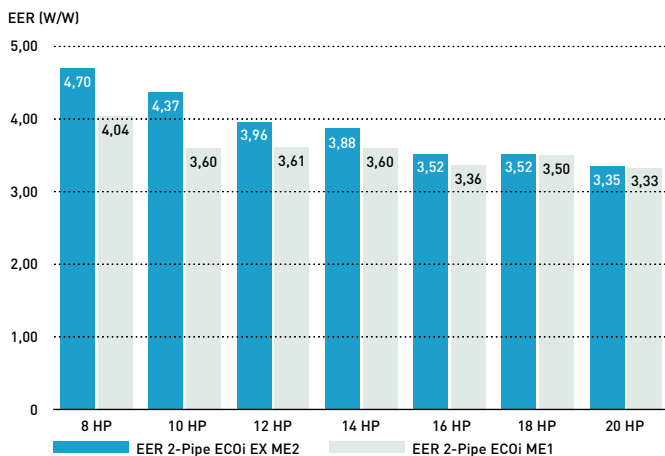

Partial load for seasonal and real system efficiency

VRF units are designed to adapt to the heating and cooling demand, adapting its performance to different outdoor conditions. When compressor runs at lower than 100 % capacity, the system is working at partial load. A wider compressor operating range results in better system performance both at full load and partial load conditions. Panasonic ECOi EX partial load is excellent, reaching a minimum of 15 % of compressor capacity.

Excellent efficiency at any condition and partial load

In both heating and cooling mode, Panasonic ECOi EX is reaching exceptional levels of efficiency.

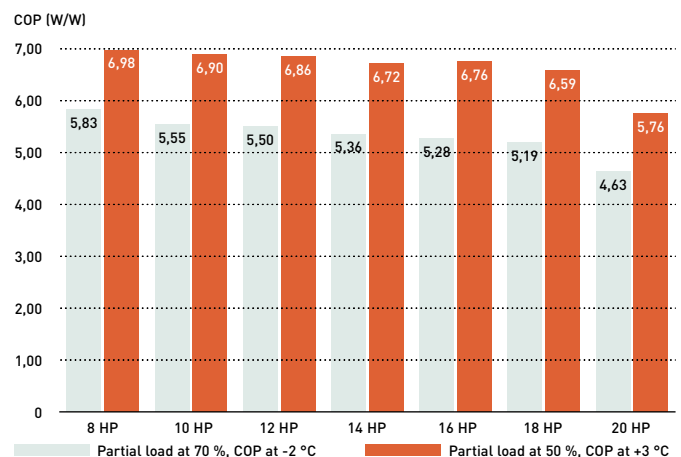
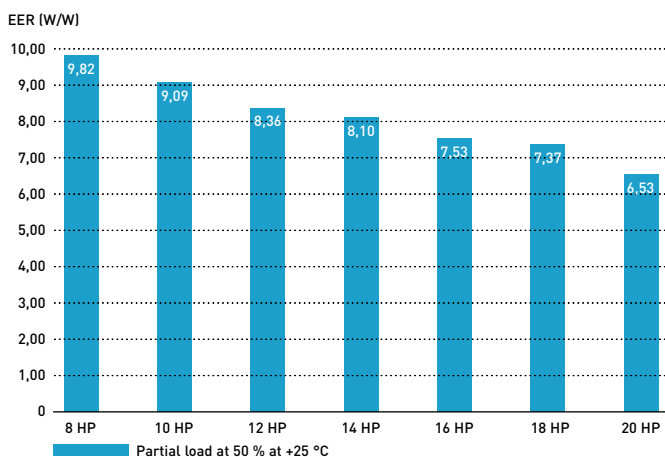



SEER and SCOP following EN-14825

When better partial load, better efficiency is achieved in real operation. The EN-14825 is showing the way to calculate considering full year operation hours at different conditions. Panasonic ECOi EX is designed to save energy in any partial load conditions. Most of operation hours system is under partial load conditions, 80 % of total operation hours is less than 70 % of full load.

In below graphs is the example for average ambient conditions, this uses Strasbourg ambient conditions for calculation.

Outside temperature distribution.

Time distribution (hours / year)

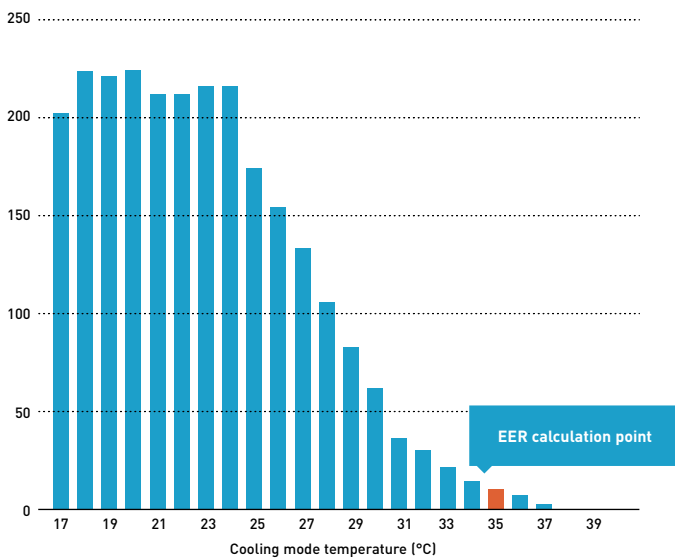

Outside temperature distribution.

Time distribution (hours / year)

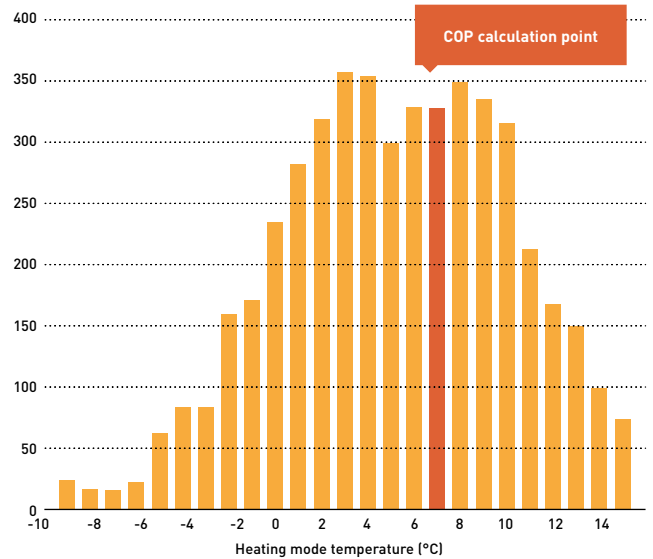

In the characteristics EER and COP only a single temperature for the assessment of the efficiency is taken as a basis in each case. Data calculated under EN-14825 conditions, not additional saving function considered for this calculation. Compressor frequency according to ambient temperature and building design.

SEER and SCOP values

ECOi EX models have superior seasonal space cooling / heating efficiency following not only EN 14825 but also COMMISSION REGULATION (EU) 2016/2281. This regulation requires to use "η" values in the technical documents from January 2018.

Please visit our websites www.aircon.panasonic.eu or www.ptc.panasonic.eu.

However, if it was necessary by setting on commissioning Panasonic, can increase efficiency additionally by "20 %" increasing evaporation refrigerant temperature range, for a higher efficiency and lower energy consumption.

SEER / SCOP

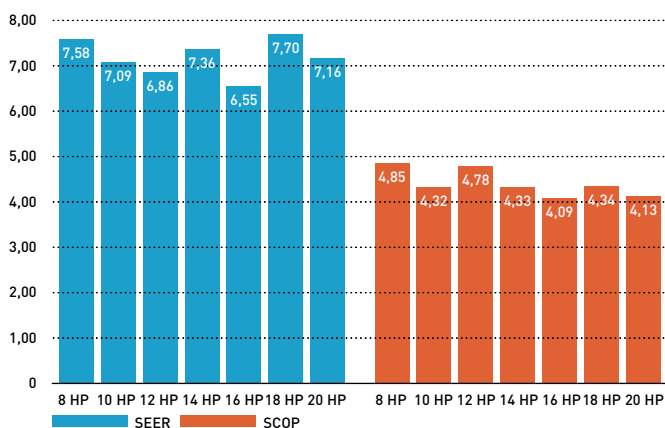

ESEER (W/W)

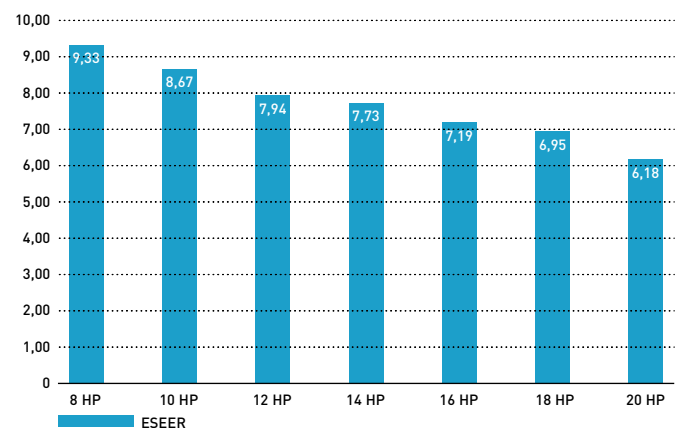

2-Pipe ECOi EX ME2 Series high performance at extreme conditions

The ECOi EX can still operate at 100 % capacity when the outside temperature is as high as 43 °C. This high power capability enables reliable operation even under extremely high temperature conditions.

Extremely high capacity at -20 °C and unique heating capacity at -25 °C

Heating capacity (kW)

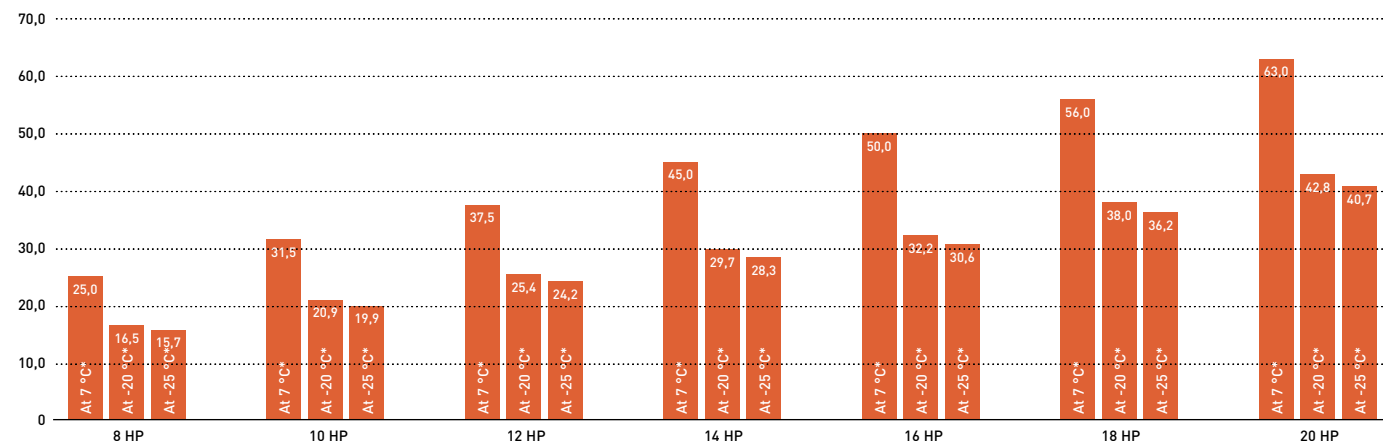

* Outdoor air temperature (°C WB).

Trusted reliability even under high and low temperature conditions

Designed to be durable enough to withstand extreme heat, 2-Pipe ECOi EX ME2 Series ensures reliable cooling operation over an extended operating range up to 52 °C, and heating operation also at minus -25 °C.

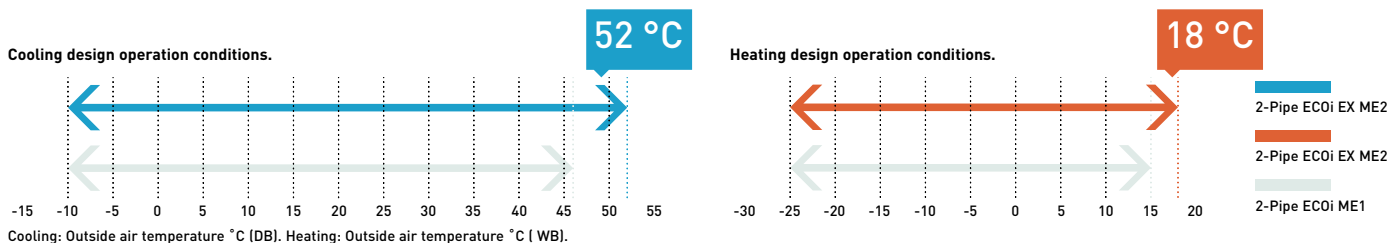

2-Pipe ECOi EX ME2 Series superior flexibility

Connectable maximum allowable indoor / outdoor capacity ratio up to 200 %*

ECOi EX attain maximum indoor unit connection capacity of up to 130 % of the unit's connection range. This limit can be overpassed and reach up to 200 % if some conditions are satisfied. With this feature, ECOi EX provides an ideal air conditioning solution for locations where full cooling / heating are not always required in all spaces at same time.

System (HP)	8	10	12	14	16	18	20	22	24	26	28	30	32	34	36	38	40	42	44	46	48	50	52	54	56	58	60	62	64	66	68	70	72	74	76	78	80
Connectable indoor units: 130 %	13	16	19	23	26	29	33	36	40	43	46	50	53	56	59															64							
Connectable indoor units: 200 %	20	25	30	35	40	45	50	55	60											64																	

Note: If more than 100 % indoor units are operated with a high load, the units may not perform at the rated capacity. For the details, please consult with an authorised Panasonic dealer. * If the following conditions are satisfied, the effective range is above 130 % up to 200 %. Obey the limited number of connectable indoor units. The lower limit of operating range for heating outdoor temperature is limited to -10 °C WB (standard -25 °C WB). Simultaneous operation is limited to less than 130 % of connectable indoor units. 1,5 kW capacity of Indoor Units are included.

Increased piping lengths and design flexibility

Adaptable to various building types and sizes. Actual piping length: 200 m. Maximum piping length: 1000 m.

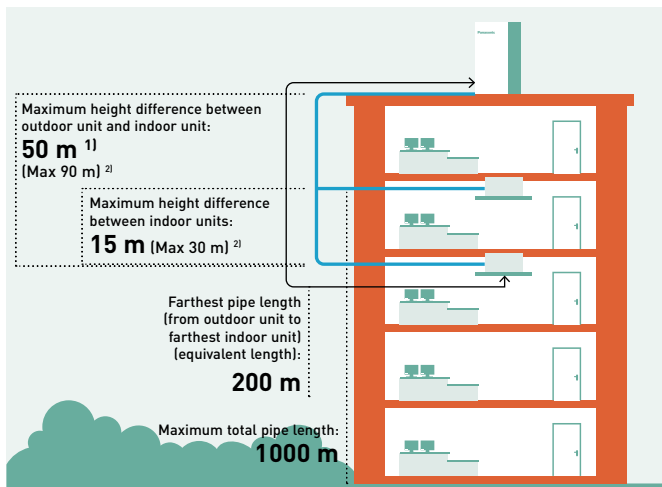

1) 40 m if the outdoor unit is below the indoor unit.
2) For height differences between outdoor unit and indoor unit > 50 m, as well as for height differences between indoor units > 15 m, contact an authorized Panasonic dealer.

Up to 50 m length difference between the longest and the shortest piping from the first branch

Flexible piping layout makes it easier to design systems for locations such as train stations, airports, schools and hospitals.

- Up to 64 units can be connected to one system
- Difference between maximum and minimum pipe runs after first branch can be a maximum of 50 m
- Larger pipe runs can be up to 200 m

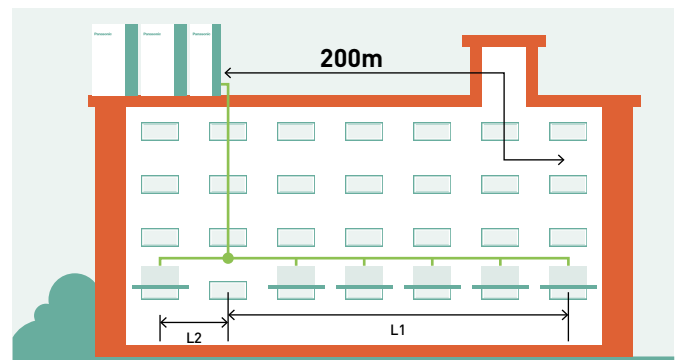

L1 = Longest pipe run. L2 = Shortest pipe run. L1 - L2 = Maximum 50 m.

Compact design

The ME2 Series has reduced the installation space required with up to 20 HP available in a single chassis. 8 - 10 HP are able to fit inside a lift for easy handling on site.

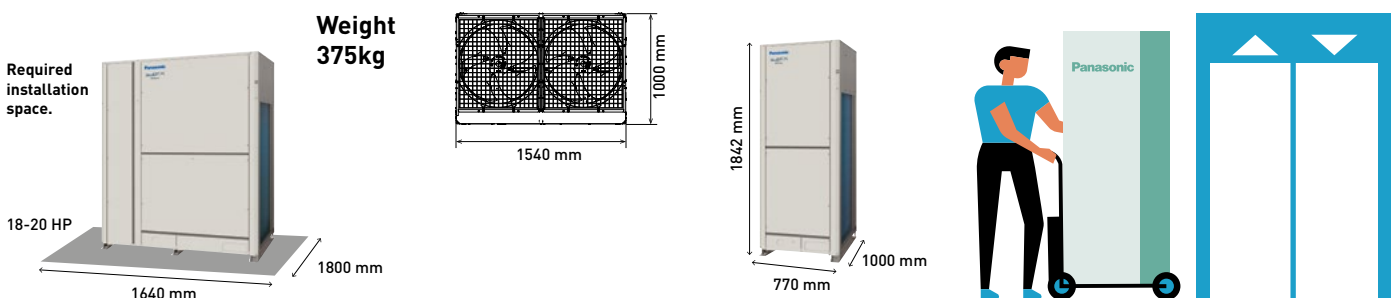

2-Pipe ECOi EX ME2 Series piping design

Select installation locations so that the lengths and sizes of refrigerant piping are within the allowable ranges shown in the figure below.

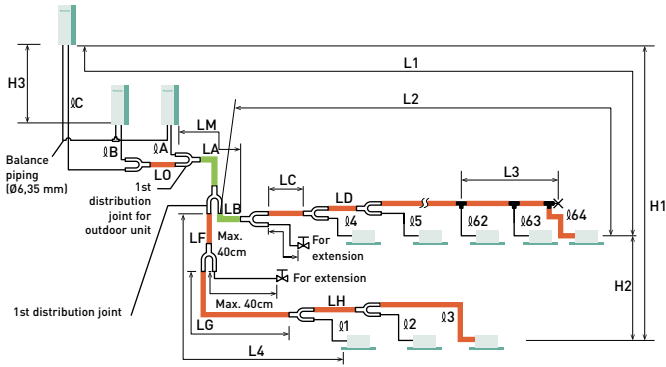

- Main piping length (maximum piping size) LM= LA + LB ...
 - Main distribution tubes LC - LH are selected according to the capacity after the distribution joint.
 - Sizes of indoor unit connection piping Ø1 - Ø64 are determined by the connection piping sizes on the indoor units.
 - Distribution joint (CZ: optional parts).
 - T-joint (field supply).
 - Ball valve (field supply).
 - Solidly welded shut (pinch weld).
- The outdoor connection main piping (LO portion) is determined by the total capacity of the outdoor units that are connected to the tube ends.
 Note: Be sure to use special R410A distribution joints (CZ: optional parts) for outdoor unit connections and piping branches.
- R410A distribution joint.**
 CZ-P680PH2BM (for outdoor unit)
 CZ-P1350PH2BM (for outdoor unit)
 CZ-P224BK2BM (for indoor unit)
 CZ-P680BK2BM (for indoor unit)
 CZ-P1350BK2BM (for indoor unit)

Ranges that apply to refrigerant piping lengths and to differences in installation heights

Items	Mark	Contents	Length (m)	
			Actual length	Equivalent length
Allowable piping length	L1	Maximum piping length	≤200 ¹⁾	≤210 ¹⁾
	Δ L (L2-L4)	Difference between maximum length and minimum length from the 1st distribution joint	≤50 ²⁾	
	LM	Maximum length of main piping (at maximum size) * Even after 1st distribution joint, LM is allowed if at maximum piping length.	— ³⁾	
	Ø1, Ø2- Ø64	Maximum length of each distribution tube	≤50 ⁴⁾	
	L1+ Ø1+ Ø2- Ø63+ ØA+ØB+LF+LG+LH	Total maximum piping length including length of each distribution tube (only liquid piping)	≤1000	
Allowable elevation difference	ØA, ØB+LO, ØC+LO	Maximum piping length from outdoor's 1st distribution joint to each outdoor unit	≤10	
	H1	When outdoor unit is installed higher than indoor unit	≤50	
	H2	When outdoor unit is installed lower than indoor unit	≤40	
	H3	Maximum difference between indoor units	≤15	
Allowable length of joint piping	H2	Maximum difference between outdoor units	≤4	
	L3	T-joint piping (field-supply); Maximum piping length between the first T-joint and solidly welded-shut point	≤2	

L = Length, H = Height

1) If the longest piping length (L1) exceeds 90 m [equivalent length], increase the sizes of the main tubes (LM) by 1 rank for gas tubes and liquid tubes. Use a field supply reducer. Select the tube size from the table of main piping sizes (Table 3) and from the table of refrigerant piping sizes (Table 8). 2) When the piping length exceeds 40 m, increase a longer liquid or gas piping by 1 rank. Refer to the Technical Data for the details. 3) If the longest main piping length (LM) exceeds 50 m, increase the main piping size at the portion before 50 m by 1 rank for the gas tubes. Use a field supply reducer. Determine the length less than the limitation of allowable maximum piping length. For the portion that exceeds 50 m, set based on the main piping size (LA) listed in Table 3. 4) If any of the piping length exceeds 30 m, increase the size of the liquid and gas tubes by 1 rank. 5) If the total distribution piping length exceeds 500 m, maximum allowable elevation difference (H2) between the indoor units is calculated by the following formula. Make sure the indoor unit's actual elevation difference should fall within the figure calculated as follows. Unit of account (meter): 15 x (2 - total piping length [m] ÷ 500).

* The outdoor connection main piping (LO portion) is determined by the total capacity of the outdoor units that are connected to the tube ends. If the size of the existing piping is already larger than the standard piping size, it is not necessary to further increase the size. ** If the existing piping is used, and the amount of on-site refrigerant charge exceeds the value listed below, then change the size of the piping to reduce the amount of refrigerant. Total amount of refrigerant for the system with 1 outdoor unit: 50kg. Total amount of refrigerant for the system with 2 outdoor units: 80kg. Total amount of refrigerant for the system with 3 outdoor units or 4 outdoor units: 105 kg.

Necessary amount of additional refrigerant charge per outdoor unit.

U-8ME2E8	U-10ME2E8	U-12ME2E8	U-14ME2E8	U-16ME2E8
5,5 kg	5,5 kg	7,0 kg	7,0 kg	7,0 kg

System limitations.

Maximum number allowable connected outdoor units	4 ¹⁾
Maximum capacity allowable connected outdoor units	224 kW [80 HP]
Maximum connectable indoor units	64 ²⁾
Maximum allowable indoor / outdoor capacity ratio	50-130 % ³⁾

1) Up to 4 units can be connected if the system has been extended.

2) In the case of 38 HP or smaller units, the number is limited by the total capacity of the connected indoor units.

3) If the following conditions are satisfied, the effective range is above 130 % and below 200 %.

A) Obey the limited number of connectable indoor units. B) The lower limit of operating range for heating outdoor temperature is limited to -10 °C WB (standard -25 °C WB). C) Simultaneous operation is limited to less than 130 % of connectable indoor units.

Refrigerant piping (existing piping can be used).

Piping size (mm)						Material Temper - 1/2 H, H							
Material Temper - 0						Material Temper - 1/2 H, H							
Ø6,35	t 0,8	Ø12,70	t 0,8	Ø19,05	t 1,2	Ø22,22	t 1,0	Ø28,58	t 1,0	Ø38,10	over t 1,35	Ø44,45	over t1,55
Ø9,52	t 0,8	Ø15,88	t 1,0			Ø25,40	t 1,0	Ø31,75	t 1,1	Ø41,28	over t 1,45	Ø44,45	over t1,55

* When bending the tubes, use a bending radius that is at least 4 times the outer diameter of the tubes. In addition, take sufficient care to avoid crushing or damaging the tubes when bending them.



2-Pipe ECOi EX ME2 Series

A VRF system delivering energy-saving performance, powerful operation, reliability and comfort, surpassing anything previously possible. It represents a true paradigm shift in air conditioning solutions.

VRF with outstanding energy-saving performance and powerful operation SEER 7,70 (18 HP model).

			8 HP	10 HP	12 HP	14 HP	16 HP	18 HP	20 HP
Outdoor unit			U-8ME2E8	U-10ME2E8	U-12ME2E8	U-14ME2E8	U-16ME2E8	U-18ME2E8	U-20ME2E8
Power supply	Voltage	V	380-400-415	380-400-415	380-400-415	380-400-415	380-400-415	380-400-415	380-400-415
	Phase		Three phase	Three phase	Three phase	Three phase	Three phase	Three phase	Three phase
	Frequency	Hz	50	50	50	50	50	50	50
Cooling capacity		kW	22,4	28,0	33,5	40,0	45,0	50,0	56,0
EER ¹⁾		W/W	4,70	4,37	3,96	3,88	3,52	3,52	3,35
ESEER		W/W	9,33	8,67	7,94	7,73	7,19	6,95	6,18
Recommended combination			4 x S-56MF2E5A	4 x S-73MF2E5A	6 x S-56MF2E5A	2 x S-60MF2E5A	6 x S-73MF2E5A	6 x S-60MF2E5A	8 x S-73MF2E5A
SEER ²⁾			7,58	7,09	6,86	7,36	6,55	7,70	7,16
$\eta_{s,c}$		%	294,3	275,4	266,6	286,0	254,3	299,2	278,2
Current		A	7,79-7,40-7,14	10,70-10,20-9,80	13,70-13,00-12,50	17,40-16,50-15,90	21,10-20,10-19,40	23,20-22,00-21,20	26,70-25,40-24,50
Input power		kW	4,77	6,41	8,47	10,30	12,80	14,20	16,70
Heating capacity		kW	25,0	31,5	37,5	45,0	50,0	56,0	63,0
COP ¹⁾		W/W	5,13	4,76	4,73	4,56	4,42	4,38	3,94
SCOP ²⁾			4,85	4,32	4,78	4,33	4,09	4,34	4,13
$\eta_{s,h}$		%	188,4	167,6	185,8	168,2	159,0	168,7	160,4
Current		A	7,96-7,56-7,29	11,10-10,50-10,10	12,90-12,30-11,80	16,60-15,80-15,20	18,90-17,90-17,30	21,10-20,10-19,40	25,90-24,60-23,70
Input power		kW	4,87	6,62	7,92	9,86	11,30	12,80	16,00
Starting current		A	1,00	1,00	1,00	2,00	2,00	2,00	2,00
External static pressure (Max)		Pa	80	80	80	80	80	80	80
Air flow		m ³ /min	224	224	232	232	232	405	405
Sound pressure	Normal mode	dB(A)	54	56	59	60	61	59	60
	Silent mode	dB(A)	51	53	56	57	58	56	57
Sound power	Normal mode	dB(A)	75	77	80	81	82	80	81
Dimension	HxWxD	mm	1842x770x1000	1842x770x1000	1842x1180x1000	1842x1180x1000	1842x1180x1000	1842x1540x1000	1842x1540x1000
Net weight		kg	210	210	270	315	315	375	375
Piping diameter ³⁾	Liquid pipe	Inch (mm)	3/8(9,52)/1/2(12,70)	3/8(9,52)/1/2(12,70)	1/2(12,70)/5/8(15,88)	1/2(12,70)/5/8(15,88)	1/2(12,70)/5/8(15,88)	5/8(15,88)/3/4(19,05)	5/8(15,88)/3/4(19,05)
	Gas pipe	Inch (mm)	3/4(19,05)/7/8(22,22)	7/8(22,22)/1(25,40)	1(25,40)/1-1/8(28,58)	1(25,40)/1-1/8(28,58)	1-1/8(28,58)/1-1/4(31,75)	1-1/8(28,58)/1-1/4(31,75)	1-1/8(28,58)/1-1/4(31,75)
	Balance pipe	Inch (mm)	1/4(6,35)	1/4(6,35)	1/4(6,35)	1/4(6,35)	1/4(6,35)	1/4(6,35)	1/4(6,35)
Refrigerant (R410A) / CO ₂ Eq		kg/T	5,60/11,6928	5,60/11,6928	8,30/17,3304	8,30/17,3304	8,30/17,3304	9,50/19,836	9,50/19,836
Maximum allowable indoor / outdoor capacity ratio % ⁴⁾			50 ~ 130(200)	50 ~ 130(200)	50 ~ 130(200)	50 ~ 130(200)	50 ~ 130(200)	50 ~ 130(200)	50 ~ 130(200)
Operating range	Cool Min ~ Max	°C	-10 ~ +52	-10 ~ +52	-10 ~ +52	-10 ~ +52	-10 ~ +52	-10 ~ +52	-10 ~ +52
	Heat Min ~ Max	°C	-25 ~ +18	-25 ~ +18	-25 ~ +18	-25 ~ +18	-25 ~ +18	-25 ~ +18	-25 ~ +18

1) EER and COP calculation is based in accordance to EN14511. 2) SEER / SCOP is calculated based on the seasonal space cooling / heating efficiency " η " values of the COMMISSION REGULATION (EU) 2016/2281. SEER, SCOP = (η + Correction) \times PEF. 3) Piping diameter under 90 m for ultimate indoor unit / over 90 m for ultimate indoor unit (if the longest piping equivalent length exceeds 90 m, increase the sizes of the main tubes by 1 rank for gas tubes and liquid tubes). 4) If the following conditions are satisfied, the effective range is above 130 % and below 200 %: A. Obey the limited number of connectable indoor units. B. The lower limit of operating range for heating outdoor temperature is limited to -10 °C WB (standard -25 °C WB). C. Simultaneous operation is limited to less than 130 % of connectable indoor units.

Technical focus

- Twin rotary inverter compressor
- High performance at extreme conditions
- Outstanding efficiency and comfort
- Extraordinary partial load, SEER and SCOP
- SEER and SCOP following EN-14825
- Oil recovery intelligent control
- Top comfort
- Superior flexibility
- Bluefin full line up EX
- Extremely high capacity at -20 °C and unique heating capacity at -25 °C
- Smooth exhaust flow by bell-mouth

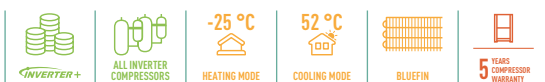



2-Pipe ECOi EX ME2 Series high efficiency model combination from 18 to 28 HP

			18 HP	20 HP	22 HP	24 HP	26 HP	28 HP
Outdoor unit			U-8ME2E8	U-10ME2E8	U-10ME2E8	U-12ME2E8	U-10ME2E8	U-12ME2E8
			U-10ME2E8	U-10ME2E8	U-12ME2E8	U-12ME2E8	U-16ME2E8	U-16ME2E8
Power supply	Voltage	V	380-400-415	380-400-415	380-400-415	380-400-415	380-400-415	380-400-415
	Phase		Three phase	Three phase	Three phase	Three phase	Three phase	Three phase
	Frequency	Hz	50	50	50	50	50	50
Cooling capacity	kW		50,0	56,0	61,5	68,0	73,0	78,5
EER ¹⁾	W/W		4,55	4,38	4,13	3,93	3,80	3,69
Current	A		18,20-17,30-16,60	21,40-20,30-19,60	24,30-23,10-22,30	28,00-26,60-25,60	31,70-30,10-29,00	34,80-33,10-31,90
Input power	kW		11,00	12,80	14,90	17,30	19,20	21,30
Heating capacity	kW		56,0	63,0	69,0	76,5	81,5	87,5
COP ¹⁾	W/W		4,96	4,77	4,76	4,69	4,55	4,56
Current	A		18,70-17,70-17,10	22,00-20,90-20,20	23,90-22,70-21,90	26,60-25,30-24,40	29,90-28,40-27,40	31,70-30,10-29,00
Input power	kW		11,30	13,20	14,50	16,30	17,90	19,20
Starting current	A		2,00	2,00	2,00	2,00	3,00	3,00
External static pressure (Max)	Pa		80	80	80	80	80	80
Air flow	m ³ /min		448	448	456	464	456	464
Sound pressure	Normal	dB(A)	58,5	59,0	61,0	62,0	62,5	63,5
	Silent mode	dB(A)	55,5	56,0	58,0	59,0	59,5	60,5
Sound power	Normal mode	dB(A)	79,5	80,0	82,0	83,0	83,5	84,5
Dimension / Net weight	HxWxD	mm / kg	1842x1600 x1000/420	1842x1600 x1000/420	1842x2010 x1000/480	1842x2420 x1000/540	1842x2010 x1000/535	1842x2420 x1000/585
	Liquid pipe	Inch (mm)	5/8(15,88)/ 3/4(19,05)	5/8(15,88)/ 3/4(19,05)	5/8(15,88)/ 3/4(19,05)	5/8(15,88)/ 3/4(19,05)	3/4(19,05)/ 7/8(22,22)	3/4(19,05)/ 7/8(22,22)
Piping diameter ²⁾	Gas pipe	Inch (mm)	1-1/8(28,58)/ 1-1/4(31,75)	1-1/8(28,58)/ 1-1/4(31,75)	1-1/8(28,58)/ 1-1/4(31,75)	1-1/8(28,58)/ 1-1/4(31,75)	1-1/4(31,75)/ 1-1/2(38,10)	1-1/4(31,75)/ 1-1/2(38,10)
	Balance pipe	Inch (mm)	1/4(6,35)	1/4(6,35)	1/4(6,35)	1/4(6,35)	1/4(6,35)	1/4(6,35)
Refrigerant (R410A) / CO ₂ Eq.	kg / T		11,20/23,3856	11,20/23,3856	13,90/29,0232	16,60/34,6608	13,90/29,0232	16,60/34,6608
Maximum allowable indoor / outdoor capacity ratio % ³⁾			50~130(200)	50~130(200)	50~130(200)	50~130(200)	50~130(200)	50~130(200)
Operating range	Cool Min ~ Max	°C	-10~+52	-10~+52	-10~+52	-10~+52	-10~+52	-10~+52
	Heat Min ~ Max	°C	-25~+18	-25~+18	-25~+18	-25~+18	-25~+18	-25~+18

2-Pipe ECOi EX ME2 Series high efficiency model combination from 30 to 40 HP

			30 HP	32 HP	34 HP	36 HP	38 HP	40 HP
Outdoor unit			U-14ME2E8	U-16ME2E8	U-10ME2E8	U-12ME2E8	U-10ME2E8	U-12ME2E8
			U-16ME2E8	U-16ME2E8	U-12ME2E8	U-12ME2E8	U-12ME2E8	U-16ME2E8
Power supply	Voltage	V	380-400-415	380-400-415	380-400-415	380-400-415	380-400-415	380-400-415
	Phase		Three phase	Three phase	Three phase	Three phase	Three phase	Three phase
	Frequency	Hz	50	50	50	50	50	50
Cooling capacity	kW		85,0	90,0	96,0	101,0	107,0	113,0
EER ¹⁾	W/W		3,68	3,52	4,05	3,95	3,84	3,75
Current	A		38,60-36,60-35,30	42,30-40,20-38,70	38,70-36,80-35,50	41,40-39,30-37,90	46,10-43,80-42,20	49,20-46,70-45,00
Input power	kW		23,10	25,60	23,70	25,60	27,90	30,10
Heating capacity	kW		95,0	100,0	108,0	113,0	119,0	127,0
COP ¹⁾	W/W		4,48	4,42	4,72	4,73	4,61	4,57
Current	A		35,40-33,60-32,40	37,70-35,80-34,60	37,80-35,90-34,60	39,00-37,10-35,80	42,60-40,50-39,00	45,90-43,60-42,00
Input power	kW		21,20	22,60	22,90	23,90	25,80	27,80
Starting current	A		4,00	4,00	3,00	3,00	4,00	4,00
External static pressure (Max)	Pa		80	80	80	80	80	80
Air flow	m ³ /min		464	464	688	696	688	696
Sound pressure	Normal	dB(A)	63,5	64,0	63,0	64,0	64,0	64,5
	Silent mode	dB(A)	60,5	61,0	60,0	61,0	61,0	61,5
Sound power	Normal mode	dB(A)	84,5	85,0	84,0	85,0	85,0	85,5
Dimension / Net weight	HxWxD	mm / kg	1842x2420 x1000/630	1842x2420 x1000/630	1842x3250 x1000/750	1842x3660 x1000/810	1842x3250 x1000/795	1842x3660 x1000/855
	Liquid pipe	Inch (mm)	3/4(19,05)/ 7/8(22,22)	3/4(19,05)/ 7/8(22,22)	3/4(19,05)/ 7/8(22,22)	3/4(19,05)/ 7/8(22,22)	3/4(19,05)/ 7/8(22,22)	3/4(19,05)/ 7/8(22,22)
Piping diameter ²⁾	Gas pipe	Inch (mm)	1-1/4(31,75)/ 1-1/2(38,10)	1-1/4(31,75)/ 1-1/2(38,10)	1-1/4(31,75)/ 1-1/2(38,10)	1-1/2(38,10)/ 1-5/8(41,28)	1-1/2(38,10)/ 1-5/8(41,28)	1-1/2(38,10)/ 1-5/8(41,28)
	Balance pipe	Inch (mm)	1/4(6,35)	1/4(6,35)	1/4(6,35)	1/4(6,35)	1/4(6,35)	1/4(6,35)
Refrigerant (R410A) / CO ₂ Eq.	kg / T		16,60/34,6608	16,60/34,6608	22,20/46,3536	24,90/51,9912	22,20/46,3536	24,90/46,3536
Maximum allowable indoor / outdoor capacity ratio % ³⁾			50~130(200)	50~130(200)	50~130(200)	50~130(200)	50~130(200)	50~130(200)
Operating range	Cool Min ~ Max	°C	-10~+52	-10~+52	-10~+52	-10~+52	-10~+52	-10~+52
	Heat Min ~ Max	°C	-25~+18	-25~+18	-25~+18	-25~+18	-25~+18	-25~+18

Data is for reference. 1) EER and COP calculation is based in accordance to EN14511. 2) Piping diameter under 90 m for ultimate indoor unit / over 90 m for ultimate indoor unit (if the longest piping equivalent length exceeds 90 m, increase the sizes of the main tubes by 1 rank for gas tubes and liquid tubes). 3) If the following conditions are satisfied, the effective range is above 130 % and below 200 %: A. Obey the limited number of connectable indoor units. B. The lower limit of operating range for heating outdoor temperature is limited to -10 °C WB (standard -25 °C WB). C. Simultaneous operation is limited to less than 130 % of connectable indoor units.

2-Pipe ECOi EX ME2 Series high efficiency model combination from 42 to 52 HP

Outdoor unit			42 HP	44 HP	46 HP	48 HP	50 HP	52 HP
			U-10ME2E8	U-12ME2E8	U-14ME2E8	U-16ME2E8	U-10ME2E8	U-12ME2E8
			U-16ME2E8	U-16ME2E8	U-16ME2E8	U-16ME2E8	U-12ME2E8	U-12ME2E8
			U-16ME2E8	U-16ME2E8	U-16ME2E8	U-16ME2E8	U-12ME2E8	U-16ME2E8
Power supply	Voltage	V	380-400-415	380-400-415	380-400-415	380-400-415	380-400-415	380-400-415
	Phase		Three phase	Three phase	Three phase	Three phase	Three phase	Three phase
	Frequency	Hz	50	50	50	50	50	50
Cooling capacity		kW	118,0	124,0	130,0	135,0	140,0	145,0
EER ¹⁾		W/W	3,69	3,62	3,62	3,52	3,87	3,82
Current		A	52,80-50,20-48,40	56,00-53,20-51,30	59,90-56,90-54,90	63,40-60,20-58,10	59,10-56,20-54,20	62,10-59,00-56,80
Input power		kW	32,00	34,30	35,90	38,40	36,20	38,00
Heating capacity		kW	132,0	138,0	145,0	150,0	155,0	160,0
COP ¹⁾		W/W	4,49	4,50	4,46	4,42	4,65	4,66
Current		A	49,10-46,60-44,90	50,70-48,20-46,40	54,30-51,50-49,70	56,60-53,80-51,80	55,00-52,20-50,40	56,60-53,80-51,90
Input power		kW	29,40	30,70	32,50	33,90	33,30	34,30
Starting current		A	5,00	5,00	6,00	6,00	5,00	5,00
External static pressure (Max)		Pa	80	80	80	80	80	80
Air flow		m ³ /min	688	696	696	696	920	928
Sound pressure	Normal	dB(A)	65,0	65,5	65,5	66,0	65,5	66,0
	Silent mode	dB(A)	62,0	62,5	62,5	63,0	62,5	63,0
Sound power	Normal mode	dB(A)	86,0	86,5	86,5	87,0	86,5	87,0
Dimension / Net weight	H x W x D	mm / kg	1842 x 3250 x 1000 / 840	1842 x 3660 x 1000 / 900	1842 x 3660 x 1000 / 945	1842 x 3660 x 1000 / 945	1842 x 4490 x 1000 / 1065	1842 x 4900 x 1000 / 1125
	Liquid pipe	Inch (mm)	3/4 (19,05) / 7/8 (22,22)	3/4 (19,05) / 7/8 (22,22)	3/4 (19,05) / 7/8 (22,22)	3/4 (19,05) / 7/8 (22,22)	3/4 (19,05) / 7/8 (22,22)	3/4 (19,05) / 7/8 (22,22)
Piping diameter ²⁾	Gas pipe	Inch (mm)	1-1/2 (38,10) / 1-5/8 (41,28)	1-1/2 (38,10) / 1-5/8 (41,28)	1-1/2 (38,10) / 1-5/8 (41,28)	1-1/2 (38,10) / 1-5/8 (41,28)	1-1/2 (38,10) / 1-5/8 (41,28)	1-1/2 (38,10) / 1-5/8 (41,28)
	Balance pipe	Inch (mm)	1/4 (6,35)	1/4 (6,35)	1/4 (6,35)	1/4 (6,35)	1/4 (6,35)	1/4 (6,35)
Refrigerant (R410A) / CO ₂ Eq.		kg / T	22,20 / 51,9912	24,90 / 51,9912	24,90 / 51,9912	24,90 / 51,9912	30,50 / 63,6840	33,20 / 69,3216
Maximum allowable indoor / outdoor capacity ratio % ³⁾			50-130 (200)	50-130 (200)	50-130 (200)	50-130 (200)	50-130 (200)	50-130 (200)
Operating range	Cool Min ~ Max	°C	-10 ~ +52	-10 ~ +52	-10 ~ +52	-10 ~ +52	-10 ~ +52	-10 ~ +52
	Heat Min ~ Max	°C	-25 ~ +18	-25 ~ +18	-25 ~ +18	-25 ~ +18	-25 ~ +18	-25 ~ +18

2-Pipe ECOi EX ME2 Series high efficiency model combination from 54 to 64 HP

Outdoor unit			54 HP	56 HP	58 HP	60 HP	62 HP	64 HP
			U-10ME2E8	U-12ME2E8	U-10ME2E8	U-12ME2E8	U-14ME2E8	U-16ME2E8
			U-12ME2E8	U-12ME2E8	U-16ME2E8	U-16ME2E8	U-16ME2E8	U-16ME2E8
			U-16ME2E8	U-16ME2E8	U-16ME2E8	U-16ME2E8	U-16ME2E8	U-16ME2E8
Power supply	Voltage	V	380-400-415	380-400-415	380-400-415	380-400-415	380-400-415	380-400-415
	Phase		Three phase	Three phase	Three phase	Three phase	Three phase	Three phase
	Frequency	Hz	50	50	50	50	50	50
Cooling capacity		kW	151,0	156,0	162,0	168,0	174,0	180,0
EER ¹⁾		W/W	3,75	3,71	3,65	3,60	3,60	3,52
Current		A	66,60-63,20-60,90	68,80-65,30-63,00	73,30-69,70-67,10	77,10-73,30-70,60	79,80-75,80-73,00	84,60-80,30-77,40
Input power		kW	40,30	42,10	44,40	46,70	48,30	51,20
Heating capacity		kW	169,0	175,0	182,0	189,0	195,0	201,0
COP ¹⁾		W/W	4,56	4,56	4,47	4,47	4,45	4,42
Current		A	61,90-58,80-56,70	63,40-60,20-58,10	68,00-64,60-62,20	70,60-67,10-64,70	73,10-69,50-67,00	76,00-72,20-69,60
Input power		kW	37,10	38,40	40,70	42,30	43,80	45,50
Starting current		A	6,00	6,00	7,00	7,00	8,00	8,00
External static pressure (Max)		Pa	80	80	80	80	80	80
Air flow		m ³ /min	920	928	920	928	928	928
Sound pressure	Normal	dB(A)	66,0	66,5	66,5	67,0	67,0	67,0
	Silent mode	dB(A)	63,0	63,5	63,5	64,0	64,0	64,0
Sound power	Normal mode	dB(A)	87,0	87,5	87,5	88,0	88,0	88,0
Dimension / Net weight	H x W x D	mm / kg	1842 x 4490 x 1000 / 1110	1842 x 4900 x 1000 / 1170	1842 x 4490 x 1000 / 1155	1842 x 4900 x 1000 / 1215	1842 x 4900 x 1000 / 1260	1842 x 4900 x 1000 / 1260
	Liquid pipe	Inch (mm)	3/4 (19,05) / 7/8 (22,22)	3/4 (19,05) / 7/8 (22,22)	3/4 (19,05) / 7/8 (22,22)	3/4 (19,05) / 7/8 (22,22)	3/4 (19,05) / 7/8 (22,22)	3/4 (19,05) / 7/8 (22,22)
Piping diameter ²⁾	Gas pipe	Inch (mm)	1-1/2 (38,10) / 1-5/8 (41,28)	1-1/2 (38,10) / 1-5/8 (41,28)	1-1/2 (38,10) / 1-5/8 (41,28)	1-1/2 (38,10) / 1-5/8 (41,28)	1-5/8 (41,28) / 1-3/4 (44,45)	1-5/8 (41,28) / 1-3/4 (44,45)
	Balance pipe	Inch (mm)	1/4 (6,35)	1/4 (6,35)	1/4 (6,35)	1/4 (6,35)	1/4 (6,35)	1/4 (6,35)
Refrigerant (R410A) / CO ₂ Eq.		kg / T	30,50 / 63,6840	33,20 / 69,3216	30,50 / 63,6840	33,20 / 69,3216	33,20 / 69,3216	33,20 / 69,3216
Maximum allowable indoor / outdoor capacity ratio % ³⁾			50-130 (200)	50-130 (200)	50-130 (200)	50-130 (200)	50-130 (200)	50-130 (200)
Operating range	Cool Min ~ Max	°C	-10 ~ +52	-10 ~ +52	-10 ~ +52	-10 ~ +52	-10 ~ +52	-10 ~ +52
	Heat Min ~ Max	°C	-25 ~ +18	-25 ~ +18	-25 ~ +18	-25 ~ +18	-25 ~ +18	-25 ~ +18

Data is for reference. 1) EER and COP calculation is based in accordance to EN14511. 2) Piping diameter under 90 m for ultimate indoor unit / over 90 m for ultimate indoor unit (if the longest piping equivalent length exceeds 90 m, increase the sizes of the main tubes by 1 rank for gas tubes and liquid tubes). 3) If the following conditions are satisfied, the effective range is above 130 % and below 200 %: A. Obey the limited number of connectable indoor units. B. The lower limit of operating range for heating outdoor temperature is limited to -10 °C WB (standard -25 °C WB). C. Simultaneous operation is limited to less than 130 % of connectable indoor units.

2-Pipe ECOi EX ME2 Series space saving model combination from 22 to 34 HP

			22 HP	24 HP	26 HP	28 HP	30 HP	32 HP	34 HP
			U-10ME2E8	U-12ME2E8	U-10ME2E8	U-12ME2E8	U-14ME2E8	U-16ME2E8	U-14ME2E8
			U-12ME2E8	U-12ME2E8	U-16ME2E8	U-16ME2E8	U-16ME2E8	U-16ME2E8	U-20ME2E8
Outdoor unit	Voltage	V	380-400-415	380-400-415	380-400-415	380-400-415	380-400-415	380-400-415	380-400-415
	Phase		Three phase	Three phase	Three phase	Three phase	Three phase	Three phase	Three phase
	Frequency	Hz	50	50	50	50	50	50	50
Cooling capacity	kW	61,5	68,0	73,0	78,5	85,0	90,0	96,0	
EER ¹⁾	W/W	4,13	3,93	3,80	3,69	3,68	3,52	3,56	
SEER ²⁾		6,90	6,86	6,62	6,60	6,88	6,55	7,21	
Current	A	24,30-23,10-22,30	28,00-26,60-25,60	31,70-30,10-29,00	34,80-33,10-31,90	38,60-36,60-35,30	42,30-40,20-38,70	44,10-41,90-40,40	
Input power	kW	14,90	17,30	19,20	21,30	23,10	25,60	27,00	
Heating capacity	kW	69,0	76,5	81,5	87,5	95,0	100,0	108,0	
COP ¹⁾	W/W	4,76	4,69	4,55	4,56	4,48	4,42	4,17	
SCOP ²⁾		4,53	4,78	4,16	4,29	4,13	4,09	4,14	
Current	A	23,90-22,70-21,90	26,60-25,30-24,40	29,90-28,40-27,40	31,70-30,10-29,00	35,40-33,60-32,40	37,70-35,80-34,60	42,80-40,60-39,20	
Input power	kW	14,50	16,30	17,90	19,20	21,20	22,60	25,90	
Starting current	A	2,00	2,00	3,00	3,00	4,00	4,00	4,00	
External static pressure (Max)	Pa	80	80	80	80	80	80	80	
Air flow	m ³ /min	456	464	456	464	464	464	637	
Sound pressure	Normal / Silent mode	dB(A)	61,0/58,0	62,0/59,0	62,5/59,5	63,5/60,5	63,5/60,5	64,0/61,0	63,0/60,0
Sound power	Normal mode	dB(A)	82,0	83,0	83,5	84,5	84,5	85,0	84,0
Dimension / Net weight	H x W x D	mm / kg	1842 x 2010 x 1000 / 480	1842 x 2420 x 1000 / 540	1842 x 2010 x 1000 / 525	1842 x 2420 x 1000 / 585	1842 x 2420 x 1000 / 630	1842 x 2420 x 1000 / 630	1842 x 2780 x 1000 / 690
Piping diameter ³⁾	Liquid pipe	Inch (mm)	5/8(15,88)/ 3/4(19,05)	5/8(15,88)/ 3/4(19,05)	3/4(19,05)/ 7/8(22,22)	3/4(19,05)/ 7/8(22,22)	3/4(19,05)/ 7/8(22,22)	3/4(19,05)/ 7/8(22,22)	3/4(19,05)/ 7/8(22,22)
	Gas pipe	Inch (mm)	1-1/8(28,58)/ 1-1/4(31,75)	1-1/8(28,58)/ 1-1/4(31,75)	1-1/4(31,75)/ 1-1/2(38,10)	1-1/4(31,75)/ 1-1/2(38,10)	1-1/4(31,75)/ 1-1/2(38,10)	1-1/4(31,75)/ 1-1/2(38,10)	1-1/4(31,75)/ 1-1/2(38,10)
	Balance pipe	Inch (mm)	1/4(6,35)	1/4(6,35)	1/4(6,35)	1/4(6,35)	1/4(6,35)	1/4(6,35)	1/4(6,35)
Refrigerant (R410A) / CO ₂ Eq.	kg / T	13,90/23,3856	16,60/34,6608	13,90/29,0232	16,60/34,6608	16,60/34,6608	16,60/34,6608	17,80/37,1664	
Maximum allowable indoor / outdoor capacity ratio % ⁴⁾		50 ~ 130(200)	50 ~ 130(200)	50 ~ 130(200)	50 ~ 130(200)	50 ~ 130(200)	50 ~ 130(200)	50 ~ 130(200)	
Operating range	Cool Min ~ Max	°C	-10 ~ +52	-10 ~ +52	-10 ~ +52	-10 ~ +52	-10 ~ +52	-10 ~ +52	-10 ~ +52
	Heat Min ~ Max	°C	-25 ~ +18	-25 ~ +18	-25 ~ +18	-25 ~ +18	-25 ~ +18	-25 ~ +18	-25 ~ +18

2-Pipe ECOi EX ME2 Series space saving model combination from 36 to 48 HP

			36 HP	38 HP	40 HP	42 HP	44 HP	46 HP	48 HP
			U-16ME2E8	U-18ME2E8	U-20ME2E8	U-10ME2E8	U-12ME2E8	U-14ME2E8	U-16ME2E8
			U-20ME2E8	U-20ME2E8	U-20ME2E8	U-16ME2E8	U-16ME2E8	U-16ME2E8	U-16ME2E8
Outdoor unit	Voltage	V	380-400-415	380-400-415	380-400-415	380-400-415	380-400-415	380-400-415	380-400-415
	Phase		Three phase	Three phase	Three phase	Three phase	Three phase	Three phase	Three phase
	Frequency	Hz	50	50	50	50	50	50	50
Cooling capacity	kW	101,0	107,0	113,0	118,0	124,0	130,0	135,0	
EER ¹⁾	W/W	3,42	3,42	3,34	3,69	3,62	3,62	3,52	
SEER ²⁾		6,86	7,32	7,16	6,57	6,6	6,7	6,55	
Current	A	47,70-45,30-43,70	50,60-48,10-46,30	54,10-51,40-49,50	52,80-50,20-48,40	56,00-53,20-51,30	59,90-56,90-54,90	63,40-60,20-58,10	
Input power	kW	25,9	31,3	33,8	32,0	34,3	35,9	38,4	
Heating capacity	kW	113,0	119,0	127,0	132,0	138,0	145,0	150,0	
COP ¹⁾	W/W	4,14	4,13	3,92	4,49	4,50	4,46	4,42	
SCOP ²⁾		4,06	4,14	4,13	4,11	4,21	4,12	4,09	
Current	A	44,60-42,40-40,80	47,10-44,70-43,10	52,40-49,80-48,00	49,10-46,60-44,90	50,70-48,20-46,40	54,30-51,50-49,7	56,60-53,80-51,8	
Input power	kW	27,30	28,80	32,40	29,40	30,70	32,50	33,90	
Starting current	A	4,00	4,00	4,00	5,00	5,00	6,00	6,00	
External static pressure (Max)	Pa	80	80	80	80	80	80	80	
Air flow	m ³ /min	637	810	810	688	696	696	696	
Sound pressure	Normal / Silent mode	dB(A)	63,5/60,5	62,5/59,5	63,0/60,0	65,0/62,0	65,5/62,5	65,5/62,5	66,0/63,0
Sound power	Normal mode	dB(A)	84,5	83,5	84,0	86,0	86,5	86,5	87,0
Dimension / Net weight	H x W x D	mm / kg	1842 x 2780 x 1000 / 690	1842 x 3140 x 1000 / 750	1842 x 3140 x 1000 / 750	1842 x 3250 x 1000 / 840	1842 x 3660 x 1000 / 900	1842 x 3660 x 1000 / 945	1842 x 3660 x 1000 / 945
Piping diameter ³⁾	Liquid pipe	Inch (mm)	3/4(19,05)/ 7/8(22,22)	3/4(19,05)/ 7/8(22,22)	3/4(19,05)/ 7/8(22,22)	3/4(19,05)/ 7/8(22,22)	3/4(19,05)/ 7/8(22,22)	3/4(19,05)/ 7/8(22,22)	3/4(19,05)/ 7/8(22,22)
	Gas pipe	Inch (mm)	1-1/2(38,10)/ 1-5/8(41,28)	1-1/2(38,10)/ 1-5/8(41,28)	1-1/2(38,10)/ 1-5/8(41,28)	1-1/2(38,10)/ 1-5/8(41,28)	1-1/2(38,10)/ 1-5/8(41,28)	1-1/2(38,10)/ 1-5/8(41,28)	1-1/2(38,10)/ 1-5/8(41,28)
	Balance pipe	Inch (mm)	1/4(6,35)	1/4(6,35)	1/4(6,35)	1/4(6,35)	1/4(6,35)	1/4(6,35)	1/4(6,35)
Refrigerant (R410A) / CO ₂ Eq.	kg / T	17,80/37,1664	19,00/39,672	19,00/39,672	22,20/46,3536	24,90/51,9912	24,90/51,9912	24,90/51,9912	
Maximum allowable indoor / outdoor capacity ratio % ⁴⁾		50 ~ 130(200)	50 ~ 130(200)	50 ~ 130(200)	50 ~ 130(200)	50 ~ 130(200)	50 ~ 130(200)	50 ~ 130(200)	
Operating range	Cool Min ~ Max	°C	-10 ~ +52	-10 ~ +52	-10 ~ +52	-10 ~ +52	-10 ~ +52	-10 ~ +52	-10 ~ +52
	Heat Min ~ Max	°C	-25 ~ +18	-25 ~ +18	-25 ~ +18	-25 ~ +18	-25 ~ +18	-25 ~ +18	-25 ~ +18

1) EER and COP calculation is based in accordance to EN14511. 2) SEER / SCOP is calculated based on the seasonal space cooling / heating efficiency "η" values of the COMMISSION REGULATION (EU) 2016/2281. SEER, SCOP = (η + Correction) × PEF. 3) Piping diameter under 90 m for ultimate indoor unit / over 90 m for ultimate indoor unit (if the longest piping equivalent length exceeds 90 m, increase the sizes of the main tubes by 1 rank for gas tubes and liquid tubes). 4) If the following conditions are satisfied, the effective range is above 130 % and below 200 %: A. Obey the limited number of connectable indoor units. B. The lower limit of operating range for heating outdoor temperature is limited to -10 °C WB (standard -25 °C WB). C. Simultaneous operation is limited to less than 130 % of connectable indoor units.



2-Pipe ECOi EX ME2 Series space saving model combination from 50 to 64 HP

			50 HP	52 HP	54 HP	56 HP	58 HP	60 HP	62 HP	64 HP
			U-14ME2E8	U-16ME2E8	U-14ME2E8	U-16ME2E8	U-18ME2E8	U-20ME2E8	U-14ME2E8	U-16ME2E8
			U-16ME2E8	U-16ME2E8	U-20ME2E8	U-20ME2E8	U-20ME2E8	U-20ME2E8	U-16ME2E8	U-16ME2E8
			U-20ME2E8	U-20ME2E8	U-20ME2E8	U-20ME2E8	U-20ME2E8	U-20ME2E8	U-16ME2E8	U-16ME2E8
Outdoor unit	Voltage	V	380-400-415	380-400-415	380-400-415	380-400-415	380-400-415	380-400-415	380-400-415	380-400-415
	Phase		Three phase	Three phase	Three phase	Three phase	Three phase	Three phase	Three phase	Three phase
	Frequency	Hz	50	50	50	50	50	50	50	50
Cooling capacity	kW		140,0	145,0	151,0	156,0	162,0	168,0	174,0	180,0
EER ¹⁾	W/W		3,55	3,46	3,49	3,41	3,40	3,35	3,60	3,52
SEER ²⁾			6,96	6,72	7,16	6,92	7,3	7,16	6,68	6,55
Current	A		64,40-61,10-58,90	68,50-65,00-62,70	70,00-66,50-64,10	74,00-70,30-67,80	76,90-73,10-70,40	80,10-76,10-73,40	79,80-75,80-73,00	84,60-80,30-77,40
Input power	kW		39,40	41,90	43,30	45,80	47,60	50,10	48,30	51,20
Heating capacity	kW		155,0	160,0	169,0	175,0	182,0	189,0	195,0	201,0
COP ¹⁾	W/W		4,29	4,27	4,11	4,08	4,06	3,94	4,45	4,42
SCOP ²⁾			4,08	4,05	4,13	4,07	4,13	4,13	4,11	4,09
Current	A		59,60-56,60-54,60	61,90-58,80-56,70	67,10-63,80-61,50	70,10-66,60-64,20	73,20-69,50-67,00	77,60-73,70-71,00	73,10-69,50-67,00	76,00-72,20-69,6
Input power	kW		36,10	37,50	41,10	42,90	44,80	48,00	43,80	45,50
Starting current	A		6,00	6,00	6,00	6,00	6,00	6,00	8,00	8,00
External static pressure [Max]	Pa		80	80	80	80	80	80	80	80
Air flow	m ³ /min		869	869	1042	1042	1215	1215	928	928
Sound pressure	Normal / Silent mode	dB(A)	65,5/62,5	65,5/62,5	65,0/62,0	65,5/62,5	64,5/61,5	65,0/62,0	67,0/64,0	67,0/64,0
Sound power	Normal mode	dB(A)	86,5	86,5	86,0	86,5	85,5	86,0	88,0	88,0
Dimension / Net weight	H x W x D	mm / kg	1842 x 4020 x 1000/1005	1842 x 4020 x 1000/1005	1842 x 4380 x 1000/1065	1842 x 4380 x 1000/1065	1842 x 4740 x 1000/1125	1842 x 4740 x 1000/1125	1842 x 4900 x 1000/1260	1842 x 4900 x 1000/1260
	Liquid pipe	Inch (mm)	3/4(19,05)/7/8(22,22)	3/4(19,05)/7/8(22,22)	3/4(19,05)/7/8(22,22)	3/4(19,05)/7/8(22,22)	3/4(19,05)/7/8(22,22)	3/4(19,05)/7/8(22,22)	3/4(19,05)/7/8(22,22)	3/4(19,05)/7/8(22,22)
Piping diameter ³⁾	Gas pipe	Inch (mm)	1-1/2(38,10)/1-5/8(41,28)	1-1/2(38,10)/1-5/8(41,28)	1-1/2(38,10)/1-5/8(41,28)	1-1/2(38,10)/1-5/8(41,28)	1-1/2(38,10)/1-5/8(41,28)	1-1/2(38,10)/1-5/8(41,28)	1-5/8(41,28)/1-3/4(44,45)	1-5/8(41,28)/1-3/4(44,45)
	Balance pipe	Inch (mm)	1/4(6,35)	1/4(6,35)	1/4(6,35)	1/4(6,35)	1/4(6,35)	1/4(6,35)	1/4(6,35)	1/4(6,35)
Refrigerant [R410A] / CO ₂ Eq.	kg / T		26,10/54,4968	26,10/54,4968	27,30/57,0024	27,30/57,0024	28,50/59,508	28,50/59,508	33,20/69,3216	33,20/69,3216
Maximum allowable indoor / outdoor capacity ratio % ⁴⁾			50 ~ 130(200)	50 ~ 130(200)	50 ~ 130(200)	50 ~ 130(200)	50 ~ 130(200)	50 ~ 130(200)	50 ~ 130(200)	50 ~ 130(200)
Operating range	Cool Min ~ Max	°C	-10 ~ +52	-10 ~ +52	-10 ~ +52	-10 ~ +52	-10 ~ +52	-10 ~ +52	-10 ~ +52	-10 ~ +52
	Heat Min ~ Max	°C	-25 ~ +18	-25 ~ +18	-25 ~ +18	-25 ~ +18	-25 ~ +18	-25 ~ +18	-25 ~ +18	-25 ~ +18

2-Pipe ECOi EX ME2 Series space saving model combination from 66 to 80 HP

			66 HP	68 HP	70 HP	72 HP	74 HP	76 HP	78 HP	80 HP
			U-10ME2E8	U-12ME2E8	U-10ME2E8	U-16ME2E8	U-16ME2E8	U-16ME2E8	U-18ME2E8	U-20ME2E8
			U-16ME2E8	U-16ME2E8	U-20ME2E8	U-16ME2E8	U-18ME2E8	U-20ME2E8	U-20ME2E8	U-20ME2E8
			U-20ME2E8	U-20ME2E8	U-20ME2E8	U-20ME2E8	U-20ME2E8	U-20ME2E8	U-20ME2E8	U-20ME2E8
Outdoor unit	Voltage	V	380-400-415	380-400-415	380-400-415	380-400-415	380-400-415	380-400-415	380-400-415	380-400-415
	Phase		Three phase	Three phase	Three phase	Three phase	Three phase	Three phase	Three phase	Three phase
	Frequency	Hz	50	50	50	50	50	50	50	50
Cooling capacity	kW		185,0	190,0	196,0	202,0	208,0	213,0	219,0	224,0
EER ¹⁾	W/W		3,52	3,49	3,47	3,42	3,42	3,39	3,38	3,35
SEER ²⁾			6,92	6,91	7,09	6,86	7,03	7,01	7,18	7,16
Current	A		85,00-80,80-77,80	88,10-83,70-80,70	91,30-86,80-83,60	95,40-90,60-87,30	98,30-93,40-90,00	101,70-96,60-93,10	103,50-98,30-94,70	106,80-101,50-97,80
Input power	kW		52,60	54,50	56,50	59,00	60,80	62,90	64,70	66,80
Heating capacity	kW		207,0	213,0	219,0	226,0	233,0	239,0	245,0	252,0
COP ¹⁾	W/W		4,16	4,18	4,05	4,14	4,12	4,03	4,03	3,94
SCOP ²⁾			4,11	4,17	4,13	4,06	4,12	4,07	4,13	4,13
Current	A		81,20-77,10-74,30	83,30-79,20-76,30	87,40-83,10-80,10	89,20-84,70-81,70	92,30-87,70-84,50	96,90-92,00-88,70	98,30-93,40-90,00	103,40-98,30-94,70
Input power	kW		49,70	51,00	54,10	54,60	56,50	59,30	60,80	64,00
Starting current	A		7,00	7,00	7,00	8,00	8,00	8,00	8,00	8,00
External static pressure [Max]	Pa		80	80	80	80	80	80	80	80
Air flow	m ³ /min		1266	1274	1439	1274	1447	1447	1620	1620
Sound pressure	Normal / Silent mode	dB(A)	66,0/63,0	66,5/63,5	65,5/62,5	66,5/63,5	66,5/63,5	66,5/63,5	66,0/63,0	66,0/63,0
Sound power	Normal mode	dB(A)	87,0	87,5	86,5	87,5	87,5	87,5	87,0	87,0
Dimension / Net weight	H x W x D	mm / kg	1842 x 5210 x 1000/1275	1842 x 5620 x 1000/1335	1842 x 5570 x 1000/1335	1842 x 5620 x 1000/1380	1842 x 5980 x 1000/1440	1842 x 5980 x 1000/1440	1842 x 6340 x 1000/1500	1842 x 6340 x 1000/1500
	Liquid pipe	Inch (mm)	3/4(19,05)/7/8(22,22)	7/8(22,22)/1(25,04)	7/8(22,22)/1(25,04)	7/8(22,22)/1(25,04)	7/8(22,22)/1(25,04)	7/8(22,22)/1(25,04)	7/8(22,22)/1(25,04)	7/8(22,22)/1(25,04)
Piping diameter ³⁾	Gas pipe	Inch (mm)	1-5/8(41,28)/1-3/4(44,45)	1-5/8(41,28)/1-3/4(44,45)	1-5/8(41,28)/1-3/4(44,45)	1-3/4(44,45)/2(50,80)	1-3/4(44,45)/2(50,80)	1-3/4(44,45)/2(50,80)	1-3/4(44,45)/2(50,80)	1-3/4(44,45)/2(50,80)
	Balance pipe	Inch (mm)	1/4(6,35)	1/4(6,35)	1/4(6,35)	1/4(6,35)	1/4(6,35)	1/4(6,35)	1/4(6,35)	1/4(6,35)
Refrigerant [R410A] / CO ₂ Eq.	kg / T		32,90/68,6952	35,60/74,3328	34,10/19,836	35,80/68,6952	36,80/76,8384	36,80/76,8384	38,00/79,344	38,00/79,344
Maximum allowable indoor / outdoor capacity ratio % ⁴⁾			50 ~ 130(200)	50 ~ 130(200)	50 ~ 130(200)	50 ~ 130(200)	50 ~ 130(200)	50 ~ 130(200)	50 ~ 130(200)	50 ~ 130(200)
Operating range	Cool Min ~ Max	°C	-10 ~ +52	-10 ~ +52	-10 ~ +52	-10 ~ +52	-10 ~ +52	-10 ~ +52	-10 ~ +52	-10 ~ +52
	Heat Min ~ Max	°C	-25 ~ +18	-25 ~ +18	-25 ~ +18	-25 ~ +18	-25 ~ +18	-25 ~ +18	-25 ~ +18	-25 ~ +18

1) EER and COP calculation is based in accordance to EN14511. 2) SEER / SCOP is calculated based on the seasonal space cooling / heating efficiency "η" values of the COMMISSION REGULATION (EU) 2016/2281. SEER, SCOP = (η + Correction) × PEF. 3) Piping diameter under 90 m for ultimate indoor unit / over 90 m for ultimate indoor unit (if the longest piping equivalent length exceeds 90 m, increase the sizes of the main tubes by 1 rank for gas tubes and liquid tubes). 4) If the following conditions are satisfied, the effective range is above 130 % and below 200 %: A. Obey the limited number of connectable indoor units. B. The lower limit of operating range for heating outdoor temperature is limited to -10 °C WB (standard -25 °C WB). C. Simultaneous operation is limited to less than 130 % of connectable indoor units.

3-Pipe ECOi EX MF3 Series



Simultaneous heating and cooling VRF system.

The Panasonic 3-Pipe ECOi EX MF3 Series offers the best solution for the most discerning customers and demanding installations.

Simultaneous heating and cooling VRF System

The Panasonic 3-Pipe ECOi EX MF3 Series offers the ideal solution to meet customer's demands.

Upgraded energy efficiency utilized ECOi EX technology.

- SEER / SCOP improved in full capacities from 8 to 16 HP
- SEER / SCOP follows LOT21 (January 2018)
- Eurovent certified EER / COP

Design flexibility.

- High reliability even under extreme temperature conditions
- Connection of up to 52 indoor units
- Slim heat recovery box with just 200 mm height
- Farthest piping length between indoor and outdoor units: 200 m

Excellent seasonal energy saving.

SEER / SCOP

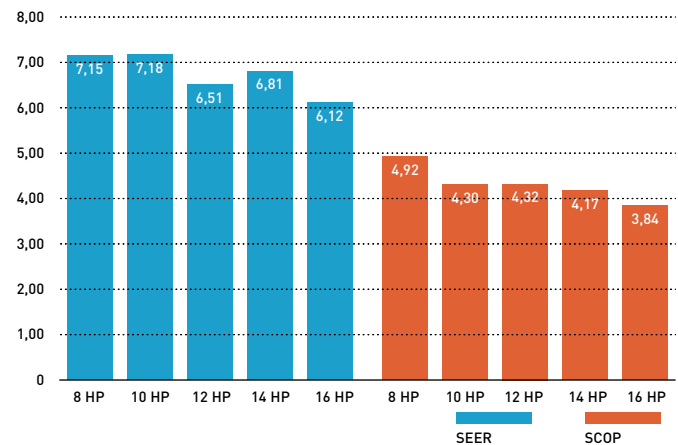

Extended design operation conditions

Cooling design operation conditions: The cooling operating range has been extended to $-10\text{ }^{\circ}\text{C}$ ~ $52\text{ }^{\circ}\text{C}$ by changing the outdoor fan to an Inverter type.

Heating design operation conditions: Stable heating operation even with an outside air temperature of $-20\text{ }^{\circ}\text{C}$. The heating operating range has been extended to $-20\text{ }^{\circ}\text{C}$ by use of a compressor with a high-pressure vessel.

Cooling design operation conditions.

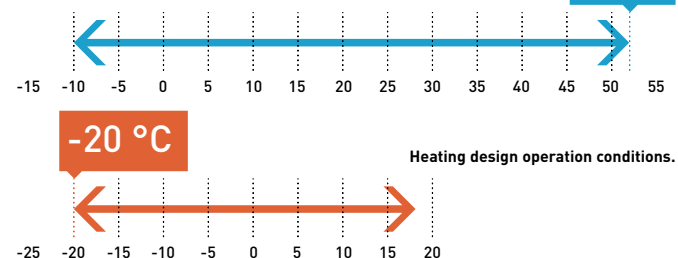

Wide temperature setting range

Wired remote controller heating temperature setting range is 16 to $30\text{ }^{\circ}\text{C}$ as standard.

Increased maximum number of connectable indoor units

Maximum 48 HP with 52 indoor units can be set up according to user needs. Connectable indoor / outdoor unit capacity ratio up to 150 %.

System (HP)	8	10	12	14	16	18	20	22	24	26	28	30	32	34	36	38	40	42	44	46	48
Connectable indoor units*: 150 %	19	24	29	34	39	43	48	52					52								

*Depending on indoor units types. Please check service manuals.

Power suppression control for energy saving (demand control) ¹⁾

The 3-Pipe ECOi EX MF3 Series has a built-in demand function which uses the inverter characteristics. With this demand function, the power consumption can be set in three steps, and operation ²⁾ at optimum performance is performed according to the setting and the power consumption. This function is useful to reduce the annual power consumption and to save electricity costs while maintaining comfort.

¹⁾ An outdoor Seri-Para I/O unit is required for demand input.

²⁾ Setting is possible as 0 % or in the range from 40 to 100 % (in steps of 5 %). At the time of shipping, setting has been done to the three steps of 0 %, 70 %, and 100 %.

Slim 3-Pipe control box kit / Multiple connection type

Heat recovery Box to connect multiple indoor units with just one box, 4, 6 and up to 8 indoor units or groups.

The height is only 200 mm, which is especially advantageous in hotel applications, where space for connecting several boxes is limited.

Individual control of multiple indoor units with solenoid valve kits.

- Any design and layout can be used in a single system.
- Cooling operation is possible up to an outdoor temperature of -10 °C.

System structure.

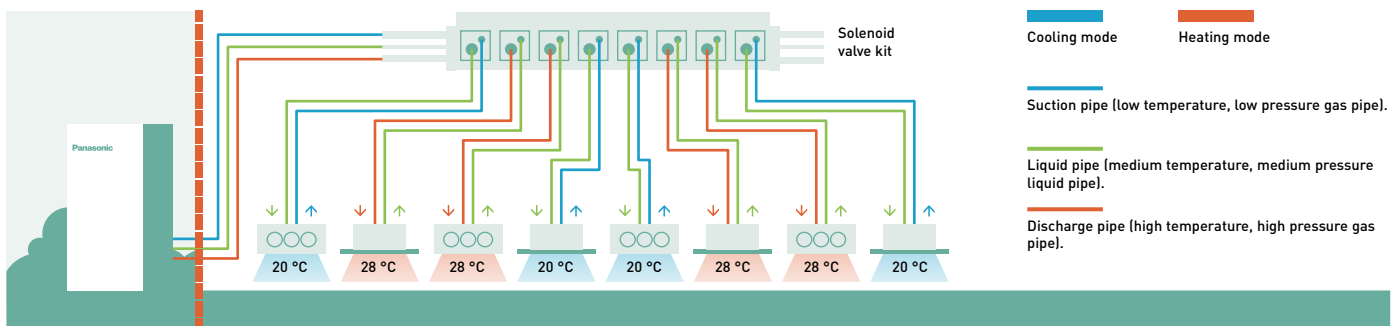

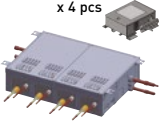
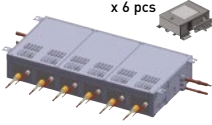
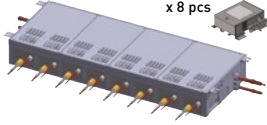
				
	1 port	4 port	6 port	8 port
56 type	CZ-P56HR3	CZ-P456HR3	CZ-P656HR3	CZ-P856HR3
160 type	CZ-P160HR3	CZ-P4160HR3	—	—

Solenoid valve kit / wiring work

Current model / single connection type.

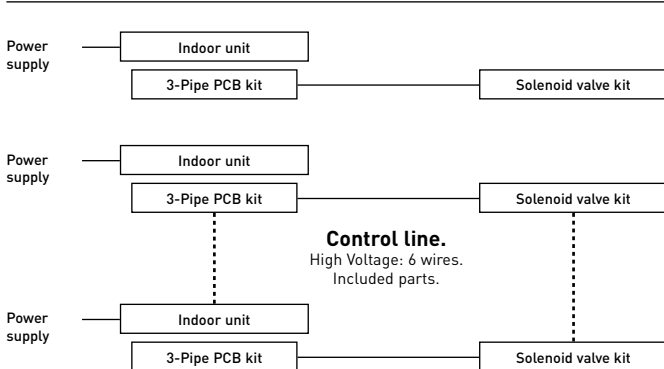

New model / multiple connection type.

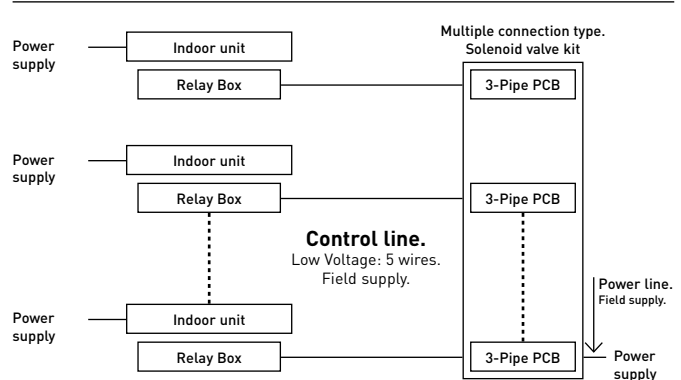

3-Pipe PCB kit.
Separately purchased.



Single HR3 kit.

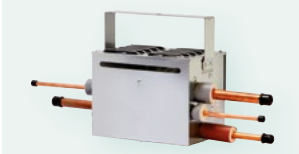

Signal Relay Box.
Included accessory.

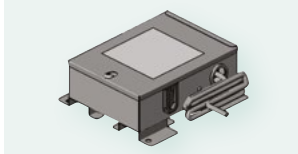

Multiple HR3 kit.

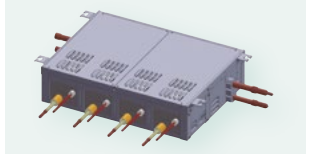

3-Pipe ECOi EX MF3 Series superior flexibility

Increased piping lengths and design flexibility

Adaptable to various building types and sizes. Actual piping length: 200 m. Maximum piping length: 500 m.

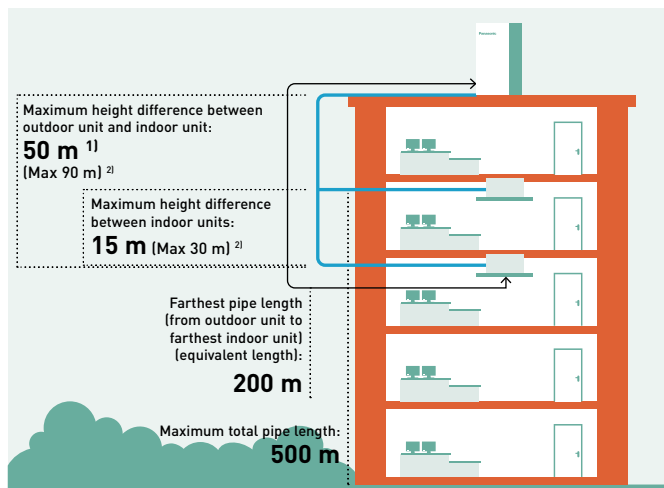

1) 40 m if the outdoor unit is below the indoor unit.

2) For height differences between outdoor unit and indoor unit > 50 m, as well as for height differences between indoor units > 15 m, contact an authorized Panasonic dealer.

Up to 40 m piping after first branch

Up to 52 units can be connected to one system. Flexible piping layout makes it easier to design systems for locations such as train stations, airports, schools and hospitals.

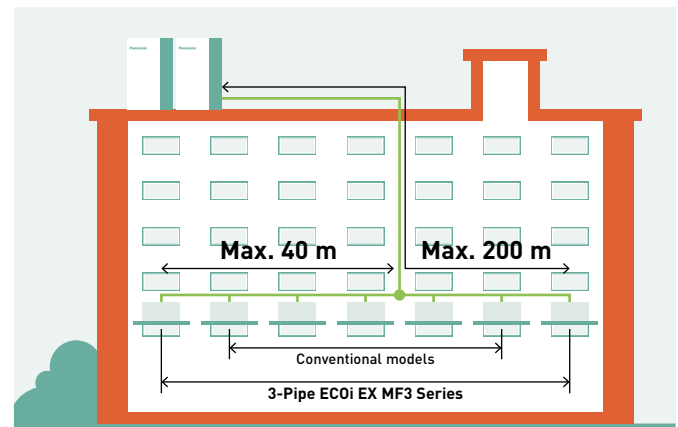

Excellent cost saving and smaller piping size

By using R410A with low pressure loss, pipe sizes for discharge, suction and liquid are all reduced. This makes it possible to aim for reduced piping space, improved workability at the site, and reduction of the piping material costs.

8 HP

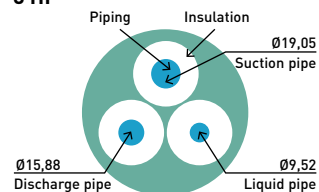

10 HP

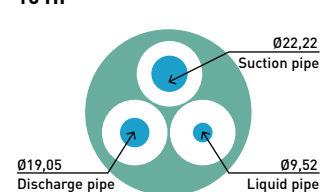

High external static pressure on condensers

With a newly designed fan, fan guard, motor, and casing, the models can be custom-installed on-site to provide up to 80 Pa of external static pressure.

An air discharge duct prevents shortages of air circulation, allowing outdoor units to be installed on every floor of a building.

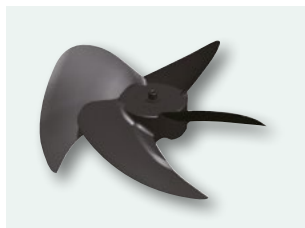

Fan.

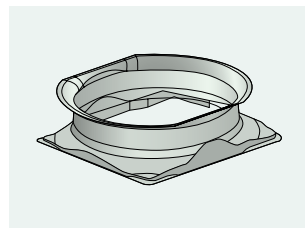

Fan motor and casing.

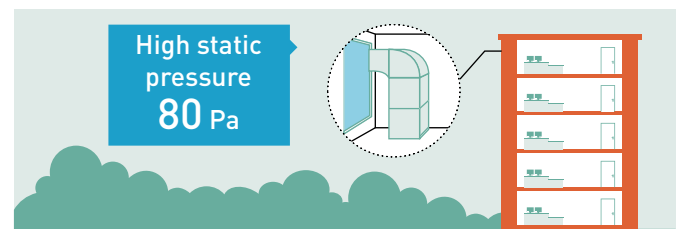



3-Pipe ECOi EX MF3 Series piping design

Select the installation location so that the length and size of refrigerant tubing are within the allowable range shown in the figure below.

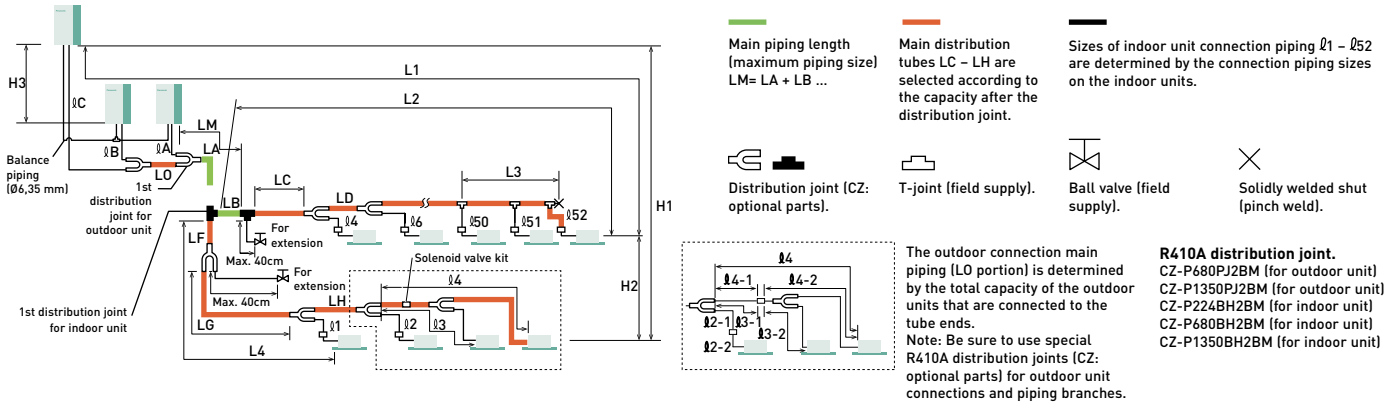

Ranges that apply to refrigerant piping lengths and to differences in installation heights

Items	Mark	Contents	Length (m)
Allowable piping length	L1	Maximum piping length	Actual length ≤200 ¹⁾ Equivalent length ≤210 ¹⁾
	$\Delta L (L2-L4)$	Difference between maximum length and minimum length from the 1st distribution joint	≤50 ²⁾
	LM	Maximum length of main piping (at maximum size) * Even after 1st distribution joint, LM is allowed if at maximum piping length.	— ³⁾
	$Q_1, Q_2 - Q_{52}$	Maximum length of each distribution tube	≤50 ⁴⁾
	$L1 + Q_1 + Q_2 - Q_{51} + Q_A + Q_B + L_F + L_G + L_H$	Total maximum piping length including length of each distribution tube (only liquid piping)	≤500
	$Q_A, Q_B + L_O, Q_C + L_O$	Maximum piping length from outdoor's 1st distribution joint to each outdoor unit	≤10
Allowable elevation difference	$Q_1-2, Q_2-2 - Q_{52}-2$	Maximum length between solenoid valve kit and indoor unit	≤30
	H1	When outdoor unit is installed higher than indoor unit	≤50
	H2	When outdoor unit is installed lower than indoor unit	≤40
Allowable length of joint piping	H3	Maximum difference between indoor units	≤15 ⁵⁾
	H3	Maximum difference between outdoor units	≤4
Allowable length of joint piping	L3	T-joint piping (field-supply); Maximum piping length between the first T-joint and solidly welded-shut end point	≤2

L = Length, H = Height

1) If the longest piping length (L1) exceeds 90 m (equivalent length), increase the sizes of the main pipes (LM) by 1 rank for suction pipes, discharge pipes and liquid pipes. Use a field supply reducer. Select the pipe size from the table of main piping sizes (Table 3) and from the table of refrigerant piping sizes (Table 8). 2) If the longest main piping length (LM) exceeds 50 m, increase the main piping size at the portion before 50 m by 1 rank for the suction pipes and discharge pipes. Use a field supply reducer. Determine the length less than the limitation of allowable maximum piping length. For the portion that exceeds 50 m, set based on the main piping size (LA) listed in Table 3. 3) If the piping length marked "L" (L2-L4) exceeds 40 m, increase the piping size at the portion after the 1st distribution joint by 1 rank for the liquid pipe, suction pipe and discharge pipe. Refer to the Technical Data for the details. 4) If any of the piping length exceeds 30 m, increase the size of the suction pipes, discharge pipes and liquid pipes by 1 rank. * The outdoor connection main piping (LO portion) is determined by the total capacity of the outdoor units that are connected to the pipe ends.

System limitations.

Maximum number allowable connected outdoor units	3
Maximum capacity allowable connected outdoor units	135 kW (48 HP)
Maximum connectable indoor units	52
Maximum allowable indoor / outdoor capacity ratio	50-150 %

1) In the case of 24 HP (type 68 kW) or smaller units, the number is limited by the total capacity of the connected indoor units.
 2) Up to 3 units can be connected if the system has been extended.
 3) It is strongly recommended that you choose the unit so the load can become between 50 and 130 %.

Additional refrigerant charge.

Liquid piping size (Inch (mm))	1/4 (6,35)	3/8 (9,52)	1/2 (12,70)	5/8 (15,88)	3/4 (19,05)	7/8 (22,22)
Amount of refrigerant charge (g/m)	26	56	128	185	259	366

Necessary amount of additional refrigerant charge per meter, according to discharge piping size.

Discharge piping size	Inch (mm)	1/2 (12,70)	5/8 (15,88)	3/4 (19,05)	7/8 (22,22)	1 (25,40)	1-1/8 (28,58)	1-1/4 (31,75)	1-1/2 (38,10)
Additional amount	g/m	12	21	31	41	55	71	89	126

Refrigerant piping.

Piping size (mm)				Material Temper - 1/2 H, H							
Material Temper - O				Material Temper - 1/2 H, H							
Ø6,35	t 0,8	Ø12,70	t 0,8	Ø19,05	t 1,2	Ø22,22	t 1,0	Ø28,58	t 1,0	Ø38,10	t 1,15
Ø9,52	t 0,8	Ø15,88	t 1,0			Ø25,40	t 1,0	Ø31,75	t 1,1	Ø41,28	t 1,20

* When bending the tubes, use a bending radius that is at least 4 times the outer diameter of the tubes. In addition, take sufficient care to avoid crushing or damaging the tubes when bending them.

**4,92
SCOP****3-Pipe ECOi EX MF3 Series****Simultaneous heating and cooling operation with heat recovery type.**

The 3-Pipe ECOi EX MF3 Series is one of the most advanced VRF systems.

Not only high-efficient performance for simultaneous heating and cooling, but also sophisticated installation and maintenance capability.

			8 HP	10 HP	12 HP	14 HP	16 HP
Outdoor unit			U-8MF3E8	U-10MF3E8	U-12MF3E8	U-14MF3E8	U-16MF3E8
Power supply	Voltage	V	380-400-415	380-400-415	380-400-415	380-400-415	380-400-415
	Phase		Three phase	Three phase	Three phase	Three phase	Three phase
	Frequency	Hz	50	50	50	50	50
Cooling capacity	kW		22,4	28,0	33,5	40,0	45,0
EER ¹⁾	W/W		5,11	4,72	3,91	3,70	3,49
Recommended combination			4 x S-56MF2E5A	4 x S-73MF2E5A	6 x S-56MF2E5A	2 x S-60MF2E5A + 4 x S-73MF2E5A	6 x S-73MF2E5A
SEER ²⁾			7,15	7,18	6,51	6,81	6,12
$\eta_{s,c}$			277,7	278,9	252,7	264,4	237,7
Current	A		7,16-6,80-6,55	9,90-9,41-9,07	3,19-13,20-12,70	18,20-17,30-16,70	21,30-20,20-19,50
Input power	kW		4,38	5,93	8,57	10,80	12,90
Heating capacity	kW		25,0	31,5	37,5	45,0	50,0
COP ¹⁾	W/W		5,25	5,17	4,51	4,21	4,17
SCOP ²⁾			4,92	4,30	4,32	4,17	3,84
$\eta_{s,h}$			190,9	166,8	167,8	162,1	149,3
Current	A		7,78-7,39-7,12	10,20-9,66-9,31	13,40-12,80-12,30	18,10-17,20-16,50	20,00-19,00-18,30
Input power	kW		4,76	6,09	8,32	10,70	12,00
Starting current	A		1,00	1,00	1,00	2,00	2,00
External static pressure (Max)	Pa		80	80	80	80	80
Air flow	m ³ /min		210	220	232	232	232
Sound pressure	Normal mode	dB(A)	54,0	57,0	60,0	61,0	62,0
	Silent mode 1 / 2	dB(A)	51,0/49,0	54,0/52,0	57,0/55,0	58,0/56,0	59,0/57,0
Sound power	Normal mode	dB(A)	76,0	78,0	81,0	82,0	82,0
Dimension	HxWxD	mm	1842 x 1180 x 1000	1842 x 1180 x 1000	1842 x 1180 x 1000	1842 x 1180 x 1000	1842 x 1180 x 1000
Net weight	kg		261	262	286	334	334
Piping diameter ³⁾	Liquid pipe	Inch (mm)	3/8(9,52)/1/2(12,70)	3/8(9,52)/1/2(12,70)	1/2(12,70)/5/8(15,88)	1/2(12,70)/5/8(15,88)	1/2(12,70)/5/8(15,88)
	Discharge pipe	Inch (mm)	5/8(15,88)/3/4(19,05)	3/4(19,05)/7/8(22,22)	3/4(19,05)/7/8(22,22)	7/8(22,22)/1(25,40)	7/8(22,22)/1(25,40)
	Suction pipe	Inch (mm)	3/4(19,05)/7/8(22,22)	7/8(22,22)/1(25,40)	1(25,40)/1-1/8(28,58)	1(25,40)/1-1/8(28,58)	1-1/8(28,58)/1-1/4(31,75)
	Balance pipe	Inch (mm)	1/4(6,35)	1/4(6,35)	1/4(6,35)	1/4(6,35)	1/4(6,35)
Refrigerant (R410A) / CO ₂ Eq.	kg / T		6,80/14,1984	6,80/14,1984	8,30/17,3304	8,30/17,3304	8,30/17,3304
Maximum allowable indoor / outdoor capacity ratio %			50 ~ 150	50 ~ 150	50 ~ 150	50 ~ 150	50 ~ 150
Operating range	Cool Min ~ Max	°C	-10 ~ +52	-10 ~ +52	-10 ~ +52	-10 ~ +52	-10 ~ +52
	Heat Min ~ Max	°C	-20 ~ +18	-20 ~ +18	-20 ~ +18	-20 ~ +18	-20 ~ +18
	Simultaneous op.	°C	-10 ~ +24	-10 ~ +24	-10 ~ +24	-10 ~ +24	-10 ~ +24

1) EER and COP calculation is based in accordance to EN14511. 2) SEER / SCOP is calculated based on the seasonal space cooling / heating efficiency "η" values of the COMMISSION REGULATION (EU) 2016/2281. SEER, SCOP = (η + Correction) × PEF. 3) Piping diameter under 90 m for ultimate indoor unit / over 90 m for ultimate indoor unit (if the longest piping equivalent length exceeds 90 m, increase the sizes of the main tubes by 1 rank for gas tubes and liquid tubes). 4) Available for S-45/56/73/106MK2E5B.

Solenoid valve kit		
KIT-P56HR3	KIT-P56HR3	3-Pipe control solenoid valve kit (up to 5,6 kW)
	CZ-P56HR3	Solenoid valve kit (up to 5,6 kW)
	CZ-CAPE2	3-Pipe control PCB
KIT-P160HR3	KIT-P160HR3	3-Pipe control solenoid valve kit (from 5,6 to 16,0 kW)
	CZ-P160HR3	Solenoid valve kit (from 5,6 kW to 16,0 kW)
	CZ-CAPE2	3-Pipe control PCB
	CZ-CAPE2 ⁴⁾	3-Pipe control PCB for wall-mounted

3-Pipe control box kit		
CZ-P456HR3	4 ports 3 pipe box (up to 5,6 kW per port)	
CZ-P656HR3	6 ports 3 pipe box (up to 5,6 kW per port)	
CZ-P856HR3	8 ports 3 pipe box (up to 5,6 kW per port)	
CZ-P4160HR3	4 ports 3 pipe box (up to 16,0 kW per port)	

- Achieving SCOP 4,92 as the top class in the industry (LOT21 Seasonal heating efficiency value for 8 HP outdoor unit)
- Simultaneous cooling and heating operation with up to 39 indoor units
- Slim heat recovery boxes with just 200 mm height fit with the ceiling space limited in hotel applications

Technical focus

- High SEER / SCOP at full Load capacity (follows LOT21)
- Eurovent certified EER / COP
- Standardisation of outdoor unit to one compact casing size
- Connection of up to 52 indoor units
- High external static pressure 80 Pa with a newly designed fan, fan guard, motor, and casing
- Silent outdoor unit operation: Minimum 54 dB(A) for 8 HP
- Bluefin coil coating as standard





3-Pipe ECOi EX MF3 Series combination from 18 to 32 HP

HP			18 HP	20 HP	22 HP	24 HP	26 HP	28 HP	30 HP	32 HP
	Outdoor unit		U-8MF3E8	U-8MF3E8	U-10MF3E8	U-12MF3E8	U-10MF3E8	U-12MF3E8	U-14MF3E8	U-16MF3E8
			U-10MF3E8	U-12MF3E8	U-12MF3E8	U-12MF3E8	U-16MF3E8	U-16MF3E8	U-16MF3E8	U-16MF3E8
Power supply	Voltage	V	380-400-415	380-400-415	380-400-415	380-400-415	380-400-415	380-400-415	380-400-415	380-400-415
	Phase		Three phase	Three phase	Three phase	Three phase	Three phase	Three phase	Three phase	Three phase
	Frequency	Hz	50	50	50	50	50	50	50	50
Cooling capacity	kW		50,0	56,0	61,5	68,0	73,0	78,5	85,0	90,0
EER ¹⁾	W/W		4,90	4,31	4,24	3,89	3,88	3,65	3,59	3,49
Current	A		16,80-16,00-15,40	21,00-20,00-19,20	23,70-22,50-21,70	28,30-26,90-25,90	31,00-29,50-28,40	35,10-33,40-32,20	39,60-37,60-36,20	42,60-40,50-39,00
Input power	kW		10,20	13,00	14,50	17,50	18,80	21,50	23,70	25,8
Heating capacity	kW		56,0	63,0	69,0	76,5	81,5	87,5	95,0	100,0
COP ¹⁾	W/W		5,23	4,77	4,79	4,47	4,50	4,31	4,19	4,17
Current	A		17,70-16,80-16,20	21,30-20,30-19,50	23,50-22,30-21,50	27,60-26,30-25,30	30,20-28,70-27,70	33,50-31,80-30,70	37,90-36,00-34,70	40,10-38,10-36,70
Input power	kW		10,70	13,20	14,40	17,10	18,10	20,30	22,70	24,00
Starting current	A		2,00	2,00	2,00	2,00	3,00	3,00	4,00	4,00
External static pressure (Max)	Pa		80	80	80	80	80	80	80	80
Air flow	m ³ /min		430	442	452	464	452	464	464	464
Sound pressure	Normal mode	dB(A)	59,0	61,0	62,0	63,0	63,5	64,5	64,5	65,0
	Silent mode 1 / 2	dB(A)	56,0/54,0	58,0/56,0	59,0/57,0	60,0/58,0	60,5/58,5	61,5/59,5	61,5/59,5	62,0/60,0
Sound power	Normal mode	dB(A)	81,5	84,0	84,5	86,0	84,5	86,0	86,0	86,0
Dimension	HxWxD	mm	1842x2360 (+60)x1000	1842x2360 (+60)x1000	1842x2360 (+60)x1000	1842x2360 (+60)x1000	1842x2360 (+60)x1000	1842x2360 (+60)x1000	1842x2360 (+60)x1000	1842x2360 (+60)x1000
Net weight	kg		523	547	548	574	596	620	668	668
Piping diameter ²⁾	Liquid pipe	Inch (mm)	5/8(15,88)/ 3/4(19,05)	5/8(15,88)/ 3/4(19,05)	5/8(15,88)/ 3/4(19,05)	5/8(15,88)/ 3/4(19,05)	3/4(19,05)/ 7/8(22,22)	3/4(19,05)/ 7/8(22,22)	3/4(19,05)/ 7/8(22,22)	3/4(19,05)/ 7/8(22,22)
	Discharge pipe	Inch (mm)	7/8(22,22)/ 1(25,40)	7/8(22,22)/ 1(25,40)	1-1/8(28,58)/ 1(25,40)	1-1/8(28,58)/ 1(25,40)	1(25,40)/ 1-1/8(28,58)	1(25,40)/ 1-1/8(28,58)	1-1/8(28,58)/ 1-1/4(31,75)	1-1/8(28,58)/ 1-1/4(31,75)
	Suction pipe	Inch (mm)	1-1/8(28,58)/ 1-1/4(31,75)	1-1/8(28,58)/ 1-1/4(31,75)	1-1/8(28,58)/ 1-1/4(31,75)	1-1/8(28,58)/ 1-1/4(31,75)	1-1/4(31,75)/ 1-1/2(38,10)	1-1/4(31,75)/ 1-1/2(38,10)	1-1/4(31,75)/ 1-1/2(38,10)	1-1/4(31,75)/ 1-1/2(38,10)
	Balance pipe	Inch (mm)	1/4(6,35)	1/4(6,35)	1/4(6,35)	1/4(6,35)	1/4(6,35)	1/4(6,35)	1/4(6,35)	1/4(6,35)
Refrigerant (R410A) / CO ₂ Eq.	kg / T		13,60/28,3968	15,10/31,5288	15,10/31,5288	16,60/34,6608	15,10/31,5288	16,60/34,6608	16,60/34,6608	16,60/34,6608
Maximum allowable indoor / outdoor capacity ratio %			50 ~ 150	50 ~ 150	50 ~ 150	50 ~ 150	50 ~ 150	50 ~ 150	50 ~ 150	50 ~ 150
Operating range	Cool Min - Max	°C	-10 ~ +52	-10 ~ +52	-10 ~ +52	-10 ~ +52	-10 ~ +52	-10 ~ +52	-10 ~ +52	-10 ~ +52
	Heat Min - Max	°C	-20 ~ +18	-20 ~ +18	-20 ~ +18	-20 ~ +18	-20 ~ +18	-20 ~ +18	-20 ~ +18	-20 ~ +18
	Simultaneous op.	°C	-10 ~ +24	-10 ~ +24	-10 ~ +24	-10 ~ +24	-10 ~ +24	-10 ~ +24	-10 ~ +24	-10 ~ +24

3-Pipe ECOi EX MF3 Series combination from 34 to 48 HP

HP			34 HP	36 HP	38 HP	40 HP	42 HP	44 HP	46 HP	48 HP
	Outdoor unit		U-8MF3E8	U-8MF3E8	U-10MF3E8	U-8MF3E8	U-10MF3E8	U-12MF3E8	U-14MF3E8	U-16MF3E8
			U-10MF3E8	U-12MF3E8	U-12MF3E8	U-16MF3E8	U-16MF3E8	U-16MF3E8	U-16MF3E8	U-16MF3E8
Power supply	Voltage	V	380-400-415	380-400-415	380-400-415	380-400-415	380-400-415	380-400-415	380-400-415	380-400-415
	Phase		Three phase	Three phase	Three phase	Three phase	Three phase	Three phase	Three phase	Three phase
	Frequency	Hz	50	50	50	50	50	50	50	50
Cooling capacity	kW		96,0	101,0	107,0	113,0	118,0	124,0	130,0	135,0
EER ¹⁾	W/W		4,10	3,90	3,88	3,72	3,72	3,58	3,55	3,49
Current	A		38,60-36,70-35,40	42,30-40,20-38,70	45,60-43,30-41,70	50,20-47,70-46,00	52,40-49,70-47,90	56,50-53,70-51,80	61,10-58,10-56,00	63,90-60,70-58,50
Input power	kW		23,40	25,90	27,60	30,40	31,70	34,60	36,60	38,70
Heating capacity	kW		108,0	113,0	119,0	127,0	132,0	138,0	145,0	150,0
COP ¹⁾	W/W		4,64	4,48	4,51	4,31	4,36	4,25	4,18	4,17
Current	A		38,90-37,00-35,60	41,60-39,50-38,10	43,60-41,40-39,90	49,30-46,80-45,10	50,60-48,10-46,30	53,70-51,00-49,10	57,90-55,00-53,00	60,10-57,10-55,00
Input power	kW		23,30	25,20	26,40	29,50	30,30	32,50	34,70	36,00
Starting current	A		4,00	4,00	4,00	5,00	5,00	5,00	6,00	6,00
External static pressure (Max)	Pa		80	80	80	80	80	80	80	80
Air flow	m ³ /min		662	674	684	674	684	696	696	696
Sound pressure	Normal mode	dB(A)	64,0	64,5	65,0	65,5	66,0	66,5	66,5	67,0
	Silent mode 1 / 2	dB(A)	61,0/59,0	61,5/59,5	62,0/60,0	62,5/60,5	63,0/61,0	63,5/61,5	63,5/61,5	64,0/62,0
Sound power	Normal mode	dB(A)	84,5	85,5	86,0	85,5	86,0	86,5	87,0	87,0
Dimension	HxWxD	mm	1842x3540 (+120)x1000	1842x3540 (+120)x1000	1842x3540 (+120)x1000	1842x3540 (+120)x1000	1842x3540 (+120)x1000	1842x3540 (+120)x1000	1842x3540 (+120)x1000	1842x3540 (+120)x1000
Net weight	kg		857	881	882	929	930	954	1002	1002
Piping diameter ²⁾	Liquid pipe	Inch (mm)	3/4(19,05)/ 7/8(22,22)	3/4(19,05)/ 7/8(22,22)	3/4(19,05)/ 7/8(22,22)	3/4(19,05)/ 7/8(22,22)	3/4(19,05)/ 7/8(22,22)	3/4(19,05)/ 7/8(22,22)	3/4(19,05)/ 7/8(22,22)	3/4(19,05)/ 7/8(22,22)
	Discharge pipe	Inch (mm)	1-1/8(28,58)/ 1-1/4(31,75)	1-1/8(28,58)/ 1-1/4(31,75)	1-1/4(31,75)/ 1-1/2(38,10)	1-1/4(31,75)/ 1-1/2(38,10)	1-1/4(31,75)/ 1-1/2(38,10)	1-1/4(31,75)/ 1-1/2(38,10)	1-1/4(31,75)/ 1-1/2(38,10)	1-1/4(31,75)/ 1-1/2(38,10)
	Suction pipe	Inch (mm)	1-1/4(31,75)/ 1-1/2(38,10)	1-1/2(38,10)/ 1-5/8(41,28)	1-1/2(38,10)/ 1-5/8(41,28)	1-1/2(38,10)/ 1-5/8(41,28)	1-1/2(38,10)/ 1-5/8(41,28)	1-1/2(38,10)/ 1-5/8(41,28)	1-1/2(38,10)/ 1-5/8(41,28)	1-1/2(38,10)/ 1-5/8(41,28)
	Balance pipe	Inch (mm)	1/4(6,35)	1/4(6,35)	1/4(6,35)	1/4(6,35)	1/4(6,35)	1/4(6,35)	1/4(6,35)	1/4(6,35)
Refrigerant (R410A) / CO ₂ Eq.	kg / T		21,90/45,72719	23,40/48,85919	23,40/48,85919	23,40/48,85919	23,40/48,85919	24,90/46,3536	24,90/51,9912	24,90/51,9912
Maximum allowable indoor / outdoor capacity ratio %			50 ~ 150	50 ~ 150	50 ~ 150	50 ~ 150	50 ~ 150	50 ~ 150	50 ~ 150	50 ~ 150
Operating range	Cool Min - Max	°C	-10 ~ +52	-10 ~ +52	-10 ~ +52	-10 ~ +52	-10 ~ +52	-10 ~ +52	-10 ~ +52	-10 ~ +52
	Heat Min - Max	°C	-20 ~ +18	-20 ~ +18	-20 ~ +18	-20 ~ +18	-20 ~ +18	-20 ~ +18	-20 ~ +18	-20 ~ +18
	Simultaneous op.	°C	-10 ~ +24	-10 ~ +24	-10 ~ +24	-10 ~ +24	-10 ~ +24	-10 ~ +24	-10 ~ +24	-10 ~ +24

1) EER and COP calculation is based in accordance to EN14511. 2) Piping diameter under 90 m for ultimate indoor unit / over 90 m for ultimate indoor unit (if the longest piping equivalent length exceeds 90 m, increase the sizes of the main tubes by 1 rank for gas tubes and liquid tubes).



Eurovent certified technical data

Panasonic's VRF systems - ECOi range is now certified by Eurovent*. The Eurovent certification verifies the performance ratings of heating and cooling systems following European standards. Data provides products efficiency with full transparency, for the benefit of customers and professionals.

Eurovent certified technical data: Mini ECOi LZ2 Series 4 to 10 HP · R32

HP		4 HP		5 HP		6 HP		8 HP		10 HP							
Outdoor unit		U-4LZ2E5		U-4LZ2E8		U-5LZ2E5		U-5LZ2E8		U-6LZ2E5		U-6LZ2E8		U-8LZ2E8		U-10LZ2E8	
Indoor units combination		MU2		MU2		MU2		MU2		MU2		MU2		MU2		MU2	
Cooling	Pc out ¹⁾ kW	12,1	12,1	14,0	14,0	15,5	15,5	22,4	22,4	28,0	28,0						
	Pec out ²⁾ kW	2,95	2,95	3,68	3,68	4,43	4,43	6,79	6,79	9,66	9,66						
	EERout	4,1	4,1	3,8	3,8	3,5	3,5	3,3	3,3	2,9	2,9						
Seasonal Cooling	SEER	8,5	8,5	8,1	8,1	7,7	7,7	7,6	7,6	7,1	7,1						
	$\eta_{s,c}$ %	337	337	322	322	305	305	299	299	280	280						
Cooling PL	PcB kW	8,9	8,9	10,3	10,3	11,4	11,4	16,5	16,5	20,6	20,6						
Condition B	EERB	6,5	6,5	5,9	5,9	5,4	5,4	5,2	5,2	4,6	4,6						
Cooling PL	PcC kW	5,7	5,7	6,6	6,6	7,3	7,3	10,6	10,6	13,2	13,2						
Condition C	EERC	11,3	11,3	10,8	10,8	10,2	10,2	9,6	9,6	8,7	8,7						
Cooling PL	PcD kW	5,4	5,4	5,6	5,6	5,8	5,8	9,0	9,0	9,5	9,5						
Condition D	EERD	15,6	15,6	15,2	15,2	15,0	15,0	16,6	16,6	18,0	18,0						
Seasonal Heating	Pdesignh kW	10,0	10,0	11,2	11,2	11,6	11,6	17,5	17,5	19,6	19,6						
	SCOP	5,1	5,1	4,6	4,6	4,6	4,6	4,6	4,6	4,6	4,6						
	$\eta_{s,h}$ %	199,0	199,0	181,4	181,4	180,6	180,6	180,6	180,6	181,0	181,0						
Heating PL	PhA kW	8,8	8,8	9,9	9,9	10,3	10,3	15,4	15,4	17,3	17,3						
Condition A	COPA	3,1	3,1	2,9	2,9	2,9	2,9	2,9	2,9	2,8	2,8						
Heating PL	PhB kW	5,4	5,4	6,0	6,0	6,2	6,2	9,4	9,4	10,5	10,5						
Condition B	COPB	4,8	4,8	4,1	4,1	4,1	4,1	4,2	4,2	4,2	4,2						
Heating PL	PhC kW	3,5	3,5	3,9	3,9	4,0	4,0	6,2	6,2	6,7	6,7						
Condition C	COPC	7,2	7,2	7,2	7,2	7,1	7,1	6,9	6,9	7,1	7,1						
Heating PL	PhD kW	4,0	4,0	4,0	4,0	4,0	4,0	6,7	6,7	6,9	6,9						
Condition D	COPD	9,1	9,1	9,3	9,3	9,3	9,3	8,7	8,7	9,2	9,2						
T bivalent	Tbiv °C	-10	-10	-7	-7	-7	-7	-7	-7	-7	-7						
	PhTbiv kW	10	10	10	10	10	10	15	15	17	17						
	COPTbiv	2,5	2,5	2,9	2,9	2,9	2,9	2,9	2,9	2,8	2,8						
Psbk	W	14	14	14	14	14	14	18	18	18	18						
Psbh	W	18	18	18	18	18	18	26	26	26	26						
Poffc	W	14	14	14	14	14	14	18	18	18	18						
Poffh	W	18	18	18	18	18	18	26	26	26	26						
Ptoc	W	14	14	14	14	14	14	18	18	18	18						
Ptoh	W	18	18	18	18	18	18	26	26	26	26						
Pckc	W	14	14	14	14	14	14	18	18	18	18						
Pckh	W	18	18	18	18	18	18	26	26	26	26						
Sound power level	dB(A)	69	69	70	70	72	72	72	72	74	74						
Sound power level in heating	dB(A)	72	72	74	74	75	75	75	75	74	75						

Eurovent certified technical data: Mini ECOi LE Series 4 to 10 HP · R410A

HP		4 HP				5 HP				6 HP				8 HP		10 HP	
Outdoor unit		U-4LE2E5		U-4LE2E8		U-5LE2E5		U-5LE2E8		U-6LE2E5		U-6LE2E8		U-8LE1E8		U-10LE1E8	
Indoor units combination		MF2	MU2	MF2	MU2	MF2	MU2	MF2	MU2	MF2	MU2	MF2	MU2	MF2	MU2	MF2	MU2
Cooling	Pc out ¹⁾ kW	12,1	12,1	12,1	12,1	14	14	14	14	15,5	15,5	15,5	15,5	22,4	22,4	28	28
	Pec out ²⁾ kW	2,88	2,88	2,88	2,88	3,68	3,68	3,68	3,68	4,56	4,56	4,56	4,56	7,23	7,23	10,77	10,77
	EERout	4,2	4,2	4,2	4,2	3,8	3,8	3,8	3,8	3,4	3,4	3,4	3,4	3,1	3,1	2,6	2,6
Seasonal Cooling	SEER	7,8	7,8	7,8	7,8	7,5	7,5	7,5	7,5	7,2	7,2	7,2	7,2	6,3	6,3	6,4	6,4
	$\eta_{s,c}$ %	311	311	311	311	296,2	296,2	296,2	296,2	286,8	286,8	286,8	286,8	247,9	247,9	251,8	251,8
Cooling PL	PcB kW	8,9	8,9	8,9	8,9	10,3	10,3	10,3	10,3	11,4	11,4	11,4	11,4	16,5	16,5	20,6	20,6
Condition B	EERB	6,7	6,7	6,7	6,7	5,9	5,9	5,9	5,9	5,4	5,4	5,4	5,4	4,8	4,8	4,4	4,4
Cooling PL	PcC kW	5,7	5,7	5,7	5,7	6,6	6,6	6,6	6,6	7,3	7,3	7,3	7,3	10,6	10,6	13,2	13,2
Condition C	EERC	12,1	12,1	12,1	12,1	11	11	11	11	10,2	10,2	10,2	10,2	7,8	7,8	8,2	8,2
Cooling PL	PcD kW	2,7	2,7	2,7	2,7	2,9	2,9	2,9	2,9	3,4	3,4	3,4	3,4	8	8	9	9
Condition D	EERD	9,6	9,6	9,6	9,6	10,3	10,3	10,3	10,3	11,7	11,7	11,7	11,7	12,8	12,8	15,4	15,4
Seasonal Heating	Pdesignh kW	10	10	10	10	12,5	12,5	12,5	12,5	13	13	13	13	17,5	17,5	19,6	19,6
	SCOP	4,9	4,9	4,9	4,9	4,4	4,4	4,4	4,4	4,2	4,2	4,2	4,2	4,2	4,2	4,3	4,3
	$\eta_{s,h}$ %	191,8	191,8	191,8	191,8	172,9	172,9	172,9	172,9	166,7	166,7	166,7	166,7	166,4	166,4	169,5	169,5
Heating PL	PhA kW	8,8	8,8	8,8	8,8	11	11	11	11	11,5	11,5	11,5	11,5	15,4	15,4	17,3	17,3
Condition A	COPA	3,5	3,5	3,5	3,5	2,8	2,8	2,8	2,8	2,6	2,6	2,6	2,6	2,7	2,7	2,6	2,6
Heating PL	PhB kW	5,3	5,3	5,3	5,3	6,7	6,7	6,7	6,7	7	7	7	7	9,4	9,4	10,5	10,5
Condition B	COPB	4,1	4,1	4,1	4,1	3,7	3,7	3,7	3,7	3,6	3,6	3,6	3,6	3,8	3,8	3,9	3,9
Heating PL	PhC kW	3,4	3,4	3,4	3,4	4,3	4,3	4,3	4,3	4,5	4,5	4,5	4,5	6	6	6,7	6,7
Condition C	COPC	7,7	7,7	7,7	7,7	7,5	7,5	7,5	7,5	7,4	7,4	7,4	7,4	6,6	6,6	6,8	6,8
Heating PL	PhD kW	4,4	4,4	4,4	4,4	4,4	4,4	4,4	4,4	4,4	4,4	4,4	4,4	6,4	6,4	6,6	6,6
Condition D	COPD	9,8	9,8	9,8	9,8	9,8	9,8	9,8	9,8	9,8	9,8	9,8	9,8	8,1	8,1	8,9	8,9
T bivalent	Tbiv °C	-10	-10	-10	-10	-9	-9	-9	-9	-7	-7	-7	-7	-7	-7	-7	-7
	PhTbiv kW	10	10	10	10	12	12	12	12	11,5	11,5	11,5	11,5	15,4	15,4	17,3	17,3
	COPTbiv	2,9	2,9	2,9	2,9	2,6	2,6	2,6	2,6	2,6	2,6	2,6	2,6	2,7	2,7	2,6	2,6
Psbk	W	9	9	9	9	9	9	9	9	9	9	9	9	18	18	18	18
Psbh	W	33	33	33	33	33	33	33	33	33	33	33	33	48	48	48	48
Poffc	W	9	9	9	9	9	9	9	9	9	9	9	9	18	18	18	18
Poffh	W	33	33	33	33	33	33	33	33	33	33	33	33	48	48	48	48
Ptoc	W	33	33	33	33	33	33	33	33	33	33	33	33	48	48	48	48
Ptoh	W	33	33	33	33	33	33	33	33	33	33	33	33	48	48	48	48
Pckc	W	33	33	33	33	33	33	33	33	33	33	33	33	48	48	48	48
Pckh	W	33	33	33	33	33	33	33	33	33	33	33	33	48	48	48	48
PSB	W	33	33	33	33	33	33	33	33	33	33	33	33	48	48	48	48
Sound power level	dB(A)	69	69	69	69	71	71	71	71	73	73	73	73	79	79	83	83
Sound power level in heating	dB(A)	72	72	72	72	75	75	75	75	75	75	75	75	83	83	84	84



Eurovent certified technical data: 2-Pipe ECOi EX ME2 Series 8 to 20 HP · R410A

HP	8 HP		10 HP		12 HP		14 HP		16 HP		18 HP		20 HP		
Outdoor unit	U-8ME2E8		U-10ME2E8		U-12ME2E8		U-14ME2E8		U-16ME2E8		U-18ME2E8		U-20ME2E8		
Indoor units combination	MF2	MU2	MF2	MU2	MF2	MU2	MF2	MU2	MF2	MU2	MF2	MU2	MF2	MU2	
Cooling	Pc out ¹⁾ kW	19,7	19,7	24,6	24,6	33,5	33,5	40	40	45	45	50	50	56	56
	Pec out ²⁾ kW	5,79	5,79	8,79	8,79	11,55	11,55	13,33	13,33	18,75	18,75	17,86	17,86	23,33	23,33
	EERout	3,4	3,4	2,8	2,8	2,9	2,9	3	3	2,4	2,4	2,8	2,8	2,4	2,4
Seasonal Cooling	SEER	7,4	7,4	7	7	6,7	6,7	7,2	7,2	6,4	6,4	7,6	7,6	7	7
	$\eta_{s,c}$ %	294,3	294,3	275,4	275,4	266,6	266,6	286	286	254,3	254,3	299,2	299,2	278,2	277
Cooling PL Condition B	PcB kW	14,5	14,5	18,1	18,1	24,6	24,6	29,4	29,4	33,1	33,1	36,8	36,8	41,2	41,2
Cooling PL Condition C	PcC kW	9,3	9,3	11,6	11,6	15,8	15,8	18,9	18,9	21,3	21,3	23,6	23,6	26,5	26,5
Cooling PL Condition D	PcD kW	8,2	8,2	9,3	9,3	8,2	8,2	8,4	8,4	9,4	9,4	10,5	10,5	11,7	11,7
Seasonal Heating	EERD	13,7	13,7	18,9	18,9	18,4	18,4	22,6	22,6	22,1	22,1	25,2	25,2	24,6	24,6
	Pdesignh kW	17,5	17,5	22	22	26,2	26,2	31,5	31,5	35	35	39,2	39,2	44,1	44,1
	SCOP	4,8	4,8	4,3	4,3	4,7	4,7	4,3	4,3	4,1	4,1	4,3	4,3	4,1	4,1
Heating PL Condition A	$\eta_{s,h}$ %	188,4	188,4	167,6	167,6	185,8	185,8	168,2	168,2	159	159	168,7	168,7	160,4	161
	PhA kW	15,4	15,4	19,4	19,4	23,1	23,1	27,8	27,8	30,9	30,9	34,6	34,6	39	39
Heating PL Condition B	COPA	2,8	2,8	2,6	2,6	2,8	2,8	2,5	2,5	2,3	2,3	2,6	2,6	2,4	2,4
	PhB kW	9,4	9,4	11,8	11,8	14,1	14,1	16,9	16,9	18,8	18,8	21,1	21,1	23,7	23,7
Heating PL Condition C	COPB	4,5	4,5	3,6	3,6	4,2	4,2	3,7	3,7	3,6	3,6	3,7	3,7	3,5	3,5
	PhC kW	6	6	7,6	7,6	9	9	10,9	10,9	12,1	12,1	13,5	13,5	15,2	15,2
Heating PL Condition D	COPC	7,2	7,2	7,7	7,7	7,7	7,7	7,4	7,4	6,6	6,6	7,1	7,1	6,9	6,9
	PhD kW	7,1	7,1	7	7	7,2	7,2	6,7	6,7	6,6	6,6	7,4	7,4	7,4	7,4
T bivalent	COPD	8,9	8,9	9,6	9,6	9,3	9,3	10,2	10,2	10	10	10,3	10,3	10,3	10,3
	Tbiv °C	-9	-9	-7	-7	-9	-9	-7	-7	-7	-7	-7	-7	-7	-7
	PhTbiv kW	16,8	16,8	19,4	19,4	25,1	25,1	27,8	27,8	30,9	30,9	34,6	34,6	39	39
	COPTbiv	2,6	2,6	2,6	2,6	2,6	2,6	2,5	2,5	2,3	2,3	2,6	2,6	2,4	2,4
Psbc	W	48	48	48	48	48	48	88	88	88	88	88	88	88	88
Psbh	W	48	48	48	48	48	48	88	88	88	88	88	88	88	88
Poffc	W	48	48	48	48	48	48	88	88	88	88	88	88	88	88
Poffh	W	48	48	48	48	48	48	88	88	88	88	88	88	88	88
Ptoc	W	48	48	48	48	48	48	88	88	88	88	88	88	88	88
Ptoh	W	48	48	48	48	48	48	88	88	88	88	88	88	88	88
Pckc	W	48	48	48	48	48	48	88	88	88	88	88	88	88	88
Pckh	W	48	48	48	48	48	48	88	88	88	88	88	88	88	88
PSB	W	48	48	48	48	48	48	88	88	88	88	88	88	88	88
Sound power level	dB(A)	80	80	81	81	85	85	86	86	87	87	86	86	86	86
Sound power level in heating	dB(A)	81	81	84	84	85	85	85	85	89	89	89	89	89	89

Eurovent certified technical data: 3-Pipe ECOi EX MF3 Series 8 to 16 HP · R410A

HP	8 HP		10 HP		12 HP		14 HP		16 HP		
Outdoor unit	U-8MF3E8		U-10MF3E8		U-12MF3E8		U-14MF3E8		U-16MF3E8		
Indoor units combination	MF2	MU2	MF2	MU2	MF2	MU2	MF2	MU2	MF2	MU2	
Cooling	Pc out ¹⁾ kW	22,4	22,4	28	28	33,5	33,5	40	40	45	45
	Pec out ²⁾ kW	7,23	7,23	10,77	10,77	12,88	12,88	15,38	15,38	19,57	19,57
	EERout	3,1	3,1	2,6	2,6	2,6	2,6	2,6	2,6	2,3	2,3
Seasonal Cooling	SEER	7	7	7	7	6,4	6,4	6,7	6,7	6	6
	$\eta_{s,c}$ %	277	277,7	278,9	278,9	252,7	252,7	264,4	264,4	237,7	237,7
Cooling PL Condition B	PcB kW	16,5	16,5	20,6	20,6	24,6	24,6	29,4	29,4	33,1	33,1
Cooling PL Condition C	PcC kW	10,6	10,6	13,2	13,2	15,8	15,8	18,9	18,9	21,3	21,3
Cooling PL Condition D	PcD kW	9,1	9,1	9,3	9,3	7,7	7,7	8,3	8,3	7,4	7,4
Seasonal Heating	EERD	7,2	7,2	8,5	8,5	7,1	7,1	8,5	8,5	9,4	9,4
	Pdesignh kW	17,5	17,5	22	22	26,2	26,2	31,5	31,5	35	35
	SCOP	4,8	4,8	4,2	4,2	4,3	4,3	4,1	4,1	3,8	3,8
Heating PL Condition A	$\eta_{s,h}$ %	189	190,9	166,8	166,8	167,8	167,8	162,1	162,1	149,3	149,3
	PhA kW	15,4	15,4	19,4	19,4	23,1	23,1	27,8	27,8	30,9	30,9
Heating PL Condition B	COPA	2,9	2,9	2,5	2,5	2,7	2,7	2,4	2,4	2,2	2,2
	PhB kW	9,4	9,4	11,8	11,8	14,1	14,1	16,9	16,9	18,8	18,8
Heating PL Condition C	COPB	4,6	4,6	3,7	3,7	3,7	3,7	3,6	3,6	3,3	3,3
	PhC kW	6	6	7,6	7,6	9	9	10,9	10,9	12,1	12,1
Heating PL Condition D	COPC	7,1	7,1	7,4	7,4	6,9	6,9	7,1	7,1	6,5	6,5
	PhD kW	6,7	6,7	6,9	6,9	6,5	6,5	6,6	6,6	6,6	6,6
T bivalent	COPD	8,7	8,7	9,4	9,4	9	9	9,6	9,6	9,6	9,6
	Tbiv °C	-9	-9	-7	-7	-9	-9	-7	-7	-7	-7
	PhTbiv kW	16,8	16,8	19,4	19,4	25,1	25,1	27,8	27,8	30,9	30,9
	COPTbiv	2,6	2,6	2,5	2,5	2,3	2,3	2,4	2,4	2,2	2,2
Psbc	W	17	17	17	17	17	17	25	25	25	25
Psbh	W	50	50	50	50	50	50	91	91	91	91
Poffc	W	17	17	17	17	17	17	25	25	25	25
Poffh	W	50	50	50	50	50	50	91	91	91	91
Ptoc	W	17	17	17	17	17	17	25	25	25	25
Ptoh	W	50	50	50	50	50	50	91	91	91	91
Pckc	W	50	50	50	50	50	50	91	91	91	91
Pckh	W	50	50	50	50	50	50	91	91	91	91
PSB	W	50	50	50	50	50	50	91	91	91	91
Sound power level	dB(A)	79	79	80	80	84	84	86	86	86	86
Sound power level in heating	dB(A)	77	77	82	82	86	86	86	86	88	88

ECO G, the gas driven VRF

ECO G

The advanced Gas Driven VRF system offers increased efficiency and performance across the range.

Improvements include increased part load performance, reduced gas consumption with a Miller-cycle engine and reduced electrical consumption by using DC-Fan motors.





1 Limited electric supply

Electric consumption of ECO G is only 9 % compared to ECOi because gas engine is utilized for the compressor driving force.

2 High demand of DHW with heating and cooling cogeneration

DHW is produced effectively thanks to heat from engine exhaust during heating and cooling.

3 Open and flexible design

ECO G system is designed to connect various Indoor units and controllers which are available for ECOi systems. With GE3 series, Pump Down system has been implemented to answer commercial needs.

4 Quick start up in heating at low ambient temperature

Gas heat pump systems make your building comfortably warm with a quick start by using waste heat from engine. Heating mode works from and ambient temperature of -21 °C.

Comparison of heating capacity.

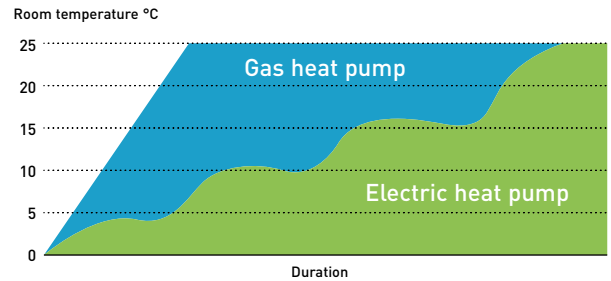

2-Pipe ECO G GE3 Series

Designed for better energy efficiency. SEER has been increased by up to 120 %.



3-Pipe ECO G GF3 Series

Domestic hot water can be supplied by effectively using waste heat generated by heating and cooling.

GE3/GF3 connectable indoor units

Type	Model number reference	2-Pipe ECO G GE3 Series	3-Pipe ECO G GF3 Series
Standard A2A indoor units	—	Yes ¹⁾	Yes ¹⁾
Water heat exchanger	PAW-250/500W(P)5G	Yes ²⁾	No
High static pressure hide-away	S-ME2E5	Yes	No
Heat recovery with DX coil	PAW-ZDX3N	Yes	Yes
Air curtain with DX coil	PAW-EAIRC-HS/LS	Yes	Yes ³⁾
AHU connection kit	PAW-MAH2/M/L	Yes	Yes ³⁾

1) Except for 1,5 kW capacity. 2) Allowed 1:1 and also mixed. If mixed, not operate at the same time WHE + DX only operate separately. 3) Smaller capacity than 16 kW only.

ECO G, the gas driven VRF

ECO G satisfies special requirements for your application and offers an environmentally friendly solution with Panasonic professional technology, providing reliable quality given its long development history, since 1985.

200.000

GHP outdoor units were sold in all over the world

Our ECO G VRF range of commercial systems is leading the industry in the development of efficient and flexible systems.



1985

Introduces first GHP (Gas Heat Pump) VRF air conditioner.

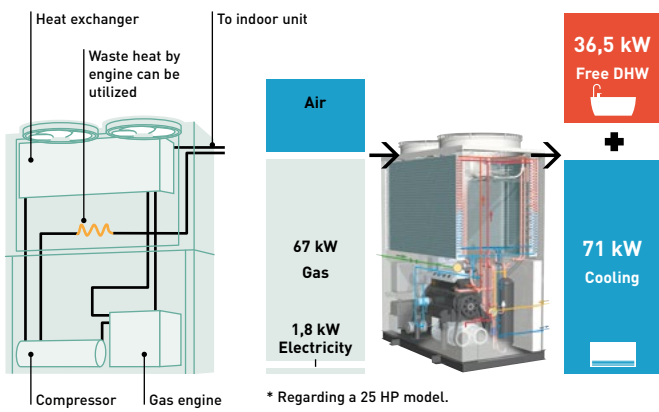

What is GHP? The Gas Heat Pump (GHP)

Panasonic Gas Heat Pump is a direct expansion system, with a compressor the same as the VRF system. A Gas engine is used as the driving source of the compressor instead of an electric motor. This gas engine compressor drive has 2 advantages:

- 1 | Waste heat from the gas engine available.
- 2 | No need for motor power consumption thanks to gas engine.

GHP is the natural choice for commercial projects, especially for those projects where power restrictions apply.

Power supply problems?

If you are short of electric power, our ECO G is a perfect solution.

- Runs on natural gas or LPG and just needs single phase supply
- Enables the building's electrical power supply to be used for other critical electrical demands
- Reduces capital cost to upgrade power substations to run heating and cooling systems
- Reduces power loadings within a building especially during peak periods
- Electricity supply freed up for other uses such as IT servers, commercial refrigeration, manufacturing, lighting, etc...

Limited electricity area.

Comparison of electrical consumption on a 71 kW outdoor unit.

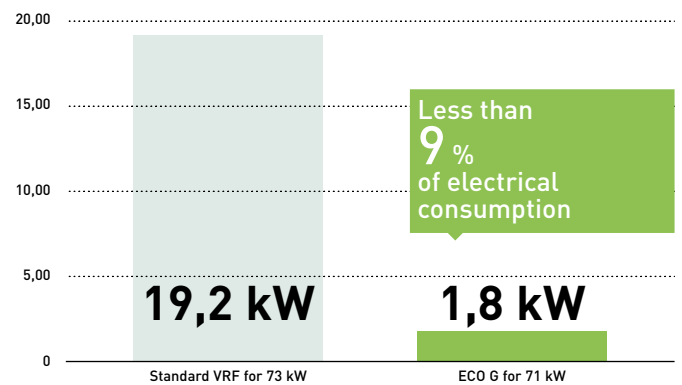

Application example: Hotel.

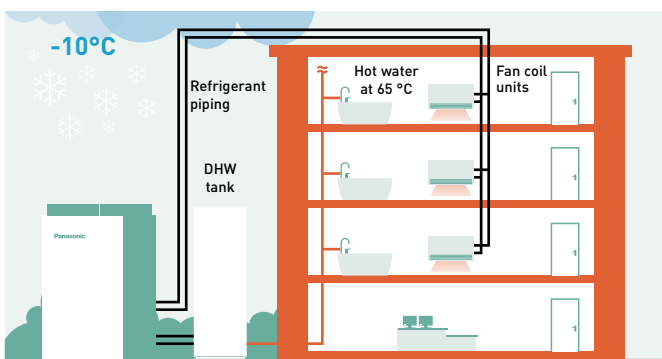

No need additional electric heaters. * This scheme is also valid with WHE.

High demand of domestic hot water in heating and cooling

The rejected heat from the engine is available for DHW production and can supply up to 46 kW of hot water at 65 °C. DHW at 65 °C is also ready to use in heating without additional electric heaters.



Quick start up and great heating capacity at low ambient temperature

Waste heat from gas engine is utilized to raise temperature quicker than electric VRF system. This contributes great heating capacity at extremely low ambient temperature.

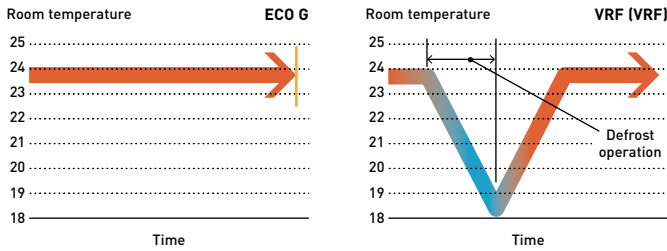

Lowest nitrogen oxide emissions.

The ECO G VRF systems have low nitrogen oxide emissions. In a pioneering development, the Panasonic ECO G features a brand lean-burn combustion system that utilizes air fuel ratio feedback control to reduce NOx emissions to an all time low.

Water chiller option.

Our ECO G system is also available with a water chiller option, which can be combined with individual outdoor units or as part of a DX chilled water mix of indoor units. The system can be operated via a BMS system or a Panasonic supplied control panel, with chilled water set points from -15 °C ~ +15 °C and heating set points 35 °C ~ +55 °C.

Application

Application	Condition	ECO G
Hotel	High DHW demand	✓
Hotel	Needs to warm up swimming pool	✓ Energy recovery of ECO G system can fulfill different requirement
Office	Quick start up is necessary	✓ Speed of start up is quicker than VRF system
Winery	1) Outlet water demand at specific temperature 2) Needs high amount of power temporary (not every month)	✓ 1) Chiller application with hydro module (ECO G + WHE) can make this special process 2) Running cost can be saved since fixed Gas tariff per month is cheaper than fixed electric tariff.
Any building	In a city with power restriction	✓ - No need an additional power transformer - Space and cost can be saved
	At extremely low ambient condition	✓ Heating capacity is kept up to -20 °C without defrost process

Project case studies



Savills HQ Dublin and Google Block R. Ireland.
ECO G 3-way units with a 243 kW load. The project has been such a success that it has recently been awarded a Panasonic PRO Award for Best Contribution of efficient projects within Europe.



Thomas Cook's Sunprime Atlantic View resort.
A holiday resort in the Canaries. Spain. 229 rooms plus full spa and swimming pool facility.



CAPITA call centre. UK.
11 ECO G 3-way units. Over 150 indoor units in meeting rooms and open-plan areas. Intelligent touch screen controller, the CZ-256ESMC2.



French winery Genevilliers, France.
ECO G 3-way units. One of the best solution utilized our ECO G solution for wine production process.

ECO G 3 Series

Introducing ECO G 3 Series.
Optimised energy saving with reliable Panasonic technologies.

Improvement in blast efficiency

3-blades fan.

Propeller shape with 3 blades is more efficient
Max. 30 % of fan electrical consumption is saved compared to conventional fan.

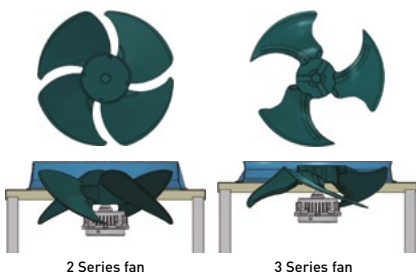

"L" type heat exchanger

Heat exchanger surface area is included by 25 % compared to conventional model to optimise efficiency.

Heat exchanger surface area **25 % up**

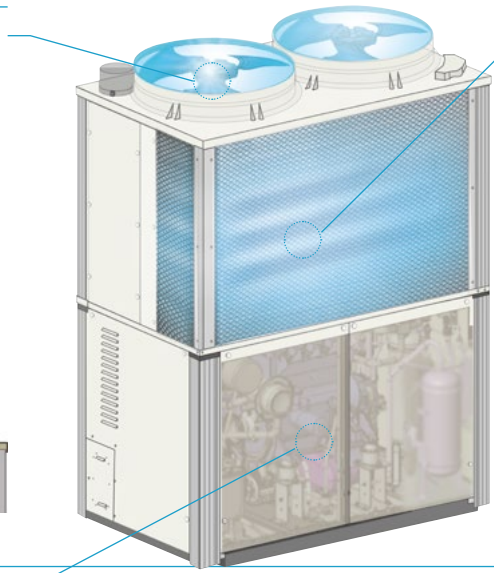
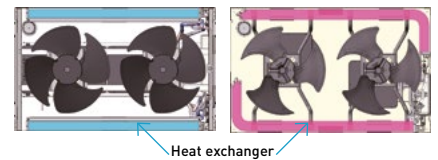

Better partial load control

Reduce start / stop loss has reduced by expanding the are where continuous operation is possible. Annual operation efficiency has further improved by better efficiency at lower partial load.

Compressor.

- Amount of internal leakage has reduced by the reduction of clearance, the compressor efficiency in the low load and low rotation region has been greatly improved. Moreover, efficiency of high speed and high load is also improved by reduction of suction pressure loss due to expansion of suction path
- Optimise compressor capacity

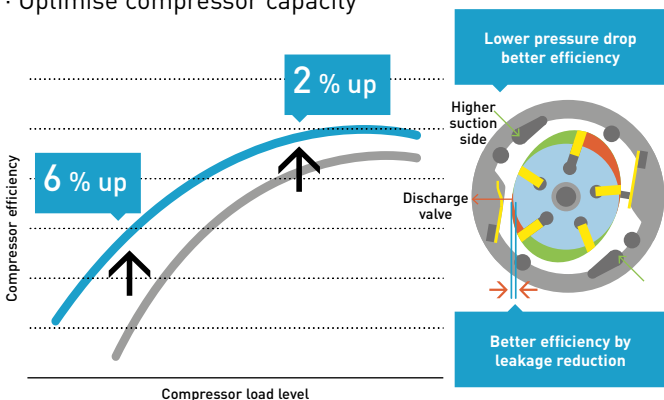

Engine.

- Continuous operation area has expanded at lower partial load by expanding operation area of lower speed
- Engine efficiency has improved by shifting output points to higher torque side

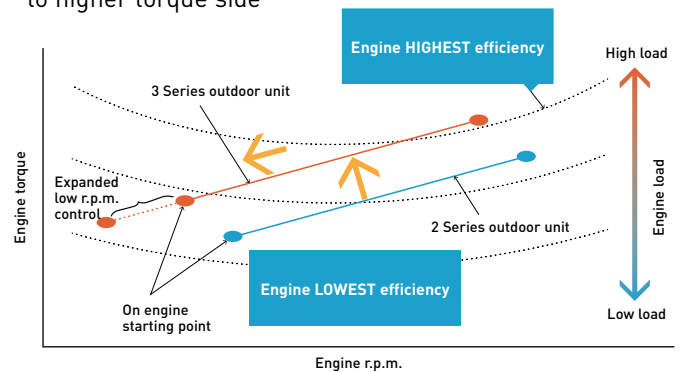

Engine pulley.

- Bigger diameter of engine pulley contributes the optimisation of the compressor rotation speed ratio with engine speed
- Higher engine pulley diameter giving better performance at partial load and reducing ON / OFF operation.

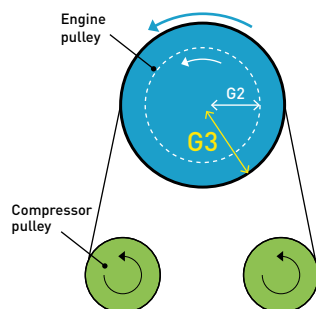

Line up of GE3 2-Pipe W-Multi.

- For new or renewal
- Available for water heat exchanger
- Maximum 60 HP combination



The highest seasonal performance in all capacity ranges

High power efficiency of W-Multi system.

ECO G 3 Series system offers seasonal efficiency which has been drastically improved with the heat exchanger design, blast efficiency, partial load control.

Compared to conventional model ECO G 2 Series.

All models are newly developed and have maximum 25 % of SEER, 15 % of SCOP better than conventional model.

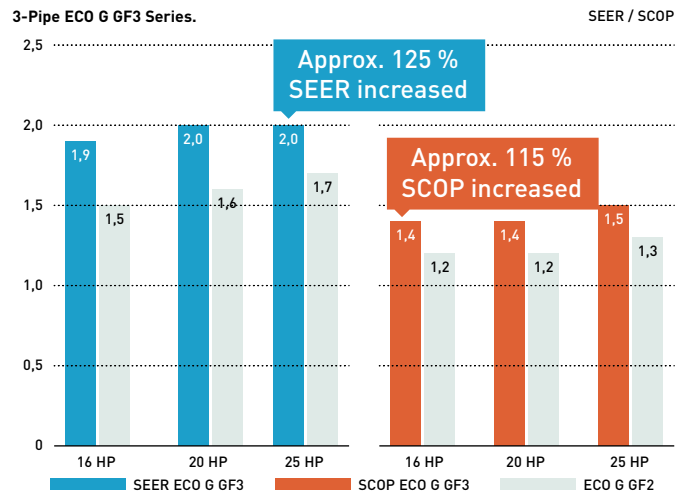
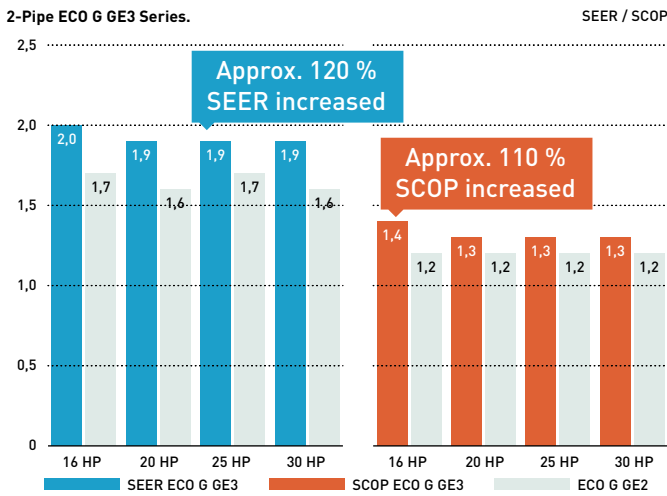

* Comparison under Panasonic condition follows EN14825.

Heating design operation conditions (GE3)

Operating range in heating has been expanded up to 24 °C (WB) for air to water system to meet the demand of swimming pool application.

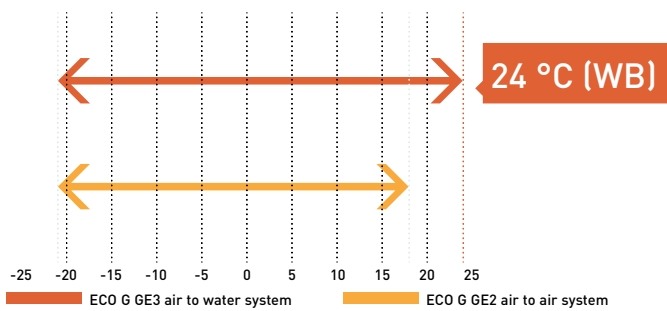

DHW priority mode setting in heating (GE3)

Ambient temperature range for DHW production is expandable by setting depending on DHW needs. Hot water at 65 °C is available in heating without additional electric heaters.

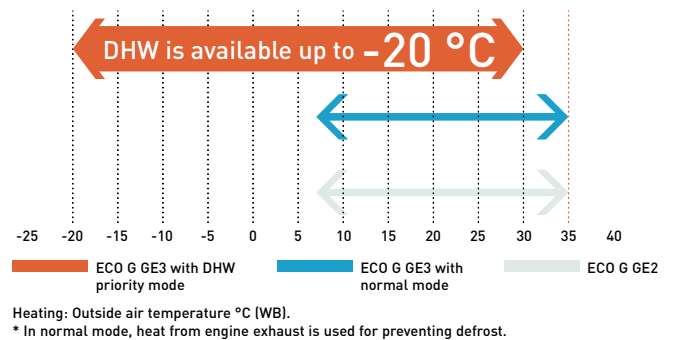

No defrost requirement (GE3 / GF3)

No defrost mode is selectable to get higher capacity under low ambient temperature.

Flexible design with wide line up of indoor units

The advanced GE3 Series can connect up to 64 indoor units.

Series	16 HP	20 HP	25 HP	30 HP	32 HP	36 HP	40 HP	45 HP	50 HP	55 HP	60 HP
2-Pipe ECO G GE3 Series	26	33	41	50	52	59	64	64	64	64	64
3-Pipe ECO G GF3 Series	24	24	24	—	—	—	—	—	—	—	—



2-Pipe ECO G GE3 Series

The GE3 Series has a top level of seasonal efficiency in this category. In addition, this product fits with special needs for commercial application thanks to DHW priority setting and auto Pump Down functions.

HP			16 HP	20 HP	25 HP	30 HP
Outdoor unit			U-16GE3E5	U-20GE3E5	U-25GE3E5	U-30GE3E5
Power supply	Voltage	V	220 - 230 - 240	220 - 230 - 240	220 - 230 - 240	220 - 230 - 240
	Phase		Single phase	Single phase	Single phase	Single phase
	Frequency	Hz	50	50	50	50
Cooling capacity		kW	45,0	56,0	71,0	85,0
Refrigeration load Pdesign		kW	45,0	56,0	71,0	85,0
$\eta_{s,c}$ (LOT21)		%	220,60	219,30	240,10	229,30
Input power		kW	1,17	1,12	1,80	1,80
Hot water in cooling mode (at 65 °C outlet)		kW	23,60	29,10	36,40	46,00
Max COP in hot water		W/W	1,55	1,55	1,49	1,47
Gas consumption cooling		kW	41,10	52,10	67,20	84,10
Heating capacity	Standard	kW	50,0	63,0	80,0	95,0
	Low temperature	kW	53,0	67,0	78,0	90,0
Refrigeration load Pdesign		kW	37,0	53,0	60,0	65,0
$\eta_{s,h}$ (LOT21)		%	150,60	143,70	146,90	151,30
Input power		kW	0,56	1,05	0,91	1,75
Gas consumption heating	Standard	kW	38,00	51,10	68,60	75,30
	Low temperature	kW	45,40	62,70	60,70	73,90
Starter amperes		A	30	30	30	30
External static pressure		Pa	10	10	10	10
Air flow		m ³ /min	370	420	460	460
Sound power	Normal	dB(A)	80	80	84	84
	Silent mode	dB(A)	77	77	81	81
Dimension	H x W x D	mm	2255 x 1650 x 1000	2255 x 1650 x 1000	2255 x 2026 x 1000	2255 x 2026 x 1000
Net weight		kg	765	765	870	880
Piping diameter	Liquid pipe	Inch (mm)	1/2(12,70)	5/8(15,88)	5/8(15,88)	3/4(19,05)
	Gas pipe	Inch (mm)	1-1/8(28,58)	1-1/8(28,58)	1-1/8(28,58)	1-1/4(31,75)
	Fuel gas	Inch (mm)	19,05(R3/4)	19,05(R3/4)	19,05(R3/4)	19,05(R3/4)
	Exhaust drain port	mm	25	25	25	25
	Hot water supply in/out		Rp3/4 (Nut, thread)	Rp3/4 (Nut, thread)	Rp3/4 (Nut, thread)	Rp3/4 (Nut, thread)
Elevation difference (in / out)			50	50	50	50
Refrigerant (R410A) / CO ₂ Eq.		kg / T	11,50/24,00	11,50/24,00	11,50/24,00	11,50/24,00
Maximum number of connectable indoor units			26	33	41	50
Operating range	Cool Min ~ Max	°C (DB)	-10 ~ +43	-10 ~ +43	-10 ~ +43	-10 ~ +43
	Heat Min ~ Max	°C (WB)	-21 ~ +18	-21 ~ +18	-21 ~ +18	-21 ~ +18

Hot water take out function added, EU safety regulation standard cleared. 25 HP chassis enlarged due to specification improvement. Pre-coat corrosion fin. Auto Pump Down function.

Technical focus

- Superior seasonal energy efficiency, maximum 240,1 %
- DHW priority setting
- Operating range in heating down to -21 °C and up to +24 °C for air to water system
- No defrost cycle

- Capacity ratio 50 ~ 200 % ¹⁾
- Option of DX or chilled water for indoor heat exchange
- Maximum total piping length: 780 m

¹⁾ 50 ~ 200 % only when one outdoor unit is installed. In other cases 50 ~ 130 %.

**2-Pipe ECO G GE3 Series combination from 32 to 60 HP**

The GE3 Series has a top level of seasonal efficiency in this category. In addition, this product fits with special needs for commercial application thanks to DHW priority setting and Auto Pump Down functions.

HP			32 HP	36 HP	40 HP	45 HP	50 HP	55 HP	60 HP
Outdoor unit			U-16GE3E5	U-16GE3E5	U-20GE3E5	U-20GE3E5	U-25GE3E5	U-25GE3E5	U-30GE3E5
			U-16GE3E5	U-20GE3E5	U-20GE3E5	U-25GE3E5	U-25GE3E5	U-30GE3E5	U-30GE3E5
Power supply	Voltage	V	220 - 230 - 240	220 - 230 - 240	220 - 230 - 240	220 - 230 - 240	220 - 230 - 240	220 - 230 - 240	220 - 230 - 240
	Phase		Single phase	Single phase	Single phase	Single phase	Single phase	Single phase	Single phase
	Frequency	Hz	50	50	50	50	50	50	50
Cooling capacity		kW	90,0	101,0	112,0	127,0	142,0	156,0	170,0
Input power		kW	2,34	2,29	2,24	2,92	3,60	3,60	3,60
Hot water in cooling mode [at 65 °C outlet]		kW	47,20	52,70	58,20	65,50	72,80	82,40	92,00
Max COP in hot water		W/W	1,55	1,55	1,55	1,52	1,49	1,48	1,47
Gas consumption cooling		kW	82,20	93,20	104,20	119,30	134,40	151,30	168,20
Heating capacity	Standard	kW	100,0	113,0	126,0	143,0	160,0	175,0	190,0
	Low temperature	kW	106,0	120,0	134,0	145,0	156,0	168,0	180,0
Input power		kW	1,12	1,61	2,10	1,96	1,82	2,66	3,50
Gas consumption heating	Standard	kW	76,00	89,10	102,20	119,70	137,20	143,90	150,60
	Low temperature	kW	90,80	108,10	125,40	123,40	121,40	134,60	147,80
Starter amperes		A	30	30	30	30	30	30	30
External static pressure		Pa	10	10	10	10	10	10	10
Air flow		m ³ /min	370/370	370/420	420/420	420/460	460/460	460/460	460/460
Sound power	Normal	dB(A)	83	83	83	86	87	87	87
	Silent mode	dB(A)	80	80	80	83	84	84	84
Dimension	Height	mm	2255	2255	2255	2255	2255	2255	2255
	Width	mm	1650 + 100 + 1650	1650 + 100 + 1650	1650 + 100 + 1650	1650 + 100 + 2026	2026 + 100 + 2026	2026 + 100 + 2026	2026 + 100 + 2026
	Depth	mm	1000	1000	1000	1000	1000	1000	1000
Net weight		kg	1530 (765 + 765)	1530 (765 + 765)	1530 (765 + 765)	1635 (765 + 870)	1740 (870 + 870)	1750 (870 + 880)	1760 (880 + 880)
	Liquid pipe	Inch (mm)	3/4 (19,05)	3/4 (19,05)	3/4 (19,05)	3/4 (19,05)	3/4 (19,05)	7/8 (22,22)	7/8 (22,22)
Piping diameter	Gas pipe	Inch (mm)	1-1/4 (31,75)	1-1/4 (31,75)	1-1/2 (38,10)	1-1/2 (38,10)	1-1/2 (38,10)	1-1/2 (38,10)	1-1/2 (38,10)
	Fuel gas	Inch (mm)	19,05 (R3/4)	19,05 (R3/4)	19,05 (R3/4)	19,05 (R3/4)	19,05 (R3/4)	19,05 (R3/4)	19,05 (R3/4)
	Exhaust drain port	mm	25	25	25	25	25	25	25
	Hot water supply in/out		Rp3/4 (Nut, thread)	Rp3/4 (Nut, thread)	Rp3/4 (Nut, thread)	Rp3/4 (Nut, thread)	Rp3/4 (Nut, thread)	Rp3/4 (Nut, thread)	Rp3/4 (Nut, thread)
Elevation difference [in / out]			50	50	50	50	50	50	50
Refrigerant (R410A) / CO ₂ Eq.		kg / T	2x 11,50/24,00	2x 11,50/24,00	2x 11,50/24,00	2x 11,50/24,00	2x 11,50/24,00	2x 11,50/24,00	2x 11,50/24,00
Maximum number of connectable indoor units			52	59	64	64	64	64	64
Operating range	Cool Min ~ Max	°C	-10 ~ +43	-10 ~ +43	-10 ~ +43	-10 ~ +43	-10 ~ +43	-10 ~ +43	-10 ~ +43
	Heat Min ~ Max	°C	-21 ~ +18	-21 ~ +18	-21 ~ +18	-21 ~ +18	-21 ~ +18	-21 ~ +18	-21 ~ +18

Data is for reference. Hot water take out function added, EU safety regulation standard cleared. 25 HP chassis enlarged due to specification improvement. Pre-coat corrosion fin. Auto Pump Down function.

Technical focus

- Maximum 60 HP combination
- Superior seasonal energy efficiency, maximum 240,1 %
- DHW priority setting
- Operating range in heating down to -21 °C and up to +24 °C for air to water system
- No defrost cycle
- Option of DX or chilled water for indoor heat exchange
- Maximum total piping length: 780 m



3-Pipe ECO G GF3 Series

Excellent performance and free domestic hot water

Panasonic 3-Pipe Multi system is capable of simultaneous heating / cooling and individual operation of each indoor unit by only one outdoor unit. As a result, efficient individual air conditioning is possible in buildings having diverse room temperatures.

In addition, domestic hot water is created for free in cooling mode without additional boilers or electric heaters.

System example.

Improved maintenance intervals. The unit only needs to be serviced every 10000 hours. This is the best in the industry.

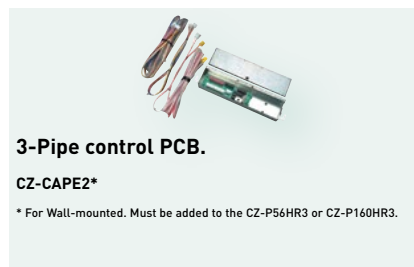
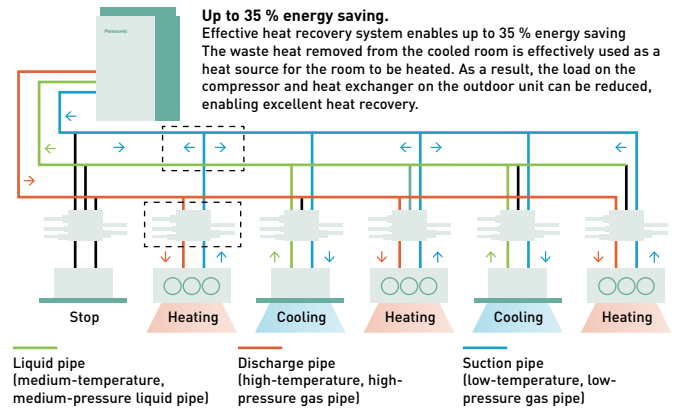

Solenoid valve kit

To be fitted on all 'zones' to allow simultaneous heating and cooling. Up to 24 indoor units are capable of simultaneous heating / cooling operation. Oil-recovery operation to gives more stable comfort air-conditioning control.

Power supply problems?

If you are short of electrical power, our gas heat pump could be the perfect solution:

- Runs on natural gas or LPG and just needs Single phase supply
- Enables the building's electrical power supply to be used for other critical electrical demands
- Reduces capital cost to upgrade power substations to run heating and cooling systems

- Reduces power loadings within a building especially during peak periods
- Electricity supply freed up for other uses such as IT servers, commercial refrigeration, manufacturing, lighting etc.

ECO G outdoor heat exchanger.

- Integrated DX and hot water coil
- No defrost required
- Faster reaction to demand for heating

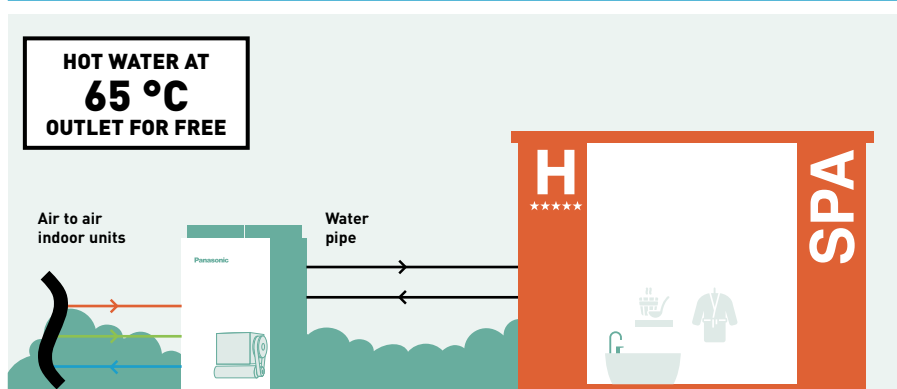
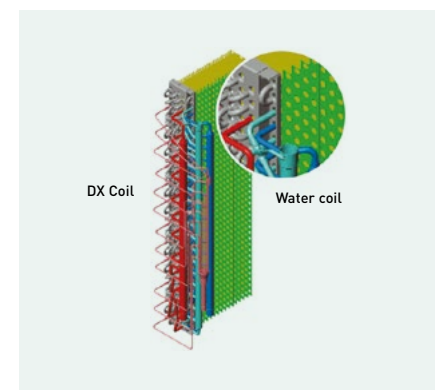

DHW production in heating and cooling

Free DHW is available 365 days a year, in all seasons. Hot water is produced effectively from waste heat from engine.

Perfect solution for hotel projects required high demand of hot water.

HP	Free DHW (in cooling mode)
16 HP	23,6 kW
20 HP	27,1 kW
25 HP	40,5 kW

**3-Pipe ECO G GF3 Series****DHW available in all seasons.**

Effective production of domestic hot water from engine waste heat in both heating and cooling, all year round.

HP			16 HP	20 HP	25 HP
Outdoor unit			U-16GF3E5	U-20GF3E5	U-25GF3E5
Power supply	Voltage	V	220 - 230 - 240	220 - 230 - 240	220 - 230 - 240
	Phase		Single phase	Single phase	Single phase
	Frequency	Hz	50	50	50
Cooling capacity		kW	45,0	56,0	71,0
Refrigeration load Pdesign		kW	45,0	56,0	71,0
$\eta_{s,c}$ (LOT21)		%	185,20	198,80	204,90
Input power		kW	1,17	1,40	1,80
Hot water in cooling mode (at 65 °C outlet)		kW	23,60	27,10	40,50
Gas consumption cooling		kW	45,80	54,80	73,70
Heating capacity	Standard	kW	50,0	63,0	80,0
	Low temperature	kW	53,0	67,0	78,0
Refrigeration load Pdesign		kW	38,0	52,0	60,0
$\eta_{s,h}$ (LOT21)		%	139,20	140,20	150,90
Input power		kW	0,56	1,05	0,91
Gas consumption heating	Standard	kW	42,20	51,10	68,60
Starter amperes		A	30	30	30
Air flow		m ³ /min	370	400	460
Sound power	Normal	dB(A)	80	81	84
	Silent mode	dB(A)	77	78	81
Dimension	HxWxD	mm	2255 x 1650 x 1000	2255 x 1650 x 1000	2255 x 2026 x 1000
Net weight		kg	775	775	880
Piping diameter	Liquid pipe	Inch (mm)	3/4 (19,05)	3/4 (19,05)	3/4 (19,05)
	Gas pipe	Inch (mm)	1 1/8 (28,58)	1 1/8 (28,58)	1 1/8 (28,58)
	Discharge	Inch (mm)	7/8 (22,22)	1 (25,40)	1 (25,40)
	Fuel gas	Inch (mm)	19,05 (R3/4)	19,05 (R3/4)	19,05 (R3/4)
	Exhaust drain port	mm	25	25	25
	Hot water supply in/out		Rp3/4 (Nut, thread)	Rp3/4 (Nut, thread)	Rp3/4 (Nut, thread)
Elevation difference (in / out)		m	50	50	50
Refrigerant (R410A) / CO ₂ Eq.		kg / T	11,50 / 24,00	11,50 / 24,00	11,50 / 24,00
Maximum number of connectable indoor units			24	24	24
Operating range	Cool Min ~ Max	°C	-10 ~ +43	-10 ~ +43	-10 ~ +43
	Heat Min ~ Max	°C	-21 ~ +18	-21 ~ +18	-21 ~ +18

Hot water take out function added, EU safety regulation standard cleared. 25 HP chassis enlarged due to specification improvement. Pre-coat corrosion fin. Auto Pump Down function.

Solenoid valve kit		
KIT-P56HR3	KIT-P56HR3	3-Pipe control solenoid valve kit (up to 5,6 kW)
	CZ-P56HR3	Solenoid valve kit (up to 5,6 kW)
KIT-P160HR3	CZ-CAPE2	3-Pipe control PCB
	KIT-P160HR3	3-Pipe control solenoid valve kit (from 5,6 to 16,0 kW)
KIT-P160HR3	CZ-P160HR3	Solenoid valve kit (from 5,6 kW to 16,0 kW)
	CZ-CAPE2	3-Pipe control PCB
CZ-CAPEK2 ¹⁾		3-Pipe control PCB for wall-mounted

1) Available for S-45/56/73/106MK2E5B.

3-Pipe control box kit	
CZ-P456HR3	4 ports 3 pipe box (up to 5,6 kW per port)
CZ-P656HR3	6 ports 3 pipe box (up to 5,6 kW per port)
CZ-P856HR3	8 ports 3 pipe box (up to 5,6 kW per port)
CZ-P4160HR3	4 ports 3 pipe box (up to 16,0 kW per port)

Outstanding seasonal energy efficiency, maximum 204,9 %

- Capacity ratio 50 ~ 200 %
- No defrost cycle
- Maximum total piping length: 780 m

Flexible installation

- Full heating capacity down to -21 °C (WB)
- DHW production for all the year
- Connection of up to 24 indoor units



Panasonic GHP/EHP Hybrid System. First intelligent technology

Taking advantage of Gas and Electricity to achieve better energy savings.

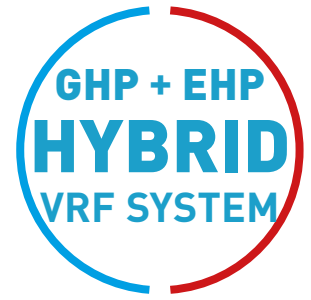

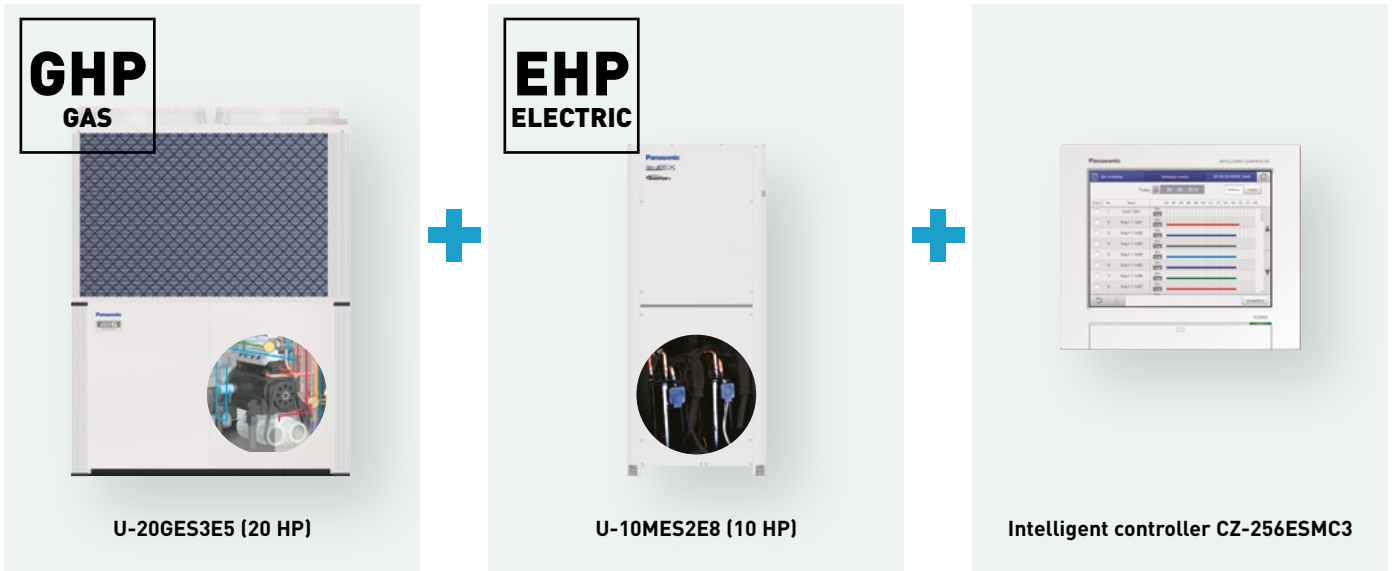

- Master unit GHP**
- Load calculation of GHP and EHP
 - Operation in accordance with the upper limit setting
 - Individual capacity control
 - Device control
 - Special control [Defrost, Oil recovery, 4 Way-valve matching / Abnormality processing]
- Slave Unit EHP**
- Intelligent controller**
- Demand monitoring
 - Indoor / total load calculation
 - Operation Ratio Indication upper limit setting of MAP according to:
 - Energy unit RRP
 - Electric power demand
 - Air conditioning load

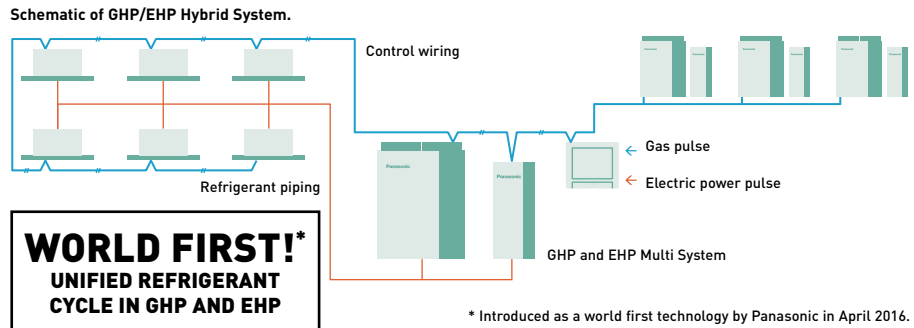

1 Peak cut of electricity consumption

Electrical peak demand is significantly reduced thanks to GHP system consuming less than 10 % of electricity of EHP system.

* Image of Hotel project.

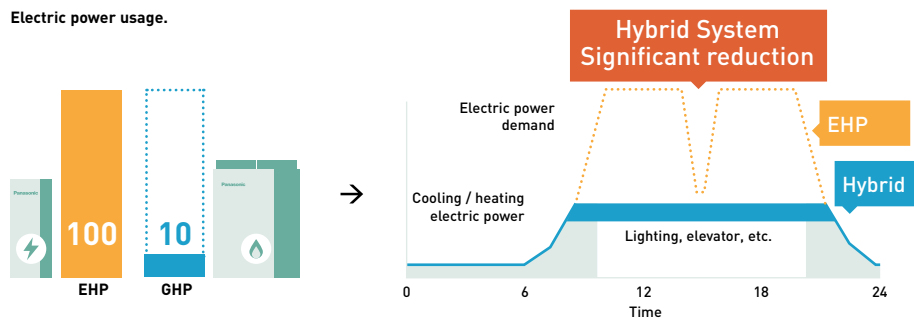

2 Optimal control to maximize energy saving

Switching the operation between GHP and EHP system on the basis of usage, energy demand, part load.

* Specification is tentative.

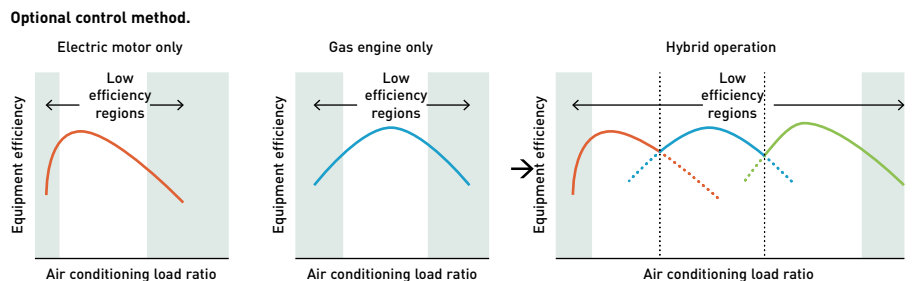

3 Free Hot Water production by GHP system

Hot water is effectively produced from waste heat of engine.

* Specification is tentative.

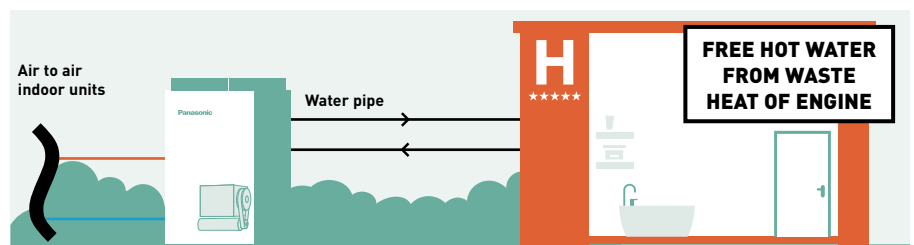

GHP/EHP Hybrid System

Panasonic's reliable ECO G / ECOi technology provides energy savings, utilising the advantages of both gas and electricity

The hybrid system can offer intelligent operation logic for better economy and efficiency by taking the best of ECO G a heating and cooling system operating in a similar was to a hybrid car.

How smartly operate a GHP and EHP system depending on your needs

4 different mode settings are available with the intelligent controller. Switch the operation between GHP and EHP or operating both units together to maximize the effect for different requirement such as economy and efficiency.

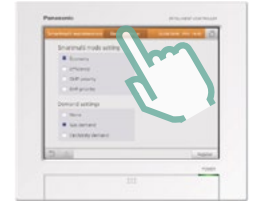

Economy mode

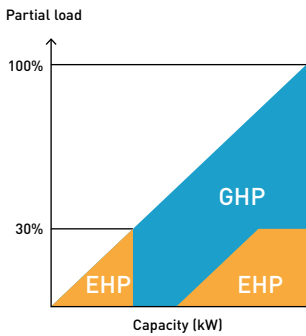

Efficiency mode

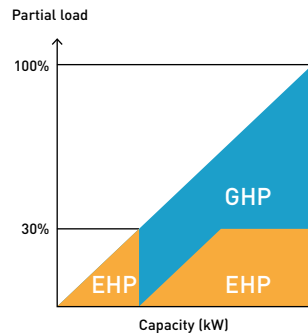

GHP first mode

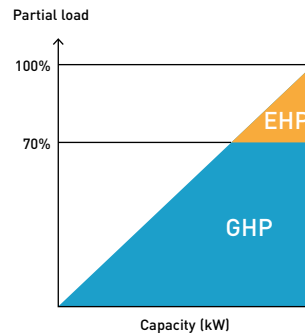

EHP first mode

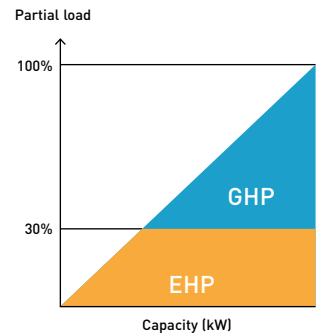

Optimal control example: Economy mode

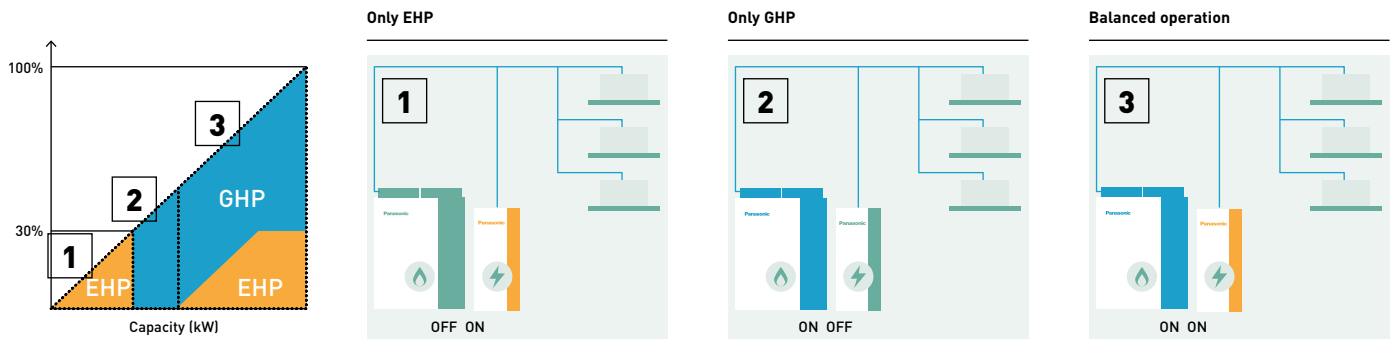

DHW priority mode in Hybrid + WHE System

When DHW is demanded during cooling operation by EHP, EHP is automatically turned "OFF" and GHP is turned "ON" to produce DHW for free.

High efficiency mode.

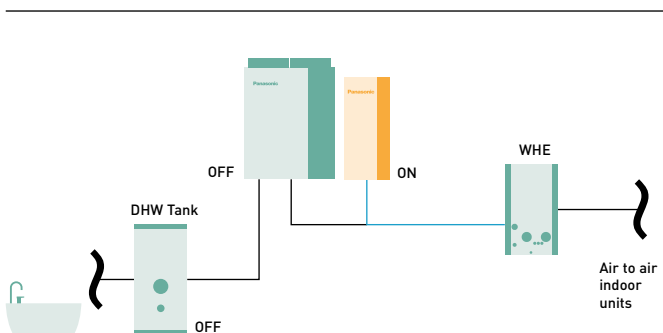

DHW priority mode.

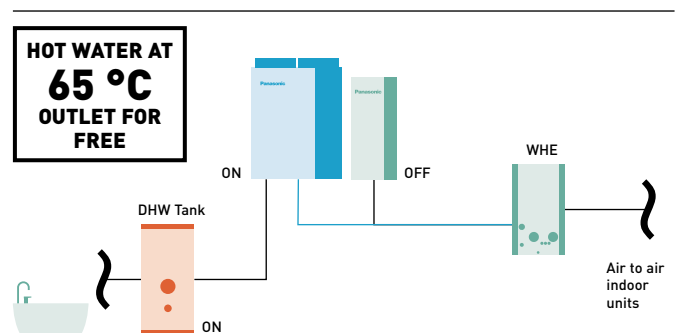



2-Pipe Hybrid GHP/EHP

- Extended lifespan with intelligent energy management. The goal is for the EHP and GHP to work at optimal speeds
- Low energy cost
- Low emissions

			Hybrid GHP	Hybrid EHP
			20 HP	10 HP
			U-20GES3E5	U-10MES2E8
Outdoor unit	Voltage	V	220 - 230 - 240	380 - 400 - 415
	Phase		Single phase	Three phase
	Frequency	Hz	50	50
Cooling capacity		kW	56,0	28,0
$\eta_{s,h}$ (LOT21)		%	211,80	275,40
Current		A	5,18	10,70/10,20/9,80
Input power		kW	1,12	6,41
Hot water in cooling mode (at 65 °C outlet)		kW	26,20	—
Gas consumption cooling		kW	52,10	—
Heating capacity		kW	63,0	31,5
$\eta_{s,h}$ (LOT21)		%	143,20	167,60
Current		A	4,79	11,10/10,50/10,10
Input power		kW	1,05	6,62
Gas consumption heating	Standard	kW	51,10	—
Starting current		A	30	1
Air flow		m ³ /min	420	224
Sound pressure	Normal mode	dB(A)	58	56
Sound power	Normal mode	dB(A)	80	77
Dimension	HxWxD	mm	2255x1650x1000	1842x770x1000
Net weight		kg	765	210
Piping diameter ¹⁾	Liquid pipe	Inch (mm)	5/8 (15,88)	3/8 (9,52)
	Gas pipe	Inch (mm)	1 1/8 (28,58)	7/8 (22,22)
	Balance pipe	Inch (mm)	1/4 (6,35)	1/4 (6,35)
Drain heater		W	40	—
Refrigerant (R410A) / CO ₂ Eq.		kg / T	11,05/23,0724	5,60/11,6928
Maximum allowable indoor / outdoor capacity ratio %			50 - 130	50 - 130
Operating range	Cool Min ~ Max	°C	-10 ~ +43	-10 ~ +43
	Heat Min ~ Max	°C	-21 ~ +18	-21 ~ +18

1) Please refer service manual when the maximum piping length exceeds 90 meters (equivalent length).

Technical focus

- 4 different setting (Economy, Efficiency, GHP first mode, EHP first mode)
- DHW energy recovery 26,2 kW (at 65 °C) by waste heat of engine
- Unified refrigerant cycle in GHP and EHP for easy installation
- DHW priority mode with WHE system
- Connection of up to 48 indoor units



Water heat exchanger for hydronic applications

When a top London restaurant opened, it needed large volumes of fresh air to ensure the optimum dining environment. ECO G units connected to the cooling coils within the air handling equipment ensured the air was introduced in the right condition in both summer and winter.



Chiller replacement. Chilled water supply to fan coils

Chiller replacement.

When some old chillers needed replacing at the end of their operational lifetime, ECO Gs with water heat exchangers enabled the project to be carried out in stages whilst still utilising the existing water pipe work and fan coils. This enabled the project to be delivered on time, to a restricted budget and avoided all issues regarding refrigerant in confined spaces.





Connection to 'close control' computer equipment

Computer room applications.

When all available electrical power needed to be utilised for the IT equipment for a leading international bank, the cooling load of over 450 kW had to be powered by gas. The outdoor units were connected via water heat exchangers to cooling coils inside the 'close control' units thereby maintaining a conditioned environment for temperature and humidity. By utilising the hot water function over 100 kW of hot water are supplied to the building and therefore the additional benefit of considerable CO₂ savings is ensured.

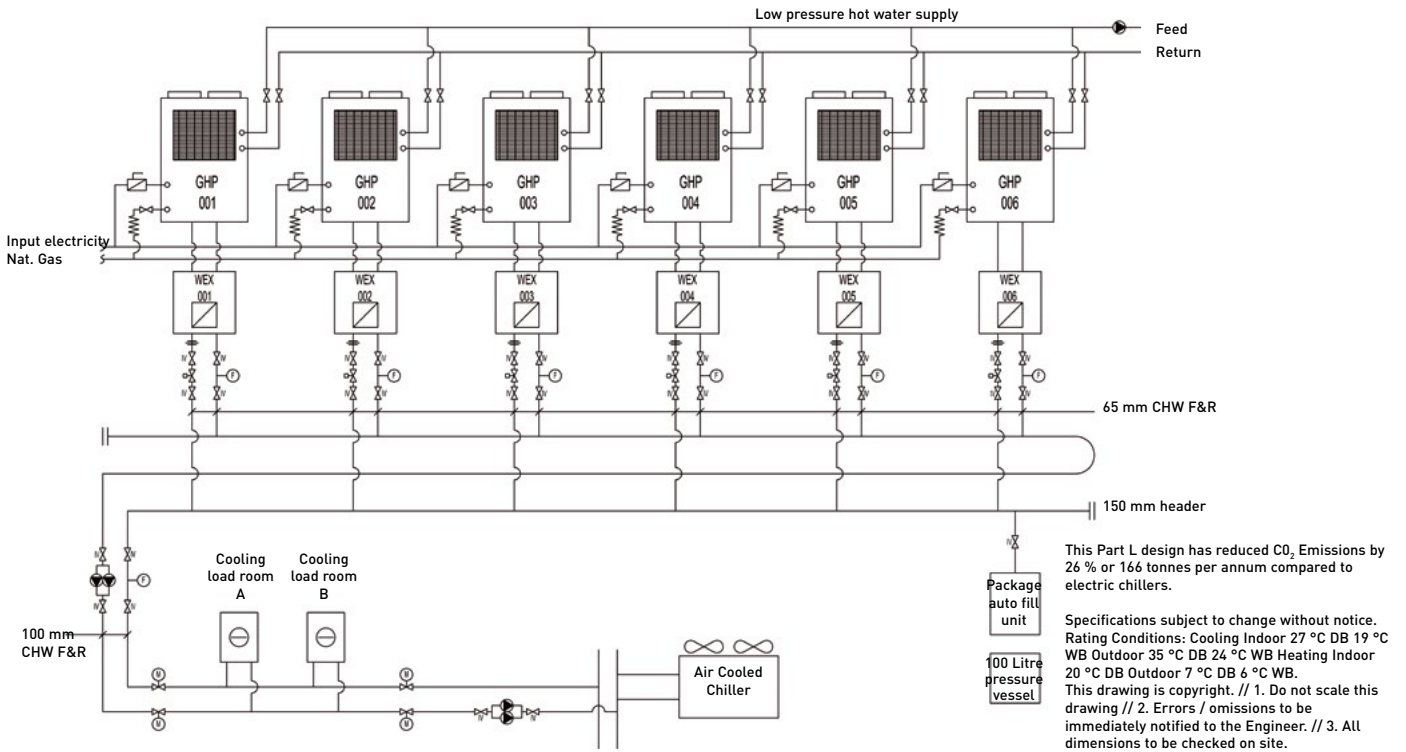

ECOi water heat exchanger

Electrical VRF with water heat exchanger
 · With this easy to install water heat exchanger unit, you can now cover projects up to 51 kW hot water demand or 44 kW on chilled application on a efficient way and cost effective

System example.

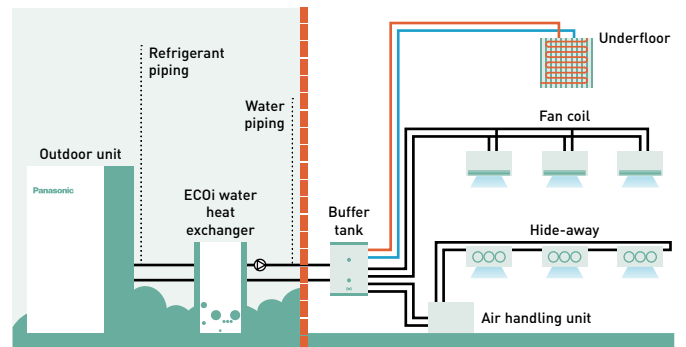

A buffer tank of minimum 280 l for 28 kW and 500 l for 50 kW is always needed.

Example of Hotel renewal of existing chiller and boiler system with Panasonic ECO G and Aquarea mixed solution

ECO G and Aquarea are the smart solution for renewal Chiller / Boiler applications with annual running cost savings around 13600€.

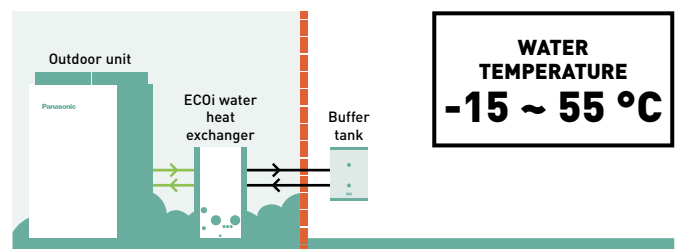

**ECOi 2-Pipe with water heat exchanger for chilled and hot water production****Water heat exchanger (WHE) for hydronic applications.**

WHE for ECOi system controlled by a CZ-RTC5B timer remote control.

Energy-efficient capacity control with superior external static pressure is now ready.

Hydrokit with A class water pump			PAW-250WP5G1	PAW-500WP5G1
Hydrokit without pump			PAW-250W5G1	PAW-500W5G1
Cooling capacity (A 35 °C, W 7 °C)	kW		25,0	50,0
Heating capacity	kW		28,0	56,0
Heating capacity (A +7 °C, W 45 °C)	kW		28,0	56,0
COP (A +7 °C, W 45 °C)	W/W		2,97	3,10
Heating Energy Efficiency class at 35 °C ¹⁾			A++	A++
$\eta_{s,h}$ (LOT1) ²⁾	%		152,00	152,00
Dimension	HxWxD	mm	1000 x 575 x 1110	1000 x 575 x 1110
Net weight		kg	135 (140 with pump)	155 (165 with pump)
Water pipe connector			Rp2 Female Thread (50A)	Rp2 Female Thread (50A)
Heating water flow ($\Delta T=5$ K, 35 °C)	m ³ /h		5,16	10,32
Capacity of integrated electric heater	kW		Not equipped	Not equipped
Flow switch			Equipped	Equipped
Water filter			Equipped	Equipped
Input power with A class water pump / without pump	kW		0,329 / 0,024	0,574 / 0,024
Maximum current with A class water pump / without pump	A		1,43 / 0,10	2,50 / 0,10
Outdoor unit			U-10ME2E8	U-20ME2E8
Sound pressure		dB(A)	56	60
Dimension	HxWxD	mm	1842 x 770 x 1000	1842 x 1540 x 1000
Net weight		kg	210	375
Piping diameter	Liquid pipe	Inch (mm)	3/8 (9,52)	5/8 (15,88)
	Gas pipe	Inch (mm)	7/8 (22,22)	1-1/8 (28,58)
Refrigerant (R410A) / CO ₂ Eq.	kg		5,6 (need Additional gas amount at site)	9,5 (need Additional gas amount at site)
Pipe length range / Pipe length for nominal capacity	m		170 / 7,5	170 / 7,5
Elevation difference (in / out)	m		50 (OD above) 35 (OD below)	50 (OD above) 35 (OD below)
Pipe length for additional gas / Additional gas amount (R410A)	m / g/m		0 < / Refer to manual	0 < / Refer to manual
Operating range	Heat Min ~ Max	°C	-11 ~ +15 ³⁾	-11 ~ +15 ³⁾
Water outlet temperature range	Cool Min ~ Max	°C	+5 ~ +15	+5 ~ +15
	Heat Min ~ Max	°C	+35 ~ +45	+35 ~ +45

1) Unit efficiency energy level: Scale from A+++ to D. 2) Seasonal space cooling / heating energy efficiency following COMMISSION REGULATION (EU) 813/2013. 3) With accessory low temperature kit -25 ~ +15 °C. Available only as a spare part.

Performance calculation in agreement with Eurovent. Sound pressure measured at 1 m from the outdoor unit and at 1,5 m height.

Accessories

PAW-3WSK Stacking kit for vertically stacking up to 3 WHE [4 pieces per Kit]

Stacking kit PAW-3WSK.

It is possible to stack up to 3 units. When stacking units, always anchor the bottom unit to the ground using the anchor holes.

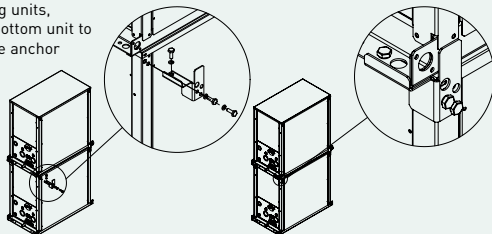

Availability of easy vertical stacking allows installations in a limited space (up to 3 units)*.

* Stacking kit (PAW-3WSK) is necessary.

Stainless steel plate heat exchanger with anti-freeze protection control.

Change over between heating and cooling operation.

Technical focus

- Heating, cooling and DHW
- A class water pump included (only in P model)
- Flexible modularity from 25 kW
- Better partial load vs standard chiller system
- Compatible with all centralized controllers
- Maximum distance between outdoor unit and WHE: 170 m
- Maximum hot water outlet temperature: 45 °C
- Minimum chilled water outlet temperature: 5 °C
- Outdoor temperature range in heating mode: -11 °C to +15 °C (with low temperature kit -25 °C*)

* Available as a spare part.



**ECO G with water heat exchanger for chilled and hot water production****Water heat exchanger (WHE) for hydronic applications.**

WHE for ECO G system controlled by a timer remote control CZ-RTC5B.

Energy-efficient capacity control with superior external static pressure is now ready.

Hydrokit with A class water pump			PAW-500WP5G1	PAW-710WP5G1
Hydrokit without pump			PAW-500W5G1	PAW-710W5G1
Cooling capacity		kW	—	—
Cooling capacity [A +35 °C, outlet W 7 °C, inlet W 12 °C]		kW	50,0	67,0
EER [A +35 °C, outlet W 7 °C, inlet W 12 °C]		W/W	0,78	0,89
Heating capacity		kW	60,0	80,0
Heating capacity [A +7 °C, W 35 °C]		kW	60,9	81,2
COP [A +7 °C, W 35 °C]		W/W	1,15	1,18
Heating capacity [A +7 °C, W 45 °C]		kW	60,0	80,0
COP [A +7 °C, W 45 °C]		W/W	1,02	1,04
Heating capacity [A -7 °C, W 35 °C]		kW	48,2	50,8
COP [A -7 °C, W 35 °C]		W/W	0,80	0,80
Heating capacity [A -15 °C, W 35 °C]		kW	46,3	50,0
COP [A -15 °C, W 35 °C]		W/W	0,80	0,80
Refrigeration load Pdesign		kW	48,0	—
Heating Energy Efficiency class at 35 °C ¹⁾			A+	—
$\eta_{s,h}$ (LOT1) ²⁾		%	130,00	128,00
Dimension	HxWxD	mm	1000 x 575 x 1110	1000 x 575 x 1110
Net weight		kg	155 (165 with pump)	160 (175 with pump)
Water pipe connector			Rp2 Female Thread [50A]	Rp2 Female Thread [50A]
Heating water flow ($\Delta T=5$ K, 35 °C)		m ³ /h	10,32	13,76
Capacity of integrated electric heater		kW	Not equipped	Not equipped
Flow switch			Equipped	Equipped
Water filter			Equipped	Equipped
Input power with A class water pump / without pump		kW	0,574 / 0,024	0,824 / 0,024
Maximum current with A class water pump / without pump		A	2,50 / 0,10	3,60 / 0,10
Outdoor unit			U-20GE3E5	U-30GE3E5
Sound power	Normal / Silent	dB(A)	80 / 77	84 / 81
Dimension	HxWxD	mm	2255 x 1650 x 1000	2255 x 2026 x 1000
Net weight		kg	765	880
Piping diameter	Liquid pipe	Inch (mm)	5/8 (15,88)	3/4 (19,05)
	Gas pipe	Inch (mm)	1-1/8 (28,58)	1-1/4 (31,75)
Refrigerant [R410A] / CO ₂ Eq.		kg / T	11,50 / 24,00	11,50 / 24,00
Pipe length range / Pipe length for nominal capacity		m	170 / 7	170 / 7
Elevation difference (in / out)		m	50 (OD above) 35 (OD below)	50 (OD above) 35 (OD below)
Operating range	Heat Min ~ Max	°C	-21 ~ +24 (until outlet temperature 45)	-21 ~ +24 (until outlet temperature 45)
Water outlet temperature range	Cool Min ~ Max	°C	-15 ~ +15	-15 ~ +15
	Heat Min ~ Max	°C	+35 ~ +55	+35 ~ +55

1) Unit efficiency energy level: Scale from A+++ to D. 2) Seasonal space cooling / heating energy efficiency following COMMISSION REGULATION (EU) 813/2013.

Performance calculation in agreement with Eurovent. Sound pressure measured at 1 m from the outdoor unit and at 1,5 m height.

Accessories

PAW-3WSK Stacking kit for vertically stacking up to 3 WHE (4 pieces per Kit)

Availability of easy vertical stacking allows installations in a limited space (up to 3 units)*.

Stainless steel plate heat exchanger with anti-freeze protection control.

Change over between heating and cooling operation.

* Stacking kit (PAW-3WSK) is necessary.

Technical focus

- Heating, cooling and DHW
- A class water pump included (only in P model)
- Installation up to 80 kW
- Free DHW from waste heat of engine
- Compatible with all centralized controllers
- Maximum distance between outdoor unit and WHE: 170 m
- Hot water outlet temperatures from 35 °C to 55 °C
- Chilled water outlet temperatures from -15 °C to +15 °C
- Minimum outdoor temperature in heating mode: -21 °C



Leak detection and automatic Pump Down for R410A refrigerant

New line-up of Pump Down Systems to detect refrigerant leaks, that offers complete assurance and safety protection. It's an ideal solution for hotels, offices and public buildings where the strict safety for end users and workers is required.



The system monitors refrigerant leakage continually and provides a warning, preventing major refrigerant loss and potential damage to the installation's efficiency. The system can reduce potential refrigerant loss by up to 90 %.

As well as ensuring safe and reliable operation, Panasonic's Pump Down system contributes towards BREEAM POL1 points and enables compliance with current EN 378 standards, covering applications where refrigeration concentration levels exceed practical safety limits of 0,44 kg/m³.

Basic Pump Down function:

- Leak detection
- Activate Pump Down process
- Collect refrigerant within receiver tank
- Close valves to isolate refrigerant

Technical focus:

- Compatible with Mini ECOi / ECOi EX / ECO G* Series with R410A refrigerant
- A receiver kit included as standard
- Includes updated controller
- Connection in two ways:
 - 1 | With local room leakage sensors
 - 2 | Using innovative algorithm
- R22 renewal possible

* For connection to GHP, additional components required dependent on configuration. Please contact your local Panasonic representative for details.



The Pump Down systems are ideal for hotels, offices and public buildings where safety of building occupants is a must.

Direct leak detection method: the safest solution for small rooms

The leak detector is connected directly to the indoor unit and the Pump Down system is directly connected to the outdoor unit PCB. The Pump Down system will activate when a leak is detected in the room and initiate a refrigerant reclaim operation immediately. This immediate reaction, and large refrigerant storage capacity, offers very high level of safety for end users, building occupants, as well as being environmentally friendly. No additional communication panels, cabling or software is required. This option should be implemented in any area that is not compliant with BS EN 378:2008.

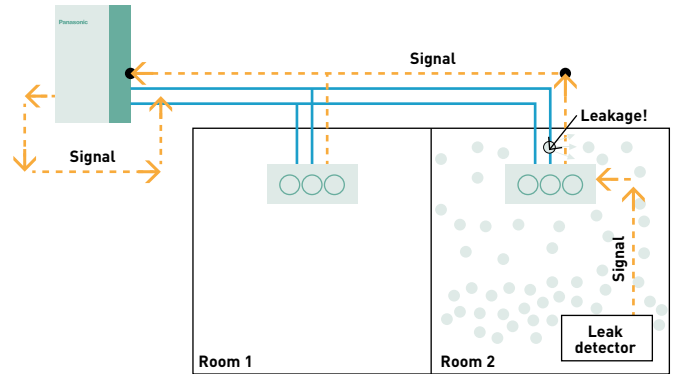

Indirect leak detection method: Unique PLC algorithm to determine refrigerant leakage

Pressure and temperature sensors constantly monitor the high / low pressure and discharge of the condensing unit to protect against potential leakage in areas not covered by leak detectors. The innovative algorithm is able to detect leakage of R410A based on abnormal changes in the following conditions, high and low pressure, and compressor discharge temperature. Once initiated via either direct or indirect detection, the unit will immediately close the liquid / discharge actuating ball valves, close the alarm terminals on the Pump Down PCB allowing an alarm to be raised at any nominated location. Reclaim of the refrigerant is via the suction line to the heat exchanger(s) of the outdoor unit(s), with any surplus refrigerant collected in the 30 l receiver tank. Once fully pumped down the suction line is closed and the unit awaits a 'Reset' and 'Recharge' command. Thanks to the simple installation and control, shown in Fig 1, Panasonic's ECOi Pump Down system can provide dramatic reduction in capital cost and installation time when compared to a standalone leak detection system, shown in Fig 2.

Fig 1: Panasonic's Pump Down system.

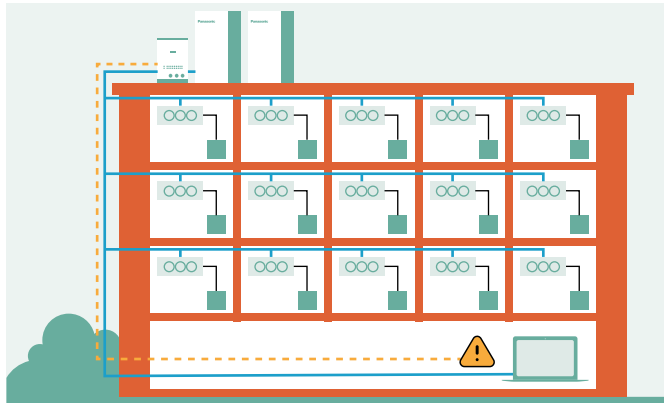
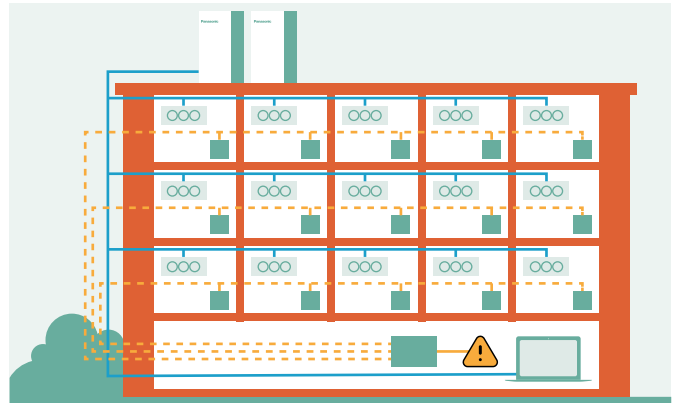

Fig 2: Standalone leak detection system.



Quick and simple installation

The unit contains actuating ball valves, a 30 L storage vessel and PLC all housed in an IP54 rated encasement. Terminals in front of the unit allow easy wiring to the alarm terminal, high / low pressure transducers and discharge temperature sensor(s) of the condensing unit(s).

Reference	Description
PAW-PUD2W-1R	Pump Down system (2 way) for 1 outdoor unit
PAW-PUD2W-2R	Pump Down system (2 way) for 2 outdoor units
PAW-PUD2W-3R*	Pump Down system (2 way) for 3 outdoor units
PAW-PUD3W-1R	Pump Down system (3 way) for 1 outdoor unit
PAW-PUD3W-2R	Pump Down system (3 way) for 2 outdoor units
PAW-PUD3W-3R*	Pump Down system (3 way) for 3 outdoor units

* Special order requiring the longer lead time than usual. For the detailed information, please contact an authorized Panasonic dealer.

Design support software for VRF

Features the unique Mounting Scheme function, providing thorough spec-in and tender quotation support for easier and faster completion of work.

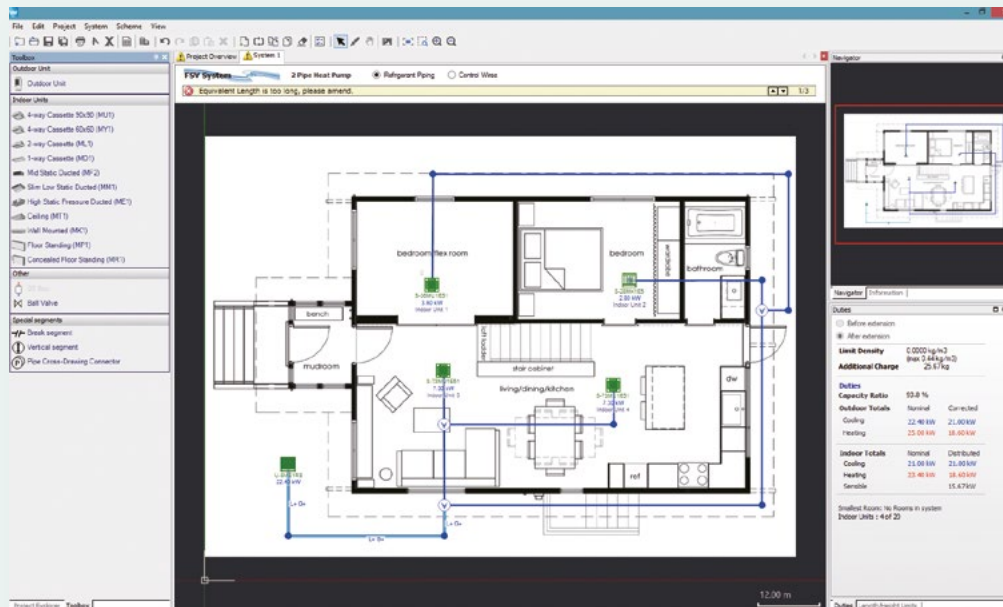

The Panasonic VRF Designer software can be used for Panasonic's latest R410A and R32 VRF Systems.

Panasonic understands the importance of the ever-increasing demands for fast and accurate responses. More and more emphasis is being placed upon energy-efficiency in our marketplace. The ability to calculate cooling / heating loads and produce information of actual design conditions is a major advantage to any architect, consultant, contractor or end user.

Panasonic appreciates the time constraints and demanding industry we are in and we are pleased to announce the launch of the next generation of our system design software program.

The Panasonic VRF Designer software has been customised to make the selection and design process as quick and easy as possible.

The design package utilises system wizards and import tools to enable both simple and complex systems to be created. In addition, the system will allow outdoor and indoor units to be dragged on an interactive desktop. This allows users to create everything from realistic floor plans with detailed piping and wiring schematics, through to installation guidance drawings, which can be sent with quotations.

Features include:

- Mounting scheme. Design selection from building floor drawing
- Variety of drawing formats. (dxf, jpg, png..etc.)
- Conventional principal scheme
- Easy to use system wizards
- Auto piping and wiring features
- Converted duties for conditions and pipework
- Auto(CAD) (dxf), Excel and PDF export
- Detailed wiring and pipework diagrams
- Automatic price quotation
- Automatic tender document assist
- SEER, SCOP
- ESEER



Panasonic's Advanced VRF software with AutoCAD® compatibility makes design easier than ever

Panasonic provides bespoke software helping system designers, installers and dealers to very quickly design and size systems, create wiring diagrams and issue bill of quantities at the push of a button.



Panasonic VRF service checker

Panasonic will make available to installers and commissioning companies the VRF service checker as a communication interface to Panasonic VRF systems. This easy to manage tool checks all parameters of the system.

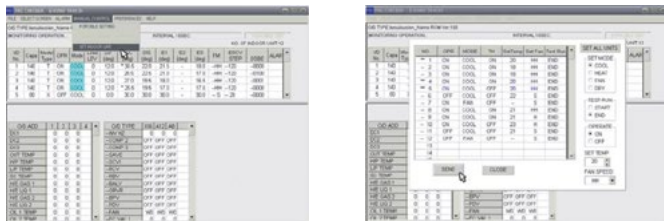

Interface Box

The VRF service checker allows:

- Connect anywhere on the P-Link for ECOi and Mini ECOi
- Search the P-Link to validate systems that are connected
- Monitor all indoor and outdoor units simultaneously on 1 screen
- Monitor all Temperature data, Pressure data, Valve position, and alarm status on 1 screen
- Data can be viewed in Graph or tabular display
- Controlling the indoor unit ON / OFF, MODE, SET POINT, FAN, and TEST mode
- Switching between various systems on the same communication P-Link (ECOi only)
- Monitor and record at a set interval
- Record and review the data at a later date
- Update software via ROM flash writer

This Panasonic VRF service checker is available from your local service partner.

R22 Renewal

Panasonic's advanced technology enables the system to work with previously installed pipe work by managing the working pressure within the system down to R22 (33 bar) levels, this ensures the system works safely and efficiently without loss of capacity.

The new equipment can offer increased COP / EER by using state of the art inverter compressor and heat exchanger technology.

Having contacted your Panasonic supplier regarding pipe work restrictions, and gained approval to use the Panasonic Renewal System, there are three main tests that have to be carried out to ensure that the system can be used effectively. Firstly a thorough inspection of the pipe work must be carried out and any damage must be repaired. Secondly an oil test must be performed to ensure that the system has not been subject to a compressor burnout during its lifetime. Lastly a VRF Renewal Kit (CZ-SLK2) must be installed within the pipe work to ensure that the system is cleaned and free of oil remnants.





























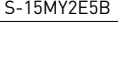





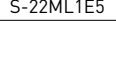



































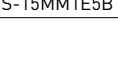
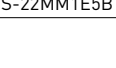











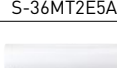
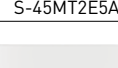





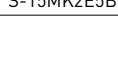





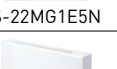
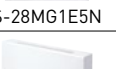
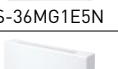



VRF Systems indoor units



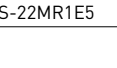
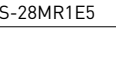
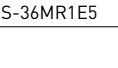

ECOi and ECO G systems indoor units range

Page		1,5 kW	2,2 kW	2,8 kW	3,0 kW	3,6 kW	4,0 kW	4,5 kW
P. 317	U2 Type 4 way 90x90 cassette · R32 / R410A							
		S-22MU2E5B	S-28MU2E5B		S-36MU2E5B	S-45MU2E5B		
P. 318	NEW Y3 Type 4 way 60x60 cassette · R32 / R410A							
		S-15MY3E	S-22MY3E	S-28MY3E	S-36MY3E	S-45MY3E		
P. 319	Y2 Type 4 way 60x60 cassette · R32 / R410A							
		S-15MY2E5B	S-22MY2E5B	S-28MY2E5B	S-36MY2E5B	S-45MY2E5B		
P. 320	L1 Type 2 way cassette · R410A							
			S-22ML1E5	S-28ML1E5	S-36ML1E5	S-45ML1E5		
P. 321	D1 Type 1 way cassette · R410A							
				S-28MD1E5	S-36MD1E5	S-45MD1E5		
P. 322	F3 Type variable static pressure adaptive duct · R32							
		S-15MF3E5B	S-22MF3E5B	S-28MF3E5B	S-36MF3E5B	S-45MF3E5B		
P. 322	F3 Type variable static pressure adaptive duct · R410A							
		S-15MF3E5A	S-22MF3E5A	S-28MF3E5A	S-36MF3E5A	S-45MF3E5A		
P. 323	F2 Type variable static pressure hide-away · R410A							
		S-15MF2E5A	S-22MF2E5A	S-28MF2E5A	S-36MF2E5A	S-45MF2E5A		
P. 324	M1 Type slim variable static pressure hide-away · R32 / R410A							
		S-15MM1E5B	S-22MM1E5B	S-28MM1E5B	S-36MM1E5B	S-45MM1E5B		
P. 325	E2 Type high static pressure hide-away · R410A							
P. 326	Heat recovery with DX coil · R410A							
					PAW-500ZDX3N	PAW-800ZDX3N	PAW-01KZDX3N	
P. 327	T2 Type ceiling · R410A							
					S-36MT2E5A	S-45MT2E5A		
P. 328	K2 Type wall-mounted · R32 / R410A							
		S-15MK2E5B	S-22MK2E5B	S-28MK2E5B	S-36MK2E5B	S-45MK2E5B		
P. 329	G1 Type floor console · R410A							
			S-22MG1E5N	S-28MG1E5N	S-36MG1E5N	S-45MG1E5N		
P. 330	P1 Type floor-standing · R410A							
			S-22MP1E5	S-28MP1E5	S-36MP1E5	S-45MP1E5		
P. 330	R1 Type concealed floor-standing · R410A							
			S-22MR1E5	S-28MR1E5	S-36MR1E5	S-45MR1E5		
P. 331	Hydrokit for ECOi, water at 45 °C · R410A							



OPTIONAL UNITS ON VENTILATION SECTION

5,6 kW

6,0 kW

7,3 kW

9,0 kW

10,6 kW

14,0 kW

16,0 kW

22,4 kW

28,0 kW



S-56MU2E5B



S-60MU2E5B



S-73MU2E5B



S-90MU2E5B



S-106MU2E5B



S-140MU2E5B



S-160MU2E5B



S-56MY3E



S-56MY2E5B



S-56ML1E5



S-73ML1E5



S-56MD1E5



S-73MD1E5



S-56MF3E5B



S-60MF3E5B



S-73MF3E5B



S-90MF3E5B



S-106MF3E5B



S-140MF3E5B



S-160MF3E5B



S-56MF3E5A



S-60MF3E5A



S-73MF3E5A



S-90MF3E5A



S-106MF3E5A



S-140MF3E5A



S-160MF3E5A



S-56MF2E5A



S-60MF2E5A



S-73MF2E5A



S-90MF2E5A



S-106MF2E5A



S-140MF2E5A



S-160MF2E5A



S-56MM1E5B



S-224ME2E5



S-280ME2E5



S-56MT2E5A



S-73MT2E5A



S-106MT2E5A



S-140MT2E5A

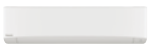

S-56MK2E5B

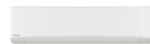

S-73MK2E5B

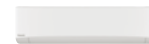

S-106MK2E5B



S-56MG1E5N



S-56MP1E5



S-71MP1E5



S-56MR1E5



S-71MR1E5



S-80MW1E5



S-125MW1E5

4 way 90x90 cassette with nanoe™ X



Large capacity VRF. Trusted power and high efficiency. These Cassettes offer upgraded Econavi and nanoe™ X technology as accessories for making application space more comfortable and efficient.

Thanks to advances in design and technology such as the high performance turbo fan which is more efficient and silent, and nanoe™ X technology and the floor temperature and humidity sensor to more control, the U2 Panasonic 4 way 90x90 cassette offers comfort.

The nanoe™ X performance varies depending on the room size, environment and usage and it may take several hours to reach the full effect. nanoe™ X is not medical device, local regulations on building design and sanitary recommendations must be followed.

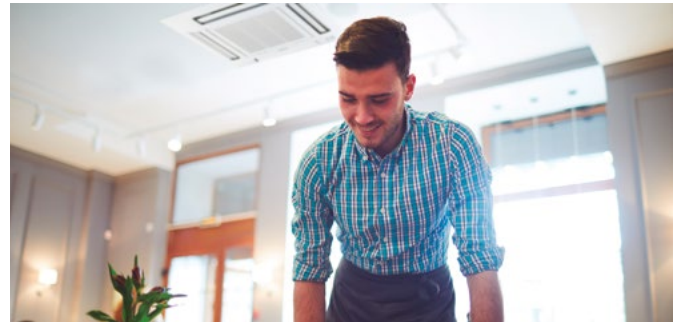

Always fresh and clean air with nanoe™ X

The 4 way 90x90 cassette with nanoe™ X, when tested, has shown to inhibit hazardous substances by 92 %, when compared to natural reduction*. In addition to the 7 effects of nanoe™ X, the indoor unit can also be cleaned with a short operation of nanoe™ X + dry mode.

* Controllers (CZ-RTC5B or CZ-RTC6/BL/BLW) are required.

After cooling/drying operation, the inside of the indoor unit is automatically dried and nanoe™ X is activated to suppress mould growth and to reduce odour.

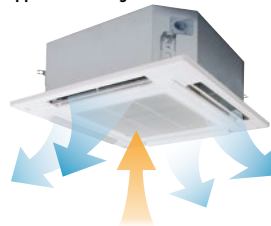

Operates the fan to discharge internal humidity.

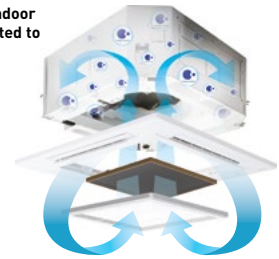

Operate the fan to circulate nanoe™ X internally.

Optional Econavi intelligent sensor

Human activity sensor and floor temperature sensor can reduce waste energy, by optimising air conditioner operation.

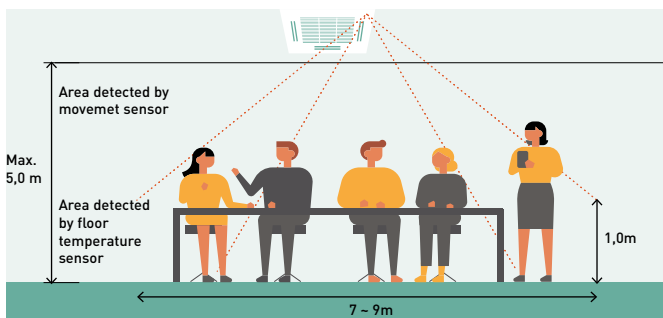

Advanced Econavi functions.

2 sensors (movement and floor temperature) can provide a reduction in wasted energy by means of effective control. The floor temperature can be detected with a ceiling height of 5 m.



Econavi exclusive panel. Optional (CZ-KPU3AW)

Movement sensor.
This sensor detects the amount of human activity, and operates effectively.

Floor temperature sensor.
This sensor detects average floor temperature and operates circulation if floor temperature is low.

Wired remote controller CZ-RTC5B or CZ-RTC6/BL is required.

Humidity sensor.

A humidity sensor positioned in the air inlet provides comfort and saves energy based on temperature and humidity.

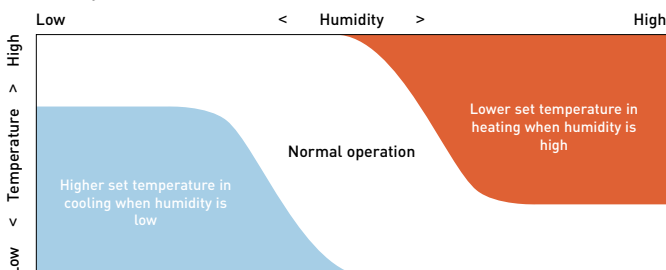

Group control, circulation function.

Circulating operation is activated when a room is unoccupied to evenly distribute air and minimize thermal stratification in both heating and cooling operation.

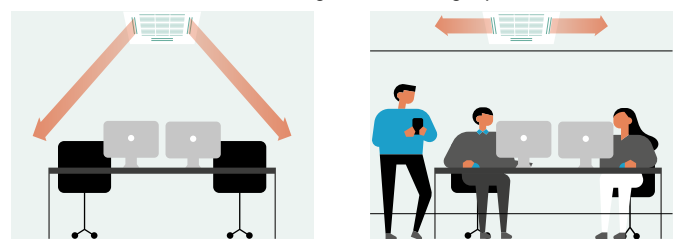

Circulation by detecting no movement (10 minutes).

Indirect air flow by detecting movement.



U2 Type 4 way 90x90 cassette - R32 / R410A

The 4 way 90x90 cassettes with integrated nanoe X Generator Mark 2 and design panel.

Panasonic introduces a modern flat panel design to blend into any space. These cassettes have been developed to satisfy customer, needs such as high energy saving, comfort and better indoor air quality.



COMPATIBLE WITH ALL PANASONIC CONNECTIVITY SOLUTIONS. FOR DETAILED INFORMATION GO TO THE CONTROL SYSTEMS SECTION

Indoor unit	S . .MU2E5B	22	28	36	45	56	60	73	90	106	140	160	
Cooling capacity	kW	2,2	2,8	3,6	4,5	5,6	6,0	7,3	9,0	10,6	14,0	16,0	
Input power	W	20,00	20,00	20,00	20,00	25,00	35,00	40,00	40,00	90,00	95,00	105,00	
Current	A	0,21	0,21	0,21	0,21	0,23	0,33	0,36	0,38	0,71	0,74	0,82	
Heating capacity	kW	2,5	3,2	4,2	5,0	6,3	7,1	8,0	10,0	11,4	16,0	18,0	
Input power	W	20,00	20,00	20,00	20,00	25,00	35,00	40,00	40,00	85,00	90,00	100,00	
Current	A	0,20	0,20	0,20	0,20	0,22	0,32	0,35	0,37	0,69	0,72	0,80	
Fan type		Turbo fan	Turbo fan	Turbo fan	Turbo fan	Turbo fan	Turbo fan	Turbo fan	Turbo fan	Turbo fan	Turbo fan	Turbo fan	
nanoe X Generator		Mark 2	Mark 2	Mark 2	Mark 2	Mark 2	Mark 2	Mark 2	Mark 2	Mark 2	Mark 2	Mark 2	
Air flow	Hi/Med/Lo	m ³ /min	14,5/13,0/11,5	14,5/13,0/11,5	14,5/13,0/11,5	15,5/13,0/11,5	16,5/13,5/11,5	21,0/16,0/13,0	22,5/16,0/13,0	23,0/18,5/14,0	34,0/25,0/19,0	36,0/26,0/20,0	37,0/28,0/24,0
Sound pressure	Hi/Med/Lo	dB(A)	30/29/28	30/29/28	30/29/28	31/29/28	32/30/28	36/32/29	37/32/29	38/35/32	44/38/34	45/39/35	46/40/38
Sound power	Hi/Med/Lo	dB(A)	45/44/43	45/44/43	45/44/43	46/44/43	47/45/43	51/47/44	52/47/44	53/50/47	59/53/49	60/54/50	61/55/53
Dimension (HxWxD)	Indoor	mm	256 x 840 x 840	256 x 840 x 840	256 x 840 x 840	256 x 840 x 840	256 x 840 x 840	256 x 840 x 840	256 x 840 x 840	256 x 840 x 840	319 x 840 x 840	319 x 840 x 840	319 x 840 x 840
	Panel	mm	33,5 x 950 x 950	33,5 x 950 x 950	33,5 x 950 x 950	33,5 x 950 x 950	33,5 x 950 x 950	33,5 x 950 x 950	33,5 x 950 x 950	33,5 x 950 x 950	33,5 x 950 x 950	33,5 x 950 x 950	33,5 x 950 x 950
Net weight (Panel)	kg	19(5)	19(5)	19(5)	19(5)	19(5)	20(5)	20(5)	20(5)	25(5)	25(5)	25(5)	
Piping diameter	Liquid	Inch (mm)	1/4 (6,35)	1/4 (6,35)	1/4 (6,35)	1/4 (6,35)	1/4 (6,35)	3/8 (9,52) ¹⁾	3/8 (9,52) ¹⁾	3/8 (9,52) ¹⁾	3/8 (9,52)	3/8 (9,52)	3/8 (9,52)
	Gas	Inch (mm)	1/2 (12,70)	1/2 (12,70)	1/2 (12,70)	1/2 (12,70)	1/2 (12,70)	5/8 (15,88) ¹⁾	5/8 (15,88) ¹⁾	5/8 (15,88) ¹⁾	5/8 (15,88)	5/8 (15,88)	5/8 (15,88)

1) When the piping diameter is (liquid) Ø1/4 (6,35) - (gas) Ø1/2 (12,70), connect the liquid socket tube (Ø1/4 (6,35) - Ø3/8 (9,52)) to the liquid tubing side indoor unit and connect the gas socket tube (Ø1/2 (12,70) - Ø5/8 (15,88)) to the gas tubing side indoor unit. * Above values are in the case of nanoe™ X OFF.

Accessories

CZ-RTC6	CONEX wired remote controller (non-wireless)
CZ-RTC6BL	CONEX wired remote controller with Bluetooth®
CZ-RTC5B	Wired remote controller with Econavi function
CZ-RWS3 + CZ-RWRU3W	Infrared remote controller and receiver
PAW-RE2C4-MOD-WH	Modbus RS-485 touch room controller with I/O, white
PAW-RE2C4-MOD-BK	Modbus RS-485 touch room controller with I/O, black
PAW-RE2D4-WH	Touch display control with 2 digital inputs, white

Accessories

PAW-RE2D4-BK	Touch display control with 2 digital inputs, black
CZ-KPU3W	Standard panel
CZ-KPU3AW	Econavi exclusive panel
CZ-CENSC1	Econavi energy savings sensor
CZ-FDU3+CZ-ATU2	Fresh air-intake kit
CZ-CGLSC1	Panasonic R32 refrigerant leak detector

Technical focus

- High performance turbo fan
- Lower noise in slow fan operation
- Ceiling height up to 5,0 m
- Industry leading lightweight design
- Econavi: Temperature, humidity and activity sensor
- nanoe™ X (Generator Mark 2= 9,6 trillion hydroxyl radicals/sec) as standard for better indoor air quality, indoor unit internal cleaning with nanoe™ X and dry operation
- Powerful drain pump gives 850 mm lift
- Fresh air knockout
- Branch duct connection
- High volume fresh air input with optional air-intake plenum and chamber (CZ-FDU3+CZ-ATU2)

Panel design

Flat design, well-matched with interior.
4-way individual flap control.

The drain pipe can be raised to a maximum height of 850 mm from the bottom of the ceiling

Integrated drain pump allows a drain height of 850 mm making the installation much easier.

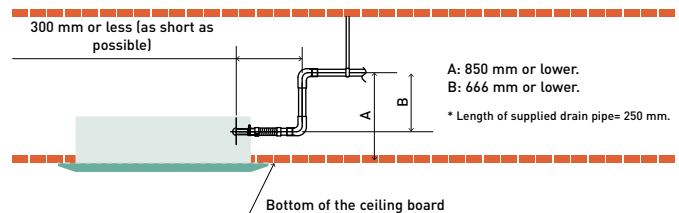

ECONAVI and INTERNET CONTROL: Optional.

Rating Conditions: Cooling Indoor 27 °C DB / 19 °C WB. Cooling Outdoor 35 °C DB / 24 °C WB. Heating Indoor 20 °C DB. Heating Outdoor 7 °C DB / 6 °C WB. (DB: Dry Bulb; WB: Wet Bulb). Specifications subject to change without notice. For detailed information about ErP / Energy Labelling, please visit our websites www.aircon.panasonic.eu or www.ptc.panasonic.eu.

NEW
2022

nanoe™ X as a standard.

NEW Y3 Type 4 way 60x60 cassette · R32 / R410A**New mini cassette with a modern panel design is available in VRF range.**

The Y3 Type not only perfectly matches with 600 x 600 mm ceiling grids but also provides the additional benefits of nanoe™ X, for better indoor air quality.



COMPATIBLE WITH ALL PANASONIC CONNECTIVITY SOLUTIONS. FOR DETAILED INFORMATION GO TO THE CONTROL SYSTEMS SECTION

Indoor unit			S-15MY3E	S-22MY3E	S-28MY3E	S-36MY3E	S-45MY3E	S-56MY3E
Cooling capacity	kW		1,5	2,2	2,8	3,6	4,5	5,6
Input power	W		35,00	35,00	35,00	40,00	40,00	45,00
Current	A		0,30	0,30	0,30	0,30	0,32	0,35
Heating capacity	kW		1,7	2,5	3,2	4,2	5,0	6,3
Input power	W		30,00	30,00	30,00	35,00	35,00	40,00
Current	A		0,25	0,25	0,30	0,30	0,30	0,30
Fan type			Centrifugal fan	Centrifugal fan	Centrifugal fan	Centrifugal fan	Centrifugal fan	Centrifugal fan
Air flow	Cool (Hi / Med / Lo)	m³/min	8,90/8,20/5,60	9,10/8,20/5,60	9,30/8,40/5,60	9,70/8,70/6,00	10,00/9,30/8,20	10,40/9,80/8,50
	Heat (Hi / Med / Lo)	m³/min	9,10/8,40/5,60	9,30/8,40/5,60	9,60/8,70/5,60	9,90/9,10/6,00	10,30/9,60/8,20	11,10/9,80/8,70
Sound pressure	Hi / Med / Lo	dB(A)	34/31/25	35/31/25	35/31/25	36/32/26	38/34/28	40/37/34
Sound power	Hi / Med / Lo	dB(A)	49/46/40	50/46/40	50/46/40	51/47/41	53/49/43	55/52/49
Dimension (HxWxD) ¹⁾	Indoor	mm	230x575x575	230x575x575	230x575x575	230x575x575	230x575x575	230x575x575
	Panel	mm	41x625x625	41x625x625	41x625x625	41x625x625	41x625x625	41x625x625
Net weight		kg	17,8(15+2,8)	17,8(15+2,8)	17,8(15+2,8)	17,8(15+2,8)	17,8(15+2,8)	17,8(15+2,8)
Piping diameter	Liquid pipe	Inch (mm)	1/4(6,35)	1/4(6,35)	1/4(6,35)	1/4(6,35)	1/4(6,35)	1/4(6,35)
	Gas pipe	Inch (mm)	1/2(12,70)	1/2(12,70)	1/2(12,70)	1/2(12,70)	1/2(12,70)	1/2(12,70)

1) Unit height is 230mm, but need 243mm height in ceiling space for its installation. * Available in Autumn 2022.

Accessories

CZ-RTC6	CONEX wired remote controller (non-wireless)
CZ-RTC6BL	CONEX wired remote controller with Bluetooth®
CZ-RTC5B	Wired remote controller with Econavi function
CZ-RWS3 + CZ-RWRY3	Infrared remote controller and receiver
PAW-RE2C4-MOD-WH	Modbus RS-485 touch room controller with I/O, white

Accessories

PAW-RE2C4-MOD-BK	Modbus RS-485 touch room controller with I/O, black
PAW-RE2D4-WH	Touch display control with 2 digital inputs, white
PAW-RE2D4-BK	Touch display control with 2 digital inputs, black
CZ-CENSC1	Econavi energy savings sensor
CZ-CGLSC1	Panasonic R32 refrigerant leak detector

Compact and stylish design

- Ceiling depth is only 250 mm
- Exposed area is only 30 mm

Technical focus

- Built-in drain pump
- DC drain pump and float switch to reduce the noise
- nanoe™ X as standard for better indoor air quality
- Self cleaning inside of the unit with nanoe™ X

Individual flap control

Better control of the air flow with 4 motors, providing individual flap control.

Perfect air distribution without direct airflow, to reduce the feeling of cold drafts.

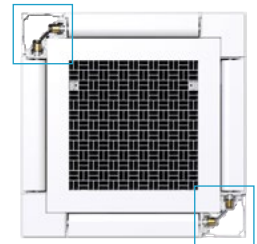

ECONAVI and INTERNET CONTROL: Optional.

**Y2 Type 4 way 60x60 cassette - R32 / R410A**

Designed to fit exactly into a 600 x 600 mm ceiling grid without the need to alter the bar configuration.

The Y2 is ideal for small commercial and retrofit applications. In addition, the improvements to efficiency make this one of the most advanced units in the industry.



COMPATIBLE WITH ALL PANASONIC CONNECTIVITY SOLUTIONS. FOR DETAILED INFORMATION GO TO THE CONTROL SYSTEMS SECTION

Indoor unit			S-15MY2E5B	S-22MY2E5B	S-28MY2E5B	S-36MY2E5B	S-45MY2E5B	S-56MY2E5B
Cooling capacity	kW		1,5	2,2	2,8	3,6	4,5	5,6
Input power	W		35,00	35,00	35,00	40,00	40,00	45,00
Current	A		0,30	0,30	0,30	0,30	0,32	0,35
Heating capacity	kW		1,7	2,5	3,2	4,2	5,0	6,3
Input power	W		30,00	30,00	30,00	35,00	35,00	40,00
Current	A		0,25	0,25	0,30	0,30	0,30	0,30
Fan type			Centrifugal fan	Centrifugal fan	Centrifugal fan	Centrifugal fan	Centrifugal fan	Centrifugal fan
Air flow	Cool (Hi / Med / Lo)	m ³ /min	8,9/8,2/5,6	9,1/8,2/5,6	9,3/8,4/5,6	9,7/8,7/6,0	10,0/9,3/8,2	10,4/9,8/8,5
	Heat (Hi / Med / Lo)	m ³ /min	9,1/8,4/5,6	9,3/8,4/5,6	9,6/8,7/5,6	9,9/9,1/6,0	10,3/9,6/8,2	11,1/9,8/8,7
Sound pressure	Hi / Med / Lo	dB(A)	34/31/25	35/31/25	35/31/25	36/32/26	38/34/28	40/37/34
Sound power	Hi / Med / Lo	dB(A)	49/46/40	50/46/40	50/46/40	51/47/41	53/49/43	55/52/49
	Indoor	mm	288 x 583 x 583	288 x 583 x 583	288 x 583 x 583	288 x 583 x 583	288 x 583 x 583	288 x 583 x 583
Dimension (H x W x D)	Panel AW	mm	31 x 700 x 700	31 x 700 x 700	31 x 700 x 700	31 x 700 x 700	31 x 700 x 700	31 x 700 x 700
	Panel BW	mm	31 x 625 x 625	31 x 625 x 625	31 x 625 x 625	31 x 625 x 625	31 x 625 x 625	31 x 625 x 625
Net weight		kg	20,4(18+2,4)	20,4(18+2,4)	20,4(18+2,4)	20,4(18+2,4)	20,4(18+2,4)	20,4(18+2,4)
Piping diameter	Liquid pipe	Inch (mm)	1/4 (6,35)	1/4 (6,35)	1/4 (6,35)	1/4 (6,35)	1/4 (6,35)	1/4 (6,35)
	Gas pipe	Inch (mm)	1/2 (12,70)	1/2 (12,70)	1/2 (12,70)	1/2 (12,70)	1/2 (12,70)	1/2 (12,70)

Accessories

CZ-RTC6	CONEX wired remote controller (non-wireless)
CZ-RTC6BL	CONEX wired remote controller with Bluetooth®
CZ-RTC5B	Wired remote controller with Econavi function
CZ-RWS3	Infrared remote controller
PAW-RE2C4-MOD-WH	Modbus RS-485 touch room controller with I/O, white
PAW-RE2C4-MOD-BK	Modbus RS-485 touch room controller with I/O, black

Accessories

PAW-RE2D4-WH	Touch display control with 2 digital inputs, white
PAW-RE2D4-BK	Touch display control with 2 digital inputs, black
CZ-KPY3AW	Panel 700 x 700 mm
CZ-KPY3BW	Panel 625 x 625 mm
CZ-CENSC1	Econavi energy savings sensor
CZ-CGLSC1	Panasonic R32 refrigerant leak detector

Technical focus

- Mini cassette fits into a 600 x 600 mm ceiling grid
- Optimised air distribution
- Multidirectional air flow
- Powerful drain pump gives 850 mm lift
- Variable speed DC fan motors and optimised heat exchanger to maximize efficiency

A drain height of approximately 850 mm from the ceiling surface

The drain height can be increased by approximately 350 mm over the conventional value by using a high-lift drain pump, and long horizontal piping is possible. A lightweight unit at 18,4 kg the unit is also very slim with a height of only 288 mm, making installation possible even in narrow ceilings.

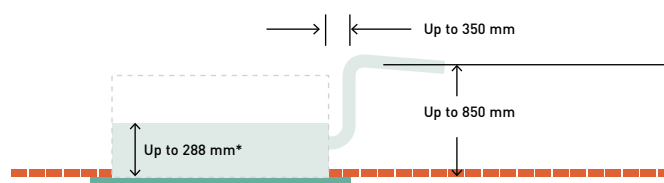

ECONAVI and INTERNET CONTROL: Optional.

Rating Conditions: Cooling Indoor 27 °C DB / 19 °C WB. Cooling Outdoor 35 °C DB / 24 °C WB. Heating Indoor 20 °C DB. Heating Outdoor 7 °C DB / 6 °C WB. [DB: Dry Bulb, WB: Wet Bulb]. Specifications subject to change without notice. For detailed information about ErP / Energy Labelling, please visit our websites www.aircon.panasonic.eu or www.ptc.panasonic.eu.

L1 Type 2 way cassette - R410A

Slim, compact and lightweight units.

Remarkable size and weight reductions have been achieved by improvement of the design around the fan, the weight of all models now being 30 kg.



COMPATIBLE WITH ALL PANASONIC CONNECTIVITY SOLUTIONS. FOR DETAILED INFORMATION GO TO THE CONTROL SYSTEMS SECTION

Indoor unit			S-22ML1E5	S-28ML1E5	S-36ML1E5	S-45ML1E5	S-56ML1E5	S-73ML1E5
Cooling capacity	kW		2,2	2,8	3,6	4,5	5,6	7,3
Input power	W		90,00	92,00	93,00	97,00	97,00	145,00
Current	A		0,45	0,45	0,45	0,45	0,45	0,65
Heating capacity	kW		2,5	3,2	4,2	5,0	6,3	8,0
Input power	W		58,00	60,00	61,00	65,00	65,00	109,00
Current	A		0,29	0,29	0,29	0,29	0,29	0,48
Fan type			Sirocco fan	Sirocco fan	Sirocco fan	Sirocco fan	Sirocco fan	Sirocco fan
Air flow	Hi / Med / Lo	m ³ /min	8,0/7,0/6,0	9,0/8,0/7,0	9,7/8,7/7,7	11,0/9,0/8,0	11,0/9,0/8,0	19,0/16,0/14,0
Sound pressure	Hi / Med / Lo	dB(A)	30/27/24	33/29/26	34/31/28	35/33/29	35/33/29	38/35/33
Dimension (HxWxD)	Indoor	mm	350x840x600	350x840x600	350x840x600	350x840x600	350x840x600	350x1140x600
	Panel	mm	8x1060x680	8x1060x680	8x1060x680	8x1060x680	8x1060x680	8x1360x680
Net weight (Panel)		kg	26,0(8,0)	26,0(8,0)	26,0(8,0)	26,0(8,0)	26,0(8,0)	26,0(8,0)
Piping diameter	Liquid pipe	Inch (mm)	1/4(6,35)	1/4(6,35)	1/4(6,35)	1/4(6,35)	1/4(6,35)	3/8(9,52)
	Gas pipe	Inch (mm)	1/2(12,70)	1/2(12,70)	1/2(12,70)	1/2(12,70)	1/2(12,70)	5/8(15,88)

Accessories

CZ-RTC6	CONEX wired remote controller (non-wireless)
CZ-RTC6BL	CONEX wired remote controller with Bluetooth®
CZ-RTC5B	Wired remote controller with Econavi function
CZ-RWS3 + CZ-RWRL3	Infrared remote controller and receiver
PAW-RE2C4-MOD-WH	Modbus RS-485 touch room controller with I/O, white

Accessories

PAW-RE2C4-MOD-BK	Modbus RS-485 touch room controller with I/O, black
PAW-RE2D4-WH	Touch display control with 2 digital inputs, white
PAW-RE2D4-BK	Touch display control with 2 digital inputs, black
CZ-02KPL2	Panel for S-22 to S-56 models
CZ-03KPL2	Panel for S-73 model

Technical focus

- Air flow and distribution is automatically altered depending on the operational mode of the unit
- Drain pump provides up to 500 mm lift height
- Simple maintenance

Simple maintenance

The drain pan is equipped with site wiring and can be removed. The fan case has a split construction, and the fan motor can be removed easily when the lower case is removed.

Auto flap control

Air flow and distribution is automatically altered depending on the operational mode of the unit.

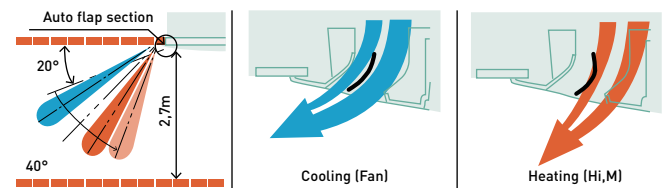

Drain pump provides up to 500 mm lift height

Maintenance of the drain pump is possible from two sides, from the left side (piping side) and from the inside of the unit.

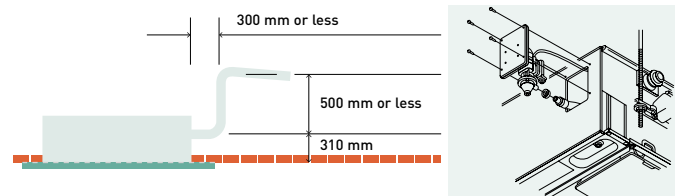

INTERNET CONTROL: Optional.

**D1 Type 1 way cassette · R410A**

Designed for installation within the ceiling void, the D1 range of slimline 1 way blow cassettes feature powerful yet quiet fans for up to 4,2 m.



COMPATIBLE WITH ALL PANASONIC CONNECTIVITY SOLUTIONS. FOR DETAILED INFORMATION GO TO THE CONTROL SYSTEMS SECTION

Indoor unit			S-28MD1E5	S-36MD1E5	S-45MD1E5	S-56MD1E5	S-73MD1E5
Cooling capacity		kW	2,8	3,6	4,5	5,6	7,3
Input power		W	51,00	51,00	51,00	60,00	87,00
Current		A	0,39	0,39	0,39	0,46	0,70
Heating capacity		kW	3,2	4,2	5,0	6,3	8,0
Input power		W	40,00	40,00	40,00	48,00	76,00
Current		A	0,35	0,35	0,35	0,41	0,65
Fan type			Sirocco fan	Sirocco fan	Sirocco fan	Sirocco fan	Sirocco fan
Air flow	Hi / Med / Lo	m ³ /min	12,0/10,0/9,0	12,0/10,0/9,0	12,0/11,0/10,0	13,0/11,5/10,0	18,0/15,0/13,0
Sound pressure	Hi / Med / Lo	dB(A)	36/34/33	36/34/33	36/35/34	38/36/34	45/40/36
Dimension (HxWxD)	Indoor	mm	200 x 1000 x 710	200 x 1000 x 710	200 x 1000 x 710	200 x 1000 x 710	200 x 1000 x 710
	Panel	mm	20 x 1230 x 800	20 x 1230 x 800	20 x 1230 x 800	20 x 1230 x 800	20 x 1230 x 800
Net weight (Panel)		kg	23,5(7,5)	23,5(7,5)	23,5(7,5)	23,5(7,5)	24,5(7,5)
Piping diameter	Liquid pipe	Inch (mm)	1/4(6,35)	1/4(6,35)	1/4(6,35)	1/4(6,35)	3/8(9,52)
	Gas pipe	Inch (mm)	1/2(12,70)	1/2(12,70)	1/2(12,70)	1/2(12,70)	5/8(15,88)

Accessories

CZ-RTC6	CONEX wired remote controller (non-wireless)
CZ-RTC6BL	CONEX wired remote controller with Bluetooth®
CZ-RTC5B	Wired remote controller with Econavi function
CZ-RWS3 + CZ-RWRD3	Infrared remote controller and receiver
PAW-RE2C4-MOD-WH	Modbus RS-485 touch room controller with I/O, white

Accessories

PAW-RE2C4-MOD-BK	Modbus RS-485 touch room controller with I/O, black
PAW-RE2D4-WH	Touch display control with 2 digital inputs, white
PAW-RE2D4-BK	Touch display control with 2 digital inputs, black
CZ-KPD2	Panel

Technical focus

- Ultra-Slim
- Suitable for standard and high ceilings
- Built-in drain pump provides 590 mm lift
- Easy to install and maintain
- Hanging height can be easily adjusted
- Uses a DC fan motor to improve energy-efficiency

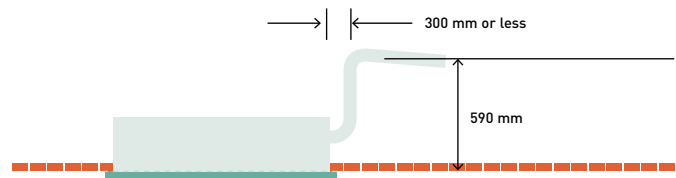
Drain height**With 3 types of air-blow systems, the units can be used in various ways**

1. One-direction "down-blow" system.
Powerful one-direction "down-blow" system reaches the floor even from high ceilings (up to 4,2 m).



2. Two-direction ceiling-mounted system.
"Down-blow" and "front-blow" systems are combined in a ceiling-mounted unit to blow air over a wide area.



3. One-direction ceiling-mounted system.
This powerful ceiling-mounted "front-blow" system efficiently air-conditions the space in front of the unit. (Additional accessories required).



INTERNET CONTROL: Optional.

Rating Conditions: Cooling Indoor 27 °C DB / 19 °C WB. Cooling Outdoor 35 °C DB / 24 °C WB. Heating Indoor 20 °C DB. Heating Outdoor 7 °C DB / 6 °C WB. (DB: Dry Bulb, WB: Wet Bulb). Specifications subject to change without notice. For detailed information about ErP / Energy Labelling, please visit our websites www.aircon.panasonic.eu or www.ptc.panasonic.eu.



F3 Type variable static pressure adaptive duct · R32 / R410A

Design adaptive ducted F3 range.

2 installation possibilities (horizontal / vertical) with high ESP 150 Pa allows for flexible installation.



COMPATIBLE WITH ALL PANASONIC CONNECTIVITY SOLUTIONS. FOR DETAILED INFORMATION GO TO THE CONTROL SYSTEMS SECTION

R32 indoor unit	S . .MF3E5B	15	22	28	36	45	56	60	73	90	106	140	160	
R410A indoor unit	S . .MF3E5A	15	22	28	36	45	56	60	73	90	106	140	160	
Cooling capacity	kW	1,5	2,2	2,8	3,6	4,5	5,6	6,0	7,3	9,0	10,6	14,0	16,0	
Input power	W	60,00	60,00	60,00	60,00	60,00	89,00	79,00	79,00	136,00	146,00	265,00	330,00	
Current	A	0,45	0,45	0,45	0,45	0,45	0,63	0,52	0,52	0,90	1,00	1,76	2,14	
Heating capacity	kW	1,7	2,5	3,2	4,2	5,0	6,3	7,1	8,0	10,0	11,4	16,0	18,0	
Input power	W	60,00	60,00	60,00	60,00	60,00	89,00	79,00	79,00	136,00	146,00	265,00	330,00	
Current	A	0,45	0,45	0,45	0,45	0,45	0,63	0,52	0,52	0,90	1,00	1,76	2,14	
R32 leakage sensors ¹⁾		2	2	2	2	2	2	2	2	2	2	2	2	
Fan type		Sirocco fan	Sirocco fan	Sirocco fan	Sirocco fan	Sirocco fan	Sirocco fan	Sirocco fan	Sirocco fan	Sirocco fan	Sirocco fan	Sirocco fan	Sirocco fan	
nano X Generator		Mark 2	Mark 2	Mark 2	Mark 2	Mark 2	Mark 2	Mark 2	Mark 2	Mark 2	Mark 2	Mark 2	Mark 2	
Air flow ²⁾	Hi/Med/Lo	m ³ /min	14,0/12,0/8,0	14,0/12,0/8,0	14,0/12,0/8,0	14,0/12,0/8,0	14,0/12,0/8,0	16,0/14,0/10,0	21,0/18,0/15,0	21,0/18,0/15,0	25,0/23,0/16,0	32,0/26,0/21,0	37,0/32,0/26,0	40,0/34,0/28,0
External static pressure	Pa		30 (10-150)	30 (10-150)	30 (10-150)	30 (10-150)	30 (10-150)	30 (10-150)	30 (10-150)	30 (10-150)	40 (10-150)	40 (10-150)	50 (10-150)	50 (10-150)
Sound pressure	Hi/Med/Lo	dB(A)	31/28/20	31/28/20	31/28/20	31/28/20	31/28/20	35/32/24	31/28/23	31/28/23	35/33/25	36/32/27	41/36/32	43/37/33
Sound power	Hi/Med/Lo	dB(A)	54/51/43	54/51/43	54/51/43	54/51/43	54/51/43	58/55/47	54/51/46	54/51/46	58/56/48	59/55/50	64/59/55	66/60/56
Dimension	HxWxD	mm	250x800x730	250x800x730	250x800x730	250x800x730	250x800x730	250x800x730	250x1000x730	250x1000x730	250x1000x730	250x1400x730	250x1400x730	250x1400x730
Net weight	kg		26	26	26	26	26	26	31	31	31	40	40	40
Piping diameter	Liquid	Inch (mm)	1/4(6,35)	1/4(6,35)	1/4(6,35)	1/4(6,35)	1/4(6,35)	1/4(6,35)	1/4(6,35)	1/4(6,35)	1/4(6,35)	3/8(9,52)	3/8(9,52)	3/8(9,52)
R32 model	Gas	Inch (mm)	1/2(12,70)	1/2(12,70)	1/2(12,70)	1/2(12,70)	1/2(12,70)	1/2(12,70)	1/2(12,70)	1/2(12,70)	1/2(12,70)	5/8(15,88)	5/8(15,88)	5/8(15,88)
Piping diameter	Liquid	Inch (mm)	1/4(6,35)	1/4(6,35)	1/4(6,35)	1/4(6,35)	1/4(6,35)	1/4(6,35)	3/8(9,52)	3/8(9,52)	3/8(9,52)	3/8(9,52)	3/8(9,52)	3/8(9,52)
R410A model	Gas	Inch (mm)	1/2(12,70)	1/2(12,70)	1/2(12,70)	1/2(12,70)	1/2(12,70)	1/2(12,70)	5/8(15,88)	5/8(15,88)	5/8(15,88)	5/8(15,88)	5/8(15,88)	5/8(15,88)

1) Only available in the R32 version. 2) Value referred to standard settings at shipment (H curve 8, M curve 5, L curve 1).

Accessories	
CZ-RTC6	CONEX wired remote controller (non-wireless)
CZ-RTC6BL	CONEX wired remote controller with Bluetooth®
CZ-RTC5B	Wired remote controller with Econavi function
CZ-RWS3 + CZ-RWRC3	Infrared remote controller and receiver
PAW-RE2C4-MOD-WH	Modbus RS-485 touch room controller with I/O, white

Accessories	
PAW-RE2C4-MOD-BK	Modbus RS-485 touch room controller with I/O, black
PAW-RE2D4-WH	Touch display control with 2 digital inputs, white
PAW-RE2D4-BK	Touch display control with 2 digital inputs, black
CZ-CENSC1	Econavi energy savings sensor
CZ-CGLSC1	Panasonic R32 refrigerant leak detector

Technical focus

- 4 installation possibilities with horizontal and vertical mounting, plus selectable rear or bottom air inlet
- Industry leading low noise with super quiet operation, minimum 22 dB(A)
- Only 250 mm height and lightweight unit from, 26 to 42 kg
- Integrated Panasonic R32 refrigerant leak detectors ¹⁾
- Improved drain pan suitable for both horizontal / vertical installation
- Drain pump included ²⁾
- nanoe™ X (Generator Mark 2= 9,6 trillion hydroxyl radicals/sec) as standard, effective even at duct connections up to 10 m and 3 bends ³⁾

1) Only available in the R32 version.
2) For use with horizontal installation only
3) Panasonic internal survey.

Vertical Installation

Vertical installation option. Variable external static pressure to support ducted installations with bends.

* Vertical installation requires additional settings on field, please check the installation manual.



Improved drain pan design

Drain pan is shared in both cases horizontal and vertical installation. No need to modify the unit.

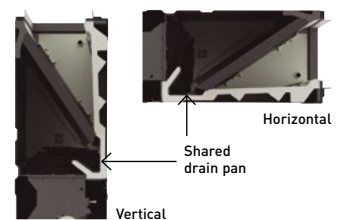

ECONAVI and INTERNET CONTROL: Optional.



F2 Type variable static pressure hide-away · R410A

The F2 type is designed specifically for applications requiring fixed square ducting.

The internal filter is equipped as standard.



COMPATIBLE WITH ALL PANASONIC CONNECTIVITY SOLUTIONS. FOR DETAILED INFORMATION GO TO THE CONTROL SYSTEMS SECTION

Indoor unit	S . .MF2E5A	15	22	28	36	45	56	60	73	90	106	140	160
Cooling capacity	kW	1,5	2,2	2,8	3,6	4,5	5,6	6,0	7,3	9,0	10,6	14,0	16,0
Input power	W	70,00	70,00	70,00	70,00	70,00	100,00	120,00	120,00	135,00	195,00	215,00	225,00
Current	A	0,57	0,57	0,57	0,57	0,57	0,74	0,89	0,89	0,97	1,30	1,44	1,50
Heating capacity	kW	1,7	2,5	3,2	4,2	5,0	6,3	7,1	8,0	10,0	11,4	16,0	18,0
Input power	W	70,00	70,00	70,00	70,00	70,00	100,00	120,00	120,00	135,00	200,00	210,00	225,00
Current	A	0,57	0,57	0,57	0,57	0,57	0,74	0,89	0,89	0,97	1,34	1,42	1,50
Fan type		Sirocco fan	Sirocco fan	Sirocco fan	Sirocco fan	Sirocco fan	Sirocco fan	Sirocco fan	Sirocco fan	Sirocco fan	Sirocco fan	Sirocco fan	Sirocco fan
Air flow ¹⁾	Hi/Med/Lo m ³ /min	14,0/13,0/9,0	14,0/13,0/9,0	14,0/13,0/9,0	14,0/13,0/9,0	14,0/13,0/10,0	16,0/15,0/12,0	21,0/19,0/15,0	21,0/19,0/15,0	25,0/23,0/19,0	32,0/26,0/21,0	34,0/29,0/23,0	36,0/32,0/25,0
External static pressure	Pa	70(10-150)	70(10-150)	70(10-150)	70(10-150)	70(10-150)	70(10-150)	70(10-150)	70(10-150)	70(10-150)	100(10-150)	100(10-150)	100(10-150)
Sound pressure	Hi/Med/Lo dB(A)	33/29/22	33/29/22	33/29/22	33/29/22	34/32/25	34/32/25	35/32/26	35/32/26	37/34/28	38/34/31	39/35/32	40/36/33
Sound power	Hi/Med/Lo dB(A)	55/51/44	55/51/44	55/51/44	55/51/44	56/54/47	56/54/47	57/54/48	57/54/48	59/56/50	60/56/53	61/57/54	62/58/55
Dimension	H x W x D mm	290 x 800 x 700	290 x 800 x 700	290 x 800 x 700	290 x 800 x 700	290 x 800 x 700	290 x 800 x 700	290 x 1000 x 700	290 x 1000 x 700	290 x 1000 x 700	290 x 1400 x 700	290 x 1400 x 700	290 x 1400 x 700
Net weight	kg	29	29	29	29	29	29	34	34	34	46	46	46
Piping diameter	Liquid Inch (mm)	1/4(6,35)	1/4(6,35)	1/4(6,35)	1/4(6,35)	1/4(6,35)	1/4(6,35)	3/8(9,52)	3/8(9,52)	3/8(9,52)	3/8(9,52)	3/8(9,52)	3/8(9,52)
	Gas Inch (mm)	1/2(12,70)	1/2(12,70)	1/2(12,70)	1/2(12,70)	1/2(12,70)	1/2(12,70)	5/8(15,88)	5/8(15,88)	5/8(15,88)	5/8(15,88)	5/8(15,88)	5/8(15,88)

1) Value referred to standard settings at shipment (H curve 8, M curve 5, L curve 1).

Accessories

CZ-RTC6	CONEX wired remote controller (non-wireless)
CZ-RTC6BL	CONEX wired remote controller with Bluetooth®
CZ-RTC5B	Wired remote controller with Econavi function
CZ-RWS3 + CZ-RWRC3	Infrared remote controller and receiver
PAW-RE2C4-MOD-WH	Modbus RS-485 touch room controller with I/O, white

Accessories

PAW-RE2C4-MOD-BK	Modbus RS-485 touch room controller with I/O, black
PAW-RE2D4-WH	Touch display control with 2 digital inputs, white
PAW-RE2D4-BK	Touch display control with 2 digital inputs, black
CZ-CENSC1	Econavi energy savings sensor

Technical focus

- Industry-leading low sound levels from 25 dB(A)
- Built-in drain pump provides 785 mm lift
- Easy to install and maintain
- Air OFF sensor avoids cold air dumping
- Configurable air temperature control

Air inlet plenum	Dampers diameters	Reference
15, 22, 28, 36, 45 and 56	2 x Ø200	CZ-DUMPA56MF2
60, 73 and 90	3 x Ø200	CZ-DUMPA90MF2
106, 140 and 160	4 x Ø200	CZ-DUMPA160MF2

More powerful drain pump

Using a high-lift drain pump, drain piping can be elevated to 700 mm from the base of the unit.

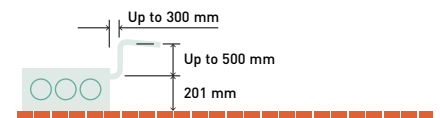

F2 Advantages

Automatic learning function for the required static pressure can be activated easily by the standard wired timer remote controller. Possible to increase the sensible cooling capacity by adjusting the air flow in order to almost completely eliminate latent losses. This is possible due to the outstanding big heat exchanger surface in combination with increasing the air flow by a manual selection of higher fan speed curves through the standard wired remote controller when commissioning the system together with the default active off-coil temperature control and the room load based variable evaporation temperature control.

Diagram 1 S-22MF2E5A

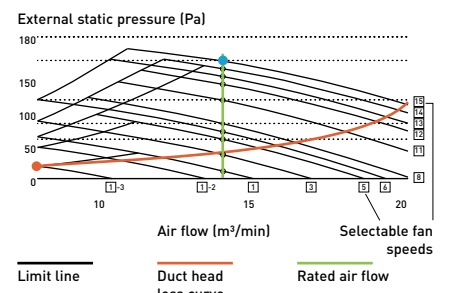

ECONAVI and INTERNET CONTROL: Optional.

Rating Conditions: Cooling Indoor 27 °C DB / 19 °C WB. Cooling Outdoor 35 °C DB / 24 °C WB. Heating Indoor 20 °C DB. Heating Outdoor 7 °C DB / 6 °C WB. (DB: Dry Bulb; WB: Wet Bulb). Specifications subject to change without notice. For detailed information about ErP / Energy Labelling, please visit our websites www.aircon.panasonic.eu or www.ptc.panasonic.eu.



M1 Type slim variable static pressure hide-away concealed duct · R32 / R410A

The ultra slim M1 type is one of the leading products of its type in the industry.

With a depth of only 200 mm it provides greater flexibility and can be used in far more applications.



COMPATIBLE WITH ALL PANASONIC CONNECTIVITY SOLUTIONS. FOR DETAILED INFORMATION GO TO THE CONTROL SYSTEMS SECTION

Indoor unit			S-15MM1E5B	S-22MM1E5B	S-28MM1E5B	S-36MM1E5B	S-45MM1E5B	S-56MM1E5B
Cooling capacity	kW		1,5	2,2	2,8	3,6	4,5	5,6
Input power	W		36,00	36,00	40,00	42,00	49,00	64,00
Current	A		0,26	0,26	0,30	0,31	0,37	0,48
Heating capacity	kW		1,7	2,5	3,2	4,2	5,0	6,3
Input power	W		26,00	26,00	30,00	32,00	39,00	54,00
Current	A		0,23	0,23	0,27	0,28	0,34	0,45
Fan type			Sirocco fan	Sirocco fan	Sirocco fan	Sirocco fan	Sirocco fan	Sirocco fan
Air flow	Hi / Med / Lo	m ³ /min	8,0/7,0/6,0	8,0/7,0/6,0	8,5/7,5/6,5	9,0/8,0/7,0	10,5/9,5/8,0	12,5/11,5/10,0
External static pressure		Pa	10(30)	10(30)	15(30)	15(40)	15(40)	15(40)
Sound pressure	Hi / Med / Lo ¹⁾	dB(A)	28/27/25 (30/29/27)	28/27/25 (30/29/27)	30/29/27 (32/31/29)	32/30/28 (34/32/30)	34/32/30 (36/34/32)	35/33/31 (37/35/32)
Sound power	Hi / Med / Lo	dB(A)	43/42/40	43/42/40	45/44/42	47/45/43	49/47/45	50/48/46
Dimension	H x W x D	mm	200 x 750 x 640	200 x 750 x 640	200 x 750 x 640	200 x 750 x 640	200 x 750 x 640	200 x 750 x 640
Net weight		kg	19	19	19	19	19	19
Piping diameter	Liquid pipe	Inch (mm)	1/4(6,35)	1/4(6,35)	1/4(6,35)	1/4(6,35)	1/4(6,35)	1/4(6,35)
	Gas pipe	Inch (mm)	1/2(12,70)	1/2(12,70)	1/2(12,70)	1/2(12,70)	1/2(12,70)	1/2(12,70)

1) By DIP switches or by RC setting.

Accessories

CZ-RTC6	CONEX wired remote controller (non-wireless)
CZ-RTC6BL	CONEX wired remote controller with Bluetooth®
CZ-RTC5B	Wired remote controller with Econavi function
CZ-RWS3 + CZ-RWRC3	Infrared remote controller and receiver
PAW-RE2C4-MOD-WH	Modbus RS-485 touch room controller with I/O, white

Accessories

PAW-RE2C4-MOD-BK	Modbus RS-485 touch room controller with I/O, black
PAW-RE2D4-WH	Touch display control with 2 digital inputs, white
PAW-RE2D4-BK	Touch display control with 2 digital inputs, black
CZ-CENSC1	Econavi energy savings sensor
CZ-CGLSC1	Panasonic R32 refrigerant leak detector

Technical focus

- Ultra-slim profile: 200 mm for all models
- DC fan motor greatly reduces power consumption
- Ideal for hotel application with very narrow false ceilings
- Easy maintenance and service by external electrical box
- Up to 40 Pa static pressure enables ductwork to be fitted
- Includes drain pump

Air outlet and inlet plenum

	Diameters	Air outlet plenum	Diameters	Air inlet plenum
22, 28 and 36	2 x Ø200	CZ-DUMPA22MMS2	2 x Ø200	CZ-DUMPA22MMR2
45 and 56	3 x Ø160	CZ-DUMPA45MMS3		

* Plenums installed with an R32 Mini ECOi system may only be used when no Panasonic R32 refrigerant leak detector is required. Please refer to technical data manual for refrigerant installation requirements.

Drain pump with increased power!

By adoption of a high-lift drain pump, the drain piping can achieve up to 500 mm lift from the outlet port of the unit.

Ultra-slim profile for all models

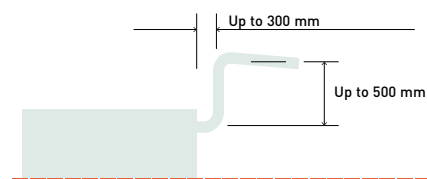
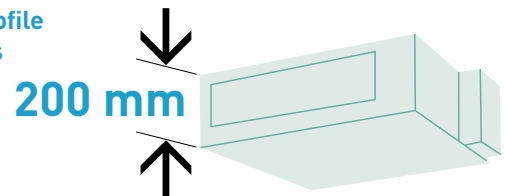

ECONAVI and INTERNET CONTROL: Optional.



E2 Type high static pressure hide-away · R410A

High pressure duct and 100 % Fresh air duct function.

The E2 range of ducted units offers improved design flexibility for extended duct layouts as a result of their increased external static pressures and reduces energy consumption



COMPATIBLE WITH ALL PANASONIC CONNECTIVITY SOLUTIONS. FOR DETAILED INFORMATION GO TO THE CONTROL SYSTEMS SECTION

Type	100 % Fresh air duct function (by using Kit for 100 % fresh air)				High pressure duct					
	S-224ME2E5		S-280ME2E5		S-224ME2E5		S-280ME2E5			
Indoor unit	Cooling	Heating	Cooling	Heating	Cooling	Heating	Cooling	Heating		
Capacity	kW	22,4	21,2	28,0	26,5	22,4	25,0	28,0	31,5	
Input power	W	290,00	290,00	350,00	350,00	440,00	440,00	715,00	715,00	
Current	A	1,85	1,85	2,20	2,20	2,45	2,45	3,95	3,95	
Air flow	Hi / Med / Lo	m ³ /min 28,3 / — / —		35,0 / — / —		56,0 / 51,0 / 44,0		72,0 / 63,0 / 53,0		
External static pressure	Pa	200		200		140 (60 - 270) ¹⁾		140 (72 - 270) ¹⁾		
Sound pressure ²⁾	Hi / Med / Lo	dB(A) 43 / — / —		44 / — / —		45 / 43 / 41		49 / 47 / 43		
Sound power	Hi / Med / Lo	dB(A) 75 / — / —		76 / — / —		77 / 75 / 73		81 / 79 / 75		
Dimension	H x W x D	mm 479 x 1453 x 1205		479 x 1453 x 1205		479 x 1453 x 1205		479 x 1453 x 1205		
Net weight	kg	102		106		102		106		
Piping diameter	Liquid pipe	Inch (mm)	3/8 (9,52)		3/8 (9,52)		3/8 (9,52)		3/8 (9,52)	
	Gas pipe	Inch (mm)	3/4 (19,05)		7/8 (22,22)		3/4 (19,05)		7/8 (22,22)	

Rating Conditions for 100 % Fresh air duct function: Cooling Outdoor 33 °C DB / 28 °C WB. Heating Outdoor 0 °C DB / -2,9 °C WB.
 1) Available to select the setting by initial setup. 2) Values with 140 Pa setting. * No filter included. ** No compatible with 3-Pipe ECO G GF3.

Accessories	
CZ-RTC6	CONEX wired remote controller (non-wireless)
CZ-RTC6BL	CONEX wired remote controller with Bluetooth®
CZ-RTC5B	Wired remote controller with Econavi function
CZ-RWS3 + CZ-RWRC3	Infrared remote controller and receiver
PAW-RE2C4-MOD-WH	Modbus RS-485 touch room controller with I/O, white

Accessories	
PAW-RE2C4-MOD-BK	Modbus RS-485 touch room controller with I/O, black
PAW-RE2D4-WH	Touch display control with 2 digital inputs, white
PAW-RE2D4-BK	Touch display control with 2 digital inputs, black
CZ-CENSC1	Econavi energy savings sensor

Technical focus

- No need of rap valve
- 100 % fresh air duct function*
- DC fan motor for more savings
- Complete flexibility for ductwork design

- Can be located into a weatherproof housing for external siting
- Air OFF sensor avoids cold air dumping
- Configurable air temperature control

* Rap valves required, see 100 % fresh air duct function below.

System example

An inspection port (450 x 450 mm or more) is required at the lower side of the indoor unit body (field supply).

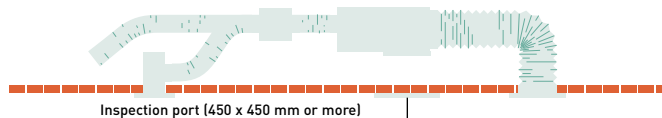

100 % fresh air duct function

The E2 duct with 100 % fresh air duct function have exceptional discharge temperature.

	Discharge Range		
	Min	Max	Default
Cooling	15 °C	24 °C	18 °C
Heating	17 °C	45 °C	40 °C

Kit for 100 % fresh air function

Kit for 100 % fresh air function for 2 way systems	
2x CZ-P160RVK2	Rap valve kit
2x CZ-CAPE2	3 way control PCB
CZ-P680BK2BM	Distribution joint kit
	1x remote controller
Kit for 100 % fresh air function for 3 way systems	
2x CZ-P160HR3	3 way valve Kit
2x CZ-CAPE2	3 way control PCB
CZ-P680BH2BM	Distribution joint kit
	1x remote controller

Plenums

Air outlet plenum (suitable for rigid + flexible duct)		
	Number of exits with diameters	Model
S-224ME2E5 / S-280ME2E5	1 x 500 mm	CZ-TREMIESPW706



ECONAVI and INTERNET CONTROL: Optional.

Rating Conditions: Cooling Indoor 27 °C DB / 19 °C WB. Cooling Outdoor 35 °C DB / 24 °C WB. Heating Indoor 20 °C DB. Heating Outdoor 7 °C DB / 6 °C WB. (DB: Dry Bulb, WB: Wet Bulb). Specifications subject to change without notice. For detailed information about ErP / Energy Labelling, please visit our websites www.aircon.panasonic.eu or www.ptc.panasonic.eu.

Heat recovery with DX coil - R410A

Motorised heat recovery by-pass device automatically controlled by unit control to use fresh air free-cooling when convenient.



COMPATIBLE WITH ALL PANASONIC CONNECTIVITY SOLUTIONS. FOR DETAILED INFORMATION GO TO THE CONTROL SYSTEMS SECTION

Indoor unit			PAW-500ZDX3N		PAW-800ZDX3N		PAW-01KZDX3N	
Power supply	Voltage	V	230		230		230	
	Phase		Single phase		Single phase		Single phase	
	Frequency	Hz	50		50		50	
Air flow		m ³ /min	8,3		13,3		16,7	
External static pressure ¹⁾		Pa	90		120		115	
Maximum current	Total full load	A	0,6		1,4		2,1	
Input power		W	150		320		390	
Sound pressure ²⁾		dB(A)	39		42		43	
Piping diameter	Liquid pipe	Inch (mm)	1/4 (6,35)		1/4 (6,35)		1/4 (6,35)	
	Gas pipe	Inch (mm)	1/2 (12,70)		1/2 (12,70)		1/2 (12,70)	
Heat recovery			Cooling	Heating	Cooling	Heating	Cooling	Heating
Temperature efficiency		%	76	76	76	76	76	76
Enthalpy efficiency		%	63	67	63	65	60	62
Saved power summer mode or winter mode*		kW	1,70	4,30 (4,80)	2,50	6,50 (7,30)	3,20	8,20 (9,00)
DX coil								
Total / Sensible capacity		kW	3,00/2,10	2,50/2,70	5,10/3,50	4,40/4,80	5,80/4,10	5,20/6,70
OFF temperature		°C	15,9	28,0 (27,3)	15,5	29,6 (29,0)	16,2	28,5 (27,8)
OFF relative humidity		%	90	16 (15)	90	14 (13)	89	15 (14)

Nominal summer conditions: Outside air: 32 °C DB, RH 50 %. Ambient air: 26 °C DB, RH 50 %. Nominal winter conditions: Outside air: -5 °C DB, RH 80 %. Ambient air: 20 °C DB, RH 50 %. Cooling mode air inlet condition: 28,5 °C DB, RH 50 %; evaporating temperature 7 °C. Heating mode air inlet condition: 13 °C DB, RH 40 % (11 °C DB, RH 45 %); condensating temperature 40 °C. DB: Dry Bulb; RH: Relative Humidity. 1) Referred to the nominal air flow after filter and plate heat exchanger. 2) Sound pressure level calculated at 1 m far from: ducted supply exhaust air ducted return - first air intake / service side, at normal condition. * Tentative data.

Accessories

CZ-RTC6	CONEX wired remote controller (non-wireless)
CZ-RTC6BL	CONEX wired remote controller with Bluetooth®
CZ-RTC5B	Wired remote controller with Econavi function
PAW-RE2C4-MOD-WH	Modbus RS-485 touch room controller with I/O, white

Accessories

PAW-RE2C4-MOD-BK	Modbus RS-485 touch room controller with I/O, black
PAW-RE2D4-WH	Touch display control with 2 digital inputs, white
PAW-RE2D4-BK	Touch display control with 2 digital inputs, black

Technical focus

- Galvanized steel self-supporting panels, internally and externally insulated
- High efficiency enthalpic heat recover, static cross flow type, made by membrane with high moisture permeability, good air tightness, excellent tear, and aging resistance, structure consisting of flat and corrugated plates. Total heat exchange with temperature efficiency up to 76 % and enthalpy efficiency up to 67 %, also at high level during summer season
- ISO16890 ePm2,5 95 % (F9 EN 779) efficiency class filter with synthetic cleanable media and COARSE 50 % (G3 EN 779) pre-filter ON fresh air, COARSE 50 % filter on return air intake
- Removable side panel to access filters and heat recovery in the event of scheduled maintenance
- Low consumption, high efficiency and low noise direct driven fans
- Supply section complete with DX coil (R410A) fitted with solenoid control valve, freon filter, contact temperature sensors on liquid and gas line, NTC sensors upstream and downstream of air flow

- Built-in electric box equipped with PCB to control internal fan speed and to interconnect outdoor / indoor units
- Duct connection by circular plastic collars

Balanced ventilation

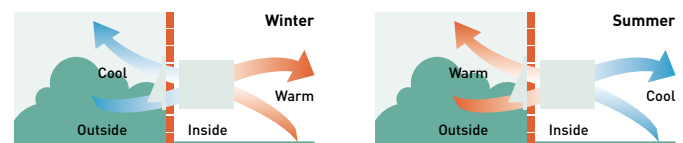

Interconnection to outdoor / indoor units

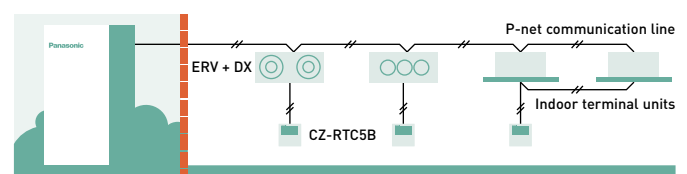

INTERNET CONTROL: Optional.



T2 Type ceiling · R410A

The T2 Type ceiling mounted units feature a DC fan motor for increased efficiency and reduced operating sound levels.

All the units are the same height and depth for a uniform appearance in mixed installations, and feature a fresh air knockout for improved air quality.



COMPATIBLE WITH ALL PANASONIC CONNECTIVITY SOLUTIONS. FOR DETAILED INFORMATION GO TO THE CONTROL SYSTEMS SECTION

Indoor unit			S-36MT2E5A	S-45MT2E5A	S-56MT2E5A	S-73MT2E5A	S-106MT2E5A	S-140MT2E5A
Cooling capacity	kW		3,6	4,5	5,6	7,3	10,6	14,0
Input power	W		35,00	40,00	40,00	55,00	80,00	100,00
Current	A		0,36	0,38	0,38	0,44	0,67	0,79
Heating capacity	kW		4,2	5,0	6,3	8,0	11,4	16,0
Input power	W		35,00	40,00	40,00	55,00	80,00	100,00
Current	A		0,36	0,38	0,38	0,44	0,67	0,79
Fan type			Sirocco fan	Sirocco fan	Sirocco fan	Sirocco fan	Sirocco fan	Sirocco fan
Air flow	Hi / Med / Lo	m³/min	14,0/12,0/10,5	15,0/12,5/10,5	15,0/12,5/10,5	21,0/18,0/15,5	30,0/25,0/23,0	32,0/28,0/24,0
Sound pressure	Hi / Med / Lo	dB(A)	36/32/30	37/33/30	37/33/30	39/35/33	42/37/36	46/40/37
Sound power	Hi / Med / Lo	dB(A)	54/50/48	55/51/48	55/51/48	57/53/51	60/55/54	62/58/55
Dimension	HxWxD	mm	235x960x690	235x960x690	235x960x690	235x1275x690	235x1590x690	235x1590x690
Net weight		kg	27	27	27	33	40	40
Piping diameter	Liquid pipe	Inch (mm)	1/4(6,35)	1/4(6,35)	1/4(6,35)	3/8(9,52)	3/8(9,52)	3/8(9,52)
	Gas pipe	Inch (mm)	1/2(12,70)	1/2(12,70)	1/2(12,70)	5/8(15,88)	5/8(15,88)	5/8(15,88)

Accessories	
CZ-RTC6	CONEX wired remote controller (non-wireless)
CZ-RTC6BL	CONEX wired remote controller with Bluetooth®
CZ-RTC5B	Wired remote controller with Econavi function
CZ-RWS3 + CZ-RWRT3	Infrared remote controller and receiver
PAW-RE2C4-MOD-WH	Modbus RS-485 touch room controller with I/O, white

Accessories	
PAW-RE2C4-MOD-BK	Modbus RS-485 touch room controller with I/O, black
PAW-RE2D4-WH	Touch display control with 2 digital inputs, white
PAW-RE2D4-BK	Touch display control with 2 digital inputs, black
CZ-CENSC1	Econavi energy savings sensor

Technical focus

- Low sound levels
- All units just 235 mm high
- Large and wide air distribution
- Easy to install and maintain
- Fresh air knockout

Air distribution is altered depending on the operational mode

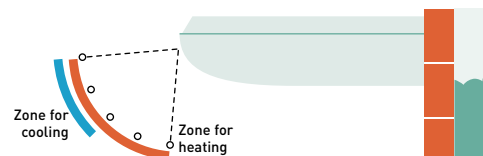

Further comfort improvement with air flow distribution

Horizontal air flow reaches maximum 9,5 m. This is ideal for wide rooms.

The wide air discharge opening expands the air flow to the left and right. The unpleasant feeling caused when the air flow directly hits the human body is prevented by the "Draft prevention position", which changes the swing width, increasing the degree of comfort.

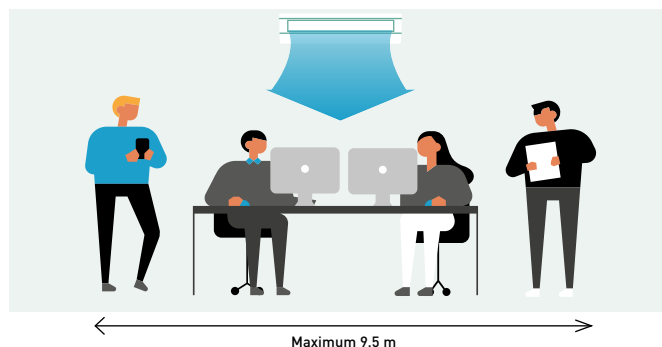

ECONAVI and INTERNET CONTROL: Optional.

Rating Conditions: Cooling Indoor 27 °C DB / 19 °C WB. Cooling Outdoor 35 °C DB / 24 °C WB. Heating Indoor 20 °C DB. Heating Outdoor 7 °C DB / 6 °C WB. (DB: Dry Bulb, WB: Wet Bulb). Specifications subject to change without notice. For detailed information about ErP / Energy Labelling, please visit our websites www.aircon.panasonic.eu or www.ptc.panasonic.eu.

**K2 Type wall-mounted · R32 / R410A**

The wall-mounted unit has a stylish smooth panel that looks good and is easy to clean.

The unit is also smaller, lighter and substantially quieter than previous models making it ideal for small offices and other commercial applications.



COMPATIBLE WITH ALL PANASONIC CONNECTIVITY SOLUTIONS. FOR DETAILED INFORMATION GO TO THE CONTROL SYSTEMS SECTION

Indoor unit			S-15MK2E5B	S-22MK2E5B	S-28MK2E5B	S-36MK2E5B	S-45MK2E5B	S-56MK2E5B	S-73MK2E5B	S-106MK2E5B
Cooling capacity	kW		1,5	2,2	2,8	3,6	4,5	5,6	7,3	10,6
Input power	W		25,00	25,00	25,00	30,00	30,00	35,00	55,00	80,00
Current	A		0,20	0,21	0,23	0,25	0,32	0,35	0,51	0,70
Heating capacity	kW		1,7	2,5	3,2	4,2	5,0	6,3	8,0	11,4
Input power	W		25,00	25,00	25,00	30,00	30,00	35,00	55,00	80,00
Current	A		0,20	0,21	0,23	0,25	0,32	0,35	0,51	0,70
Fan type			Cross flow	Cross flow	Cross flow	Cross flow	Cross flow	Cross flow	Cross flow	Cross flow
Air flow	Cool (Hi / Med / Lo)	m ³ /min	7,9/7,4/6,5	9,0/7,5/6,5	9,5/8,3/6,5	10,9/9,0/6,5	14,5/12,5/10,0	16,0/14,0/12,0	19,5/17,0/14,0	21,5/18,5/15,0
	Heat (Hi / Med / Lo)	m ³ /min	9,0/7,7/6,8	9,2/8,3/6,8	9,7/8,5/6,8	11,2/9,5/6,8	14,5/12,5/10,0	16,0/14,0/12,0	19,5/17,0/14,0	21,5/18,5/15,0
Sound pressure	Hi / Med / Lo	dB(A)	34/32/29	36/33/29	37/34/29	40/36/29	38/35/33	40/37/35	47/44/40	49/46/42
Sound power	Hi / Med / Lo	dB(A)	49/47/44	51/48/44	52/49/44	55/51/44	53/50/48	55/52/50	62/59/55	64/61/57
Dimension	H x W x D	mm	290 x 870 x 214	290 x 870 x 214	290 x 870 x 214	290 x 870 x 214	302 x 1120 x 236	302 x 1120 x 236	302 x 1120 x 236	302 x 1120 x 236
Net weight		kg	9	9	9	9	13	13	14	14
Piping diameter	Liquid pipe	Inch (mm)	1/4 (6,35)	1/4 (6,35)	1/4 (6,35)	1/4 (6,35)	1/4 (6,35)	1/4 (6,35)	3/8 (9,52) ¹⁾	3/8 (9,52)
	Gas pipe	Inch (mm)	1/2 (12,70)	1/2 (12,70)	1/2 (12,70)	1/2 (12,70)	1/2 (12,70)	1/2 (12,70)	5/8 (15,88) ¹⁾	5/8 (15,88)

1) When the piping diameter is (liquid) Ø1/4 (6,35) - (gas) Ø1/2 (12,70), connect the liquid socket tube (Ø1/4 (6,35) - Ø3/8 (9,52)) to the liquid tubing side indoor unit and connect the gas socket tube (Ø1/2 (12,70) - Ø5/8 (15,88)) to the gas tubing side indoor unit.

Accessories

CZ-RTC6	CONEX wired remote controller (non-wireless)
CZ-RTC6BL	CONEX wired remote controller with Bluetooth®
CZ-RTC5B	Wired remote controller with Econavi function
CZ-RWS3	Infrared remote controller
PAW-RE2C4-MOD-WH	Modbus RS-485 touch room controller with I/O, white
PAW-RE2C4-MOD-BK	Modbus RS-485 touch room controller with I/O, black

Accessories

PAW-RE2D4-WH	Touch display control with 2 digital inputs, white
PAW-RE2D4-BK	Touch display control with 2 digital inputs, black
CZ-CENSC1	Econavi energy savings sensor
CZ-P56SVK2	External valve for model sizes 15 to 56
CZ-P160SVK2	External valve for model sizes 73 to 106
CZ-CGLSC1	Panasonic R32 refrigerant leak detector

Technical focus

- Compact lightweight units for easy installation
- Quiet operation
- Smooth and durable design
- Piping outlet in six directions
- Air distribution is automatically altered depending on the operational mode

Air distribution is automatically altered depending on the operational mode of the unit

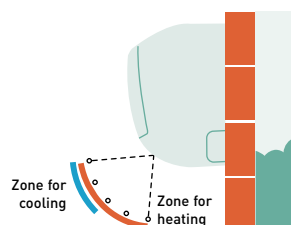
**Quiet operation**

These units are among the quietest in the industry, making them ideal for hotels and hospitals.

Lighter and smaller units

Compact and lightweight units make for easy installation. When the unit is turned OFF, the flap closes completely to prevent entry of dust into the unit and to keep the equipment clean.

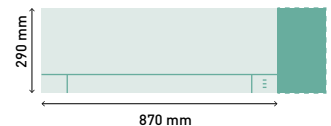
**Piping outlet in six directions**

Piping outlet is possible in six directions of; right, right rear, right bottom, left, left rear and left bottom, making installation flexible.

**External valve (optional)**

CZ-P56SVK2 (model sizes 15 to 56).
CZ-P160SVK2 (model sizes 73¹⁾ to 106).



1) When the piping diameter is liquid 1/4 (6,35) and gas 1/2 (12,70), use CZ-P56SVK2



ECONAVI and INTERNET CONTROL: Optional.



G1 Type floor console - R410A

The stylish and compact unit profile, also used for residential market range, is easy to integrate into any design of building.

Compact and versatile, this system is capable of being installed in an area with limited space. It is a perfect solution for retrofit, replacing existing radiator panels.



COMPATIBLE WITH ALL PANASONIC CONNECTIVITY SOLUTIONS. FOR DETAILED INFORMATION GO TO THE CONTROL SYSTEMS SECTION

Indoor unit		S-22MG1E5N	S-28MG1E5N	S-36MG1E5N	S-45MG1E5N	S-56MG1E5N	
Cooling capacity	kW	2,2	2,8	3,6	4,5	5,6	
Input power	W	20,00	20,00	22,00	28,00	31,00	
Current	A	0,20	0,20	0,23	0,25	0,28	
Heating capacity	kW	2,5	3,2	4,2	5,0	6,3	
Input power	W	21,00	21,00	23,00	29,00	32,00	
Current	A	0,20	0,20	0,24	0,26	0,28	
Fan type		Cross flow	Cross flow	Cross flow	Cross flow	Cross flow	
nanoe X Generator		Mark 1	Mark 1	Mark 1	Mark 1	Mark 1	
Air flow	Cool (Hi / Med / Lo)	m³/min	9,2/7,5/6,0	9,2/7,5/6,0	9,7/8,2/6,0	10,5/9,0/6,5	12,0/9,5/6,5
	Heat (Hi / Med / Lo)	m³/min	9,7/8,0/6,5	9,7/8,0/6,5	10,2/8,7/6,5	11,0/9,5/7,0	12,5/10,0/7,0
Sound pressure	Hi / Med / Lo	dB(A)	38/34/29	38/34/29	39/35/29	42/37/30	44/38/30
Dimension	H x W x D	mm	600 x 750 x 207	600 x 750 x 207	600 x 750 x 207	600 x 750 x 207	600 x 750 x 207
Net weight		kg	14	14	14	14	14
Piping diameter	Liquid pipe	Inch (mm)	1/4 (6,35)	1/4 (6,35)	1/4 (6,35)	1/4 (6,35)	1/4 (6,35)
	Gas pipe	Inch (mm)	1/2 (12,70)	1/2 (12,70)	1/2 (12,70)	1/2 (12,70)	1/2 (12,70)

Accessories	
CZ-RTC6	CONEX wired remote controller (non-wireless)
CZ-RTC6BL	CONEX wired remote controller with Bluetooth®
CZ-RTC5B	Wired remote controller with Econavi function
CZ-RWS3*	Infrared remote controller
PAW-RE2C4-MOD-WH	Modbus RS-485 touch room controller with I/O, white

Accessories	
PAW-RE2C4-MOD-BK	Modbus RS-485 touch room controller with I/O, black
PAW-RE2D4-WH	Touch display control with 2 digital inputs, white
PAW-RE2D4-BK	Touch display control with 2 digital inputs, black
CZ-CENSC1	Econavi energy savings sensor

* Infrared receiver is integrated with the unit as standard.

1 nanoe™ X: Bringing nature's balance indoors
 Panasonic's nanoe™ X technology brings nature's detergent – hydroxyl radicals – indoors to help improve protection 24/7 against several types of pollutants can be inhibited such as certain types of bacteria, viruses, mould, allergens, pollen or hazardous substances.

2 Stylish and simple
 · Clean and modern European design with slim depth
 · Modern matt white color panel
 · Washable air filter
 The stylish and compact unit profile, also used for residential market range, is easy to integrate into any design of building.



Dimension:
 W x H x D = 750 x 600 x 207 mm
Weight:
 14kg

3 Flexible easy installation
 Four different mounting styles possible:
 · Exposed (floor or wall)
 · Semi-recessed
 · Recessed

Flexible installation with 4 different options.

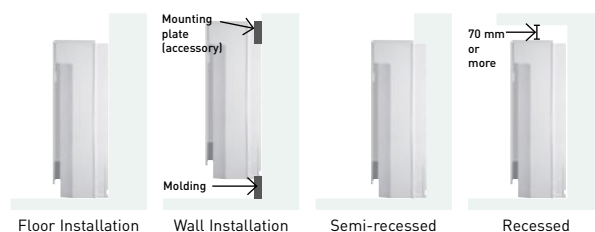

4 Functions for comfort
 · Double Air Flow direction to maximize comfort
 · Self-cleaning function
 · Compatible with Commercial Wi-Fi Adaptor for cloud control

Self-cleaning function.
 · Self cleaning function can be pre-scheduled with remote controller, up to a maximum of 90 minutes following cooling / dry operation
 · Air flow will not blow directly at occupants during self-cleaning



ECONAVI and INTERNET CONTROL: Optional.

Rating Conditions: Cooling Indoor 27 °C DB / 19 °C WB. Cooling Outdoor 35 °C DB / 24 °C WB. Heating Indoor 20 °C DB. Heating Outdoor 7 °C DB / 6 °C WB. (DB: Dry Bulb; WB: Wet Bulb). Specifications subject to change without notice. For detailed information about ErP / Energy Labelling, please visit our websites www.aircon.panasonic.eu or www.ptc.panasonic.eu.

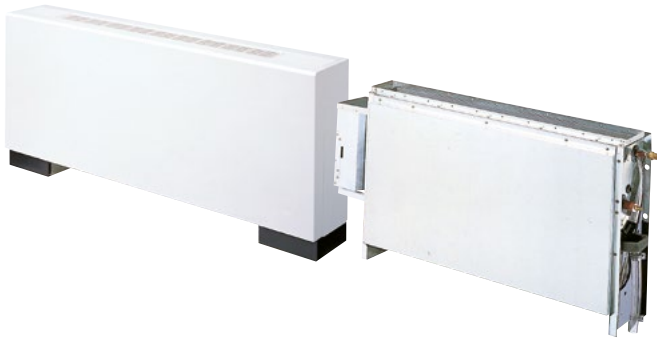

P1 Type floor-standing · R410A

The compact floor-standing P1 units are the ideal solution for providing perimeter air conditioning.

R1 Type concealed floor-standing · R410A

At just 229 mm deep, the R1 unit can be easily concealed in perimeter areas to provide powerful and effective air conditioning.



COMPATIBLE WITH ALL PANASONIC CONNECTIVITY SOLUTIONS. FOR DETAILED INFORMATION GO TO THE CONTROL SYSTEMS SECTION

P1 indoor unit			S-22MP1E5	S-28MP1E5	S-36MP1E5	S-45MP1E5	S-56MP1E5	S-71MP1E5
R1 indoor unit			S-22MR1E5	S-28MR1E5	S-36MR1E5	S-45MR1E5	S-56MR1E5	S-71MR1E5
Cooling capacity	kW		2,2	2,8	3,6	4,5	5,6	7,1
Input power	W		56,00	56,00	85,00	126,00	126,00	160,00
Current	A		0,25	0,25	0,38	0,56	0,56	0,72
Heating capacity	kW		2,5	3,2	4,2	5,0	6,3	8,0
Input power	W		40,00	40,00	70,00	91,00	91,00	120,00
Current	A		0,18	0,18	0,31	0,41	0,41	0,54
Fan type			Sirocco fan	Sirocco fan	Sirocco fan	Sirocco fan	Sirocco fan	Sirocco fan
Air flow	Hi / Med / Lo	m ³ /min	7,0/6,0/5,0	7,0/6,0/5,0	9,0/7,0/6,0	12,0/9,0/8,0	15,0/13,0/11,0	17,0/14,0/12,0
External static pressure		Pa	15	15	15	15	15	15
Sound pressure	Hi / Med / Lo	dB(A)	33/30/28	33/30/28	39/35/29	38/35/31	39/36/31	41/38/35
P1 Dimension	H x W x D	mm	615 x 1065 x 230	615 x 1065 x 230	615 x 1065 x 230	615 x 1380 x 230	615 x 1380 x 230	615 x 1380 x 230
R1 Dimension	H x W x D	mm	616 x 904 x 229	616 x 904 x 229	616 x 904 x 229	616 x 1219 x 229	616 x 1219 x 229	616 x 1219 x 229
P1 Net weight		kg	29	29	29	39	39	39
R1 Net weight		kg	21	21	21	28	28	28
Piping diameter	Liquid pipe	Inch (mm)	1/4 (6,35)	1/4 (6,35)	1/4 (6,35)	1/4 (6,35)	1/4 (6,35)	3/8 (9,52)
	Gas pipe	Inch (mm)	1/2 (12,70)	1/2 (12,70)	1/2 (12,70)	1/2 (12,70)	1/2 (12,70)	5/8 (15,88)

Accessories

CZ-RTC6	CONEX wired remote controller (non-wireless)
CZ-RTC6BL	CONEX wired remote controller with Bluetooth®
CZ-RTC5B	Wired remote controller with Econavi function
CZ-RWS3 + CZ-RWRC3	Infrared remote controller and receiver

Accessories

PAW-RE2C4-MOD-WH	Modbus RS-485 touch room controller with I/O, white
PAW-RE2C4-MOD-BK	Modbus RS-485 touch room controller with I/O, black
PAW-RE2D4-WH	Touch display control with 2 digital inputs, white
PAW-RE2D4-BK	Touch display control with 2 digital inputs, black

P1 Technical focus

- Pipes can be connected to either side of the unit from the bottom or rear
- Easy to install
- Front panel opens fully for easy maintenance
- Removable air discharge grille gives flexible airflow
- Room for condensate pump

Effective perimeter handling

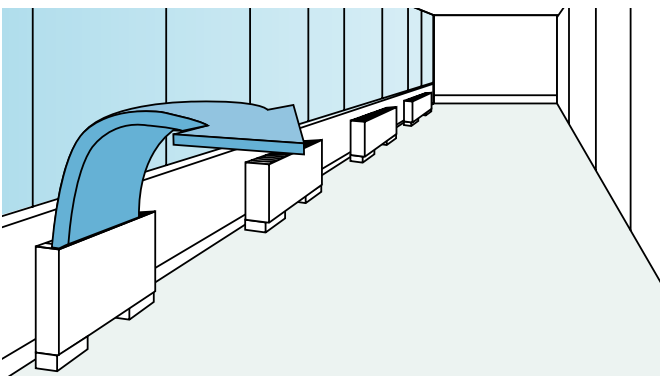

R1 Technical focus

- Chassis unit for discreet installation
- Complete with removable filters
- Pipes can be connected to either side of the unit from the bottom or rear
- Easy to install

Perimeter air conditioning with high interior quality

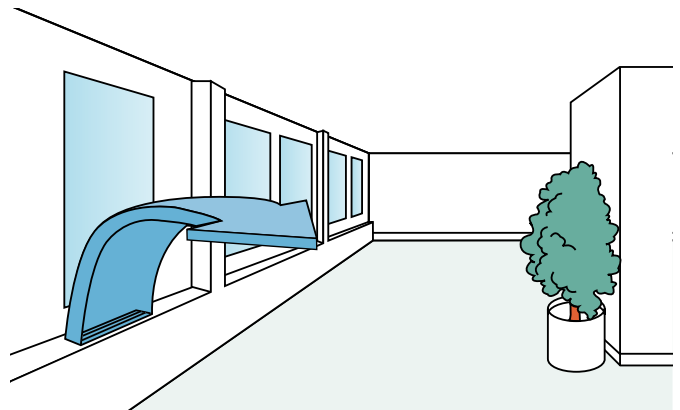

INTERNET CONTROL: Optional.

**Hydrokit for ECOi, water at 45 °C · R410A**

Connect the Hydrokit to your VRF system, together with other indoor units.

Total system performs high energy efficiency through heat recovering operation, and it gives an advantage for sustainability related assessment methods, such as BREEAM in UK.



COMPATIBLE WITH ALL PANASONIC CONNECTIVITY SOLUTIONS. FOR DETAILED INFORMATION GO TO THE CONTROL SYSTEMS SECTION

Indoor unit				S-80MW1E5	S-125MW1E5
Power supply	Voltage	V	230	230	
	Phase		Single phase	Single phase	
	Frequency	Hz	50	50	
Cooling capacity		kW	8,0	12,5	
Heating capacity		kW	9,0	14,0	
Maximum temperature		°C	-45 / -65 ¹⁾	-45 / -65 ¹⁾	
Dimension	H x W x D	mm	892 x 502 x 353	892 x 502 x 353	
Water pipe connector		Inch	R 1 ¼	R 1 ¼	
Water pump (built-in)			DC motor (A class)	DC motor (A class)	
Water flow rate	Cool	L/min	22,90	35,80	
	Heat	L/min	25,80	40,10	
Piping diameter	Liquid pipe	Inch (mm)	3/8 (9,52)	3/8 (9,52)	
	Gas pipe	Inch (mm)	5/8 (15,88)	5/8 (15,88)	
	Drain pipe	mm	15 ~ 17 (inner size)	15 ~ 17 (inner size)	
Operation range	Cool	Ambient	°C	+10 ~ +43	+10 ~ +43
		Water	°C	+5 ~ +20	+5 ~ +20
	Heat	Ambient	°C	-20 ~ +43	-20 ~ +43
		Water	°C	+25 ~ +45	+25 ~ +45
	Connectable system	3-Pipe (heat recovery type) VRF System (system capable up to 48 HP)			
	Maximum Indoor ratio (connectable hydrokit module capacity ratio)			Total indoor unit + Hydrokit capacity: up to 130 % (** ~ **% vs total outdoor unit capacity)	

1) Maximum 45 °C by refrigerant circuit (heat pump cycle), over 45 °C is provided by electric heater operation.

Accessories

CZ-RTC5B	Wired remote controller with Econavi function
PAW-RE2C4-MOD-WH	Modbus RS-485 touch room controller with I/O, white
PAW-RE2C4-MOD-BK	Modbus RS-485 touch room controller with I/O, black

Accessories

PAW-RE2D4-WH	Touch display control with 2 digital inputs, white
PAW-RE2D4-BK	Touch display control with 2 digital inputs, black

Basic principle and advantage.

Hydrokit module provides hot water by using waste heat that is recovered from standard air-conditioning indoor unit in cooling mode.

Technical focus

- Only with 3-Pipe ECOi EX MF3 Series outdoor units
- Remote controller CZ-RTC5B common use with DX coil indoor units ECOi and PACi

Hydrokit control function / CZ-RTC5B

- CZ-RTC5B can be used for hydrokit and also normal indoor unit. CZ-RTC5B checks the type of connected unit and switches between hydrokit and air conditioner display automatically

- Hydrokit mode (tank or air conditioning mode) is set during initial startup

Overview: hydromodule in VRF system

- Multiple hydromodule connection in same circuit is available
- The mode of each module can be individually set from either hot water or space heating (once set the units cannot operate in another mode, resetting will be required)
- 3-Pipe control solenoid valve kit is necessary for each indoor unit and hydromodule

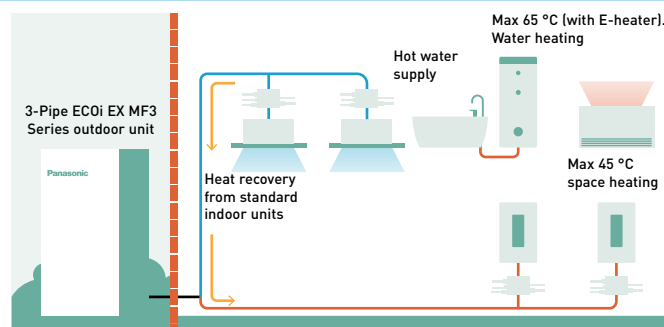

* Cold water also available.

PRO-HT Tank Series for ECOi

PRO-HT Tank DHW. Big volume and high temperature tank for commercial application.

MAXIMUM
65 °C
WATER OUTLET
TEMPERATURE



1 High performance and high saving

- A7 COP maximum 5,29 and 6,70 for ECOi 3-Pipe in case of heat recovery
- Efficient hot water production by heat recovery
- High temperature hot water without booster
- Save installation time and cost by skipping additional accessories

2 Hot water production with simultaneous heating and cooling

- Maximum water outlet temperature up to 65 °C without an electric heater
- Big volume tank from 750L to 1000L capacity
- Heat exchanger design inhibits limescale

3 Trusted quality

- Double tube heat exchanger following drinking-water regulation
- Tank and heat exchanger made with stainless steel
- Internal and external pickling

Solution example DHW tank 1000L + ECOi 3-Pipe mixed system

- Ideal offer for hotel projects
- DHW production under spontaneous heating and cooling
- Hot water up to 65 °C is efficiently produced by heat recovery
- A7 COP 6,70 considering heat recovery

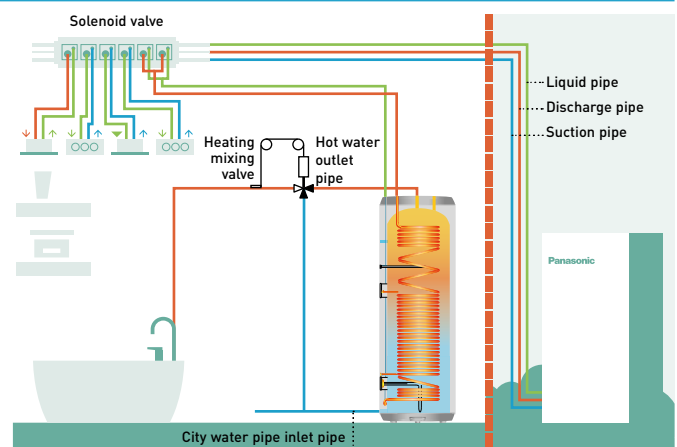

One by one system compatible list with ECOi

Model	Tank type	Product compatibility	Hot water outlet temperature
PAW-VP750LDHW-1	DHW	U-16MF3 (3-Pipe)	65 °C
PAW-VP1000LDHW-1	DHW	U-16MF3 (3-Pipe)	65 °C

**PRO-HT TANK****PRO-HT Tank DHW**

Enjoy an efficient DHW and heating and cooling tank. Panasonic commercial PRO-HT Tank solutions meet all needs of your hot water applications providing 65 °C maximum water temperature.

High temperature hot water is efficiently produced without any boosters.

Can be combined with 3-Pipe ECOi EX MF3 Series to adapt various projects from high-end residential to offices and hotels.

PRO-HT Tank			PAW-VP750LDHW-1	PAW-VP1000LDHW-1	
COP DHW (A +7 °C, W 10-55 °C) EN 16147 ¹⁾			5,29	4,81	
COP DHW (A +15 °C, W 10-55 °C) EN 16147 ²⁾			7,01	5,32	
Volume (net)	L		726	933	
Reference tapping cycle			2XL	2XL	
Standby heat loss according to EN16147	W/h		77	80	
Maximum water temperature	Heat pump	°C	65	65	
	Electrical heater	°C	85	85	
Dimension	H x Ø	mm	1855x990	2210x990	
Net weight / with water	kg		179 / 905	191 / 1124	
Stainless steel 316 L tank			Yes	Yes	
Connections to the water supply network			RP 1¼	RP 1¼	
Average insulation thickness	mm		100	100	
Number of electrical heaters x power	W		1 x 6000	1 x 6000	
Electric protection	A		16	16	
Moisture protection (PAW-VP-RTC5B-VRF)			IP24	IP24	
Heat exchanger connection	Inlet	Inch (mm)	1/2 (12,70)	1/2 (12,70)	
	Outlet	Inch (mm)	3/4 (19,05)	3/4 (19,05)	
Tubing connection between SVK and tank	Liquid pipe	Inch (mm)	3/8 (9,52)	3/8 (9,52)	
	Gas pipe	Inch (mm)	3/4 (19,05)	3/4 (19,05)	
Outdoor unit			U-16MF3E8	U-16MF3E8	
Energy consumption by chosen cycle (A +7 °C, W 10-55 °C)			kWh	4,14	5,10
Energy consumption by chosen cycle (A +15 °C, W 10-55 °C)			kWh	3,50	4,61
Power supply	Voltage	V	400	400	
	Phase		Three phase	Three phase	
	Frequency	Hz	50	50	
Maximum power consumption	Without heater	W	20400	20400	
	With heater	W	26400	26400	
Sound pressure at 1m from outdoor unit		dB(A)	52	52	
Refrigerant (R410A) / CO ₂ Eq.		kg / T	8,3 / 17,300	8,3 / 17,300	
Pipe length range from outdoor unit		m	50	50	
Elevation difference (in/out)		m	30 (OD above) 30 (OD below)	30 (OD above) 30 (OD below)	
Pipe length for nominal capacity		m	7,5	7,5	
Pipe length for additional gas		m	> 7,5	> 7,5	
Additional gas amount		g/m	Refer to manual	Refer to manual	
Operating range - outdoor ambient	Heat Min ~ Max	°C	-20 ~ +35	-20 ~ +35	

1) Heating of sanitary water up to 55 °C with inlet air temperature at 7 °C, humidity at 89 % and inlet water temperature at 10 °C. According to EN16147. 2) Heating of sanitary water up to 55 °C with inlet air temperature at 15 °C, humidity at 74 % and inlet water temperature at 10 °C. According to EN16147.

This product is designed to comply with the European Water Quality Directive 98/83/EC amended by 2015/1787/EU. The lifespan of the product is not guaranteed in the case of the use of groundwater, such as spring water or well water, the use of tap water when salt or other impurities are contained, nor in areas of acidic water quality. Maintenance and warranty costs related to these cases are the customer's responsibility.

* When connected as pressurised, safety valve is mandatory.

Accessories

PAW-VP-RTC5B-VRF	Tank Controller for ECOi system
PAW-VP-VALV-160	Expansion valve kit 16 kW
PAW-VP-VALV-280	Expansion valve kit 28 kW

Technical focus

- Water volume 750 L and 1000 L
- Maximum hot water production 65 °C without boosters
- Heating coil 52 m (750 L) and 63 m (1000 L)
- Tank material 3 mm
- ABS external case



Fan coils highlighted features

Available in a wide range of designs, the fan coils are perfectly adapted to fit within almost any location.



MORE FAN COIL OPTIONS
IN CHILLERS SECTION



1 Innovation for optimum comfort

Range of fan coil for heating and cooling with capacities from 0,2 to 9,6 kW in cooling and from 0,2 to 13,6 kW in heating. Bring full year comfort with water based systems.

2 Energy efficient and low noise fan

Dynamically balanced and specially designed fans, reinforced acoustic insulation and optimised fan speed staging for lower noise levels. Improved efficiency with optional EC fan motor.

3 Quality and efficient coil

Constructed from staggered copper tubes, mechanically expanded into aluminium fins, providing maximum heat transfer efficiency, durability and hygiene.

4 Flexible installation

Various types of unit to fit your needs with flexible installation options. A choice of service side for hydraulic connections, piping configuration and horizontal or vertical installation for ducted units.

Offering a great range of capacities and performance, available in a wide range of designs, the fan coils are perfectly adapted to fit within almost any location. Whether the requirements are for cooling only, or for both heating and cooling, there is a fan coil to suit. With a variety of piping and fan configuration, the range is capable of meeting the most stringent of requirements. Line up available in AC and EC fans, it is possible to achieve both powerful performance, but with sustainability in mind.

Controllers with sophisticated designs, provide a user friendly interface while enabling an easy and low cost integration to building management systems.



PAW-FC-RC1

Optional wired remote controller for AC fan, 2-pipe and 4-pipe application.



PAW-FC-TC903

Optional wired remote controller for AC fan 2-pipe application.



PAW-FC-907TC

Optional wired remote controller for EC fan, 2-pipe and 4-pipe application.



Smart fan coils

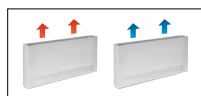

Built-in advanced thermostat.

		PAW-AAIR-200-2	PAW-AAIR-700-2	PAW-AAIR-900-2	
Total cooling capacity	Lo/Med/Hi	kW	0,2/0,3/0,6	0,8/1,0/1,2	1,2/1,5/1,7
Sensible cooling capacity	Lo/Med/Hi	kW	0,2/0,3/0,5	0,6/0,9/1,1	1,1/1,4/1,6
Water flow	Lo/Med/Hi	kg/h	40,0/59,0/95,0	129,0/178,0/207,0	198,0/261,0/300,0
Water pressure drop	Lo/Med/Hi	kPa	0,4/2,0/2,9	1,0/2,0/2,0	6,0/9,0/12,0
Inlet water temperature		°C	10	10	10
Outlet water temperature		°C	15	15	15
Inlet air temperature		°C	27,0	27,0	27,0
Outlet air temperature	Lo/Med/Hi	°C	15,0/17,0/18,0	14,0/16,0/17,0	16,0/17,0/18,0
Relative humidity of inlet air		%	47	47	47
Total heating capacity	Lo/Med/Hi	kW	0,2/0,5/0,6	0,7/1,0/1,2	0,9/1,4/1,7
Water flow	Lo/Med/Hi	kg/h	37,3/80,8/98,0	121,8/177,5/204,3	152,4/244,2/292,9
Water pressure drop	Lo/Med/Hi	kPa	0,4/2,0/2,9	0,3/0,8/1,0	0,5/1,6/2,2
Inlet water temperature		°C	35	35	35
Outlet water temperature		°C	30	30	30
Inlet air temperature		°C	19,0	19,0	19,0
Outlet air temperature	Lo/Med/Hi	°C	38,9/32,0/30,0	33,3/31,8/30,6	30,2/31,1/30,6
Air flow	Lo/Med/Hi	m ³ /min	0,9/1,9/2,7	2,6/4,2/5,3	4,1/6,1/7,7
Maximum input power	Lo/Med/Hi	W	7,0/9,0/13,0	14,0/18,0/22,0	16,0/20,0/24,0
Sound pressure	Lo/Med/Hi	dB(A)	23/33/40	24/36/42	25/36/44
Dimension (HxWxD)		mm	735x579x129	935x579x129	1135x579x129
Net weight		kg	17	20	23
3 Ways valve included			Yes	Yes	Yes
Touch screen thermostat			Yes	Yes	Yes

* Smart fan coils is produced by Innova.

Accessories

PAW-AAIR-LEGS-1 Kits of 2 legs to protect the water pipings

Accessories

PAW-AAIR-RHCABLE Motor connection cable for units with hydraulic connections on the right

Stylish floor-standing fan coils with advanced controller

The slimline of Smart fan coils delivers high efficiency climate control.

With a depth of just under 130 mm they are at the cutting edge of the market. Blending easily into the home, Smart fan coil's elegant design and product refinements are clear to see in every detail.

Exceptional ventilation efficiency means the motor uses considerably less energy (low wattage). The fan speed is continuously modulated by the temperature controller with proportional integral logic, with undoubted advantages for regulating the temperature and humidity in summer mode.

Technical focus

- 4 operation modes (auto, silent, night-time and maximum ventilation speed)
- Exclusive design
- Extremely compact (only 129 mm deep)
- Cooling and dehumidification functions possible (drain is needed)
- 3-way valve included (no overflow valve needed on the installation if more than 3 units installed)
- Touch screen thermostat

With standard cast radiators.

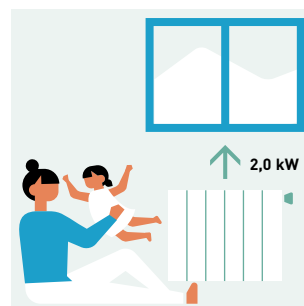

Water at 65 °C needed.

With Smart fan coil.

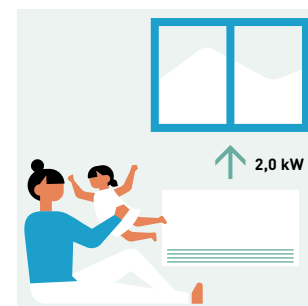

Water at 35 °C needed.

All temperature curves and capacity are available on www.panasonicproclub.com

PRO Club



Fan coils - ducted (AC)



Optional controller.
Wired remote controller.
PAW-FC-903TC



Optional controller.
Advanced wired remote controller.
PAW-FC-RC1

	Left connection (PAW-)	FC2A-D010L	FC2A-D020L	FC2A-D030L	FC2A-D040L	FC2A-D050L	FC2A-D060L	FC2A-D070L	FC2A-D080L	
	Right connection (PAW-)	FC2A-D010R	FC2A-D020R	FC2A-D030R	FC2A-D040R	FC2A-D050R	FC2A-D060R	FC2A-D070R	FC2A-D080R	
Total cooling capacity ¹⁾	Lo/Med/Hi	kW	0,7/1,0/1,5	0,7/1,2/1,7	1,0/2,0/2,5	1,2/2,4/3,2	1,7/3,2/4,6	2,7/4,6/5,8	3,4/6,1/7,3	4,6/6,1/8,1
Sensible cooling capacity ¹⁾	Lo/Med/Hi	kW	0,5/0,8/1,1	0,6/0,9/1,3	0,8/1,5/1,9	0,9/1,8/2,3	1,2/2,2/3,3	1,9/3,3/4,5	2,4/4,3/5,1	3,4/4,6/6,3
Water flow	Lo/Med/Hi	l/h	124/172/250	127/213/289	172/341/430	206/413/547	296/544/798	466/784/1003	587/1058/1252	798/1048/1400
Water pressure drop	Lo/Med/Hi	kPa	10,7/19,5/39,2	1,9/3,9/6,3	6,3/19,3/28,8	5,4/17,1/28,0	7,5/22,8/46,9	13,9/37,4/60,2	4,8/15,4/21,5	11,9/19,3/32,5
Heating capacity ²⁾	Lo/Med/Hi	kW	0,9/1,4/2,0	0,9/1,5/2,2	1,3/2,4/3,1	1,4/2,9/4,0	2,1/4,1/5,7	3,1/5,3/7,1	4,3/7,9/9,3	5,9/8,1/11,6
Sound levels										
Global sound power	Lo/Med/Hi	dB(A)	33/40/49	31/43/50	30/45/52	30/44/51	34/46/56	38/51/58	43/56/61	50/55/64
Global sound pressure ³⁾	Lo/Med/Hi	dB(A)	24/31/40	22/34/41	21/36/43	21/35/42	25/37/47	29/42/49	34/47/52	41/46/55
Fan										
Number			1	1	1	2	2	2	2	3
Air flow	Lo/Med/Hi	m ³ /h	111/190/283	105/179/265	138/274/390	173/357/499	253/486/716	350/640/933	480/893/1064	660/936/1397
Maximum external pressure		Pa	55	55	65	85	85	115	125	70
Filter			G2	G2	G2	G2	G2	G2	G2	G2
Electrical data										
Power supply	Voltage	V	230	230	230	230	230	230	230	230
	Phase		Single phase	Single phase	Single phase	Single phase	Single phase	Single phase	Single phase	Single phase
	Frequency	Hz	50/60	50/60	50/60	50/60	50/60	50/60	50/60	50/60
Power consumption	Lo/Med/Hi	W	13/24/36	10/18/29	16/37/45	15/37/56	28/55/72	37/75/105	53/100/147	90/112/188
Water connections										
Type			Female gas threaded	Female gas threaded	Female gas threaded	Female gas threaded	Female gas threaded	Female gas threaded	Female gas threaded	Female gas threaded
Water connections		Inch	1/2	1/2	1/2	1/2	1/2	1/2	3/4	3/4
Dimension and weight										
Dimension	H x W x D	mm	220 x 570 x 430	220 x 570 x 430	220 x 730 x 430	220 x 938 x 430	220 x 1122 x 430	220 x 1307 x 430	220 x 1121 x 530	220 x 1316 x 530
Weight		kg	13	13	15	20	22	26	27	38

1) According to Eurovent standard. Air: 27 °C DB / 19 °C WB. Water in/ out: 7 °C / 12 °C. 2) Air: 20 °C. Water in / out: 50 °C / 45 °C. 3) The sound pressure levels are based on (NR) characteristics of a room having volume of 100 m³ with reverberation of 0,5 seconds.

Values indicated are for 0 Pa external static pressure, for additional pressure characteristics, please refer the selection software.

Accessories	
PAW-FC-RC1	Advanced wired remote controller for fan coil
PAW-FC-903TC	Wired remote controller for fan coil
PAW-FC-2WY-11/55-1	2 way valve + drain pan for models 010-060

Accessories	
PAW-FC-2WY-65/90-1	2 way valve + drain pan for models 070-080
PAW-FC-3WY-11/55-1	3 way valve + drain pan for models 010-060
PAW-FC-3WY-65/90-1	3 way valve + drain pan for models 070-080

Technical focus

- Cooling capacity from 0,7 to 8,1 kW
- Heating capacity from 0,7 to 10,3 kW
- 5-speed AC fan motor(s)

Main features and accessories

- 2 and 4-pipe configurations
- Left or right hand arrangements
- Ease of installation
- Very low acoustic levels
- 2 way or 3 way ON / OFF valves
- Auxiliary drain pan
- Air intake with removable grid
- G2 filter

Operating limits	
Entering water temperature	From 5 to 90 °C
Indoor air temperature	From 5 to 32 °C





Fan coils - wall-mounted (AC)



Optional controller.
Wired remote
controller.
PAW-FC-903TC



Optional controller.
Advanced wired
remote controller.
PAW-FC-RC1



Infrared remote
supplied with IR
versions.
IR Controller

2-pipe			PAW-FC2A-K007	PAW-FC2A-K009	PAW-FC2A-K018	PAW-FC2A-K022
			PAW-FC2A-K007IR	PAW-FC2A-K009IR	PAW-FC2A-K018IR	PAW-FC2A-K022IR
Total cooling capacity ¹⁾	Lo/Med/Hi	kW	1,0/1,3/1,7	1,6/1,7/2,4	2,8/3,0/3,5	2,9/3,1/3,9
Sensible cooling capacity ¹⁾	Lo/Med/Hi	kW	0,7/1,0/1,2	1,2/1,3/1,9	2,1/2,3/2,7	2,3/2,5/3,1
Water flow	Lo/Med/Hi	l/h	172/231/287	270/291/418	483/508/609	502/535/669
Water pressure drop	Lo/Med/Hi	kPa	18,6/24,9/30,9	18,5/27,0/40,0	34,6/41,3/55,6	37,2/33,7/45,2
Heating capacity ²⁾	Lo/Med/Hi	kW	1,4/1,7/2,0	1,7/2,0/2,7	2,9/3,2/4,0	3,1/3,7/4,4
Sound levels						
Sound power	Lo/Med/Hi	dB(A)	45/49/51	47/52/57	49/53/56	53/57/63
Sound pressure ³⁾	Lo/Med/Hi	dB(A)	30/33/35	32/36/40	39/41/43	39/43/48
Fan						
Number			1	1	1	1
Air flow	Lo/Med/Hi	m ³ /h	282/321/360	367/413/551	532/592/680	617/709/850
Filter			G1	G1	G1	G1
Electrical data						
Power supply	Voltage	V	230	230	230	230
	Phase		Single phase	Single phase	Single phase	Single phase
	Frequency	Hz	50	50	50	50
Fuse rating		A	3	3	3	3
Power consumption	Lo/Med/Hi	W	39/42/62	30/47/59	44/50/55	50/55/70
Water connections						
Type			Female gas threaded	Female gas threaded	Female gas threaded	Female gas threaded
Water connections		Inch	1/2	1/2	1/2	1/2
Dimension and weight						
Dimension	HxWxD	mm	275 x 180 x 845	275 x 180 x 845	298 x 200 x 940	298 x 200 x 940
Weight		kg	11	11	13	13

1) According to Eurovent standard. Air: 27 °C DB / 19 °C WB. Water in / out: 7 °C / 12 °C. 2) According to Eurovent standard. Air: 20 °C. Water in / out: 45 °C / 40 °C. 3) Sound pressure considering a local of 100 m³ a reverberation time of 0,5 seconds and a distance of 1 m.

Accessories

PAW-FC-RC1	Advanced wired remote controller for fan coil
PAW-FC-903TC	Wired remote controller for fan coil

Accessories

PAW-FC2-2WY-K007	2 way valve
PAW-FC2-3WY-K007	3 way valve

Technical focus

- 4 sizes
- Cooling capacity from 1,0 to 3,9 kW
- Heating capacity from 1,4 to 4,1 kW
- Version: 2-pipes, AC fan

Main features and accessories

- 2 way or 3 way valve ON / OFF
- 3-speed AC fan motor
- Silent unit for optimum customer comfort
- Aesthetic design suitable for residential and hotel applications
- Compatible with IR controller (supplied with IR versions)
- Coil with hydrophilic fins to improve the condensate flow

Operating limits

Entering water temperature	From 5 to 60 °C
Indoor air temperature	From 6 to 40 °C





Accessories and control

Distribution joint kits



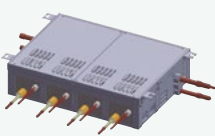
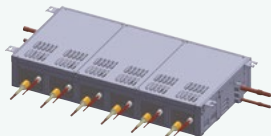
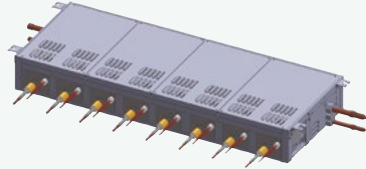

2-Pipe ME2 for outdoor units (up to 68,0 kW). ----- CZ-P680PH2BM	2-Pipe ME2 for outdoor units (from 68,0 kW to 168,0 kW). ----- CZ-P1350PH2BM	2-Pipe ME2 and Mini ECOi for indoor units (up to 22,4 kW*). ----- CZ-P224BK2BM
2-Pipe ME2 for indoor units (from 22,4 kW to 68,0 kW*). ----- CZ-P680BK2BM	2-Pipe ME2 for indoor units (from 68,0 kW to 168,0 kW*). ----- CZ-P1350BK2BM	3-Pipe MF3 for outdoor units (up to 68,0 kW). ----- CZ-P680PJ2BM
3-Pipe MF3 for outdoor units (from 68,0 kW to 135,0 kW). ----- CZ-P1350PJ2BM	3-Pipe MF3 for indoor units (up to 22,4 kW). ----- CZ-P224BH2BM	3-Pipe MF3 for indoor units (from 22,4 kW to 68,0 kW). ----- CZ-P680BH2BM
3-Pipe MF3 for indoor units (up to 68,0 kW). ----- CZ-P1350BH2BM	2-Pipe ME2 header pipe. ----- CZ-P4HP4C2BM	3-Pipe MF3 header pipe. ----- CZ-P4HP3C2BM

* In case the total capacity of indoor units connected after distribution exceeds the total capacity of the outdoor units, select the distribution piping size for the total capacity of the outdoor units.

Heat recovery box

3-Pipe control Solenoid valve kit (up to 5,6 kW). CZ-P56HR3 + CZ-CAPE2. ----- KIT-P56HR3	 Solenoid valve kit (up to 5,6 kW). ----- CZ-P56HR3	 3-Pipe control PCB. ----- CZ-CAPE2
3-Pipe control Solenoid valve kit (from 5,6 to 16,0 kW). CZ-P160HR3 + CZ-CAPE2. ----- KIT-P160HR3	Solenoid valve kit (from 5,6 kW to 16,0 kW). ----- CZ-P160HR3	3-Pipe control PCB for wall-mounted. ----- CZ-CAPEK2
 4 ports 3 pipe box (up to 5,6 kW per port). ----- CZ-P456HR3	 6 ports 3 pipe box (up to 5,6 kW per port). ----- CZ-P656HR3	 8 ports 3 pipe box (up to 5,6 kW per port). ----- CZ-P856HR3
4 ports 3 pipe box (up to 16,0 kW per port). ----- CZ-P4160HR3		

Panels

 Standard panel for 4 way 90x90 cassette. ----- CZ-KPU3W	 Econavi panel for 4 way 90x90 cassette. ----- CZ-KPU3AW	 Panel for 60x60 cassette - PY2 size 700 x 700 mm. ----- CZ-KPY3AW	 Panel for 60x60 cassette - PY2 size 625 x 625 mm. ----- CZ-KPY3BW
---	---	--	--



Panel for 4 way 60x60 cassette - PY3.

CZ-KPY4



Panel for 2 way cassette (for S-22 to S-56 models).

CZ-02KPL2



Panel for 2 way cassette (for S-73 model).

CZ-03KPL2



Panel for 1 way cassette.

CZ-KPD2

Sensors



Panasonic R32 refrigerant leak detector for MU2, MY2, MK2, MF3 and MM1 models.

CZ-CGLSC1



Econavi energy savings sensor.

CZ-CENSC1



Remote temperature sensor.

CZ-CSRC3

Plenums

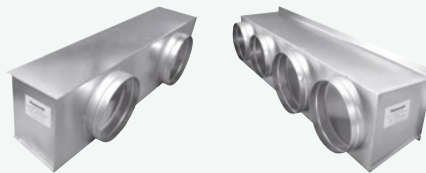

Air inlet plenum for S . .MF3E5B, S . .MF3E5A and S . .MF2E5A 15, 22, 28, 36, 45 and 56.

CZ-DUMPA56MF2

Air inlet plenum for S . .MF3E5B, S . .MF3E5A and S . .MF2E5A 60, 73 and 90.

CZ-DUMPA90MF2

Air inlet plenum for S . .MF3E5B, S . .MF3E5A and S . .MF2E5A 106, 140 and 160.

CZ-DUMPA160MF2

Air inlet plenum for S . .MM1E5B 22, 28, 36, 45 and 56.

CZ-DUMPA22MMR2

Air outlet plenum for S . .MM1E5B 22, 28 and 36.

CZ-DUMPA22MMS2

Air outlet plenum for S . .MM1E5B 45 and 56.

CZ-DUMPA45MMS3

Air outlet plenum for S-224ME1E5A / S-280ME1E5.

CZ-TREMIESPW706

* Plenums installed with an R32 Mini ECOi system may only be used when no Panasonic R32 refrigerant leak detector is required. Please refer to technical data manual for refrigerant installation requirements.

Valves



E2 Type high static pressure hide-away rap valve kit for 100 % Fresh air function.

CZ-P160RVK2

Wall-mounted external valve for model sizes 15 to 56.

CZ-P56SVK2



Wall-mounted external valve for model sizes 73 to 106.

CZ-P160SVK2

Accessories and control

VRF Smart Connectivity+



Remote controller Panasonic Net Con, RH, No PIR, R1/R2.

SER8150R0B1194

Remote controller Panasonic Net Con, RH, PIR, R1/R2.

SER8150R5B1194



Wireless ZigBee® Pro module / Green Com card.

VCM8000V5094P



Hotel Room Expansion Module 14 indoor units.

HRCEP14R

Hotel Room Controller w/ Display 42 indoor units.

HRCPDG42R



Door / window wireless sensor.

SED-WDC-G-5045



Wall / ceiling (motion) wireless sensor.

SED-MTH-G-5045

Hotel Room Controller 28 indoor units.

HRCPBG28R



CO₂ sensor.

SED-CO2-G-5045



Sensor with room temperature and humidity.

SED-TRH-G-5045



Water leakage sensor.

SED-WLS-G-5045



Cover frame. Silver.

FAS-00

Cover frame. Glossy translucent white.

FAS-03

Cover frame. Dark brown wood.

FAS-06

Cover frame. Brushed steel finish.

FAS-10

Cover frame. White.

FAS-01

Cover frame. Light tan wood.

FAS-05

Cover frame. Dark black wood.

FAS-07



Controller and touch controllers for hotels with dry contacts

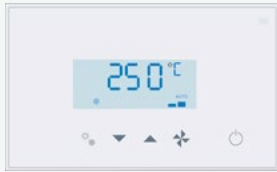

Modbus RS-485 touch room controller with I/O, white.

PAW-RE2C4-MOD-WH

Touch display control with 2 digital inputs, white.

PAW-RE2D4-WH



Modbus RS-485 touch room controller with I/O, black.

PAW-RE2C4-MOD-BK

Touch display control with 2 digital inputs, black.

PAW-RE2D4-BK

Hotel sensors for dry contacts



Wall motion sensor 24 V.

PAW-WMS-DC

Wall motion sensor 240 V AC.

PAW-WMS-AC



Ceiling motion sensor 24 V.

PAW-CMS-DC

Ceiling motion sensor 240 V AC.

PAW-CMS-AC



Power supply 24 V.

PAW-24DC



Door or window contact.

PAW-DWC

Centralised controls



System controller for 64 indoor units with weekly timer.

CZ-64ESMC3

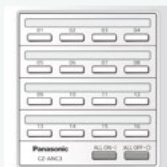

Central ON / OFF controller, up to 16 groups, 64 indoor units.

CZ-ANC3

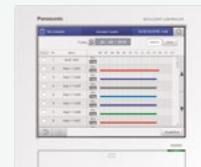

Intelligent controller (touch screen/web server) to control up to 256 indoors with included load distribution ratio (LDR).

CZ-256ESMC3

Centralised controls. BMS system. PC base



P-AIMS core software: Centralised software to control up to 1024 indoor units.

CZ-CSWKC2

P-AIMS communication adaptor.

CZ-CFUNC2

P-AIMS consumption calculation extension.

CZ-CSWAC2

P-AIMS layout display extension.

CZ-CSWGC2

P-AIMS BACnet extension.

CZ-CSWBC2

P-AIMS web application extension.

CZ-CSWWC2

Accessories and control

Panasonic AC Smart Cloud



Panasonic AC Smart Cloud. Cloud internet control. Up to 128 groups. Controls 128 units.

CZ-CFUSCC1

Accessories interfaces



Modbus RTU and TCP interface for 16 indoor units.

PAW-AC2-MBS-16P

Modbus RTU and TCP interface for 64 indoor units.

PAW-AC2-MBS-64P

Modbus RTU and TCP interface for 128 indoor units.

PAW-AC2-MBS-128P



KNX interface for 16 indoor units.

PAW-AC2-KNX-16P

KNX interface for 64 indoor units.

PAW-AC2-KNX-64P



BACnet IP and MSTP interface for 16 indoor units.

PAW-AC2-BAC-16P

BACnet IP and MSTP interface for 64 indoor units.

PAW-AC2-BAC-64P

BACnet IP and MSTP interface for 128 indoor units.

PAW-AC2-BAC-128P



Commercial Wi-Fi Adaptor.

CZ-CAPWFC1



KNX interface.

PAW-RC2-KNX-1i



Modbus RTU interface.

PAW-RC2-MBS-1



Modbus RTU interface to control 4 indoor/groups.

PAW-RC2-MBS-4



BACnet IP and MSTP.

PAW-RC2-BAC-1



RAC interface adapter for integration into P-Link, plus external input and alarm/status output.

CZ-CAPRA1



LonWorks® Interface controls up to 16 groups and 64 indoor units.

CZ-CLNC2



Centralised controls. Connection with general equipment



Adaptor for ON / OFF control of external devices.

CZ-CAPC3



Mini series parallel device controlling indoor units, maximum 1 group and 8 indoor unit.

CZ-CAPBC2



Communication Adaptor. Up to 128 groups. Controls 128 units.

CZ-CFUNC2

Individual controls



CONEX wired remote controller (non-wireless).

CZ-RTC6



CONEX wired remote controller with Bluetooth®.

CZ-RTC6BL



Design wired remote controller with Econavi function.

CZ-RTC5B



Infrared remote controller and receiver for 4 way 90x90 cassette.

CZ-RWS3 + CZ-RWRU3W



Infrared remote controller for wall-mounted, 4 way 60x60 with panel and floor console.

CZ-RWS3



Infrared remote controller and receiver for 4 way 60x60 cassette PY3 with panel.

CZ-RWS3 + CZ-RWRV3



Infrared remote controller and receiver for 2 way cassette.

CZ-RWS3 + CZ-RWRL3



Infrared remote controller and receiver for 1 way cassette.

CZ-RWS3 + CZ-RWRD3



Infrared remote controller and receiver for ceiling.

CZ-RWS3 + CZ-RWRT3



Infrared remote controller and receiver for all indoor units.

CZ-RWS3 + CZ-RWRC3

Accessories and control

Accessories PCB



T10 interface PCB with digital and relay connections.

PAW-T10

PCB for fan speed control of external EC Fan.

PAW-ECF

R-22 Replacement Kit

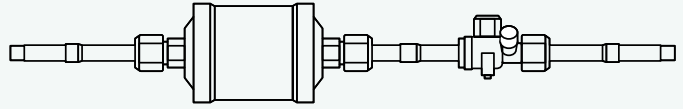

Replacement kit for R-22.

CZ-SLK2

Accessories cables



Cable for all the T10 functions.

CZ-T10



Cable to operate external EC fan.

PAW-FDC



Cable for all option monitoring signals.

PAW-OCT

Cable with force thermo OFF/leakage detection.

PAW-EXCT

Water heat exchanger accessories

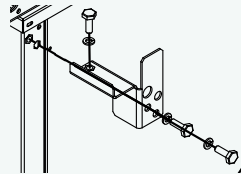

Stacking kit for vertically stacking up to 3 WHE (4 pieces per Kit).

PAW-3WSK

PRO-HT Tank accessories

Tank Controller for ECOi system.

PAW-VP-RTC5B-VRF

Expansion valve kit 16 kW.

PAW-VP-VALV-160

Expansion valve kit 28 kW.

PAW-VP-VALV-280



Smart fan coil accessories

Kits of 2 legs to protect the water pipings.

PAW-AAIR-LEGS-1

Motor connection cable for units with hydraulic connections on the right.

PAW-AAIR-RHCABLE

Fan coil accessories



Wired remote controller for fan coil.

PAW-FC-903TC



Advanced wired remote controller for fan coil.

PAW-FC-RC1



Infrared remote supplied with IR versions.

IR Controller

2 way valve + drain pan for ducted models 010-060.

PAW-FC-2WY-11/55-1

2 way valve + drain pan for ducted models 070-080.

PAW-FC-2WY-65/90-1

2 way valve for wall-mounted.

PAW-FC2-2WY-K007

3 way valve + drain pan for ducted models 010-060.

PAW-FC-3WY-11/55-1

3 way valve + drain pan for ducted models 070-080.

PAW-FC-3WY-65/90-1

3 way valve for wall-mounted.

PAW-FC2-3WY-K007

Dimensions and tube sizes of branches and headers for 2-Pipe ECOi EX and Mini ECOi Series

Optional distribution joint kits

See the installation instructions packaged with the distribution joint kit for the installation procedure.

* In case the total capacity of indoor units connected after distribution exceeds the total capacity of the outdoor units, select the distribution piping size for the total capacity of the outdoor units.

Model name	Cooling capacity after distribution	Remarks
1. CZ-P680PH2BM	Up to 68,0 kW	For outdoor unit
2. CZ-P1350PH2BM	From 68,0 kW to 168,0 kW	For outdoor unit
3. CZ-P224BK2BM*	Up to 22,4 kW	For indoor unit
4. CZ-P680BK2BM*	From 22,4 kW to 68,0 kW	For indoor unit
5. CZ-P1350BK2BM*	From 68,0 kW to 168,0 kW	For indoor unit

Tube size (with thermal insulation)

1. CZ-P680PH2BM: For outdoor unit side (capacity after distribution joint up to 68,0 kW).

Gas piping

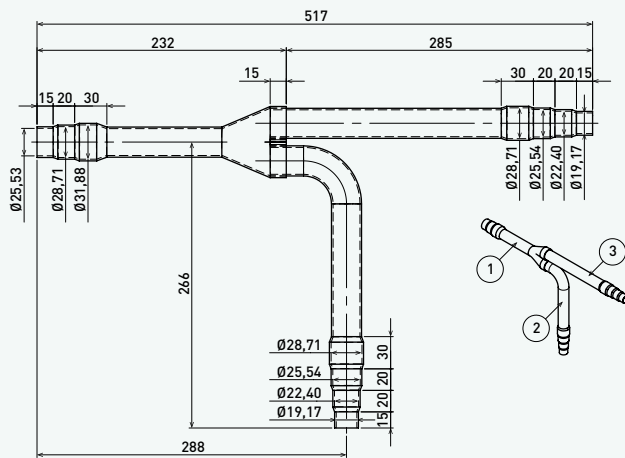

Liquid piping

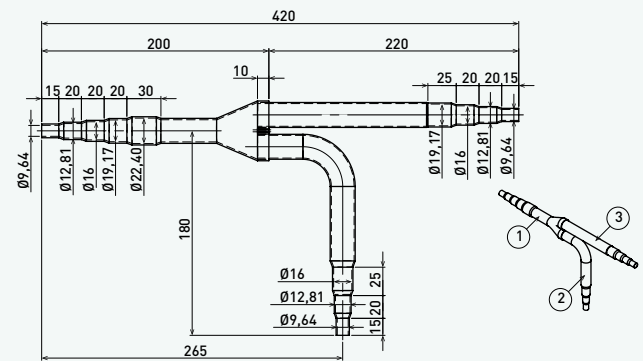

Unit: mm

2. CZ-P1350PH2BM: For outdoor unit side (capacity after distribution joint is from 68,0 kW to 168,0 kW).

Gas piping

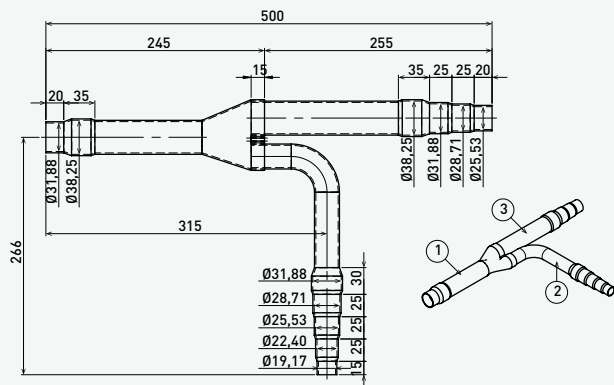

Liquid piping

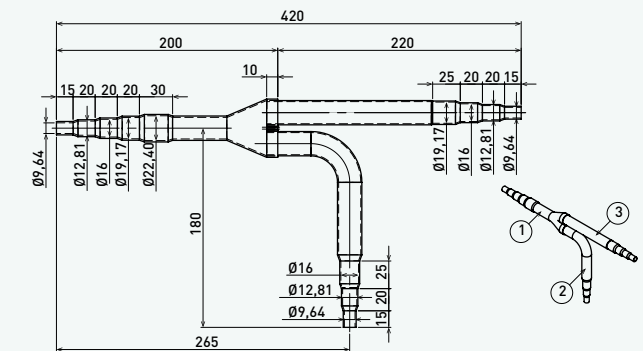

Unit: mm

3. CZ-P224BK2BM: For indoor unit side (capacity after distribution joint up to 22,4 kW).

Gas piping

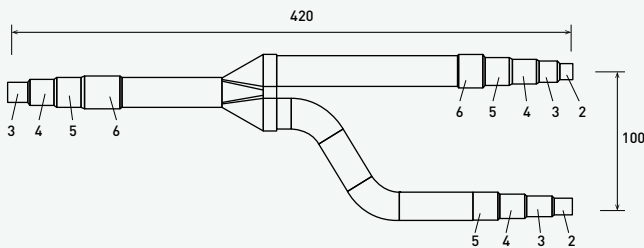

Liquid piping

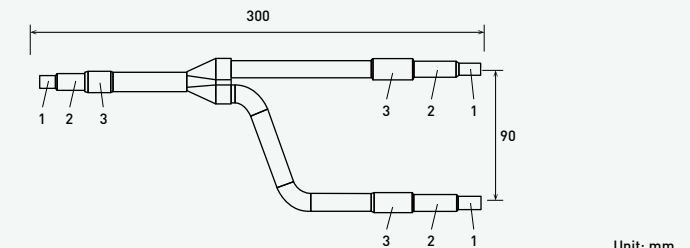

Unit: mm

4. CZ-P680BK2BM: For indoor unit side (capacity after distribution joint is from 22,4 kW to 68,0 kW).

Gas piping

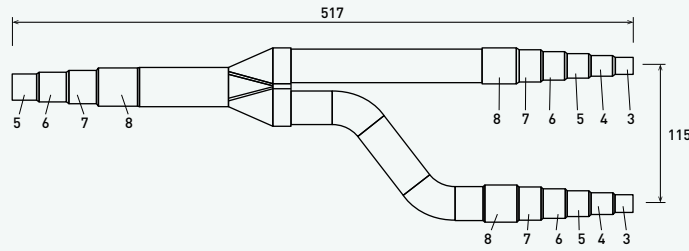

Liquid piping

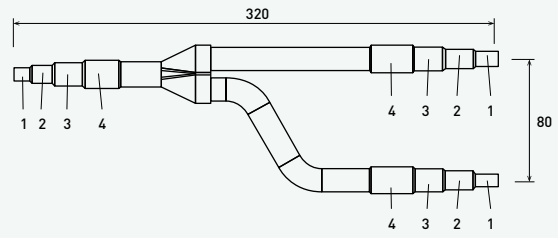

Unit: mm

5. CZ-P1350BK2BM: For indoor unit side (capacity after distribution joint is from 68,0 kW to 168,0 kW).

Gas piping

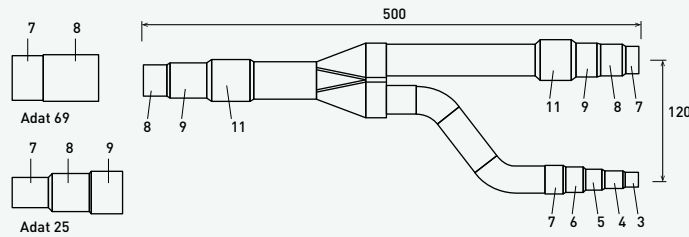

Liquid piping

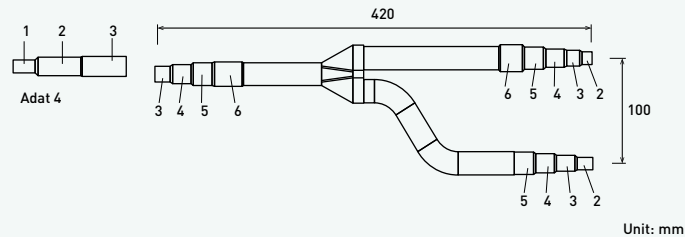

Unit: mm

Size of connection point on each part (shown are inside diameters of piping)

Diameters		1	2	3	4	5	6	7	8	9	10	11	12	13	14
Dimension	Inch	1/4	3/8	1/2	5/8	3/4	7/8	1	1 1/8	1 1/4	1 3/8	1 1/2	1 5/8	1 3/4	2
	mm	6,35	9,52	12,70	15,88	19,05	22,40	25,40	28,57	31,75	34,92	38,10	41,28	44,45	50,80

Header pipe set

CZ-P4HP4C2BM

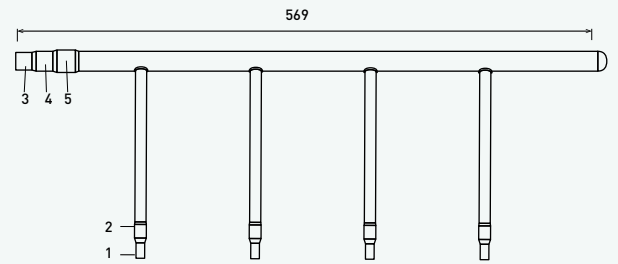
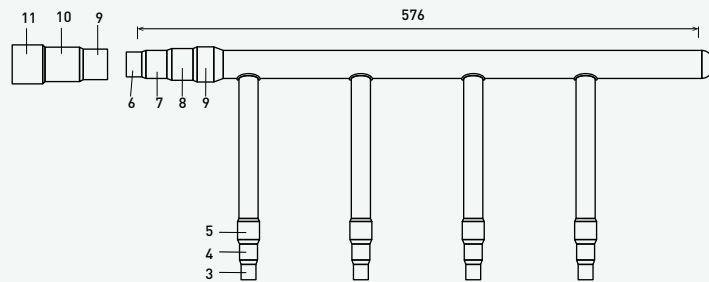

Size of connection point on each part (shown are inside diameters of piping)

Diameters		1	2	3	4	5	6	7	8	9	10	11
Dimension	Inch	1/4	3/8	1/2	5/8	3/4	7/8	1	1 1/8	1 1/4	1 3/8	1 1/2
	mm	6,35	9,52	12,70	15,88	19,05	22,40	25,40	28,57	31,75	34,92	38,10

Distribution joint Kits for Mini ECOi LE/LZ Series

CZ-P224BK2BM: For indoor unit side (capacity after distribution joint up to 22,4 kW).

Gas piping

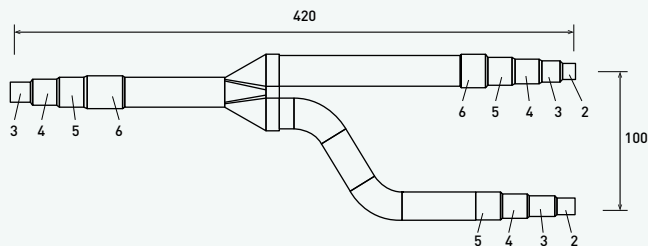

Liquid piping

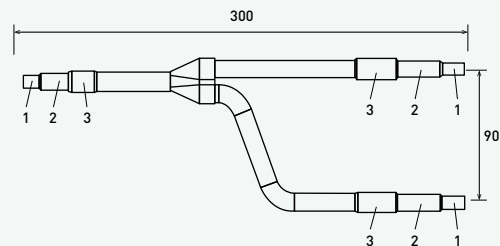

Unit: mm

Size of connection point on each part (shown are inside diameters of piping)

Diameters		1	2	3	4	5	6
Dimension	Inch	1/4	3/8	1/2	5/8	3/4	7/8
	mm	6,35	9,52	12,70	15,88	19,05	22,40

Dimensions and tube sizes of branches and headers for 3-Pipe ECOi EX MF3 Series

Optional distribution joint kits

See the installation instructions packaged with the distribution joint kit for the installation procedure.

Model name	Cooling capacity after distribution	Remarks
1. CZ-P680PJ2BM	Up to 68,0 kW	For outdoor unit
2. CZ-P1350PJ2BM	From 68,0 kW to 135,0 kW	For outdoor unit
3. CZ-P224BH2BM	Up to 22,4 kW	For indoor unit
4. CZ-P680BH2BM	From 22,4 kW to 68,0 kW	For indoor unit
5. CZ-P1350BH2BM	From 68,0 kW to 135,0 kW	For indoor unit

Piping size

1. CZ-P680PJ2BM: For outdoor unit side (capacity after distribution joint up to 68,0 kW).

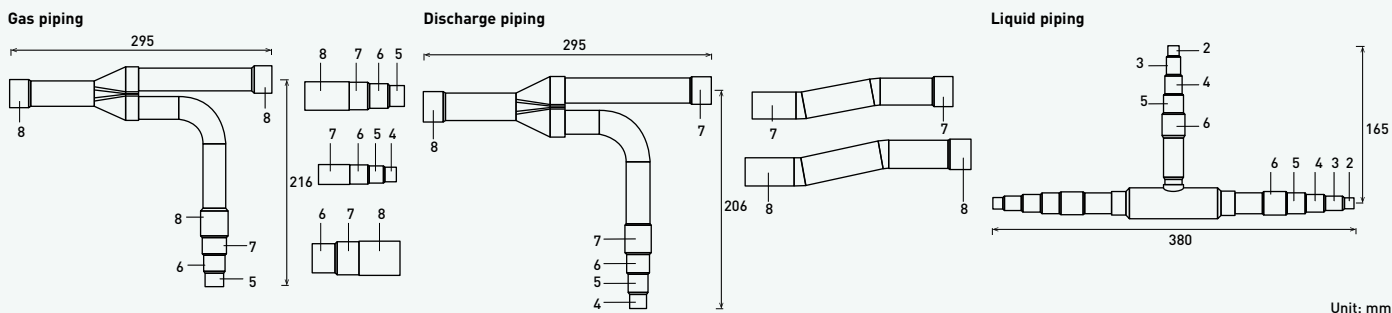

Unit: mm

2. CZ-P1350PJ2BM: For outdoor unit side (capacity after distribution joint is from 68,0 kW to 135,0 kW).

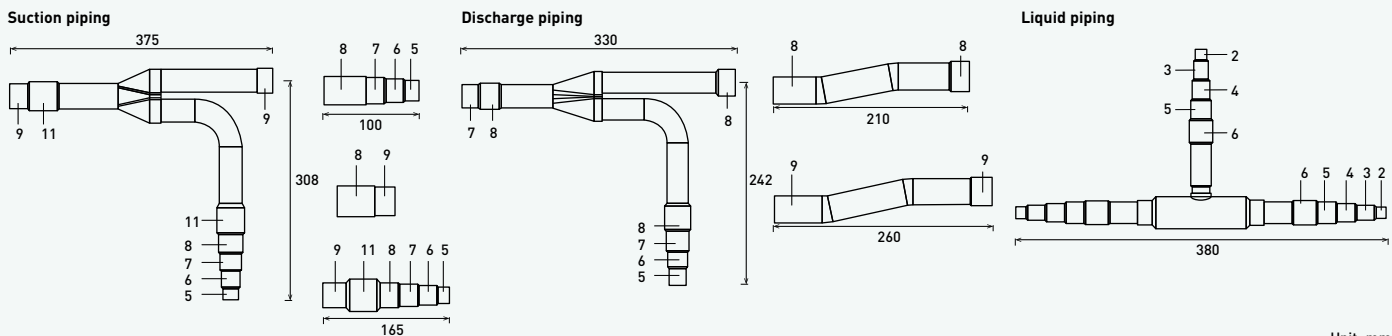

Unit: mm

3. CZ-P224BH2BM: For indoor unit side (capacity after distribution joint up to 22,4 kW).

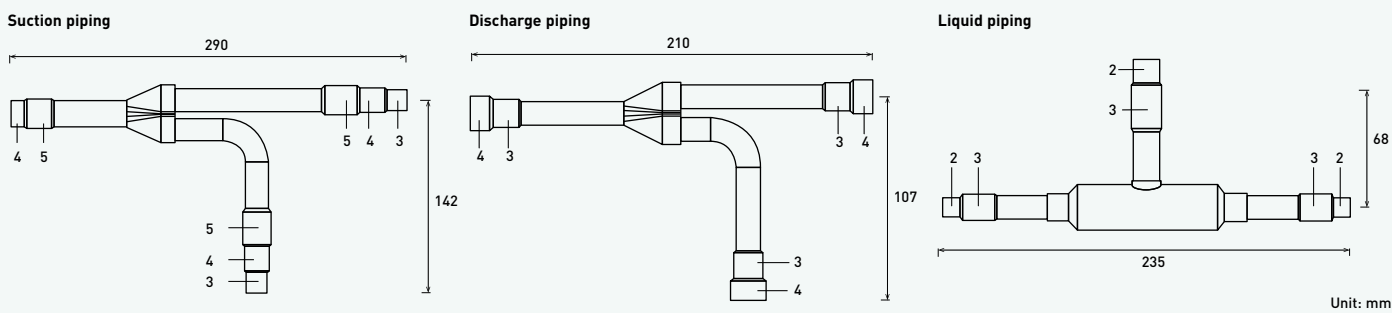

Unit: mm

4. CZ-P680BH2BM: For indoor unit side (capacity after distribution joint is from 22,4 kW to 68,0 kW).

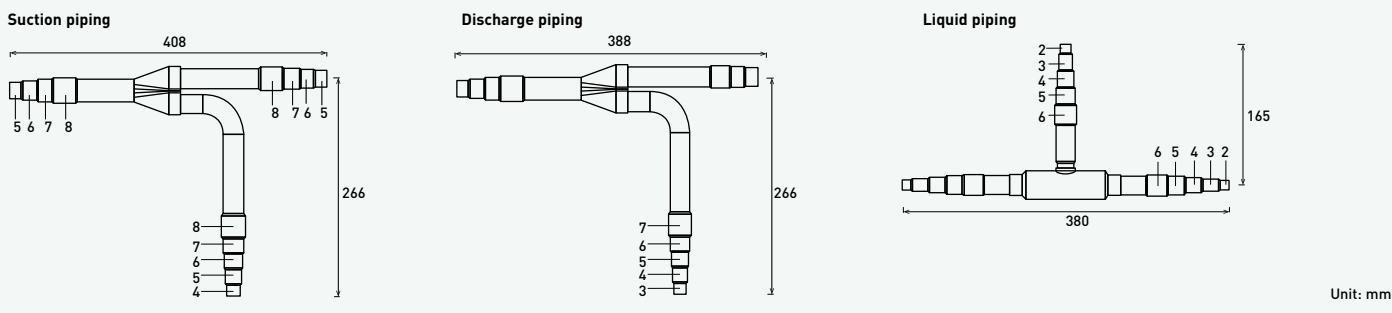

Unit: mm



5. CZ-P1350BH2BM: For indoor unit side (capacity after distribution joint is from 68,0 kW to 135,0 kW).

Suction piping

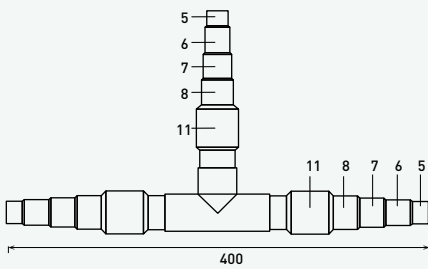

Discharge piping

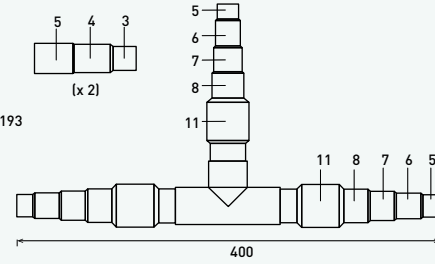

Liquid piping

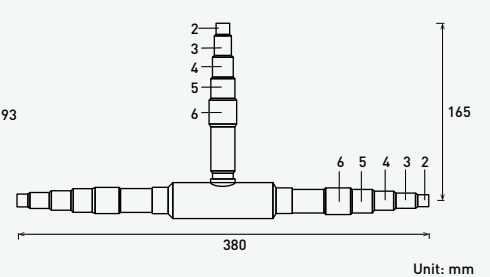

Unit: mm

Size of connection point on each part (shown are inside diameters of piping)

Diameters		1	2	3	4	5	6	7	8	9	10	11	12	13	14
Dimension	Inch	1/4	3/8	1/2	5/8	3/4	7/8	1	1 1/8	1 1/4	1 3/8	1 1/2	1 5/8	1 3/4	2
	mm	6,35	9,52	12,70	15,88	19,05	22,40	25,40	28,57	31,75	34,92	38,10	41,28	44,45	50,80

Header pipe set

CZ-P4HP3C2BM

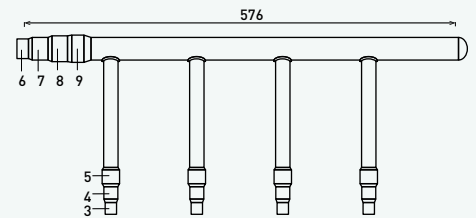
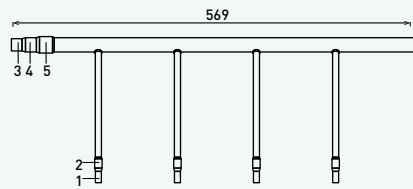
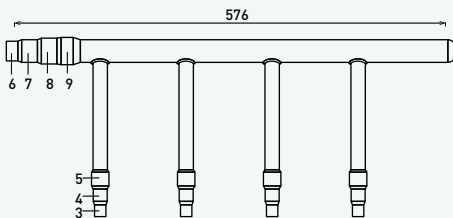

Size of connection point on each part (shown are inside diameters of piping)

Diameters		1	2	3	4	5	6	7	8	9	10	11
Dimension	Inch	1/4	3/8	1/2	5/8	3/4	7/8	1	1 1/8	1 1/4	1 3/8	1 1/2
	mm	6,35	9,52	12,70	15,88	19,05	22,40	25,40	28,57	31,75	34,92	38,10



Panasonic ventilation solutions

Panasonic ventilation solutions for maximum savings and easy integration.

Air handling unit kit	→ 352	Electric air curtains	→ 364
AHU connection kit 3,6 to 25,0 kW for PACi NX and PACi	→ 354	Air curtain with DX coil, connected to PACi systems	→ 366
AHU connection kit 16,0 to 56,0 kW for ECOi and ECO G	→ 356	Air curtain with DX coil, connected to VRF systems	→ 367
Energy recovery ventilation	→ 358	High pressure duct and 100 % fresh air duct function for all ECOi and ECO G systems	→ 368
Heat recovery with DX coil	→ 362		

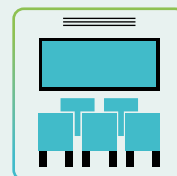
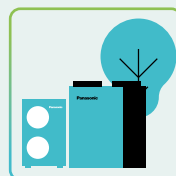
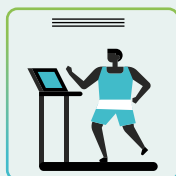
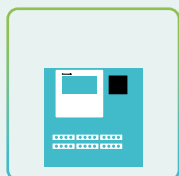

Air handling unit kit

AHU connection kits connect outdoor units to air handling systems. Combines air conditioning and fresh air in just one solution.

Application: Hotels, offices, server rooms or all large buildings where air quality control, such as humidity control and fresh air, is needed.





1 AHU connection kit 3,6 to 14,0 kW for PACi NX

CONEX Bluetooth® version (CZ-RTC6BL) is built-in. Easy connection and set-up is possible via Bluetooth®.

2 AHU connection kit 3,6 to 25,0 kW for PACi 1)

3 AHU connection kit 16, 28 and 56 kW for ECOi and ECO G

The Panasonic AHU connection kits offer a wealth of connectivity possibilities so can be easily integrated into many systems. Besides the advantages in terms of indoor air quality, air conditioning offers also an energy saving potential. For example, while uncontrolled ventilation through open windows leads to large amounts of heat being lost to the outside during the heating season or gained from the outside during the cooling season, air conditioning systems provide possibilities to utilize the extra "free" energy in heat recovery modules so that overall operating costs will be reduced. The larger area of the comfort range, the better the energy saving opportunities.

AHU connection kits connect ECOi systems to air handling unit systems, using the same refrigerant circuit as the VRF system. Large connectivity possibilities mean the Panasonic AHU connection kit can be easily integrated.

1) Compatible with R32 models. Special setting is required.

Panasonic AHU connection kit connected to outdoor unit

PACi: 3,6 to 25,0 kW.

The Air handling unit kit has been developed to better meet customer demand: IP 65 Box allows for external installation, 0-10 V demand control* and easy control by BMS.

* Only available with PACi Elite, from 3,6 to 25,0 kW.

ECOi and ECO G: 16, 28 and 56 kW.

PCB, transformer, solenoid control valve, 4 thermistors, terminal base and electrical component box.

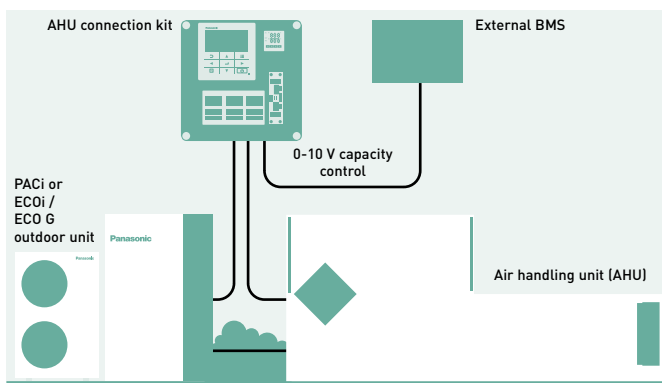

Demand control on the outdoor unit managed by external 0-10 V signal.

- AHU connection kit contains: IP65 box with PCBs and terminal connections mounted inside, expansion valve and sensors.
- Heat exchanger, fan and fan motor to be mounted in the AHU itself are field supplied.

Main components of mechanical ventilation systems

The main components of a mechanical ventilation system are the following: Air handling unit (AHU), air ducts and air distribution elements.

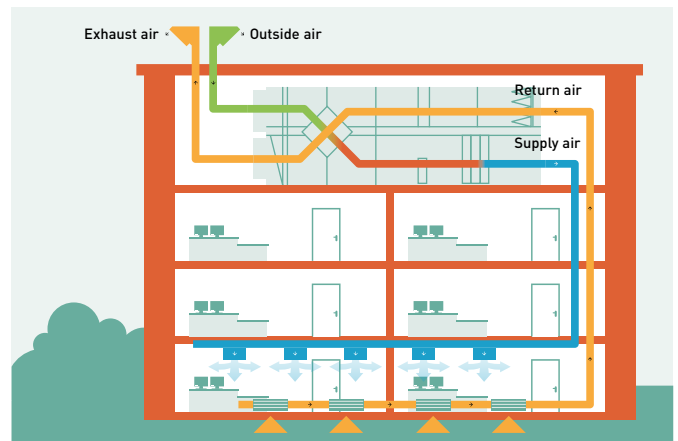

Optional parts: Following functions are available by using different control accessories:

Timer remote controller.
CZ-RTC5B.

DC 12 V outlet. Option terminal.
PAW-OCT.

Mini seri-para I/O unit.
CZ-CAPBC2
Advanced version only.

PCB to connect to T10 connector.
CZ-T10 terminal / PAW-T10 PCB

AHU connection kit 3,6 to 25,0 kW for PACi NX and PACi

Compatible with R32 or R410A outdoor units.



3 types of AHU connection kit: Advanced, Medium and Light

Reference	IP 65	0-10 V demand control*	Outdoor temperature shift compensation. Cold draft prevention
PAW-280PAH3M-1	Yes	Yes	No
PAW-280PAH2	Yes	Yes	Yes
PAW-280PAH2M	Yes	Yes	No
PAW-280PAH2L	Yes	No	No

* With CZ-CAPBC2.

Control options

Control option 1: Advanced, Medium and Light.

- The system's control is simple: control of actual suction temperature vs. set point
- Control works in the same way as that of any indoor unit
- Fan signal issued by the PCB (OFF while defrosting, for instance)

Control option 2: Advanced.

- System control by probe located at air intake. Sensor works as a 0-10 V control thermostat which manages the set point temperature. Additional probe on the air outlet helps to prevent cold drought
- All signals as standard

Control option 3: Advanced.

- System control by external environment probe. Sensor works as a 0-10 V control thermostat which manages the set point temperature. Enhances efficiency by adjusting capacity to the ambient temperature and enhances comfort as well
- All signals as standard

Control option 4: Advanced and Medium.

- System control by a 0-10 V control working from an external BMS that manages the set point for temperature or capacity. Enhances efficiency by adjusting capacity and enhances comfort as well
- All signals as standard

0-10 V control

With the 0-10 V demand control the capacity of the outdoor unit can be controlled by 20 steps.

Input voltage* [V]	0	1,0	1,5	2,0	2,5	3,0	3,5	4,0	4,5	5,0	5,5	6,0	6,5	7,0	7,5	8,0	8,5	9,0	9,5
Demand (% of nominal current)	No cut ¹⁾	40	45	50	55	60	65	70	75	80	85	90	95	100	105	110	115	120	No limit / Full capacity ²⁾
Indoor unit start / stop	Stop ¹⁾																		Start

¹⁾ No cut / stop: AHU system / indoor unit is completely switched OFF.

²⁾ No limit: No restrictions applied by BMS to AHU system / indoor unit performance (equivalent to "full-load operation" of AHU system / indoor unit).

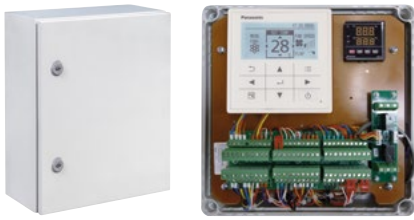

AHU connection kit 3,6 to 25,0 kW for PACi NX and PACi

Reference	PAW-	3,6 kW	5,0 kW	6,0 kW	7,5 kW	10,0 kW	12,5 kW	14,0 kW	20,0 kW	25,0 kW	
		280PAH3M-1	280PAH3M-1	280PAH3M-1	280PAH3M-1	280PAH3M-1	280PAH3M-1	280PAH3M-1	280PAH3M-1	280PAH3M-1	280PAH3M-1
Cooling capacity	kW	3,6	5,0	6,0	7,1	10,0	12,5	14,0	19,5	23,2	
Heating capacity	kW	4,0	5,6	7,0	8,0	11,2	14,0	16,0	22,4	28,0	
Air flow	Min / Max	m³/h	540/870	630/990	780/1320	780/1320	900/2160	1140/2280	1200/2400	2160/4320	2280/5040
Dimension	H x W x D	mm	500 x 400 x 150	500 x 400 x 150	500 x 400 x 150	500 x 400 x 150	500 x 400 x 150	500 x 400 x 150	500 x 400 x 150	278 x 278 x 180	278 x 278 x 180
Net weight	H3M / H2 & H2M / H2L	kg	11,5	11,5	11,5	11,5	11,5	11,5	11,5	11,50 / 4,25 / 3,98	11,50 / 4,25 / 3,98
Pipe length range	Standard	m	3/15	3/20	3/40	3/40	5/50	5/50	5/50	—	—
	Elite	m	3/40	3/40	3/40	5/50	5/85	5/85	5/85	5/90	5/60
Elevation difference (in / out)	Max	m	30	30	30	30	30	30	30	30	30
	Liquid pipe	Inch (mm)	1/4 (6,35)	1/4 (6,35)	3/8 (9,52)	3/8 (9,52)	3/8 (9,52)	3/8 (9,52)	3/8 (9,52)	3/8 (9,52)	1/2 (12,70)
Piping diameter	Gas pipe	Inch (mm)	1/2 (12,70)	1/2 (12,70)	5/8 (15,88)	5/8 (15,88)	5/8 (15,88)	5/8 (15,88)	5/8 (15,88)	1 (25,40)	1 (25,40)
	Cool Min ~ Max	°C DB	18 ~ 32	18 ~ 32	18 ~ 32	18 ~ 32	18 ~ 32	18 ~ 32	18 ~ 32	18 ~ 32	18 ~ 32
Intake temperature of AHU connection kit	Cool Min ~ Max	°C WB	14 ~ 25	14 ~ 25	14 ~ 25	14 ~ 25	14 ~ 25	14 ~ 25	14 ~ 25	—	—
	Heat Min ~ Max	°C	16 ~ 30	16 ~ 30	16 ~ 30	16 ~ 30	16 ~ 30	16 ~ 30	16 ~ 30	16 ~ 30	16 ~ 30
	Cool Min ~ Max	°C	-10 ~ +43	-10 ~ +43	-10 ~ +43	-10 ~ +43	-10 ~ +43	-10 ~ +43	-10 ~ +43	-10 ~ +43	-10 ~ +43
Ambient temperature of outdoor unit (Standard)	Heat Min ~ Max	°C	-15 ~ +24	-15 ~ +24	-15 ~ +24	-15 ~ +24	-15 ~ +24	-15 ~ +24	-15 ~ +24	-15 ~ +24	-15 ~ +24
	Cool Min ~ Max	°C	-15 ~ +46	-15 ~ +46	-15 ~ +46	-15 ~ +46	-20 ~ +48	-20 ~ +48	-20 ~ +48	-20 ~ +48	-20 ~ +48
Ambient temperature of outdoor unit (Elite)	Heat Min ~ Max	°C	-20 ~ +24	-20 ~ +24	-20 ~ +24	-20 ~ +24	-20 ~ +24	-20 ~ +24	-20 ~ +24	-20 ~ +24	-20 ~ +24
	Cool Min ~ Max	°C	-20 ~ +46	-20 ~ +46	-20 ~ +46	-20 ~ +46	-20 ~ +48	-20 ~ +48	-20 ~ +48	-20 ~ +48	-20 ~ +48

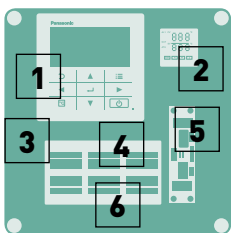

- 1 | Remote control CZ-RTC5B (CZ-RTC6 for PAW-280PAH3M-1 model)
- 2 | Intelligent thermostat for:
 - Cold draft prevention
 - Outdoor temperature shift compensation
- 3 | Plastic IP 65 Box
- 4 | Terminal base for sensors and power supply
- 5 | PAW-T10 PCB for Dry Contact
- 6 | 0-10 V demand control PCB

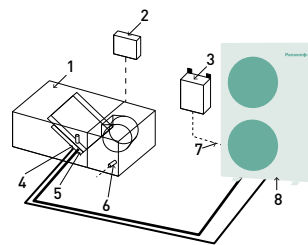

System and regulations. System overview

- 1 | AHU connection kit equipment (field supplied)
- 2 | AHU connection kit system controller (field supplied)
- 3 | AHU connection kit controller box (with control PCB)
- 4 | Thermistor for gas pipe (E2)
- 5 | Thermistor for liquid pipe (E1)
- 6 | Thermistor for suction air
- 7 | Inter-unit wiring
- 8 | Outdoor unit

AHU connection kit.



PCB, Power trans, Terminal block



Thermistor x2 (Refrigerant: E1, E2)

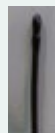

Thermistor (Air: TA; 1 sensor)



Wired remote controller. CZ-RTC5B



Wired remote controller (for PACi NX model). CZ-RTC6

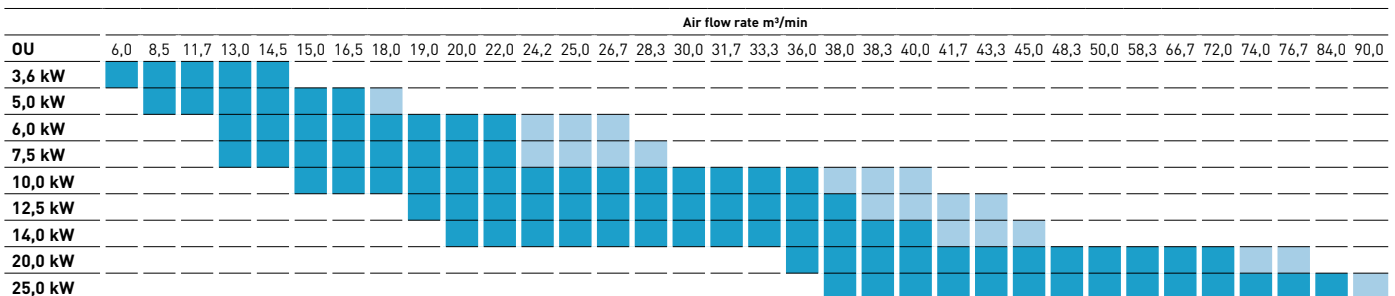

Standard range of air flow rate under standard conditions (air intake temperature in cooling mode from 18 to 32 °C DBI).

Extended range of air flow rate under special conditions (air intake temperature in cooling mode from 18 to 30 °C DBI).

AHU connection kit 16,0 to 56,0 kW for ECOi and ECO G



3 types of AHU connection kit: Advanced, Medium and Light

Reference	IP 65	0-10 V demand control*	Outdoor temperature shift compensation. Cold draft prevention
PAW-160MAH2 / PAW-280MAH2 / PAW-560MAH2	Yes	Yes	Yes
PAW-160MAH2M / PAW-280MAH2M / PAW-560MAH2M	Yes	Yes	No
PAW-160MAH2L / PAW-280MAH2L / PAW-560MAH2L	Yes	No	No

* With CZ-CAPBC2.

With ECOi outdoor units

ECOi outdoor units shall be used for AHU connection kit. 3 models for VRF system: 5 HP (PAW-160MAH2/M/L), 10 HP (PAW-280MAH2/M/L) and 20 HP (PAW-560MAH2/M/L).

With ECO G outdoor units

- One AHU connection kit may be used for one ECO G unit. Multiple AHU connection kits cannot be used
- Mixed with standard indoor units is not allowed
- Power specifications are single phase 220 V to 240 V

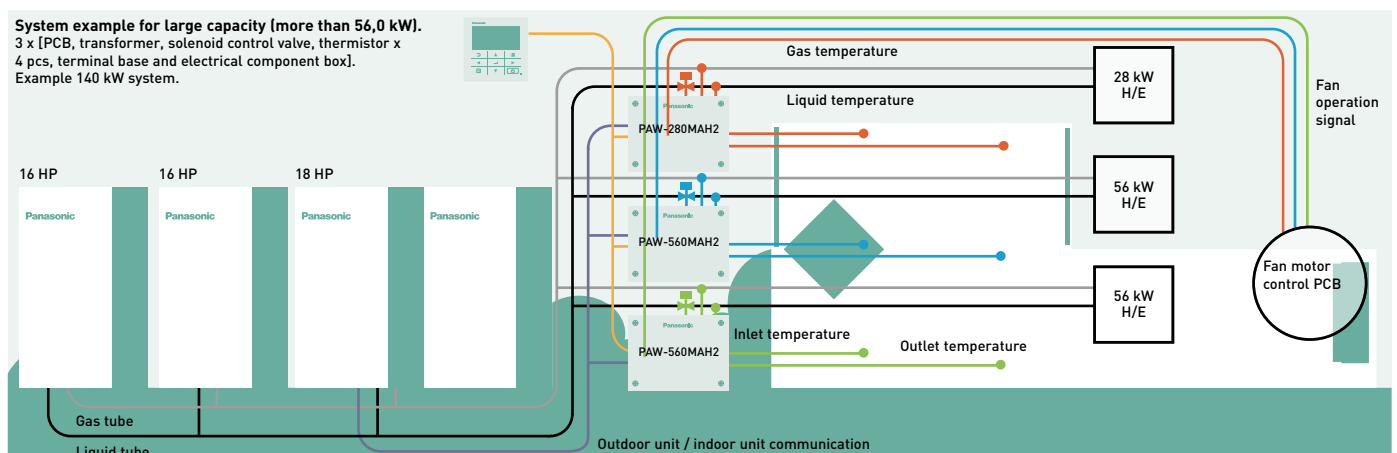



AHU connection kit 16,0 to 56,0 kW for ECOi and ECO G

Reference	PAW-	5 HP	10 HP	20 HP	30 HP	40 HP	50 HP	60 HP
		160MAH2/M/L	280MAH2/M/L	560MAH2/M/L	280MAH2/M/L 560MAH2/M/L	560MAH2/M/L	560MAH2/M/L 280MAH2/M/L	560MAH2/M/L 560MAH2/M/L
Cooling capacity	kW	14,0	28,0	56,0	84,0	112,0	140,0	168,0
Heating capacity	kW	16,0	31,5	63,0	95,0	127,0	155,0	189,0
Air flow	Cool Min/Max m³/h	2598/1140	4998/3498	10002/7002	15000/10500	19998/13998	24996/17496	30000/21000
Bypass factor recommended		0,9	0,9	0,9	0,9	0,9	0,9	0,9
Dimension	HxWxD mm	278x278x180	278x278x180	278x278x180	278x278x180	278x278x180	278x278x180	278x278x180
Net weight	kg	3,2	6,3	6,3	6,3	6,3	6,3	6,3
Pipe length range	m	10~100	10~100	10~100	10~100	10~100	10~100	10~100
Elevation difference (in / out)	Max m	10	10	10	10	10	10	10
Piping diameter	Liquid pipe Inch (mm)	3/8(9,52)	3/8(9,52)	5/8(15,88)	3/4(19,05)	3/4(19,05)	3/4(19,05)	3/4(19,05)
	Gas pipe Inch (mm)	5/8(15,88)	7/8(22,22)	1 1/8(28,58)	1 1/4(31,75)	1 1/2(38,15)	1 1/2(38,15)	1 1/2(38,15)
Intake temperature of AHU connection kit	Cool Min~Max °C DB	+18~+32	+18~+32	+18~+32	+18~+32	+18~+32	+18~+32	+18~+32
	Cool Min~Max °C WB	+13~+23	+13~+23	+13~+23	+13~+23	+13~+23	+13~+23	+13~+23
	Heat Min~Max °C	+16~+30	+16~+30	+16~+30	+16~+30	+16~+30	+16~+30	+16~+30
Ambient temperature of outdoor unit	Cool Min~Max °C	-10~+43	-10~+43	-10~+43	-10~+43	-10~+43	-10~+43	-10~+43
	Heat Min~Max °C	-20~+15	-20~+15	-20~+15	-20~+15	-20~+15	-20~+15	-20~+15

AHU connection kit / System combination

Capacity		Outdoor unit combination		AHU connection kit combination		
5 HP	16 kW	All ECOi outdoor units		PAW-160MAH2(M/L)	—	—
10 HP	28 kW	U-10ME2E8	—	PAW-280MAH2(M/L)	—	—
20 HP	56 kW	U-20ME2E8	—	PAW-560MAH2(M/L)	—	—
30 HP	84 kW	U-16ME2E8	U-14ME2E8	PAW-560MAH2(M/L)	PAW-280MAH2(M/L)	—
40 HP	112 kW	U-20ME2E8	U-20ME2E8	PAW-560MAH2(M/L)	PAW-560MAH2(M/L)	—
50 HP	140 kW	U-18ME2E8	U-16ME2E8	U-16ME2E8	PAW-560MAH2(M/L)	PAW-280MAH2(M/L)
60 HP	168 kW	U-20ME2E8	U-20ME2E8	U-20ME2E8	PAW-560MAH2(M/L)	PAW-560MAH2(M/L)
5 HP 16 kW		All ECO G outdoor units			PAW-160MAH2(M/L)	
10 HP 28 kW		All ECO G outdoor units			PAW-280MAH2(M/L)	
20 HP 56 kW		U-20GE3E5			PAW-560MAH2(M/L)	

Technical focus

- Maximum capacity / system: 60 HP (168 kW)
- Maximum piping length: 100 m (120 m equivalent)
- Elevation difference (indoor unit / indoor unit): 4 m
- In / out capacity ratio: 50~100 %
- Maximum number of AHU connection kits: 3 units*
- Outdoor temperature range in heating: -20 ~ +15 °C
- Available temperature range for the suction air at AHU connection kit: cool: +18 ~ +32 °C / heat: +16 ~ +30 °C
- The systems is controlled by the suction air (or room return air) temperature (same as standard indoor unit)
- The discharge air temperature is also controlled to prevent too-low air discharge in cooling or too-high air discharge in heating (in case of VRF)
- Demand control (forcible thermostat-OFF control by operating current)
- Defrost operation signal, Thermo-ON / OFF states output
- Drain pump control (drain-pump and the float switch to be supplied in local)
- External target temperature setting via indoor / outdoor signal interface is available with CZ-CAPBC2 (Ex. 0-10 V)
- Demand control 40 % to 120 % [5 % steps] by 0-10 V input signal

- Connectable with P-Link system. Special care for electrical noise may be necessary depending on the on-site system
- Fan control signal from the PCB can be used for control the air flow (high / mid / low and LL for Th-OFF). Need to change the fan control circuit wiring at field

* To be simultaneous operation controlled by one remote controller sensor.

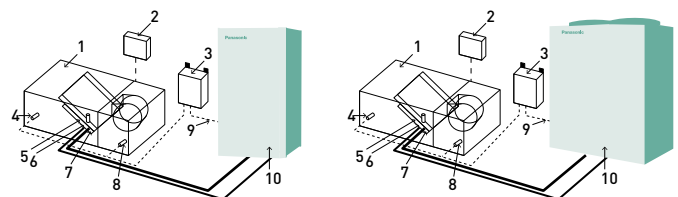

System and regulations. System overview.

- 1 | AHU Unit equipment (field supplied)
- 2 | AHU Unit system controller field supplied
- 3 | AHU connection kit controller box (with control PCB)
- 4 | Thermistor for discharge air
- 5 | Electronic expansion valve
- 6 | Thermistor for gas pipe (E3)
- 7 | Thermistor for liquid pipe (E1)
- 8 | Thermistor for suction air
- 9 | Inter-unit wiring
- 10 | Outdoor unit

Energy recovery ventilation

Panasonic energy recovery ventilators help you with your comfort and energy-saving plan.





Panasonic energy recovery ventilators can reduce the outside air load because they efficiently recover the energy lost by ventilation during the energy recovery process

This results in energy-saving ventilation and lower running costs for air-conditioning and heating equipment.

Furthermore, by designing our current models with a counter-flow heat-exchange element, we achieved products with slim body shapes and quiet operation, that create a comfortable and pleasant air-conditioned environment, whilst saving energy.

- Dramatic energy savings achieved through adoption of a high-efficiency counter-flow heat-exchange element
- Counter-flow heat exchange element used for reduced noise and slimmer, more compact body shape
- All maintenance can be performed through a single inspection aperture
- Straight air supply / exhaust system used for easier installation

Energy efficiency and ecology

Energy consumption is dramatically reduced by using a counter-flow heat-exchange element. Air conditioning load is reduced by approximately 20 %, resulting in significant energy savings.

Comparison of former and current elements

With the cross-flow element, air moves in a straight line across the element; with the counter-flow element, air flows through the element for a longer time (longer distance), so the heat-exchange effect remains unchanged even if the element is made thinner.

Heat exchange ventilation and normal ventilation

Energy-saving ventilation can be achieved through the proper use of heat-exchange ventilation and normal ventilation.

Heat exchange ventilation.

When a room is cooled or heated, the exhausted cooling / heating energy is recovered by heat-exchange ventilation.

Normal ventilation.

This is used in the spring and autumn, when rooms are not cooled or heated, that is, when there is little difference

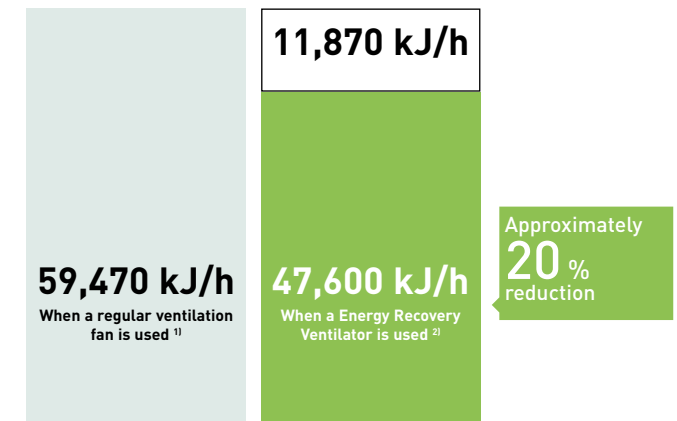

1) Two FY-27FPK7 units. 2) One FY-500ZDY8R unit.

More comfort

Quiet operation.

Low noise operation results in noticeably quieter units. All models with capacities below 500 m³/h run at noise levels below 32 dB (high setting) and even our largest 1000 m³/h-capacity model runs at only 37,5 dB (high setting).

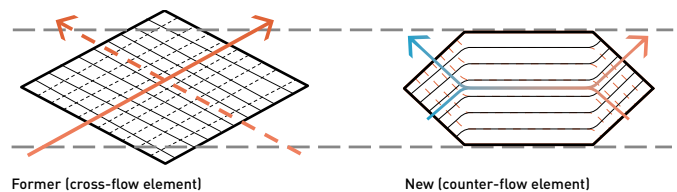

between the indoor and outdoor air conditions. In addition, at night during the hot season, when the outside air temperature drops the outside air is drawn inside without heat exchange, alleviating the load on the air conditioning equipment.

The heat exchanger is made up of a membrane manufactured from a special material covered in resin for optimal heat transmission. The nylon / polyester fibre filter offers high dust retention capacity. We have also redesigned the air ducts to obtain a long-lasting heat exchange system which does not need periodic cleaning.

Energy recovery ventilation - heat exchanger

With the cross-flow element, air moves in a straight line across the element. With the counter-flow element, air flows through the element for a longer time (longer distance), so the heat-exchange effect remains unchanged even if the element is made thinner.

Suppresses indoor temperature changes while providing fresh air. Recovers up to 77 % of the heat in the outgoing air, for an ecological and energy efficient building.

Long service life of heat-exchange element

We used a nonwoven cloth filter with a high dust collection efficiency and redesigned the air flow passages to achieve a durable heat-exchange element that requires no periodic cleaning.

Changes in air flow resistance based on number of years in service.

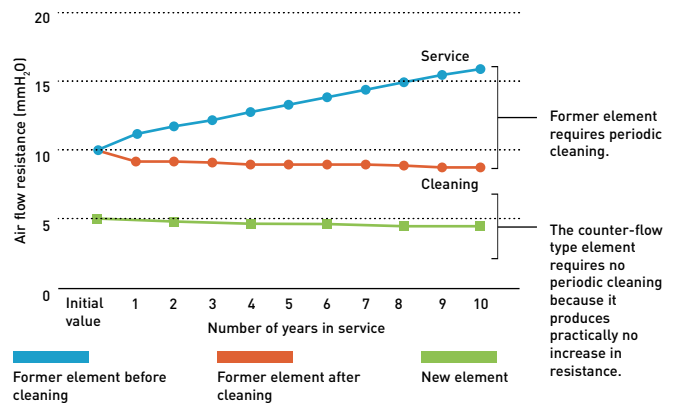

Easy installation and maintenance

Slim shape and easier installation.

Counter-flow heat exchange element used for reduced noise and slimmer, more compact body shape.

Reverse mountable direct air supply / exhaust system.

Adoption of straight air supply / exhaust system: Duct design is simplified because the air supply / exhaust ducts are straight.

Since each unit can be mounted in reverse position, only one inspection hole is needed for two units: Two units can share one inspection hole so duct work is easier and more flexible.

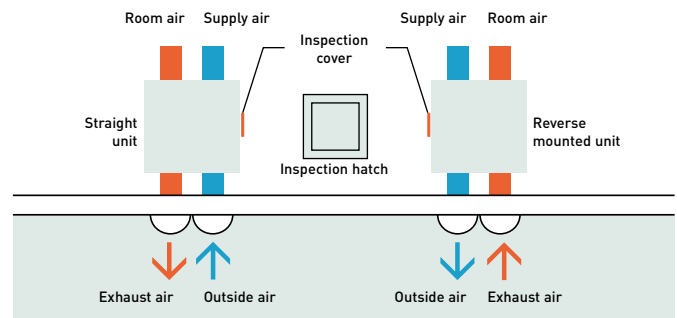

Balanced ventilation

Depending on the length and layout of intake and extract ducting, the pressure may vary. It is therefore possible to balance the airflows ensuring optimal ventilation and maximising efficiency.

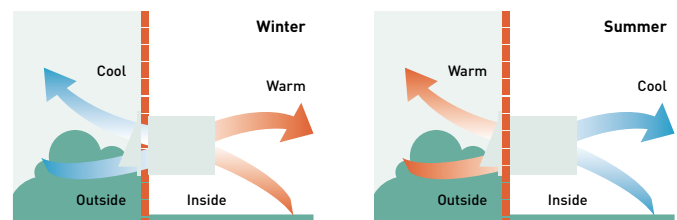

A intuitive and stylish control

- Wire controller included as standard
- Compact and flat front panel
- Filter cleaning support
 - Signal alert for clearing
 - Filter usage condition by 1/2/3/4 months
- Size (W x H x D) 116 x 120 x 40 mm

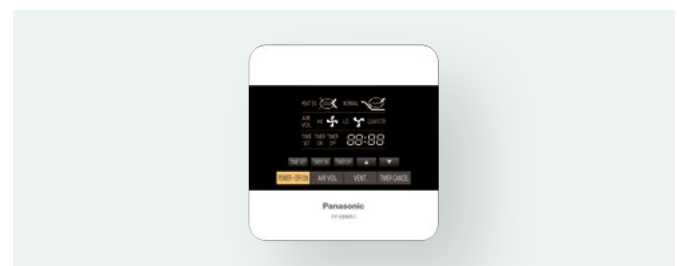



FY-250ZDY8R



FY-350ZDY8R



FY-500ZDY8R



FY-800ZDY8R



FY-01KZDY8R



Rated flow rate		250 m³/h			350 m³/h			500 m³/h			800 m³/h			1000 m³/h					
Indoor unit		FY-250ZDY8R			FY-350ZDY8R			FY-500ZDY8R			FY-800ZDY8R			FY-01KZDY8R					
Power supply	Voltage	V																	
	Phase	Single phase																	
	Frequency	Hz																	
		50			50			50			50			50					
Notch		Extra high	High	Low	Extra high	High	Low	Extra high	High	Low	Extra high	High	Low	Extra high	High	Low			
Input power	W	112,0-128,0	108,0-123,0	87,0-96,0	182,0-190,0	178,0-185,0	175,0-168,0	263,0-289,0	204,0-225,0	165,0-185,0	387,0-418,0	360,0-378,0	293,0-295,0	437,0-464,0	416,0-432,0	301,0-311,0			
Air flow	m³/h	250	250	190	350	350	240	500	500	440	800	800	630	1000	1000	700			
External static pressure	Pa	105	95	45	140	60	45	120	60	35	140	110	55	105	80	75			
Sound power	Heat exchange	30,0-31,5	29,5-30,5	23,5-26,5	32,5-33,0	30,5-31,0	22,5-25,5	36,5-37,5	34,5-35,5	31,0-32,5	37,0-37,5	36,5-37,0	33,5-34,5	37,5-38,5	37,0-37,5	33,5-34,5			
	Normal	30,0-31,5	29,5-30,5	23,5-26,5	32,5-33,0	30,5-31,0	22,5-25,5	37,5-38,5	37,0-38,0	31,0-32,5	37,0-37,5	36,5-37,0	33,5-34,5	39,5-40,5	39,0-39,5	35,5-36,5			
Temperature exchange efficiency	%	75	75	77	75	75	78	75	75	76	75	75	76	75	75	79			
Dimension	HxWxD	mm			270x882x599			317x1050x804			317x1090x904			388x1322x884			388x1322x1134		
Net weight	kg	29			49			57			71			83					

The noise level was measured within an acoustic chamber. Due to installation arrangement and surfaces within the space, actual noise levels may increase. The input, the current and the exchange efficiency are values relevant to the indicated air flows. The noise level is measured 1,5 m below the centre of the unit. The temperature exchange efficiency is an average of both cooling and heating operation.

Features

Energy efficiency and ecology.

- Up to 20 % energy saving in the installation
- Recovers up to 77 % of the heat in the outgoing air

Comfort.

- Cleaning reduced due to the revolutionary structure (every 6 months)
- Ideal for indoor spaces without windows

Easy installation and maintenance.

- 5 models for easier selection
- Reduced system height (270 mm, 317 mm and 388 mm)
- Side opening for cleaning (inspection of filter, motor and other parts)
- Installation can be reversed to share an inspection access between 2 machines
- Easy connection to the air conditioning unit
- Installation in false ceilings
- Units operate at 220 - 240 V
- High static pressure for easier installation

Technical focus

- High energy saving, up to 20 %
- Counter Cross Flow technology for better efficiency
- Long life element core
- Easy installation and 20 % less thickness
- Easy connection to air conditioning units
- Silent units

Heat recovery with DX coil for VRF

Panasonic launches a heat recovery solution for greater energy efficiency. Performing well in extreme weather conditions, it can achieve up to 77 % efficiency (63 % in enthalpy efficiency).



The counter-flow heat exchanger reduces the air conditioning load, enabling customers – typically owners of hotels, restaurants and other large commercial buildings – to reduce their energy consumption and save on the cost of maintaining comfortable room temperatures.

Energy efficiency

As the latest example of Panasonic's continued commitment to developing unbeatable, energy-efficient air conditioning technologies for commercial applications, the company has introduced a heat recovery device.

The unit features a DX coil, and is designed to recover up to 77 % of the heat from outgoing air, and a air purifying system which helps to improve air quality.

In even the most demanding commercial applications, business owners will benefit from the unit's ability to by-pass the heat exchange process when the outside air temperature is cool enough for fresh air to be drawn directly inside (free cooling).

This alleviates the load on the air conditioning equipment and consequently reduces energy bills.

Supply section complete

The supply section comes complete with the DX coil (using R410A refrigerant) – fitted with a solenoid control valve, freon filter, contact temperature sensors on the liquid and gas line, and NTC sensors on the upstream and downstream air flows. The built-in electric box is equipped with a PCB to control the internal fan speed and to interconnect the outdoor and indoor units, and the ducts are connected by circular plastic collars.

Characteristic curves

The following curves show the unit external static pressure at maximum fan speed for each model.

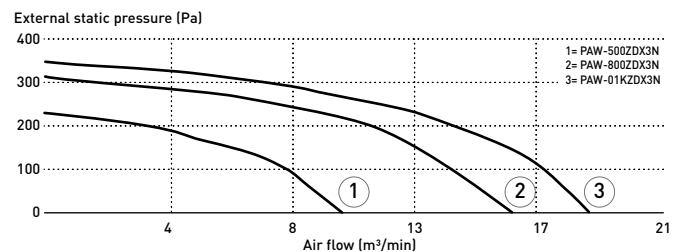

Balanced Ventilation

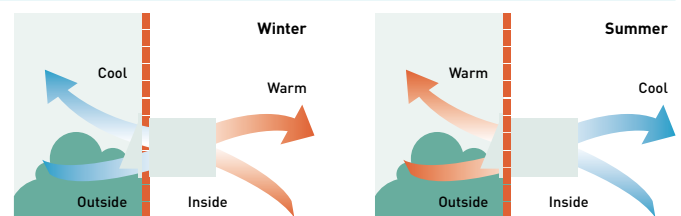



Optional controller.
CONEX wired remote controller.
CZ-RTC6 - CZ-RTC6BL



Optional Controller.
Control for hotel application.
PAW-RE2C4



Optional Controller.
Wired remote controller.
CZ-RTC5B

Indoor unit		PAW-500ZDX3N		PAW-800ZDX3N		PAW-01KZDX3N		
Power supply	Voltage	V	230	230	230	230	230	
	Phase		Single phase	Single phase	Single phase	Single phase	Single phase	
	Frequency	Hz	50	50	50	50	50	
Air flow		m ³ /min	8,33	13,33	16,67			
External static pressure ¹⁾		Pa	90	120	115			
Maximum current	Total full load	A	0,6	1,4	2,1			
	Input power	W	150	320	390			
Sound pressure ²⁾		dB(A)	39	42	43			
Piping diameter	Liquid pipe	Inch (mm)	1/4 [6,35]	1/4 [6,35]	1/4 [6,35]			
	Gas pipe	Inch (mm)	1/2 [12,70]	1/2 [12,70]	1/2 [12,70]			
Heat recovery			Cooling	Heating	Cooling	Heating	Cooling	Heating
Temperature efficiency	%		76	76	76	76	76	76
Enthalpy efficiency	%		63	67	63	65	60	62
Saved power summer mode or winter mode*	kW		1,70	4,30 [4,80]	2,50	6,50 [7,30]	3,20	8,20 [9,00]
DX coil								
Total / Sensible capacity	kW		3,00/2,10	2,50/2,70	5,10/3,50	4,40/4,80	5,80/4,10	5,20/6,70
OFF temperature	°C		15,9	28,0 [27,3]	15,5	29,6 [29,0]	16,2	28,5 [27,8]
OFF relative humidity	%		90	16 [15]	90	14 [13]	89	15 [14]

Nominal summer conditions: Outside air: 32 °C DB, RH 50 %. Ambient air: 26 °C DB, RH 50 %. Nominal winter conditions: Outside air: -5 °C DB, RH 80 %. Ambient air: 20 °C DB, RH 50 %. Cooling mode air inlet condition: 28,5 °C DB, RH 50 %; evaporating temperature 7 °C. Heating mode air inlet condition: 13 °C DB, RH 40 % (11 °C DB, RH 45 %); condensating temperature 40 °C. DB: Dry Bulb; RH: Relative Humidity. 1) Referred to the nominal air flow after filter and plate heat exchanger. 2) Sound pressure level calculated at 1 m far from: ducted supply exhaust air ducted return - first air intake / service side, at normal condition. * Tentative data.

Accessories

CZ-RTC6	CONEX wired remote controller (non-wireless)
CZ-RTC6BL	CONEX wired remote controller with Bluetooth®
CZ-RTC5B	Wired remote controller with Econavi function
PAW-RE2C4-MOD-WH	Modbus RS-485 touch room controller with I/O, White

Accessories

PAW-RE2D4-WH	Touch display control with 2 digital inputs, White
PAW-RE2C4-MOD-BK	Modbus RS-485 touch room controller with I/O, Black
PAW-RE2D4-BK	Touch display control with 2 digital inputs, Black

Interconnection

This ventilation unit is connected to an ECOi indoor unit (3,0 kW, 4,0 kW or 4,5 kW) and can be controlled by the easy-to-use ECOi remote controller.

This capability makes the system an excellent choice for hotels, offices (large and small), educational settings and other buildings requiring different temperatures in multiple rooms. The system also integrates easily with building management systems.

Technical focus

- Motorised heat recovery by-pass device automatically controlled by unit control to use fresh air free-cooling when convenient

General characteristics

- Galvanized steel self-supporting panels, internally and externally insulated
- High efficiency enthalpic heat recover, static cross flow type, made by membrane with high moisture permeability, good air tightness, excellent tear, and aging



INTERNET CONTROL: Optional.

resistance, structure consisting of flat and corrugated plates. Total heat exchange with temperature efficiency up to 76 % and enthalpy efficiency up to 67 %, also at high level during summer season

- ISO16890 ePm_{2,5} 95 % (F9 EN 779) efficiency class filter with synthetic cleanable media and COARSE 50 % (G3 EN 779) pre-filter ON fresh air, COARSE 50 % filter on return air intake
- Removable side panel to access filters and heat recovery in the event of scheduled maintenance
- Low consumption, high efficiency and low noise direct driven fans
- Supply section complete with DX coil (R410A) fitted with solenoid control valve, freon filter, contact temperature sensors on liquid and gas line, NTC sensors upstream and downstream of air flow
- Built-in electric box equipped with PCB to control internal fan speed and to interconnect outdoor / indoor units
- Duct connection by circular plastic collars
- CZ-RTC5B Timer remote controller (option)

Interconnection to outdoor / indoor units

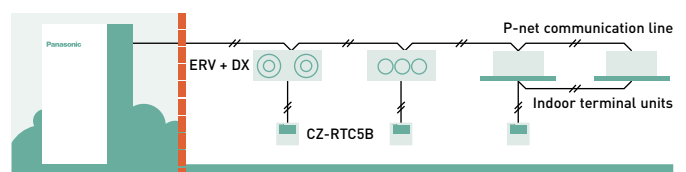

Electric air curtains

The Panasonic range of air curtains is designed for smooth operation and efficient performance. Air curtains produce a continuous stream of air blown from the top to the bottom of an open doorway and create a barrier that people and products can flow across, but air cannot.



Electric air curtain

- 1 Newly designed to maximize performance**
High air flow upgraded 145 % compared to conventional model (in the case of FY-3009U1).

- 2 Comprehensive product line up**
1,5 m wide model added in the line up.

- 3 Easier installation and maintenance**
Simple structure for easy installation and maintenance.



			FY-3009U1	FY-3012U1	FY-3015U1
Width		mm	900	1200	1500
Voltage		V	220	220	220
Air flow	Hi / Lo	m ³ /h	1100/920	1400/1270	2000/1800
Consumption	Hi / Lo	W	76/70	94/85	131/110
Current	Hi / Lo	A	0,35/0,32	0,43/0,40	0,59/0,50
Air speed	Hi / Lo	m/s	10,50/8,50	9,50/8,00	10,50/9,50
Sound pressure		dB(A)	48,5/45,0	48,5/44,5	51,5/48,0
Dimension / Net weight	H x W x D	mm / kg	900 x 231,5 x 212 / 12,0	1200 x 231,5 x 212 / 14,5	1500 x 231,5 x 212 / 18,0



Electric air curtain with DX coil

Designed to improve energy efficiency, minimise heat loss from a building, and allow retailers to keep doors open to encourage customers, our air curtains are suitable for connection to both VRF and PACi Systems.



Highly efficient heating effect

The combined air stream, which has a desirable low air current induction factor (mixing factor), can carry the selected initial temperature effect over long distances, and will reach the floor area while still at room temperature. This is necessary to avoid cooling down the interior spaces.

Available in different lengths to suit requirements between 1 and 2,5 m, both air curtains have outlet grilles that can be adjusted to five different positions. The HS model can be installed up to a height of 3,0 m with the LS model up to 2,7 m. The outlet grilles can be easily adjusted into five positions to suit different installation requirements and the air filter can be accessed without the need for specialist tools.

- High performance with EC fan motor (40 % lower running costs compared to a standard AC fan motor)
- Easy Cleaning and Servicing
- Can be connected to either Panasonic VRF or PACi systems

Heating capacity comparison: Electrical air curtain / Panasonic air curtain.

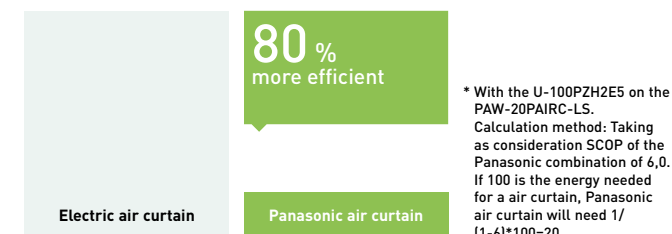

- Optional drain pump for cooling operation
- HS and LS models can be controlled via Panasonic's range of remote internet controls

The HS and LS models are ideal for connection to a ECOi or PACi system. With simple "plug and play" installation, both are fitted with an EC fan motor for a smooth operation and efficient performance. This fan guarantees 40 % lower running cost than with a standard AC fan motor. Air curtains run approximately 12 hours per day at shops, and efficient performance contributes to energy savings.

Optimised air flow velocity

- 1 | Energy losses, no air curtain installed
- 2 | Too low velocity air curtain – air curtain not efficient
- 3 | Too high velocity air curtain – considerable turbulence, energy lost to the outside, air curtain not efficient

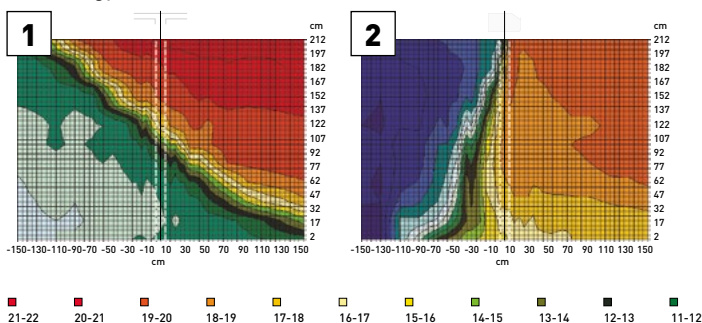

Opening without air curtain.
In an unprotected opening the cold air flows out and the cold storage room becomes much too warm.

Opening with air curtain, wrong angle.
If the angle is too small the hot air is blown into the cold storage room.

- 4 | Optimum results with the Frico air curtain connected to Panasonic VRF

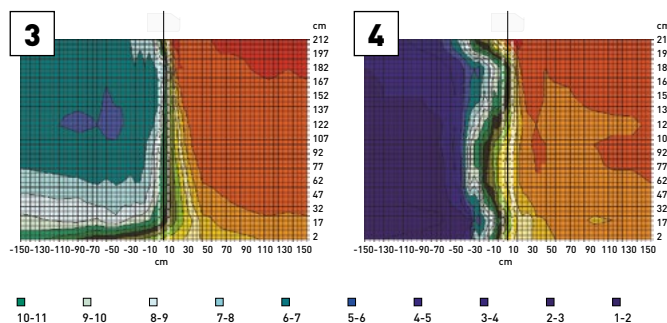

Opening with air curtain, too high speed.
Excessive speed creates turbulence, which causes energy loss and increases the cold storage temperature.

Opening with correctly adjusted air curtain.
With a correctly set air curtain unit there is a sharp separation between the different temperature zones.

Intelligent operation

Our air curtains combine air flow and heating / cooling technology to ensure optimum comfort and energy efficiency whilst also creating an effective barrier between indoor and outdoor environments. Design and installation is key to achieving the correct height / temperature settings to achieve optimum performance. Our air curtains are designed to answer the demands of the retail, commercial and industrial markets.

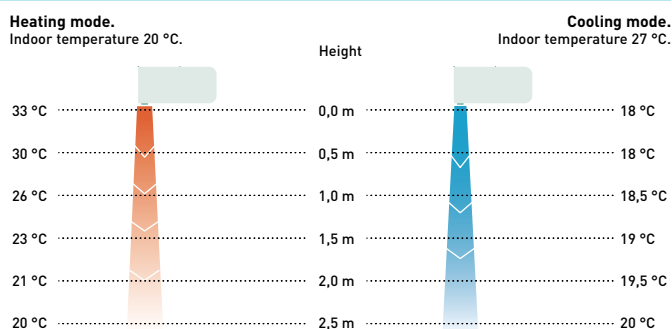

Air curtain with DX coil, connected to PACi systems

Comfort: Easy redirection of air flow by means of manual deflector.

Ease of use: Speed selector (high and low) on the unit itself.

Easy installation and maintenance: Easy installation / Compact dimensions improve installation and positioning / Easy cleaning of grid without opening of the unit.



Outdoor unit			7,1 kW	10,0 kW	14,0 kW	20,0 kW
Air outlet height 2,7 m			PAW-10PAIRC-LS-1	PAW-15PAIRC-LS-1	PAW-20PAIRC-LS-1	PAW-25PAIRC-LS-1
Cooling capacity ¹⁾	Max	kW	6,1	9,7	13,0	17,0
Heating capacity ²⁾	Max	kW	7,9	12,0	15,0	19,0
Air flow	High	m ³ /h	1800	2700	3600	4500
Heat Exchanger	Volume	L	1,67	2,85	3,94	5,03
Electric consumption fan	230 V / 50 Hz	kW	0,30	0,50	0,60	0,80
Current	230 V / 50 Hz	A	2,10	3,10	4,10	5,10
Sound pressure ³⁾	Max	dB(A)	65	66	67	69
Air outlet height 3,0 m			PAW-10PAIRC-HS-1	PAW-15PAIRC-HS-1	PAW-20PAIRC-HS-1	PAW-25PAIRC-HS-1
Cooling capacity ¹⁾	Max	kW	9,1	13,0	19,5	23,7
Heating capacity ²⁾	Max	kW	11,8	15,8	23,6	27,6
Air flow	High	m ³ /h	2700	3600	5400	6300
Heat Exchanger	Volume	L	1,67	2,85	3,94	5,12
Electric consumption fan	230 V / 50 Hz	kW	0,75	1,00	1,50	1,75
Current	230 V / 50 Hz	A	4,10	5,50	8,20	9,60
Sound pressure ³⁾	Max	dB(A)	66	67	68	68
Common data						
Dimension ⁴⁾	HxWxD	mm	260 (+140) x 1000 x 460	260 (+140) x 1500 x 460	260 (+140) x 2000 x 460	260 (+140) x 2500 x 460
Net weight	Air outlet height 2,7 m	kg	50	65	80	95
	Air outlet height 3,0 m	kg	55	65	85	110
Fan type			EC	EC	EC	EC
Piping diameter	Liquid pipe / Gas pipe	Inch (mm)	3/8 (9,52) / 5/8 (15,88)	3/8 (9,52) / 3/4 (19,05)	3/8 (9,52) / 7/8 (22,22)	3/8 (9,52) / 7/8 (22,22)
Door width		m	1,0	1,5	2,0	2,5
Refrigerant			R32	R32	R32	R32

1) Cooling capacity DX coil, air temperature in / out +27 / +18 °C, R32 and R410. 2) Heating capacity condenser, air temperature in / out +20 / +33 °C, R32 and R410. In the case of lower outdoor temperatures, an outdoor model with higher capacity may be necessary. 3) Measured in distance up to 5,0 m, direction factor 2, absorbing surfaces 200 m², Min / Max air flow. 4) 140 mm is the height of an electrical box if it is installed on the top.

Accessories

PAW-AIR1-DP Optional drain pump

Technical focus

- Now compatible with PACi NX Series
- Save up to 40 % energy costs by use of the integrated EC fan technology (higher efficiency than conventional AC fan, soft start and longer motor duration)
- 4 length of air curtain LS and HS are available 1,0, 1,5, 2,0 and 2,5 m
- Installation height up to 3,0 m
- Outlet grilles can be adjusted in five positions, to suite different indoor and installation requirements
- Control with Panasonic remote control systems (optional)
- Direct integration to BMS by optional Panasonic interfaces
- Drip tray included in all DX air curtain steps

How does it work?

Stale air from the room is taken in and ejected near the door. This creates a 'roll of air' that shields the door area, mixing with the colder incoming air. It then turns away from the door, back into the room and toward the intake screen, where it is partly drawn in again. This flow of air helps to create a barrier for heat loss yet at the same time refreshes room air

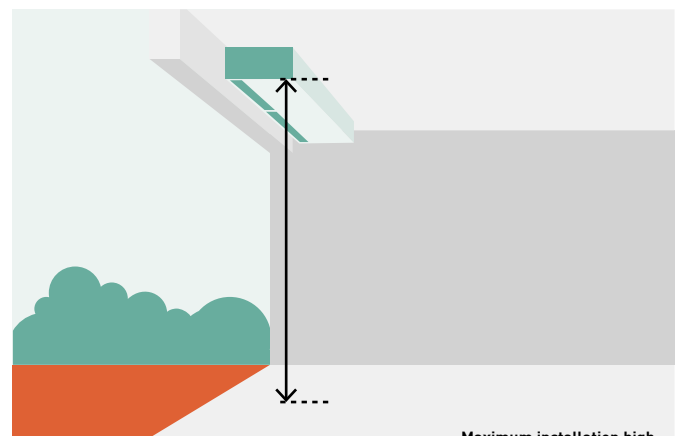

Maximum installation high.
HS: 3,0 m
LS: 2,7 m





Air curtain with DX coil, connected to VRF systems

Comfort: Easy redirection of air flow by means of manual deflector.

Ease of use: Speed selector (high and low) on the unit itself.

Easy installation and maintenance: Easy installation / Compact dimensions improve installation and positioning / Easy cleaning of grid without opening of the unit.

Outdoor unit			4 HP	4 HP	5 HP	8 HP
Air outlet height 2,7 m			PAW-10EAIRC-LS	PAW-15EAIRC-LS	PAW-20EAIRC-LS	PAW-25EAIRC-LS
Cooling capacity ¹⁾	Max	kW	6,1	9,7	13,0	17,0
Heating capacity ²⁾	Max	kW	7,9	12,0	15,0	19,0
Air flow	High	m ³ /h	1800	2700	3600	4500
Heat Exchanger	Volume	L	1,67	2,85	3,94	5,03
Electric consumption fan	230 V / 50 Hz	kW	0,30	0,50	0,60	0,80
Current	230 V / 50 Hz	A	2,10	3,10	4,10	5,10
Sound pressure ³⁾	Max	dB(A)	65	66	67	69
Air outlet height 3,0 m			PAW-10EAIRC-HS	PAW-15EAIRC-HS	PAW-20EAIRC-HS	PAW-25EAIRC-HS
Cooling capacity ¹⁾	Max	kW	9,1	13,0	19,5	23,7
Heating capacity ²⁾	Max	kW	11,8	15,8	23,6	27,6
Air flow	High	m ³ /h	2700	3600	5400	6300
Heat Exchanger	Volume	L	1,67	2,85	3,94	5,12
Electric consumption fan	230 V / 50 Hz	kW	0,75	1,00	1,50	1,75
Current	230 V / 50 Hz	A	4,10	5,50	8,20	9,60
Sound pressure ³⁾	Max	dB(A)	66	67	68	68
Common data						
Dimension ⁴⁾	H x W x D	mm	260 (+140) x 1000 x 460	260 (+140) x 1500 x 460	260 (+140) x 2000 x 460	260 (+140) x 2500 x 460
Net weight	Air outlet height 2,7 m	kg	50	65	80	95
	Air outlet height 3,0 m	kg	55	65	85	110
Fan type			EC	EC	EC	EC
Piping diameter	Liquid pipe / Gas pipe	Inch (mm)	3/8(9,52) / 5/8(15,88)	3/8(9,52) / 3/4(19,05)	3/8(9,52) / 7/8(22,22)	3/8(9,52) / 7/8(22,22)
Door width		m	1,0	1,5	2,0	2,5
Refrigerant			R32 / R410A	R32 / R410A	R32 / R410A	R32 / R410A

1) Cooling capacity DX coil, air temperature in / out +27 / +18 °C, R32 and R410. 2) Heating capacity condenser, air temperature in / out +20 / +33 °C, R32 and R410. In the case of lower outdoor temperatures, an outdoor model with higher capacity may be necessary. 3) Measured in distance up to 5,0 m, direction factor 2, absorbing surfaces 200 m², Min / Max air flow. 4) 140 mm is the height of an electrical box if it is installed on the top.

Accessories

PAW-AIR1-DP Optional drain pump

Technical focus

- Compatible with R32 and R410A refrigerant
- Save up to 40 % energy costs by use of the integrated EC fan technology (higher efficiency than conventional AC fan, soft start and longer motor duration)
- 4 length of air curtain LS and HS are available 1,0, 1,5, 2,0 and 2,5 m
- Installation height up to 3,0 m
- Outlet grilles can be adjusted in five positions, to suite different indoor and installation requirements
- Control with Panasonic remote control systems (optional)
- Direct integration to BMS by optional Panasonic interfaces
- Drip tray included in all DX air curtain steps

Internet control

An app added to your tablet or smartphone or via the Internet allows you to control and manage the system remotely. There is also the option to integrate into existing BMS systems by using other Panasonic interfaces.

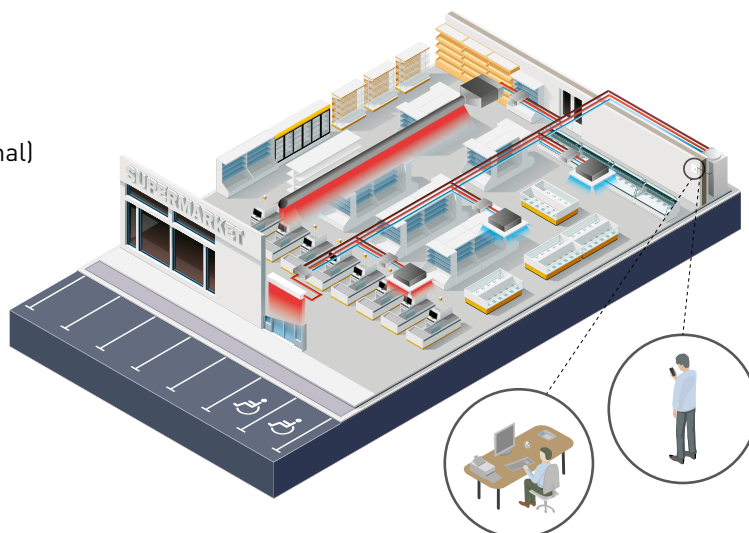

High pressure duct and 100 % fresh air duct function for all ECOi and ECO G systems

The E2 range of ducted units offers improved design flexibility for extended duct layouts as a result of their increased external static pressures and reduces energy consumption, while providing fresh air to larger spaces.



E2 Type high static pressure hide-away • R410A
High pressure duct and 100 % fresh air duct function.



COMPATIBLE WITH ALL PANASONIC CONNECTIVITY SOLUTIONS. FOR DETAILED INFORMATION GO TO THE CONTROL SYSTEMS SECTION

Type	100 % fresh air duct function (by using kit for 100 % fresh air)				High pressure duct			
	S-224ME2E5		S-280ME2E5		S-224ME2E5		S-280ME2E5	
Indoor unit	Cooling	Heating	Cooling	Heating	Cooling	Heating	Cooling	Heating
Capacity	22,4	21,2	28,0	26,5	22,4	25,0	28,0	31,5
Input power	290,00	290,00	350,00	350,00	440,00	440,00	715,00	715,00
Current	1,85	1,85	2,20	2,20	2,45	2,45	3,95	3,95
Air flow	Hi / Med / Lo	m ³ /min	28,3 / — / —	35,0 / — / —	56,0 / 51,0 / 44,0	72,0 / 63,0 / 53,0		
External static pressure		Pa	200	200	140 (60 - 270) ¹⁾	140 (72 - 270) ¹⁾		
Sound pressure ²⁾	Hi / Med / Lo	dB(A)	43 / — / —	44 / — / —	45 / 43 / 41	49 / 47 / 43		
Sound power	Hi / Med / Lo	dB(A)	75 / — / —	76 / — / —	77 / 75 / 73	81 / 79 / 75		
Dimension	H x W x D	mm	479 x 1453 x 1205	479 x 1453 x 1205	479 x 1453 x 1205	479 x 1453 x 1205		
Net weight		kg	102	106	102	106		
Piping diameter	Liquid pipe	Inch (mm)	3/8 (9,52)	3/8 (9,52)	3/8 (9,52)	3/8 (9,52)		
	Gas pipe	Inch (mm)	3/4 (19,05)	7/8 (22,22)	3/4 (19,05)	7/8 (22,22)		

Rating Conditions for 100 % Fresh air duct function: Cooling Outdoor 33 °C DB / 28 °C WB. Heating Outdoor 0 °C DB / -2,9 °C WB.
 1) Available to select the setting by initial setup. 2) Values with 140 Pa setting. * No filter included. ** No compatible with 3-Pipe ECO G GF3.

Accessories	
CZ-RTC6	CONEX wired remote controller (non-wireless)
CZ-RTC6BL	CONEX wired remote controller with Bluetooth®
CZ-RTC5B	Wired remote controller with Econavi function
CZ-RWS3 + CZ-RWRC3	Infrared remote controller and receiver
PAW-RE2C4-MOD-WH	Modbus RS-485 touch room controller with I/O, White

Accessories	
PAW-RE2D4-WH	Touch display control with 2 digital inputs, White
PAW-RE2C4-MOD-BK	Modbus RS-485 touch room controller with I/O, Black
PAW-RE2D4-BK	Touch display control with 2 digital inputs, Black
CZ-CENSC1	Econavi energy savings sensor

Technical focus

- No need of rap valve
- 100 % fresh air duct function*
- DC fan motor for more savings
- Complete flexibility for ductwork design
- Can be located into a weatherproof housing for external siting
- Air OFF sensor avoids cold air dumping
- Configurable air temperature control

* Rap valves required, see 100 % fresh air duct function below.

System example

An inspection port (450 x 450 mm or more) is required at the lower side of the indoor unit body (field supply).

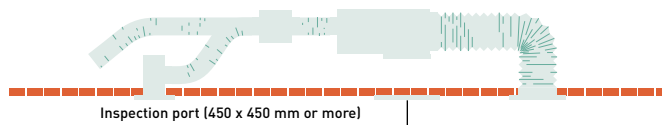

100 % fresh air duct function

The E2 duct with 100 % fresh air duct function have exceptional discharge temperature.

	Discharge Range		
	Min	Max	Default
Cooling	15 °C	24 °C	18 °C
Heating	17 °C	45 °C	40 °C

Plenums

Air outlet plenum (suitable for rigid + flexible duct)		
	Number of exits with diameters	Reference
S-224ME2E5 / S-280ME2E5	1 x 500 mm	CZ-TREMIESPW706

Kit for 100 % fresh air function

Kit for 100 % fresh air function for 2 way systems	
2x CZ-P160RVK2	Rap valve kit
2x CZ-CAPE2	3 way control PCB
CZ-P680BK2BM	Distribution joint kit
	1x remote controller
Kit for 100 % fresh air function for 3 way systems	
2x CZ-P160HR3	3 way valve Kit
2x CZ-CAPE2	3 way control PCB
CZ-P680BH2BM	Distribution joint kit
	1x remote controller



ECONAVI and INTERNET CONTROL: Optional.



Control and connectivity

Panasonic has developed the largest range of control systems to offer the best option for commercial needs.

From the individual remote controller for the residential single units up to the newest technology capable of controlling your building anywhere in the world. The simple to use cloud software can even be used from a portable device.

Control and connectivity map for Panasonic business area	→ 372	Individual controllers wireless	→ 408
VRF Smart Connectivity+	→ 374	Infrared remote controller	→ 408
Smart multi-site control solution	→ 378	Remote sensor	→ 408
Panasonic AC Smart Cloud	→ 380	Centralised controllers	→ 409
Panasonic AC Service Cloud	→ 382	System controller with schedule timer	→ 409
Panasonic AC Smart Cloud and Panasonic AC Service Cloud packages	→ 384	ON / OFF controller	→ 409
Commercial Wi-Fi Adaptor	→ 386	Intelligent controller (touch screen panel)	→ 410
CONEX. New devices and apps	→ 388	P-AIMS core software	→ 411
Remote controller with Econavi	→ 392	Local adaptor for ON / OFF control	→ 412
Datanavi	→ 394	Mini Seri-Para I/O Unit 0 -10 V	→ 412
Intelligent controller	→ 396	Communication adaptor for VRF connectivity	→ 413
Econavi Sensor	→ 398		
Controller for hotel application	→ 400	PACi and VRF connectivity	→ 414
BMS interface with P-Link	→ 402	ECOi, ECO G and PACi connectivity indoor units	→ 416
Control and connectivity	→ 404	T10 connector (CN061)	→ 416
Individual controllers wired	→ 406	Fan drive connector (CN032)	→ 417
CONEX wired remote controller	→ 406	Option connector (CN060) output external signals	→ 417
Room controller for hotel rooms	→ 406	EXCT connector (CN009)	→ 417
Display control for hotel rooms	→ 407		
Design wired remote controller	→ 407		

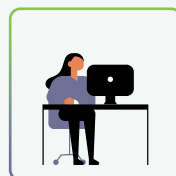
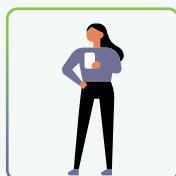
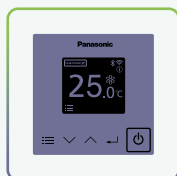

Control and connectivity map for Panasonic business areas

A wide range of control and connectivity solutions to suit a variety of applications. Integration capability, scalable solutions and smart connectivity offer a unique portfolio to meeting every customer's needs.

Integration to Home Automation or KNX.

Simple and flexible solution to integrate Panasonic heating and cooling systems into smart home energy solutions.

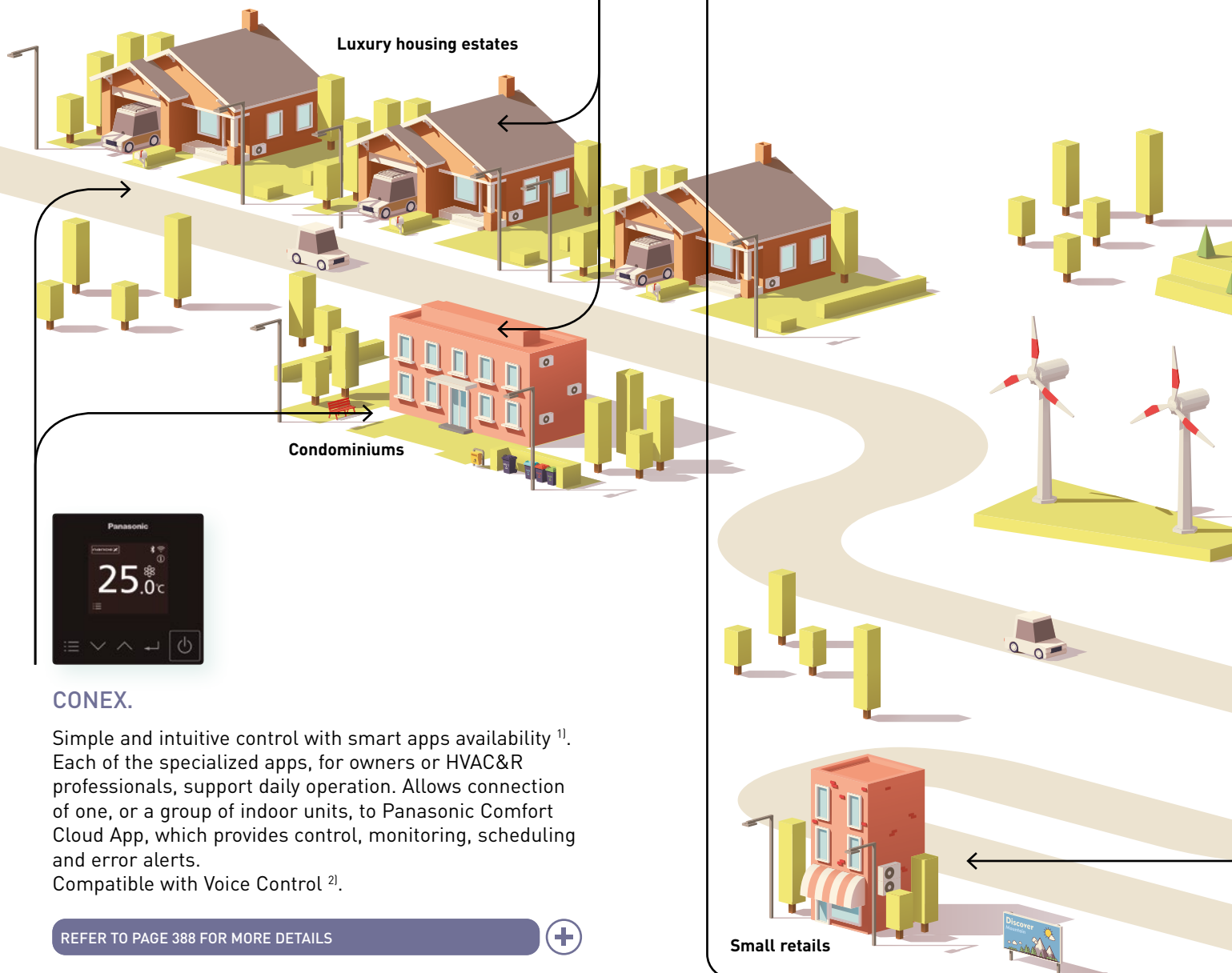

CONEX.

Simple and intuitive control with smart apps availability ¹⁾. Each of the specialized apps, for owners or HVAC&R professionals, support daily operation. Allows connection of one, or a group of indoor units, to Panasonic Comfort Cloud App, which provides control, monitoring, scheduling and error alerts. Compatible with Voice Control ²⁾.

REFER TO PAGE 388 FOR MORE DETAILS



1) App connectivity available with CZ-RTC6BL and CZ-RTC6BLW.
 2) Alexa, Google Home.... Giving indication of compatible options.
 3) Panasonic AC Smart Cloud connection required to access Panasonic AC Service Cloud.
 4) 2 DI on standard version and 4 DI/DO available on Modbus version.
 5) 128 indoor units as standard, additional communication adaptor required for 256 units.



Panasonic AC Smart / Service Cloud.

Smart multi-site solution provides users with complete scalable control for all business installations, 24/7, from any connected location.

Panasonic AC Smart Cloud for business owners and Panasonic AC Service Cloud ³⁾ for HVAC service/maintenance companies.

REFER TO PAGE 380 FOR MORE DETAILS



Hotels

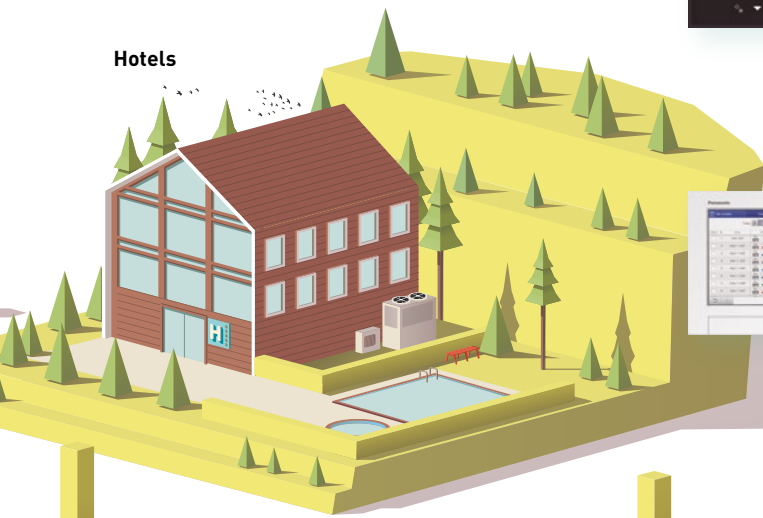

VRF Smart Connectivity+.

Control the air quality of guest rooms utilising CO₂ and humidity sensors. Easy BMS integration for entire building management.

REFER TO PAGE 374 FOR MORE DETAILS



Controller for hotel application.

Intuitive controller allowing up to 4 digital inputs and outputs ⁴⁾. Perform the most common operations in hotel rooms, such as key cards and window contacts.

REFER TO PAGE 400 FOR MORE DETAILS



Intelligent controller.

Centralized controller with large LCD touch screen display. Maximum 256 ⁵⁾ indoor units connectable, ideal for larger buildings.

REFER TO PAGE 396 FOR MORE DETAILS



Offices / Large buildings

Supermarkets

Integration with BACnet or Modbus.

Easy and reliable solution to integrate Panasonic heating and cooling systems into the building management systems in your business.

VRF Smart Connectivity+

Through thorough energy management, Panasonic's VRF Smart Connectivity+ is a completely new, state-of-the-art solution providing energy saving and comfort as well as simple installation, operation and running.

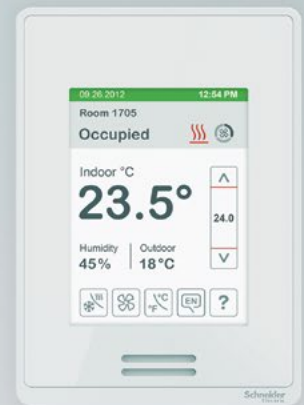

Dramatic reduction of OpEx with outstanding IAQ.

3 built-in sensors: Temperature, RH and occupancy.

ZigBee wireless sensors:
CO₂ / temperature / RH%,
window / door, ceiling / wall / water leakage.

Relay Pack, Hotel Room Controller.



User-/owner-friendly.

Colour touch screen.

Simple and easy to use.

22 languages.

Easy-to-understand error description.



Ultimate customisation.

Customisable colour background.

Custom display/icons, messages.

Programmable logic (also stand alone).

Various controls and various external connection devices.



Easy design and Plug & Play to reduce CapEx.

Simple Plug & Play VRF connection to Building Energy Management System (BEMS).

Stand alone or BEMS connected.

Easy installation of ZigBee sensors.



VRF Smart Connectivity+ offers efficient energy management and a new air conditioning control solution with high IAQ (indoor air quality).



Energy management system for rooms.

Each room is monitored by high-precision sensors, making it possible to make every room's temperature comfortable without wasting energy.

Management system for the entire building.

A Building Energy Management System (BEMS) can also be connected for Plug & Play centralised control of the building's entire energy consumption.

1 Quality air control

Optimum IAQ is realized using the CO₂ and humidity sensors. The interior environment remains comfortable, while heating and cooling costs are minimized. The CO₂ sensor can control ventilation systems, which contribute to improving the room's air quality.

2 Easy installation and integration

A remote controller is all that's required for occupancy control and optimum automatic indoor air quality (IAQ) control. Simple operation with a rented interface further contributes to increased energy efficiency and productivity for reduced capital expenditure (CapEx) and operating expense (OpEx).

3 Other equipment control

One room controller manages various devices including lighting and the blinds. A ventilation system and other external connection devices control is possible with this BEMS.

VRF Smart Connectivity+: SE8000.



Door/window sensor.

Door and window contact detection sensor to monitor opening and closing.



Wall/ceiling motion/temperature/humidity sensor.

Wall and ceiling sensor to detect the presence or absence of occupants.



CO₂ /temperature/humidity sensor.

Monitor indoor air quality, review data on interfacing devices, and control fresh air inside customisable zones.



Water leakage sensor.

Two sensing pads under the body activate when water is present between the two pads. Detecting the water, the sensor reports the event to the controller (and BEMS).



Hotel Room Controller (HRC).

The Hotel Room Controller controls connected guest room devices and aggregates data, making it visible to guest room and property management systems.

VRF Smart Connectivity+

Energy management system for rooms.

By installing a wall/ceiling motion temperature sensor, window/door sensor, and CO₂ sensor in the room, ideal, waste-free air conditioning is achieved.

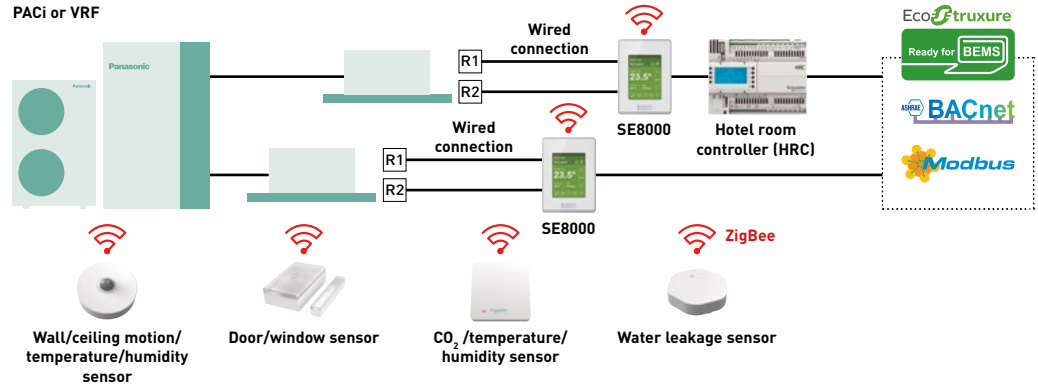

Sensing and control technology

Using sensors from Schneider Electric, high-quality occupancy control and automatic IAQ control are realised. The sensors detect the presence or absence of occupants, and the opening and closing of doors and windows to achieve the most efficient energy management for exceptional air-conditioned comfort. Flexible installation is possible to match different applications and building features such as walls, ceilings and proximity to doors and windows. No wiring means extra installation versatility.

Batteries last for up to five years (10-year battery for CO₂ sensor) and are easy to install and replace.

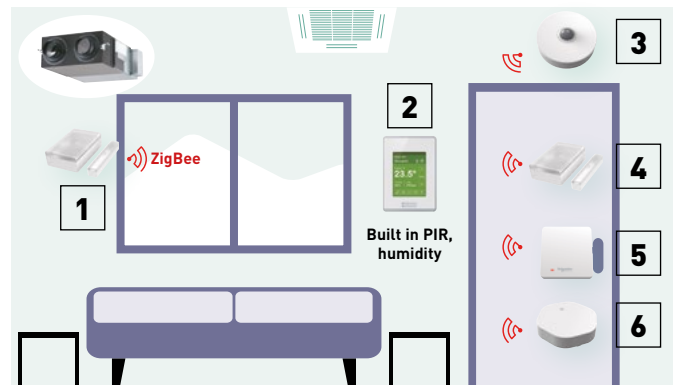

- 1 | Window sensor (option).
- 2 | Room controller.
- 3 | Ceiling motion sensor (option).
- 4 | Door sensor (option).
- 5 | CO₂ sensor (option).
- 6 | Water leakage sensor (option).



Pana Net Con, RH, No PIR, SE Brand, R1R2.
SER8150R0B1194



Pana Net Con, RH, PIR, SE Brand, R1R2.
SER8150R5B1194



Wireless ZigBee® Pro communication card.
VCM8000V5094P



Hotel room expansion module 14 indoor units.
HRCEP14R



Hotel room controller 28 indoor units.
HRCPBG28R



Hotel room controller w/display 42 indoor units.
HRCPDG42R

* Those accessories require system integrator support on site.



Sensor with room CO₂, temperature and humidity.
SED-CO2-G-5045



Sensor with room temperature and humidity.
SED-TRH-G-5045



Door/window sensor.
SED-WDC-G-5045



Wall/ceiling motion/temperature/humidity sensor.
SED-MTH-G-5045



Water leakage sensor.
SED-WLS-G-5045



Cover frame. Silver.
FAS-00



Cover frame. White.
FAS-01



Cover frame. Glossy translucent white.
FAS-03



Cover frame. Light tan wood.
FAS-05



Cover frame. Dark brown wood.
FAS-06



Cover frame. Dark black wood.
FAS-07



Cover frame. Brushed steel finish.
FAS-10

Up to 5 year battery life (batteries included). Battery life of CO₂ sensor up to 10 years. Battery level data point.



VRF Smart Connectivity+

Smart management solutions.

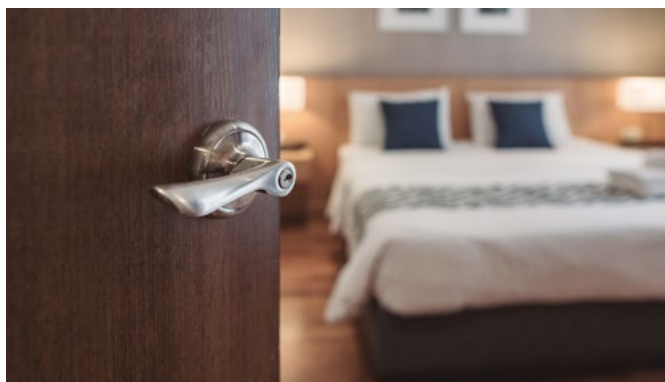

1 Hotels

Room key card or key cardless solutions for hotels.

The SE8000 and ZigBee sensor automatic detection function offer optimal air conditioning regardless of whether there is a hotel room key or not. Sensors detect the presence or absence of occupants and the opening and closing of doors and windows for the optimum air-conditioned environment guests expect. Automatic control ensures the most efficient operation when guests are away or when windows are open. This contributes to an appreciable reduction in operation costs.



2 Small and medium offices

CO₂ sensors (option) and humidity sensors.

CO₂ sensors (option) take measurements in units of ppm, and humidity sensors enable fine air quality control. This creates the most comfortable space for occupants while contributing to improved employee satisfaction.



3 Super markets

Humidity sensors.

Humidity sensors enable automatic dehumidification for the optimum IAQ regardless of climatic conditions. This creates an even more comfortable environment for customers, employees, and products themselves.

Innovative and unrivalled advantages



Colour and design to match office interiors.

Colour combinations and design can be set to match different facilities.



Easy-to-understand error description.

Error description during an emergency is easy to understand, enabling staff to respond quickly.



Customisation in 22 languages possible.

The display can be customised to match the native languages of guests to enable smooth, stress-free communication for hospitality at its finest.



Programmable logic.

Full customisation of remote controller logic possible, and updating to match conditions.

Smart multi-site control solution

Modern and scalable energy management for your Heating & Cooling Solutions. Smart multi-site control solution. One screen endless possibilities.

The new smart multi-site control solution from Panasonic allows you to have complete control of all your installations.

With a simple click, all your units from several locations, receive status updates in real-time preventing breakdowns and optimising costs.



Installation.

Easy installation and configuration.



Connectivity.

A standard LAN connection with internet access (fibre or mobile).



Reliability.

24/7/365 days connection.



Use.

Real-time control from anywhere.



Roles and permission.

Easily configure different access roles for each user.



Security.

Highly secure communication and compliant with GDPR.



What Panasonic provides you?



Energy savings.

AC can be between 40-60% of the total electricity bill.

Even small setting changes might impact in real huge saving of your buildings. Panasonic AC Smart Cloud provides you energy consumption data of your site and energy saving functions such as control setting limitation, auto off, scheduling, temperature range limits etc.



Healthy comfort.

How to secure comfort environment by avoiding wrong AC operation?

Wrong temperature settings might drive into people discomfort and also unhealthy environment for employees, visitors or customers. Allow to analyse the set point and room temp history, and fix the right mode and temperature for each room.

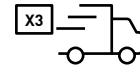

Service speed.

On average, 2-3 AC technician' visits are required on site when an error/issue appears in an AC system.

Avoid wasted site visits, analysing the behavior of the AC system remotely without necessity of a technician visit on site.



Downtime.

System "downtime" can impact the customers buying experience / productivity.

Keep your business always running, reducing the risk of system time down. Detecting potential failures in advance or fixing them quicker if it happens.

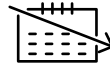

Maintenance.

A proper maintenance schedule prevents future malfunctions and reduces energy consumption.

Check remotely all the advanced parameters of the system and plan the maintenance properly. Assigning the right engineer for the required task.



Life of system.

Replacing to new HVAC is a huge impact on investment.

Making good use of the system, taking earlier action when abnormal signal occurs and keeping regular maintenance will expand the life your system, but also will keep the expected performance operation.

Full multi-site and user control.

Panasonic Smart and Service Cloud is based in location, each location can allow access for multiple users whether in the same building or via remote access. The scalability allows addition of multiple sites and customise the access of your team and the access of your trusted service.



Owner.

Easy management of permission roles and access.



Maintenance.

Maintenance companies can get an access of each sites after owners allow permission to you a simple click.



Owner.
Manage all sites.

Country/region manager.

Manage all the sites within a region.

Country/region manager.

Manage all the sites within a region.

Site manager.

Manage specific site.

Site manager.

Manage specific site.

Site manager.

Manage specific site.

Other user
Limited access

Other user
Limited access

Other user
Limited access



Maintenance.

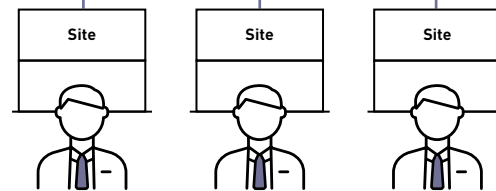

Panasonic AC Smart Cloud



Centralise control of your business premises, from wherever you are, 24/7/365.

The AC Smart Cloud system from Panasonic allows you to have complete control of all your installations from your tablet or from your computer. In a simple click, receive status updates, from all of your installations wherever the location, reducing potential breakdowns and optimising costs.



1 Comfort
Keep the comfort of workers, visitors and/or customers to increase satisfaction and productivity.

2 Return on investment
Optimising the operation of your heating and cooling system and the possibility to monitor remotely can expand the life of your assets.

3 Lower running cost
The control of settings in real time and the energy consumption monitor contributes to reduce your energy bill.

Flexible solution for your business

Scalable solution for your business



Anytime



Anywhere



Multiplatform



Internet browser



Small to large

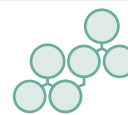

1 to multi-sites



Upgrade features ¹⁾



RAC²/PACi/ECOi/ECO G

1) Customized to meet user demand / Continuous upgrades: new functions and product introductions / IT smart management. 2) CZ-CAPRA1 is required.

Key functions and uniqueness



Multi-site monitoring.
· It doesn't matter how many sites you have. It is easy to manage, operate, compare sites, locations and rooms.

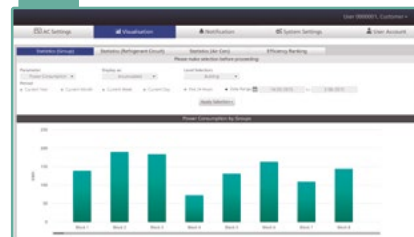

Powerful statistics for energy savings.
· Power consumption, capacity and efficiency level can be compared with different parameters (yearly / monthly / weekly / daily basis)

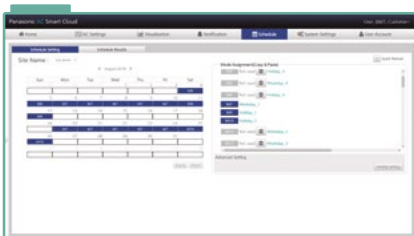

Schedule setting.
· Set yearly / weekly / holidays timers as you please



Maintenance notification.
Receive an error notification by email and with floor layout:
· Maintenance notification of ECOi / ECO G outdoor units
· Remote service checker function

Controller multi-site

Including all advantages for single site, AC Smart Cloud scalability offers you a excellent tool for multi-site management.

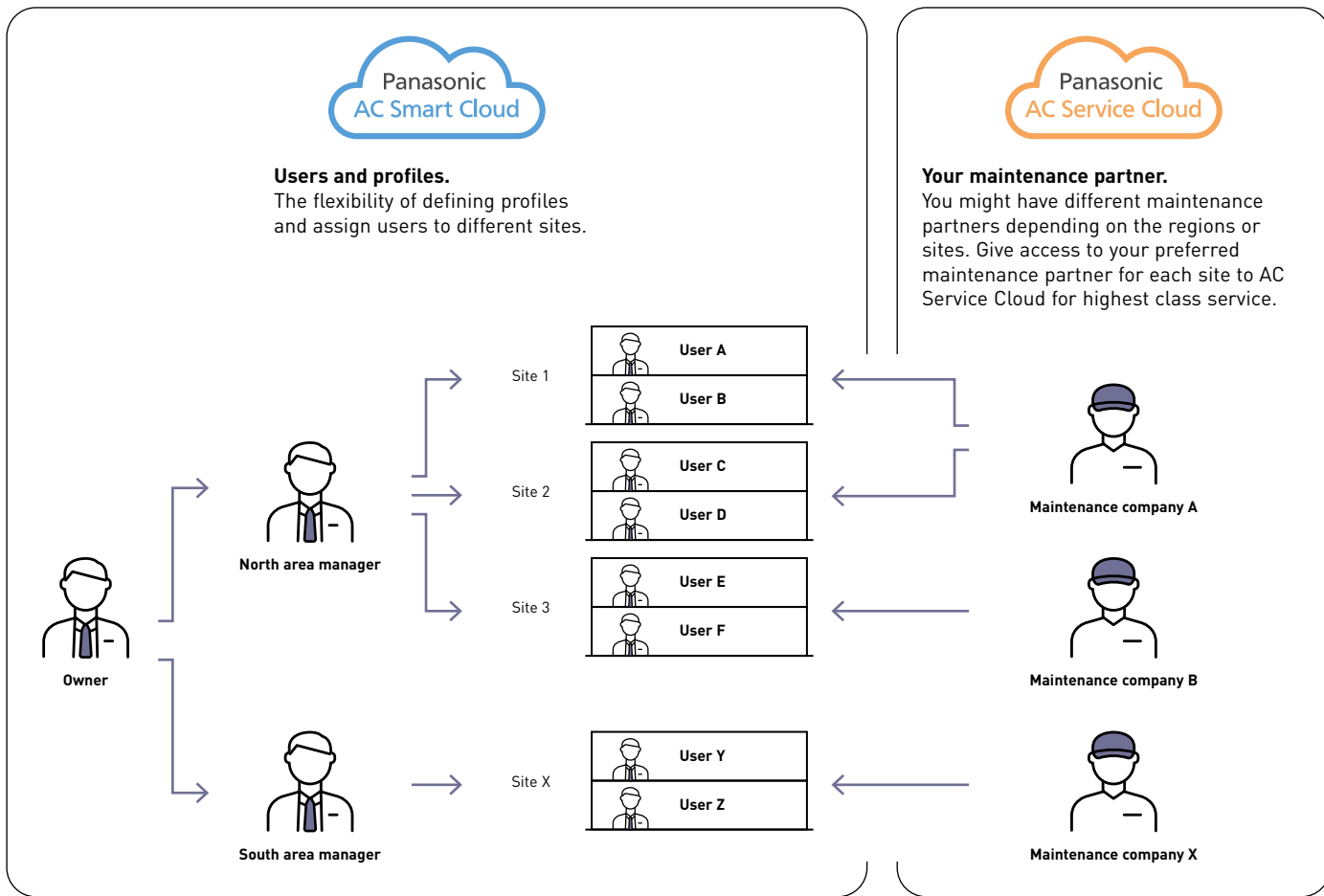

List of features

Panasonic AC Smart Cloud	Functionalities
Home screen	Overview of: operating status, location map, weather information, notification, energy consumption, efficiency, eco-friendly building list
AC settings	Indoor unit monitoring and remote control, outdoor unit details, cloud adapter details, floor map view, maintenance notification (installer)
Visualization	Statistical data regarding energy consumption, capacity and efficiency ranking; per indoor unit, unit group or refrigerant circuit
Notification	Warnings and alarms, maintenance intervals
Schedule	Schedule settings and results
Energy saving	Temperature range limits, unattended auto shutoff, temperature auto return, energy saving timer, demand/peak shaving
Demand control	Indoor unit and outdoor unit demand settings
Event control	Control inputs: alarms, digital inputs, indoor units. Control outputs: digital outputs, indoor units
System settings	CO ₂ factor, distribution groups, area allocation, cut-off requests, site management, group display, site location, software version
User account	New user registration, updating users, user lists, user roles
Floor map Editor	Floor map import and unit assignment
Help	Installer information, alarm mail setting, user data, account management, company/customer information, terms of use, privacy notice, cookie policy, user manual, FAQ. For installers: user manual, technical data, installation instructions
Additional functions for installers	Cloud adapter installation process, remote service checker data recording and download, remote cloud adapter firmware update

Panasonic AC Service Cloud

Panasonic AC Service Cloud provides maintenance companies a unique tool to deliver advanced service and maintenance features, decreasing response times, reduce sites visits and better allocate resources.



1 Response time and zero down time
Providing technical information about abnormalities and checker functions remotely enables the AC installer and maintainer to identify and fix issues much quicker, even before it occurs.

2 Reduce unnecessary trips
It reduces the cost of unnecessary trips, reducing the CO₂ emissions associated to the transport.

3 Maintenance planning
With a simple click, easily identify the nature of potential issues, enabling issue classification, prioritisation of resources and better planned site visits, through assigning the right engineer for the job.

4 All at a glance and scalability
Remotely view all sites requiring maintenance of Panasonic HVAC. Increase the number of sites maintained, taking advantage of future updates and features of the Panasonic AC Service Cloud.

Key functions

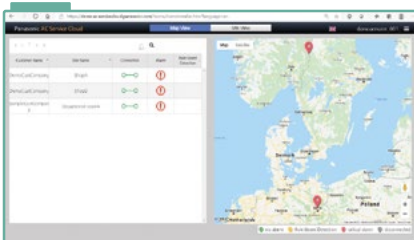

All sites at a glance.



Topology.

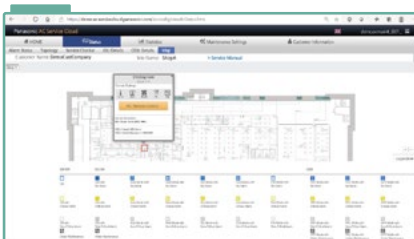

Floor map view.

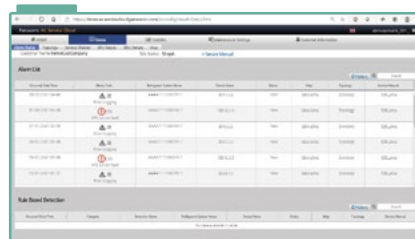

Alarm status.



Owners can manage different maintenance companies for each site, enabling or disabling access with just one click. Maintenance companies can have access to all sites where different owners gave permissions.

New system health check function

Self diagnosis function is ready in the Panasonic AC Service Cloud. It automatically detects potential malfunctions and helps to speed up your service process.

- Consecutive automatic monitoring at 15 minute intervals
- Key notifications in the event potential malfunction is detected
- 2D graph display to help with detailed analysis
- Threshold values can be easily adjusted

* For compatible models, please contact an authorized Panasonic dealer.

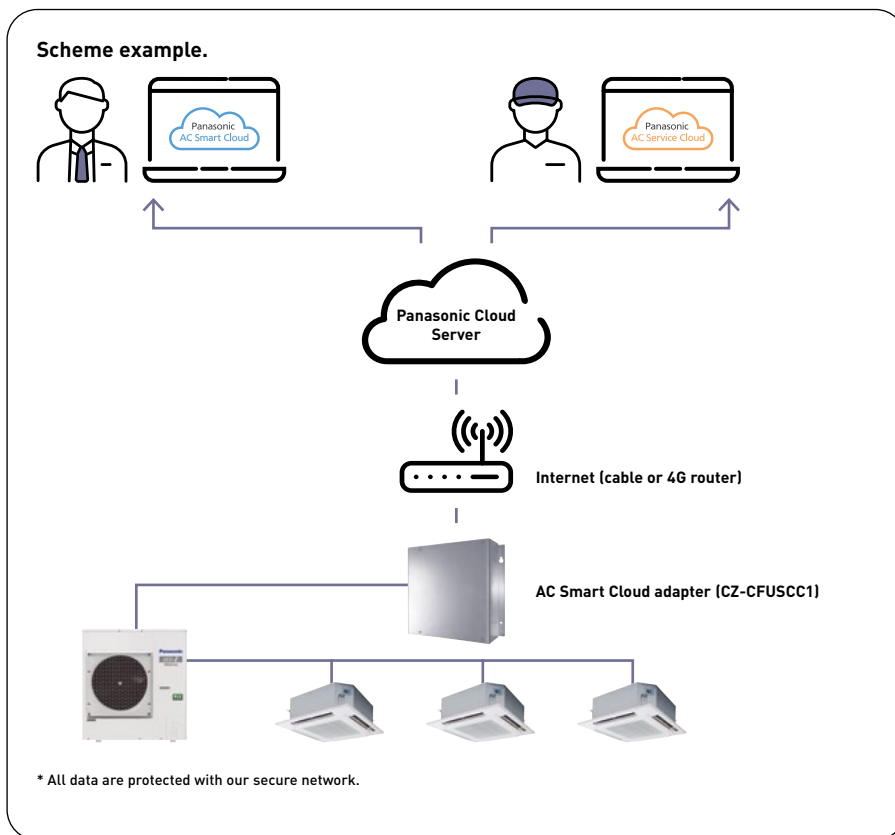
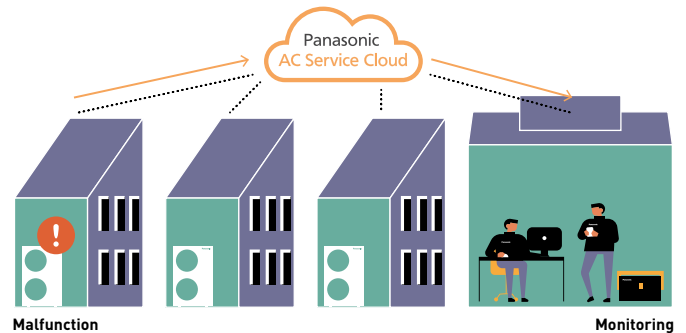

Technical requirements:

- CZ-CFUSCC1 – AC Smart Cloud adaptor
- Internet connection via: LAN with access to internet

Optional hardware:

- CZ-CAPRA1 – integration of RAC systems
- Pulse meters (supplied by others): up to 3 pulse meters (gas or power meters) can be connected to the cloud adapter, extendable by additional communication adapters (CZ-CFUSCC2)

Systems supported by AC Smart Cloud adapter:

- ECOi
- ECO G
- PACi / PACi NX
- RAC (an interface CZ-CAPRA1 is required)

List of features

Panasonic AC Service Cloud Functionalities	
Home screen	Map view and site view with site names, connection status and alarm status
Status	Alarm status, site topology, remote service checker, indoor unit monitoring and remote control, outdoor unit details, floor map view with service manual download
Statistics	Refrigerant circuit view (current data and recorded data), data table view, 2D graph view
Maintenance settings	Notifications and alarms, maintenance intervals setting (operating hours)
Customer list	List of connected customers, requests to access customer sites
Cloud adapter	Cloud adapter installation wizard, remote firmware update
Floor map editor	Floor map import and unit assignment
Help	Alarm mail setting, user data, account management, company/customer information, terms of use, privacy notice, cookie policy, user manual, user manual, technical data, installation instructions, FAQ

Panasonic AC Smart Cloud and Panasonic AC Service Cloud packages

Get the cloud base kit (CZ-CFUSCC1 + start up) and register to one of the subscription periods (1, 3 or 5 years).

The selection of the right Panasonic AC Smart Cloud package depends on the size of the installation.

	Items	Reference	Description
Up to 32 indoor units	Cloud base kit KIT-ACSCBASE32	CZ-CFUSCC1	Cloud adapter for PACi, ECOi and ECO G ¹⁾
		SR-ACSCSTART32	Panasonic AC Smart Cloud start up
	AC Smart Cloud subscription ²⁾	SR-ACSC1Y32	Subscription for 1 year
		SR-ACSC3Y32	Subscription for 3 years
		SR-ACSC5Y32	Subscription for 5 years
Up to 64 indoor units	Cloud base kit KIT-ACSCBASE64	CZ-CFUSCC1	Cloud adapter for PACi, ECOi and ECO G ¹⁾
		SR-ACSCSTART64	Panasonic AC Smart Cloud start up
	AC Smart Cloud subscription ²⁾	SR-ACSC1Y64	Subscription for 1 year
		SR-ACSC3Y64	Subscription for 3 years
		SR-ACSC5Y64	Subscription for 5 years
Up to 128 indoor units ³⁾	Cloud base kit KIT-ACSCBASE128	CZ-CFUSCC1	Cloud adapter for PACi, ECOi and ECO G ¹⁾
		SR-ACSCSTART128	Panasonic AC Smart Cloud start up
	AC Smart Cloud subscription ²⁾	SR-ACSC1Y128	Subscription for 1 year
		SR-ACSC3Y128	Subscription for 3 years
		SR-ACSC5Y128	Subscription for 5 years
Up to 512 indoor units	Cloud base kit KIT-ACSCBASE512	4x CZ-CFUSCC1	Cloud adapter for PACi, ECOi and ECO G ¹⁾
		SR-ACSCSTART512	Panasonic AC Smart Cloud start up
	AC Smart Cloud subscription ²⁾	SR-ACSC1Y512	Subscription for 1 year
		SR-ACSC3Y512	Subscription for 3 years
		SR-ACSC5Y512	Subscription for 5 years

1) Only together with start up 2) Includes first 2 years of Panasonic AC Service Cloud. 3) Model references up to 192/256/320 indoor units are also available. One cloud adapter is required per 128 indoor units.

Additional optional services.

Panasonic AC Service Cloud	SR-ACSC1Y32M	Panasonic AC Service Cloud 1 year fee
Floor map ⁵⁾	SR-ACSC1FLRUP	Upload 1 floor map or maximum 32 units
Floor map ⁵⁾	SR-ACSC1FLRCR	Create 1 floor map or maximum 32 units
Indoor assign ⁵⁾	SR-ACSC32ASSIGN	Assign indoors up to 32 units
Power meter		For power meter hardware, please discuss with your local sales representative
4G Router	PAW-ACSCRTR4G	4G Router for Panasonic AC Smart Cloud
SIM card	PAW-ACSCSIM	SIM card without data amount
Data amount of SIM card	PAW-ACSCDAT32	Data amount 1 year fee
4G connectivity kit ⁵⁾	KIT-ACSC4GCNT	4G connection kit including 4G Router and SIM card

5) Floor map and indoor assignments can be done by customer without additional charge. 5) Data amount of SIM card is not included.



Selection steps

What service do you need? There are 2 options as follows.

Panasonic AC Smart Cloud only.



Please follow step: **1**

Panasonic AC Smart Cloud + Panasonic AC Service Cloud.



Please follow step: **1 2**

* Panasonic AC Smart Cloud is always required to use Panasonic AC Service Cloud.

1 Setup for Panasonic AC Smart Cloud.



1 | Determine your number of indoor units.



Cloud adapter:
(CZ-CFUSCC1)

2 | Select the appropriate cloud base kit.

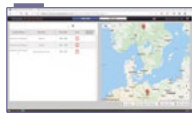

Start up.
Depending on the size of the installation.
SR-ACSCSTART**

1 or 3 or 5
years

3 | Choose your subscription length.

* One cloud adapter (CZ-CFUSCC1) is required per site.



2 Setup Panasonic Service Cloud



Determine your number of indoor units and purchase the Panasonic Service Cloud access.

* Please order multiple by 32 if you have bigger systems.

3 Choose optional services to suit your needs.

- Floor map
- Floor map creation
- Indoor assign
- Power meter
- 4G connectivity



Commercial Wi-Fi Adaptor

Panasonic CZ-CAPWFC1 interface adaptor, allows connection of one or a group of indoor units to Panasonic Comfort Cloud App, which provides control, monitoring, scheduling and error alerts.

Control PACi, ECOi and ECO G indoor units with your smartphone from wherever and whenever you are, by using Panasonic Comfort Cloud App and Commercial Wi-Fi Adaptor.



Panasonic

POWER
LINK

RESET

SETUP





1 From 1 to 200 units
 User can control up to 10 different sites, with up to 20 units / groups per site. Additionally, one adaptor can be connected to 1 indoor or to a group of up to 8 indoors.

2 Voice control compatible
 Registering the unit to Panasonic Comfort Cloud App it makes it compatible with the most popular voice assistants.

3 Multi user
 The Panasonic Comfort Cloud App allows multi-user access control, whilst allowing user restriction to specific units.

4 Easy scheduling
 Complex weekly scheduling made simple. Not only for one unit, but across multiple sites and from a smartphone.

5 Energy monitor
 See the estimated power consumption and compare with other periods, to see how energy consumption can be further reduced. Check list of units that provides consumption*.

* Function available depending on the model.

6 Error codes
 Error code notification through the App, provides early notification and allows for faster repair.



Advanced smartphone control

This scalable solution is ideal for one system, one site or multiple locations. Coupling the adaptor with the already feature rich systems, makes it an ideal solution for residential and commercial applications.



Connection Diagram

Commercial Wi-Fi Adaptor wiring length is 1,9 m and connects to indoor unit thru T10 connector and R1/R2 terminal connectors.

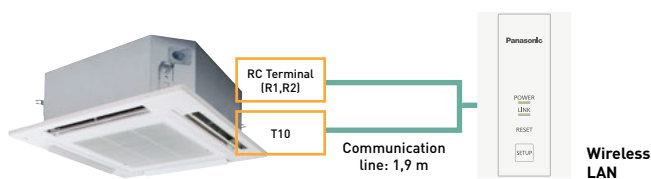

Input Voltage	DC 12 V (supplied from T10 connector)
Power Consumption	Maximum 2,4 W
Size (HxWxD)	120 x 70 x 25 mm
Weight	190 g (including communications lines)
Interface	1 x Wireless LAN
Wireless LAN Standard	IEEE 802,11 b/g/n
Frequency Range	2,4 GHz band
Operating range	0 ~ 55 °C, 20 ~ 80 RH%
Connectable indoor unit	1 unit
Length of communication line	1,9 m (included in the shipment)

Download free app: Panasonic Comfort Cloud App.

Other hardware requirements: Router and Internet (purchase and subscribe separately).

Panasonic Cloud Server is designed, operated and managed by Panasonic.

CONEX. Devices and apps

CONEX provides comfort and control for varying user needs. Accessible, flexible and scalable with different controllers and apps. Perfectly meeting requirements of modern controls for end user, installer and service. With nanoe™ X function, technology with the benefits of hydroxyl radicals.



Intuitive operation with simple and modern design panel.
Sophisticated design with black flat panel and compact body. From residential to commercial, the wired remote controller series perfectly matches with all kinds of modern building.
It enables user to recognize each function with a simple glance.

1 Intuitive control with stylish design

- Simple operation at a glance
- Clean face with full flat and black LCD display
- Compact body, only 86x86 mm

2 Control comfort with your smartphone

- Flexible control options with IoT integration
- New Panasonic H&C Control App for daily remote control operation
- Panasonic Comfort Cloud App for remote operation 24/7/365

3 Easy maintenance with service support app

- Quick and easy app set-up for system setting
- Panasonic H&C Diagnosis App enables the user to obtain detailed system operation data

* The use of apps depends on the remote controller model.

CONEX with IoT integration

The wired remote controller series is fully integrated with IoT solutions developed by Panasonic. Detailed operation, maintenance setting and service operation are all possible with smartphone or tablet.

CONEX



https://youtu.be/_USzG_9f6bk

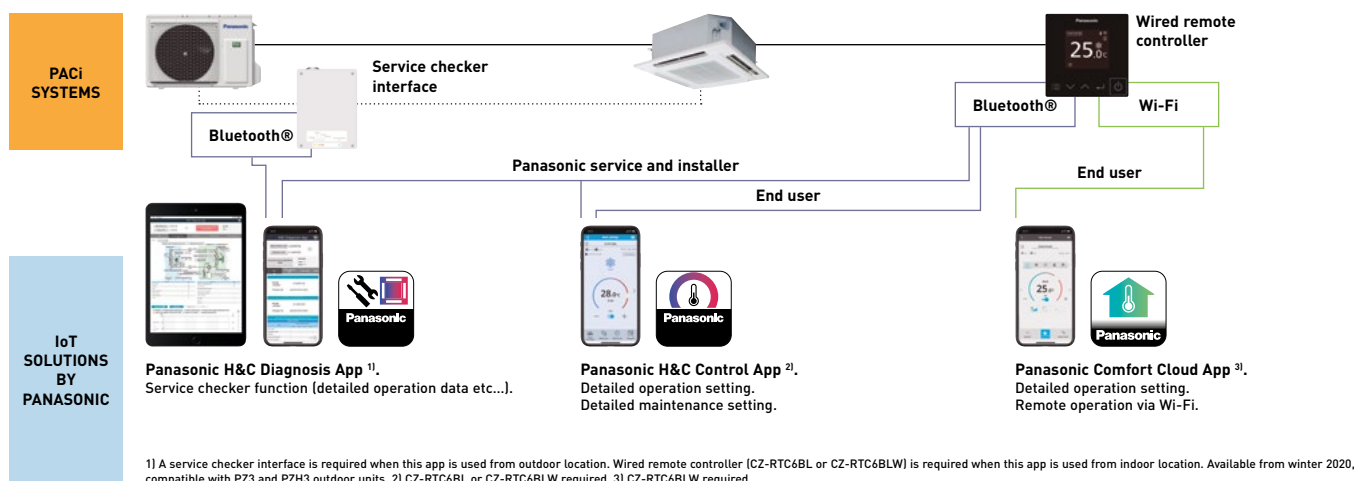

Service checker interface.

The service checker interface provides easy access to service parameters and service checker data via Bluetooth®.

- A new service checker interface* for PACi NX Series
- Bluetooth® connection
- Panasonic H&C Diagnosis App

* Available as a spare part, compatible with PACi NX Series.

Input voltage	220-240 V ~ 50-60 Hz (supplied from outdoor unit)
Power consumption	Maximum 2,4 W (including outdoor units)
Size (HxWxD)	175 x 125 x 50 mm
Weight	—
Interface	Bluetooth® 4.2 or later
Frequency range	2,4 GHz band
Operating range - Temperature / Humidity	0 ~ 40 °C / 20 ~ 80 % (no condensation)

* Frequency band in which the radio equipment operates; 2402 - 2480 MHz.

* Maximum radio-frequency power transmitted in the frequency bands in which the radio equipment operates; +0 dBm.



CONEX. Devices and apps

Flexible control options with IoT integration. 3 different apps for individual usage.

Panasonic H&C Diagnosis App for service and installer

Tool for diagnosis and troubleshooting.

Available functions:

- AC control
 - System view
 - Refrigerant circuit view
- Real-time data
 - Indoor unit
 - Outdoor unit
- Refrigerant cycle diagram and graph
- Data recording
- History data
- Error code tables

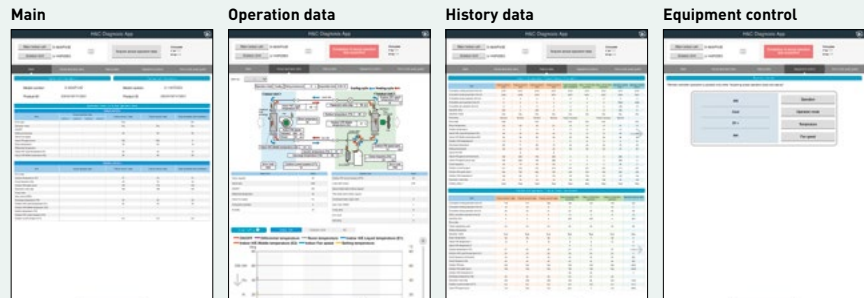

Panasonic H&C Control App for end user, service and installer

Detailed operation setting. Detailed maintenance setting.

Available functions:

- ON / OFF, mode, temperature, air flow volume, air flow direction
- Weekly timer
- All energy saving functions
- Alarm display and history
- Filter sign
- Test run
- Sensor value monitor
- Simple setting mode
- Detailed setting mode
- Key lock
- Ventilation fan control
- Display contrast adjustment
- Rotation, redundancy
- Quiet mode
- nanoe™ X
- Power consumption
- Unit naming



Panasonic Comfort Cloud App for end user

Remote operation via Wi-Fi.



Available functions:

- ON / OFF
- Mode
- Temperature
- Air flow volume
- Air flow direction
- Weekly timer
- Temperature setting range limitation
- Energy monitoring
- Alarm display
- nanoe™ X











Connectivity matrix

			
Model	CZ-RTC6	CZ-RTC6BL	CZ-RTC6BLW
Wired connection compatible with	PACi, PACi NX, ECOi, GHP	PACi, PACi NX, ECOi, GHP	PACi NX only
Wireless functions	No wireless capability	Bluetooth®	Bluetooth® + Wi-Fi
App compatibility			
Panasonic Comfort Cloud App	—	—	✓
Panasonic H&C Control App	—	✓ PACi, PACi NX, ECOi, GHP	✓ PACi NX only
Panasonic H&C Diagnosis App ¹⁾	—	✓ PACi NX only ²⁾	✓ PACi NX only ²⁾
Outdoor unit settings (remote controller connected to indoor unit)	✓ PACi NX only ²⁾	✓ PACi NX only ²⁾	✓ PACi NX only ²⁾

1) Compatible with U-71/100/125/140PZH3E5/8 and U-100/125/140PZ3E5/8. 2) When connected to PACi NX indoor and outdoor unit combination.

Function comparison

This shows the functions provided: a) by the remote controllers b) by the apps		Remote controller functionalities		Panasonic H&C Control App		Panasonic Comfort Cloud App	
							
		CZ-RTC5B	CZ-RTC6	CZ-RTC6BL(W) + app	CZ-CAPWFC1 + app	CZ-RTC6BLW + app	CZ-RTC6BLW + app
Basic operation	ON / OFF, mode, temperature, air flow volume, air flow direction	✓	✓	✓	✓	✓	✓
Timer functions	Time display	✓	—	✓	✓	✓	✓
	Easy ON / OFF timer	✓	—	✓	—	—	—
	Weekly program timer	✓	—	✓	✓	✓	✓
	Outing function	✓	✓	✓	—	—	—
	Temperature auto return	✓	—	✓	—	—	—
	Temperature setting range limitation	✓	—	✓	✓	✓	✓
Energy saving	OFF reminder	✓	—	✓	—	—	—
	Energy saving mode	✓	—	✓	—	—	—
	Schedule demand control	✓	—	✓	—	—	—
	Energy monitoring	✓	—	✓	✓	✓	✓
	Econavi	✓	✓	✓	✓	✓	✓
Maintenance	System failure information (alarm history)	✓	✓	✓	—	—	—
	Alarm display	✓	✓	✓	✓	✓	✓
	Service contact registration	✓	—	✓	—	—	—
	Filter sign	✓	✓	✓	—	—	—
	Test run	✓	✓	✓	—	—	—
	Sensor value monitor	✓	✓	✓	—	—	—
	Simple setting mode	✓	✓	✓	—	—	—
Others	Detailed setting mode	✓	✓	✓	—	—	—
	Key lock	✓	✓	✓	—	—	—
	Ventilation fan control	✓	—	✓	—	—	—
	Display contrast adjustment	✓	✓	✓	—	—	—
	Rotation	✓	—	✓	—	—	—
	Quiet operation mode	✓	—	✓	—	—	—
	nanoe™ X	✓	✓	✓	✓	✓	✓

Remote controller with Econavi

Easy to use, attractive, clear design, with new demand control functions and energy consumption display! This useful feature makes this remote controller unique!

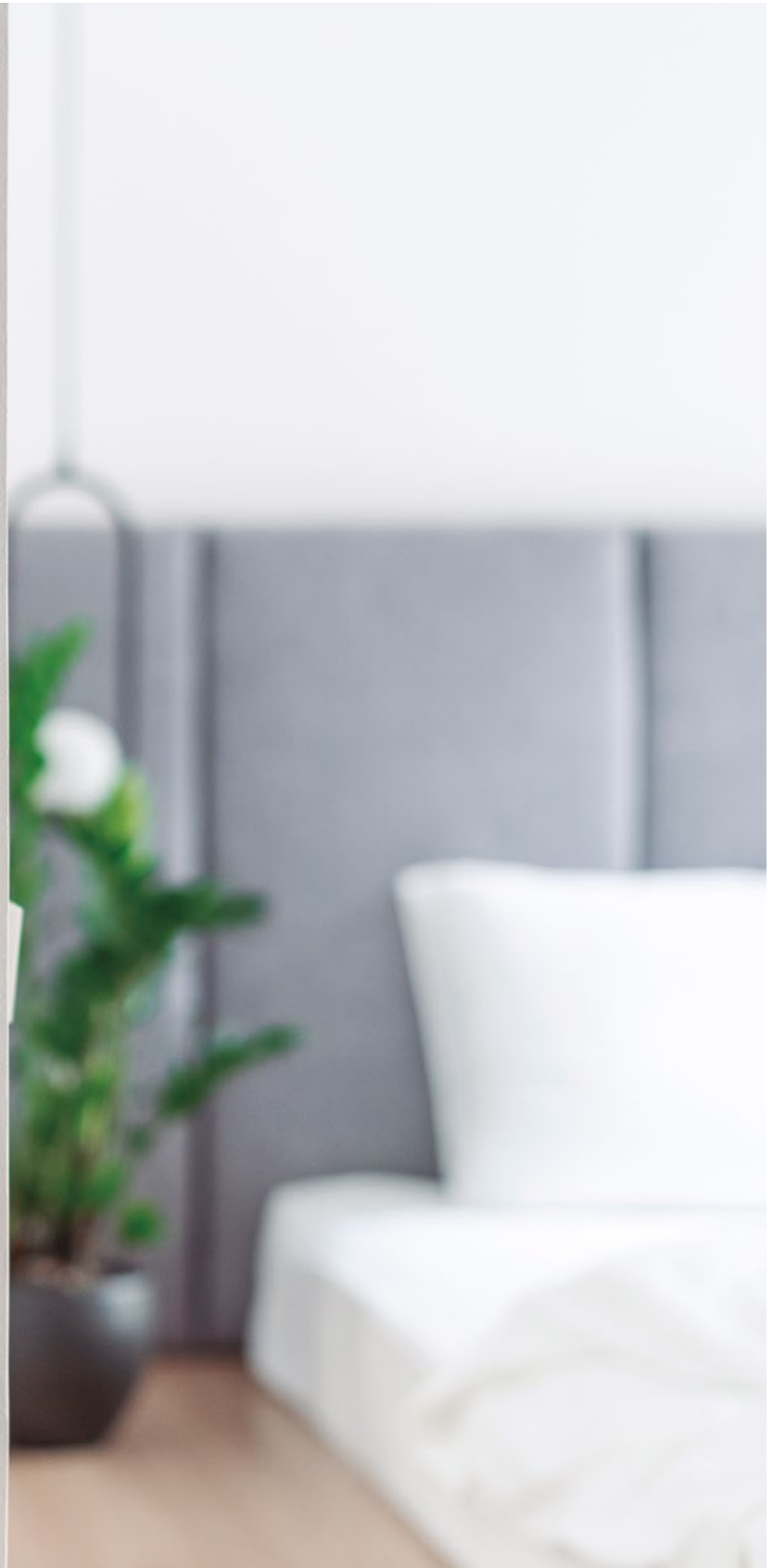



Design

The CZ-RTC5B wired remote controller is ideal for integration into the most demanding interior architectures. The touch panel features a very sleek and easy to use display, which with its compact display is only 120 x 120 x 16 mm.

Display of information

The information is mainly based on pictograms to ensure easy understanding. The minimal amount of text is available in 6 languages (English / German / French / Spanish / Italian / Polish). The screen is back lit to enable reading even during the night.

Basic function (operation display and indication)

All functions are easily available on the remote controller.

- OFF/ON timer · Weekly timer · Quiet operation · Remote controller sensor · Operation prohibit · Filter sign · Energy saving · Centralized control indication · Mode change prohibit · Automatic temperature return · Temperature range limitation · OFF remind · Schedule demand control · Ventilation · Out Function.

Key functions

- Easy setup of the timer and settings of the indoor unit
- Energy consumption display (for all R32 PACi line-up)
- Limitation of the energy consumption (Demand control) by timer.

Easy access to the menus.

With the new pictograms, the navigation, the selection and the settings are simple and easy to follow.

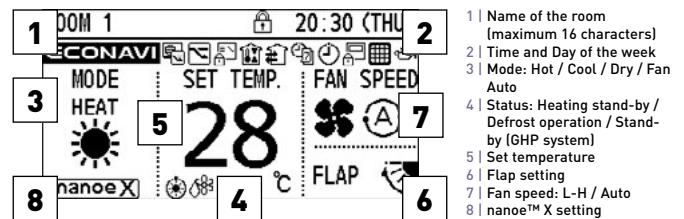

- 1 | Name of the room (maximum 16 characters)
- 2 | Time and Day of the week
- 3 | Mode: Hot / Cool / Dry / Fan Auto
- 4 | Status: Heating stand-by / Defrost operation / Stand-by (GHP system)
- 5 | Set temperature
- 6 | Flap setting
- 7 | Fan speed: L-H / Auto
- 8 | nanoe™ X setting

Easy operation and quick access to all menus

- 1 | Set temperature will be selected, when any arrow button is touched
- 2 | Select the item (Mode or Fan speed) by left/right ◀▶ key
- 3 | Change the setting by up/down ▲▼ key

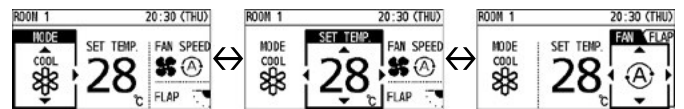

Example of easy access to the functions: air direction setting

- 1 | Select "Air direction" and press "Enter" key
- 2 | Select the unit number by up/down ▲▼ key
- 3 | Select the flap position by up/down ▲▼ key
- 4 | Press "Return" key to go back the Menu display

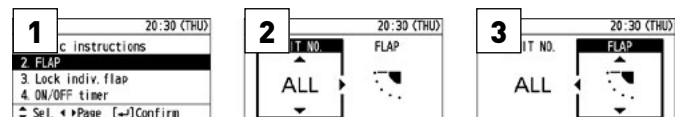

Back-up control by using CZ-RTC5B

Group wiring of 2 systems of PACi can do auto individual control: Rotation operation, back-up operation and support operation.

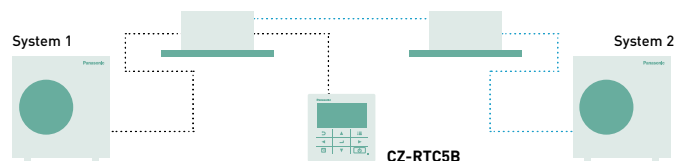

Functions available on the CZ-RTC5B

Control item	Controllability	Indoor units	
		PACi	VRF
Basic operation	Operation, Mode, Temperature setting, Air flow volume, Air flow direction	✓	✓
	Time display	✓	✓
Timer function	Easy ON / OFF timer	✓	✓
	Weekly program timer	✓	✓
	Outing function	✓	✓
Energy saving	Temperature auto return	✓	✓
	Temperature setting range limitation	✓	✓
	OFF remind	✓	✓
	Energy saving mode	✓	✓
	Schedule demand control	✓ ¹⁾	✓
	Energy monitoring - R32	✓	—

Control item	Controllability	Indoor units	
		PACi	VRF
Maintenance	System failure information	✓	✓
	Service contact registration	✓	✓
	Filter sign (rest time display) and reset	✓	✓
	Auto-address, Test run	✓	✓
	Sensor value monitor	✓	✓
	Simple / Detail setting mode	✓	✓
Others	Key lock	✓	✓
	Ventilation fan control	✓	✓
	Display contrast adjustment	✓	✓
	Remote controller sensor	✓	✓
	Quiet operation mode	✓ ¹⁾	—
	Prohibit setting control from central controller	✓	✓

All specifications subject to change without notice. 1) Not available with PACi Standard R410A line up.

Datanavi

Datanavi, a new way to connect.
Simple and easy support tool with your smartphone.



Overview of datanavi system

Just holding up your smartphone to the LED display on a remote controller (CZ-RTC5B) to receive useful AC system information super fast by Panasonic Light ID Technology. Datanavi also connects to Panasonic Cloud Server for the quick view of manuals, saving data received by Light ID.



Key functions

- Scan and Save AC system info
- Easy access to manual database
- Commissioning, F-Gas check data history

What is the Light ID technology developed by Panasonic?

Visible light transmission technology, which enables to transmit information by high-speed and invisible flashing of an LED light source.

FAST AND INTUITIVE

EASY ACCESS TO MANUAL DATABASE

ACCURATE SERVICE DATA ON YOUR SMARTPHONE

User / administrator (person in charge of AC) functions

- **Fast and intuitive.** Regular operation data, energy consumption data display
- **Easy access to data base.** Getting manuals related on demand
- **No idea what to do when an error happens?** You can share error information and contact service easily

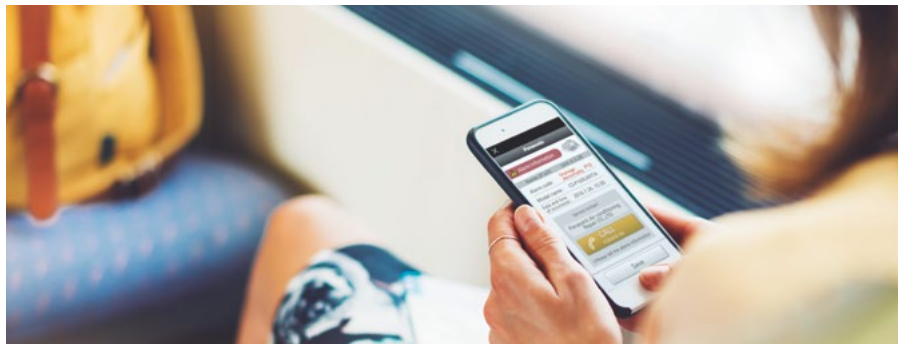

Installer / service company functions

- **Getting technical data depends on your need**
Service manual. Q and A list. Test run information
- **Accurate error information**



Regular operation

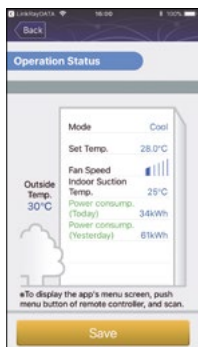

Energy management



Malfunction notice

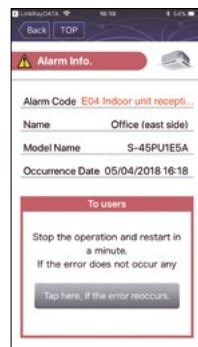

Operating manual

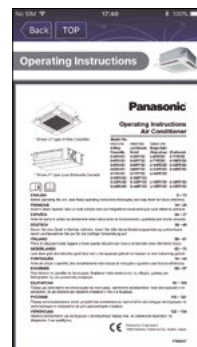

Test run info

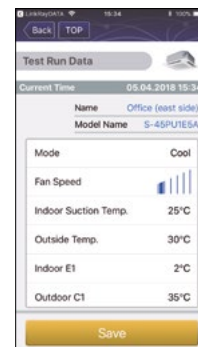

Service data



* User interface image may be updated without notification.

- Simple F-gas regulation check list
- Repair speed check list

Download free apps, try datanavi!

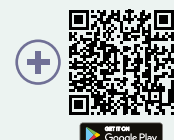
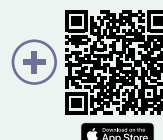

Intelligent controller

This controller is the smart solution for your advanced requirement in buildings.



Intuitive operation

The screens used for operations all follow a common pattern, with the screens being easy to read and easy to use.

- Enlarged screen (10,4 inch) with colour LCD
- Smartphone-like gestures (flick, swipe, touch)

Large screen display. Enlarged by 60 %.



Easy swipe or flick operation.

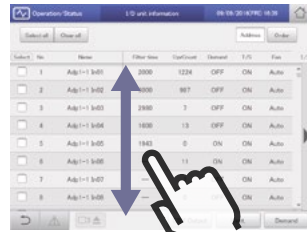

Swipe.
This is an operation where the finger is slid in a direction (up or down) on the touch panel. This is used to scroll slowly.

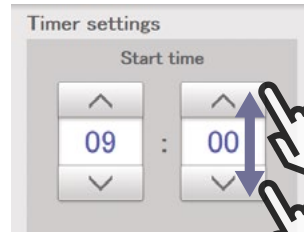

Select.
This is an up and down movement of the finger touching the screen, used to pick settings in elements such as spin boxes.

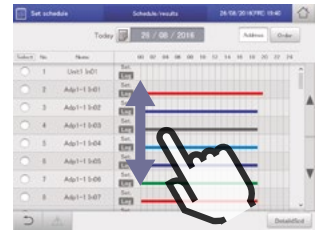

Pull out.
This is an operation where the finger on the touch panel is flicked in a direction (up or down). This is used to scroll quickly.

Enhanced functions for energy saving as standards

- Set temperature auto return settings, Auto shut OFF, set temperature range limit settings
- Demand control function

Screen of set temperature auto return setting.

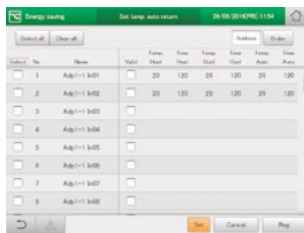

Auto shut OFF.



Screen of outdoor demand control.

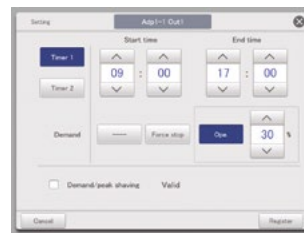

- Outdoor demand input and timer settings possible
- Indoor can be set at ± 1 °C/ ± 2 °C or thermostat OFF
- Indoor units controlled in sequence at 10-minute intervals

Energy visualization

- Energy saving plans are supported with graph display function
- Displays electricity and gas usage distribution

Screen of graph display.

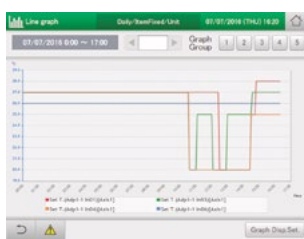

Useful parameters are shown for your better energy saving. Ex.) Bar graph:

Indoor unit: Total operating time, thermostat ON operation time (Min.)
Amount used (electricity, gas)
Electricity or gas charges

Outdoor unit: Outdoor unit operation cycles (# cycles)
Engine time in operation (Hrs.)
Cumulative Inverter power output
Cumulative PV power output

Pulse value selection per different data intervals 1 hour/1 day/ 1 month compared with last year.

Main function

Gesture function (flick, swipe, touch)	✓
Graph display (trends, comparisons)	✓
Web functions (maximum 64 users)	✓
Recipient setting for warning email	✓ (Maximum 8)
Automatic return to setting temperature	✓
Limitation of setting temperature range	✓
Left-on prevention	✓
Quiet operation of outdoor unit	✓
Occupant sensor linkage	✓
Demand function	✓
Charge calculation	✓
Log display	✓ Warning 10000 items. Status change 50000 items
Linked control (event definition 50 events, input: 32, output: 32)	✓
Under maintenance (under inspection registration)	✓

Econavi Sensor

The Econavi sensor detects presence in the room, and quietly adapts the PACi or VRF air conditioning system in order to improve comfort and energy savings.





- Detects human activity and adjusts temperature by 2 degrees (up or down) to optimise comfort and efficiency
- If there is no activity detected for a set time period, the Econavi will stop the unit or move to a new temperature previously set
- The Econavi device is installed independently of the indoor unit, and is located in the area best suited for detection

Applications

Saving energy for offices: If the air conditioning is left on after the last employee leaves the office, Econavi will automatically react, reducing or stopping the system.

Increased comfort in hotel rooms: When presence is detected in the room, the temperature is automatically adjusted to achieve best comfort.

Key points

- Compatible with cassette, wall-mounted, hide-away and Ceiling units
- Improves efficiency
- Better comfort
- Can be installed in the best location within the room for detection purposes

Sensor location image

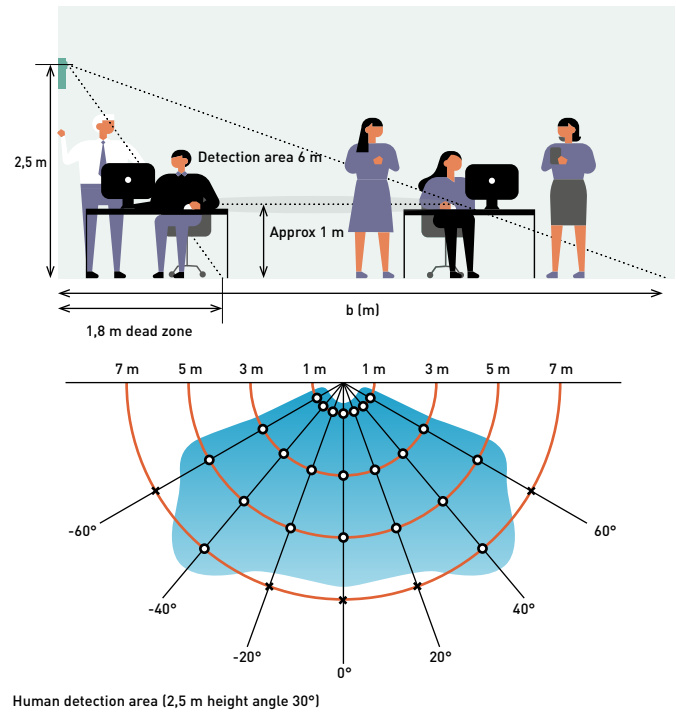

Providing outstanding energy saving performance, Panasonic's Inverter system can be connected to Econavi to detect when energy is being wasted. Econavi senses the presence or absence of people and the level of activity in each area of an office. When unnecessary heating or cooling is detected, indoor units are individually controlled to match office conditions for energy saving operation.

Detection of the level of activity enables precise power saving.

Presence or absence of people at their desks and the level of activity in the office are detected in real time. Set temperature is automatically adjusted to optimise the lower power consumption.

Remote Econavi sensor allows optimum energy operation.

Pillars, walls, cabinets and other fittings obstruct the sensor, reducing the area of detection and lowering the energy saving effect. Taking into consideration blind spots, Panasonic enables the optimum layout for sensors in any office.



Econavi sensor: CZ-CENSC1

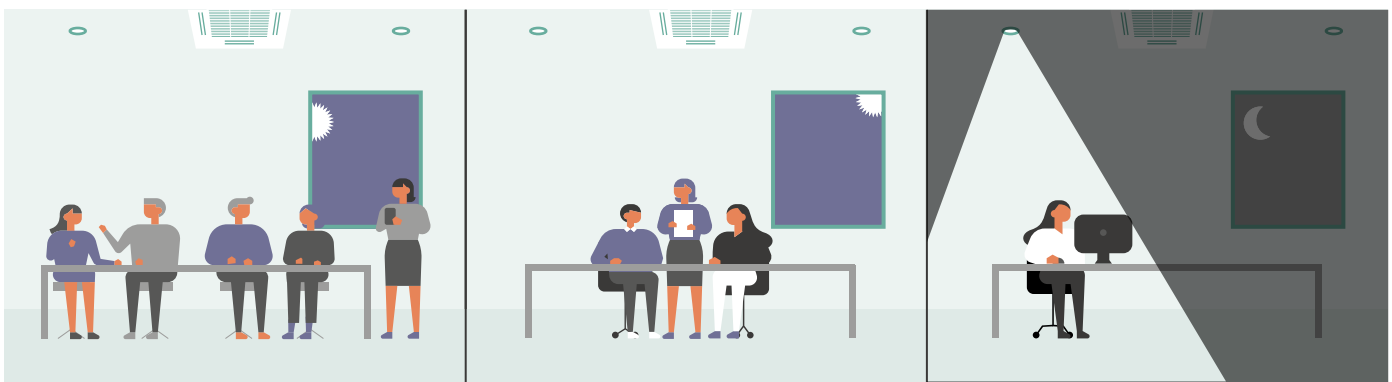

In the morning.
Thorough cooling when there is a high level of activity

In the afternoon.
Reduced cooling when there are fewer people

At night.
Automatic Thermo OFF depending on conditions at the end of the day

Controller for hotel application

Innovative line up of room controllers specially designed for hotel applications. With a modern cosmetic that match room interiors and simple operation for hotel guests.

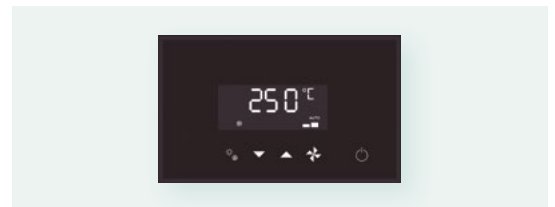
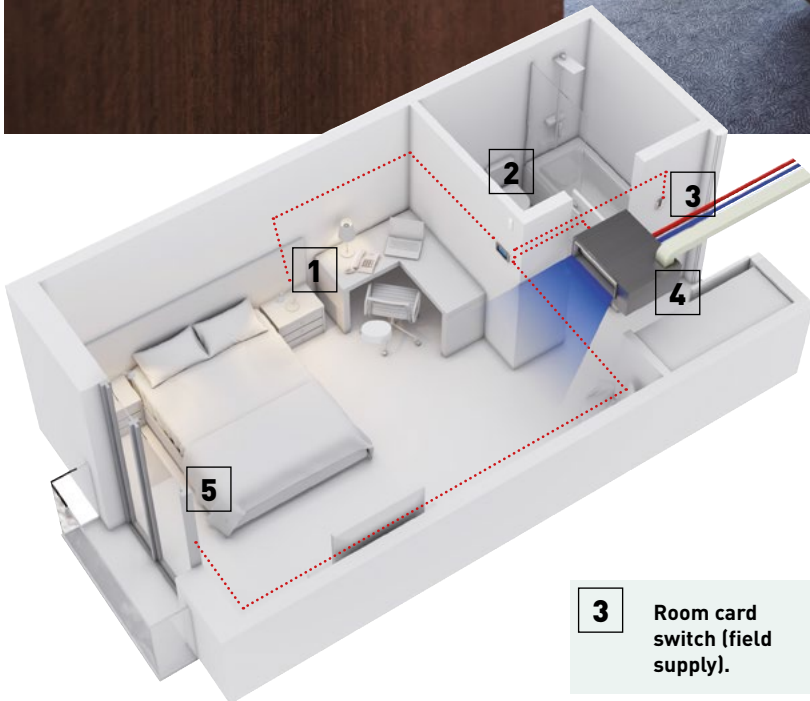

3 Room card switch (field supply).

Controller to integrate all room hotel needs in one device.
Card switch. Heating and cooling control. Light control. Window control. Possible to connect to Modbus.



Lighting control.



Wall sensor
PAW-WMS-AC (-DC).



Indoor unit. Variable static pressure hide-away.



Window contact
PAW-DWC.

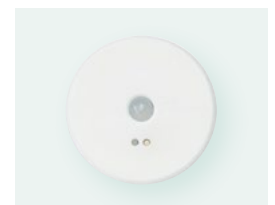

Ceiling motion sensor
PAW-CMS-AC (-DC).

- Easy to install
- Cost effective installation as all electrical cable are centralized on this remote: The lighting, card contact, motion detector, window contact and the air conditioning are controlled
- Architect inspired attractive design with 2 colors: black or white
- Stand alone and Modbus
- Bespoke finish as special order

Energy saving functions included on the device.

Turns OFF air conditioning and lighting when room is unoccupied. Disables air conditioning when window is open. Maximum/minimum setpoint temperature configurable.

Easy remote controller.

The hotel guest will have access to limited functions to control the air conditioning: ON / OFF, Temperature and Fan speed.

Easy set up.

Stand alone model with easy configuration menu to access all parameters. A pre-define scenario can be uploaded on the remote controller connected to a computer to make installation on site Plug & Play (only on the Modbus models).

New NFC fast set up.

With the new touch display control and touch room controller setting are quicker than ever. Just touching smartphone with NFC capability the settings will be saved. This function is also possible even when the control is not wired. Giving flexibility to save the setting even before installation.

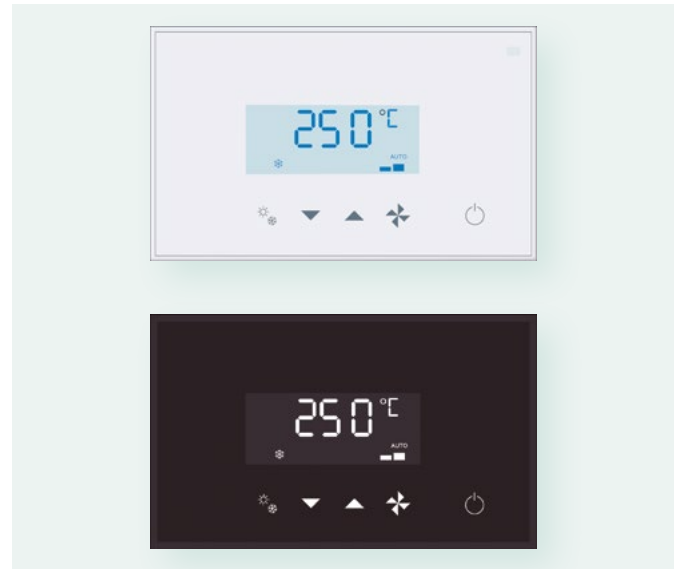

Type	Model	Colors	Digital inputs	Digital output	BMS	Inst. set up	T. sensor
Touch display controller	PAW-RE2D4-WH	White	2			NFC	Built-in
	PAW-RE2D4-BK	Black	2			NFC	Built-in
Touch room controller	PAW-RE2C4-MOD-WH	White	4	4	Modbus	NFC	Built-in
	PAW-RE2C4-MOD-BK	Black	4	4	Modbus	NFC	Built-in

Room controller: 4 digital inputs and 4 digital output

Room controller offers flexibility and easy installation thanks to 4 preconfigured options. This is available in Modbus type. Modbus references: PAW-RE2C4-MOD-WH, PAW-RE2C4-MOD-BK.

Wiring configuration example for option 2 in Modbus type.

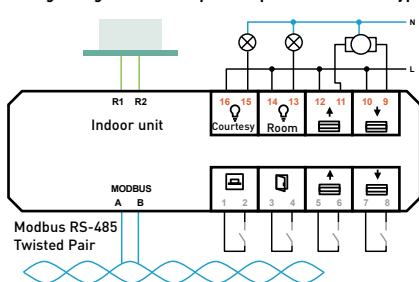

Configurations	4 options available I/O configurations: Inputs				Available I/O Configurations: Outputs			
	Digital 1-2	Digital 3-4	Digital 5-6	Analog 7-8	Relay 15-16	Relay 13-14	Relay 11-12	Relay 9-10
Option 1	Card	Window	Lighting	Temperature	Courtesy	Lighting	Not used	Valve actuator
Option 2	Card	Window	Blinds up	Blinds down	Courtesy	Lighting	Blinds up	Blinds down
Option 3	Motion sensor	Window	Door contact	Temperature	Courtesy	Lighting	Not used	Valve actuator
Option 4	Lighting	Window	Blinds up	Blinds down	Not used	Lighting	Blinds up	Blinds down

Display: 2 digital inputs

Display control allows to handle 2 inputs to perform most common operation in room hotels.

References: PAW-RE2D4-WH, PAW-RE2D4-BK.

Wiring example for display controller.

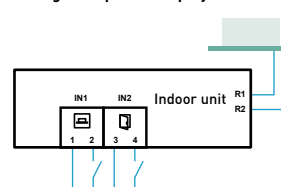

Configurations	3 options available: Inputs	
	IN1 (1-2)	IN2 (3-4)
Option 1	Card	Window
Option 2	Motion sensor	Window
Option 3	Motion sensor	Door contact

Hotel room controller	
PAW-RE2C4-MOD-WH	Modbus RS-485 touch room controller with I/O, white
PAW-RE2C4-MOD-BK	Modbus RS-485 touch room controller with I/O, black
PAW-RE2D4-WH	Touch display control with 2 digital inputs, white
PAW-RE2D4-BK	Touch display control with 2 digital inputs, black

Accessories sensors	
PAW-WMS-DC	Wall silent motion sensor 24 V
PAW-WMS-AC	Wall silent motion sensor 240 V AC
PAW-CMS-DC	Ceiling silent motion sensor 24 V
PAW-CMS-AC	Ceiling silent motion sensor 240 V AC
PAW-24DC	Power supply 24 V
PAW-DWC	Door or window contact

BMS interface with P-Link

BMS interface with Panasonic communication bus helps you to get significant savings.

In addition to reducing the time of configuration and installation, the potential mistakes can be avoided.

Easy to use and reliable interfaces for a straightforward integration.

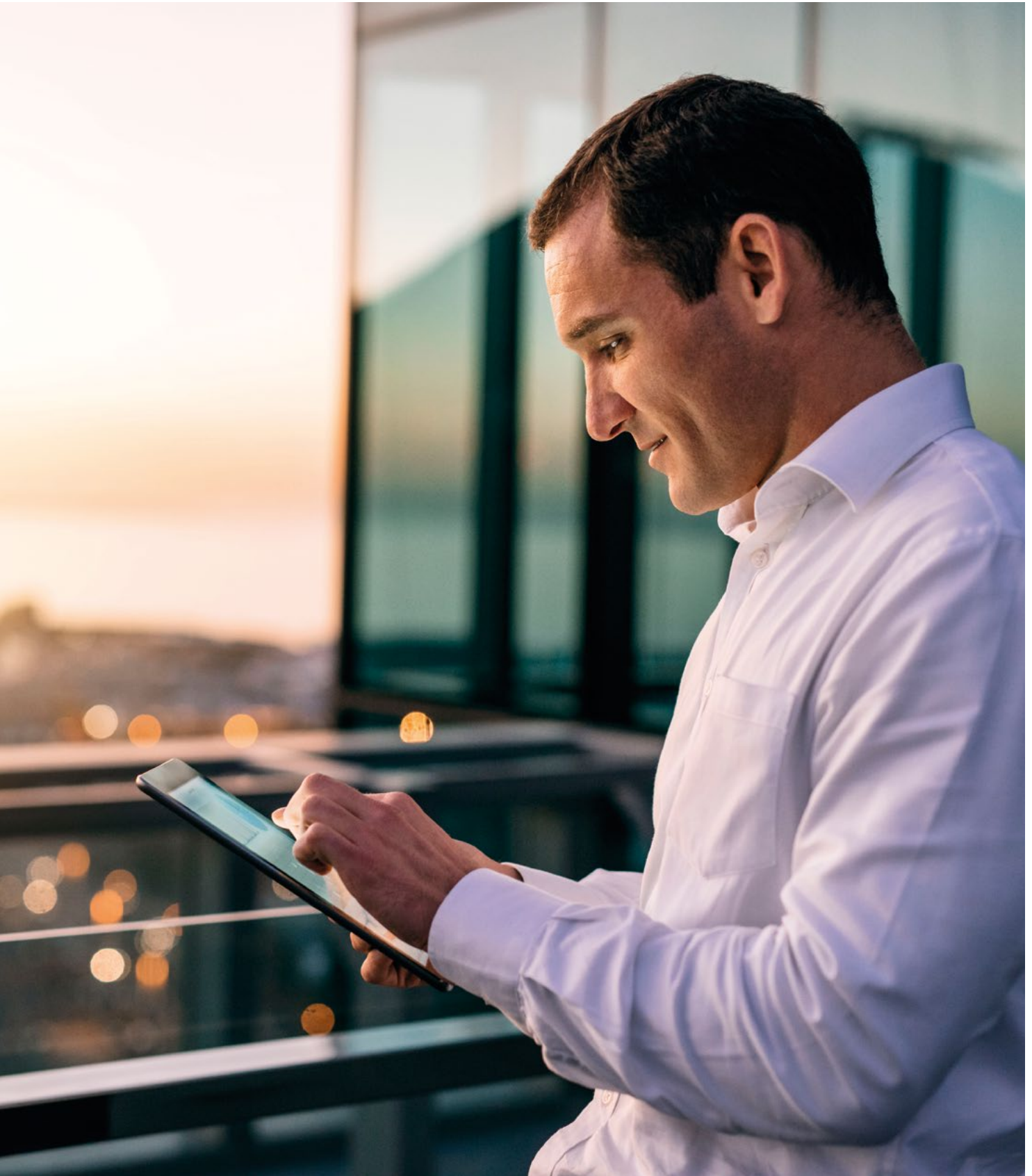



Modbus®

Home automation



1 Direct connection to P-Communication bus

- No need for additional gateway (CZ-CFUNC2)
- Significant 50 % cost saving for BMS interface*
- Avoid mistakes and reduce configuration time.

* In the case of PAW-AC2-BAC-16P by Panasonic calculation.

2 Easy configuration

- Single configuration tool for all models (Intesis MAPS)
- Firmware updates with new improvements and features
- Scan: Automatic identification of the units present in the VRF system
- Front cover LED indicators provide easy to check communication status.

3 Upgraded specifications

- Outdoor unit's signal available for the integration
- BACnet: Version 14 and BTL Certified
- Datalogging through external USB port (for service)

Direct connection to P-Communication bus

The interface can provide faster, cheaper, easier solution in your projects!

Old interface.

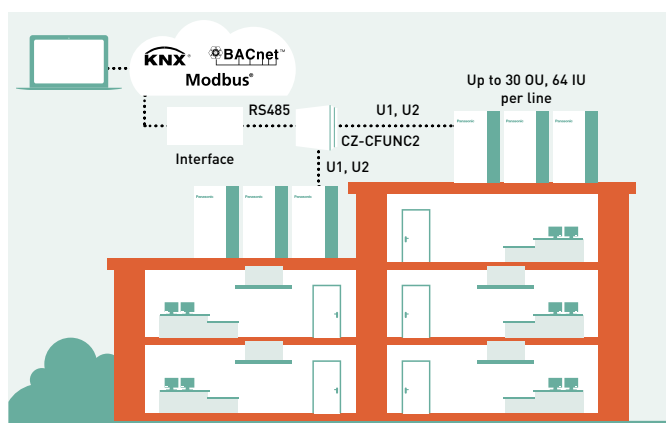

Maximum 128 indoor units can be connected. Panasonic Gateway, CZ-CFUNC2 is required.

Interface with P-communication bus.

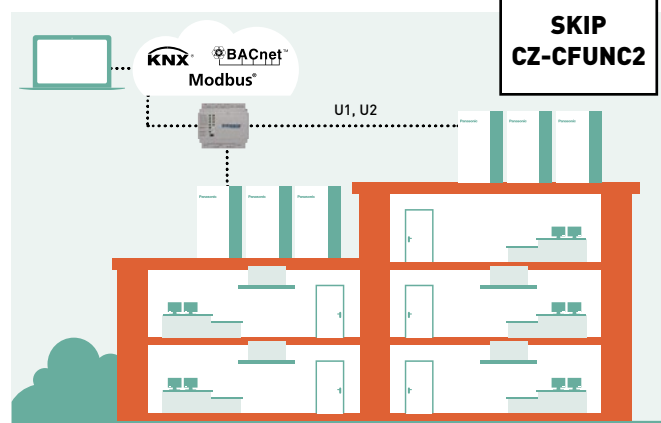

U1U2 link is connected directly to IntesisBox. Support from 16 to 128 per each box.

New! Home automation compatibility for Smart Home systems for PAW-AC2-MBS

Drivers available for:

- AMX
- Control4
- eedomus
- Elan
- Fibaro
- iRidium
- Eedom
- RTI
- Savant

Creston, Kuju and Vera available soon.



Model for BACnet	Maximum number of indoor units connected
PAW-AC2-BAC-16P	16 indoor units
PAW-AC2-BAC-64P	64 indoor units
PAW-AC2-BAC-128P	128 indoor units
Model for Modbus	Maximum number of indoor units connected
PAW-AC2-MBS-16P	16 indoor units
PAW-AC2-MBS-64P	64 indoor units
PAW-AC2-MBS-128P	128 indoor units
Model for KNX	Maximum number of indoor units connected
PAW-AC2-KNX-16P	16 indoor units
PAW-AC2-KNX-64P	64 indoor units

Version	Connectable indoor units	Connectable outdoor units	Nr. of P- Communication bus port
16	1-16	1-16	1
64	1-64	1-30	1
128	128 (1-64 / P- Communication bus port)	60 (1-30 / P- Communication bus port)	2

Control and connectivity

A wide variety of control options to meet the requirements of different applications.

Centralized control systems

Centralised control.



P-AIMS core software.
Up to 1024 indoor units.
CZ-CSWK2

Intelligent controller.



Intelligent controller.
Up to 256 indoor units touch screen with web server.
CZ-256ESMC3

Panasonic AC Smart Cloud.



Cloud internet control.
Up to 128 groups. Controls 128 units.
CZ-CFUSCC1

Connection with general equipment.



ON / OFF control for external devices such as ERV.
Controls 1 unit.
CZ-CAPC3



Mini Seri-Para I/O Unit 0 - 10 V.
Controls 1 indoor unit or a group of 8 indoor units.
CZ-CAPBC2



Communication Adaptor.
Up to 128 groups. Controls 128 units.
CZ-CFUNC2

Domestic integration to P-Link - CZ-CAPRA1

Can connect RAC range to P-Link. Full control is now possible.

Integrates any unit in big system control.

- YKEA server room integration ¹⁾
- Small offices with domestic indoors
- Tender for refurbishment (old system Domestic and VRF in one installation)

¹⁾ When duty rotation using the remote controller is set up, CZ-CAPRA1 cannot be connected.

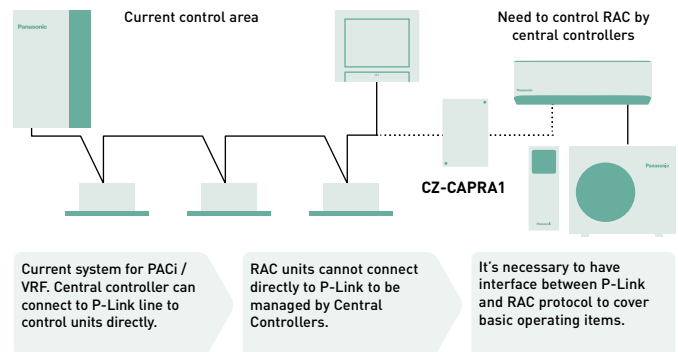

<p>Centralized Control Systems: 64 indoor units</p>	<p>Intelligent controller / Web Server: 256 indoor units</p>	<p>Panasonic AC Smart Cloud</p>
--	---	--

Basic operation items: ON / OFF, Mode select, Temperature setting, Fan speed, Flap setting, Remote control prohibit.
External input: ON / OFF control signal, Abnormal stop signal.
External output for Relay ¹⁾: Operation status (ON / OFF), Alarm status output.

¹⁾ Because current CN-CNT connector can not provide the power for external output relay, additional Input power for external relay is necessary.







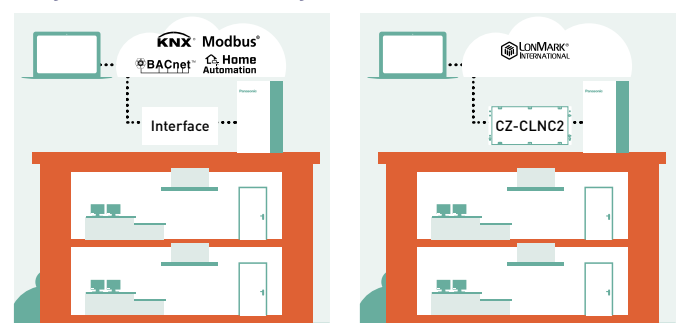

Easy connection to KNX, Modbus, Lonworks, BACnet and Proprietary Home Automation Systems

Easy and reliable solution to integrate your Panasonic heating and cooling systems into any B.M.S or E.M.S. Fully bi-directional communications with all necessary parameters.

For more information, contact Panasonic.





			Econavi control	Built-in thermostat	Indoor units which can be controlled	Use limitations	Function ON / OFF	Mode setting	Fan speed setting	Temperature setting	Air flow direction	Permit/Prohibit switching	Weekly program	BMS protocol	
Individual controllers															
Touch room controller for hotel with Dry Contacts		PAW-RE2C4-MOD-WH PAW-RE2C4-MOD-BK WH: White, BK: Black. Bespoke finish available on request.	-	✓	1 indoor unit	-	✓	✓	✓	✓	-	✓	-	Modbus + 4 digital I/O signals	
Touch display control for hotel with Dry Contacts		PAW-RE2D4-WH PAW-RE2D4-BK WH: White, BK: Black. Bespoke finish available on request.	-	✓	1 indoor unit	-	✓	✓	✓	✓	-	✓	-	Stand Alone + 2 digital inputs	
Design wired remote controller		CZ-RTC5B	✓	✓	1 group, 8 units	· Up to 2 controllers can be connected per group	✓	✓	✓	✓	✓	-	✓	-	
Wired remote controller		CZ-RTC6 Non-wireless	✓	✓	1 group, 8 units	· Up to 2 controllers can be connected per group	✓	✓	✓	✓	✓	-	-	-	
		CZ-RTC6BL With Bluetooth®	✓	✓	1 group, 8 units	· Up to 1 controller can be connected per group	✓	✓	✓	✓	✓	-	✓	-	
		CZ-RTC6BLW With Wi-Fi and Bluetooth®	✓	✓	1 group, 8 units	· Up to 1 controller can be connected per group	✓	✓	✓	✓	✓	-	✓	-	
Infrared remote controller		CZ-RWS3 + CZ-RWRU3W CZ-RWS3 + CZ-RWRY3 CZ-RWS3 CZ-RWS3 + CZ-RWRL3 CZ-RWS3 + CZ-RWRD3 CZ-RWS3 + CZ-RWRT3 CZ-RWS3 + CZ-RWRC3	✓	-	1 group, 8 units	· Up to 2 controllers can be connected per group	✓	✓	✓	✓	✓ ¹⁾	-	-	-	
Centralized controllers															
System controller with weekly timer		CZ-64ESMC3	✓	-	64 groups, maximum 64 units	· Up to 10 controllers, can be connected to one system · Main unit/sub unit (1 main unit + 1 sub unit) connection is possible · Use without remote controller is possible	✓	✓	✓	✓	✓ ¹⁾	✓	✓	-	
Central ON / OFF controller		CZ-ANC3	-	-	16 groups, maximum 64 units	· Up to 8 controllers (4 main units + 4 sub units) can be connected to one system · Use without remote controller is impossible	✓	-	-	-	-	✓	-	-	
Intelligent controller (touch screen/web server)		CZ-256ESMC3	✓	-	Main unit: 128. Up to 256 units can be expanded	· Communication adaptor CZ-CFUNC2 is necessary for connection with more than 128 units	✓	✓	✓	✓	✓ ¹⁾	✓	✓	-	

1. Setting is not possible when a remote controller unit is present (use the remote controller for setting). * All specifications subject to change without notice.

Individual controllers wired

CONEX wired remote controller

CZ-RTC6 // CZ-RTC6BL // CZ-RTC6BLW ¹⁾

- 3 line-up. CZ-RTC6: Non-wireless, CZ-RTC6BL: Bluetooth®, CZ-RTC6BLW: Wi-Fi and Bluetooth®
- Intuitive control with stylish design profile
- Clean face with full flat and black LCD display
- Dimension (HxWxD): 86 x 86 x 25 mm

Panasonic H&C Control App ²⁾.

- Daily remote control operation via Bluetooth®
- Quick and easy App set-up for system setting

Panasonic H&C Diagnosis App ³⁾.

- Easy access to service parameters and service checker data via Bluetooth®

Basic operation.

- Mode setting: Heat / Cool / Dry / Fan / Auto
- Temperature setting
- Fan speed: 5 levels
- Air flow direction
- nanoe™ X and Econavi setting
- Weekly program ⁴⁾

1) Available from Autumn 2020, compatible with new PACi NX Series.

2) CZ-RTC6BL or CZ-RTC6BLW required.

3) A service checker interface is required and available from Autumn 2020. Compatible with new PACi NX Series.

4) Can be set from Panasonic H&C Control App.



Room controller for hotel rooms

PAW-RE2C4-MOD-WH // PAW-RE2C4-MOD-BK

- Easy to install
- Cost effective installation as all electrical cables are centralised on this remote
- Architect inspired attractive design
- Direct connection to the Indoor unit with all primary functions of indoor unit available
- 2 options available: Stand alone and Modbus communication
- Colours: WH: White. BK: Black
- Room controller: 4 digital inputs and 4 digital outputs

From this remote controller.

The lighting, card contact, motion detector, window contact and the air conditioning are controlled.

Energy saving functions included on the device.

- Turns OFF air conditioning and lighting when room is unoccupied
- Disables air conditioning when window is open
- Maximum/minimum setpoint temperature configurable

Fast and simple set up.

Set up is simple and easy for room controllers. But it is extremely easy and quick with touch models, which can be set up by using smartphone with NFC technology, even when control is not yet installed / powered.

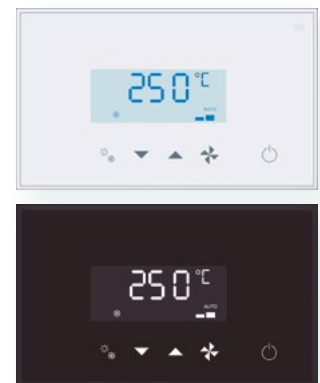



Display control for hotel rooms

PAW-RE2D4-WH // PAW-RE2D4-BK

- Easy to install
- Cost effective installation as all electrical cables are centralised on this remote
- Architect inspired attractive design
- Direct connection to the Indoor unit with all primary functions of indoor unit available
- Stand alone communication
- Colours: WH: White. BK: Black
- Basic hotel function: 2 digital inputs

From this remote controller.

The card contact, motion detector, window contact and the air conditioning are controlled.

Energy saving functions included on the device.

- Disables air conditioning when window is open
- Maximum/minimum setpoint temperature configurable

Fast and simple set up.

Set up with smartphone with NFC technology, even when control is not yet installed/powerd.

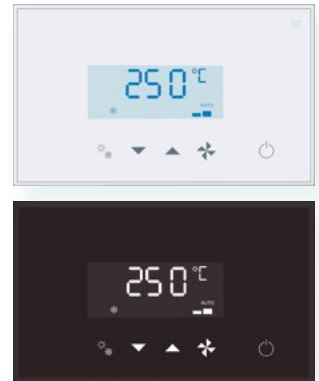

Design wired remote controller

CZ-RTC5B

- Power consumption monitor (only for PACi)
- Flat face design and touch sensor switch for stylish design and operating usability
- Functions such as for energy saving and monitoring and for service use are available on the full dot LCD (3,5" display)
- Improved illumination
- White LED backlit
- Blink when alarm occurs

Datanavi.

- Scan and save AC system info
- Easy access to manual database
- Commissioning, F-Gas check data history

* Panasonic App is required on your smartphone.

Basic Operation.

- Operation
- Mode
- Temperature setting
- Air flow volume
- Air flow direction

Timer function.

- Outing function
- Weekly program timer
- Easy ON / OFF timer
- Time display

Energy saving.

- Outing function
- Temperature setting range limitation
- Temperature auto return
- OFF remind
- Schedule demand control
- Energy saving mode
- Energy monitoring

Others.

- Key lock
- Ventilation fan control
- Display contrast adjustment
- Remote controller sensor
- Quiet operation mode
- Prohibit setting control from central controller
- Rotation / back-up control



* Power consumption monitoring is available for all PACi systems except R410A PACi Standard.

* Rotation and back-up control with CZ-RTC5B is available for all PACi systems.

Individual controllers wireless

Infrared remote controller

CZ-RWS3 + CZ-RWRU3W // CZ-RWS3 + CZ-RWRY3 // CZ-RWS3 // CZ-RWS3 + CZ-RWRL3 // CZ-RWS3 + CZ-RWRD3 // CZ-RWS3 + CZ-RWRT3 // CZ-RWS3 + CZ-RWRC3

- Easy installation for the 4 Way Cassette type simply by replacing the corner part
- 24 hour timer function
- Remote controller by main remote controller and sub controller is possible (maximum 2 remote controllers (main remote controller and sub controller) can be installed for one indoor unit)
- When CZ-RWS3 is used, infrared control becomes possible for all indoor units (1: when a separate receiver is set up in a different room, control from that room also becomes possible. 2: automatic operation by means of the emergency operation button is possible even when the remote controller has been lost or the batteries have been exhausted)
- Operation of separate energy recovery ventilators (when commercial ventilation fans or heat-exchange ventilation fans have been installed, they can be operated with this remote controller (interlocked operation with the indoor unit or independent ventilation ON / OFF)

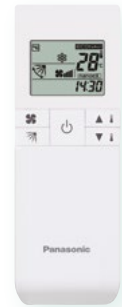

nanoeX
ECONAVI

Infrared remote controller and receiver for 4 way 90x90 cassette. CZ-RWS3 + CZ-RWRU3W



Infrared remote controller and receiver for 4 Way 60x60 cassette PY3 (with a panel). CZ-RWS3 + CZ-RWRY3

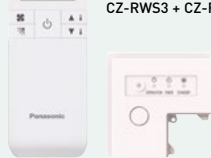

Infrared remote controller for wall-mounted, 4 way 60x60 with panel and floor console. CZ-RWS3



Infrared remote controller and receiver for 2 way cassette. CZ-RWS3 + CZ-RWRL3



Infrared remote controller and receiver for 1 way cassette. CZ-RWS3 + CZ-RWRD3



Infrared remote controller and receiver for ceiling. CZ-RWS3 + CZ-RWRT3



Infrared remote controller and receiver for all indoor units. CZ-RWS3 + CZ-RWRC3



Remote sensor

CZ-CSRC3

- This remote sensor can be connected to any PACi or VRF unit. Use it to detect the room temperature when no remote controller sensor or body sensor is used (connection to a system without a remote controller is possible)
- For joint use with a remote controller switch, use the remote controller switch as main remote controller
- Batch group control for up to 8 indoor units
- Appearance design based on simplified remote controller chassis
- Dimensions (HxWxD): 120 x 70 x 17 mm
- Weight: 70 g
- Temperature/Humidity range: 0 °C to 40 °C / 20 % to 80 % (no condensation) (indoor use only)
- Power supply: 16 V DC (supplied from indoor unit)
- Maximum number of connectable indoor units: Up to 8 units



Control contents	Part name, model No.	Quantity
Standard control <ul style="list-style-type: none"> · Control of the various operations of the indoor unit by wired or infrared remote controller · Cooling or heating mode of the outdoor unit is decided by the first priority of the remote controller · Switching between remote controller sensor and body sensor is possible 	High spec wired remote controller: CZ-RTC5B CONEX wired remote controller: CZ-RTC6 // CZ-RTC6BL // CZ-RTC6BLW Infrared remote controller: CZ-RWS3 + CZ-RWRU3W // CZ-RWS3 + CZ-RWRL3 // CZ-RWS3	1 unit each
(1) Group control <ul style="list-style-type: none"> · Up to 8 units can be connected to 1 remote controller · Operation of all indoor units in the same mode 	High spec wired remote controller: CZ-RTC5B CONEX wired remote controller: CZ-RTC6 // CZ-RTC6BL // CZ-RTC6BLW Infrared remote controller: CZ-RWS3 + CZ-RWRU3W // CZ-RWS3 + CZ-RWRL3 // CZ-RWS3	8 units
(2) Main/sub remote controller <ul style="list-style-type: none"> · Maximum 2 remote controllers per indoor unit · The button pressed last has priority · Timer setting is possible even with the sub remote controller 	Main or sub.: High spec wired remote controller: CZ-RTC5B CONEX wired remote controller: CZ-RTC6 // CZ-RTC6BL // CZ-RTC6BLW Infrared remote controller: CZ-RWS3 + CZ-RWRU3W // CZ-RWS3 + CZ-RWRL3 // CZ-RWS3	As required



Centralised controllers

System controller with schedule timer

CZ-64ESMC3

Operation with various functions from central station.

Panasonic unveils state-of-the-art digital controller.

Panasonic's innovative and easy to use interface that offers full functionality with an integrated schedule timer and system controller, making managing heating and cooling systems easier than ever before. The CZ-64ESMC3 includes Panasonic's popular schedule timer, which gives users full flexibility over when they want their property heated or cooled. Users can adjust the system for holidays, pausing operations for long periods of time so that energy isn't wasted heating or cooling an empty home or office. The controller also allows six operations per day to be programmed.

Mix of current 2 controllers: System controller + schedule timer.

System controller will be designed by taking priority on these 2 operations with following technical key points:

- Same operation feeling as wired remote controller by touch-key panel
- High visibility and usability by full-dot LCD
- Based on high wired remote controller
- Maximum 64 group of indoor units, individual control for 64 units
- 4 zone control; 1 zone = maximum 16 groups
- Several energy saving function (based on CZ-RTC5B)
- 6 timer program per day for 1 week (7 days) operation (total 6 x 7= 42 programs)
- Basic setting items (Temperature, Mode, Fan speed, Flap position) can be set by same manner as CZ-RTC5B

Function list:

Central control functions:

- Central control / individual setting
 - Start-stop prohibition for remote controller
 - Start-stop / Mode change / Temperature setting prohibition for remote controller
 - Mode change / Temperature setting prohibition for remote controller
 - Mode change prohibition for remote controller
 - Select items for prohibition
- Filter information
 - Filter sign
 - Filter sign reset
- Ventilation setting

Timer functions and external I/O:

- Weekly timer
 - Timer setting enable / disable
 - Copy of timer setting
- Maintenance
 - External signal (Start / Stop) (Demand control)
 - Centralized control master-slave setting
 - Alarm history
- Initial setting
 - Clock

Energy saving, maintenance and operating functions:

- Energy saving control
 - Econavi ON / OFF
- Filter information
 - Filter sign and hour counter display
- Maintenance
 - Service contact
- Initial setting
 - Clock display setting
 - Name Setting
 - Operation lock setting
 - Operation sound setting
 - LCD contrast setting
 - LCD backlight setting
 - Select displayed language (EN/FR/IT/ES/DE)
 - Administrator password
- Setting information list

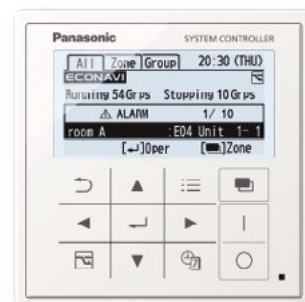

ECONAVI

Sample display image / Operation status display

Operation Status ALL



Operation Status ZONE



Operation Status GROUP



ON / OFF controller

CZ-ANC3

Only ON / OFF operation from central station.

- 16 groups of indoor units can be controlled
- Collective control and individual group (unit) control can also be performed
- Up to 8 ON / OFF controller (4 main, 4 sub) can be installed in one link system
- The operation status can be determined immediately
- Dimensions (HxWxD): 121 x 122 x 14 + 52 mm (embedding dimension)

Power supply: 220 to 240 V AC.

I/O part: Remote input (effective voltage: within 24 V DC): All ON / OFF.

Remote output (allowable voltage: within 30 V DC): ON, Alarm.

Note: As operation mode and temperature settings are not possible with the ON / OFF controller, it must be used together with a remote controller, a system controller etc.

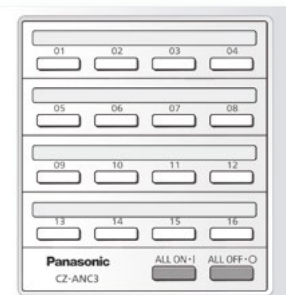

Centralised controllers

Intelligent controller (touch screen panel)

CZ-256ESMC3

Simplified load distribution ratio (LDR) for each tenant.

Dimensions (H x W x D): 240 x 280 x 20 (+60) mm.

Power supply: Single phase 100-240 V ~ 50/60 Hz.

Maximum number of connectable indoor units: 256 units (maximum per link: 64 units).

Maximum number of connectable outdoor units: 120 units (maximum per link: 30 units).

· Central control device: Up to 10 units

Enlarged display screen: 10,4 inch touch-panel colour LCD. Pursuing visibility, ease of use. Retrieve data from USB memory: Place the USB port inside the panel (USB memory available in stores).

Communication adaptor: CZ-CFUNC2*.

* CZ-CFUNC2 is required to connect more than 128 indoor units.

Functions:

- Graph display (trends, comparisons)
- Econavi ON / OFF
- Outdoor unit quiet operation ON / OFF
- Energy saving functions: Set temperature auto return settings, Auto shut OFF, Set temperature range limit settings, Energy saving for PAC current value, etc.
- Event control (such as equipment linkage)
- Performs closing at end of any period

Operation and status.

You can check to operational status (ON / OFF, operating mode, alarms, etc.) of all indoor units and outdoor units in real time. You can also select indoor units to change their settings.

Operation scheduling.

You can register daily operation schedules (ON / OFF time, operating modes, set temperatures, etc.) for individual indoor units or groups of indoor units.

Operations can be schedule for up to 2 years in advance.

Load distribution calculation for each tenant.

- Air-conditioner load distribution ratio is calculated for each unit (tenant) with used energy consumption data (m³, kWh)
- Calculated data is stored as a CSV type file
- Data from the last 365 days is stored

Web application. Web access and control from remote station.

- Accessing from remote PC
- You can monitor/operate system by using web browser



Remote controller.

The LAN terminal on this unit enables you connect it to a network. Connecting to Internet will enable you to operate the unit and check the status using a PC from a remote location*.

* Remote access rights and additional IT infrastructure / programming may be required.

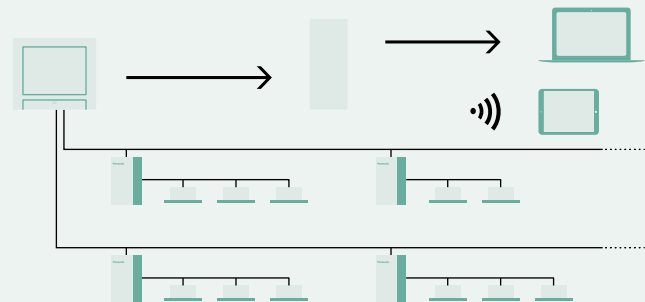

Back-up tool to save your commissioning time.

Various data such as distribution, setting, log history etc. can be saved by CSV file.

Setting data of CSV file is available to edit and import to the controller again.

You can save time for commissioning and change setting flexibly and easily by your PC.

- Customize data
 - Data recovery
- Data can be imported again by general USB.

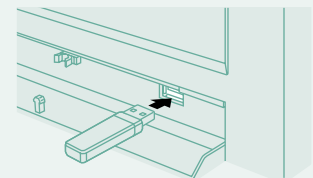

System configuration example.

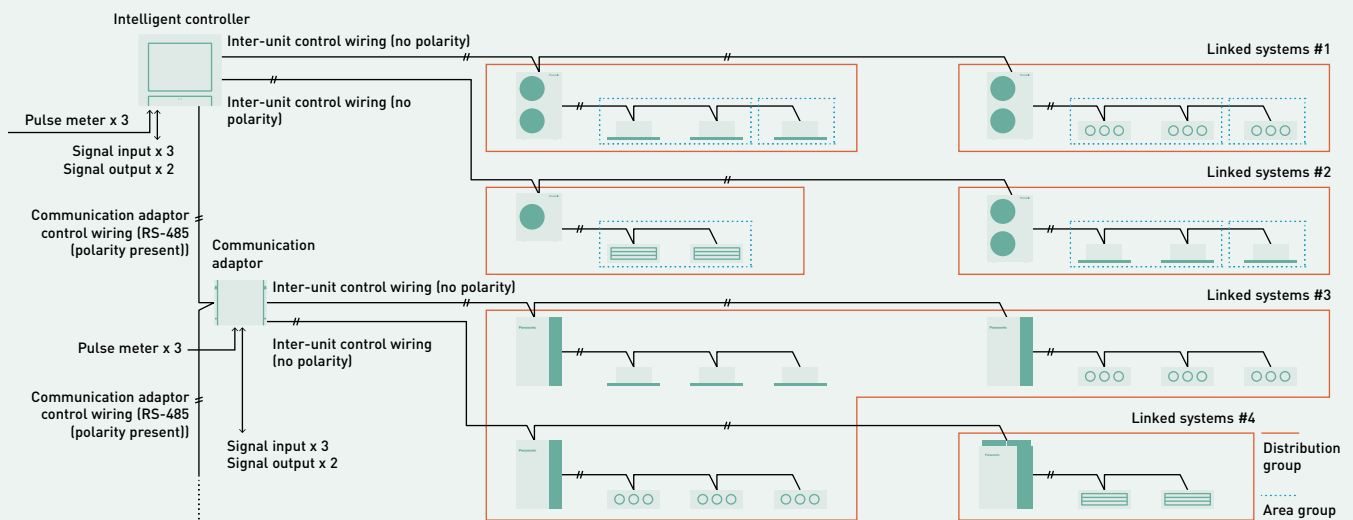



P-AIMS core software

CZ-CSWKC2 / P-AIMS core software.

Centralised software to control up to 1024 indoor units.

Functions of basic software.

- Standard remote controller for all indoor units.
- Many timer schedule programs can be set on the calendar.
- Detailed information display for alarms.
- CSV file output with alarm history, operating status.
- Automatic data back-up to HDD.

P-AIMS is suitable for large shopping centers and universities with many areas/ buildings. 1 "P-AIMS" PC can have 4 independent systems at once.

Each system can have maximum 8 C/A units, and control maximum 512 units. In total, 1024 indoor units can be controlled by 1 "P-AIMS" PC.

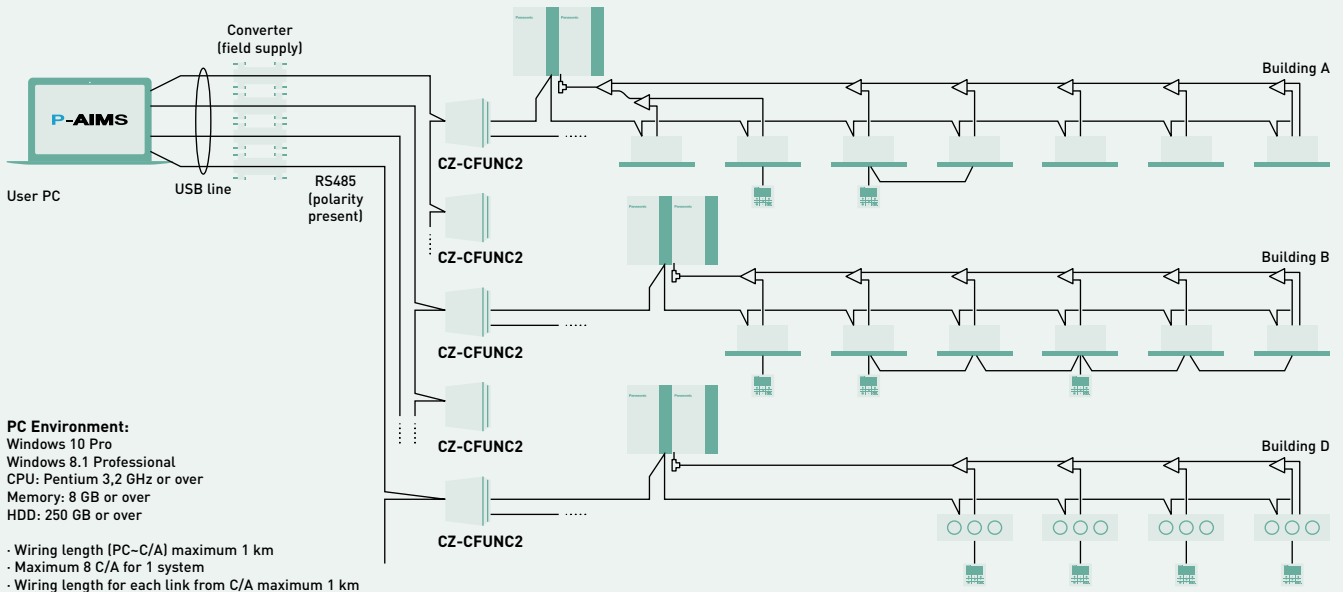

P-AIMS optional software CZ-CSWAC2 / P-AIMS consumption calculation extension.

- Air-conditioner load distribution ratio is calculated for each unit (tenant) with used energy consumption data (m³, kWh)
- Calculated data is stored as a CSV type file
- Data from the last 365 days is stored

P-AIMS optional software CZ-CSWWC2 / P-AIMS web application extension.

- Accessing P-AIMS software from remote PC
- You can monitor/operate ECOi System by using web browser (Internet Explorer)

P-AIMS optional software CZ-CSWGC2 / P-AIMS layout display extension.

- Operating status monitor is available on the layout display
- Object's layout and indoor unit's location can be checked at once
- Each unit can be controlled by virtual remote controller on the display
- Maximum 4 layout screens are shown at once

P-AIMS optional software CZ-CSWBC2 / P-AIMS BACnet extension.

- Can communicate with other equipment by BACnet protocol
- ECOi System can be controlled by both BMS and P-AIMS
- Maximum 255 indoor units can be connected to 1 PC (that has P-AIMS basic and BACnet software).



With 4 upgrade packages the basic software can be upgraded to suit individual requirements.

Centralised controllers

Local adaptor for ON / OFF control

CZ-CAPC3

Connection with general equipment.

- Control and status monitoring is possible for individual indoor unit (or any external electrical device up to 250 V AC, 10 A) by contact signal

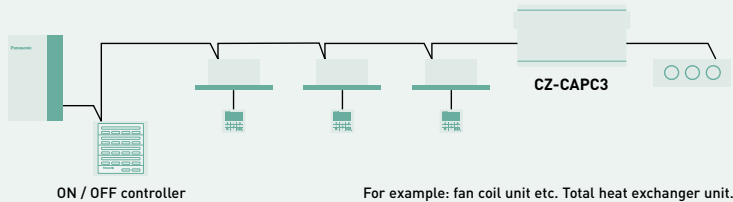

Mini Seri-Para I/O Unit 0 -10 V

CZ-CAPBC2

Connection with general equipment.

- Control and status monitoring is possible for individual indoor unit (1 group)
- In addition to operation and stop, there is a digital input function for air speed and operation mode
- Temperature setting and measuring of the indoor suction temperature can be performed from central monitoring
- Power is supplied from the T10 terminal of the indoor units
- The analog input for demand of the outdoor capacity by 20 steps (from 40 % to 120 %) by 0-10 V
- The analog input for temperature setting is 0 to 10 V, or 0 to 140 Ohm
- Separate power supply also is possible (in case of suction temperature measuring)

* Ask to your distributor.

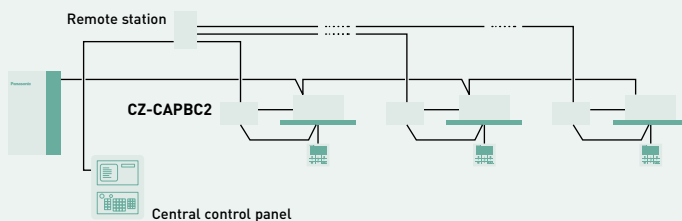



Communication adaptor for VRF connectivity

CZ-CFUNC2

This communication interface is required to connect a ECOi and GHP systems to a BMS. An additional interface is needed to convert the information into KNX / Modbus / BACnet language. CZ-CFUNC2 is very easy to operate and to connect to the Panasonic P-Link, which is the ECOi bus. From the CZ-CFUNC2, all the indoor and outdoor units of the installation can be easily control. Two linked wiring systems can be connected to one CZ-CFUNC2.

Dimensions (HxWxD): 260 x 200 x 68 mm

* As this is not a splash-proof design, it must be installed indoors or in the control panel, etc.



PACi and VRF connectivity

Controls and connectivities are the key to offer better comfort and price. Panasonic offers its customers cutting-edge technology, specially designed to ensure our air conditioning systems deliver optimal performance.



BMS
CONNECTIVITY





PACi, ECOi and ECO G connectivity

The interface has been designed specifically for Panasonic and provides complete monitoring, control and full functionality of the line-up from IntesisHome, KNX, Modbus, BACnet and LonWorks installations.

This connectivity solution with "PAW" model names is made by a third party company, please contact Panasonic for more information.

	Room controller	Interface	BMS Type	Maximum number of indoor units connected
ECOi / PACi indoor units	SER8150R0B1194 / SER8150R5B1194		Modbus / BACnet	1 Unit/group
	PAW-RE2C4-MOD-WH / PAW-RE2C4-MOD-BK		Modbus	1 Unit/group
		PAW-RC2-KNX-1i	KNX	1 (1 Group of indoor units)
		PAW-RC2-MBS-1	Modbus RTU ¹⁾	1 (1 Group of indoor units)
		PAW-RC2-MBS-4	Modbus	4 Indoor/groups
		PAW-RC2-BAC-1	BACnet	1
PACi / ECOi / ECO G P-Link		PAW-AC2-KNX-16P	KNX	16
		PAW-AC2-KNX-64P	KNX	64
		PAW-AC2-MBS-16P	Modbus	16
		PAW-AC2-MBS-64P	Modbus	64
		PAW-AC2-MBS-128P	Modbus	128
		PAW-AC2-BAC-16P	BACnet	16
		PAW-AC2-BAC-64P	BACnet	64
		PAW-AC2-BAC-128P	BACnet	128
		CZ-CLNC2	LonWorks	16 Groups of maximum 8 indoor units, in total maximum 64 indoor units

1) Interface Modbus RTU/TCP is needed in case if Modbus TCP connection. PAW-MBS-TCP2RTU (ModBus RTU Slave devices). 2) Interface CZ-CFUNC2 needed.

Airzone. Control of the hide-aways

Airzone has developed interfaces to easily connect to Panasonic Commercial hide-away units. Ensuring optimum performance, comfort and energy savings, the new system is efficient and easy to install.

Airzone full range of accessories for any duct project.



Different type of outlets



Also plenum automatic doors



Full range of remote controls (wired / Infrared, ...)

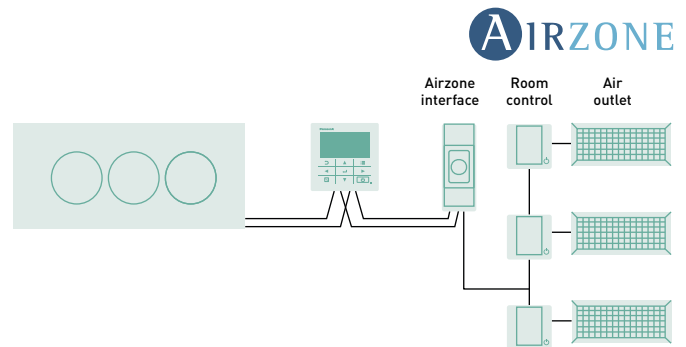

ECOi, ECO G and PACi connectivity indoor units

PCB's and cables for ECOi, ECO G and PACi indoor units.

Name of the cables	Function	Comment
CZ-T10	All T10 functions	Requires field supplied accessory
PAW-FDC	Operate external fan	Requires field supplied accessory
PAW-OCT	All option monitoring signals	Requires field supplied accessory
CZ-CAPE2	3-Pipe control PCB	Requires additional wires from spare part supply
PAW-EXCT	Forced Thermo OFF/Leakage D.	Requires field supplied accessory

Name of the PBC	Function	Comment
PAW-T10	All T10 functions	Allows easy connection "Plug & Play"
PAW-PACR3	Redundancy of 2 or 3 systems; for ECOi and PACi	Redundancy of 2 or 3 ECOi or PACi systems including temperature monitoring, error indication, back-up, alternative run

T10 connector (CN061)

CZ-T10

Panasonic has developed an optional accessory (consisting of plug + wires) called CZ-T10 to enable an easy connection to this T10 connector.

Connecting an ECOi indoor unit to an external device is easy. The T10 terminal featured in the electronic circuit board of all indoor units enables digital connection to external devices.

T10 terminal specification (T10: CN015 at indoor unit PCB).

- Control items:
 1. Start / stop input
 2. Remote controller prohibit input
 3. Start signal output
 4. Alarm signal output

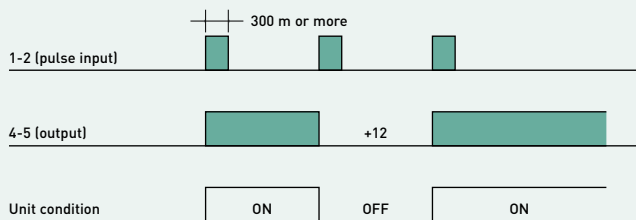

NOTE: The wire length from indoor unit to the relay must be within 2,0 m. Pulse signal changeable to static by cutting jumper JP001.

Usage example.

Forced OFF control.

Term 1 and 2: Free contact for ON / OFF signal (cut *JP1* for static signal) when the hotel card is it connected the contact must be close (the unit can be used).

Term 2 and 3: Free contact to prohibit all function in the remote controller install in the room when the hotel card is it removed the contact must be closed (the unit can not work).

Terminal = T10

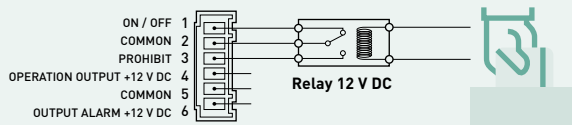

Condition:

- 1-2 (pulse input): Unit ON / OFF condition switching with a pulse signal. (1 pulse signal: shortage status more than 300 msec. or more)
- 2-3 (static input): open / operation with remote is permitted (normal condition) close / remote controller is prohibited
- 3-4 (static output): 12 V output during the unit ON / no output at OFF
- 4-5 (static output): 12 V output when some errors occur / no output at normal

Example of wiring:

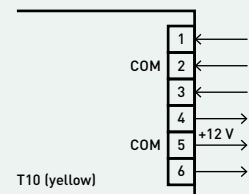

Operation ON / OFF signal output.

Condition:

- 4-5 (static output): 12 V output during the unit ON / no output at OFF

Example of wiring:

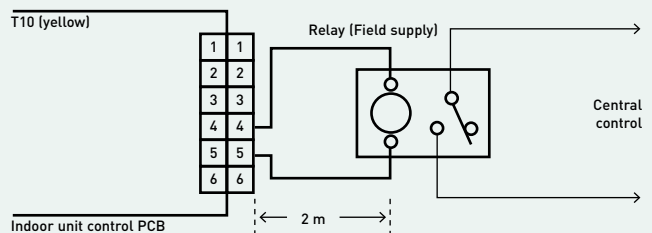

Note: The wire length from indoor unit to the Relay must be within 2,0 m. Pulse signal changeable to static by cutting jumper JP001.
* PACi-NX series is not compatible.

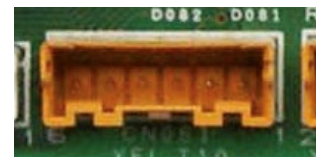



Fan drive connector (CN032)

PAW-FDC

Panasonic has developed an optional accessory (consisting of plug + wires) called PAW-FDC to enable an easy connection to this fan drive connector (CN032).

- Operating the ventilation fan from the remote controller
- Start / stop of external ventilation and total heat exchanger fans
- Works even if indoor unit is stopped
- In case of group control → all fans will operate; no individual control

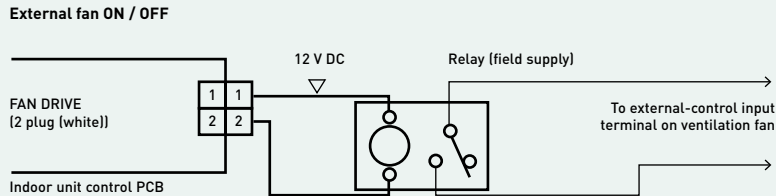

Option connector (CN060) output external signals

PAW-OCT

Panasonic has developed an optional accessory (consisting of plug + wires) called PAW-OCT to enable an easy connection to this Option Connector (CN060).

With the combination of the T10 and the option CN060 an external control of the indoor units is possible!

6P (white): Outputs external signals as shown in the figure below.

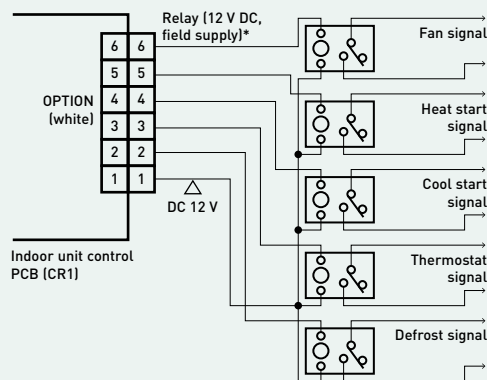

EXCT connector (CN009)

PAW-EXCT

Panasonic has developed an optional accessory (consisting of plug + wires) called PAW-EXCT to enable an easy connection to this EXCT Connector (CN009).

A) With static input.

→ **STATIC INPUT → THERMO OFF → ENERGY SAVING**

2P plug (red): Can be used for demand control. When input is present, forces the unit to operate with the thermostat OFF.

Note: The length of the wiring from the indoor unit control PCB to the relay must be 2 m or less.

· Examples of wiring:

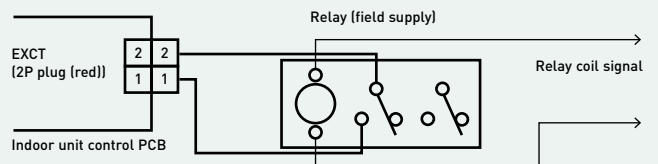

B) Example: In connection with a refrigerant sensor.

- Signal from leakage detector: non voltage, static.
- Indoor unit setting: Code 0b → 1
- Connector for leak detector: EXCT
- Outdoor unit setting:
Code C1 → 1 power output if alarm from O2 connector 230 V
Code C1 → 2 power output if alarm from O2 connector 0 V
- Displayed alarm message P14

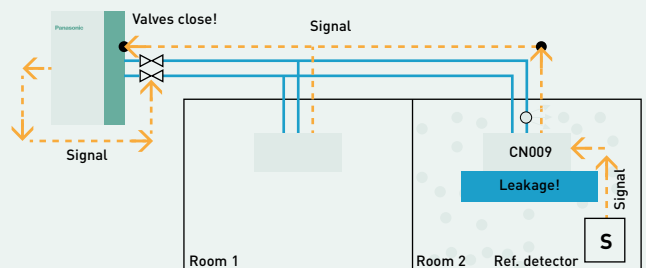

ECO *i* - W



Discover a new era of ECOi, the ECOi-W. Heat pumps and cooling only chillers

Panasonic introduces the new ECOi-W heat pumps and cooling only chiller series. These new series provides a wide variety of HVAC system solutions, to meet all of your residential, commercial and industrial needs.

ECOi-W meets the customer's needs	→ 420	Fan coils	→ 450
ECOi-W, the solution for hotels, offices and industry	→ 422	Range of fan coils	→ 452
Panasonic Certified Quality	→ 424	Fan coils - ducted	→ 454
Solutions for Hospitals	→ 426	Fan coils - high static pressure ducted	→ 456
Range of ECOi-W outdoor units	→ 428	Fan coils - 4 way cassette	→ 458
ECOi-W heat pump outdoor units		Fan coils - ceiling chassis	→ 460
U - 020/025/030/035/040 CW	→ 430	Fan coils - floor-standing chassis	→ 462
U - 045/055/065/075 CW	→ 432	Fan coils - wall-mounted	→ 464
U - 090/105/125 CW	→ 434	Smart fan coils	→ 465
U - 140/150/170/190/210 CW	→ 436	Control and connectivity	→ 466
Options for heat pump outdoor units	→ 438	Wired controllers for outdoor units	→ 466
ECOi-W cooling only outdoor units		Wired controllers for AC and EC fan coils	→ 467
U - 020/025/030/035/040 CV	→ 440	Accessories and control	→ 468
U - 045/055/065/075 CV	→ 442		
U - 090/105/125 CV	→ 444		
U - 140/150/170/190/210 CV	→ 446		
Options for cooling only outdoor units	→ 448		

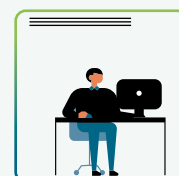
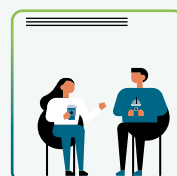
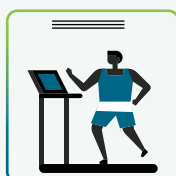
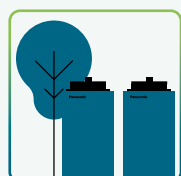

ECOi-W meets the customer's needs, with these fully customisable heat pumps and cooling only chillers

Unrivalled reliability and quality.

Panasonic solutions can be enjoyed for years to come, even in the most extreme climates. Panasonic does not compromise on product quality, safety or durability, in order to provide the ultimate comfort when you need it most.





There is a reason to choose Panasonic as your partner.

ECO*i*-W

Panasonic does not compromise on product quality, always strives for 100 % quality.

ECO*i*-W series offers smart technology meeting your needs at home and business.

Energy saving

HIGH SEER

4,68

High seasonal efficiency in cooling mode.
SEER follows COMMISSION REGULATION (EU) No 2016/2281.

HIGH SCOP

3,55

High seasonal efficiency in heating mode.
SCOP follows COMMISSION REGULATION (EU) No 813/2013.



EC MOTOR GREEN VENTILATION

EC motor green ventilation.
Range of fan coil with improved efficiency with optional EC fan motor.

High performance and comfortability



SUPER QUIET

Super quiet.
Extra quiet operation is available as standard (with sizes 20 – 40, 140 – 210).



BLUEFIN

Bluefin.
Bluefin coil comes as standard on all heat pump models. The life time of coils have been extended thanks to the hydrophilic coating.



ULTIMATE CUSTOMISATION

Ultimate customisation.
Various pump, hydraulic, ambient options offered, plus many more. Ultimate customization for your needs and environment.



AUTOMATIC FAN

Automatic fan operation.
The microprocessor control automatically adjusts the fan speed as a function of the operating conditions.



HEATING MODE

Down to -17 °C in heating mode.
The ECO*i*-W system works in heating mode at outdoor temperature down to -17 °C.



COOLING MODE

Up to 50 °C in cooling mode.
The ECO*i*-W system works in cooling mode at outdoor temperature up to 50 °C.



DEFROST LIMITING

Defrost limiting cycle (140 – 210).
Each pair of coils can be defrosted wisely while the other pair of coils are running in heating mode. This alternated defrost cycle ensures stable hot water even at low ambient conditions.

High connectivity



BMS CONNECTIVITY

BMS connectivity.
The communication port can be integrated into the ECO*i*-W system and provides easy connection and control. Modbus RTU is equipped as standard. Modbus TCP/IP, BACnet IP and BACnet MSTP as optional availability.

Reliable quality

100% QUALITY

QUALITY CERTIFIED BY PANASONIC

Quality certified by Panasonic.
Panasonic does not compromise on product quality, safety, durability in order to provide the ultimate comfort when you need it most.



Eurovent certified performance.
The performance of ECO*i*-W Series has been certified by Eurovent to prove the high quality and high performance by Panasonic.
<https://www.eurovent-certification.com/>

ErP



ECO*i*-W Series are compliant with ErP regulation.
SEER follows COMMISSION REGULATION (EU) No 2016/2281.
SCOP follows COMMISSION REGULATION (EU) No 813/2013.

Support materials for customers

AutoCAD 2D files and BIM models for ECO*i*-W full range is readily available at Panasonic PROClub.
<https://www.panasonicproclub.com>



ECOi-W, the solution for hotels, offices and industry

ECOi-W provides the optimal performance in any climatic condition.



1 High energy saving and comfort

- High SEER / SCOP
- Quiet operation
- Integration with ECOi VRF systems via BMS control
- **NEW!** Centralized remote management system

2 High flexibility

- Capacity range from 20 to 210 kW
- Customisable design
- Operating range: -17 °C (heating) to 50 °C (cooling)
- Wide range of hydraulic options
- Wide range of communication protocols

3 High quality

- Defrost limiting coil design (140 to 210 kW)
- Optimised design for service and maintenance
- Compact footprint

Operating conditions

Panasonic ECOi-W provides a wide operating range from -17 °C in heating to 50 °C in cooling.

Water outlet temperature in cooling: A uniqueness of ECOi-W, is the water outlet temperature down to -10 °C in cooling. It can ensure the operation temperature of the process equipment in factories.

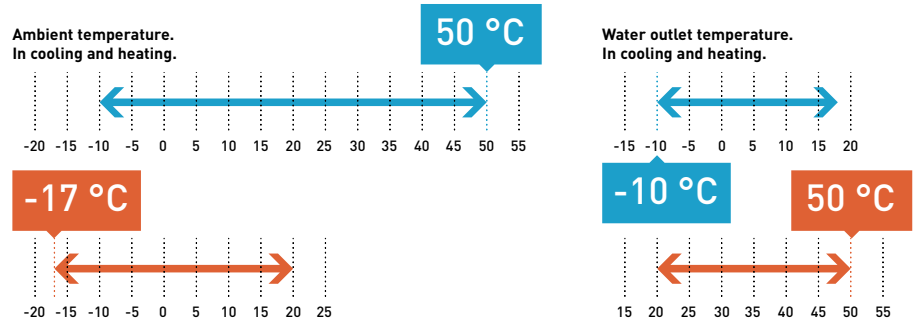

Cooling: Outside air temperature [°C (DB)]. Heating: Outside air temperature [°C (WB)].
 * With glycol 45 %, 5 °C without glycol. Special conditions apply. Please contact your local representative.

ECOi-W line-up

ECOi-W size	20	25	30	35	40	45	55	65	75	90	105	125	140	150	170	190	210	
Heat pump range	Cooling capacities (kW)																	
	Heating capacities (kW)																	
	SEER ¹⁾																	
	SCOP ¹⁾																	
	Energy efficiency class (heating) ^{1) 2)}																	
Cooling only range	Cooling capacities (kW)																	
	SEER																	
	Dimension (HxWxD)																	
	1983x1000x1000			1983x1000x1000		1986x2180x1160		1986x2180x1160		2286x2180x1160			2295x2856x2210		2321x2856x2210			

1) Those are the data with variable flow. 2) Following Eurovent and COMMISSION REGULATION (EU) No 811/2013 for low-temperature heat pumps. Scale from A+++ to D, as of 26th September 2019.

Panasonic Certified Quality

Panasonic does not compromise on product quality, safety or durability, in order to provide the ultimate comfort when you need it most.



Class A pump

Units can be equipped with an efficient pump. A wide range of single and double pump, plus pump drive option is available.

Axial AC/EC fan

The microprocessor control automatically adjusts the fan speed as a function of the operating conditions.

SWEP BP heat exchanger

Very compact & long durability of SWEP Braze Plate Heat Exchanger. Unique design for the size 140 - 210 improving frost protection and efficiency.



Model type supplied may vary.

Energy recovery

The "Desuperheater" option consists of a stainless-steel brazed plate heat exchanger which is mounted in series between the compressors and the air-cooled condenser. It can supply hot water up to 50°C free-of-charge while operating in the cooling mode, thanks to the partial recovery of condensation heat that would otherwise be rejected to the external heat source. The unit's efficiency is increased as condensing pressure can be reduced due to air cooled condenser becoming oversized.

* Optional. Available in 45-125.



Simple user friendly control

In addition to basic control functions...

- Intelligent logic control for inlet water temperature
- Night setback operation to reduce electrical consumption and noise
- Automatic test operation at the push of a button



BMS integration

Modbus RTU as standard. Modbus TCP/IP, BACnet IP and BACnet MSTP as optional availability. Integrated systems with ECOi-W Chiller, VRF and BMS control can be offered.

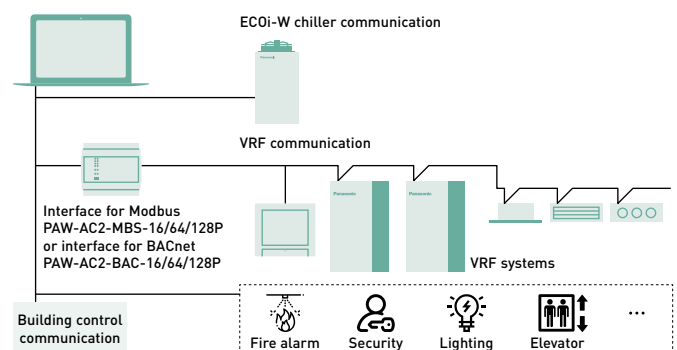
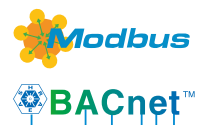



Defrost limiting coil design

- Fin space increased to prevent the coil freezing
- Number of rows increased to maintain the same capacity in standard conditions
- Designed to decrease freezing frequency as soon as outdoor air temperature goes below 7 °C

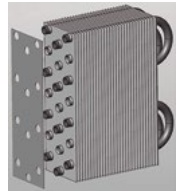

* Available in heat pump range size 140-210.

Standard coil: 2 defrost cycles every 130 min.

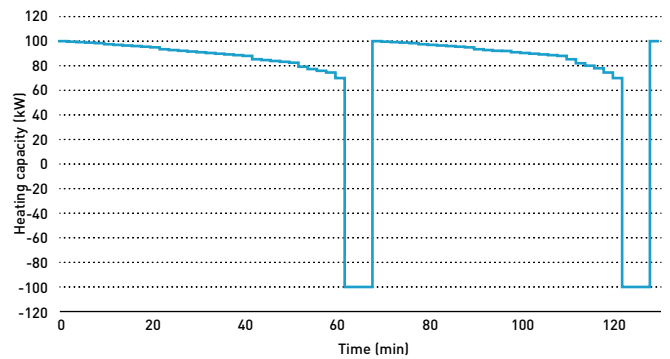

Special coil design: 1 defrost cycle every 130 min.

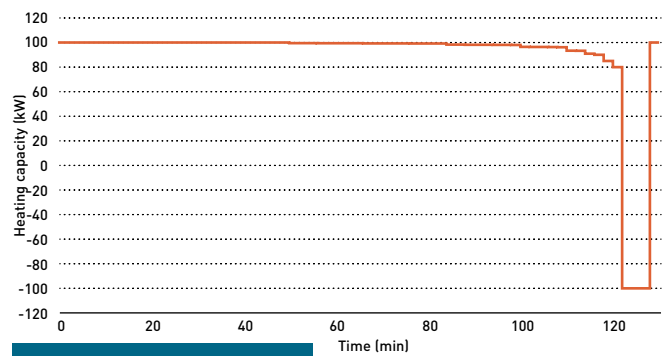

**+22 % MORE HEATING
+15 % HIGHER COP
SCOP IMPROVED**

Victaulic grooved connection

Victaulic Installation-Ready™ couplings assure proper piping installation. Optimised design to reduce installation effects, including noise and vibration attenuation.



Model type supplied may vary.

* Available in 140-210.
** Threaded Victaulic connection kit (PAW-SYSVICTH) is optional.

Bluefin for more durability

Bluefin hydrophillic coating improves defrost performance and reduces damage for a longer life time.



* Available in heat pump range.

Low noise

ECOi-W series is equipped with the compressor phonic insulation box as a standard.

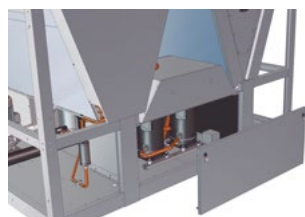

* Standard in 20-40, 140-210. Optional in 45-125.

ECOi-W quiet operation in full range.

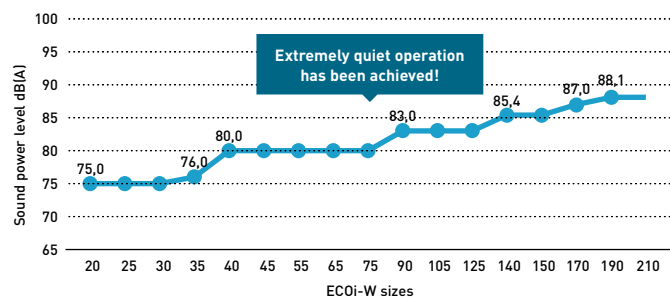

* Performance with standard fans. In the range 45-125, noise performance without low noise option.

Solutions for Hospitals

ECOi-W Series offers a reliable solution with an optimised design for service and maintenance, making it ideal for hospital applications. Remote monitoring through the ECOi-W Cloud offers enhanced service support and a highly efficient fan coil range delivers increased comfort.



1 High quality heat pumps and cooling only chillers.
ECOi-W Series provides a fully customisable design to meet the business application needs, with a capacity range from 20 kW to 210 kW. Reliable quality and an optimised design for service and maintenance are ideal for a hospital project.



2 ECOi-W Cloud - remote monitoring.
This control provides remote access, in real time, to optimise service and maintenance work. It is a useful solution for a project requiring high levels of safety and non-stop operation, such as hospitals.



3 A wide variety of fan coils.
A wide variety of units to suit your needs, with flexible installation options. High efficiency and low noise operation allows for optimum comfort. Operation in heating and cooling is possible.



4 Intuitive controllers for fan coils.
Controllers with sophisticated designs provide a user friendly interface. An easy and low cost integration to building management systems.

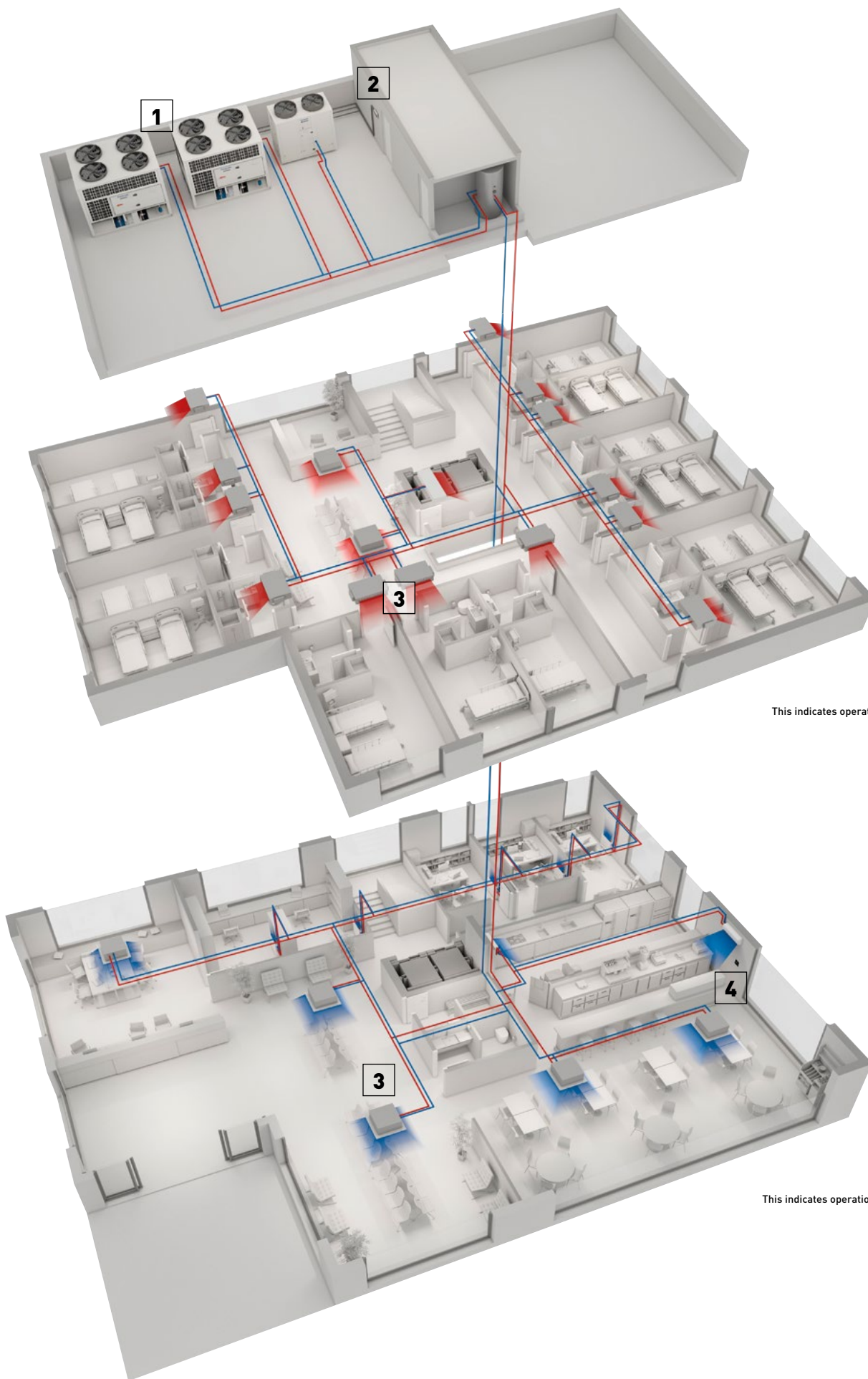

This indicates operation in winter.

This indicates operation in summer.

Range of ECOi-W outdoor units

Page	Outdoor units	20 kW	25 kW	30 kW	35 kW	40 kW	45 kW	55 kW	65 kW	75 kW
------	---------------	-------	-------	-------	-------	-------	-------	-------	-------	-------

ECOi-W 20 to 40



P. 430	Heat pump	U-020CWNB U-020CWBS	U-025CWNB U-025CWBS	U-030CWNB U-030CWBS	U-035CWNB U-035CWBS	U-040CWNB U-040CWBS
P. 440	Cooling only	U-020CVNB U-020CVBS	U-025CVNB U-025CVBS	U-030CVNB U-030CVBS	U-035CVNB U-035CVBS	U-040CVNB U-040CVBS

ECOi-W 45 to 75



P. 432	Heat pump	U-045CWNB U-045CWBM	U-055CWNB U-055CWBM	U-065CWNB U-065CWBM	U-075CWNB U-075CWBM
P. 442	Cooling only	U-045CVNB U-045CVBM	U-055CVNB U-055CVBM	U-065CVNB U-065CVBM	U-075CVNB U-075CVBM

ECOi-W 90 to 125

P. 434 Heat pump

P. 444 Cooling only

ECOi-W 140 to 210

P. 436 Heat pump

P. 446 Cooling only



90 kW

105 kW

125 kW

140 kW

150 kW

170 kW

190 kW

210 kW



U-090CWNB
U-090CWBM

U-105CWNB
U-105CWBM

U-125CWNB
U-125CWBM

U-090CVNB
U-090CVBM

U-105CVNB
U-105CVBM

U-125CVNB
U-125CVBM



U-140CWNB
U-140CWBL

U-150CWNB
U-150CWBL

U-170CWNB
U-170CWBL

U-190CWNB
U-190CWBL

U-210CWNB
U-210CWBL

U-140CVNB
U-140CVBL

U-150CVNB
U-150CVBL

U-170CVNB
U-170CVBL

U-190CVNB
U-190CVBL

U-210CVNB
U-210CVBL



U - 020/025/030/035/040 CW

Cooling capacity: 19,4 to 37,4 kW

Heating capacity: 19,5 to 41,6 kW

Compact and powerful heat pump chiller series with Panasonic quality verification.

ECOi-W Series guarantees quiet operation.



- High seasonal efficiency in cooling and heating
- Eurovent certified
- Ambient temperature operating range: -10 to +50 °C in cooling, -17 to +20 °C in heating
- Water outlet temperature range: -10 to +18 °C in cooling, +20 to +50 °C in heating
- Super quiet operation
- Optimised design for service and maintenance
- Simple user friendly control as standard
- Modbus RTU as standard

- Optional Desuperheater for free hot water up to 50 °C*
- Optional finned coil treatment
- Optional Modbus TCP/IP, BACnet IP and BACnet MSTP
- Optional remote LAN connection

* Available on special order only, please contact your local Panasonic sales representative.

Technical focus

- Chiller type: heat pump
- Compressor type (number of compressors): Scroll compressors (2)
- Refrigerant type: R410A
- Refrigerant circuit: 1
- Fan type (number of fans): axial fan (1)
- Heat exchanger: stainless steel plate heat exchanger
- Flow switch, water safety & air purge valves included
- Water filter included (mandatory to be installed on site)
- Night mode setting to save energy and reduce noise level
- Water compensation curve control
- Bluefin anti-corrosion coating
- Optional hydraulic kit

Ambient temperature.

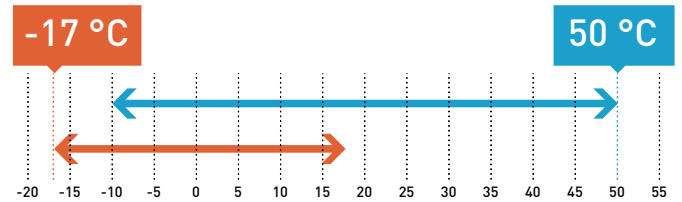

Water outlet temperature.

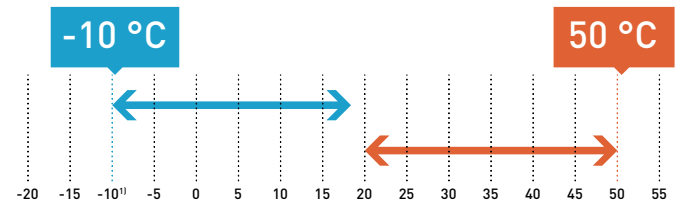

Cooling: Outside air temperature [°C (DB)]. Heating: Outside air temperature [°C (WB)].
* With glycol 45 % maximum, 5 °C without glycol.

Available options

Options	Pump drive	Hydraulic options	Ambient options	Miscellaneous options
Single pump	Variable twin speed ¹⁾	Low water pressure sensor	Finned coil treatment - epoxy	Soft starter
	Variable capacity	Water isolation valves	Rubber pads	Power supply w/o neutral
	Constant outlet pressure		Spring damper	Modbus TCP/IP
	Constant differential pressure		All seasons	BACnet MSTP
			Nordic pack	BACnet IP
			High pressure fan ²⁾	Remote LAN connection
				Desuperheater ³⁾

1) Available as standard on models 35 - 40 when pump is selected. 2) Available as standard on models 20 - 30 when pump is selected. 3) Available on models 25 - 40. 4) Available on special order only, please contact your local Panasonic sales representative.



REFER TO PAGE 438 TO SEE MORE OPTIONS FOR HEAT PUMP OUTDOOR UNITS



Optional remote control.
PAW-SYSREMKIT



Optional Shut off valves kit for model 20 - 40.
PAW-SYSSOV1

Model			20	25	30	35	40
Standard without buffer tank			U-020CWNB	U-025CWNB	U-030CWNB	U-035CWNB	U-040CWNB
With buffer tank			U-020CWBS	U-025CWBS	U-030CWBS	U-035CWBS	U-040CWBS
Power supply	Voltage	V	400	400	400	400	400
	Phase		Three phase	Three phase	Three phase	Three phase	Three phase
	Frequency	Hz	50	50	50	50	50
Cooling capacity ¹⁾		kW	18,7	23,7	26,4	35,8	38,1
Input power ¹⁾		kW	5,9	7,7	9,4	12,3	13,1
Total EER 100 % ¹⁾			3,15	3,07	2,81	2,92	2,91
SEER ^{2) 3)}			4,68	4,31	4,28	4,25	4,33
$\eta_{s,c}$ ^{2) 3)}		%	184	169	168	167	170
Heating capacity ⁴⁾		kW	19,5	26,9	29,7	37,3	41,6
Input power ⁴⁾		kW	6,1	9,3	9,9	13,2	13,5
SCOP ^{5) 5)}			3,50	3,38	3,45	3,50	3,50
$\eta_{s,h}$ ^{5) 5)}		%	137	132	135	137	137
Energy efficiency class [Scale A+++ to D] ⁶⁾			A+	A+	A+	A+	A+
Startup type			Direct	Direct	Direct	Direct	Direct
Maximum operating current		A	17,7	22,2	24,3	31,8	33,8
Startup current w/o softstarter / w softstarter		A	53/20	64/35	77/41	118/53	119/54
Sound power [w standard fans]		dB(A)	75,0	75,0	75,0	76,0	76,0
Sound pressure [w standard fans] ⁷⁾		dB(A)	42,8	42,8	42,8	43,8	43,8
Dimension [w standard fans] w/o buffer tank	H x W x D	mm	1983 x 1000 x 1000	1983 x 1000 x 1000	1983 x 1000 x 1000	1983 x 1000 x 1000	1983 x 1000 x 1000
Dimension [w standard fans] w buffer tank	H x W x D	mm	1983 x 1000 x 1507	1983 x 1000 x 1507	1983 x 1000 x 1507	1983 x 1000 x 1507	1983 x 1000 x 1507
Weight [w 1 pump] w/o buffer tank		kg	280	290	320	330	335
Weight [w 1 pump] w buffer tank		kg	345	355	385	395	400
Refrigerant [R410A]		kg	8,4	8,4	8,4	9,1	9,2
Number of refrigerant circuit			1	1	1	1	1
Compressors							
Number			2	2	2	2	2
Type			Scroll	Scroll	Scroll	Scroll	Scroll
Part load step		%	0/50/100	0/50/100	0/50/100	0/50/100	0/50/100
Crankcase heater		W	2 x 40	2 x 40	2 x 49	2 x 49	2 x 49
Evaporator							
Number			1	1	1	1	1
Type			Plate	Plate	Plate	Plate	Plate
Nominal water flow [cooling]		m ³ /h	3,35	4,36	4,64	6,16	6,44
Water pressure drop [cooling]		kPa	23	37	22	37	40
Water volume		l	1,78	1,78	2,55	2,55	2,55
Antifreeze heater		W	30	30	30	30	30
Coils							
Number			1	1	1	1	1
Frontal surface		m ²	2,4	2,4	2,4	2,8	2,8
Number of rows			2	2	2	2	2
Fans standard							
Number			1	1	1	1	1
Air flow		m ³ /h	9000	13000	13000	16000	16000
Rotation speed		r.p.m.	900	900	900	650	650
Power input [each fan]		W	620	940	940	930	930
Water connections							
Type			Male gas threaded BSPP ISO 228	Male gas threaded BSPP ISO 228	Male gas threaded BSPP ISO 228	Male gas threaded BSPP ISO 228	Male gas threaded BSPP ISO 228
Inlet - diameter		Inch	1 1/2	1 1/2	1 1/2	1 1/2	1 1/2
Outlet - diameter		Inch	1 1/2	1 1/2	1 1/2	1 1/2	1 1/2

1) Data refers to 7 °C leaving chilled water temperature and 35 °C condenser air temperature, according EN14511 standard. 2) Following COMMISSION REGULATION (EU) No 2016/2281 for comfort application chillers. 3) Those are the data with variable flow. 4) Data refers to 45 °C leaving warm water temperature and 7 °C ambient coil air temperature with 87 % R.H., according EN14511 standard. 5) Following COMMISSION REGULATION (EU) No 813/2013 for low-temperature heat pumps. 6) Following Eurovent and COMMISSION REGULATION (EU) No 811/2013 for low-temperature heat pumps. Scale from A+++ to D, as of 26th September 2019. 7) Sound pressure levels calculated at 10 meters. Sound pressure levels refer to ISO standard 3744 with parallel piped shape. * w: with, w/o: without.

Accessories	
PAW-SYSREMKIT	Remote control
PAW-CM000SP041	Cloudgate plug and play IP65 box mobile 4G Europe
PAW-CM000K001	Extension kit and cable glande for mobile [2/4G] antenna [3 m]

Accessories	
PAW-00SRTS011	Tservice wireless fee for 1 year
PAW-SYSSOV1	Shut off valves kit for model 20 - 40

4,68

3,50

SUPER QUIET

BLUEFIN

ULTIMATE CUSTOMISATION

AUTOMATIC FAN

-17 °C
HEATING MODE

50 °C
COOLING MODE

BMS CONNECTIVITY





U - 045/055/065/075 CW

Cooling capacity: 46,8 to 71,6 kW
Heating capacity: 48,5 to 75,9 kW

High seasonal efficiency in cooling, maximum SEER 4,63 in this range. ECOi-W Series offers a variety of options to meet your needs.



- High seasonal efficiency in cooling and heating
- Eurovent certified
- Ambient temperature operating range: -10 to +50 °C in cooling, -17 to +20 °C in heating
- Water outlet temperature range: -10 to +18 °C in cooling, +20 to +50 °C in heating
- Optional extra-low noise kit available
- Optimised design for service and maintenance
- Simple user friendly control as standard
- Modbus RTU as standard

- Bluefin anti-corrosion coating
- Optional hydraulic kit
- Optional Desuperheater for free hot water up to 50 °C
- Optional finned coil treatment
- Optional Modbus TCP/IP, BACnet IP and BACnet MSTP
- Optional remote LAN connection

Ambient temperature.

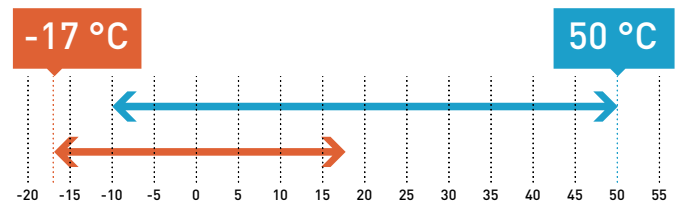

Water outlet temperature.

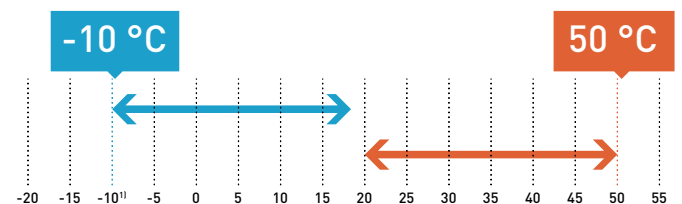

Cooling: Outside air temperature [°C (DB)]. Heating: Outside air temperature [°C (WB)].
 * With glycol 45 % maximum, 5 °C without glycol.

Technical focus

- Chiller type: heat pump
- Compressor type (number of compressors): Scroll compressors (2)
- Refrigerant type: R410A
- Refrigerant circuit: 1
- Fan type (number of fans): axial fan (1 for 45/55, 2 for 65/75)
- Heat exchanger: stainless steel plate heat exchanger
- Flow switch, water safety & air purge valves included
- Water filter included (mandatory to be installed on site)
- Night mode setting to save energy and reduce noise level
- Water compensation curve control

Available options

Options	Pump drive	Hydraulic options	Ambient options	Miscellaneous options
Single pump	Fixed speed	Low water pressure sensor	Finned coil treatment - epoxy	Soft starter
Double pump	Variable twin speed	Water isolation valves	Outdoor coil protection grid	Power supply w/o neutral
	Variable capacity	Electrical heater low power (only with buffer tank)	Rubber pads	Modbus TCP/IP
	Constant outlet pressure	Electrical heater high power (only with buffer tank)	Spring damper	BACnet MSTP
	Constant differential pressure		All seasons fan control	BACnet IP
			Extra-low noise kit	Remote LAN connection
			High pressure fan	Container transport
				Refrigerant gauge
				Desuperheater



REFER TO PAGE 438 TO SEE MORE OPTIONS FOR HEAT PUMP OUTDOOR UNITS



Optional remote control. PAW-SYSREMKIT



Optional Shut off valves kit for model 45 - 75. PAW-SYSSOV2

Model			45	55	65	75
Standard without buffer tank			U-045CWNB	U-055CWNB	U-065CWNB	U-075CWNB
With buffer tank			U-045CWBM	U-055CWBM	U-065CWBM	U-075CWBM
Power supply	Voltage	V	400	400	400	400
	Phase		Three phase	Three phase	Three phase	Three phase
	Frequency	Hz	50	50	50	50
Cooling capacity ¹⁾		kW	44,3	50,9	64,1	71,0
Input power ¹⁾		kW	15,9	18,0	21,8	24,0
Total EER 100 % ¹⁾			2,78	2,83	2,95	2,96
SEER ^{2) 3)}			4,20	4,41	4,51	4,63
$\eta_{s,c}$ ^{2) 3)}		%	165	174	177	182
Heating capacity ⁴⁾		kW	48,5	58,2	67,2	75,9
Input power ⁴⁾		kW	17,3	20,4	22,5	24,3
SCOP ^{3) 5)}			3,38	3,38	3,55	3,53
$\eta_{s,h}$ ^{3) 5)}		%	132	132	139	138
Energy efficiency class (Scale A+++ to D) ⁶⁾			A+	A+	A+	—
Startup type			Direct	Direct	Direct	Direct
Maximum operating current		A	40,2	44,2	59,4	64,4
Startup current w/o softstarter / w softstarter		A	133/66	140/73	201/101	206/106
Sound power (w standard fans)		dB(A)	80,0	80,0	80,0	80,0
Sound pressure (w standard fans) ⁷⁾		dB(A)	47,8	47,8	47,8	47,8
Dimension (w standard fans) w/o buffer tank	H x W x D	mm	1986 x 2180 x 1160	1986 x 2180 x 1160	1986 x 2180 x 1160	1986 x 2180 x 1160
Dimension (w standard fans) w buffer tank	H x W x D	mm	1986 x 2680 x 1160	1986 x 2680 x 1160	1986 x 2680 x 1160	1986 x 2680 x 1160
Weight (w 1 pump) w/o buffer tank		kg	540	550	610	620
Weight (w 1 pump) w buffer tank		kg	700	710	770	780
Refrigerant (R410A)		kg	14,5	14,9	18,9	19,0
Number of refrigerant circuit			1	1	1	1
Compressors						
Number			2	2	2	2
Type			Scroll	Scroll	Scroll	Scroll
Part load step		%	0/50/100	0/43/57/100	0/40/60/100	0/45/55/100
Crankcase heater		W	2x66	2x66	2x66	2x66
Evaporator						
Number			1	1	1	1
Type			Plate	Plate	Plate	Plate
Nominal water flow (cooling)		m ³ /h	8,06	9,18	11,30	12,31
Water pressure drop (cooling)		kPa	30	35	28	37
Water volume		l	4,10	4,10	6,10	6,10
Antifreeze heater		W	30	30	2x30	2x30
Coils						
Number			1	1	2	2
Frontal surface		m ²	4,20	4,20	5,55	5,55
Number of rows			2	2	2	2
Fans standard						
Number			1	1	2	2
Air flow		m ³ /h	22500	22500	30000	30000
Rotation speed		r.p.m.	790	790	650	650
Power input (each fan)		W	1650	1650	930	930
Water connections						
Type			Male gas threaded BSPP ISO 228	Male gas threaded BSPP ISO 228	Male gas threaded BSPP ISO 228	Male gas threaded BSPP ISO 228
Inlet - diameter		Inch	2	2	2	2
Outlet - diameter		Inch	2	2	2	2

1) Data refers to 7 °C leaving chilled water temperature and 35 °C condenser air temperature, according EN14511 standard. 2) Following COMMISSION REGULATION (EU) No 2016/2281 for comfort application chillers. 3) Those are the data with variable flow. 4) Data refers to 45 °C leaving warm water temperature and 7 °C ambient coil air temperature with 87 % R.H., according EN14511 standard. 5) Following COMMISSION REGULATION (EU) No 813/2013 for low-temperature heat pumps. 6) Following Eurovent and COMMISSION REGULATION (EU) No 811/2013 for low-temperature heat pumps. Scale from A+++ to D, as of 26th September 2019. 7) Sound pressure levels calculated at 10 meters. Sound pressure levels refer to ISO standard 3744 with parallel piped shape. * w: with, w/o: without.

Accessories	
PAW-SYSREMKIT	Remote control
PAW-CM000SP041	Cloudgate plug and play IP65 box mobile 4G Europe
PAW-CM000K0001	Extension kit and cable glante for mobile (2/4G) antenna (3 m)

Accessories	
PAW-00SRTS011	Tservice wireless fee for 1 year
PAW-SYSSOV2	Shut off valves kit for model 45 - 75

HIGH SEER
4,63

HIGH SCOP
3,55

ErP

BLUEFIN

ULTIMATE CUSTOMISATION

AUTOMATIC FAN

-17 °C
HEATING MODE

50 °C
COOLING MODE

BMS CONNECTIVITY





U - 090/105/125 CW

Cooling capacity: 91,4 to 121,9 kW
Heating capacity: 88,1 to 119,1 kW

Customizable design gives high flexibility. Wide range of communication protocols fulfill the requirements in hotels, offices, industry applications.



- High seasonal efficiency in cooling and heating
- Eurovent certified
- Ambient temperature operating range: -10 to +50 °C in cooling, -17 to +20 °C in heating
- Water outlet temperature range: -10 to +18 °C in cooling, +20 to +50 °C in heating
- Optional extra-low noise kit available
- Optimised design for service and maintenance
- Simple user friendly control as standard
- Modbus RTU as standard

- Bluefin anti-corrosion coating
- Optional hydraulic kit
- Optional Desuperheater for free hot water up to 50 °C
- Optional finned coil treatment
- Optional Modbus TCP/IP, BACnet IP and BACnet MSTP
- Optional remote LAN connection

Technical focus

- Chiller type: heat pump
- Compressor type (number of compressors): Scroll compressors (2)
- Refrigerant type: R410A
- Refrigerant circuit: 1
- Fan type (number of fans): axial fan (2)
- Heat exchanger: stainless steel plate heat exchanger
- Flow switch, water safety & air purge valves included
- Water filter included (mandatory to be installed on site)
- Night mode setting to save energy and reduce noise level
- Water compensation curve control

Ambient temperature.

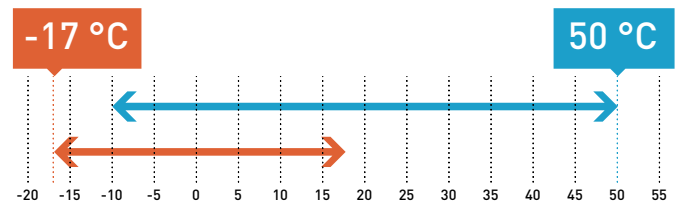

Water outlet temperature.

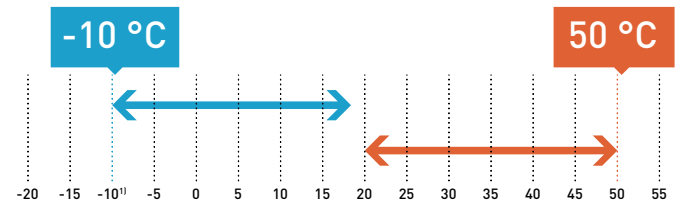

Cooling: Outside air temperature [°C (DB)]. Heating: Outside air temperature [°C (WB)].
 * With glycol 45 % maximum, 5 °C without glycol.

Available options

Options	Pump drive	Hydraulic options	Ambient options	Miscellaneous options
Single pump	Fixed speed	Low water pressure sensor	Finned coil treatment - epoxy	Soft starter
Double pump	Variable twin speed	Water isolation valves	Outdoor coil protection grid	Power supply w/o neutral
	Variable capacity	Electrical heater low power (only with buffer tank)	Rubber pads	Modbus TCP/IP
	Constant outlet pressure	Electrical heater high power (only with buffer tank)	Spring damper	BACnet MSTP
	Constant differential pressure		All seasons fan control	BACnet IP
			Extra-low noise kit	Remote LAN connection
			High pressure fan	Container transport
				Refrigerant gauge
				Desuperheater



REFER TO PAGE 438 TO SEE MORE OPTIONS FOR HEAT PUMP OUTDOOR UNITS



Optional remote control.
PAW-SYSREMKIT



Optional Shut off valves kit for model 90 - 125.
PAW-SYSSOV3

Model			90	105	125
Standard without buffer tank			U-090CWNB	U-105CWNB	U-125CWNB
With buffer tank			U-090CWBM	U-105CWBM	U-125CWBM
Power supply	Voltage	V	400	400	400
	Phase		Three phase	Three phase	Three phase
	Frequency	Hz	50	50	50
Cooling capacity ¹⁾		kW	88,7	100,8	119,3
Input power ¹⁾		kW	30,6	34,8	40,4
Total EER 100 % ¹⁾			2,90	2,89	2,96
SEER ^{2) 3)}			4,40	4,44	4,49
$\eta_{s,c}$ ^{2) 3)}		%	173	175	177
Heating capacity ⁴⁾		kW	88,1	101,0	119,1
Input power ⁴⁾		kW	33,8	38,4	45,5
SCOP ^{3) 5)}			3,40	3,43	3,43
$\eta_{s,h}$ ^{3) 5)}		%	133	134	134
Startup type			Direct	Direct	Direct
Maximum operating current		A	77,9	86,0	102,0
Startup current w/o softstarter / w softstarter		A	265/127	312/146	345/183
Sound power (w standard fans)		dB(A)	83,0	83,0	83,0
Sound pressure (w standard fans) ⁶⁾		dB(A)	50,8	50,8	50,8
Dimension (w standard fans) w/o buffer tank	H x W x D	mm	2286 x 2180 x 1160	2286 x 2180 x 1160	2286 x 2180 x 1160
Dimension (w standard fans) w buffer tank	H x W x D	mm	2286 x 2680 x 1160	2286 x 2680 x 1160	2286 x 2680 x 1160
Weight (w 1 pump) w/o buffer tank		kg	790	900	920
Weight (w 1 pump) w buffer tank		kg	950	1060	1080
Refrigerant (R410A)		kg	22,0	27,0	28,5
Number of refrigerant circuit			1	1	1
Compressors					
Number			2	2	2
Type			Scroll	Scroll	Scroll
Part load step		%	0/45/55/100	0/38/62/100	0/33/67/100
Crankcase heater		W	66/82	66/95	66/95
Evaporator					
Number			1	1	1
Type			Plate	Plate	Plate
Nominal water flow (cooling)		m ³ /h	15,73	18,25	20,95
Water pressure drop (cooling)		kPa	26	34	45
Water volume		l	10,80	10,80	10,80
Antifreeze heater		W	2x30	2x30	2x30
Coils					
Number			2	2	2
Frontal surface		m ²	6,4	6,4	6,4
Number of rows			2	3	3
Fans standard					
Number			2	2	2
Air flow		m ³ /h	42000	42000	42000
Rotation speed		r.p.m.	790	790	790
Power input (each fan)		W	1650	1650	1650
Water connections					
Type			Male gas threaded BSPP ISO 228	Male gas threaded BSPP ISO 228	Male gas threaded BSPP ISO 228
Inlet - diameter		Inch	2 1/2	2 1/2	2 1/2
Outlet - diameter		Inch	2 1/2	2 1/2	2 1/2

1) Data refers to 7 °C leaving chilled water temperature and 35 °C condenser air temperature, according EN14511 standard. 2) Following COMMISSION REGULATION (EU) No 2016/2281 for comfort application chillers. 3) Those are the data with variable flow. 4) Data refers to 45 °C leaving warm water temperature and 7 °C ambient coil air temperature with 87 % R.H., according EN14511 standard. 5) Following COMMISSION REGULATION (EU) No 813/2013 for low-temperature heat pumps. 6) Sound pressure levels calculated at 10 meters. Sound pressure levels refer to ISO standard 3744 with parallel piped shape. * w: with, w/o: without.

Accessories	
PAW-SYSREMKIT	Remote control
PAW-CM000SP041	Cloudgate plug and play IP65 box mobile 4G Europe
PAW-CM000K0001	Extension kit and cable gland for mobile (2/4G) antenna (3 m)

Accessories	
PAW-00SRTS011	Tservice wireless fee for 1 year
PAW-SYSSOV3	Shut off valves kit for model 90 - 125

HIGH SEER
4,49

HIGH SCOP
3,43

ErP

BLUEFIN

ULTIMATE CUSTOMISATION

AUTOMATIC FAN

-17 °C
HEATING MODE

50 °C
COOLING MODE

BMS CONNECTIVITY





U - 140/150/170/190/210 CW

Cooling capacity: 125,4 to 195,4 kW

Heating capacity: 143,7 to 217,6 kW

Heat pump chiller series with powerful operation by 4 scroll compressors. Maximum water outlet temperature in heating is up to 55 °C ¹⁾. Defrost limiting design ensures to provide stable hot water even at low ambient conditions.

¹⁾ Special condition apply. Please contact an authorized Panasonic dealer in the case of condition >50 °C.



- Smart defrost: Defrost limiting design to ensure a constant water outlet temperature even at very low temperatures
- High seasonal efficiency in cooling and heating
- Eurovent certified
- Ambient temperature operating range: -10 to +50 °C in cooling, -17 to +20 °C in heating
- Water outlet temperature range: -10 to +18 °C in cooling, +20 to +50 °C in heating
- Super quiet operation
- Victaulic water connections
- Optimised design for service and maintenance
- Simple user friendly control as standard
- Modbus RTU as standard
- Modbus TCP/IP as standard

- Water compensation curve control
- Bluefin anti-corrosion coating
- Optional hydraulic kit
- Optional finned coil treatment
- Optional gauges hydraulic and refrigerant
- Optional BACnet
- Remote LAN connection as standard

Technical focus

- Chiller type: heat pump
- Compressor type (number of compressors): Scroll compressors (4)
- Refrigerant type: R410A
- Refrigerant circuit: 2
- Fan type (number of fans): axial fan (4)
- Heat exchanger: stainless steel plate heat exchanger
- Flow switch, water safety & air purge valves included
- Water filter included (mandatory to be installed on site)
- Night mode setting to save energy and reduce noise level

Ambient temperature.

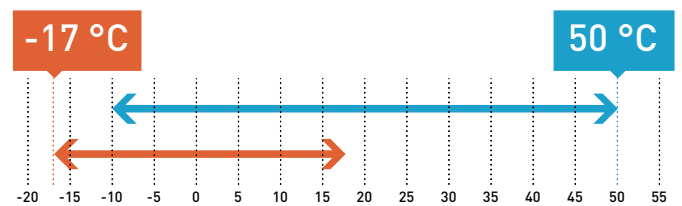

Water outlet temperature.

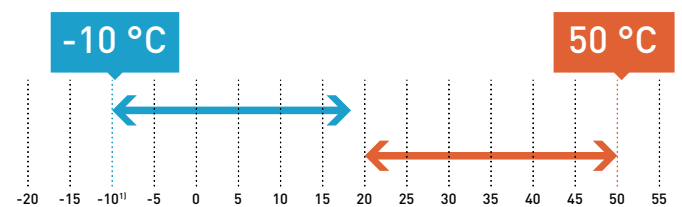

Cooling: Outside air temperature [°C (DB)]. Heating: Outside air temperature [°C (WB)].
 * With glycol 45 % maximum, 5 °C without glycol.

Available options

Options	Pump drive	Hydraulic options	Ambient options	Miscellaneous options
Single pump low pressure	Fixed speed	Low water pressure sensor	Finned coil treatment - epoxy	Soft starter
Single pump high pressure	Variable twin speed	Water isolation valves	Outdoor coil protection grid	Power supply w/o neutral
Double pump low pressure	Variable capacity	Hydraulic gauges	Rubber pads	Modbus TCP/IP
Double pump high pressure	Constant outlet pressure		Spring damper	BACnet IP
	Constant differential pressure		All seasons fan control	Container transport
			Nordic pack	Refrigerant gauge
			High pressure fan	



1 DEFROST CYCLE EVERY 130 MINUTES.

Heating Capacity: +22 %
Integrated COP: +15 %
Improved SCOP Class



REFER TO PAGE 438 TO SEE MORE OPTIONS FOR HEAT PUMP OUTDOOR UNITS



Optional remote control. PAW-SYSREMKIT

Model		140	150	170	190	210
Standard without buffer tank		U-140CWNB	U-150CWNB	U-170CWNB	U-190CWNB	U-210CWNB
With buffer tank		U-140CWBL	U-150CWBL	U-170CWBL	U-190CWBL	U-210CWBL
Power supply	Voltage	V	400	400	400	400
	Phase		Three phase	Three phase	Three phase	Three phase
	Frequency	Hz	50	50	50	50
Cooling capacity ¹⁾	kW	128,3	142,1	163,9	177,5	207,9
Input power ¹⁾	kW	43,2	47,7	54,7	61,3	69,7
Total EER 100 % ¹⁾		2,97	2,98	2,99	2,90	2,98
SEER ^{2) 3)}		4,39	4,36	4,31	4,23	4,28
$\eta_{s,c}$ ^{2) 3)}	%	173	171	169	166	168
Heating capacity ⁴⁾	kW	144,0	154,0	170,0	195,0	218,0
Input power ⁴⁾	kW	45,7	50,3	55,5	67,4	78,3
SCOP ^{3) 5)}		3,30	3,33	3,30	3,23	3,23
$\eta_{s,h}$ ^{3) 5)}	%	129	130	129	128	126
Startup type		Direct	Direct	Direct	Direct	Direct
Maximum operating current	A	108,0	119,0	136,0	153,0	170,0
Startup current w/o softstarter / w softstarter	A	251 / 130	262 / 141	324 / 161	341 / 178	396 / 201
Sound power (w standard fans)	dB(A)	85,4	85,4	87,0	88,1	88,1
Sound pressure (w standard fans) ⁶⁾	dB(A)	53,4	53,4	55,0	56,1	56,1
Dimension (w standard fans) w/o buffer tank	H x W x D	mm	2295 x 2856 x 2210	2295 x 2856 x 2210	2295 x 2856 x 2210	2295 x 2856 x 2210
Dimension (w standard fans) w buffer tank	H x W x D	mm	2295 x 3666 x 2210	2295 x 3666 x 2210	2295 x 3666 x 2210	2295 x 3666 x 2210
Weight (w 1 low Pa pump) w/o buffer tank	kg	1570	1580	1680	1750	2020
Weight (w 1 low Pa pump) w buffer tank	kg	1700	1710	1810	1880	2150
Refrigerant (R410A)	kg	2 x 24,7	2 x 24,7	24,7/33,3	2 x 33,3	2 x 33,3
Number of refrigerant circuit		2	2	2	2	2
Compressors						
Number		4	4	4	4	4
Type		Scroll	Scroll	Scroll	Scroll	Scroll
Part load step	%	0 / 24 / 26 / 48 / 50 / 52 / 74 / 76 / 100	0 / 23 / 27 / 46 / 50 / 54 / 73 / 77 / 100	0 / 20 / 24 / 44 / 45 / 55 / 69 / 80 / 100	0 / 22 / 28 / 44 / 50 / 56 / 72 / 78 / 100	0 / 19 / 31 / 38 / 50 / 62 / 69 / 81 / 100
Crankcase heater	W	4 x 66	4 x 66	3 x 66 / 82	2 x 82 / 2 x 66	2 x 95 / 2 x 66
Evaporator						
Number		1	1	1	1	1
Type		Plate	Plate	Plate	Plate	Plate
Nominal water flow (cooling)	m ³ /h	21,56	23,65	25,95	30,24	33,62
Water pressure drop (cooling)	kPa	33	39	24	32	40
Water volume	l	8,49	8,49	12,21	12,21	12,21
Antifreeze heater	W	60	60	120	120	120
Coils						
Number		4	4	4	4	4
Frontal surface	m ²	11,88	11,88	11,88	11,88	11,88
Number of rows		2+2	2+2	2+3	3+3	3+3
Fans standard						
Number		4	4	4	4	4
Air flow	m ³ /h	56000	56000	71000	86000	83000
Rotation speed	r.p.m.	900	900	900	900	900
Power input (each fan)	W	940	940	940 - 1650	1650	1650
Water connections						
Type		Victaulic	Victaulic	Victaulic	Victaulic	Victaulic
Inlet - diameter	Inch	2 1/2	2 1/2	2 1/2	2 1/2	2 1/2
Outlet - diameter	Inch	2 1/2	2 1/2	2 1/2	2 1/2	2 1/2

1) Data refers to 7 °C leaving chilled water temperature and 35 °C condenser air temperature, according EN14511 standard. 2) Following COMMISSION REGULATION (EU) No 2016/2281 for comfort application chillers. 3) Those are the data with variable flow. 4) Data refers to 45 °C leaving warm water temperature and 7 °C ambient coil air temperature with 87 % R.H., according EN14511 standard. 5) Following COMMISSION REGULATION (EU) No 813/2013 for low-temperature heat pumps. 6) Sound pressure levels calculated at 10 meters. Sound pressure levels refer to ISO standard 3744 with parallel piped shape. * w: with, w/o: without.

Accessories	
PAW-SYSREMKIT	Remote control
PAW-CM000SP041	Cloudgate plug and play IP65 box mobile 4G Europe
PAW-CM000K001	Extension kit and cable glande for mobile (2/4G) antenna (3 m)

Accessories	
PAW-00SRTS011	Tservice wireless fee for 1 year
PAW-SYSVICTH	Victaulic connection kit for model 140 - 210

HIGH SEER
4,39

HIGH SCOP
3,33

ErP

SUPER QUIET

BLUEFIN

ULTIMATE CUSTOMISATION

AUTOMATIC FAN

HEATING MODE
-17 °C

COOLING MODE
50 °C

DEFROST LIMITING

BMS CONNECTIVITY





Options table 140 - 210

Option	Type	Ref.	Description	Model				
				140	150	170	190	210
1	Capacity							
2	Refrigerant and compressor type	W	R410A, fixed speed, heat pump	•	•	•	•	•
3	Buffer tank option	NB	No buffer	Std	Std	Std	Std	Std
		BL	Buffer tank (large)	•	•	•	•	•
4	Pump option		No pump	Std	Std	Std	Std	Std
			Single pump low pressure	•	•	•	•	•
			Single pump high pressure	•	•	•	•	•
			Double pump low pressure	•	•	•	•	•
			Double pump high pressure	•	•	•	•	•
			Pump drive - fixed speed ¹⁾	Std	Std	Std	Std	Std
5	Pump drive option		Pump drive - variable twin speed (single pump)	•	•	•	•	•
			Pump drive - variable twin speed (double pump)	•	•	•	•	•
			Pump drive - variable speed capacity (single pump)	•	•	•	•	•
			Pump drive - variable speed capacity (double pump)	•	•	•	•	•
			Pump drive - constant outlet pressure (single pump)	•	•	•	•	•
			Pump drive - constant outlet pressure (double pump)	•	•	•	•	•
6	Hydraulic options		Pump drive - constant differential pressure (single pump) ²⁾	S0	S0	S0	S0	S0
			Pump drive - constant differential pressure (double pump) ²⁾	S0	S0	S0	S0	S0
			No hydraulic options	Std	Std	Std	Std	Std
			Low water pressure sensor ³⁾	•	•	•	•	•
			Water isolation valves	•	•	•	•	•
			Hydraulic gauges	•	•	•	•	•
7	Ambient options		No ambient options	Std	Std	Std	Std	Std
			Finned coil treatment - epoxy	•	•	•	•	•
			Outdoor coil protection grid ⁴⁾	•	•	•	•	•
			Rubber pads	•	•	•	•	•
			Spring damper	•	•	•	•	•
			Fan speed control (FSC)	•	•	•	•	•
8	Miscellaneous options		Nordic pack	•	•	•	•	•
			Low noise	Std	Std	Std	Std	Std
			No miscellaneous options	Std	Std	Std	Std	Std
			Soft starter	•	•	•	•	•
			Power supply w/o neutral	•	•	•	•	•
			Standard BMS option (Modbus RTU)	Std	Std	Std	Std	Std
	Modbus TCP/IP	•	•	•	•	•		
	BACnet IP	•	•	•	•	•		
	Remote LAN connection	Std	Std	Std	Std	Std		
	Container transport	•	•	•	•	•		
	Refrigerant gauge	•	•	•	•	•		

1) Fixed speed pump drive is standard when selecting a pump. Please select an alternative pump drive if required.

2) Constant differential pump drive options are only available on a special order and requires additional production time. Please contact your local sales representative.

3) Supplied loose for unit w/o pump.

4) Not available when using Nordic pack.

Std: Standard item included.

•: Optional item that can be selected.

S0: Special order item.



U - 020/025/030/035/040 CV

Cooling capacity: 19,3 to 40,9 kW

Compact and highly efficient chiller series, with SEER up to 4,78.



- High seasonal efficiency
- Ambient temperature operating range: -10 to +50 °C
- Water outlet temperature range: -10 to +18 °C
- Super quiet operation
- Optimised design for service and maintenance
- Simple user friendly control as standard
- Modbus RTU as standard

- Optional Modbus TCP/IP, BACnet IP and BACnet MSTP
- Optional remote LAN connection

* Available on special order only, please contact your local Panasonic sales representative.

Ambient temperature.

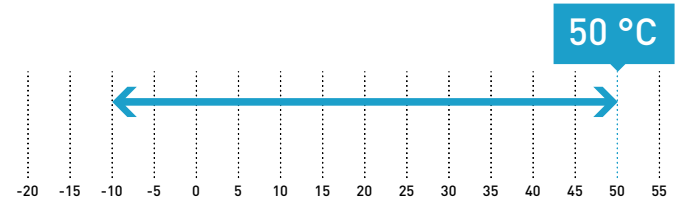

Water outlet temperature.

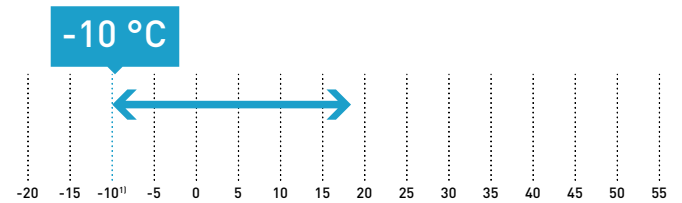

Cooling: Outside air temperature [°C (DB)].

* With glycol 45 % maximum, 5 °C without glycol.

Technical focus

- Chiller type: cooling only
- Compressor type (number of compressors): Scroll compressors (2)
- Refrigerant type: R410A
- Refrigerant circuit: 1
- Fan type (number of fans): axial fan (1)
- Heat exchanger: stainless steel plate heat exchanger
- Flow switch, water safety & air purge valves included
- Water filter included (mandatory to be installed on site)
- Night mode setting to save energy and reduce noise level
- Water compensation curve control
- Optional hydraulic kit
- Optional Desuperheater for free hot water up to 50 °C*
- Optional finned coil treatment

Available options

Options				
Pump	Pump drive	Hydraulic options	Ambient options	Miscellaneous options
Single pump (as standard)	Fixed speed ¹⁾	Low water pressure sensor	Finned coil treatment - epoxy	Soft starter
	Variable twin speed	Water isolation valves	Rubber pads	Power supply w/o neutral
	Variable capacity		Spring damper	Modbus TCP/IP
	Constant outlet pressure		All seasons	BACnet MSTP
	Constant differential pressure		High pressure fan ²⁾	BACnet IP
				Remote LAN connection
				Desuperheater ³⁾

1) Available for non-EU installation. 2) Available on models 25 - 40. 3) Available on special order only, please contact your local Panasonic sales representative.



REFER TO PAGE 448 TO SEE MORE OPTIONS FOR COOLING ONLY OUTDOOR UNITS



Optional remote control.
PAW-SYSREMKIT



Optional Shut off valves kit for model 45 - 75.
PAW-SYSSOV2

Model			20	25	30	35	40
Standard without buffer tank			U-020CVNB	U-025CVNB	U-030CVNB	U-035CVNB	U-040CVNB
With buffer tank			U-020CVBS	U-025CVBS	U-030CVBS	U-035CVBS	U-040CVBS
Power supply	Voltage	V	400	400	400	400	400
	Phase		Three phase	Three phase	Three phase	Three phase	Three phase
	Frequency	Hz	50	50	50	50	50
Cooling capacity ¹⁾		kW	19,2	24,3	27,1	36,7	39,0
Input power ¹⁾		kW	5,9	7,7	9,3	12,2	13,0
Total EER 100 % ¹⁾			3,25	3,17	2,90	3,01	3,00
SEER ²⁾			4,78	4,38	4,43	4,43	4,48
$\eta_{s,c}$ ²⁾		%	188	172	174	174	176
Startup type			Direct	Direct	Direct	Direct	Direct
Maximum operating current		A	17,7	22,2	24,3	31,8	33,8
Startup current w/o softstarter / w softstarter		A	53/28	64/35	77/49	118/53	119/54
Sound power (w standard fans)		dB(A)	75,0	75,0	75,0	76,0	76,0
Sound pressure (w standard fans) ³⁾		dB(A)	42,8	42,8	42,8	43,8	43,8
Dimension (w standard fans) w/o buffer tank	H x W x D	mm	1983 x 1000 x 1000	1983 x 1000 x 1000	1983 x 1000 x 1000	1983 x 1000 x 1000	1983 x 1000 x 1000
Dimension (w standard fans) w buffer tank	H x W x D	mm	1983 x 1000 x 1507	1983 x 1000 x 1507	1983 x 1000 x 1507	1983 x 1000 x 1507	1983 x 1000 x 1507
Weight (w 1 pump) w/o buffer tank		kg	265	275	305	315	320
Weight (w 1 pump) w buffer tank		kg	330	340	370	380	385
Refrigerant (R410A)		kg	6,5	8,4	8,4	9,1	9,2
Number of refrigerant circuit			1	1	1	1	1
Compressors							
Number			2	2	2	2	2
Type			Scroll	Scroll	Scroll	Scroll	Scroll
Part load step		%	0/50/100	0/50/100	0/50/100	0/50/100	0/50/100
Crankcase heater		W	2 x 40	2 x 40	2 x 49	2 x 49	2 x 49
Evaporator							
Number			1	1	1	1	1
Type			Plate	Plate	Plate	Plate	Plate
Nominal water flow (cooling)		m ³ /h	3,35	4,36	4,64	6,16	6,44
Water pressure drop (cooling)		kPa	23	37	22	37	40
Water volume		l	1,78	1,78	2,55	2,55	2,55
Antifreeze heater		W	30	30	30	30	30
Coils							
Number			1	1	1	1	1
Frontal surface		m ²	2,4	2,4	2,4	2,8	2,8
Number of rows			2	2	2	2	2
Fans standard							
Number			1	1	1	1	1
Air flow		m ³ /h	9000	13000	13000	16000	16000
Rotation speed		r.p.m.	900	900	900	650	650
Power input (each fan)		W	620	940	940	930	930
Water connections							
Type			Male gas threaded BSPP ISO 228	Male gas threaded BSPP ISO 228	Male gas threaded BSPP ISO 228	Male gas threaded BSPP ISO 228	Male gas threaded BSPP ISO 228
Inlet - diameter		Inch	1 1/2	1 1/2	1 1/2	1 1/2	1 1/2
Outlet - diameter		Inch	1 1/2	1 1/2	1 1/2	1 1/2	1 1/2

1) Data refers to 7 °C leaving chilled water temperature and 35 °C condenser air temperature, according EN14511 standard. 2) Following COMMISSION REGULATION (EU) No 2016/2281 for comfort application chillers. 3) Sound pressure levels calculated at 10 meters. Sound pressure levels refer to ISO standard 3744 with parallel piped shape.
* w: with, w/o: without. ** The data are calculated with variable flow.

Accessories	
PAW-SYSREMKIT	Remote control
PAW-CM0005P041	Cloudgate plug and play IP65 box mobile 4G Europe
PAW-CM000K0001	Extension kit and cable gland for mobile (2/4G) antenna (3 m)

Accessories	
PAW-00SRTS011	Tservice wireless fee for 1 year
PAW-SYSSOV1	Shut off valves kit for model 20 - 40





U - 045/055/065/075 CV

Cooling capacity: 49,8 to 75,8 kW

High seasonal efficiency and wide range options to meet the exact requirements of your project.



- High seasonal efficiency
- Ambient temperature operating range: -10 to +50 °C
- Water outlet temperature range: -10 to +18 °C
- Optional extra-low noise kit available
- Optimised design for service and maintenance
- Simple user friendly control as standard
- Modbus RTU as standard

- Optional finned coil treatment
- Optional Modbus TCP/IP, BACnet IP and BACnet MSTP
- Optional remote LAN connection

Ambient temperature.

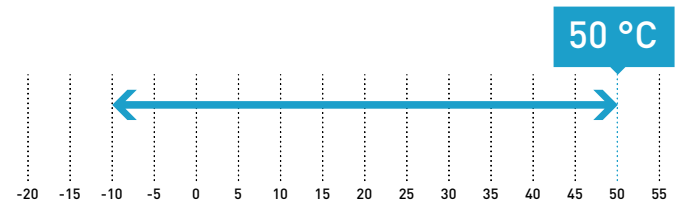

Water outlet temperature.

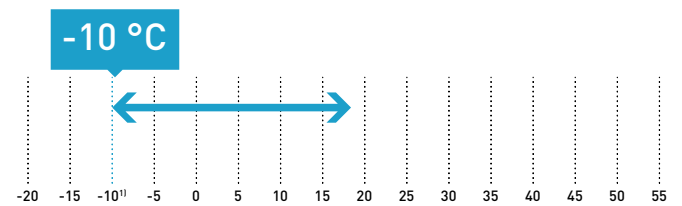

Cooling: Outside air temperature [°C (DB)].

* With glycol 45 % maximum, 5 °C without glycol.

Technical focus

- Chiller type: cooling only
- Compressor type (number of compressors): Scroll compressors (2)
- Refrigerant type: R410A
- Refrigerant circuit: 1
- Fan type (number of fans): axial fan (1 for 45/55, 2 for 65/75)
- Heat exchanger: stainless steel plate heat exchanger
- Flow switch, water safety & air purge valves included
- Water filter included (mandatory to be installed on site)
- Night mode setting to save energy and reduce noise level
- Water compensation curve control
- Optional hydraulic kit
- Optional Desuperheater for free hot water up to 50 °C

Available options

Options				
Pump	Pump drive	Hydraulic options	Ambient options	Miscellaneous options
Single pump	Fixed speed ¹⁾	Low water pressure sensor	Finned coil treatment - epoxy	Soft starter
Double pump	Variable twin speed	Water isolation valves	Outdoor coil protection grid	Power supply w/o neutral
	Variable capacity		Rubber pads	Modbus TCP/IP
	Constant outlet pressure		Spring damper	BACnet MSTP
	Constant differential pressure		All seasons fan control	BACnet IP
			Extra-low noise kit	Remote LAN connection
			High pressure fan	Container transport
				Refrigerant gauge
				Desuperheater

1) Available for non-EU installation.



REFER TO PAGE 448 TO SEE MORE OPTIONS FOR COOLING ONLY OUTDOOR UNITS



Optional remote control.
PAW-SYSREMKIT



Optional Shut off valves kit for model 45 - 75.
PAW-SYSSOV2

Model			45	55	65	75
Standard without buffer tank			U-045CVNB	U-055CVNB	U-065CVNB	U-075CVNB
With buffer tank			U-045CVBM	U-055CVBM	U-065CVBM	U-075CVBM
Power supply	Voltage	V	400	400	400	400
	Phase		Three phase	Three phase	Three phase	Three phase
	Frequency	Hz	50	50	50	50
Cooling capacity ¹⁾		kW	45,3	52,0	66,1	73,1
Input power ¹⁾		kW	15,4	17,6	21,7	24,0
Total EER 100 % ¹⁾			2,95	2,96	3,05	3,05
SEER ²⁾			4,40	4,53	4,53	4,68
$\eta_{s,c}$ ²⁾		%	173	178	178	184
Startup type			Direct	Direct	Direct	Direct
Maximum operating current		A	40,2	44,2	58,4	64,4
Startup current w/o softstarter / w softstarter		A	133,2/65,8	140,2/72,8	201,4/101,0	206,4/106,0
Sound power (w standard fans)		dB(A)	80,0	80,0	80,0	80,0
Sound pressure (w standard fans) ³⁾		dB(A)	47,8	47,8	47,8	47,8
Dimension (w standard fans) w/o buffer tank	H x W x D	mm	1986 x 2180 x 1160	1986 x 2180 x 1160	1986 x 2180 x 1160	1986 x 2180 x 1160
Dimension (w standard fans) w buffer tank	H x W x D	mm	1986 x 2680 x 1160	1986 x 2680 x 1160	1986 x 2680 x 1160	1986 x 2680 x 1160
Weight (w 1 pump) w/o buffer tank		kg	515	520	580	590
Weight (w 1 pump) w buffer tank		kg	675	680	740	750
Refrigerant (R410A)		kg	14,5	14,9	18,9	19,0
Number of refrigerant circuit			1	1	1	1
Compressors						
Number			2	2	2	2
Type			Scroll	Scroll	Scroll	Scroll
Part load step		%	0/50/100	0/43/57/100	0/40/60/100	0/45/55/100
Crankcase heater		W	2 x 66	2 x 66	2 x 66	2 x 66
Evaporator						
Number			1	1	1	1
Type			Plate	Plate	Plate	Plate
Nominal water flow (cooling)		m ³ /h	8,06	9,18	11,30	12,31
Water pressure drop (cooling)		kPa	30	35	28	37
Water volume		l	4,10	4,10	6,10	6,10
Antifreeze heater		W	30	30	2 x 30	2 x 30
Coils						
Number			1	1	2	2
Frontal surface		m ²	4,20	4,20	5,55	5,55
Number of rows			2	2	2	2
Fans standard						
Number			1	1	2	2
Air flow		m ³ /h	22500	22500	30000	30000
Rotation speed		r.p.m.	790	790	650	650
Power input (each fan)		W	1650	1650	930	930
Water connections						
Type			Male gas threaded BSPP ISO 228	Male gas threaded BSPP ISO 228	Male gas threaded BSPP ISO 228	Male gas threaded BSPP ISO 228
Inlet - diameter		Inch	2	2	2	2
Outlet - diameter		Inch	2	2	2	2

1) Data refers to 7 °C leaving chilled water temperature and 35 °C condenser air temperature, according EN14511 standard. 2) Following COMMISSION REGULATION (EU) No 2016/2281 for comfort application chillers. 3) Sound pressure levels calculated at 10 meters. Sound pressure levels refer to ISO standard 3744 with parallel piped shape.
* w: with, w/o: without. ** The data are calculated with variable flow.

Accessories	
PAW-SYSREMKIT	Remote control
PAW-CM000SP041	Cloudgate plug and play IP65 box mobile 4G Europe
PAW-CM000K001	Extension kit and cable gland for mobile (2/4G) antenna (3 m)

Accessories	
PAW-00SRTS011	Tservice wireless fee for 1 year
PAW-SYSSOV2	Shut off valves kit for model 45 - 75





U - 090/105/125 CV

Cooling capacity: 97,0 to 129,8 kW

Customizable design gives high flexibility. Wide range of communication protocols fulfill the requirements in hotels, offices, industry applications.



- High seasonal efficiency
- Ambient temperature operating range: -10 to +50 °C
- Water outlet temperature range: -10 to +18 °C
- Optional extra-low noise kit available
- Optimised design for service and maintenance
- Simple user friendly control as standard
- Modbus RTU as standard

- Optional finned coil treatment
- Optional Modbus TCP/IP, BACnet IP and BACnet MSTP
- Optional remote LAN connection

Ambient temperature.

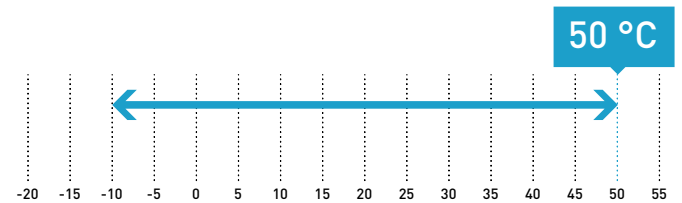

Water outlet temperature.

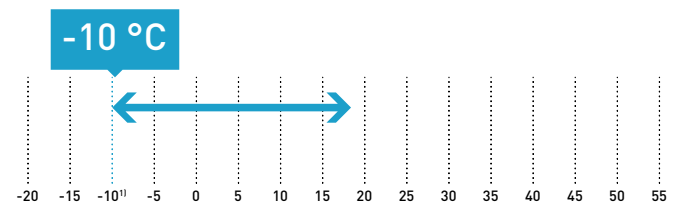

Cooling: Outside air temperature [°C (DB)].

* With glycol 45 % maximum, 5 °C without glycol.

Technical focus

- Chiller type: cooling only
- Compressor type (number of compressors): Scroll compressors (2)
- Refrigerant type: R410A
- Refrigerant circuit: 1
- Fan type (number of fans): axial fan (2)
- Heat exchanger: stainless steel plate heat exchanger
- Flow switch, water safety & air purge valves included
- Water filter included (mandatory to be installed on site)
- Night mode setting to save energy and reduce noise level
- Water compensation curve control
- Optional hydraulic kit
- Optional Desuperheater for free hot water up to 50 °C

Available options

Options				
Pump	Pump drive	Hydraulic options	Ambient options	Miscellaneous options
Single pump	Fixed speed ¹⁾	Low water pressure sensor	Finned coil treatment - epoxy	Soft starter
Double pump	Variable twin speed	Water isolation valves	Outdoor coil protection grid	Power supply w/o neutral
	Variable capacity		Rubber pads	Modbus TCP/IP
	Constant outlet pressure		Spring damper	BACnet MSTP
	Constant differential pressure		All seasons fan control	BACnet IP
			Extra-low noise kit	Remote LAN connection
			High pressure fan	Container transport
				Refrigerant gauge
				Desuperheater

1) Available for non-EU installation.



REFER TO PAGE 448 TO SEE MORE OPTIONS FOR COOLING ONLY OUTDOOR UNITS



Optional remote control.
PAW-SYSREMKIT



Optional Shut off valves kit for model 90 - 125.
PAW-SYSSOV3

Model	90		105		125	
Standard without buffer tank	U-090CVNB		U-105CVNB		U-125CVNB	
With buffer tank	U-090CVBM		U-105CVBM		U-125CVBM	
Power supply	Voltage	V	400		400	
	Phase		Three phase		Three phase	
	Frequency	Hz	50		50	
Cooling capacity ¹⁾		kW	90,7		104,0	
Input power ¹⁾		kW	30,6		34,9	
Total EER 100 % ¹⁾			2,96		2,98	
SEER ²⁾			4,45		4,50	
η_{s,c} ²⁾		%	175		177	
Startup type			Direct		Direct	
Maximum operating current		A	77,9		86,0	
Startup current w/o softstarter / w softstarter		A	264,9/127,3		312,0/145,8	
Sound power (w standard fans)		dB(A)	83,0		83,0	
Sound pressure (w standard fans) ³⁾		dB(A)	50,8		50,8	
Dimension (w standard fans) w/o buffer tank	H x W x D	mm	2286 x 2180 x 1160		2286 x 2180 x 1160	
Dimension (w standard fans) w buffer tank	H x W x D	mm	2286 x 2680 x 1160		2286 x 2680 x 1160	
Weight (w 1 pump) w/o buffer tank		kg	750		855	
Weight (w 1 pump) w buffer tank		kg	910		1015	
Refrigerant (R410A)		kg	22,0		27,0	
Number of refrigerant circuit			1		1	
Compressors						
Number			2		2	
Type			Scroll		Scroll	
Part load step		%	0/45/55/100		0/38/62/100	
Crankcase heater		W	66/82		66/95	
Evaporator						
Number			1		1	
Type			Plate		Plate	
Nominal water flow (cooling)		m ³ /h	15,73		18,25	
Water pressure drop (cooling)		kPa	26		34	
Water volume		l	10,80		10,80	
Antifreeze heater		W	2x30		2x30	
Coils						
Number			2		2	
Frontal surface		m ²	6,4		6,4	
Number of rows			2		3	
Fans standard						
Number			2		2	
Air flow		m ³ /h	42000		42000	
Rotation speed		r.p.m.	790		790	
Power input (each fan)		W	1650		1650	
Water connections						
Type			Male gas threaded BSPP ISO 228	Male gas threaded BSPP ISO 228	Male gas threaded BSPP ISO 228	Male gas threaded BSPP ISO 228
Inlet - diameter		Inch	2 1/2		2 1/2	
Outlet - diameter		Inch	2 1/2		2 1/2	

1) Data refers to 7 °C leaving chilled water temperature and 35 °C condenser air temperature, according EN14511 standard. 2) Following COMMISSION REGULATION (EU) No 2016/2281 for comfort application chillers. 3) Sound pressure levels calculated at 10 meters. Sound pressure levels refer to ISO standard 3744 with parallel piped shape.
* w: with, w/o: without. ** The data are calculated with variable flow.

Accessories	
PAW-SYSREMKIT	Remote control
PAW-CM000SP041	Cloudgate plug and play IP65 box mobile 4G Europe
PAW-CM000K0001	Extension kit and cable gland for mobile (2/4G) antenna (3 m)

Accessories	
PAW-00SRTS011	Tservice wireless fee for 1 year
PAW-SYSSOV3	Shut off valves kit for model 90 - 125





U - 140/150/170/190/210 CV

Cooling capacity: 134,0 to 208,8 kW

Powerful and efficient operation with 4 scroll compressors and superior flexibility with plug and play hydraulic options.



- High seasonal efficiency
- Ambient temperature operating range: -10 to +50 °C
- Water outlet temperature range: -10 to +18 °C
- Super quiet operation
- Victaulic water connections
- Optimised design for service and maintenance
- Simple user friendly control as standard
- Modbus RTU as standard
- Modbus TCP/IP as standard

- Optional gauges hydraulic and refrigerant
- Optional BACnet
- Remote LAN connection as standard

Technical focus

- Chiller type: cooling only
- Compressor type (number of compressors): Scroll compressors (4)
- Refrigerant type: R410A
- Refrigerant circuit: 2
- Fan type (number of fans): axial fan (4)
- Heat exchanger: stainless steel plate heat exchanger
- Flow switch, water safety & air purge valves included
- Water filter included (mandatory to be installed on site)
- Night mode setting to save energy and reduce noise level
- Water compensation curve control
- Optional hydraulic kit
- Optional finned coil treatment

Ambient temperature.

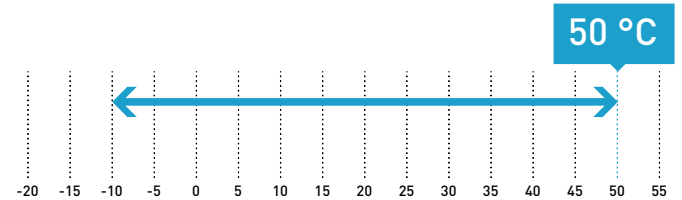

Water outlet temperature.

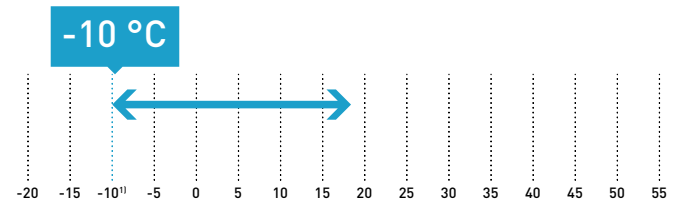

Cooling: Outside air temperature [°C (DB)].
 * With glycol 45 % maximum, 5 °C without glycol.

Available options

Options				
Pump	Pump drive	Hydraulic options	Ambient options	Miscellaneous options
Single pump Low Pressure	Fixed speed ¹⁾	Low water pressure sensor	Finned coil treatment - epoxy	Soft starter
Single pump High Pressure	Variable twin speed	Water isolation valves	Outdoor coil protection grid	Power supply w/o neutral
Double pump Low Pressure	Variable capacity	Hydraulic gauges	Rubber pads	Modbus TCP/IP
Double pump High Pressure	Constant outlet pressure		Spring damper	BACnet IP
	Constant differential pressure		All seasons fan control	Container transport
			High pressure fan ²⁾	Refrigerant gauge

1) Available for non-EU installation. 2) Available on special order only, please contact your local Panasonic sales representative



REFER TO PAGE 448 TO SEE MORE OPTIONS FOR COOLING ONLY OUTDOOR UNITS



Optional remote control. PAW-SYSREMKIT

Model			140	150	170	190	210
Standard without buffer tank			U-140CVNB	U-150CVNB	U-170CVNB	U-190CVNB	U-210CVNB
With buffer tank			U-140CVBL	U-150CVBL	U-170CVBL	U-190CVBL	U-210CVBL
Power supply	Voltage	V	400	400	400	400	400
	Phase		Three phase	Three phase	Three phase	Three phase	Three phase
	Frequency	Hz	50	50	50	50	50
Cooling capacity ¹⁾		kW	132,0	146,0	164,0	181,0	208,0
Input power ¹⁾		kW	43,1	47,6	54,8	61,1	69,8
Total EER 100 % ¹⁾			3,06	3,07	2,99	2,96	2,98
SEER ²⁾			4,40	4,45	4,38	4,40	4,25
$\eta_{s,c}$ ²⁾		%	173	175	172	173	167
Startup type			Direct	Direct	Direct	Direct	Direct
Maximum operating current		A	108,0	119,0	136,0	153,0	170,0
Startup current w/o softstarter / w softstarter		A	251/130	262/141	324/161	341/178	396/201
Sound power (w standard fans)		dB(A)	85,4	85,4	87,0	88,1	88,1
Sound pressure (w standard fans) ³⁾		dB(A)	53,4	53,4	55,0	56,1	56,1
Dimension (w standard fans) w/o buffer tank	H x W x D	mm	2295 x 2856 x 2210	2295 x 2856 x 2210	2295 x 2856 x 2210	2295 x 2856 x 2210	2295 x 2856 x 2210
Dimension (w standard fans) w buffer tank	H x W x D	mm	2295 x 3666 x 2210	2295 x 3666 x 2210	2295 x 3666 x 2210	2295 x 3666 x 2210	2295 x 3666 x 2210
Weight (w 1 low Pa pump) w/o buffer tank		kg	1510	1520	1610	1680	1940
Weight (w 1 low Pa pump) w buffer tank		kg	1640	1650	1740	1810	2070
Refrigerant (R410A)		kg	2 x 24,7	2 x 24,7	24,7/33,3	2 x 33,3	2 x 33,3
Number of refrigerant circuit			2	2	2	2	2
Compressors							
Number			4	4	4	4	4
Type			Scroll	Scroll	Scroll	Scroll	Scroll
Part load step		%	0 / 24 / 26 / 48 / 50 / 52 / 74 / 76 / 100	0 / 23 / 27 / 46 / 50 / 54 / 73 / 77 / 100	0 / 20 / 24 / 44 / 45 / 55 / 69 / 80 / 100	0 / 22 / 28 / 44 / 50 / 56 / 72 / 78 / 100	0 / 19 / 31 / 38 / 50 / 62 / 69 / 81 / 100
Crankcase heater		W	4 x 66	4 x 66	3 x 66/82	2 x 82/2 x 66	2 x 95/2 x 66
Evaporator							
Number			1	1	1	1	1
Type			Plate	Plate	Plate	Plate	Plate
Nominal water flow (cooling)		m ³ /h	21,56	23,65	25,95	30,24	33,62
Water pressure drop (cooling)		kPa	33	39	24	32	40
Water volume		l	8,49	8,49	12,21	12,21	12,21
Antifreeze heater		W	60	60	120	120	120
Coils							
Number			4	4	4	4	4
Frontal surface		m ²	11,88	11,88	11,88	11,88	11,88
Number of rows			2+2	2+2	2+3	3+3	3+3
Fans standard							
Number			4	4	4	4	4
Air flow		m ³ /h	56000	56000	71000	86000	83000
Rotation speed		r.p.m.	900	900	900	900	900
Power input (each fan)		W	940	940	940 - 1650	1650	1650
Water connections							
Type			Victaulic	Victaulic	Victaulic	Victaulic	Victaulic
Inlet - diameter		Inch	2 1/2	2 1/2	2 1/2	2 1/2	2 1/2
Outlet - diameter		Inch	2 1/2	2 1/2	2 1/2	2 1/2	2 1/2

1) Data refers to 7 °C leaving chilled water temperature and 35 °C condenser air temperature, according EN14511 standard. 2) Following COMMISSION REGULATION (EU) No 2016/2281 for comfort application chillers. 3) Sound pressure levels calculated at 10 meters. Sound pressure levels refer to ISO standard 3744 with parallel piped shape.
* w: with, w/o: without. ** The data are calculated with variable flow.

Accessories	
PAW-SYSREMKIT	Remote control
PAW-CM0005P041	Cloudgate plug and play IP65 box mobile 4G Europe
PAW-CM000K0001	Extension kit and cable gland for mobile (2/4G) antenna (3 m)

Accessories	
PAW-00SRTS011	Tservice wireless fee for 1 year
PAW-SYSVICTH	Victaulic connection kit for model 140 - 210





Options table 140 - 210

Option	Type	Ref.	Description	Model				
				140	150	170	190	210
1	Capacity							
2	Refrigerant and compressor type	V	R410A, fixed speed, cooling only	•	•	•	•	•
3	Buffer tank option	NB	No buffer	Std	Std	Std	Std	Std
		BL	Buffer tank (large)	•	•	•	•	•
4	Pump option		No pump ¹⁾	Std	Std	Std	Std	Std
			Single pump low pressure	•	•	•	•	•
			Single pump high pressure	•	•	•	•	•
			Double pump low pressure	•	•	•	•	•
			Double pump high pressure	•	•	•	•	•
			Pump drive - fixed speed ²⁾					
			Pump drive - variable twin speed (single pump)	•	•	•	•	•
			Pump drive - variable twin speed (double pump)	•	•	•	•	•
5	Pump drive option		Pump drive - variable speed capacity (single pump)	•	•	•	•	•
			Pump drive - variable speed capacity (double pump)	•	•	•	•	•
			Pump drive - constant outlet pressure (single pump)	•	•	•	•	•
			Pump drive - constant outlet pressure (double pump)	•	•	•	•	•
			Pump drive - constant differential pressure (single pump) ³⁾	S0	S0	S0	S0	S0
			Pump drive - constant differential pressure (double pump) ³⁾	S0	S0	S0	S0	S0
			No hydraulic options	Std	Std	Std	Std	Std
			Low water pressure sensor ⁴⁾	•	•	•	•	•
6	Hydraulic options		Water isolation valves	•	•	•	•	•
			Hydraulic gauges	•	•	•	•	•
			No ambient options	Std	Std	Std	Std	Std
			Finned coil treatment - epoxy	•	•	•	•	•
7	Ambient options		Outdoor coil protection grid	•	•	•	•	•
			Rubber pads	•	•	•	•	•
			Spring damper	•	•	•	•	•
			Fan speed control (FSC)	•	•	•	•	•
			Low noise	Std	Std	Std	Std	Std
			No miscellaneous options	Std	Std	Std	Std	Std
			Soft starter	•	•	•	•	•
8	Miscellaneous options		Power supply w/o neutral	•	•	•	•	•
			Standard BMS option (Modbus RTU)	Std	Std	Std	Std	Std
			Modbus TCP/IP	•	•	•	•	•
			BACnet IP	•	•	•	•	•
			Remote LAN connection	Std	Std	Std	Std	Std
			Container transport	•	•	•	•	•
			Refrigerant gauge	•	•	•	•	•

1) The system may be supplied without a pump, but in order to meet EU ErP compliance, the installation must include a variable speed pump.
 2) Fixed speed pump drive on cooling only chiller, is only suitable for installation outside of the EU due to ErP compliance.
 3) Constant differential pump drive options are only available on a special order and requires additional production time. Please contact your local sales representative.
 4) Supplied loose for unit w/o pump.

Std: Standard item included.
 •: Optional item that can be selected.
 S0: Special order item.

Explore the new range of fan coils. Designed to fit with your environment and enhance comfort

Panasonic introduces the new range of fan coils.

The key to this range is to provide performance and comfort and the ability to fit seamlessly within your environment.





Fan coils highlighted features.

Available in a wide range of designs, the fan coils are perfectly adapted to fit within almost any location.



1 Innovation for an optimum comfort

Range of fan coil for heating and cooling with capacities from 0,5 to 21,9 kW in cooling and from 0,6 to 21,5 kW in heating. Bring full year comfort with water based systems.

2 Energy efficient and low noise fan

Dynamically balanced and specially designed fans, reinforced acoustic insulation and optimised fan speed staging for lower noise levels. Improved efficiency with optional EC fan motor.

3 Quality and efficient coil

Constructed from staggered copper tubes, mechanically expanded into aluminium fins, providing maximum heat transfer efficiency, durability and hygiene.

4 Flexible installation

Various types of unit to fit your needs with flexible installation options. A choice of service side for hydraulic connections, piping configuration and horizontal or vertical installation for ducted units.

Offering a great range of capacities and performance, available in a wide range of designs, the fan coils are perfectly adapted to fit within almost any location. Whether the requirements are for cooling only, or for both heating and cooling, there is a fan coil to suit. With a variety of piping and fan configuration, the range is capable of meeting the most stringent of requirements. Line up available in AC and EC fans, it is possible to achieve both powerful performance, but with sustainability in mind.

Controllers with sophisticated designs, provide a user friendly interface while enabling an easy and low cost integration to building management systems.



PAW-FC-RC1
Optional wired remote controller for AC fan, 2-pipe and 4-pipe application.



PAW-FC-TC903
Optional wired remote controller for AC fan 2-pipe application.



PAW-FC-907TC
Optional wired remote controller for EC fan, 2-pipe and 4-pipe application.

Range of fan coils

Page	Fan Type	Operation	Capacity range	0 kW	1 kW	2 kW	3 kW	4 kW
P. 454	Ducted	AC	Cooling	0,7 to 8,1 kW	[Blue bar]			
			Heating	0,7 to 10,3 kW	[Orange bar]			
		EC	Cooling	0,5 to 9,6 kW	[Blue bar]			
			Heating	0,6 to 13,6 kW	[Orange bar]			
P. 456	High static pressure ducted	AC	Cooling	4,1 to 21,9 kW	[Blue bar]			[Blue bar]
			Heating	4,7 to 21,5 kW	[Orange bar]			[Orange bar]
		EC	Cooling	6,6 to 21,4 kW	[Blue bar]			[Blue bar]
			Heating	5,9 to 21,4 kW	[Orange bar]			[Orange bar]
P. 458	4 way cassette	AC	Cooling	1,4 to 8,6 kW	[Blue bar]			
			Heating	1,1 to 12,8 kW	[Orange bar]			
		EC	Cooling	1,4 to 9,4 kW	[Blue bar]			
			Heating	1,1 to 14,0 kW	[Orange bar]			
P. 460	Ceiling chassis	AC	Cooling	0,7 to 8,1 kW	[Blue bar]			
			Heating	0,7 to 10,3 kW	[Orange bar]			
		EC	Cooling	0,5 to 9,6 kW	[Blue bar]			
			Heating	0,6 to 13,6 kW	[Orange bar]			
P. 462	Floor-standing chassis	AC	Cooling	0,7 to 8,1 kW	[Blue bar]			
			Heating	0,7 to 10,3 kW	[Orange bar]			
		EC	Cooling	0,5 to 9,6 kW	[Blue bar]			
			Heating	0,6 to 13,6 kW	[Orange bar]			
P. 464	Wall-mounted	AC	Cooling	1,0 to 3,9 kW	[Blue bar]			
			Heating	1,4 to 4,1 kW	[Orange bar]			
P. 465	Smart fan coils	AC	Cooling	0,2 to 1,7 kW	[Blue bar]			
			Heating	0,2 to 1,7 kW	[Orange bar]			
								

Values indicated are for the full operating range. The data shown within the tables following are indicative of specific installation conditions. For full details relating to performance and operating conditions, please refer to the technical data manual.



5 kW 6 kW 7 kW 8 kW 9 kW 10 kW 11 kW 12 kW 13 kW 14 kW 15 kW 16 kW 17 kW 18 kW 19 kW 20 kW 21 kW 22 kW

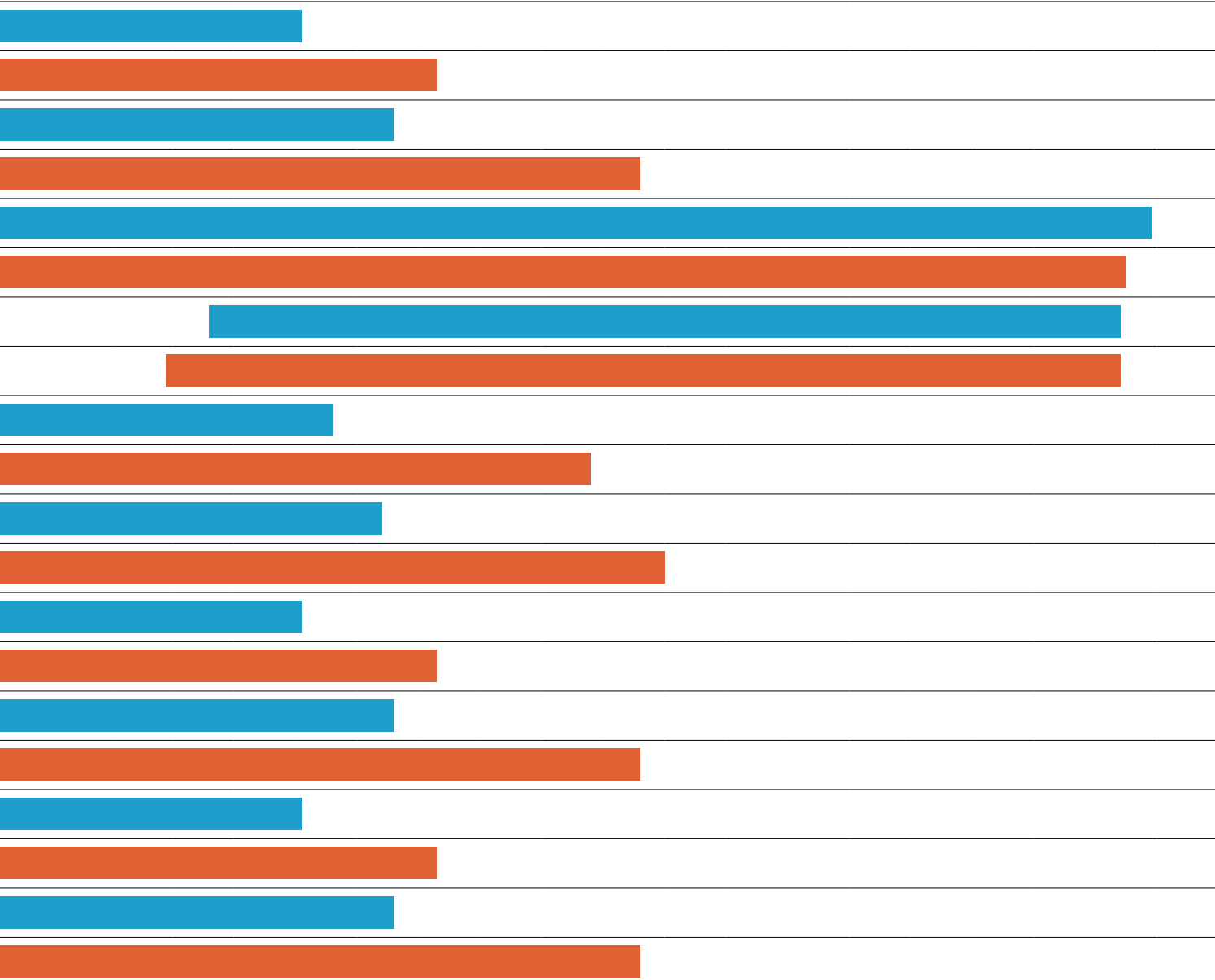



Fan coils - ducted (AC)

Optional controller.
Wired remote
controller.
PAW-FC-903TCOptional controller.
Advanced wired
remote controller.
PAW-FC-RC1

2-pipe - Left connection (PAW-)			FC2A-D010L	FC2A-D020L	FC2A-D030L	FC2A-D040L	FC2A-D050L	FC2A-D060L	FC2A-D070L	FC2A-D080L
2-pipe - Right connection (PAW-)			FC2A-D010R	FC2A-D020R	FC2A-D030R	FC2A-D040R	FC2A-D050R	FC2A-D060R	FC2A-D070R	FC2A-D080R
Total cooling capacity ¹⁾	Lo/Med/Hi	kW	0,7/1,0/1,5	0,7/1,2/1,7	1,0/2,0/2,5	1,2/2,4/3,2	1,7/3,2/4,6	2,7/4,6/5,8	3,4/6,1/7,3	4,6/6,1/8,1
Sensible cooling capacity ¹⁾	Lo/Med/Hi	kW	0,5/0,8/1,1	0,6/0,9/1,3	0,8/1,5/1,9	0,9/1,8/2,3	1,2/2,2/3,3	1,9/3,3/4,5	2,4/4,3/5,1	3,4/4,6/6,3
Water flow	Lo/Med/Hi	l/h	124/172/250	127/213/289	172/341/430	206/413/547	296/544/798	466/784/1003	587/1058/1252	798/1048/1400
Water pressure drop	Lo/Med/Hi	kPa	10,7/19,5/39,2	1,9/3,9/6,3	6,3/19,3/28,8	5,4/17,1/28,0	7,5/22,8/46,9	13,9/37,4/60,2	4,8/15,4/21,5	11,9/19,3/32,5
Heating capacity ²⁾	Lo/Med/Hi	kW	0,9/1,4/2,0	0,9/1,5/2,2	1,3/2,4/3,1	1,4/2,9/4,0	2,1/4,1/5,7	3,1/5,3/7,1	4,3/7,9/9,3	5,9/8,1/11,6
4-pipe - Left connection (PAW-)			FC4A-D010L	FC4A-D020L	FC4A-D030L	FC4A-D040L	FC4A-D050L	FC4A-D060L	FC4A-D070L	FC4A-D080L
4-pipe - Right connection (PAW-)			FC4A-D010R	FC4A-D020R	FC4A-D030R	FC4A-D040R	FC4A-D050R	FC4A-D060R	FC4A-D070R	FC4A-D080R
Total cooling capacity ¹⁾	Lo/Med/Hi	kW	0,7/0,9/1,3	0,6/1,1/1,6	1,0/1,9/2,4	1,1/2,3/3,0	1,7/3,0/4,3	2,6/4,4/5,6	3,3/5,9/6,9	4,5/5,9/8,0
Sensible cooling capacity ¹⁾	Lo/Med/Hi	kW	0,5/0,7/1,0	0,5/0,8/1,2	0,8/1,5/1,8	0,8/1,7/2,2	1,2/2,2/3,1	1,8/3,2/4,3	2,3/4,2/4,9	3,3/4,4/6,2
Water flow	Lo/Med/Hi	l/h	114/159/225	109/192/268	165/327/414	194/388/517	284/522/748	449/756/967	575/1019/1193	775/1020/1380
Water pressure drop	Lo/Med/Hi	kPa	8,3/15,2/29,0	1,5/3,4/5,6	3,0/9,5/14,4	6,4/22,3/36,8	4,2/12,8/25,1	10,2/27,7/44,5	5,9/17,9/24,4	19,3/31,1/53,6
Heating capacity ²⁾	Lo/Med/Hi	kW	0,5/0,7/1,0	0,6/0,9/1,1	1,0/1,4/1,6	0,9/1,6/2,1	1,5/2,3/3,0	1,9/2,9/3,7	2,7/3,6/4,3	3,9/5,6/7,1
Water flow	Lo/Med/Hi	l/h	79/127/178	100/146/190	164/232/274	160/273/354	251/401/508	325/505/633	456/626/736	673/963/1226
Water pressure drop	Lo/Med/Hi	kPa	1,9/3,5/5,6	1,5/3,2/5,3	5,1/9,0/11,9	9,2/26,5/42,7	10,7/24,6/29,5	20,3/43,9/52,9	67,2/117,9/137,8	33,1/63,7/75
Sound levels										
Global sound power	Lo/Med/Hi	dB(A)	33/40/49	31/43/50	30/45/52	30/44/51	34/46/56	38/51/58	43/56/61	50/55/64
Global sound pressure ³⁾	Lo/Med/Hi	dB(A)	24/31/40	22/34/41	21/36/43	21/35/42	25/37/47	29/42/49	34/47/52	41/46/55
Fan										
Number			1	1	1	2	2	2	2	3
Air flow 2-pipe	Lo/Med/Hi	m ³ /h	111/190/283	105/179/265	138/274/390	173/357/499	253/486/716	350/640/933	480/893/1064	660/936/1397
Air flow 4-pipe	Lo/Med/Hi	m ³ /h	95/168/253	89/161/241	132/263/369	162/335/467	242/466/671	334/614/885	470/859/1012	634/905/1370
Maximum external pressure		Pa	55	55	65	85	85	115	125	70
Filter			G2	G2	G2	G2	G2	G2	G2	G2
Electrical data										
Power supply	Voltage	V	230	230	230	230	230	230	230	230
	Phase		Single phase	Single phase	Single phase	Single phase	Single phase	Single phase	Single phase	Single phase
	Frequency	Hz	50/60	50/60	50/60	50/60	50/60	50/60	50/60	50/60
Power consumption 2-pipe	Lo/Med/Hi	W	13/24/36	10/18/29	16/37/45	15/37/56	28/55/72	37/75/105	53/100/147	90/112/188
Power consumption 4-pipe	Lo/Med/Hi	W	13/24/36	10/18/28	16/37/44	15/37/55	28/54/70	37/74/104	53/99/145	90/112/188
Water connections										
Type			Female gas threaded	Female gas threaded	Female gas threaded	Female gas threaded	Female gas threaded	Female gas threaded	Female gas threaded	Female gas threaded
2-pipe		Inch	1/2	1/2	1/2	1/2	1/2	1/2	3/4	3/4
	Cooling	Inch	1/2	1/2	1/2	1/2	1/2	1/2	3/4	3/4
4-pipe		Inch	1/2	1/2	1/2	1/2	1/2	1/2	1/2	1/2
	Heating	Inch	1/2	1/2	1/2	1/2	1/2	1/2	1/2	1/2
Dimension and weight										
Dimension	H x W x D	mm	220 x 570 x 430	220 x 570 x 430	220 x 730 x 430	220 x 938 x 430	220 x 1122 x 430	220 x 1307 x 430	220 x 1121 x 530	220 x 1316 x 530
Weight	2 / 4-pipes	kg	13/14	13/14	15/16	20/22	22/24	26/28	27/29	38/40

1) According to Eurovent standard. Air: 27 °C DB / 19 °C WB. Water in / out: 7 °C / 12 °C. 2) Air: 20 °C. Water in / out: 50 °C / 45 °C. 3) The sound pressure levels are based on (NR) characteristics of a room having volume of 100 m³ with reverberation of 0,5 seconds. Values indicated are for 0 Pa external static pressure, for additional pressure characteristics, please refer the selection software.

Technical focus

- Cooling capacity from 0,7 to 8,1 kW
- Heating capacity from 0,7 to 10,3 kW
- 5-speed AC fan motor(s)

Operating limits

Entering water temperature	From 5 to 90 °C
Indoor air temperature	From 5 to 32 °C

Main features and accessories

- 2 and 4-pipe configurations
- Left or right hand arrangements
- Ease of installation
- Very low acoustic levels
- 2 way or 3 way ON / OFF valves
- Auxiliary drain pan
- Air intake with removable grid
- G2 filter





Fan coils - ducted (EC)

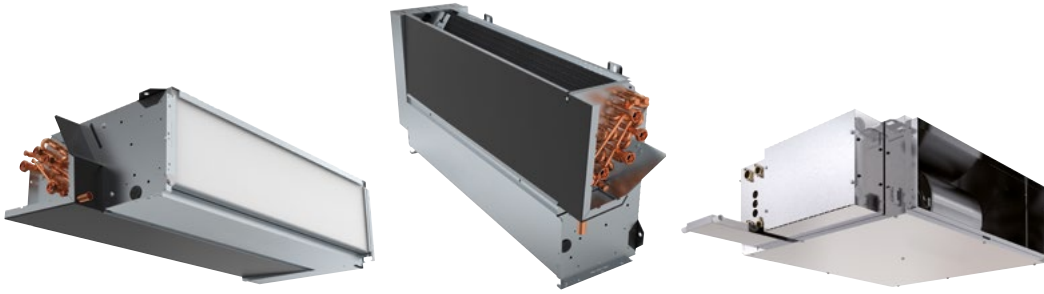

Optional controller. Wired remote controller for EC fans. PAW-FC-907TC

2-pipe - Left connection (PAW-)			FC2E-D010L	FC2E-D020L	FC2E-D030L	FC2E-D040L	FC2E-D050L	FC2E-D060L	FC2E-D070L	FC2E-D080L	FC2E-F040L
2-pipe - Right connection (PAW-)			FC2E-D010R	FC2E-D020R	FC2E-D030R	FC2E-D040R	FC2E-D050R	FC2E-D060R	FC2E-D070R	FC2E-D080R	FC2E-F040R
Total cooling capacity ¹⁾	Lo/Med/Hi	kW	0,6/1,2/2,1	0,6/1,4/2,4	0,9/2,1/3,1	1,3/2,9/4,2	1,3/4,0/5,0	2,0/4,5/5,2	2,7/5,9/6,9	5,1/6,5/8,8	3,6/6,6/9,2
Sensible cooling capacity ¹⁾	Lo/Med/Hi	kW	0,5/1,1/1,9	0,5/1,1/1,9	0,6/1,6/2,4	1,0/2,1/3,0	1,1/3,0/3,7	1,4/3,5/4,0	2,0/4,3/5,2	3,7/4,8/6,6	2,9/6,1/9,1
Water flow	Lo/Med/Hi	l/h	107/210/356	110/237/406	148/354/532	230/506/722	231/685/743	341/767/800	463/1008/1098	879/1111/1254	627/1142/1575
Water pressure drop	Lo/Med/Hi	kPa	8,2/28,2/76,9	1,5/4,6/11,0	5,0/20,5/42,1	6,4/24,4/46,3	4,9/35,1/41,0	7,8/35,8/38,8	3,0/14,0/16,6	14,1/21,4/26,6	10,6/51,2/93,8
Heating capacity ²⁾	Lo/Med/Hi	kW	0,8/1,6/2,9	0,9/1,9/3,3	1,0/2,2/3,4	1,4/3,0/5,3	1,7/5,2/5,5	2,3/5,9/6,1	3,8/7,3/8,2	6,2/8,0/9,3	4,4/8,3/11,8
4-pipe - Left connection (PAW-)			FC4E-D010L	FC4E-D020L	FC4E-D030L	FC4E-D040L	FC4E-D050L	FC4E-D060L	FC4E-D070L	FC4E-D080L	FC4E-F040L
4-pipe - Right connection (PAW-)			FC4E-D010R	FC4E-D020R	FC4E-D030R	FC4E-D040R	FC4E-D050R	FC4E-D060R	FC4E-D070R	FC4E-D080R	FC4E-F040R
Total cooling capacity ¹⁾	Lo/Med/Hi	kW	0,5/1,1/1,9	0,6/1,2/2,2	0,8/1,9/2,9	1,2/2,7/4,0	1,2/3,6/4,6	1,8/4,1/4,9	2,6/5,1/6,4	5,0/6,2/9,6	3,3/6,4/8,8
Sensible cooling capacity ¹⁾	Lo/Med/Hi	kW	0,4/0,9/1,7	0,4/1,0/1,8	0,6/1,5/2,2	0,9/1,9/2,8	1,0/2,8/3,5	1,2/3,2/3,8	1,9/3,8/4,8	3,6/4,6/7,2	2,7/5,6/8,0
Water flow	Lo/Med/Hi	l/h	92/185/327	97/206/375	129/321/493	205/457/681	212/625/686	306/707/749	443/886/977	855/1070/1242	567/1093/1511
Water pressure drop	Lo/Med/Hi	kPa	5,8/20,1/59,2	1,3/3,7/9,7	4,0/9,2/19,7	6,3/29,6/60,1	2,5/17,9/21,3	5,1/24,3/27,2	3,5/13,6/16,5	22,9/33,9/44,3	10,0/47,2/86,7
Heating capacity ²⁾	Lo/Med/Hi	kW	0,4/0,8/1,4	0,6/0,9/1,5	1,0/1,4/1,8	1,2/2,0/2,8	1,6/2,4/2,5	1,4/2,9/3,1	2,5/3,4/3,6	4,5/5,9/6,9	2,5/4,5/6,2
Water flow	Lo/Med/Hi	l/h	76/140/235	95/161/255	166/243/304	204/350/483	267/416/438	233/503/531	434/583/614	767/1011/1194	432/783/1065
Water pressure drop	Lo/Med/Hi	kPa	1,8/4,0/8,4	1,4/3,8/9,4	5,3/9,7/14,1	15,6/41,8/76,3	11,9/26,3/28,9	11,5/43,6/48,1	61,5/103,8/113,9	42,1/69,7/95,1	30,6/107,6/214,8
Sound levels											
Global sound power	Lo/Med/Hi	dB(A)	34/47/60	34/47/60	31/50/59	29/44/52	30/51/57	32/54/58	40/54/59	51/56/64	42/58/68 ³⁾
Global sound pressure ⁴⁾	Lo/Med/Hi	dB(A)	25/38/51	25/38/51	22/41/50	20/35/43	21/42/48	23/45/49	31/45/50	42/47/55	23/39/52
Fan											
Number			1	1	1	2	2	2	2	3	1
Air flow 2-pipe	Lo/Med/Hi	m ³ /h	108/228/417	98/234/413	145/380/585	170/412/678	203/645/816	245/737/912	350/850/1050	685/927/1398	592/1284/1935
Air flow 4-pipe	Lo/Med/Hi	m ³ /h	91/199/379	84/200/380	123/342/540	148/369/627	185/587/646	205/668/716	329/798/894	660/884/1079	523/1222/1864
Maximum external pressure		Pa	75	75	75	105	70	105	115	115	190
Filter			G2	G2	G2	G2	G2	G2	G2	G2	G2
Electrical data											
Power supply	Voltage	V	230	230	230	230	230	230	230	230	230
	Phase		Single phase	Single phase	Single phase	Single phase	Single phase	Single phase	Single phase	Single phase	Single phase
	Frequency	Hz	50/60	50/60	50/60	50/60	50/60	50/60	50/60	50/60	50/60
Power consumption 2-pipe	Lo/Med/Hi	W	5/11/41	5/13/41	4/16/42	2/13/43	4/24/46	2/30/54	11/44/77	23/42/108	11/62/197
Power consumption 4-pipe	Lo/Med/Hi	W	5/11/39	5/13/40	6/15/40	2/12/42	2/23/44	2/28/52	11/43/75	22/41/116	11/60/188
Water connections											
Type			Female gas threaded	Female gas threaded	Female gas threaded	Female gas threaded	Female gas threaded	Female gas threaded	Female gas threaded	Female gas threaded	Female gas threaded
2-pipe		Inch	1/2	1/2	1/2	1/2	1/2	1/2	3/4	3/4	3/4
	Cooling	Inch	1/2	1/2	1/2	1/2	1/2	1/2	3/4	3/4	3/4
4-pipe	Heating	Inch	1/2	1/2	1/2	1/2	1/2	1/2	1/2	1/2	1/2
Dimension and weight											
Dimension	HxWxD	mm	220 x 570 x 430	220 x 570 x 430	220 x 730 x 430	220 x 938 x 430	220 x 1122 x 430	220 x 1307 x 430	220 x 1121 x 530	220 x 1316 x 530	223 x 1233 x 653
Weight	2 / 4-pipes	kg	13/14	13/14	15/16	20/22	22/24	26/28	27/29	38/40	19/19

1) According to Eurovent standard. Air: 27 °C DB / 19 °C WB. Water in / out: 7 °C / 12 °C. 2) Air: 20 °C. Water in / out: 50 °C / 45 °C. 3) The sound power levels indicated are from return and radiated measurements. 4) The sound pressure levels are based on (NR) characteristics of a room having volume of 100 m³ with reverberation of 0,5 seconds. Values indicated are for 0 Pa external static pressure, for additional pressure characteristics, please refer the selection software.

Technical focus

- Cooling capacity from 0,5 to 9,6 kW
- Heating capacity from 0,6 to 13,6 kW
- Low energy consumption EC fan(s)

Operating limits

Entering water temperature	From 5 to 90 °C
Indoor air temperature	From 5 to 32 °C

Main features and accessories

- 2 and 4-pipe configurations
- Left or right hand arrangements
- Can be installed both horizontally and vertically*
- Ease of installation
- Very low acoustic levels
- 2 way or 3 way ON / OFF valves
- Auxiliary drain pan
- Air intake with removable grid
- G2 filter

* PAW-FC2E-F040 and PAW-FC4E-F040 may only be installed horizontally.



Fan coils - High static pressure ducted (AC)



Optional controller.
Wired remote
controller.
PAW-FC-903TC



Optional controller.
Advanced wired
remote controller.
PAW-FC-RC1

2-pipe - Left connection			PAW-FC2A-E070L	PAW-FC2A-E150L	PAW-FC2A-E180L	PAW-FC2A-E210L	PAW-FC2A-E240L*	PAW-FC2A-E270L*
2-pipe - Right connection			PAW-FC2A-E070R	PAW-FC2A-E150R	PAW-FC2A-E180R	PAW-FC2A-E210R	PAW-FC2A-E240R*	PAW-FC2A-E270R*
Total cooling capacity ¹⁾	Lo/Med/Hi	kW	4,4/5,5/6,4	5,6/11,5/14,2	4,9/11,5/15,0	5,2/13,7/18,6	14,3/19,8/23,3	15,8/23,0/27,5
Sensible cooling capacity ¹⁾	Lo/Med/Hi	kW	3,12/5,1	3,9/9,2/12,2	3,7/9,5/13,1	3,5/9,9/13,7	10,3/14,9/17,8	11,0/16,3/19,7
Water flow	Lo/Med/Hi	l/h	749/951/1095	966/1979/2437	837/1979/2589	899/2357/3201	2468/3410/4015	2718/3951/4740
Water pressure drop	Lo/Med/Hi	kPa	26,5/42,5/56,2	5,5/19,9/29,3	4,4/19,6/32,0	4,9/28,8/51,5	13,8/25,2/34,2	12,8/25,2/35,3
Heating capacity ²⁾	Lo/Med/Hi	kW	5,4/8,6/12,7	6,2/14,2/20,0	6,3/16,3/23,2	6,1/16,5/23,4	17,2/26,3/32,6	17,9/27,5/33,7
4-pipe - Left connection			PAW-FC4A-E070L	PAW-FC4A-E150L	PAW-FC4A-E180L	PAW-FC4A-E210L	PAW-FC4A-E240L*	PAW-FC4A-E270L*
4-pipe - Right connection			PAW-FC4A-E070R	PAW-FC4A-E150R	PAW-FC4A-E180R	PAW-FC4A-E210R	PAW-FC4A-E240R*	PAW-FC4A-E270R*
Total cooling capacity ¹⁾	Lo/Med/Hi	kW	4,0/5,4/6,0	5,3/10,1/11,9	5,5/11,2/13,6	5,9/14,4/18,8	13,3/17,7/20,5	14,3/19,9/23,4
Sensible cooling capacity ¹⁾	Lo/Med/Hi	kW	2,8/4,1/4,7	3,7/8,4/10,9	3,9/9,1/12,0	4,0/10,6/14,5	9,9/13,9/16,3	10,3/14,9/17,8
Water flow	Lo/Med/Hi	l/h	680/924/1035	919/1739/2044	951/1928/2335	1013/2478/3241	2291/3053/3526	2464/3427/4032
Water pressure drop	Lo/Med/Hi	kPa	29,7/52,1/64,4	4,1/13,5/18,4	4,7/17,4/25,0	6,6/35,2/59,1	14,5/25,0/33,0	12,8/23,3/31,5
Heating capacity ²⁾	Lo/Med/Hi	kW	3,7/6,0/7,4	5,3/11,8/15,9	5,3/11,9/15,9	5,3/11,9/16,0	7,2/11,1/13,5	7,2/11,1/13,5
Water flow	Lo/Med/Hi	l/h	636/1029/1266	906/2038/2746	911/2045/2745	916/2051/2747	1242/1910/2329	1242/1910/2329
Water pressure drop	Lo/Med/Hi	kPa	14,2/30,7/43,6	39,0/167,6/293,0	23,9/100,8/174,3	24,2/101,4/174,6	45,8/87,8/120,3	28,3/53,3/72,5
Sound levels								
Sound power return + radiated	Lo/Med/Hi	dB(A)	54/60/63	52/66/72	54/66/74	52/66/72	65/73/75	65/73/75
Sound power discharge	Lo/Med/Hi	dB(A)	53/59/62	52/64/71	52/64/71	52/64/71	64/72/75	64/72/75
Sound pressure ³⁾	Lo/Med/Hi	dB(A)	33/39/42	31/45/51	31/45/51	31/45/51	44/52/54	44/52/54
Fan								
Number			1	1	1	1	1	1
Air flow 2-pipe	Lo/Med/Hi	m ³ /h	680/1091/1562	676/2110/3197	676/2110/3197	676/2110/3197	1927/3130/3923	1927/3130/3923
Air flow 4-pipe	Lo/Med/Hi	m ³ /h	552/1132/1496	676/2110/3197	676/2110/3197	676/2110/3197	1927/3130/3923	1927/3130/3923
Maximum external pressure		Pa	110	200	200	200	220	220
Filter			G3	G3	G3	G3	G3	G3
Electrical data								
Power supply	Voltage	V	230	230	230	230	230	230
	Phase		Single phase	Single phase	Single phase	Single phase	Single phase	Single phase
	Frequency	Hz	50/60	50/60	50/60	50/60	50/60	50/60
Power consumption	Lo/Med/Hi	W	132/182/222	180/421/675	180/421/675	180/421/675	420/530/673	420/530/673
Water connections								
Type			Female gas threaded	Gas Male threaded	Gas Male threaded	Gas Male threaded	Gas Male threaded	Gas Male threaded
2-pipe		Inch	1/2	1	1 1/4	1 1/4	1 1/4	1 1/4
	Cooling	Inch	1/2	1	1	1	1 1/4	1 1/4
4-pipe	Heating	Inch	1/2	3/4	3/4	3/4	3/4	3/4
Dimension and weight								
Dimension	H x W x D	mm	250 x 698 x 1200	375 x 798 x 1380	375 x 798 x 1380	375 x 798 x 1380	450 x 798 x 1500	450 x 798 x 1500
Weight		kg	42	63	65	67	76	80

1) According to Eurovent standard. Air: 27 °C DB / 19 °C WB. Water in / out: 7 °C / 12 °C. 2) Air: 20 °C. Water in / out: 50 °C / 45 °C. 3) Informative data: Considering an hypothetical sound attenuation of the room and installation of 21 dB.

Values indicated are for 50 Pa external static pressure, for additional pressure characteristics, please refer the selection software.

* High fan speed used for capacity, water flow, sound and air flow values.

Technical focus

- 6 sizes
- Cooling capacity from 4,1 to 21,9 kW
- Heating capacity from 4,7 to 21,5 kW
- 5-speed AC fan motor

Main features and accessories

- 2 and 4-pipe, left and right hand configurations
- Static pressure up to 220Pa
- Double skin insulation
- 2 way or 3 way ON / OFF valves
- Auxiliary drain pan
- Air intake with removable grid
- G3 filter

Operating limits

Entering water temperature	From 5 to 90 °C
Indoor air temperature	From 5 to 32 °C





Fan coils - High static pressure ducted (EC)



Optional controller.
Wired remote
controller for EC fans.
PAW-FC-907TC

2-pipe - Left connection			PAW-FC2E-E150L	PAW-FC2E-E180L	PAW-FC2E-E210L	PAW-FC2E-E240L	PAW-FC2E-E270L
2-pipe - Right connection			PAW-FC2E-E150R	PAW-FC2E-E180R	PAW-FC2E-E210R	PAW-FC2E-E240R	PAW-FC2E-E270R
Total cooling capacity ¹⁾	Lo/Med/Hi	kW	7,0/11,3/14,5	7,8/13,1/17,3	8,6/14,2/19,0	9,3/16,1/20,3	10,2/18,1/23,1
Sensible cooling capacity ¹⁾	Lo/Med/Hi	kW	5,2/9,1/12,1	5,7/10,3/14,1	6,1/10,9/15,0	6,7/12,4/16,2	7,2/13,6/17,8
Water flow	Lo/Med/Hi	l/h	1207/1945/2498	1351/2259/2979	1476/2451/3275	1592/2766/3498	1751/3120/3972
Water pressure drop	Lo/Med/Hi	kPa	11,5/19,3/30,7	6,1/24,9/41,5	6,0/31,0/53,8	6,3/17,1/26,4	5,9/16,4/25,4
Heating capacity ²⁾	Lo/Med/Hi	kW	88/15,8/20,7	9,5/17,9/24,3	10,0/19,4/26,8	11,1/20,8/27,5	11,7/22,8/30,4
4-pipe - Left connection			PAW-FC4E-E150L	PAW-FC4E-E180L	PAW-FC4E-E210L	PAW-FC4E-E240L	PAW-FC4E-E270L
4-pipe - Right connection			PAW-FC4E-E150R	PAW-FC4E-E180R	PAW-FC4E-E210R	PAW-FC4E-E240R	PAW-FC4E-E270R
Total cooling capacity ¹⁾	Lo/Med/Hi	kW	5,9/9,1/11,6	6,6/10,2/13,0	7,9/12,6/16,4	8,4/14,0/17,5	8,9/15,3/19,5
Sensible cooling capacity ¹⁾	Lo/Med/Hi	kW	4,5/7,6/10,1	4,9/8,4/11,2	5,8/9,9/13,4	6,2/11,0/14,2	6,5/11,8/15,5
Water flow	Lo/Med/Hi	l/h	1011/1567/2005	1141/1764/2243	1361/2175/2826	1447/2409/3020	1529/2641/3359
Water pressure drop	Lo/Med/Hi	kPa	4,9/11,1/17,7	6,5/14,7/23,2	7,6/27,5/45,4	6,2/15,9/24,5	5,5/14,5/22,4
Heating capacity ²⁾	Lo/Med/Hi	kW	3,6/5,8/7,3	6,1/10,0/12,8	6,1/10,1/12,9	4,8/8,3/10,3	4,7/8,2/10,5
Water flow	Lo/Med/Hi	l/h	621/991/1264	1052/1729/2211	1057/1734/2227	832/1421/1780	804/1407/1804
Water pressure drop	Lo/Med/Hi	kPa	20,7/45,6/70,1	30,7/74,1/116,4	30,8/74,5/118,0	19,6/55,9/78,7	7,2/33,9/48,9
Sound levels							
Sound power return + radiated	Lo/Med/Hi	dB(A)	56/67/74	56/67/74	56/67/74	58/69/76	58/69/76
Sound power discharge	Lo/Med/Hi	dB(A)	56/65/74	56/65/74	56/65/74	58/67/76	58/67/76
Sound pressure ³⁾	Lo/Med/Hi	dB(A)	35/46/52	35/46/52	35/46/52	37/48/54	37/48/54
Fan							
Number			1	1	1	1	1
Air flow 2-pipe	Lo/Med/Hi	m ³ /h	1071/2418/3583	1071/2418/3583	1071/2418/3583	1227/2700/3829	1227/2700/3829
Air flow 4-pipe	Lo/Med/Hi	m ³ /h	1071/2418/3583	1071/2418/3583	1071/2418/3583	1227/2700/3829	1227/2700/3829
Maximum external pressure		Pa	300	300	300	300	300
Filter			G3	G3	G3	G3	G3
Electrical data							
Power supply	Voltage	V	230	230	230	230	230
	Phase		Single phase	Single phase	Single phase	Single phase	Single phase
	Frequency	Hz	50/60	50/60	50/60	50/60	50/60
Power consumption	Lo/Med/Hi	W	67/172/246	67/172/246	67/172/246	64/237/364	64/237/364
Water connections							
Type			Gas Male threaded	Gas Male threaded	Gas Male threaded	Gas Male threaded	Gas Male threaded
2-pipe		Inch	1	1 1/4	1 1/4	1 1/4	1 1/4
	Cooling	Inch	1	1	1	1 1/4	1 1/4
4-pipe	Heating	Inch	3/4	3/4	3/4	3/4	3/4
Dimension and weight							
Dimension	HxWxD	mm	375x798x1380	375x798x1380	375x798x1380	450x798x1500	450x798x1500
Weight		kg	63	65	67	76	80

1) According to Eurovent standard. Air: 27 °C DB / 19 °C WB. Water in / out: 7 °C / 12 °C. 2) Air: 20 °C. Water in / out: 50 °C / 45 °C. 3) Informative data: Considering an hypothetical sound attenuation of the room and installation of 21 dB.

Values indicated are for 50 Pa external static pressure, for additional pressure characteristics, please refer the selection software.

Technical focus

- 5 sizes
- Cooling capacity from 6,6 to 19,9 kW
- Heating capacity from 5,9 to 21,4 kW
- Low energy consumption EC fan

Main features and accessories

- 2 and 4-pipe, left and right hand configurations
- Static pressure up to 300Pa
- Double skin insulation
- 2 way or 3 way ON / OFF valves
- Auxiliary drain pan
- Air intake with removable grid
- G3 filter

Operating limits

Entering water temperature	From 5 to 90 °C
Indoor air temperature	From 5 to 32 °C





Fan coils - 4 way cassette (AC)



Optional controller.
Wired remote
controller.
PAW-FC-903TC



Optional controller.
Advanced wired
remote controller.
PAW-FC-RC1

2-pipe			PAW-FC2A-U020-2	PAW-FC2A-U030-2	PAW-FC2A-U040-2	PAW-FC2A-U050-2	PAW-FC2A-U060-2	PAW-FC2A-U070-2
Total cooling capacity ¹⁾	Lo/Med/Hi	kW	1,5/1,8/2,4	1,9/2,7/4,0	2,8/3,5/4,7	3,4/4,4/6,1	3,7/5,4/7,2	4,0/6,5/8,6
Sensible cooling capacity ¹⁾	Lo/Med/Hi	kW	1,3/1,5/2,0	1,4/2,2/3,0	2,1/2,6/3,6	2,6/3,4/4,8	2,7/4,0/5,4	3,0/4,8/6,4
Water flow	Lo/Med/Hi	l/h	265/303/404	323/493/683	478/597/801	576/762/142	636/937/1233	695/1111/1476
Water pressure drop	Lo/Med/Hi	kPa	4,3/6,8/10,9	3,6/8,5/14,4	6,9/11,2/18,3	8,4/13,0/21,9	3,4/7,5/11,5	5,6/13,0/20,5
Heating capacity ²⁾	Lo/Med/Hi	kW	2,2/2,5/3,2	2,3/3,7/4,5	3,7/4,6/6,2	4,5/6,0/8,1	4,5/7,4/10,0	5,2/9,2/12,0
4-pipe			PAW-FC4A-U020-2	PAW-FC4A-U030-2	PAW-FC4A-U040-2	—	PAW-FC4A-U060-2	PAW-FC4A-U070-2
Total cooling capacity ¹⁾	Lo/Med/Hi	kW	1,4/1,5/2,0	2,0/2,7/3,4	2,5/3,3/4,0	—	3,0/4,9/6,6	3,2/6,0/7,5
Sensible cooling capacity ¹⁾	Lo/Med/Hi	kW	1,2/1,4/1,8	1,5/2,1/2,6	2,0/2,6/3,2	—	2,3/3,8/5,1	2,5/4,6/5,9
Water flow	Lo/Med/Hi	l/h	232/258/359	342/465/576	437/563/683	—	511/851/1137	543/1030/1294
Water pressure drop	Lo/Med/Hi	kPa	6,6/8,9/13,6	4,4/8,3/11,6	6,7/11,2/15,3	—	6,0/13,9/22,2	7,1/18,9/27,5
Heating capacity ²⁾	Lo/Med/Hi	kW	0,8/0,9/1,2	2,2/3,1/3,8	3,0/3,5/4,1	—	3,7/5,5/7,0	4,5/7,1/8,9
Water flow	Lo/Med/Hi	l/h	132/153/201	374/530/658	521/603/699	—	636/939/1210	776/1214/1540
Water pressure drop	Lo/Med/Hi	kPa	25,7/33,4/53,6	13,7/24,2/35	24,2/30,9/39,8	—	7,6/13,8/20,7	10,2/20,8/30,9
Sound levels								
Global sound power 2-pipe	Lo/Med/Hi	dB(A)	36/40/49	35/47/53	42/48/57	35/40/49	38/46/54	40/52/59
Global sound power 4-pipe	Lo/Med/Hi	dB(A)	36/40/49	35/47/53	42/48/57	—	38/46/54	40/52/59
Global sound pressure 2-pipe ³⁾	Lo/Med/Hi	dB(A)	27/31/40	26/35/44	33/39/48	26/31/40	29/37/45	31/43/50
Global sound pressure 4-pipe ³⁾	Lo/Med/Hi	dB(A)	27/31/40	26/35/44	33/39/48	—	29/37/45	31/43/50
Fan								
Number			1	1	1	1	1	1
Air flow	Lo/Med/Hi	m ³ /h	360/450/659	320/504/734	486/626/900	529/720/979	500/824/1159	601/1080/1447
Filter			G1	G1	G1	G1	G1	G1
Electrical data								
Power supply	Voltage	V	230	230	230	230	230	230
	Phase		Single phase	Single phase	Single phase	Single phase	Single phase	Single phase
	Frequency	Hz	50	50	50	50	50	50
Power consumption 2-pipe	Lo/Med/Hi	W	25/35/58	17/34/58	38/58/99	28/41/66	34/61/88	44/92/125
Power consumption 4-pipe	Lo/Med/Hi	W	25/35/58	17/34/58	38/58/99	—	34/61/88	44/92/125
Water connections								
Type			Female gas threaded	Female gas threaded	Female gas threaded	Female gas threaded	Female gas threaded	Female gas threaded
2-pipe		Inch	3/4	3/4	3/4	1	1	1
4-pipe	Cooling	Inch	3/4	3/4	3/4	—	1	1
	Heating	Inch	1/2	1/2	1/2	—	3/4	3/4
Dimension and weight								
Dimension including panel	HxWxD	mm	334x720x720	334x720x720	334x720x720	339x960x960	339x960x960	339x960x960
Weight		kg	14,8	16,5	16,5	37,1	37,1	39,6
Panel reference			PAW-FC-KPY2040	PAW-FC-KPY2040	PAW-FC-KPY2040	PAW-FC-KPU5070	PAW-FC-KPU5070	PAW-FC-KPU5070

1) According to Eurovent standard. Air: 27 °C DB / 19 °C WB. Water in / out: 7 °C / 12 °C. 2) According to Eurovent standard. Air: 20 °C. Water in / out: 45 °C / 40 °C. 3) Information data considering an hypothetical sound attenuation of the room and installation of -9 dB(A).

Technical focus

- 6 sizes*
- Cooling capacity from 1,4 to 8,6 kW
- Heating capacity from 1,1 to 12,8 kW
- 3-speed AC fan motor

Main features and accessories

- 2 and 4-pipe configurations
- Very low acoustic levels
- Quick access, by simply removing the front grille
- All connections: located at the same side
- Galvanized steel sheet with thermal and acoustical insulation, avoiding condensation on the casing and providing good sound attenuation
- Cleanable synthetic-type air filter

Operating limits

Entering water temperature	From 5 to 90 °C
Indoor air temperature	From 5 to 32 °C

* 5 sizes available for 4-pipe configuration.





Fan coils - 4 way cassette (EC)



Optional controller.
Wired remote
controller for EC fans.
PAW-FC-907TC

2-pipe			PAW-FC2E-U020-2	PAW-FC2E-U030-2	PAW-FC2E-U040-2	PAW-FC2E-U050-2	PAW-FC2E-U060-2	PAW-FC2E-U070-2
Total cooling capacity ¹⁾	Lo/Med/Hi	kW	1,6/1,8/2,4	1,9/2,9/4,0	2,8/3,5/4,7	3,4/4,4/6,1	3,7/5,5/7,2	4,1/6,5/9,6
Sensible cooling capacity ¹⁾	Lo/Med/Hi	kW	1,3/1,5/2,0	1,4/2,2/3,1	2,1/2,7/3,6	2,6/3,5/4,7	2,7/4,1/5,4	3,0/4,9/7,2
Water flow	Lo/Med/Hi	l/h	267/306/409	325/497/688	481/604/808	579/765/1050	640/944/1243	700/1119/1649
Water pressure drop	Lo/Med/Hi	kPa	4,2/6,9/11,2	3,5/8,6/14,6	6,8/11,4/18,6	8,4/13,1/22,2	3,4/7,6/11,7	5,8/13,1/24,6
Heating capacity ²⁾	Lo/Med/Hi	kW	2,2/2,5/3,2	2,3/3,7/4,5	3,7/4,6/6,2	4,5/6,0/8,1	4,5/7,4/10,0	5,2/9,2/13,0
4-pipe			PAW-FC4E-U020-2	PAW-FC4E-U030-2	PAW-FC4E-U040-2	—	PAW-FC4E-U060-2	PAW-FC4E-U070-2
Total cooling capacity ¹⁾	Lo/Med/Hi	kW	1,4/1,5/2,0	2,0/2,7/3,4	2,6/3,2/4,0	—	3,0/5,0/6,6	3,2/6,1/7,9
Sensible cooling capacity ¹⁾	Lo/Med/Hi	kW	1,2/1,4/1,9	1,5/2,1/2,6	2,1/2,6/3,3	—	2,3/3,8/5,1	2,6/4,7/6,3
Water flow	Lo/Med/Hi	l/h	234/262/344	344/464/581	442/556/690	—	516/858/1144	549/1041/1366
Water pressure drop	Lo/Med/Hi	kPa	6,6/9,1/14,0	4,4/8,2/11,7	6,7/10,9/15,5	—	6,0/14,1/22,4	7,2/19,2/30,1
Heating capacity ²⁾	Lo/Med/Hi	kW	0,8/0,9/1,2	2,2/3,1/3,8	3,0/3,5/4,1	—	3,7/5,5/7,0	4,5/7,1/9,8
Water flow	Lo/Med/Hi	l/h	132/153/201	374/530/658	521/603/699	—	636/939/1210	776/1214/1686
Water pressure drop	Lo/Med/Hi	kPa	25,7/33,4/53,6	13,7/24,2/35	24,2/30,9/39,8	—	7,6/13,8/20,7	10,2/20,8/36
Sound levels								
Global sound power 2-pipe	Lo/Med/Hi	dB(A)	36/40/49	35/47/53	42/48/57	35/40/49	38/46/54	40/52/59
Global sound power 4-pipe	Lo/Med/Hi	dB(A)	36/40/49	35/44/53	42/48/57	—	38/46/54	40/52/59
Global sound pressure 2-pipe ³⁾	Lo/Med/Hi	dB(A)	27/31/40	26/35/44	33/39/48	26/31/40	29/37/45	31/43/50
Global sound pressure 4-pipe ³⁾	Lo/Med/Hi	dB(A)	27/31/40	26/35/44	33/39/48	—	29/37/45	31/43/50
Fan								
Number			1	1	1	1	1	1
Air flow	Lo/Med/Hi	m ³ /h	360/450/659	320/504/734	486/626/900	529/720/979	500/824/1159	601/1080/1598
Filter			G1	G1	G1	G1	G1	G1
Electrical data								
Power supply	Voltage	V	230	230	230	230	230	230
	Phase		Single phase	Single phase	Single phase	Single phase	Single phase	Single phase
	Frequency	Hz	50	50	50	50	50	50
Power consumption 2-pipe	Lo/Med/Hi	W	9/13/29	7/14/32	13/22/57	7/12/25	9/23/25	11/40/115
Power consumption 4-pipe	Lo/Med/Hi	W	9/13/29	7/14/32	13/22/57	—	9/23/46	11/40/115
Water connections								
Type			Female gas threaded	Female gas threaded	Female gas threaded	Female gas threaded	Female gas threaded	Female gas threaded
2-pipe	Inch		3/4	3/4	3/4	1	1	1
4-pipe	Cooling	Inch	3/4	3/4	3/4	—	1	1
	Heating	Inch	1/2	1/2	1/2	—	3/4	3/4
Dimension and weight								
Dimension including panel	HxWxD	mm	334x720x720	334x720x720	334x720x720	339x960x960	339x960x960	339x960x960
Weight		kg	14,8	16,5	16,5	37,1	37,1	39,6
Panel reference			PAW-FC-KPY2040	PAW-FC-KPY2040	PAW-FC-KPY2040	PAW-FC-KPU5070	PAW-FC-KPU5070	PAW-FC-KPU5070

1) According to Eurovent standard. Air: 27 °C DB / 19 °C WB. Water in / out: 7 °C / 12 °C. 2) According to Eurovent standard. Air: 20 °C. Water in / out: 45 °C / 40 °C. 3) Information data considering an hypothetical sound attenuation of the room and installation of -9 dB(A).

Technical focus

- 6 sizes*
- Cooling capacity from 1,4 to 9,4 kW
- Heating capacity from 1,1 to 14,0 kW
- Low energy consumption EC fan

Main features and accessories

- 2 and 4-pipe configurations
- Very low acoustic levels
- Quick access, by simply removing the front grille
- All connections: located at the same side
- Galvanized steel sheet with thermal and acoustical insulation, avoiding condensation on the casing and providing good sound attenuation
- Cleanable synthetic-type air filter

Operating limits

Entering water temperature	From 5 to 90 °C
Indoor air temperature	From 5 to 32 °C

* 5 sizes available for 4-pipe configuration.





Fan coils - ceiling chassis (AC)

Optional controller.
Wired remote
controller.
PAW-FC-903TCOptional controller.
Advanced wired
remote controller.
PAW-FC-RC1

2-pipe - Left connection (PAW-)			FC2A-T010L	FC2A-T020L	FC2A-T030L	FC2A-T040L	FC2A-T050L	FC2A-T060L	FC2A-T070L	FC2A-T080L
2-pipe - Right connection (PAW-)			FC2A-T010R	FC2A-T020R	FC2A-T030R	FC2A-T040R	FC2A-T050R	FC2A-T060R	FC2A-T070R	FC2A-T080R
Total cooling capacity ¹⁾	Lo/Med/Hi	kW	0,7/1,0/1,5	0,7/1,2/1,7	1,0/2,0/2,5	1,2/2,4/3,2	1,7/3,2/4,6	2,7/4,6/5,8	3,4/6,1/7,3	4,6/6,1/8,1
Sensible cooling capacity ¹⁾	Lo/Med/Hi	kW	0,5/0,8/1,1	0,6/0,9/1,3	0,8/1,5/1,9	0,9/1,8/2,3	1,2/2,2/3,3	1,9/3,3/4,5	2,4/4,3/5,1	3,4/4,6/6,3
Water flow	Lo/Med/Hi	l/h	124/172/250	127/213/289	172/341/430	206/413/547	296/544/798	466/784/1003	587/1058/1252	798/1048/1400
Water pressure drop	Lo/Med/Hi	kPa	10,7/19,5/39,2	1,9/3,9/6,3	6,3/19,3/28,8	5,4/17,1/28,0	7,5/22,8/46,9	13,9/37,4/60,2	4,8/15,4/21,5	11,9/19,3/32,5
Heating capacity ²⁾	Lo/Med/Hi	kW	0,9/1,4/2,0	0,9/1,5/2,2	1,3/2,4/3,1	1,4/2,9/4,0	2,1/4,1/5,7	3,1/5,3/7,1	4,3/7,9/9,3	5,9/8,1/11,6
4-pipe - Left connection (PAW-)			FC4A-T010L	FC4A-T020L	FC4A-T030L	FC4A-T040L	FC4A-T050L	FC4A-T060L	FC4A-T070L	FC4A-T080L
4-pipe - Right connection (PAW-)			FC4A-T010R	FC4A-T020R	FC4A-T030R	FC4A-T040R	FC4A-T050R	FC4A-T060R	FC4A-T070R	FC4A-T080R
Total cooling capacity ¹⁾	Lo/Med/Hi	kW	0,7/0,9/1,3	0,6/1,1/1,6	1,0/1,9/2,4	1,1/2,3/3,0	1,7/3,0/4,3	2,6/4,4/5,6	3,3/5,9/6,9	4,5/5,9/8,0
Sensible cooling capacity ¹⁾	Lo/Med/Hi	kW	0,5/0,7/1,0	0,5/0,8/1,2	0,8/1,5/1,8	0,8/1,7/2,2	1,2/2,2/3,1	1,8/3,2/4,3	2,3/4,2/4,9	3,3/4,4/6,2
Water flow	Lo/Med/Hi	l/h	114/159/225	109/192/268	165/327/414	194/388/517	284/522/748	449/756/967	575/1019/1193	775/1020/1380
Water pressure drop	Lo/Med/Hi	kPa	8,3/15,2/29,0	1,5/3,4/5,6	3,0/9,5/14,4	6,4/22,3/36,8	4,2/12,8/25,1	10,2/27,7/44,5	5,9/17,9/24,4	19,3/31,1/53,6
Heating capacity ²⁾	Lo/Med/Hi	kW	0,5/0,7/1,0	0,6/0,9/1,1	1,0/1,4/1,6	0,9/1,6/2,1	1,5/2,3/3,0	1,9/2,9/3,7	2,7/3,6/4,3	3,9/5,6/7,1
Water flow	Lo/Med/Hi	l/h	79/127/178	100/146/190	164/232/274	160/273/354	251/401/508	325/505/633	456/626/736	673/963/1226
Water pressure drop	Lo/Med/Hi	kPa	1,9/3,5/5,6	1,5/3,2/5,3	5,1/9,0/11,9	9,2/26,5/42,7	10,7/24,6/29,5	20,3/43,9/52,9	67,2/117,9/137,8	33,1/63,7/75
Sound levels										
Global sound power	Lo/Med/Hi	dB(A)	33/40/49	31/43/50	30/45/52	30/44/51	34/46/56	38/51/58	43/56/61	50/55/64
Global sound pressure ³⁾	Lo/Med/Hi	dB(A)	24/31/40	22/34/41	21/36/43	21/35/42	25/37/47	29/42/49	34/47/52	41/46/55
Fan										
Number			1	1	1	2	2	2	2	3
Air flow 2-pipe	Lo/Med/Hi	m ³ /h	111/190/283	105/179/265	138/274/390	173/357/499	253/486/716	350/640/933	480/893/1064	660/936/1397
Air flow 4-pipe	Lo/Med/Hi	m ³ /h	95/168/253	89/161/241	132/263/369	162/335/467	242/466/671	334/614/885	470/859/1012	634/905/1370
Filter			G2	G2	G2	G2	G2	G2	G2	G2
Electrical data										
Power supply	Voltage	V	230	230	230	230	230	230	230	230
	Phase		Single phase	Single phase	Single phase	Single phase	Single phase	Single phase	Single phase	Single phase
	Frequency	Hz	50/60	50/60	50/60	50/60	50/60	50/60	50/60	50/60
Power consumption 2-pipe	Lo/Med/Hi	W	13/24/36	10/18/29	16/37/45	15/37/56	28/55/72	37/75/105	53/100/147	90/112/188
Power consumption 4-pipe	Lo/Med/Hi	W	13/24/36	10/18/28	16/37/44	15/37/55	28/54/70	37/74/104	53/99/145	90/112/188
Water connections										
Type			Female gas threaded	Female gas threaded	Female gas threaded	Female gas threaded	Female gas threaded	Female gas threaded	Female gas threaded	Female gas threaded
2-pipe		Inch	1/2	1/2	1/2	1/2	1/2	1/2	3/4	3/4
4-pipe	Cooling	Inch	1/2	1/2	1/2	1/2	1/2	1/2	3/4	3/4
	Heating	Inch	1/2	1/2	1/2	1/2	1/2	1/2	1/2	1/2
Dimension and weight										
Dimension	HxWxD	mm	225 x 766 x 477	225 x 766 x 477	225 x 951 x 477	225 x 1136 x 477	225 x 1321 x 477	225 x 1506 x 477	225 x 1319 x 477	225 x 1506 x 477
Weight	2 / 4-pipes	kg	19/20	19/20	22/23	27/29	30/32	35/37	35/37	47/49

1) According to Eurovent standard. Air: 27 °C DB / 19 °C WB. Water in / out: 7 °C / 12 °C. 2) Air: 20 °C. Water in / out: 50 °C / 45 °C. 3) The sound pressure levels are based on (NR) characteristics of a room having volume of 100 m³ with reverberation of 0,5 seconds.

Technical focus

- Cooling capacity from 0,7 to 8,1 kW
- Heating capacity from 0,7 to 10,3 kW
- 5-speed AC fan motor(s)

Main features and accessories

- 2 and 4-pipe configurations
- Left or right hand arrangements
- Ease of installation
- Very low acoustic levels
- 2 way or 3 way ON / OFF valves
- Auxiliary drain pan
- Air intake with removable grid
- G2 filter

Operating limits

Entering water temperature	From 5 to 90 °C
Indoor air temperature	From 5 to 32 °C



Fan coils - ceiling chassis (EC)



Optional controller.
Wired remote
controller for EC fans.
PAW-FC-907TC

2-pipe - Left connection (PAW-)			FC2E-T010L	FC2E-T020L	FC2E-T030L	FC2E-T040L	FC2E-T050L	FC2E-T060L	FC2E-T070L	FC2E-T080L
2-pipe - Right connection (PAW-)			FC2E-T010R	FC2E-T020R	FC2E-T030R	FC2E-T040R	FC2E-T050R	FC2E-T060R	FC2E-T070R	FC2E-T080R
Total cooling capacity ¹⁾	Lo/Med/Hi	kW	0,6/1,2/2,1	0,6/1,4/2,4	0,9/2,1/3,1	1,3/2,9/4,2	1,3/4,0/5,0	2,0/4,5/5,2	2,7/5,9/6,9	5,1/6,5/8,8
Sensible cooling capacity ¹⁾	Lo/Med/Hi	kW	0,5/1,1/1,9	0,5/1,1/1,9	0,6/1,6/2,4	1,0/2,1/3,0	1,1/3,0/3,7	1,4/3,5/4,0	2,0/4,3/5,2	3,7/4,8/6,6
Water flow	Lo/Med/Hi	l/h	107/210/356	110/237/406	148/354/532	230/506/722	231/685/743	341/767/800	463/1008/1098	879/1111/1254
Water pressure drop	Lo/Med/Hi	kPa	8,2/28,2/76,9	1,5/4,6/11,0	5,0/20,5/42,1	6,4/24,4/46,3	4,9/35,1/41,0	7,8/35,8/38,8	3,0/14,0/16,6	14,1/21,4/26,6
Heating capacity ²⁾	Lo/Med/Hi	kW	0,8/1,6/2,9	0,9/1,9/3,3	1,0/2,2/3,4	1,4/3,0/5,3	1,7/5,2/5,5	2,3/5,9/6,1	3,8/7,3/8,2	6,2/8,0/9,3
4-pipe - Left connection (PAW-)			FC4E-T010L	FC4E-T020L	FC4E-T030L	FC4E-T040L	FC4E-T050L	FC4E-T060L	FC4E-T070L	FC4E-T080L
4-pipe - Right connection (PAW-)			FC4E-T010R	FC4E-T020R	FC4E-T030R	FC4E-T040R	FC4E-T050R	FC4E-T060R	FC4E-T070R	FC4E-T080R
Total cooling capacity ¹⁾	Lo/Med/Hi	kW	0,5/1,1/1,9	0,6/1,2/2,2	0,8/1,9/2,9	1,2/2,7/4,0	1,2/3,6/4,6	1,8/4,1/4,9	2,6/5,1/6,4	5,0/6,2/9,6
Sensible cooling capacity ¹⁾	Lo/Med/Hi	kW	0,4/0,9/1,7	0,4/1,0/1,8	0,6/1,5/2,2	0,9/1,9/2,8	1,0/2,8/3,5	1,2/3,2/3,8	1,9/3,8/4,8	3,6/4,6/7,2
Water flow	Lo/Med/Hi	l/h	92/185/327	97/206/375	129/321/493	205/457/681	212/625/686	306/707/749	443/886/977	855/1070/1242
Water pressure drop	Lo/Med/Hi	kPa	5,8/20,1/59,2	1,3/3,7/9,7	4,0/9,2/19,7	6,3/29,6/60,1	2,5/17,9/21,3	5,1/24,3/27,2	3,5/13,6/16,5	22,9/33,9/44,3
Heating capacity ²⁾	Lo/Med/Hi	kW	0,4/0,8/1,4	0,6/0,9/1,5	1,0/1,4/1,8	1,2/2,0/2,8	1,6/2,4/2,5	1,4/2,9/3,1	2,5/3,4/3,6	4,5/5,9/6,9
Water flow	Lo/Med/Hi	l/h	76/140/235	95/161/255	166/243/304	204/350/483	267/416/438	233/503/531	434/583/614	767/1011/1194
Water pressure drop	Lo/Med/Hi	kPa	1,8/4,0/8,4	1,4/3,8/9,4	5,3/9,7/14,1	15,6/41,8/76,3	11,9/26,3/28,9	11,5/43,6/48,1	61,5/103,8/113,9	42,1/69,7/95,1
Sound levels										
Global sound power	Lo/Med/Hi	dB(A)	34/47/60	34/47/60	31/50/59	29/44/52	30/51/57	32/54/58	40/54/59	51/56/64
Global sound pressure ³⁾	Lo/Med/Hi	dB(A)	25/38/51	25/38/51	22/41/50	20/35/43	21/42/48	23/45/49	31/45/50	42/47/55
Fan										
Number			1	1	1	2	2	2	2	3
Air flow 2-pipe	Lo/Med/Hi	m ³ /h	108/228/417	98/234/413	145/380/585	170/412/678	203/645/816	245/737/912	350/850/1050	685/927/1398
Air flow 4-pipe	Lo/Med/Hi	m ³ /h	91/199/379	84/200/380	123/342/540	148/369/627	185/587/646	205/668/716	329/798/894	660/884/1079
Filter			G2	G2	G2	G2	G2	G2	G2	G2
Electrical data										
Power supply	Voltage	V	230	230	230	230	230	230	230	230
	Phase		Single phase	Single phase	Single phase	Single phase	Single phase	Single phase	Single phase	Single phase
	Frequency	Hz	50/60	50/60	50/60	50/60	50/60	50/60	50/60	50/60
Power consumption 2-pipe	Lo/Med/Hi	W	5/11/41	5/13/41	4/16/42	2/13/43	4/24/46	2/30/54	11/44/77	23/42/108
Power consumption 4-pipe	Lo/Med/Hi	W	5/11/39	5/13/40	6/15/40	2/12/42	2/23/44	2/28/52	11/43/75	22/41/116
Water connections										
Type			Female gas threaded	Female gas threaded	Female gas threaded	Female gas threaded	Female gas threaded	Female gas threaded	Female gas threaded	Female gas threaded
2-pipe		Inch	1/2	1/2	1/2	1/2	1/2	1/2	3/4	3/4
4-pipe	Cooling	Inch	1/2	1/2	1/2	1/2	1/2	1/2	3/4	3/4
	Heating	Inch	1/2	1/2	1/2	1/2	1/2	1/2	1/2	1/2
Dimension and weight										
Dimension	HxWxD	mm	225 x 766 x 477	225 x 766 x 477	225 x 951 x 477	225 x 1136 x 477	225 x 1321 x 477	225 x 1506 x 477	225 x 1319 x 477	225 x 1506 x 477
Weight	2 / 4-pipes	kg	19/20	19/20	22/23	27/29	30/32	35/37	35/37	47/49

1) According to Eurovent standard. Air: 27 °C DB / 19 °C WB. Water in / out: 7 °C / 12 °C. 2) Air: 20 °C. Water in / out: 50 °C / 45 °C. 3) The sound pressure levels are based on (NR) characteristics of a room having volume of 100 m³ with reverberation of 0,5 seconds.

Technical focus

- Cooling capacity from 0,5 to 9,6 kW
- Heating capacity from 0,6 to 13,6 kW
- Low energy consumption EC fan(s)

Main features and accessories

- 2 and 4-pipe configurations
- Left or right hand arrangements
- Ease of installation
- Very low acoustic levels
- 2 way or 3 way ON / OFF valves
- Auxiliary drain pan
- Air intake with removable grid
- G2 filter

Operating limits

Entering water temperature	From 5 to 90 °C
Indoor air temperature	From 5 to 32 °C





Fan coils - floor-standing chassis (AC)

Optional controller.
Wired remote
controller.
PAW-FC-903TCOptional controller.
Advanced wired
remote controller.
PAW-FC-RC1

2-pipe - Left connection (PAW-)			FC2A-P010L	FC2A-P020L	FC2A-P030L	FC2A-P040L	FC2A-P050L	FC2A-P060L	FC2A-P070L	FC2A-P080L
2-pipe - Right connection (PAW-)			FC2A-P010R	FC2A-P020R	FC2A-P030R	FC2A-P040R	FC2A-P050R	FC2A-P060R	FC2A-P070R	FC2A-P080R
Total cooling capacity ¹⁾	Lo/Med/Hi	kW	0,7/1,0/1,5	0,7/1,2/1,7	1,0/2,0/2,5	1,2/2,4/3,2	1,7/3,2/4,6	2,7/4,6/5,8	3,4/6,1/7,3	4,6/6,1/8,1
Sensible cooling capacity ¹⁾	Lo/Med/Hi	kW	0,5/0,8/1,1	0,6/0,9/1,3	0,8/1,5/1,9	0,9/1,8/2,3	1,2/2,2/3,3	1,9/3,3/4,5	2,4/4,3/5,1	3,4/4,6/6,3
Water flow	Lo/Med/Hi	l/h	124/172/250	127/213/289	172/341/430	206/413/547	296/544/798	466/784/1003	587/1058/1252	798/1048/1400
Water pressure drop	Lo/Med/Hi	kPa	10,7/19,5/39,2	1,9/3,9/6,3	6,3/19,3/28,8	5,4/17,1/28,0	7,5/22,8/46,9	13,9/37,4/60,2	4,8/15,4/21,5	11,9/19,3/32,5
Heating capacity ²⁾	Lo/Med/Hi	kW	0,9/1,4/2,0	0,9/1,5/2,2	1,3/2,4/3,1	1,4/2,9/4,0	2,1/4,1/5,7	3,1/5,3/7,1	4,3/7,9/9,3	5,9/8,1/11,6
4-pipe - Left connection (PAW-)			FC4A-P010L	FC4A-P020L	FC4A-P030L	FC4A-P040L	FC4A-P050L	FC4A-P060L	FC4A-P070L	FC4A-P080L
4-pipe - Right connection (PAW-)			FC4A-P010R	FC4A-P020R	FC4A-P030R	FC4A-P040R	FC4A-P050R	FC4A-P060R	FC4A-P070R	FC4A-P080R
Total cooling capacity ¹⁾	Lo/Med/Hi	kW	0,7/0,9/1,3	0,6/1,1/1,6	1,0/1,9/2,4	1,1/2,3/3,0	1,7/3,0/4,3	2,6/4,4/5,6	3,3/5,9/6,9	4,5/5,9/8,0
Sensible cooling capacity ¹⁾	Lo/Med/Hi	kW	0,5/0,7/1,0	0,5/0,8/1,2	0,8/1,5/1,8	0,8/1,7/2,2	1,2/2,2/3,1	1,8/3,2/4,3	2,3/4,2/4,9	3,3/4,4/6,2
Water flow	Lo/Med/Hi	l/h	114/159/225	109/192/268	165/327/414	194/388/517	284/522/748	449/756/967	575/1019/1193	775/1020/1380
Water pressure drop	Lo/Med/Hi	kPa	8,3/15,2/29,0	1,5/3,4/5,6	3,0/9,5/14,4	6,4/22,3/36,8	4,2/12,8/25,1	10,2/27,7/44,5	5,9/17,9/24,4	19,3/31,1/53,6
Heating capacity ²⁾	Lo/Med/Hi	kW	0,5/0,7/1,0	0,6/0,9/1,1	1,0/1,4/1,6	0,9/1,6/2,1	1,5/2,3/3,0	1,9/2,9/3,7	2,7/3,6/4,3	3,9/5,6/7,1
Water flow	Lo/Med/Hi	l/h	79/127/178	100/146/190	164/232/274	160/273/354	251/401/508	325/505/633	456/626/736	673/963/1226
Water pressure drop	Lo/Med/Hi	kPa	1,9/3,5/5,6	1,5/3,2/5,3	5,1/9,0/11,9	9,2/26,5/42,7	10,7/24,6/29,5	20,3/43,9/52,9	67,2/117,9/137,8	33,1/63,7/75
Sound levels										
Global sound power	Lo/Med/Hi	dB(A)	33/40/49	31/43/50	30/45/52	30/44/51	34/46/56	38/51/58	43/56/61	50/55/64
Global sound pressure ³⁾	Lo/Med/Hi	dB(A)	24/31/40	22/34/41	21/36/43	21/35/42	25/37/47	29/42/49	34/47/52	41/46/55
Fan										
Number			1	1	1	2	2	2	2	3
Air flow 2-pipe	Lo/Med/Hi	m ³ /h	111/190/283	105/179/265	138/274/390	173/357/499	253/486/716	350/640/933	480/893/1064	660/936/1397
Air flow 4-pipe	Lo/Med/Hi	m ³ /h	95/168/253	89/161/241	132/263/369	162/335/467	242/466/671	334/614/885	470/859/1012	634/905/1370
Filter			G2	G2	G2	G2	G2	G2	G2	G2
Electrical data										
Power supply	Voltage	V	230	230	230	230	230	230	230	230
	Phase		Single phase	Single phase	Single phase	Single phase	Single phase	Single phase	Single phase	Single phase
	Frequency	Hz	50/60	50/60	50/60	50/60	50/60	50/60	50/60	50/60
Power consumption 2-pipe	Lo/Med/Hi	W	13/24/36	10/18/29	16/37/45	15/37/56	28/55/72	37/75/105	53/100/147	90/112/188
Power consumption 4-pipe	Lo/Med/Hi	W	13/24/36	10/18/28	16/37/44	15/37/55	28/54/70	37/74/104	53/99/145	90/112/188
Water connections										
Type			Female gas threaded	Female gas threaded	Female gas threaded	Female gas threaded	Female gas threaded	Female gas threaded	Female gas threaded	Female gas threaded
2-pipe		Inch	1/2	1/2	1/2	1/2	1/2	1/2	3/4	3/4
4-pipe	Cooling	Inch	1/2	1/2	1/2	1/2	1/2	1/2	3/4	3/4
	Heating	Inch	1/2	1/2	1/2	1/2	1/2	1/2	1/2	1/2
Dimension and weight										
Dimension ⁴⁾	HxWxD	mm	477 x 225 x 766	766 x 225 x 477	477 x 225 x 951	477 x 225 x 1136	477 x 225 x 1321	477 x 225 x 1506	575 x 225 x 1319	575 x 225 x 1506
Weight	2 / 4-pipes	kg	19/20	19/20	22/23	27/29	30/32	35/37	35/37	47/49

1) According to Eurovent standard. Air: 27 °C DB / 19 °C WB. Water in / out: 7 °C / 12 °C. 2) Air: 20 °C. Water in / out: 50 °C / 45 °C. 3) The sound pressure levels are based on (NR) characteristics of a room having volume of 100 m³ with reverberation of 0,5 seconds. 4) Without support feet.

Technical focus

- Cooling capacity from 0,7 to 8,1 kW
- Heating capacity from 0,7 to 10,3 kW
- 5-speed AC fan motor(s)

Main features and accessories

- 2 and 4-pipe configurations
- Left or right hand arrangements
- Ease of installation
- Very low acoustic levels
- 2 way or 3 way ON / OFF valves
- Auxiliary drain pan
- Air intake with removable grid
- G2 filter
- PAW-FC-SFS feet for floor-standing units

Operating limits

Entering water temperature	From 5 to 90 °C
Indoor air temperature	From 5 to 32 °C





Fan coils - floor-standing chassis (EC)



Optional controller.
Wired remote
controller for EC fans.
PAW-FC-907TC

2-pipe - Left connection (PAW-)			FC2E-P010L	FC2E-P020L	FC2E-P030L	FC2E-P040L	FC2E-P050L	FC2E-P060L	FC2E-P070L	FC2E-P080L
2-pipe - Right connection (PAW-)			FC2E-P010R	FC2E-P020R	FC2E-P030R	FC2E-P040R	FC2E-P050R	FC2E-P060R	FC2E-P070R	FC2E-P080R
Total cooling capacity ¹⁾	Lo/Med/Hi	kW	0,6/1,2/2,1	0,6/1,4/2,4	0,9/2,1/3,1	1,3/2,9/4,2	1,3/4,0/5,0	2,0/4,5/5,2	2,7/5,9/6,9	5,1/6,5/8,8
Sensible cooling capacity ¹⁾	Lo/Med/Hi	kW	0,5/1,1/1,9	0,5/1,1/1,9	0,6/1,6/2,4	1,0/2,1/3,0	1,1/3,0/3,7	1,4/3,5/4,0	2,0/4,3/5,2	3,7/4,8/6,6
Water flow	Lo/Med/Hi	l/h	107/210/356	110/237/406	148/354/532	230/506/722	231/685/743	341/767/800	463/1008/1098	879/1111/1254
Water pressure drop	Lo/Med/Hi	kPa	8,2/28,2/76,9	1,5/4,6/11,0	5,0/20,5/42,1	6,4/24,4/46,3	4,9/35,1/41,0	7,8/35,8/38,8	3,0/14,0/16,6	14,1/21,4/26,6
Heating capacity ²⁾	Lo/Med/Hi	kW	0,8/1,6/2,9	0,9/1,9/3,3	1,0/2,2/3,4	1,4/3,0/5,3	1,7/5,2/5,5	2,3/5,9/6,1	3,8/7,3/8,2	6,2/8,0/9,3
4-pipe - Left connection (PAW-)			FC4E-P010L	FC4E-P020L	FC4E-P030L	FC4E-P040L	FC4E-P050L	FC4E-P060L	FC4E-P070L	FC4E-P080L
4-pipe - Right connection (PAW-)			FC4E-P010R	FC4E-P020R	FC4E-P030R	FC4E-P040R	FC4E-P050R	FC4E-P060R	FC4E-P070R	FC4E-P080R
Total cooling capacity ¹⁾	Lo/Med/Hi	kW	0,5/1,1/1,9	0,6/1,2/2,2	0,8/1,9/2,9	1,2/2,7/4,0	1,2/3,6/4,6	1,8/4,1/4,9	2,6/5,1/6,4	5,0/6,2/9,6
Sensible cooling capacity ¹⁾	Lo/Med/Hi	kW	0,4/0,9/1,7	0,4/1,0/1,8	0,6/1,5/2,2	0,9/1,9/2,8	1,0/2,8/3,5	1,2/3,2/3,8	1,9/3,8/4,8	3,6/4,6/7,2
Water flow	Lo/Med/Hi	l/h	92/185/327	97/206/375	129/321/493	205/457/681	212/625/686	306/707/749	443/886/977	855/1070/1242
Water pressure drop	Lo/Med/Hi	kPa	5,8/20,1/59,2	1,3/3,7/9,7	4,0/9,2/19,7	6,3/29,6/60,1	2,5/17,9/21,3	5,1/24,3/27,2	3,5/13,6/16,5	22,9/33,9/44,3
Heating capacity ²⁾	Lo/Med/Hi	kW	0,4/0,8/1,4	0,6/0,9/1,5	1,0/1,4/1,8	1,2/2,0/2,8	1,6/2,4/2,5	1,4/2,9/3,1	2,5/3,4/3,6	4,5/5,9/6,9
Water flow	Lo/Med/Hi	l/h	76/140/235	95/161/255	166/243/304	204/350/483	267/416/438	233/503/531	434/583/614	767/1011/1194
Water pressure drop	Lo/Med/Hi	kPa	1,8/4,0/8,4	1,4/3,8/9,4	5,3/9,7/14,1	15,6/41,8/76,3	11,9/26,3/28,9	11,5/43,6/48,1	61,5/103,8/113,9	42,1/69,7/95,1
Sound levels										
Global sound power	Lo/Med/Hi	dB(A)	34/47/60	34/47/60	31/50/59	29/44/52	30/51/57	32/54/58	40/54/59	51/56/64
Global sound pressure ³⁾	Lo/Med/Hi	dB(A)	25/38/51	25/38/51	22/41/50	20/35/43	21/42/48	23/45/49	31/45/50	42/47/55
Fan										
Number			1	1	1	2	2	2	2	3
Air flow 2-pipe	Lo/Med/Hi	m ³ /h	108/228/417	98/234/413	145/380/585	170/412/678	203/645/816	245/737/912	350/850/1050	685/927/1398
Air flow 4-pipe	Lo/Med/Hi	m ³ /h	91/199/379	84/200/380	123/342/540	148/369/627	185/587/646	205/668/716	329/798/894	660/884/1079
Filter			G2	G2	G2	G2	G2	G2	G2	G2
Electrical data										
Power supply	Voltage	V	230	230	230	230	230	230	230	230
	Phase		Single phase	Single phase	Single phase	Single phase	Single phase	Single phase	Single phase	Single phase
	Frequency	Hz	50/60	50/60	50/60	50/60	50/60	50/60	50/60	50/60
Power consumption 2-pipe	Lo/Med/Hi	W	5/11/41	5/13/41	4/16/42	2/13/43	4/24/46	2/30/54	11/44/77	23/42/108
Power consumption 4-pipe	Lo/Med/Hi	W	5/11/39	5/13/40	6/15/40	2/12/42	2/23/44	2/28/52	11/43/75	22/41/116
Water connections										
Type			Female gas threaded	Female gas threaded	Female gas threaded	Female gas threaded	Female gas threaded	Female gas threaded	Female gas threaded	Female gas threaded
2-pipe		Inch	1/2	1/2	1/2	1/2	1/2	1/2	3/4	3/4
4-pipe	Cooling	Inch	1/2	1/2	1/2	1/2	1/2	1/2	3/4	3/4
	Heating	Inch	1/2	1/2	1/2	1/2	1/2	1/2	1/2	1/2
Dimension and weight										
Dimension ⁴⁾	HxWxD	mm	477 x 225 x 766	766 x 225 x 477	477 x 225 x 951	477 x 225 x 1136	477 x 225 x 1321	477 x 225 x 1506	575 x 225 x 1319	575 x 225 x 1506
Weight	2 / 4-pipes	kg	19/20	19/20	22/23	27/29	30/32	35/37	35/37	47/49

1) According to Eurovent standard. Air: 27 °C DB / 19 °C WB. Water in / out: 7 °C / 12 °C. 2) Air: 20 °C. Water in / out: 50 °C / 45 °C. 3) The sound pressure levels are based on (NR) characteristics of a room having volume of 100 m³ with reverberation of 0,5 seconds. 4) Without support feet.

Technical focus

- Cooling capacity from 0,5 to 9,6 kW
- Heating capacity from 0,6 to 13,6 kW
- Low energy consumption EC fan(s)

Main features and accessories

- 2 and 4-pipe configurations
- Left or right hand arrangements
- Ease of installation
- Very low acoustic levels
- 2 way or 3 way ON / OFF valves
- Auxiliary drain pan
- Air intake with removable grid
- G2 filter
- PAW-FC-SFS feet for floor-standing units

Operating limits

Entering water temperature	From 5 to 90 °C
Indoor air temperature	From 5 to 32 °C



Fan coils - wall-mounted (AC)



Optional controller.
Wired remote
controller.
PAW-FC-903TC



Optional controller.
Advanced wired
remote controller.
PAW-FC-RC1



Infrared remote
supplied with IR
versions.
IR Controller

2-pipe			PAW-FC2A-K007	PAW-FC2A-K009	PAW-FC2A-K018	PAW-FC2A-K022
			PAW-FC2A-K007IR	PAW-FC2A-K009IR	PAW-FC2A-K018IR	PAW-FC2A-K022IR
Total cooling capacity ¹⁾	Lo/Med/Hi	kW	1,0/1,3/1,7	1,6/1,7/2,4	2,8/3,0/3,5	2,9/3,1/3,9
Sensible cooling capacity ¹⁾	Lo/Med/Hi	kW	0,7/1,0/1,2	1,2/1,3/1,9	2,1/2,3/2,7	2,3/2,5/3,1
Water flow	Lo/Med/Hi	l/h	172/231/287	270/291/418	483/508/609	502/535/669
Water pressure drop	Lo/Med/Hi	kPa	18,6/24,9/30,9	18,5/27,0/40,0	34,6/41,3/55,6	37,2/33,7/45,2
Heating capacity ²⁾	Lo/Med/Hi	kW	1,4/1,7/2,0	1,7/2,0/2,7	2,9/3,2/4,0	3,1/3,7/4,4
Sound levels						
Sound power	Lo/Med/Hi	dB(A)	45/49/51	47/52/57	49/53/59	56/59/63
Sound pressure ³⁾	Lo/Med/Hi	dB(A)	32/36/38	34/39/44	40/43/46	43/46/50
Fan						
Number			1	1	1	1
Air flow	Lo/Med/Hi	m ³ /h	282/321/360	367/413/551	532/592/680	617/709/850
Filter			G1	G1	G1	G1
Electrical data						
Power supply	Voltage	V	230	230	230	230
	Phase		Single phase	Single phase	Single phase	Single phase
	Frequency	Hz	50	50	50	50
Fuse rating		A	3	3	3	3
Power consumption	Lo/Med/Hi	W	39/42/62	30/47/59	44/50/55	50/55/70
Water connections						
Type			Female gas threaded	Female gas threaded	Female gas threaded	Female gas threaded
Water connections		Inch	1/2	1/2	1/2	1/2
Dimension and weight						
Dimension	HxWxD	mm	275 x 180 x 845	275 x 180 x 845	298 x 200 x 940	298 x 200 x 940
Weight		kg	11	11	13	13

1) According to Eurovent standard. Air: 27 °C DB / 19 °C WB. Water in / out: 7 °C / 12 °C. 2) According to Eurovent standard. Air: 20 °C. Water in / out: 45 °C / 40 °C. 3) Sound pressure considering a local of 100 m³ a reverberation time of 0,5 seconds and a distance of 1 m.

Technical focus

- 4 sizes
- Cooling capacity from 1,0 to 3,9 kW
- Heating capacity from 1,4 to 4,1 kW
- Version: 2-pipes, AC fan

Main features and accessories

- 2 way or 3 way valve ON / OFF
- 3-speed AC fan motor
- Silent unit for optimum customer comfort
- Aesthetic design suitable for residential and hotel applications
- Compatible with IR controller (supplied with IR versions)
- Coil with hydrophilic fins to improve the condensate flow

Operating limits

Entering water temperature	From 5 to 60 °C
Indoor air temperature	From 6 to 40 °C





Smart fan coils

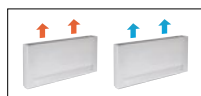

Built-in advanced thermostat.

			PAW-AAIR-200-2	PAW-AAIR-700-2	PAW-AAIR-900-2
Total cooling capacity	Lo/Med/Hi	kW	0,2/0,3/0,6	0,8/1,0/1,2	1,2/1,5/1,7
Sensible cooling capacity	Lo/Med/Hi	kW	0,2/0,3/0,5	0,6/0,9/1,1	1,1/1,4/1,6
Water flow	Lo/Med/Hi	kg/h	40,0/59,0/95,0	129,0/178,0/207,0	198,0/261,0/300,0
Water pressure drop	Lo/Med/Hi	kPa	0,4/2,0/2,9	1,0/2,0/2,0	6,0/9,0/12,0
Inlet water temperature		°C	10	10	10
Outlet water temperature		°C	15	15	15
Inlet air temperature		°C	27,0	27,0	27,0
Outlet air temperature	Lo/Med/Hi	°C	15,0/17,0/18,0	14,0/16,0/17,0	16,0/17,0/18,0
Relative humidity of inlet air		%	47	47	47
Total heating capacity	Lo/Med/Hi	kW	0,2/0,5/0,6	0,7/1,0/1,2	0,9/1,4/1,7
Water flow	Lo/Med/Hi	kg/h	37,3/80,8/98,0	121,8/177,5/204,3	152,4/244,2/292,9
Water pressure drop	Lo/Med/Hi	kPa	0,4/2,0/2,9	0,3/0,8/1,0	0,5/1,6/2,2
Inlet water temperature		°C	35	35	35
Outlet water temperature		°C	30	30	30
Inlet air temperature		°C	19,0	19,0	19,0
Outlet air temperature	Lo/Med/Hi	°C	38,9/32,0/30,0	33,3/31,8/30,6	30,2/31,1/30,6
Air flow	Lo/Med/Hi	m ³ /min	0,9/1,9/2,7	2,6/4,2/5,3	4,1/6,1/7,7
Maximum input power	Lo/Med/Hi	W	7,0/9,0/13,0	14,0/18,0/22,0	16,0/20,0/24,0
Sound pressure	Lo/Med/Hi	dB(A)	23/33/40	24/36/42	25/36/44
Dimension (HxWxD)		mm	735x579x129	935x579x129	1135x579x129
Net weight		kg	17	20	23
3 Ways valve included			Yes	Yes	Yes
Touch screen thermostat			Yes	Yes	Yes

* Smart fan coils is produced by Innova.

Accessories

PAW-AAIR-LEGS-1 Kits of 2 legs to protect the water pipings

Accessories

PAW-AAIR-RHCABLE Motor connection cable for units with hydraulic connections on the right

Stylish floor-standing fan coils with advanced controller

The slimline of Smart fan coils delivers high efficiency climate control.

With a depth of just under 130 mm they are at the cutting edge of the market. Blending easily into the home, Smart fan coil's elegant design and product refinements are clear to see in every detail.

Exceptional ventilation efficiency means the motor uses considerably less energy (low wattage). The fan speed is continuously modulated by the temperature controller with proportional integral logic, with undoubted advantages for regulating the temperature and humidity in summer mode.

Technical focus

- 4 operation modes (auto, silent, night-time and maximum ventilation speed)
- Exclusive design
- Extremely compact (only 129 mm deep)
- Cooling and dehumidification functions possible (drain is needed)
- 3-way valve included (no overflow valve needed on the installation if more than 3 units installed)
- Touch screen thermostat

With standard cast radiators.

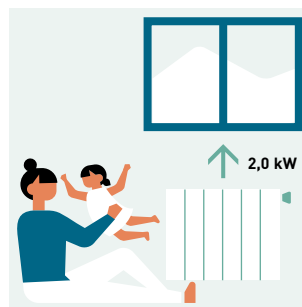

Water at 65 °C needed.

With Smart fan coil.

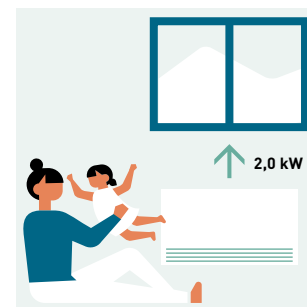

Water at 35 °C needed.

All temperature curves and capacity are available on www.panasonicproclub.com

PRO Club



Control and connectivity



Simple user friendly control for outdoor units

A control panel with intuitive design is equipped on all ECOi-W systems as standard. The microprocessor based control has a new IHM logic and implements a smart handling for your demand.

Basic operation.

- ON / OFF setting
- Cooling / Heating mode setting

Energy Saving.

- Intelligent logic control for inlet water temperature
- Night setback operation to reduce electrical consumption and noise
- Part load operating mode
- Maximum discharge temperature control

Service / Maintenance.

- Automatic test operation at the push of a button
- Alarm notice with the latest 10 alarms
- Counter for operating hours of compressor and pump
- Compressor operating limits saved in a flash memory

Others.

- BMS compatible (RS485 ModBus RTU or BACnet MSTP protocol)



Remote control kit

PAW-SYSREMKIT

Simple remote control for the need to be installed remotely from the units.

Features:

- 8 lines of display with selectable blue and white back light
- Push-and-roll knob for easy operation
- Schedule function
- Alarm button with LED indicator
- Firmware can be upgraded via USB interface



New remote monitoring service ECOi-W Cloud

PAW-CM000SP041.

Remote access in real time to optimise the service and maintenance work.

Alarm notification via e-mail.

Reporting and graph visualization with 300 varieties.

Various LED signals on the hardware to check the status on site.

Technical focus:

- Maximum 10 outdoor units connectable
- Modbus RTU is required
- History of data interval up to 5 minutes
- 4G SIM card fitted
- IP65 casing
- Optional antenna is available in the case that 4G signal is not good enough





Wired controllers for AC and EC fan coils

Advanced wired remote controller (AC)

PAW-FC-RC1

This advanced controller provides a higher level of comfort in heating. The sensor can be used as a water flow sensor, stopping the fan when the water temperature is low, avoiding cold drafts in winter.

Features:

- For 2-pipe and 4-pipe, AC fan
- Change Over function (cold draft prevention)
- Room thermostat
- 3 outputs, 230 V relays for fan control
- 2 outputs, 230 V relays for heating / cooling control
- Connection to BMS - Modbus RTU slave
- 1 DI for presence detection (key card switch)
- 1 AI for sensor



Wired remote controller (EC)

PAW-FC-907TC

Stylish and sophisticated design with backlit LCD display, is suitable for installation within a wide variety of locations such as office, hotel and residential applications. By connecting the controller to the range of EC fan coils, the user can take advantage of the improved performance, higher levels of efficiency and thus improved energy savings.

Features:

- For 2-pipe and 4-pipe, EC fan
- Back lit LCD screen with touch control
- Adjustable range EC fan control
- Economiser
- Connection to BMS via Modbus
- 1 DI for presence detection (key card switch)



Wired remote controller (AC)

PAW-FC-903TC







Feature rich and perfectly adapted to control AC fan coils, the PAW-FC-903TC is the addition for any fan coil. With intuitive user interface provided by the push button control and large LCD display, it will fit seamlessly with almost any location.

Features:

- For 2-pipe, AC fan
- Back lit LCD screen
- 3 speed control relay, for fan
- Economizer



Accessories and control

Wired remote controller for outdoor units	Remote monitoring service ECOi-W Cloud		
 <p>Remote control for the need to be installed remotely from the units.</p> <p>----- PAW-SYSREMKIT</p>	 <p>Cloudgate plug and play IP65 box mobile 4G Europe.</p> <p>----- PAW-CM000SP041</p>	<p>Extension kit and cable gland for mobile (2/4G) antenna (3 m).</p> <p>----- PAW-CM000K0001</p>	<p>Tservice wireless fee for 1 year. Periodic prepaid subscriptions identified by software "tokens" loaded in customer's private portal.</p> <p>----- PAW-00SRTS011</p>
Shut off valves			Victaulic connection kit
 <p>Shut off valves kit for model 20 - 40.</p> <p>----- PAW-SYSSOV1</p>	<p>Shut off valves kit for model 45 - 75.</p> <p>----- PAW-SYSSOV2</p>	<p>Shut off valves kit for model 90 - 125.</p> <p>----- PAW-SYSSOV3</p>	<p>Victaulic connection kit for model 140 - 210.</p> <p>----- PAW-SYSVICHTH</p>
Wired remote controller for fan coil			
 <p>Wired remote controller for fan coil.</p> <p>----- PAW-FC-903TC</p>	 <p>Advanced wired remote controller for fan coil.</p> <p>----- PAW-FC-RC1</p>	 <p>Wired remote controller for EC fan coil.</p> <p>----- PAW-FC-907TC</p>	
Fan coil ceiling, floor-standing and ducted valve accessories			
<p>2 way valve + drain pan for 2-pipe ceiling, floor-standing and ducted models 010-060.</p> <p>----- PAW-FC-2WY-11/55-1</p>	<p>2 way valve + drain pan for 2-pipe ceiling, floor-standing and ducted models 070-080.</p> <p>----- PAW-FC-2WY-65/90-1</p>	<p>2 way valve + drain pan for 2-pipe ducted model F040.</p> <p>----- PAW-FC-2WY-F040</p>	
<p>3 way valve + drain pan for 2-pipe ceiling, floor-standing and ducted models 010-060.</p> <p>----- PAW-FC-3WY-11/55-1</p>	<p>3 way valve + drain pan for 2-pipe ceiling, floor-standing and ducted models 070-080.</p> <p>----- PAW-FC-3WY-65/90-1</p>	<p>3 way valve + drain pan for 2-pipe ducted model F040.</p> <p>----- PAW-FC-3WY-F040</p>	
<p>2 way valve + drain pan for 4-pipe ceiling, floor-standing and ducted models 010-060.</p> <p>----- PAW-FC4-2WY-010</p>	<p>2 way valve + drain pan for 4-pipe ceiling, floor-standing and ducted models 070-080.</p> <p>----- PAW-FC4-2WY-070</p>	<p>2 way valve + drain pan for 4-pipe ducted model F040.</p> <p>----- PAW-FC4-2WY-F040</p>	
<p>3 way valve + drain pan for 4-pipe ceiling, floor-standing and ducted model 010.</p> <p>----- PAW-FC4-3WY-010</p>	<p>3 way valve + drain pan for 4-pipe ceiling, floor-standing and ducted models 020-060.</p> <p>----- PAW-FC4-3WY-020</p>	<p>3 way valve + drain pan for 4-pipe ceiling, floor-standing and ducted models 070-080.</p> <p>----- PAW-FC4-3WY-070</p>	



3 way valve + drain pan for 4-pipe ducted model F040

PAW-FC4-3WY-F040

Fan coil high static ducted valve accessories

2 way valve + drain pan for 2-pipe high static ducted models E070.

PAW-FC2-2WY-E070

2 way valve + drain pan for 2-pipe high static ducted models E150-E180.

PAW-FC-2WY-150

2 way valve + drain pan for 2-pipe high static ducted models E210-E240.

PAW-FC2-2WY-E210

3 way valve + drain pan for 2-pipe high static ducted models E070.

PAW-FC2-3WY-E070

3 way valve + drain pan for 2-pipe high static ducted models E150-E180.

PAW-FC-3WY-150

3 way valve + drain pan for 2-pipe high static ducted models E210-E240.

PAW-FC2-3WY-E210

2 way valve + drain pan for 4-pipe high static ducted model E070.

PAW-FC4-2WY-E070

2 way valve + drain pan for 4-pipe high static ducted models E150-E180.

PAW-FC4-2WY-E150

2 way valve + drain pan for 4-pipe high static ducted models E210-E240.

PAW-FC4-2WY-E210

3 way valve + drain pan for 4-pipe high static ducted model E070.

PAW-FC4-3WY-E070

3 way valve + drain pan for 4-pipe high static ducted models E150-E180.

PAW-FC4-3WY-E150

3 way valve + drain pan for 4-pipe high static ducted models E210-E240.

PAW-FC4-3WY-E210

Fan coil cassette valve accessories

2 way valve + drain pan for 2-pipe cassette models U020-U040.

PAW-FC2-2WY-U020

2 way valve + drain pan for 2-pipe cassette models U050-U070.

PAW-FC2-2WY-U050

3 way valve + drain pan for 2-pipe cassette models U020-U040.

PAW-FC2-3WY-U020

3 way valve + drain pan for 2-pipe cassette models U050-U070.

PAW-FC2-3WY-U050

2 way valve + drain pan for 4-pipe cassette models U020-U040.

PAW-FC4-2WY-U020

2 way valve + drain pan for 4-pipe cassette models U050-U070.

PAW-FC4-2WY-U050

3 way valve + drain pan for 4-pipe cassette models U020-U040.

PAW-FC4-3WY-U020

3 way valve + drain pan for 4-pipe cassette models U050-U070.

PAW-FC4-3WY-U050

Fan coil wall-mounted valve accessories

2 way valve for 2-pipe wall-mounted K007-K022.

PAW-FC2-2WY-K007

3 way valve for 2-pipe wall-mounted K007-K022.

PAW-FC2-3WY-K007

Smart fan coil accessories

Kits of 2 legs to protect the water pipings.

PAW-AAIR-LEGS-1

Motor connection cable for units with hydraulic connections on the right.

PAW-AAIR-RHCABLE



PACi



Panasonic condensing units - CR Series with natural refrigerant

Panasonic's CO₂ condensing units - CR Series provide the ideal solution for supermarkets, convenience stores and gas stations.

Keeping food always fresh at right temperature in showcases or cold rooms is a very critical point. And one of the biggest challenges for those retailers has been the expensive effects of refrigeration breakdowns which can result in costly product wastage.

Panasonic PACi NX Elite can cool rooms down to 8 °C

Panasonic PACi NX Elite offers a high quality and efficient solution for high temperature refrigeration applications for facilities such as wine cellars, food processing facilities and supermarkets.

Choose the sustainable green solution by Panasonic	→ 472
Natural solution with high energy saving	→ 474
A sustainable refrigeration systems in your food retail	→ 476
The safe refrigeration systems for your healthcare business	→ 477
CO ₂ transcritical condensing units - CR Series	→ 478
Technology by Panasonic	→ 480
Range of CO ₂ condensing units - CR Series	→ 482
CO ₂ Condensing units - CR Series	→ 483

Panasonic PACi NX Elite can cool rooms down to 8 °C	→ 484
Bringing nature's balance indoors	→ 486
PACi NX Series Elite wall-mounted Inverter+ · R32	→ 488
PACi NX Series Elite 4 way 90x90 cassette Inverter+ · R32	→ 489
PACi NX Series Elite ceiling Inverter+ · R32	→ 490
PACi NX Series Elite adaptive ducted unit Inverter+ · R32	→ 491



Choose the sustainable green solution by Panasonic

Environmentally friendly CO₂ condensing units - CR Series.



CO ₂ condensing units - CR Series					Medium temperature solutions with PACi NX
MT/LT Type	MT Type	MT/LT Type	MT Type	MT/LT Type	
Capacity range (kW)					Capacity range (kW)
4 (MT) / 2 (LT)	7,5	8 (MT) / 4 (LT)	15	16 (MT) / 8 (LT)	2,1 to 23,2
Low temperature					Low temperature
✓	—	✓	—	✓	—
Medium temperature					Medium temperature
—	✓	✓	—	✓	✓
High Temperature					High Temperature
—	—	—	—	—	✓
Heat recovery port					Heat recovery port
—	✓	✓	—	✓	—
ET (Evaporation Temperature) set points range					Room temp. set point
-45 ~ -5 °C	-20 ~ -5 °C	-45 ~ -5 °C	-20 ~ -5 °C	-45 ~ -5 °C	+8 ~ +24 °C WB
Room size example (m³)*					Room size example (m²)*
40 (MT) / 10 (LT)	80	80 (MT) / 20 (LT)	200	200 (MT) / 50 (LT)	From 6

* Room size is reference. Please contact to authorized Panasonic dealer for calculation.

Energy saving



Natural CO₂ / R744.
R744 refrigerant provides higher energy saving and lower CO₂ emission compared to R404A. Zero ODP and GWP=1 means natural substance.



Inverter+.
Inverter Plus System classification highlights Panasonic's highest performing systems.



High efficiency compressor.
Powerful 2-stage CO₂ rotary compressor by Panasonic. It delivers high performance all year around.

High connectivity



BMS connectivity.
The system can be supervised with major monitoring system.

High performance and comfortability



Super quiet.
Systems operate extremely quiet. Minimum 33 dB(A) @10 m with 4 HP model.

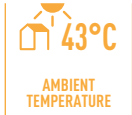

Operating range up to 43 °C.
The system operates up to 43 °C, allowing for installation in various locations.



Anti corrosion coating.
Selectable fin type with or without an anti corrosion coating. The anti corrosion coating prevents salt damage for a longer lifespan.



Heat recovery port.
The heat recovery port is available to cut running costs as optional. By utilizing exhausted heat generated by refrigeration to the energy source for heating.



Automatic fan.
Microprocessor control automatically adjusts the outdoor fan speed in CO₂ systems for efficient operation.



5 Years compressor warranty.
We guarantee the outdoor unit compressors in the entire range for five years.

Why CO₂? Natural refrigerant

EU F-Gas regulation is a key priority for European countries. It ensures compliance with the Kigali Amendment supporting international climate commitments on greenhouse gases and leading the global transition to climate-friendly HFC-free technologies. Carbon dioxide (R744) is regaining its place in the refrigeration world. Driven by environmental concerns, legislation now requires increased adoption of 'alternative' refrigerants, such as CO₂. CO₂ is an environmentally-friendly solution, with zero ODP and "GWP" (Global Warming Potential)=1 means natural substance in the atmosphere.

In Europe a step-by-step HFC reduction has been in place since the F-Gas regulation was introduced in 2015. Countries all over the world have actively been preparing to enact the necessary domestic legislation to implement the agreement to reduce the use of HFCs. Panasonic is now able to provide a solution in Europe with CO₂ refrigeration systems to prevent global warming and to support environment-friendly retail operations. The following table shows how well R744 (CO₂) performs regarding environmental impact and safety.

ODP (Ozone Depletion Potential) = 0 - GWP (Global Warming Potential) = 1.

	Next generation refrigerant			Current refrigerant	
	CO ₂	Ammonia	Isobutane	R410A	R404A
ODP	0	0	0	0	0
GWP	1	0	4	2090	3920
Flammability	Non flammable	Light flammable	Flammable	Non flammable	Non flammable
Toxicity	No	Yes	No	No	No

Comparison of CO₂ emissions

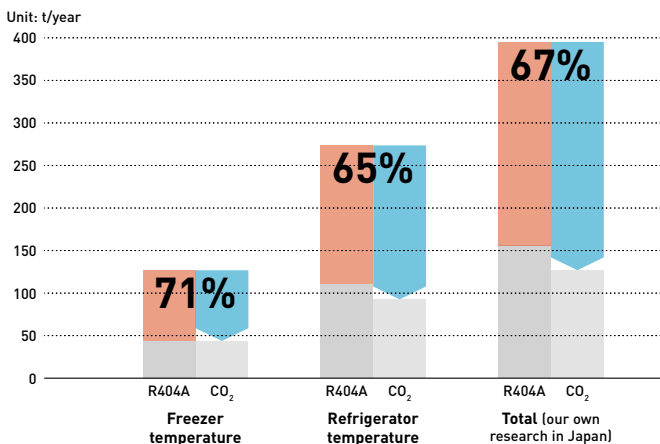

ENERGY SAVING
25,4 % Freezer
16,2 % Refrigeration

CO₂ EMISSION
67 % Reduction

Direct influence ¹⁾ Indirect influence ²⁾

1) Direct influence presents the effect of refrigerant leakage comparing R744 [CO₂] with R404A.
2) Indirect influence presents CO₂ emissions linked to power consumption of CO₂ unit and conventional units.

By Panasonic research in Japan. Comparing 6 shops average for R404A inverter multi condensing unit.

Natural solution with high energy saving

Panasonic CO₂ condensing units - CR Series with natural refrigerant: The environmentally friendly and reliable solution for convenience stores, supermarket, gas stations and cold rooms.



Showcases

Convenience stores, supermarkets, service stations.

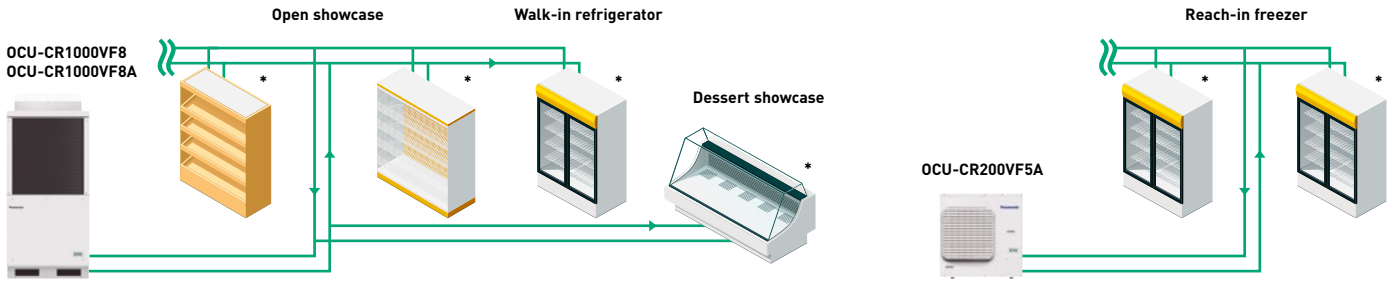

* Controllers: PAW-CO2-PANEL-C or local supply.

Cold room application to keep food fresh

Multiple installation capabilities. Unparalleled flexibility:

- Food retail applications (c-store, supermarkets, gas-stations)
- Food service applications (restaurants, canteens, schools)
- Non-food applications (warehousing, industrial storage, healthcare)

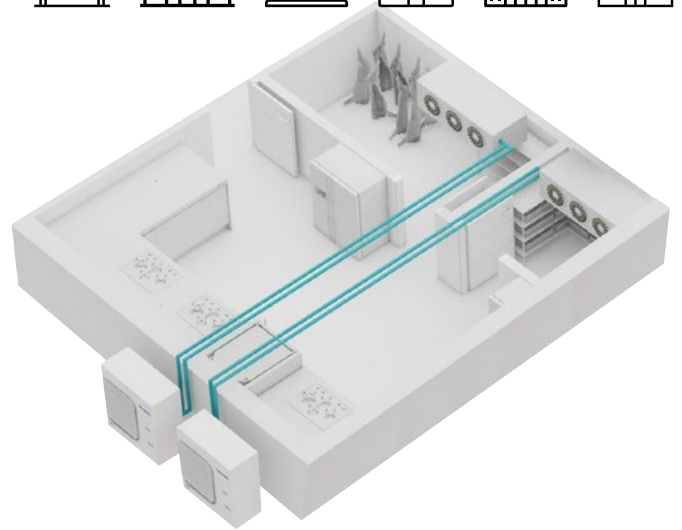

Cold room application integrated with PACi NX Series

Panasonic offers various solutions for cold rooms by combining a wide range of products. Integrated with PACi NX Series, it allows for flexible design and installation.

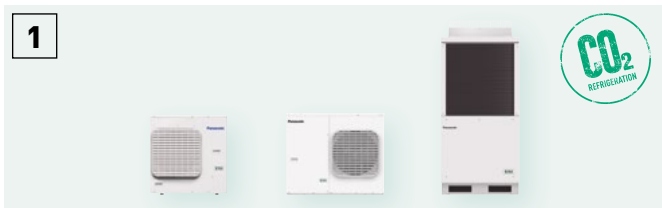

CO₂ condensing units - CR Series for refrigerated room.



PACi NX Series for cooling rooms between 8 °C WB and 24 °C.

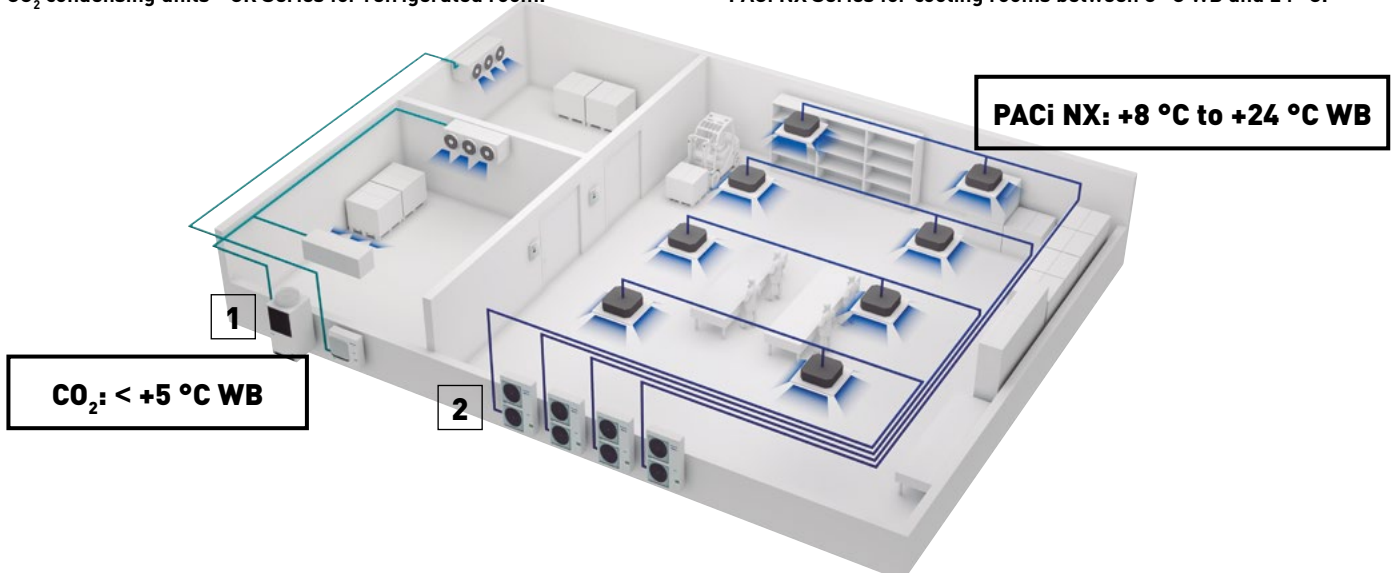

A sustainable refrigeration systems in your food retail

CO₂ refrigerant is the choice to curb carbon footprint of any business organization, especially to food retailers, to whom it brings key advantages. Panasonic professional strongly supports your projects to meet customer's request!



1
10 HP MT TYPE
(OCU-CR1000VF8).

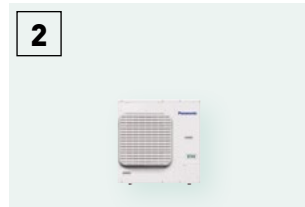

2
2 HP MT/LT TYPE
(OCU-CR200VF5A).

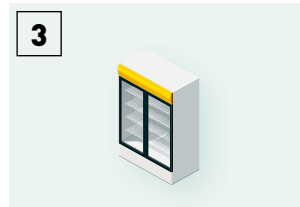

3
Reach-in freezer (field supplied).

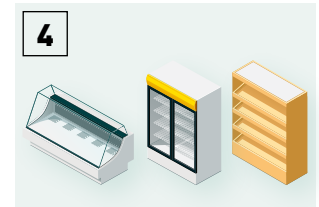

4
Serve-over counters,
showcase and walk-in
refrigerator (field supplied).

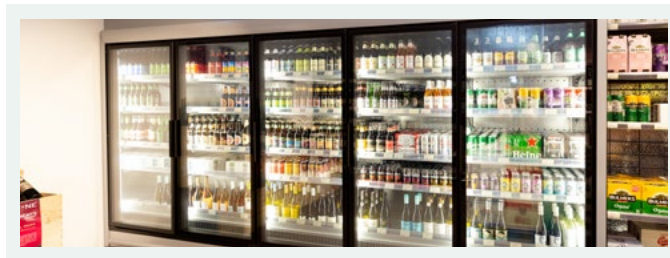
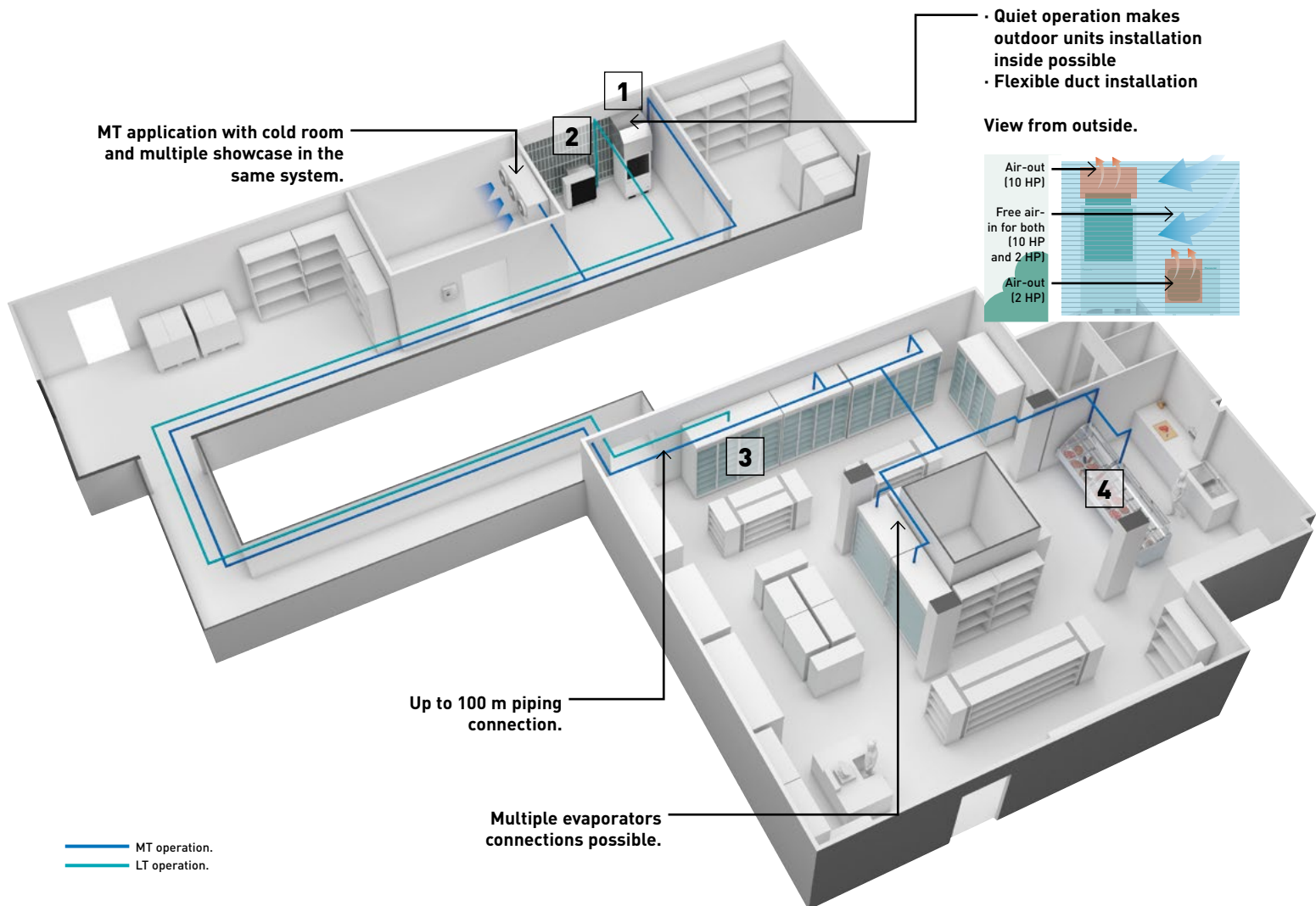

Nolan's Supermarket.
A particular focus of the project was to create a state-of-the-art refrigeration system operating on the 'Zero Ozone Depletion' plus ultra-low GWP of 1 natural refrigerant CO₂ and as part of the scheme. Panasonic units also has several unique thermo-physical properties. The high performance, reliable and ultimately very efficient.



The safe refrigeration systems for your healthcare business

CO₂ is the right refrigerant to curb carbon footprint of any business organization. In addition, there are advantages specially for healthcare business.

The project example shows one of the warehouse in the healthcare laboratory which requires several cold rooms there to keep bio-products safely.



1
10 HP LT TYPE
(OCU-CR1000VF8A).



2
10 HP MT TYPE
(OCU-CR1000VF8).

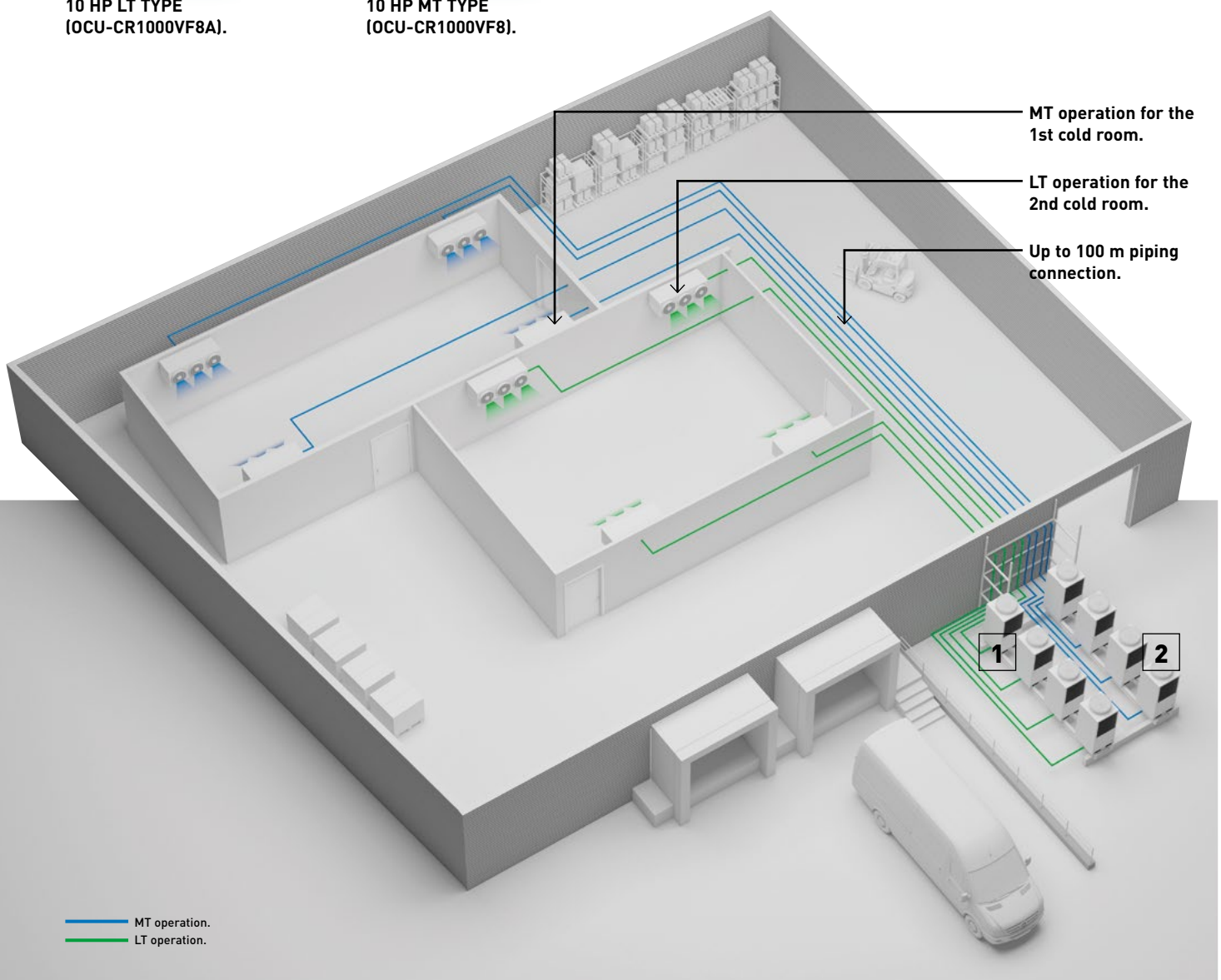

STEMCELL Technologies.

STEMCELL Technologies is a global biotechnology company that develops, manufactures and sells products and provides services that support academic and industrial scientists.

Panasonic CO₂ condensing units - CR Series have been chosen to fulfill the expectation of environmental-friendly and safety requirements.

The products with reliable quality and high performance was also an essential point.

CO₂ transcritical condensing units - CR Series

4 HP MT/LT Type, a new line-up in CR Series, offers a wide range of refrigeration systems, meeting the specific needs of small retail stores.



1 Superior efficiency with reliable quality

- Panasonic has combined the 2-stage compressor with the split cycle for increased efficiency
- High seasonal performance. SEPR: Maximum 3,83 in cooling, 1,92 in freezing ¹⁾
- High COP at high ambient temperature

1) 200VF5A.

2 Flexible installation

- Set-points at medium or low temperature available depending on applications
- Compact unit
- Silent operation
- Long piping length: Maximum 100 m ²⁾
- High external static pressure ²⁾
- Transfer pressure control for stable electric expansion valve control in showcases ²⁾

2) 1000VF8/8A.

3 Heat recovery port as renewable energy

- Maximum 16,7 kW of heating for free
- Optional possibility to get subsidy (depending on location)
- Easy connection process

Superior cooling capacity at each evaporating temperature

CO₂ transcritical condensing units - CR Series have a high cooling capacity at each set point. The CO₂ 2-stage compressor developed by Panasonic is designed to compress CO₂ refrigerant twice; it reduces the load in operation by half (compared to 1-stage refrigerant compression) and delivers increased durability and reliability. Units can be programmed to run at low and medium temperatures at initial set-up. These settings can then be modified by turning a simple and user friendly rotary switch to further enhance energy savings.

MT/LT TYPE
200VF5A - 4 kW / 2 kW

MT TYPE
400VF8 - 7,5 kW

MT TYPE
1000VF8 - 15 kW

NEW MT/LT TYPE
400VF8A - 8 kW / 4 kW

MT/LT TYPE
1000VF8A - 16 kW / 8 kW

3,83
SEPR
COOLING*

1,92
SEPR
FREEZING*

* SEPR values has been tested at 3-part laboratory.

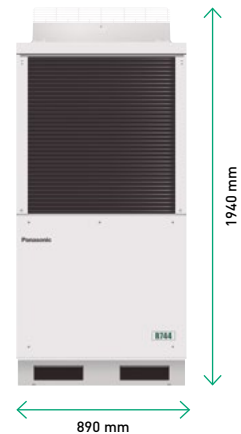
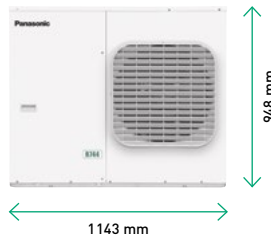
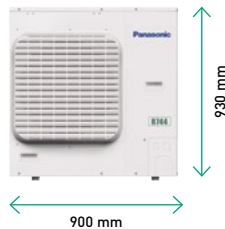

OCU-CR200VF5A(SL) ¹⁾.
Cooling capacity (kW)

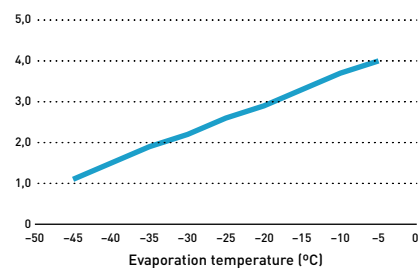

OCU-CR400VF8(SL) ²⁾.
Cooling capacity (kW)

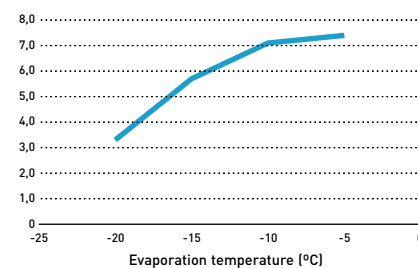

OCU-CR1000VF8(SL) ²⁾.
Cooling capacity (kW)

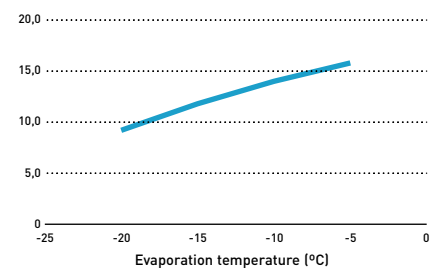

OCU-CR400VF8A(SL) ²⁾.
Cooling capacity (kW)

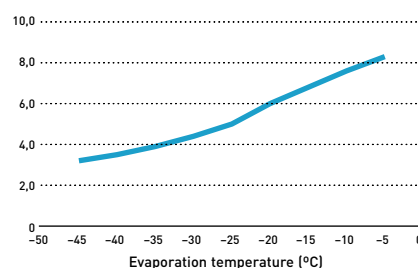

OCU-CR1000VF8A(SL) ²⁾.
Cooling capacity (kW)

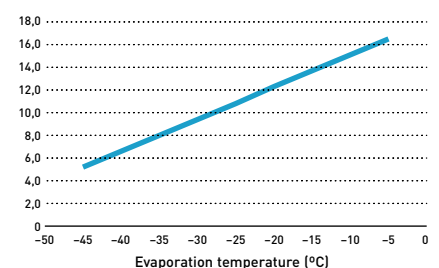

1) Ambient temperature: 32 °C, 230 V, refrigerant: R744, suction gas temperature: 18 °C.

2) Ambient temperature: 32 °C, 400 V, refrigerant: R744, suction gas temperature: 18 °C.

Technology by Panasonic

Excellent quality control established by skilled factory team.
Reliability is our main target and therefore we offer compressor warranties of 5 years, and 2 year warranties on other components!



Reliable CO₂ technology by Panasonic

- Reliable quality: Made in Japan
- 10000 units sold and installed in 3700 retail operations such as convenience stores and supermarkets in Japan*
- Excellent quality control established by skilled factory team
- Panasonic offers 5 year warranties on compressors and 2 years on components
- The 5 year compressor warranty matches the products long lifespan

* As of the end of November 18.

Panasonic's combined technology of the 2-stage compressor with the split cycle

- Panasonic 2-stage rotary compressor delivering powerful performance for more than 20 years
- Split cycle* enhances cooling effect

The video for detailed information is ready!

* Available for 200VF5A and 1000VF8A models.
** In the case that the standard cycle with 1-stage rotary compressor was compared.

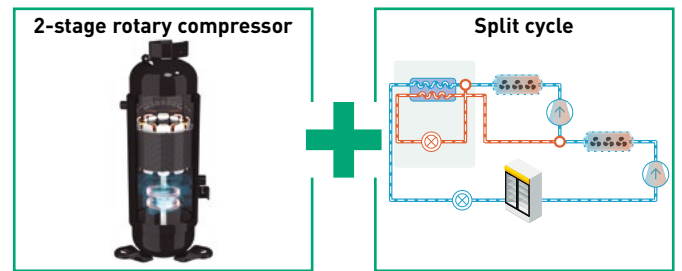

Standard cycle.

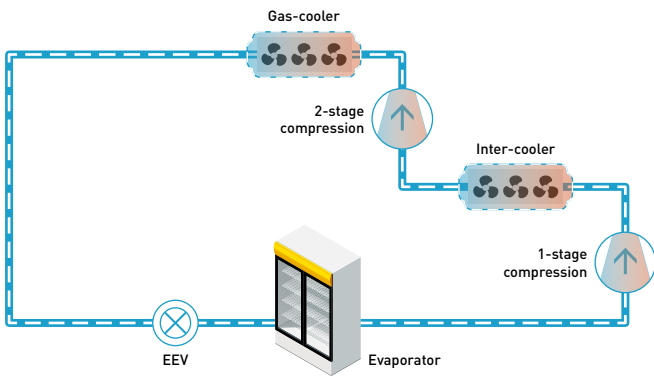

Split cycle.

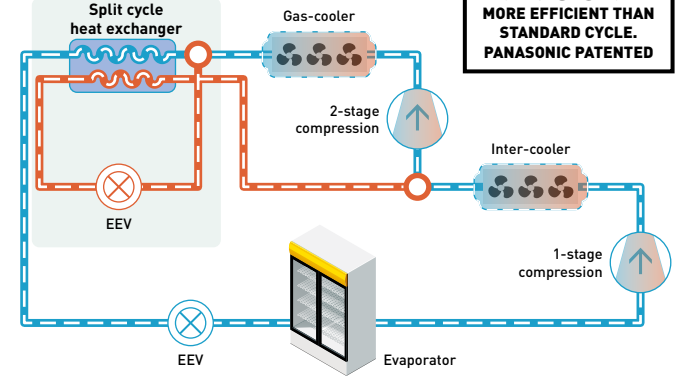

UP TO 50%
MORE EFFICIENT THAN
STANDARD CYCLE.
PANASONIC PATENTED**

Heat recovery function for heating

This function offers refrigeration combined with heating all in one system. The ground-breaking solution allows for increased opportunity to cut running costs by utilizing exhausted heat from refrigeration and transferring to the energy source for heating.

1) Under the condition: ambient temperature 32 °C, evaporation temperature -10 °C. 100 % Partial load. 2) Local supply.

**16,7 kW¹⁾
OF HOT
WATER FOR
FREE**

What is heat recovery function?

New solution example.

Heat recovery system can produce both heating and refrigeration.

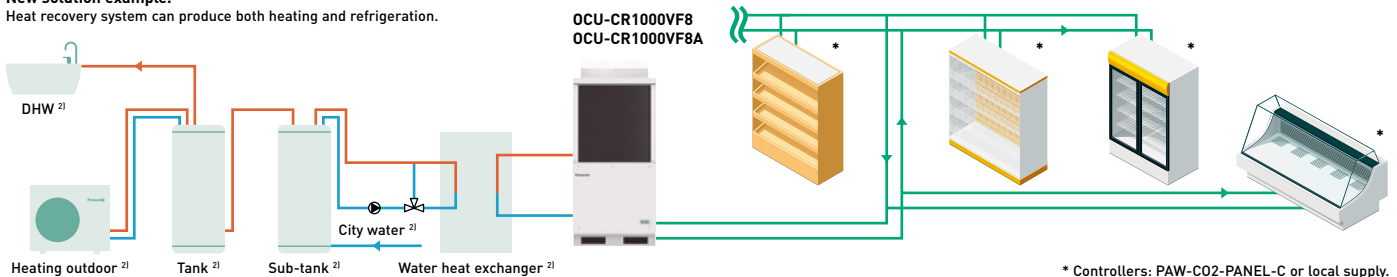

* Controllers: PAW-CO2-PANEL-C or local supply.

Design support tool available in Panasonic PRO Club.

Panasonic has launched a new online calculator to support engineers, installers, and technicians to quickly make calculations when specifying solutions for commercial refrigeration systems. The calculator can be found on Panasonic's PRO Club.

- Evaporation temperature selection
- Cooling capacity calculator
- Refrigerant pipe calculation
- Electric expansion valves calculation
- Refrigerant amount calculation

Ready to works on all devices, computers, tablets and smartphones!!

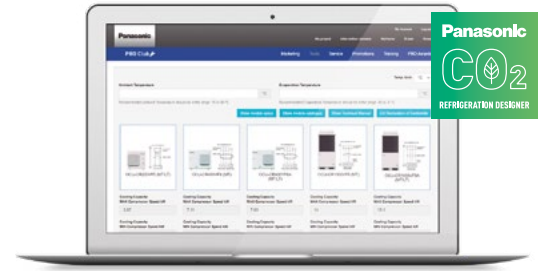

PRO Club

www.panasonicproclub.com
or connect simply with your smartphone to the PRO Club using this QR



New control panel and electric expansion valves.

An intelligent controller has been redesigned with a compact chassis. This controller has the smart program especially for showcases and cold rooms.

Electric expansion valves (EEVs) are ready with 7 different sizes to meet precisely the field demand.



Intelligent controller with compact chassis.

- MPXPRO control fully pre-programmed for MT and LT on the same panel
- Compact structure size: 300 x 220 x 120 mm
- Necessary cables, EEV stator, temperature and pressure probes as standard equipment
- Ultracap technology as standard equipment for emergency EEV's closing in the event of mains power failure
- Smart defrost functions, advanced superheat control, light and showcase curtain management, etc
- Own display user terminal plus keypad for programming, built-in switching power supply, Modbus, etc
- Management of HACCP alarms

Model reference

PAW-C02-PANEL-C



Electric expansion valves (EEVs) line-up.

- EEV's E2V-CW with 3/8" ODF copper fittings for high pressure applications (CO₂)
- Operation refrigerant temperature: -40 T 70 °C
- Maximum operating pressure for all the models 03, 05, 09, 11, 14, 18, 24 (MOP) 140 barg
- Maximum operating pressure difference for 03, 05, 09, 11, 14, 18, (MOPD) 120 bar and 24 (MOPD) 85 bar
- Bipolar stator hermetic IP69K as standard equipment (supplied on panel)
- Mechanical strainer as standard equipment (500 mm mesh)
- Equipercentile control particularly effective at partial load with reliable operation even after 1,2 billion steps

Model reference

PAW-E2V03CWACO	PAW-E2V11CWACO	PAW-E2V24CWACO
PAW-E2V05CWACO	PAW-E2V14CWACO	
PAW-E2V09CWACO	PAW-E2V18CWACO	

Modbus compatibility with monitoring system

Panasonic CO₂ condensing units - CR Series can be supervised by major monitoring system such as CAREL, Eliwell, Danfoss and RDM. Monitoring system ensures the recording, monitoring and reporting of temperature conditions etc... of entire CO₂ condensing units - CR Series system at shops.

Monitoring system



Standard boss
& boss-mini

AK-SM Series*

TelevisGo

DMTOUCH

* M2M1-10 gateway (Model code: FDS021) is required in addition to the monitoring system. M2M1-10 gateway is a local supply.

New CO₂ service checker

The service checker is a useful tool which supports your technical tasks on the field such as commissioning, maintenance and troubleshooting for Panasonic CO₂ condensing units - CR Series. Panasonic will supply the DRX file where the Panasonic unit's library is included with the acquisition of the CO₂ service checker.

To use it, is necessary to download free Device Manager software from the Eliwell website:

Visit: <https://www.eliwell.com/en/Family/DeviceManager.html> using this QR.



Eliwell product name: Device Manager 100.
Eliwell part number: DMP1000002000.

Main features:

- Reading and recording variable technical parameters
- Main technical parameters available*: pressures, temperatures, opening of expansion valves, states of solenoid valves, rotational speeds of the gas-cooler fan motor, frequency and compressor's current, etc.
- Setting change of operating values possible
- 2D graph visualization for the detailed analysis
- Monitoring an alarm status, for example the status of the compressor oil level, etc.

* Please check all the parameters available in the manual.

Model reference

PAW-C02-CHECKER



Range of CO₂ condensing units - CR Series

Outdoor units	MT	4,0 kW	7,0 kW	8,0 kW	15,0 kW	16,0 kW
	LT		2,0 kW		4,0 kW	

4 kW MT / LT
(200VF5A)



OCU-CR200VF5A
OCU-CR200VF5ASL

7,5 kW MT
(400VF8)



OCU-CR400VF8
OCU-CR400VF8SL

7,5 kW MT / LT
(400VF8A)

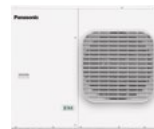

OCU-CR400VF8A
OCU-CR400VF8ASL

15 kW MT
(1000VF8)



OCU-CR1000VF8
OCU-CR1000VF8SL

16 kW MT / LT
(1000VF8A)



OCU-CR1000VF8A
OCU-CR1000VF8ASL

CO₂ Condensing units - CR Series

Standard outdoor unit		OCU-CR200VF5A	OCU-CR400VF8	OCU-CR400VF8A	OCU-CR1000VF8	OCU-CR1000VF8A			
Anti corrosion coating outdoor unit		OCU-CR200VF5ASL	OCU-CR400VF8SL	OCU-CR400VF8ASL	OCU-CR1000VF8SL	OCU-CR1000VF8ASL			
Type (MT: medium temp. LT: low temp.)		MT (4 kW) / LT (2 kW)	MT (7,5 kW)	MT (8 kW) / LT (4 kW)	MT (15 kW)	MT (16 kW) / LT (8 kW)			
Power supply	Voltage	V	220/230/240	380/400/415	380/400/415	380/400/415	380/400/415		
	Phase		Single phase	Three phase	Three phase	Three phase	Three phase		
	Frequency	Hz	50	50	50	50	50		
Cooling capacity at ET -10 °C AT 32 °C	kW	3,70	7,10	7,7	14,00	15,10			
Cooling capacity at ET -35 °C AT 32 °C	kW	1,80	—	3,8	—	8,00			
Evaporator connection		Multiple	Multiple	Multiple	Multiple	Multiple			
Evaporation temperature	Min ~ Max °C	-45 ~ -5	-20 ~ -5	-45 ~ -5	-20 ~ -5	-45 ~ -5			
Ambient temperature	Min ~ Max °C	-20 ~ +43	-15 ~ +43	-20 ~ +45	-15 ~ +43	-15 ~ +43			
Refrigerant		R744	R744	R744	R744	R744			
Design pressure liquid line	Mpa	12	8	8	8	8			
Design pressure suction line	Mpa	8	8	8	8	8			
User system external alarm. Digital input. Non-voltage contact		Yes	Yes	Yes	Yes	Yes			
Liquid tube electromagnetic valve	Vac	220/230/240	220/230/240	220/230/240	220/230/240	220/230/240			
Showcase operation ON / OFF signal. Digital input. Non-voltage contact		Yes	Yes	Yes	Yes	Yes			
Modbus communication line (RS485)	Ports	2	2	2	2	2			
Compressor type		2- stage rotary	2- stage rotary	2- stage rotary	2- stage rotary	2- stage rotary			
Dimension	H x W x D mm	930 x 900 x 437	948 x 1143 x 609	948 x 1143 x 609	1941 x 890 x 890	1941 x 890 x 890			
Net weight	Kg	70	136	136	293	320			
Piping diameter	Suction pipe	Inch (mm)	3/8(9,52)	1/2(12,70)	1/2(12,70)	3/4(19,05)	3/4(19,05)		
	Liquid pipe	Inch (mm)	1/4(6,35)	3/8(9,52)	3/8(9,52)	5/8(15,88)	5/8(15,88)		
Length of connection piping	m	25	50	50	100 ¹⁾	100 ¹⁾			
PED	CAT	I	II	II	II	II			
Air flow	m ³ /min	54	59	59	220	220			
External static pressure	Pa	17	50	50	58	58			
Heat recovery port		—	—	Yes	—	Yes			
Standard performance									
Ambient temperature	°C	32	32	32	32	32			
Evaporating temperature	°C	-10	-35	-10	-10	-35			
Cooling capacity	kW	3,70	1,80	7,10	7,7	3,8	14,00	15,10	8,00
Power consumption	kW	1,79	1,65	4,00	4,5	3,8	8,20	8,20	7,57
Nominal load ampere	A	7,94	7,26	6,14	7,2	6,2	12,60	12,60	11,60
Sound pressure	dB(A)	35,5 ²⁾	35,5 ²⁾	33 ³⁾	33 ³⁾	33 ³⁾	36,0 ⁴⁾	36,0 ⁴⁾	36,0 ⁴⁾
Necessary accessories									
Drier filter liquid line, diameter 6,35 mm	D-152T	Yes (included: delivered with the unit)	Yes (included: delivered with the unit)	Yes (included: delivered with the unit)	—	—			
Drier filter liquid line, diameter 15,88 mm	D-155T	—	—	—	Yes (included: delivered with the unit)	Yes (included: delivered with the unit)			
Suction filter, diameter 19,05 mm (outer diameter welding)	S-008T	—	Yes (included: delivered with the unit)	Yes (included: delivered with the unit)	Yes (included: delivered with the unit)	Yes (included: delivered with the unit)			

1) PZ-68S (refrigeration oil) must be added if >50 m. 2) ET-10 °C, 65 S-1, 10 m from product. 3) ET-10 °C, 80 S-1, 10 m from product. 4) ET -10 °C, 60 S-1, 10 m from product.

Accessories

PAW-C02-PANEL-C	Panel with MPXPRO control, stator, probes, etc.
SPK-TU125	Tube connector adaptor for vacuum and service
CZ-C02LBR0L500	Lubrication oil PZ-68S (0,5 L)
PAW-E2V03CWACO	Electric expansion valve 3,8" ODF high pressure without stator, size 3
PAW-E2V05CWACO	Electric expansion valve 3,8" ODF high pressure without stator, size 5
PAW-E2V09CWACO	Electric expansion valve 3,8" ODF high pressure without stator, size 9
PAW-E2V11CWACO	Electric expansion valve 3,8" ODF high pressure without stator, size 11
PAW-E2V14CWACO	Electric expansion valve 3,8" ODF high pressure without stator, size 14
PAW-E2V18CWACO	Electric expansion valve 3,8" ODF high pressure without stator, size 18
PAW-E2V24CWACO	Electric expansion valve 3,8" ODF high pressure without stator, size 24
PAW-C02-CHECKER	CO ₂ service checker

Spare parts for service and maintenance

80203513179000	Suction filter, diameter 19,05 mm (outer diameter welding)
80203517115003	Lubrication oil PZ-68S (4,0 L)*
80203517117000	Lubrication oil PZ-68S (0,5 L)*
80203513180000	Filter dryer D-152T (type CO-082-S)
80203513179000	Filter dryer D-155T (type CO-085-S)

* You can find the PZ-68S oil "Safety Sheet" in the SAFETY section of our pipe selection software, available on our PRO Club platform.



Panasonic PACi NX Elite can cool rooms down to 8 °C

Panasonic PACi NX Elite offers a high quality and efficient solution for high temperature refrigeration applications for facilities such as wine cellars, food processing facilities and supermarkets.

**COOLING ROOMS
BETWEEN 8 °C WB
AND 24 °C WB**





Solutions for cold rooms. Set the room temperature to 8 °C

Complete range from 2,1 to 23,2 kW. This unique solution is perfect for:

Wine cellars, ice cream factories, flower shops, supermarkets, grain stores, food storage, food processing, food distribution, lunchrooms, vegetable processing...

Just like all the indoor units in the PACi NX range, these units are compatible with all Panasonic control and monitoring solutions, which can be scaled from controlling a single zone to monitoring geographically distributed facilities.

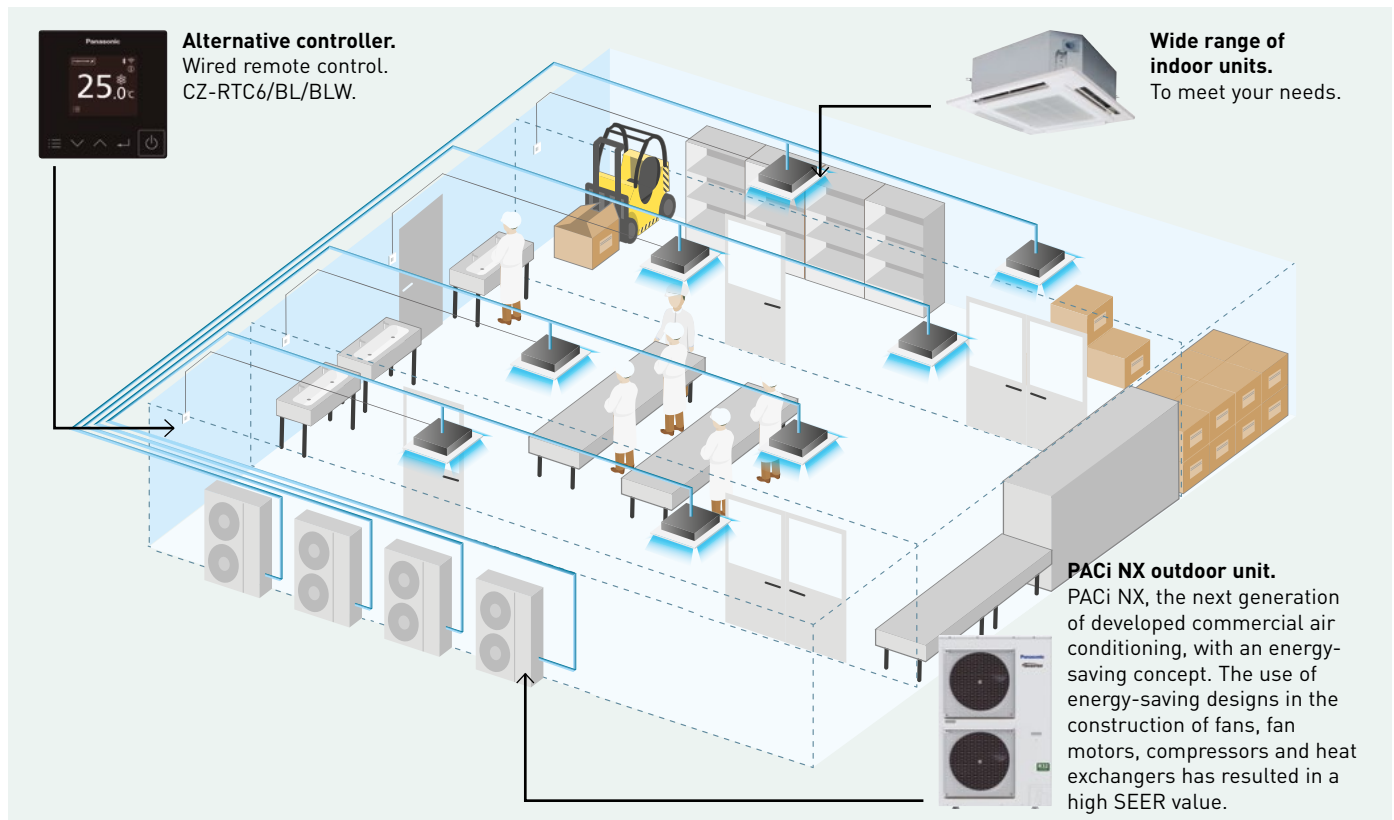

- Flexibility with different type of indoors
- Benefits of hydroxyl radicals
- Out of the box solution from Panasonic. Outdoor, indoor, controller comes as package
- Provides wide scale of control options (individual, central, cloud)
- Redundancy for 2 systems with CONEX controller range and up to 3 systems with PAW-PACR3 optional redundancy controller



Wine cellars and special low temperature rooms

One of the main features of the PACi NX series is the possibility of adjusting the product for special applications, not just for regular cooling applications. The purpose of this product information is to explain in detail these special applications that need a cooling operation to maintain the room temperature at +8 ~ +24 °C WB (or +10 ~ +30 °C DB). In order to do this in terms of enthalpy, the indoor unit needs to be oversized and certain parameters need to be adjustable.

Temperature range for wine cellar

	Indoor	Outdoor
Cooling operation	+8 ~ +24 °C WB	-5 (-15) ~ 43 °C DB

Temperature range – temperature range for wine cellar.

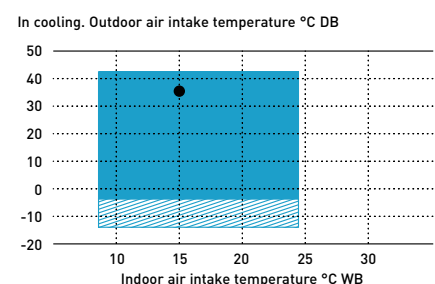

Only allowed after installation of wind and snow vents.

Area where cooling capacity is established for this purpose.

Bringing nature's balance indoors



nanoe™ X, technology with the benefits of hydroxyl radicals.

Abundant in nature, hydroxyl radicals (also known as OH radicals) have the capacity to inhibit pollutants, viruses, and bacteria to clean and deodorise. nanoe™ X technology can bring these incredible benefits indoors so that hard surfaces, soft furnishings, and the indoor environment can be a cleaner and more pleasant place to be.



Panasonic's nanoe™ X technology takes this a step further and brings nature's detergent – hydroxyl radicals – indoors to help create an ideal environment

Thanks to the nanoe™ X properties, several types of pollutants can be inhibited such as certain types of bacteria, viruses, mould, allergens, pollen and certain hazardous substances.

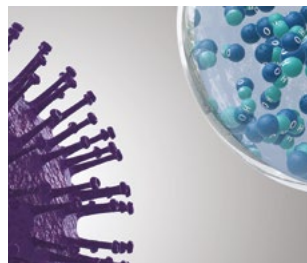

1 | nanoe™ X reliably reaches pollutants.

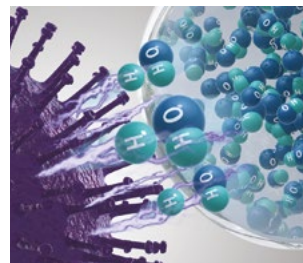

2 | Hydroxyl radicals denature pollutants' proteins.

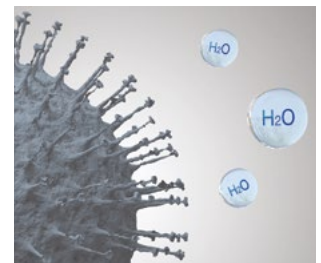

3 | Pollutants activity is inhibited.

What is unique about nanoe™ X?

Effective on fabrics and surfaces.

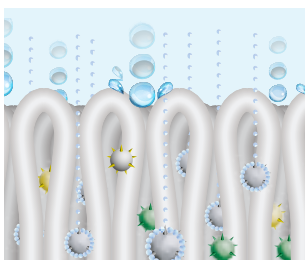

1 | At one billionth of a metre, nanoe™ X is much smaller than steam and can deeply penetrate cloth fabrics to deodorise.

Longer lifespan.



2 | Contained in tiny water particles, nanoe™ X has a longer lifespan to spread easily around the room.

Huge quantity.



3 | nanoe X Generator Mark 2 produces 9,6 trillion hydroxyl radicals per second. Greater amounts of hydroxyl radicals contained in nanoe™ X lead to higher performance on inhibition of pollutants.

Maintenance-free.



The image shows nanoe X Generator Mark 2.

4 | No maintenance, no replacement required. nanoe™ X is a filter free solution that does not require maintenance, as its atomisation electrode is enveloped with water during its generation process and it is made with Titanium.

7 effects of nanoe™ X – Panasonic unique technology

Deodorises



Odours

Capacity to inhibit 5 types of pollutants



Bacteria and viruses



Mould

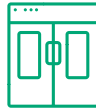

Allergens



Pollen



Hazardous substances



Skin and hair

* Refer to <https://aircon.panasonic.eu> for more details and validation data.

nanoe™ X, internationally-validated technology in testing facilities

The effectiveness of nanoe™ X technology has been tested by 3rd party laboratories in Germany, France, Denmark, Malaysia and Japan.

The nanoe™ X performance varies depending on the room size, environment and usage and it may take several hours to reach the full effect. nanoe™ X is not medical device, local regulations on building design and sanitary recommendations must be followed.

Test results conducted under controlled laboratory conditions. Performance of nanoe™ X might differ in real life environment.

	Tested contents		Result	Capacity	Time	Testing organisation	Report No.
Airborne	Virus	Bacteriophage ΦX174	99,7 % inhibited	Approx. 25 m³	6 h	Kitasato Research Center for Environmental Science	24_0300_1
	Bacteria	Staphylococcus aureus	99,9 % inhibited	Approx. 25 m³	4 h	Kitasato Research Center for Environmental Science	2016_0279
Adhered	Virus	SARS-CoV-2	91,4 % inhibited	6,7 m³	8 h	Texcell (France)	1140-01 C3
		SARS-CoV-2	99,9 % inhibited	45 L	2 h	Texcell (France)	1140-01 A1
	Virus	Xenotropic murine leukemia virus	99,999 % inhibited	45 L	6 h	Charles River Biopharmaceutical Services GmbH	—
		Influenza (H1N1 subtype)	99,9 % inhibited	1 m³	2 h	Kitasato Research Center for Environmental Science	21_0084_1
		Bacteriophage ΦX174	99,80% inhibited	25 m³	8 h	Japan Food Research Laboratories	13001265005-01
	Bacteria	Staphylococcus aureus	99,9 % inhibited	20 m³	8 h	Danish Technological Institute	868988
	Pollen	Ambrosia pollen	99,4 % inhibited	20 m³	8 h	Danish Technological Institute	868988
Odours	Cigarette smoke odour	Odour intensity reduced by 2,4 levels	Approx. 23 m³	0,2 h	Panasonic Product Analysis Center	4AA33-160615-N04	

First nanoe™ device was developed by Panasonic in 2003

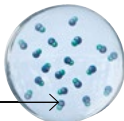
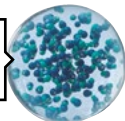
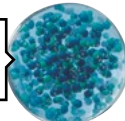
Generator	nanoe™	nanoe™ X	
	2003	Mark 1 - 2016	Mark 2 - 2019
	480 billion hydroxyl radicals/sec	4,8 trillion hydroxyl radicals/sec	9,6 trillion hydroxyl radicals/sec
Ion particle structure		10x times 	20x times 

nanoe™ X: improving protection 24/7



Acts to clean the work area, such as meat or fish handling in hotel kitchens, food handling in industrial processes, laboratories, wine cellars, etc. So that the indoor environment can be a cleaner and more pleasant place to be all day long and keep the processes in better bacterial conditions.

nanoe™ X works together with the cooling function when during the day but can work independently when the area is not occupied.

Give the system the strength to increase the protection of persons, air, colds stuffs and working surfaces with nanoe™ X technology and convenient control via the Panasonic Comfort Cloud App.

Cleans the air even when there is no work activity.





Leave the nanoe™ X mode ON to inhibit certain pollutants and deodorize before start the work activity again.

Improves your environment and better protects the products handled when you are or not at work.

Enjoy a cleaner comfortable space both when working indoors and simply when it comes to better protecting products in the cold room.



Panasonic Heating & Cooling Solutions is incorporating nanoe™ technology in a wide range of equipment

-  **Wall-mounted.**
Built-in nanoe X Generator Mark 2.
-  **Ceiling.**
Built-in nanoe X Generator Mark 2.
-  **4 Way 90x90 cassette.**
Built-in nanoe X Generator Mark 1.
-  **Adaptive ducted unit.**
Built-in nanoe X Generator Mark 2.



PACi NX Series Elite wall-mounted Inverter+ · R32

For light refrigeration applications.



		Low temperature								
Kit		36	50	60	71	100	125	140		
Indoor unit - 1		S-6010PK3E	S-6010PK3E	S-6010PK3E	S-6010PK3Ex2	S-6010PK3E	S-6010PK3E	S-6010PK3E	S-6010PK3E	
Indoor unit - 2		—	—	—	—	S-6010PK3E	S-6010PK3E	S-6010PK3E	S-6010PK3E	
Outdoor unit		U-36PZH3E5	U-50PZH3E5	U-60PZH3E5	U-71PZH3E5/8	U-100PZH3E5/8	U-125PZH3E5/8	U-140PZH3E5/8		
Outdoor 35 °C (DB)	Indoor 15 °C (WB)	Cooling capacity	kW	3,50	4,90	5,80	6,90	9,30	11,60	13,60
		EER		4,55	3,83	3,56	3,14	3,60	3,09	3,19
		Input power	kW	0,77	1,28	1,63	2,20	2,58	3,75	4,27
	Indoor 12 °C (WB)	Cooling capacity	kW	3,19	4,46	5,28	6,28	8,46	10,56	12,38
		EER		4,22	3,55	3,30	2,91	3,35	2,87	2,96
		Input power	kW	0,75	1,25	1,60	2,16	2,53	3,68	4,18
	Indoor 8 °C (WB)	Cooling capacity	kW	2,10	2,94	3,27	4,14	5,58	6,96	8,16
		EER		3,50	2,94	2,14	2,41	2,77	2,38	2,45
		Input power	kW	0,60	1,00	1,52	1,72	2,01	2,93	3,33
Outdoor 30 °C (DB)	Indoor 15 °C (WB)	Cooling capacity	kW	3,75	5,24	5,92	7,04	9,95	12,41	14,55
		EER		5,29	4,45	3,86	3,40	4,19	3,60	3,70
		Input power	kW	0,71	1,18	1,53	2,07	2,37	3,45	3,93
	Indoor 12 °C (WB)	Cooling capacity	kW	3,43	4,80	5,39	6,42	9,11	11,37	13,33
		EER		4,95	4,17	3,60	3,17	3,93	3,37	3,47
		Input power	kW	0,69	1,15	1,50	2,02	2,32	3,38	3,84
	Indoor 8 °C (WB)	Cooling capacity	kW	2,10	2,94	3,48	4,14	5,58	6,96	8,16
		EER		3,90	3,28	2,97	2,61	3,09	2,65	2,73
		Input power	kW	0,54	0,90	1,17	1,58	1,81	2,63	2,99
Indoor unit	Dimension (HxWxD)	mm	302 x 1120 x 236	302 x 1120 x 236	302 x 1120 x 236	302 x 1120 x 236	302 x 1120 x 236	302 x 1120 x 236	302 x 1120 x 236	
	Net weight	kg	14	14	14	14	14	14	14	
	nanoe X Generator		Mark 2	Mark 2	Mark 2	Mark 2	Mark 2	Mark 2	Mark 2	
Outdoor unit	Dimension (HxWxD)	mm	695 x 875 x 320	695 x 875 x 320	695 x 875 x 320	996 x 940 x 340	1416 x 940 x 340	1416 x 940 x 340	1416 x 940 x 340	
	Net weight	kg	42	42	43	65	98	98	98	

Tentative data

Accessories

CZ-RTC6	CONEX wired remote controller (non-wireless)
CZ-RTC6BL	CONEX wired remote controller with Bluetooth®
CZ-RTC6BLW	CONEX wired remote controller with Wi-Fi and Bluetooth®
CZ-RTC5B	Wired remote controller with Econavi function and datanavi
CZ-RWS3	Infrared remote controller
PAW-PACR3	Interfaces to run 3 units on back-up and alternative run

Accessories

PAW-WTRAY	Tray for condenser water compatible with outdoor elevation platform
PAW-GRDBSE20	Outdoor base ground support for noise and vibration absorption
PAW-GRDSTD40	Outdoor elevation platform 400 x 900 x 400 mm
CZ-CENSC1	Econavi energy savings sensor

Technical focus

- Modern design with flat face and compact size
- DC fan for better efficiency and control
- Six directional piping outlet
- nanoe™ X (Generator Mark 2= 9,6 trillion hydroxyl radicals/sec) as standard for better indoor air quality
- Wired remote control CZ-RTC6BL allows easy system setting via Bluetooth®
- Easy connection and control of external fan or ERV using the connector PAW-FDC on the indoor unit PCB. The external device can be controlled by the remote control of the Panasonic indoor unit

Closed discharge port

When the unit is turned OFF, the flap closes completely to prevent dust getting into the unit and to keep the equipment clean.

Quiet operation

These units are among the quietest in the industry, making them ideal for all types of installations.

Piping outlet in six directions

Piping outlet is possible in six directions of; right, right rear, right bottom, left, left rear and left bottom, making the installation work more flexible.



PACi NX Series Elite 4 way 90x90 cassette Inverter+ · R32

For light refrigeration applications.



			Low temperature									
Kit			36	50	60	71	100	125	140	200	250	
Indoor unit - 1			S-6071PU3E	S-6071PU3E	S-6071PU3E	S-1014PU3E	S-1014PU3E	S-1014PU3E	S-1014PU3E	S-1014PU3E	S-1014PU3E	
Indoor unit - 2			—	—	—	—	—	—	S-1014PU3E	S-1014PU3E	S-1014PU3E	
Outdoor unit			U-36PZH3E5	U-50PZH3E5	U-60PZH3E5	U-71PZH3E5/8	U-100PZH3E5/8	U-125PZH3E5/8	U-140PZH3E5/8	U-200PZH2E8	U-250PZH2E8	
Outdoor 35 °C (DB)	Indoor 15 °C (WB)	Cooling capacity	kW	3,50	4,90	5,80	6,90	9,30	11,60	13,60	18,50	23,20
		EER		5,12	4,05	3,81	3,65	3,97	3,46	3,51	3,38	2,97
		Input power	kW	0,68	1,21	1,52	1,89	2,34	3,35	3,88	5,48	7,82
	Indoor 12 °C (WB)	Cooling capacity	kW	3,19	4,46	5,28	6,28	8,46	10,56	12,38	16,84	21,11
		EER		4,78	3,76	3,54	3,39	3,69	3,22	3,25	3,13	2,75
		Input power	kW	0,67	1,19	1,49	1,85	2,29	3,28	3,80	5,37	7,66
	Indoor 8 °C (WB)	Cooling capacity	kW	2,10	2,94	3,48	4,14	5,58	9,43	8,16	11,10	13,92
		EER		3,96	3,12	2,94	2,81	3,06	2,21	2,70	2,60	2,28
		Input power	kW	0,53	0,94	1,19	1,47	1,83	4,27	3,03	4,27	6,10
Outdoor 30 °C (DB)	Indoor 15 °C (WB)	Cooling capacity	kW	3,75	5,24	5,92	7,04	9,95	12,44	14,55	20,17	25,29
		EER		5,99	4,71	4,14	3,96	4,62	4,03	4,08	4,00	3,51
		Input power	kW	0,63	1,11	1,43	1,78	2,15	3,08	3,57	5,04	7,19
	Indoor 12 °C (WB)	Cooling capacity	kW	3,43	4,80	5,39	6,42	9,11	11,37	13,33	18,50	23,20
		EER		5,60	4,41	3,86	3,69	4,33	3,77	3,82	3,75	3,30
		Input power	kW	0,61	1,09	1,40	1,74	2,11	3,02	3,49	4,93	7,04
	Indoor 8 °C (WB)	Cooling capacity	kW	2,10	2,94	3,48	4,14	5,58	6,96	8,16	11,10	13,92
		EER		4,41	3,47	3,18	3,04	3,41	2,97	3,00	2,89	2,54
		Input power	kW	0,48	0,85	1,09	1,36	1,64	2,35	2,72	3,84	5,47
Indoor unit	Dimension (HxWxD)	mm	256x840x840	256x840x840	256x840x840	319x840x840	319x840x840	319x840x840	319x840x840	319x840x840	319x840x840	
	Net weight	kg	19	19	20	20	25	25	25	25	25	
	nanoe X Generator		Mark 1	Mark 1	Mark 1	Mark 1	Mark 1	Mark 1	Mark 1	Mark 1	Mark 1	
Outdoor unit	Dimension (HxWxD)	mm	695x875x320	695x875x320	695x875x320	996x940x340	1416x940x340	1416x940x340	1416x940x340	1500x980x370	1500x980x370	
	Net weight	kg	42	42	43	65	98	98	98	117	128	

Tentative data

Accessories

CZ-RTC6	CONEX wired remote controller (non-wireless)
CZ-RTC6BL	CONEX wired remote controller with Bluetooth®
CZ-RTC6BLW	CONEX wired remote controller with Wi-Fi and Bluetooth®
CZ-RTC5B	Wired remote controller with Econavi function and datanavi
CZ-RWS3 + CZ-RWRU3W	Infrared remote controller and receiver

Accessories

CZ-KPU3AW	Econavi exclusive panel
PAW-WTRAY	Tray for condenser water compatible with outdoor elevation platform
PAW-GRDBSE20	Outdoor base ground support for noise and vibration absorption
PAW-GRDSTD40	Outdoor elevation platform 400x900x400 mm
CZ-FDU3+CZ-ATU2	Fresh air-intake kit

Technical focus

- High performance turbo fan
- Econavi: An optional intelligent sensor to reduce waste of energy
- nanoe™ X (Generator Mark 1= 4,8 trillion hydroxyl radicals/sec) as standard for better indoor air quality, indoor unit internal cleaning with nanoe™ X and dry operation
- Lower noise in slow fan operation
- Light weight, easy piping and integrated drain pump for quick installation
- Wired remote control CZ-RTC6BL allows easy system setting via Bluetooth®
- High volume fresh air input with optional air-intake plenum and chamber (CZ-FDU3+CZ-ATU2)



nanoe™ X as a standard.

PACi NX Series Elite ceiling Inverter+ · R32

For light refrigeration applications.



Low temperature

Kit			36	50	60	71	100	125	140	200	250	
Indoor unit - 1			S-6071PT3E	S-6071PT3E	S-1014PT3E	S-1014PT3E	S-1014PT3E	S-1014PT3E	S-1014PT3E	S-1014PT3E	S-1014PT3E	
Indoor unit - 2			—	—	—	—	—	—	S-1014PT3E	S-1014PT3E	S-1014PT3E	
Outdoor unit			U-36PZH3E5	U-50PZH3E5	U-60PZH3E5	U-71PZH3E5/8	U-100PZH3E5/8	U-125PZH3E5/8	U-140PZH3E5/8	U-200PZH2E8	U-250PZH2E8	
Outdoor 35 °C (DB)	Indoor 15 °C (WB)	Cooling capacity	kW	3,50	4,90	5,80	6,90	9,30	11,60	13,60	18,50	23,20
		EER		4,67	3,71	3,63	3,67	3,92	3,30	3,45	3,32	2,92
		Input power	kW	0,75	1,32	1,60	1,88	2,37	3,52	3,94	5,57	7,94
	Indoor 12 °C (WB)	Cooling capacity	kW	3,19	4,46	5,28	6,28	8,46	10,56	12,38	16,84	21,11
		EER		4,33	3,45	3,37	3,41	3,64	3,06	3,21	3,08	2,71
		Input power	kW	0,74	1,29	1,57	1,84	2,32	3,45	3,86	5,46	7,78
	Indoor 8 °C (WB)	Cooling capacity	kW	2,10	2,94	3,48	4,14	5,58	6,51	8,16	11,10	13,92
		EER		3,59	2,86	2,79	2,82	3,02	2,98	2,66	2,55	2,25
		Input power	kW	0,59	1,03	1,25	1,47	1,85	2,19	3,07	4,34	6,19
Outdoor 30 °C (DB)	Indoor 15 °C (WB)	Cooling capacity	kW	3,75	5,24	5,92	7,04	9,95	12,41	14,55	20,17	25,29
		EER		5,43	4,32	3,93	3,98	4,56	3,83	4,01	3,94	3,46
		Input power	kW	0,69	1,21	1,50	1,77	2,18	3,24	3,62	5,12	7,30
	Indoor 12 °C (WB)	Cooling capacity	kW	3,43	4,80	5,39	6,42	9,11	11,37	13,33	18,50	23,20
		EER		5,08	4,04	3,66	3,71	4,27	3,59	3,76	3,69	3,25
		Input power	kW	0,68	1,19	1,47	1,73	2,13	3,17	3,55	5,01	7,15
	Indoor 8 °C (WB)	Cooling capacity	kW	2,10	2,94	3,48	4,14	5,58	6,96	8,16	11,10	13,92
		EER		4,00	3,18	3,02	3,06	3,36	2,82	2,96	2,85	2,50
		Input power	kW	0,53	0,92	1,15	1,35	1,66	2,46	2,76	3,90	5,56
Indoor unit	Dimension (HxWxD)	mm	235x1275x690	235x1275x690	235x1590x690	235x1590x690	235x1590x690	235x1590x690	235x1590x690	235x1590x690	235x1590x690	
	Net weight	kg	34	34	40	40	40	40	40	40	40	
	nanoe X Generator		Mark 2	Mark 2	Mark 2	Mark 2	Mark 2	Mark 2	Mark 2	Mark 2	Mark 2	
Outdoor unit	Dimension (HxWxD)	mm	695x875x320	695x875x320	695x875x320	996x940x340	1416x940x340	1416x940x340	1416x940x340	1500x980x370	1500x980x370	
	Net weight	kg	42	42	43	65	98	98	98	117	128	

Tentative data

Accessories

CZ-RTC6	CONEX wired remote controller (non-wireless)
CZ-RTC6BL	CONEX wired remote controller with Bluetooth®
CZ-RTC6BLW	CONEX wired remote controller with Wi-Fi and Bluetooth®
CZ-RTC5B	Wired remote controller with Econavi function and datanavi
CZ-RWS3 + CZ-RWRT3	Infrared remote controller and receiver

Accessories

PAW-WTRAY	Tray for condenser water compatible with outdoor elevation platform
PAW-GRDBSE20	Outdoor base ground support for noise and vibration absorption
PAW-GRDSTD40	Outdoor elevation platform 400 x 900 x 400 mm
CZ-CENSC1	Econavi energy savings sensor

Technical focus

- Wide air distribution for large rooms
- Horizontal air flow reaches maximum 9,5 m
- Fresh air connection available on the unit
- Slim design with 235 m height fits narrow space
- Silent operation
- nanoe™ X (Generator Mark 2= 9,6 trillion hydroxyl radicals/sec) as standard for better indoor air quality
- Wired remote control CZ-RTC6BL allows easy system setting via Bluetooth®
- Twin, Triple and Double-twin split options
- Easy connection and control of external fan or ERV using the connector PAW-FDC on the indoor unit PCB. The external device can be controlled by the remote control of the Panasonic indoor unit

Further comfort improvement with airflow distribution

Horizontal air flow reaches maximum 9,5 m. This is ideal for wide rooms.

The wide air discharge opening expands the air flow to the left and right. The unpleasant feeling caused when the air flow directly hits the human body is prevented by the "Draft prevention position", which changes the swing width, so that the degree of comfort is increased.

**PACi NX Series Elite adaptive ducted unit Inverter+ · R32**

For light refrigeration applications.



			Low temperature									
Kit			36	50	60	71	100	125	140	200	250	
Indoor unit - 1			S-6071PF3E	S-6071PF3E	S-6071PF3E	S-1014PF3E	S-1014PF3E	S-1014PF3E	S-1014PF3E	S-1014PF3E	S-1014PF3E	
Indoor unit - 2			—	—	—	—	—	—	S-1014PF3E	S-1014PF3E	S-1014PF3E	
Outdoor unit			U-36PZH3E5	U-50PZH3E5	U-60PZH3E5	U-71PZH3E5/8	U-100PZH3E5/8	U-125PZH3E5/8	U-140PZH3E5/8	U-200PZH2E8	U-250PZH2E8	
Outdoor 35 °C (DB)	Indoor 15 °C (WB)	Cooling capacity	kW	3,50	4,90	5,80	0,00	9,30	11,60	13,60	18,50	23,20
		EER		3,98	3,20	3,52	3,50	3,94	3,36	3,64	3,50	3,08
		Input power	kW	0,88	1,53	1,65	1,97	2,36	3,45	3,74	5,29	7,54
	Indoor 12 °C (WB)	Cooling capacity	kW	3,19	4,46	5,28	6,28	8,46	10,56	12,38	16,84	21,11
		EER		3,69	2,97	3,26	3,25	3,66	3,12	3,38	3,25	2,86
		Input power	kW	0,86	1,50	1,62	1,93	2,31	3,38	3,67	5,18	7,39
	Indoor 8 °C (WB)	Cooling capacity	kW	2,10	2,94	3,48	4,14	5,58	6,96	8,16	11,10	13,92
		EER		3,06	2,46	2,70	2,69	3,03	2,59	2,80	2,69	2,37
		Input power	kW	0,69	1,19	1,29	1,54	1,84	2,69	2,92	4,13	5,88
Outdoor 30 °C (DB)	Indoor 15 °C (WB)	Cooling capacity	kW	3,75	5,24	5,92	7,04	9,95	12,44	14,55	20,17	25,29
		EER		4,63	3,72	3,81	3,80	4,58	3,91	4,23	4,14	3,65
		Input power	kW	0,81	1,41	1,55	1,85	2,17	3,17	3,44	4,87	6,94
	Indoor 12 °C (WB)	Cooling capacity	kW	3,43	4,80	5,39	6,42	9,11	11,37	13,33	18,50	23,20
		EER		4,33	3,49	3,55	3,54	4,29	3,66	3,96	3,89	3,42
		Input power	kW	0,79	1,38	1,52	1,81	2,12	3,11	3,37	4,76	6,79
	Indoor 8 °C (WB)	Cooling capacity	kW	2,10	2,94	3,48	4,14	5,58	6,96	8,16	11,10	13,92
		EER		3,41	2,75	2,93	2,92	3,38	2,88	3,12	3,00	2,64
		Input power	kW	0,62	1,07	1,19	1,42	1,65	2,42	2,62	3,70	5,28
Indoor unit	Dimension (HxWxD)	mm	250x1000x730	250x1000x730	250x1000x730	250x1400x730	250x1400x730	250x1400x730	250x1400x730	250x1400x730	250x1400x730	
	Net weight	kg	30	30	30	39	39	39	39	39	39	
	nanoe X Generator		Mark 2	Mark 2	Mark 2	Mark 2	Mark 2	Mark 2	Mark 2	Mark 2	Mark 2	
Outdoor unit	Dimension (HxWxD)	mm	695x875x320	695x875x320	695x875x320	996x940x340	1416x940x340	1416x940x340	1416x940x340	1500x980x370	1500x980x370	
	Net weight	kg	42	42	43	65	98	98	98	117	128	

Tentative data

Accessories

CZ-RTC6	CONEX wired remote controller (non-wireless)
CZ-RTC6BL	CONEX wired remote controller with Bluetooth®
CZ-RTC6BLW	CONEX wired remote controller with Wi-Fi and Bluetooth®
CZ-RTC5B	Wired remote controller with Econavi function and datanavi
CZ-RWS3 + CZ-RWRC3	Infrared remote controller and receiver
PAW-WTRAY	Tray for condenser water compatible with outdoor elevation platform

Accessories

PAW-GRDBSE20	Outdoor base ground support for noise and vibration absorption
PAW-GRDSTD40	Outdoor elevation platform 400 x 900 x 400 mm
CZ-CENSC1	Econavi energy savings sensor
CZ-56DAF2	Air outlet plenum for S-3650PF3E
CZ-90DAF2	Air outlet plenum for S-6071PF3E
CZ-160DAF2	Air outlet plenum for S-1014PF3E

Technical focus

- 2 installation possibilities (horizontal / vertical)
- Maximum external static pressure: 150 Pa
- Selectable inlet air position (rear / bottom entry)
- Improved drain pan suitable for both horizontal / vertical installation
- Drain pump included
- nanoe™ X (Generator Mark 2= 9,6 trillion hydroxyl radicals/sec) as standard for the long duct piping case*
- Wired remote control CZ-RTC6BL allows easy system setting via Bluetooth®

* The performance of nanoe™ X air can be expected even by 10 m long duct by Panasonic internal survey.

2 installation possibilities (horizontal / vertical)

Vertical installation is newly available. ESP 150Pa, sufficient for remotely installing units away from the rooms.

**Improved drain pan design**

Drain pan is shared in both cases horizontal and vertical installation.

No need to modify the unit.

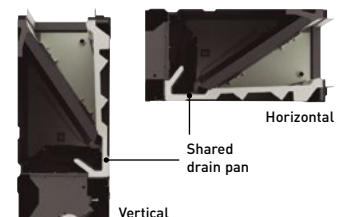



Dimensions

Aquarea

Aquarea EcoFlex	→ 494
All in One H Generation	→ 495
All in One J Generation	→ 496
All in One Compact	→ 496
Hydraulic module J and H Generation	→ 497
Hydraulic module F Generation	→ 497
Outdoor units	→ 498
Smart fan coils	→ 500
Buffer tank	→ 501
Enamelled tanks	→ 501
Stainless steel tanks	→ 503
Heat recovery ventilation unit	→ 503
DHW Stand Alone	→ 504

Domestic

Heatcharge VZ	→ 505
Etherea	→ 506
TZ super-compact	→ 508
BZ super-compact	→ 510
UZ and PZ super-compact	→ 511
Floor console	→ 512
Low static pressure hide-away	→ 513
Outdoor units Free Multi System Z	→ 514
Outdoor units Multi Wall TZ	→ 515

Commercial

Wall-mounted Professional	→ 516
Wall-mounted	→ 518
4 way 60x60 cassette	→ 519
4 way 90x90 cassette	→ 520
Ceiling	→ 521
Adaptive ducted unit	→ 524
High static pressure hide-away	→ 525
4 way 60x60 cassette	→ 526
Outdoor units	→ 526
PACi PRO-HT Tank	→ 530
PACi water heat exchanger	→ 530

VRF Systems

Mini ECOi LZ2 Series	→ 531
Mini ECOi LE2/LE1 Series	→ 532
2-Pipe ECOi EX ME2 Series	→ 533
3-Pipe ECOi EX MF3 Series	→ 533
ECO G GE3 Series	→ 534
ECO G GF3 Series	→ 535
3-Pipe Control Box Kit	→ 536
2-Pipe Hybrid EHP / GHP	→ 536
Water heat exchanger	→ 538
U2 Type 4 way 90x90 cassette	→ 539
Y3 Type 4 way 60x60 cassette	→ 540
Y2 Type 4 way 60x60 cassette	→ 541
L1 Type 2 Way Cassette	→ 541
D1 Type 1 way cassette	→ 542
F3 Type variable static pressure adaptive duct	→ 543
F2 Type variable static pressure hide-away	→ 544
M1 Type slim variable static pressure hide-away concealed duct	→ 545
E2 Type high static pressure hide-away	→ 546
Heat recovery with DX coil	→ 546
T2 Type ceiling	→ 547
K2 Type wall-mounted	→ 548
G1 Type floor console	→ 549
P1 Type floor-standing	→ 549
R1 Type concealed floor-standing	→ 550
Hydrokit for ECOi, water at 45 °C	→ 550
ECOi PRO-HT Tank	→ 551
Smart fan coils	→ 551

Ventilation

AHU connection kit PACi NX	→ 552
AHU Connection Kit	→ 552
Energy recovery ventilation	→ 553
Heat recovery with DX coil	→ 553
Electric air curtain	→ 554
Air curtain with DX coil	→ 554
E2 Type high static pressure hide-away	→ 555

Control

VRF Smart Connectivity+	→ 556
Commercial Wi-Fi Adaptor	→ 558
Design wired remote controller	→ 558
Econavi sensor	→ 558
Remote sensor	→ 558
CONEX wired remote controller	→ 558
Intelligent controller (touch screen/web server)	→ 558
Infrared remote controller	→ 558
System controller with weekly timer	→ 559
Seri-Para I/O unit for outdoor unit	→ 559
Mini Seri-Para I/O Unit 0 -10 V	→ 559
Central ON/OFF controller	→ 559
Local adaptor for ON/OFF control	→ 559
Communication adaptor	→ 559

Chiller

ECOi-W 20 to 40 with condenser fans standard	→ 560
ECOi-W 20 to 40 with condenser fans standard and buffer tank	→ 560
ECOi-W 45 to 55 with condenser fans standard	→ 561
ECOi-W 45 to 55 with condenser fans standard and buffer tank	→ 561
ECOi-W 65 to 75 with condenser fans standard	→ 562
ECOi-W 65 to 75 with condenser fans standard and buffer tank	→ 562
ECOi-W 90 to 125 with condenser fans standard	→ 563
ECOi-W 90 to 125 with condenser fans standard and buffer tank	→ 563
ECOi-W 140 to 210 without pump	→ 564
ECOi-W 140 to 210 with 1 pump and buffer tank	→ 565

Refrigeration

CR Series 4,0 kW	→ 566
CR Series 7,5 and 8,0 kW	→ 566
CR Series 15,0 and 16,0 kW	→ 567

Aquarea EcoFlex tank unit

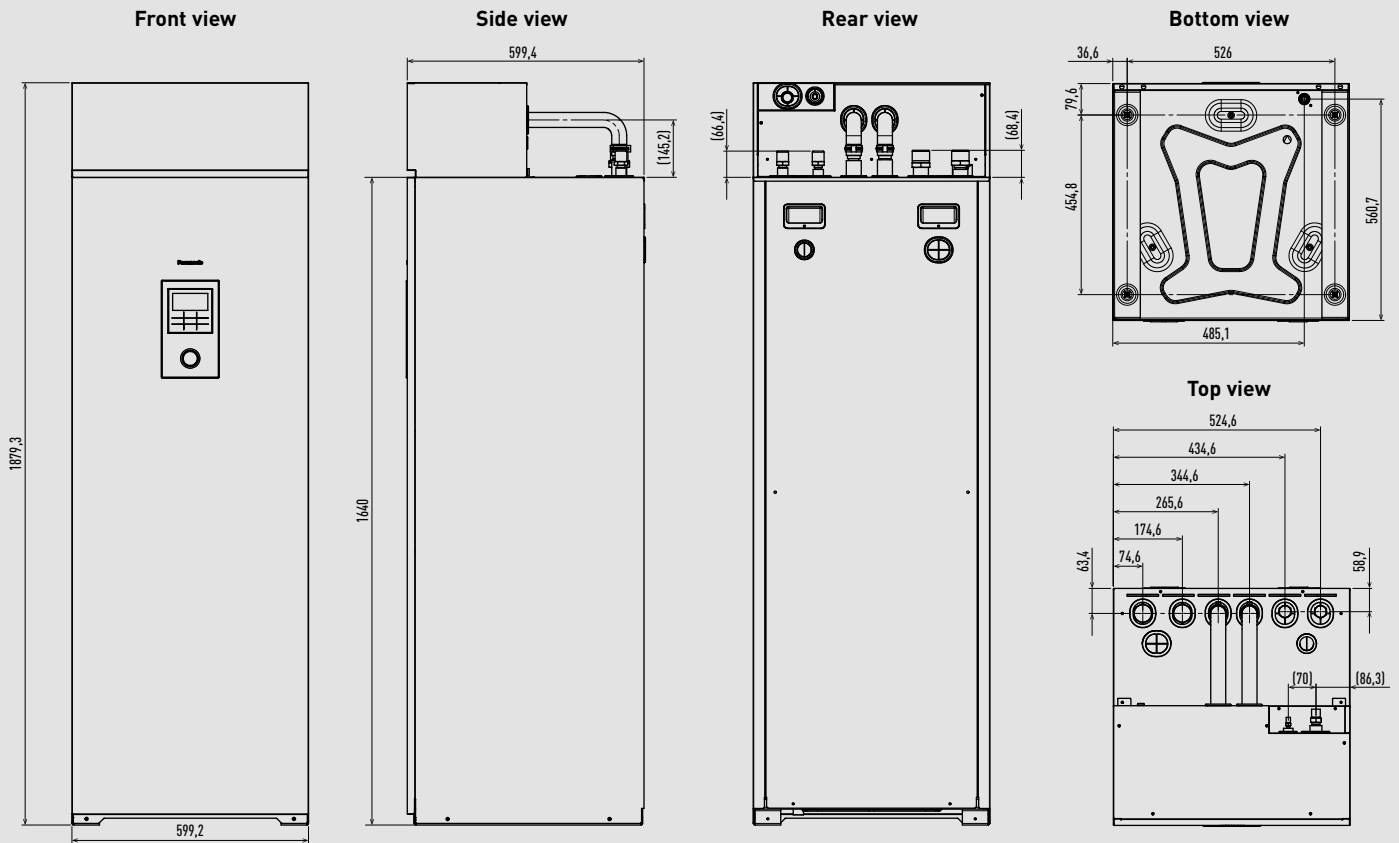

Unit: mm

Aquarea EcoFlex ducted unit

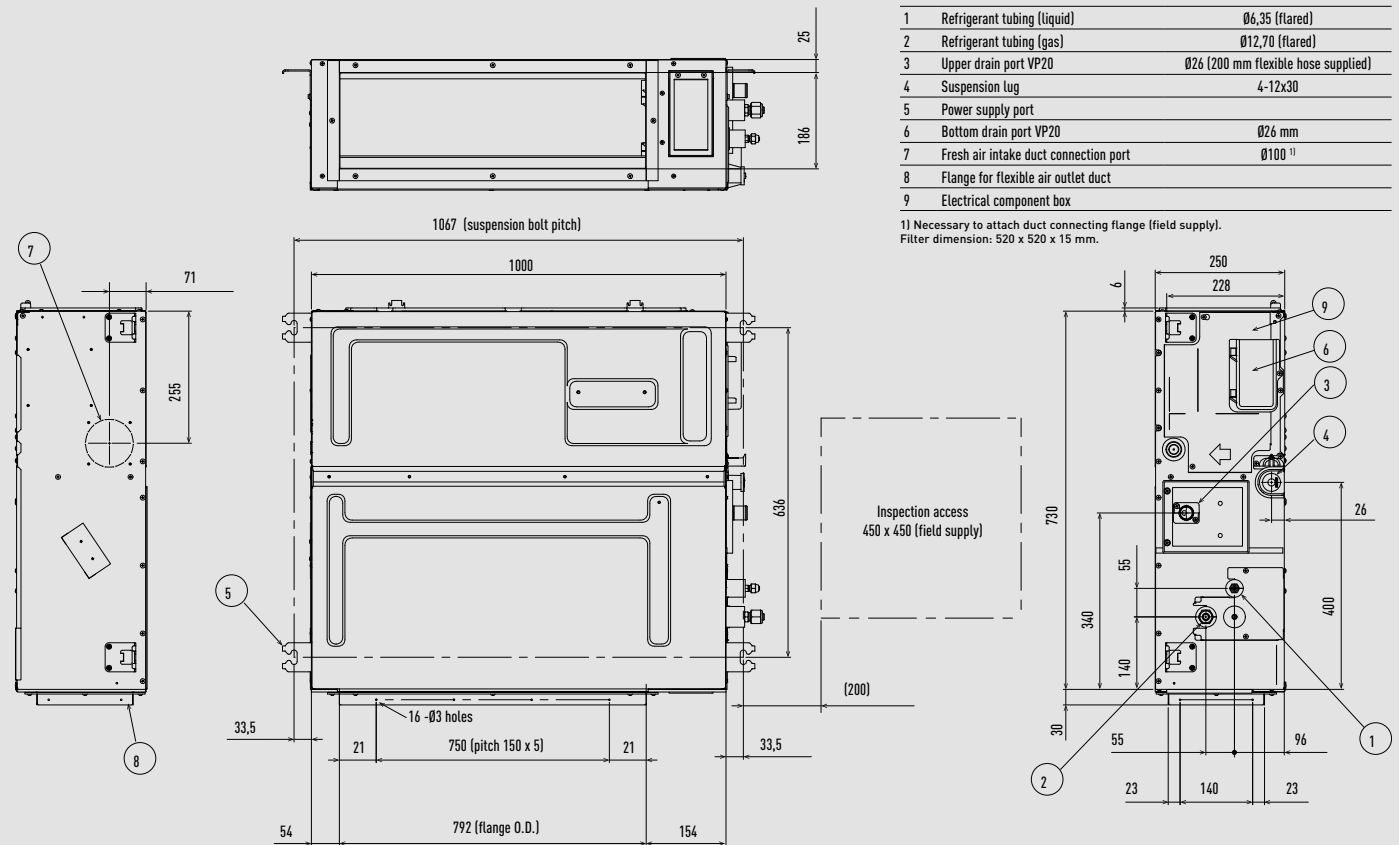

Unit: mm



Aquarea EcoFlex outdoor unit

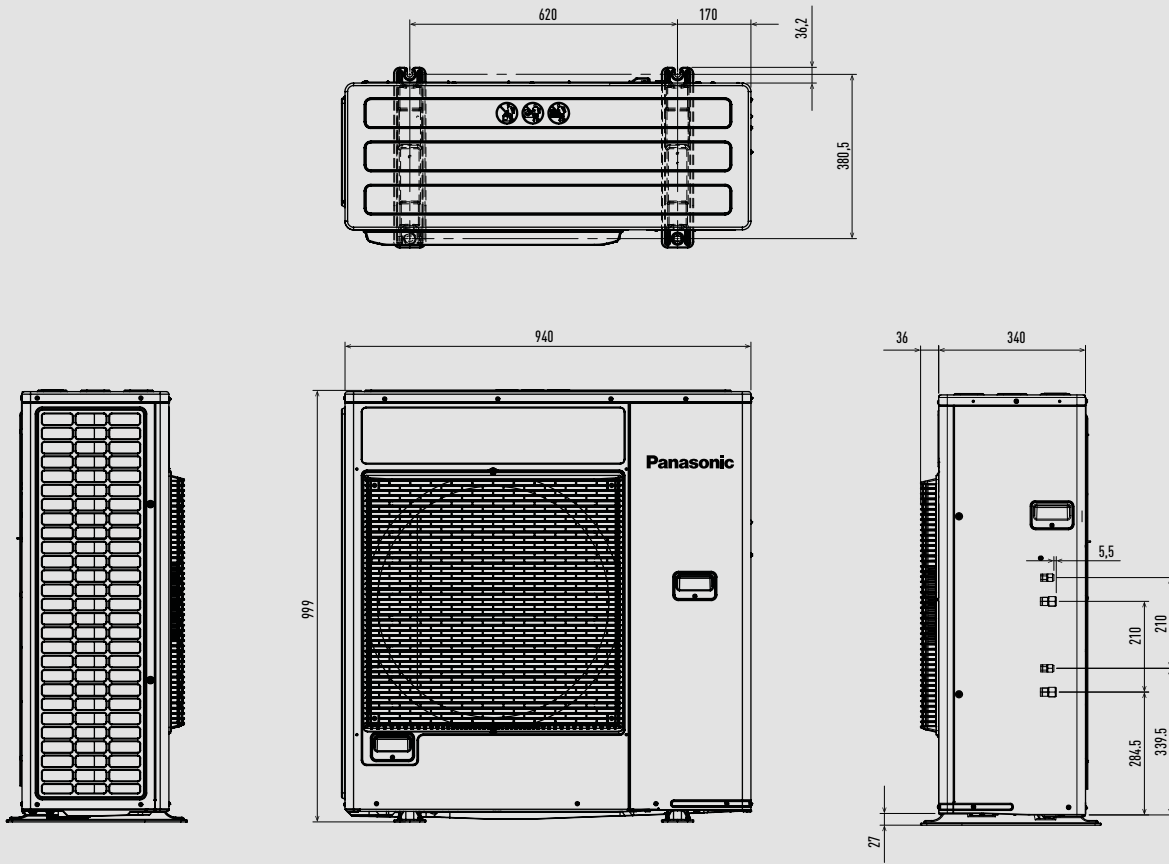

Unit: mm

Aquarea All in One H Generation

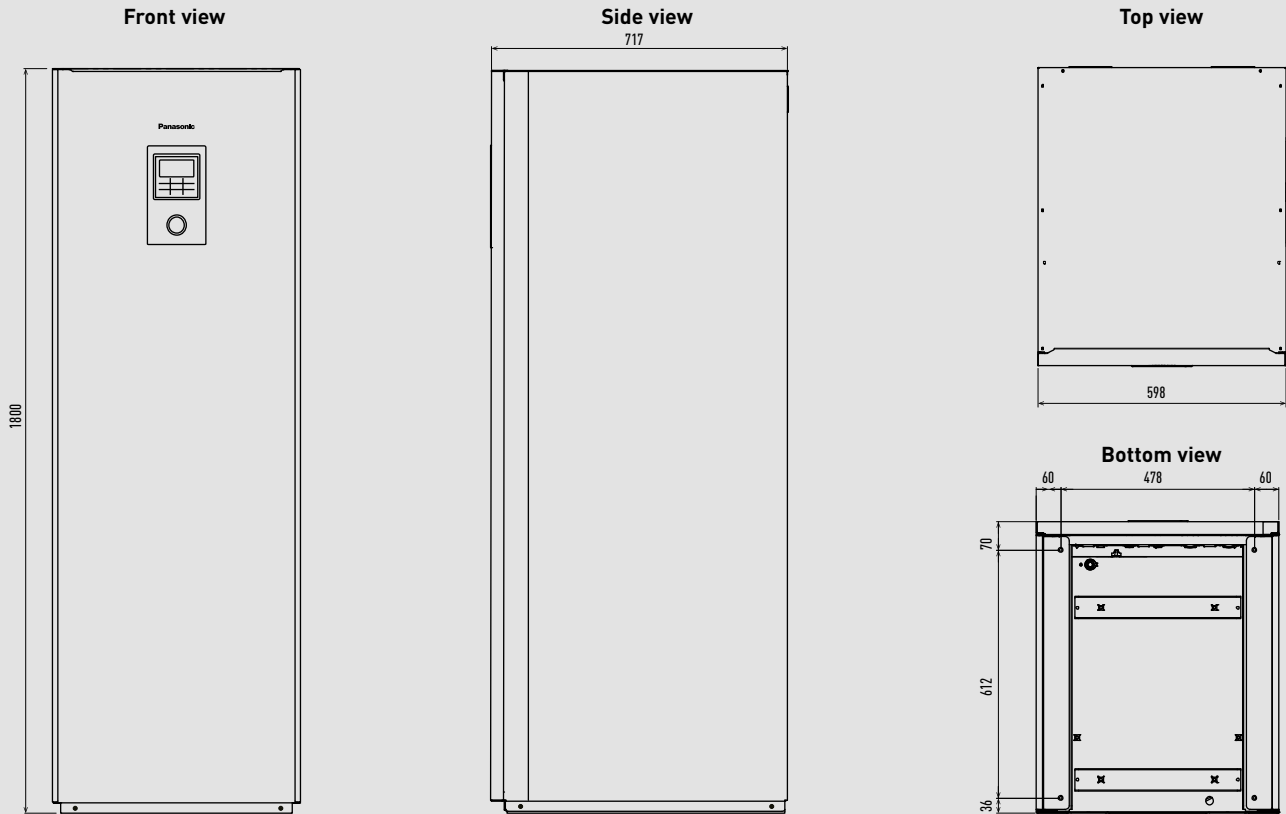

Unit: mm

Aquarea All in One J Generation

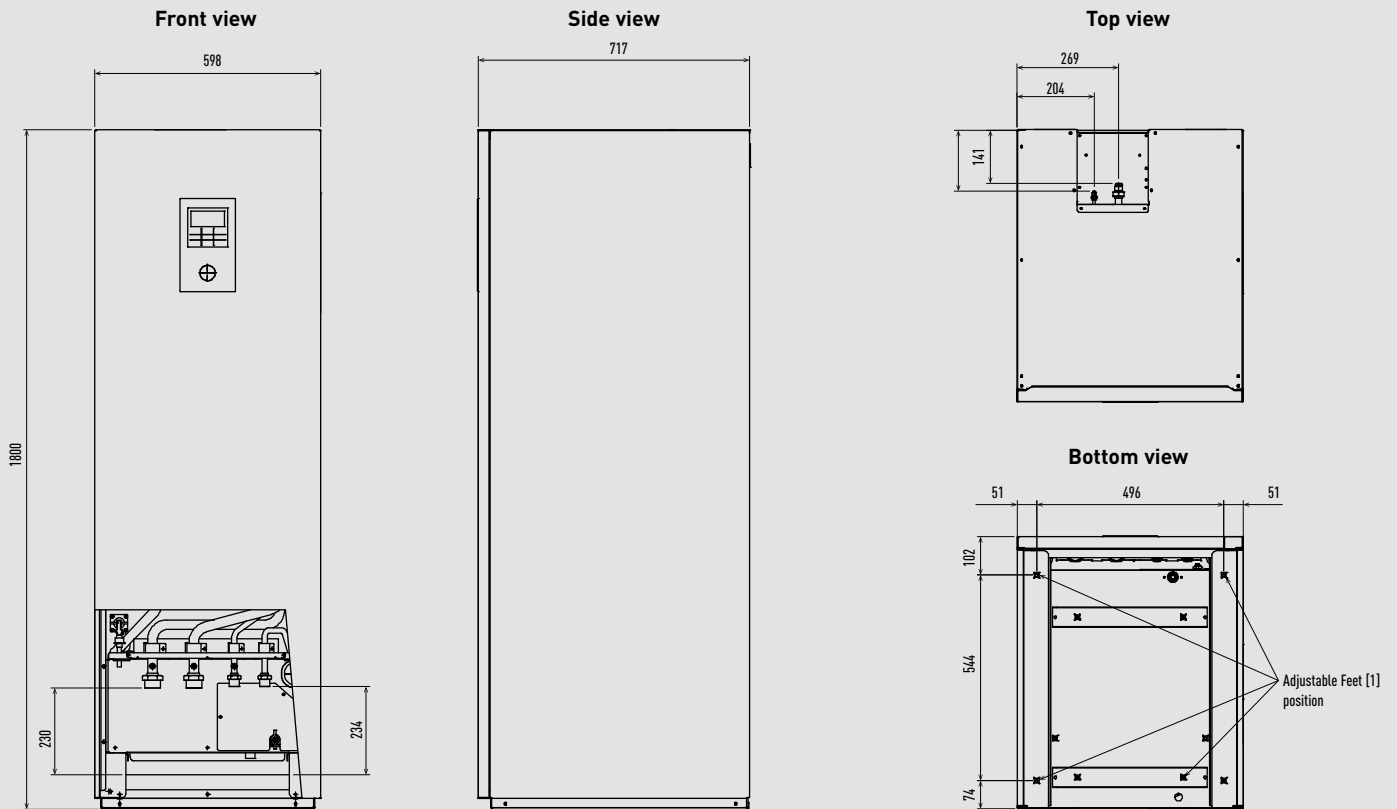

Unit: mm

Aquarea All in One Compact

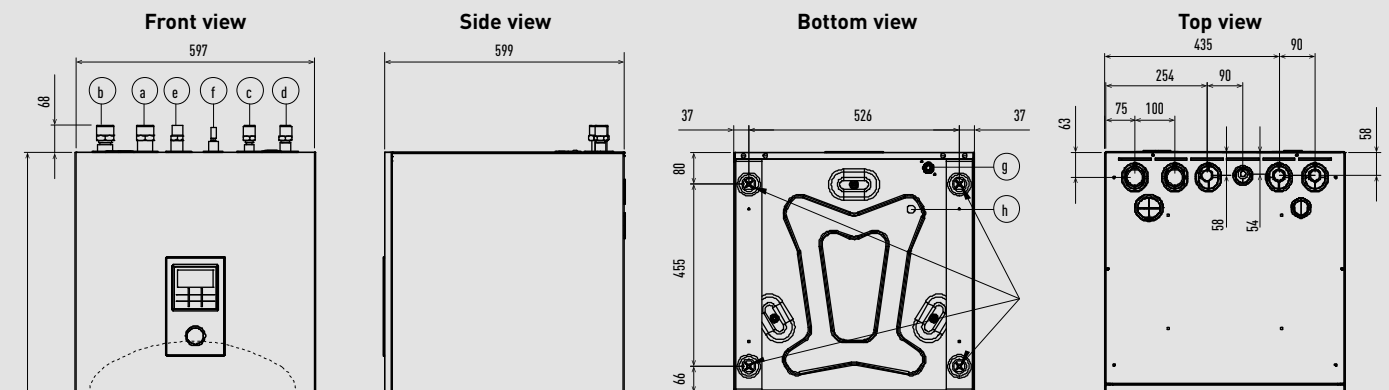

Tube connector	Function	Connector size
a	Water inlet (from space heating/cooling)	R 1 1/4"
b	Water outlet (to space heating/cooling)	R 1 1/4"
c	Cold water inlet (domestic hot water tank)	R 3/4"
d	Hot water outlet (domestic hot water tank)	R 3/4"
e	Refrigerant gas	7/8-14UNF
f	Refrigerant liquid	7/16-20UNF
g	Domestic hot water tank discharge (drain tap) type: ball valve	Rc 1/2"
h	Drain water hole	---

Unit: mm

Aquarea High Performance Bi-bloc outdoor unit 3 and 5kW

Space necessary for installation

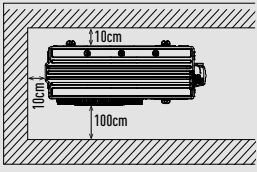

Anchor bolt pitch 355 x 260

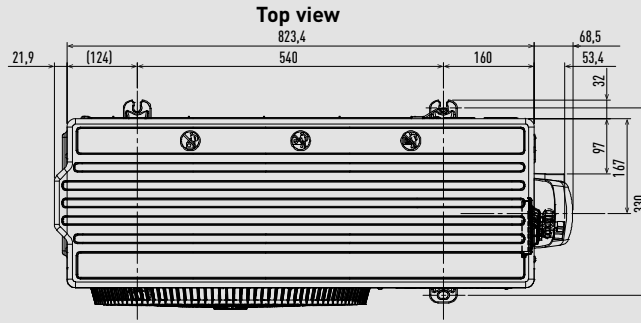

Side view

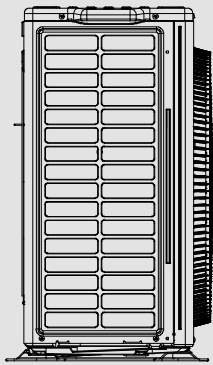

Front view

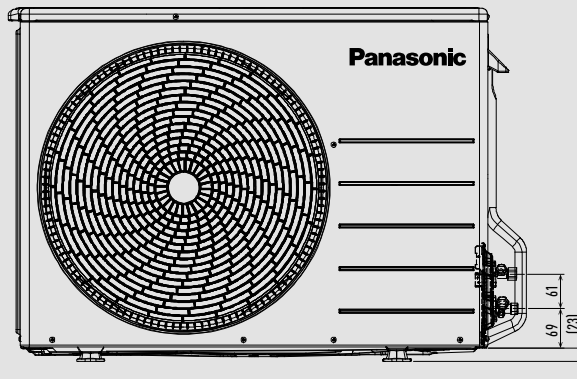

Side view

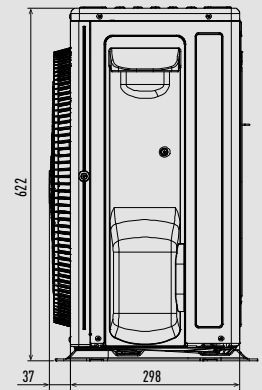

Unit: mm

Aquarea High Performance Bi-bloc outdoor unit 7 and 9kW

Space necessary for installation

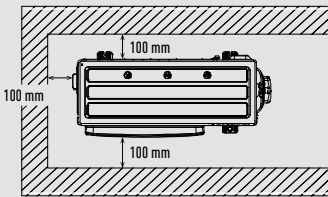

Anchor bolt pitch 360,5 x 613

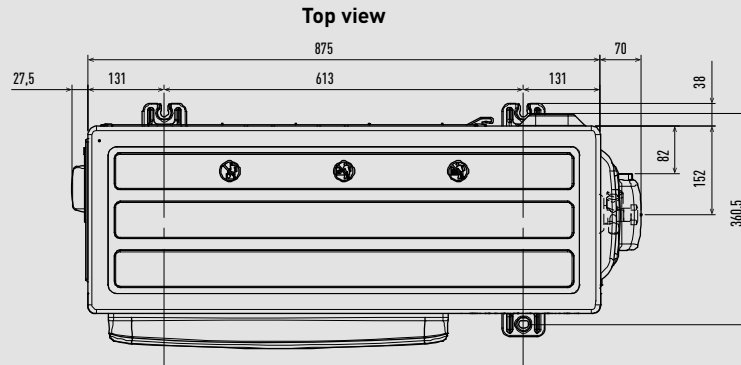

Side view

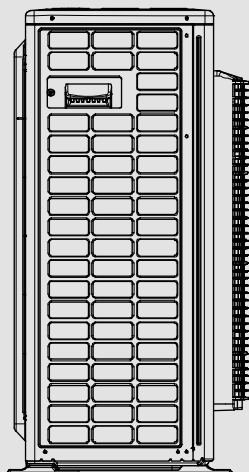

Front view

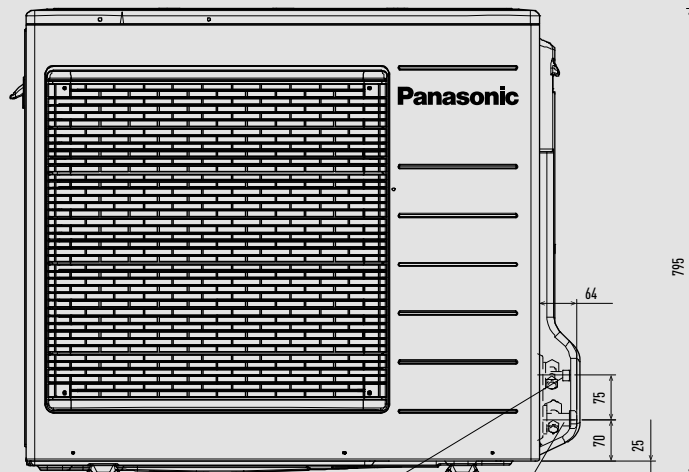

Side view

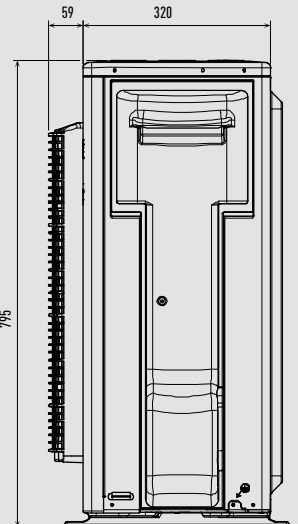

2-way valve at liquid side (high pressure)

3-way valve at gas side (low pressure)

Unit: mm



Aquarea High Performance, T-CAP and HT Bi-bloc outdoor unit from 9 to 16 kW (except High Performance 9 kW single phase)

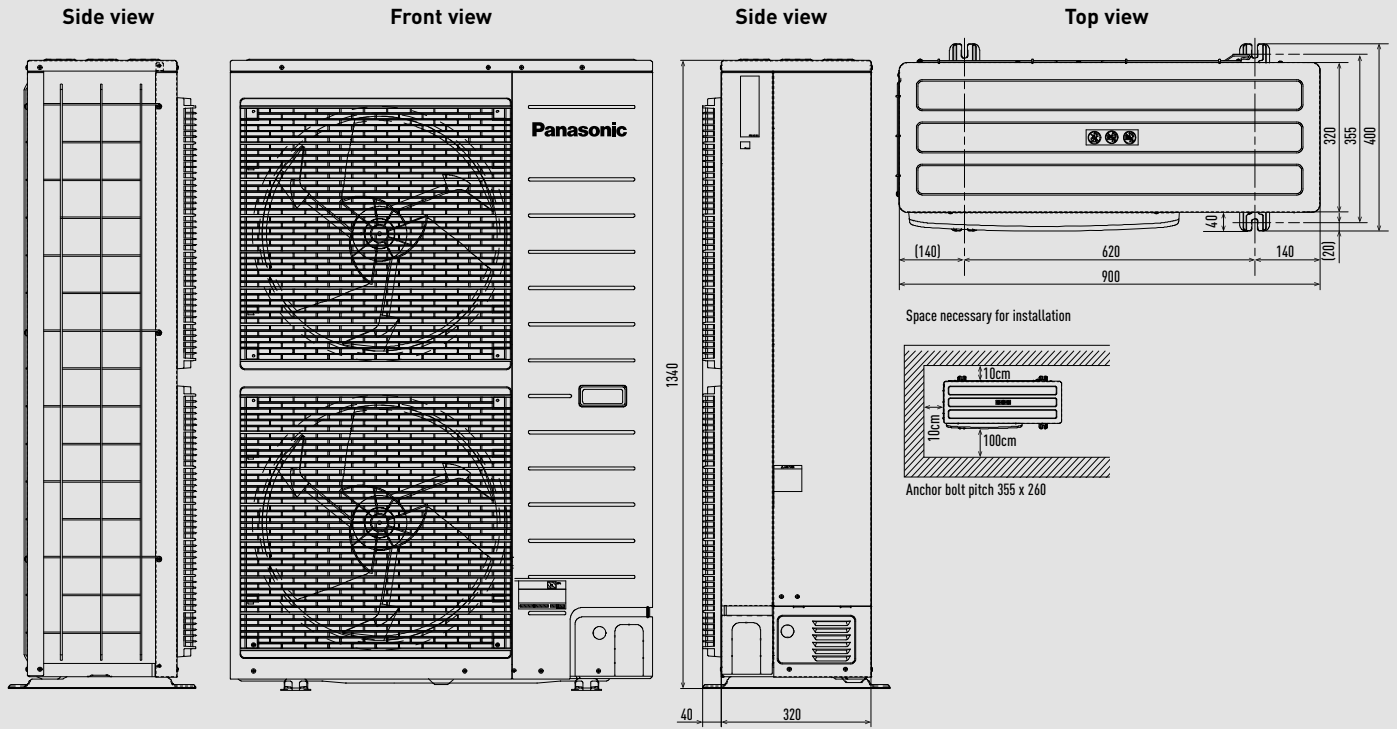

Unit: mm

Aquarea High Performance Mono-bloc outdoor unit from 5 to 9kW

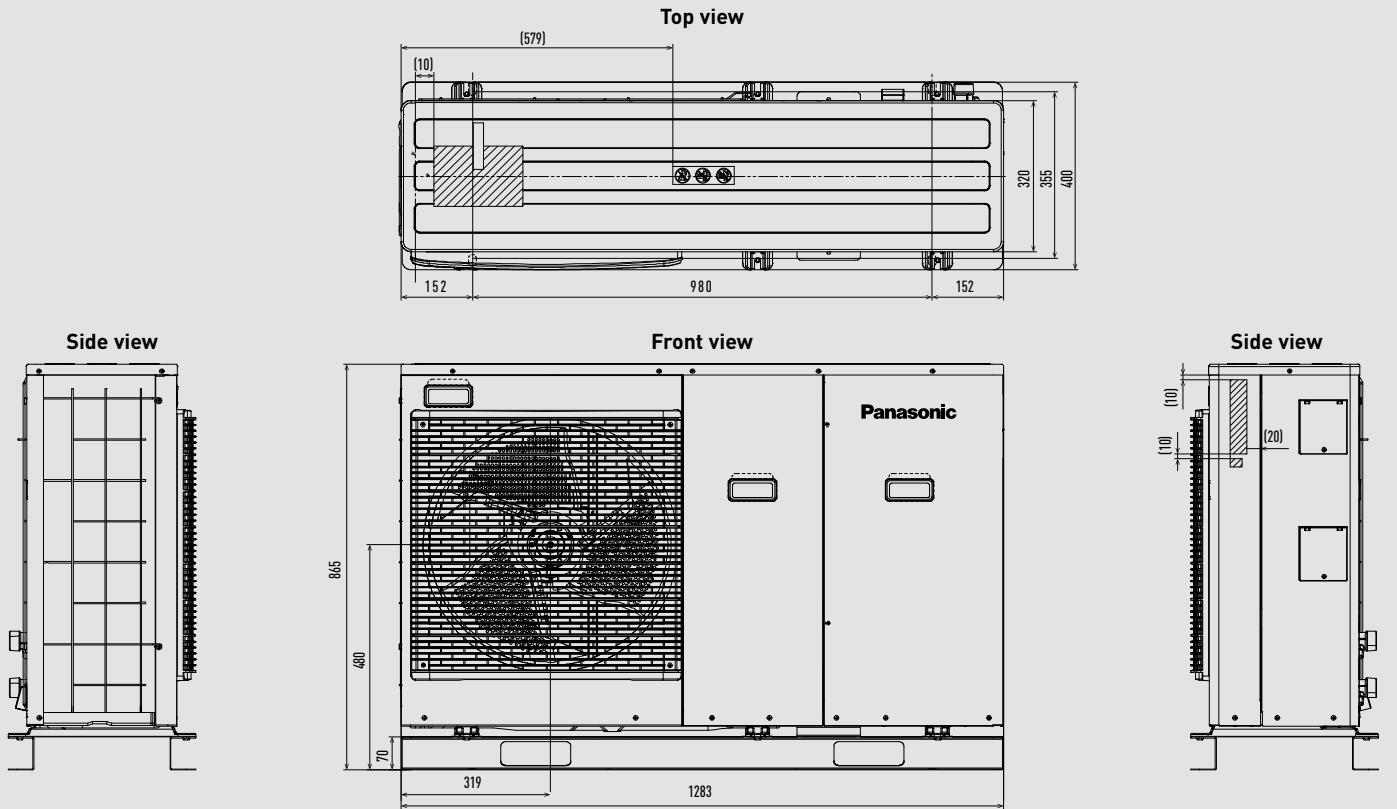

Unit: mm

Aquarea High Performance, T-CAP and HT Mono-bloc outdoor unit and T-CAP Bi-bloc Super Quiet outdoor unit from 9 to 16 kW (except High Performance 9 kW)

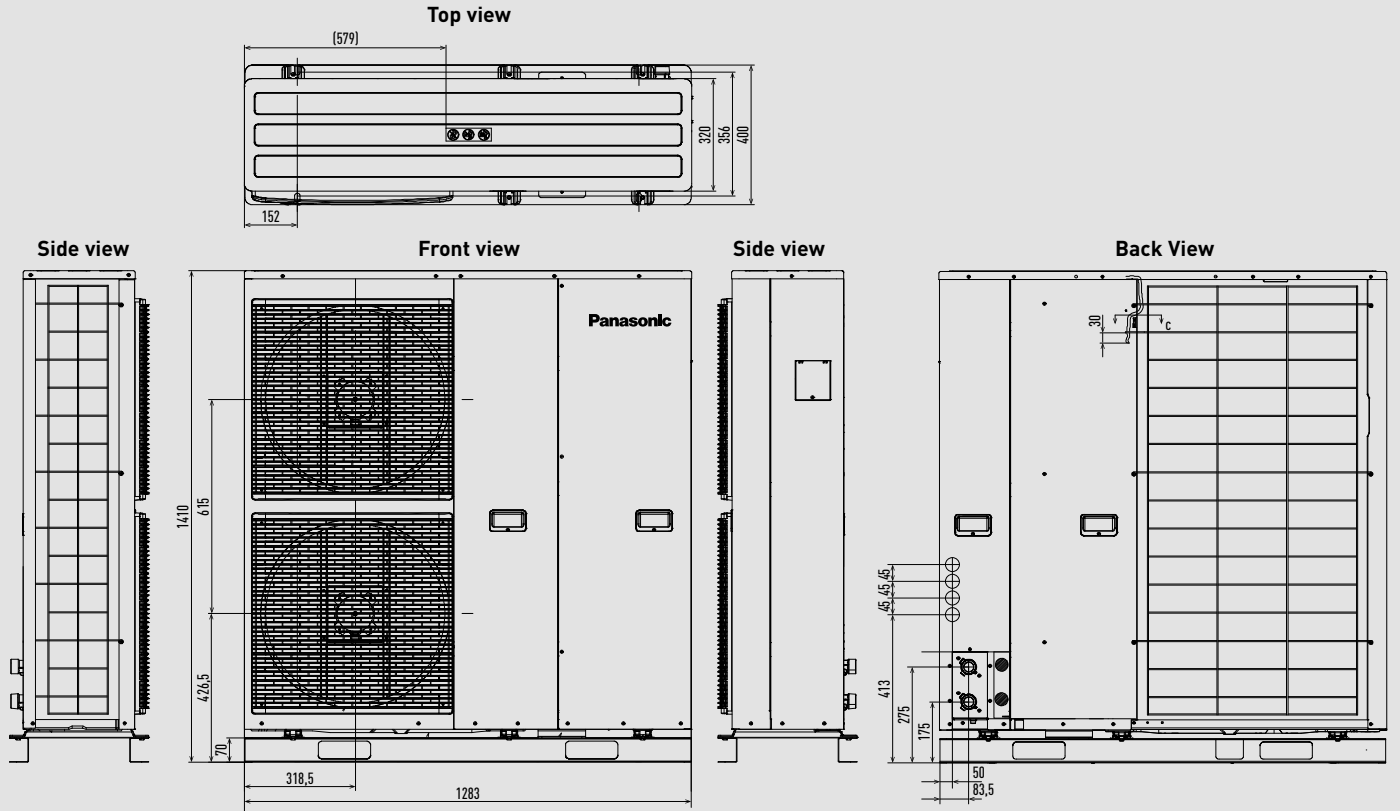

Unit: mm

Smart fan coils

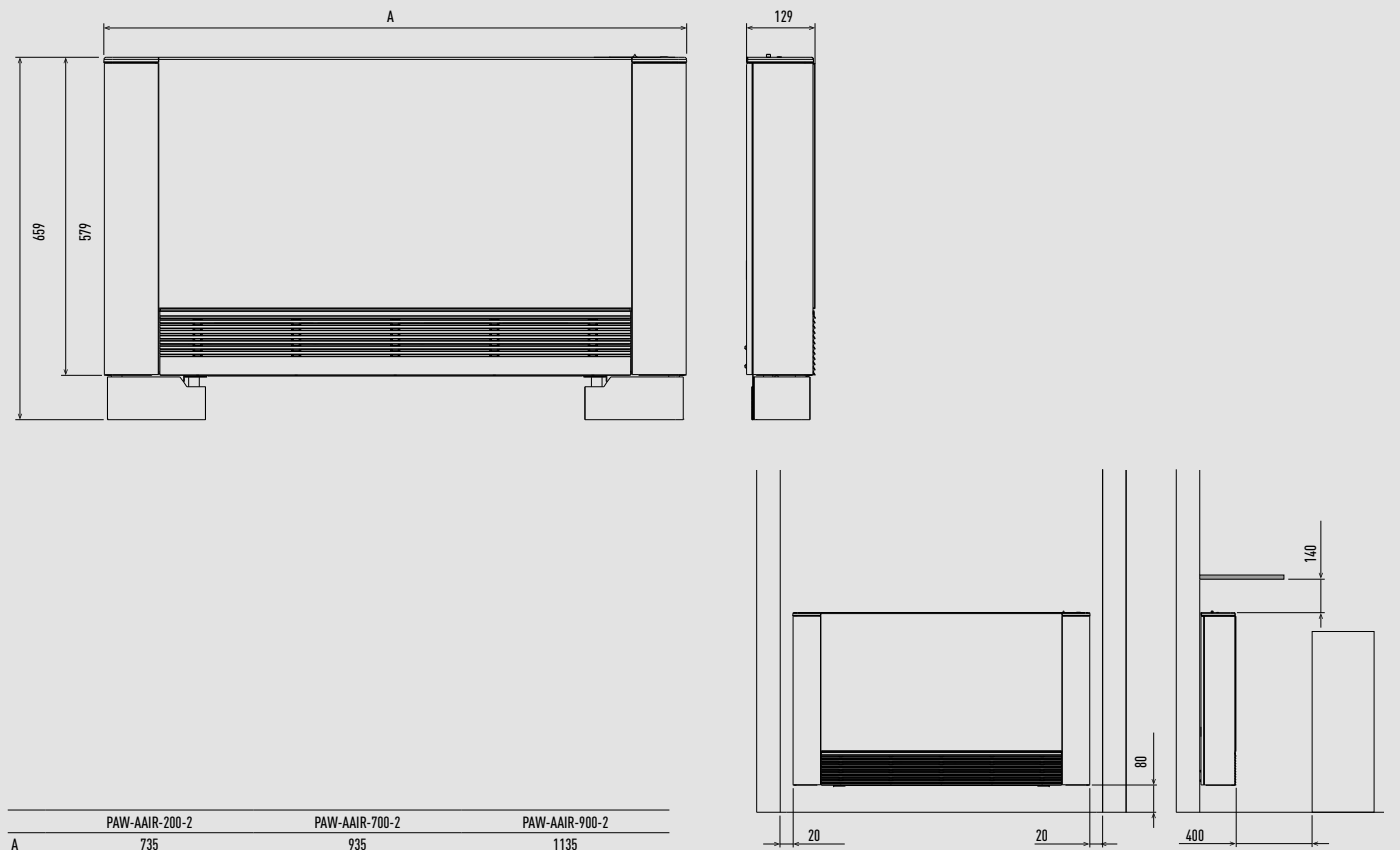

Unit: mm



Buffer tank - PAW-BTANK50L-2 / PAW-BTANK100L / PAW-BTANK200L / PAW-BTANK300L

	A*	B*	C	D	E	Ø
PAW-BTANK50L-2	704	636	422	192	96	435
PAW-BTANK100L	1243	1175	962	192	96	435
PAW-BTANK200L	1340	1275	941	301	155	595
PAW-BTANK300L	1820	1755	1421	301	155	595

Tolerance +/- 5 mm. * Total height tolerance +0 / -13 mm.

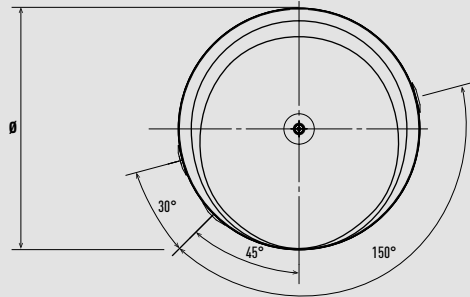
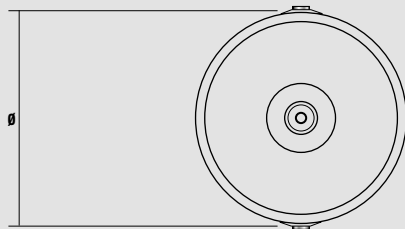
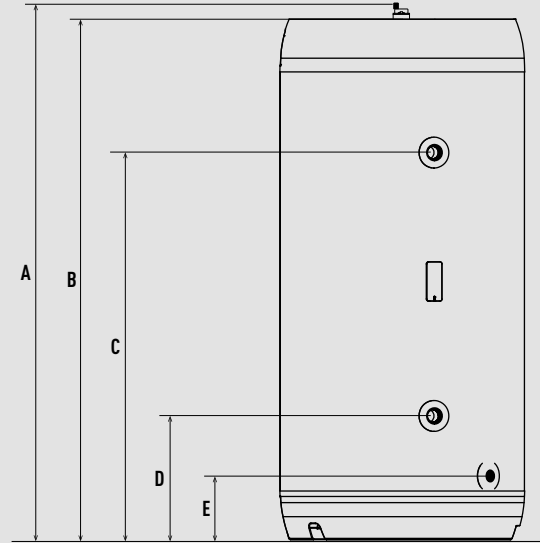
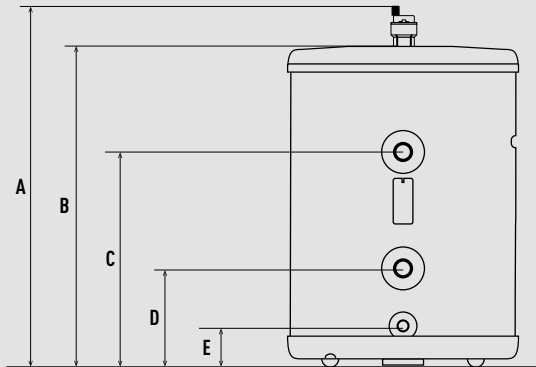

Unit: mm

Enamelled tank - PAW-TA15C1E5STD

Connection point for vertical assembly

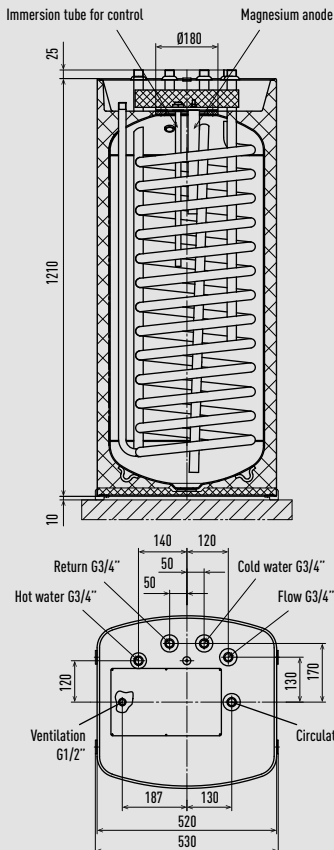

Connection point for hanging assembly

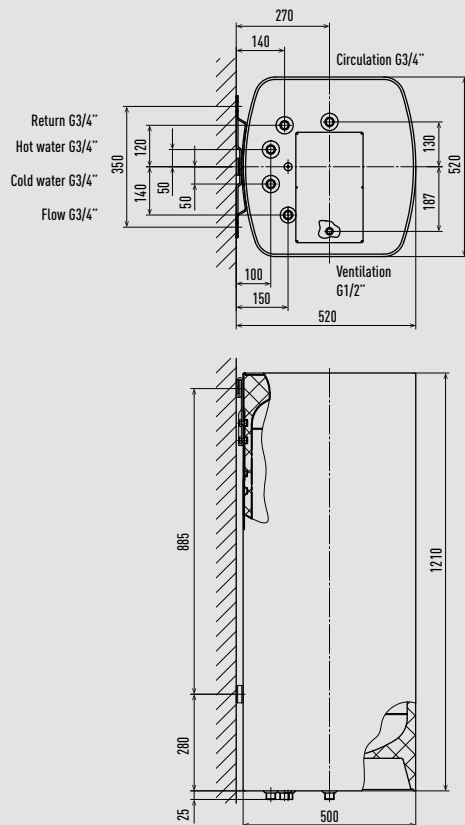

Unit: mm

Enamelled tanks - PAW-TA20C1E5STD / PAW-TA30C1E5STD / PAW-TA40C1E5STD

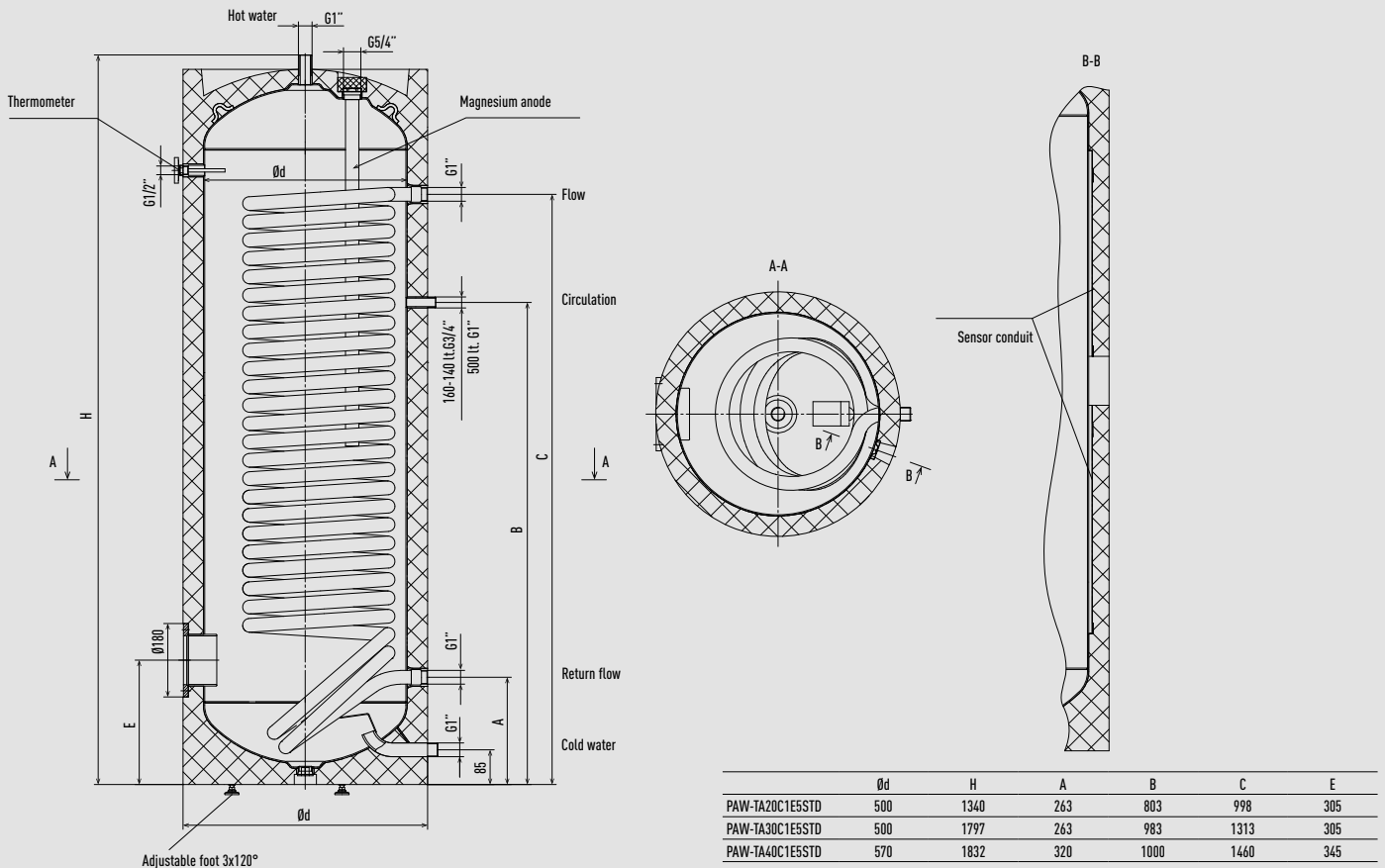

Unit: mm

Enamelled tank - PAW-TA30C2E5STD

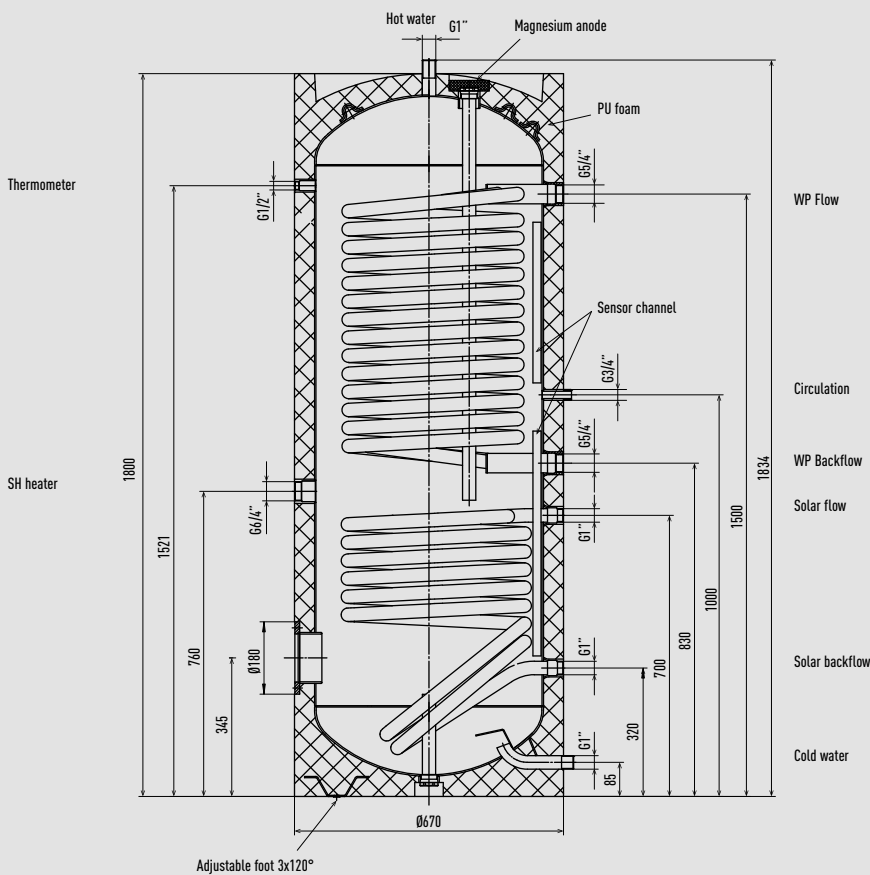

Unit: mm

DHW Stand Alone

Wall-mounted

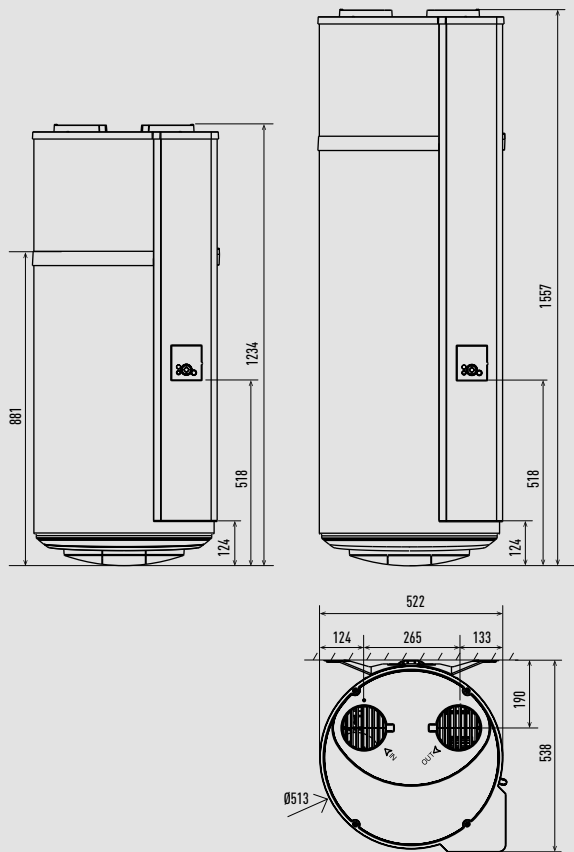

Floor-standing

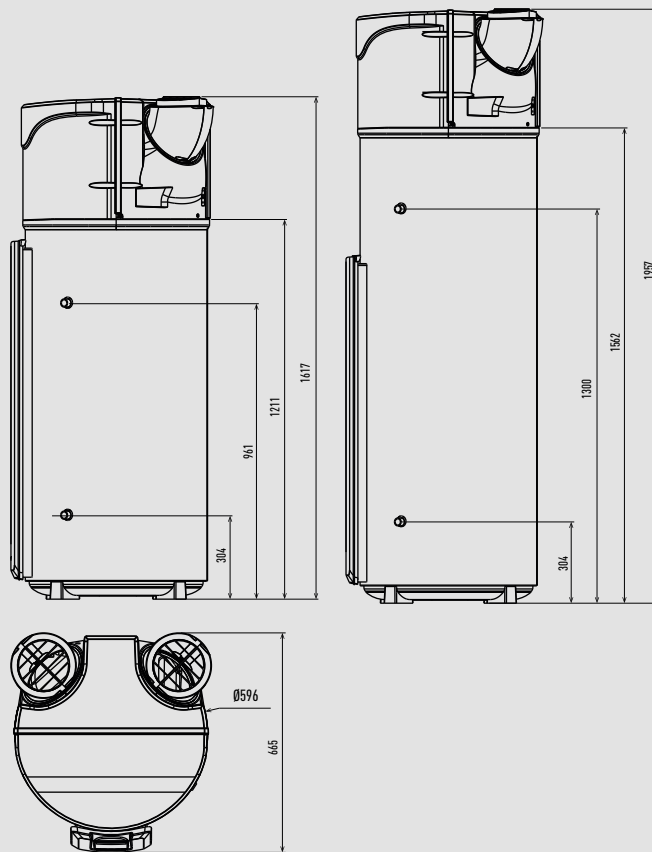

Unit: mm



Wall-mounted Heatcharge VZ

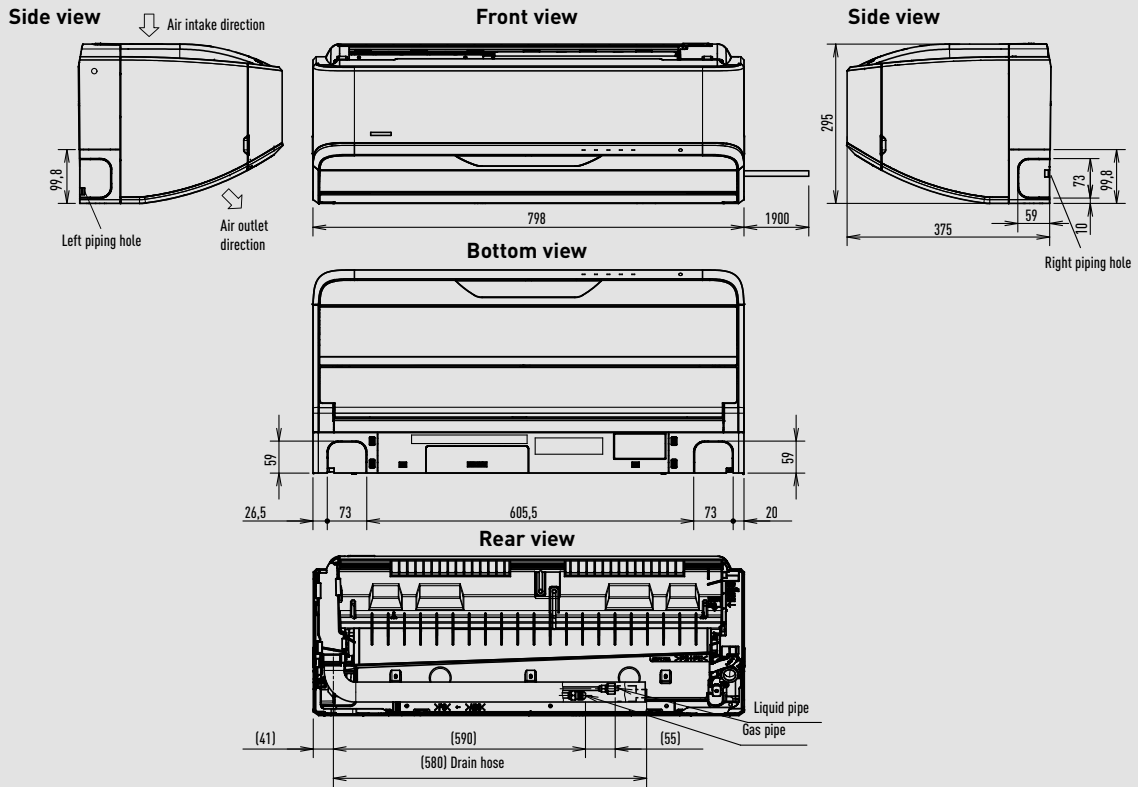

Relative position between the indoor unit and the installation plate

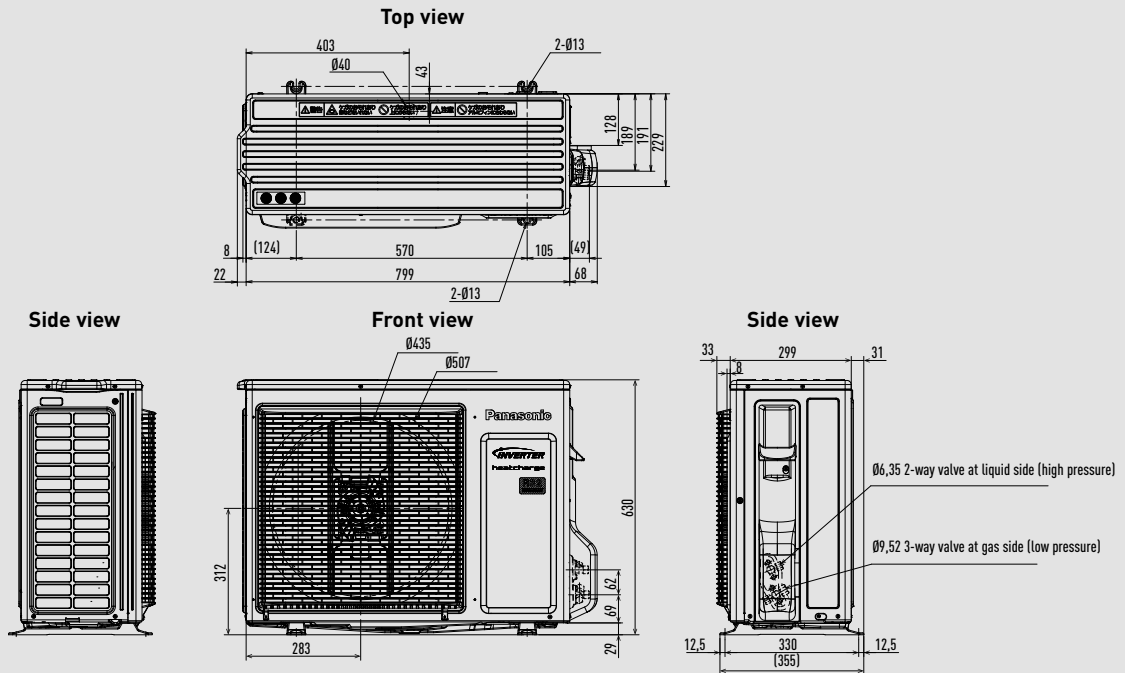
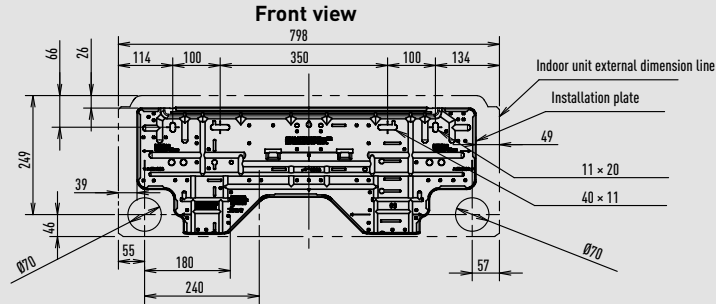

Wall-mounted Etherea (from 1,6 to 4,2 kW)

Side view

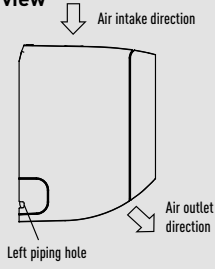

Front view

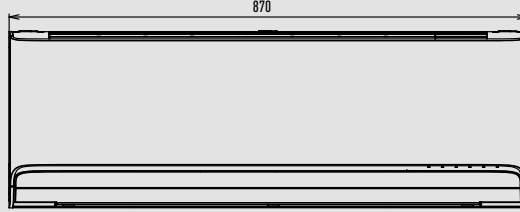

Side view

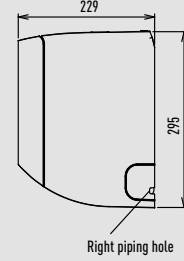

Bottom view

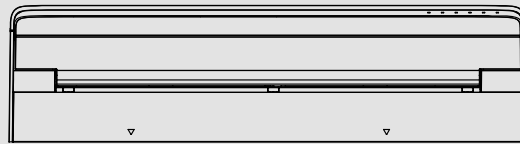

Rear view

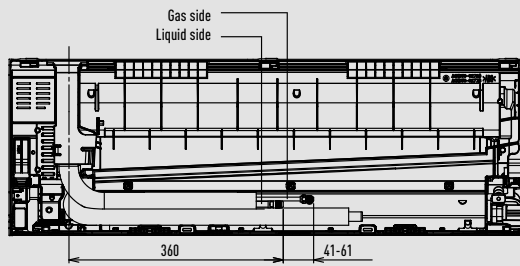

Relative position between the indoor unit and the installation plate

Front view

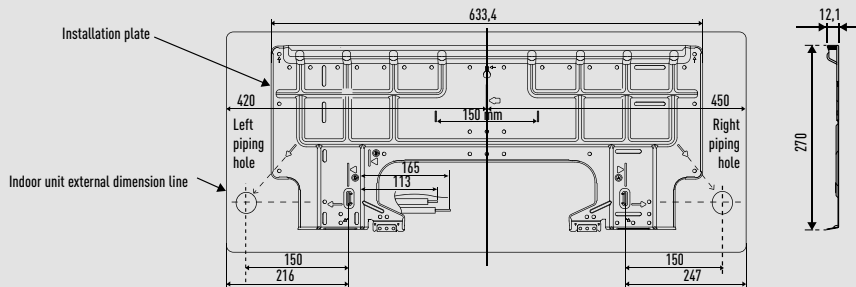

Top view

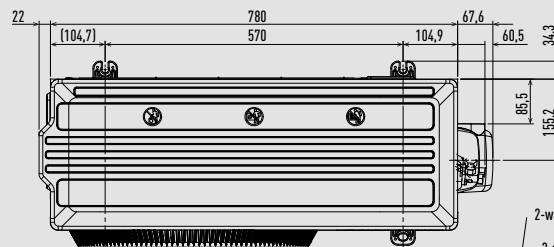

Side view

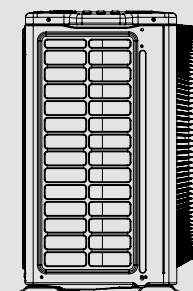

Front view

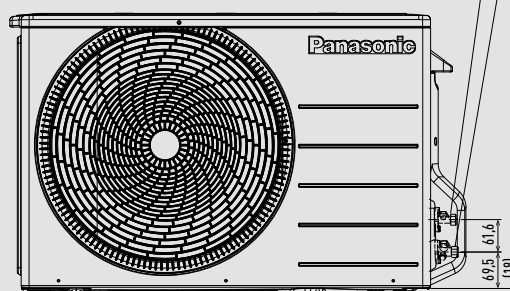

Side view

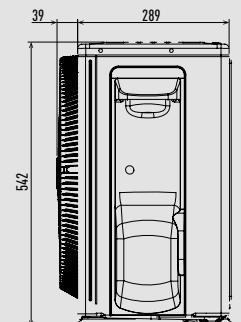



Wall-mounted Etherea (5,0 and 7,1 kW)

Side view

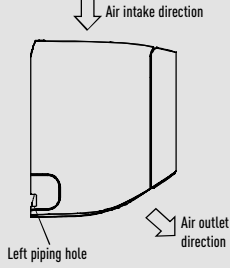

Front view

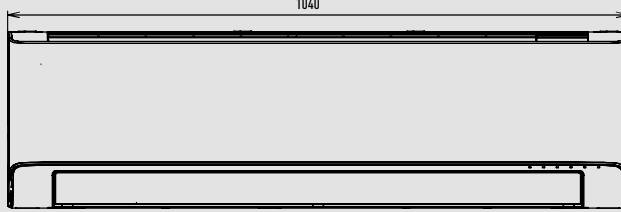

Side view

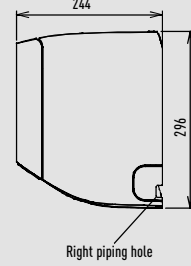

Bottom view

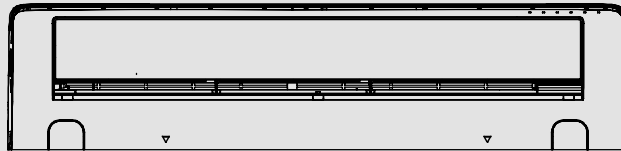

Rear view

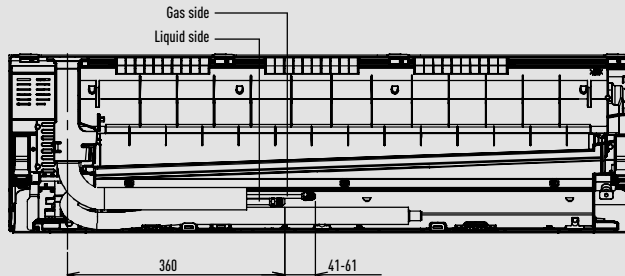

Relative position between the indoor unit and the installation plate

Front view

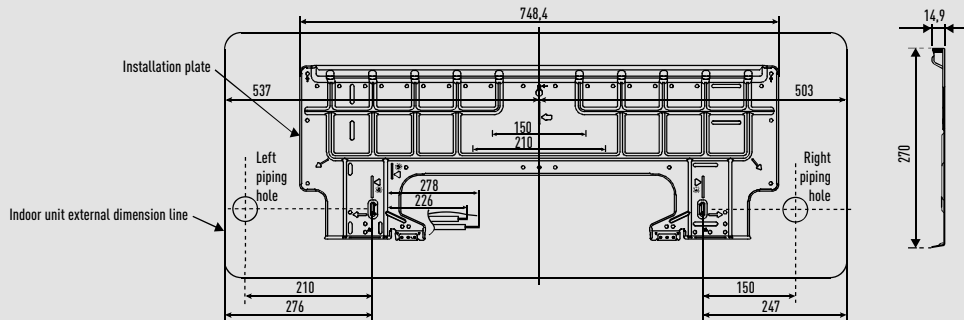

Top view

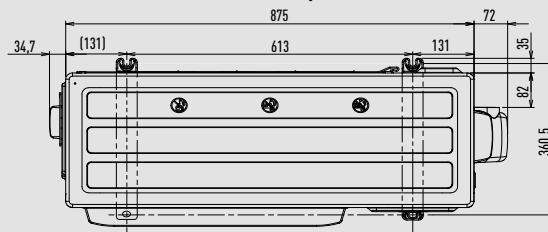

Side view

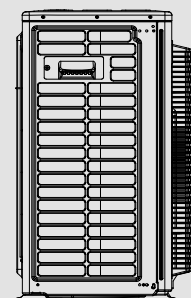

Front view

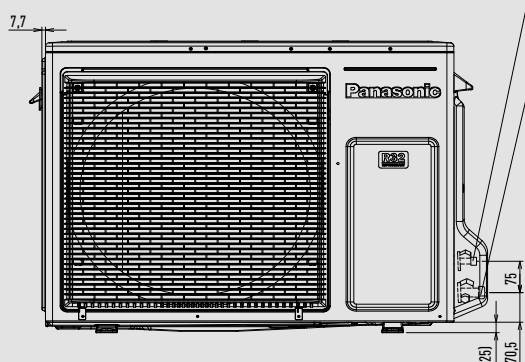

2-way valve at liquid side (high pressure)

3-way valve at gas side (low pressure)

Side view

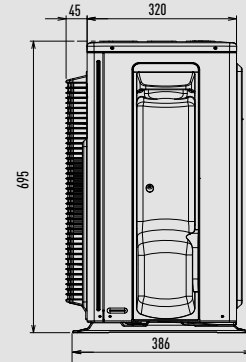

Wall-mounted TZ super-compact (from 1,6 to 5,0 kW)

Side view

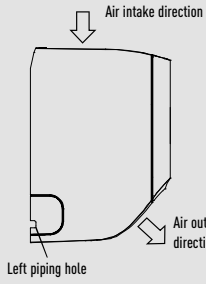

Front view



Side view

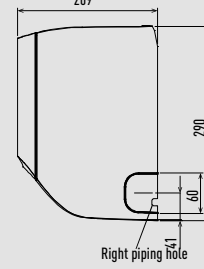

Bottom view

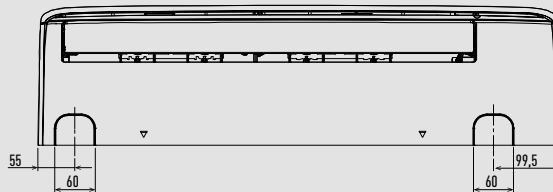

Rear view

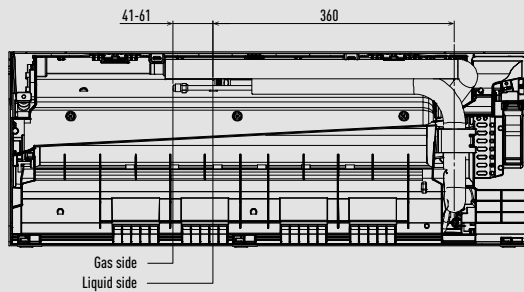

Relative position between the indoor unit and the installation plate
Front view

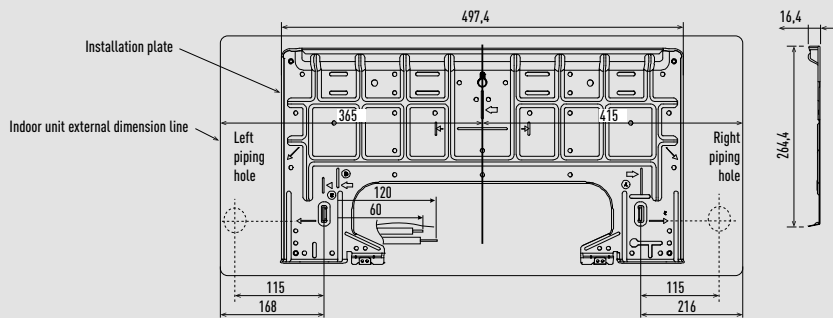

CU-TZ20WKE / CU-TZ25WKE / CU-TZ35WKE / CU-TZ42WKE

Top view

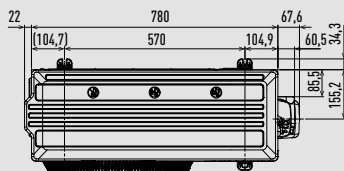

CU-TZ50WKE

Top view

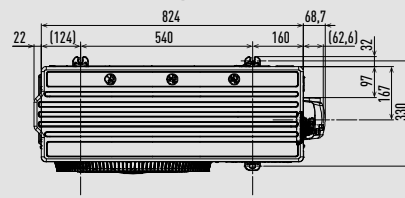

Side view

Front view

Side view

Side view

Front view

Side view

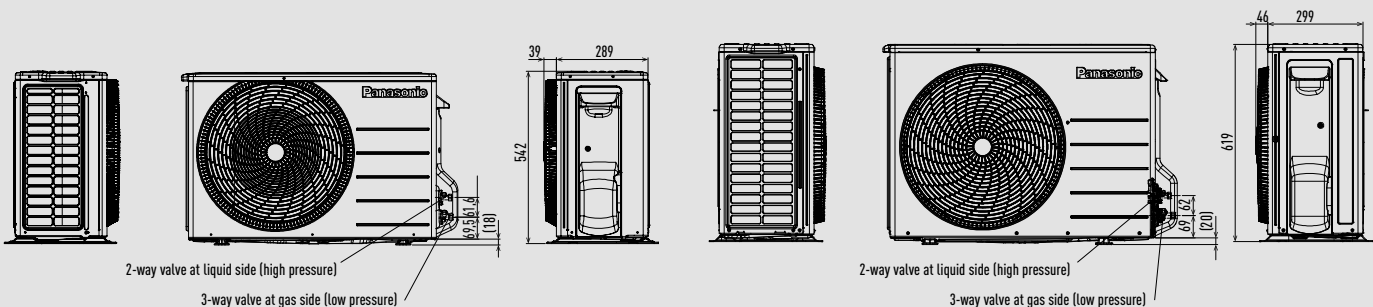

Unit: mm



Wall-mounted TZ super-compact (6,0 and 7,1 kW)

Side view

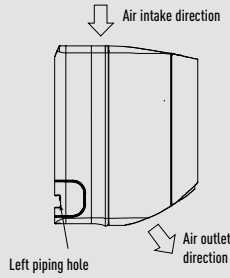

Front view

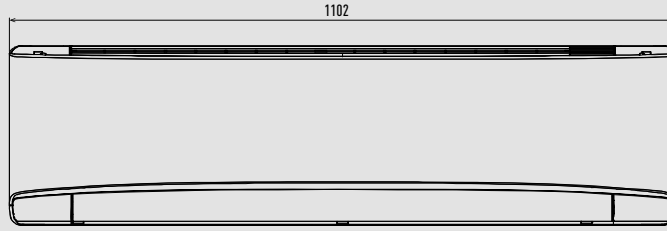

Side view

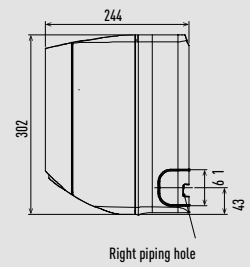

Bottom view

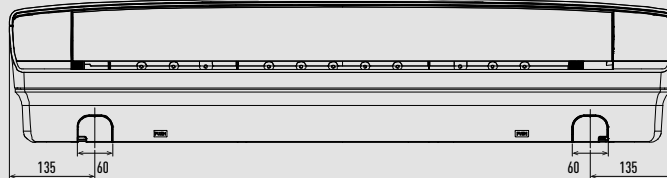

Rear view

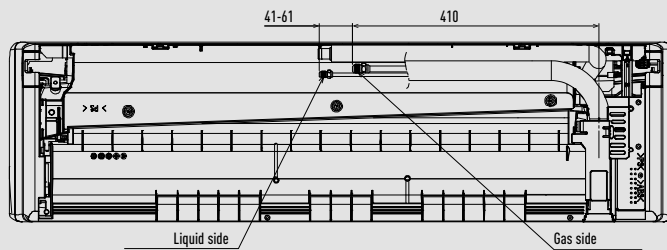

Relative position between the indoor unit and the installation plate

Front view

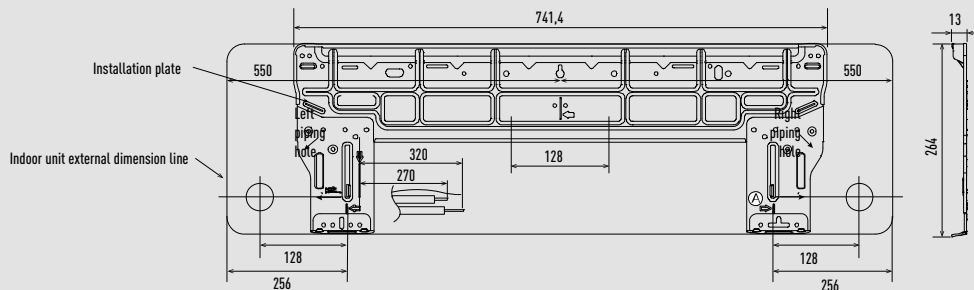

CU-TZ60WKE

Top view

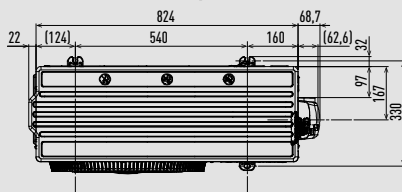

CU-TZ71WKE

Top view

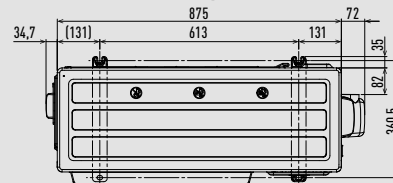

Side view

Front view

Side view

Side view

Front view

Side view

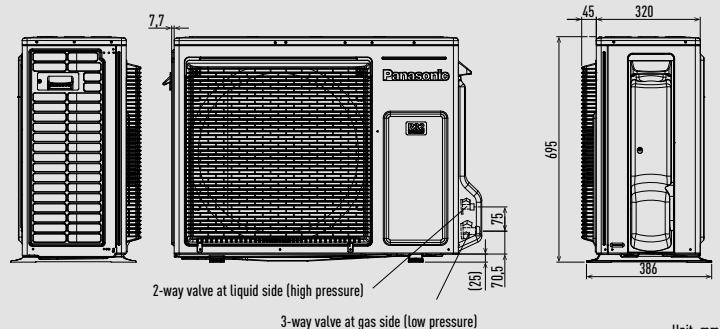
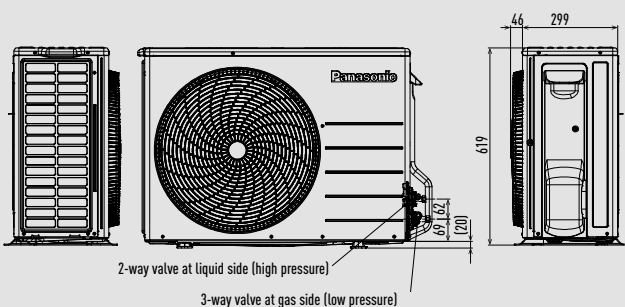

Unit: mm

Wall-mounted BZ super-compact

Side view

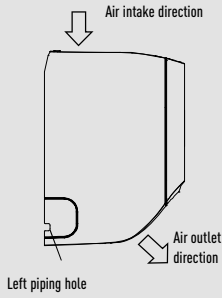

Front view



Side view

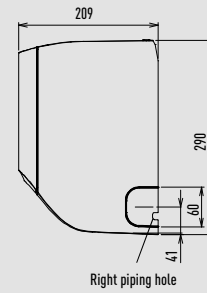

Bottom view

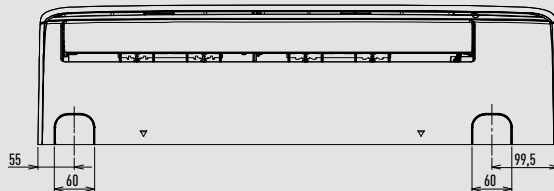

Rear view

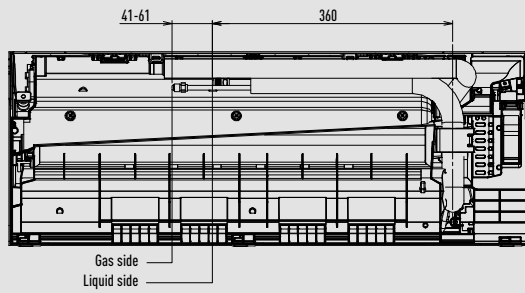

Relative position between the indoor unit and the installation plate
Front view

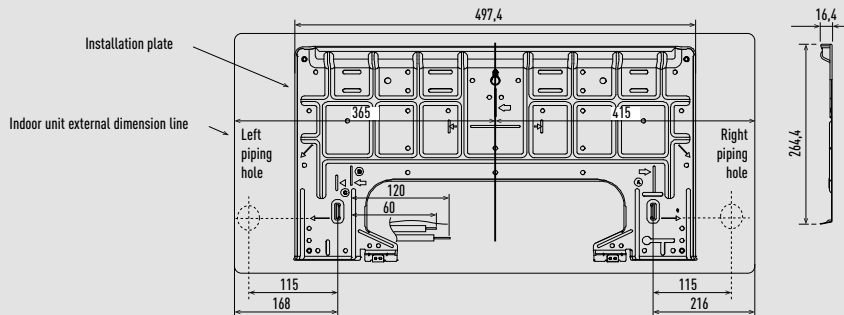

CU-BZ25XKE / CU-BZ35XKE

Top view

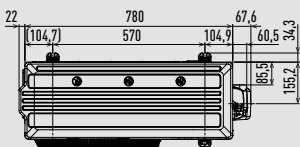

Front view

Side view

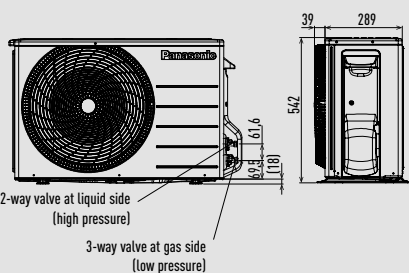

CU-BZ50XKE

Top view

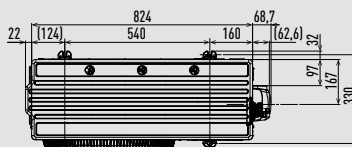

Front view

Side view

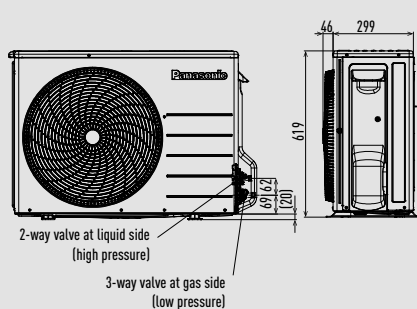

CU-BZ60XKE

Top view

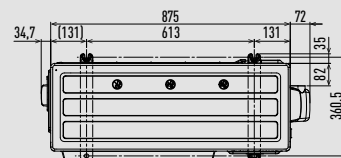

Front view

Side view

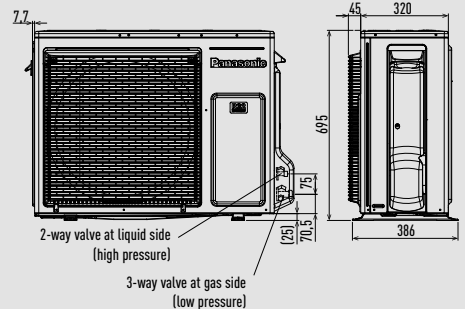

Unit: mm



Wall-mounted UZ and PZ super-compact

Side view

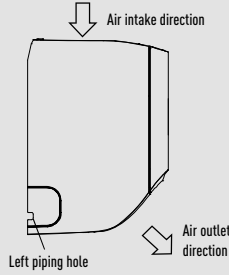

Front view

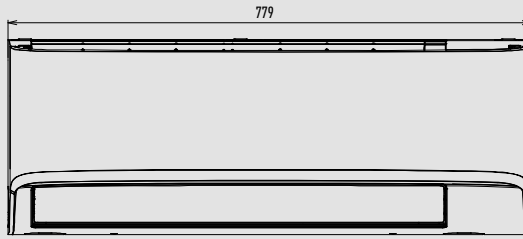

Side view

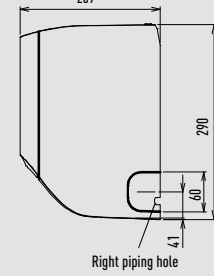

Bottom view

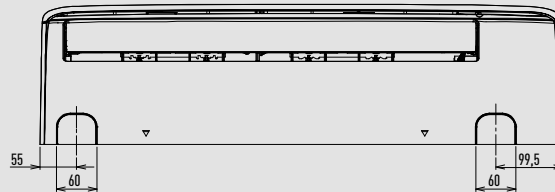

Rear view

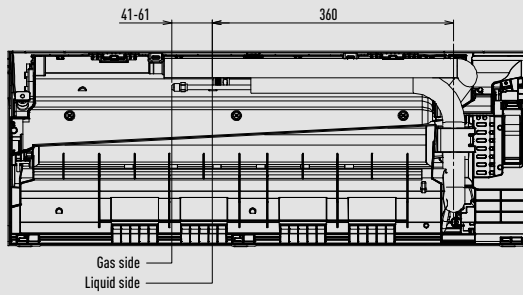

Relative position between the indoor unit and the installation plate
Front view

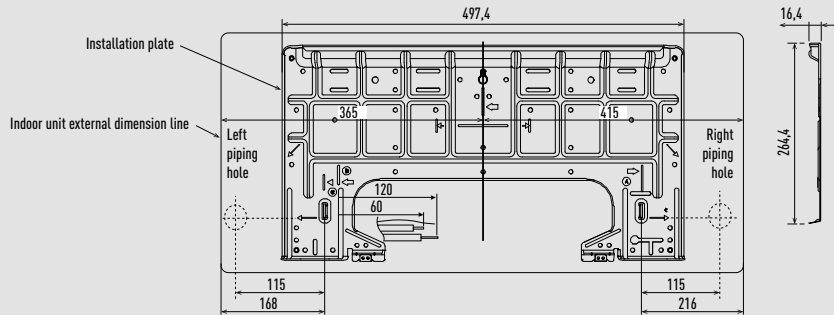

CU-PZ25WKE / CU-PZ35WKE / CU-UZ25WKE / CU-UZ35WKE

Top view

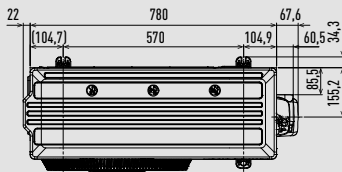

CU-PZ50WKE / CU-UZ50WKE

Top view

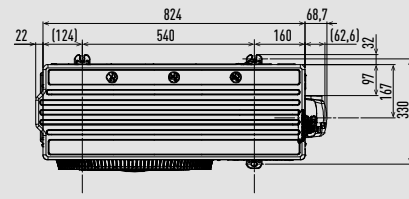

Side view

Front view

Side view

Side view

Front view

Side view

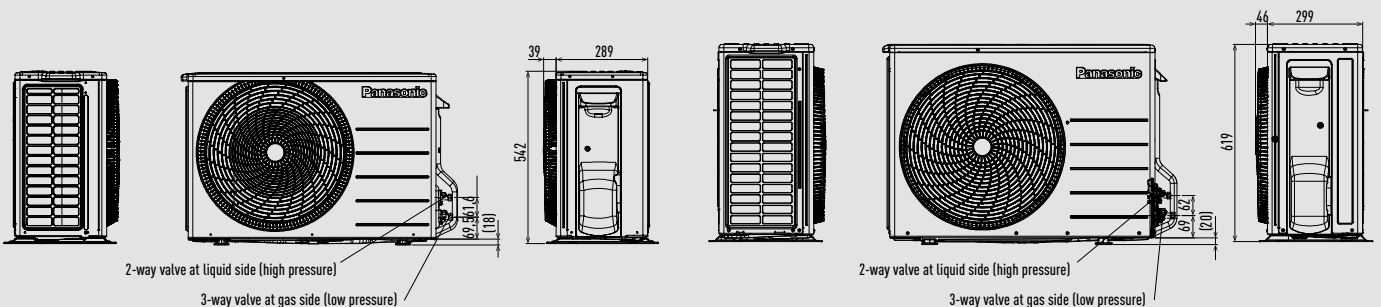

Unit: mm

Floor console

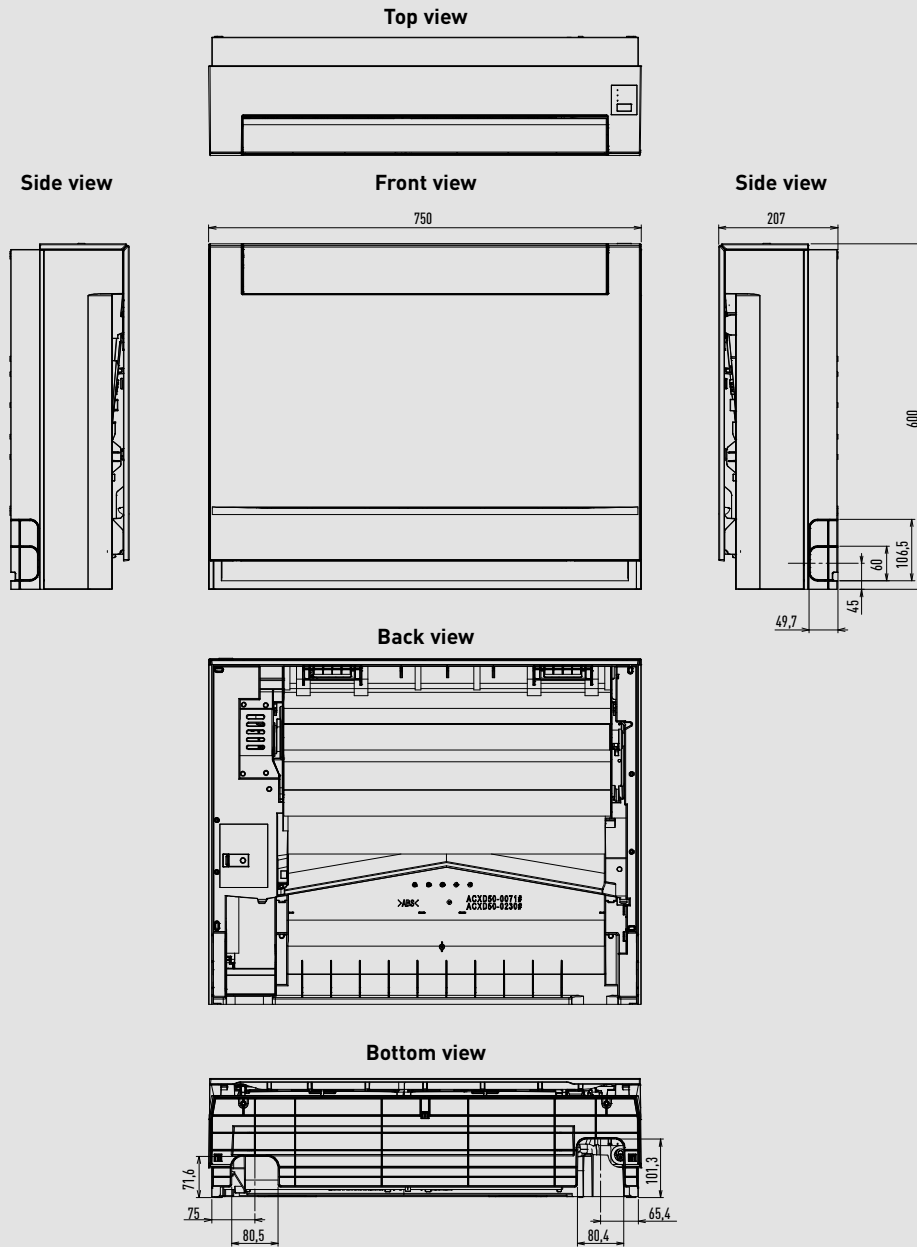

CU-Z25UBEA

CU-Z35UBEA

CU-Z50UBEA

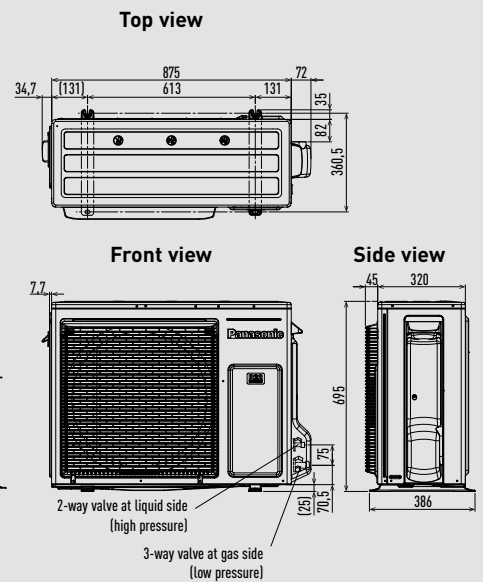
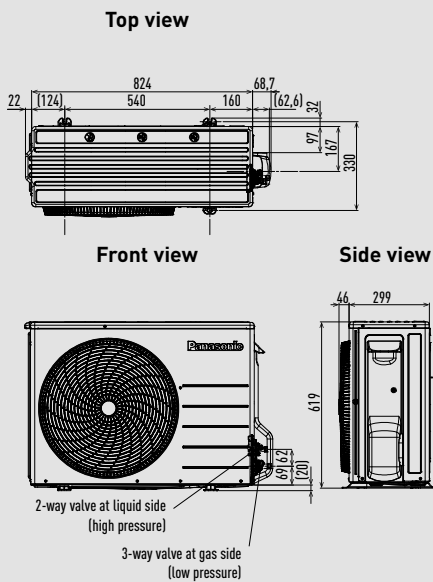
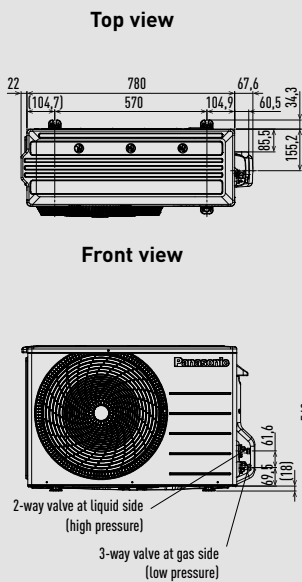

Unit: mm

Outdoor units Free Multi System Z

CU-2Z35TBE / CU-2Z41TBE / CU-2Z50TBE

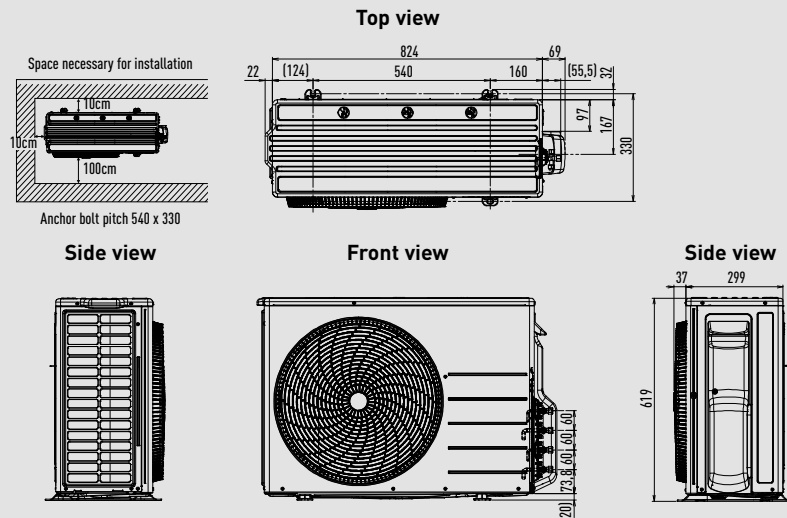

CU-3Z52TBE / CU-3Z68TBE / CU-4Z68TBE

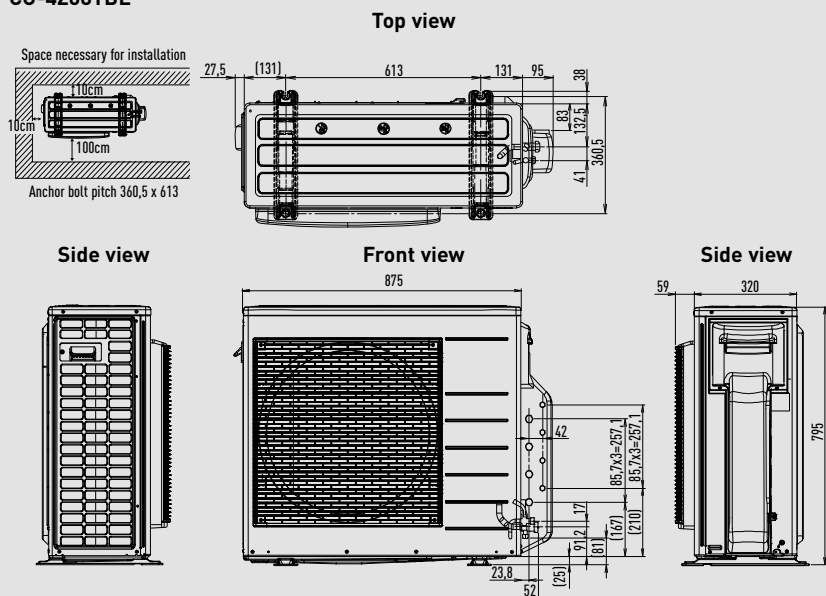

CU-4Z80TBE / CU-5Z90TBE

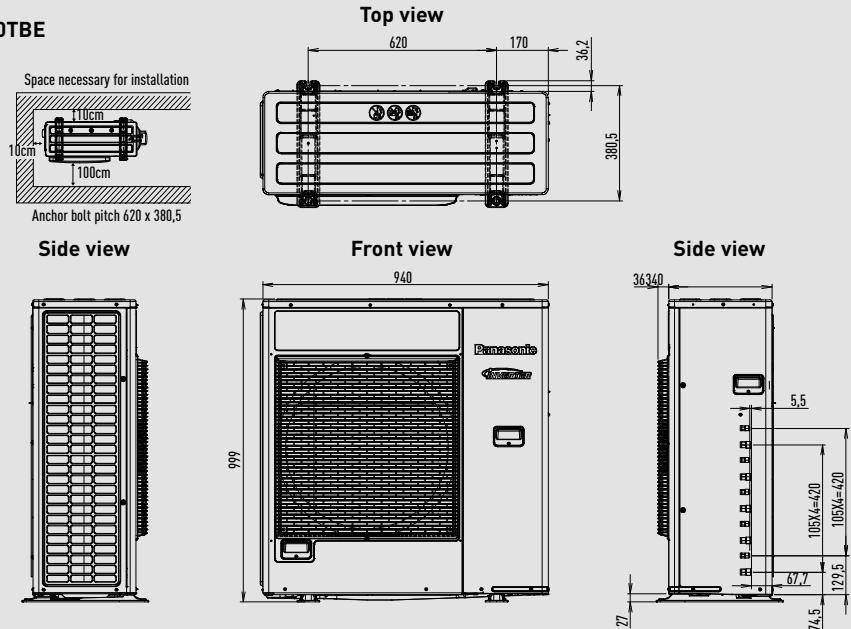

Unit: mm



Outdoor units Multi Wall TZ

CU-2TZ41TBE / CU-2TZ50TBE

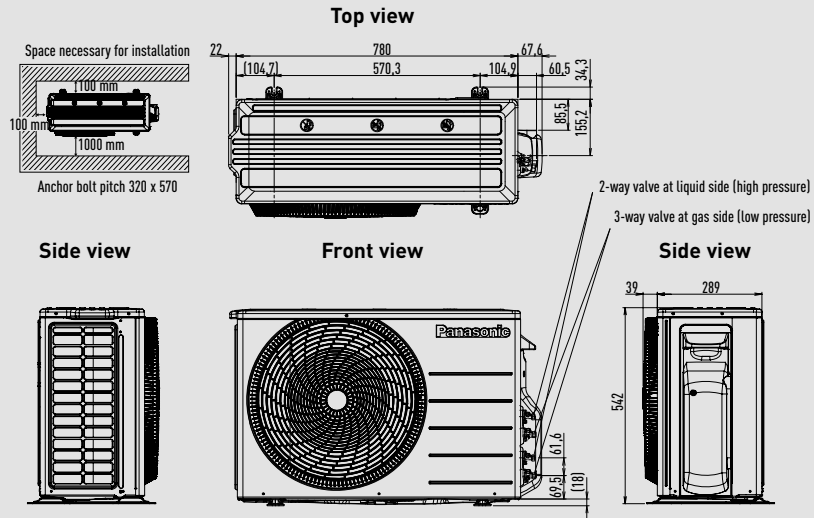

CU-3TZ52TBE

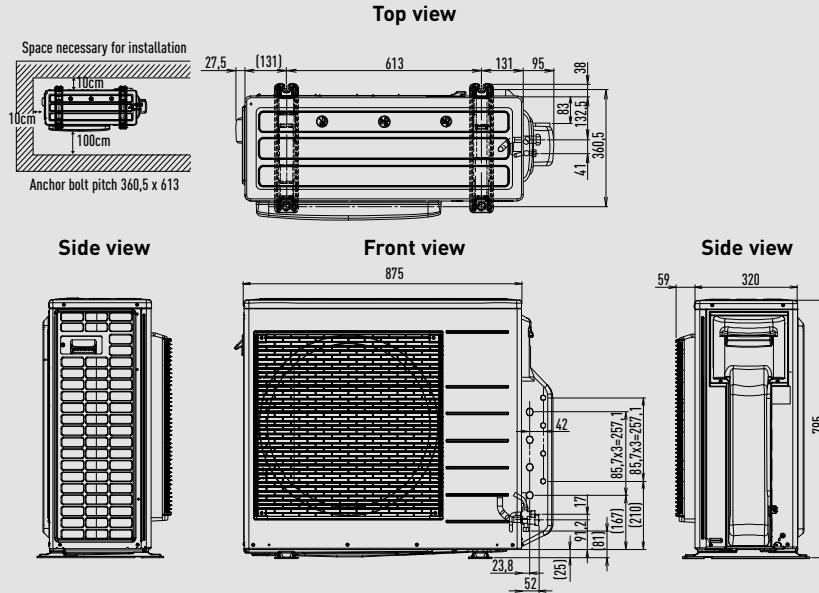

Wall-mounted Professional (from 2,5 to 4,2 kW)

Side view

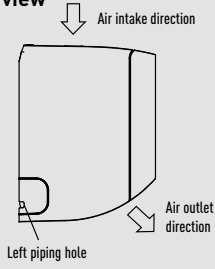

Front view

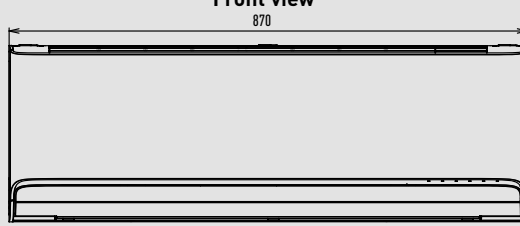

Side view

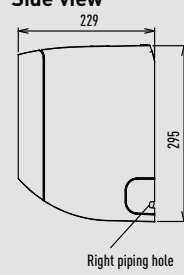

Bottom view

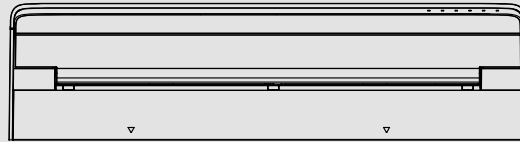

Rear view

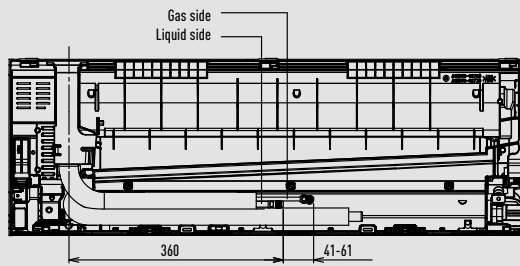

Relative position between the indoor unit and the installation plate

Front view

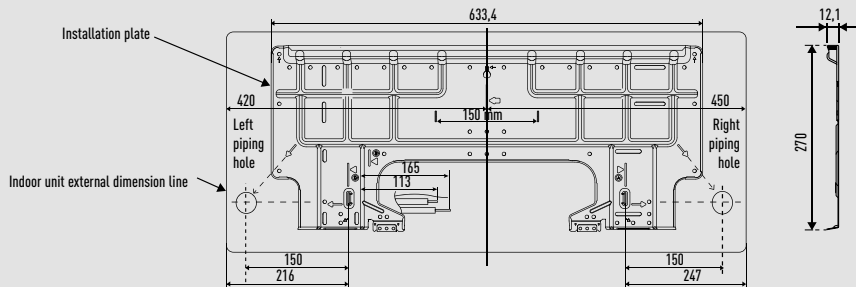

Top view

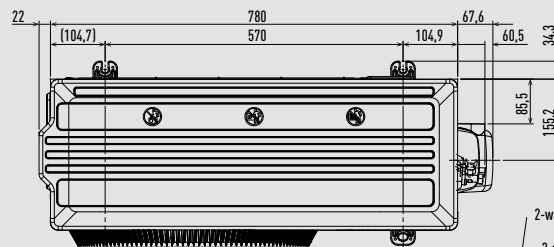

Side view

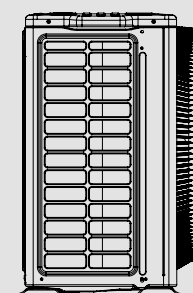

Front view

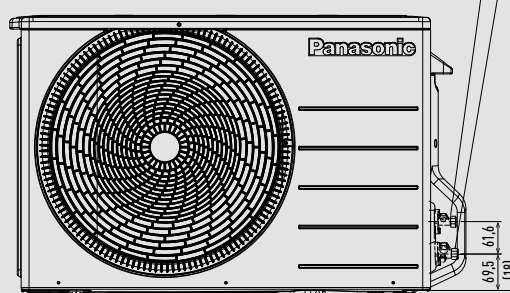

2-way valve at liquid side (high pressure)

3-way valve at gas side (low pressure)

Side view

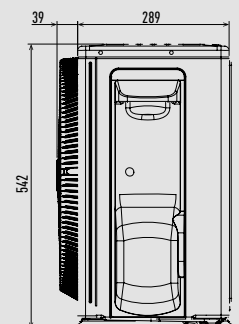



Wall-mounted Professional (5,0 and 7,1 kW)

Side view

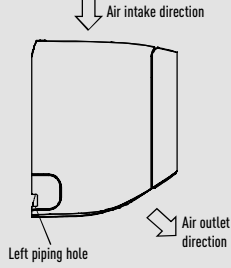

Front view

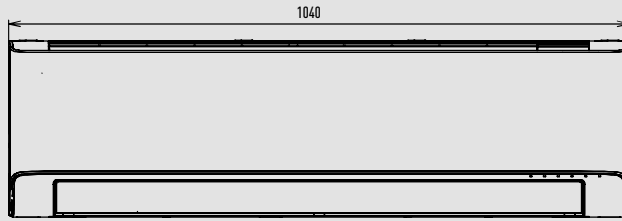

Side view

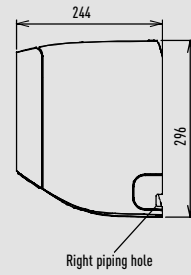

Bottom view

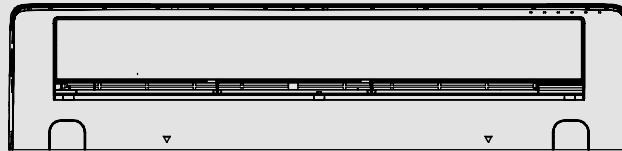

Rear view

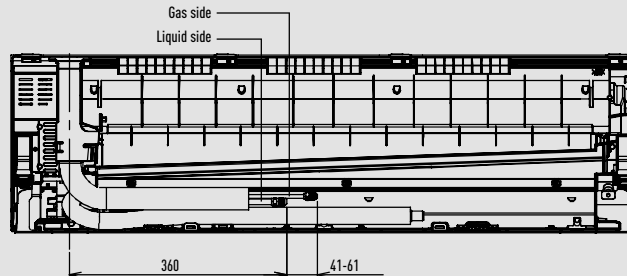

Relative position between the indoor unit and the installation plate

Front view

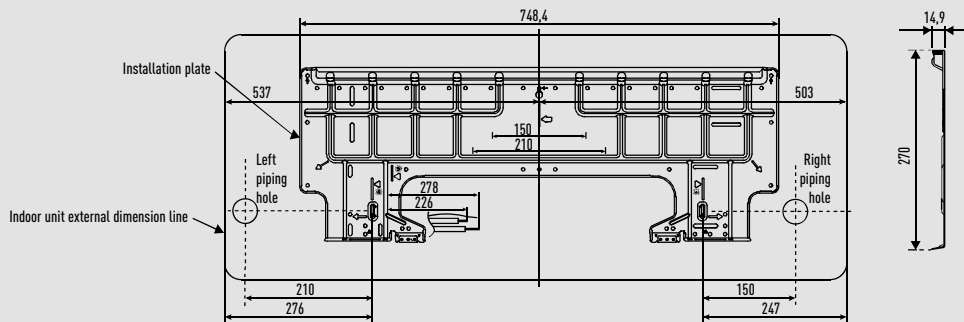

Top view

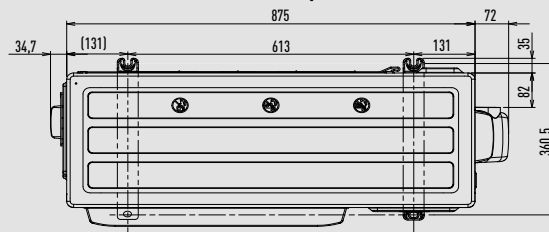

Side view

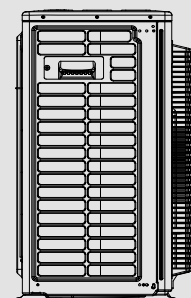

Front view

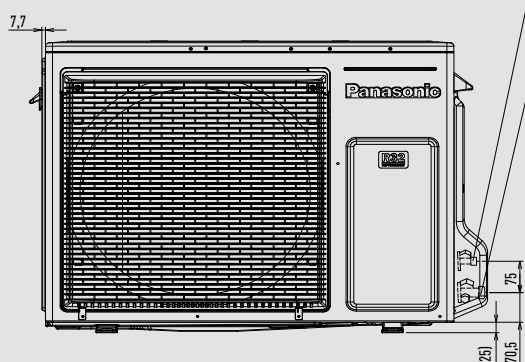

2-way valve at liquid side (high pressure)

3-way valve at gas side (low pressure)

Side view

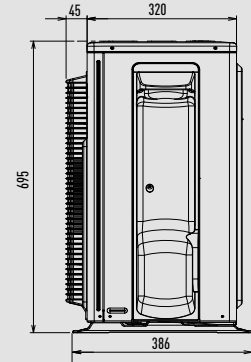

PACi NX Series wall-mounted

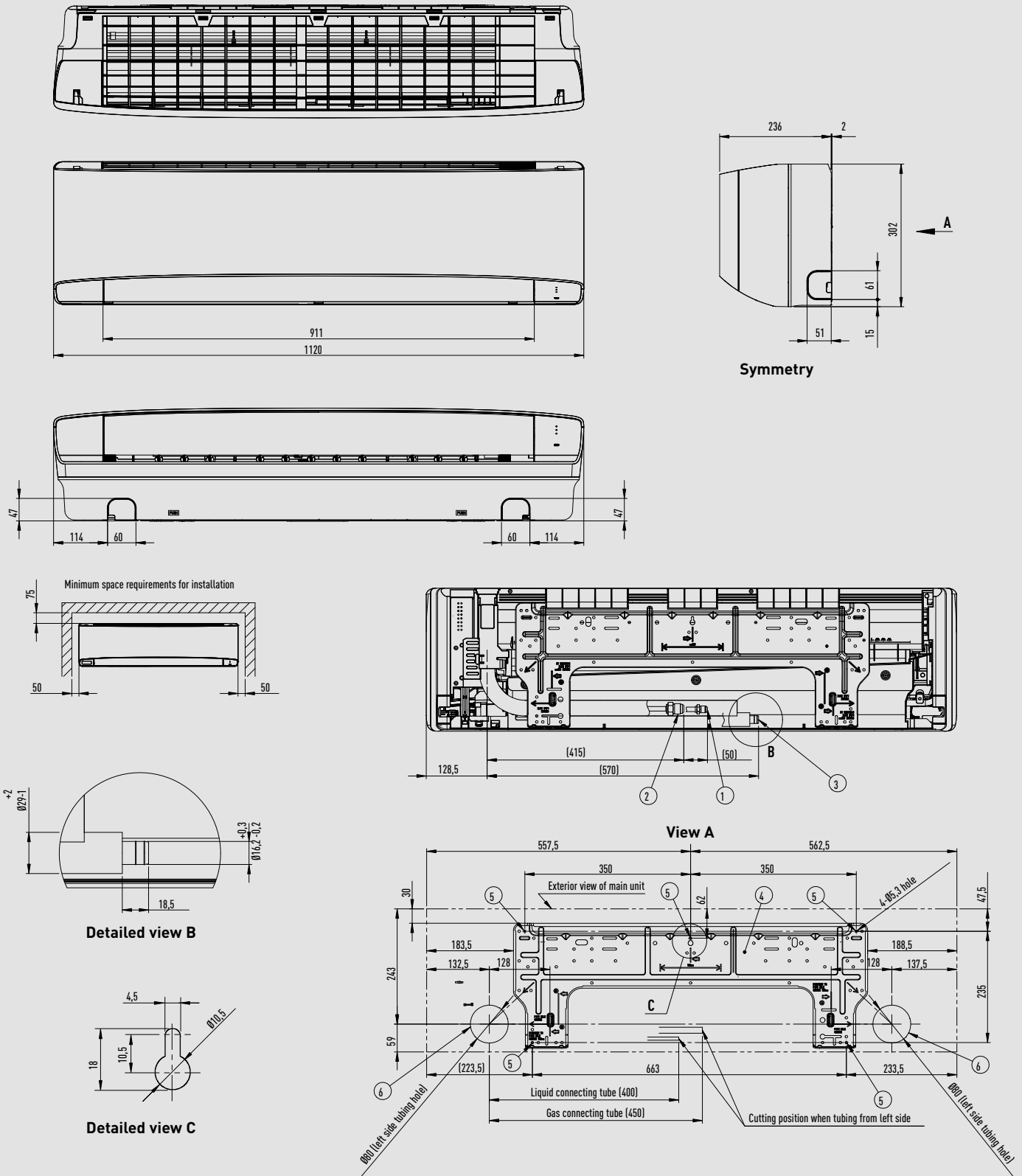

Type	S-3650PK3E	S-6010PU3E
1 Refrigerant tubing (liquid)	Ø6,35 (flared)	Ø9,52 (flared) ¹⁾
2 Refrigerant tubing (gas)	Ø12,70 (flared)	60: Ø15,88 (flared) ²⁾ 71: Ø15,88 (flared) 100: Ø15,88 (flared)
3 Drain hose		
4 Rear panel		
5 Rear panel fixing holes (Ø5,3 holes or as shown in figure "C")		
6 Tubing and wiring holes (Ø80)		

1) When connecting with U-60PZ3E5, U-71PZ3E5 or U-60PZH3E5, connect the liquid socket tube (Ø9,52 - Ø6,35) to the liquid tubing side indoor unit.
2) When connecting with U-60PZ3E5 or U-60PZH3E5, connect the gas socket tube (Ø15,88 - Ø12,7) to the gas tubing side indoor unit.



PACi NX Series 4 way 60x60 cassette

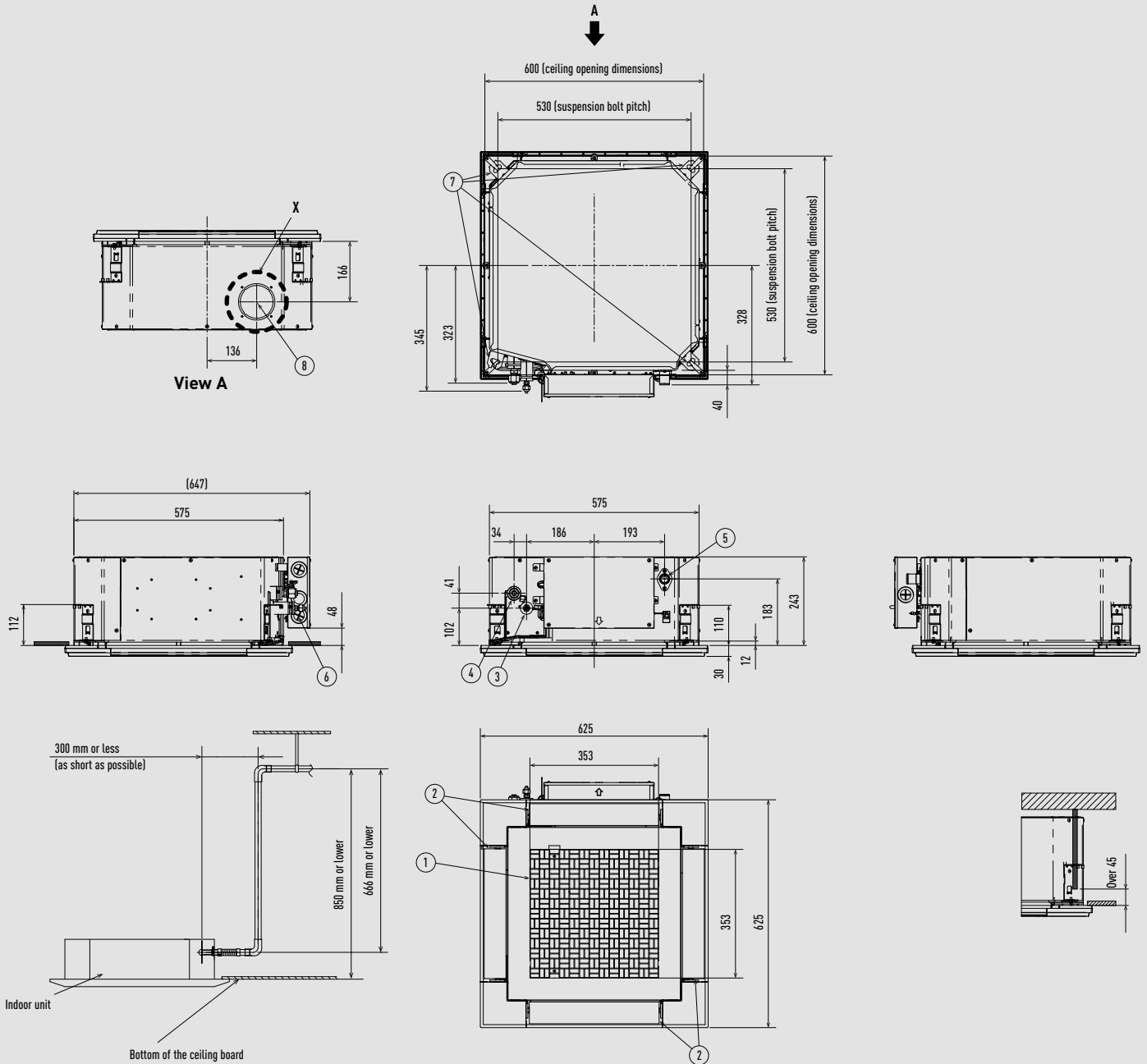

* Length of supplied drain pipe= 250 mm.

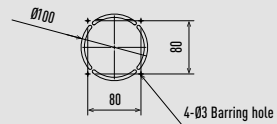

Detailed view X

Type	25-50	60
1 Air intake grille		
2 Air outlet		
3 Refrigerant tubing (liquid)	Ø6,35 (flared)	Ø9,52 (flared) ¹⁾
4 Refrigerant tubing (gas)	Ø12,70 (flared)	Ø15,88 (flared) ²⁾
5 Drain tube connection port VP20		
6 Power supply port		
7 Suspension bolt hole (4-11 x 26 slot)		
8 Fresh air intake duct connection port (Ø100) ³⁾		

1) When connecting with U-60PZ3E5A or U-60PZH3E5, connect the liquid socket tube (Ø9,52-Ø6,35) to the liquid tubing side indoor unit.
 2) When connecting with U-60PZ3E5A or U-60PZH3E5, connect the gas socket tube (Ø15,88-Ø12,70) to the gas tubing side indoor unit.
 3) Necessary to attach duct connecting flange (field supply).

Filter dimension: 362 x 362 x 15 mm.



PACi NX Series ceiling (S-3650PT3E)

Detailed view of intaking outside air duct connection port

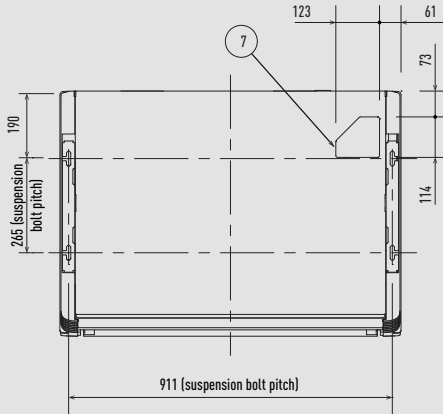
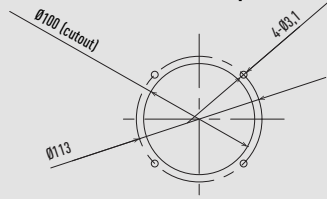

Distance of each exposed bolt must be of equal length within 50 mm.

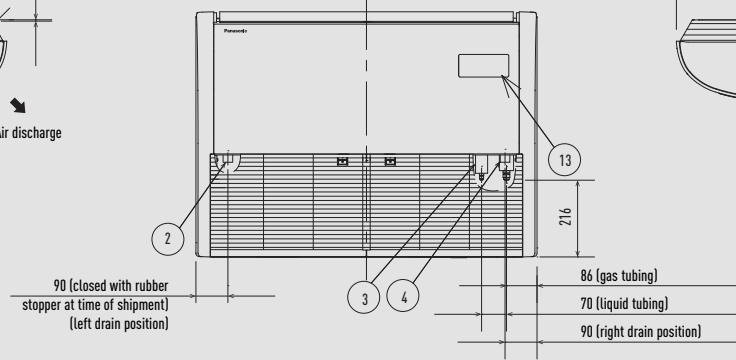
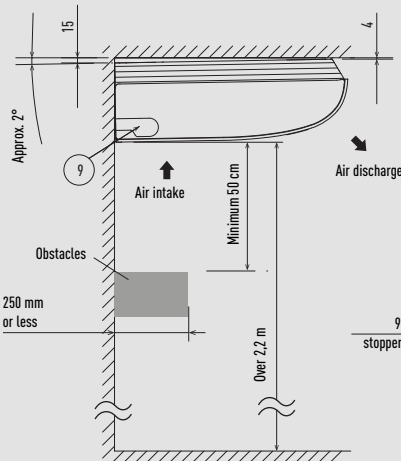
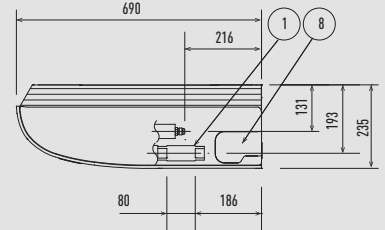
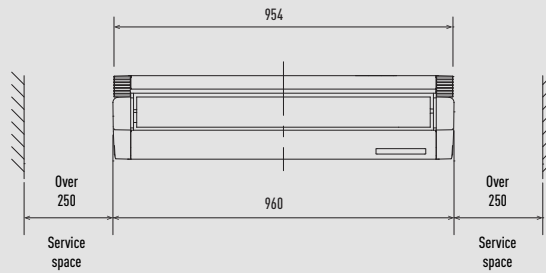
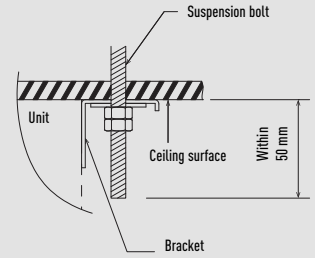

Hole position of indoor unit rear-side (figure shows view from front)

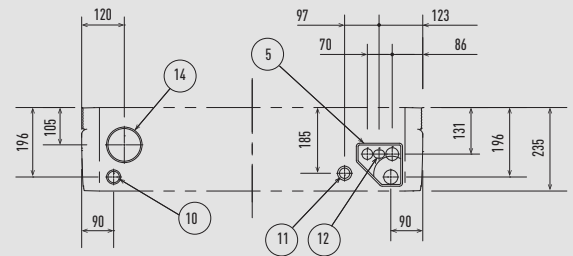

Tubing hole position on wall surface (figure shows view from front)

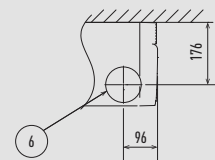

1	Drain port VP20	Inside diameter Ø26 mm, drain hose supplied
2	Left drain position	
3	Refrigerant tubing (liquid)	Ø6,35mm (flared)
4	Refrigerant tubing (gas)	Ø12,7mm (flared)
5	Cover of rear tubing hole	
6	Tubing hole on wall surface	Ø100 mm
7	Upper side tubing port	
8	Right side drain hose outlet port (cutout)	
9	Left side drain hose outlet port (cutout)	
10	Left-rear side drain hose outlet port (cutout)	
11	Power inlet port	
12	Remote control wiring and inter-unit wiring inlet port	
13	Wireless remote controller receiver installation location	
14	Outside air intake duct connection port	Ø100 mm (cutout)

Filter dimension: 421 x 250 x 16 mm x 2 pcs.

PACi NX Series ceiling (S-6071PT3E)

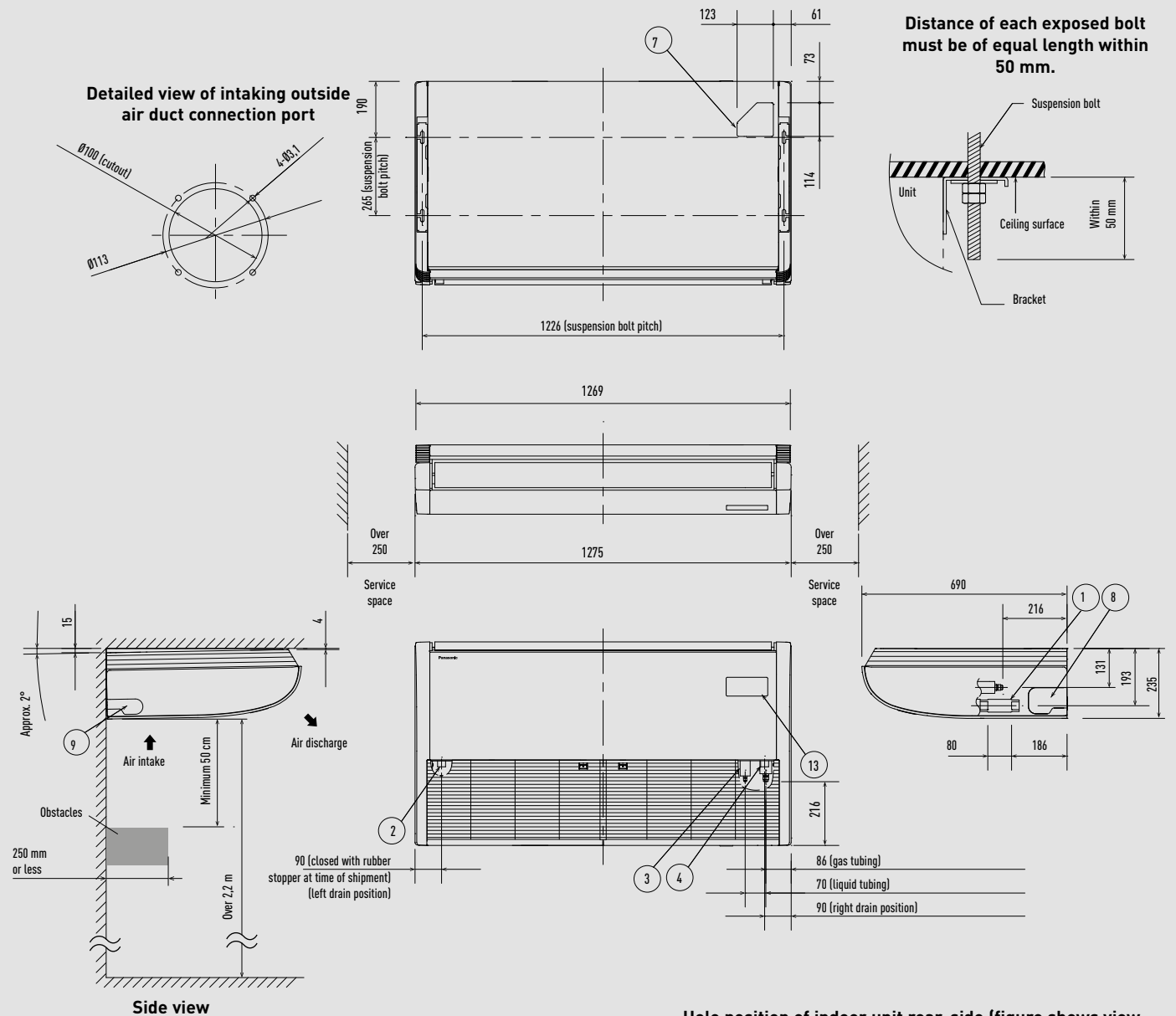

Hole position of indoor unit rear-side (figure shows view from front)

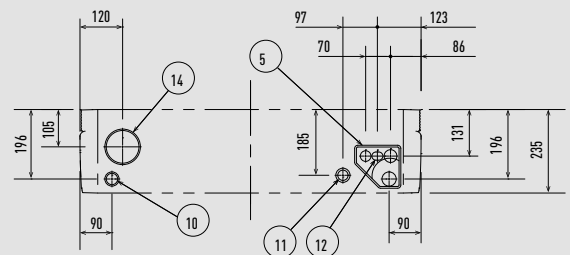

Tubing hole position on wall surface (figure shows view from front)

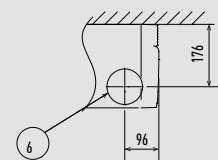

1	Drain port VP20	Inside diameter Ø26 mm, drain hose supplied
2	Left drain position	
3	Refrigerant tubing (liquid)	Ø9,52 (flared) ¹⁾
4	Refrigerant tubing (gas)	Ø15,88 (flared) ²⁾
5	Cover of rear tubing hole	
6	Tubing hole on wall surface	Ø100 mm
7	Upper side tubing port	
8	Right side drain hose outlet port (cutout)	
9	Left side drain hose outlet port (cutout)	
10	Left-rear side drain hose outlet port (cutout)	
11	Power inlet port	
12	Remote control wiring and inter-unit wiring inlet port	
13	Wireless remote controller receiver installation location	
14	Outside air intake duct connection port	Ø100 mm (cutout)

1) When connecting with U-60PZ3E5, U-71PZ3E5 or U-60PZH3E5, connect the liquid socket tube (Ø9,52 - Ø6,35) to the liquid tubing side indoor unit.
 2) When connecting with U-60PZ3E5 or U-60PZH3E5, connect the gas socket tube (Ø15,88 - Ø12,7) to the gas tubing side indoor unit.

Filter dimension: 579 x 250 x 16 mm x 2 pcs.

Unit: mm

PACi NX Series ceiling (S-1014PT3E)

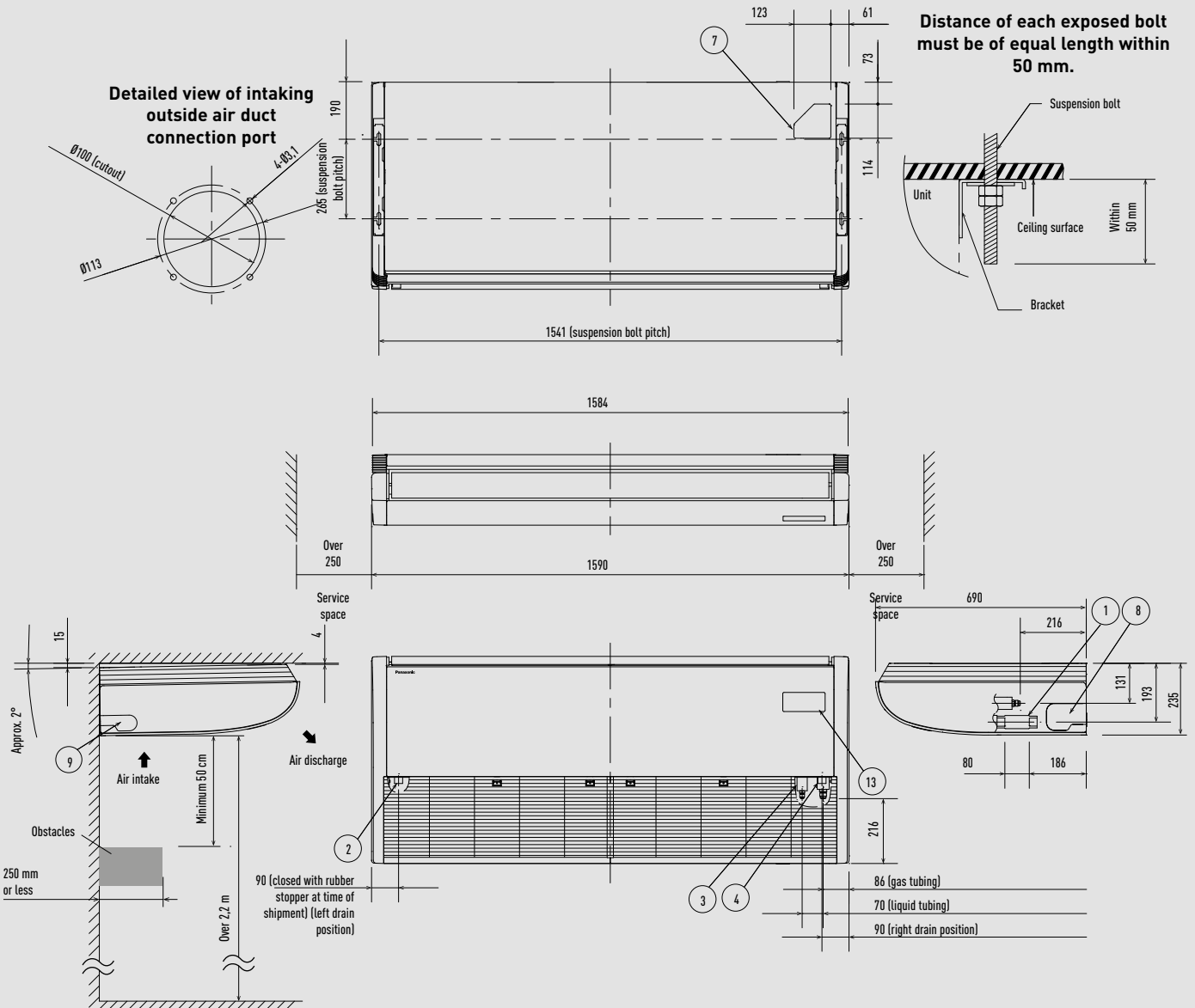

Hole position of indoor unit rear-side (figure shows view from front)

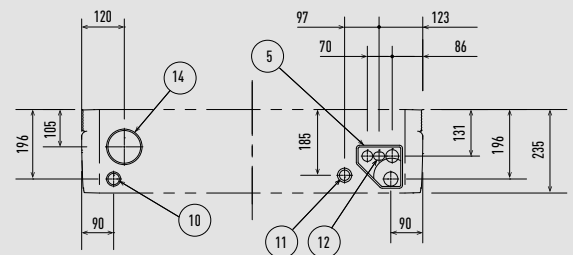

Tubing hole position on wall surface (figure shows view from front)

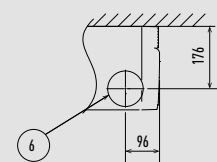

1	Drain port VP20	Inside diameter Ø26 mm, drain hose supplied
2	Left drain position	
3	Refrigerant tubing (liquid)	Ø9,52 (flared)
4	Refrigerant tubing (gas)	Ø15,88 (flared)
5	Cover of rear tubing hole	
6	Tubing hole on wall surface	Ø100 mm
7	Upper side tubing port	
8	Right side drain hose outlet port (cutout)	
9	Left side drain hose outlet port (cutout)	
10	Left-rear side drain hose outlet port (cutout)	
11	Power inlet port	
12	Remote control wiring and inter-unit wiring inlet port	
13	Wireless remote controller receiver installation location	
14	Outside air intake duct connection port	Ø100 mm (cutout)

Filter dimension: 736 x 250 x 16 mm x 2 pcs.

PACi NX Series adaptive ducted unit

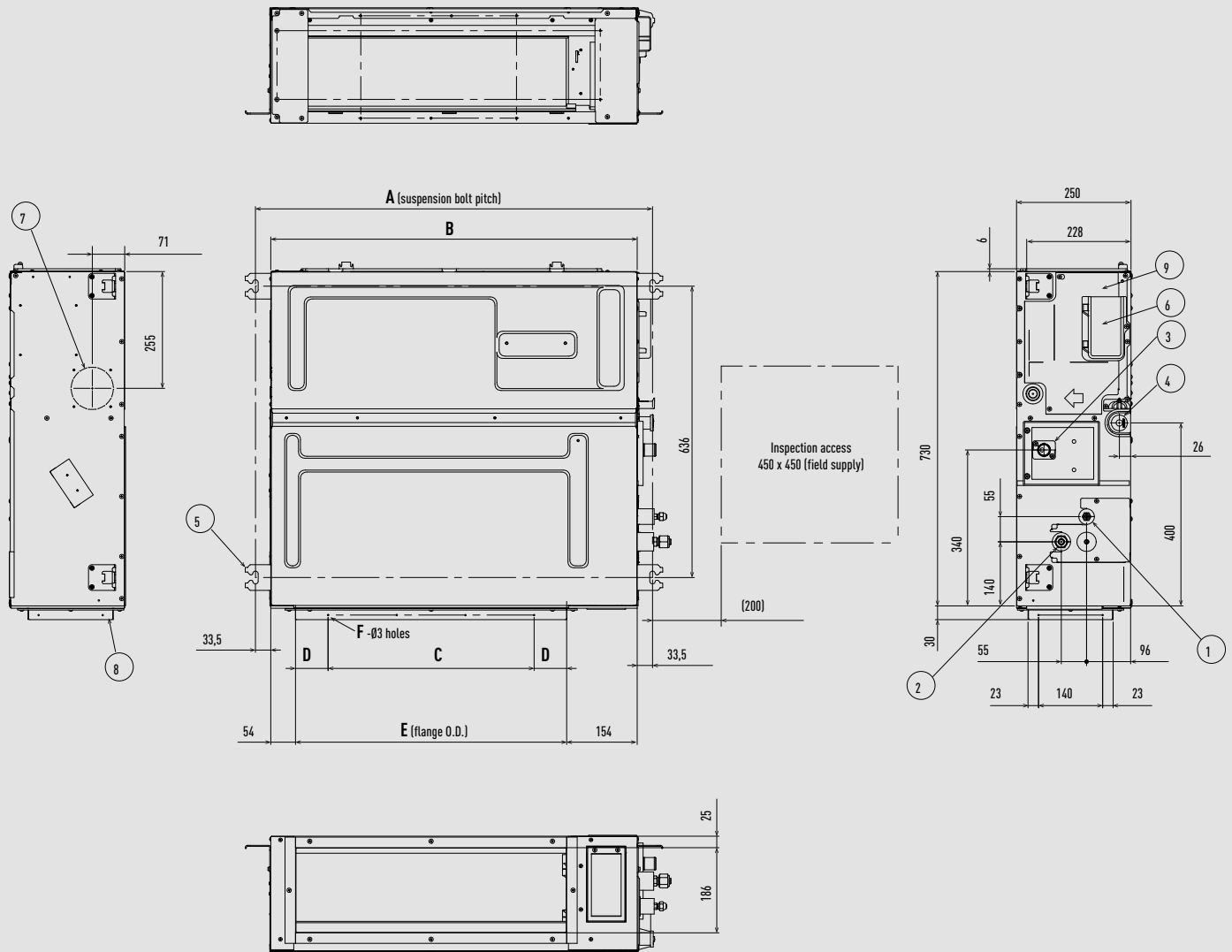

Type	A	B	C	D	E	F
	mm	mm	mm	mm	mm	Q'ty
S-3650PF3E	867	800	450 (pitch 150 x 3)	71	592	12
S-6071PF3E	1067	1000	750 (pitch 150 x 5)	21	792	16
S-1014PF3E	1467	1400	1050 (pitch 150 x 7)	71	1192	20

Type	S-3650PF3E	S-6071PF3E	S-1014PF3E
1 Refrigerant tubing (liquid)	Ø6,35 (flared)	Ø9,52 (flared) ¹⁾	Ø9,52 (flared)
2 Refrigerant tubing (gas)	Ø12,70 (flared)	60: Ø15,88 (flared) ²⁾ 71: Ø15,88 (flared)	Ø15,88 (flared)
3 Upper drain port VP20	Ø26 (200 mm flexible hose supplied)		
4 Suspension lug	4-12x30		
5 Power supply port			
6 Bottom drain port VP20	Ø26 mm		
7 Fresh air intake duct connection port	Ø100 ³⁾		
8 Flange for flexible air outlet duct			
9 Electrical component box			

1) When connecting with U-60PZ3E5, U-71PZ3E5 or U-60PZH3E5, connect the liquid socket tube (Ø9,52 - Ø6,35) to the liquid tubing side indoor unit.
 2) When connecting with U-60PZ3E5 or U-60PZH3E5, connect the gas socket tube (Ø15,88 - Ø12,7) to the gas tubing side indoor unit.
 3) Necessary to attach duct connecting flange (field supply).

Filter dimension: 520 x 520 x 15 mm.

* 319 mm for S-1014PU3E.
 ** 187 mm for S-1014PU3E.

Unit: mm



Big PACi high static pressure hide-away 20,0-25,0 kW

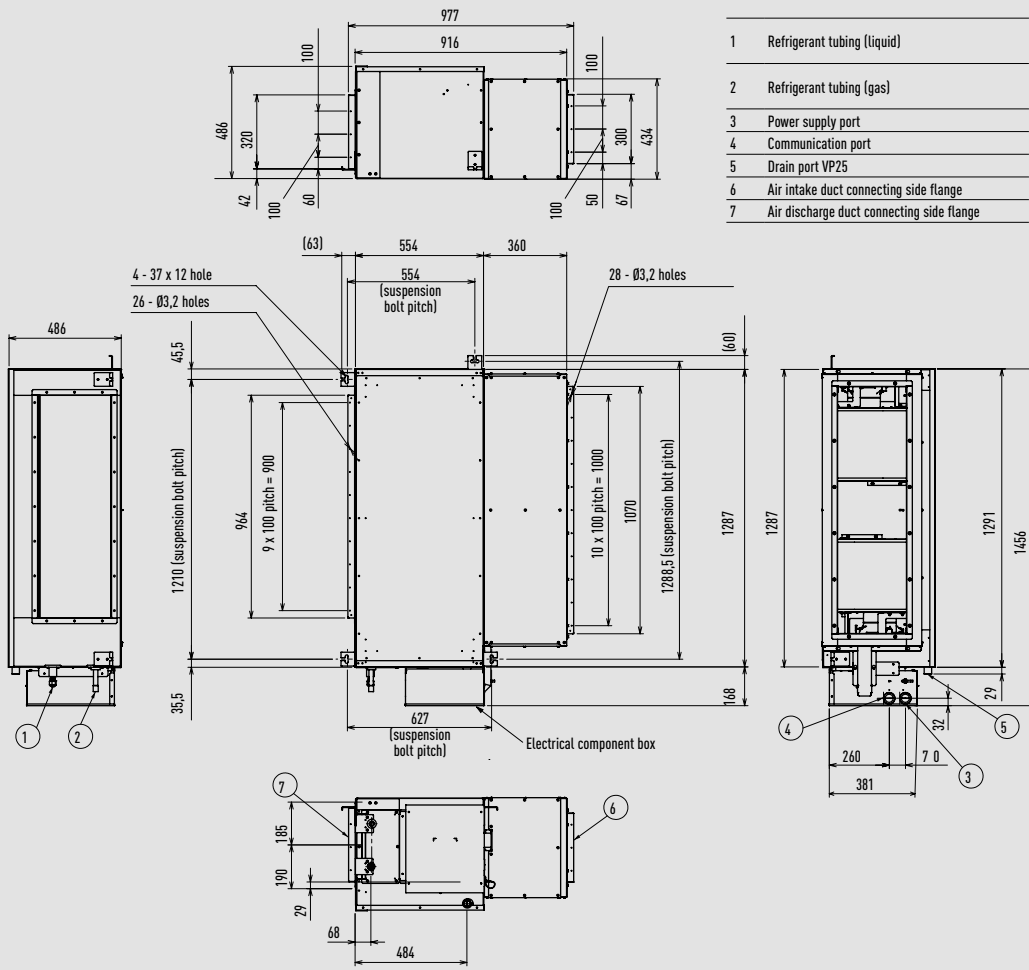

		S-200PE3E5B	S-250PE3E5B
1	Refrigerant tubing (liquid)	Connection tubing Ø12,70 → Ø9,52	Ø12,70 (flared)
2	Refrigerant tubing (gas)	Connection tubing Ø19,05 → Ø25,40	Ø19,05 (brazing)
3	Power supply port		
4	Communication port		
5	Drain port VP25		
6	Air intake duct connecting side flange		
7	Air discharge duct connecting side flange		

Dimensions of suspension bolt pitch and unit.
Required Minimum Space for Installation and Service

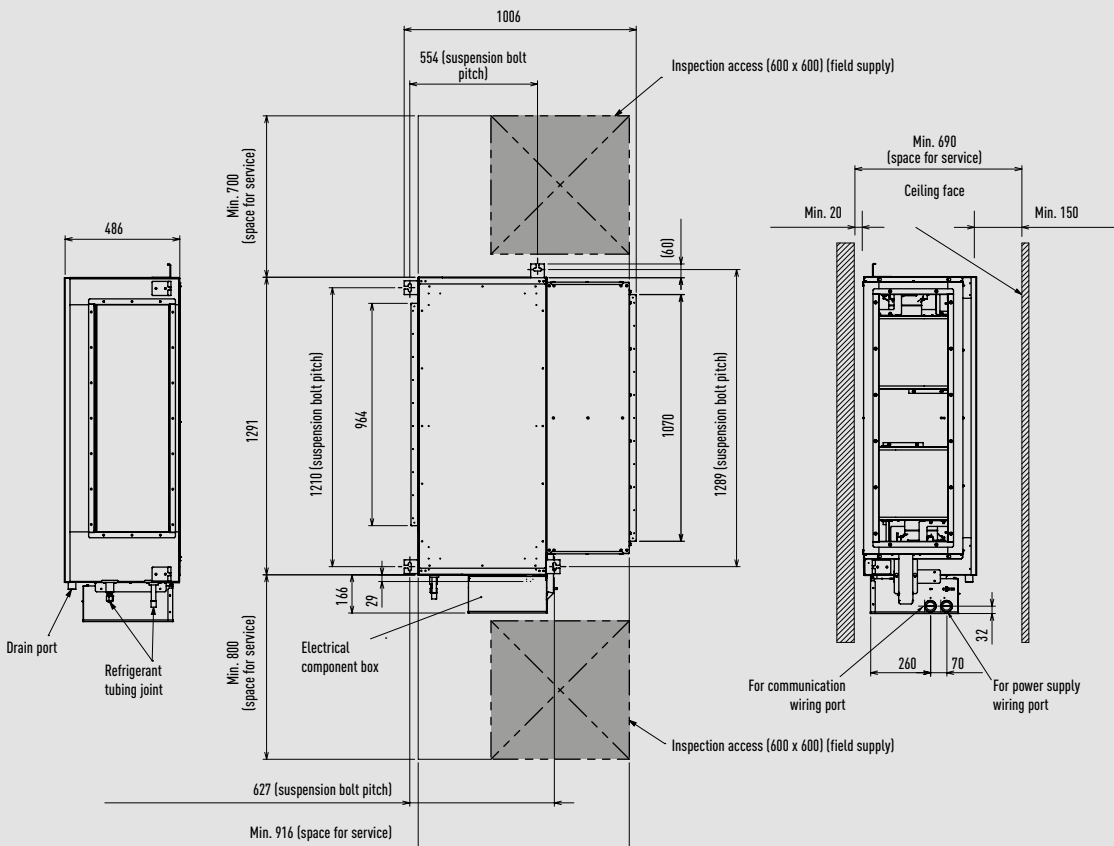

PACi 4 way 60x60 cassette

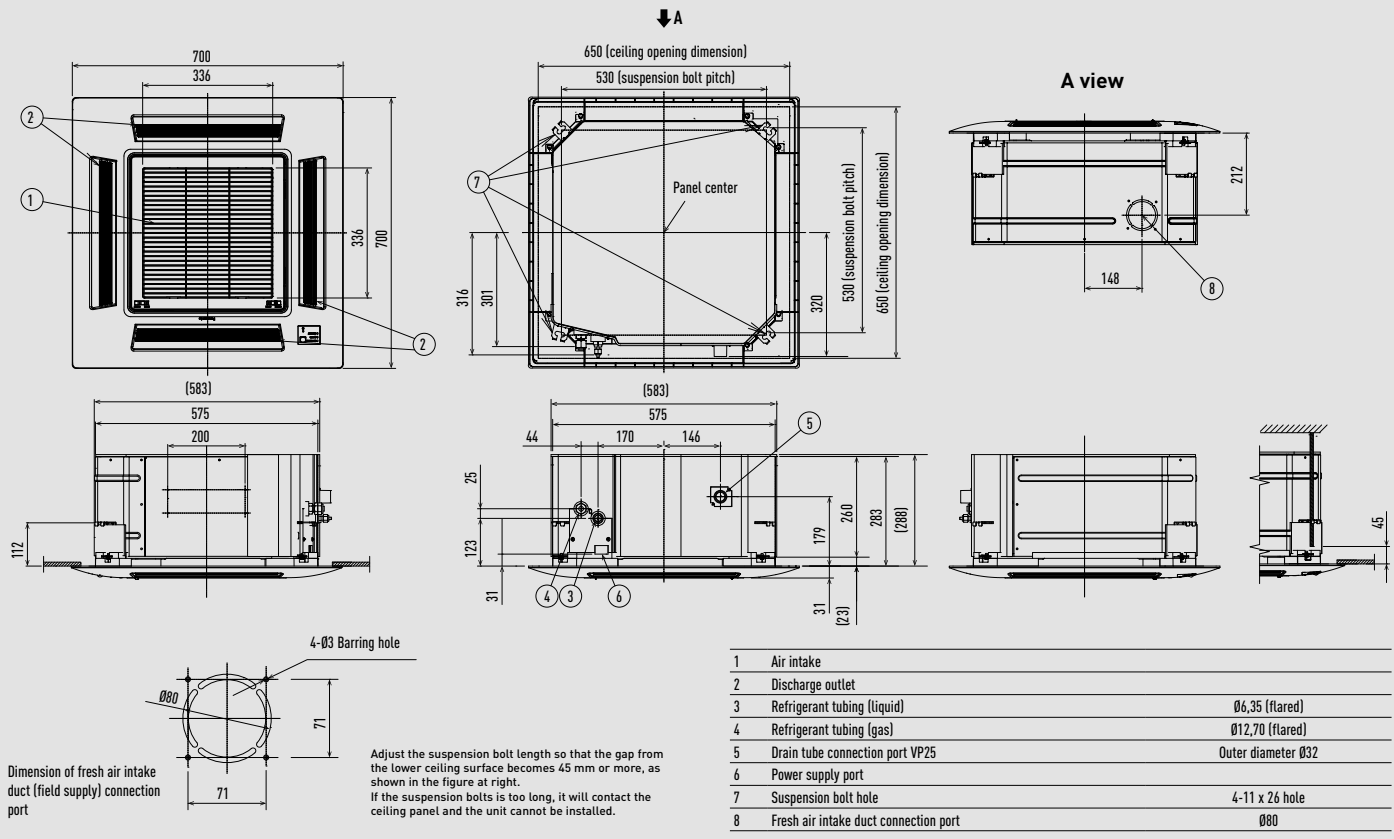

Unit: mm

PACi NX Series Elite outdoor unit from 2,5 to 6,0 kW and Standard 6,0 and 7,1 kW

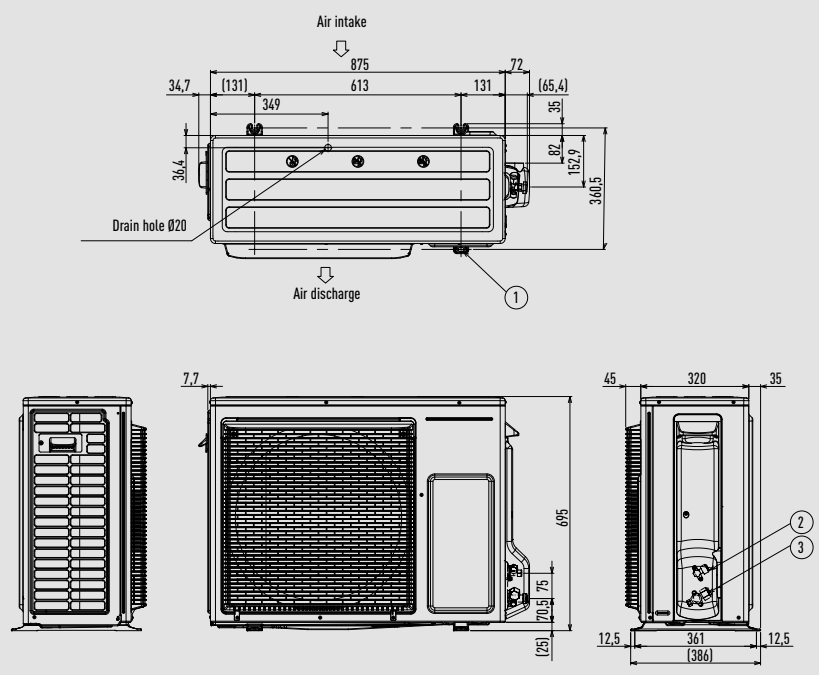

1	Mounting hole (4-R6,5), anchor bolt: M10
2	Refrigerant tubing (liquid tube), Ø6,35 (flared)
3	Refrigerant tubing (gas tube), Ø12,70 (flared). U-71P23E5, Ø15,88 (flared)

Unit: mm

PACi NX Series Standard outdoor unit 3,6 and 5,0 kW

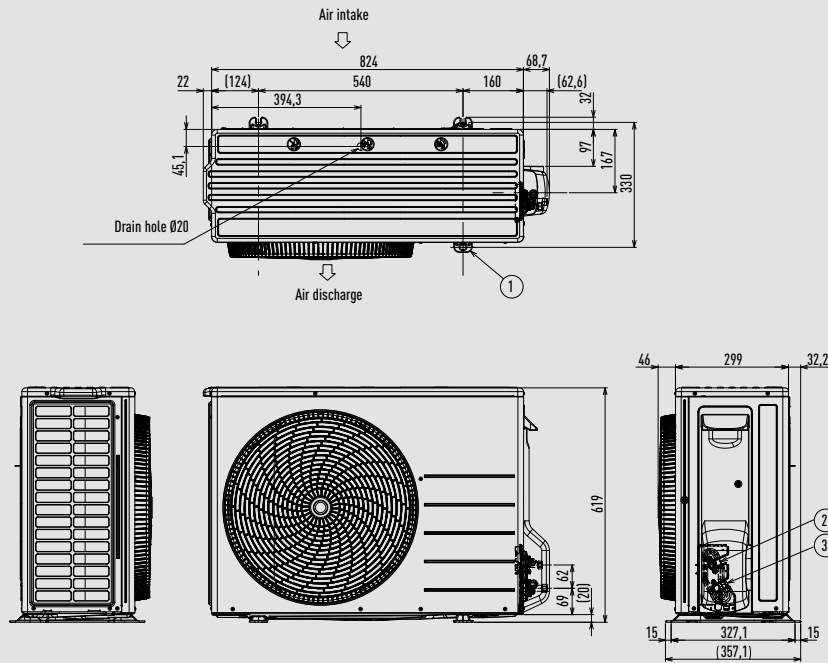

- | | |
|---|--|
| 1 | Mounting hole (4-R6,5), anchor bolt: M10 |
| 2 | Refrigerant tubing (liquid tube), Ø6,35 (flared) |
| 3 | Refrigerant tubing (gas tube), Ø12,70 (flared) |

Unit: mm

PACi NX Series Standard outdoor unit from 10,0 to 14,0 kW

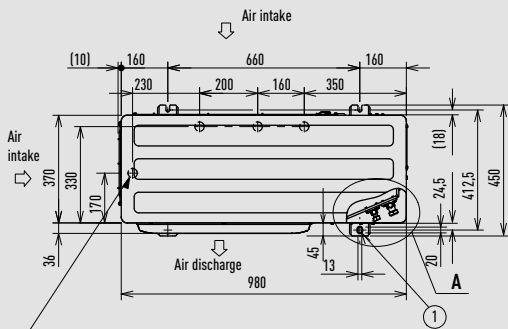

- | | |
|---|--|
| 1 | Mounting hole, anchor bolt: M10 |
| 2 | Refrigerant tubing (liquid tube), Ø9,52 (flared) |
| 3 | Refrigerant tubing (gas tube), Ø15,88 (flared) |
| 4 | Refrigerant piping hole |
| 5 | Electrical wiring port (Ø13) |
| 6 | Electrical wiring port (Ø22) |
| 7 | Electrical wiring port (Ø27) |
| 8 | Electrical wiring port (Ø35) |

4xØ32 holes (holes for drain). When using a drain pipe, install the drain socket (field supply) on to the drain hole. Seal the other drain hole with the rubber cap

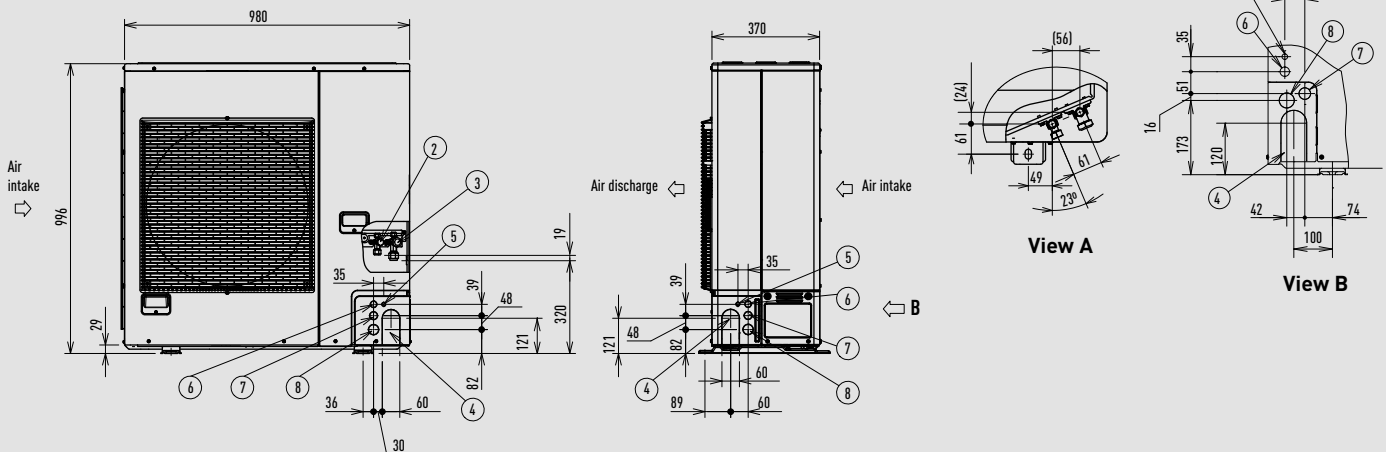

Unit: mm



Big PACi outdoor unit 20,0-25,0 kW

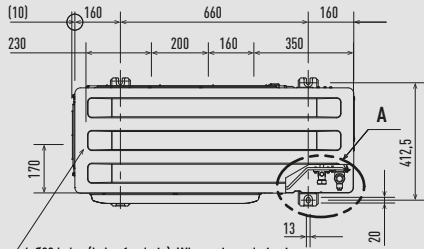

4xØ32 holes (holes for drain). When using a drain pipe, install the drain socket (field supply) onto the drain port. Seal the other drain port with the rubber cap.

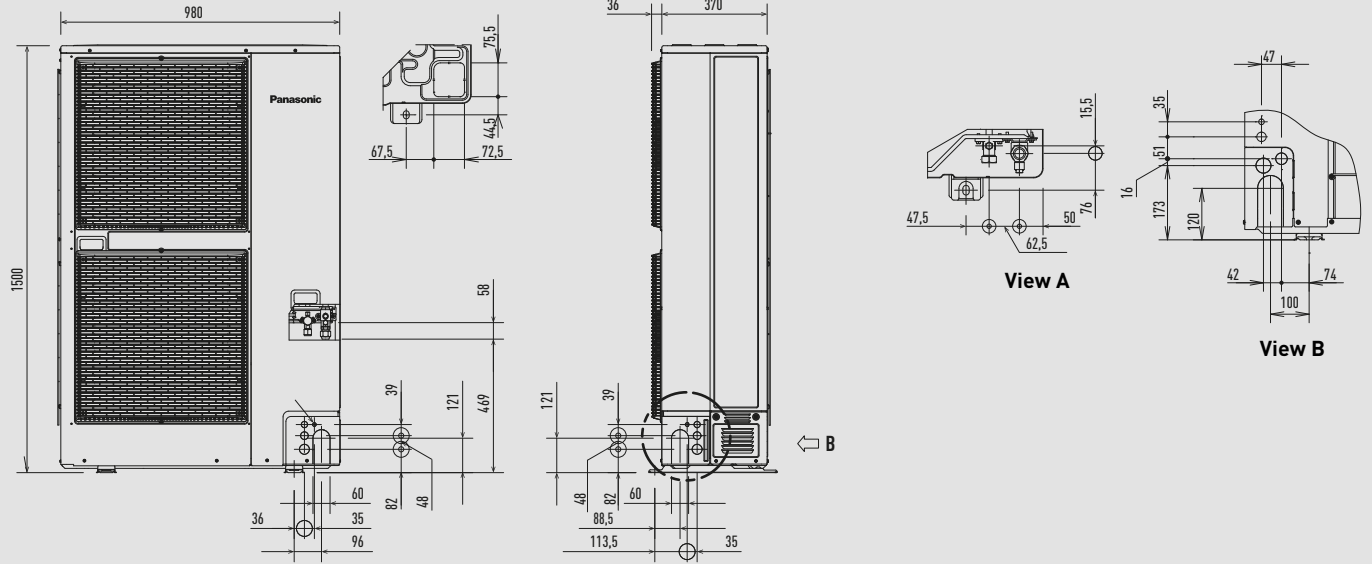

Unit: mm

PACi Elite outdoor unit 3,6 and 5,0 kW

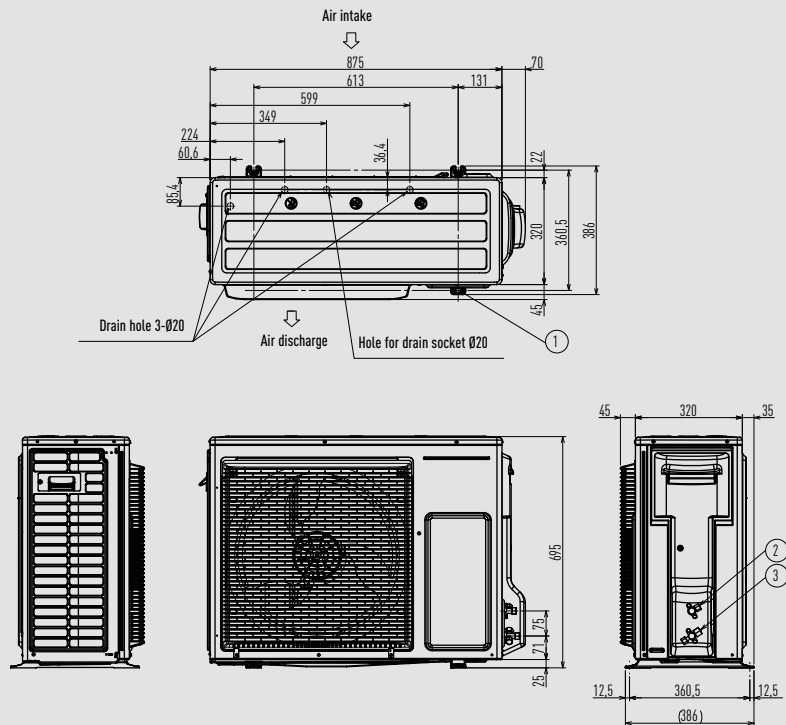

- 1 Mounting hole (4-R6,5), anchor bolt: M10
- 2 Refrigerant tubing (liquid tube), Ø6,35 (flared)
- 3 Refrigerant tubing (gas tube), Ø12,70 (flared)

Unit: mm

PACi PRO-HT Tank

PAW-VP750LDHW-1

PAW-VP1000LDHW-1

PAW-VP380L

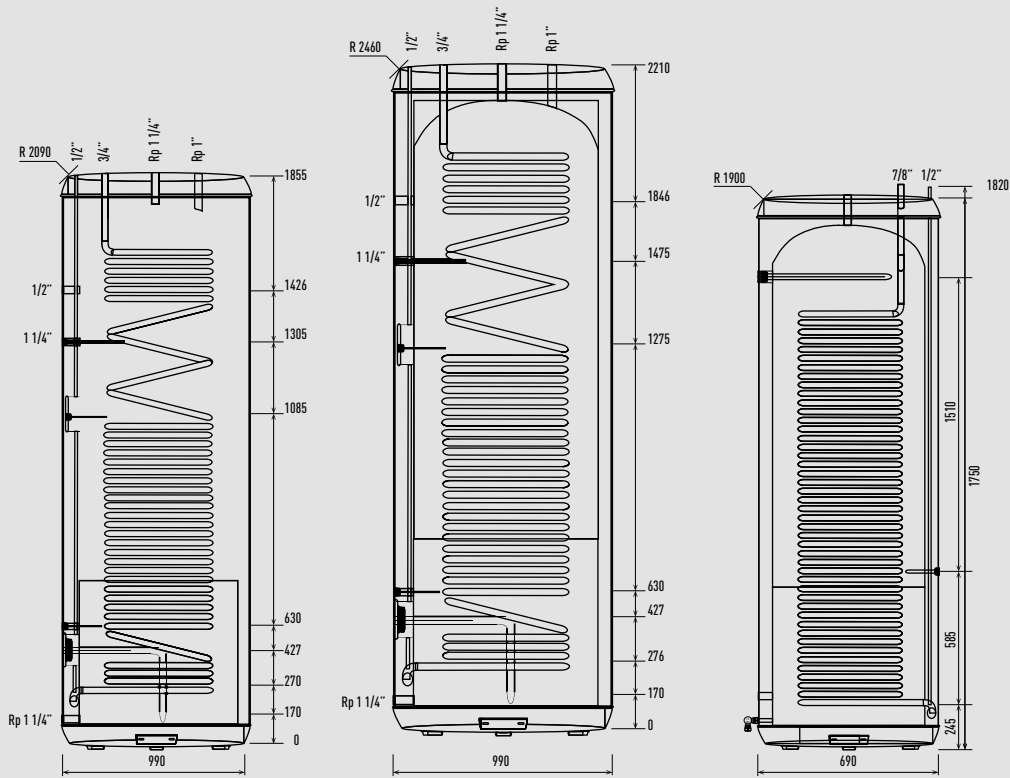

Note: R value indicates maximum overturning height.

Unit: mm

PACi water heat exchanger

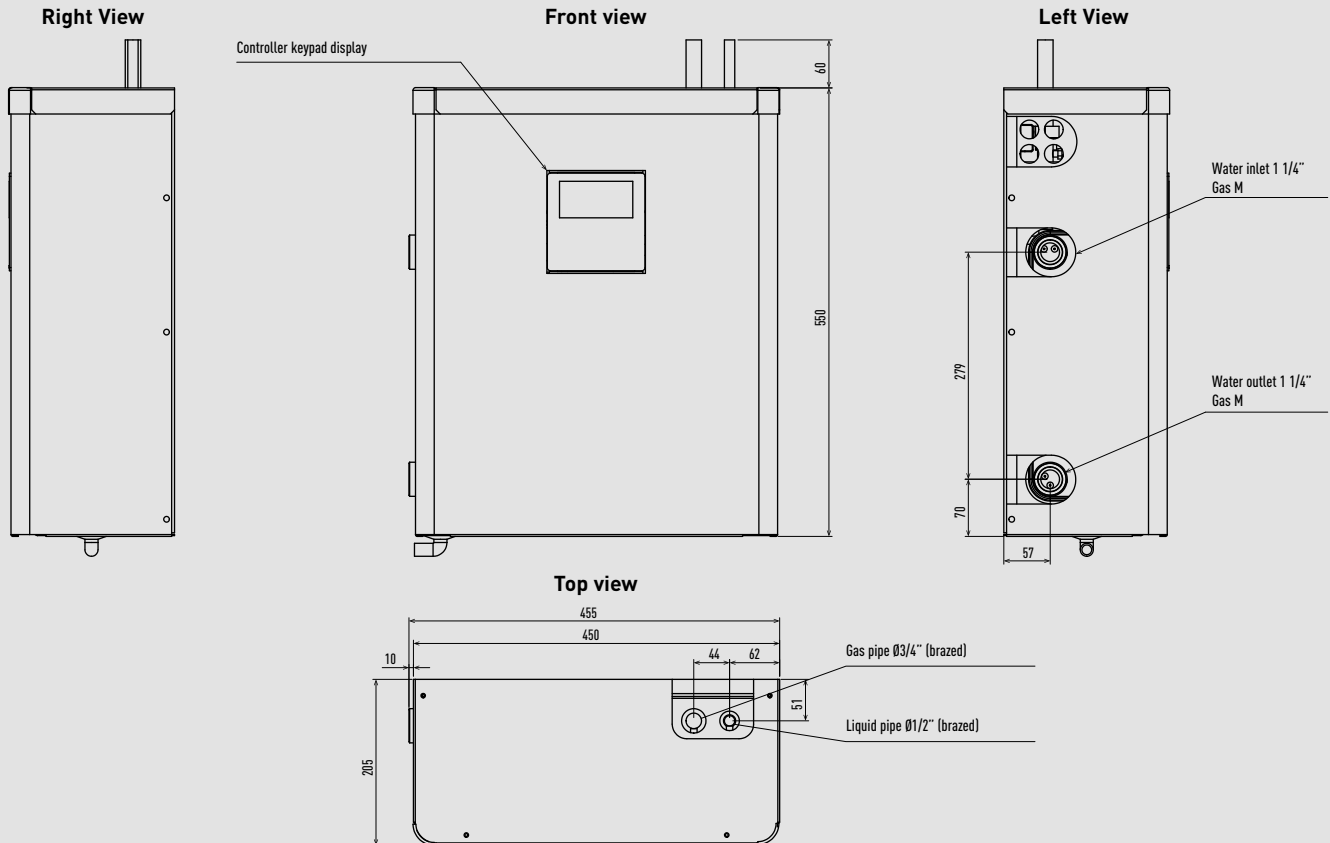

Unit: mm



Mini ECOi LZ2 Series 4 to 6 HP

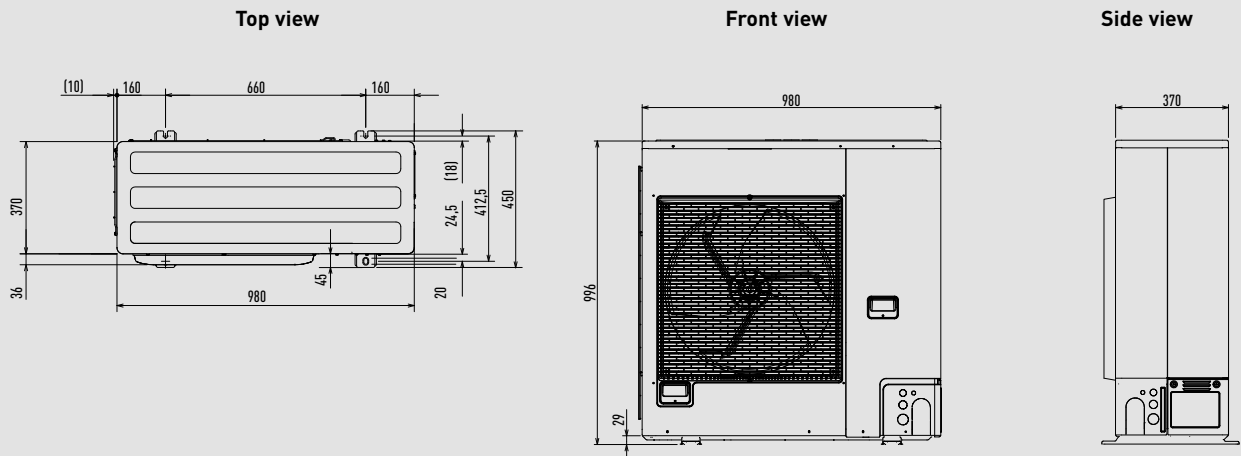

Unit: mm

Mini ECOi LZ2 Series 8 and 10 HP

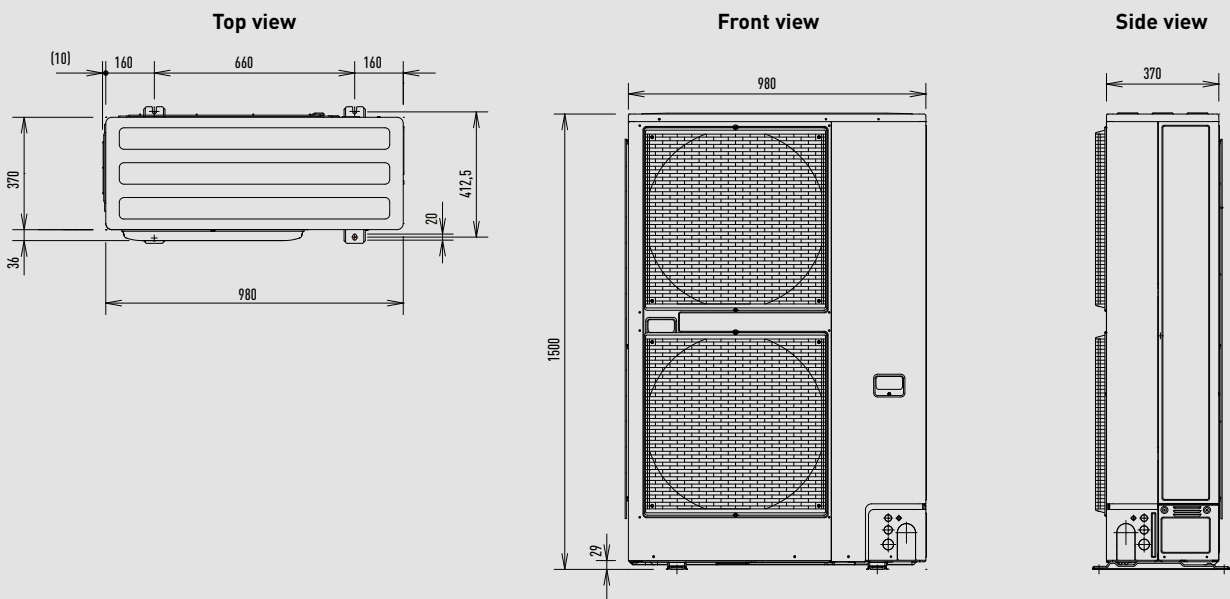

Unit: mm

Mini ECOi LE2 Series High Efficiency 4 to 6 HP

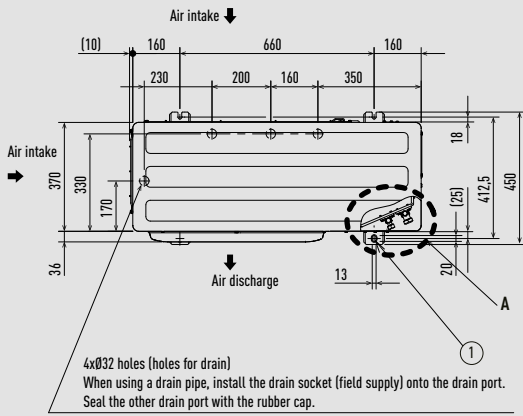

A View

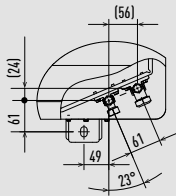

View Z

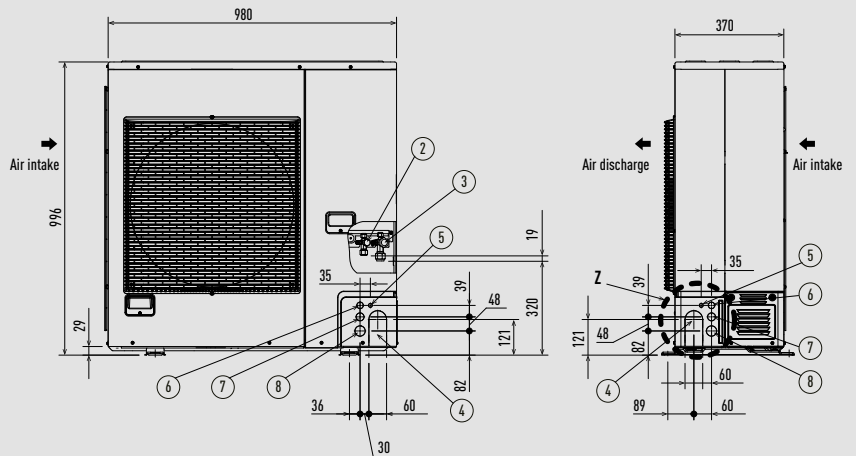
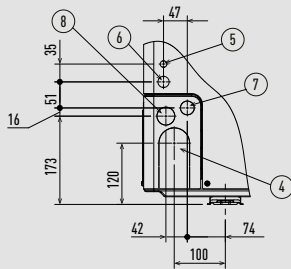

- 1 Mounting hole (4-R6.5), anchor bolt: M10
- 2 Refrigerant tubing (liquid), Ø9,52 (flared)
- 3 Refrigerant tubing (gas), Ø19,05 (flared)
- 4 Refrigerant piping port
- 5 Electrical wiring port (Ø13)
- 6 Electrical wiring port (Ø22)
- 7 Electrical wiring port (Ø27)
- 8 Electrical wiring port (Ø35)

Unit: mm

Mini ECOi LE1 Series High Efficiency 8 and 10 HP

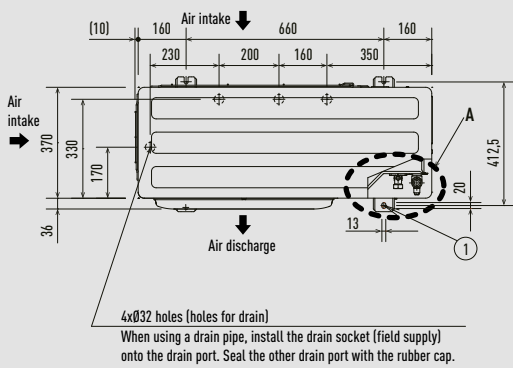

A View

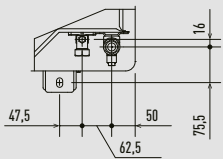

View Z

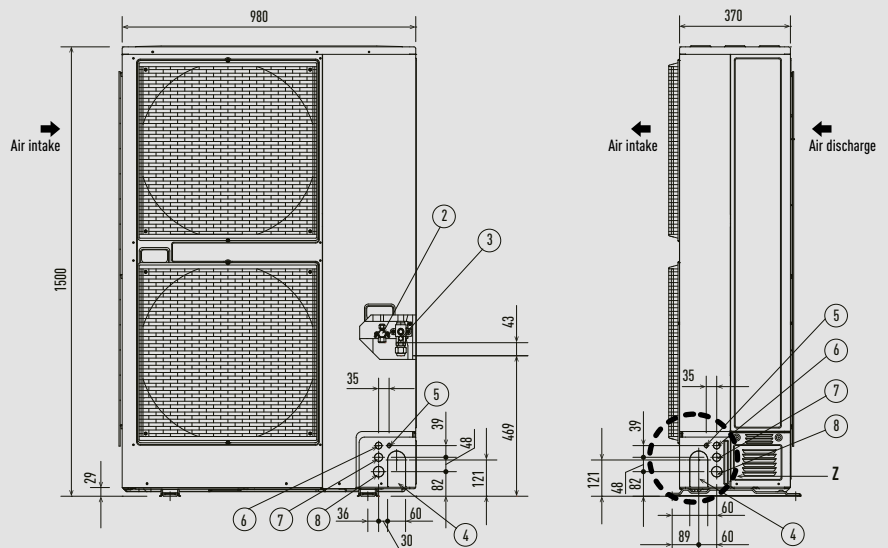
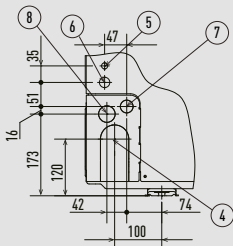

- 1 Mounting hole (4-R6.5), anchor bolt: M10
- 2 Refrigerant tubing (liquid), Ø9,52 (flared)
- 3 Refrigerant tubing (gas), Ø19,05 (flared)
- 4 Refrigerant piping port

- 5 Electrical wiring port (Ø13)
- 6 Electrical wiring port (Ø22)
- 7 Electrical wiring port (Ø27)
- 8 Electrical wiring port (Ø35)

The piping of the gas main has a diameter of Ø22,22, but the connection to the service valve of the outdoor unit has a diameter of Ø19,05, so a flare has to be used. Consequently, be sure to use the enclosed joint tube B and joint tube A in making connections (brazing).

Unit: mm



2-Pipe ECOi EX ME2 Series 8 and 10 HP

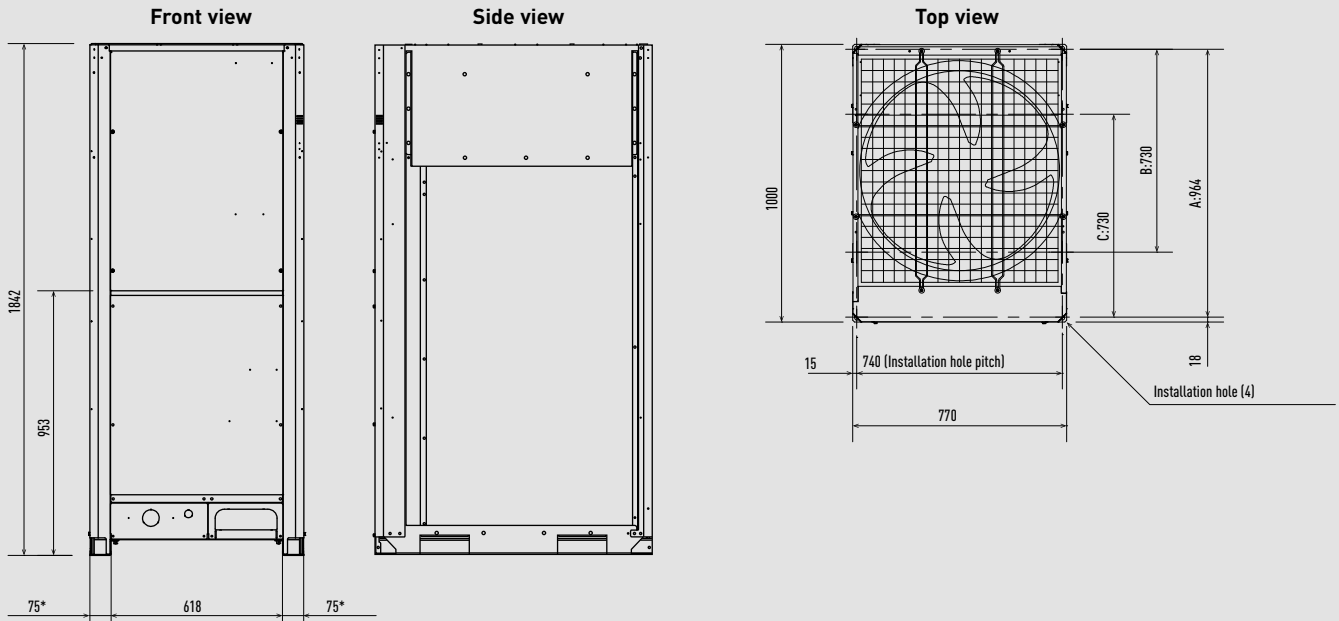

According to the installation site, you may choose the setting position in the depth direction of the anchor bolt from A, B or C.

- A: 964 (Installation hole pitch). The piping is routed out from the front.
- B: 730 (Installation hole pitch)*. The piping is routed out from the bottom.
- C: 730 (Installation hole pitch).

* Installation fixing bracket. Installation side.

Unit: mm

2-Pipe ECOi EX ME2 Series 12, 14 and 16 HP / 3-Pipe ECOi EX MF3 Series 8 to 16 HP

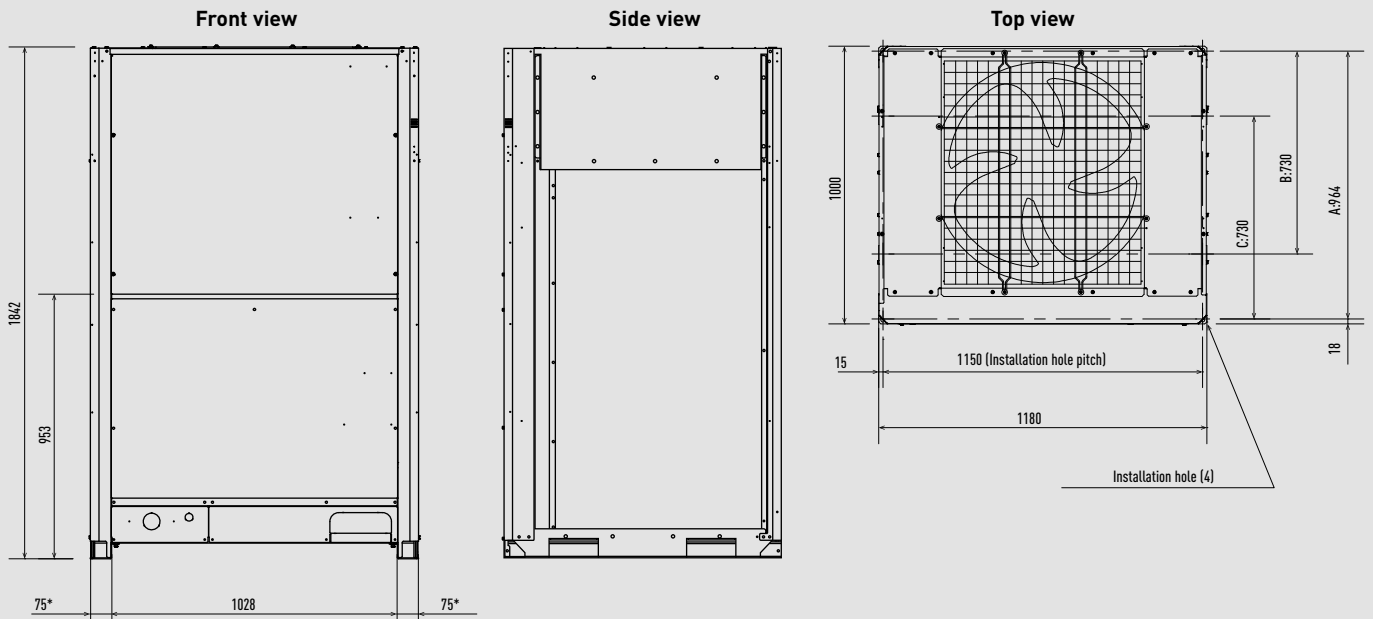

According to the installation site, you may choose the setting position in the depth direction of the anchor bolt from A, B or C.

- A: 964 (Installation hole pitch). The piping is routed out from the front.
- B: 730 (Installation hole pitch)*. The piping is routed out from the bottom.
- C: 730 (Installation hole pitch).

* Installation fixing bracket. Installation side.

Unit: mm

2-Pipe ECOi EX ME2 Series 18 and 20 HP

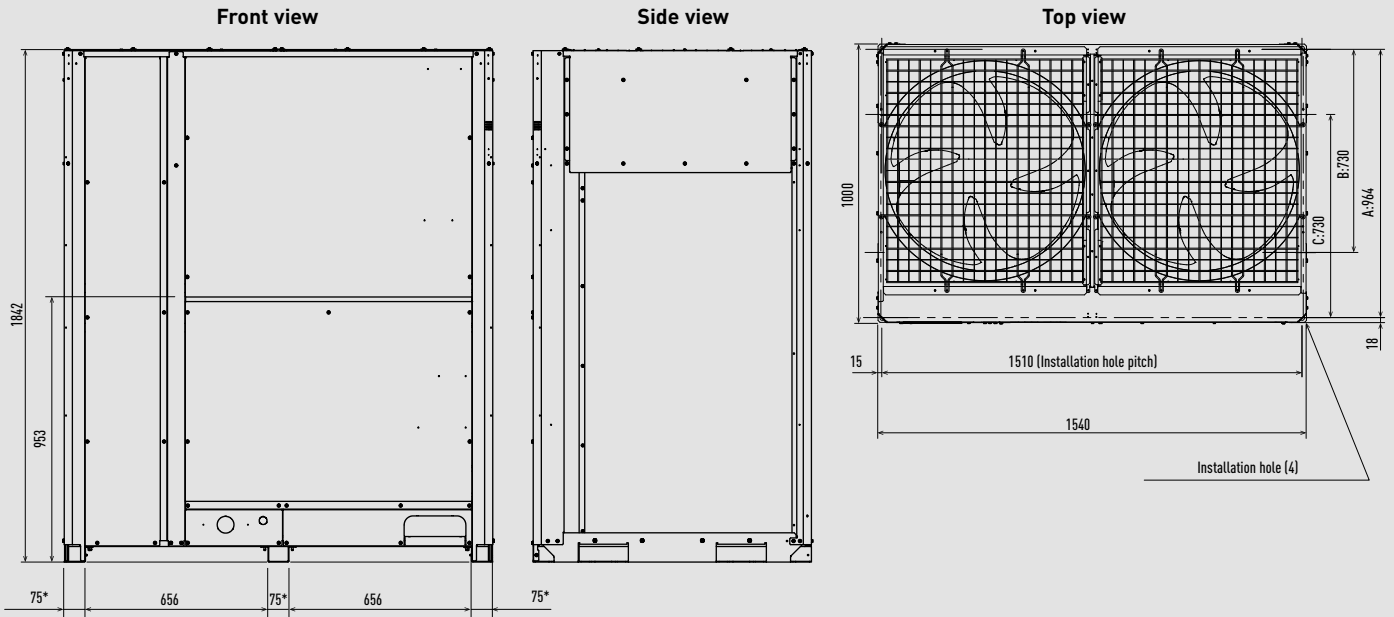

According to the installation site, you may choose the setting position in the depth direction of the anchor bolt from A, B or C.

A: 964 (Installation hole pitch). The piping is routed out from the front.
 B: 730 (Installation hole pitch)*. The piping is routed out from the bottom.
 C: 730 (Installation hole pitch).

* Installation fixing bracket. Installation side.

Unit: mm

ECO G GE3 Series 16 and 20 HP

Type	16 HP	20 HP
1 Refrigerant tubing (gas)	Ø28,58	
2 Refrigerant tubing (liquid)	Ø12,70	Ø15,88
3 Exhaust gas drain port	Hose outer diameter: Ø25 (accessory)	
4 Electrical power supply port	Ø28	
5 Inter-unit cable port	Ø28	
6 Fuel gas port	R3/4	
7 Condensation drain opening	Ø20	
8 Rain and condensation outlet		

Type	16 HP	20 HP
9 Engine exhaust outlet		
10 Suspension holes 4-Ø20x30		
11 Anchor holes 4-22x30		
12 Segmented display		
13 Coolant intake (top)		
14 Air intake		
15 Coolant level		
16 Hot water inlet	Rp3/4	
17 Hot water outlet	Rp3/4	

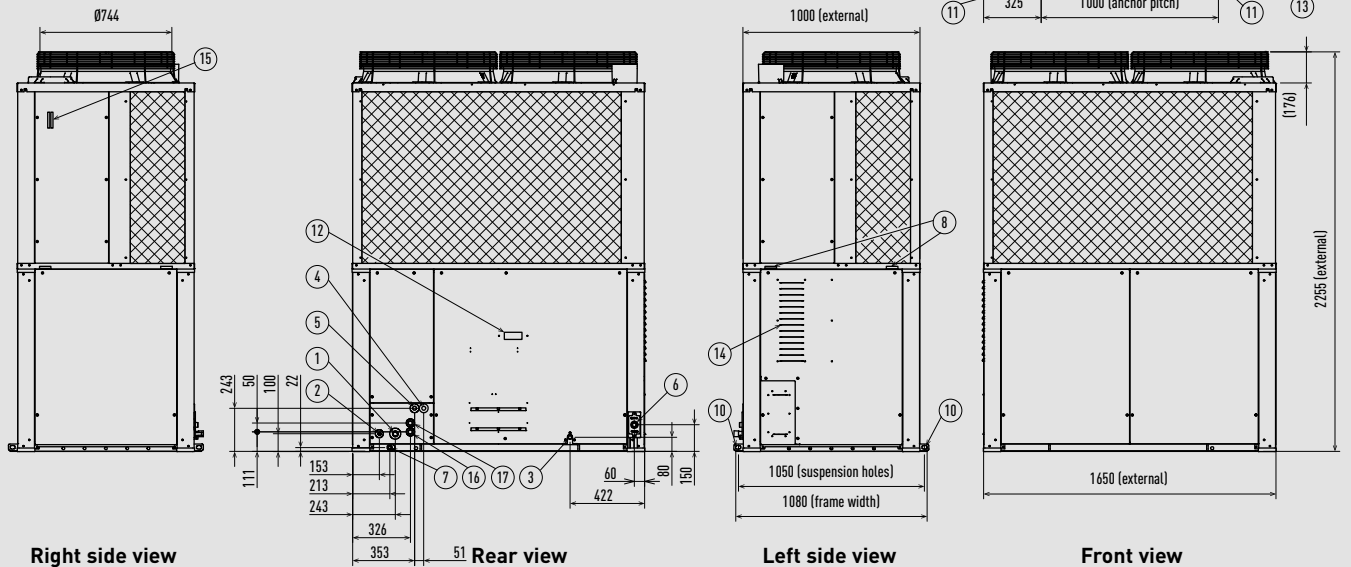

Unit: mm

ECO G GF3 Series 25 HP

1	Suction Refrigerant tubing (gas)	Ø28,58
2	Discharge Refrigerant tubing (gas)	Ø25,40
3	Refrigerant tubing (liquid)	Ø19,05
4	Exhaust gas drain port	Hose outer diameter: Ø25 (accessory)
5	Electrical power supply port	Ø28
6	Inter-unit cable port	Ø28
7	Fuel gas port	R3/4
8	Condensation drain opening	Ø20
9	Rain and condensation outlet	

10	Engine exhaust outlet	
11	Suspension holes 4-Ø20x30	
12	Anchor holes 4-22x30	
13	Segmented display	
14	Coolant intake (top)	
15	Air intake	
16	Coolant level	
17	Hot water inlet	Rp3/4
18	Hot water outlet	Rp3/4

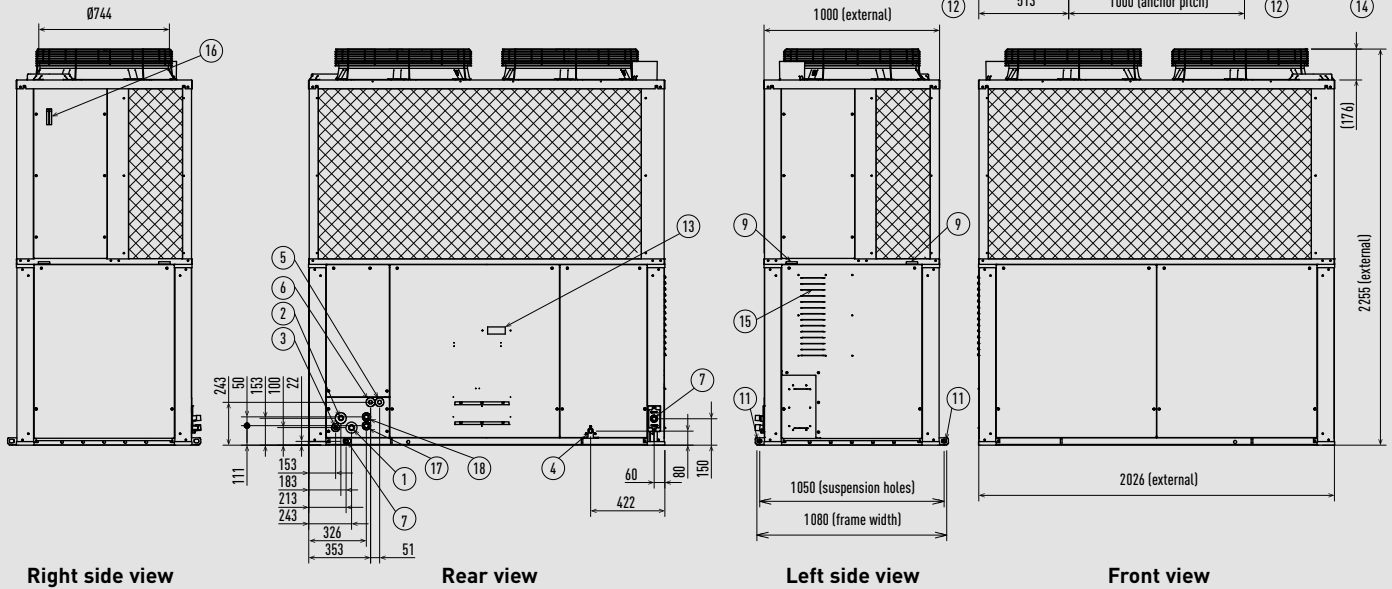

Unit: mm

3-Pipe Control Box Kit / Multiple connection type

Heat recovery box dimensions

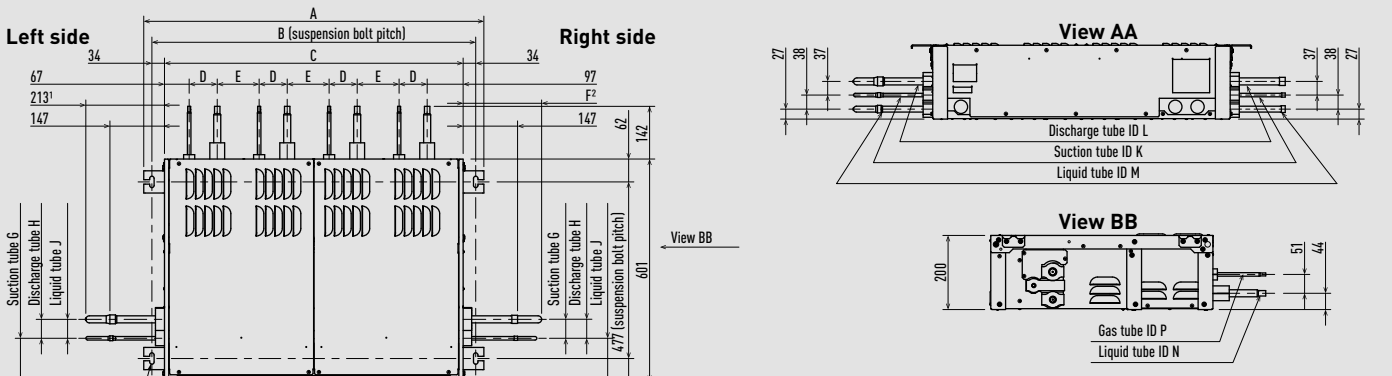

	A	B	C	D	E	F	G	H	J	K	L	M	N	P
Type 456	919	874	807	67	113	213	51	51	117	Ø19,05	Ø15,88	Ø9,52	Ø6,35	Ø12,70
Type 4160	919	874	807	67	113	207	55	54	113	Ø9,52	Ø15,88	Ø28,58	Ø25,40	Ø15,88
Type 656	1297	1253	1185	67	113	213	54	55	115	Ø25,40	Ø19,05	Ø12,70	Ø6,35	Ø12,70
Type 856	1675	1631	1563	67	113	213	53	53	115	Ø28,58	Ø22,22	Ø12,70	Ø6,35	Ø12,70

Valve dimensions

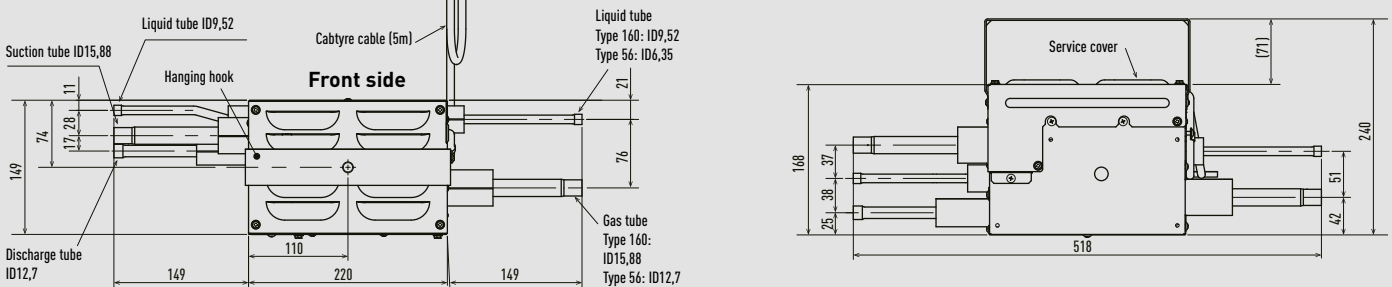

Unit: mm

2-Pipe Hybrid EHP - U-10MES2E8

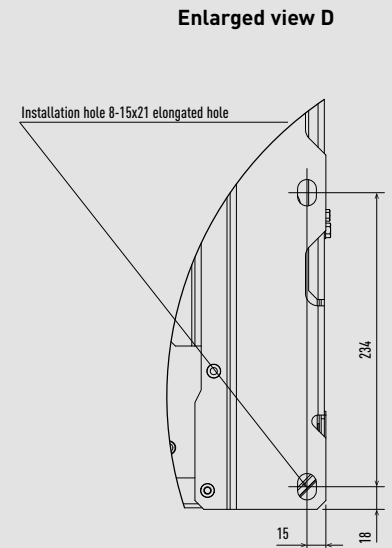
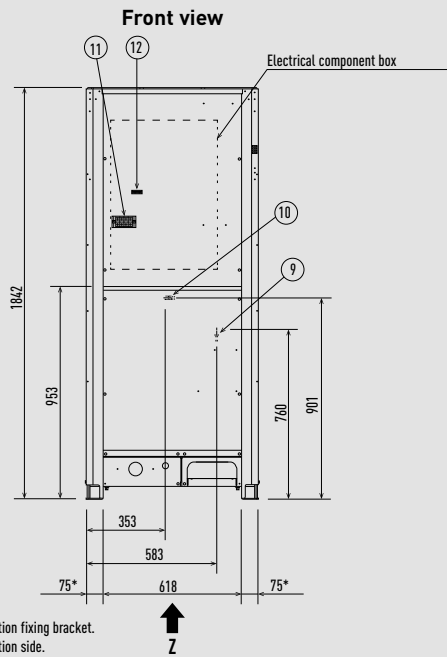
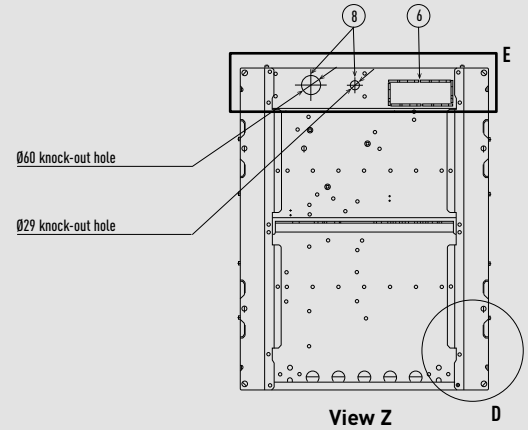
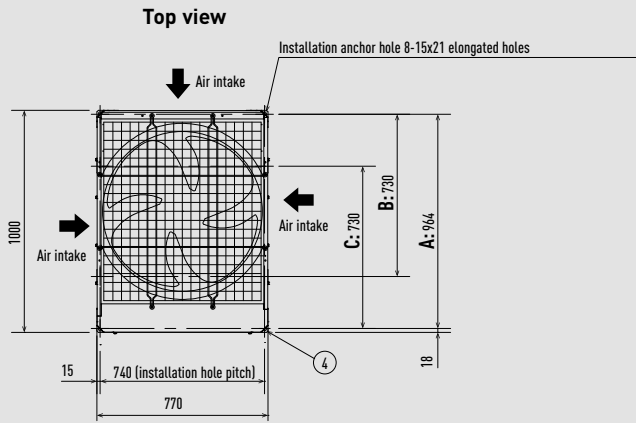

* Installation fixing bracket.
Installation side.

Z

Enlarged view E

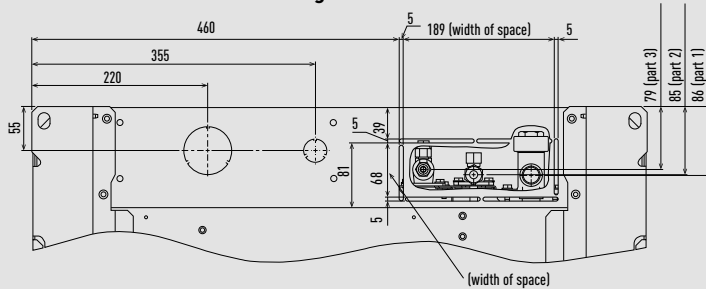

Position of refrigerant tube connection

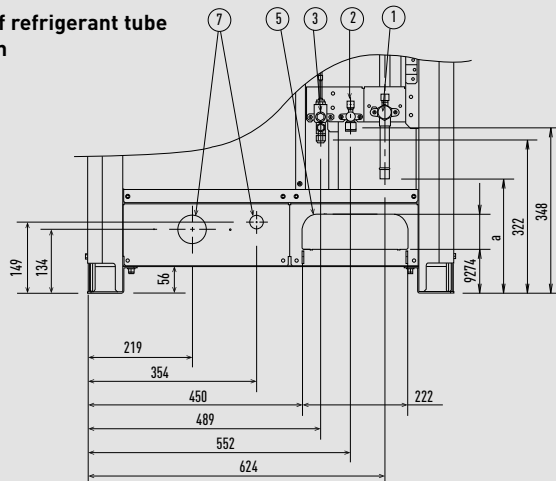

- 1 Refrigerant tubing (gas), Ø22,22 (brazed)
- 2 Refrigerant tubing (liquid), Ø9,52 (flared)
- 3 Refrigerant tubing (balance), Ø6,35 (flared)
- 4 Installation holes(8-15x21 elongated holes), anchor bolts M12 or larger
- 5 Refrigerant tubing port (front: knock-out hole)
- 6 Refrigerant tubing port (bottom: slit hole)
- 7 Electrical wiring port (front: Ø60, Ø29 knock-out hole - for conduit connection)
- 8 Electrical wiring port (bottom: Ø60, Ø29 knock-out hole - for conduit connection)
- 9 Pressure outlet port (for high pressure: Ø7,94 Schrader type connection)
- 10 Pressure outlet port (for low pressure: Ø7,94 Schrader type connection)
- 11 Terminal plate
- 12 Terminal plate for inter-unit control wiring and/or inter-outdoor unit control wiring

According to the installation site, you may choose the setting position in the depth direction of the anchor bolt from "A", "B" or "C".

A: 964 (Installation hole pitch) * The tubing is routed out from the front.
B: 730 (Installation hole pitch) * The tubing is routed out from the bottom.
C: 730 (Installation hole pitch)

2-Pipe Hybrid GHP - U-20GES3E5

1	Refrigerant tubing (gas), Ø28,58	10	Engine exhaust outlet
2	Refrigerant tubing (liquid), Ø15,88	11	Suspension holes 4-Ø20x30
3	Knock out hole. Refrigerant tubing (balance)	12	Anchor holes 4-22x30
4	Exhaust gas drain port. Hose outer diameter: Ø25 (accessory)	13	7 segmented display
5	Electrical power supply port, Ø28	14	Coolant intake (top)
6	Inter-unit cable port, Ø28	15	Air intake
7	Fuel gas port, R3/4	16	Coolant level
8	Condensation drain opening, Ø20	17	Hot water inlet, Rp3/4
9	Rain and condensation outlet	18	Hot water outlet, Rp3/4

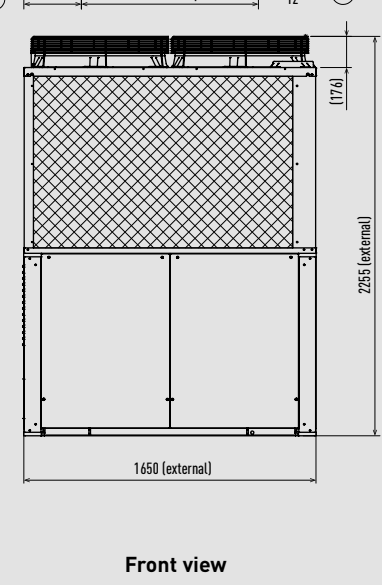
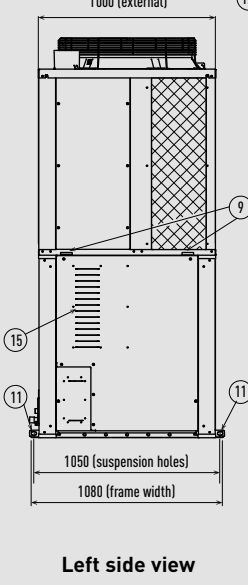
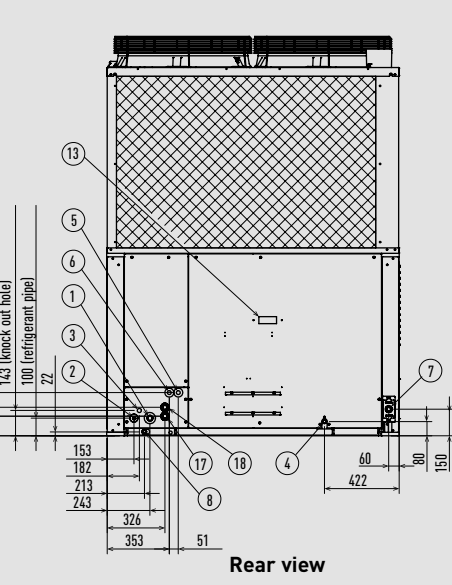
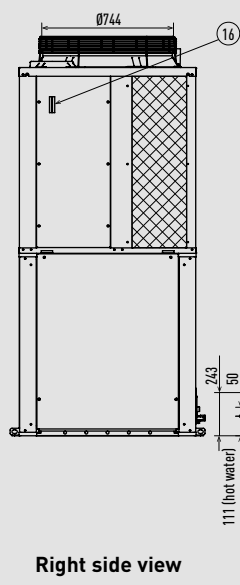
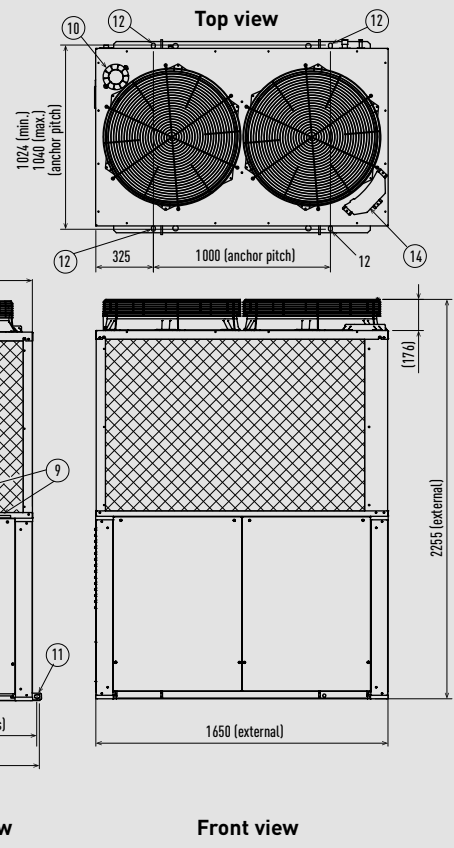

Unit: mm

Water heat exchanger for chilled and hot water production

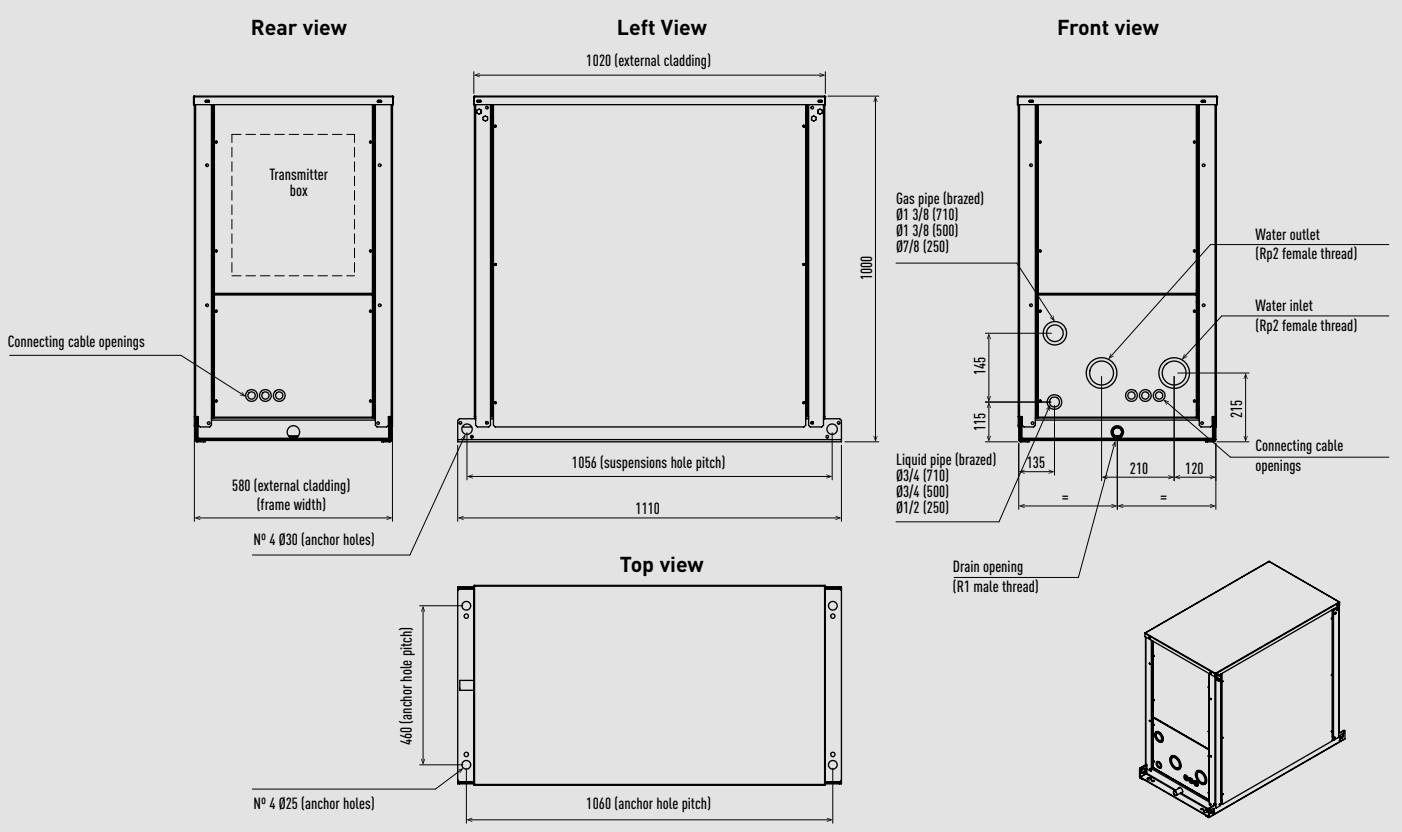

Unit: mm

U2 Type 4 way 90x90 cassette

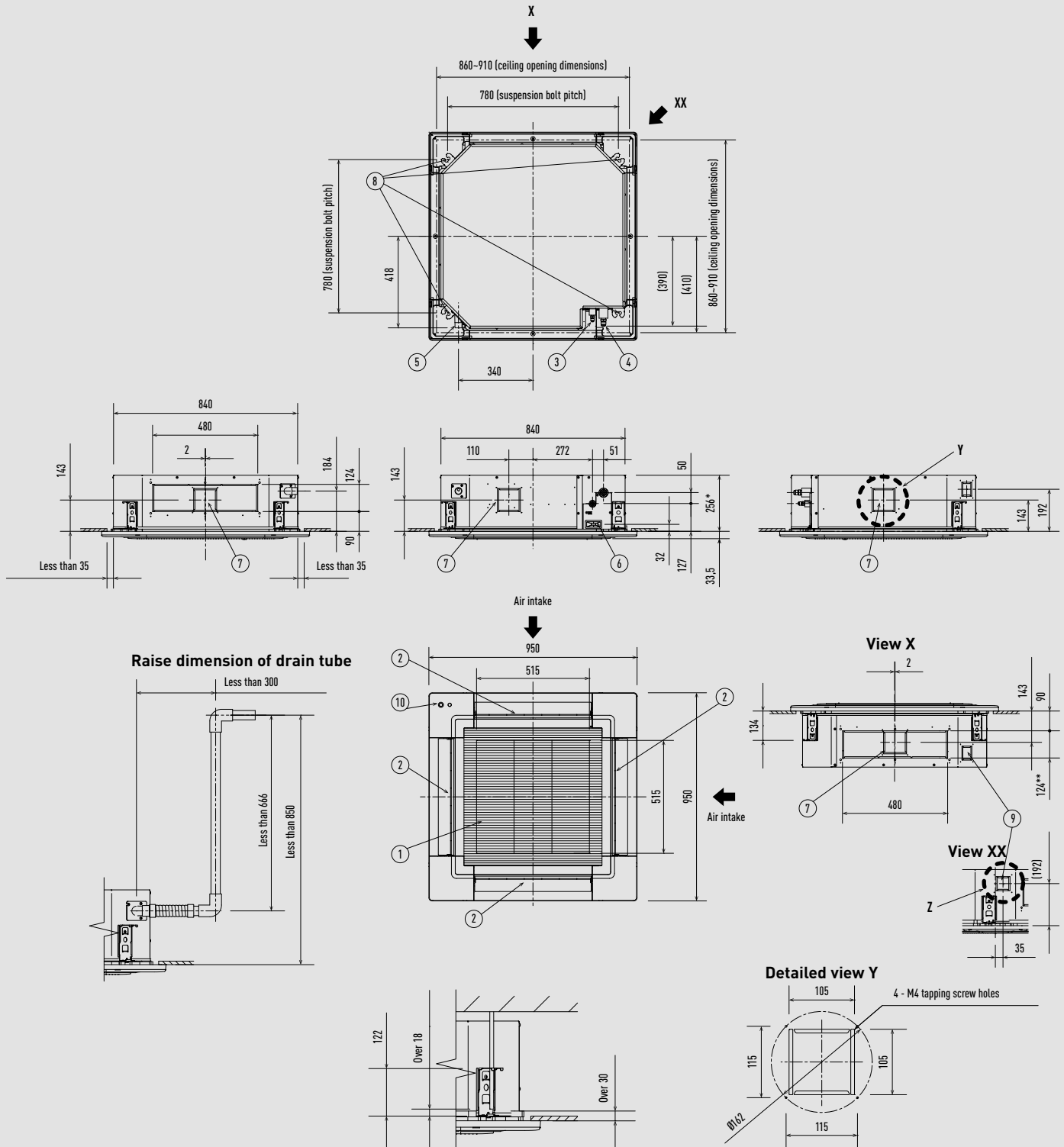

Raise dimension of drain tube

The length of the suspension bolts should be selected so that there is a gap of 30 mm or more below the lower surface of the ceiling (18 mm or more below the lower surface of the main unit), as shown in the figure at right. If the suspension bolt is too long, it will contact the ceiling panel and the unit cannot be installed. Filter dimension: 520 x 520 x 15 mm.

* 319 mm for S-106MU2E5B / S-140MU2E5B / S-160MU2E5B.
 ** 187 mm for S-106MU2E5B / S-140MU2E5B / S-160MU2E5B.

Type	22-56	60-160
1 Air intake		
2 Discharge outlet		
3 Refrigerant tubing (liquid)	Ø6,35 (flared)	Ø9,52 (flared)
4 Refrigerant tubing (gas)	Ø12,70 (flared)	Ø15,88 (flared)
5 Drain tube connection port VP25	Outer diameter Ø32	
6 Power supply port		
7 Suspension bolt hole	4-12x30 elongated hole	
8 Fresh air intake duct connection port	Ø100 ¹⁾	
9 Suspension bolt hole	4-12x30 elongated hole	
10 Econavi sensor (only CZ-KPU3A)		

1) Necessary to attach duct connecting flange/field supplied.

Y3 Type 4 way 60x60 cassette

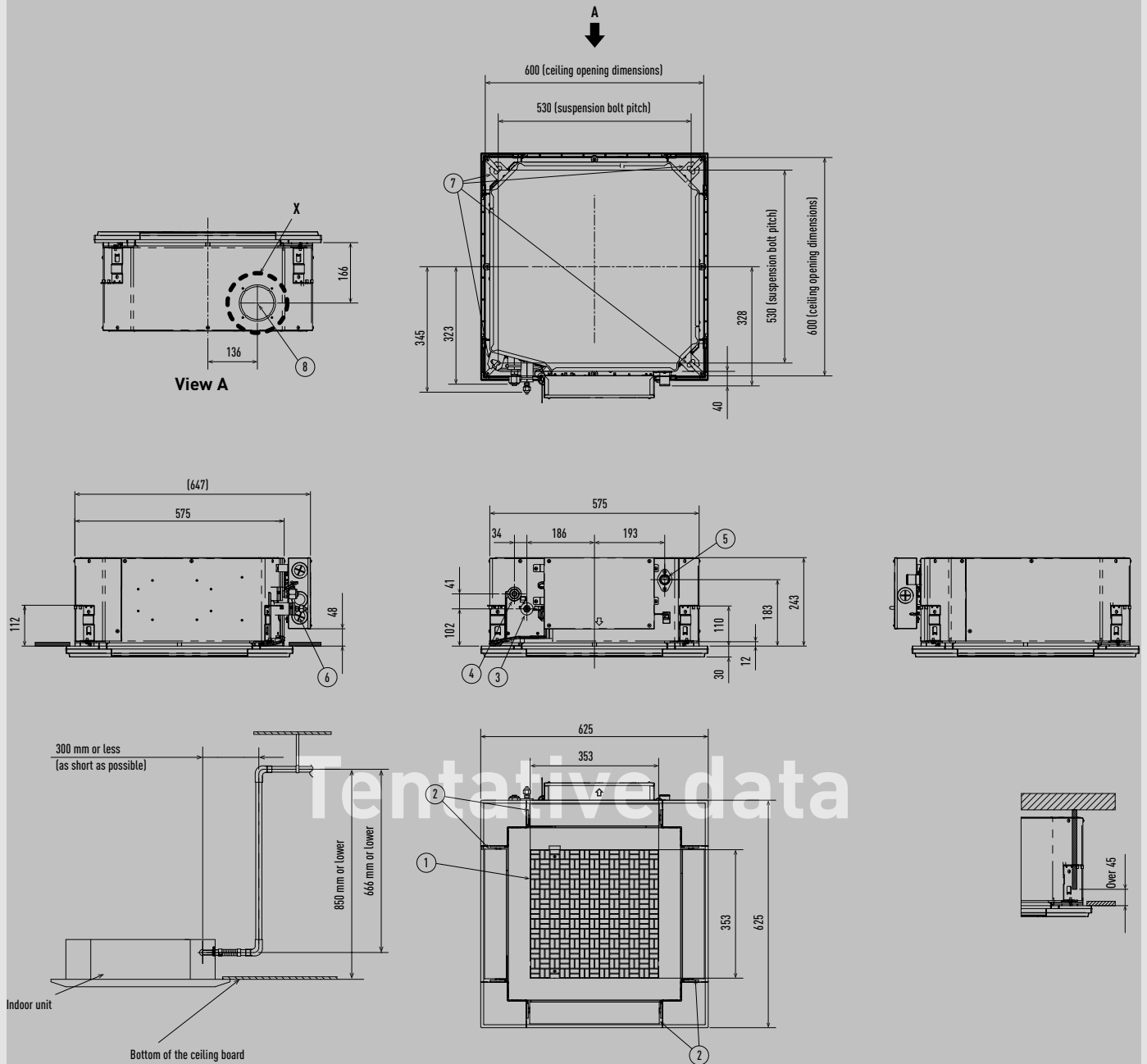

* Length of supplied drain pipe= 250 mm.

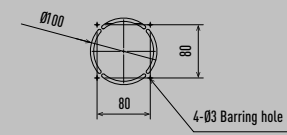

Detailed view X

Type	25-50	60
1 Air intake grille		
2 Air outlet		
3 Refrigerant tubing (liquid)	Ø6,35 (flared)	Ø9,52 (flared) ¹⁾
4 Refrigerant tubing (gas)	Ø12,70 (flared)	Ø15,88 (flared) ²⁾
5 Drain tube connection port VP20		
6 Power supply port		
7 Suspension bolt hole (4-11 x 26 slot)		
8 Fresh air intake duct connection port (Ø100) ³⁾		

1) When connecting with U-60PZ3E5A or U-60PZH3E5, connect the liquid socket tube (Ø9,52-Ø6,35) to the liquid tubing side indoor unit.
 2) When connecting with U-60PZ3E5A or U-60PZH3E5, connect the gas socket tube (Ø15,88-Ø12,70) to the gas tubing side indoor unit.
 3) Necessary to attach duct connecting flange (field supply).

Filter dimension: 362 x 362 x 15 mm.



Y2 Type 4 way 60x60 cassette

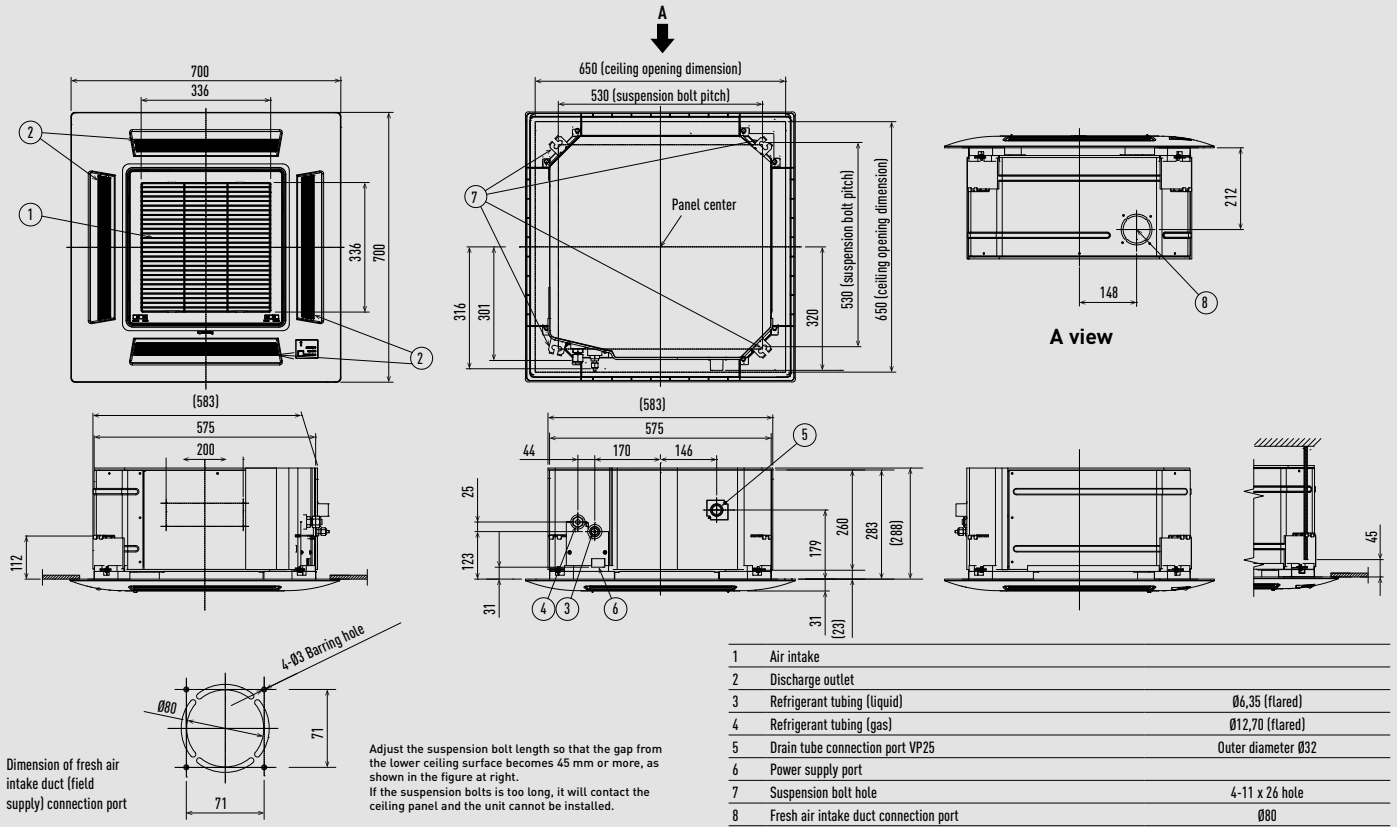

Unit: mm

L1 Type 2 Way Cassette

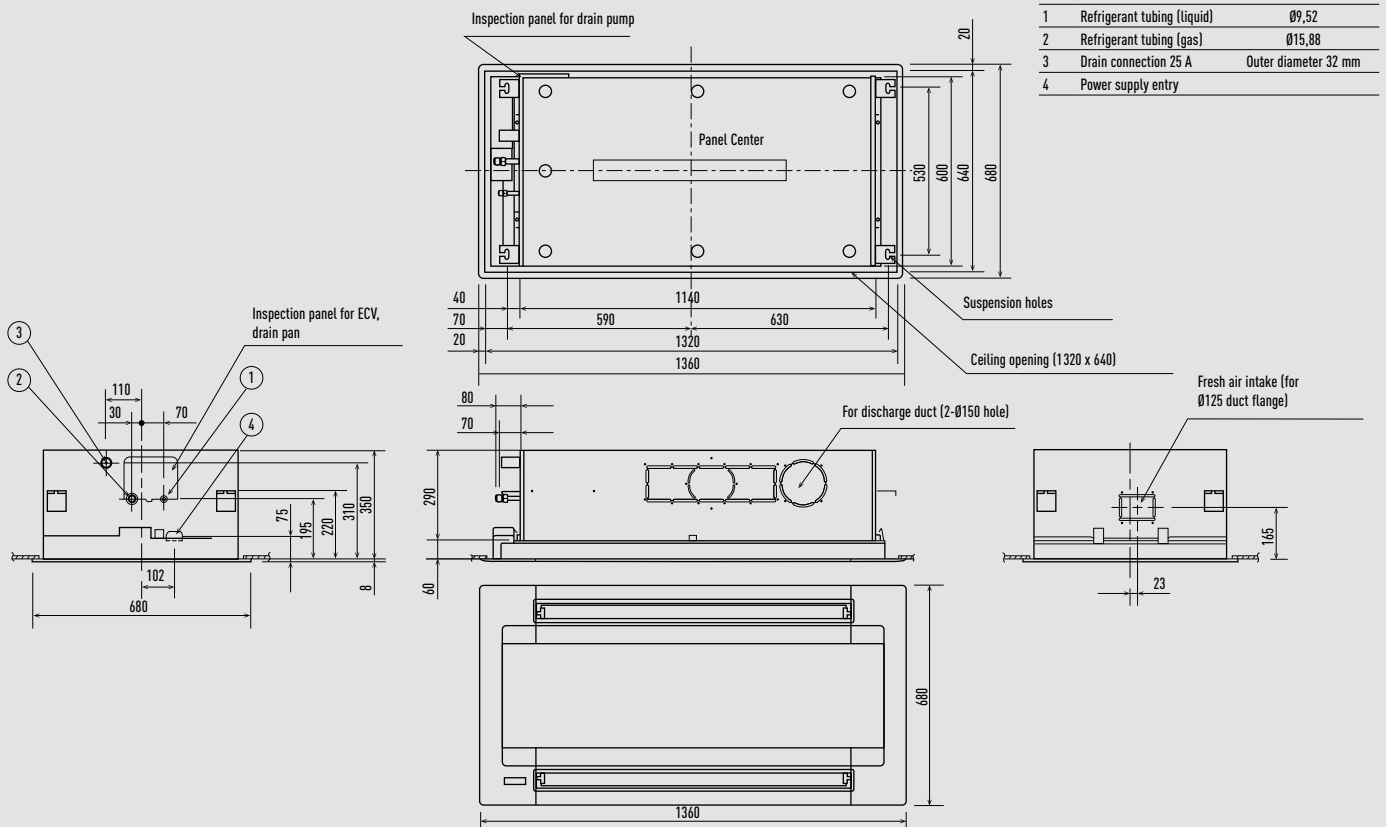

Unit: mm

D1 Type 1 way cassette

	28-56	73
1	Air intake grille	
2	Discharge outlet	
3	Ø6,35 (flared)	Ø9,52 (flared)
4	Ø12,70 (flared)	Ø15,88 (flared)
5	Drain tube connection port VP25 Outer diameter:32	
6	Power supply entry	
7	Discharge duct connection port (for descending ceiling)	
8	Fresh air intake duct connection port Ø100	
9	Installation port for wireless remote controller receiver	
10	Suspension bolt hole 4-12 x 30 mm	

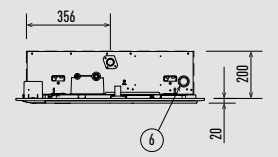
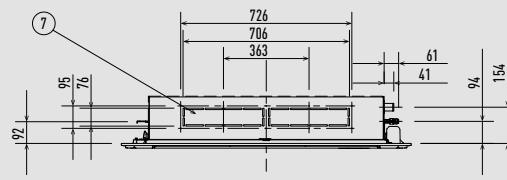
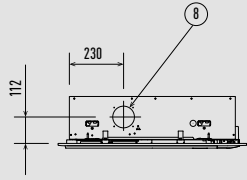
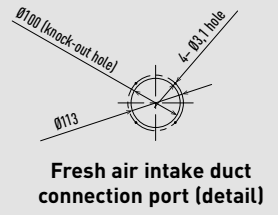
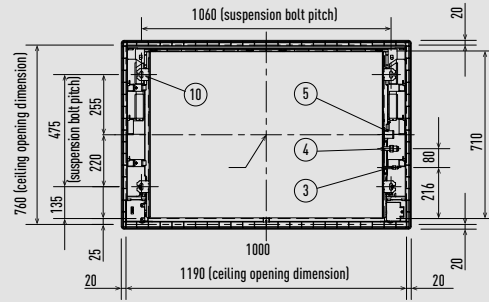

Required space for installation

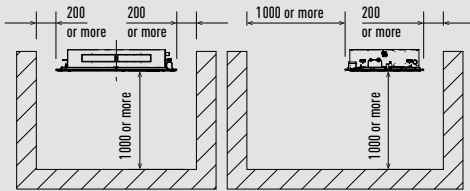

Front view

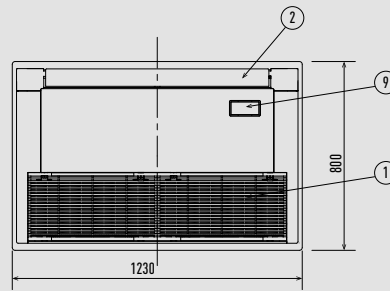

Unit: mm



F3 Type variable static pressure adaptive duct

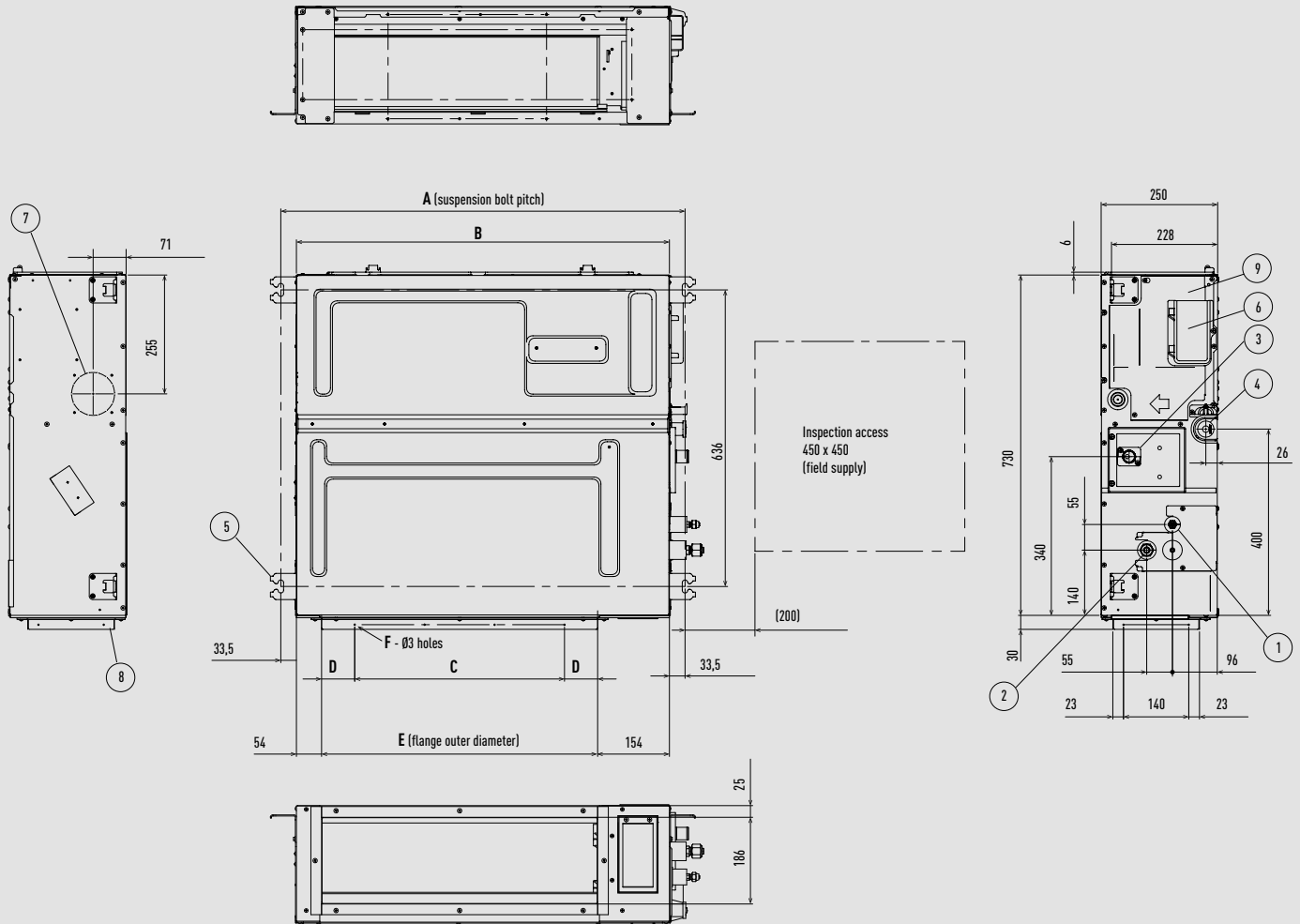

	A	B	C	D	E	F
	mm	mm	mm	mm	mm	Ø"ty
S-15MF3E5B, S-22MF3E5B, S-28MF3E5B, S-36MF3E5B, S-45MF3E5B, S-56MF3E5B S-15MF3E5A, S-22MF3E5A, S-28MF3E5A, S-36MF3E5A, S-45MF3E5A, S-56MF3E5A	867	800	450 (pitch 150 x 3)	71	592	12
S-60MF3E5B, S-73MF3E5B, S-90MF3E5B S-60MF3E5A, S-73MF3E5A, S-90MF3E5A	1067	1000	750 (pitch 150 x 5)	21	792	16
S-106MF3E5B, S-140MF3E5B, S-160MF3E5B S-106MF3E5A, S-140MF3E5A, S-160MF3E5A	1467	1400	1050 (pitch 150 x 7)	71	1192	20

Type	15-90MF3E5B	106-160MF3E5B	15-56MF3E5A	60-160MF3E5A
1 Refrigerant tubing (liquid)	Ø6,35 (flared)	Ø9,52 (flared)	Ø12,70 (flared)	Ø15,88 (flared)
2 Refrigerant tubing (gas)				
3 Upper drain tube connection port VP20	Outer diameter 26 mm 200 mm flexible hose supplied			
4 Bottom drain tube connection port VP20	Outer diameter 26 mm			
5 Suspension lug	4-12 x 30 mm			
6 Power supply outlet				
7 Fresh air intake port	Ø100 mm*			
8 Flange for flexible air discharge duct				
9 Electrical component box				

* Necessary to attach duct connecting flange (field supply).

F2 Type variable static pressure hide-away

S-15MF2E5A / S-22MF2E5A / S-28MF2E5A / S-36MF2E5A / S-45MF2E5A / S-56MF2E5A

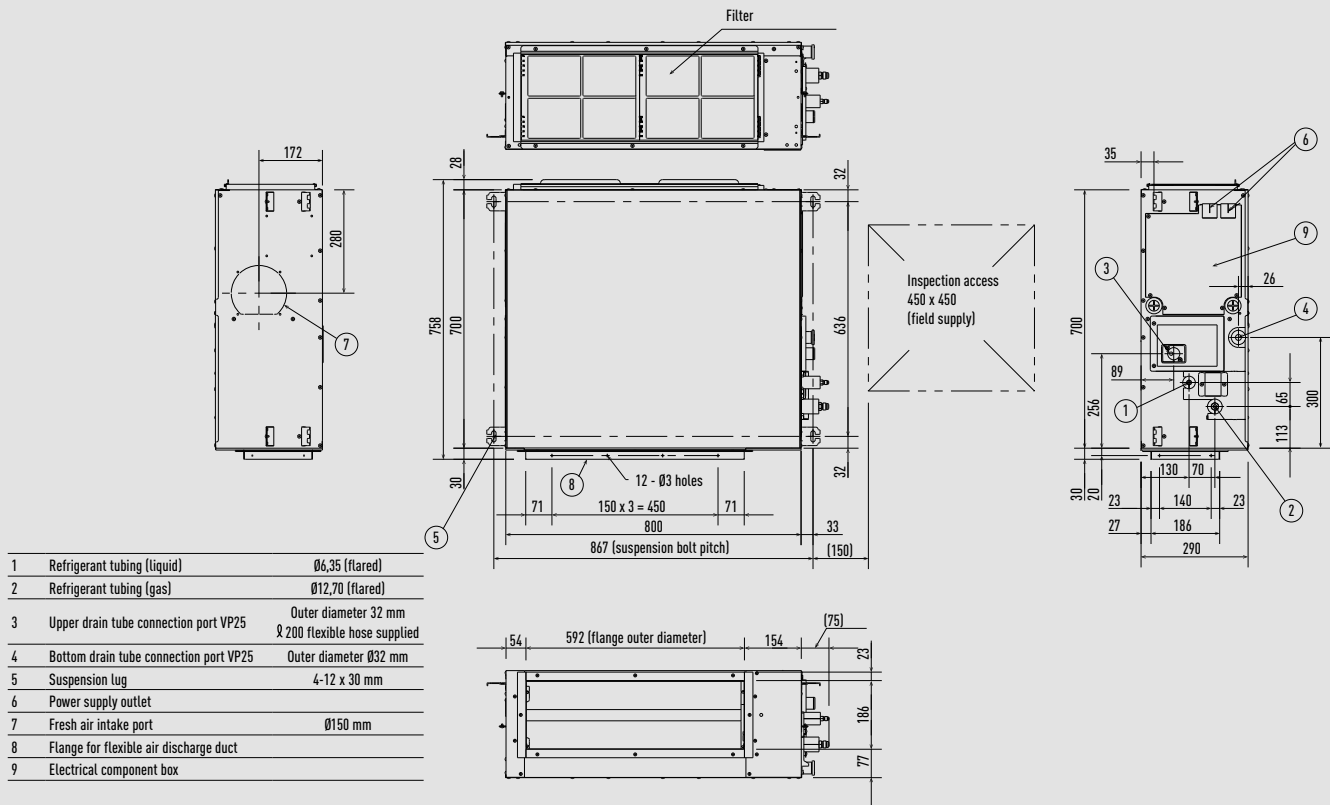

S-60MF2E5A / S-73MF2E5A / S-90MF2E5A

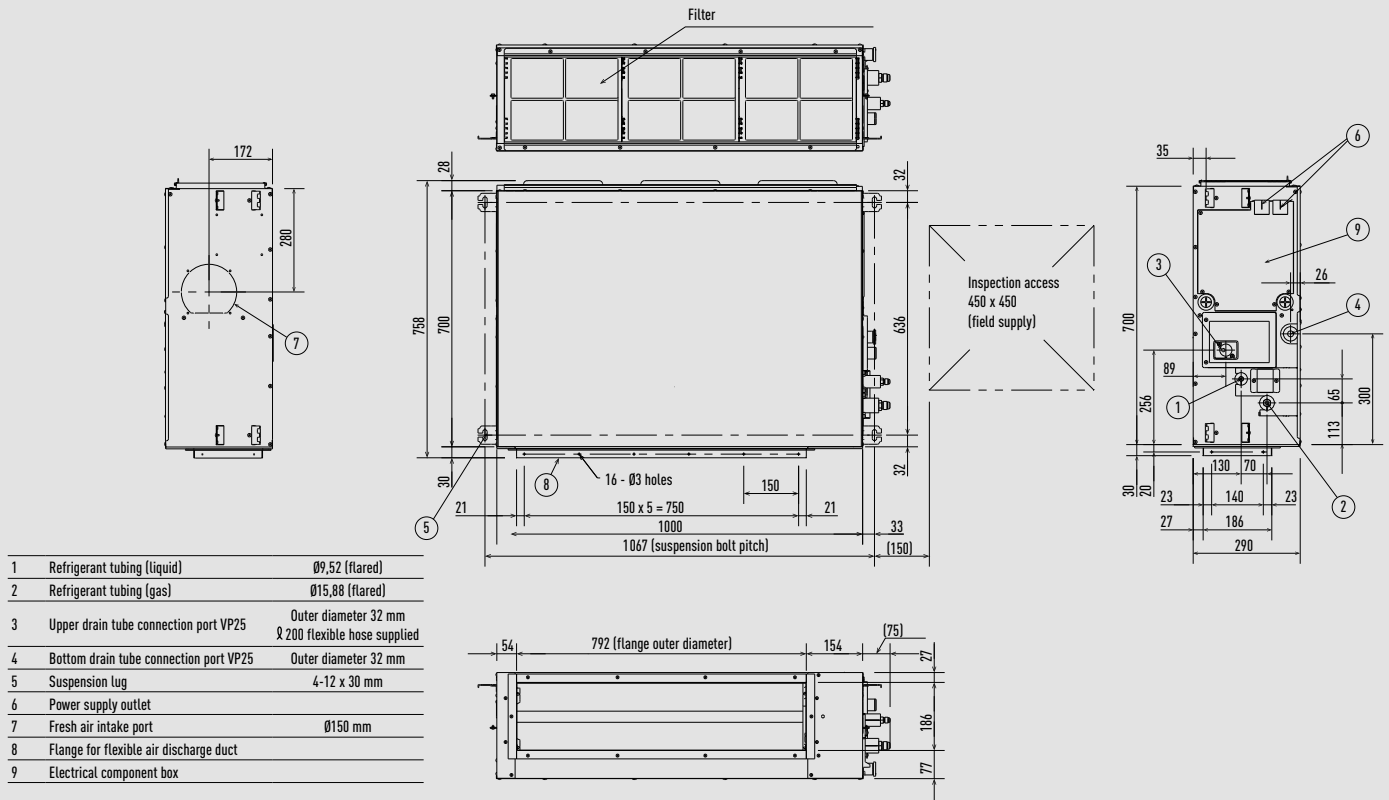



F2 Type variable static pressure hide-away

S-106MF2E5A / S-140MF2E5A / S-160MF2E5A

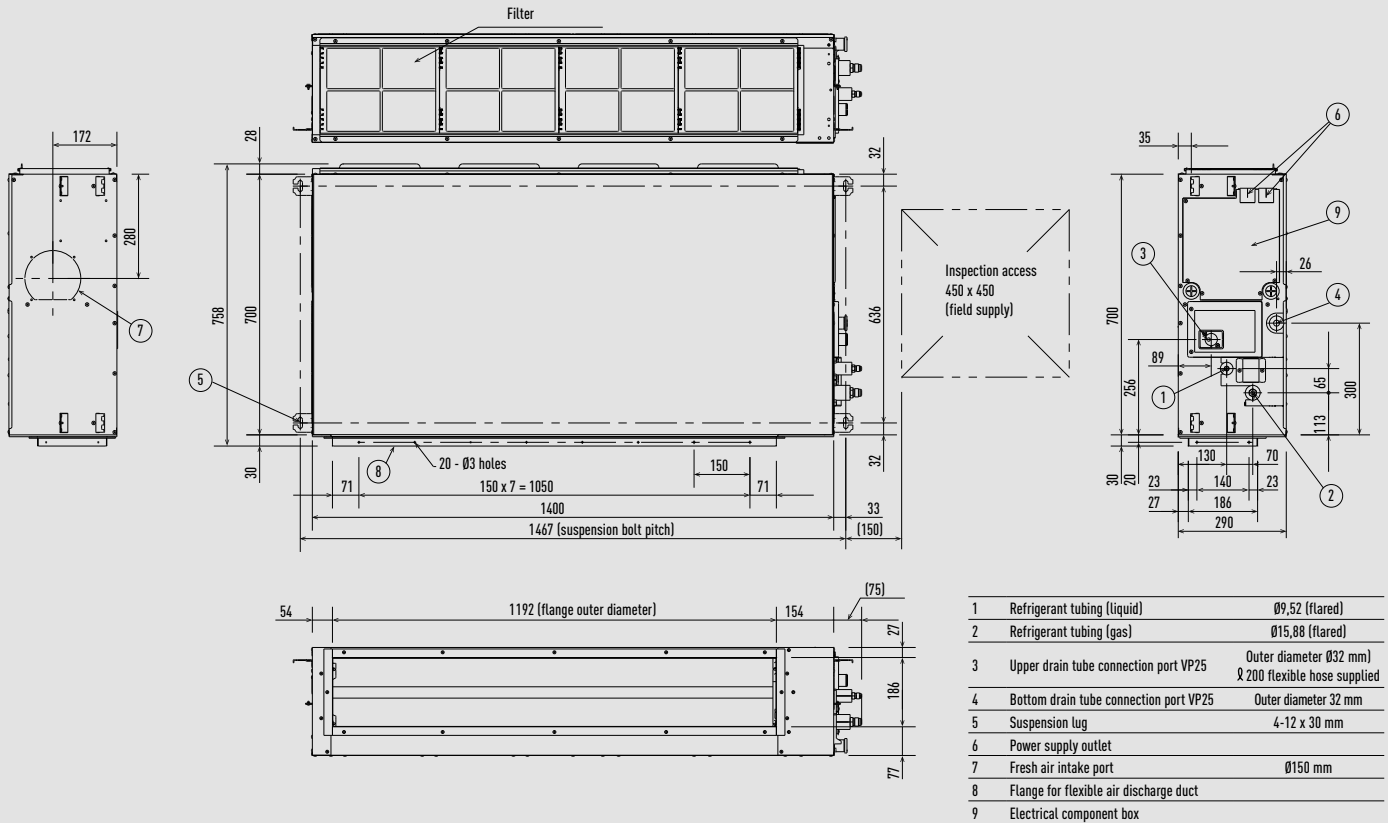

Unit: mm

M1 Type slim variable static pressure hide-away concealed duct

1	Refrigerant piping (narrow tube)	
2	Refrigerant piping (wide tube)	
3	Upper and bottom drain port	Outer diameter 26 mm
4	Suspension lug	
5	Power supply outlet	2-Ø30
6	Flange for air intake duct	
7	PL cover	
8	Electrical component box	
9	Frame filter	
10	Signal output board	ACC-SG-AGB: optional

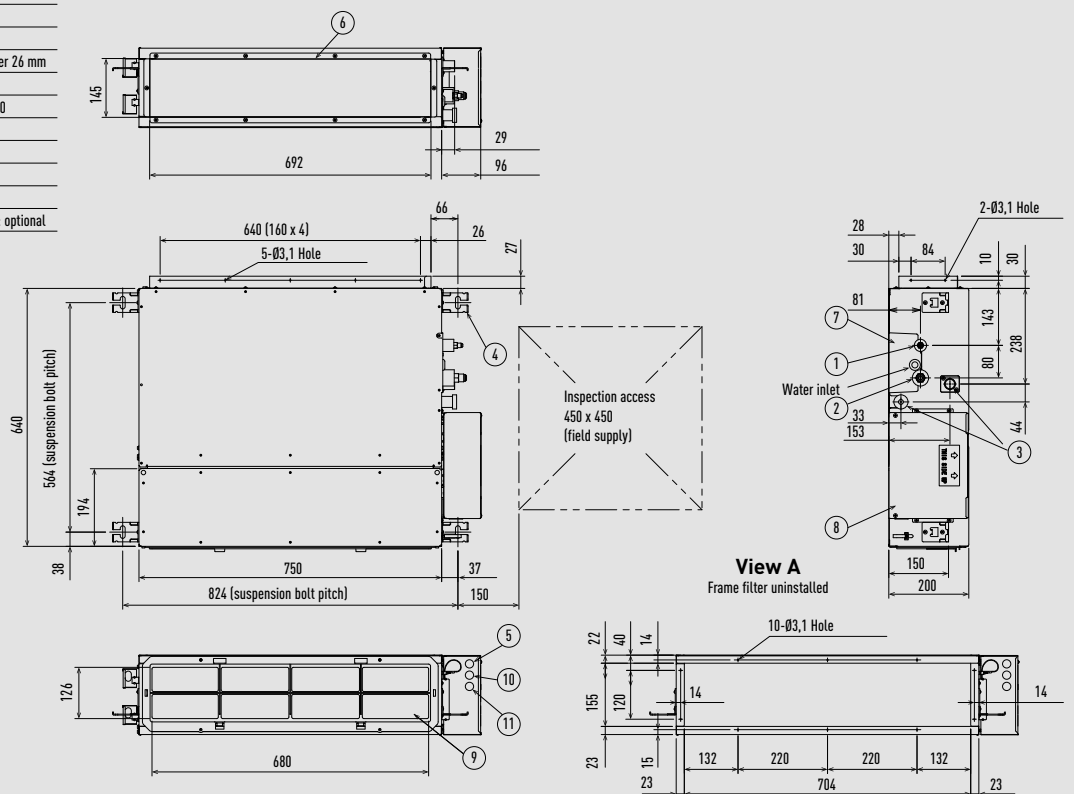

Unit: mm

E2 Type high static pressure hide-away

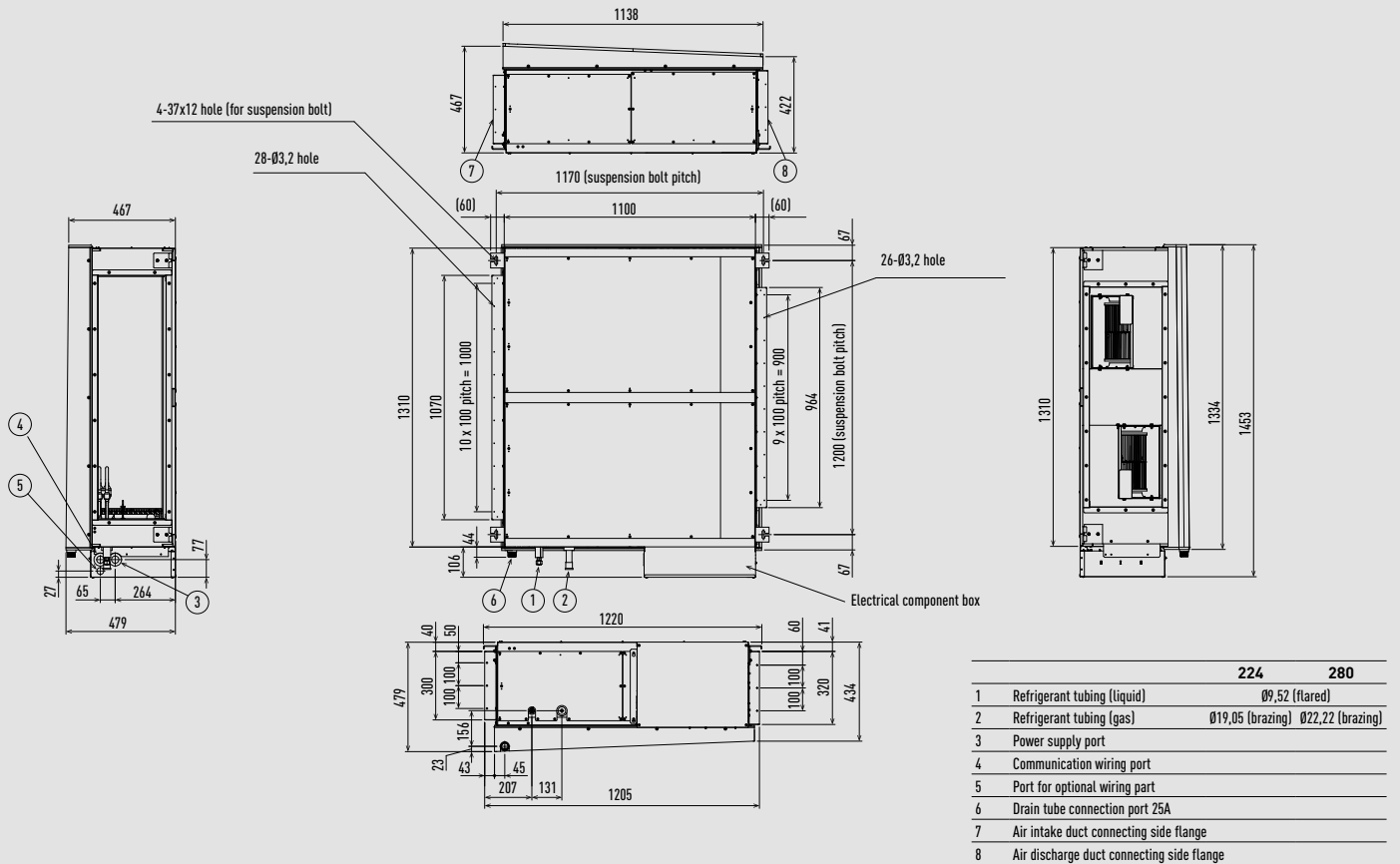

Unit: mm

Heat recovery with DX coil

	A	B	C	D	E	E1	F	F1	G	L	T	K	M	N	P	R	S	Y	Z	Net weight
PAW-500ZDX3N	904	1400	107	200	825	1395	960	830	19	955	500	135	270	350	135	135	202	350	135	90 - 98
PAW-800ZDX3N	1134	1695	85	250	1115	1685	1190	1060	19	1200	678	170	388	500	170	170	228	415	195	100 - 110
PAW-01KZDX3N	1216	1700	85	250	1130	1700	1273	1140	19	1290	621	171	388	550	146	241	151	415	195	105 - 120

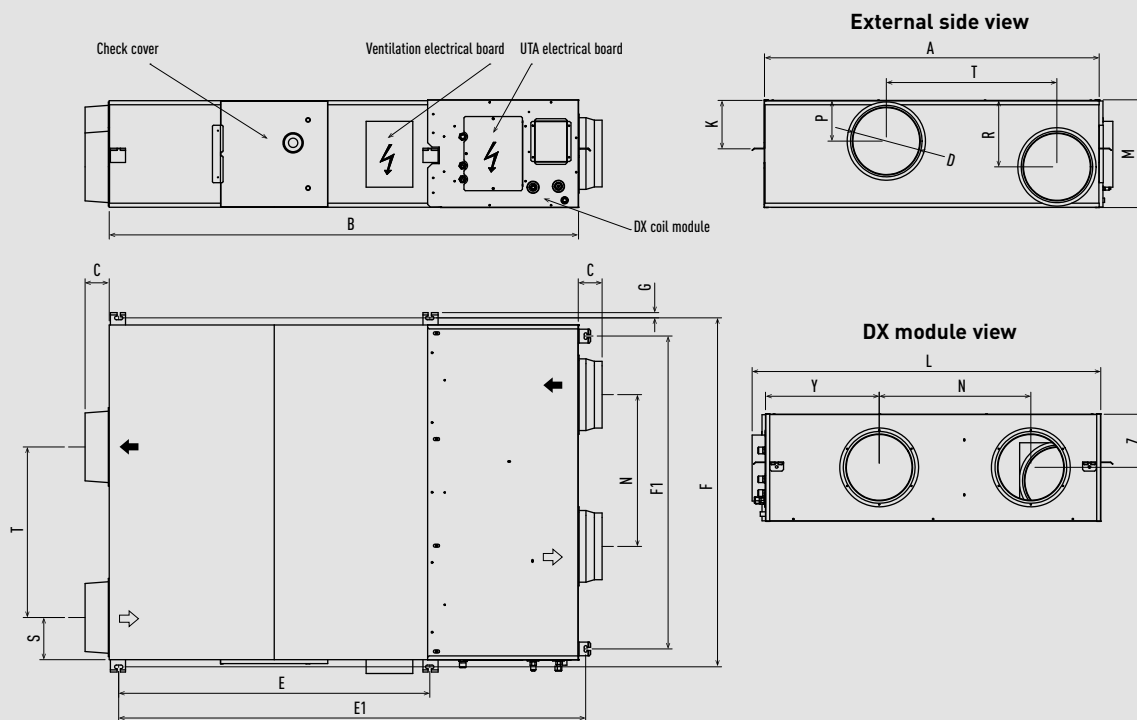

Unit: mm

T2 Type ceiling

S-36MT2E5A / S-45MT2E5A / S-56MT2E5A

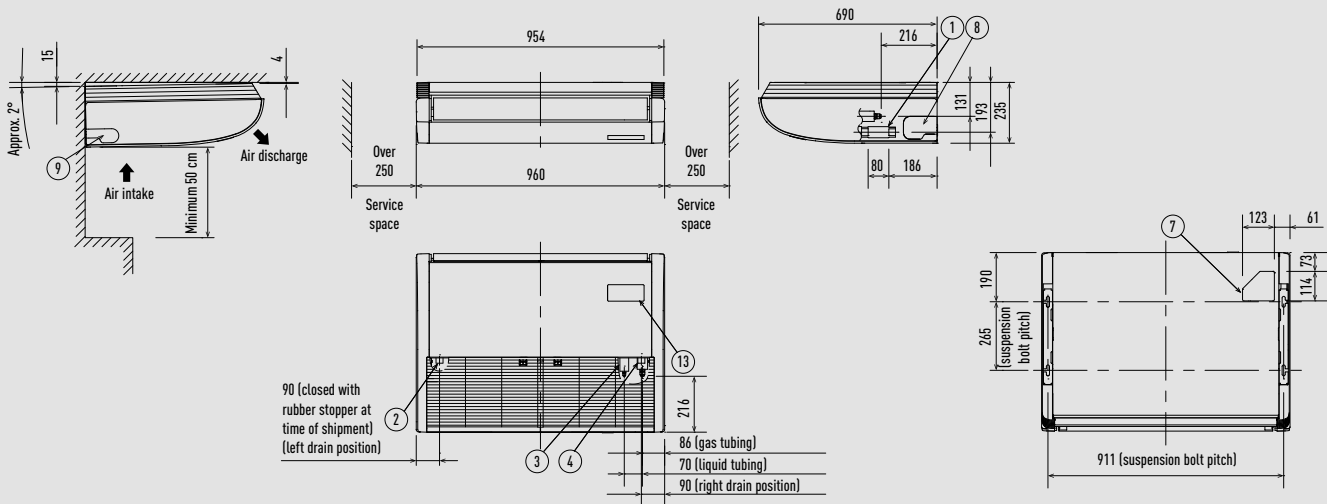

S-73MT2E5A

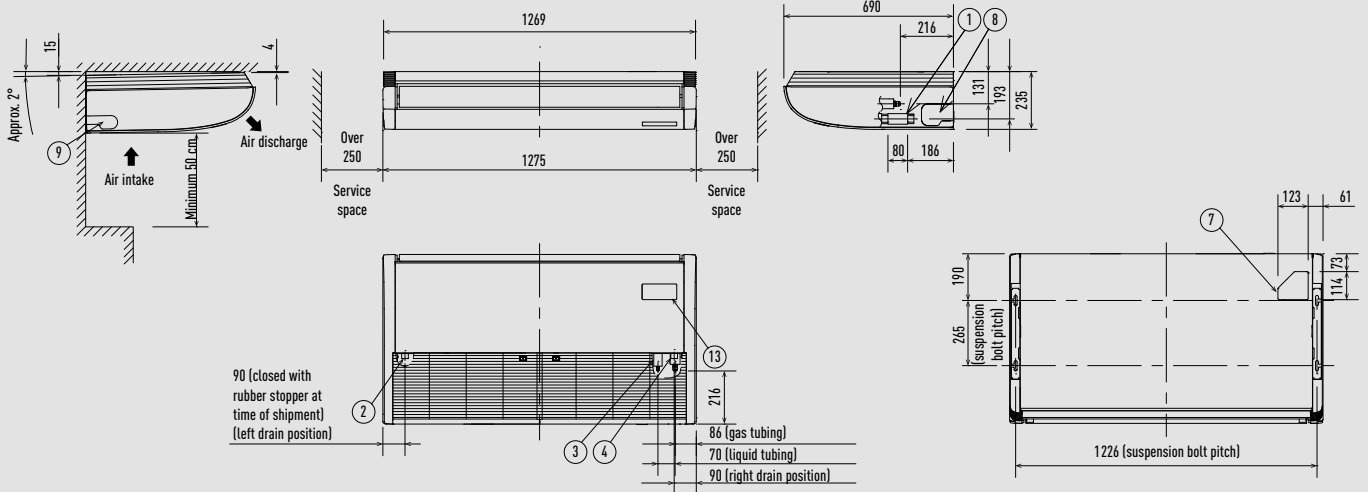

S-106MT2E5A / S-140MT2E5A

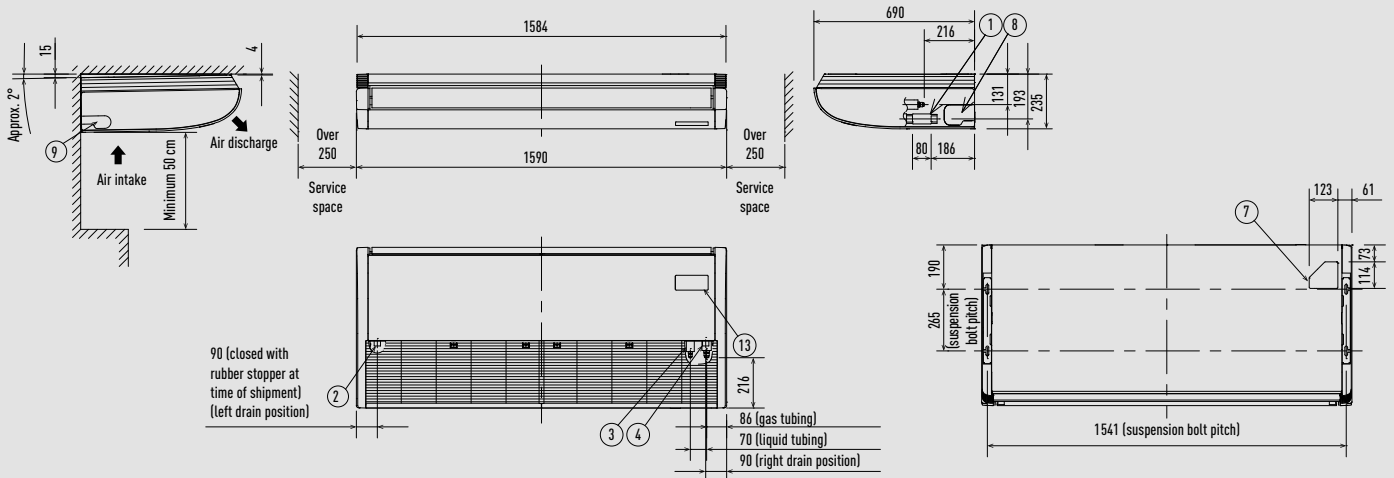

1	Drain tube connection port VP20	Inside diameter Ø26 mm, drain hose supplied
2	Left drain position	
3	Refrigerant tubing (liquid)	Ø9,52 (flared)
4	Refrigerant tubing (gas)	Ø15,88 (flared)
5	Left side drain hose outlet port (cut out)	

6	Tubing hole on wall surface	Ø100 mm
7	Upper side tubing port	
8	Right side drain hose outlet port (cut out)	
9	Wireless remote controller receiver installation location	

Unit: mm

K2 Type wall-mounted

S-15MK2E5B / S-22MK2E5B / S-28MK2E5B / S-36MK2E5B

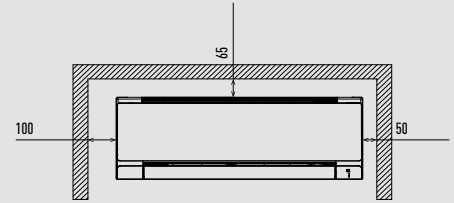
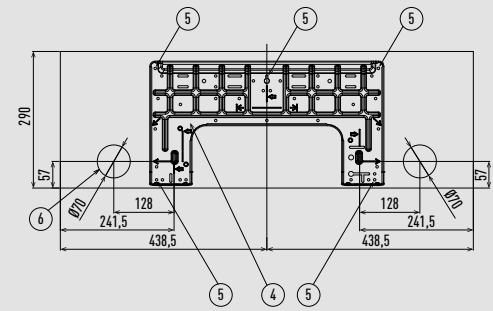
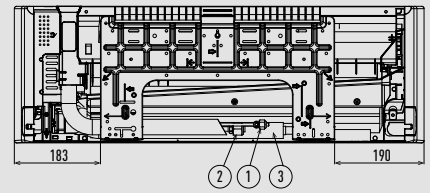
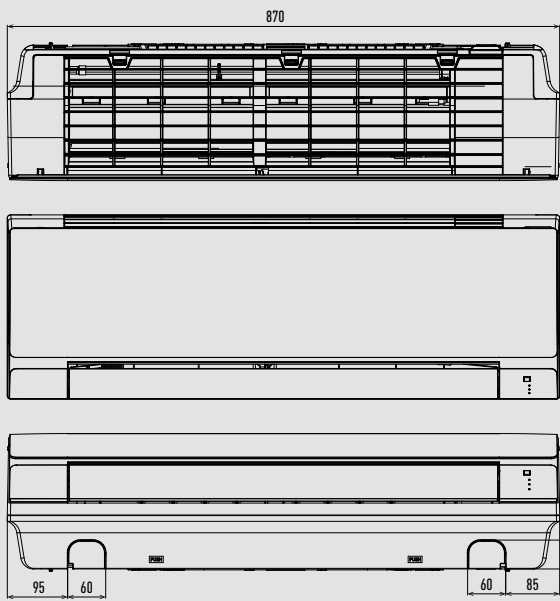

1	Refrigerant tubing (liquid)	Ø6,35 (flared)
2	Drain hose	Outer diameter 16 mm
3	Rear panel	PL Back
4	Refrigerant tubing (gas)	Ø12,70 (flared)
5	Rear panel fixing holes	
6	Piping and wiring holes	Ø70

S-45MK2E5B / S-56MK2E5B / S-73MK2E5B / S-106MK2E5B

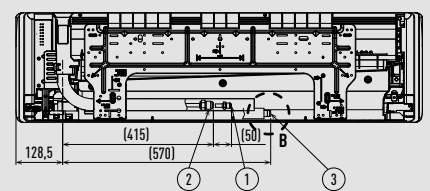
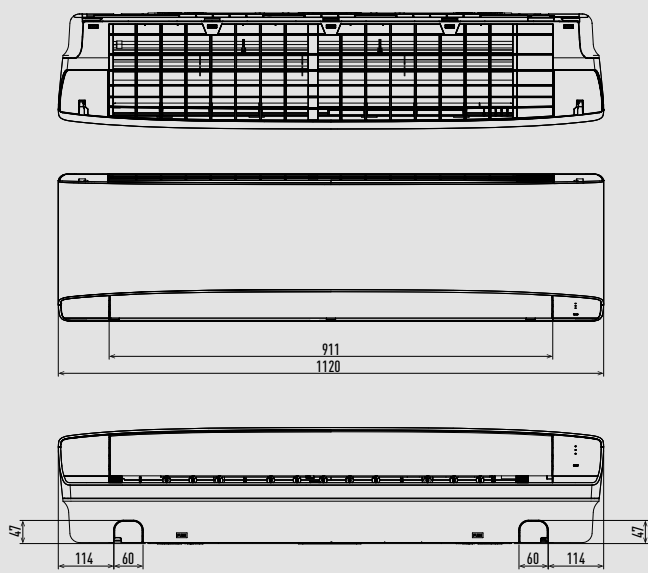

View A

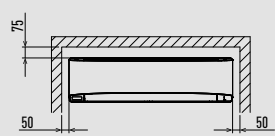
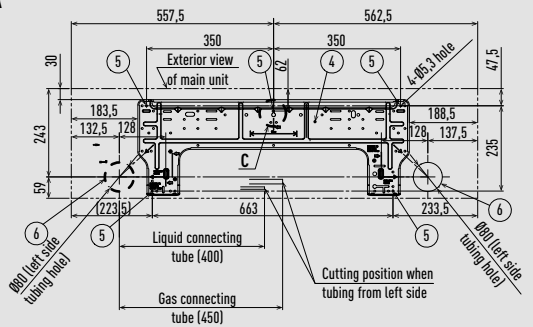

Minimum space requirements for installation

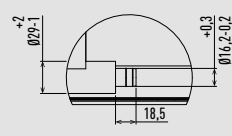

Detailed view B

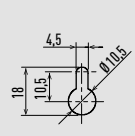

Detailed view C

Type	45-56	73-106
1	Refrigerant tubing (liquid)	Ø6,35 (flared)
2	Refrigerant tubing (gas)	Ø12,70 (flared)
3	Drain hose	
4	Rear panel	
5	Rear panel fixing holes (Ø5,3 holes or as shown in figure "C")	
6	Tubing and wiring holes (Ø80)	

Unit: mm

R1 Type concealed floor-standing

- 1 4- \varnothing 12 hole (for fastening the indoor unit to the floor with screws)
- 2 Air filter
- 3 Refrigerant tubing (liquid)
- 4 Refrigerant tubing (gas)
- 5 Level adjusting bolt
- 6 Drain tube connection port (20 A)
- 7 Flange for the air-outlet duct

	A	B	C	D	E	F	Liquid pipes	Gas pipes
22-36	904	692	672	665	500	86	\varnothing 6,35	\varnothing 12,70
45								
56	1219	1007	1002	980	900	51		
71							\varnothing 9,52	\varnothing 15,88

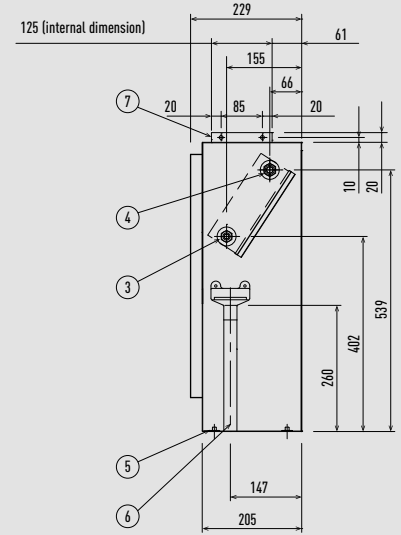
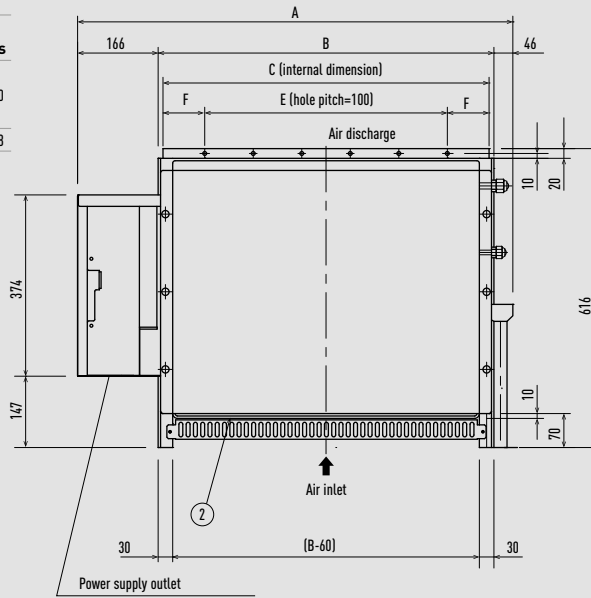
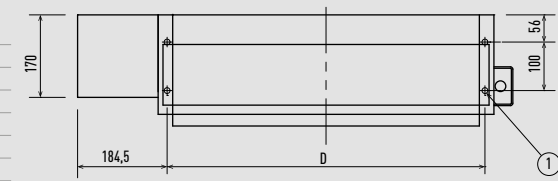

Unit: mm

Hydrokit for ECOi, water at 45 °C

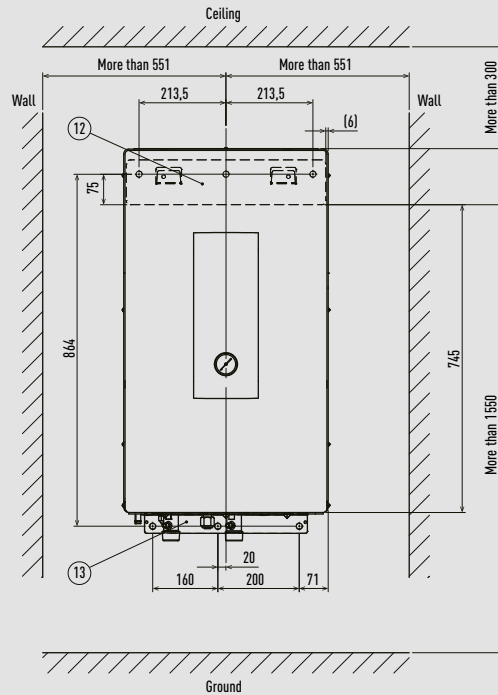
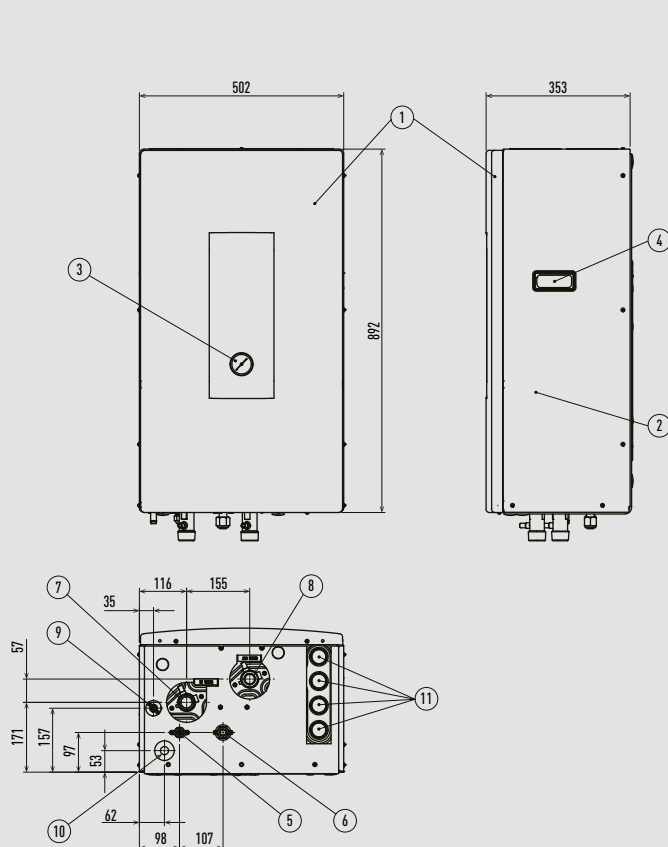

Unit: mm



ECOi PRO-HT Tank

PAW-VP750LDHW-1

PAW-VP1000LDHW-1

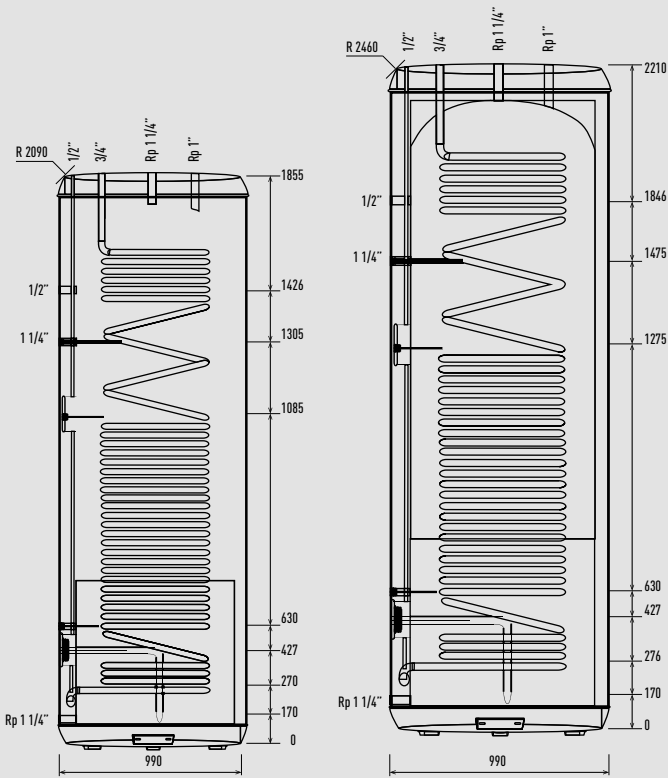

Note: R value indicates maximum overturning height.

Unit: mm

Smart fan coils

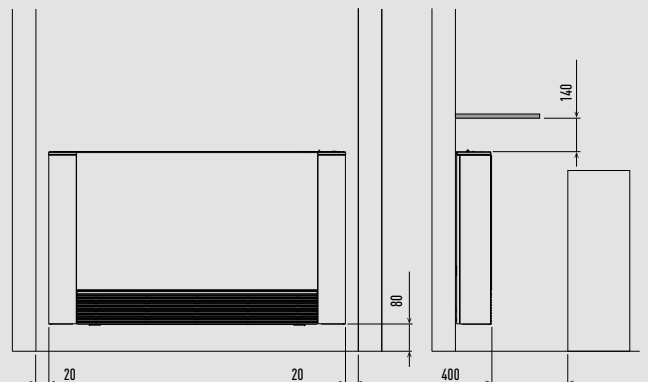
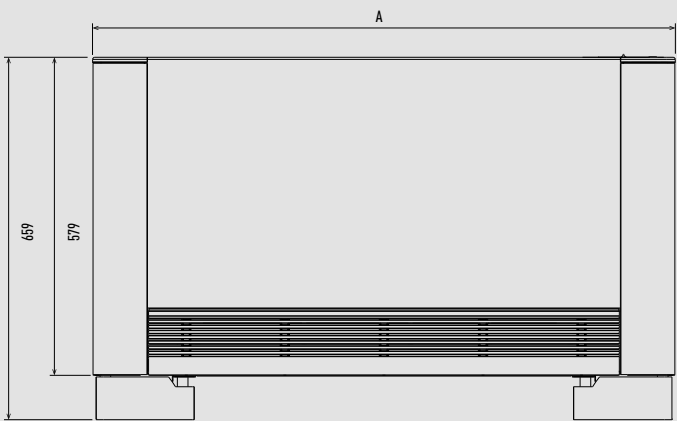

	PAW-AAIR-200-2	PAW-AAIR-700-2	PAW-AAIR-900-2
A	735	935	1135

Unit: mm

AHU connection kit 3,6 to 14,0 kW for PACi NX

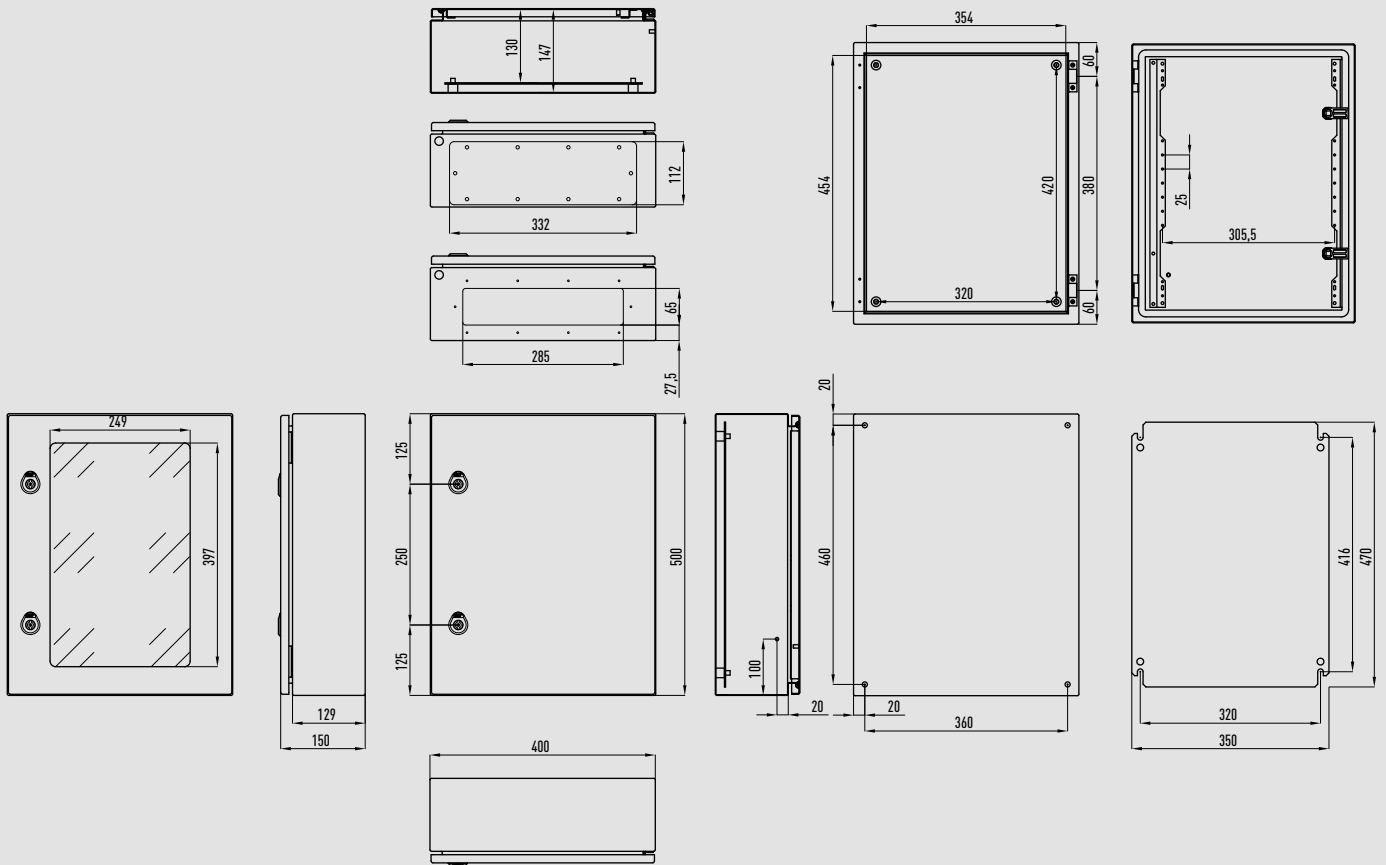

Unit: mm

AHU Connection Kit

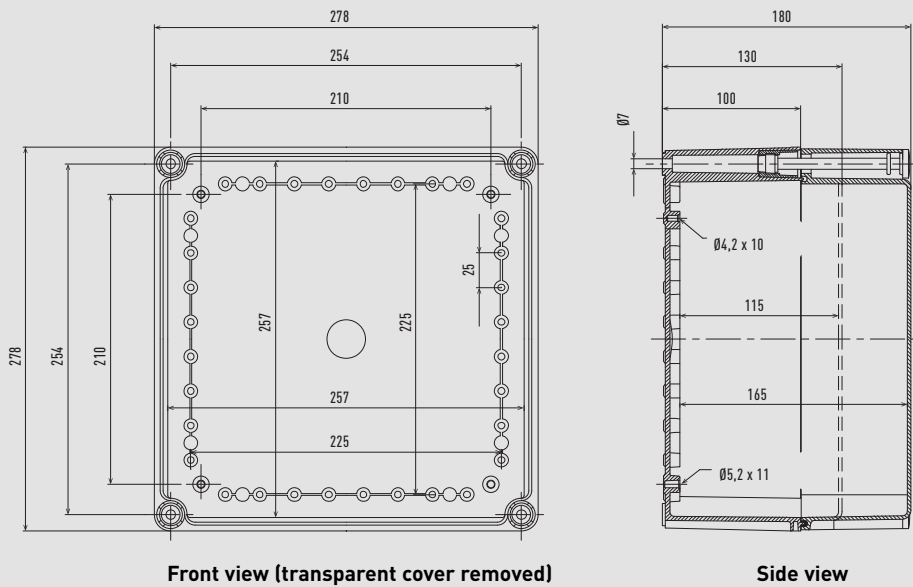

Front view (transparent cover removed)

Side view

Unit: mm



Energy recovery ventilation

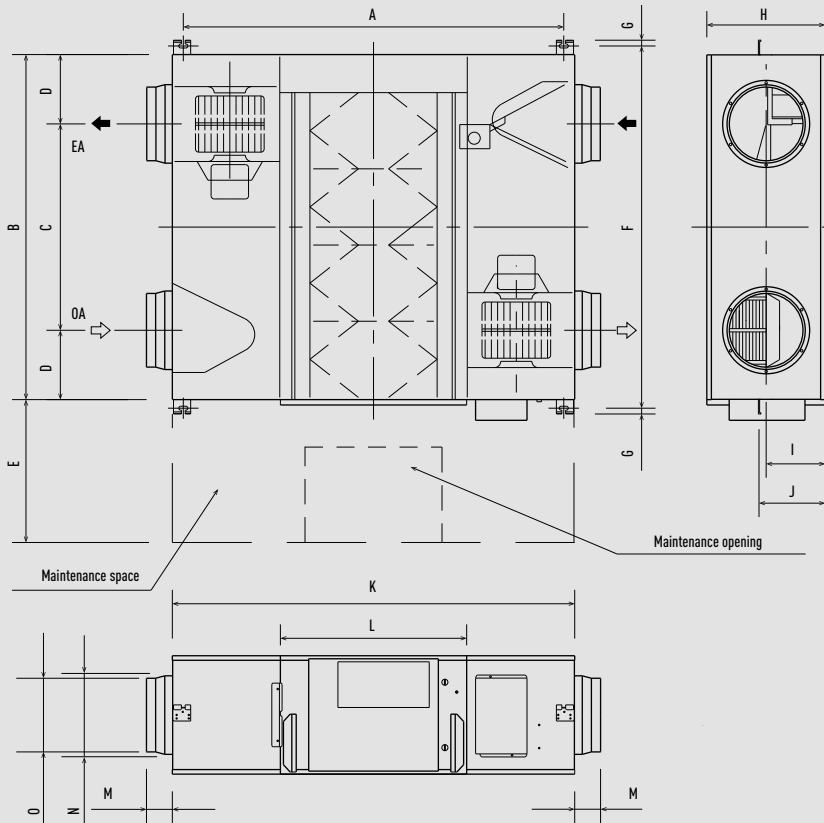

	FY-250ZDY8R	FY-350ZDY8R	FY-500ZDY8R	FY-800ZDY8R	FY-01KZDY8R
A	810	978	1018	1250	1250
B	599	804	904	884	1134
C	315	580	640	428	678
D	142	112	132	228	228
E	600	600	600	600	600
F	655	860	960	940	1190
G	19	19	19	19	19
H	270	317	317	388	388
I	135	159	159	194	194
J	159	182	182	218	218
K	882	1050	1090	1322	1322
L	414	470	470	612	612
M	95	70	70	85	85
N	164	164	210	258	258
O	144	144	194	242	242

Unit: mm

Heat recovery with DX coil

	A	B	C	D	E	E1	F	F1	G	L	T	K	M	N	P	R	S	Y	Z	Net weight
PAW-500ZDX3N	904	1400	107	200	825	1395	960	830	19	955	500	135	270	350	135	135	202	350	135	90 - 98
PAW-800ZDX3N	1134	1695	85	250	1115	1685	1190	1060	19	1200	678	170	388	500	170	170	228	415	195	100 - 110
PAW-01KZDX3N	1216	1700	85	250	1130	1700	1273	1140	19	1290	621	171	388	550	146	241	151	415	195	105 - 120

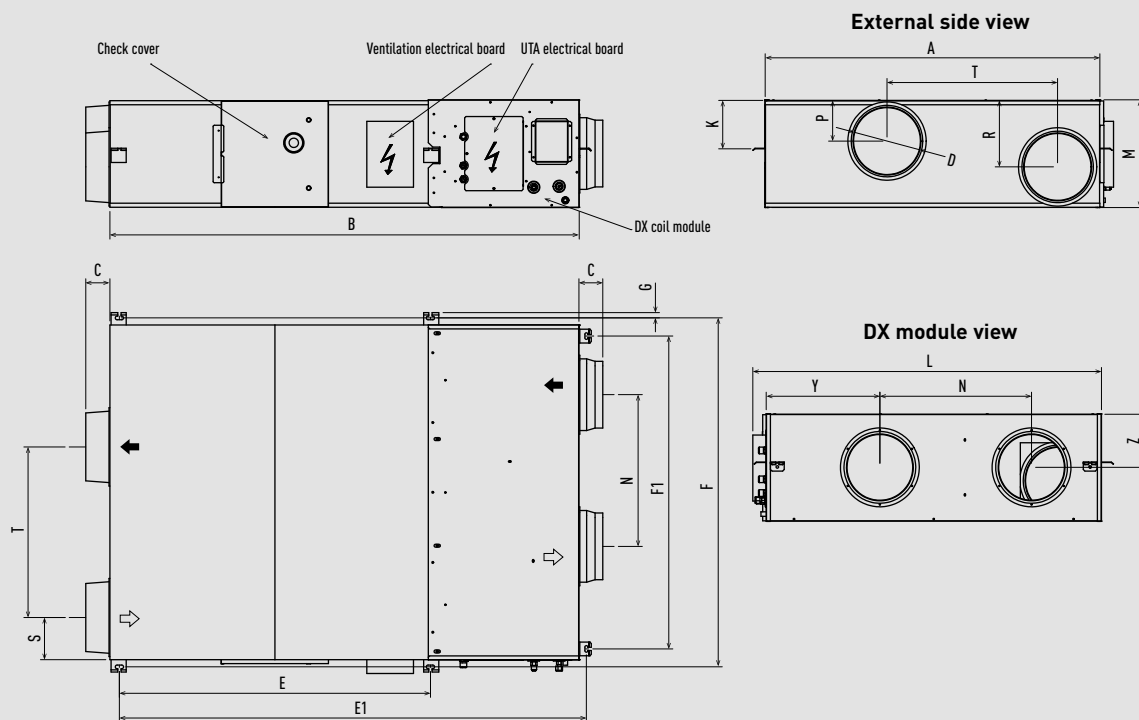

Unit: mm

Electric air curtain

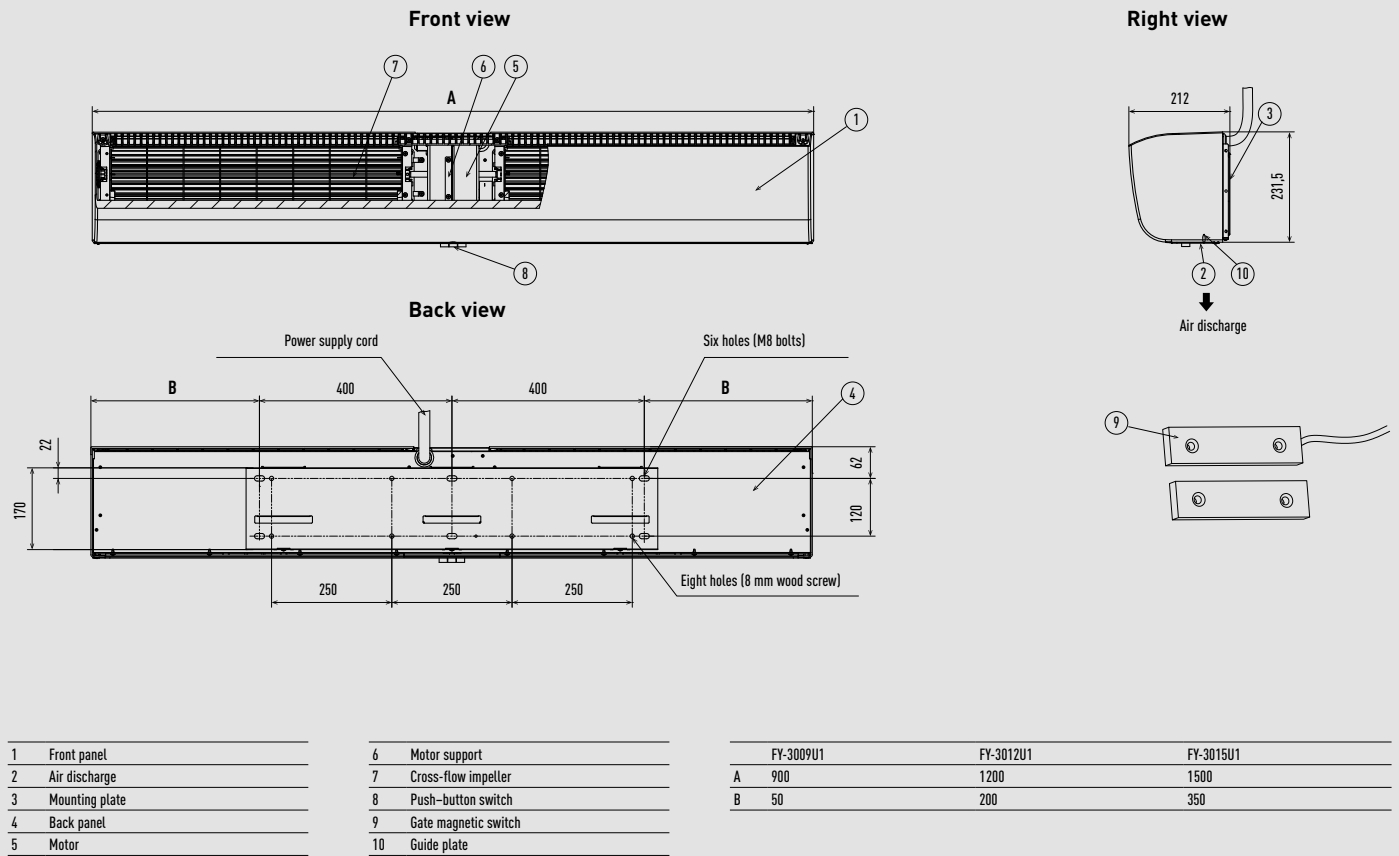

Unit: mm

Air curtain with DX coil

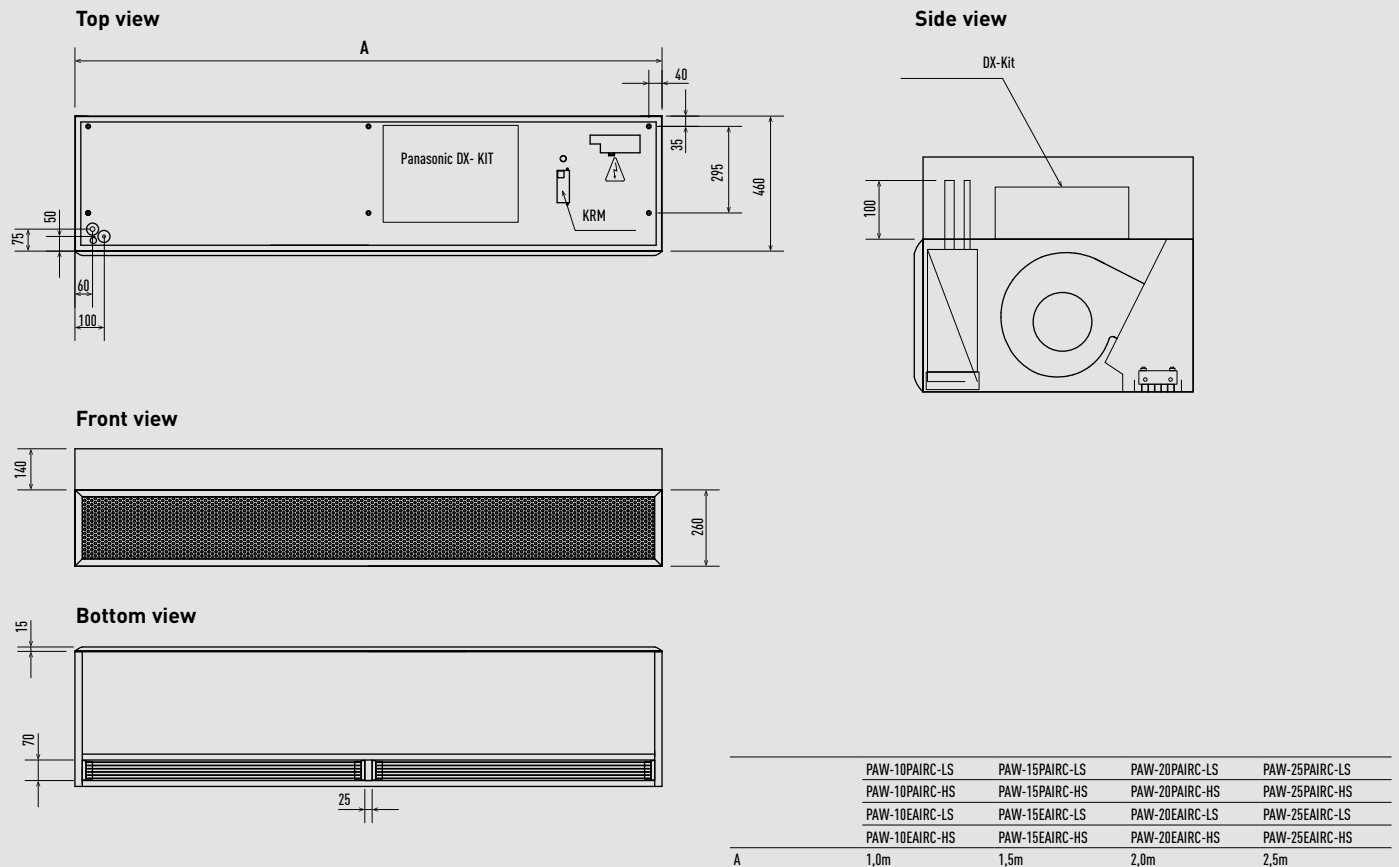

Unit: mm



E2 Type high static pressure hide-away

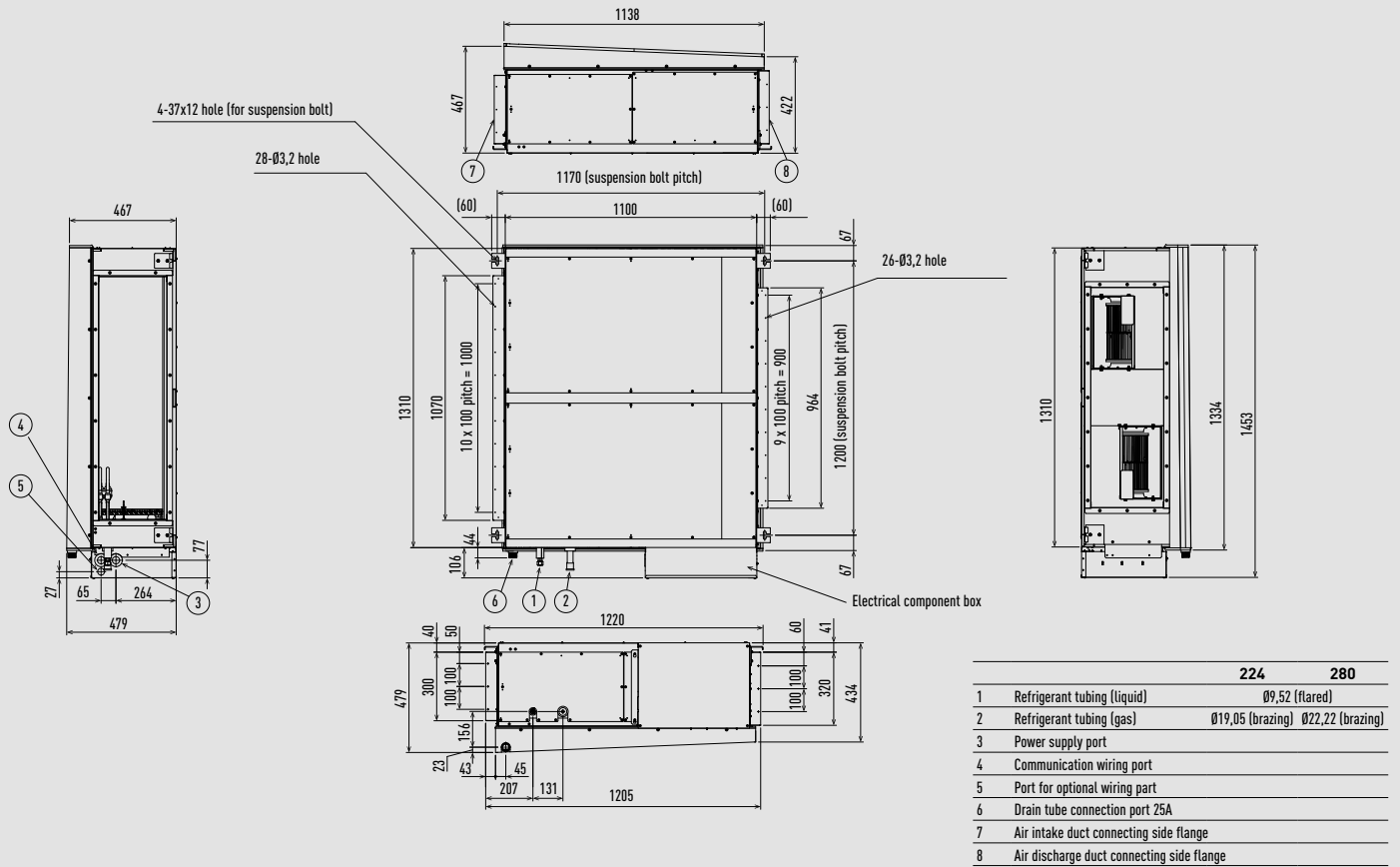

Unit: mm

Room controller for SE8000

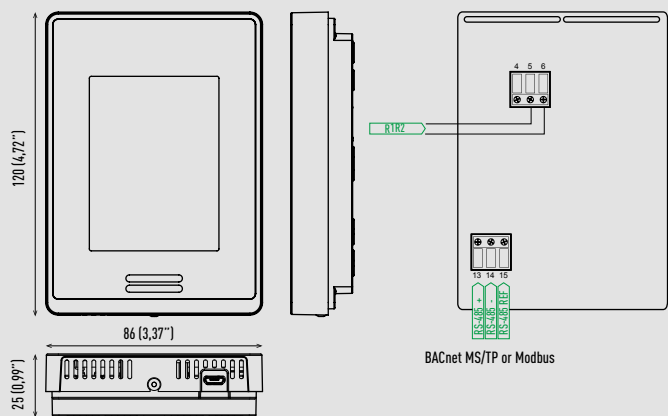

Check with your local government for instruction on disposal of these products.

THIS PRODUCT FOR COMMERCIAL USE ONLY.



Dimensions:

Height: 12 cm/4,72 in.
Width: 8,6 cm/3,39 in.
Depth: 2,7 cm/1,06 in.

Power requirements:

16 Vdc from Panasonic R-R IDU connectors.
50/60 Hz, 4 VA, Class 2 Supply.

Range from indoor unit:

Recommended 500 ft (150 m).

Operating conditions:

0 °C to 50 °C (32 °F to 122 °F).
0% to 95% R.H. non-condensing.

Storage conditions:

-30 °C to 50 °C (-22 °F to 122 °F).
0% to 95% R.H. non-condensing.

Temperature sensor:

Local 10 K NTC type 2 thermistor.

Temperature sensor resolution:

± 0,1 °C (± 0,2 °F).

Temperature sensor accuracy:

± 0,5 °C (± 0,9 °F) @ 21 °C (70 °F) typical calibrated.

Humidity sensor and calibration:

Single point calibrated bulk polymer type sensor.

Humidity sensor precision:

Reading range from 10% to 90% R.H. non-condensing.
10% to 20% precision: 10%.
20% to 80% precision: 5%.
80% to 90% precision: 10%.

Humidity sensor stability:

Less than 1,0% yearly (typical drift).

Wiring:

Maximum wire length between last indoor unit to SER8150Rx81194 equals 490 ft (150 m) with AWG #18 wire (0,82 mm²).
Refer to Panasonic VRF guidelines "Wiring system diagram for remote controller" for this limitation.

Approximate shipping weight:

0,34 kg (0,75 lb)

Unit: mm

Wall/ceiling wireless sensor SED-MTH-G-5045

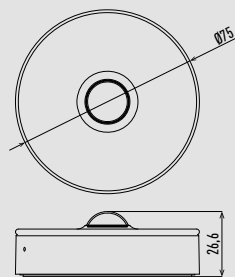

Dimensions:
70 mm diameter x 26,6 mm.

Colour:
White.

Weight:
59 g.

Communication:
ZigBee 3,0 HA.

Detection range:
Ceiling: Ø4m (installation height 2,5 m).
Wall: R5m (installation height 1,2 m).

Battery voltage:
3 V.

Battery cell:
LR03 AAA (2 pcs).

Battery life:
Up to 5 years.

Ambient temperature:
-10 °C ~ +50 °C.

Certification



Check with your local government for instruction on disposal of these products.

Door/window wireless sensor SED-WDC-G-5045

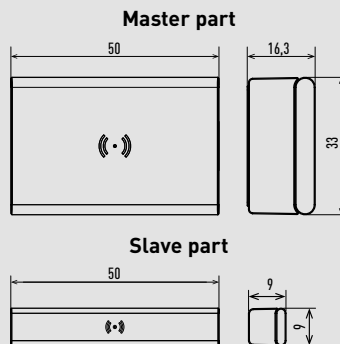

Dimensions:
Master part: 50 x 33 x 16,3 mm.
Slave part: 50 x 9 x 9 mm.

Colour:
White / transparent.

Weight:
30 g

Communication:
ZigBee 3,0 HA.

Detection range:
Trigger 'close': wood 30 mm, metal 18 mm.
Trigger 'open': wood 32 mm, metal 20 mm.

Battery voltage:
3 V.

Battery cell:
CR2450.

Battery life:
Up to 5 years.

Ambient temperature:
-10 °C ~ +50 °C.

Certification



Check with your local government for instruction on disposal of these products.

Unit: mm



CO₂ sensor SED-CO2-G-5045

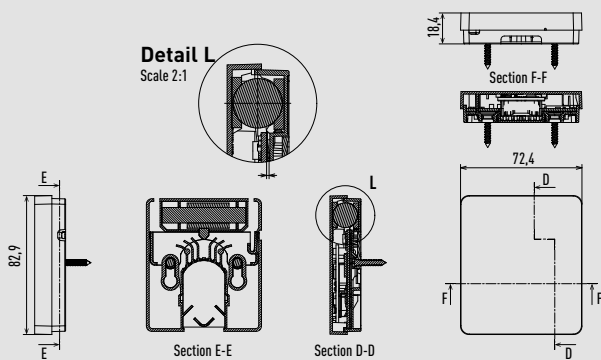

Certification



Check with your local government for instruction on disposal of these products.

Dimensions:

3,26 x 2,85 x 0,72 inches.
82,9 x 72,4 x 18,4 mm.

Operating temperature:

0 °C to 50 °C (32 °F to 122 °F).

Temperature accuracy:

±0,3 °C (0,54 °F) typical within operating range.

Humidity range:

0% to 100%.

Humidity accuracy:

± 3% RH (typical within 0% to 80% RH).

Measurement range:

0 to 5000ppm.

Measurement/Transmission intervals:

2,5 minutes (day), 10 minutes (evening).

Note: Battery life will be reduced should interval be shortened (i.e, using remote temperature/humidity functions).

CO₂ accuracy at NTP:

±60 ppm +3% of reading (400 - 2,000 ppm range).

Communication:

Zigbee 3.0 Green Power (encrypted, bi-directional).

Battery voltage:

3,6 V.

Battery cell:

AA Lithium ion.

Battery life:

10+ years (non-replaceable).

Note: Battery life can be reduced when sensor is operated at temperatures approaching the operating limits.

Ambient temperature:

-30 °C to 70 °C.

Unit: mm

Hotel room controller (HRC)

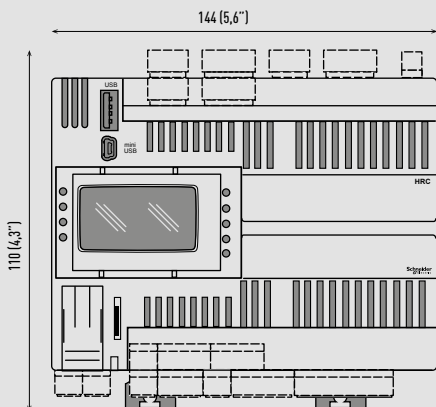

Dimensions:

5,6 x 4,3 x 2,4 inches.
144 x 110 x 60,5 mm.

Digital inputs:

12.

High voltage relay digital outputs:

10 x 3 A SPST +250 VAC relays.

Analog inputs:

2 x configurable analog inputs.

DI: voltage free DI, 10 kΩ input impedance.

0-20 mA: range 0,1000, < 150 Ω impedance.

0-10 V: range 0,1000 > 10 kΩ impedance.

Analog outputs:

6 x 0-10 V outputs, Load impedance > 700 Ω.

Supply voltage:

24 VAC + 10% NOT ISOLATED.
+20...38 Vdc NOT ISOLATED.

Supply frequency:

50/60 Hz.

Power cycle:

35 VA / 15 W.

Operating temperature:

-20 to 60 °C (-4 to 140 °F) conforming to UL 60730-1.

Storage temperature:

-30 to 70 °C (-22 to 158 °F).

* Power supply is not included.

Certification



Check with your local government for instruction on disposal of these products.

CZ-CAPWFC1 Commercial Wi-Fi Adaptor

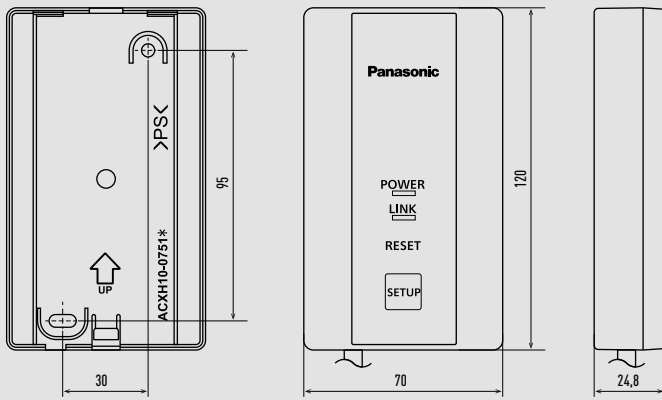

CZ-RTC6 / BL / BLW CONEX wired remote controller

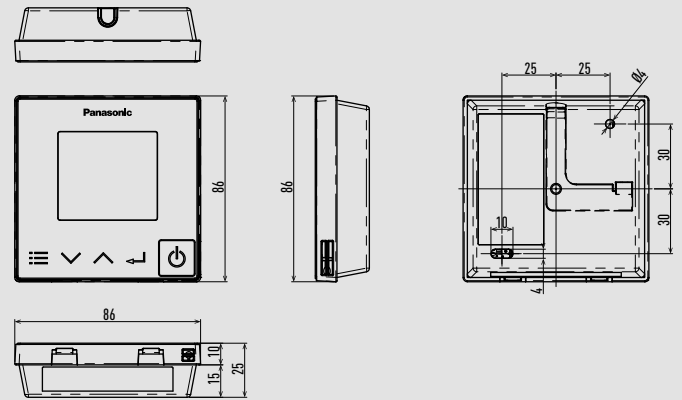

CZ-RTC5B design wired remote controller

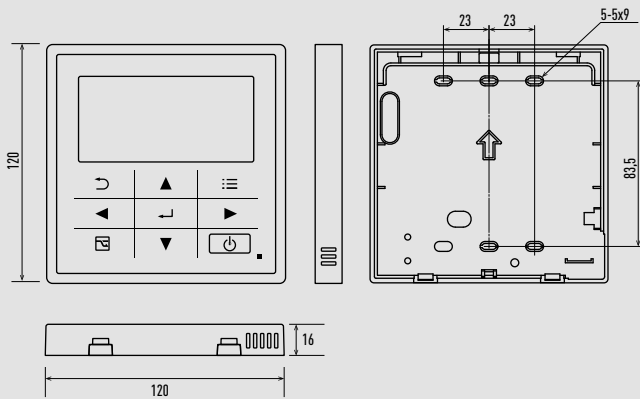

CZ-256ESMC3 intelligent controller (touch screen/web server)

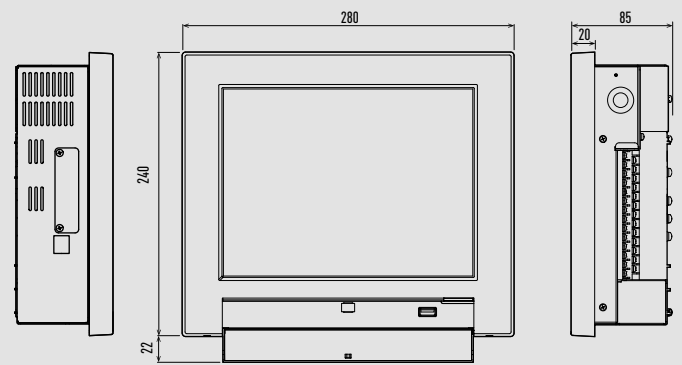

CZ-CENS1 Econavi sensor

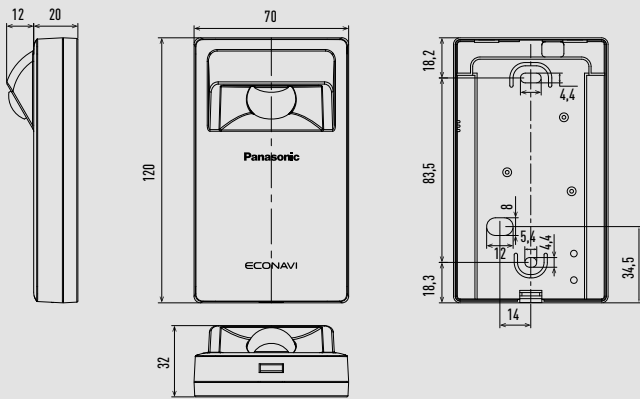

CZ-RWS3 infrared remote controller

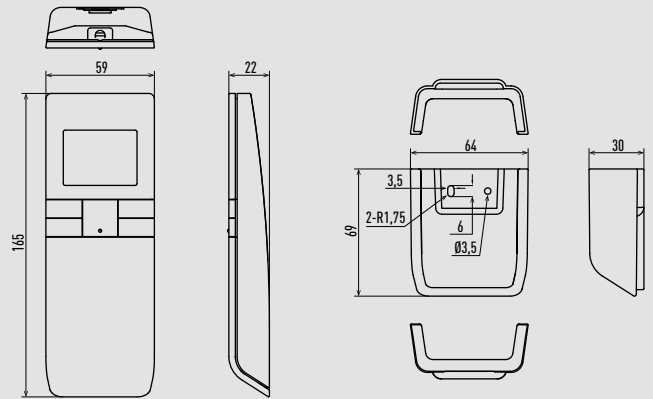

CZ-CSRC3 remote sensor

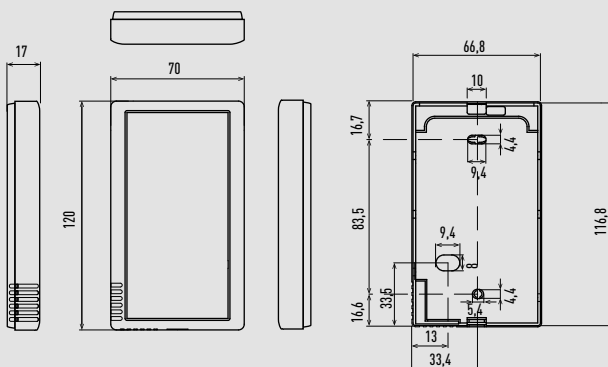



CZ-64ESMC3 system controller with weekly timer

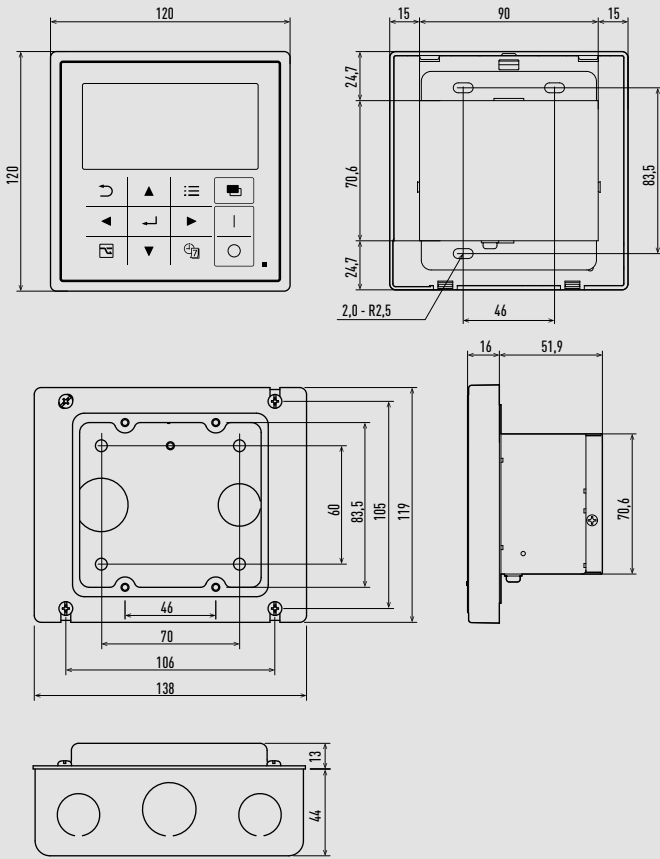

CZ-ANC3 central ON/OFF controller

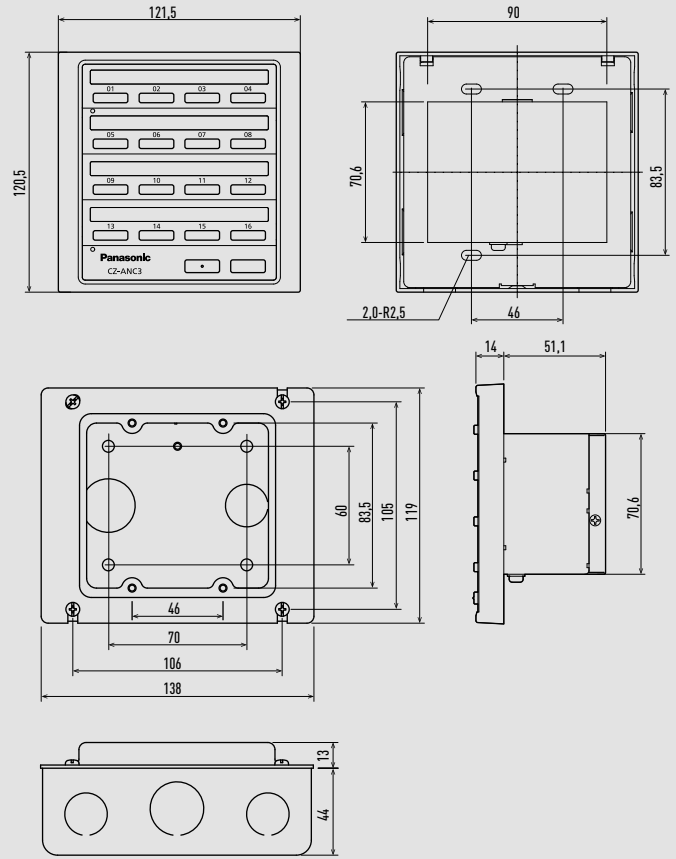

CZ-CAPDC2 Seri-Para I/O unit for outdoor unit

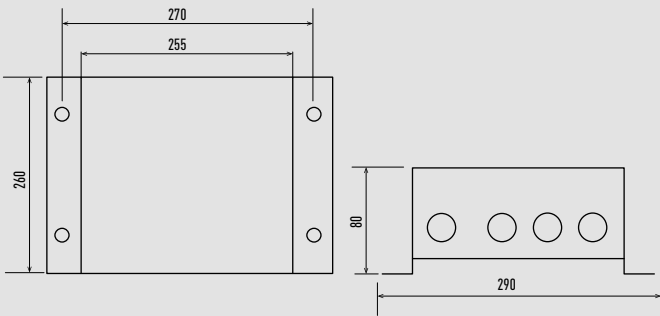

CZ-CAPC3 local adaptor for ON/OFF control

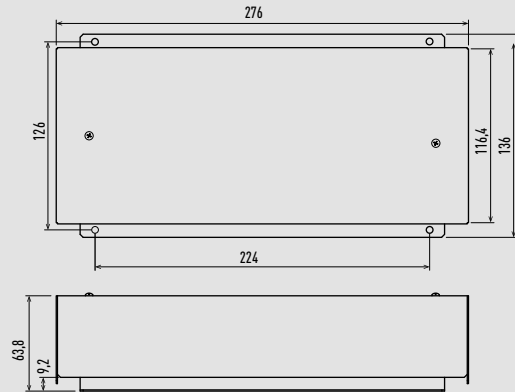

CZ-CAPBC2 Mini Seri-Para I/O Unit 0 -10 V

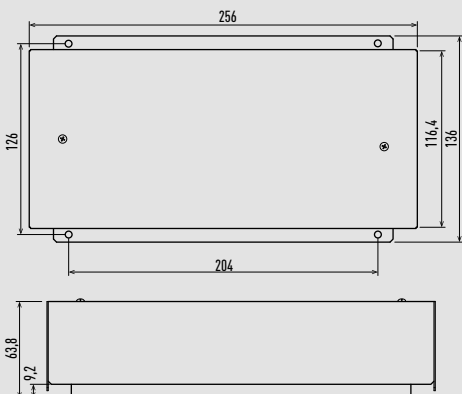

CZ-CFUNC2 communication adaptor

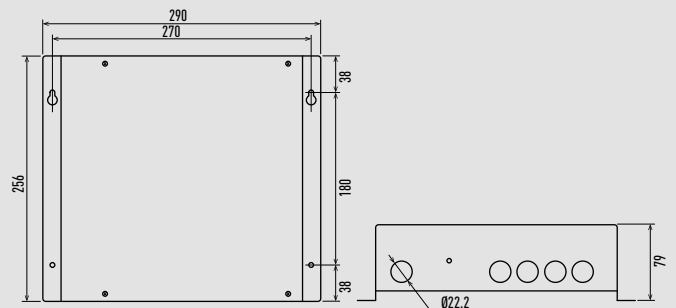

ECOi-W 20 to 40 with condenser fans standard

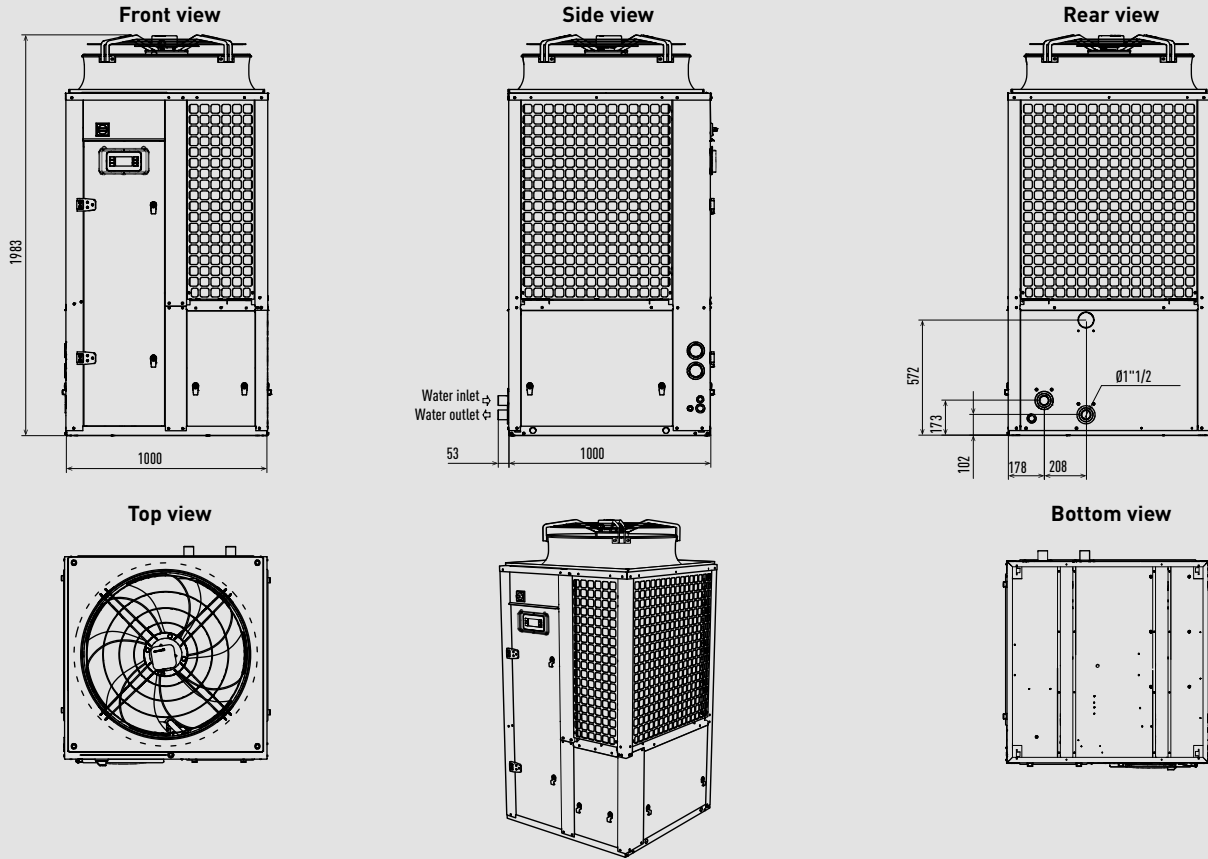

Unit: mm

ECOi-W 20 to 40 with condenser fans standard and buffer tank

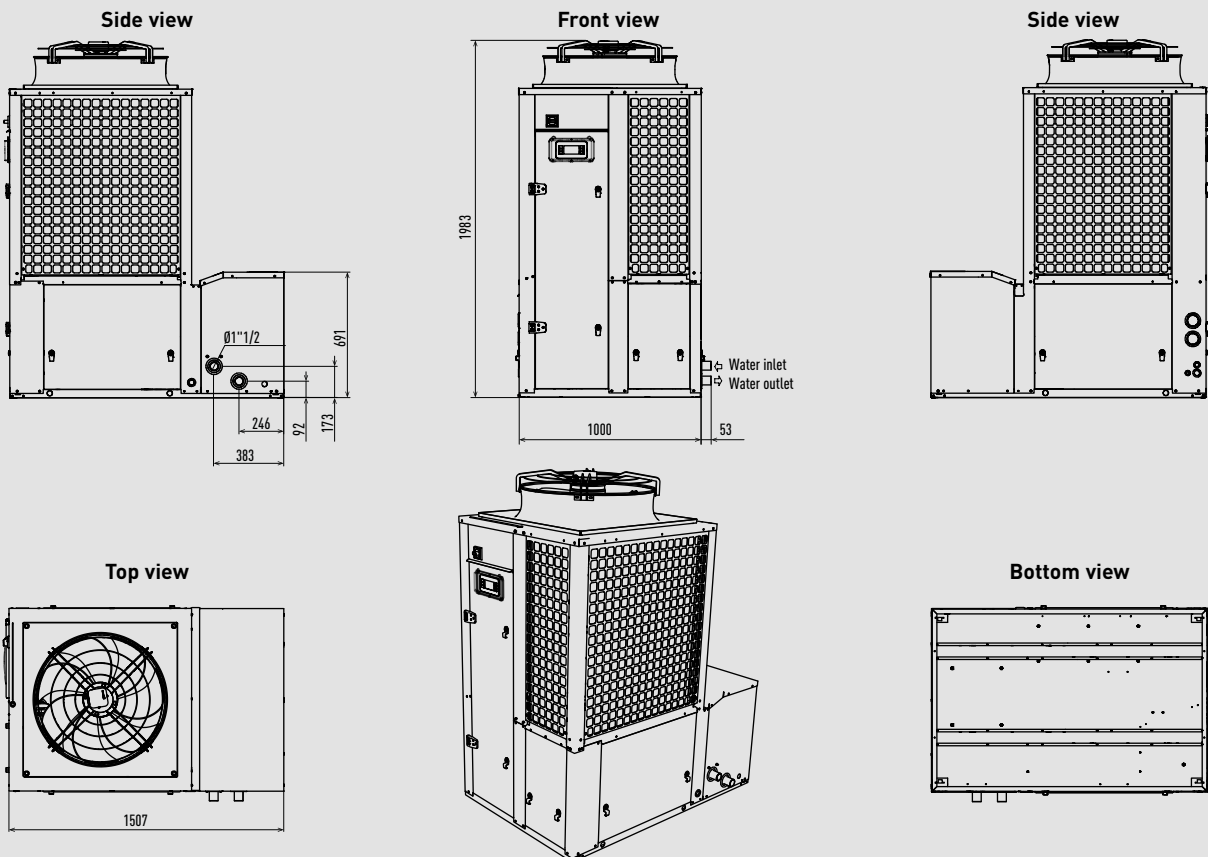

Unit: mm



ECOi-W 45 to 55 with condenser fans standard

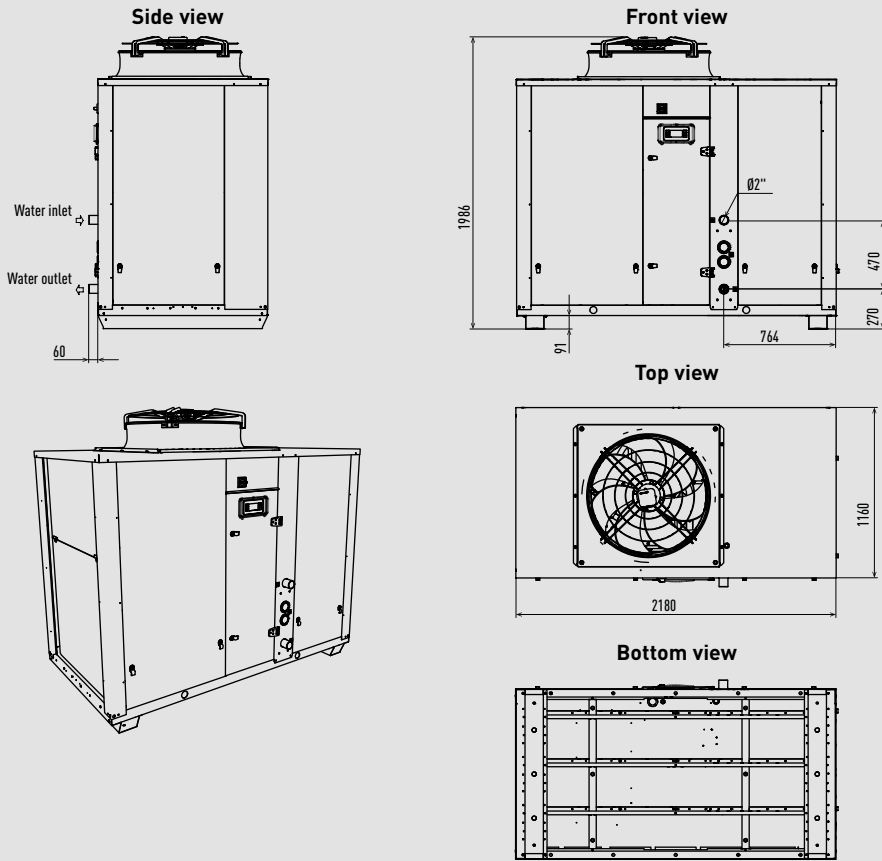

Unit: mm

ECOi-W 45 to 55 with condenser fans standard and buffer tank

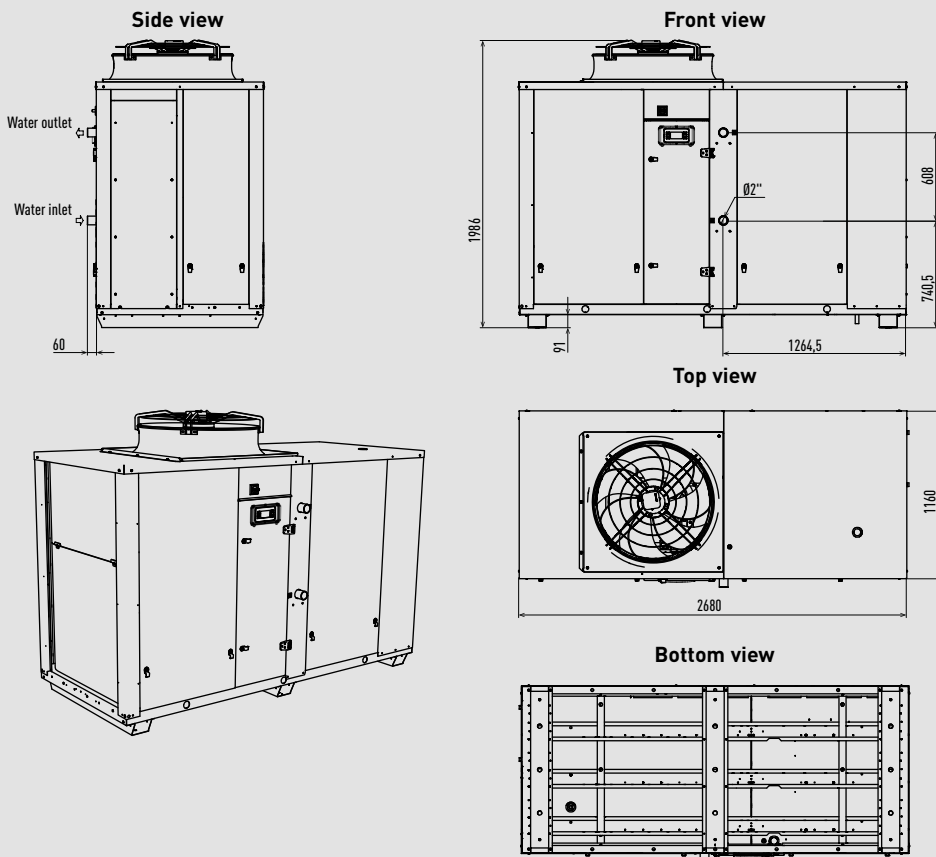

Unit: mm

ECOi-W 65 to 75 with condenser fans standard

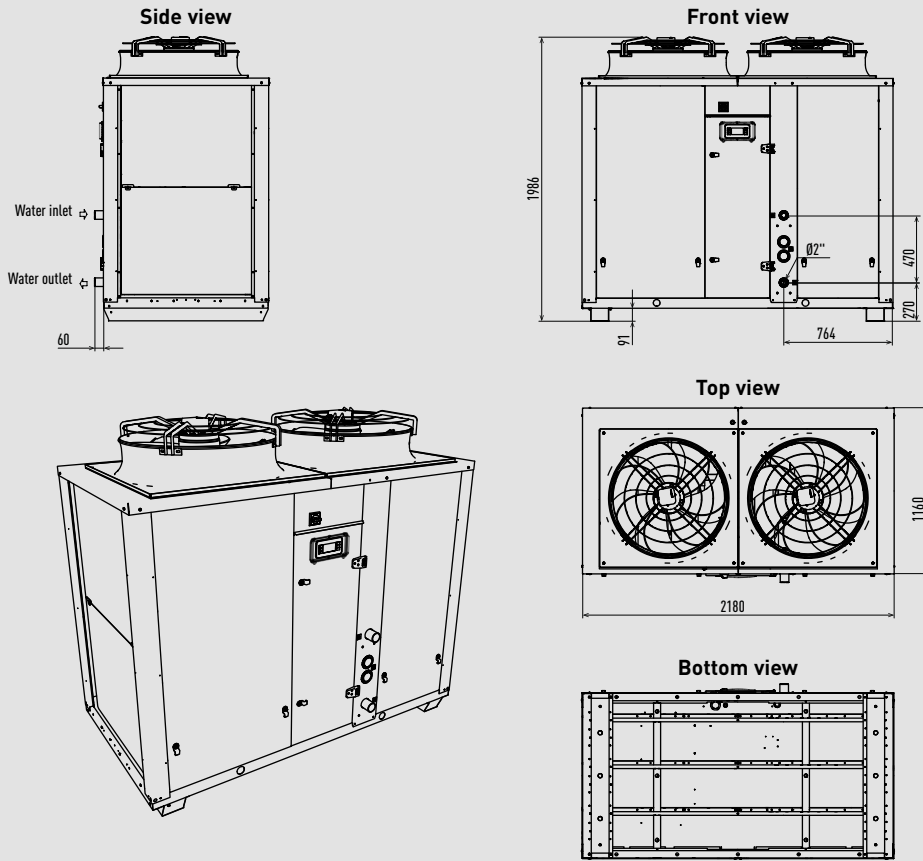

Unit: mm

ECOi-W 65 to 75 with condenser fans standard and buffer tank

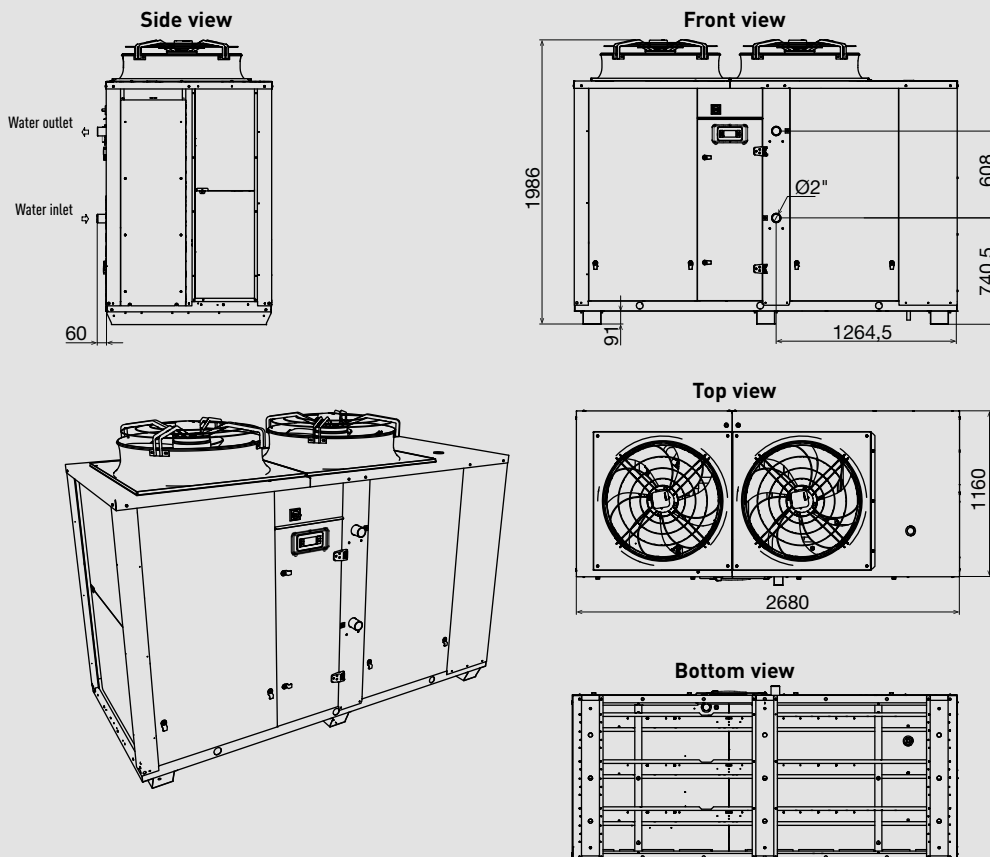

Unit: mm



ECOi-W 90 to 125 with condenser fans standard

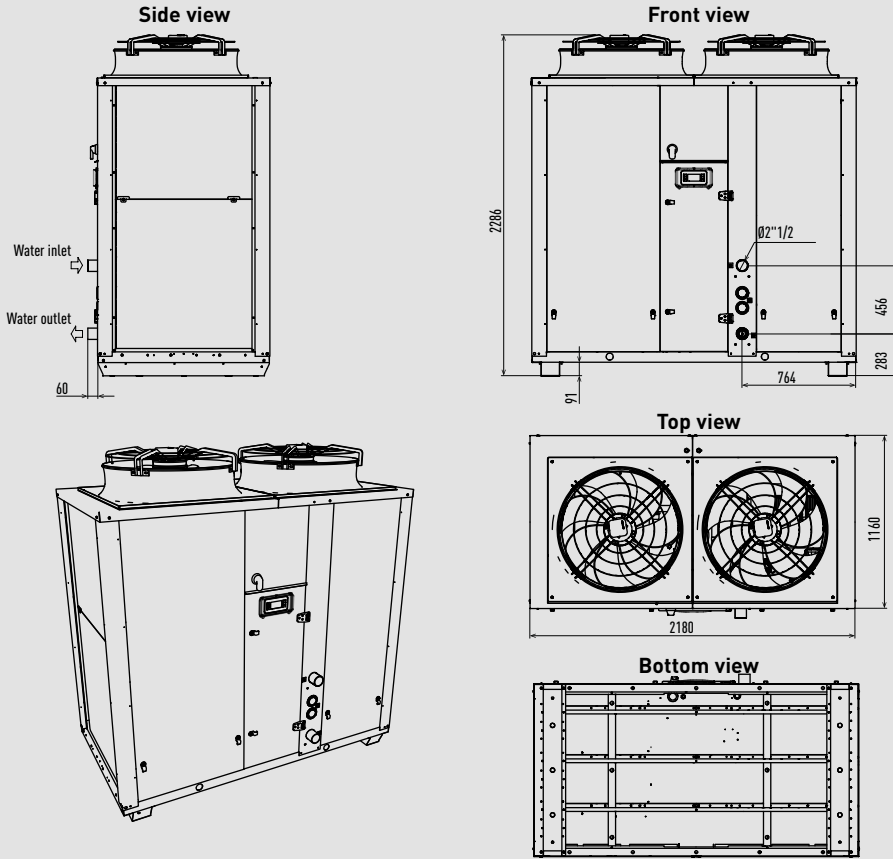

Unit: mm

ECOi-W 90 to 125 with condenser fans standard and buffer tank

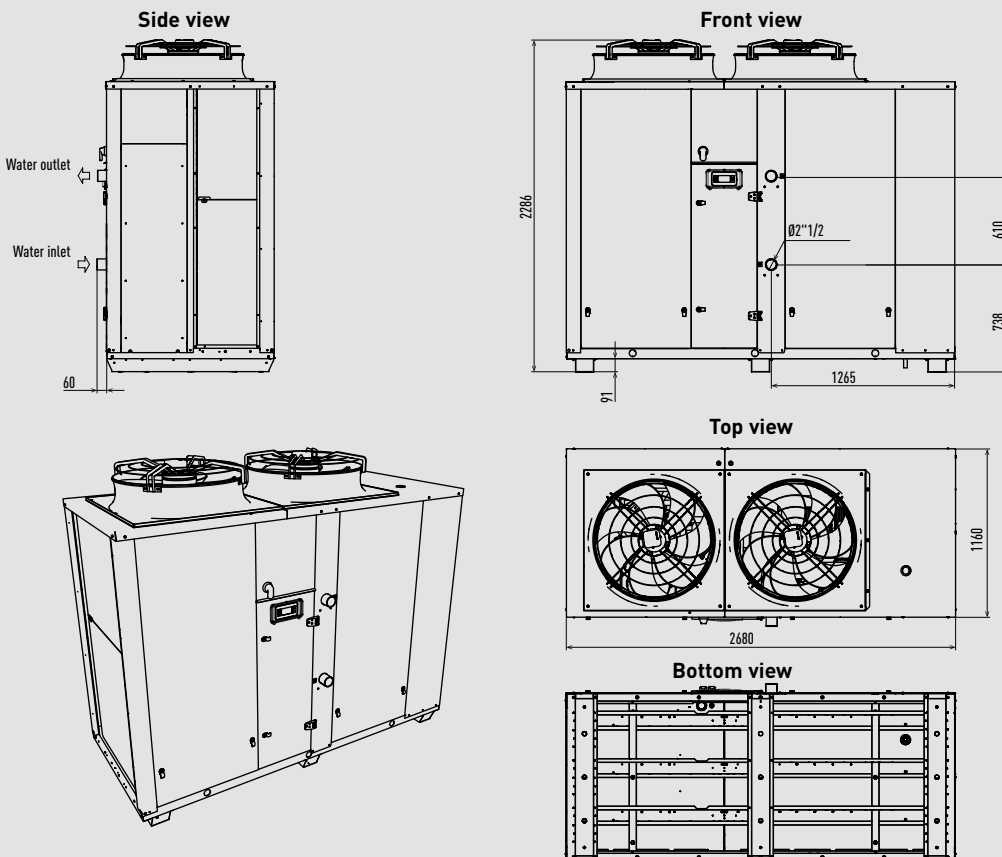

Unit: mm

ECOi-W 140 to 210 without pump

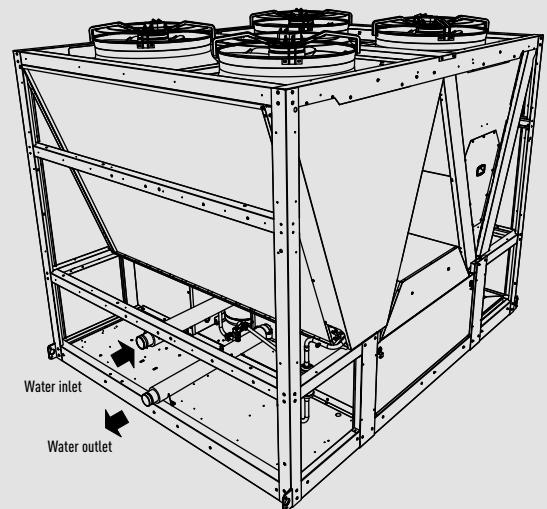
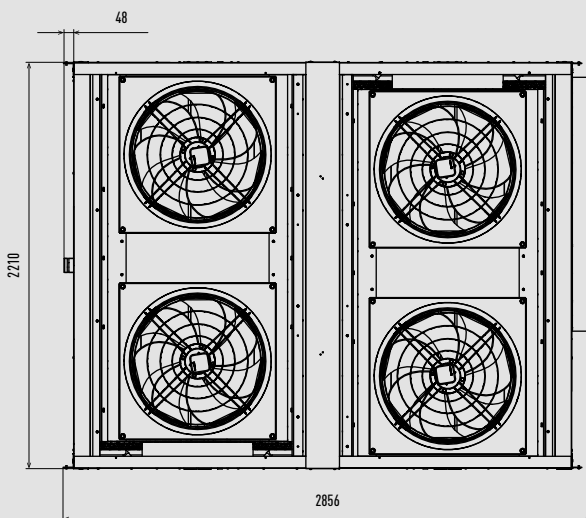
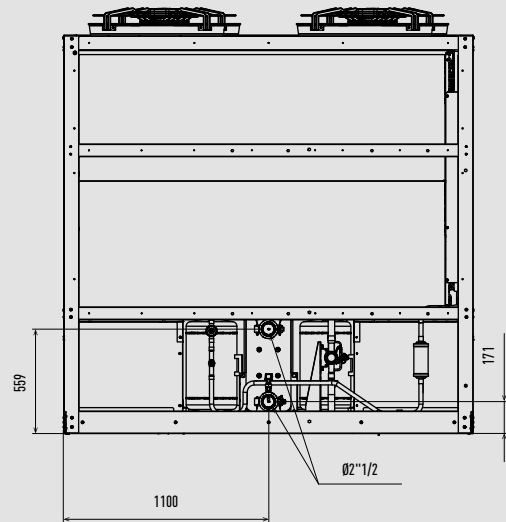
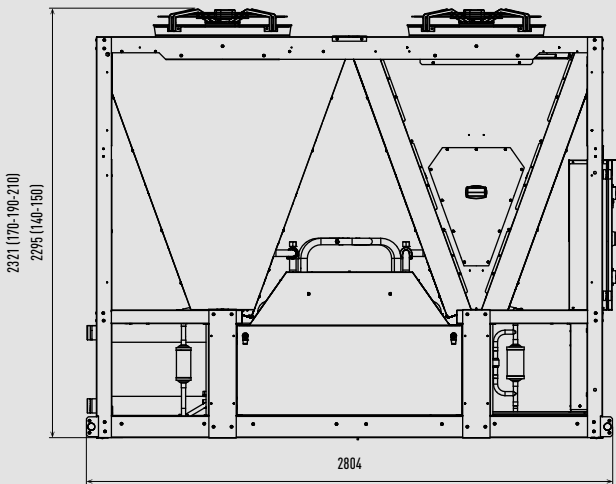
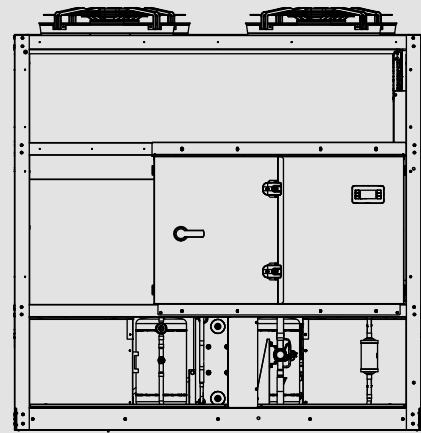
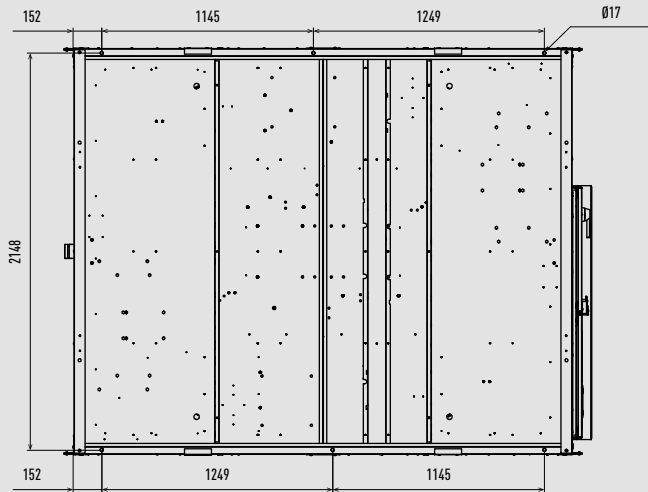



ECOi-W 140 to 210 with 1 pump and buffer tank

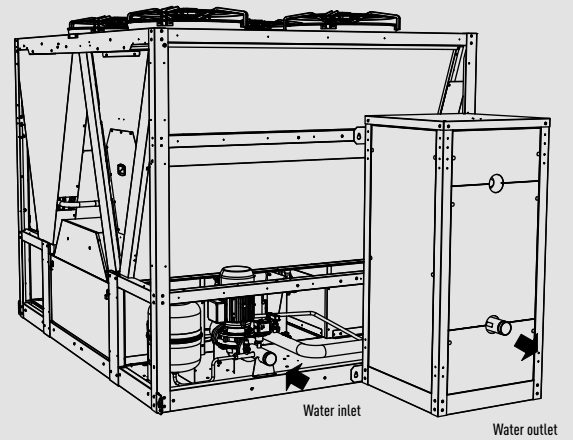
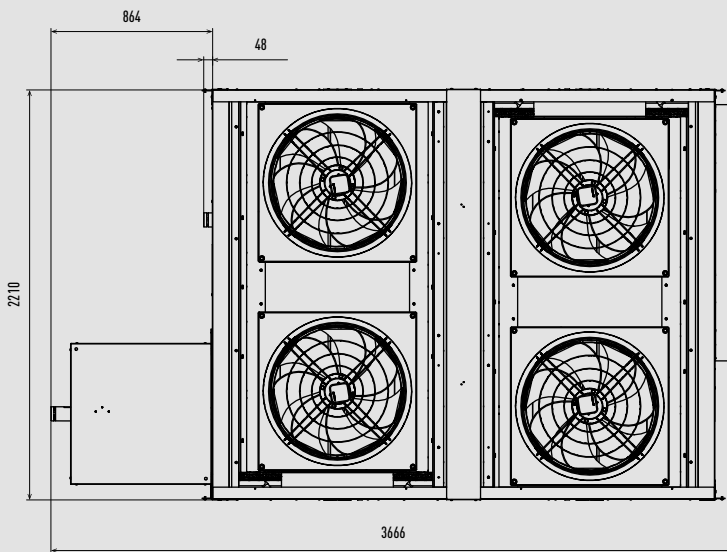
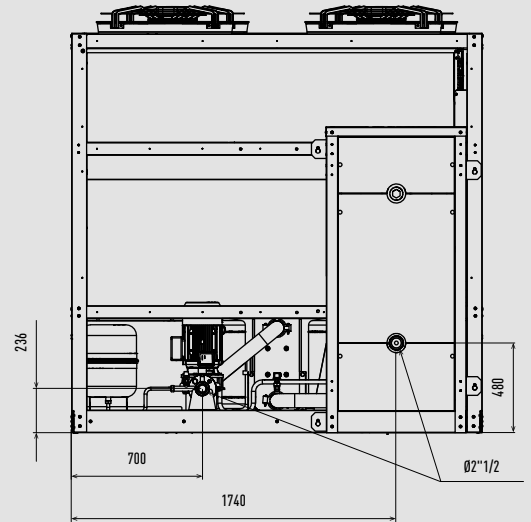
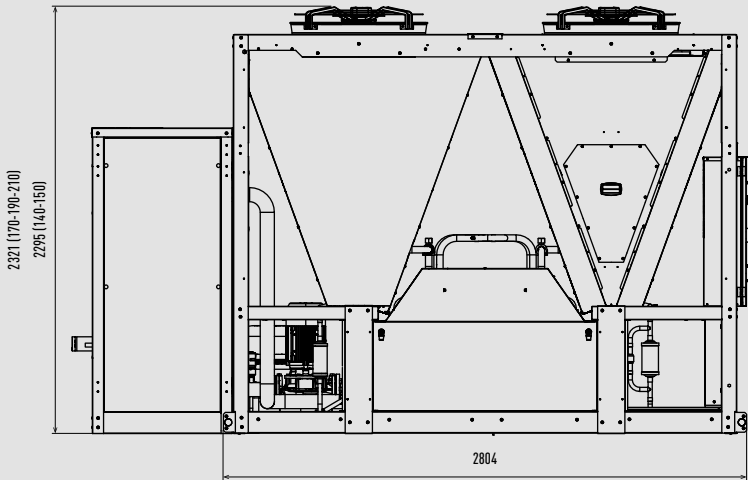
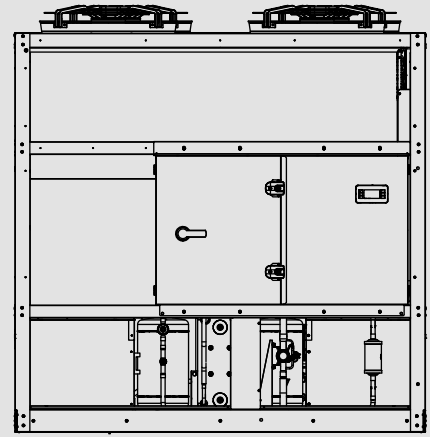
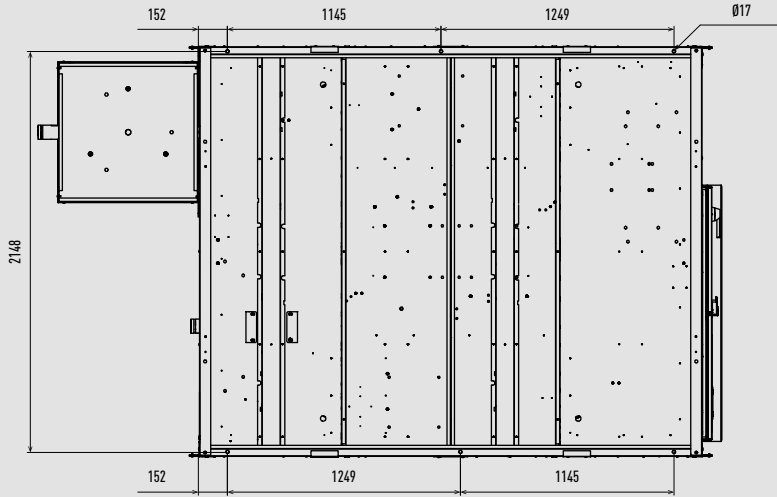

Condensing units - CR Series OCU-CR200VF5A / OCU-CR200VF5ASL

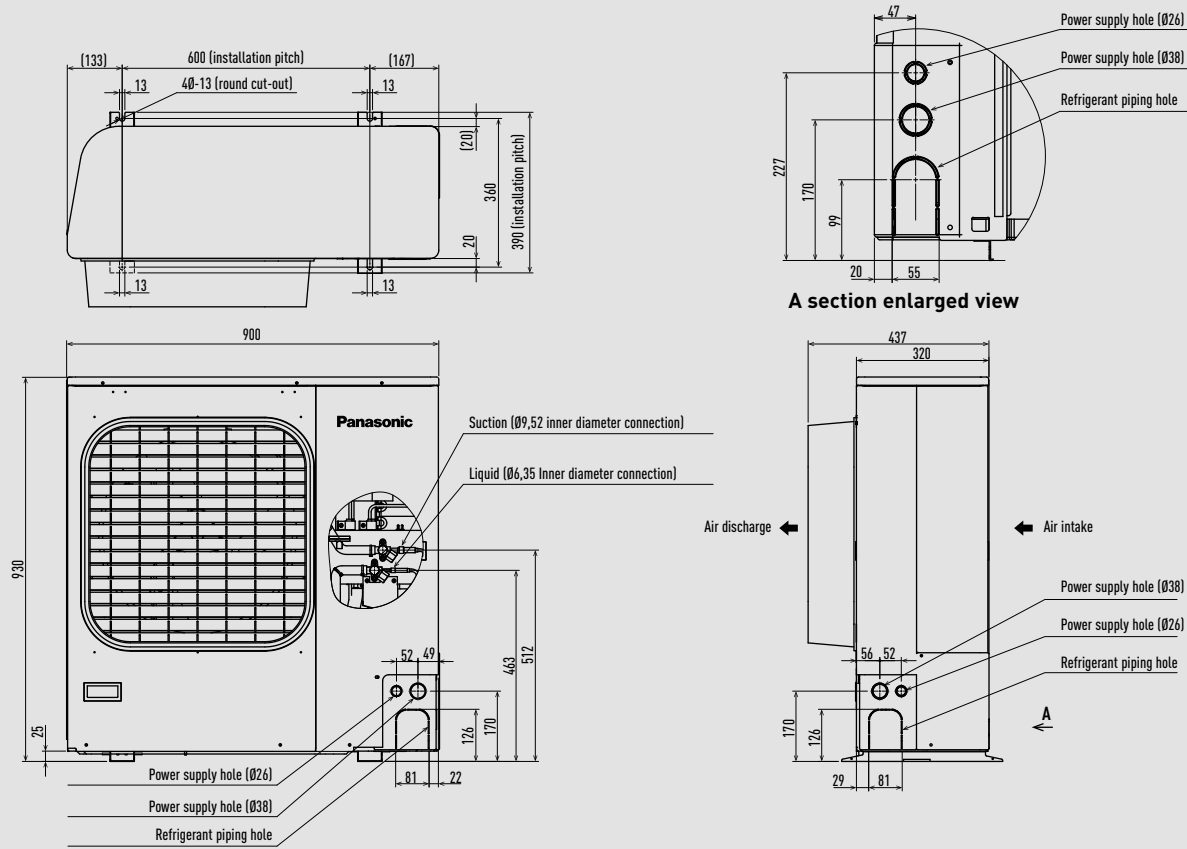

Unit: mm

Condensing units - CR Series OCU-CR400VF8 / OCU-CR400VF8SL / OCU-CR400VF8A / OCU-CR400VF8ASL

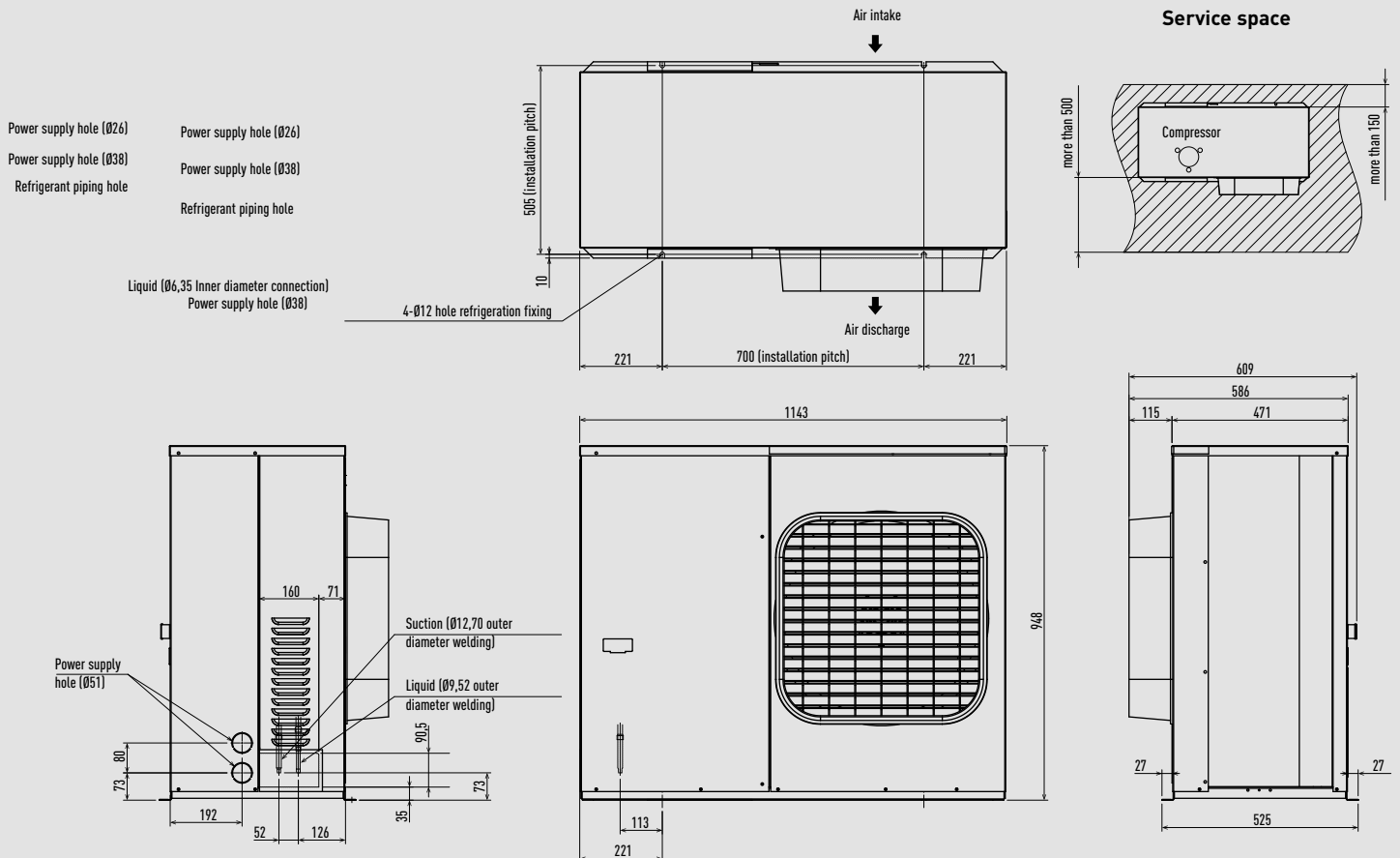

Unit: mm



Condensing units - CR Series OCU-CR1000VF8 / OCU-CR1000VF8SL / OCU-CR1000VF8A / OCU-CR1000VF8ASL

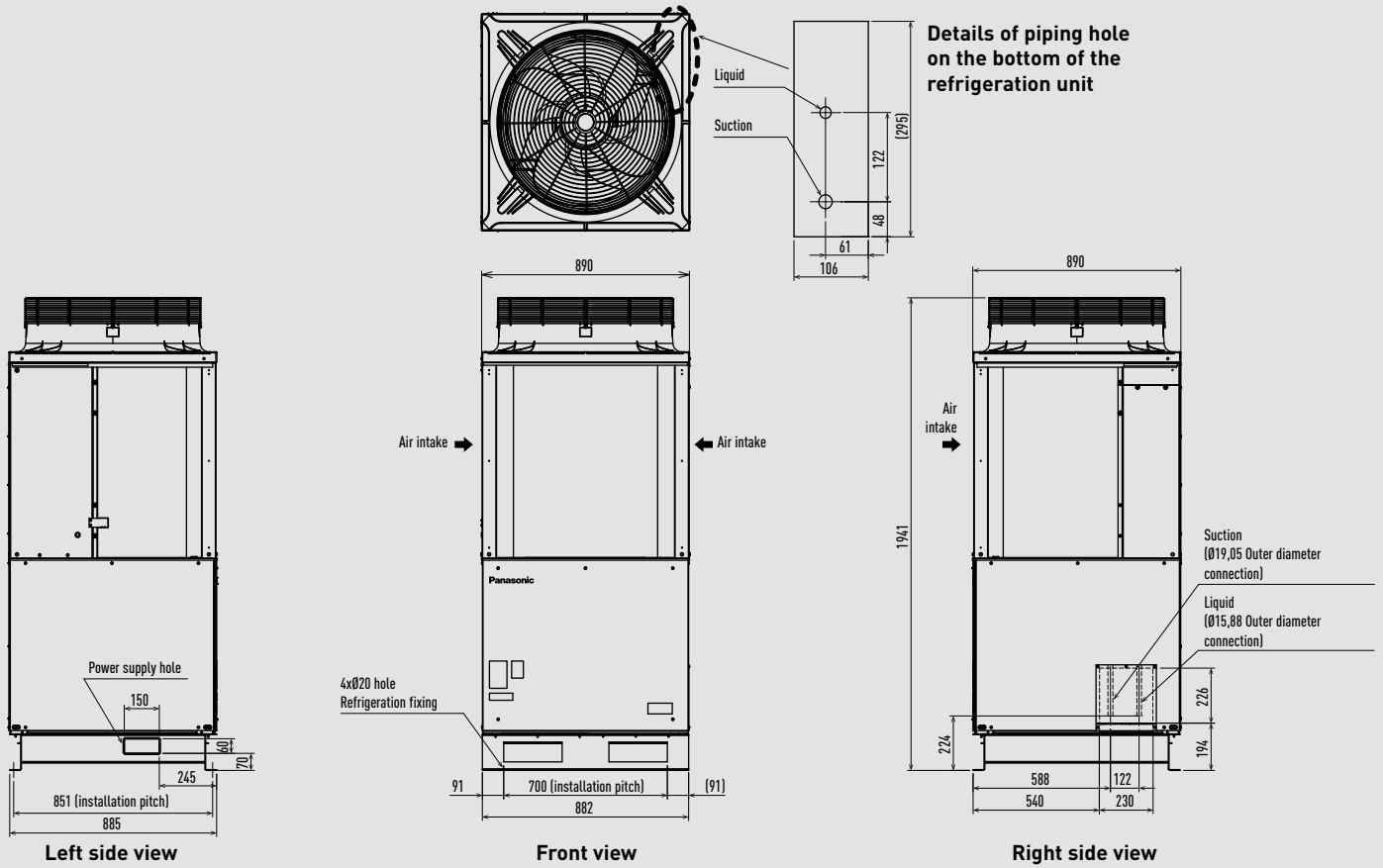

Unit: mm

Wiring diagrams

Domestic

Wall-mounted kits 1x1	→ 569
Floor console kits 1x1	→ 570
Low static pressure hide-away kits 1x1	→ 570
Free Multi System 2 rooms	→ 571
Free Multi System 3 rooms	→ 571
Free Multi System 4 rooms	→ 572
Free Multi System 5 rooms	→ 572

Commercial

Wall-mounted Professional kits 1x1	→ 573
PACi NX wall-mounted kits 1x1	→ 573
PACi NX 4 way 60x60 cassette kits 1x1	→ 574
PACi NX 4 way 90x90 cassette kits 1x1	→ 574
PACi NX ceiling kits 1x1	→ 575
PACi NX adaptive ducted unit kits 1x1	→ 575
Big PACi high static pressure hide-away kits 1x1	→ 576
PACi 4 way 60x60 cassette kits 1x1	→ 576
PACi NX twin system	→ 577
PACi NX triple system	→ 577
PACi NX double-twin system	→ 578

VRF Systems

Mini ECOi Series	→ 578
ECOi EX and ECO G Series	→ 579
Hybrid GHP/EHP	→ 579

Wall-mounted kits 1x1

Indoor unit

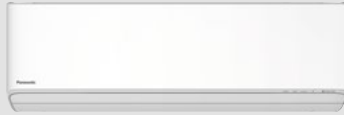

Outdoor unit

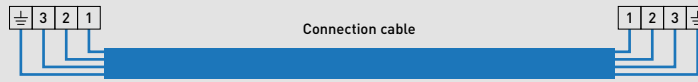

Attention: Wall-mounted Etherea and TZ super-compact have different connection terminals

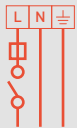

Single phase
Power supply
230 V / 50 Hz



Infrared remote controller (included in the delivery)

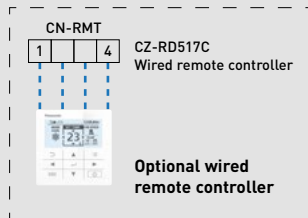

Optional wired remote controller

Power supply to indoor or outdoor depending on model, see table.

Wall-mounted Heatcharge VZ · R32

Indoor unit	Power supply	Recommended fuse	Connection indoor / outdoor	Outdoor unit
CS-VZ9SKE	230 V (indoor)	16 A	4 x 1,5 mm ²	CU-VZ9SKE
CS-VZ12SKE	230 V (indoor)	16 A	4 x 1,5 mm ²	CU-VZ12SKE

Wall-mounted Etherea Graphite grey, Silver and Matt white · R32

Indoor unit	Power supply	Recommended fuse	Power supply cable	Connection indoor / outdoor	Outdoor unit
CS-XZ20XKEW / CS-Z20XKEW	230 V (indoor)	16 A	3 x 1,5 mm ²	4 x 1,5 mm ²	CU-Z20XKE
CS-XZ25XKEW / CS-Z25XKEW	230 V (indoor)	16 A	3 x 1,5 mm ²	4 x 1,5 mm ²	CU-Z25XKE
CS-XZ35XKEW / CS-Z35XKEW	230 V (indoor)	16 A	3 x 1,5 mm ²	4 x 1,5 mm ²	CU-Z35XKE
— / CS-Z42XKEW	230 V (indoor)	16 A	3 x 1,5 mm ²	4 x 1,5 mm ²	CU-Z42XKE
CS-XZ50XKEW / CS-Z50XKEW	230 V (indoor)	16 A	3 x 2,5 mm ²	4 x 2,5 mm ²	CU-Z50XKE
— / CS-Z71XKEW	230 V (indoor)	20 A	3 x 2,5 mm ²	4 x 2,5 mm ²	CU-Z71XKE

Wall-mounted TZ super-compact · R32

Indoor unit	Power supply	Recommended fuse	Power supply cable	Connection indoor / outdoor	Outdoor unit
CS-TZ20WKEW	230 V (indoor)	16 A	3 x 1,5 mm ²	4 x 1,5 mm ²	CU-TZ20WKE
CS-TZ25WKEW	230 V (indoor)	16 A	3 x 1,5 mm ²	4 x 1,5 mm ²	CU-TZ25WKE
CS-TZ35WKEW	230 V (indoor)	16 A	3 x 1,5 mm ²	4 x 1,5 mm ²	CU-TZ35WKE
CS-TZ42WKEW	230 V (indoor)	16 A	3 x 1,5 mm ²	4 x 1,5 mm ²	CU-TZ42WKE
CS-TZ50WKEW	230 V (indoor)	16 A	3 x 2,5 mm ²	4 x 2,5 mm ²	CU-TZ50WKE
CS-TZ60WKEW	230 V (indoor)	20 A	3 x 2,5 mm ²	4 x 2,5 mm ²	CU-TZ60WKE
CS-TZ71WKEW	230 V (indoor)	20 A	3 x 2,5 mm ²	4 x 2,5 mm ²	CU-TZ71WKE

Wall-mounted BZ super-compact · R32

Indoor unit	Power supply	Recommended fuse	Power supply cable	Connection indoor / outdoor	Outdoor unit
CS-BZ25XKE	230 V (indoor)	16 A	3 x 1,5 mm ²	4 x 1,5 mm ²	CU-BZ25XKE
CS-BZ35XKE	230 V (indoor)	16 A	3 x 1,5 mm ²	4 x 1,5 mm ²	CU-BZ35XKE
CS-BZ50XKE	230 V (indoor)	16 A	3 x 2,5 mm ²	4 x 2,5 mm ²	CU-BZ50XKE
CS-BZ60XKE	230 V (indoor)	20 A	3 x 2,5 mm ²	4 x 2,5 mm ²	CU-BZ60XKE

Wall-mounted UZ super-compact · R32

Indoor unit	Power supply	Recommended fuse	Power supply cable	Connection indoor / outdoor	Outdoor unit
CS-UZ25WKE	230 V (indoor)	16 A	3 x 1,5 mm ²	4 x 1,5 mm ²	CU-UZ25WKE
CS-UZ35WKE	230 V (indoor)	16 A	3 x 1,5 mm ²	4 x 1,5 mm ²	CU-UZ35WKE
CS-UZ50WKE	230 V (indoor)	16 A	3 x 2,5 mm ²	4 x 2,5 mm ²	CU-UZ50WKE

Wall-mounted PZ super-compact · R32

Indoor unit	Power supply	Recommended fuse	Power supply cable	Connection indoor / outdoor	Outdoor unit
CS-PZ25WKE	230 V (indoor)	16 A	3 x 1,5 mm ²	4 x 1,5 mm ²	CU-PZ25WKE
CS-PZ35WKE	230 V (indoor)	16 A	3 x 1,5 mm ²	4 x 1,5 mm ²	CU-PZ35WKE
CS-PZ50WKE	230 V (indoor)	16 A	3 x 2,5 mm ²	4 x 2,5 mm ²	CU-PZ50WKE

Floor console kits 1x1

Indoor unit



Infrared remote controller (included in the delivery)

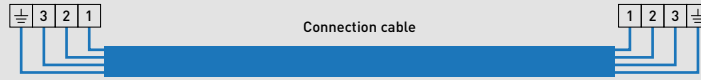

Outdoor unit



Single phase
Power supply
230 V / 50 Hz

Floor console - R32

Indoor unit	Power supply	Recommended fuse	Power supply cable	Connection indoor / outdoor	Outdoor unit
CS-Z25UFEAW	230 V (outdoor)	16 A	3 x 1,5 mm ²	4 x 1,5 mm ²	CU-Z25UBEA
CS-Z35UFEAW	230 V (outdoor)	16 A	3 x 1,5 mm ²	4 x 1,5 mm ²	CU-Z35UBEA
CS-Z50UFEAW	230 V (outdoor)	16 A	3 x 2,5 mm ²	4 x 2,5 mm ²	CU-Z50UBEA

Low static pressure hide-away kits 1x1

Indoor unit



CZ-RD52CP
Included wired
remote controller

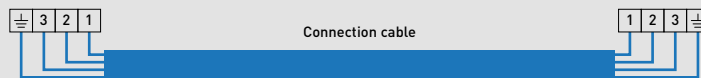

Outdoor unit



Single phase
Power supply
230 V / 50 Hz

Low Static Pressure Hide Away - R32

Indoor unit	Power supply	Recommended fuse	Power supply cable	Connection indoor / outdoor	Outdoor unit
CS-Z25UD3EAW	230 V (outdoor)	16 A	3 x 1,5 mm ²	4 x 1,5 mm ²	CU-Z25UBEA
CS-Z35UD3EAW	230 V (outdoor)	16 A	3 x 1,5 mm ²	4 x 1,5 mm ²	CU-Z35UBEA
CS-Z50UD3EAW	230 V (outdoor)	16 A	3 x 2,5 mm ²	4 x 1,5 mm ²	CU-Z50UBEA
CS-Z60UD3EAW	230 V (outdoor)	16 A	3 x 2,5 mm ²	4 x 1,5 mm ²	CU-Z60UBEA



Free Multi System 2 rooms

Indoor unit

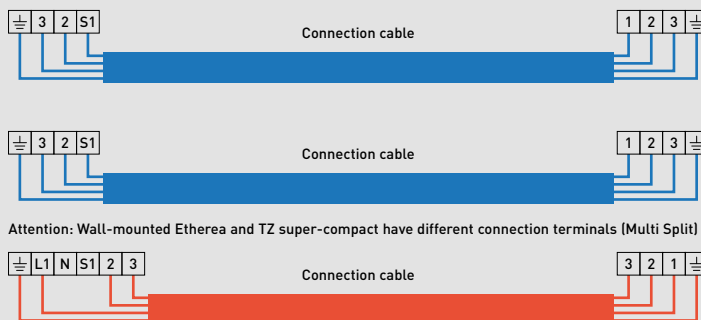
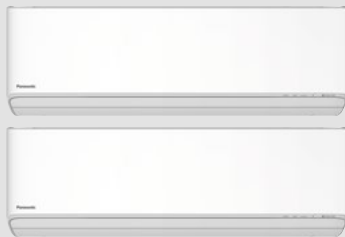

Attention: Wall-mounted Etherea and TZ super-compact have different connection terminals (Multi Split)

Outdoor unit



Single phase
Power supply
230 V / 50 Hz / 16 A

Free Multi System - R32

Outdoor unit	Power supply	Recommended fuse	Power supply cable	Connection indoor / outdoor
CU-2Z35TBE	230 V	16 A	3 x 1,5 mm ²	4 x 1,5 mm ²
CU-2Z41TBE	230 V	16 A	3 x 1,5 mm ²	4 x 1,5 mm ²
CU-2Z50TBE	230 V	16 A	3 x 1,5 mm ²	4 x 1,5 mm ²
CU-2TZ41TBE	230 V	16 A	3 x 1,5 mm ²	4 x 1,5 mm ²
CU-2TZ50TBE	230 V	16 A	3 x 1,5 mm ²	4 x 1,5 mm ²

Free Multi System 3 rooms

Indoor unit

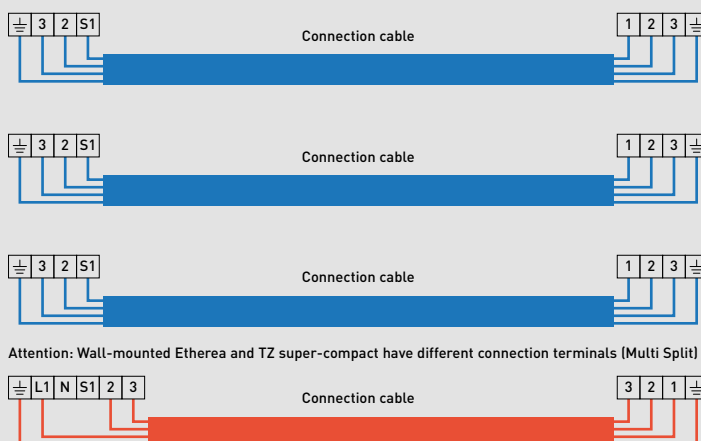

Attention: Wall-mounted Etherea and TZ super-compact have different connection terminals (Multi Split)

Outdoor unit



Single phase
Power supply
230 V / 50 Hz / 16 A

Free Multi System - R32

Outdoor unit	Power supply	Recommended fuse	Power supply cable	Connection indoor / outdoor
CU-3Z52TBE	230 V	16 A	3 x 2,5 mm ²	4 x 1,5 mm ²
CU-3Z68TBE	230 V	16 A	3 x 2,5 mm ²	4 x 1,5 mm ²
CU-3TZ52TBE	230 V	16 A	3 x 2,5 mm ²	4 x 1,5 mm ²

Free Multi System 4 rooms

Indoor unit

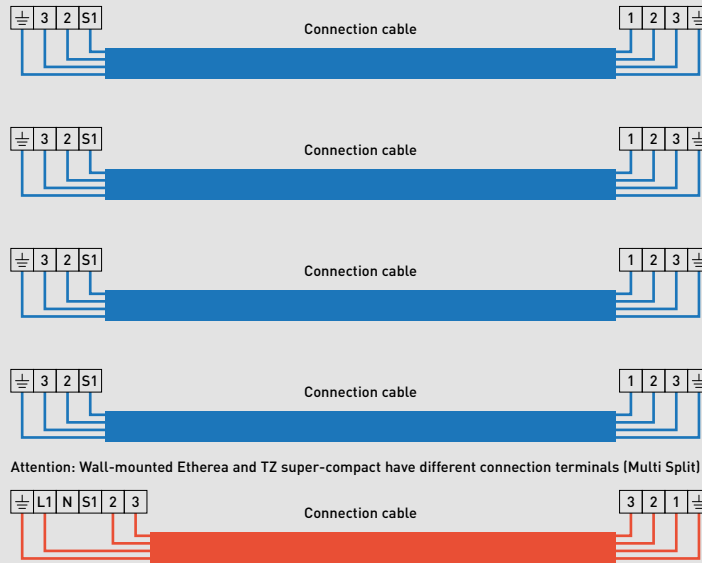

Attention: Wall-mounted Etherea and TZ super-compact have different connection terminals (Multi Split)

Outdoor unit



Single phase
Power supply
230 V / 50 Hz / 20 A

Free Multi System · R32

Outdoor unit	Power supply	Recommended fuse	Power supply cable	Connection indoor / outdoor
CU-4Z68TBE	230 V	20 A	3 x 2,5 mm ²	4 x 1,5 mm ²
CU-4Z80TBE	230 V	20 A	3 x 2,5 mm ²	4 x 1,5 mm ²

Free Multi System 5 rooms

Indoor unit

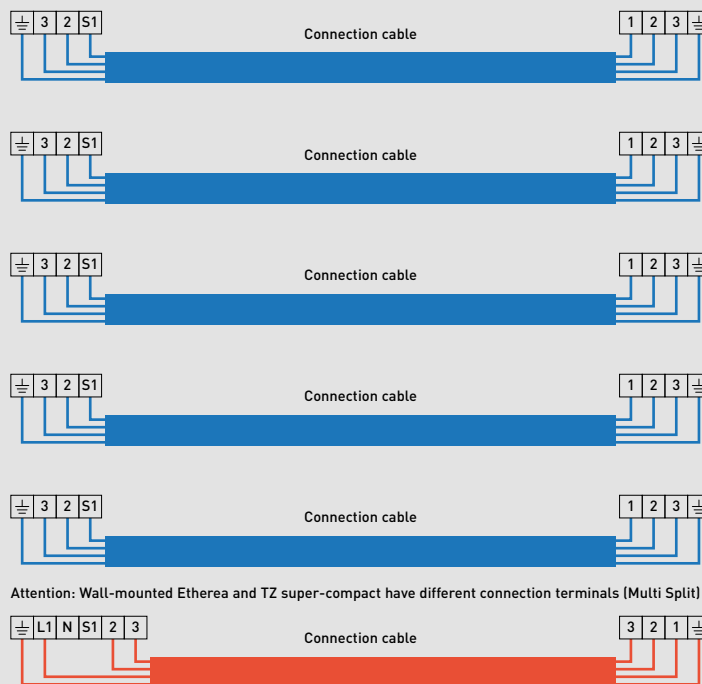

Attention: Wall-mounted Etherea and TZ super-compact have different connection terminals (Multi Split)

Outdoor unit

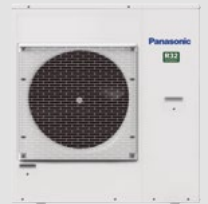

Single phase
Power supply
230 V / 50 Hz / 25 A

Free Multi System · R32

Outdoor unit	Power supply	Recommended fuse	Power supply cable	Connection indoor / outdoor
CU-5Z90TBE	230 V	25 A	3 x 4,0 mm ²	4 x 1,5 mm ²



Wall-mounted Professional kits 1x1

Indoor unit

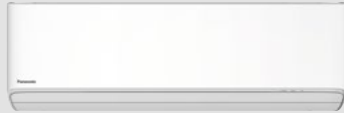

Outdoor unit

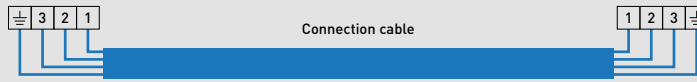

Single phase
Power supply
230 V / 50 Hz



Included wired remote controller

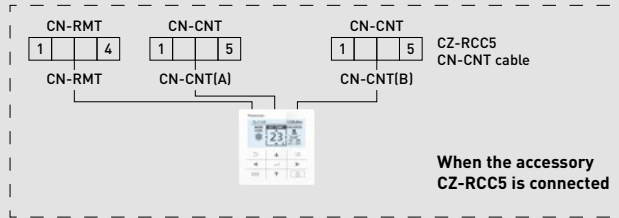

When the accessory CZ-RCC5 is connected

Wall-mounted Professional -25 °C · R32

Indoor unit	Power supply	Recommended fuse	Connection indoor / outdoor	Outdoor unit
CS-Z25YKEA	230 V (indoor)	16 A	4 x 1,5 mm ²	CU-Z25YKEA
CS-Z35YKEA	230 V (indoor)	16 A	4 x 1,5 mm ²	CU-Z35YKEA
CS-Z42YKEA	230 V (indoor)	16 A	4 x 1,5 mm ²	CU-Z42YKEA
CS-Z50YKEA	230 V (indoor)	16 A	4 x 2,5 mm ²	CU-Z50YKEA
CS-Z71YKEA	230 V (indoor)	20 A	4 x 2,5 mm ²	CU-Z71YKEA

PACi NX wall-mounted kits 1x1

Indoor unit

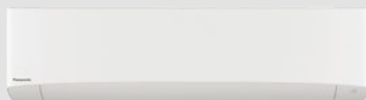

Outdoor unit



Cable 2 x 0,75 mm²

CZ-RTC6
CONEX wired remote controller (non-wireless)



CZ-RWS3
Infrared remote controller

Optional infrared remote controller



Single phase
Power supply
230 V / 50 Hz / *

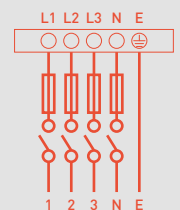

Three phase
Power supply
3 x 400 V / 1 N - 50 Hz / **

Single phase

Indoor unit	Connection indoor / outdoor	Outdoor unit	Power supply	Circuit breaker*
S-3650PK3E	4 x 1,5 mm ²	U-36PZH3E5	220 / 230 / 240V	20 A
S-3650PK3E	4 x 1,5 mm ²	U-50PZH3E5		20 A
S-6010PK3E	4 x 1,5 mm ²	U-60PZH3E5		25 A
S-6010PK3E	4 x 2,5 mm ²	U-71PZH3E5		25 A
S-6010PK3E	4 x 2,5 mm ²	U-100PZH3E5		35 A
S-6010PK3E	4 x 1,5 mm ²	U-36PZ3E5		16 A
S-6010PK3E	4 x 1,5 mm ²	U-50PZ3E5		16 A
S-6010PK3E	4 x 1,5 mm ²	U-60PZ3E5A		20 A
S-6010PK3E	4 x 1,5 mm ²	U-71PZ3E5A		20 A
S-6010PK3E	4 x 2,5 mm ²	U-100PZ3E5		35 A

Three phase

Indoor unit	Connection indoor / outdoor	Outdoor unit	Power supply	Circuit breaker**
S-6010PK3E	4 x 2,5 mm ²	U-71PZH3E8	380 / 400 / 415V	16 A
S-6010PK3E	4 x 2,5 mm ²	U-100PZH3E8		16 A
S-6010PK3E	4 x 2,5 mm ²	U-100PZ3E8		16 A

PACi NX 4 way 60x60 cassette kits 1x1

Indoor unit

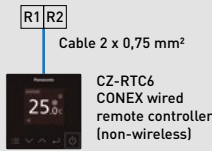
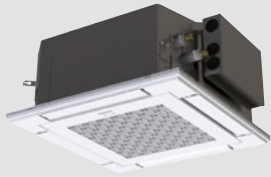

Outdoor unit



Single phase
Power supply
230 V / 50 Hz / 16 A

Single phase

Indoor unit	Connection indoor / outdoor	Outdoor unit	Power supply	Circuit breaker
S-36PY3E	4 x 1,5 mm ²	U-36PZH3E5	220 / 230 / 240 V	16 A
S-50PY3E	4 x 1,5 mm ²	U-50PZH3E5		16 A
S-60PY3E	4 x 1,5 mm ²	U-60PZH3E5		16 A
S-25PY3E	4 x 1,5 mm ²	U-25PZ3E5		16 A
S-36PY3E	4 x 1,5 mm ²	U-36PZ3E5		16 A
S-50PY3E	4 x 1,5 mm ²	U-50PZ3E5		16 A
S-60PY3E	4 x 1,5 mm ²	U-60PZ3E5A		16 A

PACi NX 4 way 90x90 cassette kits 1x1

Indoor unit

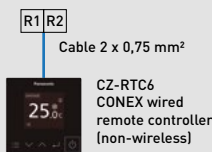

Single phase
Power supply
230 V / 50 Hz / *

Outdoor unit

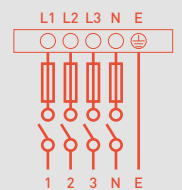

Three phase
Power supply
3 x 400 V / 1 N - 50 Hz / **

Single phase

Indoor unit	Connection indoor / outdoor	Outdoor unit	Power supply	Circuit breaker*
S-3650PU3E	4 x 1,5 mm ²	U-36PZH3E5	220 / 230 / 240 V	20 A
S-3650PU3E	4 x 1,5 mm ²	U-50PZH3E5		20 A
S-6071PU3E	4 x 1,5 mm ²	U-60PZH3E5		25 A
S-6071PU3E	4 x 2,5 mm ²	U-71PZH3E5		25 A
S-1014PU3E	4 x 2,5 mm ²	U-100PZH3E5		35 A
S-1014PU3E	4 x 2,5 mm ²	U-125PZH3E5		40 A
S-1014PU3E	4 x 2,5 mm ²	U-140PZH3E5		40 A
S-3650PU3E	4 x 1,5 mm ²	U-36PZ3E5		16 A
S-3650PU3E	4 x 1,5 mm ²	U-50PZ3E5		16 A
S-6071PU3E	4 x 1,5 mm ²	U-60PZ3E5A		20 A
S-6071PU3E	4 x 1,5 mm ²	U-71PZ3E5A		20 A
S-6010PK3E	4 x 2,5 mm ²	U-100PZ3E5		35 A
S-1014PU3E	4 x 2,5 mm ²	U-125PZ3E5		40 A
S-1014PU3E	4 x 2,5 mm ²	U-140PZ3E5		40 A

Three phase

Indoor unit	Connection indoor / outdoor	Outdoor unit	Power supply	Circuit breaker**
S-6071PU3E	4 x 2,5 mm ²	U-71PZH3E8	380 / 400 / 415 V	16 A
S-1014PU3E	4 x 2,5 mm ²	U-100PZH3E8		16 A
S-1014PU3E	4 x 2,5 mm ²	U-125PZH3E8		16 A
S-1014PU3E	4 x 2,5 mm ²	U-140PZH3E8		16 A
S-1014PU3E	4 x 2,5 mm ²	U-100PZ3E8		20 A
S-1014PU3E	4 x 2,5 mm ²	U-125PZ3E8		20 A
S-1014PU3E	4 x 2,5 mm ²	U-140PZ3E8		20 A



PACi NX ceiling kits 1x1

Indoor unit

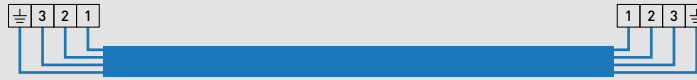
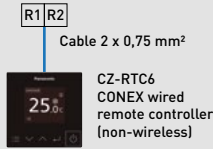

Outdoor unit

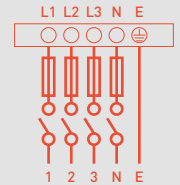

Single phase
Power supply
230 V / 50 Hz / *

Three phase
Power supply
3 x 400 V / 1 N - 50 Hz / **

Single phase

Indoor unit	Connection indoor / outdoor	Outdoor unit	Power supply	Circuit breaker*
S-3650PT3E	4 x 1,5 mm ²	U-36PZH3E5	220 / 230 / 240 V	20 A
S-3650PT3E	4 x 1,5 mm ²	U-50PZH3E5		20 A
S-6071PT3E	4 x 1,5 mm ²	U-60PZH3E5		25 A
S-6071PT3E	4 x 2,5 mm ²	U-71PZH3E5		25 A
S-1014PT3E	4 x 2,5 mm ²	U-100PZH3E5		35 A
S-1014PT3E	4 x 2,5 mm ²	U-125PZH3E5		40 A
S-1014PT3E	4 x 2,5 mm ²	U-140PZH3E5		40 A
S-3650PT3E	4 x 1,5 mm ²	U-36PZ3E5		16 A
S-3650PT3E	4 x 1,5 mm ²	U-50PZ3E5		16 A
S-6071PT3E	4 x 1,5 mm ²	U-60PZ3E5A		20 A
S-6071PT3E	4 x 1,5 mm ²	U-71PZ3E5A		20 A
S-6010PK3E	4 x 2,5 mm ²	U-100PZ3E5		35 A
S-1014PT3E	4 x 2,5 mm ²	U-125PZ3E5		40 A
S-1014PT3E	4 x 2,5 mm ²	U-140PZ3E5		40 A

Three phase

Indoor unit	Connection indoor / outdoor	Outdoor unit	Power supply	Circuit breaker**
S-6071PT3E	4 x 2,5 mm ²	U-71PZH3E8	380 / 400 / 415 V	16 A
S-1014PT3E	4 x 2,5 mm ²	U-100PZH3E8		16 A
S-1014PT3E	4 x 2,5 mm ²	U-125PZH3E8		16 A
S-1014PT3E	4 x 2,5 mm ²	U-140PZH3E8		16 A
S-1014PT3E	4 x 2,5 mm ²	U-100PZ3E8		20 A
S-1014PT3E	4 x 2,5 mm ²	U-125PZ3E8		20 A
S-1014PT3E	4 x 2,5 mm ²	U-140PZ3E8		20 A

PACi NX adaptive ducted unit kits 1x1

Indoor unit

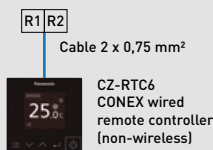

Outdoor unit

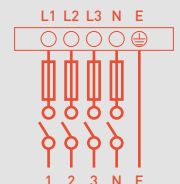

Single phase
Power supply
230 V / 50 Hz / *

Three phase
Power supply
3 x 400 V / 1 N - 50 Hz / **

Single phase

Indoor unit	Connection indoor / outdoor	Outdoor unit	Power supply	Circuit breaker*
S-3650PF3E	4 x 1,5 mm ²	U-36PZH3E5	220 / 230 / 240 V	20 A
S-3650PF3E	4 x 1,5 mm ²	U-50PZH3E5		20 A
S-6071PF3E	4 x 1,5 mm ²	U-60PZH3E5		25 A
S-6071PF3E	4 x 2,5 mm ²	U-71PZH3E5		25 A
S-1014PF3E	4 x 2,5 mm ²	U-100PZH3E5		35 A
S-1014PF3E	4 x 2,5 mm ²	U-125PZH3E5		40 A
S-1014PF3E	4 x 2,5 mm ²	U-140PZH3E5		40 A
S-3650PF3E	4 x 1,5 mm ²	U-36PZ3E5		16 A
S-3650PF3E	4 x 1,5 mm ²	U-50PZ3E5		16 A
S-6071PF3E	4 x 1,5 mm ²	U-60PZ3E5A		20 A
S-6071PF3E	4 x 1,5 mm ²	U-71PZ3E5A		20 A
S-6010PK3E	4 x 2,5 mm ²	U-100PZ3E5		35 A
S-1014PF3E	4 x 2,5 mm ²	U-125PZ3E5		40 A
S-1014PF3E	4 x 2,5 mm ²	U-140PZ3E5		40 A

Three phase

Indoor unit	Connection indoor / outdoor	Outdoor unit	Power supply	Circuit breaker**
S-6071PF3E	4 x 2,5 mm ²	U-71PZH3E8	380 / 400 / 415 V	16 A
S-1014PF3E	4 x 2,5 mm ²	U-100PZH3E8		16 A
S-1014PF3E	4 x 2,5 mm ²	U-125PZH3E8		16 A
S-1014PF3E	4 x 2,5 mm ²	U-140PZH3E8		16 A
S-1014PF3E	4 x 2,5 mm ²	U-100PZ3E8		20 A
S-1014PF3E	4 x 2,5 mm ²	U-125PZ3E8		20 A
S-1014PF3E	4 x 2,5 mm ²	U-140PZ3E8		20 A

Big PACi high static pressure hide-away 20,0-25,0 kW kits 1x1

Indoor unit

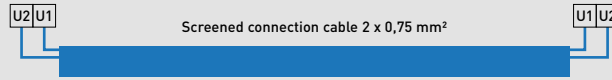

Outdoor unit

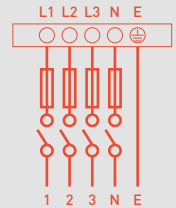
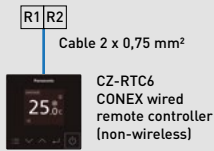

Single phase
Power supply
230 V / 50 Hz / 10 A

Three phase
Power supply
3 x 400 V / 1 N - 50 Hz

Three phase

Indoor unit	Power supply	Outdoor unit	Power supply	Circuit breaker
S-200PE3E5B	220/230/240 V	U-200PZH2E8	380/400/415 V	16 A
S-250PE3E5B		U-250PZH2E8		20 A

PACi 4 way 60x60 cassette kits 1x1

Indoor unit

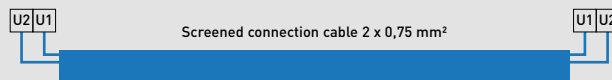

Outdoor unit

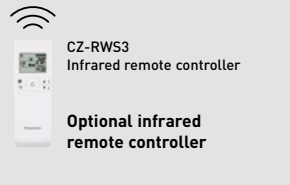
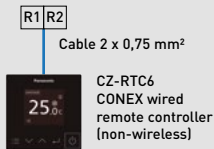

Single phase
Power supply
230 V / 50 Hz / 3 A

Single phase
Power supply
230 V / 50 Hz / 16 A

Single phase

Indoor unit	Power supply	Outdoor unit	Power supply	Circuit breaker
S-36PY2E5B	220/230/240 V	U-36PZH3E5	220/230/240 V	16 A
S-50PY2E5B		U-50PZH3E5		16 A



PACi NX twin system



Single phase

Outdoor unit	Power supply	Circuit breaker*
U-71PZH3E5	220 / 230 / 240 V	25 A
U-100PZH3E5		30 A
U-125PZH3E5		25 A
U-140PZH3E5		35 A
U-100PZ3E5		35 A
U-125PZ3E5		40 A
U-140PZ3E5		40 A

1) Optional infrared remote controller is also possible. Wireless receivers may be required depending on indoor units.

Three phase

Outdoor unit	Power supply	Circuit breaker**
U-71PZH3E8	380 / 400 / 415 V	16 A
U-100PZH3E8		16 A
U-125PZH3E8		16 A
U-140PZH3E8		16 A
U-200PZH2E8		20 A
U-250PZH2E8		30 A
U-100PZ3E8		16 A
U-125PZ3E8	20 A	
U-140PZ3E8	20 A	

PACi NX triple system

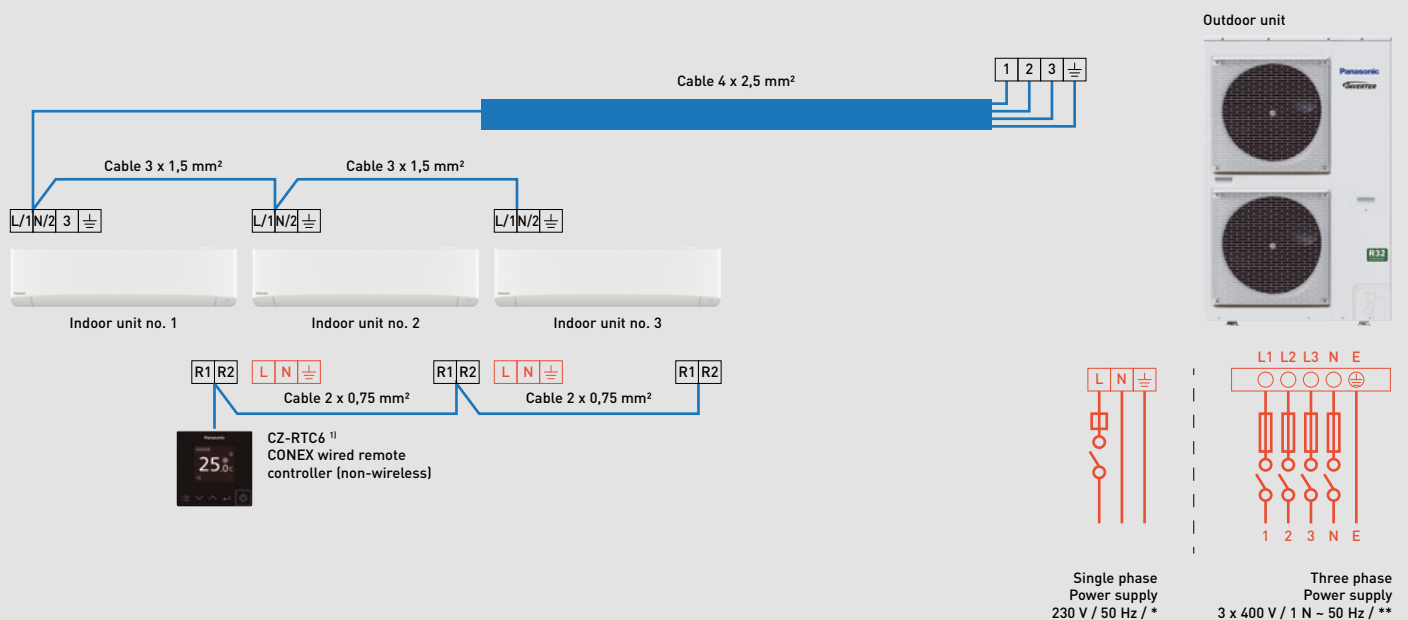

Single phase

Outdoor unit	Power supply	Circuit breaker*
U-100PZH3E5	220 / 230 / 240 V	35 A
U-125PZH3E5		35 A
U-140PZH3E5		40 A

1) Optional infrared remote controller is also possible. Wireless receivers may be required depending on indoor units.

Three phase

Outdoor unit	Power supply	Circuit breaker**
U-100PZH3E8	380 / 400 / 415 V	16 A
U-125PZH3E8		16 A
U-140PZH3E8		16 A

PACi NX double-twin system

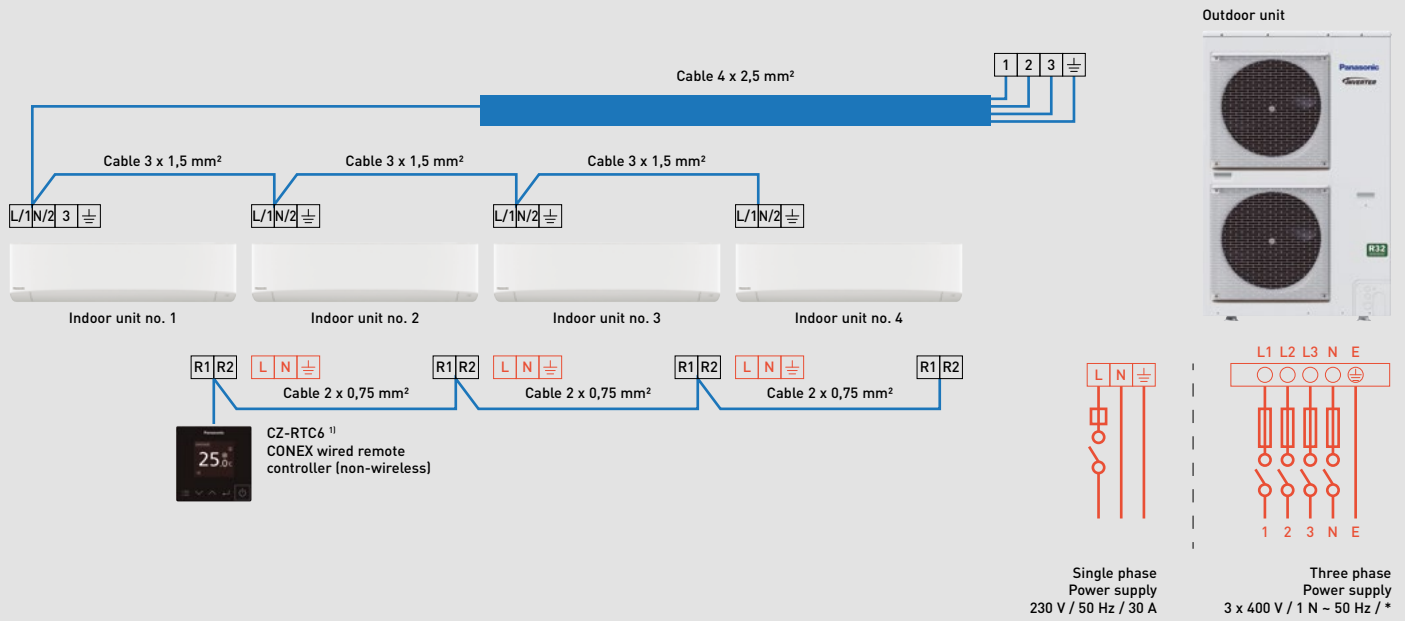

Single phase

Outdoor unit	Power supply	Circuit breaker
U-125PZH3E5	220 / 230 / 240 V	35 A

Three phase

Outdoor unit	Power supply	Circuit breaker*
U-125PZH3E8	380 / 400 / 415 V	16 A

1) Optional infrared remote controller is also possible. Wireless receivers may be required depending on indoor units.

Mini ECOi Series

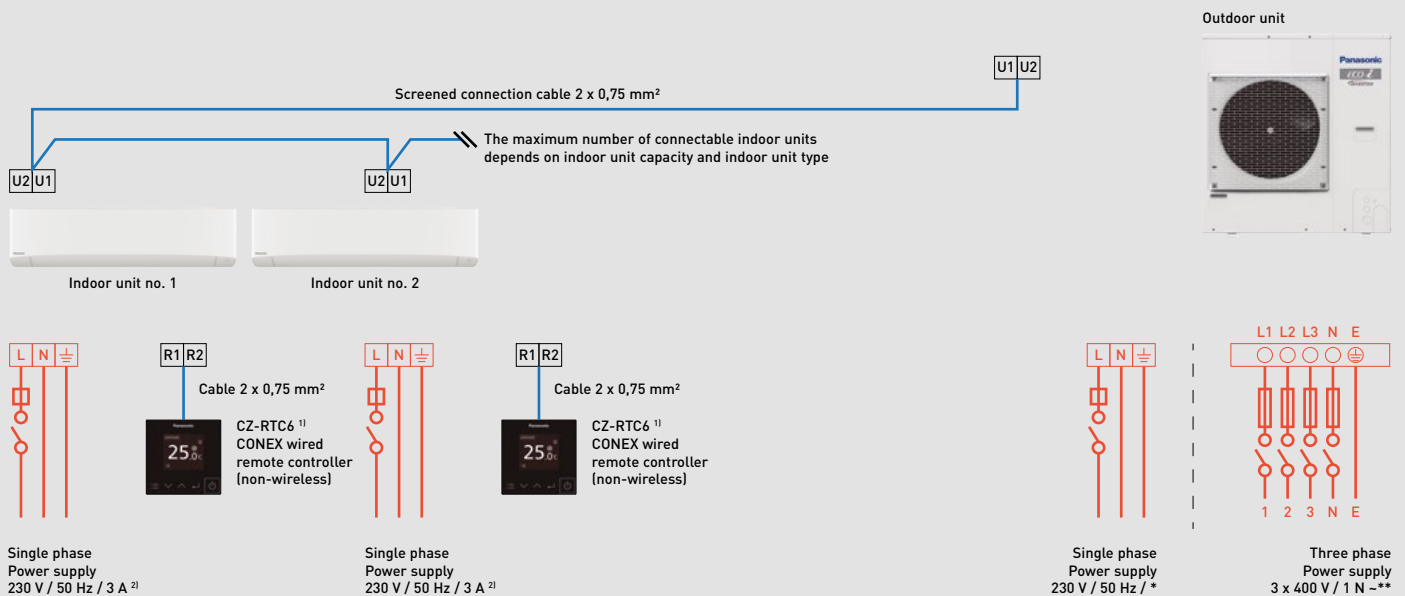

Single phase

Outdoor unit	Power supply	Circuit breaker*
U-4LZ2E5	220 / 230 / 240 V	20 A
U-5LZ2E5		25 A
U-6LZ2E5		30 A
U-4LE2E5		20 A
U-5LE2E5		25 A
U-6LE2E5		30 A

Three phase

Outdoor unit	Power supply	Circuit breaker**
U-4LZ2E8	380 / 400 / 415 V	10 A
U-5LZ2E8		16 A
U-6LZ2E8		16 A
U-8LZ2E8		16 A
U-10LZ2E8		20 A
U-4LE2E8		10 A
U-5LE2E8		16 A
U-6LE2E8		16 A
U-8LE1E8		16 A
U-10LE1E8		20 A

1) Wireless remote controller is also possible. Wireless receivers may be required depending on indoor units.

2) 10 A for single indoor connection to S-224ME2E5 / S-280ME2E5, in combination with U-8LE1E8 / U-10LE1E8.

ECOi EX and ECO G Series

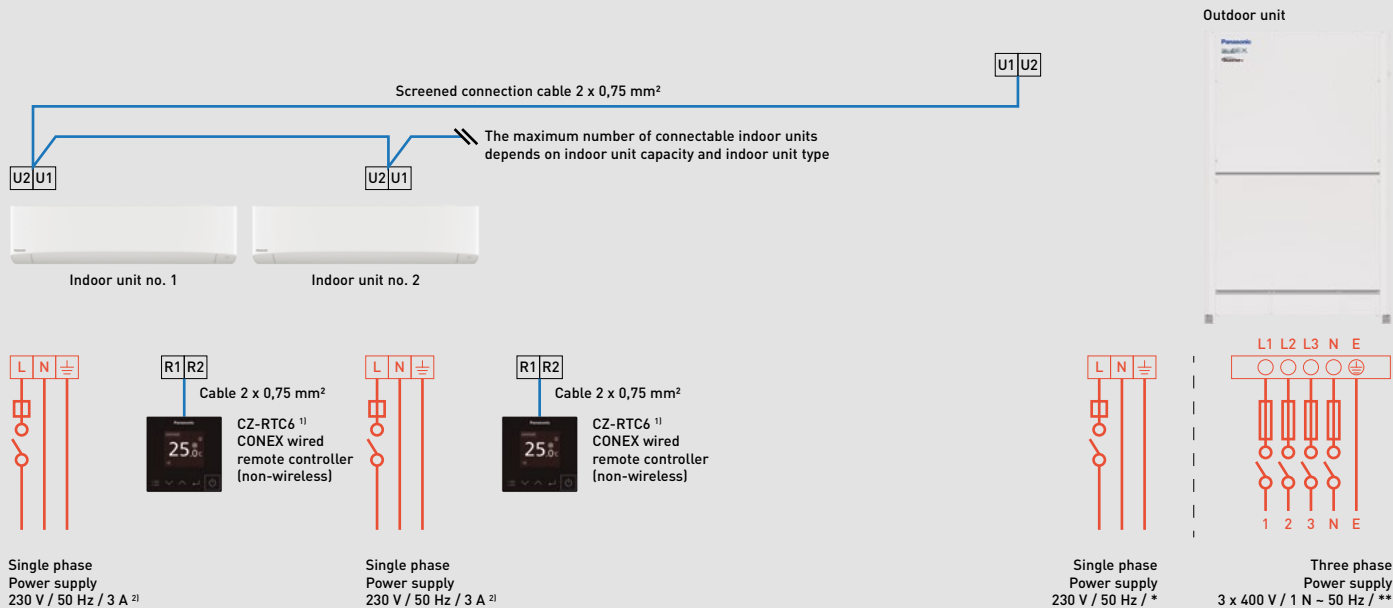

ECOi EX Series

2-Pipe		3-Pipe	
Outdoor unit	Power supply	Outdoor unit	Power supply
U-8ME2E8	16 A	U-8MF3E8	16 A
U-10ME2E8	16 A	U-10MF3E8	20 A
U-12ME2E8	20 A	U-12MF3E8	380 / 400 / 415 V
U-14ME2E8	25 A	U-14MF3E8	25 A
U-16ME2E8	30 A	U-16MF3E8	40A
U-18ME2E8	40A		30 A
U-20ME2E8	40A		

ECO G Series

2-Pipe		3-Pipe	
Outdoor unit	Power supply	Outdoor unit	Power supply
U-16GE3E5	16 A	U-16GF3E5	16 A
U-20GE3E5	220 / 230 / 240 V	U-20GF3E5	220 / 230 / 240 V
U-25GE3E5	240 V	U-25GF3E5	16 A
U-30GE3E5	16 A		16 A

1) Wireless remote controller is also possible. Wireless receivers may be required depending on indoor units.
2) 10 A for single indoor connection to S-224ME2E5 / S-280ME2E5.

Hybrid GHP/EHP

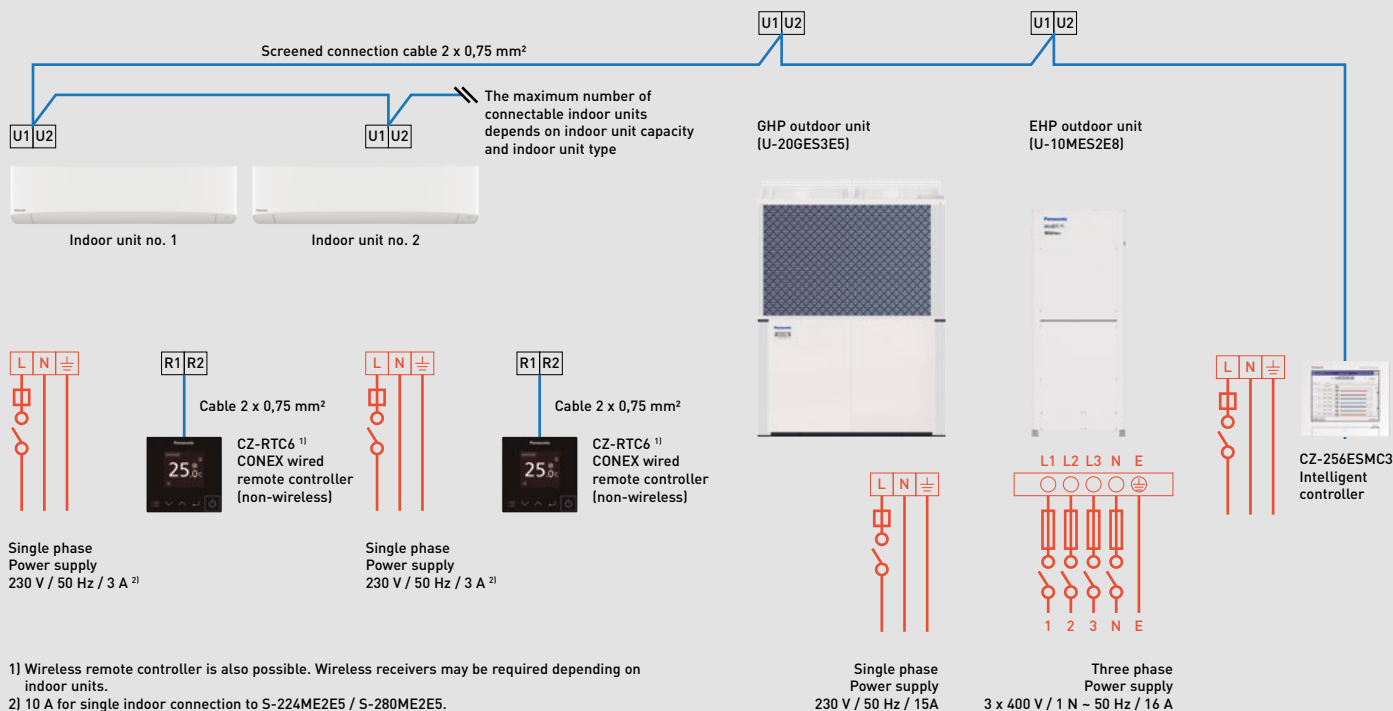

1) Wireless remote controller is also possible. Wireless receivers may be required depending on indoor units.
2) 10 A for single indoor connection to S-224ME2E5 / S-280ME2E5.

Notes

A large grid of small dots for taking notes, consisting of approximately 30 columns and 40 rows.

Notes

A large grid of small dots for taking notes, consisting of 20 columns and 40 rows.

Panasonic Heating & Cooling Solutions customer service

If your end customer is seeking further support from Panasonic directly, please forward the following ways to contact us:

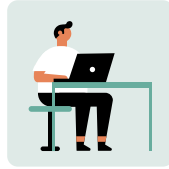

Use our European website www.aircon.panasonic.eu for contacting us. Panasonic has implemented a new contact page on the Panasonic Heating & Cooling Solutions website for potential or existing Panasonic customers.



Another option is to contact the highly experienced teams at the Panasonic call centres, who are more than qualified to support Panasonic clients in 13 different languages across Europe.

Our call centres in Europe for end customers:

Country	Phone number	Opening times	Country	Phone number	Opening times
Belgium	+32 2 320 55 38	Mo-Fr 9-17h	Norway	+47 69 67 61 00	Mo-Fr 9-17h
Denmark	+45 89 87 45 00	Mo-Fr 9-17h	Poland	800 080 911	Mo-Fr 9-17h
Finland	+35 8646041590	Mo-Fr 9-17h	Portugal	800 78 22 20	Mo-Fr 9-17h
France	0800 805 215	Mo-Fr 9-17h	Spain	+34 900 828 787	Mo-Fr 9-17h
Germany	+49 611 71187211	Mo-Sat 7-18h	Sweden	+46 85 221 81 00	Mo-Fr 9-17h
Hungary	+36 1 700 89 65	Mo-Fr 9-17h	Switzerland DE	+41 415615366	Mo-Fr 9-17h
Ireland	1800 939 977	Mo-Fr 9-17h	Switzerland FR	+41 435880049	Mo-Fr 9-17h
Italy	+39 2 6433235	Mo-Fr 9-17h	Switzerland IT	+41 435880048	Mo-Fr 9-17h
Luxembourg	+32 2 320 55 38	Mo-Fr 9-17h	United Kingdom	0808 208 2115	Mo-Fr 9-17h
Netherlands	+31 73 6402 538	Mo-Sat 7-18h			



www.aircon.panasonic.eu

heating & cooling solutions

Panasonic Marketing Europe GmbH Panasonic Heating & Ventilation Air-conditioning Europe

Hagenauer Strasse 43, 65203 Wiesbaden, Germany
www.aircon.panasonic.eu

Ireland

Panasonic Heating & Cooling Solutions

1 The Courtyard, Kilcarbery Business Park, Nangor Road, Dublin D22 R791, Ireland
☎ 1800 939 977
www.aircon.panasonic.ie

Belgium / France / Luxembourg

Panasonic Solutions Chauffage & Refroidissement

1 à 7 Rue du 19 Mars 1962 92238, Gennevilliers Cedex, France
☎ 0800 805 215 (France)
☎ +32 2 320 55 38 (Belgium & Luxembourg)
www.aircon.panasonic.eu

Austria / Germany / Switzerland

Panasonic Heiz- & Kühlsysteme

Hagenauer Str. 43 65203 Wiesbaden, Germany
☎ +49 611 711 87 211 (Germany)
☎ +43 1 253 22 120 (Austria)
☎ +41 41 561 53 66 (Switzerland)
✉ HLK-Support-DE@eu.panasonic.com (Germany)
✉ HLK-Support-AT@eu.panasonic.com (Austria)
✉ HLK-Support-CH@eu.panasonic.com (Switzerland)
www.aircon.panasonic.eu

Poland

Panasonic Heating & Cooling Solutions

Wotoska 9, 02-583, Warszawa, Poland
☎ 800 080 911
www.aircon.panasonic.pl

Netherlands

Panasonic Heating & Cooling Solutions

Europalaan 28E 5332 BC, 's-Hertogenbosch, The Netherlands
☎ +31 736 402 538
www.aircon.panasonic.nl

Spain / Portugal

Panasonic Heating & Cooling Solutions

WTC Almeda Park Plaça de la Pau, s/n, edificio 6, planta 4ª, local D, 08940 Cornellà de Llobregat, Spain
☎ 900 82 87 87 (Spain)
☎ 800 78 22 20 (Portugal)
www.aircon.panasonic.eu

Cyprus / Greece / Italy / Malta

Panasonic Heating & Cooling Solutions

Viale dell'Innovazione, 3 20126, Milano, Italy
☎ +39 2 6433235 (Customer Service)
www.aircon.panasonic.eu

Denmark / Finland / Norway / Sweden

Panasonic Heating & Cooling Solutions

Sundbybergsvägen 1, 171 73 Solna, Sweden
☎ +46 85 221 81 00 (Sweden)
☎ +45 89 87 45 00 (Denmark)
☎ +47 69 67 61 00 (Norway)
☎ +35 86 46 04 15 90 (Finland)
www.aircon.panasonic.eu

Czech Republic / Slovakia

Panasonic Heating & Cooling Solutions

Křižíkova 148/34, 186 00 Praha 8, Czech Republic
☎ +420 236 032 911
✉ panasonic.praha@eu.panasonic.com
www.aircon.panasonic.cz

Albania / Bosnia / Bulgaria / Croatia / Hungary / Kosovo / Montenegro / Romania / Serbia / Slovenia

Panasonic Heating & Cooling Solutions

Alíz utca 4. – Office Garden III, 1117 Budapest, Hungary
☎ +36 1 700 89 65
✉ panasonicaquarea@eu.panasonic.com
www.aircon.panasonic.eu

United Kingdom

Panasonic Heating & Ventilation Air-conditioning UK Ltd.

Building 3, Albany Place, Hydeway, Welwyn Garden City, AL7 3BT, United Kingdom
☎ +44 1707 378 670
✉ sales@panasonic.com



Do not add or replace refrigerant other than the specified type. Manufacturer is not responsible for the damage and deterioration in safety due to usage of the other refrigerant.
The outdoor units in this catalogue contains fluorinated greenhouse gases with a GWP higher than 150.

Panasonic®

To find out how Panasonic cares for you,
log on to: www.aircon.panasonic.eu

Panasonic Marketing Europe GmbH
Panasonic Heating & Ventilation Air-conditioning Europe
Hagenauer Strasse 43, 65203 Wiesbaden, Germany