

Use & Care Guide
Manual de Uso y Cuidado
Manuel d'entretien et d'utilisation

Kenmore^{®/MD}

400 Series Canister Vacuum Cleaner

Aspiradora con tanque
Aspirateur-traîneau

Model/Modelo/Modèle: BC2005

Vacuum Cleaner Help Line:

1-877-531-7321 (US) / 1-844-608-3081 (CA)

8:00am - 5:00pm EST, M-F

www.kenmorefloorcare.com

Kenmore and the Kenmore logo are registered trademarks of KCD IP, LLC and/or Transform SR Brands LLC and are used under license.



TABLE OF CONTENTS

SECTION	PAGE
Before Using Your New Vacuum Cleaner	2
Kenmore Vacuum Cleaner Warranty	3
Important Safety Instructions.....	4-5
Parts and Features.....	6-8
Assembly Instructions.....	9-10
Operating Instructions	10-15
Performance/Safety Features	16
Canister Care.....	17-21
Troubleshooting	22-23
Requesting Assistance or Service.....	Back page

BEFORE USING YOUR NEW VACUUM CLEANER

Read this Use & Care Guide. It will help you assemble and operate your new Kenmore vacuum cleaner in the safest and most effective way.

For more information about vacuum cleaner care and operation, call the Vacuum Cleaner Help Line at 1-877-531-7321 (US) / 1-844-608-3081 (CA). You will need the complete model and serial numbers when requesting information.

Your vacuum cleaner's model and serial numbers are located on the Model and Serial Number Plate. Use the space below to record the model number and serial number of your new Kenmore vacuum cleaner.

Model No. _____

Serial No. _____

Date of Purchase _____

Keep this book and your sales check (receipt) in a safe place for future reference.

PACKING LIST

Your KENMORE VACUUM CLEANER is packaged with the following parts and components assembled separately in the carton:

- Canister Vacuum Cleaner
- Floor Nozzle
- Handle & Hose Assembly
- Telescoping Wand
- Bare Floor Tool
- 3-in-1 Combination Tool
- Dust Bag (2-pack)
- Use & Care Guide

KENMORE VACUUM CLEANER WARRANTY

KENMORE LIMITED WARRANTY

FOR ONE YEAR from the date of sale this product is warranted against defects in material or workmanship.

WITH PROOF OF SALE a defective product will be replaced free of charge.

The Kenmore brand is used under license. Direct all claims for warranty service to: Cleva North America, Inc., 1-877-531-7321 (US) / 1-844-608-3081 (CA).

This warranty does not cover filters or belts, which are expendable parts that can wear out from normal use within the warranty period.

This warranty is void if this product is ever used for other than private household purposes. This warranty gives you specific legal rights, and you may also have other rights which vary from state to state.

Cleva North America, Inc., Greenville SC 29607

IMPORTANT SAFETY INSTRUCTIONS

Read all instructions in this guide before assembling or using your vacuum cleaner.

WARNING!

Your safety is important to us. To reduce the risk of fire, electrical shock, injury to persons or damage when using your vacuum cleaner, follow basic safety precautions including the following:

- Use your vacuum cleaner only as described in this guide. Use only with manufacturer's recommended attachments.
- Do not leave vacuum cleaner when plugged in. Unplug from outlet when not in use and before performing maintenance.
- To reduce the risk of electrical shock – Do not use outdoors or on wet surfaces.
- Do not allow to be used as a toy. Close attention is necessary when used by or near children.
- Do not use with a damaged cord or plug. If vacuum cleaner is not working as it should, has been dropped, damaged, left outdoors, or dropped in water, immediately discontinue use and call 1-877-531-7321 (US) / 1-844-608-3081 (CA) for assistance.
- Do not pull or carry by cord, use cord as a handle, close a door on cord, or pull cord around sharp edges or corners. Do not run vacuum cleaner over cord. Keep cord away from heated surfaces.
- Do not unplug by pulling on cord. To unplug, grasp the plug, not the cord.
- Do not handle plug or vacuum cleaner with wet hands.
- Do not put any objects into openings.
- Do not use with any opening blocked; keep free of dust, lint, hair, and anything that may reduce air flow.
- Keep hair, loose clothing, fingers, and all parts of body away from openings and moving parts.
- Turn off all controls before unplugging.
- Use extra care when cleaning on stairs.
- Do not put on chairs, tables, etc. Keep on floor.
- Do not use vacuum cleaner to pick up flammable or combustible liquids (gasoline, cleaning fluid, perfumes, etc.), or use in areas where they may be present. The fumes from these substances can create a fire hazard or explosion.
- Do not pick up anything that is burning or smoking, such as cigarettes, matches, or hot ashes.
- Do not use vacuum cleaner without dust cup and/or filters in place.
- Always change the dust bag after vacuuming carpet cleaners or freshener, powders, and fine dust. These products clog the bag, reduce airflow and can cause the bag to burst. Failure to change the bag could cause permanent damage to the vacuum cleaner.
- Do not use the vacuum cleaner to pick up sharp hard objects, small toys, pins, paper clips, etc. They may damage the vacuum cleaner.
- Do not operate the vacuum cleaner without the exhaust filter or filter door in place.
- The hose contains electrical wires. Do not use when damaged, cut, or punctured. Replace if cut or worn. Do not pick up sharp objects.
- Always turn off and unplug vacuum

IMPORTANT SAFETY INSTRUCTIONS

cleaner before connecting or disconnecting either hose or wand.

- Hold plug when rewinding onto cord reel. Do not allow plug to whip when rewinding.

- You are responsible for making sure that your vacuum cleaner is not used by anyone unable to operate it properly.

SAVE THESE INSTRUCTIONS

Proper assembly and safe use of your vacuum cleaner are your responsibilities. Your vacuum cleaner is intended for Household Use. Read this Use & Care Guide carefully for important use and safety information. This guide contains safety statements under warning and caution symbols.

PARTS AND FEATURES

It is important to know your vacuum cleaner's parts and features to ensure its proper and safe use. Review these before using your vacuum cleaner.

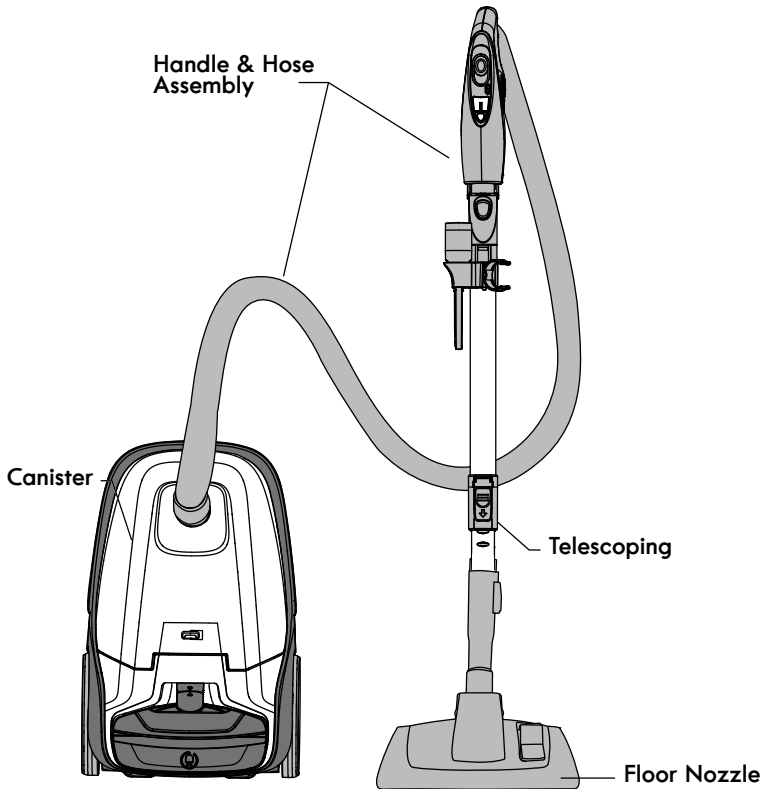

REPLACEMENT PARTS

Part	Part No. (US)	Part No. (CA)
Dust Bag (2-pack)	53291	-
Dust Bag (6-pack)	53292	63292
Exhaust Filter	86880	86880
Motor Safety Filter	81002	81002
Floor Nozzle	591030101	591030101
Bare Floor Tool	KC83QEEXZV06	KC83QEEXZV06
3-in-1 Combination Tool	561055134	561055134
To order a replacement part, call 1-877-531-7321 (US) / 1-844-608-3081 (CA).		

CANISTER

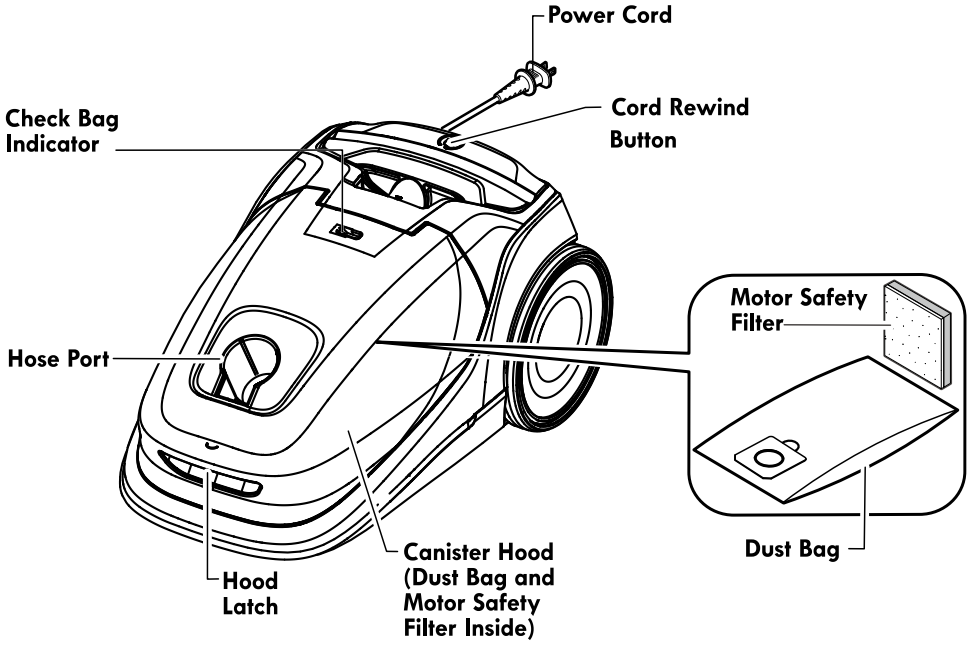

ATTACHMENTS

Bare Floor Tool (Stored in Canister)

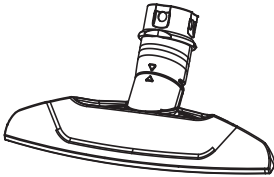

3-in-1 Combination Tool

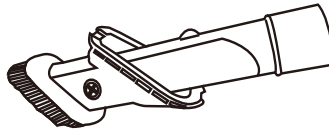

Dust Bag (2-Pack)

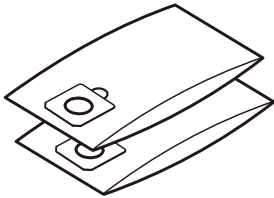

HANDLE & HOSE ASSEMBLY

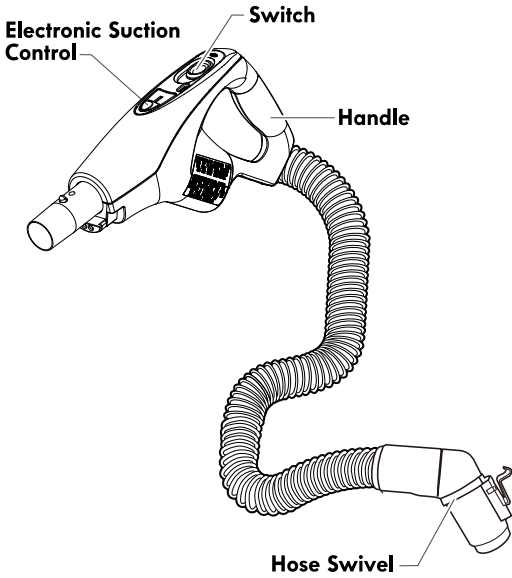

TELESCOPING WAND

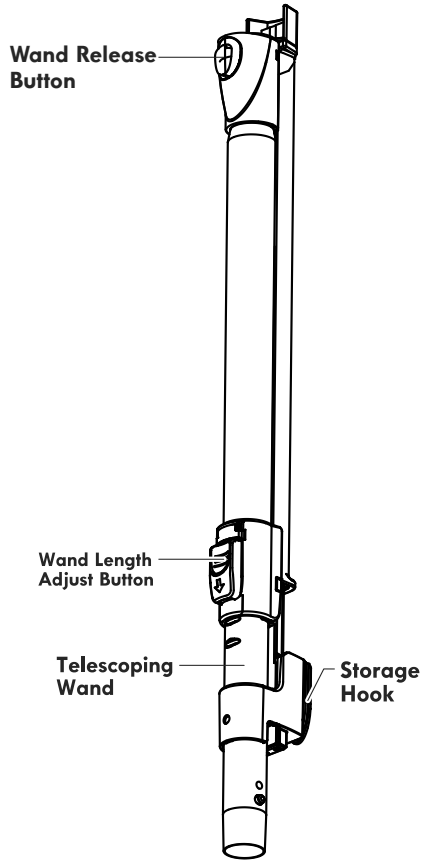

FLOOR NOZZLE

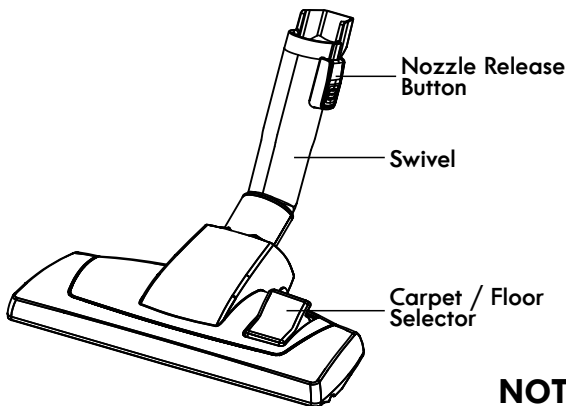

NOTE: This model is not equipped with a PowerMate® motorized nozzle. A PowerMate® is available for additional purchase. For details call the Vacuum Cleaner Help Line or see kenmorefloorcare.com.



Please pay special attention to these hazard alert boxes, and follow any instructions given. **WARNING** statements alert you to such hazards as fire, electric shock, burns and personal injury. **CAUTION** statements alert you to such hazards as personal injury and/or property damage.

ASSEMBLY INSTRUCTIONS

Before assembling the vacuum cleaner, check the **PACKING LIST** (page 2). Use this list to verify that you have received all the components of your new Kenmore vacuum cleaner.



WARNING

Electrical Shock Hazard

DO NOT plug into electrical supply until assembly is complete. Failure to do so could result in electrical shock or injury.

FLOOR NOZZLE

Align wand and insert onto floor nozzle until the wand locks into place.

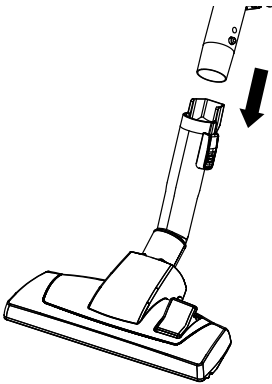

HANDLE ASSEMBLY

Insert wand into handle until lock button snaps in place.

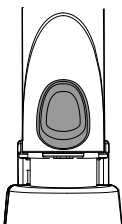

To remove: Press wand release button and pull up on handle.

To store: Disconnect hose from wand and canister to prevent stress on hose during storage.

Store hose in a loosely coiled position so the hose covering is not stressed.

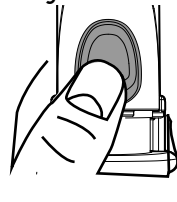

WAND (TELESCOPING)

The wand length is adjustable and requires no assembly. To adjust, simply push on the wand adjust button and slide the upper wand to the desired height.

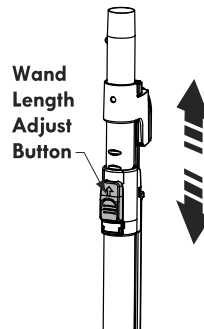

NOTE: When adjusting the wand length you may have to hold the floor nozzle with your hand or foot.

ASSEMBLY INSTRUCTIONS

HOSE

To install: Line up the hose latch tab with the notch in the canister hood, and insert hose into canister until it snaps into place.

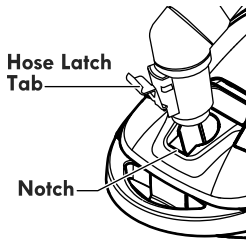

IMPORTANT: Push hose firmly into the canister until the hose latch tab snaps into place. The vacuum cleaner will not operate until hose is fully connected.

To remove: Do not open hood before removing hose. With hood closed, press

the hose latch tab in to release and remove hose.

CANISTER

1. Open the canister hood.
2. Check to see that the dust bag is properly installed. See **DUST BAG CHANGING** (page 18-19) for instructions.
3. Check to see that the motor safety filter is properly installed. See **MOTOR SAFETY FILTER CLEANING** (page 19-20) for instructions.

OPERATING INSTRUCTIONS

HOW TO START

WARNING

Personal Injury and Product Damage Hazard

- **ALWAYS** turn off the vacuum cleaner before unplugging.
- The cord moves rapidly when rewinding. Keep children away and provide a clear path when rewinding the cord to prevent personal injury.
- **DO NOT** use outlets above counters. Damage from cord to items in surrounding area could occur.
- When any abnormality/failure occurs, stop using the product immediately and disconnect the power plug.

HOW TO START

NOTE: To reduce the risk of electric shock, this vacuum cleaner has a polarized plug; one blade is wider than the other. This plug will fit in a polarized outlet only one way. If the plug does not fit fully in the outlet, reverse the plug. If it still does not fit, contact a qualified electrician to install the proper outlet. Do not change the plug in any way.



WARNING

Personal Injury and Product Damage Hazard

- **DO NOT** run over power cord with floor nozzle. Personal injury or product damage could result.
- **DO NOT** pull plug from wall by the power cord. If there is damage to the cord or plug, personal injury or property damage could result.

1. Pull cord out of canister to desired length. The cord will not rewind until the cord rewind button is pushed.

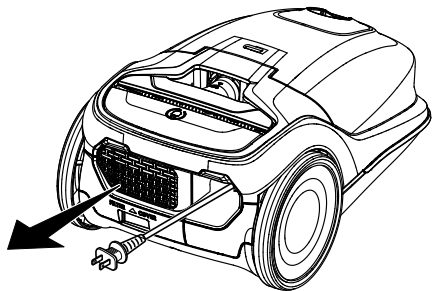

2. Plug the polarized power cord into a 120 Volt outlet located near the floor.

To rewind: Turn off and unplug the vacuum cleaner. Hold the plug while rewinding to prevent damage or injury from the moving cord. Push cord rewind button.

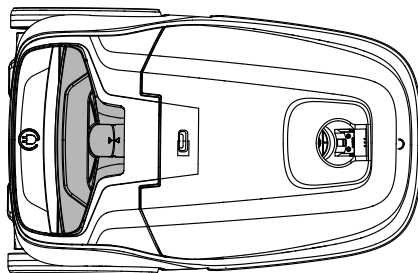

3. Select a position on the handle 3-way On/Off switch. Slide the switch forward to the CARPET or FLOOR position to turn on suction to the floor nozzle. Slide the switch all the way back to turn the vacuum cleaner off.

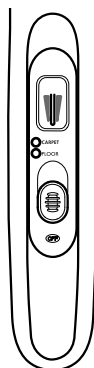

4. Press the carpet / floor selector on the floor nozzle to release the brush and squeegee for cleaning bare floors. When cleaning carpets, press the carpet / floor selector on the floor nozzle to retract the brush and squeegee.

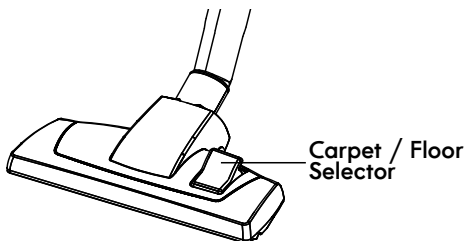

HOW TO START

NOTE: This 3-way On/Off switch can also be fitted with a PowerMate® motorized nozzle, which is sold separately. When using the PowerMate®:

Slide the switch forward to the CARPET position to turn on suction from the canister motor and the PowerMate® brushroll. The CARPET indicator button will turn green, and the PowerMate® brushroll will start to spin.

Slide the switch forward to the FLOOR position to turn on canister motor suction only. The FLOOR indicator button will turn green, and the PowerMate brushroll will not spin. Slide the switch all the way back to turn the vacuum cleaner off. The CARPET and FLOOR indicators will both become gray.

VACUUMING TIPS

FOR BEST CLEANING RESULTS

- Slide suction control toward HIGH to increase suction for carpets, and bare floors.
- Slide suction control towards LOW POWER to decrease suction for lightweight rugs or drapes.

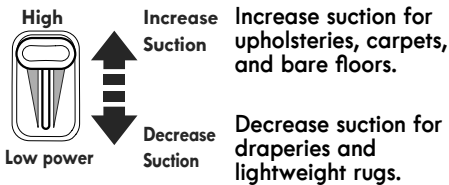

- Keep the airflow passage open. Check each assembly area in REMOVING CLOGS (page 17) occasionally for clogs. Turn off and unplug vacuum cleaner from outlet before checking.

SUGGESTED SWEEPING PATTERN

For best cleaning action, the floor nozzle should be pushed straight away from you and pulled straight back. At the end of each pull stroke, the direction of the floor nozzle should be changed to point into the next section to be cleaned. This pattern should be continued across the carpet with slow, gliding motions.

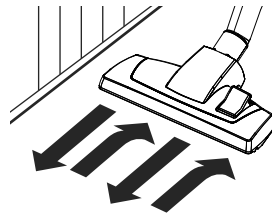

NOTE: Fast, jerky strokes do not provide complete cleaning.

FLOOR NOZZLE STORAGE

The wand has a “U” shaped storage hook that slides into the “U” shaped slot on the canister. The storage hook allows the wands and floor nozzle to be stored with the canister to conserve storage space. The canister must be stored on end for this feature to be used.

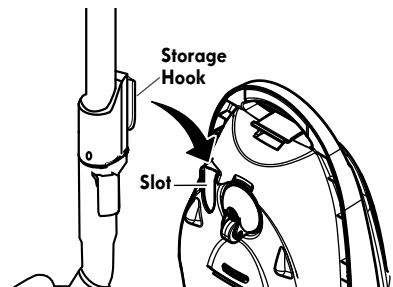

ATTACHMENTS



CAUTION

DO NOT attach or remove handle or wands while vacuum cleaner is **ON**. This could cause sparking and damage the electrical contacts or electronic controls.

ATTACHMENT STORAGE

This vacuum cleaner is equipped with onboard attachment storage. The bare floor tool is stored in the canister, See ATTACHMENT USE TABLE on page 15.

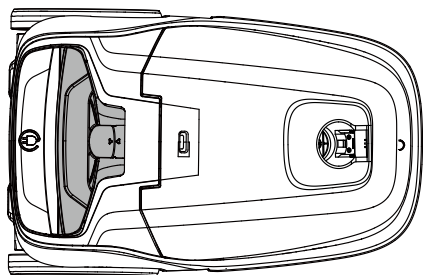

3-IN-1 COMBINATION TOOL

The 3-in-1 combination tool can be attached to the end of the wand and the handle.

Slide the collar of the tool over the open end of the wand or handle.

Use the 3-in-1 combination tool in crevice tool mode for cleaning in tight spaces such as furniture, between cushions, and stairs. See ATTACHMENT USE TABLE (page 15).

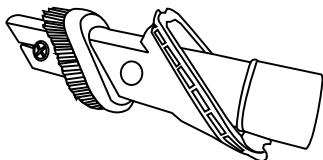

Set the combination tool in dusting brush mode by pressing the release button and sliding the dusting brush side of the brush tool to the end of the combination tool.

Use in dusting brush mode for cleaning loose surfaces such as drapes. See ATTACHMENT USE TABLE (page 15).

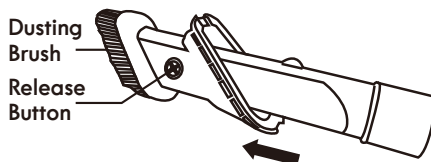

Press the release button to remove the brush tool. Set the combination tool in upholstery brush mode as shown. Use in upholstery brush mode for cleaning fabric surfaces such as fabric sofa. See ATTACHMENT USE TABLE (page 15).

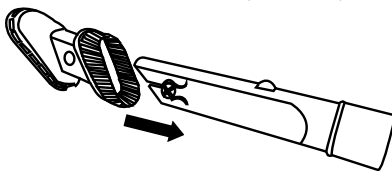

Upholstery
Brush

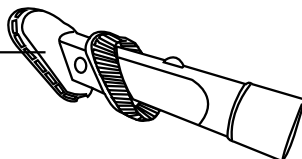

To return the combination tool to crevice tool mode, press the release button and slide the brush tool down the combination tool.

ATTACHMENTS

ATTACHMENTS ON HANDLE

NOTE: If the floor nozzle is attached, turn vacuum cleaner off before removing handle from wand.

1. Press wand release button and pull up on handle.

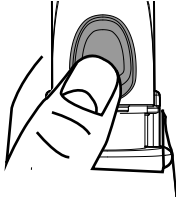

2. Slide attachments onto handle as needed. To use the bare floor tool, align the middle hole on the bare floor tool with the tab on the handle and push together. The bare floor tool will click into place. See ATTACHMENT USE TABLE (page 15).

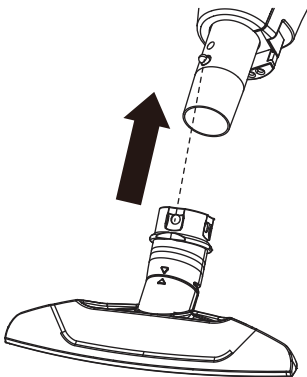
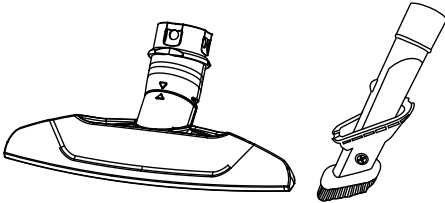

ATTACHMENTS ON WAND



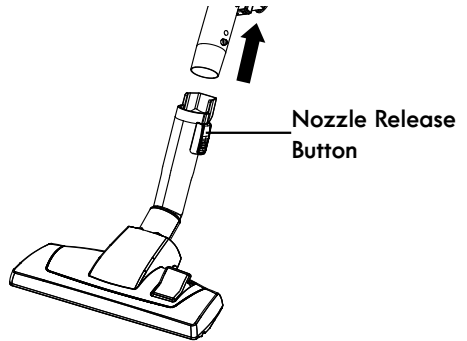

1. To remove floor nozzle from wand, press the nozzle release button and pull to remove.

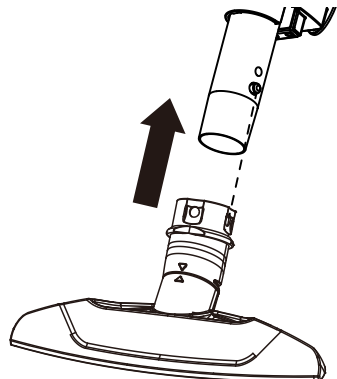
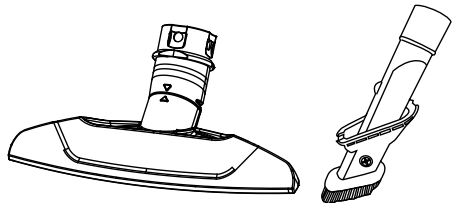

2. Slide attachments onto wand as needed. To use the bare floor tool, align the side hole on the bare floor tool with the tab on the wand and push together. The bare floor tool will click into place. See ATTACHMENT USE TABLE (page 15).

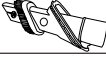

ATTACHMENT USE TABLE

CLEANING AREA							
ATTACHMENT	Furniture ¹	Between Cushions ¹	Drapes ¹	Stairs	Bare Floors	Carpeted Floors/Rugs	Walls
Bare Floor Tool 				✓	✓		✓
Floor Nozzle 					✓ ²	✓	
Dusting Brush 	✓	✓		✓			
Floor Nozzle 	✓		✓	✓			✓
Upholstery Brush 	✓		✓				

1. Always clean attachments before using on fabrics.

2. Press the carpet / floor selector on the floor nozzle to release the brush and squeegee for cleaning bare floors.

PERFORMANCE/SAFETY FEATURES

CHECK BAG INDICATOR

When the vacuum cleaner is running with normal airflow, the CHECK BAG indicator is green. The indicator turns to dark red whenever the airflow becomes blocked. If that occurs, check the disposable dust bag, motor safety filter and other possible clog locations shown in REMOVING CLOGS (page 17).

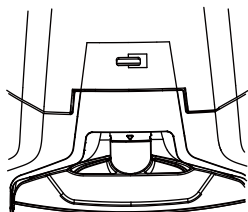

To correct problem: See "Check Bag Indicator activates" in TROUBLESHOOTING (page 22).

NOTE: The indicator may activate when using certain attachments due to reduced airflow through attachment.

THERMAL PROTECTOR

This vacuum cleaner has a thermal protector which automatically trips to protect the vacuum cleaner from overheating. If a clog prevents the normal flow of air to the motor, the thermal protector turns the motor off automatically. This allows the motor to cool in order to prevent possible damage to the vacuum cleaner.

To correct problem: Turn off and unplug vacuum cleaner to allow the vacuum cleaner to cool and the thermal protector to reset. Check for and remove clogs, if necessary. Also check and clean or replace any clogged filters. Wait approximately fifty (50) minutes and plug the vacuum cleaner in and turn back on to see if the motor protector has reset.

If the canister motor does not resume operation after the reset procedure described above, immediately discontinue use and call 1-877-531-7321 (US) / 1-844-608-3081 (CA) for assistance.

CANISTER CARE

REMOVING CLOGS

The vacuum cleaner creates suction that picks up dirt. Rapidly moving air carries the dirt to the dust bag through the airflow passages. The dust bag lets the air pass through, while it traps the dirt.

For best cleaning results, keep the airflow passage open. Check the starred (★) areas occasionally for clogs. Turn off and unplug vacuum cleaner from outlet before checking.

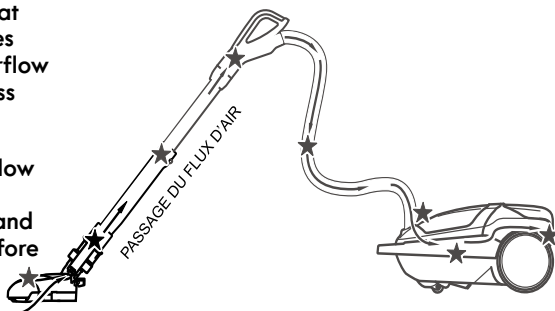

TO CHECK FOR CLOGS:

- Check dust bag and change if full. See **DUST BAG CHANGING** (page 18-19).
- Check motor safety filter and exhaust filter and clean or replace if dirty. See **MOTOR SAFETY FILTER CLEANING** (page 19-20) and **EXHAUST FILTER CHANGING** (page 20-21).
- Check floor nozzle for any dirt.

If the vacuum cleaner still has poor suction, do the following:

1. Connect the hose to the canister and turn vacuum cleaner on. Check the end of the hose for suction. If there is good

suction on the hose handle, there is no clog in the hose. If the suction is bad, remove any dirt or debris in the hose and handle.

2. Connect hose handle to wand. Check the end of the wand for suction. If there is good suction at the end of the wand, there is no clog in the wand. If the suction is bad, remove any dirt or debris in the wand.
3. Check floor nozzle swivel. Remove any dirt or debris.

CLEANING EXTERIOR AND ATTACHMENTS

1. Turn off and unplug vacuum cleaner. DO NOT drip water on vacuum cleaner.
2. To clean exterior, or to reduce static electricity and dust build-up, wipe outer surface with a clean, soft cloth that has been dipped in a solution of mild liquid detergent and water, then wrung dry. Wipe dry after cleaning.



CAUTION

Do not use attachments if they are wet. Attachments used in dirty areas, such as under a refrigerator, should not be used on other surfaces until they are washed. They could leave marks.

DUST BAG CHANGING

For best cleaning results, the dust bag should be changed often. The CHECK BAG indicator will come on when the bag needs to be changed or the airflow is blocked.

NOTE: See REPLACEMENT PARTS for part number and purchase details (page 6).

1. Turn off and unplug vacuum cleaner.
2. Remove hose from canister.
3. Squeeze the hood release button, then lift canister hood.

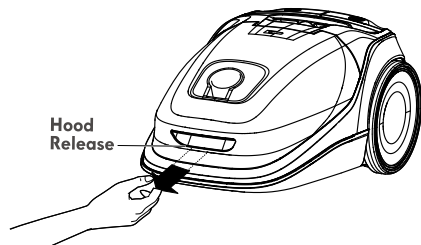

4. Pull bag out of the bag mount.

NOTE: The bag mount will flip forward

after removing bag. This will prevent the hood from closing until a new bag is installed.

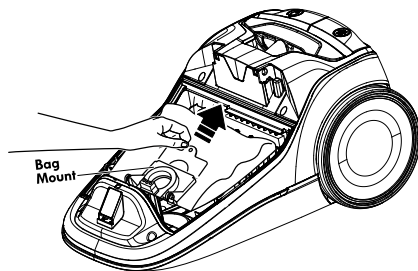

5. Check the motor safety filter and clean or, if necessary replace. See MOTOR SAFETY FILTER CLEANING (page 19-20).

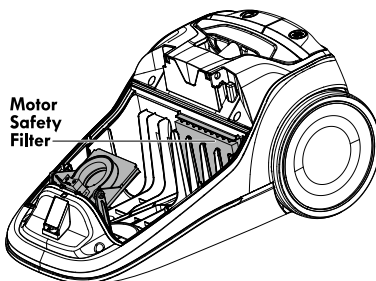

DUST BAG CHANGING

NOTE: DO NOT bend or crease the middle of the cardboard when installing the bag into the bag mount slots.

6. Rotate bag mount down and install bag into slots per illustration, pushing down until the cardboard tab locks into position and the holes align.

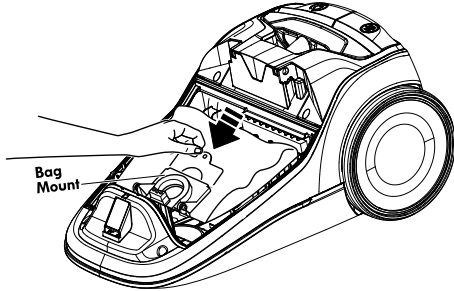

7. Tuck the bag securely into the bag cavity so that none of the bag will be pinched by the hood.
8. Close and latch canister hood.
9. Insert hose into canister until it snaps in place.
10. Plug cord into wall outlet.

CAUTION
NEVER REUSE A DUST BAG.

Very fine materials, such as carpet freshener, face powder, fine dust, plaster, soot, new carpet lint, etc. can clog the bag and cause it to burst before it is full, which may damage the vacuum cleaner motor. Change bag more often when vacuuming these materials.

MOTOR SAFETY FILTER CLEANING



WARNING

Electrical Shock Hazard

Turn off and unplug vacuum cleaner from electrical outlet. Do not operate the vacuum cleaner without the motor safety filter. Be sure the filter is dry and properly installed to prevent motor failure and/or electrical shock.

MOTOR SAFETY FILTER

Check motor safety filter occasionally and clean when dirty.

NOTE: See REPLACEMENT PARTS for part number and purchase details (page 6).

1. Remove the bag as outlined in the DUST BAG CHANGING (page 18-19) section.
2. Lift the rubber retainer and pull out motor safety filter as shown.

MOTOR SAFETY FILTER CLEANING

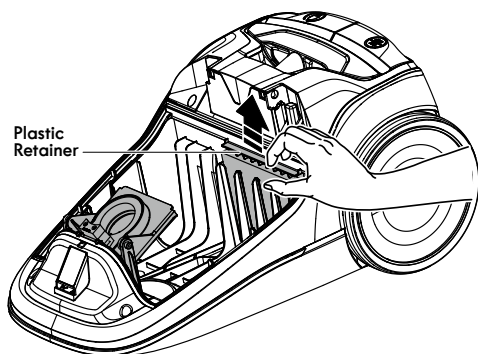

3. Wash filter in warm soapy water, rinse, then dry. Do not clean in dishwasher or install while damp.
4. Slide the filter back into place under the ribs in the bag cavity.
5. Replace the bag as outlined in the DUST BAG CHANGING (page 18-19) section.

EXHAUST FILTER CHANGING



WARNING

Fire and/or Electrical Shock Hazard

Do not operate with a clogged exhaust filter or without the exhaust filter installed. Do not operate without filter cover installed.

EXHAUST FILTER - HEPA MEDIA

The exhaust filter cartridge must be replaced when dirty. Replace the filter when the entire surface area is covered evenly. The filter CANNOT be washed as it will lose its dust trapping ability.

NOTE: See REPLACEMENT PARTS for part number and purchase details (page 6).

1. Push latch up to release the exhaust filter cover from slot in canister.

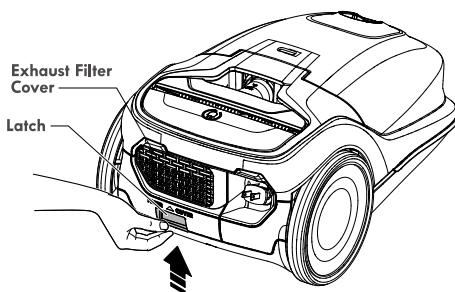

2. Pull filter cover and outward to remove it from filter chamber in the canister.
3. Remove the exhaust filter cartridge from the filter cover.

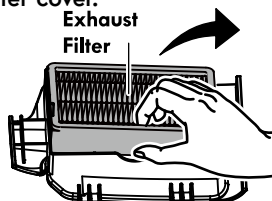

EXHAUST FILTER CHANGING

4. Insert the new exhaust filter cartridge into the filter cover with the rubber seal upward.

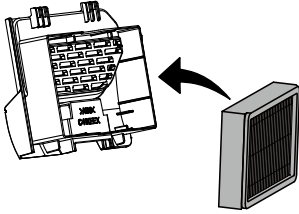

5. To replace the exhaust filter cover, insert the two tabs on the cover into the slots at the top of the filter chamber.

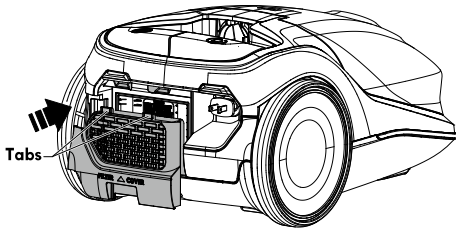

6. Rotate filter cover down until it snaps into place.

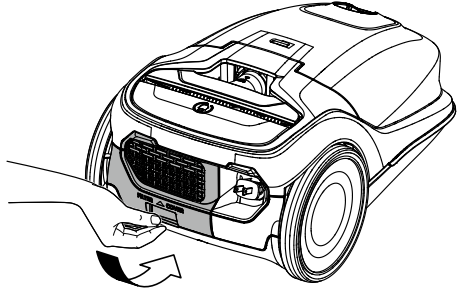

TROUBLESHOOTING

Review this table to find do-it-yourself solutions for minor performance problems. Any other service needed call 1-877-531-7321 (US) / 1-844-608-3081 (CA) for assistance.



WARNING

Always turn off and unplug vacuum cleaner before performing maintenance to the vacuum cleaner. Failure to do so could result in electrical shock or personal injury.

PROBLEM	POSSIBLE CAUSE	SOLUTION
Vacuum cleaner won't start	Unplugged at wall outlet.	Plug in firmly, press On/Off switch.
	Tripped circuit breaker/blown fuse at household service panel.	Reset circuit breaker or replace fuse.
	Loose hose electrical connections.	Reconnect hose ends.
Poor job of dirt pick-up.	Full or clogged dust bag.	Change bag.
	Clogged airflow passages.	Clear airflow passages.
	Dirty filters.	Clean/change filters.
	Wrong power level selected.	Adjust control.
	Hole in hose.	Replace hose.
	Worn floor nozzle.	Change floor nozzle.
	Canister hood open.	Close and latch hood.
Vacuum cleaner starts but shuts off.	Hose or hood electrical connections.	Check connections, reconnect hose ends.
	Tripped thermal protector in canister.	See THERMAL PROTECTOR (page 16).
CHECK BAG Indicator activates.	Full or clogged dust bag.	Change bag.
	Dirty filters.	Clean/change filters.
	Blocked airflow passage.	Clear blockage from airflow passage.
	Certain attachment tools.	This is normal. Light should go off when tool is removed.

TROUBLESHOOTING

Vacuum cleaner picks up moveable rugs -or- floor nozzle pushes too hard.	Suction too strong.	Slide the electronic suction control to a lower power setting.
Cord won't rewind.	Dirty power cord.	Clean the power cord.
	Cord jammed.	Pull out cord and rewind.
Vacuum cleaner leaves marks on carpet.	Wrong vacuuming pattern.	See VACUUMING TIPS (page 12).