

EVEP916  
EFEP956  
EFEP916  
EFE914

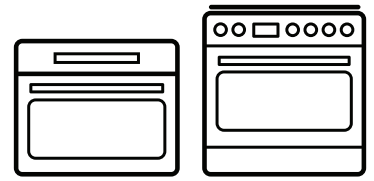

---

90cm Cooker

---

Installation & User manual



## CONGRATULATIONS

Thank you for purchasing an Electrolux cooker. You've chosen a product that brings with it decades of professional experience and innovation. Ingenious and stylish, it has been designed with you in mind. So whenever you use it, you can be safe in the knowledge that you'll get great results every time.

Welcome to Electrolux.

## BEFORE USING YOUR APPLIANCE

Check for any damage or marks. If you find the appliance damaged or marked you must report it within 7 days to claim for damages under the manufacturers warranty.

Before you use the appliance, we recommend that you read through the whole user manual which provides the description of the product and its functions. To avoid the risks that are always present when you use a gas appliance, it is important that the product is installed correctly and that you read the safety instructions carefully to avoid misuse and hazards.

For future reference, please store this booklet in a safe place.

This appliance complies with the requirements of Australian Standard AS/NZS 60335.2.6.

## CONDITIONS OF USE

This appliance is intended to be used in household and similar applications such as:

- Staff kitchen areas in shops, offices and other working environments
- Farm houses
- By clients in hotel/motel rooms and other residential type environments
- Bed and breakfast type environments

## BEFORE YOU CALL

Please ensure you read the instruction manual fully before you call for service, or a full service fee could be applicable.

## RECORD MODEL AND SERIAL NUMBER HERE:

Model number: \_\_\_\_\_

Serial number: \_\_\_\_\_

## CONTENTS

General warnings _____	3
Important safety instructions _____	4
EVEP916 components _____	5
EFEP956 components _____	6
EFEP916 components _____	7
EFE914 components _____	8
Before using your appliance _____	9
Before using your appliance – gas hob model ____	12
Using the oven _____	13
Steam assisted baking _____	19
Using the food probe _____	20
Oven cooking functions _____	23
Oven baking guide _____	27
Steam cooking _____	28
Oven cooking guide _____	29
Dealing with cooking problems _____	30
Oven cooking tips _____	31
Oven troubleshooting _____	32
Using the induction hob _____	33
Induction hob troubleshooting _____	40
Using the gas hob _____	42
Gas hob troubleshooting _____	43
Cleaning your appliance _____	44
Pyrolytic cleaning _____	46
Cleaning the oven door _____	48
Installation of EFE914, EFEP916 & EFEP956 ____	50
Installation of EVEP916 _____	58
Cabinet construction for built-in oven _____	59
Wiring requirements _____	60
Electrical and gas connections _____	61
LPG conversion for EFE914 & EFEP916 ____	62
Testing the operation of the gas cooker ____	63
Warranty _____	64
Notes _____	65

### IMPORTANT INFORMATION THAT MAY IMPACT YOUR MANUFACTURER'S WARRANTY

Adherence to the directions for use in this manual is extremely important for health and safety. Failure to strictly adhere to the requirements in this manual may result in personal injury, property damage and affect your ability to make a claim under the Electrolux manufacturer's warranty provided with your product. Products must be used, installed and operated in accordance with this manual. You may not be able to claim on the Electrolux manufacturer's warranty in the event that your product fault is due to failure to adhere this manual.

## GENERAL WARNINGS

Please read this user manual carefully and store in a handy place for later reference. Pass the user manual on to possible new owners of the appliance.

Read the following carefully to avoid damage or injury.

*NOTE: You must read these warnings carefully before installing or using the appliance. If you need assistance, contact your Customer Care Department. The manufacturer will not accept liability, should these instructions or any other safety instructions incorporated in this user manual be ignored.*

### SYMBOLS



#### **WARNING!**

**This symbol indicates information concerning your personal safety.**



#### **CAUTION!**

**This symbol indicates information on how to avoid damaging the appliance.**



#### **IMPORTANT!**

**This symbol indicates tips and information about use of the appliance.**



#### **ENVIRONMENT!**

**This symbol indicates tips and information about economical and ecological use of the appliance.**



#### **WARNING!**

- This appliance must not be used as a space heater.
- In order to avoid fire, the appliance must be kept clean and vents kept unobstructed.
- Do not spray aerosols in the vicinity of this appliance whilst it is in operation.
- Do not use or store flammable materials in this appliance storage compartment or near this appliance.
- Do not line the bottom of the oven with foil or cookware.
- Always use gloves when handling hot items inside the oven.
- Always turn the grill off immediately after use as fat left behind may catch fire.
- Do not hang any objects from the hob as it may block the air vents.
- Do not modify this appliance.
- To maintain safe operation, it is recommended that the product be inspected every 5 years by an authorised service person.

- Do not install an aftermarket lid or cover over this appliance.
- The appliance must be earthed.
- Switch the appliance off at the isolation switch before attempting to change the light globe.
- The cooking process must be supervised. A short term cooking process must be supervised continuously.



#### **CAUTION!**

**Read the following carefully to avoid an electric shock or fire.**

It is important to use your appliance safely. Check these safety points before using your appliance.

#### **Installation, cleaning and servicing**

- An authorised person must install this appliance. (Certificate of Compliance to be retained).
- Before using the appliance, ensure that all packing materials are removed from the appliance.
- In order to avoid any potential hazard, the enclosed installation instructions must be followed.
- Ensure that all specified vents, openings and airspaces are not blocked.
- Where the appliance is built into a cabinet, the cabinet material must be capable of withstanding 85°C.
- Only authorised personnel should carry out servicing. (Certificate of Compliance to be retained).
- Always ensure the appliance is switched off before cleaning or replacing parts.
- Do not use steam cleaners, as this may cause moisture build up.
- Always clean the appliance immediately after any food spillage.
- This appliance must be earthed.
- Due to the weight (freestanding 95-100kg, built in 70kg) and size of cookers, 2 persons are required to manually manoeuvre them. Remove loose items such as trivets, oven racks and trays to minimise weight.
- Do not use the oven door handle to lift the cooker, instead open the oven door and lift the roof of the oven cavity.
- Take care when lifting to avoid any sharp edges not intended for lifting.
- Disconnection in the fixed wiring must occur in accordance with the AS/NZS3000 wiring rules.

## IMPORTANT SAFETY INSTRUCTIONS

### INFORMATION ON DISPOSAL FOR USERS



#### ENVIRONMENT!

- Most of the packaging materials are recyclable. Please dispose of these materials through your local recycling depot or by placing them in appropriate collection containers.
- If you wish to discard this product, please contact your local authorities and ask for the correct method of disposal.



#### WARNING!

#### OVEN

- During use the appliance becomes hot. Care should be taken to avoid touching the hot surfaces inside the oven.
- Always use gloves when handling hot items inside the oven.
- Switch the appliance off before removing the oven light glass for globe replacement.
- To avoid an accident, ensure that oven shelves and fittings are always inserted into the appliance in accordance with the instructions.
- Do not use the door as a shelf.
- Do not push down on the open oven door.
- Do not cover the grill insert with foil, as fat left there may catch fire.
- Always keep the grill dish clean as any fat there may catch fire.
- Always turn the grill off immediately after use, as fat left there may catch fire.
- Do not leave the grill on unattended.
- To avoid a fire, ensure the grill tray and fittings are always inserted into the appliance in accordance with the instructions.

#### GAS HOB MODEL

- Do not allow pots to boil dry, as damage to both pan and hob may result.
- Do not operate the cooktop for an extended period of time without a pot or pan on the burner.
- Do not allow large cookware to overhang the hob onto the adjacent benchtop. This will cause scorching to the benchtop surface.
- Ensure burner bodies and trivets are properly located.
- Unattended cooking with oil or fat on a hob can be dangerous and result in fire.
- In order to avoid a fire do not store items on the cooking surface.

#### INDUCTION HOB MODEL

- In order to avoid a fire do not store items on the cooking surface.
- Do not place heat resistant mats, wire mats or aluminium foil under pots and pans.
- Do not allow pots to boil dry, as damage to both pan and hob may result.
- Do not use the hob as extra bench space or as a cutting board.
- Do not allow large cookware to overhang the hob onto the adjacent benchtop. This will cause scorching to the benchtop surface.
- Do not slide pans across the surface of the ceramic glass as it could result in scratching of the surface.
- The induction hob is not intended to be operated by means of an external timer or separate remote-control system.
- Use only induction specific cookware.
- If the hob surface is cracked, switched off the appliance to avoid the possibility of electric shock.
- Metallic objects such as knives, forks, spoons and lids should not be placed on the hob surface since they can get hot.
- After use, switch off the hob element by its control and do not rely on automatic switch off.
- Unattended cooking with oil or fat on a hob can be dangerous and result in fire.
- The appliance is not intended to be operated by means of an external timer or remote control system.
- Users with an implanted pacemaker must keep their upper body minimum 30cm from induction cooking zones that are switched on.



#### WARNING!

#### CHILD SAFETY

- This appliance is not intended for use by persons (including children) with reduced physical, sensory or mental capabilities, or lack of experience and knowledge, unless they have been given supervision or instruction concerning use of the appliance by a person responsible for their safety.
- Children should be supervised to ensure that they do not play with the appliance.
- During use this appliance becomes hot. Care should be taken to avoid touching hot surfaces, eg. Oven door, heating elements, hobs or trivets.
- Accessible parts will also become hot when in use. To avoid burns and scalds children should be kept away.
- Always turn pan handles to the side or rear to prevent accidental knocking and to keep out of reach of children.



# EVEP916 COMPONENTS

## Multi function electric oven and programmable controller

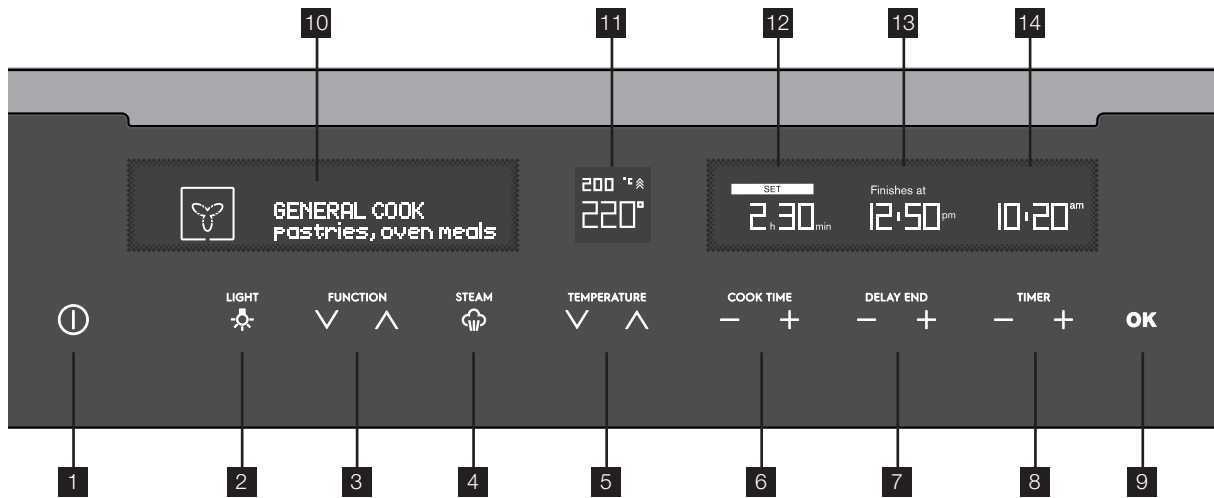

- |                                    |                                      |                               |
|------------------------------------|--------------------------------------|-------------------------------|
| <b>1</b> ON/OFF                    | <b>6</b> Cook time control           | <b>11</b> Temperature display |
| <b>2</b> Light on/off              | <b>7</b> Delay end control           | <b>12</b> Cook time display   |
| <b>3</b> Cooking function selector | <b>8</b> Set clock and timer control | <b>13</b> Delay end display   |
| <b>4</b> Steam cooking option      | <b>9</b> Instant confirm             | <b>14</b> Clock/timer display |
| <b>5</b> Temperature control       | <b>10</b> Cooking function display   |                               |



- |                                     |                              |                                 |
|-------------------------------------|------------------------------|---------------------------------|
| <b>15</b> Control panel (see above) | <b>16</b> Exhaust air outlet | <b>17</b> Quadruple glazed door |
|-------------------------------------|------------------------------|---------------------------------|

# EFEP956 COMPONENTS

## Induction hob, multi function electric oven and programmable controller

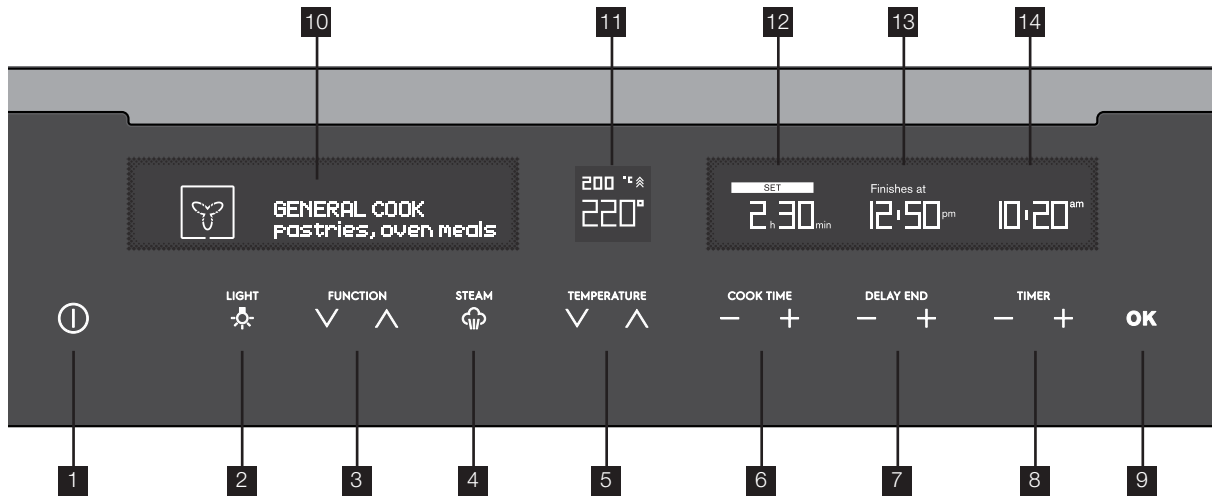

- |                                    |                                      |                               |
|------------------------------------|--------------------------------------|-------------------------------|
| <b>1</b> ON/OFF                    | <b>6</b> Cook time control           | <b>11</b> Temperature display |
| <b>2</b> Light on/off              | <b>7</b> Delay end control           | <b>12</b> Cook time display   |
| <b>3</b> Cooking function selector | <b>8</b> Set clock and timer control | <b>13</b> Delay end display   |
| <b>4</b> Steam cooking option      | <b>9</b> Instant confirm             | <b>14</b> Clock/timer display |
| <b>5</b> Temperature control       | <b>10</b> Cooking function display   |                               |

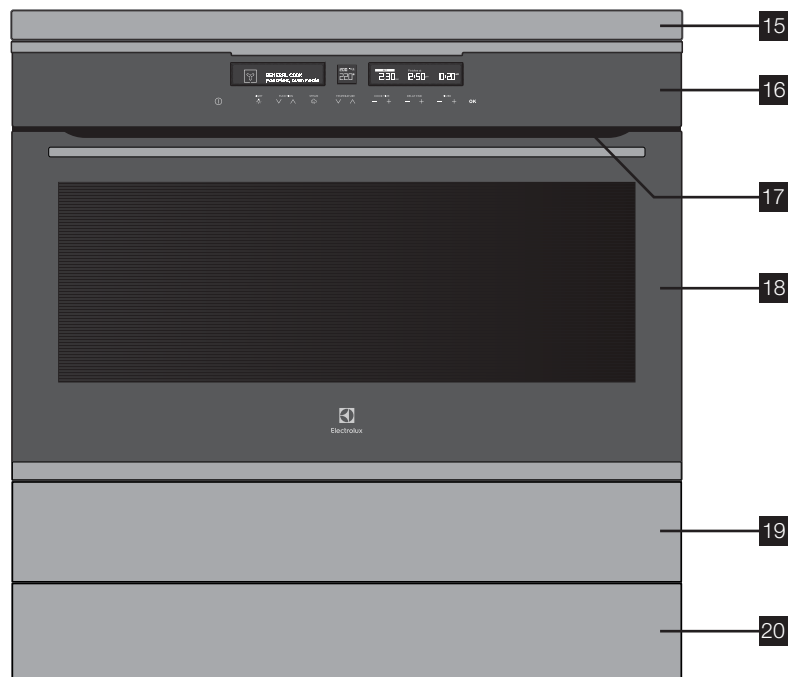

- |                                     |                                 |                                |
|-------------------------------------|---------------------------------|--------------------------------|
| <b>15</b> Induction hob             | <b>17</b> Exhaust air outlet    | <b>19</b> Storage compartment  |
| <b>16</b> Control panel (see above) | <b>18</b> Quadruple glazed door | <b>20</b> Removable kick panel |

# EFEP916 COMPONENTS

## Gas hob, multi function electric oven and programmable controller

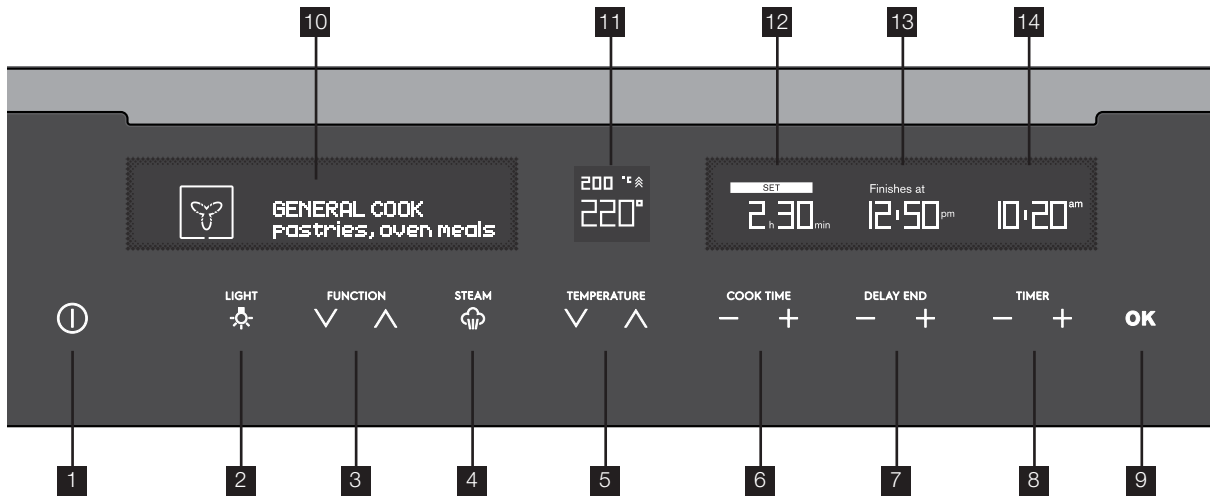

- |                                    |                                      |                               |
|------------------------------------|--------------------------------------|-------------------------------|
| <b>1</b> ON/OFF                    | <b>6</b> Cook time control           | <b>11</b> Temperature display |
| <b>2</b> Light on/off              | <b>7</b> Delay end control           | <b>12</b> Cook time display   |
| <b>3</b> Cooking function selector | <b>8</b> Set clock and timer control | <b>13</b> Delay end display   |
| <b>4</b> Steam cooking option      | <b>9</b> Instant confirm             | <b>14</b> Clock/timer display |
| <b>5</b> Temperature control       | <b>10</b> Cooking function display   |                               |

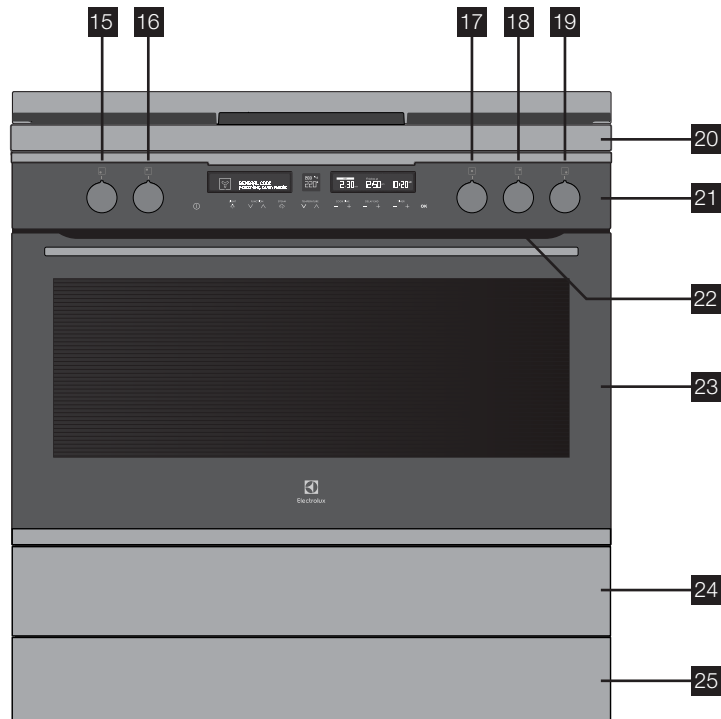

- |                                     |                                     |                                 |
|-------------------------------------|-------------------------------------|---------------------------------|
| <b>15</b> Semi rapid burner control | <b>19</b> Rapid burner control      | <b>23</b> Quadruple glazed door |
| <b>16</b> Auxiliary burner control  | <b>20</b> Gas hob                   | <b>24</b> Storage door          |
| <b>17</b> Wok burner control        | <b>21</b> Control panel (see above) | <b>25</b> Removable kick panel  |
| <b>18</b> Semi rapid burner control | <b>22</b> Exhaust air outlet        |                                 |

# EFE914 COMPONENTS

## Gas hob, multi-function electric oven with electronic timer

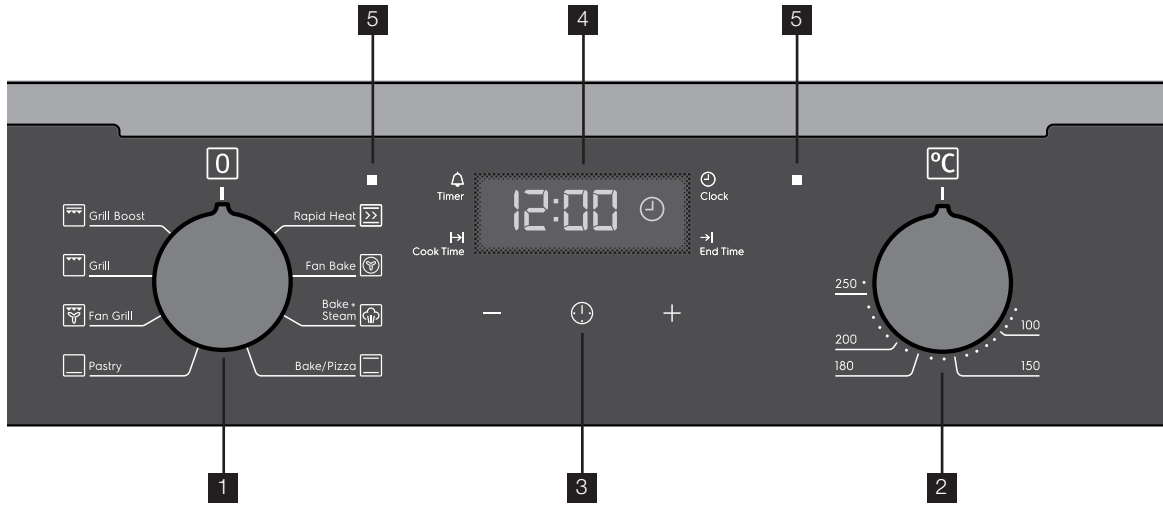

- 1** Cooking function selector
- 2** Temperature control
- 3** Electronic clock control
- 4** Clock/timer display
- 5** Oven indicator

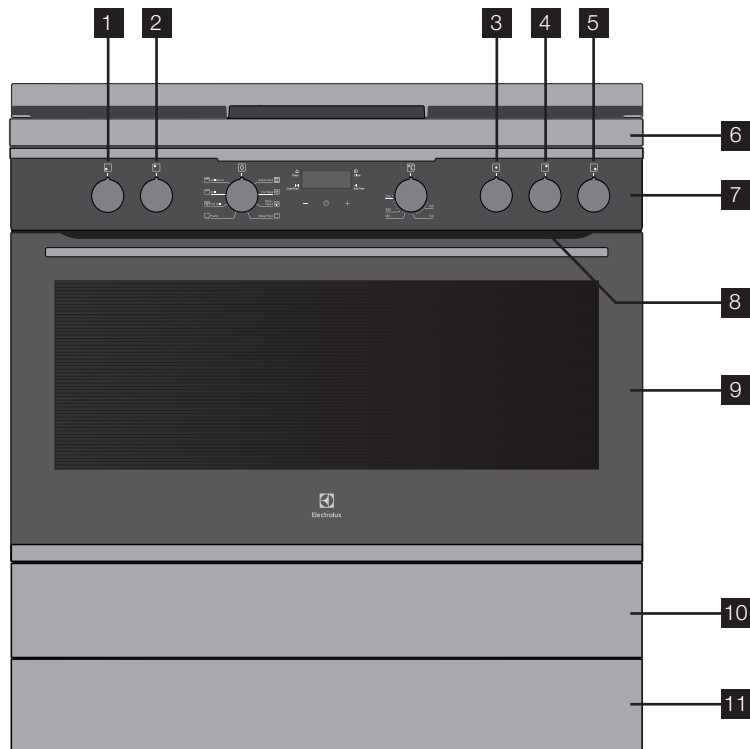

- |                                    |                                    |                                |
|------------------------------------|------------------------------------|--------------------------------|
| <b>1</b> Semi rapid burner control | <b>5</b> Rapid burner control      | <b>9</b> Quadruple glazed door |
| <b>2</b> Auxiliary burner control  | <b>6</b> Gas hob                   | <b>10</b> Storage door         |
| <b>3</b> Wok burner control        | <b>7</b> Control panel (see above) | <b>11</b> Removable kick panel |
| <b>4</b> Semi rapid burner control | <b>8</b> Exhaust air outlet        |                                |

## BEFORE USING YOUR APPLIANCE

### Preparing the appliance

- 1 Please remove all stickers, leaflets and boxes from the door and from the floor of the oven before operation.
- 2 Please wipe out the oven interior prior to operation with warm soapy water and polish dry with a soft clean cloth. Do not close the oven door until the oven is completely dry.
- 3 Do not line the oven with foil. It will damage the enamel.

### Setting the time

The time of day must be set before the appliance can operate.

#### Touch control electronic clock (EFE914)

- After the appliance has been electrically connected "12.00" will be displayed and the "clock" indicator will flash.
- To set the time of day, press – or +. 5 seconds after the last change, the "clock" indicator will disappear, confirming the time has been set.

*NOTE: The clock has a 24-hour display.*

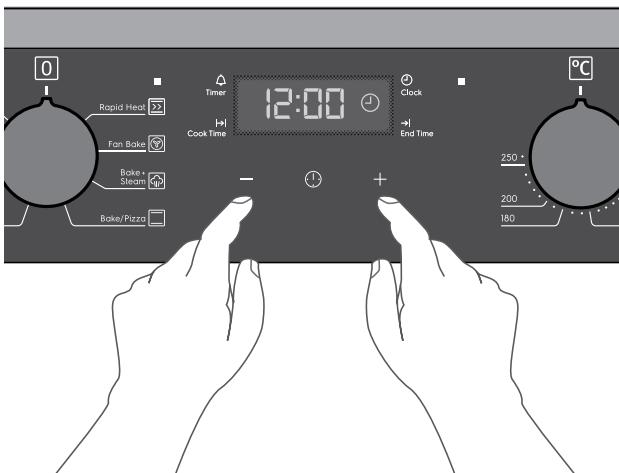

#### Programmable controller (EVEP916, EFEP916, EFEP956)

After the appliance has been electrically connected "Set Clock" will illuminate under the clock display and the Hour digits will flash.

- 1 Use the timer + and - to set the hour portion of the current time (including AM/PM).
- 2 Press OK when the hours are set correctly. The Minute digits will flash.
- 3 Use the timer + and - to set the minutes portion of the current time.
- 4 Press OK when the minutes are set correctly. You can turn off the oven or it will do so after 8 seconds. Once the time has been entered, the clock advances minute by minute.

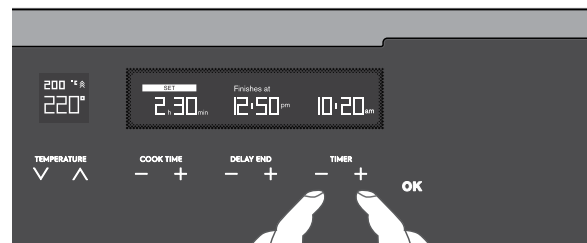

#### **i** IMPORTANT!

- The clock will remember the time for 24 hours without power.
- The display has 2 levels of brightness.
- Brightest illumination: whenever the oven is in use.
- Medium illumination: whenever the oven is not in use.

#### **i** IMPORTANT!

**New appliances can have a smell during first use. It is recommended to 'run in' the oven before you cook for the first time. Operate the oven, empty, at a temperature of 180°C for approximately 1 hour. Please ensure the room is well ventilated during this process.**

## BEFORE USING YOUR APPLIANCE (CONTINUED)

### Slides (Telescopic runners)

- 1 The oven is supplied with a set of slides and instructions on how to assemble. Ensure the rack and slides are of the same hand, eg. left hand side should be fitted on the left hand rack.
- 2 The instructions also show recommended slide positions on the rack.

### Installing the slides (telescopic runners)

- 1 Obtain left hand side rack and left hand slide – see image to identify.

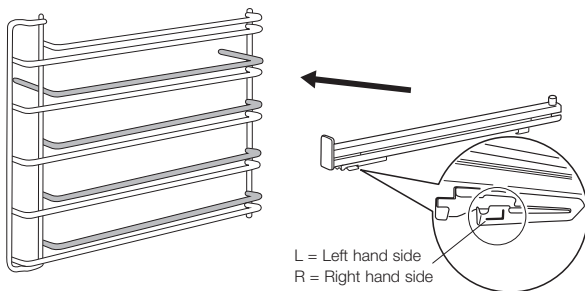

- 2 The shaded wires indicate the wire the slide can be mounted on. Fit slide rear clips to the rear of wire at an angle as shown below.

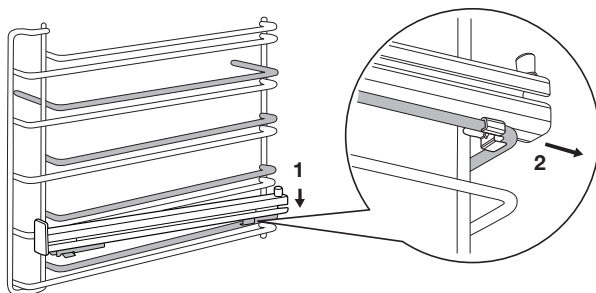

- 3 Push slide front clip over wire until secured.

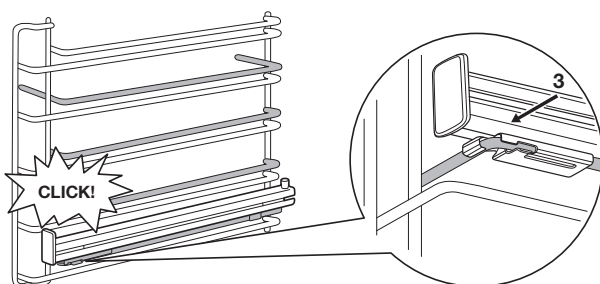

### Installing the side racks

- 1 Insert the rear peg into the rear access hole provided, ensuring peg is fully inserted.
- 2 Then locate the front peg into the front access hole and push in firmly.

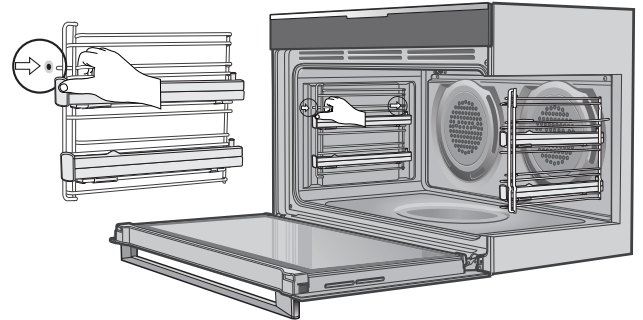

### Fitting the shelves and grill dish carrier between the side rack wires

The shelves are designed so that they have maximum extension but cannot be accidentally pulled right out. The grill dish carrier is designed the same way and can slot straight into the side racks.

To fit a shelf or grill dish carrier to side racks:

- 1 Locate the rear edge of the shelf/carrier in between guide rails of the side rack - see diagram.
- 2 Ensure the same rail positions on both sides of the oven are being engaged. With the front edge raised, begin to slide the shelf into the oven.
- 3 Once the detents have passed the front edge of the side rack, the shelf can be pushed completely in. When fully inserted the shelf/carrier should not interfere with the closed oven door.

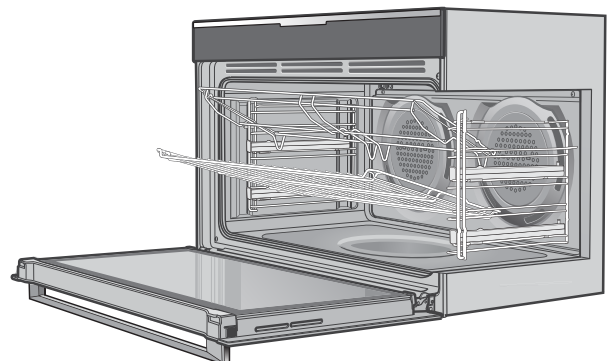



## BEFORE USING YOUR APPLIANCE (CONTINUED)

### Positioning the dishes on the grill dish carrier

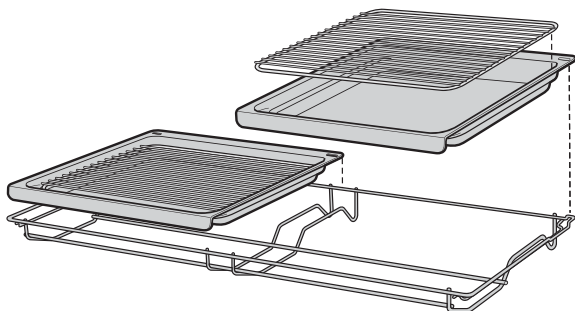

### Fitting the shelves and grill dish carrier onto telescopic slides

To fit a shelf or grill dish carrier to telescopic slides:

- 1 With the slides fully pushed in, push the shelf/carrier along the top of the slide until it hits the back post.
- 2 Drop the front of the shelf/carrier ensuring it sits behind the front post of the slide (see illustration). When fully inserted the shelf/carrier should not interfere with the closed oven door.

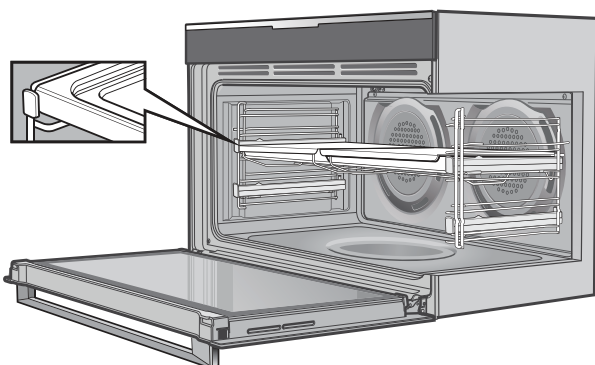

## BEFORE USING THE APPLIANCE - GAS HOB MODEL

### Installing the trivets

- 1 Position the 2 side trivets onto the hob first, ensuring the 2 corner location recesses are to the back of the hob.
- 2 Position the middle trivet ensuring the trivet fingers are aligned with the side trivet fingers.
- 3 The wok support sits on top of the trivet above the wok burner.

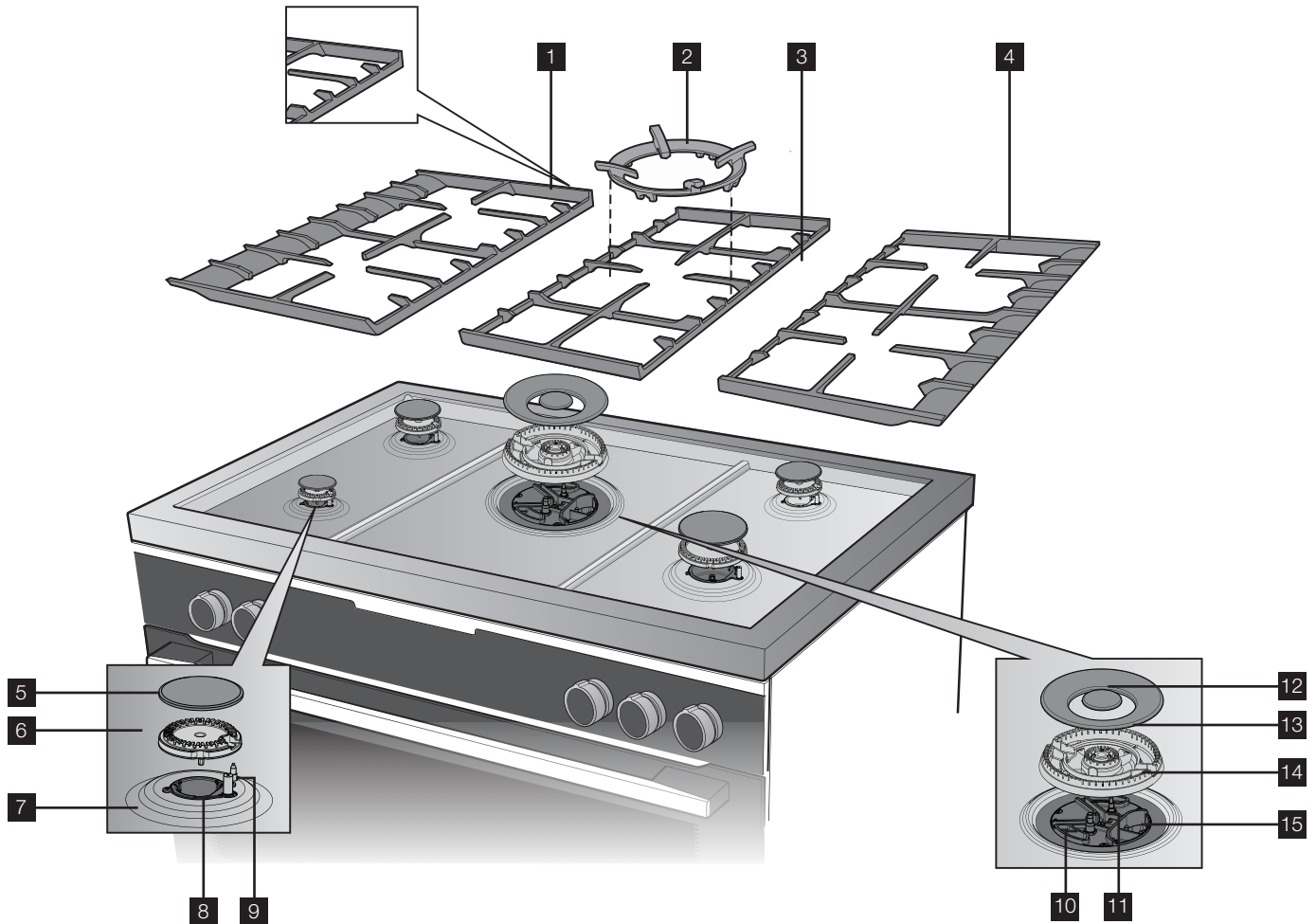

- |                         |  |                         |
|-------------------------|--|-------------------------|
| 1 Side trivet           | 7 Standard burner cup                    | 12 Wok burner inner cap |
| 2 Wok support           | 8 Standard burner spark plug             | 13 Wok burner outer cap |
| 3 Middle trivet         | 9 Standard burner flame safeguard sensor | 14 Wok burner crown     |
| 4 Side trivet           | 10 Wok burner flame safeguard sensor     | 15 Wok burner body      |
| 5 Standard burner cap   | 11 Wok burner spark plug                 |                         |
| 6 Standard burner crown |  |                         |

### Installing the standard burners

- 1 The burner crown must be fitted correctly onto the burner cup or damage will occur during operation.
- 2 To do this, align the outer hole and outer recess of the burner crown around the spark plug and flame safeguard sensor. Drop down ensuring the location ribs on the bottom of the crown drop into the location recesses.
- 3 Burner cap and burner crown must be clean and located correctly for the burner to light.

### Installing the wok burners

- 1 The wok burner crowns must also be fitted correctly onto the wok burner cups.
- 2 To do this, align the sausage shaped cutouts on the burner crown with the sausage shaped cutouts on the burner body. Drop down ensuring the centre location pin of the crown has dropped into the corresponding recess in the body.
- 3 The 2 burner caps are simply positioned over the top of the burner crown.

*NOTE: When the burners are correctly fitted they will sit level on the hob.*

## USING THE OVEN

### Operating your oven temperature and function selectors model (EFE914)

To set the oven, turn the function selector to the desired cooking function and then turn the temperature selector to the desired temperature. An indicator light above the temperature selector will come on. When the temperature is reached the heating source switches itself off and the indicator light goes out. When the oven temperature falls below the desired setting, the heating source switches on and the indicator light comes on again.

Once the food is cooked, turn the temperature selector off in an anti-clockwise direction. Do not force it right round in a clockwise direction as this will result in damage to the thermostat. Turn the multifunction selector off.

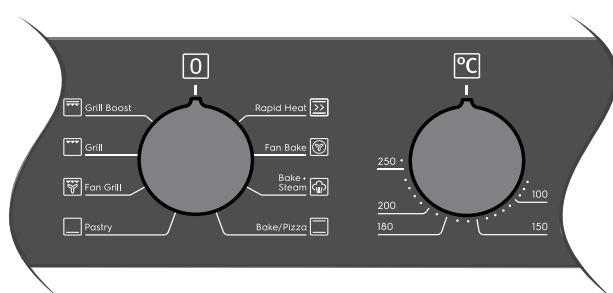

### Operating your programmable controller model (EVEP916, EFEP916, EFEP956)

#### Turning the oven on

- Switch on the oven by touching the **ⓘ** ON/OFF symbol. The LCD control panel will come on and inform you that you need to select a cooking function.
- If you do not select a function within 20 seconds the oven will turn off.

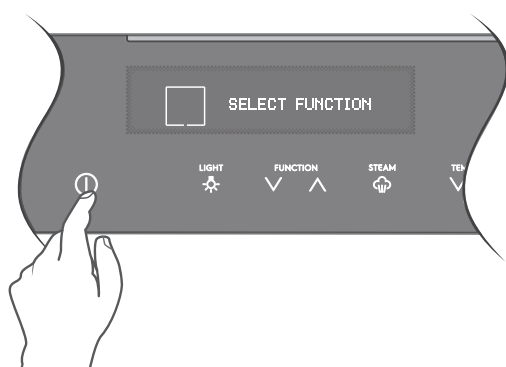

#### Select a cooking function

Your oven will have a selection of functions. Press the function **^** or function **v** symbols as many times as necessary until the desired function appears.

Cooking suggestions will appear under the function name and suggested cooking temperatures will appear above the temperature selector.

If no other symbol is touched within 8 seconds the oven will switch on and begin to heat up to the displayed temperature.

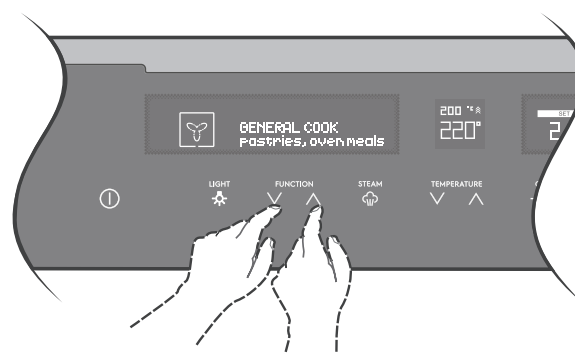

#### Selecting a temperature

The temperature is electronically controlled.

The temperature can be selected within the range of 30°C to 250°C and can be adjusted at any time. To set the temperature, press the temperature **^** and temperature **v** symbols to reach the desired setting.

Press OK, or if no further changes are made within 8 seconds the oven begins to heat up to the set temperature. The current oven temperature will appear above set temperature.

When the temperature is reached, "Set temperature reached" will appear, only the target temperature will be displayed.

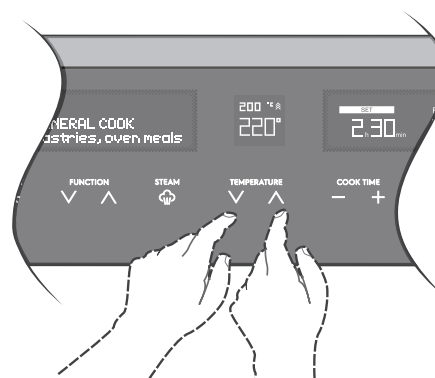

#### Turning the oven off

Touch the **ⓘ** 'ON/OFF' symbol to switch off the oven.

### **i** IMPORTANT!

#### Pre-heating

Pre-heating your oven is recommended in several cooking and grilling functions. Pre-heating your appliance allows it to reach the required temperature quickly and efficiently as well as cook your food at the correct temperature for the entire cook time.

#### Programmable controller (EVEP916, EFEP916, EFEP956)

These models are equipped with a built-in rapid heat-up that activates each time you start an oven function. During the rapid heat-up phase the heat comes from the element surrounding the fan as well as the grill elements above

## USING THE OVEN (CONTINUED)

the food. This combination will heat up your oven 30% quicker than it would on standard “Bake”. The oven will automatically revert to the set cooking function once the preset temperature is reached.

### Function selector model with Rapid Heat (EFE914)

To preheat your oven select the “Rapid Heat” function. This function allows your oven to reach the preset temperature quicker than any other cooking function.

- 1 Turn the function selector to “Rapid Heat”.
- 2 Set the desired preheat temperature, by rotating your oven temperature selector. When the indicator light above the temperature selector goes out, the oven has reached the desired temperature. Select the oven function you require for cooking or baking and place the food in the oven.

### Cooling / Vent fan

The appliance is fitted with a cooling fan. This prevents the kitchen cabinet from overheating and reduces the condensation inside the oven. It will operate whenever the oven is in use and blow warm air across the top of the oven door.

*NOTE: If the oven is still hot from cooking, the cooling fan will keep running to cool the oven down and will switch off by itself once cool.*

### Condensation

Excess condensation may fog the oven door. This may happen when cooking large quantities of food from a cold start. Minimise condensation by:

- Keeping the amount of water used whilst cooking to a minimum.
- Making sure the oven door is firmly closed.
- Baking custard in a baking dish that is slightly smaller than the water container.
- Cooking casseroles with the lid on.

*NOTE: If using water in cooking, this will turn to steam and may condense outside your appliance. This is not a problem or fault with your oven.*

## Operating the touch control clock models EFE914

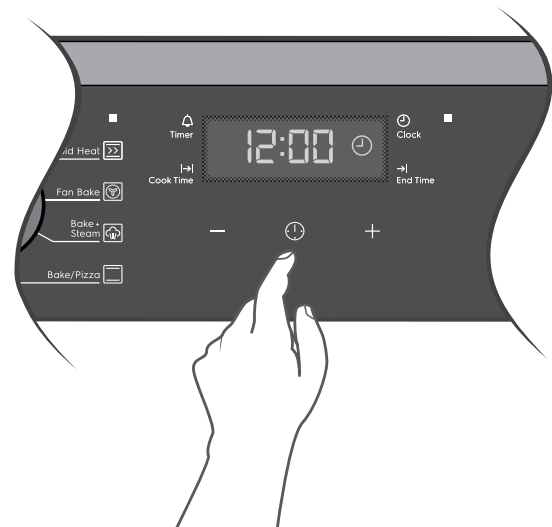

### General features

Your touch control clock has the following features:

- **Timer** – allows you to set a countdown time that will beep when the set time has elapsed.
- **Cooking duration** – You can set a cooking duration. A timer will count down the preset cooking time, beep when the time has elapsed and turn the oven off.
- **End cooking time** – you can set a cooking finish time. A timer will count down the preset cooking time, beep when the finish time has been reached and turn the oven off.
- **Delayed start cooking time** – You can combine the cooking time and stop cooking time to switch the oven on and off at a specific time during the day.

*NOTE: Your touch control clock only operates with your main oven.*

### Setting the time of day

You must set the time of day before you can operate your appliance. When power is supplied to your oven “12.00” will be displayed and the “clock” indicator **I** will flash.

- 1 To set the time of day in hours and minutes, press **■** or **+**. 5 seconds after the last change, the “clock” indicator **I** will disappear, confirming the time has been set.



*NOTE: The clock has a 24-hour display.*

### Change the time of day (Daylight saving)

- 1 Press **⌚** until the “clock” indicator **I** begins flashing.
- 2 Press **■** or **+** to change the time. 5 seconds after the last change, the “clock” indicator **I** will disappear, confirming the time has been set.

## USING THE OVEN (CONTINUED)

### Setting the timer

- 1 Press  until the “timer” indicator **I** begins flashing.
- 2 Set the countdown time you want by using **■** and **+**. 5 seconds after the last change the “timer” indicator **I** will stop flashing, confirming the timer has been set.
- 3 To stop the beeper, press **■**, **+** or .

### Setting the cooking duration

- 1 Check the clock displays the correct time of day.
- 2 Select the desired oven function and temperature. The oven indicator light will glow and the heating source will come on.
- 3 Press  until the “cook time” indicator **I** begins flashing.
- 4 Set the cooking duration you want by using **■** or **+**. 5 seconds after the last change, the “cook time” indicator **I** will stop flashing, and the time of day will be displayed.

*NOTE: Do not forget to add preheating time if necessary.*



### Setting the cooking end time

- 1 Check the clock displays the correct time of day.
- 2 Select the desired oven function and temperature. The oven indicator light will glow and the heating source will come on.
- 3 Press  until the “end time” indicator **I** begins flashing.
- 4 Enter the time of day you want to finish cooking by pressing **■** or **+**. 5 seconds after the last change, the “end time” indicator **I** will stop flashing and the current time of day will be displayed.

### Setting the delayed start cooking time

- 1 Program the “cook time” and “end time” as described in the relevant sections. Once both the “cook time” and “end time” have been set, the “cook time” and “end time” indicators will stop flashing and the current time of day will be displayed.

### To check or cancel settings

- 1 To check your settings, press  until the setting you want is displayed. A red light will flash next to the mode (cook time, end time etc) that is currently on display.
- 2 To cancel “delayed start” press  until a light flashes next to “cook time”. Press and hold **■** until the clock no longer reverses (“0:00” and you will hear a beep). If you have left the temperature and function knobs at a setting the oven will start once the “end time” light stops flashing.

- 3 To cancel “auto off” press  until a light flashes next to “cook time”. Press and hold **■** until the clock no longer reverses (“0:00” and you will hear a beep). This automatically cancels “delayed start”. If you have left the temperature and function knobs at a setting, the oven will start once the “cook time” light stops flashing. Because you have cancelled “auto off” the oven will continue to heat until you manually turn it off.

### On completion of cooking

The oven will turn off, the timer will beep and the “end time” and/or “cook time” indicators will flash.

- 1 Turn the function and temperature controls to the off position.
- 2 Press **+** or **■** or  to stop the timer from beeping.

### Switching the clock display ON and OFF

- 1 Press together **+** and **■** for 2 seconds to switch ‘off’ the display.
- 2 Press together **+** and **■** for 2 seconds to switch the clock display ‘on’ again.

*NOTE: If a timer mode is set, then it is not possible to switch the display off.*

### Operating the programmable controller models (EVEP916, EFEP916, EFEP956)

#### Cooking with the timer

Your oven is equipped with a programmable controller that can be used to turn the oven on and off automatically. The ‘cook time’ controls are used to automatically turn the oven off after a set amount of time. The ‘Delay End’ controls are used to set the time of day that you want the cooking cycle to finish at.

#### Setting the cook time

- 1 Select the desired oven function and cooking temperature.
- 2 Touch the cook time **+** symbol as often as necessary (or hold), until the desired cook time has been set.
- 3 Press ‘OK’ or after 8 seconds from the last time adjustment the oven will start cooking and the ‘cook time’ display will countdown to zero.
- 4 The oven will turn off and beep when the ‘cook time’ display reaches zero.

## USING THE OVEN (CONTINUED)

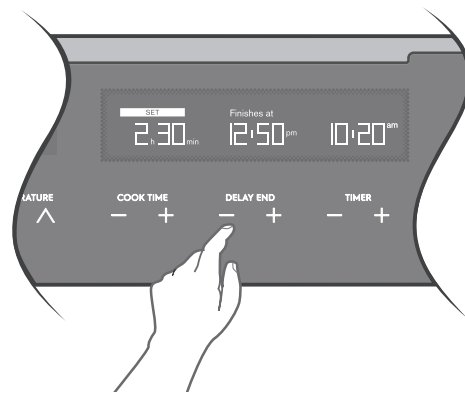
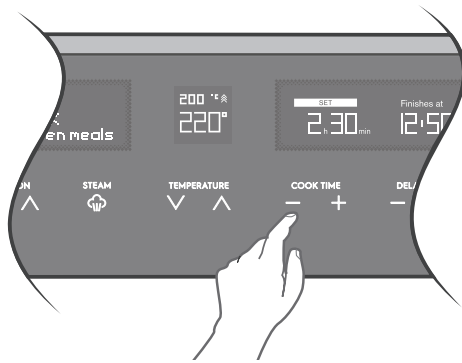

### **i** IMPORTANT!

- When you use the 'cook time' function, the 'Finishes at' display activates and tells you what time of day the oven will turn off (based on the set cook time).
- During cooking, you can adjust the cook time with the Cook time **-** or **+** symbols.
- When the cook time has elapsed, an audible signal will sound for two minutes, the oven will switch off and COOKING FINISHED will be displayed.
- To stop the audible signal, press any of the symbols on the control panel.
- If you wish to cook a bit longer, press the cook time **+** symbol for each additional minute you require. The oven automatically reverts to the function and temperature previously programmed. This feature is available for 5 minutes after cooking has finished. After that, the oven automatically switches off.

### Setting the delay end time

The delay end function can be used to switch the oven on and off at a specific time during the day.

- 1 Check the clock displays the correct time of day.
- 2 Select the desired oven function and cooking temperature.
- 3 Set the required cook time.
- 4 Press the 'delay end' symbol **+** to move the end time.
- 5 Touch 'OK' or after 8 seconds from the last time adjustment the SET icon will light and your oven is now programmed. The oven will start its cooking cycle to finish at the set 'end time'.
- 6 When the oven has finished cooking, cook time can be extended or the beeper turned off just as in 'cook time' mode.

- 7 Touch the 'delay end' **+** symbol to move the end time forward.
- 8 Touch 'OK' or after 8 seconds from the last time adjustment the SET icon will light and the oven is now programmed.

The oven will commence its cooking cycle to finish at the set 'end time'.

### **i** IMPORTANT!

- 30 seconds after a cooking function has started, it is no longer possible to delay the start time.
- In order to delay a cooking function that has already started, the oven needs to be switched off then switched on again and re-programmed.
- Even though the heating element turns off, the oven will still retain substantial heat. This will continue to cook food until it is removed or the oven cools down. If you do not plan on being present when the oven turns off, you should take this extra heating time into account.

### Timers

The appliance has two timers which can be used one at a time. The count up timer can be used to measure a period of time. The count down timer beeps at the end of a preset time.

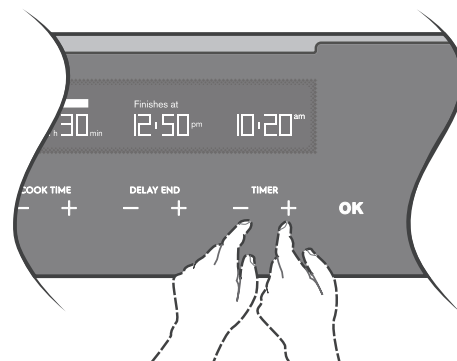



## USING THE OVEN (CONTINUED)

### Setting the count up timer

The timer can be used independently of the oven for measuring a count up period. There is no alert provided with this timer.

- 1 Touch either 'timer' **+** or **-**.
- 2 00min will be displayed along with a bell and the up arrow will flash.
- 3 To begin the count up timer press OK or wait 8 seconds.
- 4 To reset the count up timer, press 'timer' **-** once to show 00min. Press OK to restart or wait 8 seconds.
- 5 To cancel the count up timer press 'timer' **-** twice.

### Setting the count down timer

The timer can be used independently of the oven for setting a count down period. When the period of time has elapsed, an audible signal sounds.

- 1 Touch either 'timer' **+** or **-**.
- 2 00min will be displayed along with a bell and the up arrow will flash.
- 3 Touch the 'timer' **+** to set the countdown period.
- 4 The timer bell icon  will flash.
- 5 To begin the count down timer press OK or wait 8 seconds. When the timer starts, the bell will stop flashing and the timer will begin to count down.
- 6 When the set time has elapsed, an audible signal will sound for 2 minutes. The time indication '00min' and the timer bell will flash on the display.
- 7 To stop the signal, touch either of the 'timer' **+** or **-** symbols.
- 8 To cancel the count down timer, continue to touch 'timer' **-** until zero is reached.

### Adjusting the clock

- 9 Switch on the oven by touching  'ON/OFF' symbol.
- 10 Select 'SETTINGS' from the function list and touch OK.
- 11 Select 'SET CLOCK' from the list and touch OK.
- 12 'Set Clock' will illuminate under the clock display.
- 13 Use the timer **+** and **-** to set the hour portion of the current time (including AM/PM).
- 14 Touch 'OK' when the hours are set correctly.
- 15 Use the timer **+** and **-** to set the minutes portion of the current time.
- 16 Touch 'OK' when the minutes are set correctly. TIME SAVED will be displayed and then the function display will revert to the 'set clock' menu. Turn off the oven or it will do so after 8 seconds.

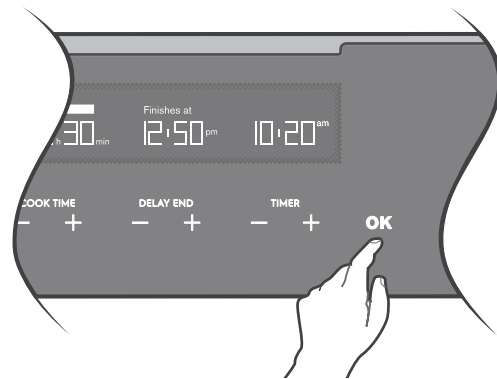

### Additional functionality

#### Light on/off

Turn the oven lamps off and on when in any cooking mode by simply touching the symbol .

#### Activating the child-proof lock

When the child lock is engaged, the oven cannot be switched on.

- 1 Switch on the oven by touching the  'ON/OFF' symbol.
- 2 Select 'SETTINGS' from the function list and touch 'OK'.
- 3 Select 'ACTIVATE LOCK' from the list and touch 'OK'.
- 4 The words LOCKED are displayed, a single beep will sound to confirm the operation. The child lock is now engaged.

#### De-activating the child lock

- 1 Touch any symbol on the control panel (including the  'ON/OFF' symbol). 'Locked' will appear on the display.
- 2 Touch any symbol again. The display will instruct you to touch both 'cook time' symbols for 2 seconds.
- 3 Hold until a beep sounds. The child lock is now released and the oven is ready to use.

#### Other settings

The 'Settings' function gives the opportunity to change oven functionality.

- 1 Switch on the oven by touching the  'ON/OFF' symbol.
- 2 Select 'SETTINGS' from the function list and touch OK.
- 3 Select 'SET CLOCK' to change the time of day.
- 4 Select 'TIME OF DAY' to have the time permanently displayed or not.
- 5 Select 'BUZZER VOLUME' to adjust the 'beep on touch' and alarm loudness.

## USING THE OVEN (CONTINUED)

- 6 Select 'KEY TONE' to turn the 'beep on touch' on or off.
- 7 Select 'SCREEN BRIGHTNESS' to adjust the brightness of the display.
- 8 Select 'SCREEN CONTRAST' to adjust the contrast of the display.
- 9 Select 'TEMPERATURE UNITS' to change between Celsius and Fahrenheit units.
- 10 Select 'ACTIVATE LOCK' to turn child lock on.
- 11 Touch 'OK' to go into each selection to change its settings.

### Safety cut-out features

The oven automatically switches itself off if the temperature is not adjusted or the appliance is left operating after a period of time. The oven switches itself off after:

- 12.5 hours when the temperature is set between 30°C and 120°C.
- 8.5 hours when the temperature is set between 120°C and 200°C.
- 5.5 hours when the temperature is set between 200°C and 250°C.

### Demo mode

This mode is intended to be used in retail shops to demonstrate the oven functionality without any power consumption except to the oven lights.

The following instructions demonstrate how to enter and exit 'DEMO' mode.

- 1 Ensure the oven is off by touching the ① 'ON/OFF' symbol.
- 2 Touch and hold the ① 'ON/OFF' symbol until the display turns ON then OFF. Immediately after, touch both the cooktime symbols simultaneously. Hold until a triple beep sounds.

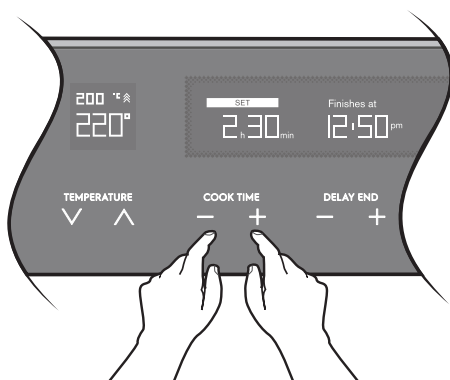

### Condensation

Excess condensation may fog the oven door. This may happen when cooking large quantities of food from a cold start. Minimise condensation by:

- Keeping the amount of water used whilst cooking to a minimum.
- Making sure the oven door is firmly closed.
- Baking custard in a baking dish that is slightly smaller than the water container.
- Cooking casseroles with the lid on.

*NOTE: If using water in cooking, this will turn to steam and condense outside your appliance. This is not a problem or fault with your oven.*

## STEAM ASSISTED BAKING

All Electrolux range of ovens have the ability to add steam while baking.

Cooking with steam is a great addition to straight 'hot air' cooking. Steam brings out all the natural flavours and goodness in the food, cooks evenly from surface to centre and retains more nutrients and vitamins. Steam assisted cooking consistently produces juicy, succulent interiors with crisp, golden exteriors.

### **! WARNING!**

#### **Risk of burns and damage to the appliance**

- Do not open the appliance door when the steam function operates, with the exception of preheating.
- Open the appliance door with care after the steam function stops.
- Refer to cleaning the appliance for cleaning after the steam function operates.

#### **Function selector model (EFE914)**

- 1 Open the oven door
- 2 Add 200ml of tap water to the cavity well. Fill the cavity well with water only when the oven is cold.

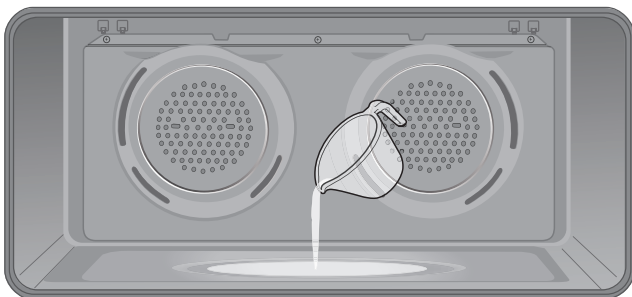

- 3 Set the 'Bake + steam' function.

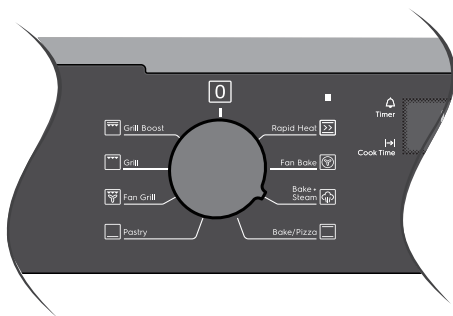

- 4 Turn the knob for the temperature to select a temperature.
- 5 Preheat the oven for 10 minutes or according to the recipe suggestions.
- 6 Place food in the appliance and close the oven door.

### **! CAUTION**

**Do not refill the cavity well with water during cooking or when the oven is hot.**

- 7 To deactivate the appliance, turn the knob for the oven functions to off position.
- 8 Remove water from the cavity well.

#### **Programmable controller models (EVEP916, EFEP916, EFEP956)**

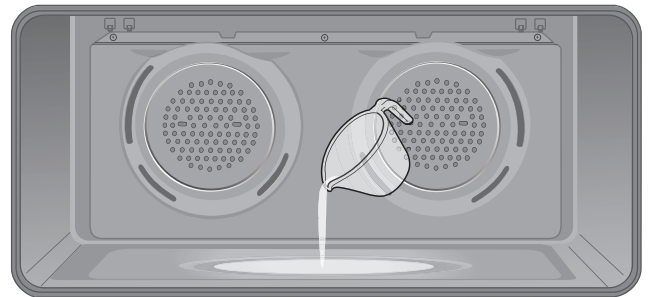

- 1 Open the oven door.
- 2 Fill the cavity well with 200ml of water (only when the oven is cold).
- 3 Set the 'Fan cooking' function.

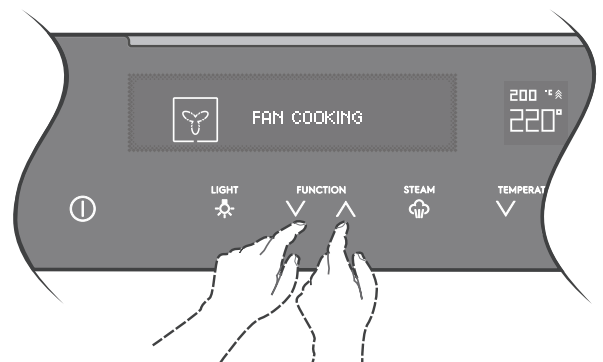

- 4 Activate the Steam button by touching . The steam control works only with the 'Fan cooking' function.
- 5 The indicator turns on.
- 6 Set the temperature using the and temperature symbols.
- 7 Preheat the oven for 10 minutes or according to the recipe suggestions.
- 8 Place food in the appliance and close the oven door.

### **! CAUTION**

**Do not refill the cavity well with water during cooking or when the oven is hot to avoid damage to enamel.**

### **! WARNING!**

**Make sure that the appliance is cool before you remove the remaining water from the cavity well.**

## USING THE FOOD PROBE (EVEP916, EFEP916, EFEP956)

The Food Probe measures the core temperature of the food. When the food reaches the desired set core temperature, the oven turns off. The Food Probe has a core temperature range of 50 – 99°C.

There are two temperatures to set:

- The oven temperature
- The core temperature of the food

### **! WARNING!**

**Only use the Food Probe supplied or the correct replacement parts.**

### **! CAUTION**

**Always check if food is cooked throughout before eating.**

### **! WARNING!**

**After use, always remove the Food Probe from the oven cavity.**

### **! WARNING!**



**The food probe is hot. There is a risk of burns. Be careful when you remove the tip and plug of the Food Probe.**

*NOTE: Food must be completely defrosted when inserting the Food Probe. If the food is too cold, the Food Probe function will not work.*

### Using the Food probe:

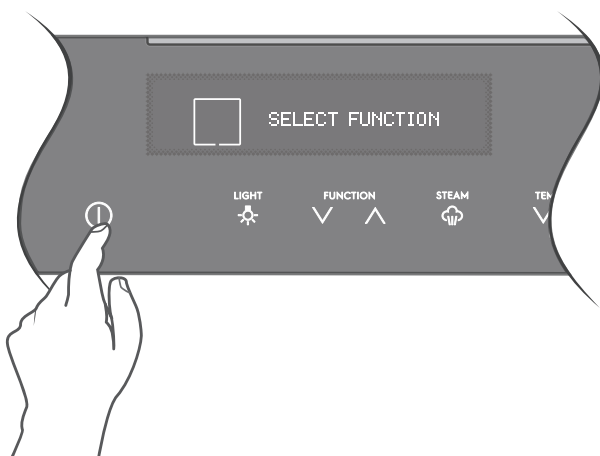
- 1 Switch on the oven** by touching the  symbol.



- 2 Select a cooking function** by pressing the  function or  function as many times as necessary until the desired function appears.

*NOTE: When using the Food Probe, the duration and end time functions do not operate.*

- 3 Select the oven temperature** by pressing the temperature  or temperature  to reach the desired setting. Allow oven to preheat.

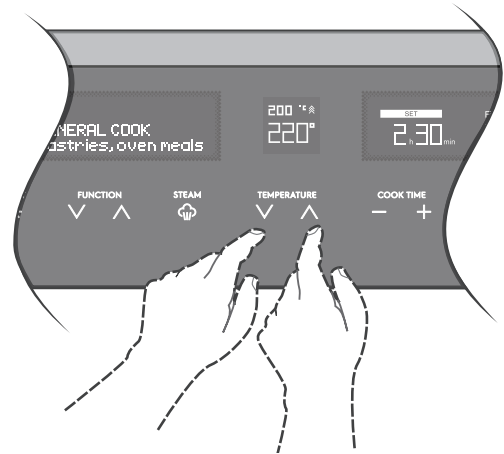

- 4 Put the tip of the Food Probe into the centre of the food**, with at least 75% of the probe inserted into the food.

### Meat

For large pieces of meat, insert the tip of the Food Probe into the centre of the meat, with at least 75% of the probe inserted into the meat.

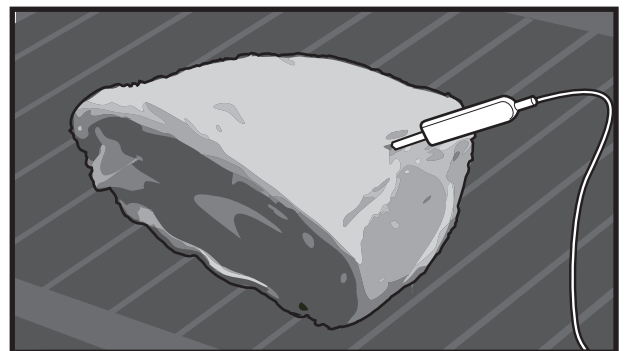

## USING THE FOOD PROBE (CONTINUED)

### Fish

For best results, place the whole fish onto the wire rack and prop it up in the swimming position (i.e. using half a potato or onion). Alternatively the fish can be laid flat. Insert the Food Probe behind the head with at least 75% of the probe inserted into the fish towards the bones in the middle of the fish.

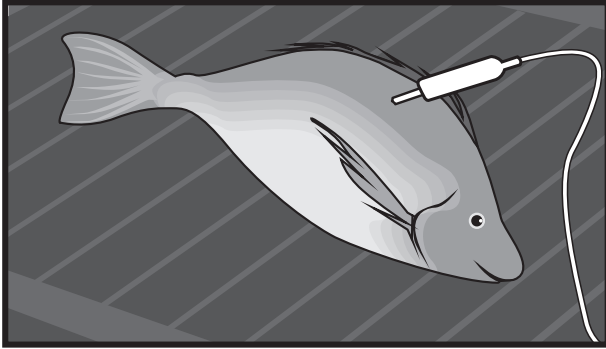

### Poultry

Place the whole poultry on the wire rack breast side up. Insert the Food Probe with at least 75% of the probe into the breast of the poultry. Place the probe in a direction toward the neck end of the poultry.

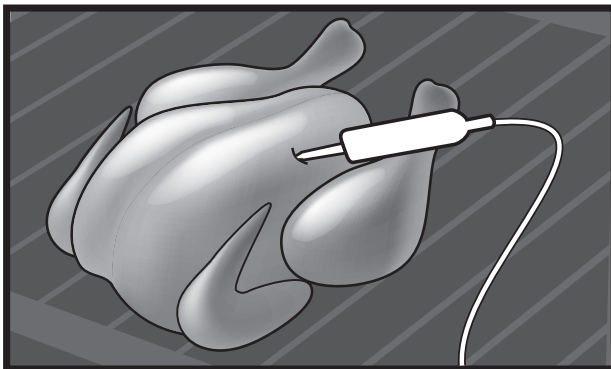

### CAUTION

To prevent the Food Probe from being damaged by excessive heat, there must be a gap of a few centimetres between the grill element and the Food Probe. The meat may expand during the cooking process.

- 5 Put the plug of the Food Probe into the socket** on the top right hand corner of the front frame. Ensure plug is fully inserted into the socket.

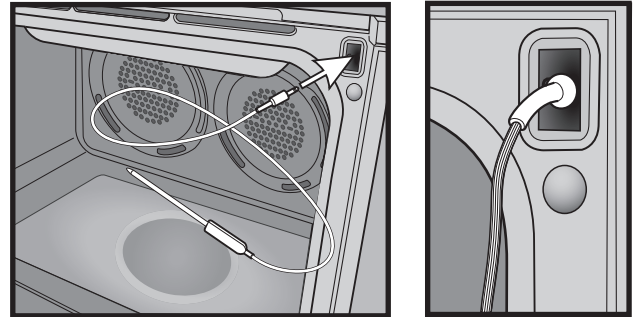

### CAUTION

After pre-heating, the front of the oven will be hot. Care should be taken when inserting the food probe plug.

*NOTE: The Food Probe will only work for the following functions:*

- Fan cooking
- Traditional bake
- Fan assist bake
- Roast

If you have selected a function that is not compatible with the Food Probe, you will see the message "REMOVE FOOD PROBE".

- 6 Set the desired food core temperature** by pressing the temperature  $\wedge$  or temperature  $\vee$  to reach the desired setting.

To change the desired food core temperature during cooking, press and hold the  $\wedge$  and  $\vee$  at the same time. To cancel the Food Probe operation, simply unplug the probe from the socket.

## USING THE FOOD PROBE (CONTINUED)

### Core temperatures of different foods

The temperatures in the table are given as a guide and may vary depending on the composition of the food.

Food	Core temp in °C
<b>Poultry</b>	
Chicken	80-85
Chicken breast	75-80
Duck	80-85
Duck breast, rare to medium rare	55-60
Turkey	80-85
Turkey breast	80-85
Goose	80-90
<b>Pork</b>	
Shoulder of pork	85-90
Fillet of pork, rare to medium rare	62-70
Loin of pork, well done	72-80
<b>Beef</b>	
Tenderloin or sirloin, rare	45-52
Tenderloin or sirloin, medium rare to medium	55-62
Tenderloin or sirloin, well done	65-75
<b>Veal*</b>	
Joint of veal or shoulder, lean	75-80
Joint of veal, shoulder	75-80
Knuckle of veal	85-90
<b>Lamb**</b>	
Leg of lamb, medium rare	60-65
Leg of lamb, well done	70-80
Saddle of lamb, medium rare	55-60
<b>Fish</b>	
Whole fish	65-70
Fish fillet	60-65
<b>Miscellaneous</b>	
Meat loaf, all kinds	80-90

\* Veal core temperatures are for well done.

\*\* Lamb temperatures are for cuts of Lamb with the bone still in. For boneless, cooking times will be slightly less.

*NOTE: The oven temperature needs to be set at least 10 higher than the desired food core temperature.*

- 7 The appliance will calculate the approximate end time.** The end time is different for different quantities of food, set oven temperatures and function modes.

*NOTE: The estimated end time will be displayed after approximately 30 minutes.*

*NOTE: The Food Probe temperature will not be displayed until the oven is at the desired temperature. Once the oven is at the desired temperature, the Food Probe temperature will cycle between the desired food core temperature and the actual food core temperature.*

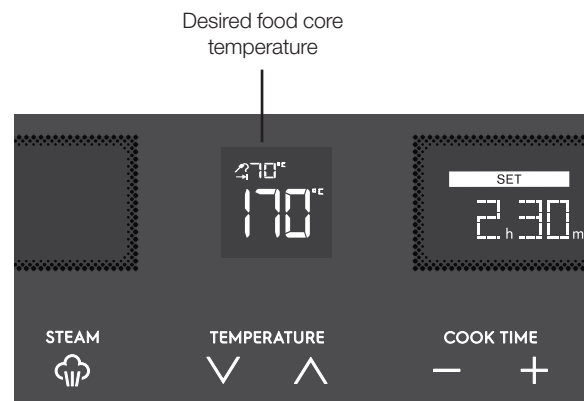
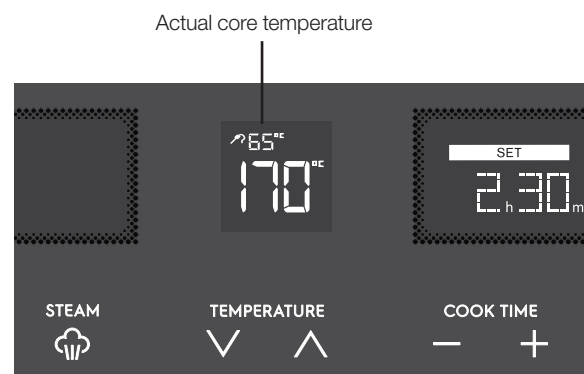









**NOTE: The end time/cook time function cannot be set whilst using the Food Probe function.**

- 8 When the food is at the desired food core temperature,** an audible signal will sound for 2 minutes. To stop the signal, press the Ⓛ symbol on the control panel.
- 9 Remove the Food Probe plug from the socket** and remove the food from the oven.

**NOTE: All meat/fish/poultry should be rested, covered for at least 10 minutes.**



## OVEN COOKING FUNCTIONS – EFE914

Symbol	Function Description
<b>Rapid Heat</b> 	<p>Heat comes from the element surrounding the fan as well as the smaller element above the food. This allows you to preheat your oven 30% quicker than on standard 'Bake'. 'Rapid Heat' is ideal for cooking frozen pre-cooked foods such as savoury pastries, pizzas, mini meals (TV dinners), meat pies and fruit pies. Simply place the food in the oven straight from the freezer and heat. Cook in the upper half of the oven for best results.</p>
<b>Fan Bake</b> 	<p>Heat comes from the element surrounding the fan. This fan circulates the hot air around the oven cavity so that you can put your food in different places in the oven and still cook them at the same time. You can use 'Fan Bake' function for multi-shelf cooking, reheating cooked foods, pastries and complete oven meals. It will cook at a lower temperature and be faster than baking. Please note that some variation in browning is normal.</p> <p><i>NOTE: The food probe function can be introduced into this cooking cycle.</i></p>
<b>Bake + Steam</b> 	<p>Bake + Steam adds humidity at the beginning of the baking process. In bakery products, this allows the dough to rise and helps create a moist interior while obtaining a golden and crispy crust. Before preheating, when the oven is cold, add water to the cavity well. Refer to chapter 'Steam assisted cooking' for more details. For best results preheat the empty oven for 10 minutes prior to inserting food.</p> <p><i>NOTE: The food probe function can be introduced into this cooking cycle.</i></p>
<b>Bake</b> 	<p>Heat comes from two elements, one above and one below the food. The bottom element is a clean heat element and is below the floor of the oven. Both elements are controlled by the thermostat and will turn on and off to maintain set temperature. You can use the 'Bake' function for single trays of biscuits, scones, muffins, cakes, slices, casseroles, baked puddings, roasts and delicate egg dishes.</p> <p><i>NOTE: The food probe function can be introduced into this cooking cycle.</i></p>
<b>Pastry</b> 	<p>Heat comes from the clean heat element below the food. The element is controlled by the thermostat and will turn on and off to maintain the set temperature. The 'Pastry' function can be used to add extra browning to the bases of pizzas, pies, and pastries. Cook in the lower half of the oven when you are using only one shelf.</p> <p><i>NOTE: The food probe function can be introduced into this cooking cycle.</i></p>
<b>Pizza</b> 	<p>'Pizza' is a combination of 'Pastry' and 'Fan Cook' and offers you the combined benefits of both functions. Heat comes from the element surrounding the fan as well as the clean heat element below the oven floor. The 'pizza' function is ideal for foods that require cooking and browning of the base. It is great for foods such as pizzas, quiches, meat pies and fruit pies. Simply put the food in the middle of the oven and select the desired temperature.</p> <p><i>NOTE: The food probe function can be introduced into this cooking cycle.</i></p>
<b>Fan Grill</b> 	<p>'Fan Grill' offers you the benefits of both 'Bake' and traditional 'Grill' functions. The grill element turns on and off to maintain set temperature while the fan circulates the heated air.</p> <p><b>Fan grill with the oven door closed.</b></p> <p>You can use 'Fan Grill' for large cuts of meat, which gives you a result that is similar to 'roisserie' cooked meat. Put your food on the grill shelf in position 2. When using 'Fan Grill' it is not necessary to turn food over during the cooking cycle. Set temperature to 180°C.</p> <p><i>NOTE: The food probe function can be introduced into this cooking cycle.</i></p>
<b>Grill</b> 	<p>'Grill' function directs radiant heat from the powerful upper element onto the food. You can use the 'Grill' function for tender cuts of meat, steak, chops, sausages, fish, cheese toasties and other quick cooking foods.</p> <p><b>Grill with the oven door closed.</b></p> <p>Preheat your grill for 3 minutes to get the best results. This will help seal in the natural juices of steak, chops etc for better flavour. Place the grill shelf in position 4 with grill dish below to catch any spills.</p>

### **Grill Boost**















'Grill Boost' directs radiant heat from 2 powerful upper elements onto the food. You can use the 'Maxi Grill' function for tender cuts of meat, steak, chops, sausages, fish, cheese toasties and other quick cooking foods.







#### **Grill with the oven door closed.**

'Grill Boost' allows you to take full advantage of the large grill dish area and will cook faster than normal 'Grill'. For best results it is recommended to preheat your grill for 3 minutes. This will help seal in the natural juices of steak, chops etc for a better flavour. Place the grill shelf in position 4 with grill dish below to catch any spills..

## OVEN COOKING FUNCTIONS – EVEP916, EFEP916, EFEP956

Symbol	Function Description
<p><b>Fan cook</b></p> 	<p>Heat comes from the element surrounding the fan. This fan circulates the hot air around the oven cavity so that you can put your food in different places in the oven and still cook them at the same time. You can use the 'Fan Cooking' function for multi-shelf cooking, reheating cooked foods, pastries and complete oven meals. It will cook at a lower temperature and be faster than baking. Please note that some variation in browning is normal.</p> <p>Steam can be added to 'Fan Cooking' at the beginning of the baking process. In bakery products, this allows the dough to rise and helps create a moist interior while obtaining a golden and crispy crust. Refer to 'Steam Assisted Cooking' chapter for more information.</p> <p> <i>NOTE: Add steam to the cooking function. Refer to page 16.</i></p> <p> <i>NOTE: Where fitted, the food probe function can be introduced into this cooking cycle.</i></p>
<p><b>Traditional bake</b></p> 	<p>Heat comes from two elements, one above and one below the food. The bottom element is a clean heat element and is below the floor of the oven. Both elements are controlled by the thermostat and will turn on and off to maintain set temperature. You can use the 'Traditional Bake' function for single shelf cooking, single trays of biscuits, scones, muffins, cakes, slices, casseroles, baked puddings, roasts and delicate egg dishes. This is a general function that can be used for most cooking.</p> <p> <i>NOTE: Where fitted, the food probe function can be introduced into this cooking cycle.</i></p>
<p><b>Fan assist bake</b></p> 	<p>Heat comes from two elements, one above and one below the food. The fan circulates the hot air around the oven cavity so that you can put the food in different places in the oven and still cook them at the same time. You should only use a maximum of two shelves with 'Fan Assist Bake'. Do not use the bottom shelf. If the two shelves are used, food on the shelf in the higher position will cook first and should then be removed to allow the food on the lower shelf to finish cooking.</p> <p> <i>NOTE: Where fitted, the food probe function can be introduced into this cooking cycle.</i></p>
<p><b>Roast</b></p> 	<p>This function starts at a higher temperature to seal the meat. The oven will then automatically reduce to the selected temperature to cook the meat for as long as desired. For example, if you use the default 200°C the 'Roast' cycle will start at 240°C and then lower to 200°C.</p> <p> <i>NOTE: Where fitted, the food probe function can be introduced into this cooking cycle.</i></p>
<p><b>Pastry</b></p> 	<p>The 'Pastry' function is specially designed for food that require extra browning such as the bases of pastries and pies. Heat comes from the element below the food. If you choose the default setting, the oven will heat up to 230°C in order to brown the food. You should then lower the temperature as required. Cook in the lower half of the oven when you are using only one shelf.</p>
<p><b>Pizza</b></p> 	<p>'Pizza' is a combination of 'Pastry' and 'Fan Assist Bake' and offers you the combined benefits of both functions. Heat switches between the element surrounding the fan and the clean heat element below the oven floor. The 'Pizza' function is ideal for foods that require cooking and browning on the base. It is for foods such as pizzas, quiches, meat pies and fruit pies. Simply place the food in the middle of the oven and set the desired temperature.</p>
<p><b>Cook from frozen</b></p> 	<p>The 'Cook from Frozen' function is ideal for cooking frozen pre-cooked foods such as savoury pastries, pizzas, mini meals (TV dinners), meat pies and fruit pies. Heat comes from the element surrounding the fan as well as a smaller element above the food. Simply place the food in the oven straight from the freezer and heat. Cook in the upper half of the oven for best results.</p>
<p><b>Full grill</b></p> 	<p>'Full Grill' directs radiant heat from two powerful upper grill elements onto the food. You can use 'Full Grill' function for tender cuts of meat, steak, chops, sausages, fish, cheese toasties and other quick cooking foods. <b>Grill with the oven door closed.</b></p> <p>'Full Grill' allows you to take full advantage of the large grill dish area and will cook faster than the 'Half Grill' function. For best results it is recommended to preheat your grill for three minutes. This will help seal in the natural juices of steak, chops etc for a better flavour.</p> <p>Full Grill has 2 temperature settings, 'LO' and 'HI'.</p>

## OVEN COOKING FUNCTIONS (CONTINUED)

Symbol	Function Description
<b>Left grill</b> 	<p>The 'Left Grill' directs radiant heat from only one of the powerful upper elements onto the food. The 'Left Grill' function is used instead of 'Full Grill' when only half the amount of grill area is needed. Left Grill has 2 temperature settings, 'LO' and 'HI'.</p> <p><b>Grill with the oven door closed.</b></p>
<b>Fan grill</b> 	<p>'Fan Grill' offers you the benefits of both fan assist bake and traditional grill functions. The grill element turns on and off to maintain set temperature while the fan circulates the heated oven air.</p> <p><b>Grill with the oven door closed.</b></p> <p>You can use 'Fan Grill' for large cuts of meat, which gives you a result similar to 'rotisserie' cooked meat. Put your food on a shelf in the second lowest shelf position. Put the grill dish on the lowest shelf position to catch any spills. When using 'Fan Grill' it is not necessary to turn the food over during the cooking cycle. Set temperature to 180°C.</p>
<b>Keep warm</b> 	<p>The 'Keep Warm' function is a low temperature oven function designed to keep your food at a perfect eating temperature without cooking it further. Heat comes from the smaller elements above the food and is circulated by the fan. Use 'Keep Warm' to keep your food warm while you prepare the rest of the meal or afterwards while you wait for the late arrival.</p> <p>Note: After cooking, the oven retains enough heat to continue to cook food even if the elements are turned off. The 'Keep Warm' function recognises this by giving you a warning message. If this happens the function will not start.</p>
<b>Defrost</b> 	<p>The 'Defrost' function uses low temperature air that is circulated by the fan. You can defrost (thaw) your food before you cook it. You can also use 'Defrost' to raise your yeast dough and to dry fruit, vegetables and herbs. The 'Defrost' function does not have a suggested temperature but uses the ambient heat in the oven cavity.</p>
<b>Pyro</b> 	<p>The 'Pyrolytic Cleaning' function cleans by burning off the spatters and accumulated dirt and grease from the oven liner, at high temperature. This process produces ash which can be wiped out of the oven cavity.</p>
<b>Food probe</b> 	<p>The Food Probe measures the core temperature of the food. When the food reaches the required set core temperature, the oven turns off. The Food Probe has a core temperature range of 50 – 99 °C.</p>

## OVEN BAKING GUIDE

### Oven shelf location

Your oven has 5 positions for mounting the shelves or grill dish carrier. These are numbered from 1 (the lowest shelf position) to 5 (the highest shelf position). See diagram.

To give maximum space above and below the shelves, load them in this way:

- When cooking with 1 shelf, use position 2 or 3.
- When cooking with 2 shelves, use position 1 and 3.
- When grilling use position 4 or 5.

*NOTE: Use the oven efficiently, by cooking many trays of food at the same time e.g. 2 trays of scones, small cakes or sausage rolls.*

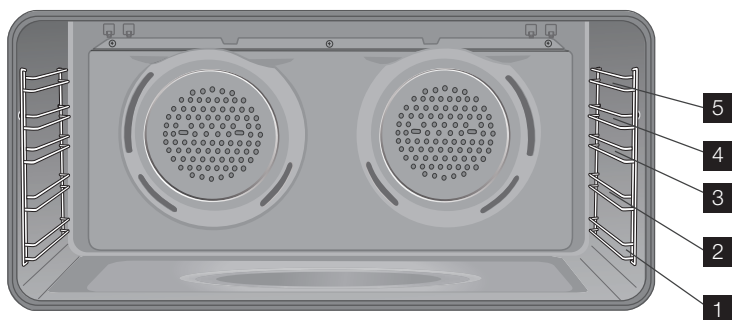

### Choosing the best oven settings

The following table is intended as a guide and experience may show some variation in cooking times necessary to meet individual requirements. We recommend that you preheat your oven for 30 minutes.

### Modes without Oven Fan

Food		Temperature °C	Oven shelf position*	Time in minutes
Scones	Plain or fruit	220	2 or 3	10 – 15
Biscuits	Rolled	170	3	13 – 18
	Spooned	190	3	13 – 18
	Shortbread biscuits	160	3	30 – 35
Meringues	Hard - individual	110	3	90
	Soft - individual	180	3	15 – 20
	Pavlova - 6 egg	110	3	75
Cakes	Cupcakes	190	2 or 3	15 – 20
	Sponge - 4 egg	180	2 or 3	20 – 30
	Shallow butter cake	180	3	25 – 30
Pastry – short crust	Cornish pasties	200	3	40 – 45
	Custard tart	200/180	3	Pastry 8/200 Whole tart 10/200 & 20/180
Pastry – choux	Cream puffs	210	3	25 – 30
Yeast goods	Bread	210	3	25 – 30

## STEAM COOKING

### Modes with Oven Fan

Food		Temperature °C	Oven shelf position*		Time in minutes
			single shelf	multi shelf	
Scones	Plain or fruit	210	2 or 3	1 & 3	10 – 15
Biscuits	Rolled	150	2 or 3	1 & 3	13 – 18
	Spooned	180	2 or 3	1 & 3	13 – 18
	Shortbread	150	2 or 3	1 & 3	13 – 18
Meringues	Hard – individual	100	2 or 3	1 & 3	90
	Soft – individual	165	2 or 3	1 & 3	15 – 20
	Pavlova – 6 egg	100	2 or 3	1 & 3	75
Cakes	Cupcakes	180	2 or 3	1 & 3	15 – 20
	Sponge – 4 egg	170	2 or 3	1 & 3	20 – 30
	Shallow butter cake	170	2 or 3	1 & 3	25 – 30
	Rich fruit cake	170	2 or 3	1 & 3	60
Pastry – short crust	Cornish pasties	180	2 or 3	1 & 3	40 – 45
	Custard tart	190/170	2 or 3	1 & 3	20 – 30
	Whole tart				Pastry 8/190 Whole tart 10/190 & 20/170
Pastry – choux	Cream puffs	200	2 or 3	1 & 3	25 – 30
Yeast goods	Bread	200	3	1 & 3	25 – 30

\* Counting from the bottom shelf up.

### Bake + Steam function

Food		Water in cavity well (ml)	Temperature °C	Oven shelf position*	Time in minutes
Yeast goods	Bread loaves	200	180 - 200	2 or 3	35 - 45
	Bread rolls	200	190 - 210	2 or 3	20 - 25
	Gluten free bread	200	180 - 200	2 or 3	40 - 50
	Pizza (fresh)	200	210 - 220	2 or 3	15 - 20
	Focaccia	200	160 - 170	2 or 3	20 - 30
Biscuits	Rolled	200	160 - 170	2 or 3	10 - 15
	Spooned	200	160 - 170	2 or 3	10 - 15
Scones	Plain or fruit	200	200 - 210	2 or 3	10 - 15
Cake	Cupcakes	200	180	2 or 3	20 - 25
	Sponge – 4 eggs	200	170	2 or 3	20 - 30
	Shallow butter cake	200	170	2 or 3	25 - 30
Pastry – choux	Cream puffs	200	200	2 or 3	20 - 30
Puff pastry		200	200	2 or 3	15 - 20
Frozen croissants		200	170 - 180	2 or 3	15 - 25

\*Counting from the bottom position up



## OVEN COOKING GUIDE

### Roasting meat

- 1 Place the meat in the oven and set the temperature between 180°C and 200°C. (It is recommended to wrap your meats in an oven roasting bag or foil to prevent fats and oils from splattering, making it easier to clean your oven.)
- 2 Use the grill/oven dish and grill insert. Place the meat on the insert.
- 3 Do not pierce the meat, as this will allow juices to escape.
- 4 When the meat is cooked, take the roast out of the oven, wrap in aluminium foil and leave to stand for about 10 minutes. This will help retain the juices when the meat is carved. The table shows temperatures and cooking times for different kinds of meat. These may vary depending on the thickness or bone content of the meat.

Meat	Recommended temperature		Minutes per kilogram
Beef	180°C - 200°C	Rare	35 - 40
		Medium	45 - 50
		Well done	55 - 60
Lamb	180°C - 200°C	Medium	40
		Well done	60
Veal	180°C - 200°C	Well done	60
Pork	180°C - 200°C	Well done	60

### Roasting poultry and fish

- 1 Place the poultry or fish in an oven set at a moderate temperature of 180°C.
- 2 Place a layer of foil over the fish for about three quarters of the cooking time.

The table shows temperatures and cooking times for different kinds of fish and poultry. These may vary depending on the thickness or bone content of the meat.

Poultry & Fish	Recommended temperature	Minutes per kilogram
Chicken	180°C - 200°C	45 - 50
Duck	180°C - 200°C	60 - 70
Turkey	180°C - 200°C	40 - 45
		(>10kg)
		35 - 40
		(<10kg)
Fish	180°C - 200°C	20

### Grilling Guide



#### WARNING!

**Always clean the grill/oven dish after every use. Excessive fat build-up may cause a fire. Grilling is conducted with the oven door closed.**

As a method of cooking, grilling can be used to:

- Enhance the flavours of vegetables, fish, poultry and meat.
- Seal the surface of the food and retain the natural juices.

This table shows how to grill different types of meat:

<b>Beef</b>	Tenderloin, rump, sirloin. Brush with oil or melted butter, especially if meat is very lean.
<b>Lamb</b>	Loin chops, short loin chops, chump chops, and forequarter chops. Remove skin or cut at intervals to stop curling. Brush with oil or melted butter.
<b>Sausages</b>	Prick sausages to stop skin from bursting.
<b>Poultry</b>	Divide into serving pieces. Brush with oil.
<b>Fish</b>	Brush with oil or melted butter and lemon juice.
<b>Bacon</b>	Remove rind. Grill flat.

### Guide to better grilling

<b>Steak</b>	15 - 20 minutes
<b>Chops</b>	20 - 30 minutes
<b>Fish</b>	8 - 10 minutes
<b>Bacon</b>	4 - 5 minutes

No definite times can be given for grilling because this depends on your own tastes and the size of the food. These times should only be used as a guide and remember to turn the food over halfway through the cooking process.

For better grilling results, follow these easy instructions:

- 1 Preheat grill for at least 5 minutes.
- 2 Choose only prime cuts of meat or fish. If the cut is less than 5mm thick it will dry out. If the cut is more than 40mm thick, the outside may burn whilst the inside remains raw.
- 3 Do not place aluminium foil under the food as this prevents fats and oils from draining away, which could result in a fire.
- 4 Baste the food during cooking with butter, olive oil or marinade. Grilled food is better if marinated before cooking.
- 5 Use tongs to turn food as a fork pierces the surface and will let juices escape.

### Fan Grill

The "Fan Grill" assists the grilling process by circulating the heat evenly around the food. The recommended temperature setting is 180°C for all fan grilling functions.

- 1 Place the grill dish on the bottom rack.
- 2 Place meat/poultry on an oven shelf above the grill dish.
- 3 Wipe off any oil or fat which spatters while the oven is still warm.

## DEALING WITH COOKING PROBLEMS

<b>Problem</b>	<b>Causes</b>	<b>Remedies</b>
Uneven cooking:	<p>Incorrect shelf position.</p> <p>Oven tray too large.</p> <p>Trays not centralised.</p> <p>Air flow in oven uneven.</p> <p>Grill dish affecting thermostat.</p>	<p>Select shelf that puts food in the centre of the oven.</p> <p>Experiment with other trays or dishes.</p> <p>Centre trays.</p> <p>Rotate food during cooking.</p> <p>Remove grill dish from oven on bake modes.</p>
Baked products too brown on top:	<p>Oven not preheated.</p> <p>Baking tins too large for the recipe.</p> <p>Baking tins not evenly spaced.</p> <p>Products not evenly sized or spaced on trays.</p> <p>Baking temperature too high.</p>	<p>Preheat the oven.</p> <p>Use correct size tins.</p> <p>Stagger baking tins at least 3cm between tins and the oven walls.</p> <p>Make into same size and shape, and spread evenly over trays.</p> <p>Lower the temperature.</p>
Baked products too brown on bottom:	<p>Baking tins too large for the recipe.</p> <p>Baking tins are dark metal or glass.</p> <p>Food too low in the oven.</p> <p>Oven door opened too frequently during baking.</p> <p>Baking temperature too high.</p> <p>Grill dish affecting thermostat.</p>	<p>Use correct size tins.</p> <p>Change to shiny, light tins or lower the temperature by 10°C.</p> <p>Cook one shelf higher.</p> <p>Don't open the oven door until at least half the cooking time has passed.</p> <p>Lower the temperature.</p> <p>Remove grill dish from oven on bake modes.</p>
Cakes have a cracked, thick crust:	<p>Baking temperature too high.</p> <p>Food too high in oven.</p> <p>Cake batter over mixed.</p> <p>Pan too deep.</p> <p>Baking pans dark.</p>	<p>Lower the temperature.</p> <p>Cook one shelf lower.</p> <p>Mix just long enough to combine ingredients.</p> <p>Check size of pan and use recommended size.</p> <p>Change to shiny pans.</p>
Baked products are pale, flat and undercooked:	<p>Baking temperature too low.</p> <p>Food too low in oven.</p> <p>Baking time too short.</p> <p>Incorrect tin size.</p>	<p>Raise the temperature.</p> <p>Cook one shelf higher.</p> <p>Increase cooking time.</p> <p>Use correct size tin.</p>
Cakes fallen in the centre:	<p>Baking temperature too low.</p> <p>Baking time too short.</p> <p>Proportions of ingredients incorrect in the recipe.</p> <p>Opening door too early in baking.</p>	<p>Raise the temperature.</p> <p>Increase cooking time.</p> <p>Check recipe.</p> <p>Do not open the door until the last quarter of cooking time.</p>
Roast meat & potatoes not browning in fan oven:	<p>Poor hot air circulation.</p> <p>Grill dish affecting thermostat.</p>	<p>Elevate food onto a rack to allow air circulation.</p> <p>Remove grill dish from oven on bake modes.</p>
Juices running out of meat:		Do not pierce meat with fork, turn with tongs.
Grilled meats overcooked on outside & raw in the centre:		Grill at lower insert position.
Grilled chops & steaks curling:		Cut into fat every 2cm.

## OVEN COOKING TIPS

- For best baking results preheat oven for 30 minutes.
- Select the correct shelf location for food being cooked.
- One of the grill trays can be used in the oven as a baking dish.
- Make sure dishes will fit into the oven before you switch it on.
- Keep edges of baking dishes at least 40mm from the side of the oven. This allows free circulation of heat and ensures even cooking.
- Do not open the oven door more than necessary.
- Do not place foods with a lot of liquid into the oven with other foods. This will cause food to steam and not brown.
- After the oven is turned off it retains the heat for some time. Use this heat to finish custards or to dry bread.
- Do not use a lot of cooking oil when roasting. This will prevent splattering oil on the sides of the oven and the oven door. Polyunsaturated fats can leave residue which is very difficult to remove.
- When cooking foods which require a high heat from below (e.g. tarts), place the cooking dish on a scone tray in the desired shelf position.
- For sponges and cakes use aluminium, bright finished or non-stick utensils.
- Remove unnecessary trays or dishes when roasting or baking.

### Get to know your new oven with this simple test cake recipe

Although we strive for a perfect performing oven, it's possible that there will be some variation in colour when baking. Therefore, we suggest this simple, easy and delicious to make Simple Test Cake, it can help you understand your new oven. All ovens do sometimes have hot or cold spots, therefore it is important to judge with your eye as you may require to rotate during baking.

### Simple Test Cake Recipe

#### Ingredients

- 125g butter, softened to room temperature
- 1 cup caster sugar
- 1 teaspoon pure vanilla essence
- 4 large eggs
- 2 cups self-raising flour
- Pinch of salt
- 4 tablespoons (80ml) full-cream milk

#### Method:

- 1 Butter base and sides of two, 20cm straight-sided round or square cake pans. Then line the base with grease proof or baking paper.
- 2 Preheat oven to moderate '180°C' (170°C fan forced) and ensure oven shelf is in the centre position of oven.
- 3 Cream softened butter and sugar until light in colour.
- 4 Add vanilla essence.
- 5 Then eggs one at a time, beating well after each addition.
- 6 Sift flour and salt into the mixture and beat until well combined.
- 7 Add milk and beat or stir to combine.
- 8 Spoon mixture equally between prepared cake pans.
- 9 Bake in preheated oven, middle shelf for about 25 to 35 minutes or until when tested with a fine cake skewer it comes out clean, or the edges of the cakes have come away slightly from the sides of the cake pans.
- 10 Remove from oven to wire cake rack and rest for 5 minutes before removing from cake pans. Cool completely.

#### To serve

Sandwich together with your favourite jam or conserve, and dust top with pure icing sugar.

*NOTE: If desired, substitute butter for either margarine or olive oil spread. Recipe is based on the Australian standard metric 250ml cup and 20ml tablespoon sets.*

## OVEN TROUBLESHOOTING

If there is a problem with your appliance, please check the points listed below before calling for service. It may be possible to avoid a call by fixing the problem yourself and be able to continue cooking.

Problem	Possible cause	Remedy
Oven or grill not working	Time of day is not set	Set time of day
	Power is not turned on	Switch on electricity
	Controls are incorrectly set	Reset controls
	Oven is in 'Demo' mode	Exit Demo mode
	Household fuse has blown or circuit breaker tripped	Check fuses or circuit breakers
	Child-proof oven lock is activated	Deactivate child lock
Oven light not working	Light may be turned off at control panel	Turn light on
	Lamp blown or loose socket	Replace or tighten lamp
	Household fuse has blown	Check fuses
Oven not heating enough	Foil trays on bottom of oven	Remove foil trays
	A timer function is activated	Refer timer functions
	Household fuse has blown or circuit breaker tripped	Check fuses or circuit breakers
Clock flashing on display	Power interruption	Reset the time
Unit smoking when first used	Protective oils being removed	Turn grill on high for 30mins and then oven on 200° for 1 hour
Functions and temperature appear on display but oven does not work	Oven is in 'Demo' mode	Exit Demo mode
When the door is open the fan stops	This is normal operation	
When a non fan mode is selected the oven fan starts	The fan is used to help the oven get to the selected temperature as quickly as possible	
The light stays on when the door is closed	An oven function has been selected	
	The light has been turned on at the control panel	Turn light off
The light does not activate when the door is opened	Lamp blown or loose socket	Replace or tighten lamp
Shelf or telescopic runner slides out when door is opened	Oven cavity is not level with the ground	Perform a check using a level to verify cause (refer to installation section). If not level refer to installer
Limescale residue on base of oven	Residual minerals from evaporated water	Follow the procedure for cleaning the cavity well. There may be some minor residual marks after cleaning

### Further Information

When you need information, service or replacement parts or have a warranty enquiry, please contact the Customer Care Centre:

- Australia - 1300 363 640, 8.00am-5.00pm EST Monday to Friday
- New Zealand - 0800 436 245, 8.00am-5.00pm EST Monday to Friday

Please have the following information ready: Model, Number & Serial Number. This is shown on the data plate which is visible when the oven door is open.

## USING THE INDUCTION HOB

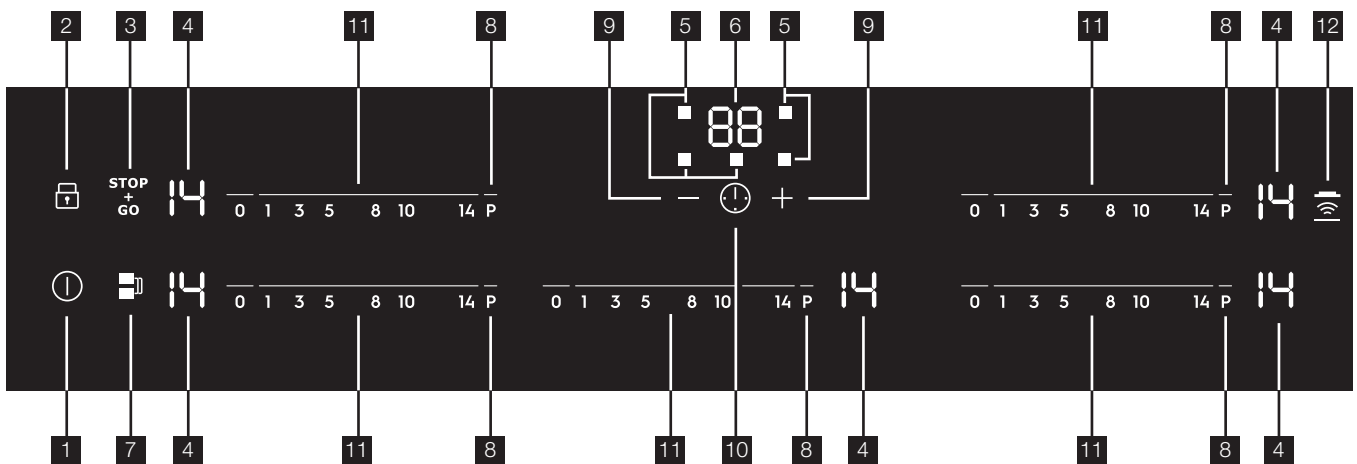

Use the sensor fields to operate the appliance. The displays, indicators and sounds tell which functions operate.

Sensor field	Function
1	ⓘ Activates and deactivates the hob.
2	🔒 Locks and unlocks the control panel.
3	STOP + GO Activates and deactivates the STOP + GO function.
4	Heat setting display Indicates the selected heat setting.
5	Timer indicators of cooking zones Indicates which of the cooking zones you have set the timer for.
6	Timer display Indicates the time in minutes.
7	🔗 Activates and deactivates the Bridge function.
8	P Activates and deactivates the Power function.
9	+ / - Increases or decreases the time.
10	🕒 Sets the Timer functions.
11	Control bar Sets the heat setting.
12	Hob2Hood Activates and deactivates the manual mode of the Hob2Hood function.

## USING THE INDUCTION HOB (CONTINUED)

	Display	Function
4		Indicates the cooking zone is deactivated.
4		Indicates the cooking zone is operated.
4		Indicates the <sup>STOP</sup> function is operated.
4		Indicates the Automatic Heat Up function is operated.
4		Indicates the Power function is operated.
4		Indicates there is a malfunction (refer to malfunction list).
4		Indicates how much residual heat is left on a zone.
4		Indicates the Child Safety Lock is operated.
4		Indicates the use of incorrect cookware, too small or no cookware on the cooking zone.
4		Indicates the Automatic Switch Off function has operated.



### WARNING!

/ / **Risk of burns from residual heat!**

**The residual heat display indicates how much heat is left on the ceramic glass when the zone is deactivated. Use this display to help avoid the risk of burns.**

## USING THE INDUCTION HOB (CONTINUED)

### Activation and deactivation

Touch **1** for 1 second to activate or deactivate the appliance.

*NOTE: When using cookware greater than 220mm the manufacturer recommends that the centre zone be used.*

### Automatic switch off

THE APPLIANCE WILL AUTOMATICALLY SWITCH OFF IF:

- All cooking zones are deactivated (**0**).
- You do not set the heat setting after you activate the appliance.
- You spill something or put something on the control panel for more than 10 seconds (a pan, a cloth, etc). An acoustic signal will sound and the appliance will switch off. Remove the object or clean the control panel.
- The appliance becomes too hot (eg. when a saucepan boils dry). Before you use the appliance again, wait for the cooking zone to cool down.
- You use incorrect cookware. The symbol **F** will come on and the cooking zone will deactivate automatically after 2 minutes.
- A cooking zone is on for an extreme length of time. The symbol **□** will show and the appliance will switch off. See below.
- The length of time that various settings can run for before automatic switch off occurs are shown below:
  - **0** - **1** - **3** - 6 hours
  - **4** - **7** - 5 hours
  - **8** - **9** - 4 hours
  - **10** - **14** - 1.5 hours

### The heat setting

To adjust the heat setting, place your finger over the heat bar graphic and slide across. The display will show the adjusted heat setting.

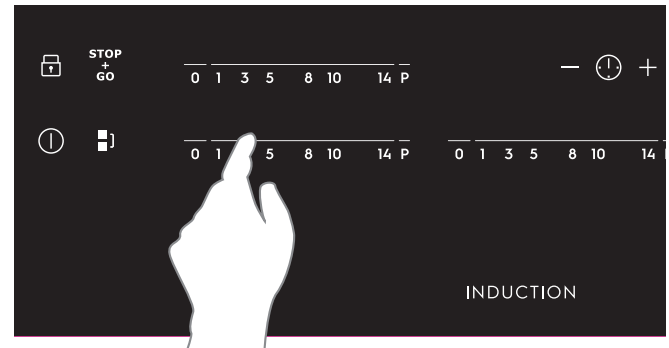

*NOTE: When you use cookware larger than 180mm the manufacturer recommends that you put it on the rear cooking zones.*

### Bridge function

The Bridge function connects two cooking zones together and then operates them as one. You can use this function for cookware larger than 260mm.

First set the heat setting for one of the cooking zones.

To activate the Bridge function touch **1**. The indicator will then come on. To set or change the heat setting, touch either one of the control sensors.

To deactivate the Bridge function touch **1**. The indicator will go off. The cooking zones will then operate independently.

### Fast heat up function

You can get a required heat setting in a shorter time if you activate the Fast Heat Up function. This will run the cooking zone at maximum until the required heat setting is reached.

To start the Fast Heat Up function for a cooking zone:

- 1 Touch the power function sensor **P** (**P** will come on).
- 2 Immediately touch your required heat setting. After 3 seconds **P** comes on in the display.
- 3 The zone will heat at maximum until your required heat setting is reached. The display will then change from **P** back to the required heat setting.
- 4 To stop the Fast Heat Up function change the heat setting.



## USING THE INDUCTION HOB (CONTINUED)

### Power management

Power management divides the power between the front and rear zones for each of the 2 outer modules. See illustration below:

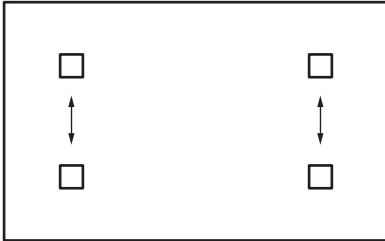

This allows either the front or rear zone to draw power from the other, if maximum power is required.

### The timer

#### The count down timer

Use the count down timer to set how long you want a cooking zone to operate.

#### **i** IMPORTANT!

- To select the cooking zone: touch the sensor again and again until the correct zone indicator is displayed.
- Immediately, touch the **+** sensor to set the time (00 - 99 minutes). When the timer indicator of the cooking zone starts to flash more slowly the time will begin to count down.
- To see the remaining time select the cooking zone with the sensor. The display will show the remaining time.
- To change the count down timer: select the cooking zone with the sensor and touch **+** or **-**.
- To deactivate the count down timer select the cooking zone with the sensor and touch **-** until the time counts down to 00. The timer indicator will go out.

When the timer count down comes to an end, the cooking zone will deactivate, the 00 will flash and a beep sound will occur for 20 seconds.

The beep sound and flashing can be deactivated immediately by touching the sensor.

#### **i** IMPORTANT!

When the two timer functions operate at the same time, the display shows the count up timer first.

#### The Minute minder

You can use the timer as a minute minder when the cooking zones are not in operation. Touch . Then touch **+** or **-** of the timer to set the time. When the timer countdown comes to an end, 00 will flash and a beep sound will occur for 30 seconds. The beep sound and flashing can be deactivated immediately by touching the sensor.

#### The Stop+Go function





Use the function to close down all of your operating cooking zones to the lowest heat setting with just one touch.

- To activate this function touch . The indicator will come on and the symbol will show on all operating zones.
- When is activated, you cannot change the heat setting.
- To deactivate this function touch again. The heat setting that you set before comes back on.



## USING THE INDUCTION HOB (CONTINUED)

### Deactivating the beep sound

The beeping sound can be deactivated if required.



- First deactivate the hob.
- Then hold down  for 3 seconds. The displays will come on and then go out. Then hold down  for 3 seconds. 60 will now be displayed.
- Touch  and change display to 61. The sound will now be off.
- When the sound is deactivated you will still hear sounds when:
  - 1 You touch .
  - 2 You put something on the control panel.
  - 3 The timer alert comes on.

To reactivate the sound:

- First deactivate the hob.
- Then hold down  for 3 seconds. The displays will come on and then go out. Then hold down  for 3 seconds. 61 will now be displayed.
- Touch  and change display to 60. The sound will now be on.









### Lock

Use this function to prevent an accidental change of the heat settings.

- First set the heat setting.
- To start this function touch . The symbol  will then show on all zones for 4 seconds before reverting back to the heat settings.
- The indicator above the lock sensor will remain on.
- Timer functions will continue to operate after the lock is activated.
- To stop this function touch  again. Deactivating the appliance will also stop this function.

### Child safety lock

Use this function to prevent an accidental operation of the hob.

- To activate this function, first turn the hob on by touching the  sensor.
- Then hold down the  sensor for 2 seconds.  will then show on all zones for 4 seconds before reverting back to the  heat setting.
- Turn the hob off by touching the  sensor again and the hob is now in a mode where the heat settings cannot be accidentally operated.
- To unlock, first turn the hob back on by touching the  sensor, and then hold down the  sensor again. Touch  again to switch off. This will bring the hob back to normal operating mode.

## USING THE INDUCTION HOB (CONTINUED)

### Hob2Hood

This is an advanced automatic function which connects the hob to a special hood. Both the hob and the hood have an infra-red signal communicator. The speed of the fan is defined automatically on the basis of the mode setting and the temperature of the hottest cooking zone on the hob. You can also operate the fan from the hob manually.

#### IMPORTANT!

For most hoods, the remote system is originally deactivated. Activate it before you use the function. For more information refer to your hood user manual.

### Operating the function automatically





The default automatic mode from the factory is H5. You can change the automatic mode by following the instructions below. When you activate the job the hood will adjust the fan speed automatically. Please note the below table is a guide, the fan speed varies depending on the temperature measured on the cooking zones of the cooktop which can be affected by the heat setting(s) selected as well as the size and volume of what you are cooking.

### Automatic modes

	Automatic light	Boiling <sup>1)</sup>	Frying <sup>2)</sup>
Mode H0	Off	Off	Off
Mode H1	On	Off	Off
Mode H2 <sup>3)</sup>	On	Fan speed 1	Fan speed 1
Mode H3	On	Off	Fan speed 1
Mode H4	On	Fan speed 1	Fan speed 1
Mode H5	On	Fan speed 1	Fan speed 2
Mode H6	On	Fan speed 2	Fan speed 3

1. The hob detects the boiling process and activates fan speed in accordance with automatic mode.
2. The hob detects the frying process and activates fan speed in accordance with automatic mode.
3. This mode activates the fan and the light and does not rely on the temperature.

### Changing the automatic mode

1. Deactivate the appliance
2. Touch  for 3 seconds. The display comes on and goes off.
3. Touch  for 3 seconds.
4. Touch  a few times until  comes on.
5. Touch  of the Timer to select an automatic mode.

#### IMPORTANT!

To operate the hood directly on the hood panel, deactivate the automatic mode of the function.

When you finish cooking and deactivate the hob, the hood fan may still operate for a certain period of time. After that time the system deactivates the fan automatically and prevents you from accidental activation of the fan for the next 30 seconds.

## USING THE INDUCTION HOB (CONTINUED)

### Helpful hints and tips

#### IMPORTANT!

Induction cooking uses a strong electromagnetic field to induce energy into the metal of the cookware. This energy makes the cookware become hot.

### Cookware for induction cooking

#### IMPORTANT!

It is important to use cookware that is appropriate for induction cooking. When purchasing cookware always check the manufacturer's specifications.

### Cookware material

- **Correct:** cast iron, steel, enamelled steel, stainless steel, the bottom made of multi-layer.
- **Not correct:** aluminium, copper, brass, glass, ceramic, porcelain.

### Cookware is correct for an induction hob if...

- some water boils very quickly on a zone set to the highest heat setting.
- a magnet pulls on to the bottom of the cookware.
- The bottom of the cookware must be as thick and flat as possible.

### Cooking guide

Heat setting	Use to:	Time	Hints	Nominal power consumption
 1	Keep warm.	as required	Place lid on cookware.	3%
1-3	Hollandaise sauce, melt: butter, chocolate, gelatine.	5-25min	Mix from time to time.	3-8%
1-3	Solidify: fluffy omelettes, baked eggs.	10-40min	Cook with a lid on.	3-8%
3-5	Simmer rice and milk-based dishes, heating up ready-cooked meals.	25-50min	Add twice as much liquid as rice, mix milk dishes part way through.	3-8%
5-7	Steam vegetables, fish, meat.	20-45min	Add a few tablespoons of liquid.	13-18%
7-9	Steam potatoes.	20-60min	Use max. of 1/4 litre of water for 750g of potatoes.	18-25%
7-9	Cook larger quantities of food, stews and soups.	60-150min	Up to 3 litres of liquid plus ingredients.	18-25%
9-12	Gentle fry: escalope, veal cordon bleu, cutlets, rissoles, sausages, liver, roux, eggs, pancakes, doughnuts.	as necessary	Turn halfway through.	25-45%
12-13	Heavy fry, hash browns, loin steaks, steaks.	5-15min	Turn halfway through.	45-64%
14	Boil water, cook pasta, sear meat (goulash, pot roast), deep fry chips.			100%
<b>P</b>	Boil large quantities of water. Power management is activated.			

#### IMPORTANT!

### Information on acrylamides

According to the newest scientific knowledge, if you brown foods (especially those containing starch), acrylamides can

### Use of the cooking zones

#### IMPORTANT

Always ensure the normal sized cookware is centred over the crosses of the heating zones. Extremely large cookware however cook on two cooking zones at the same time.

#### ENVIRONMENT!

### Energy saving

- If possible, always put the lids on the cookware.
- Put cookware on a cooking zone before you start it.
- Use the residual heat to keep the food warm or to melt it.
- Do not use cookware where the base diameter is smaller than 125mm.

### Eco timer

Whenever the countdown timer is used the heat setting will deactivate before the final countdown time is reached. Residual heat left in the cookware will complete the final stage of cooking and hence some energy is saved. The difference in the operation time depends on the heat setting level and the length of the cooking operation.





pose a health risk. Thus, we recommend that you cook at the lowest temperatures and do not overly brown food.

#### IMPORTANT!

The data in the table is for guidance only.

## INDUCTION HOB TROUBLESHOOTING

If there is a problem with the appliance, please check the points listed below before calling for service. It may be possible to avoid a call by fixing the problem yourself and be able to continue cooking.

Problem	Possible cause	Remedy
You cannot activate the appliance or operate it.		Activate the appliance again and set the heat setting in less than 10 seconds.
	You touched 2 or more sensor fields at the same time.	Touch only one sensor field.
	The Stop+Go function is activated.	Refer to Stop+Go instruction.
	There is water or fat stains on the control panel.	Clean the control panel.
An acoustic signal sounds and the appliance deactivates. An acoustic signal sounds when the appliance is deactivated.	You have put something on one or more sensor fields.	Remove the object from the sensor field.
The appliance deactivates.	You have put something on the sensor field.	Remove the object from the sensor field.
The residual heat indicator does not come on.	The cooking zone is not hot because it operated only for a short time.	If the cooking zone operated sufficiently long to be hot, speak to the service centre.
The Automatic Heat Up function does not operate.	The cooking zone is already hot.	Let the cooking zone become sufficiently cool.
	The highest heat setting is set.	The highest heat setting has the same power as the Automatic Heat Up function.
The heat setting changes between two levels.	The Power management is activated.	Refer to Power management instruction.
The sensor fields become hot.	The cookware is too large or you put it too near to the controls.	Put large cookware on the rear cooking zones if necessary.
There is no signal when you touch the panel sensor fields.	The signals are deactivated.	Refer to the OffSound control instruction.
 comes on.	The Automatic Switch Off has activated.	Deactivate the appliance and activate it again.
 comes on.	The Lock or Child safety lock function is activated.	Refer to the Lock and Child safety lock instruction.
 comes on.	No cookware is on the cooking zone.	Put cookware on the cooking zone.
	The cookware is incorrect.	Use correct cookware.
	The diameter of the bottom of the cookware is too small for the cooking zone.	Use cookware that has a bottom diameter greater than 125mm.
 and a number comes on.	The cookware does not cover the cross.	Cover the cross fully.
	There is an error in the appliance.	Disconnect the appliance from the electrical supply for some time. Disconnect the fuse from the electrical system of the house. Connect it again. If  comes on again, speak to the service centre.

## INDUCTION HOB TROUBLESHOOTING (CONTINUED)

Problem	Possible cause	Remedy
E3 comes on.	The electrical connection is incorrect. The supply voltage is out of range.	Speak to a qualified electrician to check the installation.
E4 comes on.	There is an error in the appliance because a pot has boiled dry. The overheating protection for the cooking zone and the automatic switch off has operated.	Deactivate the appliance. Remove the hot cookware. After approximately 30 seconds, activate the cooking zone again. If the cookware was the problem, the error message will go out but the residual heat indicator will stay. Check to see if the cookware is appropriate for induction cooking.
E8 comes on.	The electrical connection is incorrect. One or more phases are missing.	Have a qualified electrician check if the installation is correct with the connection illustration. If E8 comes on again, speak to the service centre.
A crack noise can be heard.	Can be caused by cookware made of different materials (sandwich construction).	This is a normal noise from this style of cookware.
A whistle sound can be heard.	Can be caused by one or more cooking zones operating at high power levels and the cookware made of different materials.	This is a normal noise from this style of cookware.
A humming sound can be heard.	Can be caused by one or more cooking zones operating at high power levels.	This is a normal noise and is not caused by appliance malfunction.
A clicking sound can be heard.	Can be caused by electrical switching inside the unit.	This is a normal noise and is not caused by appliance malfunction.
A hissing and buzzing sound can be heard.	Can be caused by the fan operating inside the unit.	This is a normal noise and is not caused by appliance malfunction.

### Further information

When you need information, service or replacement parts or have a warranty enquiry, please contact the Customer Care Centre:

- Australia - 1300 363 640, 8.00am - 5.00pm EST Monday to Friday
- New Zealand - 0800 436 245, 8.00am - 5.00pm EST Monday to Friday

Please have the following information ready: Model, Model Number & Serial Number. This is shown on the data plate which is visible when the oven door is open.

## USING THE GAS HOB

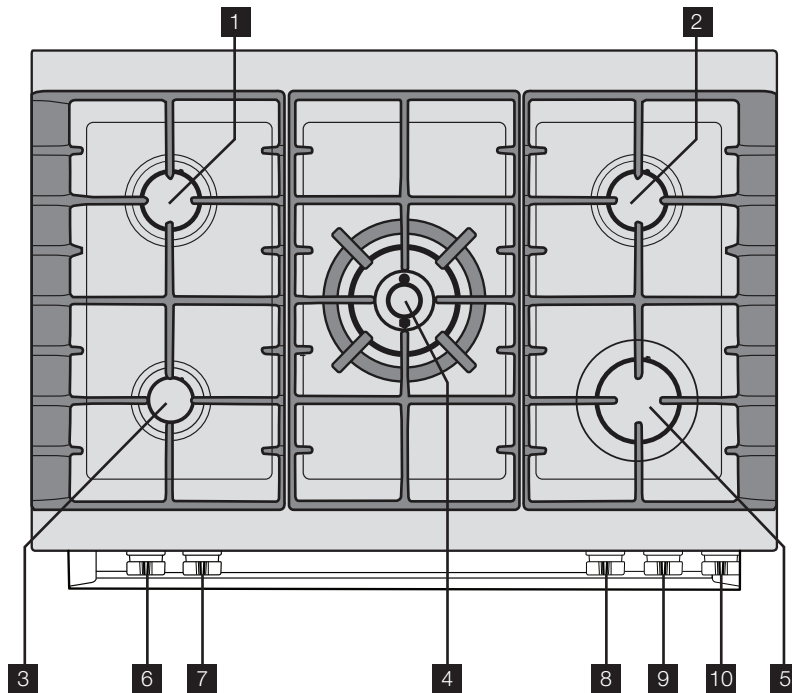

- |   |  |  |
|---|--|--|
| <b>1</b> 9.0MJ/h Medium heat burners. Used for simmering with mid-sized cookware. | <b>4</b> 22.0 MJ/h dual valve wok burner. Used for very fast heating with woks and large cookware. | <b>7</b> Left hand front burner control.   |
| <b>2</b> 5.1MJ/h Low heat burner. Used for simmering with small cookware.         | <b>5</b> High heat burner.   | <b>8</b> Wok burner dual control.          |
| <b>3</b> 5.1MJ/h Low heat burner. Used for simmering with small cookware.         | <b>6</b> Left hand rear burner control.  | <b>9</b> Right hand rear burner control.   |
|   |  | <b>10</b> Right hand front burner control. |

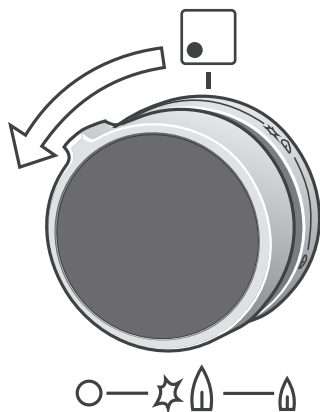

### Control knob for high, medium & low heat burners

To light a burner with this knob, firstly depress and turn anti-clockwise to the 'HI' flame position. The knob may be released once the flame is established and turned further anti-clockwise to reduce the flame height as desired.

*NOTE: If the flame goes out when either knob is released, simply depress the knob again, this time holding it down for approximately 5 seconds.*

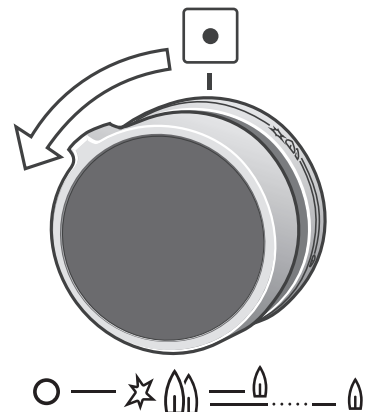

### Control knob for the wok burner

To light the wok burner, depress the knob and turn anti-clockwise to ignite the inner and outer burners . The knob may be released when both inside and outside flames are established. Turning the knob further anti-clockwise will reduce the height of the outer flame.

Turning the knob further to the single flame/single line will extinguish the outer flame and control the height of the inner flame.

Turning the knob clockwise back to will reignite the outer flame.



## GAS HOB TROUBLESHOOTING

If there is a problem with the appliance, please check the points listed below before calling for service. It may be possible to avoid a call by fixing the problem yourself and be able to continue cooking.

Problem	Possible cause	Remedy
Burner will not light even though the sparker is working.	Knob not held down long enough in 'High' position for flame safeguard to engage.	Repeat lighting procedure and hold knob down for 5 seconds in 'High' position.
	Gas supply valve turned off.	Turn on gas supply to appliance.
	Wrong knob turned off.	Ensure the knob you are turning corresponds to the burner you want to light.
No spark is obtained when control knob is activated.	Port blockage in ignition area.	Ensure the ports in the ignition area are clean and dry.
	Ignition spark plugs wet or dirty.	Dry or clean ignition spark plugs.
	Electricity supply is disconnected or switched off.	Switch on electricity or check fuses.
Flames uneven or tending to lift.	Ignition spark plugs wet or dirty.	Dry or clean ignition spark plugs.
	Flame ports blocked or wet.	Clean or dry flame ports.
Flames not staying on when knob released.	Burner incorrectly fitted.	Ensure this component is fitted correctly.
	Knob not held down long enough in 'High' position for flame safeguard to engage.	Repeat lighting procedure and hold knob down for 5 seconds in 'High' position.
	Knob not set between 'High' and 'Low'.	Knob <b>MUST</b> be set between these positions.
Low heat, slow cooking.	Dirt or spillage on flame safeguard sensor.	Clean flameguard sensor tip.
	Incorrect cooking burner selection for the size of pot being used.	Refer to page 36 for correct burner selection.

### Flame safeguard

The gas hob is fitted with a safety system that will stop the flow of gas if for any reason the flame goes out during operation. If this happens, the burner can be restarted, but will require the knob to remain depressed for approximately 5 seconds.



#### **WARNING!**

- Keep hands clear of burners when lighting.
- If burner does not ignite within 5 seconds, turn knob to 'Off' position, allow gas to disperse, then try lighting again.
- Burners **MUST** be operated between 'HIGH' and 'LOW' settings only.



#### **ENVIRONMENT!**

To conserve gas, place the pan centrally over the burner and adjust the flame so that it does not go past the edge of the cookware.

*NOTE: In the absence of electrical power, carry out the ignition directly to the burner with a hand held ignition source.*

### Further information

When you need information, service or replacement parts or have a warranty enquiry, please contact the Customer Care Centre:

- Australia - 1300 363 640, 8.00am-5.00pm EST Monday to Friday
- New Zealand - 0800 436 245, 8.00am-5.00pm EST Monday to Friday

Please have the following information ready: Model, Model Number & Serial Number. This is shown on the data plate which is visible when the oven door is open.

## CLEANING YOUR APPLIANCE



### WARNING!

- Always make sure that the appliance is electrically isolated before cleaning. This can be done by the functional switch nearby.
- Do not line the bottom of the oven with foil or cookware.
- Do not use steam cleaners.

### Stainless steel parts



### WARNING!

**The oven door trim, the control panel trim and the storage compartment are made from a special stainless steel that resists finger marks and should only be cleaned with warm water and a mild detergent. Do not use stainless steel cleaners, abrasive cleaners or harsh solvents on these parts.**

*NOTE: Make sure you follow the polish or brushing lines in the stainless steel.*

- All grades of stainless steel can stain, discolour or become greasy. You must clean these regularly by following the procedures below if you want your appliance to look its best, perform well and have a long life.
- Care must be taken when wiping exposed stainless steel edges, they can be sharp!
- The stainless steel gas hob, side panels and kick panel can be cleaned with stainless steel cleaners if it becomes soiled or discoloured.
- A suitable cleaner can be purchased from Electrolux Customer Care Centres.

### Oven door

- DO NOT use the oven without the inner and middle door glass fitted.
- NEVER spray any caustic cleaners on any surface of the door or damage to the surface coatings will result.
- DO NOT use metal utensils, scrapers, scourers, or abrasive cleaners to clean the glass or any of the door trims. These will damage or scratch the surface coatings and degrade the finish and appearance.
- DO NOT place glass in dishwasher.
- Use only warm water and liquid detergent with a soft cloth to clean the glass or trims.
- Before refitting the glass panes to the door ensure they are dried with a soft cloth.

- The glass edges have been specially ground to remove any sharp edges. However it is glass, and should be handled carefully to avoid injury to your person and damage to the glass.
- Ensure glass panels are refitted to the door in the same order and orientation they came out from.

### Gas hob

- The trivets can be removed for cleaning by carefully lifting them from the hob.
- Clean by washing with warm soapy water.
- The burner caps and crowns are also removable for cleaning.
- If the caps, crowns and cups are heavily soiled, use a non-abrasive cleaning compound.
- Flame port blockages should be removed by using a matchstick or brush.
- Do not clean them with abrasive or caustic type cleaners, or clean them in a dishwasher.
- The hob glass can be cleaned with the supplied razor blade scraper.

### Induction hob

- Remove all spilt food and fat with the supplied razor blade scraper, while the ceramic glass is still warm but not hot. Wipe clean with dishwashing detergent on a damp cloth.
- If aluminium foil, plastic items or high sugar content foods are allowed to melt on the ceramic glass, clean immediately with the supplied razor blade scraper before the surface has cooled down, otherwise pitting of the surface can occur.

*NOTE: Items with high sugar content not only include jam and fruit, but also vegetables such as peas, tomatoes and carrots.*

- When the ceramic glass is cool, apply a suitable ceramic glass cleaner.
- It is important to follow the cleaner manufacturer's instructions. Remove any cleaning residue from the surface as staining of the cooktop may occur.
- Do not use abrasive sponges or scourers, as they may scratch the surface.
- Any pitting, staining, scratches or other surface deterioration is excluded from the warranty.
- Sometimes SURFACE stains appear to be 'bubble' marks under the ceramic glass. These can be cleaned off with a razor blade scraper and ceramic cleaner.

## CLEANING YOUR APPLIANCE (CONTINUED)

### Oven

- Always keep your appliance clean. Ensure that fats and oils do not accumulate around elements or fans.
- Always keep the oven dish, baking trays, grill dish and grill dish inserts clean, as any fat deposits may catch fire.
- Always wrap your meats in foil or an oven roasting bag to minimise cleaning. Any polyunsaturated fats can leave a varnish-like residue which is very difficult to remove.

### Grill

- Always keep the grill dish and grill dish insert clean, as any fat deposits may catch fire.

### Removing the shelves and grill dishes

- Slide the shelves and grill dish carrier towards you until they reach the front stop.
- Tilt them up at the front to clear the side supports, taking care not to spill the contents.
- Lift them clear.
- Wash the shelves and grill dish in hot soapy water.
- Reverse the above steps to put the shelves and grill dishes back again.
- Ensure that they are placed between the 2 support wires or correctly onto the runners.

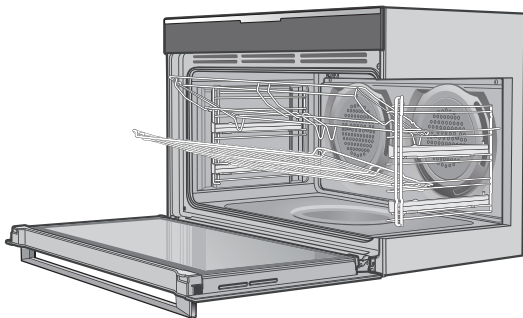

### Removing the shelf supports

- Grasp the shelf support at the front.
- Pull it firmly inwards.

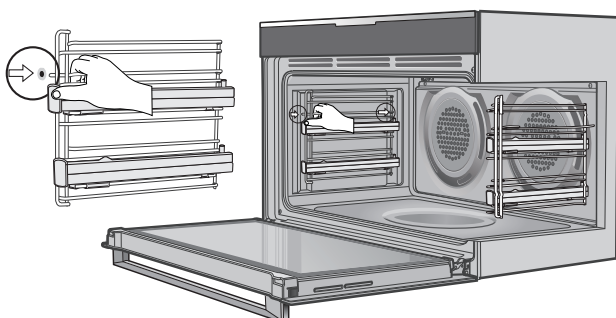

### Releasing the grill element

To release the grill element so that the oven roof can be accessed for cleaning, push the element upwards and rotate the 3 clips backwards and away from the element rod. This will allow the front of the element to drop down.

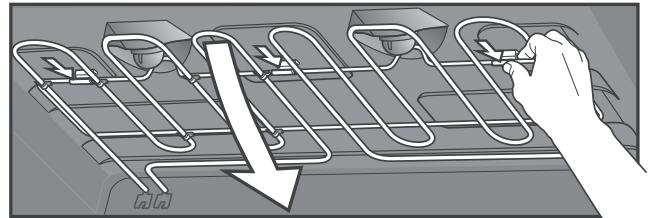

### ! WARNING

The door glass on this appliance is made from a tough, durable material that withstands heating and cooling without breaking. However, it must be remembered that it is **GLASS**, it may break. Treat it accordingly! Should you have any questions about the glass in your new appliance, please contact the customer care centre by dialling 1300 363 640.

**Do not use harsh abrasive cleaners or sharp metal scrapers to clean the oven door since they can scratch the surface, which may result in shattering of the glass.**

## CLEANING YOUR APPLIANCE WITH PYROLITIC CLEANING

### EVEP916, EFEP956 & EFEP916

#### Cleaning Reminder

After a recommended period of time the oven will remind you to clean the oven. Once this period of time has elapsed, when turning the oven off you will get a message "TIME TO CLEAN YOUR OVEN". Press the on/off button to clear the message and run the Pyrolytic cycle. After the Pyrolytic cycle has finished, the cleaning reminder will reset. The "Cleaning Reminder" setting can be enabled/disabled in the settings menu.

Alternatively while the "TIME TO CLEAN YOUR OVEN" message is displayed, you can press the "ok" button and you will get the option to "REMIND ME AGAIN".

#### Pyrolytic cleaning of the oven cavity

The oven has the Pyrolytic self-cleaning function, it cleans by burning off the spatters and accumulated dirt and grease from the oven liner, at high temperature. This process produces ash which can then be wiped out of the oven cavity.

Pyrolytic cleaning will not remove limestone residue left in the cavity well when water evaporates. It is recommended that the residue is cleaned prior to conducting Pyrolytic cleaning cycles. See 'Cleaning the cavity well' on this page.



#### WARNING!

**During the pyrolytic cleaning process the oven becomes extremely hot.**

DO NOT use Hob during Pyrolytic cleaning

- Please keep small children at a safe distance.
- Never clean non-stick baking trays and tins in the oven during the pyrolytic cycle. High temperatures damage the non-stick coating and poisonous gas is released.
- To prevent damage, do not use acids, sprays or similar cleaning agents.



#### CAUTION!

- **During pyrolytic cleaning the air outlet exhaust above the door must be kept clear of any obstruction (e.g. bulky tea towels).**
- **Do not use your oven to clean miscellaneous items (e.g. cookware).**



#### WARNING!

**Before carrying out the Pyrolytic function**

- 1 All accessories must be removed from the oven, including shelves, trays and side racks.**
- 2 Clean large deposits, spills or grease from the oven cavity.**

**3 Clean limestone residue from the cavity well.**

**4 Choose your Pyrolytic cleaning cycle from the following:**

Soiling	Duration
light clean	1 hr 30mins
medium clean	2hrs
heavy clean	2hr 30mins

*Note: Duration includes heat-up time, excluding cool-down time.*

#### Light clean

This is an energy saving cycle that can be used on a regular basis if the oven is lightly soiled. Possibly after every 2nd or 3rd roast.

#### Medium clean

Use this as the regular cycle about once every 2-3 months.

#### Heavy clean

When the oven is very dirty it may need a longer cycle to clean it thoroughly. This cycle will clean the dirtiest of ovens.

#### Food Probe

Clean the Food Probe after each use and let it dry. Use a soft cloth with warm water and a cleaning agent. Only clean the probe end and not the plug.

#### Cleaning the cavity well

The cleaning procedure removes limestone residue from the cavity well after cooking with steam.



#### WARNING!

**Perform the cleaning procedure at least every 5-10 Bake + Steam cooking cycles.**

- 1 Mix 200ml of tap water with 150ml of white vinegar and put the mix in the cavity well.
- 2 Let the water and vinegar mix dissolve the limestone residue at the ambient temperature for 45 minutes.
- 3 Remove the water and vinegar mix with a soft cloth and clean the cavity with warm water and a soft cloth.

*NOTE: Pyrolytic cleaning cycle does not clean left over salts from evaporation. Please use the following procedure to clean the cavity well.*

*The oven should be reasonably dry before using the Pyrolytic clean function.*

## CLEANING YOUR APPLIANCE WITH PYROLITIC CLEANING (CONTINUED)

### Select the Pyrolytic clean function.

Use cooking function selector to pick the 'pyro clean' function.

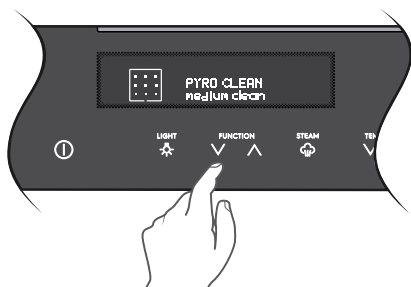

### Selecting the required cleaning cycle

Use the 'cook time' control to select Light, Medium or Heavy depending on the soiling of the oven.

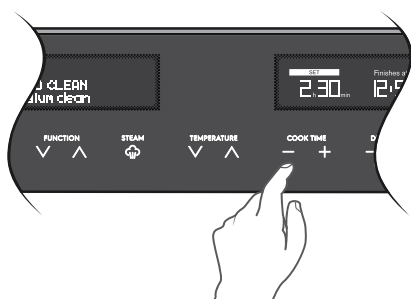

### Start Pyrolytic

Unlike other cooking functions, you **MUST** touch 'OK' for the pyrolytic cycle to start. The display will prompt you to remove all shelves and trays. You must touch 'OK' again to start. The oven light will then go out and the Pyrolytic function will start.

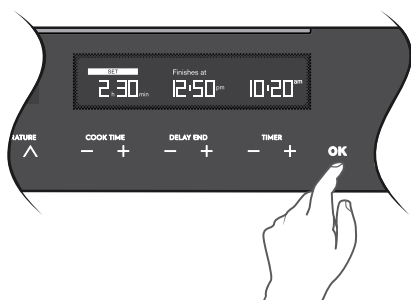

### **i** IMPORTANT

**At the beginning of Pyrolytic cleaning the door will automatically lock  will appear on the display. During the Pyrolytic cleaning cycle there may be some burn off odours. It is advised to keep the room well ventilated during this cycle.**

The door will only unlock when the oven has cooled to a safe temperature. Turning the function off will not unlock the door. This will only happen when safe temperatures are reached.

When the pyrolytic cleaning function is on, it is advisable not to use a cooktop. This may cause overheating and damage.

*NOTE: The cooling fan will operate at an increased speed for Pyrolytic cleaning and will continue to run until the oven has cooled down. This is normal.*

*It is recommended to clean the oven regularly to keep it in its best condition.*

### After Pyrolytic cleaning

After cool-down wipe the ash out of the oven with a soft damp cloth and warm water.

To restore the enamel shine to more difficult areas, use a damp cloth with vinegar and detergent.

### **!** CAUTION

**Do not turn off the mains power supply to the oven during the Pyrolytic cycle. This could damage the appliance.**

## CLEANING THE OVEN DOOR

### WARNING

#### Slides (telescopic runners)

- Do not subject slides to temperatures greater than 300°C.
- Do not place slides in a dishwasher.
- Do not use a knife or sharp objects to clean slides.
- Do not add oil or any other lubricant to slides.

#### Positioning the door for dismantling

The door needs to be positioned at an angle to aid in the disassembly of the panes.

- Open the door fully to gain access to the hinges.
- Push down the hinge locking tab on both hinges.

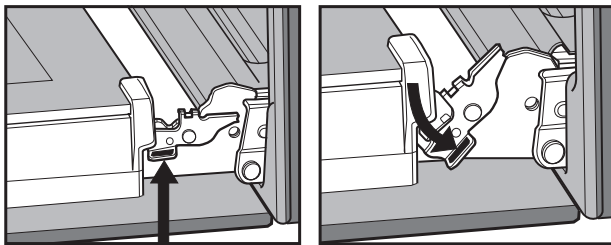

- Gently close the door until it stops in the partially open position on the locking tab.

*NOTE: The door cannot fully close with the locking tab in this down position.*

#### Removing the top door trim

- Push in the 2 tabs on either side of the trim.
- Lift the trim away from the door.

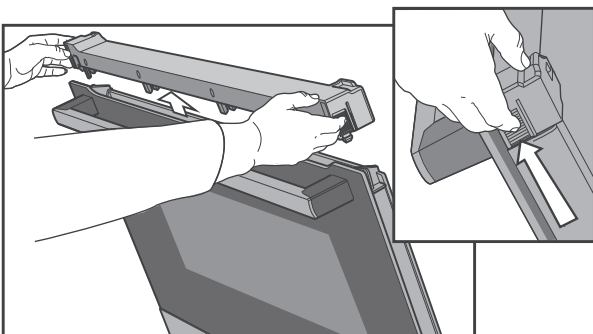

#### Removing the glass panes

- Remove the inner glass and middle glass layers from the door.
- Clean the glass using detergent and warm water. Wipe clean and dry thoroughly.
- The outside glass cannot be removed from the door and hence can be cleaned in-situ.

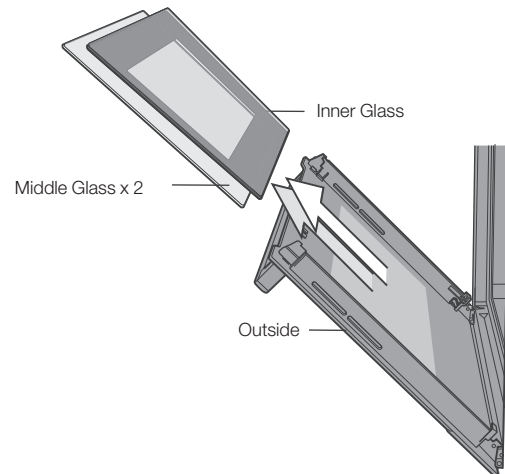

#### Reassembling the glass panes & and top door trim

- Replace the middle glass back to the door first. The middle glass is a clear pane and orientation of the glass is not important.
- Replace the inner glass next ensuring the side that is painted is facing away from the oven cavity.
- Replace the top door trim ensuring the 2 side tabs have clipped into the column.
- Pull the hinge locking tabs back up and close the door.

#### Changing the light globes

- Switch the appliance off at the isolation switch before attempting to change the light globe.
- There are 2 light globes located in the top of the oven cavity towards the rear.
- To get access to the globes, firstly drop the element down as explained on page 41.
- To remove, turn oven light glass anti-clockwise.
- A special high temperature resistant borosilicate globe should be used. This can be purchased from the Customer Care Centre.

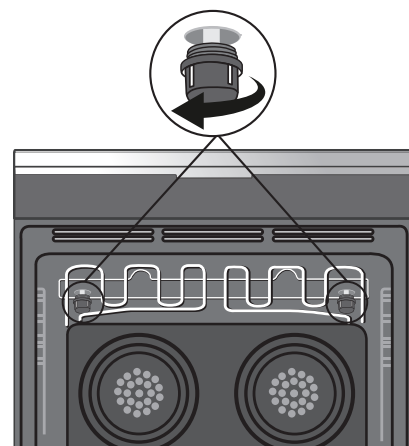



## CLEANING THE OVEN DOOR (CONTINUED)

### Storage compartment (selected models)

The storage compartment is accessible through the pivoting door.

Unused oven racks and grill dishes can be stored here.

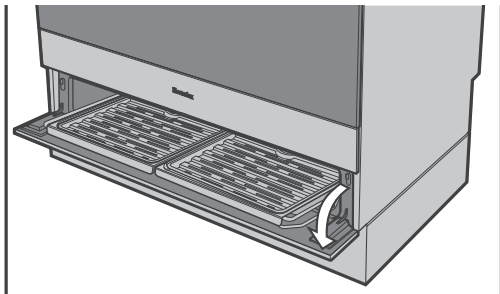

### **WARNING!**

**DO NOT** store flammable or combustible items in the storage compartments. This is not a compartment for warming food.



## INSTALLATION OF EFE914, EFEP916 & EFEP956

### Cabinet requirement

Models EFE914, EFEP916 & EFEP956 are designed to fit into a 900mm wide gap between standard kitchen cabinets. The appliance integrates with the kitchen cabinets by matching the height, depth and kick panel. The cooker may also be installed at the end of a line of benches or with a free space either side. In addition, a slot-in type installation is catered for allowing a continuous cabinetry kick panel to be used.

### WARNING!

- The cooker must be installed and serviced only by an authorised person.
- A Certificate of Compliance MUST be supplied to be kept by the customer.
- The packing materials must be removed before you install the cooker.
- The surrounding kitchen cabinets must be able to withstand 85°C. Electrolux WILL NOT accept responsibility for damage caused by installation into kitchen cabinets which cannot withstand 85°C.
- The pipes used for installation MUST have sufficient loops so the cooker can be moved for service (gas models).
- The vents, openings and air spaces MUST NOT be blocked.
- Two anti-tilt brackets are supplied and stored in the base of the packaging
- The anti-tilt brackets and chain or front stops MUST be installed to avoid accidental tipping (freestanding and slot-in models).
- You MUST NOT lift or pull the cooker by the door handle.
- The cooker MUST be checked every five years.
- If the supply cord is damaged, it must be replaced by the manufacturer, its service agent or similarly qualified persons in order to avoid a hazard.
- The appliance must not be installed behind a decorative door in order to avoid overheating.
- Due to the weight (95-100kg) and size of the cooker, 2 persons are required to install it.

### Gas model clearance requirements

- Ensure the appliance is installed in accordance with clauses 6.2.5 and 6.10.1.1 of AS/NZS 5601.1 or clauses 6.9.1 and 6.9.5 of AS/NZS 5601.2 with regard to clearances to combustible surfaces and materials, and clearances to rangehoods and exhaust fans, to ensure clearances of 200mm from burners to vertical combustible surfaces observe the minimum dimension of 100mm from each side of the cooker to combustible surfaces.
- Clearances to combustible surfaces may be reduced if combustible surfaces are protected in accordance with clause 6.10.1.2 of AS/NZS 5601.1, or clause 6.9.2 of AS/NZS 5601.2.
- When setting the cooker height, ensure the top of the cooker is at least 10mm higher than the level of the benchtop.

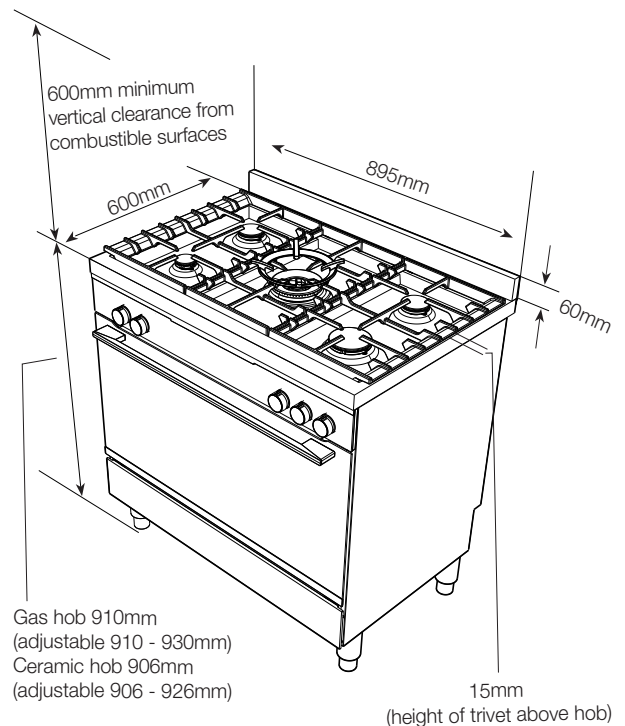

## INSTALLATION OF EFE914, EFEP916 & EFEP956 (CONTINUED)

### Freestanding installation



The freestanding type installation requires four screw-in feet to be installed before it can be fitted in between cabinets, with cabinets on one side or without adjacent cabinets. There is no clearance requirement to adjacent side cabinets.

To ensure cooker's stability, the anti-tilt brackets must be installed.

Four screw-in feet are supplied with the appliance and can be found in the accessories pack in the oven.

Freestanding models are supplied with a clip-on kick panel.

### Cabinet construction for freestanding installation

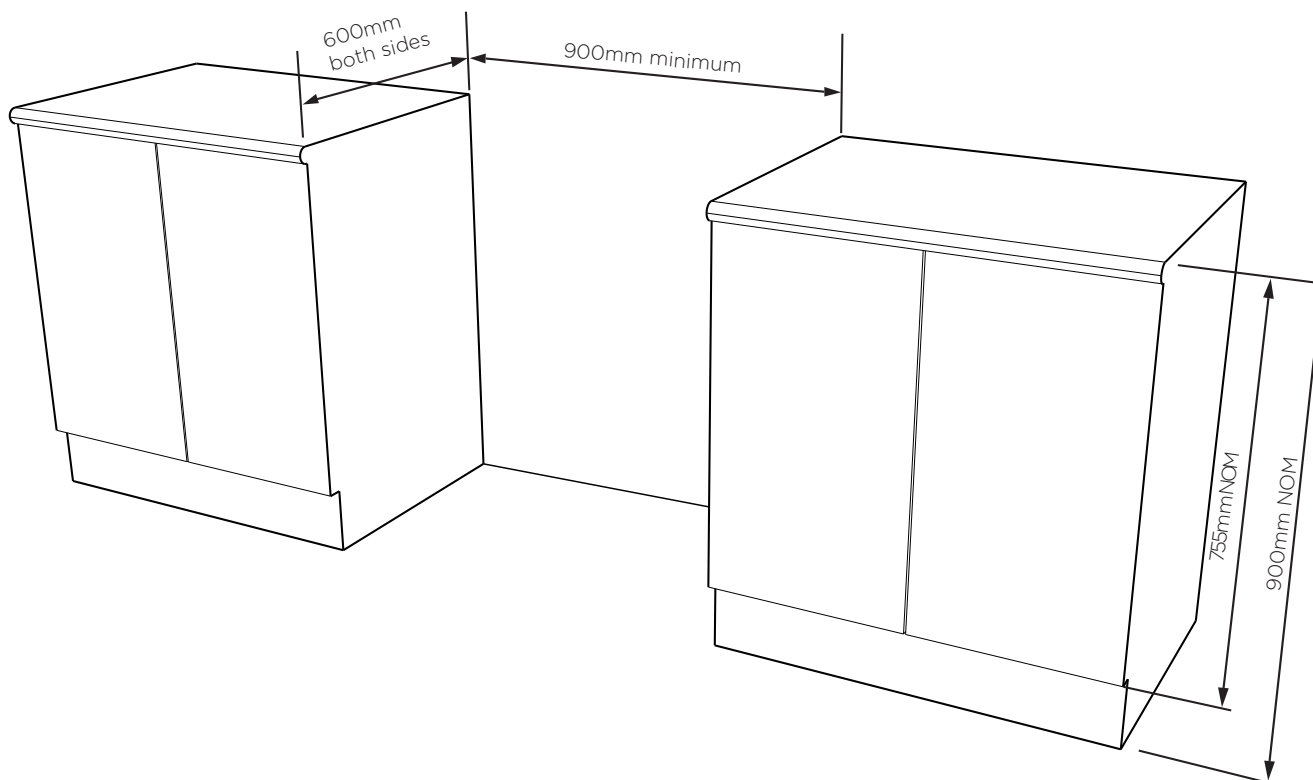

## INSTALLATION OF EFE914, EFEP916 & EFEP956 (CONTINUED)

### Installation of screw-in feet

Freestanding appliances are supplied with four screw-in feet in the internal accessory pack. The screw-in feet can be adjusted by turning the lower half clockwise or anti-clockwise.

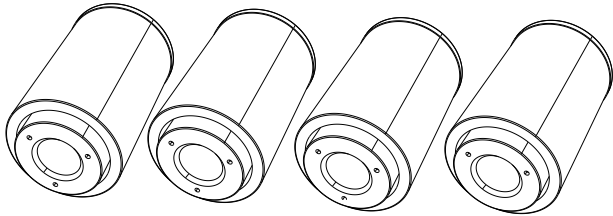

### **i** IMPORTANT!

- To minimise the weight of the oven for easier installation, remove the oven door and oven internal accessory pack. Refer to page 48 for instructions on how to remove the oven door.
- If the appliance is a gas hob model, remove the burner cap and burner crown. Store all items safely, away from the installation area.

Tilt and carefully lay the appliance on its back to gain access to the installation point for the screw in feet.

### **!** CAUTION

- To avoid scratching the floor and the appliance itself, fold the packaging carton board and place it underneath the appliance as protection.
- Do not lay the appliance on its sides or its front.

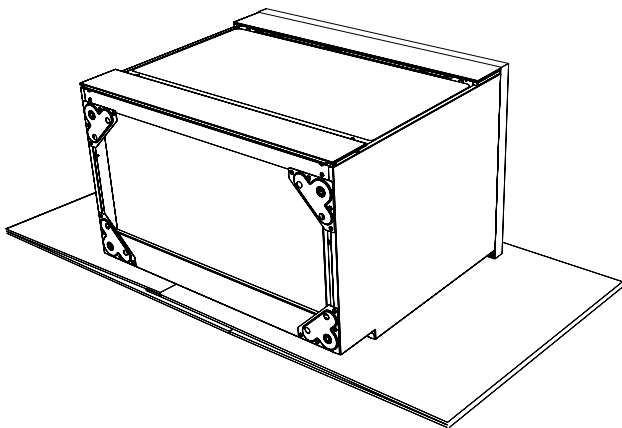

Install the four supplied feet via the four installation points. Make sure that each foot is securely fastened.

### **!** CAUTION

- Do not over-torque the foot.

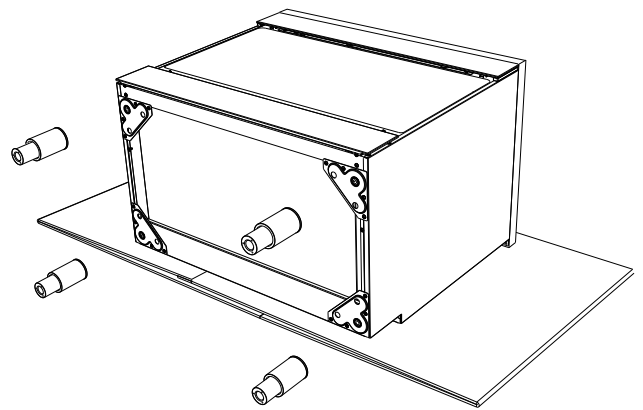

Adjust the height of the screw-in feet to make sure the hob surface is 10mm above the bench when appliance is upright.

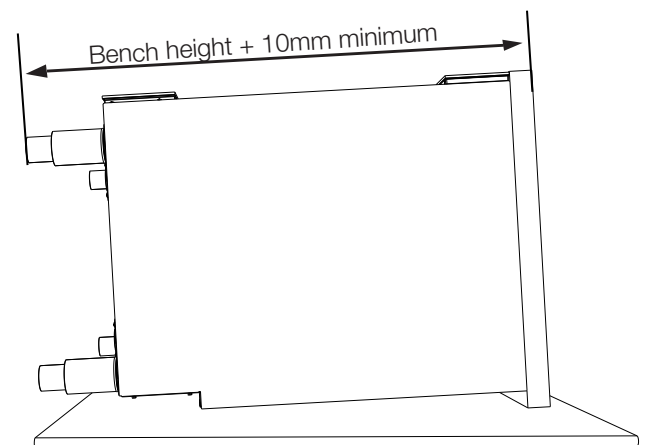

Tilt the appliance upright by lifting the back of the hob and pivoting it about the back two feet.

### **!** WARNING

**Heavy item! This step must be performed by two persons.**

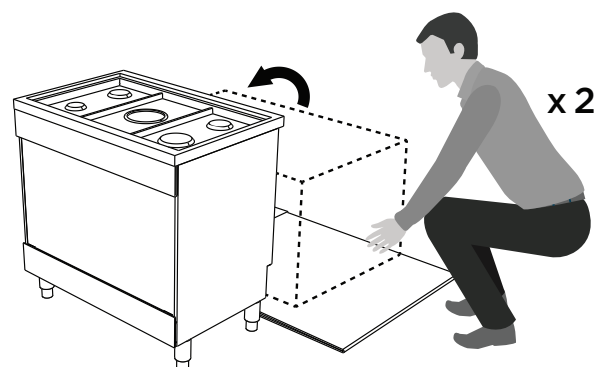

### Levelling oven

Place a level in the oven as below making sure the level sits on the front and rear forms. Adjust the feet accordingly to level the appliance.

## INSTALLATION OF EFE914, EFEP916 & EFEP956 (CONTINUED)

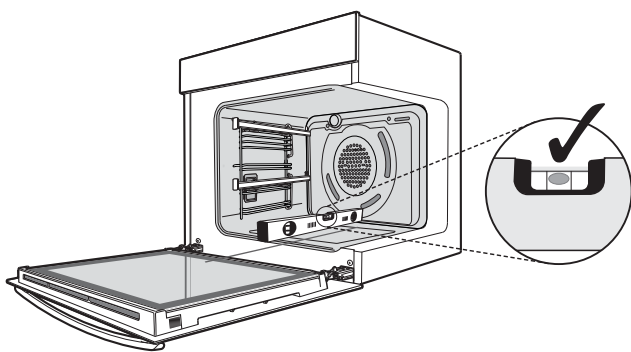

### Installing splashback

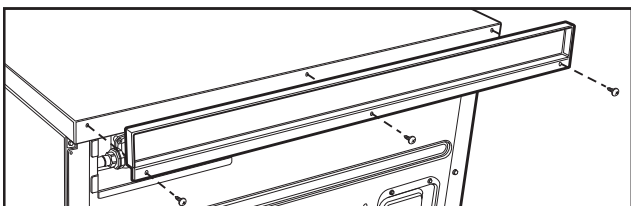

Fit splashback to rear of hob with three screws provided.

### Installing the anti-tilt brackets

To ensure cooker stability, the anti-tilt brackets must be installed.

There are left and right engagement slots for the anti-tilt bracket at the bottom rear of the appliance.

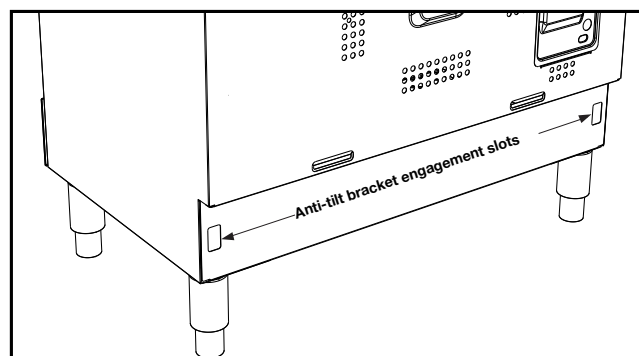

The following steps must be followed to ensure the correct installation of anti-tilt brackets and the stability of the appliances.

### **!** CAUTION

It is not recommended to push and pull the appliance on uneven or rough surface. Use other means to maneuver the appliance if necessary.

- 1 Carefully push the appliance into the cabinet cavity until the back of the oven is flush against the back wall.
- 2 Use non-permanent methods to mark a line on the wall along the top surface of the splashback. This line is used as a reference line to locate the correct location of where the anti-tilt brackets need to be installed.
- 3 After the reference line is marked, pull the appliance out of the cabinet cavity to install the anti-tilt brackets.

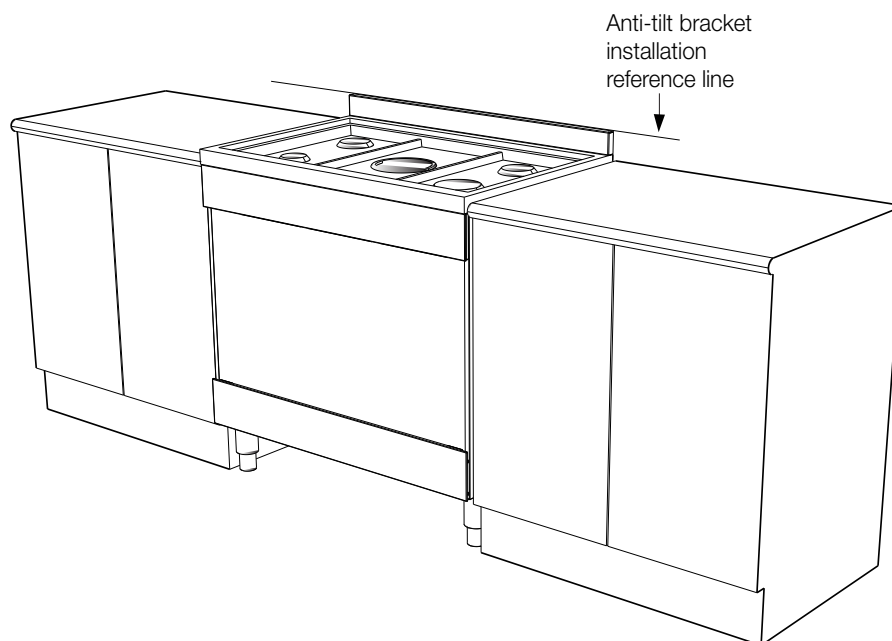

## INSTALLATION OF EFE914, EFEP916 & EFEP956 (CONTINUED)

### **WARNING**

**Appropriate fasteners must be used to suit the type of wall on which the anti-tilt brackets are installed.**

- 4 The anti-tilt brackets must be secured to the rear wall of the cavity with appropriate fastener according to dimensions in diagram.

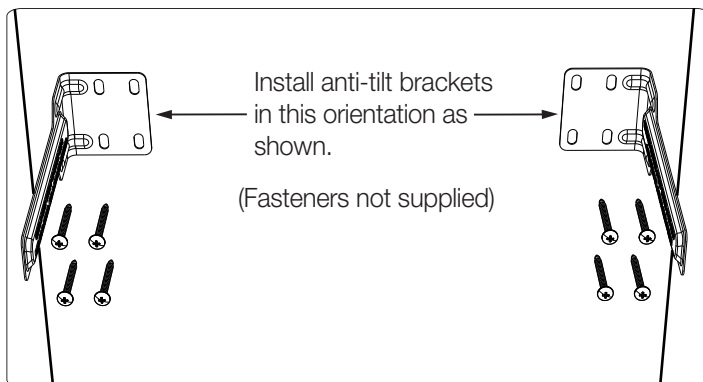
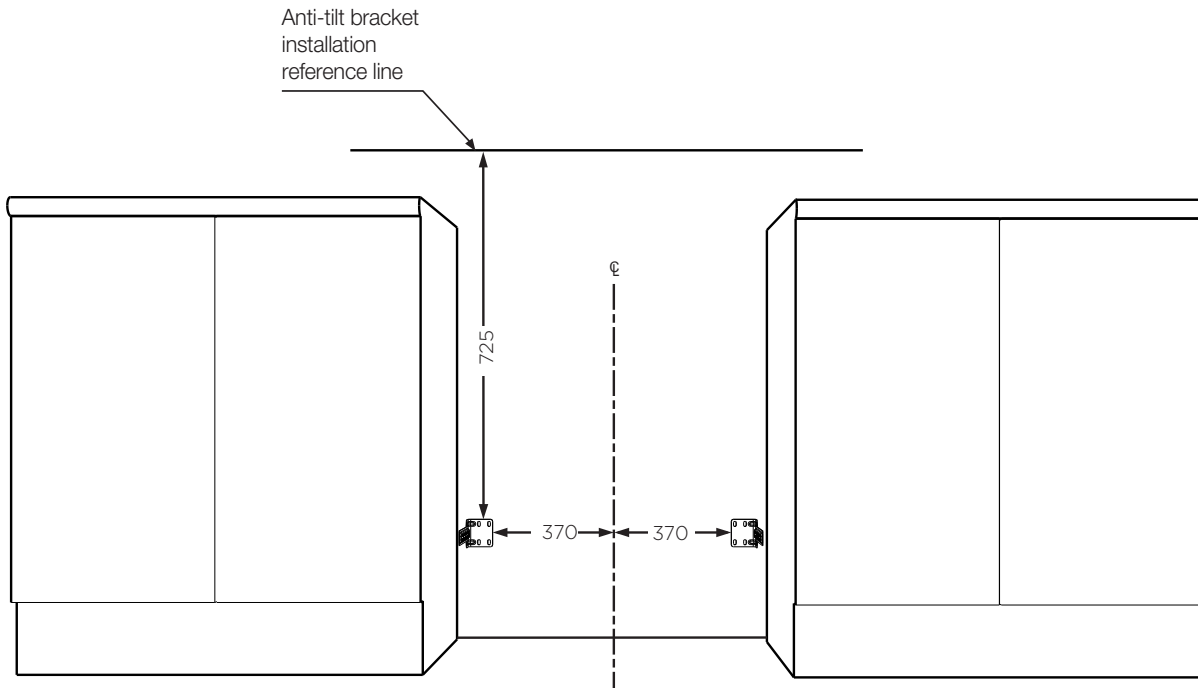

Connect services to the appliance prior to placing into cavity.

To locate appliance, slide into cavity ensuring the anti-tilt brackets fully engaged with the rear left and right engagement slots.

The unit must be pushed against the wall on installation.

Re-install oven door, burner body, burner caps and trivets after the appliance is placed in the cavity.

Gas only: Check that the gas hose, if used, has not been kinked during installation.

### **Installing the clip-on kick panel**

Freestanding models are supplied with a clip-on kick panel that can be assembled to clip onto the front feet for a more integrated and seamless kitchen appearance.

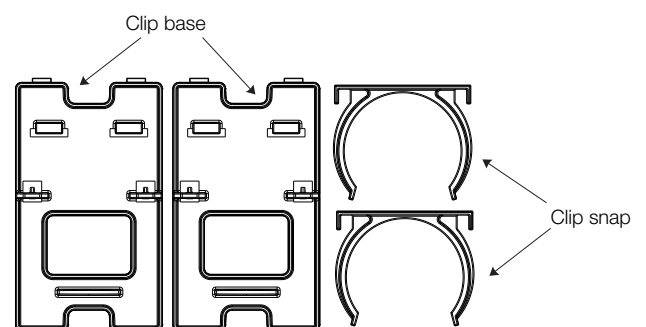

## INSTALLATION OF EFE914, EFEP916 & EFEP956 (CONTINUED)

- 1 Assemble the clip snap onto the base.

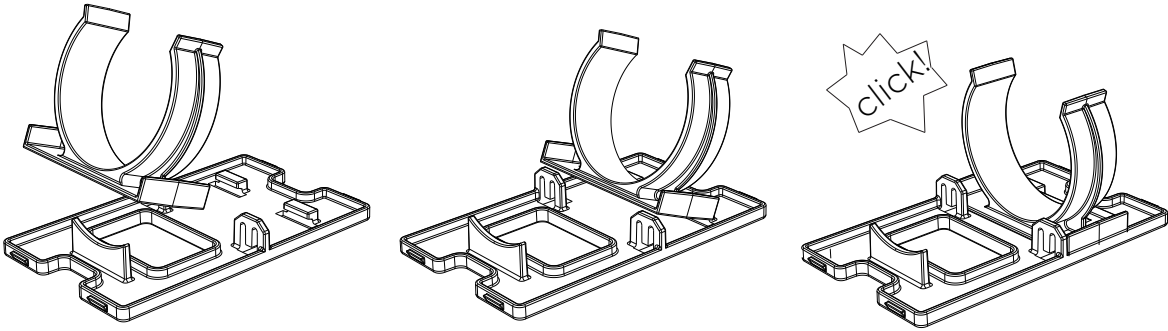

- 2 Press in both assembled clip modules into the kick panel in the orientation as shown below.

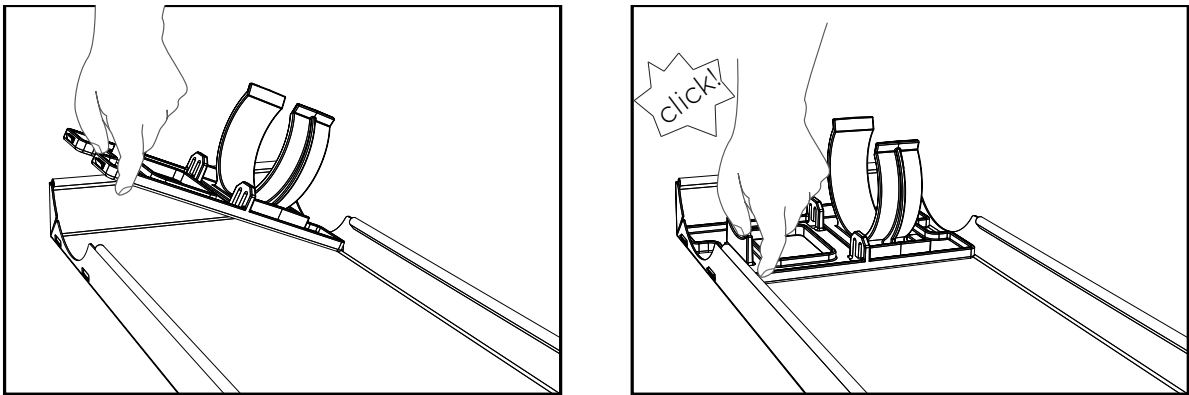

- 3 Make sure both clip modules are in the same orientation after installation.

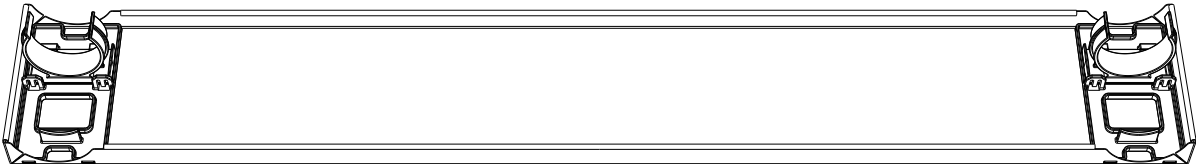

- 4 Clip the kick panel onto the front feet of the appliance. Make sure the kick panel snaps onto the larger section of the front feet.

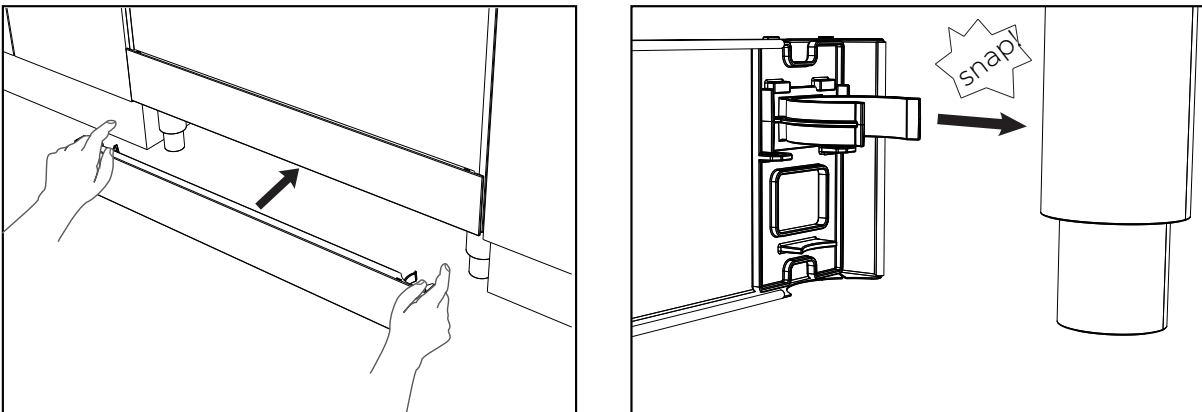

## INSTALLATION OF EFE914, EFEP916 & EFEP956 (CONTINUED)

### Slot-in installation

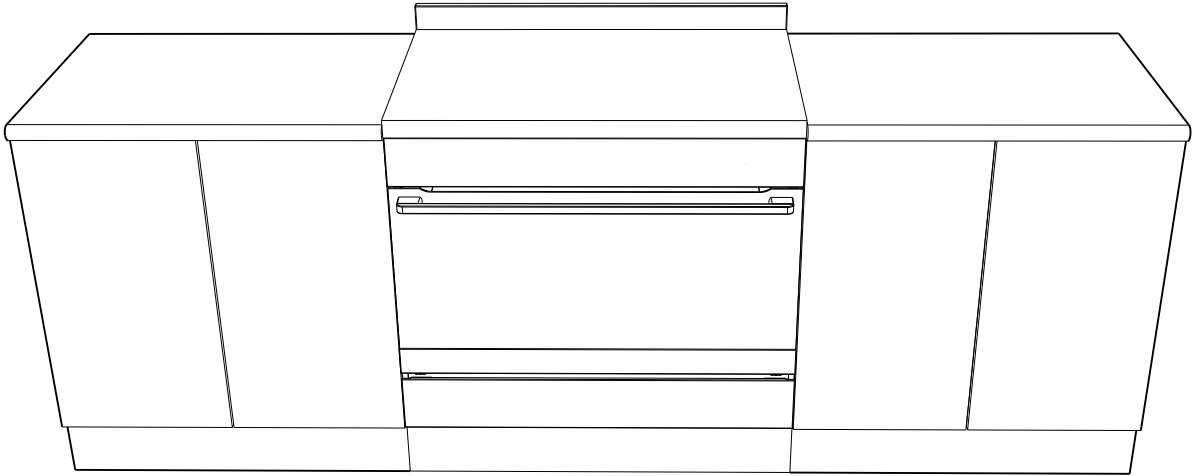

The slot-in type installation use the appliance as supplied. The appliance can be mounted on a plinth. This enables a continuous cupboard kickboard to be installed, giving a more integrated appearance. There is no clearance requirement between oven and adjacent side cabinets.

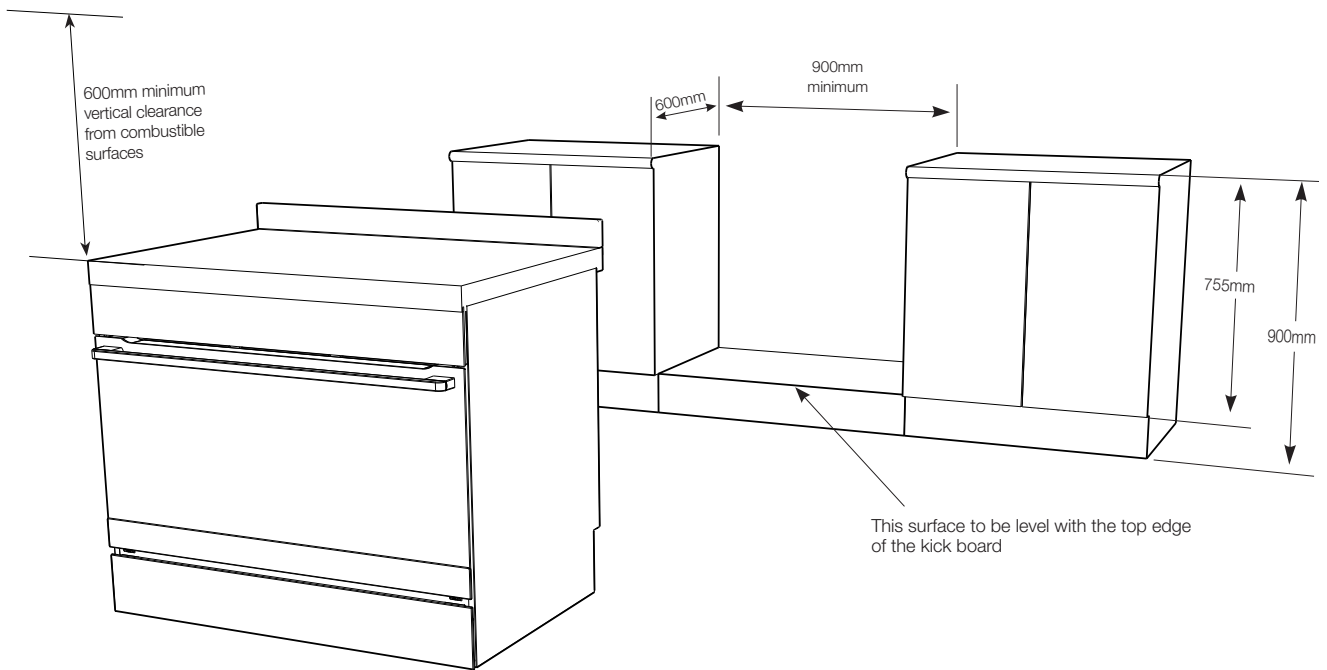



## INSTALLATION OF EFE914, EFEP916 & EFEP956 (CONTINUED)

The anti-tilt brackets are to be secured to the back wall with appropriate fasteners.

Two stops are to be screwed to the plinth in locations as shown (stops provided). The stops locate into slots in the base of the appliance to prevent the product from being pulled forward when installed.

Measurements from the rear wall are to be adjusted if there are tiles etc. that come between the appliance and the wall.

Once services are connected, product can be lifted onto the plinth and pushed back carefully, ensuring the appliance engages into both brackets at the rear and the front stops.

If the product requires removal for service, it must be lifted at the front approximately 5mm to clear the front stops prior to being pulled forward.

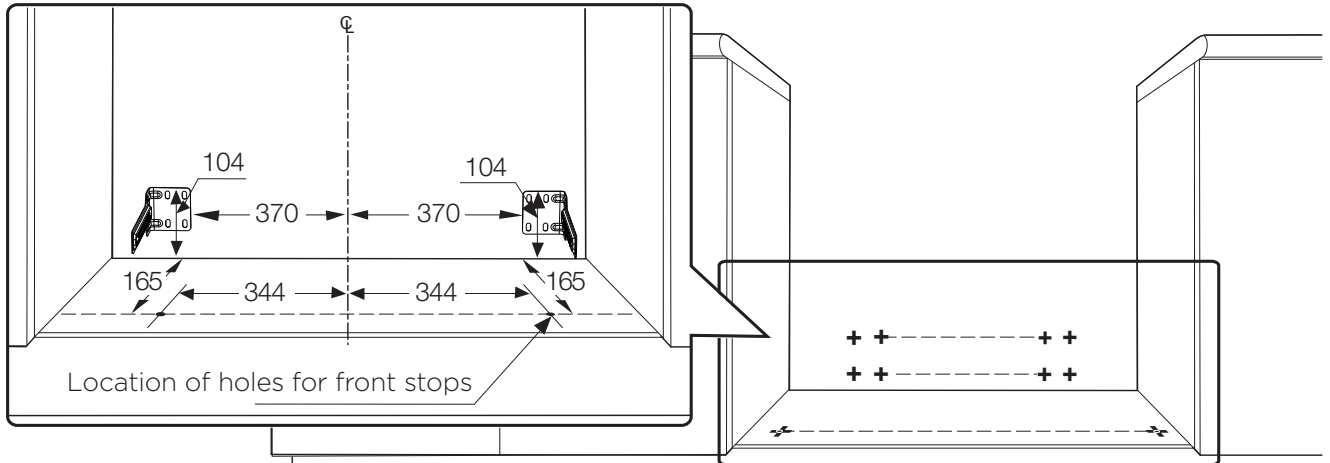

Measurements are to be adjusted to account for the thickness of any skirting board or tiles coming between the back of the appliance and the wall

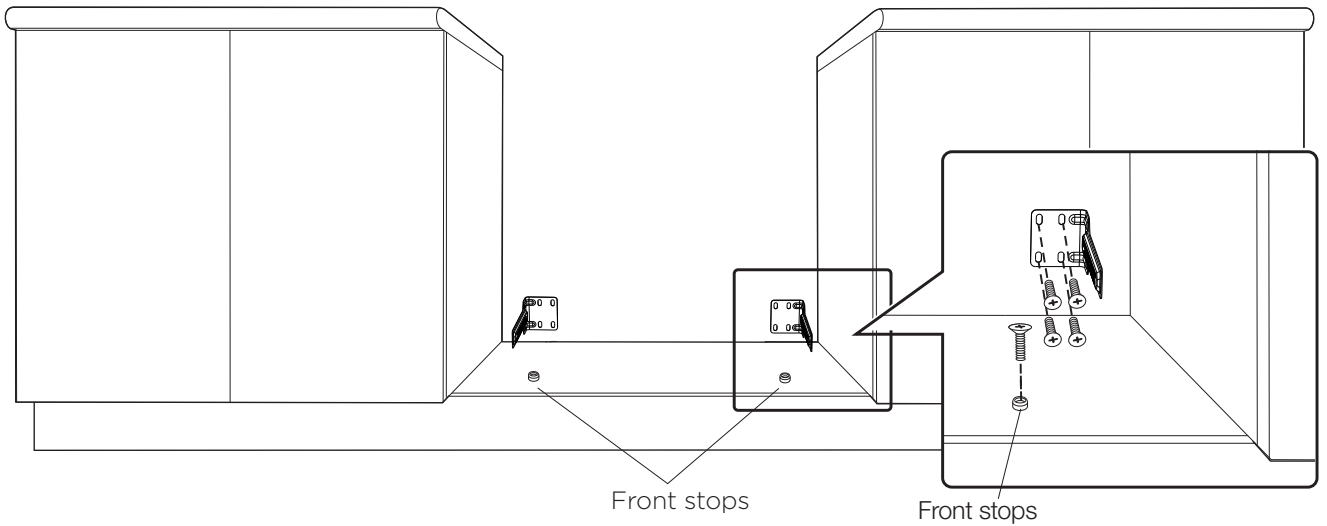

## INSTALLATION OF EVEP916

### Underbench installation

Your underbench oven looks best when the control panel is directly under the benchtop. An upper infill panel may be added if the cooktop placed above the benchtop is too deep. \*Refer to cooktop installation instructions for required clearance between cooktop and oven.

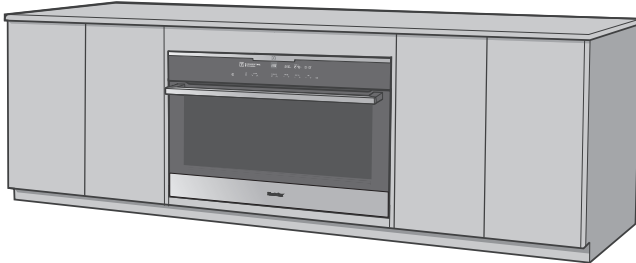

### Vertical cabinet installation

The oven can be built into a vertical cabinet in the same manner as an underbench. The required cavity dimensions are the same and the product is secured to the cabinet in the same way.

For the best integration within a kitchen, install this appliance in a cupboard that gives a flush fit with the surrounding cupboard fronts. A recess of 20mm is ideal.

*NOTE: Your appliance must be mounted on a horizontal surface for the full width and depth of the product.*

*NOTE: A ventilation slot 20mm wide is required at the rear of the base of the cabinet floor.*

The cooker **MUST** be installed in compliance with:

- Wiring connections in AS/NZS 3000 Wiring Rules.
- Local regulations, municipal building codes and other statutory regulations.

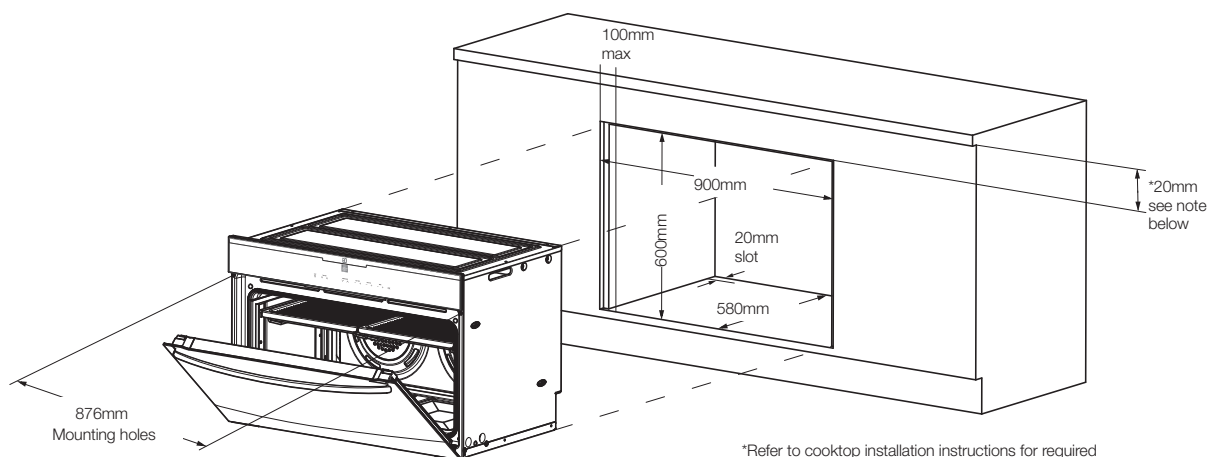

\*Refer to cooktop installation instructions for required clearance between cooktop and oven.

*NOTE: If a powerpoint is fitted it must be accessible with the appliance installed.*

# CABINET CONSTRUCTION FOR BUILT IN OVEN

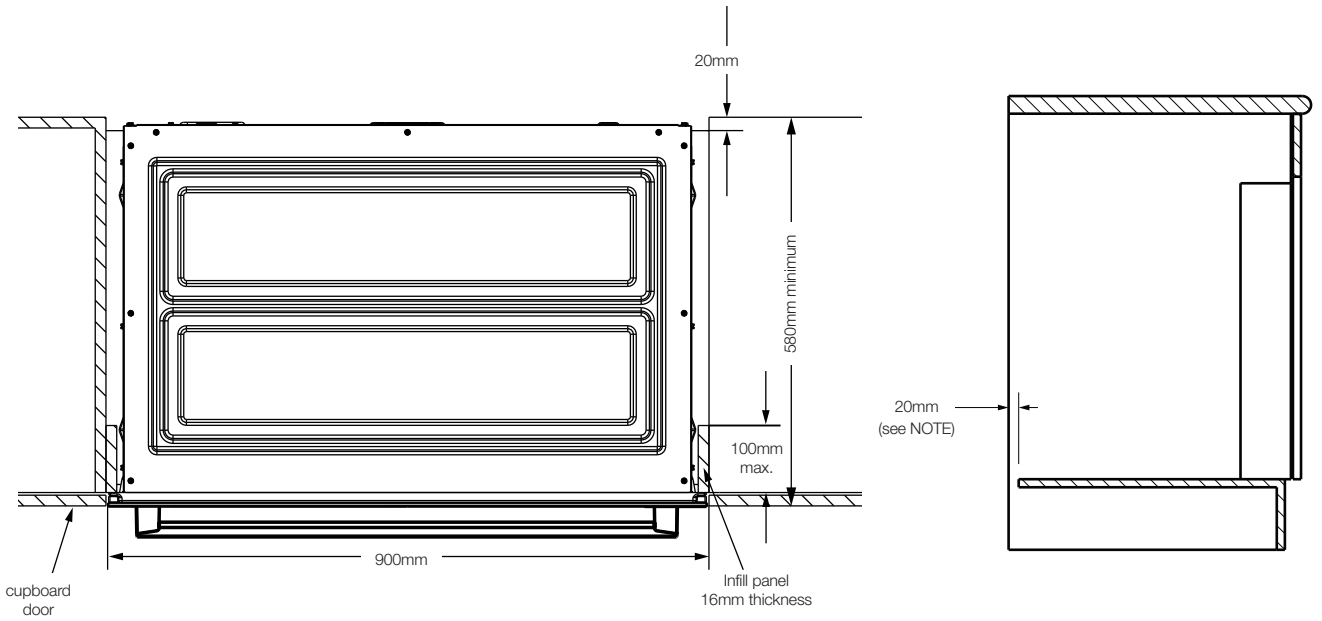

## Oven dimensions

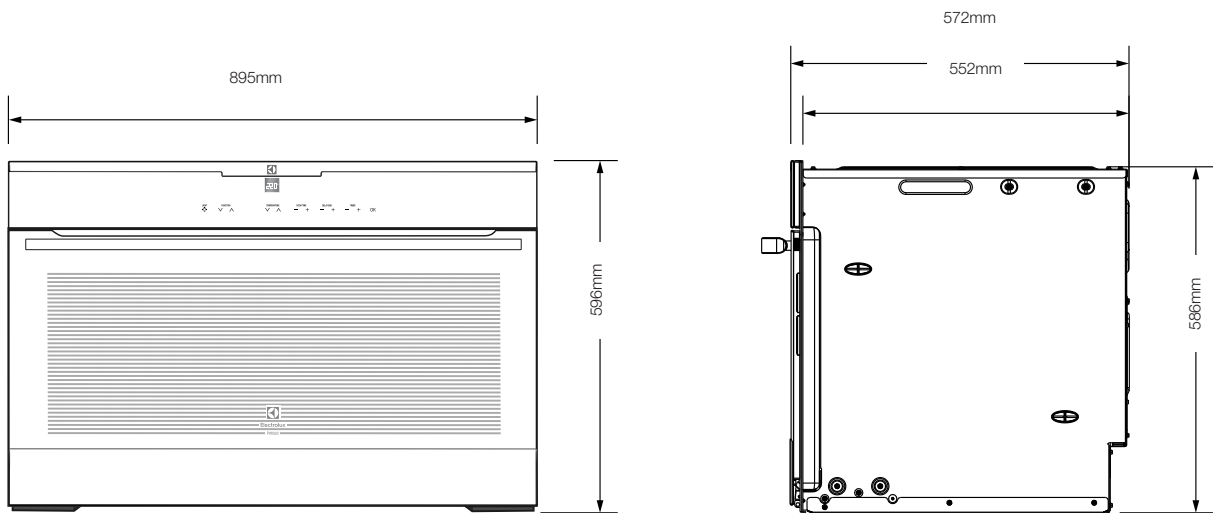

## WIRING REQUIREMENTS

### For New Zealand Only:

The cooking range must be connected to the supply by a supply cord fitted with the appropriately rated plug. This plug is to be compatible with the socket-outlet fitted to the final sub-circuit in the fixed wiring that is intended to supply this cooking range.

Supply cord size required:

EVEP916, EFEP916 – 4mm<sup>2</sup>

EFEP956 – 10mm<sup>2</sup>

EFE914 – 1.5mm<sup>2</sup>

Data plate gives information about rating is located behind the bottom of the oven door

- A functional switch **MUST** be provided near the appliance in an accessible position (AS/NZS 3000 - Clause 4.7.1).
- Wiring **MUST** be protected against mechanical failure (AS/NZS 3000 - Clause 3.9).
- This cooker requires a means of disconnection incorporated into the fixed wiring.
- The cooker **MUST** be properly earthed.
- This range must be connected with cable of 75°C rating minimum.
- This product has passed the insulation resistance test after manufacture. If the resistance reading is low at installation, it is probably caused by moisture from the atmosphere being absorbed by the elements after the range has been produced. (Pass at 0.01 MW AS/NZS 3000 Wiring Rules Clause 8.3.6.2).

*Note: When connections are made to a multi-phase 230/240V supply, the bridge piece **MUST** be removed from between the active connections.*

### Rated Power Input

Model	Total kW	A1 kW	A2 kW
EFEP956	15.2	6.0	9.5

### **i** IMPORTANT!

**Before you cook in your new oven it is important that the protective oils used in the manufacture of the product be removed.**

- Make sure that the room is well ventilated (to allow smoke to escape).
- Run the grill on high for 30 minutes without grill dish.
- Then run the oven on 220°C for 1 hour.

### Connecting to services and commissioning

This appliance must be installed by an authorised person, according to all codes and regulations of:

- Electrical supply authorities.
- Building regulations.
- Local government and council authorities.
- AS/NZS5601.1 (particular attention to 6.10.1 and figure 6.3, and clause 6.10.1.11).
- AS/NZS 3000 (particular attention to clause 4.3.11 and clause 3.9).

### Hard wiring detail

- 1 Remove terminal cover plate from rear panel of appliance.
- 2 Fit wires through hole in cover plate and make connections to terminals.
- 3 Engage wires into plastic clip. Secure plastic clip with two long silver screws (supplied in separate bag).
- 4 Replace cover plate onto rear panel.

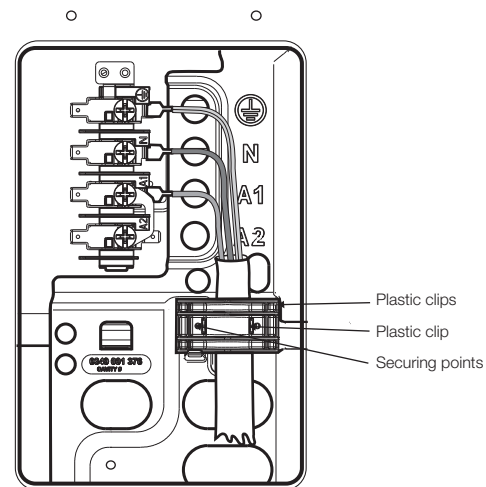

### Electrical connection location - Model EVEP916

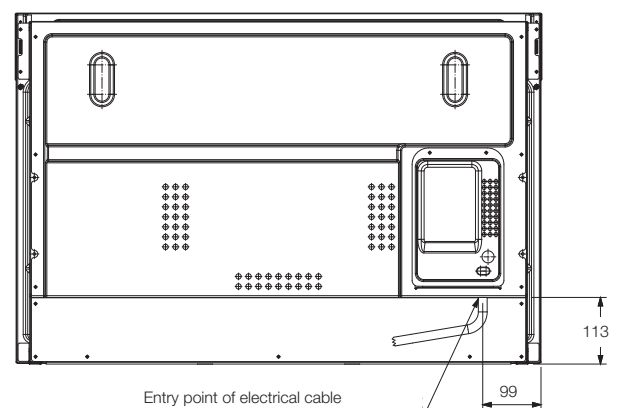

# ELECTRICAL & GAS CONNECTIONS

## Models EFE914, EFEP916, EFEP956

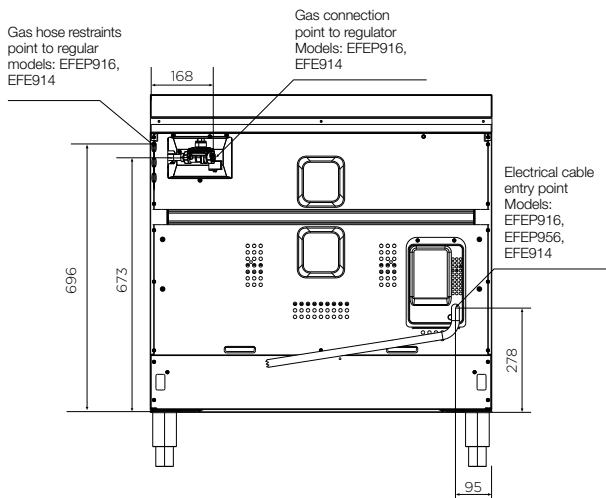

## Installing the gas cooker

### Gas pressures

The following table shows the supply and operating pressures for various gases.

Gas type	Natural gas	Universal LPG
Supply pressure at inlet to appliance regulator	1.13 (kPa)	2.75
	Minimum	kPa
Operating pressure at appliance test point	1.00 (kPa)	2.60 kPa

The following table shows the injector sizes for each burner.

Injector Orifice	Natural gas	Universal LPG
Low heat burner	1.00mm	0.55mm
Medium heat burner	1.35mm	0.70mm
High heat burner	1.60mm	0.90mm
Intense heat dual wok burner	0.85mm (inner)	0.75mm (inner)
	2 x 1.25mm (outer)	2 x 1.60mm (outer)

## Checking piping size

To work out a suitable pipe size for connection use the information in this table:

Model	Natural gas	Universal LPG
EFEP916	57.2 MJ/h	49.9 MJ/h
EFE914	57.2 MJ/h	49.9 MJ/h

For information and requirements about construction and capacity of consumer piping refer to AS5601 series of standards.

## Gas connection

Read these points before connecting to the gas supply:

- The appliance is preset for natural gas use. If LPG is to be used see Conversion to LPG section.
- Gas installation must be made in accordance with AS5601, the local gas fitting regulations, municipal codes and other statutory regulations.
- The gas connection point is a 1/2" BSP external thread located at the rear of the appliance as shown.
- A regulator is supplied which must be fitted to the appliance. Ensure that when fitted the pressure test point of regulator is accessible.
- The regulator is to be fitted to the manifold inlet at the rear of the appliance and the connection thread is sealed using a tape or jointing compound suitable for gas connections. The consumer piping is then connected to the inlet of the regulator, either:
  - 1 directly, or
  - 2 using a hose assembly and in accordance with Clause 6.10.1.9 of AS 5601.1 (High level connection) together with the supplied elbow. The elbow is fitted to the inlet of the regulator and oriented to allow the hose to hang downwards. The connection thread between the regulator and elbow is sealed using a tape or jointing compound suitable for gas connections.

## LPG CONVERSION MODELS EFEP916 & EFE914

This appliance is supplied set up for Natural Gas usage. A conversion kit is included with the product for Universal LPG usage. The conversion kit contains 10 injectors and 1 LPG sticker.

Please follow the procedure below if a conversion to suit UNIVERSAL LPG is required:

- 1 Remove the hotplate trivets, burner caps and burner crowns to access the hotplate injectors. Replace the factory fitted injectors with the appropriate injectors, as supplied. Refer to injector orifice table for injector sizes. The injector size is stamped on the side of the injector.
- 2 Unscrew the top hat nut from the regulator. The top hat nut and control pressure spring assembly will disengage as an assembly.
- 3 Unscrew the threaded pin from top hat.
- 4 Upturn threaded pin, so spring is free and screw pin back into the top hat until firm.
- 5 Refit the top hat nut assembly to the regulator ensuring that it is fully screwed down. The regulator is now set for connection to LPG.
- 6 Turn on the gas supply and at each new connection check for leaks using soapy water. Each hotplate valve should be turned on, one at a time, and the injector hole blanked off for several seconds.
- 7 The operation of the regulator can be confirmed by connecting a manometer to the pressure test point located on the side of the regulator body adjacent to the outlet.

With the appliance operating check the outlet pressure:

- when all burners of the appliance are operating at maximum,
- when the smallest burner of the appliance is operating at minimum.

Under these conditions the outlet pressure should not vary from the nominal outlet pressure of 2.60kPa by more than  $\pm 0.52\text{kPa}$ .

- 8 If the regulator appears to not be performing satisfactorily then check the following points:

- If the outlet pressure is consistently too low then the inlet pressure may be too low and adjustment of an upstream regulator may be needed, or an upstream regulator or valve with insufficient flow capacity may be present in the gas supply line. If this is suspected then it may be necessary to repeat the checks whilst measuring both the inlet and outlet pressure to determine if the inlet pressure is in the range 2.75 – 7.00kPa.
- Check that the insert has been fitted correctly.
- Check that the turret screw is fully screwed down.

- Check that the regulator has been fitted to the gas supply line in the correct orientation, the arrow on the base of the body indicates the direction of gas flow.

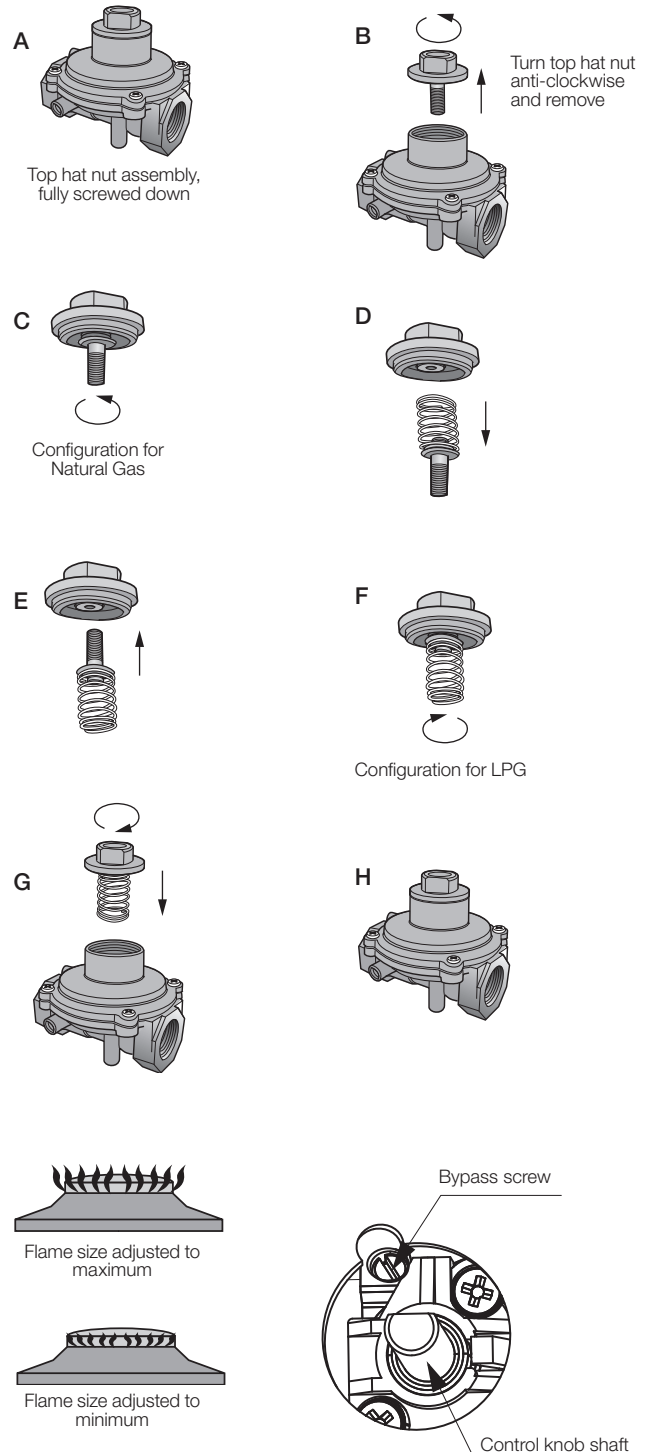

**NOTE:** The cooker **MUST** be tested after installation, before handing over to the customer. You **MUST** have a manometer and a connecting tube.

## TESTING THE OPERATION OF THE GAS COOKER

### Checking gas supply

- 1 Check the manometer zero point is correct.
- 2 Connect the manometer to the cooker pressure test point. This is located on the regulator.
- 3 Turn on the gas supply and the electricity and try to ignite the gas.

*NOTE: It will take additional time to light the gas for the first time as air needs to be purged from the pipes.*

- 4 Check the operating pressure for the particular gas type.

### Checking the function of the regulator

With the appliance operating check the outlet pressure:

- When all burners of the appliance are operating at maximum,
- When the smallest burner of the appliance is operating at minimum.

Under these conditions the outlet pressure should not vary from the nominal outlet pressure by more than  $\pm 20\%$  of the nominal outlet pressure (i.e.  $\pm 0.20\text{kPa}$  for Natural Gas).

If the regulator appears to not be performing satisfactorily then check the following points:

- 1 If the outlet pressure is consistently too low then the inlet pressure may be too low and adjustment of an upstream regulator may be needed, or an upstream regulator or valve with insufficient flow capacity may be present in the gas supply line. If this is suspected then it may be necessary to repeat the checks whilst measuring both the inlet and outlet pressure to determine if the inlet pressure is in the range 1.13 – 5kPa.
- 2 Check that the regulator has been fitted to the gas supply line in the correct orientation, the arrow on the base of the body indicates the direction of gas flow.

Once these checks have been completed, if the regulator still fails to perform in a satisfactory manner it should be replaced.

### Testing the cooker features

- Observe the flame appearance on each burner. If it is much smaller or larger than expected, then the injector size needs checking.

*NOTE: When flame is unsatisfactory, then refer to the Electrolux Technical Publications and correct the fault, if possible.*

When maximum flame appearance is correct, then check the turn-down setting on each burner. If the settings appear to be incorrect, proceed as follows:

- 1 Adjust the bypass screw mounted on the body of each hotplate control. This is accessible when the control knob and the control panel are removed.
- 2 Check the ignition on all burners both separately and in combination.
- 3 Check the operation of the electrical components, if applicable.
- 4 If you are satisfied that the cooker is operating correctly, then turn it off and show the customer how to use it. Make sure you ask the customer to operate the clock and controls.

*NOTE: If the cooker cannot be adjusted to perform correctly, then inform the customer of the problem and put a warning notice on the cooker. If the problem is dangerous, then disconnect the cooker. If there is a fault, then the customer should be advised to contact the manufacturer's local service organisation or the retailer.*



**Electrolux Warranty**

FOR SALES IN AUSTRALIA AND NEW ZEALAND  
 APPLIANCE: ELECTROLUX BUILT-IN OVENS, COOKTOPS AND  
 FREESTANDING COOKER

**This document sets out the terms and conditions of the product warranties for Electrolux Appliances. It is an important document. Please keep it with your proof of purchase documents in a safe place for future reference should there be a manufacturing defect in your Appliance. This warranty is in addition to other rights you may have under the Australian Consumer Law.**

**1. In this warranty:**

- (a) 'ACL' or 'Australian Consumer Law' means Schedule 2 to the Competition and Consumer Act 2010;
- (b) 'Appliance' means any Electrolux product purchased by you and accompanied by this document;
- (c) 'ASC' means Electrolux's authorised serviced centres;
- (d) 'Electrolux' is the brand controlled by Electrolux Home Products Pty Ltd of 163 O'Riordan Street, Mascot NSW 2020, ABN 51 004 762 341 in respect of Appliances purchased in Australia and Electrolux (NZ) Limited (collectively "Electrolux") of 3-5 Niall Burgess Road, Mount Wellington, in respect of Appliances purchased in New Zealand;
- (e) 'Warranty Period' means the period specified in clause 3 of this warranty;
- (f) 'you' means the purchaser of the Appliance not having purchased the Appliance for re-sale, and 'your' has a corresponding meaning.

**2. Application:** This warranty only applies to new Appliances, purchased and used in Australia or New Zealand and is in addition to (and does not exclude, restrict, or modify in any way) other rights and remedies under a law to which the Appliances or services relate, including any non-excludable statutory guarantees in Australia and New Zealand.

**3. Warranty Period:** Subject to these terms and conditions, this warranty continues in Australia for a period of 24 months and in New Zealand for a period of 24 months, following the date of original purchase of the Appliance.

**4. Repair or replace warranty:** During the Warranty Period, Electrolux or its ASC will, at no extra charge if your Appliance is readily accessible for service, without special equipment and subject to these terms and conditions, repair or replace any parts which it considers to be defective. Electrolux may, in its absolute discretion, choose whether the remedy offered for a valid warranty claim is repair or replacement. Electrolux or its ASC may use refurbished parts to repair your Appliance. You agree that any replaced Appliances or parts become the property of Electrolux.

**5. Travel and transportation costs:** Subject to clause 7, Electrolux will bear the reasonable cost of transportation, travel and delivery of the Appliance to and from Electrolux or its ASC. Travel and transportation will be arranged by Electrolux as part of any valid warranty claim.

**6. Proof of purchase** is required before you can make a claim under this warranty.

**7. Exclusions:** You may not make a claim under this warranty unless the defect claimed is due to faulty or defective parts or workmanship. This warranty does not cover:

- (a) light globes, batteries, filters or similar perishable parts;
- (b) parts and Appliances not supplied by Electrolux;
- (c) cosmetic damage which does not affect the operation of the Appliance;

- (d) damage to the Appliance caused by:
  - (i) negligence or accident;
  - (ii) misuse or abuse, including failure to properly maintain or service;
  - (iii) improper, negligent or faulty servicing or repair works done by anyone other than an Electrolux authorised repairer or ASC;
  - (iv) normal wear and tear;
  - (v) power surges, electrical storm damage or incorrect power supply;
  - (vi) incomplete or improper installation;
  - (vii) incorrect, improper or inappropriate operation;
  - (viii) insect or vermin infestation;
  - (ix) failure to comply with any additional instructions supplied with the Appliance;

In addition, Electrolux is not liable under this warranty if:

- (a) the Appliance has been, or Electrolux reasonably believes that the Appliance has been, used for purposes other than those for which the Appliance was intended, including where the Appliance has been used for any non-domestic purpose;
- (b) the Appliance is modified without authority from Electrolux in writing;
- (c) the Appliance's serial number or warranty seal has been removed or defaced

**8. How to claim under this warranty:** To enquire about claiming under this warranty, please follow these steps:

- (a) carefully check the operating instructions, user manual and the terms of this warranty;
- (b) have the model and serial number of the Appliance available;
- (c) have the proof of purchase (e.g. an invoice) available;
- (d) telephone the numbers shown below.

**9. Australia:** For Appliances and services provided by Electrolux in Australia: Electrolux goods come with guarantees that cannot be excluded under the Australian Consumer Law. You are entitled to a replacement or refund for a major failure and for compensation for any other reasonably foreseeable loss or damage. You are also entitled to have the Appliance repaired or replaced if the Appliance fails to be of acceptable quality and the failure does not amount to a major failure. 'Acceptable quality' and 'major failure' have the same meaning as referred to in the ACL.

**10. New Zealand:** For Appliances and services provided by Electrolux in New Zealand, the Appliances come with a guarantee by Electrolux pursuant to the provisions of the Consumer Guarantees Act, the Sale of Goods Act and the Fair Trading Act. Where the Appliance was purchased in New Zealand for commercial purposes the Consumer Guarantee Act does not apply.

**11. Confidentiality:** You accept that if you make a warranty claim, Electrolux and its agents including ASC may exchange information in relation to you to enable Electrolux to meet its obligations under this warranty.

**Important Notice**

Before calling for service, please ensure that the steps listed in clause 8 above have been followed.

<p><b>FOR SERVICE</b>            or to find the address of your nearest authorised service centre in Australia  <b>PLEASE CALL 13 13 49</b>  <small>For the cost of a local call (Australia only)</small></p>	<p><b>AUSTRALIA</b>            ELECTROLUX HOME PRODUCTS            163 O'Riordan Street, Mascot NSW 2020            electrolux.com.au</p>	<p><b>FOR SPARE PARTS</b>            or to find the address of your nearest spare parts centre in Australia  <b>PLEASE 13 13 50</b>  <small>For the cost of a local call (Australia only)</small></p>
<p><b>FOR SERVICE</b>            or to find the address of your nearest authorised service centre in New Zealand  <b>PLEASE CALL 0800 10 66 10</b>  <small>(New Zealand only)</small></p>	<p><b>NEW ZEALAND</b>            ELECTROLUX (NZ) Limited            3-5 Niall Burgess Road, Mount Wellington            electrolux.co.nz</p>	<p><b>FOR SPARE PARTS</b>            or to find the address of your nearest spare parts centre in New Zealand  <b>PLEASE 0800 10 66 20</b>  <small>(New Zealand only)</small></p>







**Electrolux Home Products Australia**

telephone: 1300 363 640  
fax: 1800 350 067  
email: [customercare@electrolux.com.au](mailto:customercare@electrolux.com.au)  
web: [electrolux.com.au](http://electrolux.com.au)

**shop.electrolux.com.au**



**Electrolux Home Products New Zealand**

telephone: 0800 436 245  
fax: 0800 225 088  
email: [customercare@electrolux.co.nz](mailto:customercare@electrolux.co.nz)  
web: [electrolux.co.nz](http://electrolux.co.nz)



**To add a touch of professional inspiration to your home, visit [electrolux.com.au](http://electrolux.com.au) or [electrolux.co.nz](http://electrolux.co.nz)**

[electrolux.com.au](http://electrolux.com.au)



or [electrolux.co.nz](http://electrolux.co.nz)



**P/No. A17030801 Rev:B**

**ECN: 101105**

© 2019 Electrolux Home Products Pty Ltd.

EMAN\_E100\_90cm\_Cooker\_May19