



RADIO TEST REPORT

Test Report No. : 12510206S-A-R3

Applicant : TAIYO YUDEN CO., LTD.
Type of Equipment : Bluetooth low energy / ANT / 802.15.4 Module
Model No. : EYSKBN
FCC ID : RYYEYSKBN
Test regulation : FCC Part 15 Subpart C: 2018
Test Result : Complied

1. This test report shall not be reproduced in full or partial, without the written approval of UL Japan, Inc.
2. The results in this report apply only to the sample tested.
3. This sample tested is in compliance with the limits of the above regulation.
4. The test results in this test report are traceable to the national or international standards.
5. This test report must not be used by the customer to claim product certification, approval, or endorsement by any agency of the Federal Government.
6. This test report covers Radio technical requirements.
It does not cover administrative issues such as Manual or non-Radio test related Requirements. (if applicable)
7. The all test items in this test report are conducted by UL Japan, Inc. Shonan EMC Lab.
8. The opinions and the interpretations to the result of the description in this report are outside scopes where UL Japan has been accredited.
9. This report is a revised version of 12510206S-A-R2. 12510206S-A-R2 is replaced with this report.

Date of test: September 25 to October 15, 2018

Representative test engineer:

Yosuke Ishikawa
Engineer
Consumer Technology Division

Approved by:

Hikaru Shirasawa
Engineer
Consumer Technology Division



- The testing in which "Non-accreditation" is displayed is outside the accreditation scopes in UL Japan.
 There is no testing item of "Non-accreditation".

UL Japan, Inc.
Shonan EMC Lab.

1-22-3 Megumigaoka, Hiratsuka-shi, Kanagawa-ken, 259-1220 JAPAN
Telephone : +81 463 50 6400
Facsimile : +81 463 50 6401

13-EM-F0429

CONTENTS	PAGE
SECTION 1: Customer information.....	4
SECTION 2: Equipment under test (E.U.T.).....	4
SECTION 3: Test specification, procedures & results.....	6
SECTION 4: Operation of E.U.T. during testing.....	9
SECTION 5: Conducted Emission.....	12
SECTION 6: Radiated Spurious Emission	13
SECTION 7: Antenna Terminal Conducted Tests.....	15
APPENDIX 1: Test data	16
Conducted Emission	16
6 dB Bandwidth and 99 % Occupied Bandwidth.....	26
Maximum Peak Output Power	33
Average Output Power	37
Burst rate confirmation	41
Radiated Spurious Emission	43
Conducted Spurious Emission	73
Power Density	88
APPENDIX 2: Test instruments	93
APPENDIX 3: Photographs of test setup	95
Conducted Emission	95
Worst Case Position	97

SECTION 1: Customer information

Company Name : TAIYO YUDEN CO., LTD.
Address : 8-1,Sakae-cho, Takasaki-shi, Gunma 370-8522 ,Japan
Telephone Number : +81-27-324-2313
Facsimile Number : +81-27-324-2314
Contact Person : Hideki Kato

SECTION 2: Equipment under test (E.U.T.)

2.1 Identification of E.U.T.

Type of Equipment : Bluetooth low energy / ANT / 802.15.4 Module
Model No. : EYSKBN
Serial No. : Refer to Section 4, Clause 4.2
Rating : DC 3 V (DC 1.7 V - 5.5 V), 0.02 A, 50 Hz
Receipt Date of Sample : September 21, 2018
Country of Mass-production : Japan
Condition of EUT : Engineering prototype
(Not for Sale: This sample is equivalent to mass-produced items.)
Modification of EUT : No Modification by the test lab

2.2 Product Description

Model: EYSKBN (referred to as the EUT in this report) is a Bluetooth low energy / ANT / 802.15.4 Module.

Radio Specification

< Bluetooth (BT) Low Energy (LE) (1 Mbps, 2 Mbps) BLE Long range (500 kbps, 125 kbps)>

Radio Type : Transceiver
Frequency of Operation : 2402 MHz - 2480 MHz
Modulation : GFSK
Antenna type : Monopole Antenna
Antenna Gain : -0.6 dBi
Clock frequency (Maximum) : 32 MHz

< ANT (1 Mbps) >

Radio Type : Transceiver
Frequency of Operation : 2402 MHz - 2480 MHz
Modulation : GFSK
Antenna type : Monopole Antenna
Antenna Gain : -0.6 dBi
Clock frequency (Maximum) : 32 MHz

< Nordic Original (2 Mbps) >

Radio Type : Transceiver
Frequency of Operation : 2402 MHz - 2480 MHz
Modulation : GFSK
Antenna type : Monopole Antenna
Antenna Gain : -0.6 dBi
Clock frequency (Maximum) : 32 MHz

< IEEE802.15.4 >

Radio Type : Transceiver
Frequency of Operation : 2405 MHz - 2475 MHz
Modulation : O-QPSK, DSSS
Antenna type : Monopole Antenna
Antenna Gain : -0.6 dBi
Clock frequency (Maximum) : 32 MHz

SECTION 3: Test specification, procedures & results

3.1 Test Specification

Test Specification : FCC Part 15 Subpart C
FCC Part 15 final revised on March 12, 2018 and effective April 11, 2018

Title : FCC 47CFR Part15 Radio Frequency Device Subpart C Intentional Radiators
Section 15.207 Conducted limits
Section 15.247 Operation within the bands 902-928MHz,
2400-2483.5MHz, and 5725-5850MHz

3.2 Procedures and results

Item	Test Procedure	Specification	Worst margin	Results	Remarks
Conducted Emission	FCC: ANSI C63.10-2013 6. Standard test methods	FCC: Section 15.207	19.7 dB 0.39419 MHz, N,L,QP Tx BT LE 2 Mbps 2440 MHz	Complied	-
	IC: RSS-Gen 8.8	IC: RSS-Gen 8.8			
6dB Bandwidth	FCC: KDB 558074 D01 15.247 Meas Guidance v05	FCC: Section 15.247(a)(2)	See data.	Complied	Conducted
	IC: -	IC: RSS-247 5.2(a)			
Maximum Peak Output Power	FCC: KDB 558074 D01 15.247 Meas Guidance v05	FCC: Section 15.247(b)(3)		Complied	Conducted
	IC: RSS-Gen 6.12	IC: RSS-247 5.4(d)			
Power Density	FCC: KDB 558074 D01 15.247 Meas Guidance v05	FCC: Section 15.247(e)		Complied	Conducted
	IC: -	IC: RSS-247 5.2(b)			
Spurious Emission Restricted Band Edges	FCC: KDB 558074 D01 15.247 Meas Guidance v05	FCC: Section15.247(d)	1.6 dB 9608.000 MHz, AV, Hori. Tx BT LE 2 Mbps 2402 MHz	Complied#	Conducted (below 30 MHz)/ Radiated (above 30 MHz) *1)
	IC: RSS-Gen 6.13	IC: RSS-247 5.5 RSS-Gen 8.9 RSS-Gen 8.10			

Note: UL Japan, Inc.'s EMI Work Procedures No. 13-EM-W0420 and 13-EM-W0422.

*1) Radiated test was selected over 30 MHz based on section 15.247(d) and KDB 558074 D01 15.247 Meas Guidance v05 8.5 and 8.6.

Symbols:

Complied The data of this test item has enough margin, more than the measurement uncertainty.

Complied# The data of this test item meets the limits unless the measurement uncertainty is taken into consideration.

* In case any questions arise about test procedure, ANSI C63.10: 2013 is also referred.

FCC Part 15.31 (e)

The RF Module has its own regulator. The RF Module is constantly provided voltage through the regulator regardless of input voltage. Therefore, this EUT complies with the requirement.

FCC Part 15.203 Antenna requirement

It is impossible for end users to replace the antenna, because the antenna is mounted inside of the EUT. Therefore the equipment complies with the requirement.

UL Japan, Inc.

Shonan EMC Lab.

1-22-3 Megumigaoka, Hiratsuka-shi, Kanagawa-ken, 259-1220 JAPAN

Telephone : +81 463 50 6400

Facsimile : +81 463 50 6401

3.3 Addition to standard

Item	Test Procedure	Specification	Worst margin	Results	Remarks
99% Occupied Bandwidth	RSS-Gen 6.7	IC: -	N/A	Complied	Conducted

Other than above, no addition, exclusion nor deviation has been made from the standard.

3.4 Uncertainty

EMI

The following uncertainties have been calculated to provide a confidence level of 95 % using a coverage factor $k=2$.

Shonan EMC Lab.

Item	Frequency range	Uncertainty (+/-)				
		No. 1 SAC / SR	No. 2 SAC / SR	No. 3 SAC / SR	No. 4 SAC / SR	No. 5,6,8 SR
Conducted emission (AC Mains) LISN	150 kHz-30 MHz	2.5 dB	2.5 dB	2.5 dB	2.6 dB	2.6 dB
Radiated emission (Measurement distance: 3 m)	9 kHz-30 MHz	3.2 dB	3.2 dB	3.3 dB	-	-
	30 MHz-200 MHz	4.9 dB	4.8 dB	4.9 dB	-	-
	200 MHz-1 GHz	6.1 dB	6.1 dB	6.1 dB	-	-
	1 GHz-6 GHz	4.7 dB	4.7 dB	4.7 dB	-	-
	6 GHz-18 GHz	5.3 dB	5.3 dB	5.3 dB	-	-
Radiated emission (Measurement distance: 1 m)	18 GHz-40 GHz	5.6 dB	5.6 dB	5.6 dB	-	-
	1 GHz-18 GHz	5.6 dB	5.6 dB	5.6 dB	-	-
	18 GHz-40 GHz	5.9 dB	5.9 dB	5.9 dB	-	-

SAC=Semi-Anechoic Chamber

SR= Shielded Room is applied besides radiated emission

Antenna terminal test	Uncertainty (+/-)
Power Measurement above 1 GHz (Average Detector)_SPM-06	0.48 dB
Power Measurement above 1 GHz (Peak Detector)_SPM-06	0.66 dB
Power Measurement above 1 GHz (Average Detector)_SPM-07	0.47 dB
Power Measurement above 1 GHz (Peak Detector)_SPM-07	0.64 dB
Power Measurement above 1 GHz (Average Detector)_SPM-13	0.90 dB
Power Measurement above 1 GHz (Peak Detector)_SPM-13	1.04 dB
Spurious emission (Conducted) below 1GHz	1.8 dB
Spurious emission (Conducted) 1 GHz-3 GHz	1.7 dB
Spurious emission (Conducted) 3 GHz-18 GHz	2.5 dB
Spurious emission (Conducted) 18 GHz-26.5 GHz	2.5 dB
Spurious emission (Conducted) 26.5 GHz-40 GHz	2.7 dB
Bandwidth Measurement	1.01 %
Duty cycle and Time Measurement	0.012 %

UL Japan, Inc.

Shonan EMC Lab.

1-22-3 Megumigaoka, Hiratsuka-shi, Kanagawa-ken, 259-1220 JAPAN

Telephone : +81 463 50 6400

Facsimile : +81 463 50 6401

3.5 Test Location

UL Japan, Inc. Shonan EMC Lab.
1-22-3, Megumigaoka, Hiratsuka-shi, Kanagawa-ken 259-1220 JAPAN
Telephone: +81 463 50 6400, Facsimile: +81 463 50 6401
JAB Accreditation No. RTL02610
FCC Test Firm Registration Number: 839876

Test site	IC Registration Number	Width x Depth x Height (m)	Size of reference ground plane (m) / horizontal conducting plane	Maximum measurement distance
No.1 Semi-anechoic chamber	2973D-1	20.6 x 11.3 x 7.65	20.6 x 11.3	10 m
No.2 Semi-anechoic chamber	2973D-2	20.6 x 11.3 x 7.65	20.6 x 11.3	10 m
No.3 Semi-anechoic chamber	2973D-3	12.7 x 7.7 x 5.35	12.7 x 7.7	5 m
No.4 Semi-anechoic chamber	-	8.1 x 5.1 x 3.55	8.1 x 5.1	-
No.1 Shielded room	-	6.8 x 4.1 x 2.7	6.8 x 4.1	-
No.2 Shielded room	-	6.8 x 4.1 x 2.7	6.8 x 4.1	-
No.3 Shielded room	-	6.3 x 4.7 x 2.7	6.3 x 4.7	-
No.4 Shielded room	-	4.4 x 4.7 x 2.7	4.4 x 4.7	-
No.5 Shielded room	-	7.8 x 6.4 x 2.7	7.8 x 6.4	-
No.6 Shielded room	-	7.8 x 6.4 x 2.7	7.8 x 6.4	-
No.8 shielded room	-	3.45 x 5.5 x 2.4	3.45 x 5.5	-
No.1 Measurement room	-	2.55 x 4.1 x 2.5	-	-

3.6 Test data, Test instruments, and Test set up

Refer to APPENDIX.

SECTION 4: Operation of E.U.T. during testing

4.1 Operating Mode(s)

Mode	Remarks*
Bluetooth (BT) Low Energy (LE) 500 kbps *)	Maximum Packet Size, PRBS9
Bluetooth (BT) Low Energy (LE) 2 Mbps	Maximum Packet Size, PRBS9
ANT 1 Mbps	1 Mbps
Nordic Original 2 Mbps	2 Mbps
IEEE802.15.4	
*The worst condition was determined based on the test result of Maximum Peak Output Power (Mid Channel)	
*Power of the EUT was set by the software as follows; Power settings: +8 dBm,-40 dBm Software: 10_BLE_TEST_tool-BT5.xls Radio_test_tool_20180918.xls	
*This setting of software is the worst case. Any conditions under the normal use do not exceed the condition of setting. In addition, end users cannot change the settings of the output power of the product.	

*The details of Operating mode(s)

Test Item	Operating Mode	Tested frequency
Conducted Emission	Tx BT LE 2 Mbps Tx BT LE 500 kbps	2402 MHz, 2440 MHz, 2480 MHz
	Tx ANT 1 Mbps Tx Nordic Original 2 Mbps	2402 MHz, 2441 MHz, 2480 MHz
	Tx IEEE 802.15.4	2405 MHz, 2440 MHz, 2475 MHz
Spurious Emission	Tx BT LE 2 Mbps Tx BT LE 500 kbps	2402 MHz, 2440 MHz, 2480 MHz
	Tx ANT 1Mbps Tx Nordic Original 2 Mbps	2402 MHz, 2441 MHz, 2480 MHz
	Tx IEEE 802.15.4	2405 MHz, 2440 MHz, 2475 MHz
Maximum Peak Output Power	Tx BT LE 1 Mbps Tx BT LE 125 kbps Tx BT LE 500 kbps Tx BT LE 2 Mbps	2402 MHz, 2440 MHz, 2480 MHz
	Tx ANT 1Mbps Tx Nordic Original 2 Mbps	2402 MHz, 2441 MHz, 2480 MHz
	Tx IEEE 802.15.4	2405 MHz, 2440 MHz, 2475 MHz
Power Density 6dB Bandwidth 99% Occupied Bandwidth Conducted Spurious Emission	Tx BT LE 500 kbps Tx BT LE 2 Mbps	2402 MHz, 2440 MHz, 2480 MHz
	Tx ANT 1 Mbps Tx Nordic Original 2 Mbps	2402 MHz, 2441 MHz, 2480 MHz
	Tx IEEE 802.15.4	2405 MHz, 2440 MHz, 2475 MHz

UL Japan, Inc.

Shonan EMC Lab.

1-22-3 Megumigaoka, Hiratsuka-shi, Kanagawa-ken, 259-1220 JAPAN

Telephone : +81 463 50 6400

Facsimile : +81 463 50 6401

4.2 Configuration and peripherals

Radiated Emission and Conducted Emission test

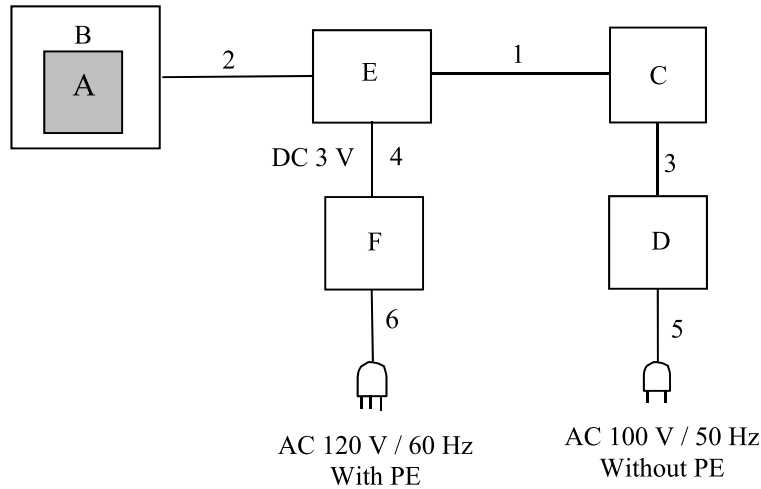

Antenna Terminal conducted test

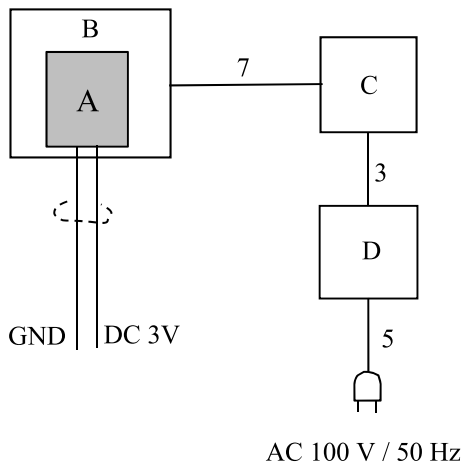

For Radiated Emission

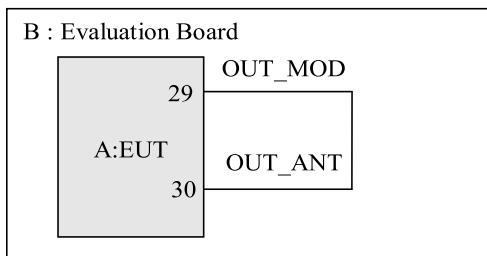

For Antenna Terminal Test

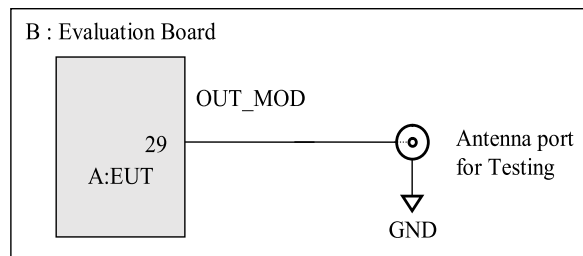

* Cabling and setup(s) were taken into consideration and test data was taken under worse case conditions.
The circuit of the evaluation board is designed based on the complete design required by the manufacturer of the module, and nothing is included between OUT_MOD and OUT_ANT.

Description of EUT and support equipment

No.	Item	Model number	Serial number	Manufacturer	Remarks
A	Bluetooth low energy / ANT / 802.15.4 Module	EYSKBN	1 *1) 3 *2) 2 *3) 5 *4) 6 *5)	TAIYO YUDEN	EUT
B	Evaluation Board	TE8952 *1) TE8783-1 *3)	-	TAIYO YUDEN	-
C	Laptop PC	PC-VK25TXZCE *6) CF-T2 *7)	2X017171A 4CKSA46826	NEC	-
D	AC Adaptor	ADP-75SB EB *6) CF-AA1625A *7)	2837264DE 1625AM406Z21913F	NEC	-
E	Control board	-	-	TAIYO YUDEN	-
F	DC Power Supply	PAN60-10A	NL002383	Kikusui	-

- *1) Used for ANT and Nordic Original mode (+8 dBm setting) for Radiated Emission and Conducted Emission test
*2) Used for BT LE mode (+8 dBm setting) for Radiated Emission and Conducted Emission test
*3) Used for BT LE mode (+8 dBm setting) for Antenna Terminal conducted test
*4) Used for BT LE mode (-40 dBm setting) for Antenna Terminal conducted test
*5) Used for ANT and Nordic Original mode (+8dBm setting) for Antenna Terminal conducted test
*6) Used for Radiated Emission, Conducted Emission and IEEE802.15.4 125 kbps for Antenna Terminal conducted test
*7) Used outside IEEE802.15.4 125 kbps for Antenna Terminal conducted test

List of cables used

No.	Name	Length (m)	Shield		Remarks
			Cable	Connector	
1	USB Cable	1.8	Shielded	Shielded	-
2	Signal Cable	0.2	Unshielded	Unshielded	-
3	DC Cable	1.8 *1) 1.2 *2)	Unshielded	Unshielded	-
4	DC Cable	2.6	Unshielded	Unshielded	-
5	AC Cable	0.9 *1) 0.8 *2)	Unshielded	Unshielded	-
6	AC Cable	2.0	Unshielded	Unshielded	-
7	DC Cable	0.5	Unshielded	Unshielded	-

- *1) Used for Radiated Emission, Conducted Emission and IEEE802.15.4 125 kbps for Antenna Terminal conducted test
*2) Used outside IEEE802.15.4 125 kbps for Antenna Terminal conducted test

SECTION 5: Conducted Emission

Test Procedure and conditions

EUT was placed on a urethane platform of nominal size, 1.0 m by 1.5 m, raised 0.8 m above the conducting ground plane.

The rear of tabletop was located 40 cm to the vertical conducting plane. The rear of EUT, including peripherals aligned and flushed with rear of tabletop. All other surfaces of tabletop were at least 80cm from any other grounded conducting surface. EUT was located 80 cm from a Line Impedance Stabilization Network (LISN) / Artificial mains Network (AMN) and excess AC cable was bundled in center.

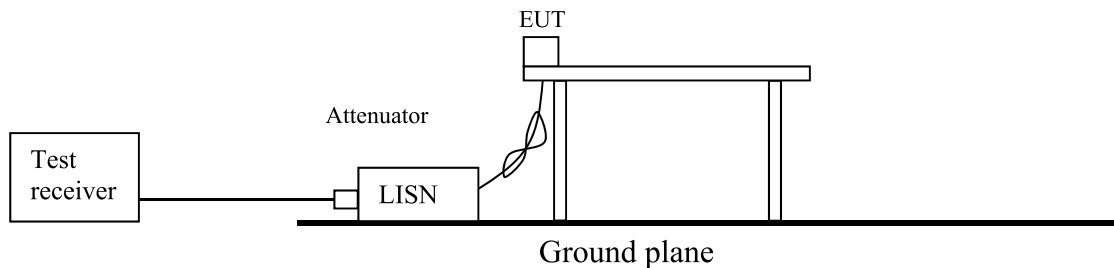

For the tests on EUT with other peripherals (as a whole system)

I/O cables that were connected to the peripherals were bundled in center. They were folded back and forth forming a bundle 30 cm to 40 cm long and were hung at a 40 cm height to the ground plane. All unused 50ohm connectors of the LISN (AMN) were resistivity terminated in 50 ohm when not connected to the measuring equipment.

The AC Mains Terminal Continuous disturbance Voltage has been measured with the EUT in a Shielded Room. The EUT was connected to a LISN (AMN).

An overview sweep with peak detection has been performed.

The test results and limit are rounded off to one decimal place, so some differences might be observed.

Detector	: QP and CISPR AV
Measurement range	: 0.15 MHz - 30 MHz
Test data	: APPENDIX
Test result	: Pass

UL Japan, Inc.

Shonan EMC Lab.

1-22-3 Megumigaoka, Hiratsuka-shi, Kanagawa-ken, 259-1220 JAPAN

Telephone : +81 463 50 6400

Facsimile : +81 463 50 6401

SECTION 6: Radiated Spurious Emission

Test Procedure

It was measured based on "8.5 and 8.6 of KDB 558074 D01 15.247 Meas Guidance v05".

[For below 1 GHz]

EUT was placed on a urethane platform of nominal size, 0.5 m by 0.5 m, raised 0.8 m above the conducting ground plane. The Radiated Electric Field Strength has been measured in a Semi Anechoic Chamber with a ground plane.

[For above 1 GHz]

EUT was placed on a urethane platform of nominal size, 0.5 m by 0.5 m, raised 1.5 m above the conducting ground plane.

The Radiated Electric Field Strength has been measured in a Semi Anechoic Chamber with absorbent materials lined on a ground plane.

The height of the measuring antenna varied between 1 and 4 m and EUT was rotated a full revolution in order to obtain the maximum value of the electric field strength.

The measurements were performed for both vertical and horizontal antenna polarization with the Test Receiver, or the Spectrum Analyzer.

The measurements were made with the following detector function of the test receiver and the Spectrum analyzer (in linear mode).

The test was made with the detector (RBW/VBW) in the following table.

When using Spectrum analyzer, the test was made with adjusting span to zero by using peak hold.

Test Antennas are used as below;

Frequency	30 MHz to 200 MHz	200 MHz to 1 GHz	Above 1 GHz
Antenna Type	Biconical	Logperiodic	Horn

In any 100 kHz bandwidth outside the restricted band in which the spread spectrum intentional radiator is operating, the radio frequency power that is produced by the intentional radiator confirmed 20 dB below that in the 100 kHz bandwidth within the band that contains the highest level of the desired power, based on a radiated measurement.

20 dBc was applied to the frequency over the limit of FCC 15.209 / Table 4 of RSS-Gen 8.9(IC) and outside the restricted band of FCC15.205 / Table 6 of RSS-Gen 8.10 (IC).

Frequency	Below 1 GHz	Above 1 GHz		20 dBc
Instrument used	Test Receiver	Spectrum Analyzer		Spectrum Analyzer
Detector	QP	PK	AV *1)	PK
IF Bandwidth	BW 120 kHz	RBW: 1 MHz VBW: 3 MHz	11.12.2.5.2 RBW: 1 MHz VBW: 3 MHz Detector: Power Averaging (Linear voltage) Trace: 100 traces Duty factor was added to the results.	RBW: 100 kHz VBW: 300 kHz

*1) Average Power Measurement was performed based on ANSI C63.10-2013.

UL Japan, Inc.

Shonan EMC Lab.

1-22-3 Megumigaoka, Hiratsuka-shi, Kanagawa-ken, 259-1220 JAPAN

Telephone : +81 463 50 6400

Facsimile : +81 463 50 6401

Below 1 GHz

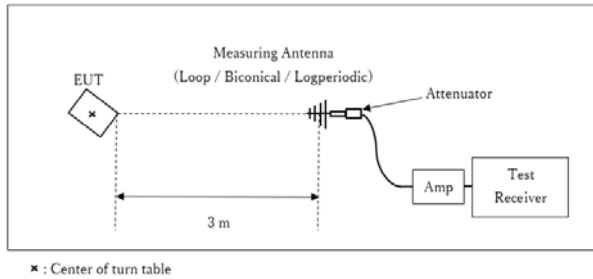

Test Distance: 3 m

1 GHz - 13 GHz

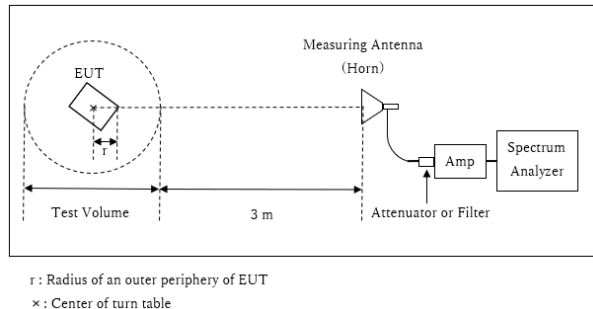

Distance Factor: $20 \times \log(3.98 \text{ m}^*/3.0 \text{ m}) = 2.46 \text{ dB}$
* Test Distance: $(3 + \text{Test Volume} / 2) - r = 3.98 \text{ m}$

Test Volume: 2 m
(Test Volume has been calibrated based on CISPR 16-1-4.)
 $r = 0.02 \text{ m}$

13 GHz - 26.5 GHz

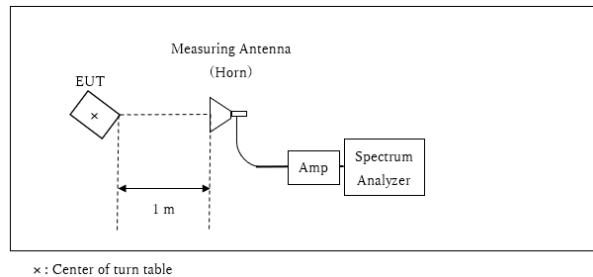

Distance Factor: $20 \times \log(1.0 \text{ m}^* / 3.0 \text{ m}) = -9.54 \text{ dB}$
*Test Distance: 1 m

- The carrier level and noise levels were confirmed at each position of X, Y and Z axes of EUT to see the position of maximum noise, and the test was made at the position that has the maximum noise.
The test results and limit are rounded off to one decimal place, so some differences might be observed.

Worst position:

(BT LE 500 kbps, 2 Mbps)

	Below 1 GHz	1 GHz - 2.8 GHz	2.8 GHz - 13 GHz	13 GHz - 18 GHz	18 GHz - 26.5 GHz
Horizontal	X	X	X	X	X
Vertical	X	Z	Z	X	Z

(ANT 1 Mbps, Nordic Original 2 Mbps, IEEE 802.15.4)

	Below 1 GHz	1 GHz - 2.8 GHz	2.8 GHz - 13 GHz	13 GHz - 18 GHz	18 GHz - 26.5 GHz
Horizontal	X	X	X	X	X
Vertical	X	Z	Z	X	Z

Measurement range : 30 MHz - 26.5 GHz

Test data : APPENDIX

Test result : Pass

UL Japan, Inc.

Shonan EMC Lab.

1-22-3 Megumigaoka, Hiratsuka-shi, Kanagawa-ken, 259-1220 JAPAN

Telephone : +81 463 50 6400

Facsimile : +81 463 50 6401

SECTION 7: Antenna Terminal Conducted Tests

Test Procedure

The tests were made with below setting connected to the antenna port.

Test	Span	RBW	VBW	Sweep time	Detector	Trace	Instrument used
6dB Bandwidth	10 MHz	100 kHz	300 kHz	Auto	Peak	Max Hold	Spectrum Analyzer
99% Occupied Bandwidth *1)	Enough width to display emission skirts	1 to 5 % of OBW	Three times of RBW	Auto	Peak	Max Hold	Spectrum Analyzer
Maximum Peak Output Power	-	-	-	Auto	Peak/Average *2)	-	Spectrum Analyzer *3) *4)
Peak Power Density	1.5 times the 6dB Bandwidth	3 kHz	9.1 kHz	Auto	Peak	Max Hold	Spectrum Analyzer *5)
Conducted Spurious Emission *6)	9 kHz to 150 kHz	200 Hz	620 Hz	Auto	Peak	Max Hold	Spectrum Analyzer
	150 kHz to 30 MHz	10 kHz	30 kHz				

*1) Peak hold was applied as Worst-case measurement.
*2) Reference data
*3) Peak Power Measurement was performed based on Section 11.9.1.1 RBW \geq DTS bandwidth of "ANSI C63.10-2013".
*4) Average Power Measurement was performed based on Section 11.9.2.2.4 Method AVGSA-2 of "ANSI C63.10-2013".
*5) Section 11.10.2 Method PKPSD (peak PSD) of "ANSI C63.10-2013".
*6) In the frequency range below 30 MHz, RBW was narrowed to separate the noise contents.
Then, wide-band noise near the limit was checked separately, however the noise was not detected as shown in the chart.
(9 kHz - 150 kHz: RBW = 200 Hz, 150 kHz - 30 MHz: RBW = 10 kHz)

The test results and limit are rounded off to two decimals place, so some differences might be observed.

Test data : APPENDIX
Test result : Pass

APPENDIX 1: Test data

Conducted Emission

DATA OF CONDUCTED EMISSION TEST

UL Japan, Inc. Shonan EMC Lab. No.1 Shielded Room
Date : 2018/10/15

Mode : Tx BT LE 500 kbps 2440 MHz
Power : DC 3 V (AC 120 V / 60 Hz)
Temp./Humi. : 23 deg.C / 52 %RH

Remarks : -

Limit1 : FCC 15C (15.207) QP
Limit2 : FCC 15C (15.207) AV

Engineer : Shiro Kobayashi

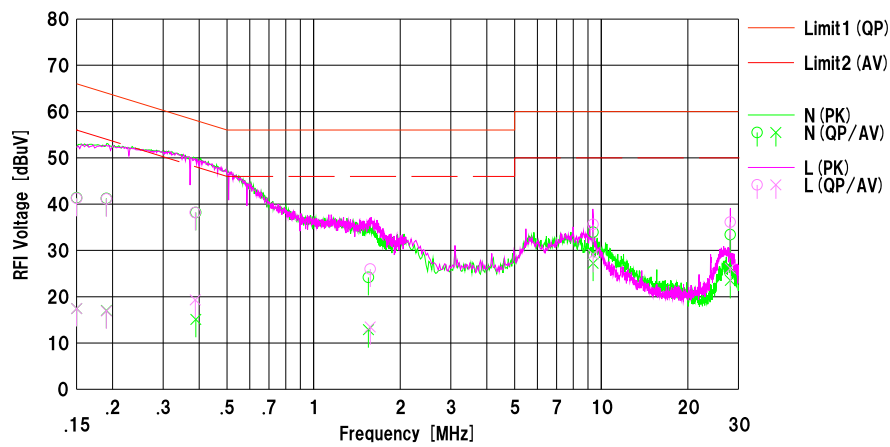

No.	Freq. [MHz]	Reading		C.Fac [dB]	Results		Limit		Margin		Phase	Comment
		<QP> [dBuV]	<AV> [dBuV]		<QP> [dBuV]	<AV> [dBuV]	<QP> [dBuV]	<AV> [dBuV]	<QP> [dB]	<AV> [dB]		
1	0.15000	28.90	5.00	12.45	41.35	17.45	66.00	56.00	24.6	38.5	N	
2	0.19038	28.80	4.60	12.44	41.24	17.04	64.02	54.02	22.7	36.9	N	
3	0.38947	25.70	2.60	12.50	38.20	15.10	58.07	48.07	19.8	32.9	N	
4	1.55133	11.60	0.30	12.58	24.18	12.88	56.00	46.00	31.8	33.1	N	
5	9.37324	20.90	14.20	13.03	33.93	27.23	60.00	50.00	26.0	22.7	N	
6	28.11210	19.60	9.70	13.81	33.41	23.51	60.00	50.00	26.5	26.4	N	
7	0.15000	28.80	5.00	12.45	41.25	17.45	66.00	56.00	24.7	38.5	L	
8	0.19038	28.70	4.50	12.44	41.14	16.94	64.02	54.02	22.8	37.0	L	
9	0.38787	25.70	6.80	12.50	38.20	19.30	58.11	48.11	19.9	28.8	L	
10	1.57376	13.40	0.90	12.58	25.98	13.48	56.00	46.00	30.0	32.5	L	
11	9.36972	22.60	16.10	13.03	35.63	29.13	60.00	50.00	24.3	20.8	L	
12	28.11165	22.30	12.30	13.81	36.11	26.11	60.00	50.00	23.8	23.8	L	

Calculation:Result [dBuV] =Reading [dBuV] +C.Fac (LISN (AMN) +Cable+ATT) [dB]
LISN (AMN):SLS-02

Conducted Emission

Report No.	12510206S-A-R3
Test place	Shonan EMC Lab. No.1 Semi Anechoic Chamber
Date	October 15, 2018
Temperature / Humidity	23 deg. C / 52 % RH
Engineer	Shiro Kobayashi
Mode	Tx BT LE 500 kbps

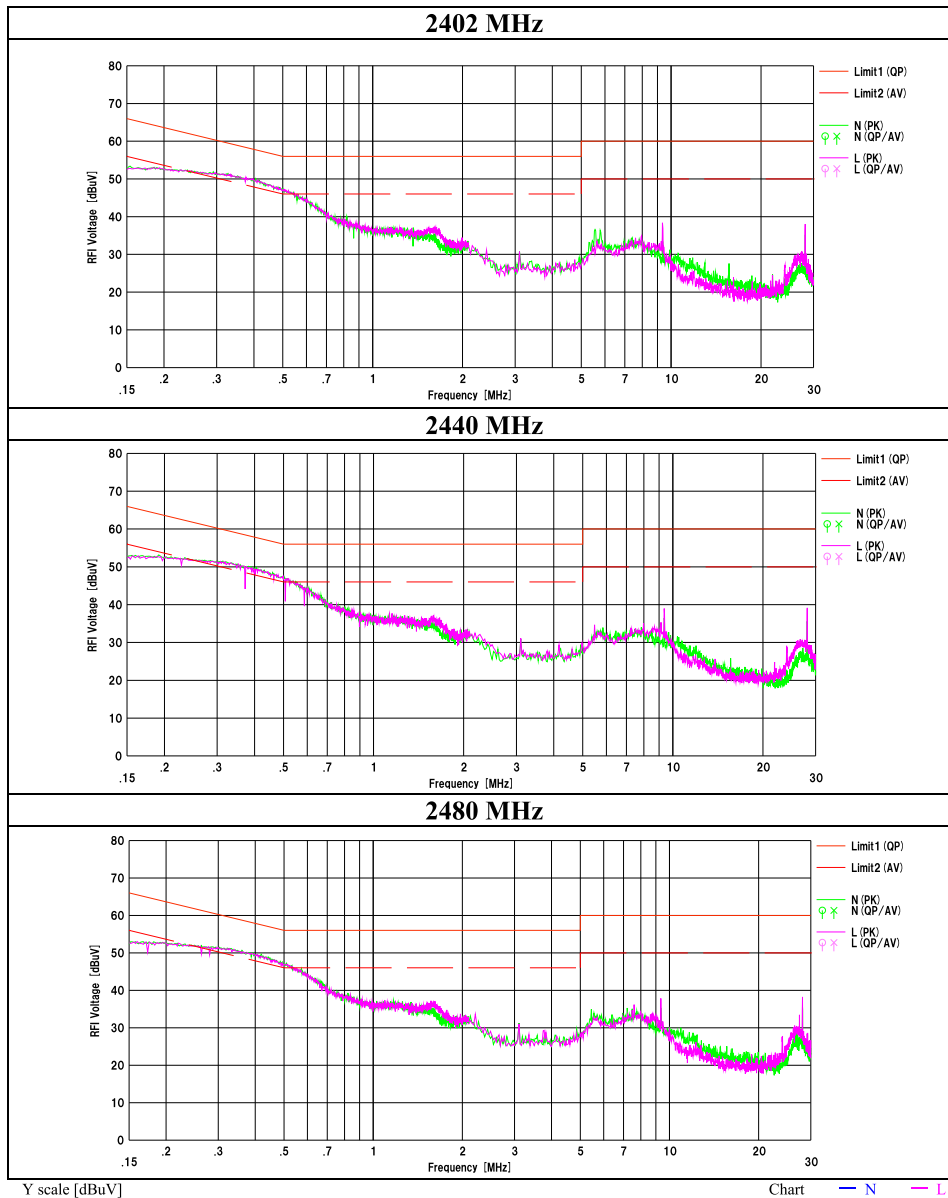

UL Japan, Inc.

Shonan EMC Lab.

1-22-3 Megumigaoka, Hiratsuka-shi, Kanagawa-ken, 259-1220 JAPAN

Telephone : +81 463 50 6400

Facsimile : +81 463 50 6401

Conducted Emission

DATA OF CONDUCTED EMISSION TEST

UL Japan, Inc. Shonan EMC Lab. No.1 Shielded Room
Date : 2018/10/15

Mode : Tx BT LE 2 Mbps 2440 MHz
Power : DC 3 V (AC 120 V / 60 Hz)
Temp./Humi. : 23 deg.C / 52 %RH

Remarks : -

Limit1 : FCC 15C (15.207) QP
Limit2 : FCC 15C (15.207) AV

Engineer : Shiro Kobayashi

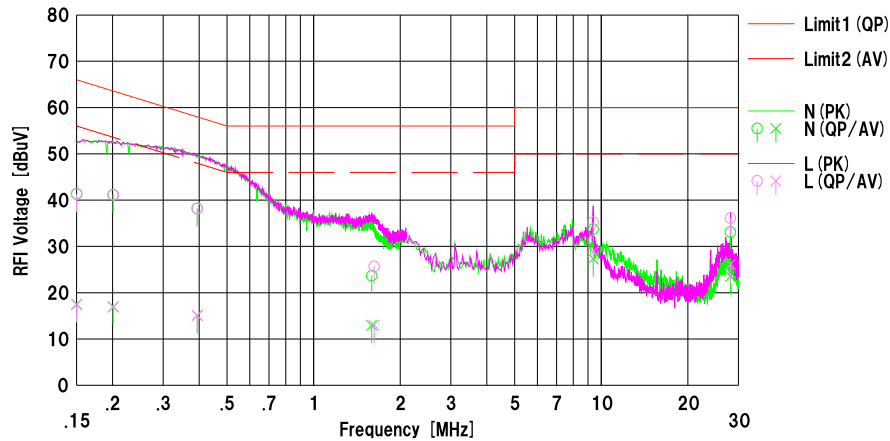

No.	Freq. [MHz]	Reading		CFac [dB]	Results		Limit		Margin		Phase	Comment
		<QP> [dBuV]	<AV> [dBuV]		<QP> [dBuV]	<AV> [dBuV]	<QP> [dBuV]	<AV> [dBuV]	<QP> [dB]	<AV> [dB]		
1	0.15000	28.90	5.00	12.45	41.35	17.45	66.00	56.00	24.6	38.5	N	
2	0.20086	28.70	4.50	12.43	41.13	16.93	63.57	53.57	22.4	36.6	N	
3	0.39419	25.70	2.60	12.50	38.20	15.10	57.97	47.97	19.7	32.8	N	
4	1.59314	11.10	0.40	12.58	23.68	12.98	56.00	46.00	32.3	33.0	N	
5	9.38230	20.70	14.30	13.03	33.73	27.33	60.00	50.00	26.2	22.6	N	
6	28.14510	19.30	9.70	13.81	33.11	23.51	60.00	50.00	26.8	26.4	N	
7	0.15000	28.80	5.10	12.45	41.25	17.55	66.00	56.00	24.7	38.4	L	
8	0.20142	28.70	4.50	12.43	41.13	16.93	63.55	53.55	22.4	36.6	L	
9	0.39419	25.70	2.60	12.50	38.20	15.10	57.97	47.97	19.7	32.8	L	
10	1.62450	13.10	0.40	12.58	25.68	12.98	56.00	46.00	30.3	33.0	L	
11	9.38100	22.20	15.80	13.03	35.23	28.83	60.00	50.00	24.7	21.1	L	
12	28.14760	22.30	12.30	13.81	36.11	26.11	60.00	50.00	23.8	23.8	L	

Calculation: Result [dBuV] = Reading [dBuV] + C.Fac (LISN (AMN) + Cable + ATT) [dB]
LISN (AMN): SLS-02

Conducted Emission

Report No.	12510206S-A-R3
Test place	Shonan EMC Lab. No.1 Semi Anechoic Chamber
Date	October 15, 2018
Temperature / Humidity	23 deg. C / 52 % RH
Engineer	Shiro Kobayashi
Mode	Tx BT LE 2 Mbps

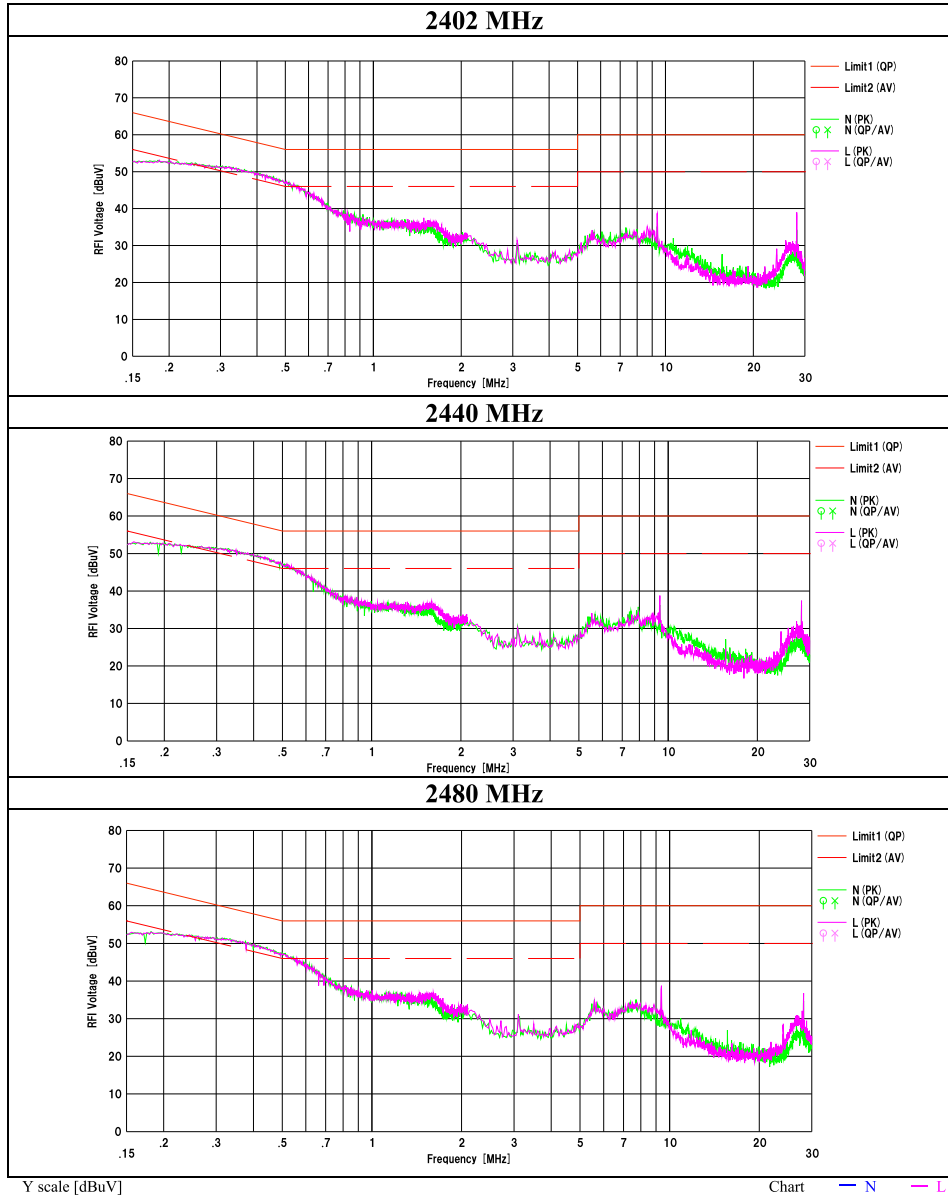

UL Japan, Inc.

Shonan EMC Lab.

1-22-3 Megumigaoka, Hiratsuka-shi, Kanagawa-ken, 259-1220 JAPAN

Telephone : +81 463 50 6400

Facsimile : +81 463 50 6401

Conducted Emission

DATA OF CONDUCTED EMISSION TEST

UL Japan, Inc. Shonan EMC Lab. No.1 Shielded Room
Date : 2018/10/15

Mode : Tx ANT 1 Mbps 2441 MHz
Power : DC 3 V (AC 120 V / 60 Hz)
Temp./Humi. : 23 deg.C / 52 %RH

Remarks : -

Limit1 : FCC 15C (15.207) QP
Limit2 : FCC 15C (15.207) AV

Engineer : Shiro Kobayashi

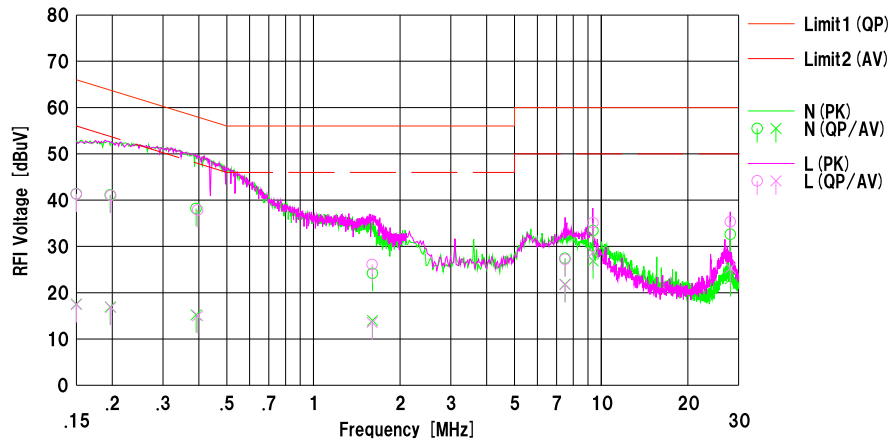

No.	Freq. [MHz]	Reading		CFac [dB]	Results		Limit		Margin		Phase	Comment
		<QP> [dBuV]	<AV> [dBuV]		<QP> [dBuV]	<AV> [dBuV]	<QP> [dBuV]	<AV> [dBuV]	<QP> [dB]	<AV> [dB]		
1	0.15000	28.90	5.10	12.45	41.35	17.55	66.00	56.00	24.6	38.4	N	
2	0.19679	28.70	4.50	12.44	41.14	16.94	63.74	53.74	22.6	36.8	N	
3	0.39107	25.70	2.70	12.50	38.20	15.20	58.04	48.04	19.8	32.8	N	
4	1.60405	11.60	1.40	12.58	24.18	13.98	56.00	46.00	31.8	32.0	N	
5	7.48548	14.50	8.90	12.94	27.44	21.84	60.00	50.00	32.5	28.1	N	
6	9.37361	20.40	13.90	13.03	33.43	26.93	60.00	50.00	26.5	23.0	N	
7	28.11931	18.80	9.20	13.81	32.61	23.01	60.00	50.00	27.3	26.9	N	
8	0.15000	28.85	5.00	12.45	41.30	17.45	66.00	56.00	24.7	38.5	L	
9	0.19739	28.60	4.40	12.43	41.03	16.83	63.72	53.72	22.6	36.8	L	
10	0.39600	25.40	2.50	12.50	37.90	15.00	57.94	47.94	20.0	32.9	L	
11	1.60053	13.50	1.00	12.58	26.08	13.58	56.00	46.00	29.9	32.4	L	
12	7.48500	14.30	8.80	12.94	27.24	21.74	60.00	50.00	32.7	28.2	L	
13	9.36728	22.10	15.70	13.03	35.13	28.73	60.00	50.00	24.8	21.2	L	
14	28.10192	21.50	11.50	13.81	35.31	25.31	60.00	50.00	24.6	24.6	L	

Calculation: Result [dBuV] = Reading [dBuV] + C.Fac (LISN (AMN) + Cable + ATT) [dB]
LISN (AMN): SLS-02

Conducted Emission

Report No.	12510206S-A-R3
Test place	Shonan EMC Lab. No.1 Semi Anechoic Chamber
Date	October 15, 2018
Temperature / Humidity	23 deg. C / 52 % RH
Engineer	Shiro Kobayashi
Mode	Tx ANT 1 Mbps

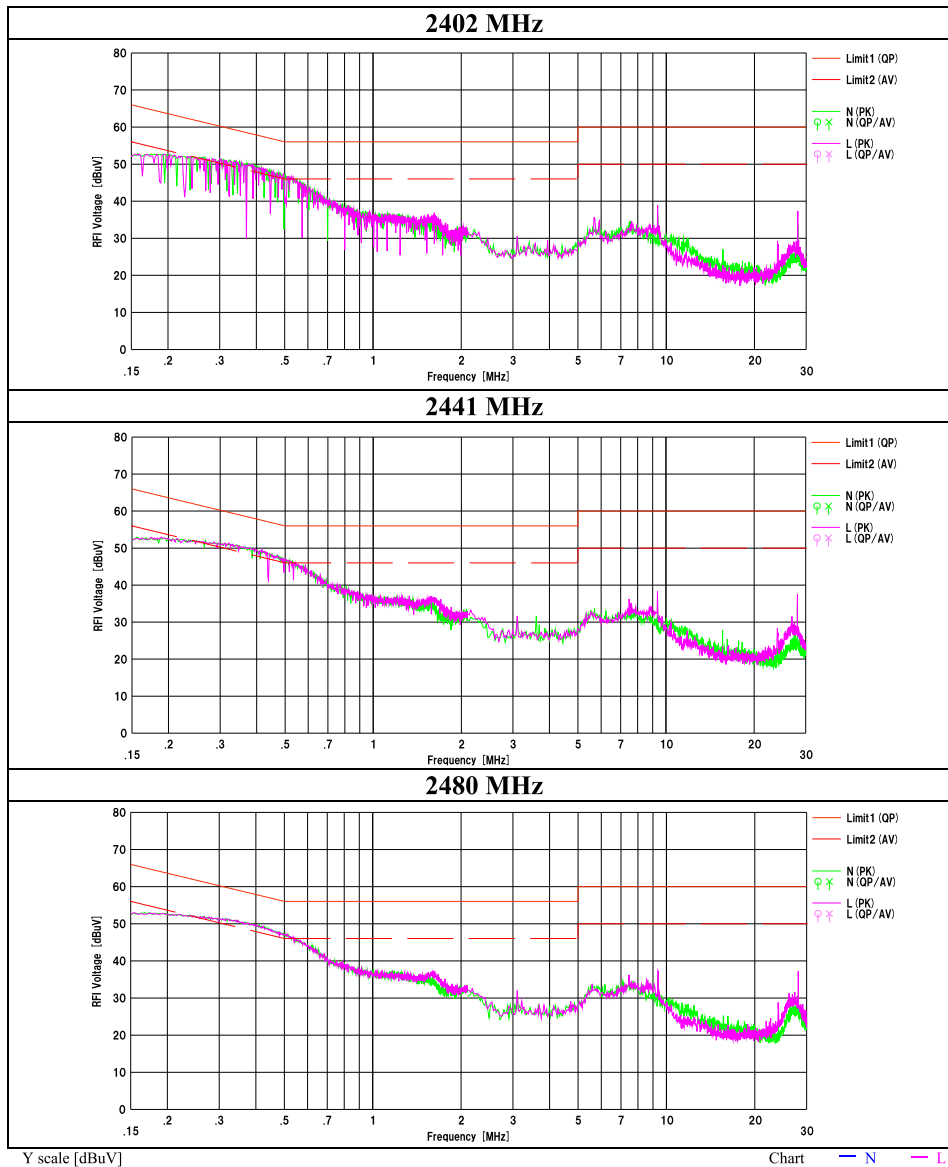

UL Japan, Inc.

Shonan EMC Lab.

1-22-3 Megumigaoka, Hiratsuka-shi, Kanagawa-ken, 259-1220 JAPAN

Telephone : +81 463 50 6400

Facsimile : +81 463 50 6401

Conducted Emission

DATA OF CONDUCTED EMISSION TEST

UL Japan, Inc. Shonan EMC Lab. No.1 Shielded Room
Date : 2018/10/15

Mode : Tx Nordic Original 2 Mbps 2441 MHz
Power : DC 3 V (AC 120 V / 60 Hz)
Temp./Humi. : 23 deg.C / 52 %RH

Remarks : -

Limit1 : FCC 15C (15.207) QP
Limit2 : FCC 15C (15.207) AV

Engineer : Shiro Kobayashi

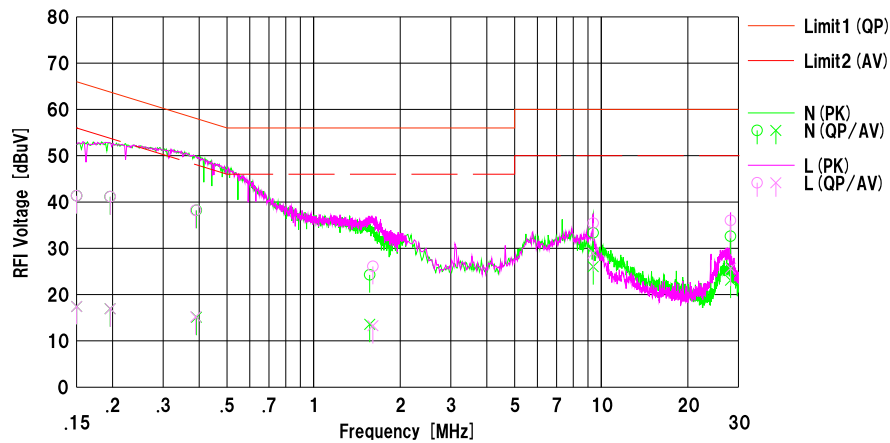

No.	Freq. [MHz]	Reading		C.Fac	Results		Limit		Margin		Phase	Comment
		<QP> [dBuV]	<AV> [dBuV]		<QP> [dBuV]	<AV> [dBuV]	<QP> [dBuV]	<AV> [dBuV]	<QP> [dB]	<AV> [dB]		
1	0.15000	28.90	5.00	12.45	41.35	17.45	66.00	56.00	24.6	38.5	N	
2	0.19622	28.70	4.50	12.44	41.14	16.94	63.77	53.77	22.6	36.8	N	
3	0.39168	25.70	2.60	12.50	38.20	15.10	58.03	48.03	19.8	32.9	N	
4	1.56712	11.70	1.00	12.58	24.28	13.58	56.00	46.00	31.7	32.4	N	
5	9.37942	20.30	13.00	13.03	33.33	26.03	60.00	50.00	26.6	23.9	N	
6	28.15820	18.80	9.30	13.81	32.61	23.11	60.00	50.00	27.3	26.8	N	
7	0.15000	28.90	5.00	12.45	41.35	17.45	66.00	56.00	24.6	38.5	L	
8	0.19647	28.70	4.50	12.44	41.14	16.94	63.76	53.76	22.6	36.8	L	
9	0.38928	25.70	2.70	12.50	38.20	15.20	58.08	48.08	19.8	32.8	L	
10	1.60819	13.50	0.70	12.58	26.08	13.28	56.00	46.00	29.9	32.7	L	
11	9.37925	22.40	15.90	13.03	35.43	28.93	60.00	50.00	24.5	21.0	L	
12	28.15820	22.20	11.90	13.81	36.01	25.71	60.00	50.00	23.9	24.2	L	

Calculation: Result [dBuV] = Reading [dBuV] + C.Fac (LISN (AMN) + Cable + ATT) [dB]
LISN (AMN): SLS-02

Conducted Emission

Report No.	12510206S-A-R3
Test place	Shonan EMC Lab. No.1 Semi Anechoic Chamber
Date	October 15, 2018
Temperature / Humidity	23 deg. C / 52 % RH
Engineer	Shiro Kobayashi
Mode	Tx Nordic Original 2 Mbps

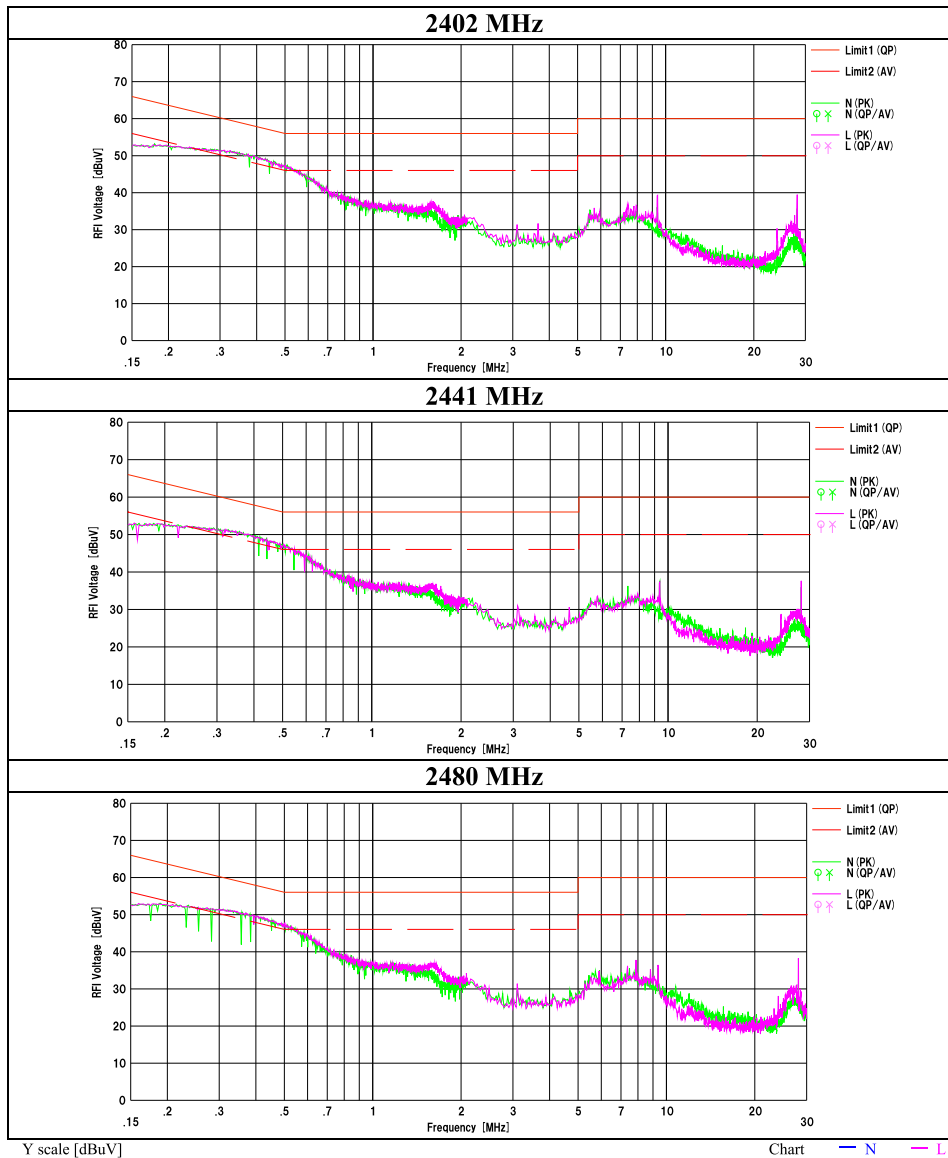

UL Japan, Inc.

Shonan EMC Lab.

1-22-3 Megumigaoka, Hiratsuka-shi, Kanagawa-ken, 259-1220 JAPAN

Telephone : +81 463 50 6400

Facsimile : +81 463 50 6401

Conducted Emission

DATA OF CONDUCTED EMISSION TEST

UL Japan, Inc. Shonan EMC Lab. No.1 Shielded Room
Date : 2018/10/15

Mode : Tx IEEE802.15.4 2440 MHz
Power : DC 3 V (AC 120 V / 60 Hz)
Temp./Humi. : 23 deg.C / 52 %RH

Remarks : -

Limit1 : FCC 15C (15.207) QP
Limit2 : FCC 15C (15.207) AV

Engineer : Shiro Kobayashi

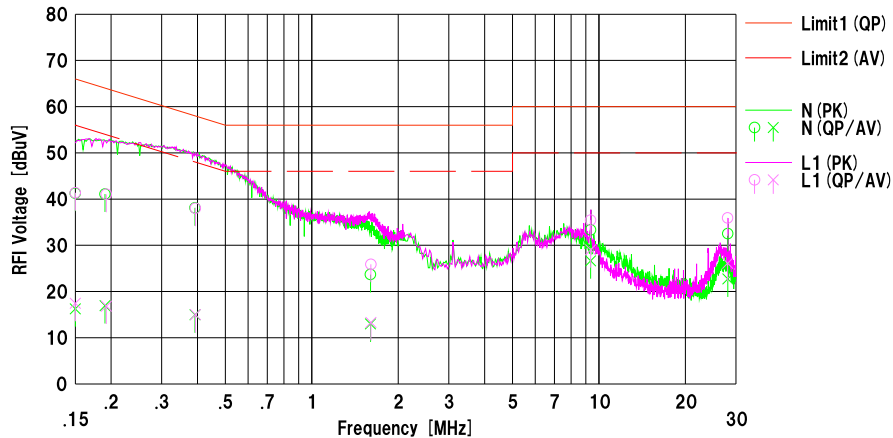

No.	Freq. [MHz]	Reading		C.Fac [dB]	Results		Limit		Margin		Phase	Comment
		<QP> [dBuV]	<AV> [dBuV]		<QP> [dBuV]	<AV> [dBuV]	<QP> [dBuV]	<AV> [dBuV]	<QP> [dB]	<AV> [dB]		
1	0.15000	28.80	3.80	12.45	41.25	16.25	66.00	56.00	24.7	39.7	N	
2	0.19043	28.64	4.50	12.44	41.08	16.94	64.02	54.02	22.9	37.0	N	
3	0.39171	25.60	2.44	12.50	38.10	14.94	58.03	48.03	19.9	33.0	N	
4	1.60158	11.10	0.40	12.58	23.68	12.98	56.00	46.00	32.3	33.0	N	
5	9.36241	20.30	13.60	13.03	33.33	26.63	60.00	50.00	26.6	23.3	N	
6	28.13103	18.70	8.90	13.81	32.51	22.71	60.00	50.00	27.4	27.2	N	
7	0.15000	28.90	5.00	12.45	41.35	17.45	66.00	56.00	24.6	38.5	L1	
8	0.19239	28.60	4.40	12.43	41.03	16.83	63.93	53.93	22.9	37.1	L1	
9	0.39315	25.50	2.50	12.50	38.00	15.00	58.00	48.00	20.0	33.0	L1	
10	1.60737	13.30	0.70	12.58	25.88	13.28	56.00	46.00	30.1	32.7	L1	
11	9.36170	22.40	16.00	13.03	35.43	29.03	60.00	50.00	24.5	20.9	L1	
12	28.08196	22.10	12.30	13.81	35.91	26.11	60.00	50.00	24.0	23.8	L1	

Calculation: Result [dBuV] = Reading [dBuV] + C.Fac (LISN (AMN) + Cable + ATT) [dB]
LISN (AMN) : SLS-02

Conducted Emission

Report No.	12510206S-A-R3
Test place	Shonan EMC Lab. No.1 Semi Anechoic Chamber
Date	October 15, 2018
Temperature / Humidity	23 deg. C / 52 % RH
Engineer	Shiro Kobayashi
Mode	Tx IEEE 802.15.4

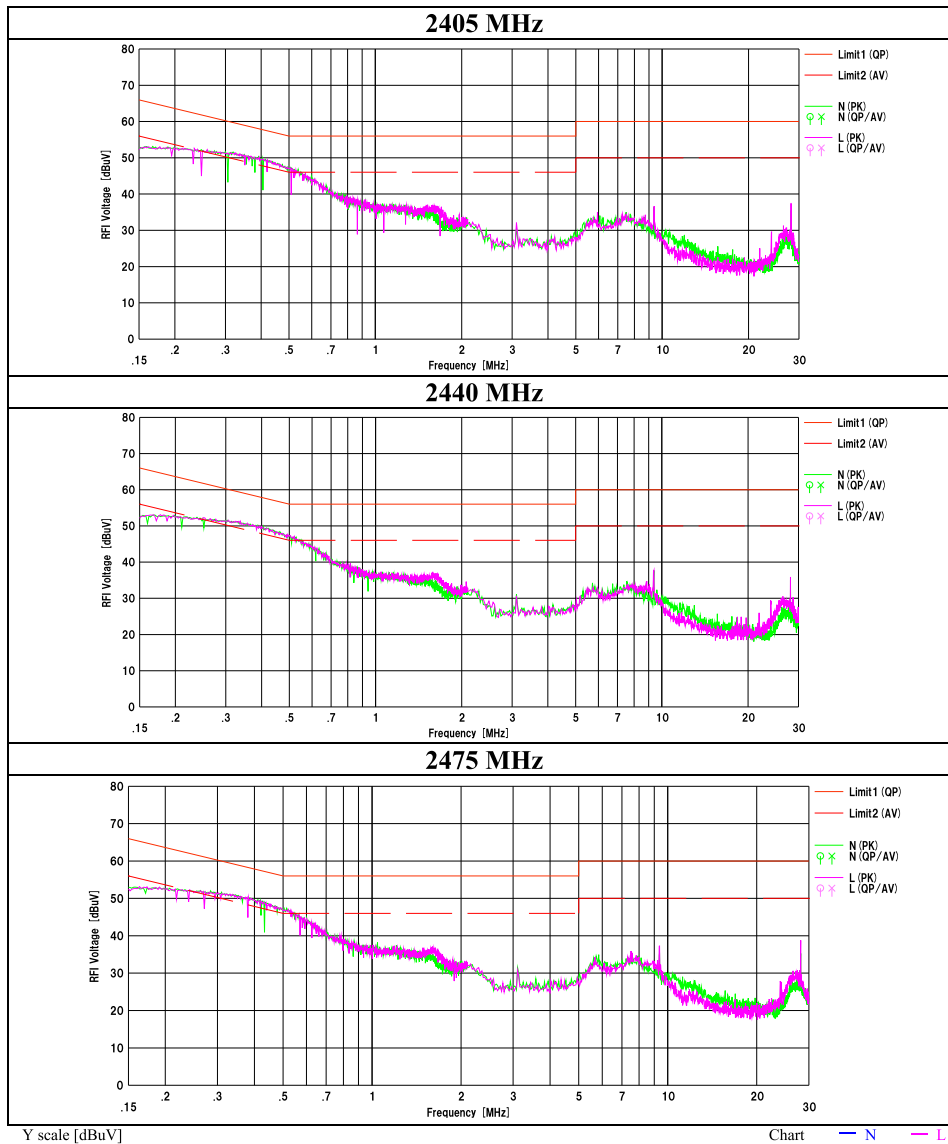

UL Japan, Inc.

Shonan EMC Lab.

1-22-3 Megumigaoka, Hiratsuka-shi, Kanagawa-ken, 259-1220 JAPAN

Telephone : +81 463 50 6400

Facsimile : +81 463 50 6401

6 dB Bandwidth and 99 % Occupied Bandwidth

Report No. 12510206S-A-R3
Test place Shonan EMC Lab. No.1 Measurement Room / No.5 Shielded Room
Date September 25, 2018 September 26, 2018 October 1, 2018 October 12, 2018
Temperature / Humidity 26 deg. C / 50 % RH 25 deg. C / 49 % RH 25 deg. C / 59 % RH 25 deg. C / 36 % RH
Engineer Yosuke Ishikawa Yosuke Ishikawa Shiro Kobayashi Kazutaka Takeyama
Mode Tx

Mode	Frequency [MHz]	99% Occupied Bandwidth [kHz]	6dB Bandwidth [MHz]	Limit for 6dB Bandwidth [MHz]
BT LE 500 kps	2402	1043.9	0.740	> 0.5000
	2440	1050.1	0.724	> 0.5000
	2480	1047.4	0.724	> 0.5000
BT LE 2 Mbps	2402	2054.8	1.166	> 0.5000
	2440	2056.9	1.176	> 0.5000
	2480	2059.2	1.187	> 0.5000
ANT 1 Mbps	2402	886.3	0.506	> 0.5000
	2441	892.9	0.509	> 0.5000
	2480	894.1	0.503	> 0.5000
Nordic Original 2 Mbps	2402	1708.7	0.849	> 0.5000
	2441	1714.0	0.858	> 0.5000
	2480	1720.8	0.828	> 0.5000
IEEE802.15.4	2405	2262.7	1.574	> 0.5000
	2440	2259.1	1.551	> 0.5000
	2475	2253.7	1.584	> 0.5000

99%Occupied Bandwidth

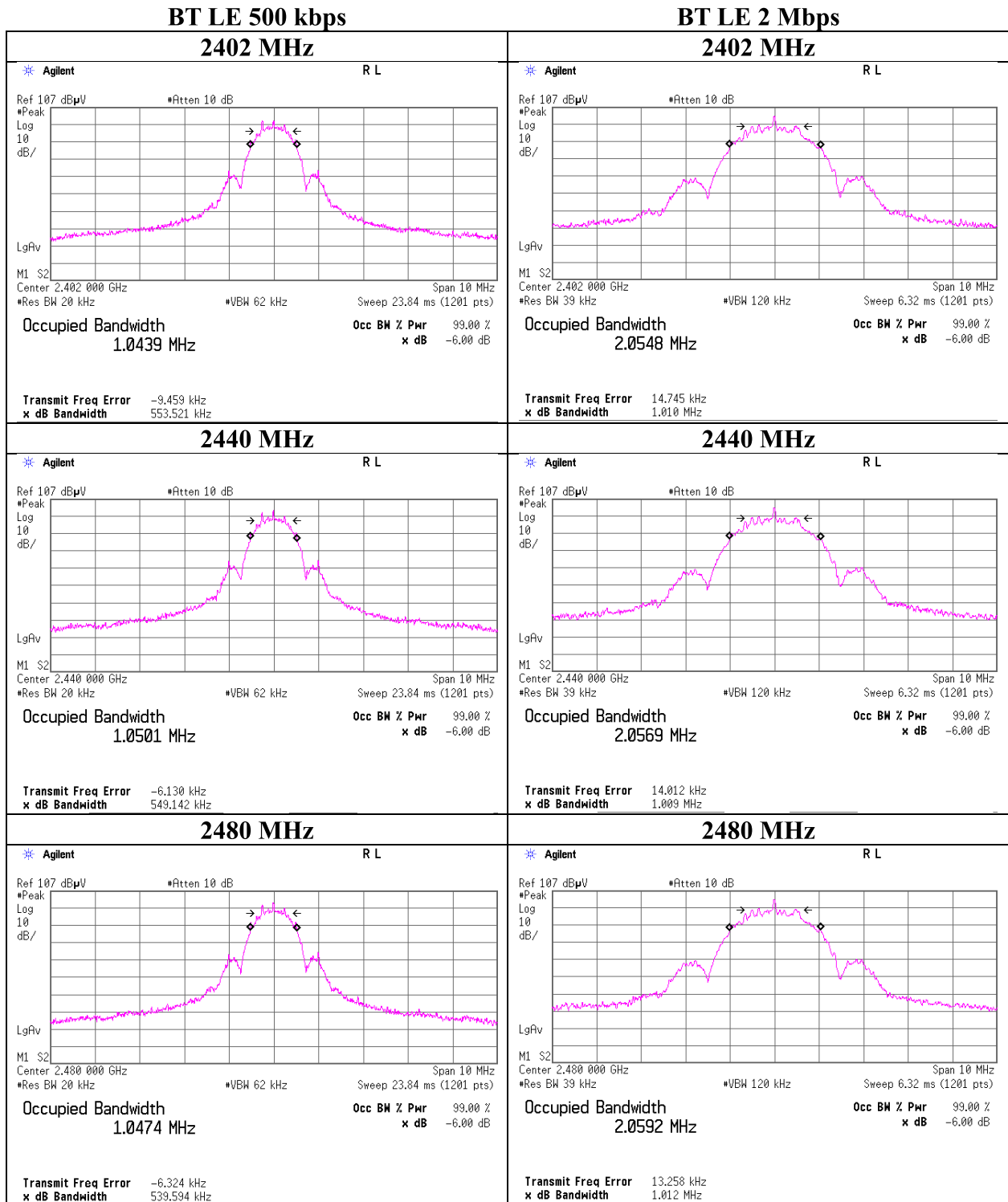

99% Occupied Bandwidth

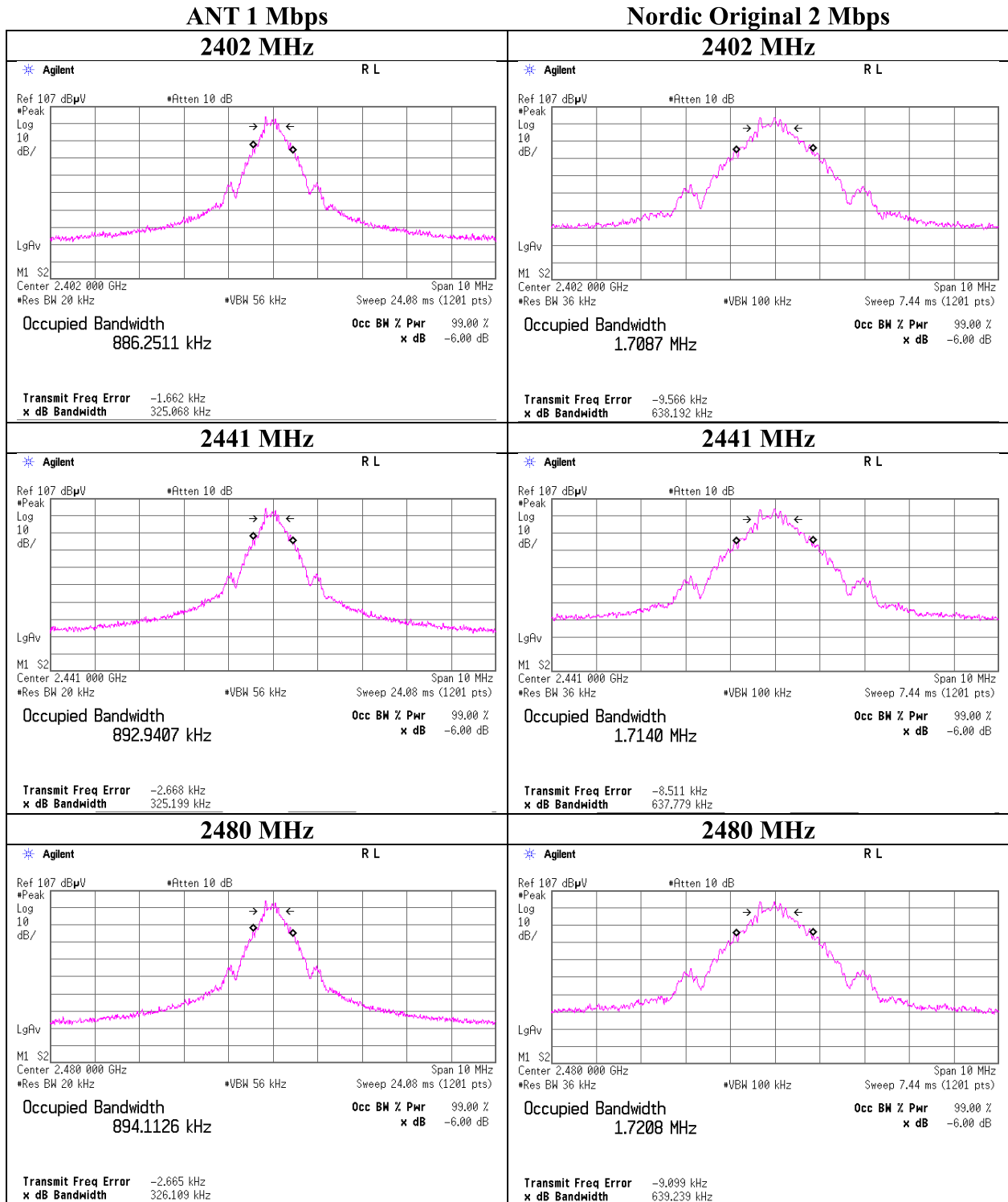

99% Occupied Bandwidth

IEEE802.15.4

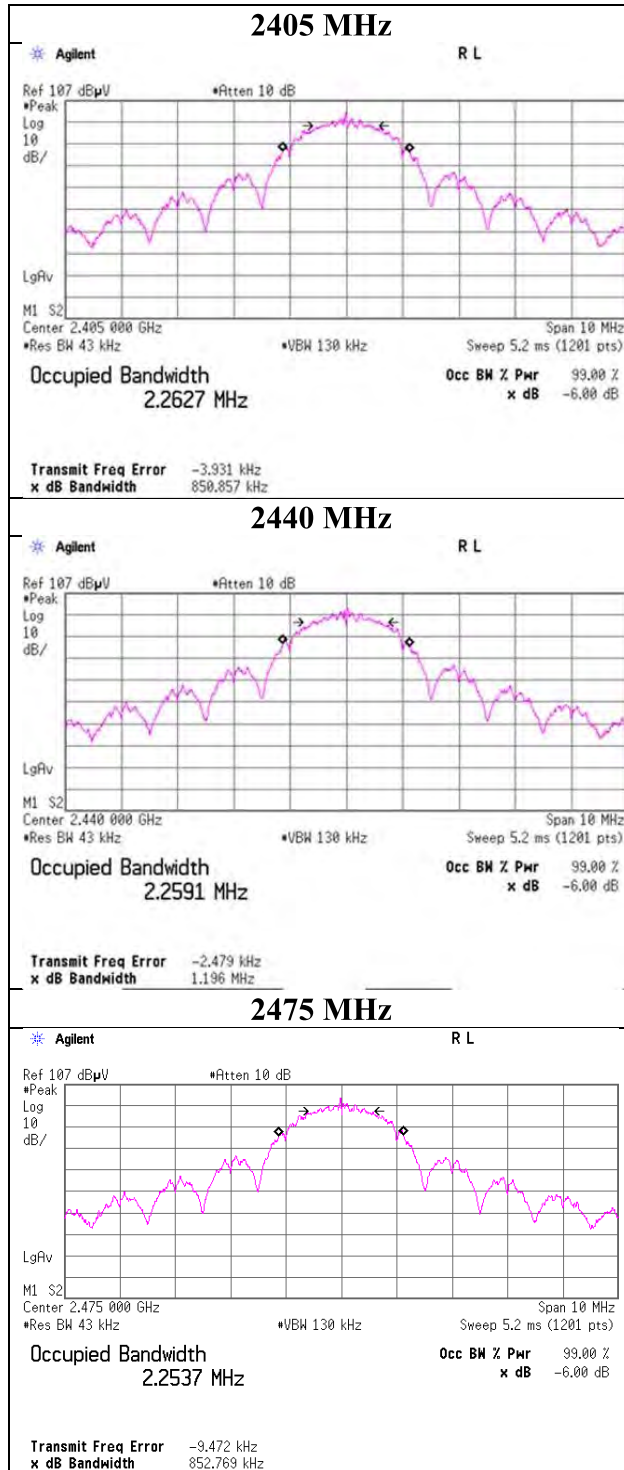

6dB Bandwidth

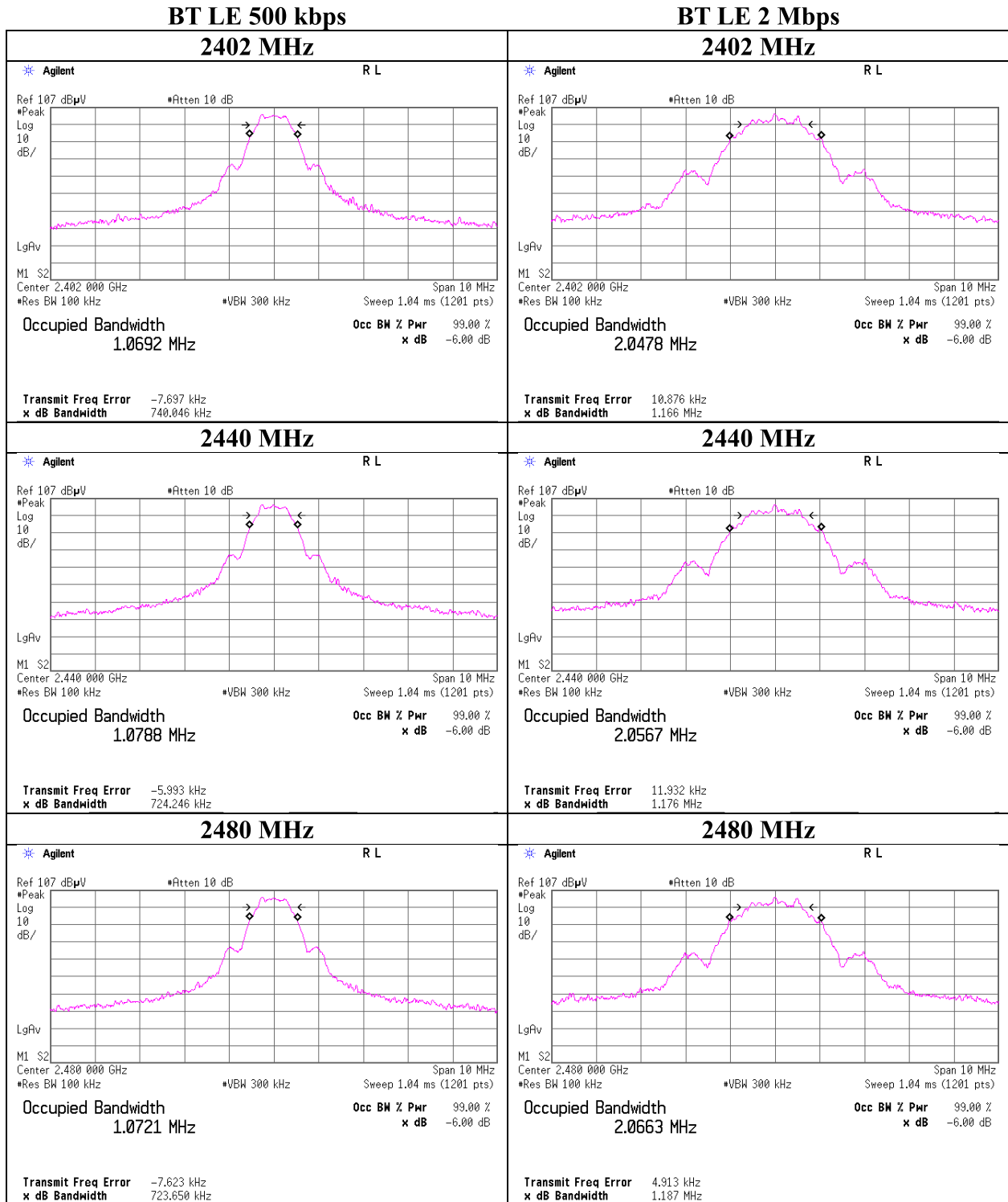

UL Japan, Inc.

Shonan EMC Lab.

1-22-3 Megumigaoka, Hiratsuka-shi, Kanagawa-ken, 259-1220 JAPAN

Telephone : +81 463 50 6400

Facsimile : +81 463 50 6401

6dB Bandwidth

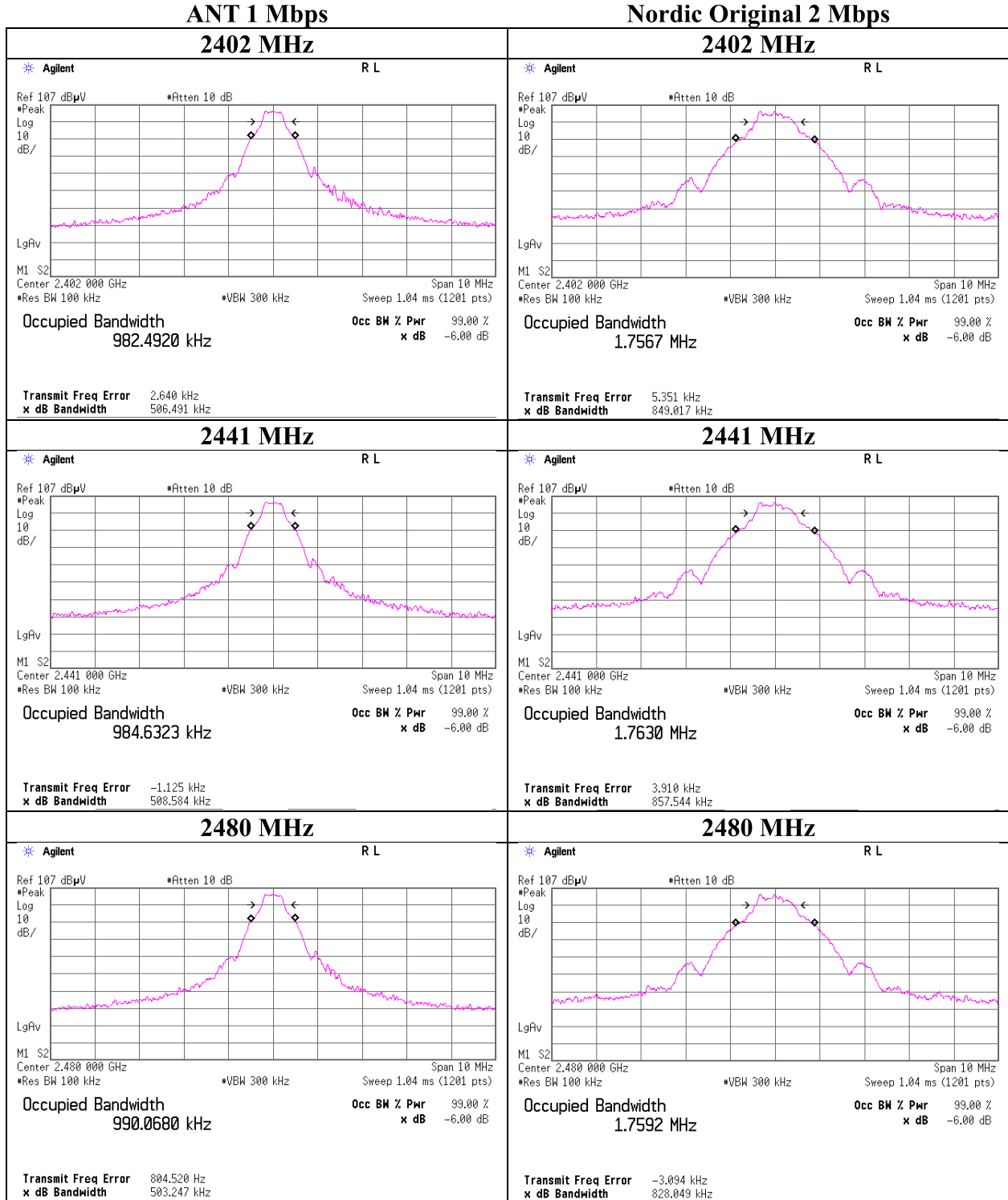

UL Japan, Inc.

Shonan EMC Lab.

1-22-3 Megumigaoka, Hiratsuka-shi, Kanagawa-ken, 259-1220 JAPAN

Telephone : +81 463 50 6400

Facsimile : +81 463 50 6401

6dB Bandwidth

IEEE802.15.4

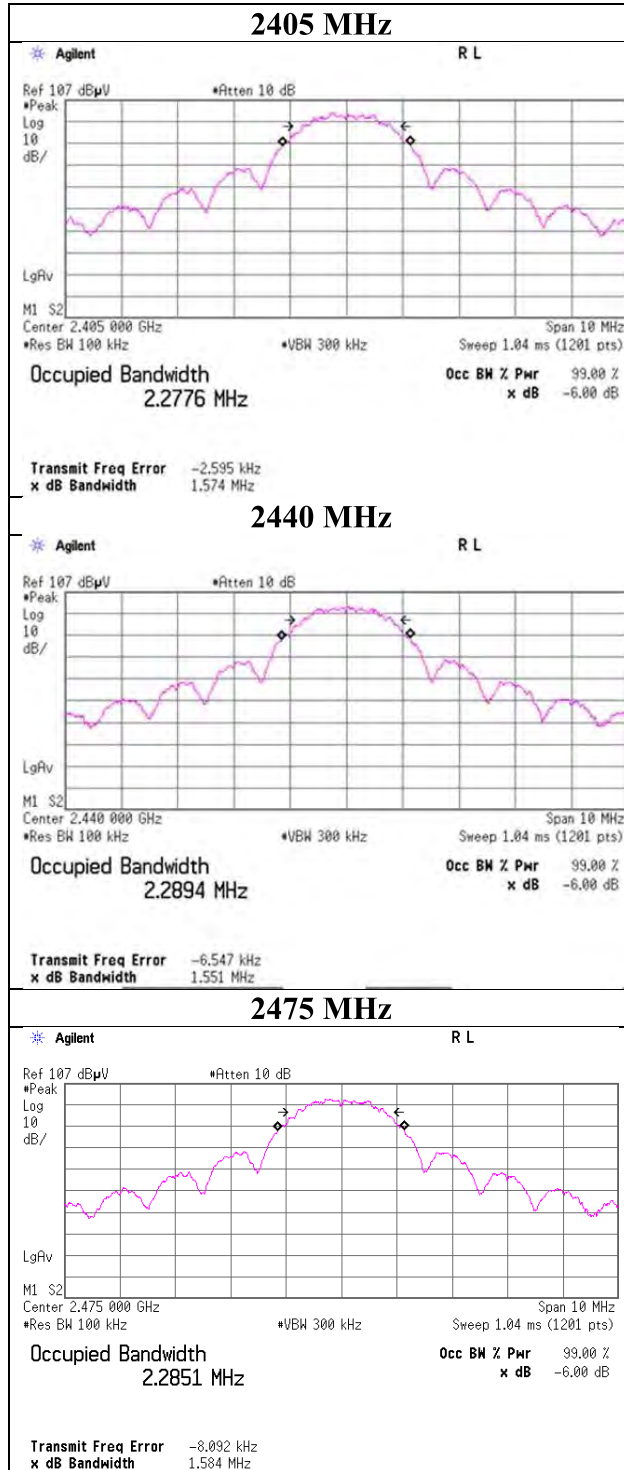

Maximum Peak Output Power

Report No. 12510206S-A-R3
Test place Shonan EMC Lab. No.1 Measurement Room
Date September 25, 2018
Temperature / Humidity 26 deg. C / 50 % RH
Engineer Yosuke Ishikawa
Mode Tx(+8 dBm Setting)

BT LE 1 Mbps				Conducted Power					e.i.r.p. for RSS-247					
Freq. [MHz]	Reading [dBm]	Cable Loss [dB]	Atten. Loss [dB]	Result		Limit		Margin [dB]	Antenna Gain [dBi]	Result		Limit		Margin [dB]
				[dBm]	[mW]	[dBm]	[mW]			[dBm]	[mW]	[dBm]	[mW]	
2402	-4.10	1.69	9.85	7.44	5.55	30.00	1000	22.56	-0.60	6.84	4.83	36.02	4000	29.18
2440	-3.93	1.70	9.84	7.61	5.77	30.00	1000	22.39	-0.60	7.01	5.02	36.02	4000	29.01
2480	-4.00	1.71	9.84	7.55	5.69	30.00	1000	22.45	-0.60	6.95	4.95	36.02	4000	29.07

BT LE 125 kbps				Conducted Power					e.i.r.p. for RSS-247					
Freq. [MHz]	Reading [dBm]	Cable Loss [dB]	Atten. Loss [dB]	Result		Limit		Margin [dB]	Antenna Gain [dBi]	Result		Limit		Margin [dB]
				[dBm]	[mW]	[dBm]	[mW]			[dBm]	[mW]	[dBm]	[mW]	
2402	-4.06	1.69	9.85	7.48	5.60	30.00	1000	22.52	-0.60	6.88	4.88	36.02	4000	29.14
2440	-3.82	1.70	9.84	7.72	5.92	30.00	1000	22.28	-0.60	7.12	5.15	36.02	4000	28.90
2480	-3.99	1.71	9.84	7.56	5.70	30.00	1000	22.44	-0.60	6.96	4.97	36.02	4000	29.06

BT LE 500 kbps				Conducted Power					e.i.r.p. for RSS-247					
Freq. [MHz]	Reading [dBm]	Cable Loss [dB]	Atten. Loss [dB]	Result		Limit		Margin [dB]	Antenna Gain [dBi]	Result		Limit		Margin [dB]
				[dBm]	[mW]	[dBm]	[mW]			[dBm]	[mW]	[dBm]	[mW]	
2402	-4.04	1.69	9.85	7.50	5.62	30.00	1000	22.50	-0.60	6.90	4.90	36.02	4000	29.12
2440	-3.81	1.70	9.84	7.73	5.93	30.00	1000	22.27	-0.60	7.13	5.16	36.02	4000	28.89
2480	-3.99	1.71	9.84	7.56	5.70	30.00	1000	22.44	-0.60	6.96	4.97	36.02	4000	29.06

BT LE 2 Mbps				Conducted Power					e.i.r.p. for RSS-247					
Freq. [MHz]	Reading [dBm]	Cable Loss [dB]	Atten. Loss [dB]	Result		Limit		Margin [dB]	Antenna Gain [dBi]	Result		Limit		Margin [dB]
				[dBm]	[mW]	[dBm]	[mW]			[dBm]	[mW]	[dBm]	[mW]	
2402	-4.09	1.69	9.85	7.45	5.56	30.00	1000	22.55	-0.60	6.85	4.84	36.02	4000	29.17
2440	-3.91	1.70	9.84	7.63	5.79	30.00	1000	22.37	-0.60	7.03	5.05	36.02	4000	28.99
2480	-4.04	1.71	9.84	7.51	5.64	30.00	1000	22.49	-0.60	6.91	4.91	36.02	4000	29.11

Sample Calculation:

Result = Reading + Cable Loss (including the cable(s) customer supplied) + Attenuator Loss

e.i.r.p. Result = Conducted Power Result + Antenna Gain

Maximum Peak Output Power

Report No. 12510206S-A-R3
Test place Shonan EMC Lab. No.5 Shielded Room
Date September 26, 2018 October 1, 2018 October 12, 2018
Temperature / Humidity 25 deg. C / 49 % RH 25 deg. C / 59 % RH 25 deg. C / 36 % RH
Engineer Yosuke Ishikawa Shiro Kobayashi Kazutaka Takeyama
Mode Tx(+8 dBm Setting)

ANT 1 Mbps				Conducted Power					e.i.r.p. for RSS-247					
Freq. [MHz]	Reading [dBm]	Cable Loss [dB]	Atten. Loss [dB]	Result		Limit		Margin [dB]	Antenna Gain [dBi]	Result		Limit		Margin [dB]
				[dBm]	[mW]	[dBm]	[mW]			[dBm]	[mW]	[dBm]	[mW]	
2402	-3.91	1.69	9.85	7.63	5.79	30.00	1000	22.37	-0.60	7.03	5.05	36.02	4000	28.99
2441	-3.72	1.70	9.84	7.82	6.05	30.00	1000	22.18	-0.60	7.22	5.27	36.02	4000	28.80
2480	-3.94	1.71	9.84	7.61	5.77	30.00	1000	22.39	-0.60	7.01	5.02	36.02	4000	29.01

Nordic Original 2 Mbps				Conducted Power					e.i.r.p. for RSS-247					
Freq. [MHz]	Reading [dBm]	Cable Loss [dB]	Atten. Loss [dB]	Result		Limit		Margin [dB]	Antenna Gain [dBi]	Result		Limit		Margin [dB]
				[dBm]	[mW]	[dBm]	[mW]			[dBm]	[mW]	[dBm]	[mW]	
2402	-3.92	1.69	9.85	7.62	5.78	30.00	1000	22.38	-0.60	7.02	5.04	36.02	4000	29.00
2441	-3.75	1.70	9.84	7.79	6.01	30.00	1000	22.21	-0.60	7.19	5.24	36.02	4000	28.83
2480	-3.96	1.71	9.84	7.59	5.74	30.00	1000	22.41	-0.60	6.99	5.00	36.02	4000	29.03

IEEE802.15.4				Conducted Power					e.i.r.p. for RSS-247					
Freq. [MHz]	Reading [dBm]	Cable Loss [dB]	Atten. Loss [dB]	Result		Limit		Margin [dB]	Antenna Gain [dBi]	Result		Limit		Margin [dB]
				[dBm]	[mW]	[dBm]	[mW]			[dBm]	[mW]	[dBm]	[mW]	
2405	-3.89	1.69	9.85	7.65	5.82	30.00	1000	22.35	-0.60	7.05	5.07	36.02	4000	28.97
2440	-3.75	1.70	9.84	7.79	6.01	30.00	1000	22.21	-0.60	7.19	5.24	36.02	4000	28.83
2475	-3.95	1.71	9.84	7.60	5.75	30.00	1000	22.40	-0.60	7.00	5.01	36.02	4000	29.02

Sample Calculation:

Result = Reading + Cable Loss (including the cable(s) customer supplied) + Attenuator Loss

e.i.r.p. Result = Conducted Power Result + Antenna Gain

Maximum Peak Output Power

Report No. 12510206S-A-R3
Test place Shonan EMC Lab. No.1 Measurement Room
Date September 25, 2018
Temperature / Humidity 26 deg. C / 50 % RH
Engineer Yosuke Ishikawa
Mode Tx(-40 dBm Setting)

BT LE 1 Mbps				Conducted Power					e.i.r.p. for RSS-247					
Freq. [MHz]	Reading [dBm]	Cable Loss [dB]	Atten. Loss [dB]	Result		Limit		Margin [dB]	Antenna Gain [dBi]	Result		Limit		Margin [dB]
				[dBm]	[mW]	[dBm]	[mW]			[dBm]	[mW]	[dBm]	[mW]	
2402	-40.17	1.69	0.00	-38.48	0.00014	30.00	1000	68.48	-0.60	-39.08	0.00012	36.02	4000	75.10
2440	-40.64	1.70	0.00	-38.94	0.00013	30.00	1000	68.94	-0.60	-39.54	0.00011	36.02	4000	75.56
2480	-41.26	1.71	0.00	-39.55	0.00011	30.00	1000	69.55	-0.60	-40.15	0.00010	36.02	4000	76.17

BT LE 125 kbps				Conducted Power					e.i.r.p. for RSS-247					
Freq. [MHz]	Reading [dBm]	Cable Loss [dB]	Atten. Loss [dB]	Result		Limit		Margin [dB]	Antenna Gain [dBi]	Result		Limit		Margin [dB]
				[dBm]	[mW]	[dBm]	[mW]			[dBm]	[mW]	[dBm]	[mW]	
2402	-40.14	1.69	0.00	-38.45	0.00014	30.00	1000	68.45	-0.60	-39.05	0.00012	36.02	4000	75.07
2440	-40.62	1.70	0.00	-38.92	0.00013	30.00	1000	68.92	-0.60	-39.52	0.00011	36.02	4000	75.54
2480	-41.23	1.71	0.00	-39.52	0.00011	30.00	1000	69.52	-0.60	-40.12	0.00010	36.02	4000	76.14

BT LE 500 kbps				Conducted Power					e.i.r.p. for RSS-247					
Freq. [MHz]	Reading [dBm]	Cable Loss [dB]	Atten. Loss [dB]	Result		Limit		Margin [dB]	Antenna Gain [dBi]	Result		Limit		Margin [dB]
				[dBm]	[mW]	[dBm]	[mW]			[dBm]	[mW]	[dBm]	[mW]	
2402	-40.11	1.69	0.00	-38.42	0.00014	30.00	1000	68.42	-0.60	-39.02	0.00013	36.02	4000	75.04
2440	-40.63	1.70	0.00	-38.93	0.00013	30.00	1000	68.93	-0.60	-39.53	0.00011	36.02	4000	75.55
2480	-41.25	1.71	0.00	-39.54	0.00011	30.00	1000	69.54	-0.60	-40.14	0.00010	36.02	4000	76.16

BT LE 2 Mbps				Conducted Power					e.i.r.p. for RSS-247					
Freq. [MHz]	Reading [dBm]	Cable Loss [dB]	Atten. Loss [dB]	Result		Limit		Margin [dB]	Antenna Gain [dBi]	Result		Limit		Margin [dB]
				[dBm]	[mW]	[dBm]	[mW]			[dBm]	[mW]	[dBm]	[mW]	
2402	-39.98	1.69	0.00	-38.29	0.00015	30.00	1000	68.29	-0.60	-38.89	0.00013	36.02	4000	74.91
2440	-40.47	1.70	0.00	-38.77	0.00013	30.00	1000	68.77	-0.60	-39.37	0.00012	36.02	4000	75.39
2480	-41.15	1.71	0.00	-39.44	0.00011	30.00	1000	69.44	-0.60	-40.04	0.00010	36.02	4000	76.06

Sample Calculation:

Result = Reading + Cable Loss (including the cable(s) customer supplied) + Attenuator Loss

e.i.r.p. Result = Conducted Power Result + Antenna Gain

*The equipment and cables were not used for factor 0 dB of the data sheets.

Maximum Peak Output Power

Report No. 12510206S-A-R3
Test place Shonan EMC Lab. No.1 Measurement Room / No.5 Shielded Room
Date September 25, 2018 October 1, 2018 October 12, 2018
Temperature / Humidity 26 deg. C / 50 % RH 25 deg. C / 59 % RH 25 deg. C / 36 % RH
Engineer Yosuke Ishikawa Shiro Kobayashi Kazutaka Takeyama
Mode Tx(-40 dBm Setting)

ANT 1 Mbps				Conducted Power					e.i.r.p. for RSS-247					
Freq. [MHz]	Reading [dBm]	Cable Loss [dB]	Atten. Loss [dB]	Result		Limit		Margin [dB]	Antenna Gain [dBi]	Result		Limit		Margin [dB]
				[dBm]	[mW]	[dBm]	[mW]			[dBm]	[mW]	[dBm]	[mW]	
2402	-40.58	1.69	0.00	-38.89	0.00013	30.00	1000	68.89	-0.60	-39.49	0.00011	36.02	4000	75.51
2441	-41.00	1.70	0.00	-39.30	0.00012	30.00	1000	69.30	-0.60	-39.90	0.00010	36.02	4000	75.92
2480	-41.78	1.71	0.00	-40.07	0.00010	30.00	1000	70.07	-0.60	-40.67	0.00009	36.02	4000	76.69

Nordic Original 2 Mbps				Conducted Power					e.i.r.p. for RSS-247					
Freq. [MHz]	Reading [dBm]	Cable Loss [dB]	Atten. Loss [dB]	Result		Limit		Margin [dB]	Antenna Gain [dBi]	Result		Limit		Margin [dB]
				[dBm]	[mW]	[dBm]	[mW]			[dBm]	[mW]	[dBm]	[mW]	
2402	-40.49	1.69	0.00	-38.80	0.00013	30.00	1000	68.80	-0.60	-39.40	0.00011	36.02	4000	75.42
2441	-40.39	1.70	0.00	-38.69	0.00014	30.00	1000	68.69	-0.60	-39.29	0.00012	36.02	4000	75.31
2480	-41.70	1.71	0.00	-39.99	0.00010	30.00	1000	69.99	-0.60	-40.59	0.00009	36.02	4000	76.61

IEEE802.15.4				Conducted Power					e.i.r.p. for RSS-247					
Freq. [MHz]	Reading [dBm]	Cable Loss [dB]	Atten. Loss [dB]	Result		Limit		Margin [dB]	Antenna Gain [dBi]	Result		Limit		Margin [dB]
				[dBm]	[mW]	[dBm]	[mW]			[dBm]	[mW]	[dBm]	[mW]	
2405	-40.57	1.69	0.00	-38.88	0.00013	30.00	1000	68.88	-0.60	-39.48	0.00011	36.02	4000	75.50
2440	-41.01	1.70	0.00	-39.31	0.00012	30.00	1000	69.31	-0.60	-39.91	0.00010	36.02	4000	75.93
2475	-41.58	1.71	0.00	-39.87	0.00010	30.00	1000	69.87	-0.60	-40.47	0.00009	36.02	4000	76.49

Sample Calculation:

Result = Reading + Cable Loss (including the cable(s) customer supplied) + Attenuator Loss

e.i.r.p. Result = Conducted Power Result + Antenna Gain

*The equipment and cables were not used for factor 0 dB of the data sheets.

Average Output Power
(Reference data for RF Exposure)

Report No. 12510206S-A-R3
Test place Shonan EMC Lab. No.1 Measurement Room
Date September 25, 2018
Temperature / Humidity 26 deg. C / 50 % RH
Engineer Yosuke Ishikawa
Mode Tx(+8 dBm Setting)

BT LE 1 Mbps

Freq. [MHz]	Reading [dBm]	Cable Loss [dB]	Atten. Loss [dB]	Result (Time average)		Duty factor [dB]	Result (Burst power average)	
				[dBm]	[mW]		[dBm]	[mW]
2402	-4.94	1.69	9.85	6.60	4.57	0.67	7.27	5.33
2440	-4.90	1.70	9.84	6.64	4.61	0.67	7.31	5.38
2480	-4.73	1.71	9.84	6.82	4.81	0.67	7.49	5.61

BT LE 125 kbps

Freq. [MHz]	Reading [dBm]	Cable Loss [dB]	Atten. Loss [dB]	Result (Time average)		Duty factor [dB]	Result (Burst power average)	
				[dBm]	[mW]		[dBm]	[mW]
2402	-4.28	1.69	9.85	7.26	5.32	0.11	7.37	5.46
2440	-4.09	1.70	9.84	7.45	5.56	0.11	7.56	5.70
2480	-4.22	1.71	9.84	7.33	5.41	0.11	7.44	5.55

BT LE 500 kbps

Freq. [MHz]	Reading [dBm]	Cable Loss [dB]	Atten. Loss [dB]	Result (Time average)		Duty factor [dB]	Result (Burst power average)	
				[dBm]	[mW]		[dBm]	[mW]
2402	-4.72	1.69	9.85	6.82	4.81	0.39	7.21	5.26
2440	-4.38	1.70	9.84	7.16	5.20	0.39	7.55	5.69
2480	-4.57	1.71	9.84	6.98	4.99	0.39	7.37	5.46

BT LE 2 Mbps

Freq. [MHz]	Reading [dBm]	Cable Loss [dB]	Atten. Loss [dB]	Result (Time average)		Duty factor [dB]	Result (Burst power average)	
				[dBm]	[mW]		[dBm]	[mW]
2402	-6.69	1.69	9.85	4.85	3.05	2.38	7.23	5.28
2440	-6.46	1.70	9.84	5.08	3.22	2.38	7.46	5.57
2480	-6.67	1.71	9.84	4.88	3.08	2.38	7.26	5.32

Sample Calculation:

Result (Time average) = Reading + Cable Loss (including the cable(s) customer supplied) + Attenuator Loss

Result (Burst power average) = Time average + Duty factor

*The equipment and cables were not used for factor 0 dB of the data sheets.

Average Output Power
(Reference data for RF Exposure)

Report No. 12510206S-A-R3
Test place Shonan EMC Lab. No.5 Shielded Room
Date September 26, 2018 October 1, 2018 October 12, 2018
Temperature / Humidity 25 deg. C / 49 % RH 25 deg. C / 59 % RH 25 deg. C / 36 % RH
Engineer Yosuke Ishikawa Shiro Kobayashi Kazutaka Takeyama
Mode Tx(+8 dBm Setting)

ANT 1 Mbps

Freq. [MHz]	Reading [dBm]	Cable Loss [dB]	Atten. Loss [dB]	Result (Time average)		Duty factor [dB]	Result (Burst power average)	
				[dBm]	[mW]		[dBm]	[mW]
2402	-4.22	1.69	9.85	7.32	5.40	0.23	7.55	5.69
2441	-4.12	1.70	9.84	7.42	5.52	0.23	7.65	5.82
2480	-4.34	1.71	9.84	7.21	5.26	0.23	7.44	5.55

Nordic Original 2 Mbps

Freq. [MHz]	Reading [dBm]	Cable Loss [dB]	Atten. Loss [dB]	Result (Time average)		Duty factor [dB]	Result (Burst power average)	
				[dBm]	[mW]		[dBm]	[mW]
2402	-4.45	1.69	9.85	7.09	5.12	0.44	7.53	5.66
2441	-4.22	1.70	9.84	7.32	5.40	0.44	7.76	5.97
2480	-4.47	1.71	9.84	7.08	5.11	0.44	7.52	5.65

IEEE802.15.4

Freq. [MHz]	Reading [dBm]	Cable Loss [dB]	Atten. Loss [dB]	Result (Time average)		Duty factor [dB]	Result (Burst power average)	
				[dBm]	[mW]		[dBm]	[mW]
2405	-4.20	1.69	9.85	7.34	5.42	0.06	7.40	5.50
2440	-4.10	1.70	9.84	7.44	5.55	0.06	7.50	5.62
2475	-4.18	1.71	9.84	7.37	5.46	0.06	7.43	5.53

Sample Calculation:

Result (Time average) = Reading + Cable Loss (including the cable(s) customer supplied) + Attenuator Loss

Result (Burst power average) = Time average + Duty factor

*The equipment and cables were not used for factor 0 dB of the data sheets.

Average Output Power
(Reference data for RF Exposure)

Report No. 12510206S-A-R3
Test place Shonan EMC Lab. No.1 Measurement Room
Date September 25, 2018
Temperature / Humidity 26 deg. C / 50 % RH
Engineer Yosuke Ishikawa
Mode Tx(-40 dBm Setting)

BT LE 1 Mbps

Freq. [MHz]	Reading [dBm]	Cable Loss [dB]	Atten. Loss [dB]	Result (Time average)		Duty factor [dB]	Result (Burst power average)	
				[dBm]	[mW]		[dBm]	[mW]
2402	-41.15	1.69	0.00	-39.46	0.00011	0.67	-38.79	0.00013
2440	-41.62	1.70	0.00	-39.92	0.00010	0.67	-39.25	0.00012
2480	-42.28	1.71	0.00	-40.57	0.00009	0.67	-39.90	0.00010

BT LE 125 kbps

Freq. [MHz]	Reading [dBm]	Cable Loss [dB]	Atten. Loss [dB]	Result (Time average)		Duty factor [dB]	Result (Burst power average)	
				[dBm]	[mW]		[dBm]	[mW]
2402	-40.50	1.69	0.00	-38.81	0.00013	0.11	-38.70	0.00013
2440	-41.02	1.70	0.00	-39.32	0.00012	0.11	-39.21	0.00012
2480	-41.63	1.71	0.00	-39.92	0.00010	0.11	-39.81	0.00010

BT LE 500 kbps

Freq. [MHz]	Reading [dBm]	Cable Loss [dB]	Atten. Loss [dB]	Result (Time average)		Duty factor [dB]	Result (Burst power average)	
				[dBm]	[mW]		[dBm]	[mW]
2402	-40.71	1.69	0.00	-39.02	0.00013	0.39	-38.63	0.00014
2440	-41.12	1.70	0.00	-39.42	0.00011	0.39	-39.03	0.00013
2480	-41.86	1.71	0.00	-40.15	0.00010	0.39	-39.76	0.00011

BT LE 2 Mbps

Freq. [MHz]	Reading [dBm]	Cable Loss [dB]	Atten. Loss [dB]	Result (Time average)		Duty factor [dB]	Result (Burst power average)	
				[dBm]	[mW]		[dBm]	[mW]
2402	-42.79	1.69	0.00	-41.10	0.00008	2.38	-38.72	0.00013
2440	-43.36	1.70	0.00	-41.66	0.00007	2.38	-39.28	0.00012
2480	-43.90	1.71	0.00	-42.19	0.00006	2.38	-39.81	0.00010

Sample Calculation:

Result (Time average) = Reading + Cable Loss (including the cable(s) customer supplied) + Attenuator Loss

Result (Burst power average) = Time average + Duty factor

*The equipment and cables were not used for factor 0 dB of the data sheets.

Average Output Power
(Reference data for RF Exposure)

Report No. 12510206S-A-R3
Test place Shonan EMC Lab. No.1 No.5 Shielded Room
Date September 26, 2018 October 1, 2018 October 12, 2018
Temperature / Humidity 25 deg. C / 49 % RH 25 deg. C / 59 % RH 25 deg. C / 36 % RH
Engineer Yosuke Ishikawa Shiro Kobayashi Kazutaka Takeyama
Mode Tx(-40 dBm Setting)

ANT 1 Mbps

Freq. [MHz]	Reading [dBm]	Cable Loss [dB]	Atten. Loss [dB]	Result (Time average)		Duty factor [dB]	Result (Burst power average)	
				[dBm]	[mW]		[dBm]	[mW]
2402	-41.12	1.69	0.00	-39.43	0.00011	0.23	-39.20	0.00012
2441	-41.65	1.70	0.00	-39.95	0.00010	0.23	-39.72	0.00011
2480	-42.43	1.71	0.00	-40.72	0.00008	0.23	-40.49	0.00009

Nordic Original 2 Mbps

Freq. [MHz]	Reading [dBm]	Cable Loss [dB]	Atten. Loss [dB]	Result (Time average)		Duty factor [dB]	Result (Burst power average)	
				[dBm]	[mW]		[dBm]	[mW]
2402	-41.39	1.69	0.00	-39.70	0.00011	0.44	-39.26	0.00012
2441	-41.85	1.70	0.00	-40.15	0.00010	0.44	-39.71	0.00011
2480	-42.58	1.71	0.00	-40.87	0.00008	0.44	-40.43	0.00009

IEEE802.15.4

Freq. [MHz]	Reading [dBm]	Cable Loss [dB]	Atten. Loss [dB]	Result (Time average)		Duty factor [dB]	Result (Burst power average)	
				[dBm]	[mW]		[dBm]	[mW]
2405	-41.03	1.69	0.00	-39.34	0.00012	0.06	-39.28	0.00012
2440	-41.44	1.70	0.00	-39.74	0.00011	0.06	-39.68	0.00011
2475	-42.12	1.71	0.00	-40.41	0.00009	0.06	-40.35	0.00009

Sample Calculation:

Result (Time average) = Reading + Cable Loss (including the cable(s) customer supplied) + Attenuator Loss

Result (Burst power average) = Time average + Duty factor

*The equipment and cables were not used for factor 0 dB of the data sheets.

Burst rate confirmation

Report No. 12510206S-A-R3
Test place Shonan EMC Lab. No.1 Measurement Room
Date September 25, 2018
Temperature / Humidity 26 deg. C / 50 % RH
Engineer Yosuke Ishikawa
Mode Tx

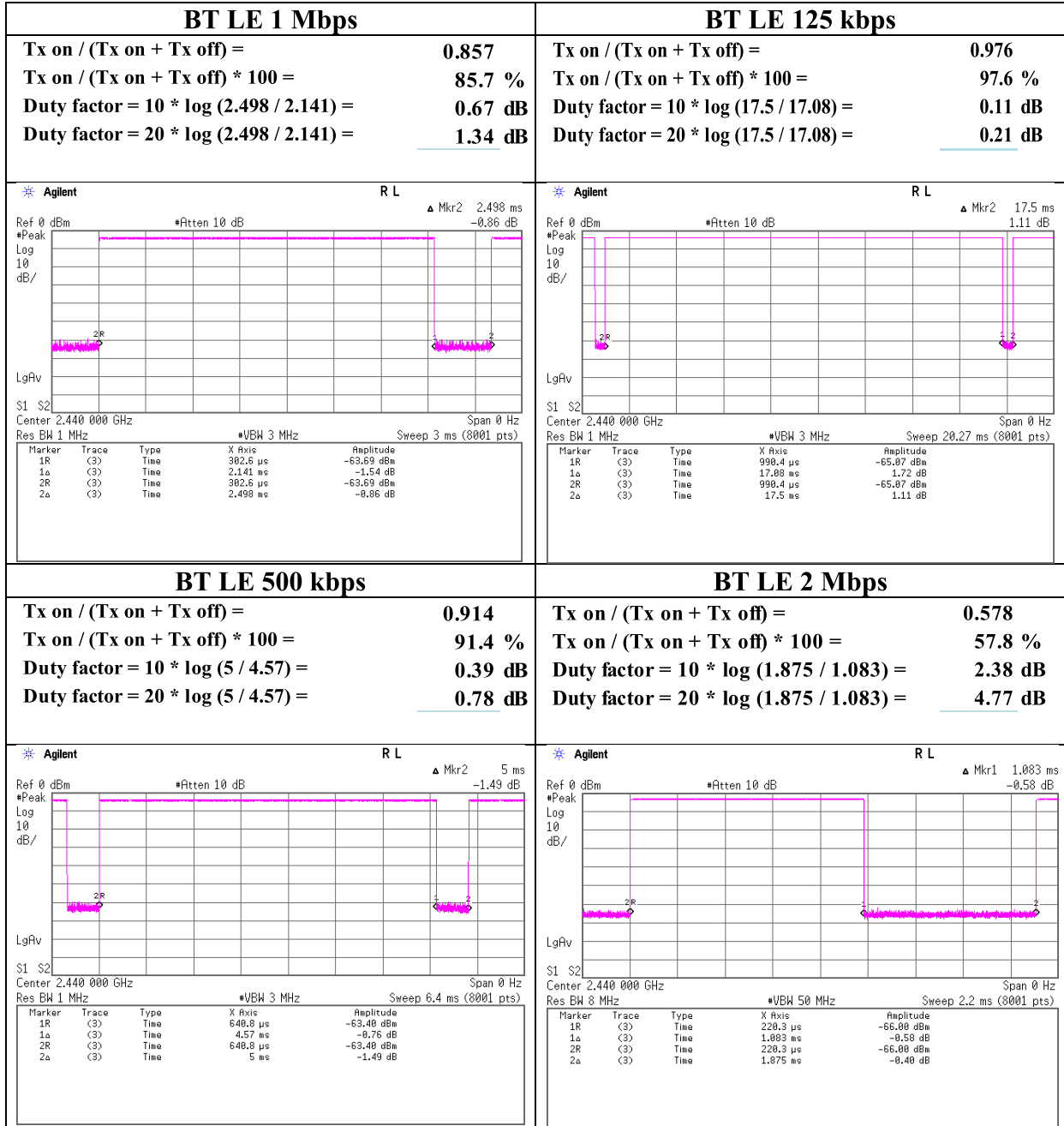

* Since the burst rate is not different between the channels, the data has been obtained on the representative channel.

Burst rate confirmation

Report No. 12510206S-A-R3
Test place Shonan EMC Lab. No.5 Shielded Room
Date September 26, 2018 October 1, 2018
Temperature / Humidity 25 deg. C / 49 % RH 25 deg. C / 59 % RH
Engineer Yosuke Ishikawa Shiro Kobayashi
Mode Tx

ANT 1 Mbps

Nordic Original 2 Mbps

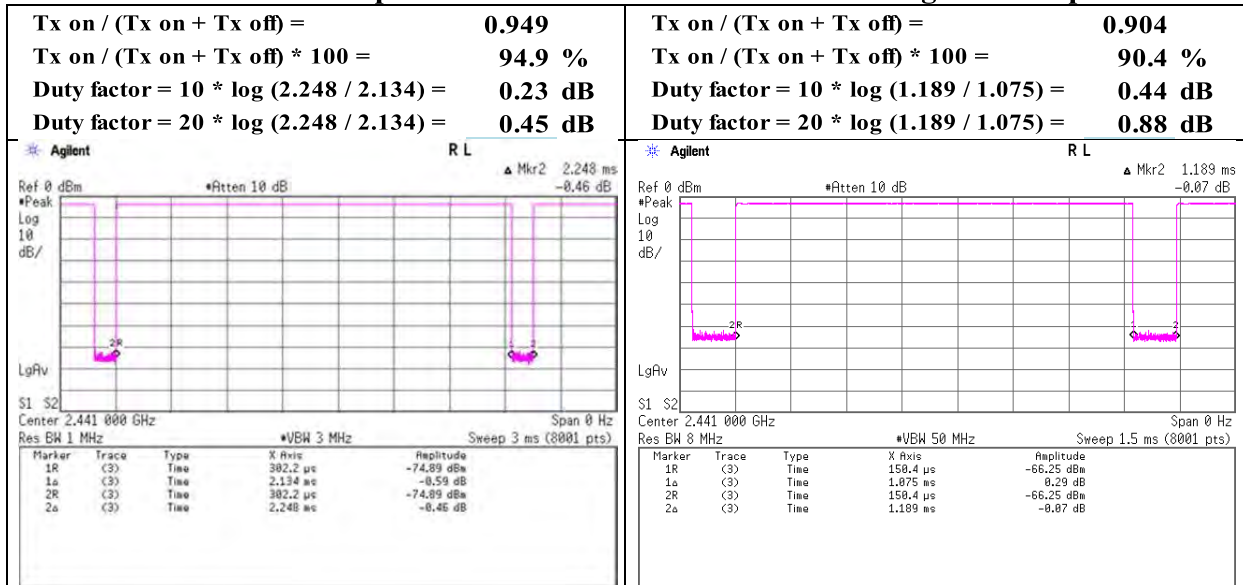

IEEE802.15.4

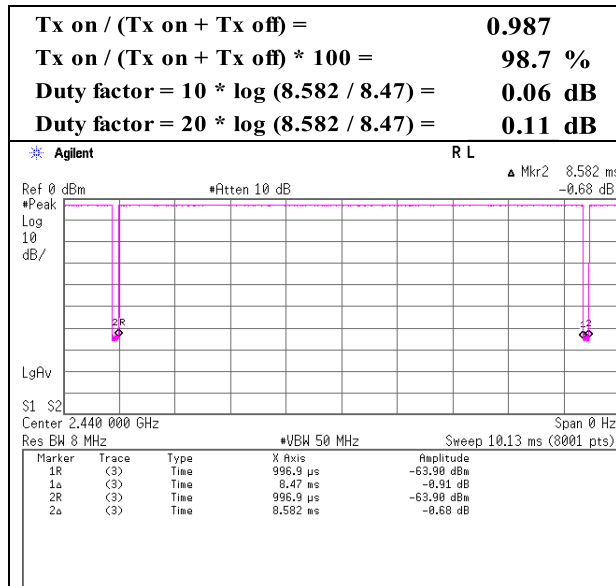

* Since the burst rate is not different between the channels, the data has been obtained on the representative channel.

Radiated Spurious Emission

Report No.	12510206S-A-R3			
Test place	Shonan EMC Lab.			
Semi Anechoic Chamber	No.3	No.2	No.3	No.3
Date	October 13, 2018	September 26, 2018	October 6, 2018	October 11, 2018
Temperature / Humidity	24 deg.C, 42 %RH	22 deg. C / 65 % RH	22 deg.C / 52%RH	24 deg.C, 42 %RH
Engineer	Shiro Kobayashi	Kazutaka Takeyama	Yosuke Ishikawa	Yasumasa Owaki
	(30 MHz - 1000 MHz)	(1 GHz - 2.8 GHz)	(2.8 GHz -13 GHz)	(13 GHz -26.5GHz)
Mode	Tx BT LE 500 kbps 2402 MHz			

(* PK: Peak, AV: Average, QP: Quasi-Peak)

Polarity	Frequency [MHz]	Detector	Reading [dBuV]	Ant.Fac. [dB/m]	Loss [dB]	Gain [dB]	Distance Factor [dB]	Result [dBuV/m]	Limit [dBuV/m]	Margin [dB]	Height [cm]	Angle [deg]	Remark
Hori.	31.683	QP	22.70	18.05	6.48	32.20	0.00	15.03	40.00	24.9	151	2	
Hori.	187.626	QP	22.90	16.25	7.83	32.09	0.00	14.89	43.50	28.6	122	1	
Hori.	928.807	QP	22.00	22.09	11.17	30.84	0.00	24.42	46.00	21.5	100	273	
Hori.	2390.000	PK	43.10	27.91	13.89	36.58	2.46	50.78	73.90	23.1	148	1	
Hori.	4804.000	PK	49.68	31.43	6.51	43.91	2.46	46.17	73.90	27.7	124	0	
Hori.	7206.000	PK	47.71	36.79	8.23	43.66	2.46	51.53	73.90	22.3	100	210	
Hori.	9608.000	PK	48.13	38.51	9.21	43.64	2.46	54.67	73.90	19.2	100	0	
Hori.	19216.000	PK	51.58	40.14	11.69	48.17	-9.54	45.70	73.90	28.2	141	0	
Vert.	30.393	QP	23.00	18.55	6.45	32.20	0.00	15.80	40.00	24.2	100	300	
Vert.	190.159	QP	23.10	16.34	7.84	32.08	0.00	15.20	43.50	28.3	100	357	
Vert.	953.951	QP	21.30	22.15	11.25	30.62	0.00	24.08	46.00	21.9	100	122	
Vert.	2390.000	PK	43.30	27.91	13.89	36.58	2.46	50.98	73.90	22.9	150	234	
Vert.	4804.000	PK	50.57	31.43	6.51	43.91	2.46	47.06	73.90	26.8	100	28	
Vert.	7206.000	PK	47.83	36.79	8.23	43.66	2.46	51.65	73.90	22.2	100	0	
Vert.	9608.000	PK	49.19	38.51	9.21	43.64	2.46	55.73	73.90	18.1	100	0	
Vert.	19216.000	PK	47.99	40.14	11.69	48.17	-9.54	42.11	73.90	31.7	130	99	

Result = Reading + Ant.Fac. + Loss (Cable+(Attenuator or Filter)(below 18 GHz)) - Gain(Amplifier) + Distance factor

Distance factor : 1 GHz - 13 GHz : 20log (3.98 m / 3.0 m) = 2.46 dB

13 GHz - 40 GHz : 20log (1.0 m / 3.0 m) = -9.54 dB

Average measurement value with duty factor

Polarity	Frequency [MHz]	Detector	Reading [dBuV]	Ant.Fac. [dB/m]	Loss [dB]	Gain [dB]	Duty Factor [dB]	Distance Factor [dB]	Result [dBuV/m]	Limit [dBuV/m]	Margin [dB]	Remark
Hori.	2390.000	AV	34.00	27.91	13.89	36.58	0.78	2.46	42.46	53.90	11.4	*1)
Hori.	4804.000	AV	42.57	31.43	6.51	43.91	0.78	2.46	39.84	53.90	14.1	
Hori.	7206.000	AV	40.43	36.79	8.23	43.66	0.78	2.46	45.03	53.90	8.9	
Hori.	9608.000	AV	40.57	38.51	9.21	43.64	0.78	2.46	47.89	53.90	6.0	
Hori.	19216.000	AV	43.78	40.14	11.69	48.17	0.78	-9.54	38.68	53.90	15.2	
Vert.	2390.000	AV	34.20	27.91	13.89	36.58	0.78	2.46	42.66	53.90	11.2	*1)
Vert.	4804.000	AV	42.65	31.43	6.51	43.91	0.78	2.46	39.92	53.90	14.0	
Vert.	7206.000	AV	39.71	36.79	8.23	43.66	0.78	2.46	44.31	53.90	9.6	
Vert.	9608.000	AV	40.53	38.51	9.21	43.64	0.78	2.46	47.85	53.90	6.1	
Vert.	19216.000	AV	38.53	40.14	11.69	48.17	0.78	-9.54	33.43	53.90	20.5	

Result = Reading + Ant.Fac. + Loss (Cable+(Attenuator or Filter)(below 18 GHz)) - Gain(Amplifier) + Duty factor + Distance factor

Distance factor : 1 GHz - 13 GHz : 20log (3.98 m / 3.0 m) = 2.46 dB

13 GHz - 40 GHz : 20log (1.0 m / 3.0 m) = -9.54 dB

Duty factor refer to "Duty factor Calculation chart" sheet.

*1) Not out of band emission (Leakage Power)

20 dBc Data Sheet (RBW 100 kHz, VBW 300 kHz)

Polarity	Frequency [MHz]	Detector	Reading [dBuV]	Ant.Fac. [dB/m]	Loss [dB]	Gain [dB]	Distance Factor [dB]	Result [dBuV/m]	Limit [dBuV/m]	Margin [dB]	Remark
Hori.	2402.000	PK	96.70	27.90	13.90	36.57	2.46	104.39	-	-	
Hori.	2400.000	PK	45.00	27.91	13.90	36.58	2.46	52.69	84.39	31.7	
Vert.	2402.000	PK	96.70	27.90	13.90	36.57	2.46	104.39	-	-	
Vert.	2400.000	PK	44.44	27.91	13.90	36.58	2.46	52.13	84.39	32.3	

Result = Reading + Ant.Fac. + Loss (Cable+(Attenuator or Filter)(below 18 GHz)) - Gain(Amplifier) + Distance factor

Distance factor : 1 GHz - 13 GHz : 20log (3.98 m / 3.0 m) = 2.46 dB

13 GHz - 40 GHz : 20log (1.0 m / 3.0 m) = -9.54 dB

UL Japan, Inc.

Shonan EMC Lab.

1-22-3 Megumigaoka, Hiratsuka-shi, Kanagawa-ken, 259-1220 JAPAN

Telephone : +81 463 50 6400

Facsimile : +81 463 50 6401

Radiated Spurious Emission
(Reference Plot for band-edge)

Report No.	12510206S-A-R3
Test place	Shonan EMC Lab.
Semi Anechoic Chamber	No.2
Date	September 26, 2018
Temperature / Humidity	22 deg. C / 65 % RH
Engineer	Kazutaka Takeyama
	(1 GHz – 2.8 GHz)
Mode	Tx BT LE 500 kbps 2402 MHz

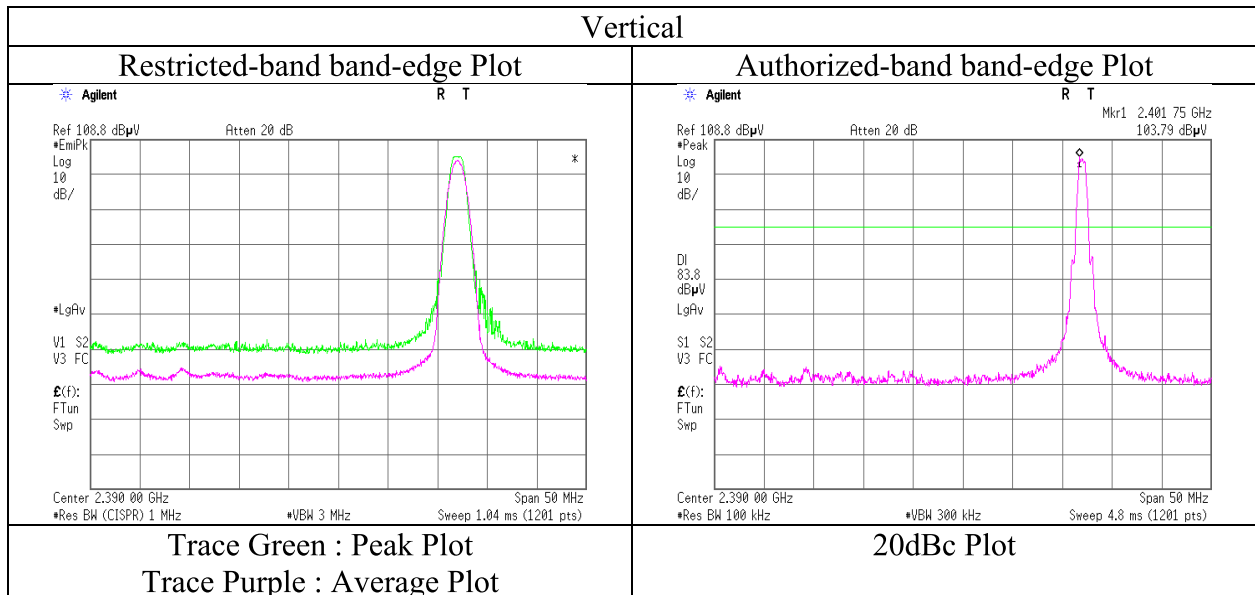
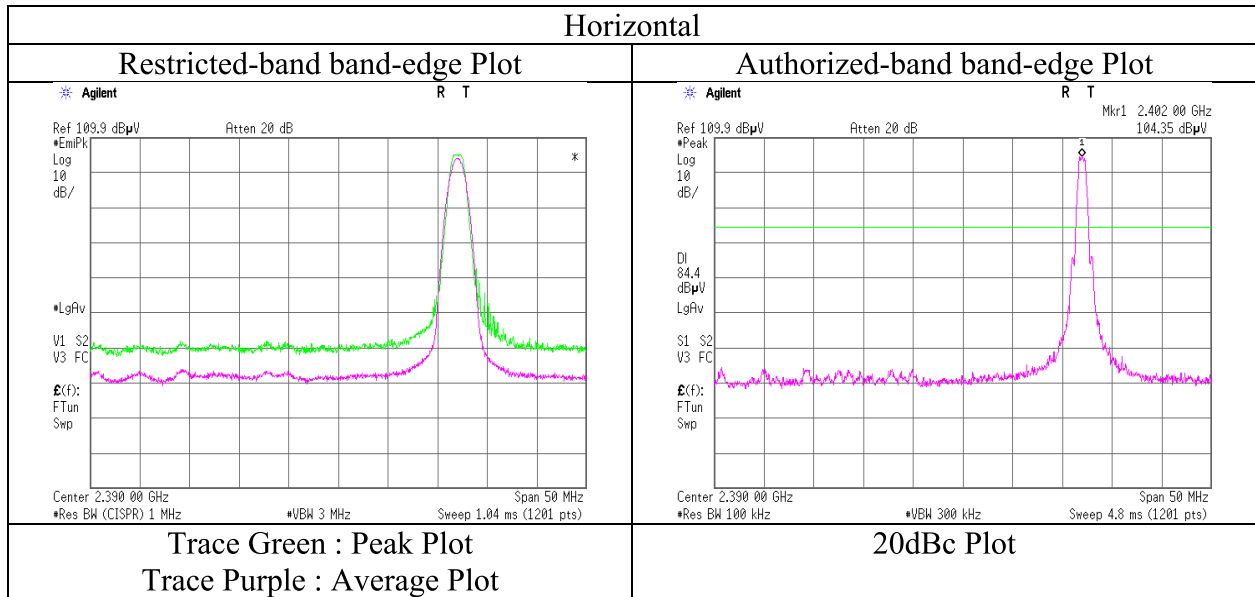

* Final result of restricted band edge was shown in tabular data.

Radiated Spurious Emission

Report No.	12510206S-A-R3			
Test place	Shonan EMC Lab.			
Semi Anechoic Chamber	No.3	No.2	No.3	No.3
Date	October 13, 2018	September 26, 2018	October 6, 2018	October 11, 2018
Temperature / Humidity	24 deg.C, 42 %RH	22 deg. C / 65 % RH	22 deg.C / 52%RH	24 deg.C, 42 %RH
Engineer	Shiro Kobayashi	Kazutaka Takeyama	Yosuke Ishikawa	Yasumasa Owaki
	(30 MHz - 1000 MHz)	(1 GHz - 2.8 GHz)	(2.8 GHz -13 GHz)	(13 GHz -26.5GHz)
Mode	Tx BT LE 500 kbps 2440 MHz			

(* PK: Peak, AV: Average, QP: Quasi-Peak)

Polarity	Frequency [MHz]	Detector	Reading [dBuV]	Ant.Fac. [dB/m]	Loss [dB]	Gain [dB]	Distance Factor [dB]	Result [dBuV/m]	Limit [dBuV/m]	Margin [dB]	Height [cm]	Angle [deg]	Remark
Hori.	31.013	QP	22.70	18.31	6.47	32.20	0.00	15.28	40.00	24.7	151	358	
Hori.	185.499	QP	22.60	16.14	7.84	32.09	0.00	14.49	43.50	29.0	126	3	
Hori.	919.753	QP	21.90	22.03	11.14	30.92	0.00	24.15	46.00	21.8	100	277	
Hori.	4880.000	PK	49.58	31.37	6.56	43.90	2.46	46.07	73.90	27.8	151	305	
Hori.	7320.000	PK	47.49	37.00	8.31	43.66	2.46	51.60	73.90	22.3	157	196	
Hori.	9760.000	PK	47.85	38.92	9.21	43.56	2.46	54.88	73.90	19.0	100	0	
Hori.	19520.000	PK	52.55	40.09	11.88	47.70	-9.54	47.28	73.90	26.6	138	0	
Vert.	33.531	QP	23.00	17.31	6.52	32.20	0.00	14.63	40.00	25.3	100	300	
Vert.	189.454	QP	22.80	16.36	7.84	32.08	0.00	14.92	43.50	28.5	100	3	
Vert.	890.210	QP	21.80	22.16	11.04	31.15	0.00	23.85	46.00	22.1	100	122	
Vert.	4880.000	PK	49.06	31.37	6.56	43.90	2.46	45.55	73.90	28.3	100	40	
Vert.	7320.000	PK	48.56	37.00	8.31	43.66	2.46	52.67	73.90	21.2	100	209	
Vert.	9760.000	PK	47.49	38.92	9.21	43.56	2.46	54.52	73.90	19.3	100	0	
Vert.	19520.000	PK	49.60	40.09	11.88	47.70	-9.54	44.33	73.90	29.5	128	99	

Result = Reading + Ant.Fac. + Loss (Cable+(Attenuator or Filter)(below 18 GHz)) - Gain(Amplifier) + Distance factor

Distance factor : 1 GHz - 13 GHz : 20log (3.98 m / 3.0 m) = 2.46 dB

13 GHz - 40 GHz : 20log (1.0 m / 3.0 m) = -9.54 dB

Average measurement value with duty factor

Polarity	Frequency [MHz]	Detector	Reading [dBuV]	Ant.Fac. [dB/m]	Loss [dB]	Gain [dB]	Duty Factor [dB]	Distance Factor [dB]	Result [dBuV/m]	Limit [dBuV/m]	Margin [dB]	Remark
Hori.	4880.000	AV	41.30	31.37	6.56	43.90	0.78	2.46	38.57	53.90	15.3	
Hori.	7320.000	AV	39.46	37.00	8.31	43.66	0.78	2.46	44.35	53.90	9.6	
Hori.	9760.000	AV	39.34	38.92	9.21	43.56	0.78	2.46	47.15	53.90	6.8	
Hori.	19520.000	AV	44.04	40.09	11.88	47.70	0.78	-9.54	39.55	53.90	14.4	
Vert.	4880.000	AV	40.72	31.37	6.56	43.90	0.78	2.46	37.99	53.90	15.9	
Vert.	7320.000	AV	39.36	37.00	8.31	43.66	0.78	2.46	44.25	53.90	9.7	
Vert.	9760.000	AV	39.47	38.92	9.21	43.56	0.78	2.46	47.28	53.90	6.6	
Vert.	19520.000	AV	39.91	40.09	11.88	47.70	0.78	-9.54	35.42	53.90	18.5	

Result = Reading + Ant.Fac. + Loss (Cable+(Attenuator or Filter)(below 18 GHz)) - Gain(Amplifier) + Duty factor + Distance factor

Distance factor : 1 GHz - 13 GHz : 20log (3.98 m / 3.0 m) = 2.46 dB

13 GHz - 40 GHz : 20log (1.0 m / 3.0 m) = -9.54 dB

Duty factor refer to "Duty factor Calculation chart" sheet.

*1) Not out of band emission (Leakage Power)

UL Japan, Inc.

Shonan EMC Lab.

1-22-3 Megumigaoka, Hiratsuka-shi, Kanagawa-ken, 259-1220 JAPAN

Telephone : +81 463 50 6400

Facsimile : +81 463 50 6401

Radiated Spurious Emission

Report No.	12510206S-A-R3			
Test place	Shonan EMC Lab.			
Semi Anechoic Chamber	No.3	No.2	No.3	No.3
Date	October 13, 2018	September 26, 2018	October 6, 2018	October 11, 2018
Temperature / Humidity	24 deg.C, 42 %RH	22 deg. C / 65 % RH	22 deg.C / 52%RH	24 deg.C, 42 %RH
Engineer	Shiro Kobayashi	Kazutaka Takeyama	Yosuke Ishikawa	Yasumasa Owaki
	(30 MHz - 1000 MHz)	(1 GHz - 2.8 GHz)	(2.8 GHz -13 GHz)	(13 GHz -26.5GHz)
Mode	Tx BT LE 500 kbps 2480 MHz			

(* PK: Peak, AV: Average, QP: Quasi-Peak)

Polarity	Frequency [MHz]	Detector	Reading [dBuV]	Ant.Fac. [dB/m]	Loss [dB]	Gain [dB]	Distance Factor [dB]	Result [dBuV/m]	Limit [dBuV/m]	Margin [dB]	Height [cm]	Angle [deg]	Remark
Hori.	30.207	QP	22.70	18.62	6.45	32.20	0.00	15.57	40.00	24.4	151	357	
Hori.	193.341	QP	22.80	16.48	7.85	32.08	0.00	15.05	43.50	28.4	125	3	
Hori.	901.951	QP	22.00	22.11	11.08	31.08	0.00	24.11	46.00	21.8	100	273	
Hori.	2483.500	PK	51.00	27.67	13.96	36.52	2.46	58.57	73.90	15.3	150	175	
Hori.	4960.000	PK	49.23	31.54	6.61	43.89	2.46	45.95	73.90	27.9	100	300	
Hori.	7440.000	PK	48.56	37.10	8.38	43.65	2.46	52.85	73.90	21.0	149	195	
Hori.	9920.000	PK	47.33	38.97	9.22	43.48	2.46	54.50	73.90	19.4	100	0	
Hori.	19840.000	PK	50.76	39.94	12.02	47.72	-9.54	45.46	73.90	28.4	142	0	
Vert.	31.866	QP	23.00	17.97	6.48	32.20	0.00	15.25	40.00	24.7	100	300	
Vert.	188.104	QP	22.80	16.32	7.84	32.08	0.00	14.88	43.50	28.6	100	1	
Vert.	886.196	QP	22.00	22.21	11.03	31.17	0.00	24.07	46.00	21.9	100	156	
Vert.	2483.500	PK	50.00	27.67	13.96	36.52	2.46	57.57	73.90	16.3	150	9	
Vert.	4960.000	PK	48.52	31.54	6.61	43.89	2.46	45.24	73.90	28.6	100	0	
Vert.	7440.000	PK	47.99	37.10	8.38	43.65	2.46	52.28	73.90	21.6	100	230	
Vert.	9920.000	PK	45.51	38.97	9.22	43.48	2.46	52.68	73.90	21.2	100	0	
Vert.	19840.000	PK	47.94	39.94	12.02	47.72	-9.54	42.64	73.90	31.2	129	101	

Result = Reading + Ant.Fac. + Loss (Cable+(Attenuator or Filter)(below 18 GHz)) - Gain(Amplifier) + Distance factor

Distance factor : 1 GHz - 13 GHz : 20log (3.98 m / 3.0 m) = 2.46 dB

13 GHz - 40 GHz : 20log (1.0 m / 3.0 m) = -9.54 dB

Average measurement value with duty factor

Polarity	Frequency [MHz]	Detector	Reading [dBuV]	Ant.Fac. [dB/m]	Loss [dB]	Gain [dB]	Duty Factor [dB]	Distance Factor [dB]	Result [dBuV/m]	Limit [dBuV/m]	Margin [dB]	Remark
Hori.	2483.500	AV	36.20	27.67	13.96	36.52	0.78	2.46	44.55	53.90	9.4	*1)
Hori.	4960.000	AV	40.76	31.54	6.61	43.89	0.78	2.46	38.26	53.90	15.6	
Hori.	7440.000	AV	40.05	37.10	8.38	43.65	0.78	2.46	45.12	53.90	8.8	
Hori.	9920.000	AV	38.85	38.97	9.22	43.48	0.78	2.46	46.80	53.90	7.1	
Hori.	19840.000	AV	41.43	39.94	12.02	47.72	0.78	-9.54	36.91	53.90	17.0	
Vert.	2483.500	AV	37.00	27.67	13.96	36.52	0.78	2.46	45.35	53.90	8.6	*1)
Vert.	4960.000	AV	40.25	31.54	6.61	43.89	0.78	2.46	37.75	53.90	16.2	
Vert.	7440.000	AV	39.49	37.10	8.38	43.65	0.78	2.46	44.56	53.90	9.3	
Vert.	9920.000	AV	38.14	38.97	9.22	43.48	0.78	2.46	46.09	53.90	7.8	
Vert.	19840.000	AV	38.14	39.94	12.02	47.72	0.78	-9.54	33.62	53.90	20.3	

Result = Reading + Ant.Fac. + Loss (Cable+(Attenuator or Filter)(below 18 GHz)) - Gain(Amplifier) + Duty factor + Distance factor

Distance factor : 1 GHz - 13 GHz : 20log (3.98 m / 3.0 m) = 2.46 dB

13 GHz - 40 GHz : 20log (1.0 m / 3.0 m) = -9.54 dB

Duty factor refer to "Duty factor Calculation chart" sheet.

*1) Not out of band emission (Leakage Power)

UL Japan, Inc.

Shonan EMC Lab.

1-22-3 Megumigaoka, Hiratsuka-shi, Kanagawa-ken, 259-1220 JAPAN

Telephone : +81 463 50 6400

Facsimile : +81 463 50 6401

Radiated Spurious Emission
(Reference Plot for band-edge)

Report No.	12510206S-A-R3
Test place	Shonan EMC Lab.
Semi Anechoic Chamber	No.2
Date	September 26, 2018
Temperature / Humidity	22 deg. C / 65 % RH
Engineer	Kazutaka Takeyama
	(1 GHz – 2.8 GHz)
Mode	Tx BT LE 500 kbps 2480 MHz

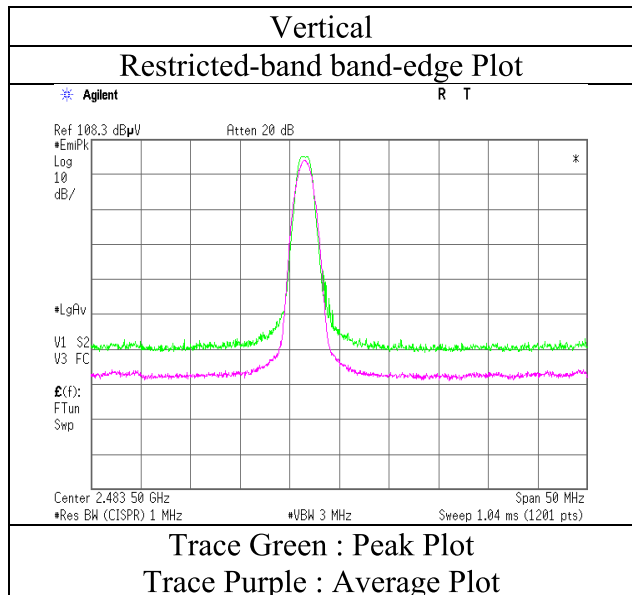
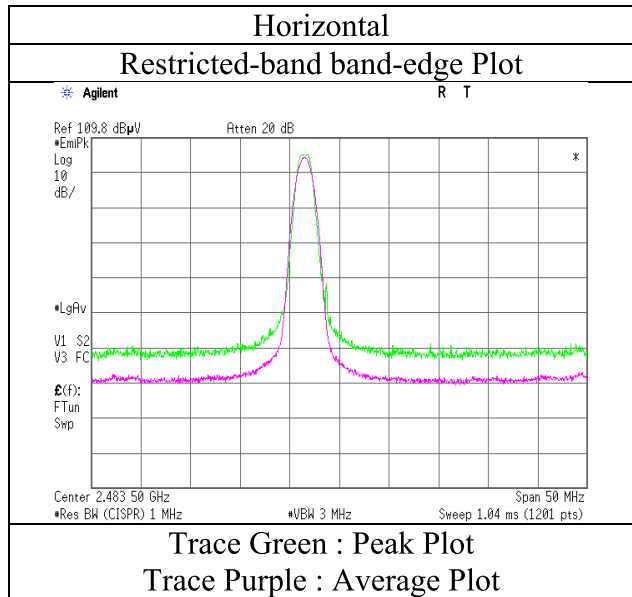

* Final result of restricted band edge was shown in tabular data.

Radiated Spurious Emission
(Plot data, Worst case)

Report No.	12510206S-A-R3			
Test place	Shonan EMC Lab.			
Semi Anechoic Chamber	No.3	No.2	No.3	No.3
Date	October 13, 2018	September 26, 2018	October 6, 2018	October 11, 2018
Temperature / Humidity	24 deg.C, 42 %RH	22 deg. C / 65 % RH	22 deg.C / 52%RH	24 deg.C, 42 %RH
Engineer	Shiro Kobayashi (30 MHz - 1000 MHz)	Kazutaka Takeyama (1 GHz - 2.8 GHz)	Yosuke Ishikawa (2.8 GHz -13 GHz)	Yasumasa Owaki (13 GHz -26.5GHz)
Mode	Tx BT LE 500 kbps 2440 MHz			

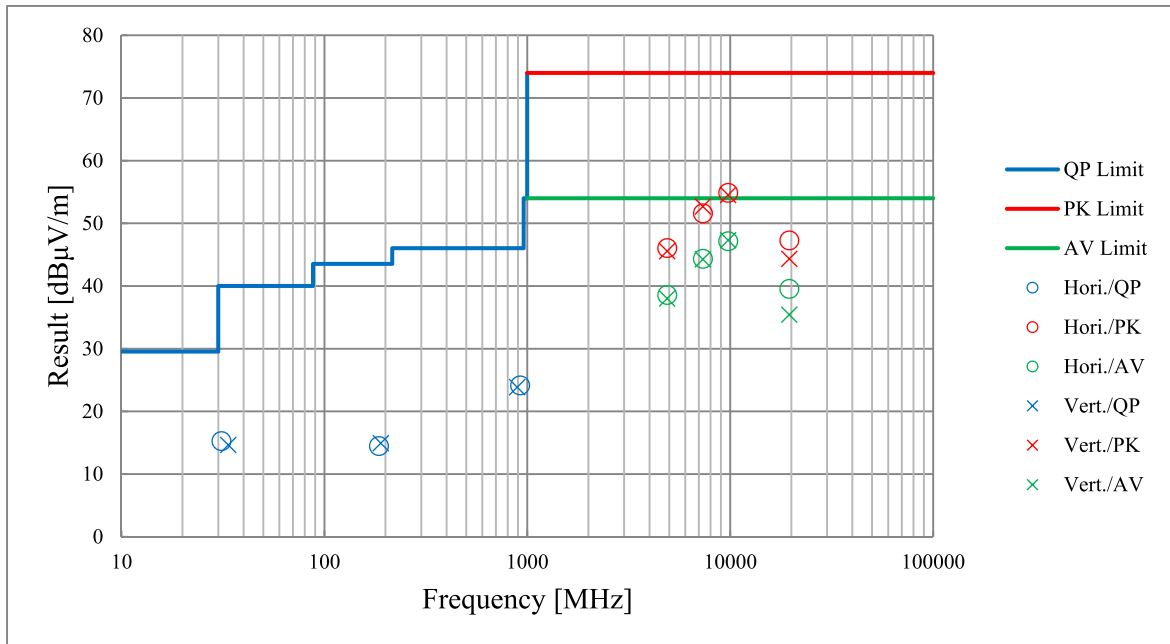

*These plots data contains sufficient number to show the trend of characteristic features for EUT.

Radiated Spurious Emission

Report No.	12510206S-A-R3		
Test place	Shonan EMC Lab.		
Semi Anechoic Chamber	No.3	No.3	No.1
Date	October 10, 2018	October 6, 2018	October 11, 2018
Temperature / Humidity	25 deg. C / 50 % RH	22 deg.C / 52 %RH	23 deg.C / 56 %RH
Engineer	Yohsuke Matsuzawa (30 MHz - 1000 MHz)	Yosuke Isikawa (1 GHz - 13 GHz)	Yasumasa Owaki (13 GHz -26.5GHz)
Mode	Tx BT LE 2 Mbps 2402 MHz		

(* PK: Peak, AV: Average, QP: Quasi-Peak)

Polarity	Frequency [MHz]	Detector	Reading [dBuV]	Ant.Fac. [dB/m]	Loss [dB]	Gain [dB]	Distance Factor [dB]	Result [dBuV/m]	Limit [dBuV/m]	Margin [dB]	Height [cm]	Angle [deg]	Remark
Hori.	31.826	QP	22.60	17.99	6.48	32.20	0.00	14.87	40.00	25.1	150	359	
Hori.	188.177	QP	22.70	16.32	7.84	32.08	0.00	14.78	43.50	28.7	123	2	
Hori.	919.954	QP	21.80	22.03	11.14	30.92	0.00	24.05	46.00	21.9	100	271	
Hori.	2390.000	PK	43.10	27.91	13.89	36.58	2.46	50.78	73.90	23.1	145	3	
Hori.	4804.000	PK	49.11	31.43	6.51	43.91	2.46	45.60	73.90	28.3	100	317	
Hori.	7206.000	PK	48.16	36.79	8.23	43.66	2.46	51.98	73.90	21.9	100	0	
Hori.	9608.000	PK	49.15	38.51	9.21	43.64	2.46	55.69	73.90	18.2	100	0	
Hori.	19216.000	PK	51.29	40.14	11.69	48.17	-9.54	45.41	73.90	28.4	140	0	
Vert.	30.895	QP	23.10	18.36	6.47	32.20	0.00	15.73	40.00	24.2	100	310	
Vert.	191.786	QP	23.00	16.31	7.84	32.08	0.00	15.07	43.50	28.4	100	3	
Vert.	896.976	QP	21.60	22.10	11.06	31.11	0.00	23.65	46.00	22.3	100	125	
Vert.	2390.000	PK	44.00	27.91	13.89	36.58	2.46	51.68	73.90	22.2	223	119	
Vert.	4804.000	PK	50.46	31.43	6.51	43.91	2.46	46.95	73.90	26.9	100	0	
Vert.	7206.000	PK	48.18	36.79	8.23	43.66	2.46	52.00	73.90	21.9	100	0	
Vert.	9608.000	PK	48.89	38.51	9.21	43.64	2.46	55.43	73.90	18.4	100	0	
Vert.	19216.000	PK	46.66	40.14	11.69	48.17	-9.54	40.78	73.90	33.1	128	99	

Result = Reading + Ant.Fac. + Loss (Cable+(Attenuator or Filter)(below 18 GHz)) - Gain(Amplifier) + Distance factor

Distance factor : 1 GHz - 13 GHz : 20log (3.98 m / 3.0 m) = 2.46 dB

13 GHz - 40 GHz : 20log (1.0 m / 3.0 m) = -9.54 dB

Average measurement value with duty factor

Polarity	Frequency [MHz]	Detector	Reading [dBuV]	Ant.Fac. [dB/m]	Loss [dB]	Gain [dB]	Duty Factor [dB]	Distance Factor [dB]	Result [dBuV/m]	Limit [dBuV/m]	Margin [dB]	Remark
Hori.	2390.000	AV	34.10	27.91	13.89	36.58	4.77	2.46	46.55	53.90	7.4	*1)
Hori.	4804.000	AV	41.34	31.43	6.51	43.91	4.77	2.46	42.60	53.90	11.3	
Hori.	7206.000	AV	40.21	36.79	8.23	43.66	4.77	2.46	48.80	53.90	5.1	
Hori.	9608.000	AV	40.96	38.51	9.21	43.64	4.77	2.46	52.27	53.90	1.6	
Hori.	19216.000	AV	40.65	40.14	11.69	48.17	4.77	-9.54	39.54	53.90	14.4	
Vert.	2390.000	AV	34.60	27.91	13.89	36.58	4.77	2.46	47.05	53.90	6.9	*1)
Vert.	4804.000	AV	41.01	31.43	6.51	43.91	4.77	2.46	42.27	53.90	11.6	
Vert.	7206.000	AV	40.04	36.79	8.23	43.66	4.77	2.46	48.63	53.90	5.3	
Vert.	9608.000	AV	40.94	38.51	9.21	43.64	4.77	2.46	52.25	53.90	1.7	
Vert.	19216.000	AV	36.20	40.14	11.69	48.17	4.77	-9.54	35.09	53.90	18.8	

Result = Reading + Ant.Fac. + Loss (Cable+(Attenuator or Filter)(below 18 GHz)) - Gain(Amplifier) + Duty factor + Distance factor

Distance factor : 1 GHz - 13 GHz : 20log (3.98 m / 3.0 m) = 2.46 dB

13 GHz - 40 GHz : 20log (1.0 m / 3.0 m) = -9.54 dB

Duty factor refer to "Duty factor Calculation chart" sheet.

*1) Not out of band emission (Leakage Power)

20 dBc Data Sheet (RBW 100 kHz, VBW 300 kHz)

Polarity	Frequency [MHz]	Detector	Reading [dBuV]	Ant.Fac. [dB/m]	Loss [dB]	Gain [dB]	Distance Factor [dB]	Result [dBuV/m]	Limit [dBuV/m]	Margin [dB]	Remark
Hori.	2402.000	PK	96.60	27.90	13.90	36.57	2.46	104.29	-	-	
Hori.	2400.000	PK	63.40	27.91	13.90	36.58	2.46	71.09	84.29	13.2	
Vert.	2402.000	PK	97.30	27.90	13.90	36.57	2.46	104.99	-	-	
Vert.	2400.000	PK	64.00	27.91	13.90	36.58	2.46	71.69	84.99	13.3	

Result = Reading + Ant.Fac. + Loss (Cable+(Attenuator or Filter)(below 18 GHz)) - Gain(Amplifier) + Distance factor

Distance factor : 1 GHz - 13 GHz : 20log (3.98 m / 3.0 m) = 2.46 dB

13 GHz - 40 GHz : 20log (1.0 m / 3.0 m) = -9.54 dB

UL Japan, Inc.

Shonan EMC Lab.

1-22-3 Megumigaoka, Hiratsuka-shi, Kanagawa-ken, 259-1220 JAPAN

Telephone : +81 463 50 6400

Facsimile : +81 463 50 6401

**Radiated Spurious Emission
(Reference Plot for band-edge)**

Report No.	12510206S-A-R3	No.3	No.1
Test place	Shonan EMC Lab.	October 6, 2018	October 11, 2018
Semi Anechoic Chamber	No.3	22 deg.C / 52 %RH	23 deg.C / 56 %RH
Date	October 10, 2018	Yosuke Isikawa	Yasumasa Owaki
Temperature / Humidity	25 deg. C / 50 % RH	(1 GHz - 13 GHz)	(13 GHz -26.5GHz)
Engineer	Yohsuke Matsuzawa	(1 GHz - 13 GHz)	
Mode	Tx BT LE 2 Mbps 2402 MHz		

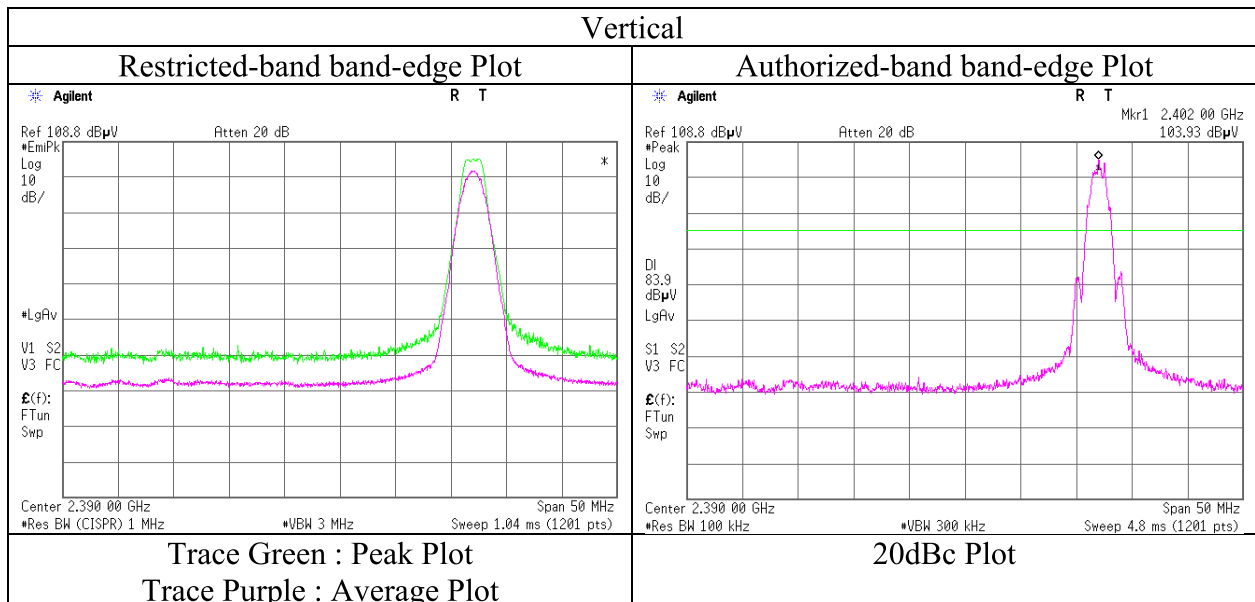
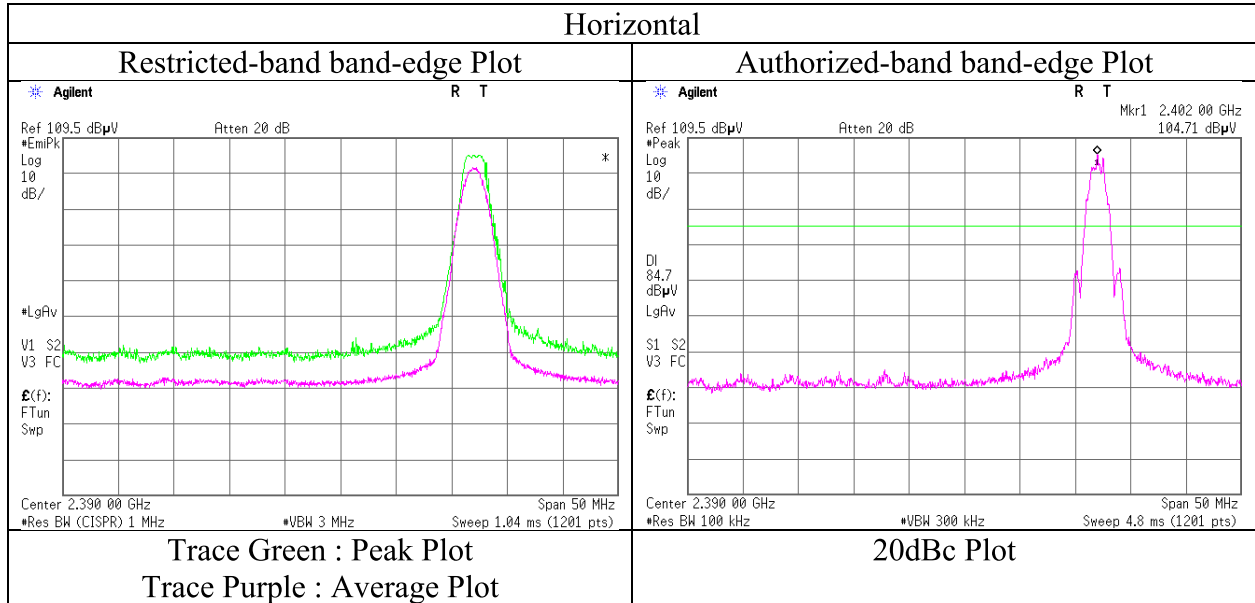

* Final result of restricted band edge was shown in tabular data.

Radiated Spurious Emission

Report No.	12510206S-A-R3		
Test place	Shonan EMC Lab.		
Semi Anechoic Chamber	No.3	No.3	No.1
Date	October 10, 2018	October 6, 2018	October 11, 2018
Temperature / Humidity	25 deg. C / 50 % RH	22 deg.C / 52 %RH	23 deg.C / 56 %RH
Engineer	Yohsuke Matsuzawa (30 MHz - 1000 MHz)	Yosuke Isikawa (1 GHz - 13 GHz)	Yasumasa Owaki (13 GHz -26.5GHz)
Mode	Tx BT LE 2 Mbps 2440 MHz		

(* PK: Peak, AV: Average, OP: Quasi-Peak)

Polarity	Frequency [MHz]	Detector	Reading [dBuV]	Ant.Fac. [dB/m]	Loss [dB]	Gain [dB]	Distance Factor [dB]	Result [dBuV/m]	Limit [dBuV/m]	Margin [dB]	Height [cm]	Angle [deg]	Remark
Hori.	30.535	QP	23.00	18.50	6.46	32.20	0.00	15.76	40.00	24.2	150	359	
Hori.	190.585	QP	22.80	16.27	7.84	32.08	0.00	14.83	43.50	28.6	125	1	
Hori.	918.148	QP	22.00	22.02	11.13	30.93	0.00	24.22	46.00	21.7	100	270	
Hori.	4880.000	PK	48.85	31.37	6.56	43.90	2.46	45.34	73.90	28.5	100	0	
Hori.	7320.000	PK	47.00	37.00	8.31	43.66	2.46	51.11	73.90	22.7	100	0	
Hori.	9760.000	PK	47.58	38.92	9.21	43.56	2.46	54.61	73.90	19.2	100	0	
Hori.	19520.000	PK	52.45	40.09	11.88	47.70	-9.54	47.18	73.90	26.7	139	0	
Vert.	31.987	QP	23.00	17.93	6.49	32.20	0.00	15.22	40.00	24.7	100	312	
Vert.	187.134	QP	22.90	16.17	7.84	32.09	0.00	14.82	43.50	28.6	100	2	
Vert.	912.442	QP	21.70	22.04	11.11	30.98	0.00	23.87	46.00	22.1	100	155	
Vert.	4880.000	PK	48.51	31.37	6.56	43.90	2.46	45.00	73.90	28.9	100	0	
Vert.	7320.000	PK	46.80	37.00	8.31	43.66	2.46	50.91	73.90	22.9	100	0	
Vert.	9760.000	PK	47.60	38.92	9.21	43.56	2.46	54.63	73.90	19.2	100	0	
Vert.	19520.000	PK	48.40	40.09	11.88	47.70	-9.54	43.13	73.90	30.7	128	99	

Result = Reading + Ant.Fac. + Loss (Cable+(Attenuator or Filter)(below 18 GHz)) - Gain(Amplifier) + Distance factor

Distance factor : 1 GHz - 13 GHz : 20log (3.98 m / 3.0 m) = 2.46 dB

13 GHz - 40 GHz : 20log (1.0 m / 3.0 m) = -9.54 dB

Average measurement value with duty factor

Polarity	Frequency [MHz]	Detector	Reading [dBuV]	Ant.Fac. [dB/m]	Loss [dB]	Gain [dB]	Duty Factor [dB]	Distance Factor [dB]	Result [dBuV/m]	Limit [dBuV/m]	Margin [dB]	Remark
Hori.	4880.000	AV	40.40	31.37	6.56	43.90	4.77	2.46	41.66	53.90	12.3	
Hori.	7320.000	AV	38.88	37.00	8.31	43.66	4.77	2.46	47.76	53.90	6.2	
Hori.	9760.000	AV	39.46	38.92	9.21	43.56	4.77	2.46	51.26	53.90	2.7	
Hori.	19520.000	AV	40.29	40.09	11.88	47.70	4.77	-9.54	39.79	53.90	14.1	
Vert.	4880.000	AV	40.35	31.37	6.56	43.90	4.77	2.46	41.61	53.90	12.3	
Vert.	7320.000	AV	38.77	37.00	8.31	43.66	4.77	2.46	47.65	53.90	6.3	
Vert.	9760.000	AV	39.34	38.92	9.21	43.56	4.77	2.46	51.14	53.90	2.8	
Vert.	19520.000	AV	37.17	40.09	11.88	47.70	4.77	-9.54	36.67	53.90	17.2	

Result = Reading + Ant.Fac. + Loss (Cable+(Attenuator or Filter)(below 18 GHz)) - Gain(Amplifier) + Duty factor + Distance factor

Distance factor : 1 GHz - 13 GHz : 20log (3.98 m / 3.0 m) = 2.46 dB

13 GHz - 40 GHz : 20log (1.0 m / 3.0 m) = -9.54 dB

Duty factor refer to "Duty factor Calculation chart" sheet.

*1) Not out of band emission (Leakage Power)

Radiated Spurious Emission

Report No.	12510206S-A-R3		
Test place	Shonan EMC Lab.		
Semi Anechoic Chamber	No.3	No.3	No.1
Date	October 10, 2018	October 6, 2018	October 11, 2018
Temperature / Humidity	25 deg. C / 50 % RH	22 deg.C / 52 %RH	23 deg.C / 56 %RH
Engineer	Yohsuke Matsuzawa (30 MHz - 1000 MHz)	Yosuke Isikawa (1 GHz - 13 GHz)	Yasumasa Owaki (13 GHz -26.5GHz)
Mode	Tx BT LE 2 Mbps 2480 MHz		

(* PK: Peak, AV: Average, QP: Quasi-Peak)

Polarity	Frequency [MHz]	Detector	Reading [dBuV]	Ant.Fac. [dB/m]	Loss [dB]	Gain [dB]	Distance Factor [dB]	Result [dBuV/m]	Limit [dBuV/m]	Margin [dB]	Height [cm]	Angle [deg]	Remark
Hori.	30.453	QP	22.80	18.53	6.46	32.20	0.00	15.59	40.00	24.4	151	358	
Hori.	192.649	QP	23.00	16.43	7.85	32.08	0.00	15.20	43.50	28.3	123	359	
Hori.	918.852	QP	21.80	22.03	11.13	30.92	0.00	24.04	46.00	21.9	100	272	
Hori.	2483.500	PK	51.60	27.67	13.96	36.52	2.46	59.17	73.90	14.7	232	354	
Hori.	4960.000	PK	47.86	31.54	6.61	43.89	2.46	44.58	73.90	29.3	100	0	
Hori.	7440.000	PK	47.39	37.10	8.38	43.65	2.46	51.68	73.90	22.2	100	0	
Hori.	9920.000	PK	46.87	38.97	9.22	43.48	2.46	54.04	73.90	19.8	100	0	
Hori.	19840.000	PK	50.32	39.94	12.02	47.72	-9.54	45.02	73.90	28.8	142	0	
Vert.	31.871	QP	23.20	17.97	6.48	32.20	0.00	15.45	40.00	24.5	100	308	
Vert.	196.162	QP	22.80	16.43	7.86	32.08	0.00	15.01	43.50	28.4	100	2	
Vert.	911.797	QP	21.70	22.05	11.11	30.99	0.00	23.87	46.00	22.1	100	130	
Vert.	2483.500	PK	51.30	27.67	13.96	36.52	2.46	58.87	73.90	15.0	100	111	
Vert.	4960.000	PK	48.58	31.54	6.61	43.89	2.46	45.30	73.90	28.6	100	0	
Vert.	7440.000	PK	47.23	37.10	8.38	43.65	2.46	51.52	73.90	22.3	100	0	
Vert.	9920.000	PK	46.39	38.97	9.22	43.48	2.46	53.56	73.90	20.3	100	0	
Vert.	19840.000	PK	47.66	39.94	12.02	47.72	-9.54	42.36	73.90	31.5	128	100	

Result = Reading + Ant.Fac. + Loss (Cable+(Attenuator or Filter)(below 18 GHz)) - Gain(Amplifier) + Distance factor

Distance factor : 1 GHz - 13 GHz : $20\log(3.98\text{ m} / 3.0\text{ m}) = 2.46\text{ dB}$

13 GHz - 40 GHz : $20\log(1.0\text{ m} / 3.0\text{ m}) = -9.54\text{ dB}$

Average measurement value with duty factor

Polarity	Frequency [MHz]	Detector	Reading [dBuV]	Ant.Fac. [dB/m]	Loss [dB]	Gain [dB]	Duty Factor [dB]	Distance Factor [dB]	Result [dBuV/m]	Limit [dBuV/m]	Margin [dB]	Remark
Hori.	2483.500	AV	39.70	27.67	13.96	36.52	4.77	2.46	52.04	53.90	1.9	*1)
Hori.	4960.000	AV	40.18	31.54	6.61	43.89	4.77	2.46	41.67	53.90	12.2	
Hori.	7440.000	AV	39.55	37.10	8.38	43.65	4.77	2.46	48.61	53.90	5.3	
Hori.	9920.000	AV	38.60	38.97	9.22	43.48	4.77	2.46	50.54	53.90	3.4	
Hori.	19840.000	AV	39.16	39.94	12.02	47.72	4.77	-9.54	38.63	53.90	15.3	
Vert.	2483.500	AV	39.40	27.67	13.96	36.52	4.77	2.46	51.74	53.90	2.2	*1)
Vert.	4960.000	AV	40.47	31.54	6.61	43.89	4.77	2.46	41.96	53.90	11.9	
Vert.	7440.000	AV	39.14	37.10	8.38	43.65	4.77	2.46	48.20	53.90	5.7	
Vert.	9920.000	AV	38.33	38.97	9.22	43.48	4.77	2.46	50.27	53.90	3.6	
Vert.	19840.000	AV	35.80	39.94	12.02	47.72	4.77	-9.54	35.27	53.90	18.6	

Result = Reading + Ant.Fac. + Loss (Cable+(Attenuator or Filter)(below 18 GHz)) - Gain(Amplifier) + Duty factor + Distance factor

Distance factor : 1 GHz - 13 GHz : $20\log(3.98\text{ m} / 3.0\text{ m}) = 2.46\text{ dB}$

13 GHz - 40 GHz : $20\log(1.0\text{ m} / 3.0\text{ m}) = -9.54\text{ dB}$

Duty factor refer to "Duty factor Calculation chart" sheet.

*1) Not out of band emission (Leakage Power)

UL Japan, Inc.

Shonan EMC Lab.

1-22-3 Megumigaoka, Hiratsuka-shi, Kanagawa-ken, 259-1220 JAPAN

Telephone : +81 463 50 6400

Facsimile : +81 463 50 6401

Radiated Spurious Emission
(Reference Plot for band-edge)

Report No.	12510206S-A-R3	No.3	No.1
Test place	Shonan EMC Lab.	October 6, 2018	October 11, 2018
Semi Anechoic Chamber	No.3	October 6, 2018	October 11, 2018
Date	October 10, 2018	22 deg.C / 52 %RH	23 deg.C / 56 %RH
Temperature / Humidity	25 deg. C / 50 % RH	Yosuke Isikawa	Yasumasa Owaki
Engineer	Yohsuke Matsuzawa	(1 GHz - 13 GHz)	(13 GHz -26.5GHz)
Mode	Tx BT LE 2 Mbps 2480 MHz		

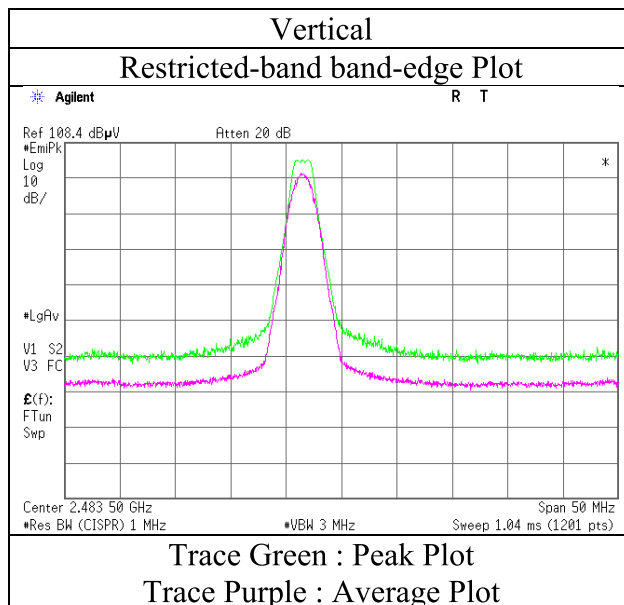
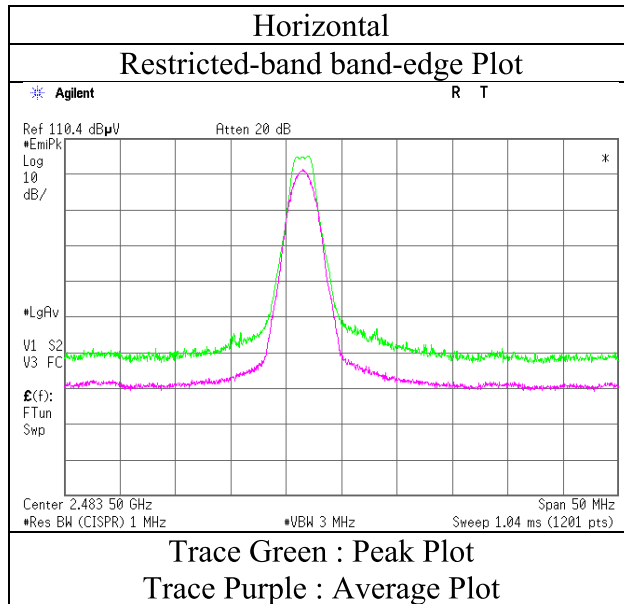

* Final result of restricted band edge was shown in tabular data.

Radiated Spurious Emission
(Plot data, Worst case)

Report No.	12510206S-A-R3		
Test place	Shonan EMC Lab.		
Semi Anechoic Chamber	No.3	No.3	No.1
Date	October 10, 2018	October 6, 2018	October 11, 2018
Temperature / Humidity	25 deg. C / 50 % RH	22 deg.C / 52 %RH	23 deg.C / 56 %RH
Engineer	Yohsuke Matsuzawa (30 MHz - 1000 MHz)	Yosuke Isikawa (1 GHz - 13 GHz)	Yasumasa Owaki (13 GHz -26.5GHz)
Mode	Tx BT LE 2 Mbps 2440 MHz		

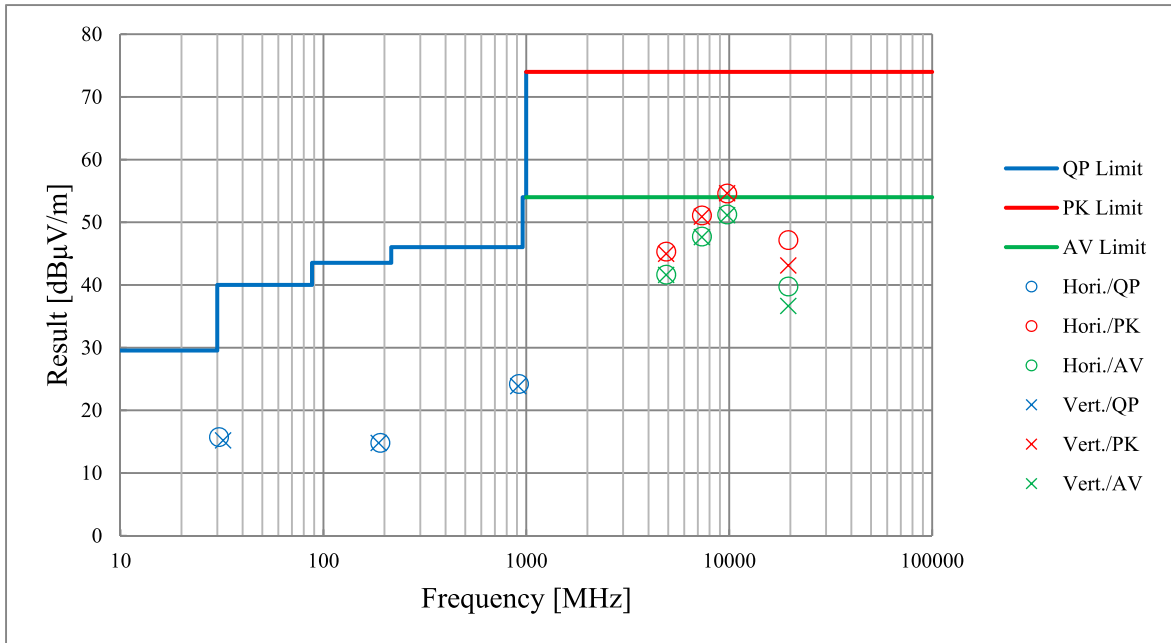

*These plots data contains sufficient number to show the trend of characteristic features for EUT.

Radiated Spurious Emission

Report No. 12510206S-A-R3
Test place Shonan EMC Lab.
Semi Anechoic Chamber No.3 No.3 No.3 No.3
Date October 13, 2018 October 7, 2018 October 8, 2018 October 9, 2018
Temperature / Humidity 24 deg.C, 42 %RH 22 deg.C, 55 %RH 25 deg.C, 50 %RH 24 deg.C, 54 %RH
Engineer Shiro Kobayashi Makoto Hosaka Shiro Kobayashi Shiro Kobayashi
(30 MHz - 1000 MHz) (1 GHz - 2.8 GHz) (2.8 GHz -13 GHz) (13 GHz -26.5 GHz)
Mode Tx ANT 1 Mbps 2402 MHz

(* PK: Peak, AV: Average, QP: Quasi-Peak)

Polarity	Frequency [MHz]	Detector	Reading [dBuV]	Ant.Fac. [dB/m]	Loss [dB]	Gain [dB]	Distance Factor [dB]	Result [dBuV/m]	Limit [dBuV/m]	Margin [dB]	Height [cm]	Angle [deg]	Remark
Hori.	30.911	QP	23.10	18.35	6.47	32.20	0.00	15.72	40.00	24.2	153	2	
Hori.	194.418	QP	22.80	16.44	7.85	32.08	0.00	15.01	43.50	28.4	124	359	
Hori.	920.289	QP	21.70	22.03	11.14	30.91	0.00	23.96	46.00	22.0	100	359	
Hori.	2338.063	PK	53.10	27.93	14.06	43.70	2.46	53.85	73.90	20.0	264	326	
Hori.	2390.000	PK	51.75	27.86	14.11	43.71	2.46	52.47	73.90	21.4	331	345	
Hori.	4804.000	PK	50.48	31.43	6.49	43.91	2.46	46.95	73.90	26.9	150	193	
Hori.	7206.000	PK	49.19	36.79	8.31	43.66	2.46	53.09	73.90	20.8	326	121	
Hori.	9608.000	PK	50.05	38.51	9.20	43.64	2.46	56.58	73.90	17.3	120	22	
Hori.	19214.790	PK	47.77	40.14	11.68	48.17	-9.54	41.88	73.90	32.0	141	33	
Vert.	31.214	QP	23.20	18.23	6.47	32.20	0.00	15.70	40.00	24.3	100	302	
Vert.	196.830	QP	22.80	16.49	7.87	32.08	0.00	15.08	43.50	28.4	100	354	
Vert.	910.717	QP	21.70	22.06	11.11	31.00	0.00	23.87	46.00	22.1	100	211	
Vert.	2338.043	PK	52.44	27.93	14.06	43.70	2.46	53.19	73.90	20.7	140	62	
Vert.	2390.000	PK	49.77	27.86	14.11	43.71	2.46	50.49	73.90	23.4	151	292	
Vert.	4804.000	PK	50.71	31.43	6.49	43.91	2.46	47.18	73.90	26.7	159	134	
Vert.	7206.000	PK	48.15	36.79	8.31	43.66	2.46	52.05	73.90	21.8	151	32	
Vert.	9608.000	PK	49.54	38.51	9.20	43.64	2.46	56.07	73.90	17.8	315	260	
Vert.	19214.970	PK	43.68	40.14	11.68	48.17	-9.54	37.79	73.90	36.1	138	28	

Result = Reading + Ant.Fac. + Loss (Cable+(Attenuator or Filter)(below 18 GHz)) - Gain(Amplifier) + Distance factor

Distance factor : 1 GHz - 13 GHz : 20log(3.98 m / 3.0 m) = 2.46 dB

13 GHz - 40 GHz : 20log(1.0 m / 3.0 m) = -9.54 dB

Average measurement value with duty factor

Polarity	Frequency [MHz]	Detector	Reading [dBuV]	Ant.Fac. [dB/m]	Loss [dB]	Gain [dB]	Duty Factor [dB]	Distance Factor [dB]	Result [dBuV/m]	Limit [dBuV/m]	Margin [dB]	Remark
Hori.	2338.063	AV	47.05	27.93	14.06	43.70	0.45	2.46	48.25	53.90	5.7	
Hori.	2390.000	AV	41.94	27.86	14.11	43.71	0.45	2.46	43.11	53.90	10.8	*1)
Hori.	4804.000	AV	42.54	31.43	6.49	43.91	0.45	2.46	39.46	53.90	14.4	
Hori.	7206.000	AV	39.79	36.79	8.31	43.66	0.45	2.46	44.14	53.90	9.8	
Hori.	9608.000	AV	40.00	38.51	9.20	43.64	0.45	2.46	46.98	53.90	6.9	
Hori.	19214.790	AV	41.13	40.14	11.68	48.17	0.45	-9.54	35.69	53.90	18.2	
Vert.	2338.043	AV	45.09	27.93	14.06	43.70	0.45	2.46	46.29	53.90	7.6	
Vert.	2390.000	AV	40.84	27.86	14.11	43.71	0.45	2.46	42.01	53.90	11.9	*1)
Vert.	4804.000	AV	42.23	31.43	6.49	43.91	0.45	2.46	39.15	53.90	14.8	
Vert.	7206.000	AV	39.19	36.79	8.31	43.66	0.45	2.46	43.54	53.90	10.4	
Vert.	9608.000	AV	40.59	38.51	9.20	43.64	0.45	2.46	47.57	53.90	6.3	
Vert.	19214.970	AV	35.24	40.14	11.68	48.17	0.45	-9.54	29.80	53.90	24.1	

Result = Reading + Ant.Fac. + Loss (Cable+(Attenuator or Filter)(below 18 GHz)) - Gain(Amplifier) + Duty factor + Distance factor

Distance factor : 1 GHz - 13 GHz : 20log(3.98 m / 3.0 m) = 2.46 dB

13 GHz - 40 GHz : 20log(1.0 m / 3.0 m) = -9.54 dB

Duty factor refer to "Duty factor Calculation chart" sheet.

*1) Not out of band emission (Leakage Power)

20 dBc Data Sheet (RBW 100 kHz, VBW 300 kHz)

Polarity	Frequency [MHz]	Detector	Reading [dBuV]	Ant.Fac. [dB/m]	Loss [dB]	Gain [dB]	Distance Factor [dB]	Result [dBuV/m]	Limit [dBuV/m]	Margin [dB]	Remark
Hori.	2402.000	PK	105.75	27.86	14.12	43.71	2.46	106.48	-	-	
Hori.	2400.000	PK	52.68	27.86	14.12	43.71	2.46	53.41	86.48	33.1	
Vert.	2402.000	PK	103.04	27.86	14.12	43.71	2.46	103.77	-	-	
Vert.	2400.000	PK	51.02	27.86	14.12	43.71	2.46	51.75	83.77	32.0	

Result = Reading + Ant.Fac. + Loss (Cable+(Attenuator or Filter)(below 18 GHz)) - Gain(Amplifier) + Distance factor

Distance factor : 1 GHz - 13 GHz : 20log(3.98 m / 3.0 m) = 2.46 dB

13 GHz - 40 GHz : 20log(1.0 m / 3.0 m) = -9.54 dB

UL Japan, Inc.

Shonan EMC Lab.

1-22-3 Megumigaoka, Hiratsuka-shi, Kanagawa-ken, 259-1220 JAPAN

Telephone : +81 463 50 6400

Facsimile : +81 463 50 6401

Radiated Spurious Emission
(Reference Plot for band-edge)

Report No.	12510206S-A-R3
Test place	Shonan EMC Lab.
Semi Anechoic Chamber	No.3
Date	October 7, 2018
Temperature / Humidity	22 deg.C, 55 %RH
Engineer	Makoto Hosaka
	(1 GHz – 2.8 GHz)
Mode	Tx ANT 1 Mbps 2402 MHz

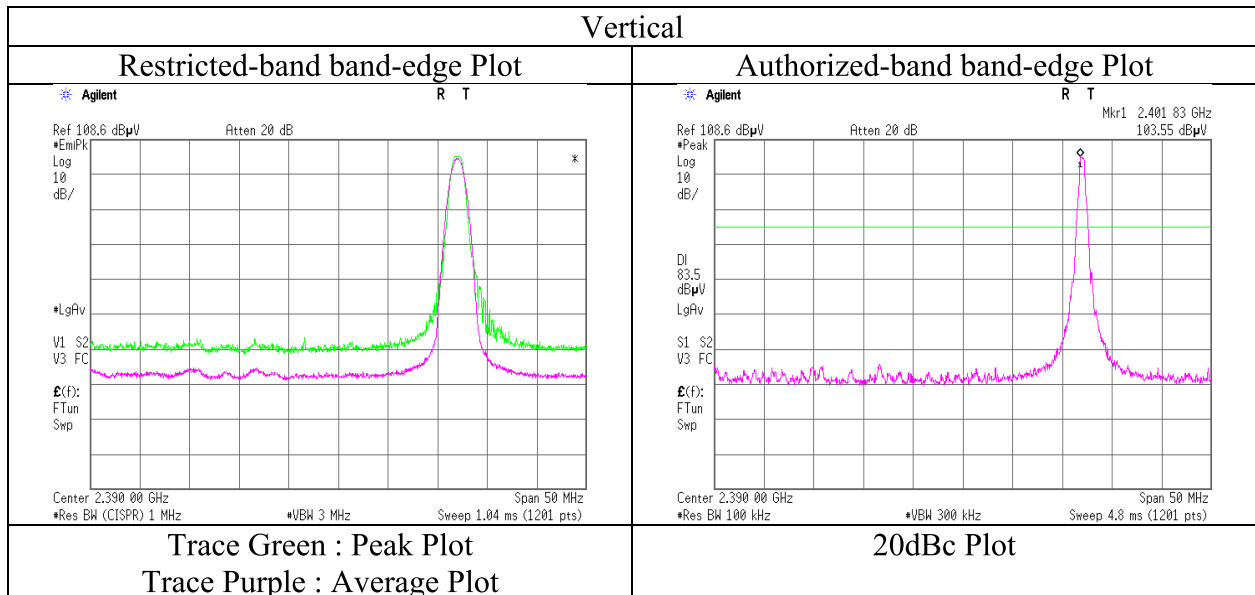
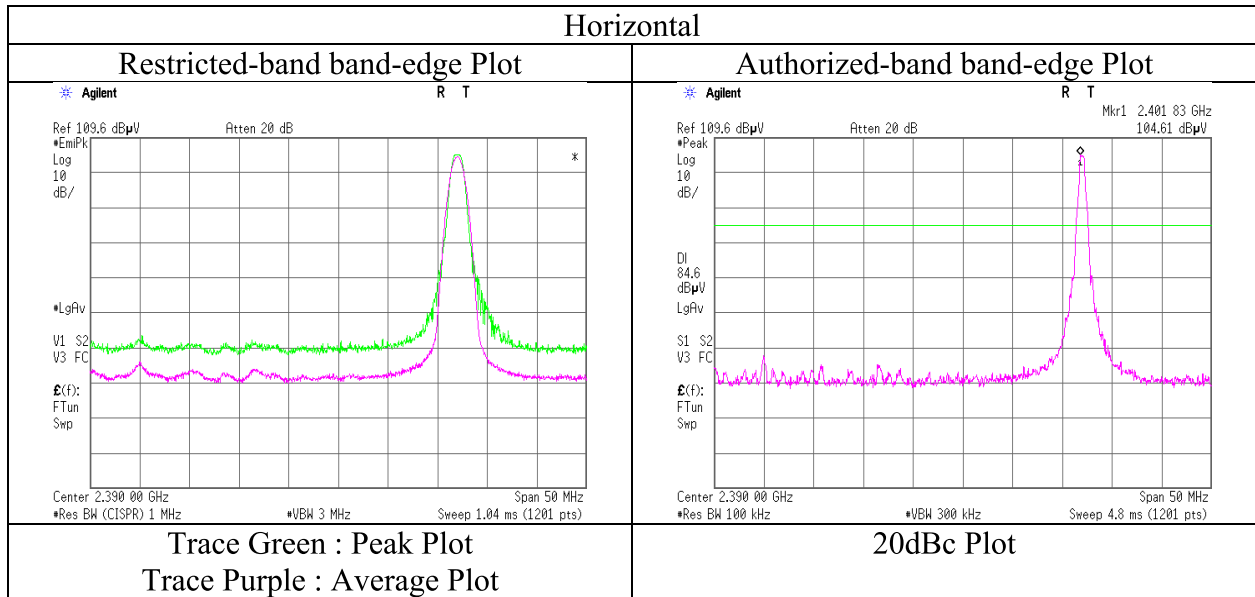

* Final result of restricted band edge was shown in tabular data.

Radiated Spurious Emission

Report No. 12510206S-A-R3
Test place Shonan EMC Lab.
Semi Anechoic Chamber No.3 No.3 No.3 No.3
Date October 13, 2018 October 7, 2018 October 8, 2018 October 9, 2018
Temperature / Humidity 24 deg.C, 42 %RH 22 deg.C, 55 %RH 25 deg.C, 50 %RH 24 deg.C, 54 %RH
Engineer Shiro Kobayashi Makoto Hosaka Shiro Kobayashi Shiro Kobayashi
(30 MHz - 1000 MHz) (1 GHz - 2.8 GHz) (2.8 GHz -13 GHz) (13 GHz -26.5 GHz)
Mode Tx ANT 1 Mbps 2441 MHz

(* PK: Peak, AV: Average, QP: Quasi-Peak)

Polarity	Frequency [MHz]	Detector	Reading [dBuV]	Ant.Fac. [dB/m]	Loss [dB]	Gain [dB]	Distance Factor [dB]	Result [dBuV/m]	Limit [dBuV/m]	Margin [dB]	Height [cm]	Angle [deg]	Remark
Hori.	30.433	QP	22.80	18.54	6.46	32.20	0.00	15.60	40.00	24.4	150	359	
Hori.	182.241	QP	22.60	16.06	7.84	32.09	0.00	14.41	43.50	29.0	125	2	
Hori.	940.268	QP	22.00	22.18	11.21	30.73	0.00	24.66	46.00	21.3	100	7	
Hori.	2377.048	PK	51.59	27.85	14.10	43.71	2.46	52.29	73.90	21.6	152	2	
Hori.	2505.010	PK	52.15	27.61	14.20	43.72	2.46	52.70	73.90	21.2	221	182	
Hori.	4882.000	PK	49.31	31.37	6.53	43.90	2.46	45.77	73.90	28.1	139	336	
Hori.	7323.000	PK	48.72	37.01	8.40	43.66	2.46	52.93	73.90	20.9	194	234	
Hori.	9764.000	PK	47.63	38.92	9.22	43.56	2.46	54.67	73.90	19.2	150	0	
Hori.	19527.040	PK	49.08	40.08	11.88	47.70	-9.54	43.80	73.90	30.1	141	15	
Vert.	30.988	QP	23.30	18.32	6.47	32.20	0.00	15.89	40.00	24.1	100	300	
Vert.	193.416	QP	22.70	16.48	7.85	32.08	0.00	14.95	43.50	28.5	100	353	
Vert.	920.412	QP	21.90	22.03	11.14	30.91	0.00	24.16	46.00	21.8	100	210	
Vert.	2377.041	PK	50.83	27.85	14.10	43.71	2.46	51.53	73.90	22.3	152	82	
Vert.	4882.000	PK	48.56	31.37	6.53	43.90	2.46	45.02	73.90	28.8	161	316	
Vert.	7323.000	PK	47.59	37.01	8.40	43.66	2.46	51.80	73.90	22.1	136	229	
Vert.	9764.000	PK	47.73	38.92	9.22	43.56	2.46	54.77	73.90	19.1	150	0	
Vert.	19526.720	PK	47.94	40.08	11.88	47.70	-9.54	42.66	73.90	31.2	139	0	

Result = Reading + Ant.Fac. + Loss (Cable+(Attenuator or Filter)(below 18 GHz)) - Gain(Amplifier) + Distance factor

Distance factor : 1 GHz - 13 GHz : 20log (3.98 m / 3.0 m) = 2.46 dB

13 GHz - 40 GHz : 20log (1.0 m / 3.0 m) = -9.54 dB

Average measurement value with duty factor

Polarity	Frequency [MHz]	Detector	Reading [dBuV]	Ant.Fac. [dB/m]	Loss [dB]	Gain [dB]	Duty Factor [dB]	Distance Factor [dB]	Result [dBuV/m]	Limit [dBuV/m]	Margin [dB]	Remark
Hori.	2377.048	AV	45.07	27.85	14.10	43.71	0.45	2.46	46.22	53.90	7.7	
Hori.	2505.010	AV	44.99	27.61	14.20	43.72	0.45	2.46	45.99	53.90	7.9	
Hori.	4882.000	AV	39.56	31.37	6.53	43.90	0.45	2.46	36.47	53.90	17.4	
Hori.	7323.000	AV	38.63	37.01	8.40	43.66	0.45	2.46	43.29	53.90	10.6	
Hori.	9764.000	AV	38.99	38.92	9.22	43.56	0.45	2.46	46.48	53.90	7.4	
Hori.	19527.040	AV	39.46	40.08	11.88	47.70	0.45	-9.54	34.63	53.90	19.3	
Vert.	2377.041	AV	43.68	27.85	14.10	43.71	0.45	2.46	44.83	53.90	9.1	
Vert.	4882.000	AV	39.43	31.37	6.53	43.90	0.45	2.46	36.34	53.90	17.6	
Vert.	7323.000	AV	38.41	37.01	8.40	43.66	0.45	2.46	43.07	53.90	10.8	
Vert.	9764.000	AV	38.74	38.92	9.22	43.56	0.45	2.46	46.23	53.90	7.7	
Vert.	19526.720	AV	38.75	40.08	11.88	47.70	0.45	-9.54	33.92	53.90	20.0	

Result = Reading + Ant.Fac. + Loss (Cable+(Attenuator or Filter)(below 18 GHz)) - Gain(Amplifier) + Duty factor + Distance factor

Distance factor : 1 GHz - 13 GHz : 20log (3.98 m / 3.0 m) = 2.46 dB

13 GHz - 40 GHz : 20log (1.0 m / 3.0 m) = -9.54 dB

Duty factor refer to "Duty factor Calculation chart" sheet.

*1) Not out of band emission (Leakage Power)