

INTELLIGENT TRACKING SELFIE STICK

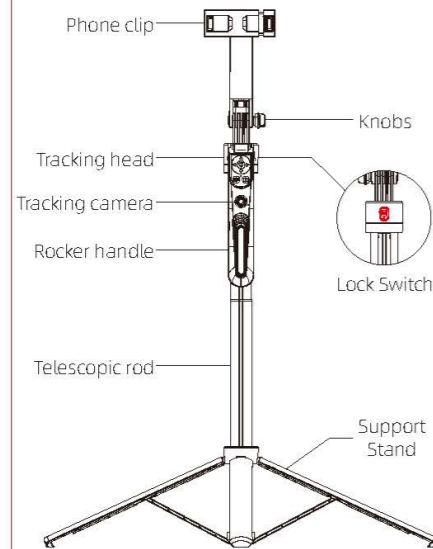

INSTRUCTION MANUAL
H9S-C Series

Products Introduction



Directions for use

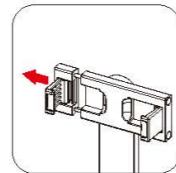

Pull out the phone clip to install the phone

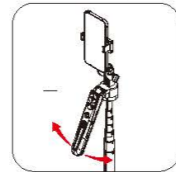

Lift up to unlock to use the rocker arm



Tighten the knob to secure the phone clip

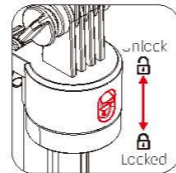

Unlock the head when using the head

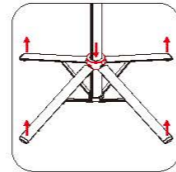

Open the stand from the bottom

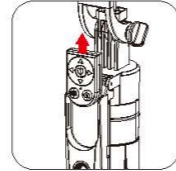

Push up on the remote to remove it

Remote Control

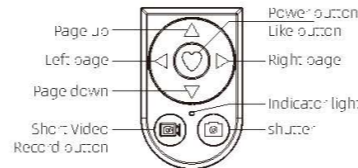

- 1) Please turn on the Bluetooth function on your cell phone before use.
 - 2) Long press the power button on the remote control to turn on the phone.
 - 3) When your phone searches for the Bluetooth device named "Selfie", click and select pairing.
 - 4) Open the camera and short video APP, and press the function button of the remote control to realize the corresponding operation.
 - 5) Press and hold the power button for about 2 seconds to turn off the camera.
- Hint: Please scan the QR code on this manual to get the detailed tutorial according to your cell phone category.

Extended Interface

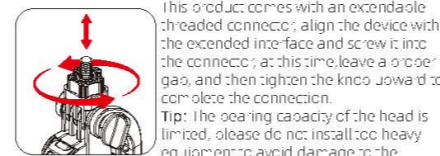

This product comes with an extendable threaded connector; align the device with the extended interface and screw it into the connector; at this time, leave a proper gap, and then tighten the knob toward to complete the connection.
Tip: The bearing capacity of the head is limited, please do not install too heavy equipment to avoid damage to the equipment.

Intelligent Tracking Head

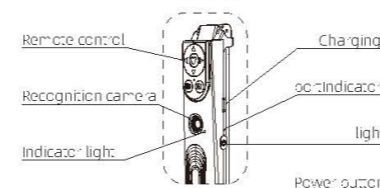

- Hint: Please unlock the tracking head before turning it on.
- 1) Long press the power button to turn on the power.
 - 2) Click the power button to pause tracking, and the indicator light flashes.
 - 3) Double-click the power button to enter the slow rotation mode, click the power button to stop. Triple-click the power button to enter the fast rotation mode.
 - 4) Long press the power button to turn off the device.
- 5) **Charging**
Use USB 5V adapter to connect to the charging port for charging. When charging, the red indicator light is on; the charging is finished when the indicator light turns green.
- 6) **Intelligent Gesture Control**
Under power-on state
[Gesture-Palm] Hold for 2S until the indicator light is on to stop tracking.
[Gesture-OK] Hold for 2 seconds until the indicator light is on to turn on the tracking.



Stop Tracking



Open Tracking

*Fill Light

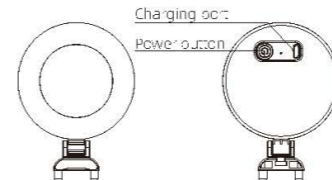

- 1) Power button: click to turn on the light, click again to switch the light mode until power off; long press the power button to adjust the brightness of the light.
- 2) Charging: use the USB 5V adapter to connect to the charging port for charging.

*The fill light is optional, please refer to the configuration of the purchased products

Video Tutorials



iOS



Android

Please according to the cell phone system
Scan the QR code above to get the detailed tutorial

Fault Resolution

- 1) Bluetooth remote control can not be turned on.
>>> Charge the remote control and retry after charging.
- 2) Bluetooth cannot be connected/fails to work properly after power on.
>>> Remove the Bluetooth pairing on your phone, restart the Bluetooth remote control and re-pair the connection.
- 3) If Android phone can't take photos with the remote control.
>>> ① Press the photo button to adjust the volume; Open Camera App, change "Volume Function" to default or take photo, then you can take photo with remote control.
>>> ② Press the photo button can not adjust the volume; Follow the steps in question 2 to re-pair and connect.
- 4) When the target is lost, the gimbal stops and the indicator light blinks, then you can walk into the field of view of the camera again. To ensure the recognition accuracy, please use it within 1-3 meters from the tracker.

Note

- 1) Do not store the product in a low-temperature, humid environment.
- 2) Do not expose the product to high temperatures such as sunlight or fire.
- 3) Do not use the product in places where the equipment is restricted to avoid violating public order.
- 4) This product contains small parts, please keep it out of the reach of infants and young children to prevent them from swallowing it accidentally.
- 5) The pictures and dimensions shown on the package and manual are for reference only, please refer to the actual product.

FCC COMPLIANCE STATEMENT:

This device complies with part 15 of the FCC Rules. Operation is subject to the following two conditions:
(1) This device may not cause harmful interference, and
(2) this device must accept any interference received, including interference that may cause undesired operation.

Note: This equipment has been tested and found to comply with the limits for a Class B digital device, pursuant to Part 15 of the FCC Rules. These limits are designed to provide reasonable protection against harmful interference in a residential installation. This equipment generates, uses and can radiate radio frequency energy and, if not installed and used in accordance with the instructions, may cause harmful interference to radio communications.

However, there is no guarantee that interference will not occur in a particular installation. If this equipment does cause harmful interference to radio or television reception, which can be determined by turning the equipment off and on, the user is encouraged to try to correct the interference by one or more of the following measures: Reorient or relocate the receiving antenna. Increase the separation between the equipment and receiver. Connect the equipment into an outlet on a circuit different from that to which the receiver is connected. Consult the dealer or an experienced radio/TV technician for help.

Warning: Changes or modifications to this unit not expressly approved by the part responsible for compliance could void the user's authority to operate the equipment.

FCC Radiation Exposure Statement

The device has been evaluated to meet general RF exposure requirement. The device can be used in portable exposure condition without restriction.