

CoreTigo TigoHub i4

USER MANUAL



Table of Contents

Table of Contents	2
List of Tables	3
1. Introduction	5
1.1. Structure	6
1.2. Typographical Conventions	6
1.3. Symbols	6
1.4. Deviating Views	6
2. Safety	7
2.1. General Note	7
2.2. Electrical Connection	7
2.3. Intended Use	7
2.4. Personnel Qualification	8
3. Requirements	9
4. Pre-Installation	10
4.1. Description	10
4.2. Overview	10
4.3. Functional Diagram	11
4.4. LEDs	12
4.5. Electrical Wiring	14
4.6. Electrical Connection	15
5. Mounting	16
6. Configuration and Setup	17
6.1. PD (Process Data) Configuration	17
6.2. Device Configuration	20
7. Firmware Update	31
8. Diagnostics and Troubleshooting	32
8.1. Power Supply LEDs	32
8.2. IOLWLED	32
8.3. Ports LEDs	32
9. Guidelines and Regulations	33
9.1. RF Exposure Warnings	33
9.2. Class B Warning	33
9.3. Modification Statements	33
9.4. FCC, ISED Regulatory Notices	33

10. TechnicalData.....	35
11. CustomerSupport	40
Appendix–PartNumber.....	41

ListofFigures

Figure1:TigoHubi4.....	5
Figure2:TigoHubi4SampleConnectivity	9
Figure3:TigoHubi4BackLabel	10
Figure4:TigoHubi4FunctionalDiagram	11
Figure5:TigoHubi4LEDs	12
Figure6: ElectricalSchematicDiagram	15
Figure7:TigoHubi4Mountings	16
Figure8:PDoutConfiguration Example.....	18
Figure 9:PDinConfiguration Example.....	19
Figure10:BlockDiagram-Power	37
Figure11:BlockDiagram-Ports1and2.....	37
Figure12:BlockDiagram-Ports3and4.....	38

ListofTables

Table1:SymbolsUsed	6
Table2:PowerLEDs	13
Table3:IOLWLEDs.....	13
Table4:PortsLEDs	13
Table5:DigitalOutputsLEDs	14
Table6:PDConfiguration	17
Table7:CQPortModeConfiguration	17
Table8:PDin/PDoutConfiguration	18
Table 9: PDoutConfiguration Example	18
Table 10: PDinConfigurationExample	19
Table11:PowerLEDs	32
Table12:IOLWLEDs	32
Table13:PortsLEDs	32
Table14:Technical Data	34

VersionControl

AuthorName	Description	Revision	Date
BennyZelman	Documentcreation	00	07.11.21
	Addedchapter6	01	12.06.2022

AcronymsandAbbreviations

Acronymsandabbreviationsusedinthisdocumentarelistedinthis table.

Symbol	Meaning
CEC	CanadianElectricalCode
DI	DigitalInput
DIO	DigitalInput/Output
DO	DigitalOutput
FCC	FederalCommunicationsCommission
FOTA	FirmwareOverTheAir
FW	Firmware
HW	Hardware
IF	Interface
IO	Input/Output
IODD	Input/OutputDeviceDescription
iIODD	InternalInput/OutputDeviceDescription
IOL	Input/OutputLink
IOLW	IO-LinkWireless
ISDU	IndexedServiceDataUnit
LED	Light-EmittingDiode
NEC	NationalElectricalCode
NFPA	NationalFireProtectionAssociation
OD	OnDemand
PD	ProcessData
SMA	SubMiniatureversionA
SW	Software
UID	UniqueID

1. Introduction

This User Manual introduces the **TigoHubi4** (P/N: CT261-007-4P) and instructs how to perform setup, configuration, mounting, and troubleshooting.

The **TigoHubi4** is a Multiport hub for IO-Link Wireless connectivity of IO-Link and DIO devices.

It connects up-to 4 IO-Link and up to a combination of 6 IO-Link/DIO devices and convertsto IO-Link Wireless.

Read this User Manual carefully before using the device.



Figure 1: TigoHubi4

References:

-  TigoEngine – User Manual
 - TigoMaster2TH–UserManual
-

1.1. Structure

This section of this User Manual build on one another.

1.2. Typographical Conventions

Enumerations are shown in list form with bullet points.

- Entry1
- Entry2
- Entry3



Instructional steps are shown in list form with numbers.

1. Step1.
2. Step2.
3. Step3.

Decimal numbers are shown without additional indicators and are not spelled out (e.g. 123).

1.3. Symbols

Table 1: Symbols Used

Symbol	Meaning
	Note: This symbol indicates a general note.
	Warning: This symbol indicates a security notice which must be observed.
	Reference: This symbol indicates a cross-reference to other documentation.

1.4. Deviating Views

The product views and illustrations in this User Manual may deviate from the actual product. They are intended only as illustrative material.

2. Safety

2.1. General Note

This User Manual is intended for any qualified personnel using the device. All safety messages, integrated safety messages, property damage messages, and valid legal regulations must be observed by its users.



Technical capabilities on behalf of the user are presumed.

2.2. Electrical Connection

TigoHubi4 shall be supplied by an isolated power source that meets the following requirements:

- Limited-Energy Circuit in accordance with UL/CSA 61010-1 or
- Limited Power Source (LPS) in accordance with (UL/CSA 60950-1 or EN 62368-1, Annex Q) or
- Class 2 supply source which complies with the National Electrical Code (NEC), NFPA 70, Clause 725.121 and Canadian Electrical Code (CEC), Part I, C22.1.



Warning: Wiring of DIO devices must be according to the specified instructions. Incorrect wiring may result in damage to the TigoHub i4 and the connected devices.



Warning: Product applications other than those described in this User Manual are not permitted.

2.3. Intended Use

TigoHubi4 is an IO-Link Wireless Device with an IP65 enclosure.

TigoHubi4 is intended for indoor use only in a service area away from the public or in a panel. TigoHub i4 converts four IO-Link/DIO ports to a single IO-Link Wireless port.

TigoHubi4 houses two M12L-coded connectors for Power In and Power Out, 4M12A-coded connectors for sensors/actuators and an SMA connector for external antenna.

2.4. PersonnelQualification

The product may only be Installed, mounted, configured, operated, or demounted by qualified personnel. When working with electricity, technical skills must be demonstrated under all the following circumstances:

- Safety and health at work
- Mounting and connecting of electrical equipment
- Measurement and analysis of electrical functions and systems
- Evaluation of the safety of electrical systems and equipment

 **Warning:**CoreTigoLtd. does not assume any warranty or liability for damage caused to the product due to non-compliance with security measures or incorrect product installation.

3. Requirements

TigoHubi4 is implemented based on the IO-Link Wireless standard for W-Devices.

TigoHubi4 is part of an IO-Link Wireless environment. It communicates with an IO-Link Wireless Master. Therefore, to use it, an IO-Link Wireless Master, IO-Link and DIO devices, and a power cable are required.

Refer to the illustration in Figure 2 below for sample connectivity:

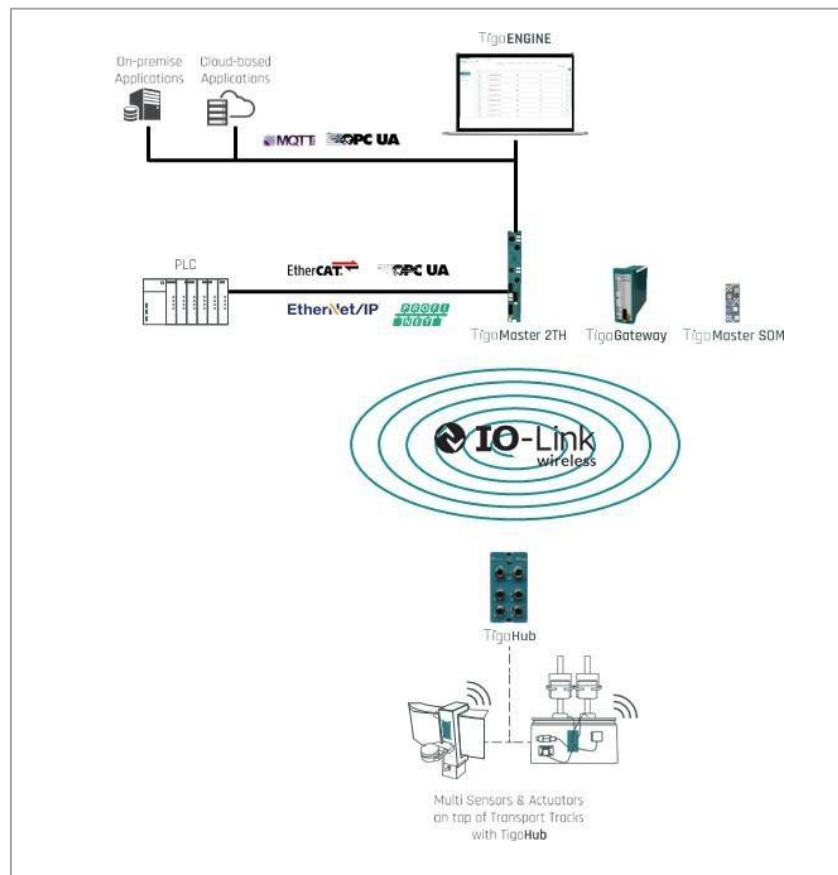

Figure 2: TigoHubi4 Sample Connectivity

- A. IO-Link Class A Device
- B. IO-Link Class B Device
- C. DI Devices
- D. DO Devices
- E. IO-Link Wireless Master
- F. Power Source – 24VDC
- G. TigoHubi4

4. Pre-Installation

4.1. Description

IO-Link devices or DI/DO devices can be connected to aTigoHub i4 using A-codedM12 cables. The TigoHub i4 can be connected to an IO-Link Wireless Master using the TigoEngine engineering tool, the Integrated web server tool, or a PLC.

4.2. Overview

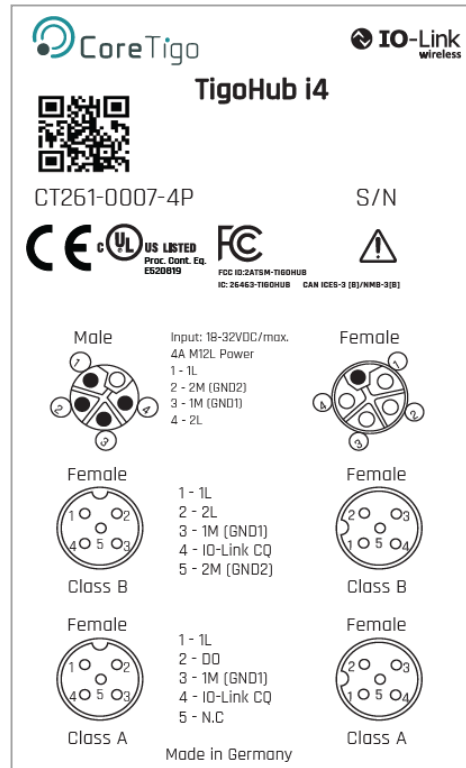

Figure3:TigoHubi4BackLabel

Label:

- A. TigoHubi4Model
- B. InputPowerSupplyRange
- C. ProductNumber
- D. QRCODE(URL)
- E. FCC ID
- F. ClassAportsconnectivitydiagram
- G. ClassBportsconnectivitydiagram

4.3. FunctionalDiagram

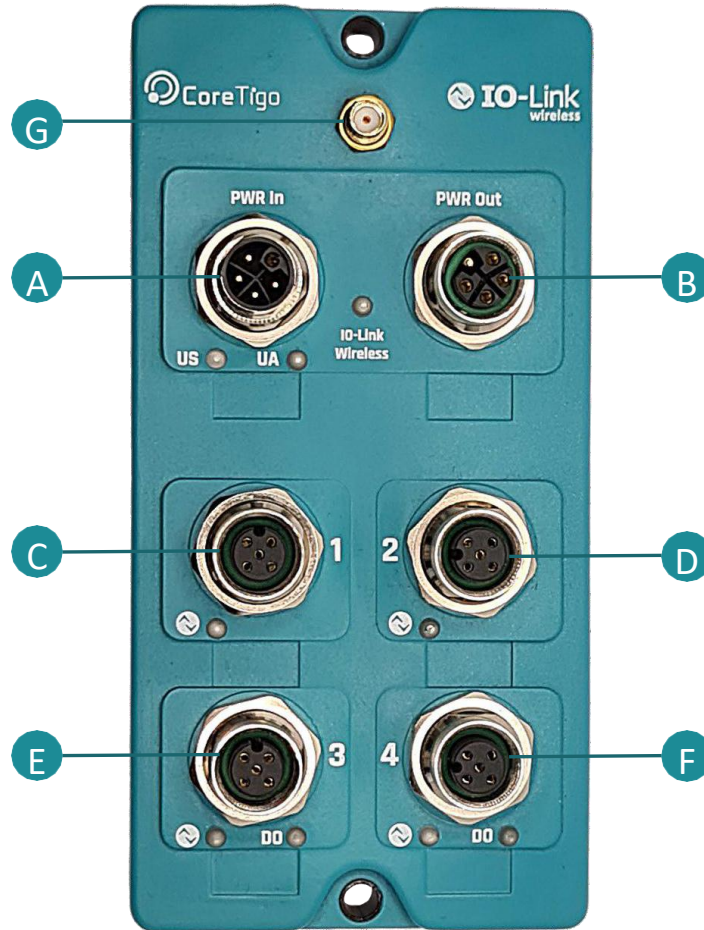

Figure4:TigoHubi4FunctionalDiagram

- A. Powerinput
- B. Poweroutput
- C. Port1
- D. Port2
- E. Port3
- F. Port4
- G. Antennaconnector

4.4. LEDS

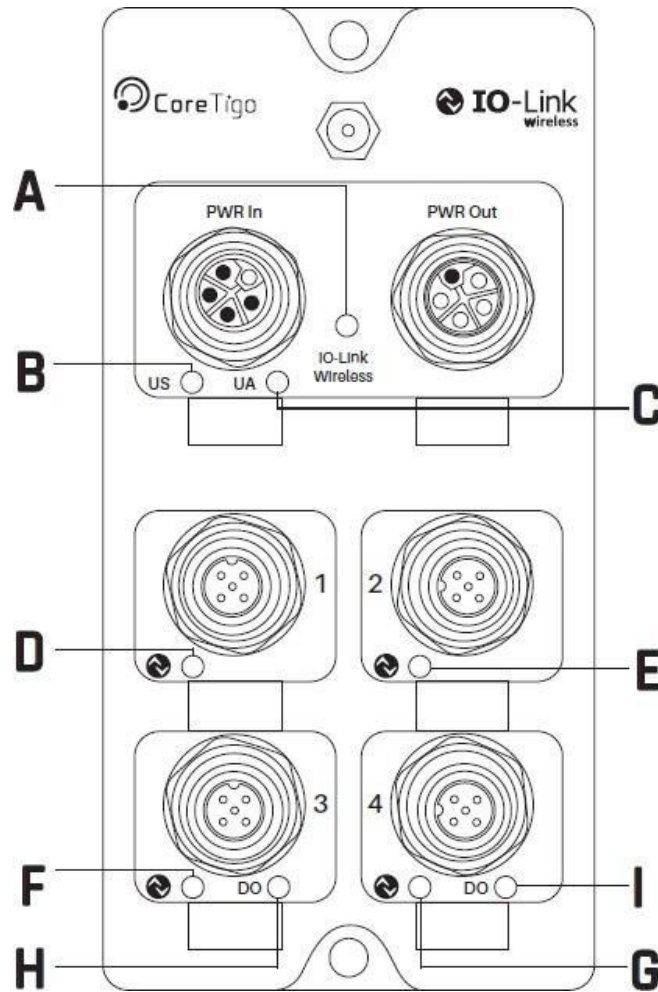

Figure5:TigoHubi4 LEDs

- A. IO-LinkWirelessStatus(**Red/Green/Orange**)
- B. PowerSupply1(**Red/Green/Orange**)
- C. PowerSupply2(**Red/Green/Orange**)
- D. Port 1(**Red/Green/Orange**)
- E. Port 2(**Red/Green/Orange**)
- F. Port 3(**Red/Green/Orange**)
- G. Port 4(**Red/Green/Orange**)
- H. DigitalOutput1(**Green**)
- I. DigitalOutput2(**Green**)

4.4.1. PowerSupplyLEDs

The following table describes the indication of PowerSupply1 and PowerSupply2 LEDs

Table2:PowerLEDs

LEDColor	Indication
Green	PowersupplyvoltageOK

4.4.2. IO-LinkWirelessLEDs

Table3:IOLWLEDs

LEDColor	Indication
Green	Deviceunpaired
BLINKING Green (350msec on, 350msec off)	Devicepaired
FLASHING Green (900msec on, 100msec off)	Deviceconnected
Orange	Safemode
BLINKING Red	Fault
Off	Inactive

4.4.3. PortsLEDs

The following table describes the indications of Ports1-4 LEDs.

Table4:PortsLEDs

LEDColor	Indication
Green	PortconfiguredasIOL,operational,invaliddata
BLINKING Green	PortconfiguredasIOL,operational,validdata
Orange	PortconfiguredasIO,operational,invaliddata
BLINKING Orange	PortconfiguredasIO,operational,validdata
Red	PortconfiguredasIOL,not operational
BLINKING Red	Fault
OFF	Inactive

4.4.4. DigitalOutputsLEDs

The following table describes the indications of Digital Outputs 1-2 LEDs.

Table 5: Digital Outputs LEDs

LED Color	Indication
Green	Output set to high
OFF	Output set to low

4.5. Electrical Wiring

TigoHubi4 has six M12 connectors.

- **4x IO-Link Connector:** 5 pins, A-Coded female connector.



Maximum current supply to IO-Link device is 2A for 24VDC Class A port and 4A for 24VDC class B port.

- **Power Input Connector:** 5 pins, L-Coded male connector.



Voltage higher than 32VDC is forbidden, as it can damage the TigoHubi4. Maximum current supply is 8A when using 24VDC.

- **Power Output Connector:** 5 pins, L-Coded female connector.



Maximum current supply for cascading power is 4A per each 1L and 2L, when using 24VDC.

4.6. ElectricalConnection

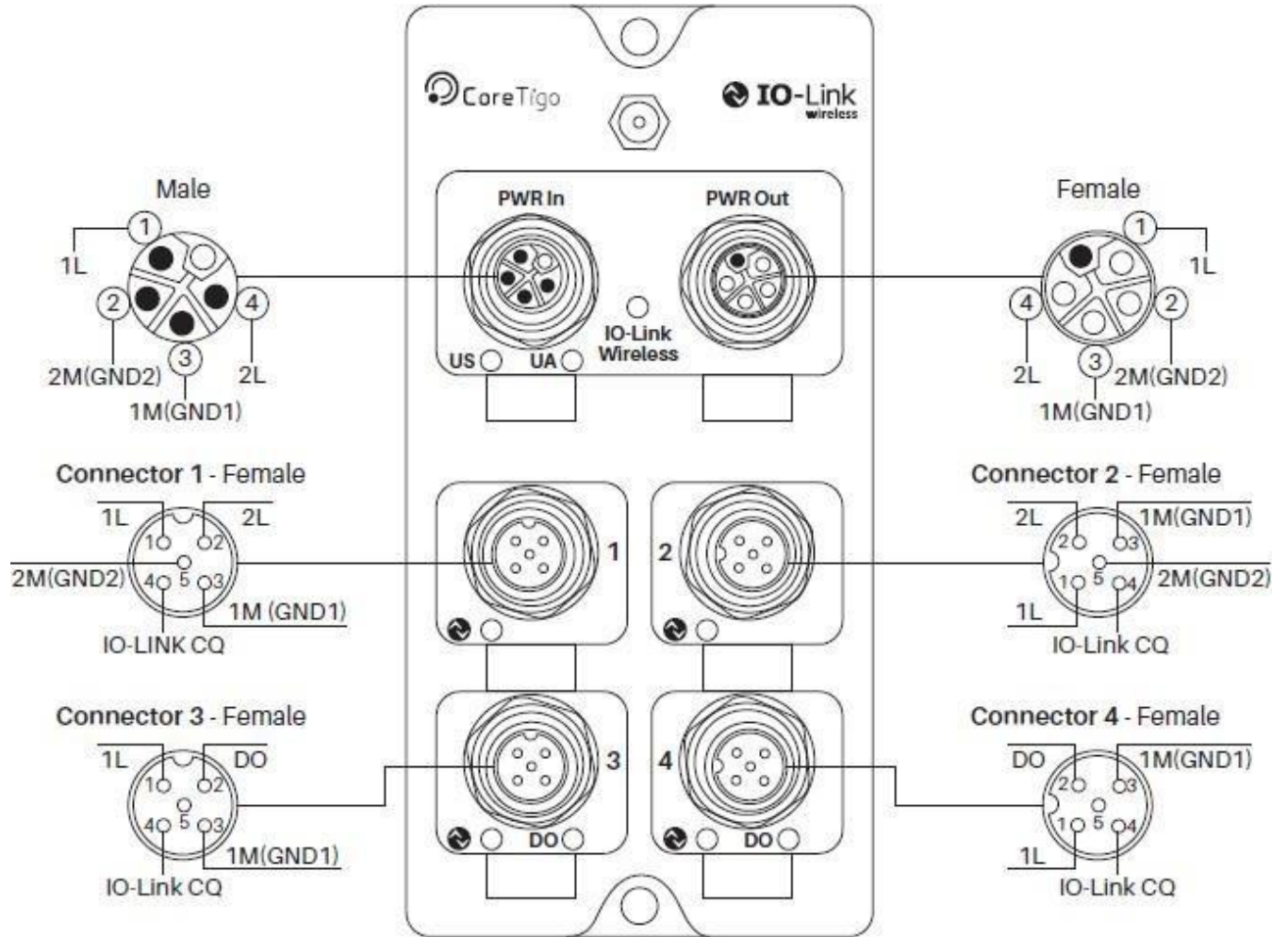

Figure6:ElectricalSchematicDiagram

5. Mounting

TigoHubi4 is mounted using 2M4 screws, at the holes indicated in red in the illustration below:



Figure7:TigoHubi4Mountings

6. Configuration and Setup

The Process Data (PD) of TigoHub i4 can be configured to define the mapping of the PD of the various connected devices.

The configuration, through an internal-IODD (iIODD) table which describes the properties and capabilities of the device, is set through ISDU (Block Parameterization) by the TigoEngine to the TigoHub i4, where it is saved in an external flash drive.

Unlike single device connectivity units such as the TigoBridge, which do not require configuration for connectivity, TigoHub i4 requires configuration and connects to the wired devices according to the following iIODD table parameters:

- Aggregated PD length
- Port configurations

6.1. PD (Process Data) Configuration

TigoHubi4 acquires the PD mapping according to the following configurations.

Table 6: PD Configuration

PD Configuration	
Aggregated PD Length	
Port PD Length	
Port PDO Offset	
▪ Aggregated PD length must be the sum of all the ports PD length + 1 Byte for DO/DI	
▪ DO/DI byte will always be the Least Significant Byte	

For each port, the user can configure the CQ port mode (pin#4) as either:

Table 7: CQ Port Mode Configuration

CQ Port Mode (Pin#4) Configuration
IO-Link
DO
DI
Inactive

For each class A port, the user can set the IQ port mode (pin#2-only DO) to either **Enable/Disable**.

In each port configuration, the user can configure the PDin and PDout behavior in case of a port mode "IO-Link" as:

Table8:PDin/PDoutConfiguration

PDin/PDoutConfigurationforPortModelOLink	
PDin:canbesetto	Length or Offset
PDout:canbesetto	Length or Offset

Theusercanalsoconfigurethefollowingparameters:

- DOinitialvalueincaseofaportmode“CQDO”oriftheIQisenabled,canbeeither**Low**or**High**.
- IOLCycletime(μs–quotedasadecimalnumber)
- Wiredconnectiontimeout(sec–quotedasadecimalnumber).Thisvaluestateshowmuchtimethe TigoHub i4 should wait for an operational response from the IOL device. Default value = 1 sec.

6.1.1. PDoutConfigurationExample

FollowingisanexampleofaPDoutconfiguration(ProcessDataoutfromtheMaster).

Table9:PDoutConfigurationExample

PDoutConfiguration	
AggregatedPDoutLength	32(Maximum)
Port1	PDoutLength= 14 PDoutOffset=17
Port2	PDoutLength=7 PDoutOffset=0
Port4	PDoutLength= 10 PDoutOffset=7
DO	Port3IQenable Port3CQDO

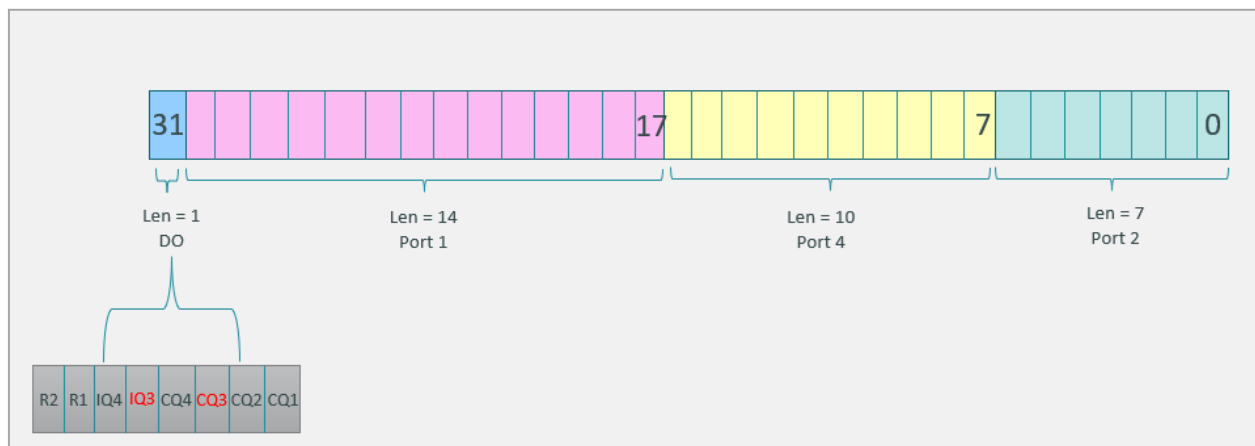

Figure8:PDoutConfigurationExample

6.1.2. PDinConfigurationExample

FollowingisanexampleofaPDinconfiguration(ProcessDataintotheMaster).

Table10:PDinConfigurationExample

PDinConfiguration	
AggregatedPDinLength	6
Port1	PDinLength=2PDinOffset=0
Port2	PDinLength=3PDinOffset=2
Port4	Port 2 CQ Port4 CQ

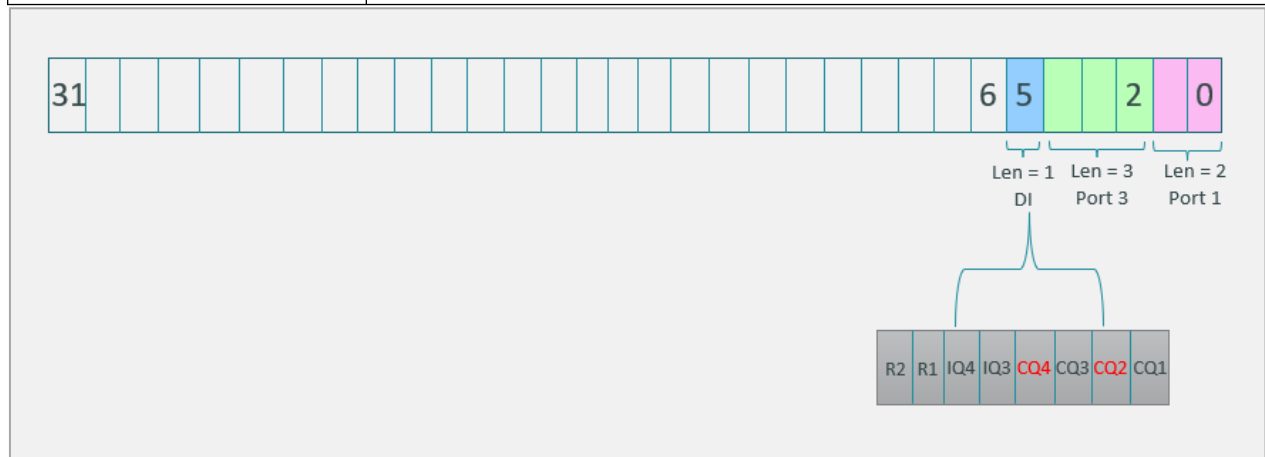

Figure9:PDinConfigurationExample

6.1.3. IO-LinkPortsValidationandBackup

ForIOLinkPortsvalidationandbackup,thefollowinguseroptionsareavailable:

- NONE
- TYPECOMPATIBLEV10–forrevision1.0ofthewiredstandard
- TYPECOMPATIBLEV11–forrevision1.1ofthewiredstandard

Ifoneoftheabove“TYPECOMPATIBLE”optionsisselected,theshouldfillthefollowing fields for comparison with the end device:

- DeviceID
- VendorID

If“NONE”isselected,thefieldsabovecanbeleftblank,optionally.

Warnings:



- If a mandatory port is not connected, TigoHub i4 will be set to “Safe Mode”. This means it will not communicate any PD between the wireless and the wired ports, even for connected ports. ISDU and diagnostic data will still be available.
- If an optional port is not connected, TigoHub i4 will remain in Normal Mode and PD for the rest of the connected ports will be communicated as well as the ISDU and Events.

6.2. Device Configuration



Reference: Refer to chapter 6 of the *TigoEngine User Manual* for a description of how to connect to a new **TigoMaster** in the **TigoEngine** application.

When the Master is connected its details appear in the table in the **Masters** view.

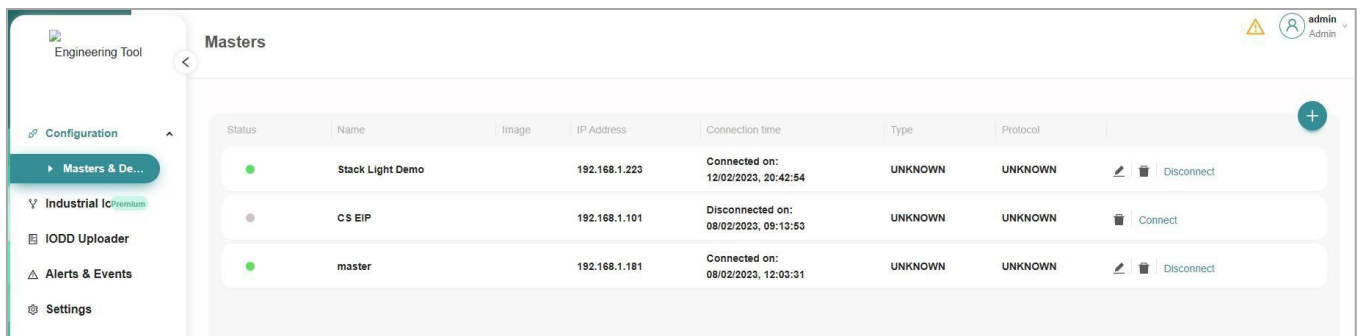

Status	Name	Image	IP Address	Connection time	Type	Protocol	
●	Stack Light Demo		192.168.1.223	Connected on: 12/02/2023, 20:42:54	UNKNOWN	UNKNOWN	Disconnect
●	CS EIP		192.168.1.101	Disconnected on: 08/02/2023, 09:13:53	UNKNOWN	UNKNOWN	Connect
●	master		192.168.1.181	Connected on: 08/02/2023, 12:03:31	UNKNOWN	UNKNOWN	Disconnect

1. In the side panel, under **Configuration** click **Masters and Devices**.
2. Click on any of the parameters in a selected Master on the list. The tabs above the list become available.
3. Access the **PORT CONFIGURATION** tab.

The configured ports are displayed.

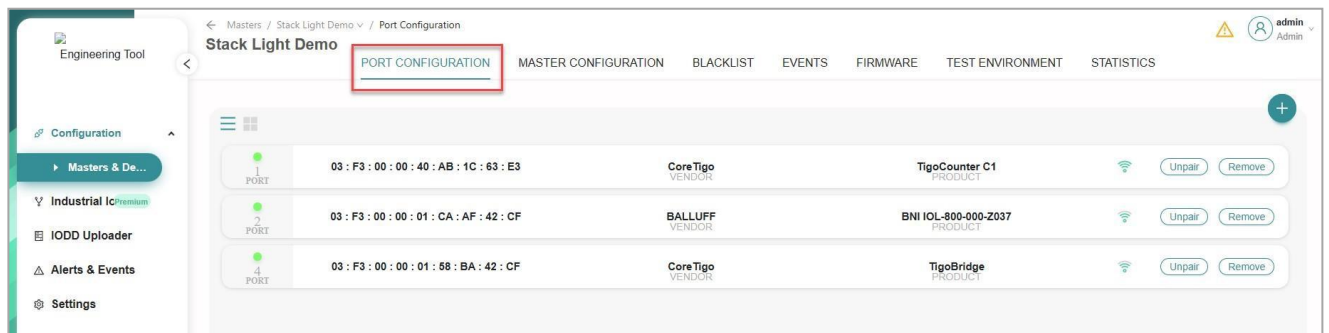

PORT	MAC Address	VENDOR	PRODUCT	Actions
1 PORT	03 : F3 : 00 : 00 : 40 : AB : 1C : 63 : E3	CoreTigo	TigoCounter C1	Unpair Remove
2 PORT	03 : F3 : 00 : 00 : 01 : CA : AF : 42 : CF	BALLUFF	BNI IOL-900-000-Z037	Unpair Remove
4 PORT	03 : F3 : 00 : 00 : 01 : 58 : BA : 42 : CF	CoreTigo	TigoBridge	Unpair Remove

- Click on the **PRODUCT** parameter on the port list to view the details of the product.

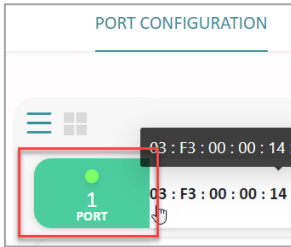

The **Details** sub-tab opens displaying the details of the device.

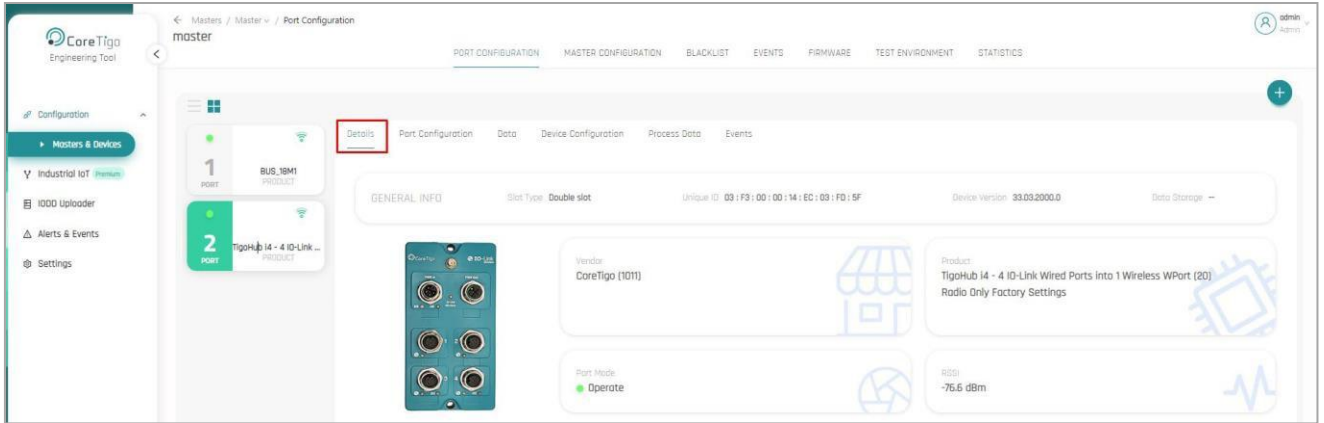

- Click on the **Port Configuration** sub-tab to view the defined configuration parameters of this port.

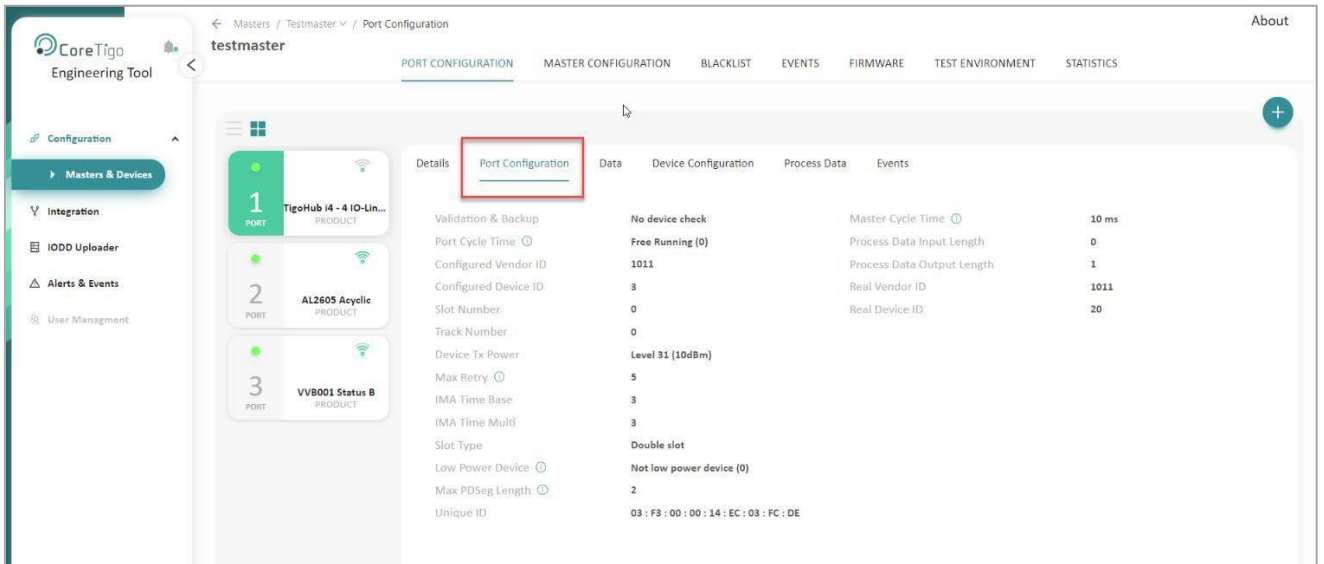

6. Click on the **Data** sub-tab to write and read on-demand (OD) data.

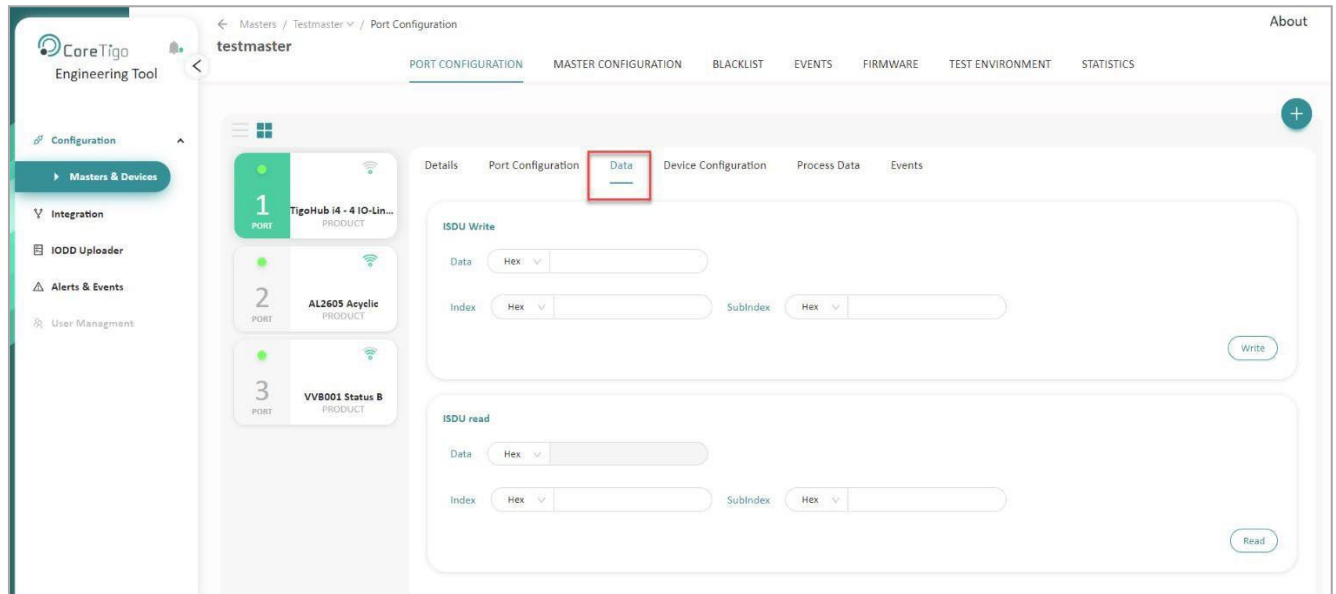

For example, to read the vendor ID of the device:

- Under **ISDU Read**, insert the relevant digits in the **Index** and **Sub-Index** fields.
- Click the **Read** button on the right-hand side of the screen.
- A **Success** notification appears.

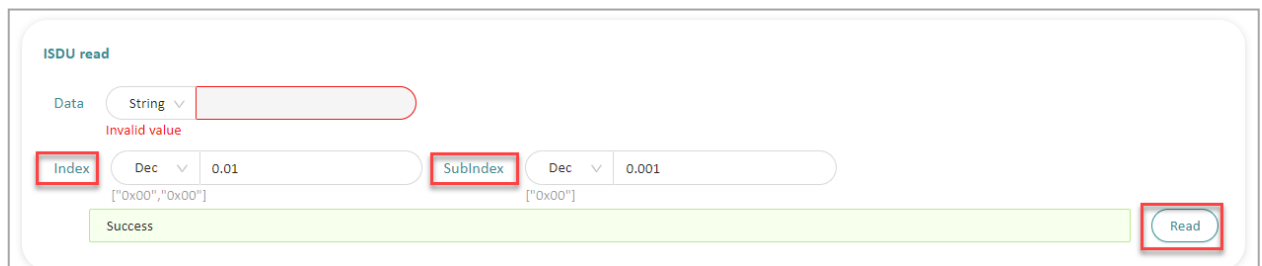

- In the **Data** field, select from the dropdown list the display options of **Dec/Hex/String**.
- The **Vendor ID** is displayed in the **Data** field.

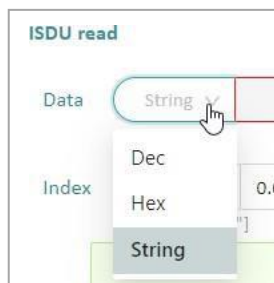

- Similar actions can be performed in **Write** mode.

7. Click on the **Process Data** sub-tab to view the **PDin** and **PDout** for each device.

8. Click on the **Device Configuration** sub-tab to view the main **TigoHubi4** configuration setup.

Prerequisite: WIODD files of TigoHubi4 should be uploaded beforehand.

Reference: Refer to chapter 16 of the *TigoEngineUserManual* for a description of how to upload IODD files.

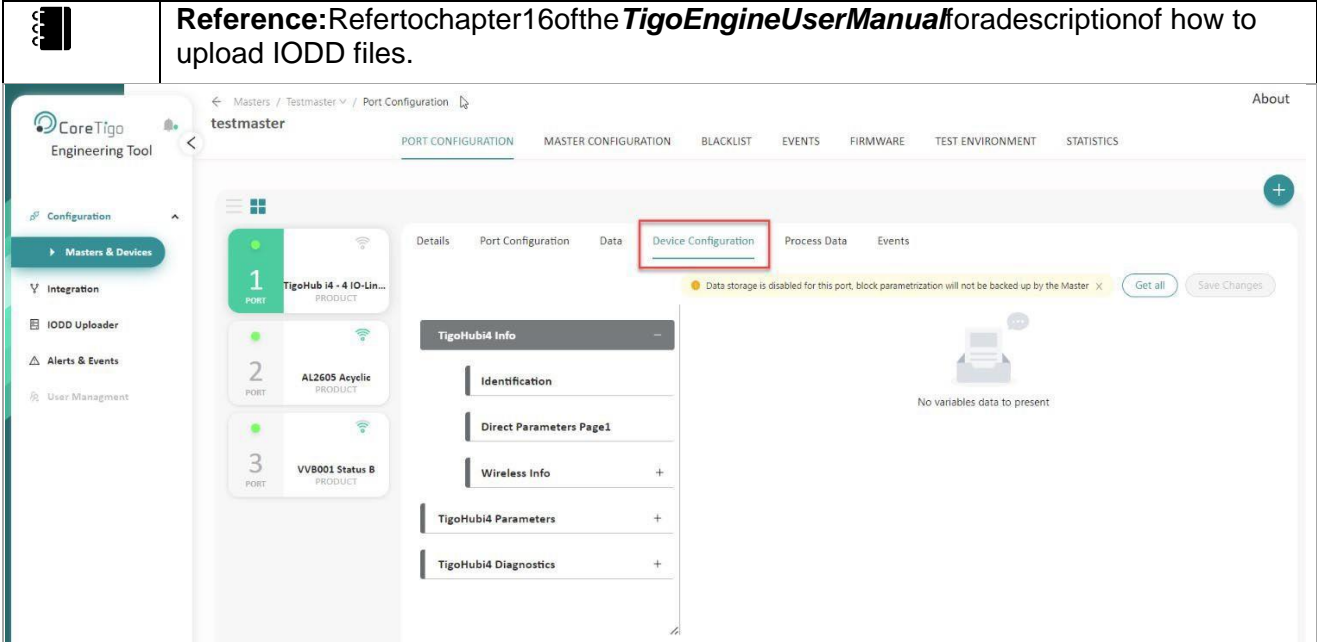

9. Open the **Configurator** menu, accessible in the side-panel, under **TigoHubi4 Parameters**.

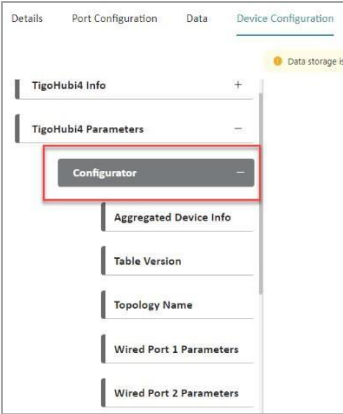

The **Latest Configuration Consistency Status** field displays information regarding any inconsistency errors that may occur during the modification of TigoHub i4 parameters.

Modifying multiple parameters of the TigoHubi4 is possible, but some inconsistency errors may occur after saving the changes.

10. To easily identify these errors, click the **Read** button.

Any inconsistent parameters will appear in the **Latest Configuration Consistency Status** field.



In the event that more than one parameter requires modification, an error will occur and the process will need to be repeated.

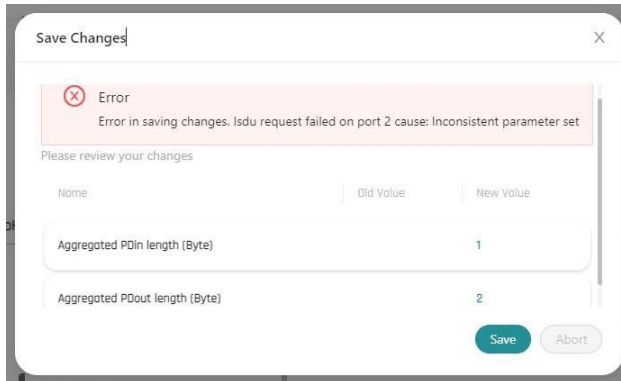

The **Configurator** displays all available configurations screens. For instance, the **Wired Port 2 Parameters** screen shows information regarding Port 2 of the TigoHub i4.

11. The user can configure any of the ports separately. For

example, to configure Port 1:

- Click the **Get All** button to retrieve all the available data for the device.
- Click on **Wired Port 1 Parameters** in the side-panel menu.
- The **Port 1 Configuration** screen opens with the retrieved data populated.

For example:

- the **IDLPDInLength** field displays zero because this device has no incoming data.
- the **IDLPDoutLength** field displays one because this device has output data. In this example the relevant device is a smart light connected to the **TigoHub i4**.

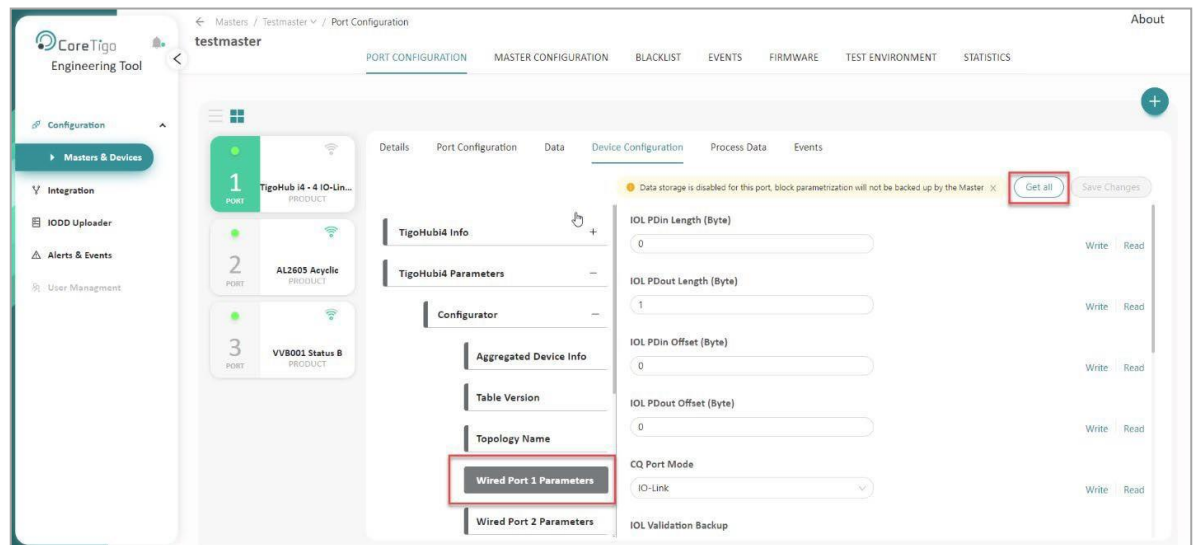

- The user can select values from the dropdown lists in any field with a value greater than zero.

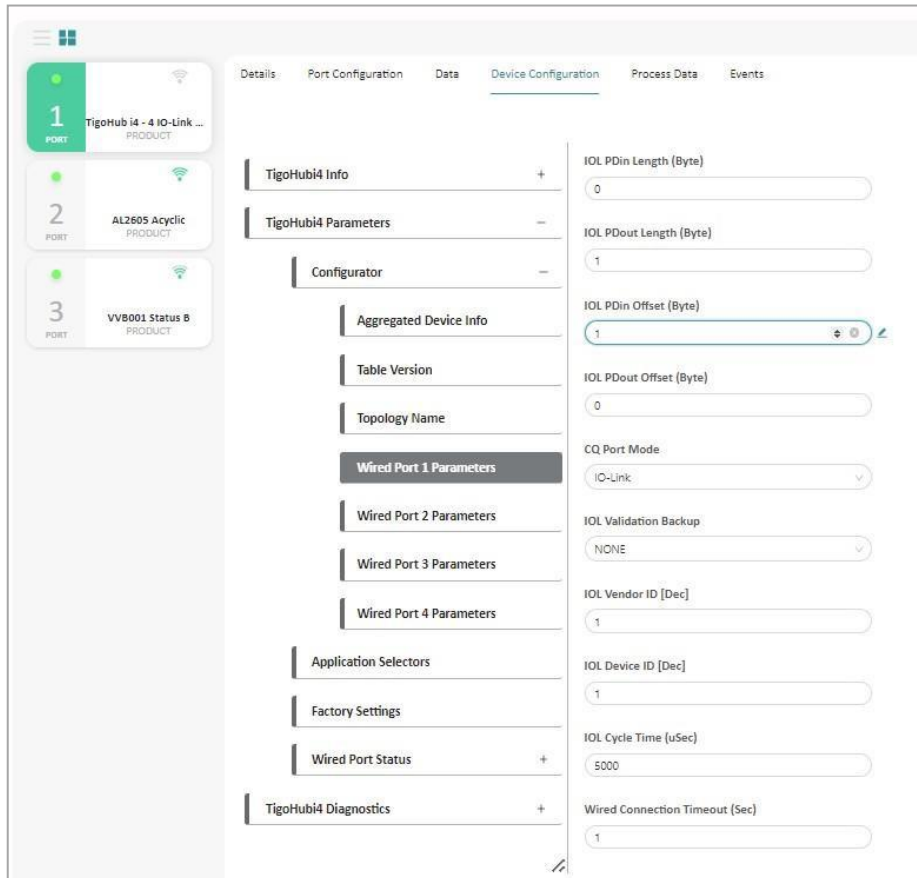

- In the different **Port Parameters** displays, the user can select Offset values for PDin and PDout.
- The **IOL PDin Length** determines the number of bytes the user wants to allocate from the IO-Link wired device, and the **Wdevice PDin Offset** determines the exact byte location from which the data will be aggregated (see the figure above).
- Note that the first device does not have to be connected to Port 1 for data aggregation and connectivity does not have to be sequential.
- The user can select the type of data for this Port 1, in the **CQ Port Mode** field from the options available in the dropdown list – **Deactivated/IO Link/DI CQ/DO CQ. (DI=Digital Input, DO=Digital Output)**.
- The user can perform a validation test on a connected device through the **IOL Validation Backup** field. Select an option from the available dropdown list. The default option here is **NONE**.
Options include **TYPE COMPATIBLE V10** and **TYPE COMPATIBLE V11**. These types refer to the IO Link versions. The connected device should match the expected type. If it doesn't the connection will fail.
- For the **IOL Validation Backup** test, select an option from the available dropdown list for **IOL Vendor ID** and **IOL Device ID**. These are only relevant for the validation test and should be left blank when not in use.
- The user can determine the **IOL Cycle Time** in microseconds—the frequency by which the device communicates with the Master (which translates to latency). Default = 0.

In any case the value for the wired cycle time will be at least the minimum cycle time of the device, even if the value the user inserts is smaller.

- The user can define the **Wired Connection Timeout** in seconds. This is a time limit within which the connected device must respond, before the port is closed.

For example, if the connected smart light does not turn on after 1 sec, the port is closed automatically as the assumption is that there is a malfunction. The default value is 1 sec.

- The user can determine that a specific port will be defined as mandatory. Use the **Is Mandatory** field for this. This is usually important for safety considerations.

When a port is defined as mandatory and it is not connected, the **TigoHubi4** will enter **Safe Mode** i.e. no PDin or PDout will be available, only OD-ISDUs and Diagnostics. Select an option from the available dropdown list – **Optional/Mandatory**, for this port. Disconnection alerts can be configured in the IODD table.

Note: When a port is defined as **Mandatory** and it returns a **COMLOST** notification during operation, TigoHub i4 will issue an Event and reset itself entering **Safe Mode**.

- If the device is reconnected to this port, TigoHubi4 will issue another Event and reset itself entering **Regular Mode**.
- If the port is defined as **Optional**, TigoHubi4 will issue an Event but will not reset or enter **Safe Mode**.
 - The user can determine the initial value of the DOCQ in the **DOCQ Initial Value** field. These are appropriate for IO Digital devices which receive or transmit digitally (0/1), connected to the **TigoHub i4**.
 - For ports 1 and 2 there is only 1 CQ pin, and for ports 3 and 4 there are two pins each, one is a CQ and the other is an IQ. Select an option from the available dropdown list – **Low/High** – i.e. 0 or 1.

12. Click the **Save Changes** button at the top right-hand corner of the screen.

All changes are saved and a consistency check is automatically performed.

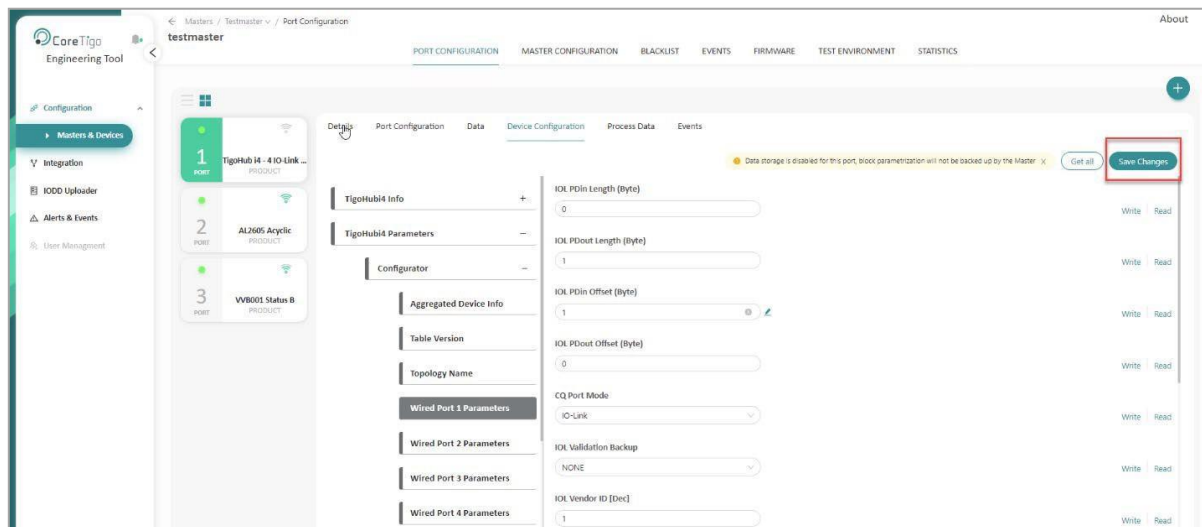

6.2.1. FactorySettings

The user can return the configured values to the factory default values. This will return the TigoHub i4 to the default values configured on its flash drive.

1. Click on the **Device Configurations** sub-tab to view the main **TigoHubi4** configuration setup.

Prerequisite: WIODD files of TigoHubi4 should be uploaded beforehand.



Reference: Refer to chapter 16 of the *TigoEngineUserManual* for a description of how to upload IODD files.

2. Open the **Factory Settings** menu, accessible in the side-panel, under **TigoHubi4 Parameters**.

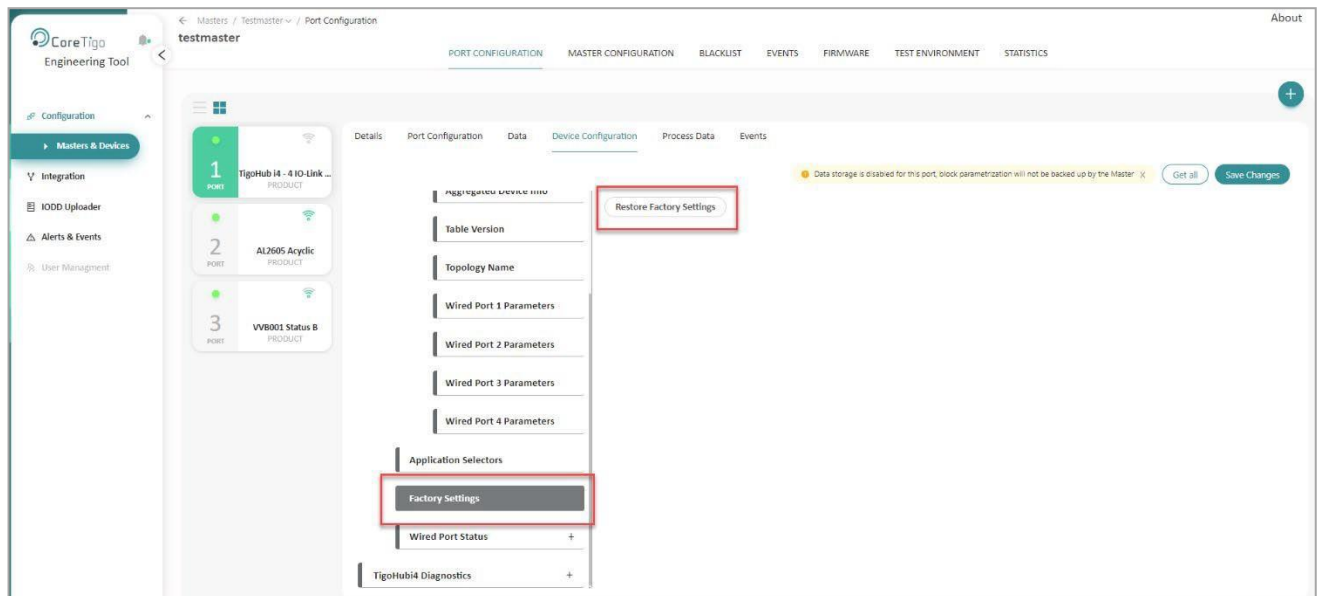

3. Click the **Restore Factory Settings** button.

A check icon appears alongside the **Restore Factory Settings** button.



The device resets to the default factory settings.

- Verify this by accessing the **Details** sub-tab as shown below.

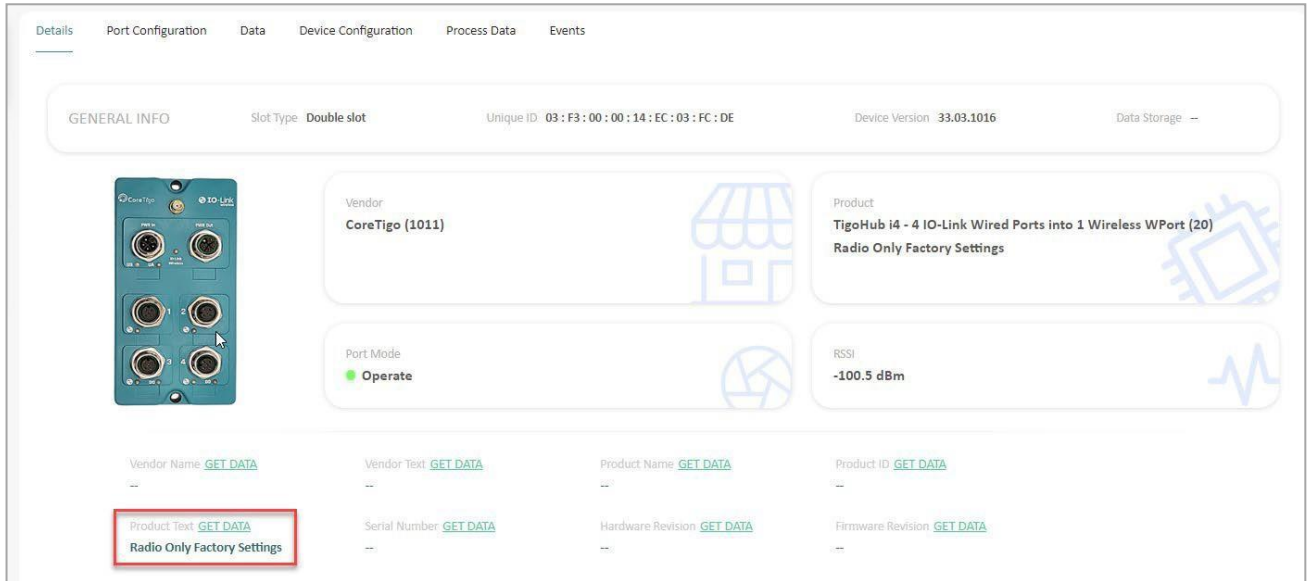

The screenshot shows the 'Details' sub-tab of the TigoHubi4 web interface. The navigation bar includes tabs for 'Details', 'Port Configuration', 'Data', 'Device Configuration', 'Process Data', and 'Events'. The main content area is titled 'GENERAL INFO' and displays the following information:

- Slot Type: Double slot
- Unique ID: 03:F3:00:00:14:EC:03:FC:DE
- Device Version: 33.03.1016
- Data Storage: --
- Vendor: CoreTigo (1011)
- Product: TigoHub i4 - 4 IO-Link Wired Ports into 1 Wireless WPort (20) Radio Only Factory Settings
- Port Mode: Operate
- RSSI: -100.5 dBm
- Vendor Name: GET DATA
- Vendor Text: GET DATA
- Product Name: GET DATA
- Product ID: GET DATA
- Product Text: GET DATA (highlighted with a red box)
- Serial Number: GET DATA
- Hardware Revision: GET DATA
- Firmware Revision: GET DATA

6.2.2. Application Selectors

This enables the user to select which application is communicating with the TigoHubi4 and by definition all **Write** and **Read** actions will be appropriated to the selected device.

- Click on the **Device Configurations** sub-tab to view the main **TigoHubi4** configuration setup.

Prerequisite: WIODD files of TigoHubi4 should be uploaded beforehand.

	<p>Reference: Refer to chapter 16 of the <i>TigoEngineUserManual</i> for a description of how to upload IODD files.</p>
---	--

- Open the **Application Selectors** menu, accessible in the side-panel, under **TigoHubi4 Parameters**.

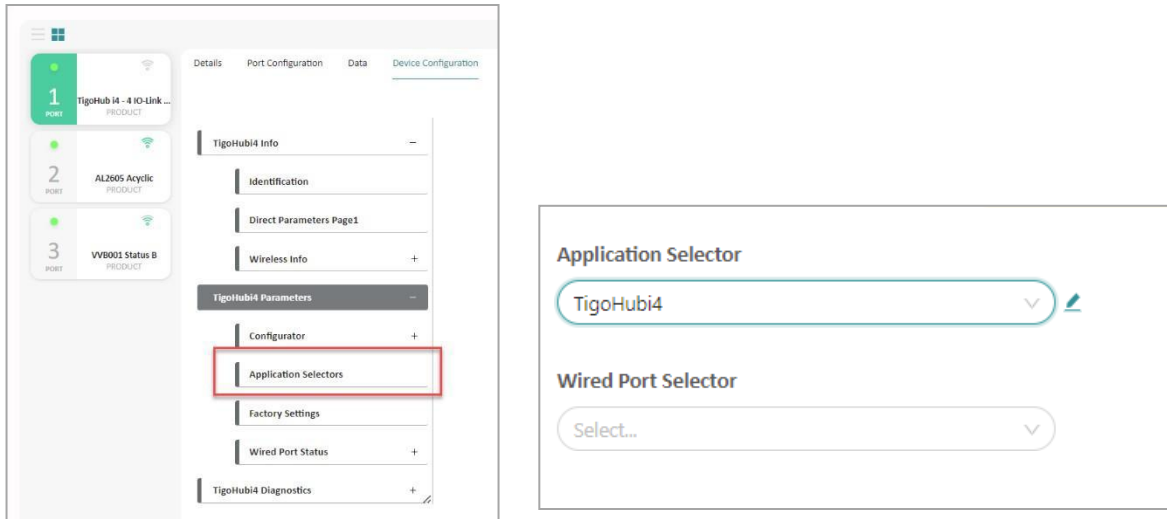

- In the **Application Selector** field, select from the dropdown list, the relevant application to communicate with e.g. TigoHub i4 itself (default) or one of the Wired Ports.

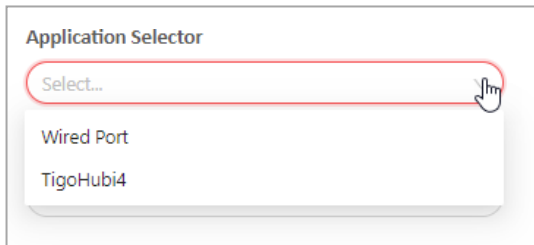

- If a **Wired Port** is selected, a further dropdown list opens to select the relevant wired port.

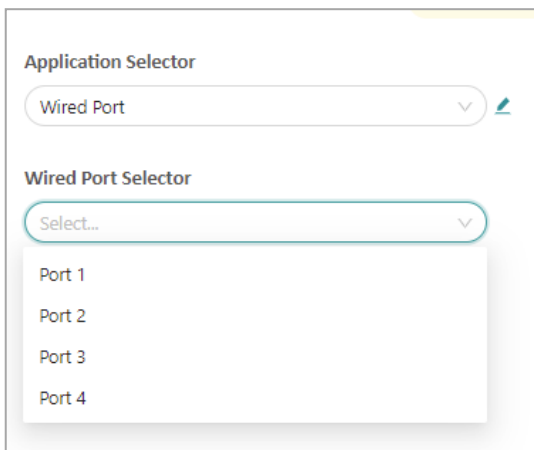

5. After making these selections, click the **Save Changes** button. A **Save Changes** confirmation box opens.

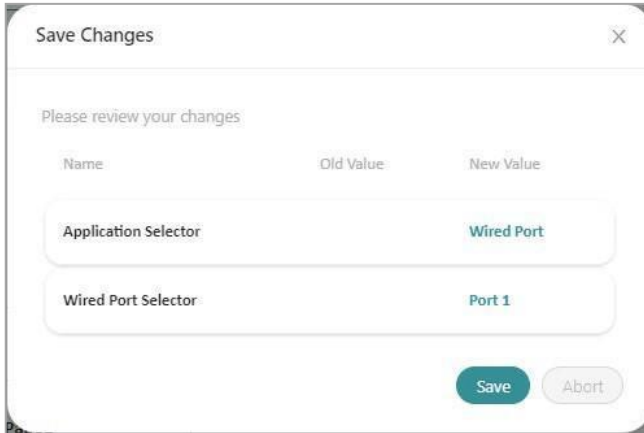

The image shows a 'Save Changes' dialog box with a close button (X) in the top right corner. Below the title bar, it says 'Please review your changes'. There is a table with three columns: 'Name', 'Old Value', and 'New Value'. The first row shows 'Application Selector' with 'Wired Port' as the new value. The second row shows 'Wired Port Selector' with 'Port 1' as the new value. At the bottom, there are two buttons: 'Save' (highlighted in green) and 'Abort'.

Name	Old Value	New Value
Application Selector		Wired Port
Wired Port Selector		Port 1

6. Click the **Save** button.
A **Success** notification appears.
7. Verify that the relevant application has been selected by accessing the **Details** sub-tab. All of the other sub-tabs are also now updated to reflect the selected application.

7. FirmwareUpdate

Firmware(FW)canbeupdatedwirelessly(FOTA)usingtheTigoEngine. Please refer to the ***TigoEngine User Manual*** for detailed instructions.

ContactCoreTigoSupportifneeded(<https://support.coretigo.com/index.php?/home/login>)

8. Diagnostics and Troubleshooting

Troubleshooting is performed using the LED display or the Tigo Engine software. Refer to the *Tigo Engine User Manual* for detailed instructions.

8.1. Power Supply LEDs

The following table describes the indication of Power Supply 1 and Power Supply 2 LEDs

Table 11: Power LEDs

LED Color	Indication
Green	Power supply voltage OK

8.2. IOLW LED

The following table describes the indications of IOLink Wireless LEDs.

Table 12: IOLW LEDs

LED Color	Indication
Green	Device unpaired
BLINKING Green (350msec on, 350msec off)	Device paired
FLASHING Green (900msec on, 100msec off)	Device connected
Orange	Safe mode
BLINKING Red	Fault
Off	Inactive

8.3. Ports LEDs

The following table describes the indications of Ports 1-4 LEDs.

Table 13: Ports LEDs

LED Color	Indication
Green	Port configured as IOL, operational, invalid data
BLINKING Green	Port configured as IOL, operational, valid data
Orange	Port configured as IO, operational, invalid data
BLINKING Orange	Port configured as IO, operational, valid data
Red	Port configured as IOL, not operational
BLINKING Red	Fault
OFF	Inactive

9. Guidelines and Regulations

FCCID: 2ATSM-TIGOHUB

IC:26463-TIGOHUB

9.1. RF Exposure Warnings



Warning: This device is only authorized for use in a mobile application. At least 20 cm of separation distance between the TigoHub i4 device and the user's body must be always maintained. La distance entre l'utilisateur et le produit ne devrait pas être inférieure à 20cm

9.2. Class B Warning

The FCC Wants You to Know

This equipment has been tested and found to comply with the limits for a Class B digital device, pursuant to part 15 of the FCC Rules. These limits are designed to provide reasonable protection against harmful interference in a residential installation. This equipment generates, uses and can radiate radio frequency energy and, if not installed and used in accordance with the instructions, may cause harmful interference to radio communications. However, there is no guarantee that interference will not occur in a particular installation. If this equipment does cause harmful interference to radio or television reception, which can be determined by turning the equipment off and on, the user is encouraged to contact [CoreTigo support- https://support.coretigo.com/](https://support.coretigo.com/)

CANICES-3(B)/NMB-3(B)

This Class B digital apparatus complies with Canadian ICES-003. Cet appareil numérique de classe B est conforme à la norme canadienne ICES-003.

9.3. Modification Statements

FCC Warning (Modification Statement)

CoreTigo LTD has not approved any changes or modifications to this device by the user. Any changes or modifications can void the user's authority to operate the equipment.

ISED Warning (Modification Statement)

CoreTigo n'approuve aucune modification apportée à l'appareil par l'utilisateur, quelle qu'en soit la nature. Tout changement ou modification peuvent annuler le droit d'utilisation de l'appareil par l'utilisateur.

9.4. FCC, ISED Regulatory Notices

Interference Statement

This device complies with Part 15 of the FCC Rules. Operation is subject to the following two conditions: (1) this device may not cause interference, and (2) this device must accept any interference, including interference that may cause undesired operation of the device.

Le présent appareil est conforme aux CNR d'Industrie Canada applicables aux appareils radio exempts de licence. L'exploitation est autorisée aux deux conditions suivantes : (1) l'appareil ne doit pas produire de brouillage, et (2) l'utilisateur de l'appareil doit accepter tout brouillage radioélectrique subi, même si le brouillage est susceptible d'en compromettre le fonctionnement.

Wireless Notice

This device complies with FCC/ISED radiation exposure limits set forth for an uncontrolled environment and meets the FCC radio frequency (RF) Exposure Guidelines and RSS-102 of the ISED radio frequency (RF) Exposure rules. This transmitter must not be co-located or operating in conjunction with any other antenna or transmitter.

Le présent appareil est conforme à l'exposition aux radiations FCC / ISED définies pour un environnement non contrôlé et répond aux directives d'exposition de la fréquence de la FCC radiofréquence (RF) et RSS-102 de la fréquence radio (RF) ISED règles d'exposition. L'émetteur ne doit pas être colocalisé ni fonctionner conjointement avec à autre antenne ou autre émetteur.

This device contains licence-exempt transmitter(s)/receiver(s) that comply with Innovation, Science and Economic Development Canada's licence-exempt RSS(s). Operation is subject to the following two conditions:

(1) This device may not cause interference.

(2) This device must accept any interference, including interference that may cause undesired operation of the device.

10. TechnicalData

Table14:TechnicalData

Electrical Data	
InputVoltage	18-32VDC.Max.InputCurrent8[A]* *TigoHubi4shouldbesuppliedfromalimited,Class2,powersupplyorvia overcurrent protective device (fuse, breacker, etc.) rated 8A max.
InputCurrent	Max.InputCurrent4[A]pereach1L,2L.
OutputVoltageon1L	EqualstoInputVoltage
OutputVoltageon2L	EqualstoInputVoltage
TypicalCurrentConsumption	30[mA]** **For24VDCSupplyinput,withoutIOLinkdevicecurrentconsumption.
MaxOutputSupplyCurrent (PWR OUT port)	MaxOutputSupplyCurrent(cascadingPWRoutport)4[A]pereach 1L, 2L.
MaxOutputSupplyCurrent (Class A Port)	2 [A](1L)
MaxOutputSupplyCurrent (Class B Port)	2+2[A] (1L+2L)
MechanicalParameters	
Weight	222gr
Mounting	2xM4screws
WirelessParameters	
OperatingFrequency	2.4GHzISMband
CommunicationStandard	IO-LinkWireless
Modulation	GFSK,Modulationindex= 0.5
RadioPeak OutputPower	10[dBm]
Interfaces	
LEDs	<ul style="list-style-type: none"> • PowerSupply[1,2] • IO-LinkWirelessStatus • Ports[1..4]Status • Digitaloutputs[1,2]

Interfaces	
Connectors	<ul style="list-style-type: none"> • PowerInputconnector:PlugM12,Lcoded <ul style="list-style-type: none"> ○ Pinnumber1:Input1L(PowerSupply1) ○ Pinnumber2:Input2MGND2 ○ Pinnumber3:Input1MGND1 ○ Pinnumber4:Input2L(PowerSupply2) ○ Pinnumber5:Earthchassis • PowerOutputConnector:SocketM12,Lcoded <ul style="list-style-type: none"> ○ Pinnumber1:Output1L(PowerSupply1) ○ Pinnumber2:Output2M(GND2) ○ Pinnumber3:Output1M(GND1) ○ Pinnumber4:Output2L(PowerSupply2) ○ Pinnumber5:Earthchassis • Ports[1,2]Connectors:SocketM12,Acoded,ClassB <ul style="list-style-type: none"> ○ Pinnumber1:Output1L(PowerSupply1) ○ Pinnumber2:Output2L(PowerSupply2) ○ Pinnumber3:Output1M(GND1) ○ Pinnumber4:IOLCQ(Datasignal) ○ Pinnumber5:Output2M(GND2) • Ports[3,4]Connectors:SocketM12,Acoded,ClassB <ul style="list-style-type: none"> ○ Pinnumber1:Output1L(PowerSupply1) ○ Pinnumber2:DigitalOutput ○ Pinnumber3:Output1M(GND1) ○ Pinnumber4:IOLCQ(Datasignal) ○ Pinnumber5:Notconnected
Antenna	SMACconnectorforexternalantenna.
Communication	
Protocols	<ul style="list-style-type: none"> • IOLink <ul style="list-style-type: none"> ○ Supportedtransmission types:COM1,COM2,COM3 ○ Revision1.1.2 ○ ClassA,B • IOLinkWireless <ul style="list-style-type: none"> ○ Version1.1
OperatingFrequencyBands	2401–2480[MHz]
Maximum Radio-Frequency Power	10[dBm]

Regulation	
CE	<ul style="list-style-type: none"> • EN301489-17 • EN300328 • EN62479 • EN61326-1
FCC	<ul style="list-style-type: none"> • FCC ID: 2ATSM-TIGOHUB • FCCCFRTITLE47Part15SubpartCSection15.247 • FCCCFRTITLE47Part15SubpartB
Safety	IEC61010-1 UL61010-1andCSAC22.2No.61010-1
RoHS	Complied
Reach	Complied
Qualifications	
Shock&Vibrations	<ul style="list-style-type: none"> • SineVibration: IEC60068-2-6 • Randomvibration: IEC60068-2-64 • Shock: IEC 60068-2-27 • Bumps:IEC60068-2-27

To read more about IO-Link Wireless solutions follow this link <https://www.coretigo.com/solutions/>.

Operating Conditions	
Operating Temperature	-20°C to 65°C
Relative Humidity Rating	RH5% to 93%, non-condensing
Altitude	Upto 2000m
Pollution	Degree 3
IP Rating	IP65
Emission	<ul style="list-style-type: none"> • EN61000-6-2 <ul style="list-style-type: none"> ○ EN55016-2-3 Radiated emission ○ EN55022 Conducted emission
Immunity	<ul style="list-style-type: none"> • EN61000-6-2 <ul style="list-style-type: none"> ○ EN61000-4-2 Electrostatic discharge ○ EN61000-4-3 Radiated immunity ○ EN61000-4-4 Fast transients/burst ○ EN61000-4-5 Surge immunity ○ EN61000-4-6 Conducted immunity

BlockDiagrams

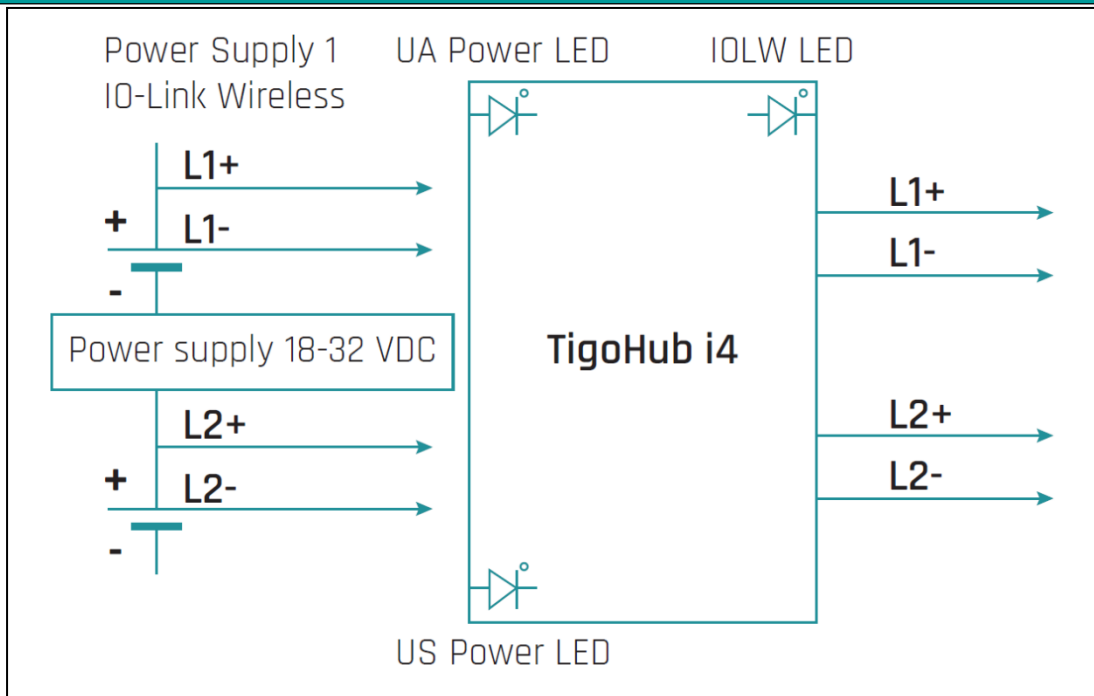

Figure10:BlockDiagram- Power

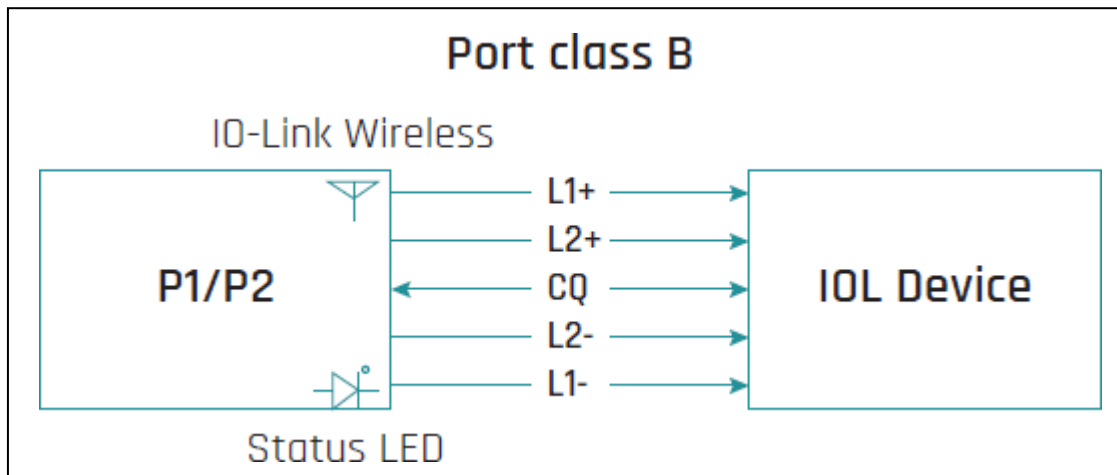

Figure11:BlockDiagram-Ports1and2

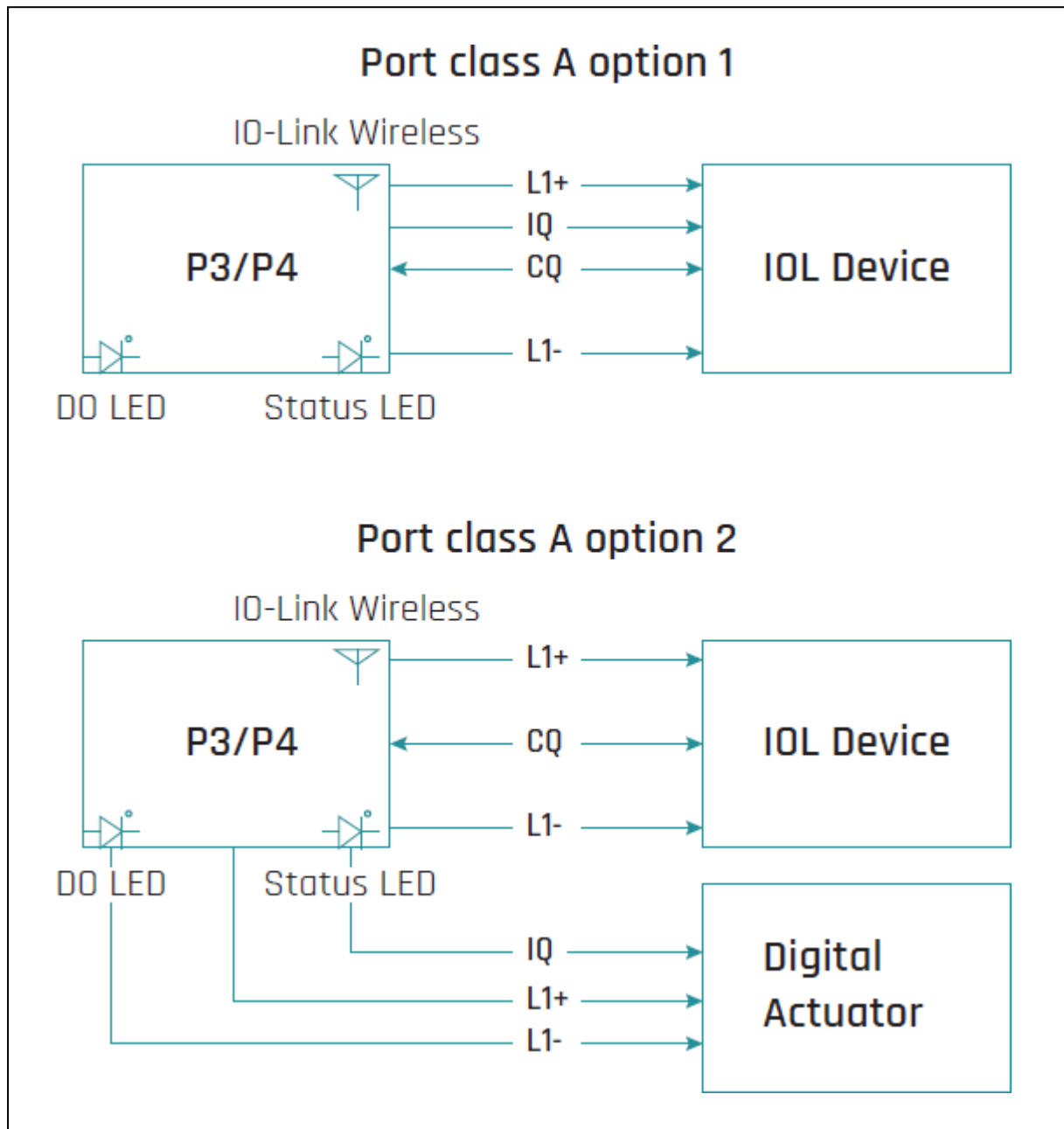

Figure12:BlockDiagram-Ports3and4

Dimensions

Units are in mm



11. CustomerSupport

For any issue, question, or to report a bug, contact support@coretigo.com

Or visit our Customer Success Portal at: <https://support.coretigo.com/index.php?/home/login>

Appendix–PartNumber

Partnumber:CT221-0057-03

- Generation:2
- ProductIdentifier:2
- ProductType:1
- Protocol: 0057
- Characters IdentifierofFeatures
- Version:03

CT(GXY-ZZZZiii-vv)					
G	X	Y	ZZZZ	iii	vv
Generation	Product Identifier	Product Type	Protocol	Feature'sCharacter Identifier	Version