

OWNER'S MANUAL

2024 RAM 2500/3500



RAM



ROADSIDE ASSISTANCE

24 HOURS, 7 DAYS A WEEK AT YOUR SERVICE. CALL 1-800-521-2779 OR VISIT CHRYSLER.RSAHELP.COM (USA) CALL 1-800-363-4869 OR VISIT FCA.ROADSIDEAID.COM (CANADA) SERVICES: Flat Tire Service, Out Of Gas/Fuel Delivery, Battery Jump Assistance, Lockout Service and Towing Service Please see the Customer Assistance chapter in this Owner's Manual for further information.

FCA US LLC reserves the right to modify the terms or discontinue the Roadside Assistance Program at any time. The Roadside Assistance Program is subject to restrictions and conditions of use, that are determined solely by FCA US LLC.

Vehicle images are for illustration purposes only.
Actual products sold may vary.



This Owner's Manual illustrates and describes the operation of features and equipment that are either standard or optional on this vehicle. This manual may also include a description of features and equipment that are no longer available or were not ordered on this vehicle. Please disregard any features and equipment described in this manual that are not on this vehicle. FCA US LLC reserves the right to make changes in design and specifications, and/or make additions to or improvements to its products without imposing any obligation upon itself to install them on products previously manufactured.

With respect to any vehicles sold in Canada, the name FCA US LLC shall be deemed to be deleted and the name FCA Canada Inc. used in substitution therefore.

⚠ WARNING: Operating, servicing and maintaining a passenger vehicle or off-highway motor vehicle can expose you to chemicals including engine exhaust, carbon monoxide, phthalates, and lead, which are known to the State of California to cause cancer and birth defects or other reproductive harm. To minimize exposure, avoid breathing exhaust, do not idle the engine except as necessary, service your vehicle in a well-ventilated area and wear gloves or wash your hands frequently when servicing your vehicle. For more information go to **www.P65Warnings.ca.gov/passenger-vehicle**.

TABLE OF CONTENTS

1	INTRODUCTION	9
2	GETTING TO KNOW YOUR VEHICLE.....	18
3	GETTING TO KNOW YOUR INSTRUMENT PANEL	89
4	STARTING AND OPERATING	120
5	MULTIMEDIA	209
6	SAFETY	267
7	IN CASE OF EMERGENCY.....	314
8	SERVICING AND MAINTENANCE.....	332
9	TECHNICAL SPECIFICATIONS	392
10	CUSTOMER ASSISTANCE	401
11	INDEX.....	405

1

2

3

4

5

6

7

8

9

10

11

INTRODUCTION

SYMBOLS KEY	10
VAN CONVERSIONS/CAMPERS	10
CONSUMER INFORMATION — TRUCK-CAMPER LOADING	10
VEHICLE MODIFICATIONS/ALTERATIONS	12
SYMBOL GLOSSARY	12

GETTING TO KNOW YOUR VEHICLE

KEYS	18
Key Fob	18
SENTRY KEY	21
IGNITION SWITCH	21
Keyless Enter 'n Go™ Ignition	21
REMOTE START — IF EQUIPPED (GASOLINE)	22
How To Use Remote Start	23
To Exit Remote Start Mode	23
Remote Start Front Defrost Activation — If Equipped	23
Remote Start Comfort Systems — If Equipped	23
Remote Start Windshield Wiper De-Icer Activation — If Equipped	24
Remote Start Abort Message	24
REMOTE START— IF EQUIPPED (DIESEL)	24
How To Use Remote Start	24
VEHICLE SECURITY SYSTEM — IF EQUIPPED	25
To Arm The System	25
To Disarm The System	25
Rearming Of The System	25
Security System Manual Override	26

DOORS	26
Manual Door Locks	26
Power Door Locks — If Equipped	26
Power Side Steps — If Equipped	27
Keyless Enter 'n Go™ — Passive Entry (If Equipped)	27
Automatic Unlock Doors On Exit — If Equipped	28
Automatic Door Locks — If Equipped	28
Child-Protection Door Lock	28
STEERING WHEEL	29
Tilt Steering Column	29
Heated Steering Wheel — If Equipped	29
UCONNECT VOICE RECOGNITION — IF EQUIPPED	30
Introducing Voice Recognition	30
Basic Voice Commands	30
Get Started	30
Additional Information	31
DRIVER MEMORY SETTINGS — IF EQUIPPED	31
Programming The Memory Feature	31
Linking And Unlinking The Remote Keyless Entry Key Fob To Memory	31
Memory Position Recall	32
Programming The Memory Feature	32
Linking And Unlinking The Remote Keyless Entry Key Fob To Memory	32
Memory Position Recall	32
SEATS	33
Manual Adjustment Front Seats — If Equipped	33
Manual Adjustment Rear Seats	34
Power Adjustment Front Seats — If Equipped	34

Heated Seats — If Equipped	35
Ventilated Seats — If Equipped	36
Head Restraints	37

DRIVER ADJUSTABLE PEDALS — IF EQUIPPED	38
MIRRORS	39
Inside Rearview Mirror	39
Illuminated Vanity Mirror — If Equipped	41
Outside Mirrors	41
Outside Automatic Dimming Mirror — If Equipped	43
Power Mirrors — If Equipped	43
Power Folding Outside Mirrors — If Equipped	43
Automatic Power Folding Mirrors — If Equipped	44
Tilt Side Mirrors In Reverse — If Equipped	44
Power Convex Mirror Switch — If Equipped	44
Forward Utility Lights and Rear Guidance Lights — If Equipped	45
Heated Mirrors — If Equipped	46

Universal Garage Door Opener (HomeLink®) — If Equipped	46
Before You Begin Programming HomeLink®	46
Erasing All The HomeLink® Channels	46
Identifying Whether You Have A Rolling Code Or Non-Rolling Code Device	46
Programming HomeLink® To A Garage Door Opener	47
Programming HomeLink® To A Miscellaneous Device	47
Reprogramming A Single HomeLink® Button	48
Canadian/Gate Operator Programming	48
Security	48
Troubleshooting Tips	49

EXTERIOR LIGHTS	49	Automatic Temperature Control (ATC)	61	RamBox Safety Warning	82
Headlight Switch	49	Climate Voice Recognition — If Equipped	61	Bed Divider — If Equipped	82
Multifunction Lever	50	Operating Tips	61	TRI-FOLD TONNEAU COVER — IF EQUIPPED	83
Daytime Running Lights (DRLs) — If Equipped	50	INTERIOR STORAGE AND EQUIPMENT	62	Tri-Fold Tonneau Cover Removal	83
High/Low Beam Switch	50	Storage	62	Tri-Fold Tonneau Cover Installation	85
Automatic High Beam Headlamp Control —		USB/AUX Control	66	Tri-Fold Tonneau Cover Cleaning	88
If Equipped	50	Electrical Power Outlets	67		
Flash-To-Pass	50	Power Inverter — If Equipped	68		
Automatic Headlights — If Equipped	50	Wireless Charging Pad — If Equipped	70		
Directional LED Headlamp System —		WINDOWS	71		
If Equipped	51	Power Windows	71	MIDLINE INSTRUMENT CLUSTER — GAS ENGINE	89
Parking Lights And Panel Lights	51	Automatic Window Features	71	Midline Instrument Cluster Descriptions —	
Automatic Headlights With Wipers	51	Reset Auto-Up — If Equipped	72	Gas Engine	90
Headlight Illumination On Approach	51	Window Lockout Switch	72	HIGHLINE INSTRUMENT CLUSTER — GAS ENGINE	91
Headlight Delay	51	Power Sliding Rear Window — If Equipped	72	Highline Instrument Cluster Descriptions —	
Lights-On Reminder	51	Manual Sliding Rear Window — If Equipped	72	Gas Engine	92
Front Fog Lights — If Equipped	52	Wind Buffeting	72	PREMIUM INSTRUMENT CLUSTER — GASOLINE	93
Turn Signals	52	POWER SUNROOF — IF EQUIPPED	73	Premium Instrument Cluster Descriptions —	
Lane Change Assist — If Equipped	52	Single Pane Power Sunroof	73	Gasoline	94
Cargo Lights/Trailer Spotter Lights/Trailer		HOOD	74	MIDLINE INSTRUMENT CLUSTER — DIESEL ENGINE	95
Hitch Light With Bed Lights — If Equipped	52	To Open The Hood	74	Midline Instrument Cluster Descriptions —	
Battery Saver	53	To Close The Hood	74	Diesel Engine	96
INTERIOR LIGHTS	53	TAILGATE	74	HIGHLINE INSTRUMENT CLUSTER —	
Courtesy Lights	53	Opening	74	DIESEL ENGINE	97
Illuminated Entry	55	Closing	75	Highline Instrument Cluster Descriptions —	
WINDSHIELD WIPERS AND WASHERS	55	Tailgate Removal	75	Diesel Engine	98
Windshield Wiper Operation	55	Bed Step — If Equipped	76	PREMIUM INSTRUMENT CLUSTER — DIESEL	99
Rain Sensing Wipers — If Equipped	56	PICKUP BOX	77	Premium Instrument Cluster Descriptions —	
CLIMATE CONTROLS	56	Cargo Camera — If Equipped	78	Diesel	101
Automatic Climate Control Descriptions		Bed Rail Tie-Down System — If Equipped	79	INSTRUMENT CLUSTER DISPLAY	101
And Functions	56	RAMBOX — IF EQUIPPED	80	Instrument Cluster Display Location and	
Manual Climate Control Descriptions		Locking And Unlocking RamBox	80	Controls	101
And Functions	59	RamBox Cargo Storage Bins	80	Oil Life Reset	103

Display Menu Items	104	STARTING THE ENGINE — DIESEL ENGINE	123	8-Speed Automatic Transmission — If Equipped	134
Diesel Messages And Warnings — 6.7L Cummins® Diesel Engine	107	Automatic Transmission	123	6-Speed Automatic Transmission — If Equipped	136
Battery Saver On/Battery Saver Mode Message — Electrical Load Reduction Actions — If Equipped	110	Keyless Enter 'n Go™ — Ignition	123	AUXILIARY SWITCHES — IF EQUIPPED	140
WARNING LIGHTS AND MESSAGES	111	Extreme Cold Weather	124	ACTIVE NOISE CANCELLATION	140
Red Warning Lights	111	Normal Starting Procedure — Engine Manifold Air Temperature Above 66° F (19° C)	125	FOUR-WHEEL DRIVE OPERATION — IF EQUIPPED	140
Yellow Warning Lights	113	Starting Procedure — Engine Manifold Air Temperature 0° F To 66° F (-18° C to 19° C)	125	Electronically Shifted Transfer Case (8-Speed Transmission) — If Equipped	140
Yellow Indicator Lights	115	Starting Procedure — Engine Manifold Air Temperature Below 0° F (-18° C)	126	Electronically Shifted Transfer Case (6-Speed Transmission) — If Equipped	143
Green Indicator Lights	117	Starting Fluids	126	Manually Shifted Transfer Case — If Equipped	145
White Indicator Lights	118	NORMAL OPERATION — DIESEL ENGINE	127	AIR SUSPENSION SYSTEM — IF EQUIPPED	146
Blue Indicator Lights	118	Cold Weather Precautions	127	Description	146
ONBOARD DIAGNOSTIC SYSTEM — OBD II	118	Engine Idling	128	Air Suspension Modes	147
Onboard Diagnostic System (OBD II) Cybersecurity	118	Noise	129	Instrument Cluster Display Messages	147
EMISSIONS INSPECTION AND MAINTENANCE PROGRAMS	119	Stopping The Engine	129	Operation	147
STARTING AND OPERATING		Idle Shutdown	129	AXLE LOCKER SYSTEM — IF EQUIPPED	148
STARTING THE ENGINE — GASOLINE ENGINE	120	Programmable Maximum Vehicle Speed	129	STABILIZER/SWAY BAR SYSTEM — POWER WAGON ONLY	149
Automatic Transmission	120	Operating Precautions	129	SAFE OFF-ROAD DRIVING — POWER WAGON, REBEL OR OFF-ROAD PACKAGE EQUIPPED ONLY	149
Tip Start Feature	120	Cooling System Tips	130	Off-Road Driving Tips And Vehicle Characteristics	149
Keyless Enter 'n Go™ — Ignition	120	ENGINE BLOCK HEATER — IF EQUIPPED	130	Driving In Snow, Mud And Sand	150
Normal Starting Using ENGINE START/ STOP Button	120	ENGINE BREAK-IN RECOMMENDATIONS — GASOLINE ENGINE	130	Crossing Obstacles (Rocks And Other High Points)	151
AutoPark — Rotary Shifter and 8-Speed Transmission Only	121	ENGINE BREAK-IN RECOMMENDATIONS — DIESEL ENGINE	131	Hill Climbing	152
Extended Park Starting	122	PARKING BRAKE	131	Driving Through Water	153
If Engine Fails To Start	122	DIESEL EXHAUST BRAKE — ENGINE BRAKING (IF EQUIPPED)	132	Airing Down For Off-Road Driving	154
Cold Weather Operation (Below -22° F Or -30° C)	123	AUTOMATIC TRANSMISSION	133	Vehicle Recovery	154
After Starting	123	Ignition Park Interlock	133	After Driving Off-Road	155
		Brake/Transmission Shift Interlock (BTSI) System	133		

LIMITED-SLIP DIFFERENTIAL	156	TRAILER CAMERAS — IF EQUIPPED	184	Operating Tips	204
WINCH USAGE — IF EQUIPPED	156	Trailer Surround View Camera System	184	General Maintenance	204
Things To Know Before Using Your Winch	156	AUX Camera	187	RECREATIONAL TOWING	
Understanding The Features Of Your Winch	157	ENGINE RUNAWAY — DIESEL ENGINE	187	(BEHIND MOTORHOME)	204
Winch Accessories	157	REFUELING THE VEHICLE — GASOLINE ENGINE	187	Towing This Vehicle Behind Another Vehicle	204
Operating Your Winch	157	Loose Fuel Filler Cap Message	188	Recreational Towing — Two-Wheel Drive	
Rigging Techniques	162	REFUELING THE VEHICLE — DIESEL ENGINE	188	Models	205
HYDRAULIC POWER STEERING	163	Diesel Exhaust Fluid	189	Recreational Towing — Four-Wheel Drive	
Hydraulic Power Steering Fluid Check	163	VEHICLE LOADING	191	Models	205
CRUISE CONTROL SYSTEMS — IF EQUIPPED	163	Gross Vehicle Weight Rating (GVWR)	191	DRIVING TIPS	207
Cruise Control	163	Payload	191	Driving On Slippery Surfaces	207
Adaptive Cruise Control (ACC)	165	Gross Axle Weight Rating (GAWR)	191	Driving Through Water	207
PARKSENSE FRONT/REAR PARK ASSIST —		Tire Size	191	Off-Road Driving Tips	208
IF EQUIPPED	172	Rim Size	191		
ParkSense Sensors	172	Inflation Pressure	191	MULTIMEDIA	
ParkSense Warning Display	172	Curb Weight	191	UCONNECT SYSTEMS	209
ParkSense Display	172	Loading	191	CYBERSECURITY	209
Enabling And Disabling Front And/Or Rear		TRAILER TOWING	192	UCONNECT SETTINGS	209
ParkSense	175	Common Towing Definitions	192	Customer Programmable Features	210
Service The ParkSense Front/Rear Park Assist		Trailer Hitch Type and Maximum		UCONNECT INTRODUCTION	227
System	175	Trailer Weight	194	System Overview	227
Cleaning The ParkSense System	175	Trailer Towing Weights		Safety And General Information	229
ParkSense System Usage Precautions	175	(Maximum Trailer Weight Ratings)	195	UCONNECT MODES	229
LANESENSE — IF EQUIPPED	176	Trailer And Tongue Weight	195	Steering Wheel Audio Controls	229
LaneSense Operation	176	Trailer Reverse Steering Control —		Radio Mode	230
Turning LaneSense On Or Off	176	If Equipped	195	Media Mode	236
LaneSense Warning Message	177	Towing Requirements	198	Phone Mode	238
Changing LaneSense Status	178	Towing Tips	202	CONNECTED VEHICLE SERVICES —	
Turn Signal Activated Blind Spot Assist —		SNOWPLOW	203	IF EQUIPPED	245
If Equipped	178	Before Plowing	203	Is My Vehicle Connected?	245
PARKVIEW REAR BACK UP CAMERA	178	Snowplow Prep Package Model Availability	203	Introduction To Connected Vehicle	
SURROUND VIEW CAMERA SYSTEM —		Over The Road Operation With Snowplow		Services	245
IF EQUIPPED	180	Attached	204		

Getting Started With Connected Vehicle Services	246	TRAILER TOW — IF EQUIPPED	263	IN CASE OF EMERGENCY	
Using SiriusXM Guardian™	247	Trailer Info	264	HAZARD WARNING FLASHERS	314
Manage My SiriusXM Guardian™ Account	255	Cameras	264	ASSIST AND SOS SYSTEM — IF EQUIPPED	314
CONNECTED SERVICES FAQs	255	Light Check	265	JACKING AND TIRE CHANGING	317
Connected Services SOS FAQs — If Equipped	255	Setup	266	Preparations For Jacking	317
Connected Services Remote Door Lock/Unlock FAQs	255	SAFETY		Jack Location	318
Connected Services Roadside Assistance FAQs	256	SAFETY FEATURES	267	Removal Of Jack And Tools	318
Connected Services Send & Go FAQs — If Equipped	256	Anti-Lock Brake System (ABS)	267	Removing The Spare Tire	319
Connected Services Vehicle Finder FAQs	256	Rear Seat Reminder Alert (RSRA)	267	Jacking Instructions	320
Connected Services Stolen Vehicle Assistance FAQs — If Equipped	256	Electronic Brake Control (EBC) System	268	To Stow The Flat Or Spare	323
Connected Services Remote Vehicle Start FAQs	257	AUXILIARY DRIVING SYSTEMS	273	Reinstalling The Jack And Tools	324
Connected Services Remote Horn & Lights FAQs	257	Blind Spot Monitoring (BSM) — If Equipped	273	Hub Caps/Wheel Covers — If Equipped	324
Connected Services Account FAQs — If Equipped	257	Forward Collision Warning (FCW) With Mitigation — If Equipped	278	JUMP STARTING	325
Data Collection & Privacy	258	Tire Pressure Monitoring System (TPMS)	280	Preparations For Jump Start	325
RADIO OPERATION AND MOBILE PHONES	259	OCCUPANT RESTRAINT SYSTEMS	286	Jump Starting Procedure	326
Regulatory And Safety Information	259	Occupant Restraint Systems Features	286	GEAR SELECTOR OVERRIDE	327
OFF-ROAD PAGES — IF EQUIPPED	259	Important Safety Precautions	286	6-Speed Transmission	327
Off-Road Pages Status Bar	260	Seat Belt Systems	287	MANUAL PARK RELEASE	327
Vehicle Dynamics	260	Supplemental Restraint Systems (SRS)	293	8-Speed Transmission	327
Accessory Gauge	261	Child Restraints	299	IF YOUR ENGINE OVERHEATS	328
Pitch & Roll	262	SAFETY TIPS	311	FREEING A STUCK VEHICLE	329
Suspension	262	Transporting Passengers	311	TOWING A DISABLED VEHICLE	329
Forward Facing Camera	263	Transporting Pets	311	Two-Wheel Drive Models	330
		Connected Vehicles	311	Four-Wheel Drive Models	331
		Safety Checks You Should Make Inside The Vehicle	312	EMERGENCY TOW HOOKS — IF EQUIPPED	331
		Periodic Safety Checks You Should Make Outside The Vehicle	313	ENHANCED ACCIDENT RESPONSE SYSTEM (EARS)	331
		Exhaust Gas	313	EVENT DATA RECORDER (EDR)	331
		Carbon Monoxide Warnings	313		

SERVICING AND MAINTENANCE

SCHEDULED SERVICING	332
Maintenance Plan — Gasoline Engine	333
Maintenance Plan — Diesel Engine	335
ENGINE COMPARTMENT	338
6.4L Gasoline Engine	338
6.7L Diesel Engine — 6-Speed 68RFE	339
6.7L Diesel Engine	340
Checking Oil Level	341
Adding Washer Fluid	341
Maintenance-Free Battery	341
Pressure Washing	342
VEHICLE MAINTENANCE	342
Engine Oil	342
Engine Oil Filter	343
Engine Air Cleaner Filter	343
Air Conditioner Maintenance	344
Accessory Drive Belt Inspection	347
Draining Fuel/Water Separator Filter — Diesel Engine	347
Engine Mounted Fuel Filter Replacement — Diesel Engine	348
Underbody Mounted Fuel Filter Replacement — Diesel Engine	349
Priming If The Engine Has Run Out Of Fuel — Diesel Engine	349
Intervention Regeneration Strategy — Message Process Flow	350
Diesel Exhaust Fluid (DEF)	350
Body Lubrication	350
Windshield Wiper Blades	351
Exhaust System	352
Cooling System	353

Charge Air Cooler — Inter-Cooler	355
Brake System	355
Automatic Transmission	356
Rear Axle And 4x4 Front Driving Axle Fluid Level	358
Transfer Case	358
Noise Control System Required Maintenance & Warranty	358
Fuses	360
Bulb Replacement	366
TIRES	372
Tire Safety Information	372
Tires — General Information	378
Tire Types	381
Spare Tires — If Equipped	381
Wheel And Wheel Trim Care	382
Snow Traction Devices	383
Tire Rotation Recommendations	386

DEPARTMENT OF TRANSPORTATION

UNIFORM TIRE QUALITY GRADES	387
Treadwear	387
Traction Grades	387
Temperature Grades	387

STORING THE VEHICLE

BODYWORK	388
Protection From Atmospheric Agents	388
Body And Underbody Maintenance	388
Preserving The Bodywork	389

INTERIORS

Seats And Fabric Parts	390
Plastic And Coated Parts	390
Leather Surfaces	391
Glass Surfaces	391

TECHNICAL SPECIFICATIONS

VEHICLE IDENTIFICATION NUMBER (VIN)	392
BRAKE SYSTEM	392
Hydraulic Brake Assist — If Equipped	392
WHEEL AND TIRE TORQUE SPECIFICATIONS	392
Torque Specifications	392
FUEL REQUIREMENTS — GASOLINE ENGINE	393
6.4L Engine	393
Reformulated Gasoline	394
Materials Added To Fuel	394
Gasoline/Oxygenate Blends	394
Do Not Use E-85 In Non-Flex Fuel Vehicles	394
CNG And LP Fuel System Modifications	394
Methylcyclopentadienyl Manganese Tricarbonyl (MMT) In Gasoline	394
Fuel System Cautions	395
FUEL REQUIREMENTS — DIESEL ENGINE	395
Fuel Specifications	395
Biodiesel Fuel Requirements	396
FLUID CAPACITIES	397
ENGINE FLUIDS AND LUBRICANTS	398
CHASSIS FLUIDS AND LUBRICANTS	400

CUSTOMER ASSISTANCE

SUGGESTIONS FOR OBTAINING SERVICE

FOR YOUR VEHICLE	401
Prepare For The Appointment	401
Prepare A List	401
Be Reasonable With Requests	401
IF YOU NEED ASSISTANCE	401
Roadside Assistance	401
FCA US LLC Customer Assistance Center	402

FCA Canada Customer Care	402
Mexico	402
Puerto Rico And US Virgin Islands	402
Customer Assistance For The Hearing Or Speech Impaired (TDD/TTY)	402
Service Contract	403
WARRANTY INFORMATION	403
MOPAR® PARTS	403
REPORTING SAFETY DEFECTS	403
In The 50 United States And Washington, D.C.	403
In Canada	403
PUBLICATION ORDER FORMS	404
Change Of Ownership Or Address	404
GENERAL INFORMATION	404

INTRODUCTION

Dear Customer,

Congratulations on the purchase of your new Ram vehicle. Be assured that it represents precision workmanship, distinctive styling, and high quality.



This is a specialized utility vehicle. It can go places and perform tasks that are not intended for conventional passenger vehicles. It handles and maneuvers differently from many passenger vehicles both on-road and off-road, so take time to become familiar with your vehicle. If equipped, the two-wheel drive version of this vehicle was designed for on-road use only. It is not intended for off-road driving or use in other severe conditions suited for a four-wheel drive vehicle. Before you start to drive this vehicle, read the Owner's Manual. Be sure you are familiar with all vehicle controls, particularly those used for braking, steering, transmission, and transfer case shifting. Learn how your vehicle handles on different road surfaces. Your driving skills will improve with experience. When driving off-road, or working the vehicle, don't overload the vehicle or expect the vehicle to overcome the natural laws of physics. Always observe federal, state, provincial and local laws wherever you drive. As with other vehicles of this type, failure to operate this vehicle correctly may result in loss of control or a collision → page 207.

This Owner's Manual has been prepared with the assistance of service and engineering specialists to acquaint you with the operation and maintenance of your vehicle. It is supplemented by customer-oriented documents. Within this information, you will find a description of the services that FCA US LLC offers to its customers as well as the details of the terms and conditions for maintaining its validity. Please take the time to read all of these publications carefully before driving your vehicle for the first time. Following the instructions, recommendations, tips, and important warnings in this manual will help ensure safe and enjoyable operation of your vehicle.

This Owner's Manual describes all versions of this vehicle. Options and equipment dedicated to specific markets or versions are not expressly indicated in the text. Therefore, you should only consider the information that is related to the trim level, engine, and version that you have purchased. Any content introduced throughout the Owner's Information, which may or may not be applicable to your vehicle, will be identified with the wording "If Equipped". All data contained in this publication are intended to help you use your vehicle in the best possible way. FCA US LLC aims at a constant improvement of the vehicles produced. For this reason, it reserves the right to make changes to the model described for technical and/or commercial reasons. For further information, contact an authorized dealer.

When it comes to service, remember that authorized dealers know your Ram best, have factory-trained technicians, genuine Mopar® parts, and care about your satisfaction.

SYMBOLS KEY

WARNING!	These statements apply to operating procedures that could result in a collision, bodily injury and/or death.
CAUTION!	These statements apply to procedures that could result in damage to your vehicle.
NOTE:	A suggestion which will improve installation, operation, and reliability. If not followed, may result in damage.
TIP:	General ideas/solutions/suggestions on easier use of the product or functionality.
PAGE REFERENCE ARROW 	Follow this reference for additional information on a particular feature.
FOOTNOTE 	Supplementary and relevant information pertaining to the topic.

If you do not read the entire Owner's Manual, you may miss important information. Observe all Cautions and Warnings.

VAN CONVERSIONS/CAMPERS

The New Vehicle Limited Warranty does not apply to body modifications or special equipment installed by van conversion/camper manufacturers/body builders. US residents refer to the Warranty Information, Section 2.1.C. Canadian residents refer to the "What Is Not Covered" section of the Warranty Information. Such equipment includes video monitors, DVD/Blu-Ray™, heaters, stoves, refrigerators, etc. For warranty coverage and service on these items, contact the applicable manufacturer.

CONSUMER INFORMATION — TRUCK-CAMPER LOADING

This information is provided in fulfillment of the requirement by the United States Government, Department of Transportation, National Highway Traffic Safety Administration, that "every manufacturer of trucks that are capable of accommodating slide-in campers, manufactured on or after April 1, 1973 shall provide... at the time of original purchase to the first person who purchases the truck"... information on Truck Camper Loading.

A slide-in camper document is provided in your vehicle's glove compartment that contains your Vehicle Identification Number, truck model, cargo weight rating, and the forward/rearward limit of a camper. To obtain additional dimensional and technical specifications for your vehicle, please visit <https://www.ramtrucks.com>.

Figure 1 illustrates the dimensions describing the forward and rearward limits of the zone in which the Center of Gravity (CG) of a slide-in camper must be located, to provide satisfactory vehicle handling and to prevent overload of the front and rear axles.

Figure 2 illustrates a proper match between truck and camper.

NOTE:

The camper Center of Gravity falls within the specified zone.

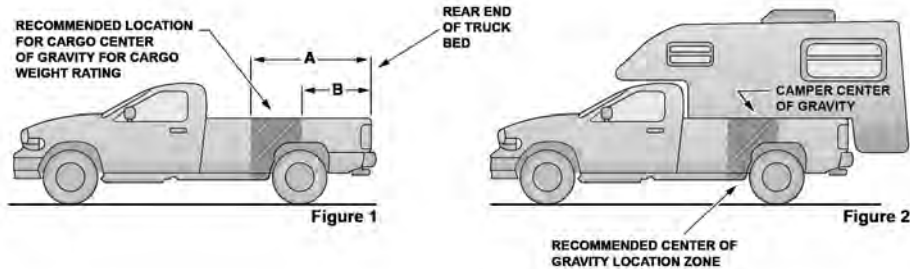

A010500004US

A — Forward Limit of Camper CG
 B — Rearward Limit of Camper CG

When the truck is used to carry a slide-in camper, the total cargo load of the truck consists of the manufacturer's camper weight figure, the weight of installed additional camper equipment not included in the manufacturer's camper weight figure, the weight of camper cargo, and the weight of passengers in the camper. The total cargo load should not exceed the truck's cargo weight rating and the camper's CG should fall within the truck's recommended CG zone when installed.

Secure loose items to prevent weight shifts that could affect the balance of your vehicle. When the truck camper is loaded, drive to a scale and weigh the front and rear wheels separately, to determine axle loads. Individual axle loads should not exceed either of the Gross Axle Weight Ratings (GAWR). The total of the axle loads should not exceed the Gross Vehicle Weight Rating (GVWR). If weight ratings are exceeded, move or remove items to get the total weight below the ratings.

NOTE:

These ratings are also provided on the vehicle certification label located on the driver's side B-pillar. See [page 191](#) for more information. For any additional instructions, please contact your conversion/camper manufacturer or an authorized dealer.

VEHICLE MODIFICATIONS/ALTERATIONS

WARNING!



Any modifications or alterations to this vehicle could seriously affect its roadworthiness and safety and may lead to a collision resulting in serious injury or death.







SYMBOL GLOSSARY





Some car components have colored labels with symbols indicating precautions to be observed when using this component. It is important to follow all warnings when operating your vehicle. See below for the definition of each symbol ⇨ page 111.

NOTE:







Warning and Indicator lights are different based upon equipment options and current vehicle status. Some telltales are optional and may not appear.







Red Warning Lights	
	Air Bag Warning Light ⇨ page 111
	Battery Charge Warning Light ⇨ page 111
	Brake Warning Light ⇨ page 111





Red Warning Lights	
	Door Open Warning Light ⇨ page 111
	Electronic Throttle Control (ETC) Warning Light ⇨ page 112
	Engine Coolant Temperature Warning Light ⇨ page 112
	Hood Open Warning Light ⇨ page 112
	Oil Pressure Warning Light ⇨ page 112
	Oil Temperature Warning Light ⇨ page 112

Red Warning Lights	
	Seat Belt Reminder Warning Light ⇨ page 112
	Tailgate Open Warning Light ⇨ page 112
	Trailer Brake Disconnected Warning Light ⇨ page 112
	Transmission Temperature Warning Light ⇨ page 112
	Vehicle Security Warning Light ⇨ page 113







Yellow Warning Lights	
	Adaptive Cruise Control (ACC) Fault Warning Light ⇨ page 113







Yellow Warning Lights	
	Air Suspension Fault Warning Light ⇨ page 113
	Anti-Lock Brake System (ABS) Warning Light ⇨ page 113
	Cruise Control Fault Warning Light ⇨ page 114
	Engine Check/Malfunction Indicator Warning Light (MIL) ⇨ page 114
	Electronic Stability Control (ESC) Active Warning Light ⇨ page 113
	Electronic Stability Control (ESC) OFF Warning Light ⇨ page 113







Yellow Warning Lights	
	LaneSense Warning Light ↪ page 113
	Low Washer Fluid Warning Light ↪ page 113
	Low Fuel Warning Light ↪ page 114
	Low Coolant Level Warning Light ↪ page 114
	Loose Fuel Filler Cap Warning Light ↪ page 114
	Rear Axle Locker Fault Warning Light ↪ page 114



Yellow Warning Lights	
	Service Forward Collision Warning (FCW) or Pedestrian Emergency Braking (PEB) Warning Light ↪ page 114
	Service LaneSense Warning Light ↪ page 114
	Service 4WD Warning Light ↪ page 114
	Sway Bar Fault Warning Light ↪ page 115
	Tire Pressure Monitoring System (TPMS) Warning Light ↪ page 115



Yellow Indicator Lights	
	Air Suspension Payload Protection Indicator Light ↪ page 116







Yellow Indicator Lights	
	Air Suspension Alternate Trailer Height Indicator Light ↔ page 115
	Air Suspension Bed Lowering Mode Indicator Light ↔ page 115
	Air Suspension Ride Height Raising Indicator Light ↔ page 116
	Air Suspension Ride Height Lowering Indicator Light ↔ page 116
	Cargo Indicator Light ↔ page 116
	Cold Ambient Derate Mode Indicator Light ↔ page 116





Yellow Indicator Lights	
	Diesel Exhaust Brake Indicator Light ↔ page 116
	Forward Collision Warning (FCW) or Pedestrian Emergency Braking (PEB) Off Indicator Light ↔ page 116
	Front And Rear Axle Lock Indicator Light ↔ page 116
	4WD Lock Indicator Light ↔ page 116
	4WD Low Indicator Light ↔ page 116
	4WD High Indicator Light ↔ page 116

Yellow Indicator Lights	
	Low Diesel Exhaust Fluid (DEF) Indicator Light ⇨ page 116
	NEUTRAL Indicator Light ⇨ page 116
	Rear Axle Lock Indicator Light ⇨ page 116
	Snowplow Mode Indicator Light ⇨ page 116
	SWAY BAR Indicator Light ⇨ page 117
	TOW/HAUL Indicator Light ⇨ page 117

Yellow Indicator Lights	
	Trailer Merge Assist Indicator Light ⇨ page 117
	Wait To Start Indicator Light ⇨ page 117
	Water In Fuel Indicator Light ⇨ page 117

Green Indicator Lights	
	Adaptive Cruise Control (ACC) Set With Target Indicator Light ⇨ page 117
	Adaptive Cruise Control (ACC) Set With No Target Detected Indicator Light ⇨ page 117
	Automatic Diesel Exhaust Brake Indicator Light ⇨ page 117

Green Indicator Lights	
	Cruise Control Set Indicator Light ⇨ page 117
	ECO Mode Indicator Light ⇨ page 117
	Front Fog Indicator Light ⇨ page 117
	Parking/Headlights On Indicator Light ⇨ page 117
	LaneSense Indicator Light ⇨ page 117
	Turn Signal Indicator Lights ⇨ page 117

White Indicator Lights	
	Adaptive Cruise Control (ACC) Ready Indicator Light ⇨ page 118
	Cruise Control Ready Indicator Light ⇨ page 118
	Hill Descent Control (HDC) Indicator Light ⇨ page 118
	LaneSense Indicator Light ⇨ page 118
Blue Indicator Lights	
	High Beam Indicator Light ⇨ page 118

GETTING TO KNOW YOUR VEHICLE

KEYS

KEY FOB

Your vehicle is equipped with a key fob which supports Passive Entry, Remote Keyless Entry, Keyless Enter 'n Go™ (if equipped), and Remote Start (if equipped). The key fob allows you to lock or unlock all doors, tailgate, and the RamBox (if equipped) as well as activate the Panic Alarm from distances up to approximately 66 ft (20 m). The key fob does not need to be pointed at the vehicle to activate the system. The key fob also contains an emergency key, which is stored in the rear of the key fob.

NOTE:

- The key fob's wireless signal may be blocked if the key fob is located next to a mobile phone, laptop, or other electronic device. This may result in poor performance.
- If your vehicle is equipped with a Wireless Charging Pad, the key fob may not be detected if it is placed within 6 inches (15 cm) of the pad ↪ page 70.
- With the ignition in the ON position and the vehicle moving at 2 mph (4 km/h), all RKE commands are disabled.



Key Fob

- 1 — Unlock
- 2 — Tailgate Release (If Equipped)
- 3 — Lock
- 4 — Remote Start (If Equipped)
- 5 — Panic
- 6 — Emergency Key

In case the ignition switch does not change with the push of a button, the key fob may have a low or fully depleted battery. A low key fob battery can be verified by referring to the instrument cluster, which will display directions to follow.

NOTE:

A low key fob battery condition may be indicated by a message in the instrument cluster display, or by the LED light on the key fob. If the LED key fob light no longer illuminates from key fob button pushes, then the key fob battery requires replacement ↪ page 404.

To Lock/Unlock The Doors And Tailgate

Push and release the unlock button on the key fob once to unlock the driver's door, or, twice within five seconds to unlock all doors, the tailgate and the RamBox (if equipped). To lock all the doors and the tailgate, push the lock button once.

When the doors are unlocked, the turn signals will flash and the illuminated entry system will be activated. When the doors are locked, the turn signals will flash and the horn will chirp.

All doors can be programmed to unlock on the first push of the unlock button. The horn chirp when the lock button is pushed can be programmed on/off within Unconnect Settings ↪ page 209.

Using The Panic Feature

To turn the Panic feature on or off, push the Panic button on the key fob. When the Panic feature is activated, the turn signals will flash, the horn may pulse on and off (if equipped with horn alarm), and the interior lights will turn on.

The Panic feature will stay on for three minutes unless you turn it off by either pushing the Panic button a second time or driving the vehicle at a speed of 15 mph (24 km/h) or greater.

NOTE:

- The interior lights will turn off if you place the ignition in the ON/RUN position while the Panic feature is activated. However, the exterior lights and horn (if equipped with horn alarm) will remain on.
- You may need to be less than 35 ft (11 m) from the vehicle when using the key fob to turn off the Panic Alarm due to the radio frequency noises emitted by the system.

Key Left Vehicle Feature

If a valid key fob is no longer detected inside the vehicle while the vehicle's ignition system is in the ON/RUN or START position, the message "Key Fob Has Left The Vehicle" will be shown in the instrument cluster display along with an interior chime. An exterior audible and visual alert will also be activated to warn the driver.

The vehicle's horn will rapidly chirp three times along with a single flash of the vehicle's exterior lights.

NOTE:

- The doors have to be open and then closed in order for the vehicle to detect a key fob. The Key Left Vehicle feature will activate when the first door is closed and no key fob is detected in the vehicle. If the warning has been activated, and the other doors are closed, no other warnings will be issued.
- These alerts will not be activated in situations where either the vehicle's engine is left running with the key fob inside, or the key fob's wireless signals are blocked.

Replacing The Battery In The Key Fob

The replacement battery model is one CR2032 battery.

NOTE:

- Customers are recommended to use a battery obtained from Mopar®. Aftermarket coin battery dimensions may not meet the original OEM coin battery dimensions.
- Perchlorate material — special handling may apply. See www.dtsc.ca.gov/hazardouswaste/perchlorate for further information.
- Do not touch the battery terminals that are on the back housing or the printed circuit board.
- Do not replace the coin battery if the LED on the key fob above the top row buttons blinks when a button is pressed. The coin battery should last a minimum of three years with normal vehicle usage.

1. Remove the emergency key (1) by pushing the emergency key release button (2) on the side of the key fob, and pulling the emergency key out with your other hand.

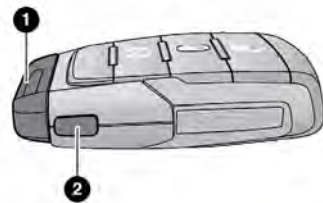

A0204000040US

Emergency Key Removal

- 1 — Emergency Key
 - 2 — Emergency Key Release Button
-
2. Hold the key fob with the button side facing down, and locate the small rectangular gap on the left side between the housing and the back cover of the key fob. Use a small screwdriver (or similar tool) to pry open the left side of the fob cover while applying pressure until the cover snaps open.
 3. Next, locate the gap on the right side of the key fob, which is positioned farther to the edge than the left side gap. Pry open the right side, and remove the back cover.

4. Remove the battery by using a suitable tool, such as a screwdriver, to slide the battery downward and back toward the key ring.



Key Fob Battery Location

NOTE:

When replacing the battery, ensure the (+) sign on the battery is facing upward. Avoid touching the new battery with your fingers. Skin oils may cause battery deterioration. If you touch a battery, clean it with rubbing alcohol.

5. Replace the battery by using your thumb to push down and slide the battery under the small lip on the top edge of the opening.



Key Fob Battery Replacement

6. To assemble the key fob case, line up the top edge of the back cover with the top of the fob, and press the edges into the interlocking hinges until all edges snap together with no large visual gaps.
7. Reinsert the emergency key until it locks into place.

NOTE:

The key fob battery should only be replaced by qualified technicians. If the battery requires replacement, see an authorized dealer.

WARNING!

- The integrated key fob contains a coin cell battery. Do not ingest the battery; there is a chemical burn hazard. If the coin cell battery is swallowed, it can cause severe internal burns in just two hours and can lead to death.
- If you think a battery may have been swallowed or placed inside any part of the body, seek immediate medical attention.

(Continued)

WARNING!

- Keep new and used batteries away from children. If the battery compartment does not close securely, stop using the product and keep it away from children.

Programming And Requesting Additional Key Fobs

Programming the key fob may be performed by an authorized dealer.

NOTE:

- Once a key fob is programmed to a vehicle, it cannot be repurposed and reprogrammed to another vehicle.
- Only key fobs that are programmed to the vehicle electronics can be used to start and operate the vehicle.

WARNING!

- Always remove the key fobs from the vehicle and lock all doors when leaving the vehicle unattended.
- For vehicles equipped with Keyless Enter 'n Go™ Ignition, always remember to place the ignition in the OFF position when exiting the vehicle.

Duplication of key fobs may be performed at an authorized dealer. This procedure consists of programming a blank key fob to the vehicle electronics. A blank key fob is one that has never been programmed.

NOTE:

- When having the Sentry Key Immobilizer system serviced, bring all vehicle keys with you to an authorized dealer.
- Emergency keys must be ordered to the correct key cut to match the vehicle locks.
- It is not mandatory to replace the key fob if a new emergency key is needed, and vice versa.

SENTRY KEY

The Sentry Key Immobilizer system prevents unauthorized vehicle operation by disabling the engine. The system does not need to be armed or activated. Operation is automatic, regardless of whether the vehicle is locked or unlocked.

The system uses a key fob, keyless push button ignition and a Radio Frequency (RF) receiver to prevent unauthorized vehicle operation. Therefore, only key fobs that are programmed to the vehicle can be used to start and operate the vehicle. The system cannot reprogram a key fob obtained from another vehicle.

After placing the ignition in the ON/RUN position, the Vehicle Security Light will turn on for three seconds for a bulb check. If the light remains on after the bulb check, it indicates that there is a problem with the electronics. In addition, if the light begins to flash after the bulb check, it indicates that someone attempted to start the engine with an invalid key fob. If a valid key fob is used to start the engine but there is an issue with the vehicle electronics, the engine will start and shut off after two seconds.

If the Vehicle Security Light turns on during normal vehicle operation (vehicle running for longer than 10 seconds), it indicates that there is a fault in the electronics. Should this occur, have the vehicle serviced as soon as possible by an authorized dealer.

CAUTION!

The Sentry Key Immobilizer system is not compatible with some aftermarket Remote Start systems. Use of these systems may result in vehicle starting problems and loss of security protection.

All of the key fobs provided with your new vehicle have been programmed to the vehicle electronics

➡ page 404.

NOTE:

A key fob that has not been programmed is also considered an invalid key.

IGNITION SWITCH**KEYLESS ENTER 'N GO™ IGNITION**

This feature allows the driver to operate the ignition switch with the push of a button as long as the key fob is in the passenger compartment.

The START/STOP ignition button has several operating modes that are labeled and will illuminate when in position. These modes are OFF, ACC, ON/RUN, and START.

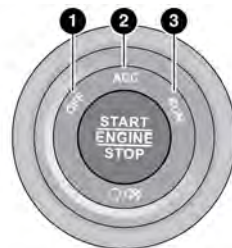

A0205000015US

Keyless Push Button Ignition

- 1 — OFF
- 2 — ACC (Accessory)
- 3 — ON/RUN

The push button ignition can be placed in the following modes:

OFF

- The engine is stopped
- Some electrical devices (e.g. power locks, alarm, etc.) are still available

ACC

- Engine is not started
- Some electrical devices are available (e.g. power sunroof, power windows, etc.)

RUN

- Driving position
- All electrical devices are available (e.g. climate controls, heated seats, etc.)

START

- The engine will start (when foot is on the brake)

NOTE:

If the ignition switch does not change the mode by pushing the button, the key fob may have a low or depleted battery. In this situation, a backup method can be used to operate the ignition switch. Put the nose side (side opposite of the emergency key) of the key fob against the START/STOP ignition button and push to operate the ignition switch.

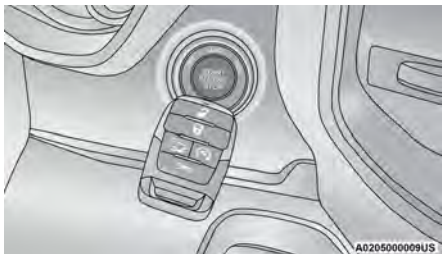
**Backup Starting Method****WARNING!**

- When exiting the vehicle, always remove the key fob from the vehicle and lock your vehicle.
- Never leave children alone in a vehicle, or with access to an unlocked vehicle.
- Allowing children to be in a vehicle unattended is dangerous for a number of reasons. A child or others could be seriously or fatally injured. Children should be warned not to touch the parking brake, brake pedal or the gear selector.

*(Continued)***WARNING!**

- Do not leave the key fob in or near the vehicle, or in a location accessible to children, and do not leave the Keyless Enter 'n Go™ Ignition in the ON/RUN position. A child could operate power windows, other controls, or move the vehicle.
- Do not leave children or animals inside parked vehicles in hot weather. Interior heat buildup may cause serious injury or death.

CAUTION!

An unlocked vehicle is an invitation for thieves. Always remove key fob from the vehicle and lock all doors when leaving the vehicle unattended.

NOTE:

- The key fob may not be detected by the vehicle Keyless Enter 'n Go™ system if it is located next to a mobile phone, laptop or other electronic device; these devices may block the key fob's wireless signal and prevent the Keyless Enter 'n Go™ system from starting the vehicle.
- For more information on engine starting procedures, see ↪ page 120.
- When opening the driver's door and the ignition is in the ON/RUN (engine not running) position, a chime will sound to remind you to place the ignition in the OFF position. In addition to the chime, the message "Ignition or Accessory ON" will display in the instrument cluster display.

**REMOTE START — IF EQUIPPED
(GASOLINE)**

This system uses the key fob to start the engine conveniently from outside the vehicle while still maintaining security. The system has a range of approximately 328 ft (100 m).

Remote Start is used to defrost windows in cold weather, and to reach a comfortable climate in all ambient conditions before the customer enters the vehicle.

NOTE:

Obstructions between the vehicle and key fob may reduce this range ↪ page 404.

WARNING!

- Do not start or run an engine in a closed garage or confined area. Exhaust gas contains carbon monoxide which is odorless and colorless. Carbon monoxide is poisonous and can cause serious injury or death when inhaled.
- Keep key fobs away from children. Operation of the Remote Start system, windows, door locks or other controls could cause serious injury or death.

HOW TO USE REMOTE START

Push and release the Remote Start button on the key fob twice within five seconds. The vehicle doors will lock, the parking lights will flash, and the horn will chirp twice (if programmed). Then, the engine will start, and the vehicle will remain in the Remote Start mode for a 15 minute cycle.

Pushing the Remote Start button a third time shuts the engine off.

To drive the vehicle, push the unlock button, and place the ignition in the ON/RUN position.

NOTE:

- With Remote Start, the engine will only run for 15 minutes.
- Remote Start can only be used twice.
- If an engine fault is present or fuel level is low, the vehicle will start and then shut down in 10 seconds.
- The parking lights will turn on and remain on during Remote Start mode.
- For security, power window and power sunroof operation (if equipped) are disabled when the vehicle is in the Remote Start mode.
- The ignition must be placed in the ON/RUN position before the Remote Start sequence can be repeated for a third cycle.
- If your power door locks were unlocked, Remote Start will automatically lock the doors.

All of the following conditions must be met before the engine will remote start:

- Gear selector in PARK
- Doors closed

- Hood closed
- Hazard switch off
- Brake switch inactive (brake pedal not pressed)
- Battery at an acceptable charge level
- Panic button not pushed
- Fuel meets minimum requirement
- System not disabled from previous Remote Start event
- Vehicle Security system not active
- Malfunction Indicator Light (MIL) is not illuminated

WARNING!

- Do not start or run an engine in a closed garage or confined area. Exhaust gas contains carbon monoxide which is odorless and colorless. Carbon monoxide is poisonous and can cause serious injury or death when inhaled.
- Keep key fobs away from children. Operation of the Remote Start system, windows, door locks or other controls could cause serious injury or death.

TO EXIT REMOTE START MODE

To drive the vehicle after starting the Remote Start system, push and release the START/STOP ignition button while pressing the brake pedal prior to the end of the 15 minute cycle.

The Remote Start system will turn the engine off if the Remote Start button on the key fob is pushed again, or if the engine is allowed to run for the entire 15 minute cycle. Once the ignition is placed in the ON/RUN position, the climate controls will resume the previously set operations (temperature, blower control, etc.).

NOTE:

- For vehicles equipped with the Keyless Enter 'n Go™ — Passive Entry feature, the message “Remote Start Active — Push Start Button” will display in the instrument cluster display until you push the START/STOP ignition button.
- To avoid unintentional shutdowns, the system will disable for two seconds after receiving a valid Remote Start request.

REMOTE START FRONT DEFROST ACTIVATION — IF EQUIPPED

When Remote Start is active, and the outside ambient temperature is 40°F (4.5°C) or below, the system will automatically activate front defrost for 15 minutes or less. The timing is dependent on the ambient temperature. Once the timer expires, the system will automatically adjust the settings depending on ambient conditions. See “Remote Start Comfort Systems — If Equipped” in the next section for detailed operation.

REMOTE START COMFORT SYSTEMS — IF EQUIPPED

When Remote Start is activated, the front and rear defroster will automatically turn on in cold weather conditions. The heated steering wheel and driver heated seat feature will turn on if programmed in the Comfort menu screen within Uconnect Settings  page 209. In warm weather, the driver vented seat feature will automatically turn on when Remote Start is activated, if programmed in the Comfort menu screen. The vehicle will adjust the climate control settings depending on the outside ambient temperature.

NOTE:

If the vehicle is equipped with a rear climate system, it will remain off to allow for optimal front row performance.

Automatic Temperature Control (ATC) — If Equipped

The climate controls will automatically adjust to the optimal temperature and mode settings depending on the outside ambient temperature. This will occur until the ignition is placed in the ON/RUN position where the climate controls will resume their previous settings.

Manual Temperature Control (MTC) — If Equipped

- In ambient temperatures of 40 °F (4.5 °C) or below, the climate settings will default to maximum heat, with fresh air entering the cabin. If the front defrost timer expires, the vehicle will enter Mix mode.
- In ambient temperatures from 40 °F (4.5 °C) to 78 °F (26 °C), the climate settings will be based on the last settings selected by the driver.
- In ambient temperatures of 78 °F (26 °C) or above, the climate settings will default to MAX A/C, Bi-Level mode, with Recirculation on.

For more information on ATC, MTC, and climate control settings, see ↪ page 56.

NOTE:

These features will stay on through the duration of Remote Start, or until the ignition is placed in the ON/RUN position. The climate control settings will change, and exit the automatic defaults, if manually adjusted by the driver while the vehicle is in Remote Start mode. This includes turning the climate controls off using the OFF button.

REMOTE START WINDSHIELD WIPER DE-ICER ACTIVATION — IF EQUIPPED

When Remote Start is active and the outside ambient temperature is less than 33 °F (0.6 °C), the Windshield Wiper De-Icer will activate. Exiting Remote Start will resume its previous operation. If the Windshield Wiper De-Icer was active, the timer and operation will continue.

REMOTE START ABORT MESSAGE

One of the following messages will display in the instrument cluster display if the vehicle fails to remote start or exits Remote Start prematurely:

- Remote Start Canceled — Door Open
- Remote Start Canceled — Hood Open
- Remote Start Canceled — Liftgate Open
- Remote Start Canceled — Fuel Low
- Remote Start Canceled — Time Expired
- Remote Start Canceled — System Fault
- Remote Start Disabled — Start Vehicle to Reset

The instrument cluster display message stays active until the ignition is placed in the ON/RUN position.

REMOTE START— IF EQUIPPED (DIESEL)

This system uses the key fob to start the engine conveniently from outside the vehicle while still maintaining security. The system has a range of approximately 328 ft (100 m).

Remote Start is used to defrost windows in cold weather, and to reach a comfortable climate in all ambient conditions before the driver enters the vehicle.

NOTE:

- Obstructions between the vehicle and the key fob may reduce this range.
- The Remote Start system will wait for the Wait To Start Indicator Light to extinguish before cranking the engine. This allows time for the engine preheat cycle to heat the cylinder air, and is normal in cold weather. For further information on the Wait To Start Indicator Light and the preheat cycle, see ↪ page 117.

HOW TO USE REMOTE START

Push and release the Remote Start button on the key fob twice within five seconds. The vehicle doors will lock, the parking lights will flash, and the horn will chirp twice (if programmed). Then, the engine will start, and the vehicle will remain in the Remote Start mode for a 15 minute cycle.

Pushing the Remote Start button a third time shuts the engine off.

To drive the vehicle, push the unlock button, and place the ignition in the ON/RUN position.

All of the following conditions must be met before the engine will remote start:

- Gear selector in PARK
- Doors closed
- Hood closed
- Hazard switch off
- Brake switch inactive (brake pedal not pressed)
- Battery at an acceptable charge level
- Panic button not pushed
- Fuel meets minimum requirement
- Water In Fuel Indicator Light is not illuminated

- Wait To Start Indicator Light is not illuminated
- Malfunction Indicator Light (MIL) is not illuminated

For additional functions of the Remote Start system, see  page 23.

WARNING!

- Do not start or run an engine in a closed garage or confined area. Exhaust gas contains carbon monoxide which is odorless and colorless. Carbon monoxide is poisonous and can cause serious injury or death when inhaled.
- Keep key fobs away from children. Operation of the Remote Start system, windows, door locks or other controls could cause serious injury or death.

VEHICLE SECURITY SYSTEM — IF EQUIPPED

The Vehicle Security system monitors the vehicle doors, hood, tailgate, and the Keyless Enter 'n Go™ Ignition for unauthorized operation. While the Vehicle Security system is armed, interior switches for door locks and tailgate release are disabled. If something triggers the alarm, the Vehicle Security system will provide the following audible and visible signals:

- The horn will pulse
- The turn signals will flash
- The Vehicle Security Light in the instrument cluster will flash

TO ARM THE SYSTEM

Follow these steps to arm the Vehicle Security system:

1. Make sure the vehicle's ignition is placed in the OFF position.
 - For vehicles equipped with Keyless Entry, make sure the vehicle's keyless ignition system is OFF.
2. Perform one of the following methods to lock the vehicle:
 - Push the lock button on the interior power door lock switch with the driver and/or passenger door open.
 - Push the lock button on the exterior Passive Entry door handle with a valid key fob available in the same exterior zone  page 27.
 - Push the lock button on the key fob.
3. If any doors are open, close them.

TO DISARM THE SYSTEM

The Vehicle Security system can be disarmed using any of the following methods:

- Push the unlock button on the key fob.
- Grab the Passive Entry door handle to unlock the door  page 27.
- Cycle the ignition out of the OFF position to disarm the system.

NOTE:

- The driver's door key cylinder cannot arm or disarm the Vehicle Security system. Use of the door key cylinder when the system is armed will sound the alarm when the door is opened.

- The Vehicle Security system remains armed when the power tailgate (if equipped) is opened using the tailgate button on the key fob.
- If Passive Entry (if equipped) is used to unlock the tailgate, the Vehicle Security system is disarmed and the rest of the vehicle doors will remain locked unless all doors are set to unlock on first press within Uconnect Settings.
- When the Vehicle Security system is armed, the interior power door lock switches will not unlock the doors.

The Vehicle Security system is designed to protect your vehicle. However, you can create conditions where the system will give you a false alarm. If one of the previously described arming sequences has occurred, the Vehicle Security system will arm regardless of whether you are in the vehicle or not. If you remain in the vehicle and open a door, the alarm will sound. If this occurs, disarm the Vehicle Security system.

If the Vehicle Security system is armed and the battery becomes disconnected, the Vehicle Security system will remain armed when the battery is reconnected; the exterior lights will flash, and the horn will sound. If this occurs, disarm the Vehicle Security system.

REARMING OF THE SYSTEM

If something triggers the alarm and no action is taken to disarm it, the Vehicle Security system will turn the horn off after a 29 second cycle (with five seconds between cycles and up to eight cycles if the trigger remains active) and then rearm itself.

SECURITY SYSTEM MANUAL OVERRIDE

The Vehicle Security system will not arm if you lock the doors using the manual door lock.

DOORS

MANUAL DOOR LOCKS

The power door locks can be manually locked from inside the vehicle by using the door lock knob. To lock each door, push the door lock knob on each door trim panel downward. To unlock the front doors, pull the inside door handle to the first detent. To unlock the rear doors, pull the door lock knob on the door trim panel upward. If the lock knob is down when the door is closed, the door will lock. Therefore, make sure the key fob is not inside the vehicle before closing the door.

NOTE:

Manually locking the vehicle will not arm the Vehicle Security system.

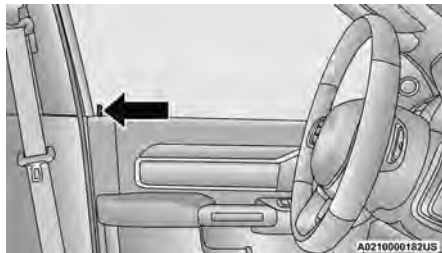

Door Lock Knob

WARNING!

- Do not leave children or animals inside parked vehicles in hot weather. Interior heat buildup may cause serious injury or death.
- For personal security and safety in the event of an collision, lock the vehicle doors as you drive as well as when you park and leave the vehicle.
- Before exiting a vehicle, always shift the automatic transmission into PARK, apply the parking brake, place the ignition in the OFF position, remove the key fobs from vehicle, and lock all doors to completely lock your vehicle.
- Never leave children alone in a vehicle, or with access to an unlocked vehicle. Leaving children in a vehicle unattended is dangerous for a number of reasons. A child or others could be seriously or fatally injured. Children should be warned not to touch the parking brake, brake pedal or the gear selector.
- Allowing children to be in a vehicle unattended is dangerous for a number of reasons. A child or others could be seriously or fatally injured. Children should be warned not to touch the parking brake, brake pedal or the gear selector.
- Do not leave the key fob in or near the vehicle, or in a location accessible to children, and do not leave the Keyless Enter 'n Go™ Ignition in the ACC or ON/RUN position. A child could operate power windows, other controls, or move the vehicle.

POWER DOOR LOCKS — IF EQUIPPED

The power door lock switches are located on each front door panel. Push the switch to lock or unlock the doors.

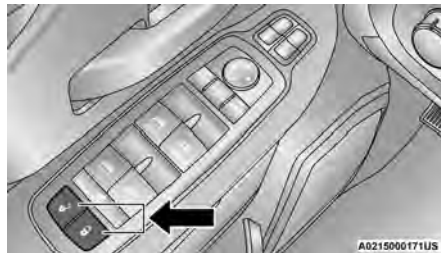

Power Door Lock Switches

The driver's door will unlock automatically if the key fob is detected inside the vehicle when the door lock button on the front door panel is used to lock the door. This will occur for two attempts. Upon the third attempt, the doors will lock even if the key fob is inside.

NOTE:

If the key fob is located next to a mobile phone, laptop, or other electronic device, the wireless signal may get blocked, and the driver's door may not unlock automatically.

If the door lock switch is pushed while the ignition is in the ACC or ON/RUN position and the driver's door is open, the doors will not lock.

If a rear door is locked, it cannot be opened from inside the vehicle without first unlocking the door. The door may be unlocked manually by raising the lock knob.

POWER SIDE STEPS — IF EQUIPPED

The Power Side Steps will extend a step for easier entry and exit of the vehicle.

When configured for Auto mode, the Power Side Steps will deploy when any of the doors are opened, or when the deploy setting is activated through the touchscreen. When configured for Store mode, the steps will not deploy unless the setting is selected manually through the Controls menu within the touchscreen.

If the vehicle speed exceeds 5 mph (8 km/h), or if the retract setting is selected within Uconnect Settings ↗ page 209, the steps will retract.

KEYLESS ENTER 'N GO™ — PASSIVE ENTRY (IF EQUIPPED)

The Passive Entry system is an enhancement to the vehicle's key fob and a feature of Keyless Enter 'n Go™. This feature allows you to lock and unlock the vehicle's door(s) without having to push the key fob lock or unlock buttons.

NOTE:

- Passive Entry may be programmed on or off within Uconnect Settings ↗ page 209.
- The key fob may not be detected by the vehicle Passive Entry system if it is located next to a mobile phone, laptop, or other electronic device; these devices may block the key fob's wireless signal and prevent the Passive Entry system from locking/unlocking the vehicle.
- Passive Entry unlock initiates illuminated approach (low beams, license plate lamp, position lamps) for whichever duration is set between 0, 30, 60 or 90 seconds. Passive Entry unlock also initiates two flashes of the turn signals.

- If wearing gloves, if it has been raining/snowing, or if there is salt/dirt covering the Passive Entry door handle, the unlock sensitivity can be affected, resulting in a slower response time.
- The doors may unlock when water is sprayed on the Passive Entry door handles if the key fob is located outside of the vehicle within 5 ft (1.5 m) of the handle.
- If the vehicle is unlocked by Passive Entry and no door is opened within 60 seconds, the vehicle will relock and (if equipped) will arm the Vehicle Security system.

To Unlock From The Driver Or Passenger Side

With a valid Passive Entry key fob within 5 ft (1.5 m) of the door handle, grab the handle to unlock the vehicle. Grabbing the driver's door handle will unlock the driver door automatically. Grabbing the passenger door handle will unlock all doors and the tailgate automatically.

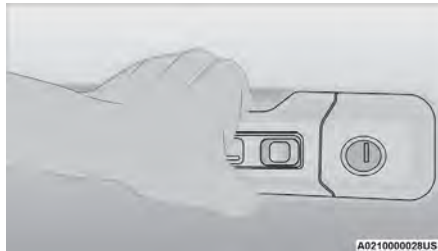

Grab The Door Handle To Unlock

NOTE:

- Either the driver door only or all doors will unlock when you grab hold of the front driver's door handle, depending on the selected setting in the Uconnect system ↗ page 209.
- All doors will unlock when the front passenger door handle is grabbed regardless of the driver's door unlock preference setting.

Frequency Operated Button Integrated Key (FOBIK-Safe)

To minimize the possibility of unintentionally locking a Passive Entry key fob inside your vehicle, the Passive Entry system is equipped with an automatic door unlock feature which will function if the ignition is in the OFF position.

There are five situations that trigger a FOBIK-Safe search in any Passive Entry vehicle:

- A lock request is made by a valid Passive Entry key fob while a door is open.
- A lock request is made by the Passive Entry door handle while a door is open.
- A lock request is made by the door panel switch while the door is open.
- When the Vehicle Security system is in pre-arm or armed status and the tailgate transitions from open to closed.
- When the tailgate transitions from open to closed and Remote Start is active.

When any of these situations occur, after all open doors are shut, the FOBIK-Safe search will be executed. If it detects a Passive Entry key fob inside the vehicle, the vehicle will unlock and alert the customer.

NOTE:

The vehicle will only unlock the doors when a valid Passive Entry key fob is detected inside the vehicle. The vehicle will not unlock the doors when any of the following conditions are true:

- The doors are manually locked using the door lock knobs.
- Three attempts are made to lock the doors using the door panel switch and then the doors are closed.
- There is a valid Passive Entry key fob outside the vehicle within 5 ft (1.5 m) of a Passive Entry door handle.

To Lock The Vehicle's Doors And Tailgate:

With one of the vehicle's Passive Entry key fobs within 5 ft (1.5 m) of either front door handles, pushing the Passive Entry lock button will lock the vehicle.

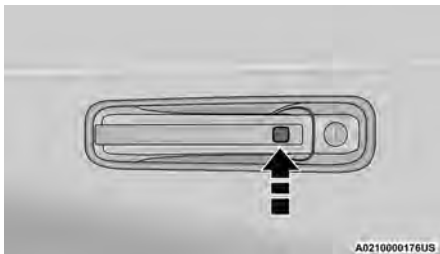

Push The Door Handle Button To Lock

Do NOT grab the door handle when pushing the door handle lock button. This could unlock the door(s).



Do NOT Grab The Door Handle When Locking

NOTE:

- After pushing the door handle button, you must wait two seconds before you can lock or unlock the doors, using either Passive Entry door handle. This is done to allow you to check if the vehicle is locked by pulling the door handle without the vehicle unlocking.
- If Passive Entry is disabled using the Uconnect Settings, the key fob protection described in "Frequency Operated Button Integrated Key (FOBIK-Safe)" remains active/functional.
- The Passive Entry system will not operate if the key fob battery is depleted ⇨ page 18.
- The LED light on the key fob will not blink if the key fob battery is low or fully depleted, but a low key fob battery condition will still support the Passive Entry system functionality. When the key fob battery is low, the instrument cluster will display a message indicating that the key fob battery is low ⇨ page 404.

AUTOMATIC UNLOCK DOORS ON EXIT – IF EQUIPPED

The doors will unlock automatically on vehicles with power door locks after the following sequence of actions:

1. The Automatic Unlock Doors On Exit feature is enabled within Uconnect Settings ⇨ page 209.
2. All doors are closed.
3. The gear selector was not in PARK, then is placed in PARK.
4. Any door is opened.

AUTOMATIC DOOR LOCKS – IF EQUIPPED

The auto door lock feature default condition is enabled. When enabled, the door locks will lock automatically when the vehicle speed exceeds 15 mph (24 km/h). The auto door lock feature is enabled/disabled within the Uconnect Settings ⇨ page 209.

CHILD-PROTECTION DOOR LOCK

To provide a safer environment for small children riding in the rear seats, the rear doors are equipped with a Child-Protection Door Lock system.

To use the system, open each rear door, use a flat-blade screwdriver, and rotate the dial to the lock or unlock position. When the Child-Protection Door Lock system is engaged, the door can be opened only by using the outside door handle even though the inside door lock is in the unlocked position.

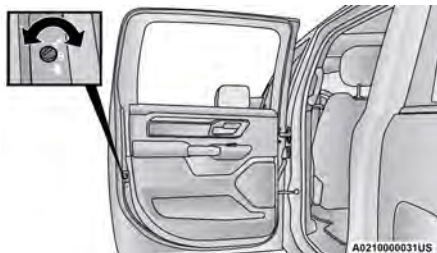

Child Lock Control

NOTE:

- After disengaging the Child-Protection Door Lock system, always test the door from the inside to make certain it is in the unlocked position.
- After engaging the Child-Protection Door Lock system, always test the door from the inside to make certain it is in the locked position.
- For emergency exit with the system engaged, pull up on the door lock knob (unlocked position), lower the window, and open the door with the outside door handle.

WARNING!

Avoid trapping anyone in the vehicle in a collision. Remember that the rear doors cannot be opened from the inside door handle when the Child Protection Door Locks are engaged.

NOTE:

Always use this device when carrying children. After engaging the child lock on both rear doors, check for effective engagement by trying to open a door with the internal handle. Once the Child-Protection Door Lock system is engaged, it is impossible to open the doors from inside the vehicle. Before getting out of the vehicle, be sure to check that there is no one left inside.

STEERING WHEEL**TILT STEERING COLUMN**

This feature allows you to tilt the steering column upward or downward. The tilt lever is located on the steering column, below the multifunction lever.

Pull the lever toward the steering wheel to unlock the steering column. With one hand firmly on the steering wheel, move the steering column up or down, as desired. Release the lever to lock the steering column firmly in place.



Tilt Steering Lever

WARNING!

Do not adjust the steering column while driving. Adjusting the steering column while driving or driving with the steering column unlocked, could cause the driver to lose control of the vehicle. Failure to follow this warning may result in serious injury or death.

2

HEATED STEERING WHEEL — IF EQUIPPED

The steering wheel contains a heating element that helps warm your hands in cold weather. The heated steering wheel has only one temperature setting. Once the heated steering wheel has been turned on, it will stay on until the operator turns it off. The heated steering wheel may not turn on when it is already warm.

The heated steering wheel button is located within the Uconnect system and, if equipped, on the instrument panel below the radio. You can access the button through the Climate or Controls menu of the touchscreen.

- Press the heated steering wheel button once to turn the heating element on.
- Press the heated steering wheel button a second time to turn the heating element off.

NOTE:

The engine must be running for the heated steering wheel to operate.

For information on use with the Remote Start system, see  page 23.

WARNING!

- Persons who are unable to feel pain to the skin because of advanced age, chronic illness, diabetes, spinal cord injury, medication, alcohol use, exhaustion, or other physical conditions must exercise care when using the steering wheel heater. It may cause burns even at low temperatures, especially if used for long periods.
- Do not place anything on the steering wheel that insulates against heat, such as a blanket or steering wheel covers of any type or material. This may cause the steering wheel heater to overheat.

UCONNECT VOICE RECOGNITION — IF EQUIPPED

INTRODUCING VOICE RECOGNITION

Start using Uconnect Voice Recognition with these helpful quick tips. It provides the key Voice Commands and tips you need to know to control your vehicle's Voice Recognition (VR) system.



Uconnect 3 With 5-inch Display

If you see the NAV icon on the bottom bar or in the Apps menus of your 8.4-inch touchscreen, you have the Uconnect 5 NAV system. If not, you have a Uconnect 5 with 8.4-inch display system.

BASIC VOICE COMMANDS

The following basic Voice Commands can be given at any point while using your Uconnect system.

Push the VR button  or for the Uconnect 5/5 NAV, say the vehicle's "Wake Up" word, "Hey Uconnect".

After the beep, say:

- "**Cancel**" to stop a current voice session.
- "**Help**" to hear a list of suggested Voice Commands.
- "**Repeat**" to listen to the system prompts again.

Notice the visual cues that inform you of your Voice Recognition system's status.

NOTE:

On Uconnect 5 systems, the factory default "Wake Up" word is set to "Hey Uconnect" and can be reprogrammed through the Uconnect Settings.

GET STARTED

All you need to control your Uconnect system with your voice are the buttons on your steering wheel.

1. Visit UconnectPhone.com to check mobile device and feature compatibility and to find phone pairing instructions.
2. Reduce background noise. Wind noise and passenger conversations are examples of noise that may impact recognition.
3. Speak clearly at a normal pace and volume while facing straight ahead. The microphone is located in the headliner and aimed at the driver.

4. Each time you give a Voice Command, you must first push either the VR or Phone button, wait until after the beep, then say your Voice Command. You can also say the vehicle "Wake Up" word and state your command. Some examples of "Wake Up" words include "Hey Uconnect" or "Hey Ram".
5. You can interrupt the help message or system prompts by pushing the VR or Phone button and saying a Voice Command from the current category.



Uconnect Voice Command Buttons

- 1 — For The Uconnect 5/5 NAV System Vehicles Equipped With Navigation: Push The Phone Button To Begin Radio, Media, Navigation, Climate, Start Or Answer A Phone Call, And Send Or Receive A Text
- 1 — For The Uconnect 5/5 NAV System Vehicles Not Equipped With Navigation: Push The Phone Button To Answer An Incoming Phone Call
- 2 — Push To Access The Tile Feature
- 3 — Push The Hang Up Button To End A Call Currently In Progress

ADDITIONAL INFORMATION

© 2023 FCA US LLC. All rights reserved. Mopar and Uconnect are registered trademarks, and Mopar Owner Connect is a trademark of FCA US LLC. SiriusXM® and all related marks and logos are trademarks of SiriusXM® Radio Inc.

Uconnect System Support:

- US residents visit www.DriveUconnect.com or call: 1-877-855-8400 (24 hours a day 7 days a week)
- Canadian residents visit www.DriveUconnect.ca or call: 1-800-465-2001 (English) or 1-800-387-9983 (French)

SiriusXM Guardian™ services support:

- US residents visit www.driveuconnect.com/sirius-xm-guardian or call: 1-844-796-4827
- Canadian residents visit <https://www.driveuconnect.ca/en/sirius-xm-guardian> or call: 1-877-324-9091

DRIVER MEMORY SETTINGS — IF EQUIPPED

This feature allows the driver to save up to two different memory profiles for easy recall through a memory switch. Each memory profile saves desired position settings for the following features:

- Driver's seat
- Easy Entry/Exit Seat operation (if equipped)
- Adjustable pedals (if equipped)
- Side mirrors
- A set of desired radio station presets

NOTE:

- If equipped with power convex mirrors, these mirror positions will not set as part of a memory profile ↪ page 39.
- Your vehicle is equipped with two key fobs, each can be linked to either memory position 1 or 2.

The driver memory settings switch is located on the driver door, next to the door handle, and consists of three buttons:

- The set (S) button, which is used to activate the memory save function.
- The (1) and (2) buttons which are used to recall either of two saved memory profiles.

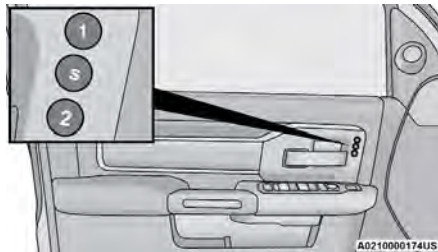

Driver Memory Settings Buttons

Programming The Memory Feature

To create a new memory profile, perform the following:

NOTE:

Saving a new memory profile will erase the selected profile from memory.

1. Place the vehicle's ignition in the ON/RUN position (do not start the engine).
2. Adjust all memory profile settings to desired preferences (i.e., driver's seat, outside mirrors, adjustable pedals (if equipped), and radio station presets).
3. Push the set (S) button on the memory switch, and then push the desired memory button (1 or 2) within five seconds. The instrument cluster display will show which memory position has been set.

NOTE:

Memory profiles can be set without the vehicle in PARK, but the vehicle must be in PARK to recall a memory profile.

Linking And Unlinking The Remote Keyless Entry Key Fob To Memory

Your key fob can be programmed to recall one of two saved memory profiles.

NOTE:

Before programming your key fob you must select the "Personal Settings Linked to Key Fob" feature through the Uconnect system ↪ page 209.

To program your key fob, perform the following:

1. Place the vehicle's ignition in the OFF position.
2. Select a desired memory profile 1 or 2.
3. Once the profile has been recalled, push and release the set (S) button on the memory switch.
4. Push and release button (1) or (2) accordingly. "Memory Profile Set" (1 or 2) will display in the instrument cluster.
5. Push and release the lock button on the key fob within 10 seconds.

NOTE:

Your key fob can be unlinked from your memory settings by pushing the set (S) button, followed by pushing the unlock button on the key fob within 10 seconds.

Memory Position Recall

NOTE:

If a recall is attempted when the vehicle is not in PARK, a message will display in the instrument cluster display.

To recall the memory settings for driver one or two, push the desired memory button number (1 or 2) or the unlock button on the key fob linked to the desired memory position.

A recall can be canceled by pushing any of the memory buttons (S, 1, or 2) during a recall. When a recall is canceled, the driver seat will stop moving. A delay of one second will occur before another recall can be selected.

Programming The Memory Feature

To create a new memory profile, perform the following:

NOTE:

Saving a new memory profile will erase the selected profile from memory.

1. Place the vehicle's ignition in the ON/RUN position (do not start the engine).
2. Adjust all memory profile settings to desired preferences (i.e., driver's seat, outside mirrors, adjustable pedals (if equipped), and radio station presets).
3. Push the set (S) button on the memory switch, and then push the desired memory button (1 or 2) within five seconds. The instrument cluster display will show which memory position has been set.

NOTE:

Memory profiles can be set without the vehicle in PARK, but the vehicle must be in PARK to recall a memory profile.

Linking And Unlinking The Remote Keyless Entry Key Fob To Memory

Your key fob can be programmed to recall one of two saved memory profiles.

NOTE:

Before programming your key fob you must select the "Personal Settings Linked to Key Fob" feature through the Uconnect system ➔ page 209.

To program your key fob, perform the following:

1. Place the vehicle's ignition in the OFF position.
2. Select a desired memory profile 1 or 2.
3. Once the profile has been recalled, push and release the set (S) button on the memory switch.
4. Push and release button (1) or (2) accordingly. "Memory Profile Set" (1 or 2) will display in the instrument cluster.
5. Push and release the lock button on the key fob within 10 seconds.

NOTE:

Your key fob can be unlinked from your memory settings by pushing the set (S) button, followed by pushing the unlock button on the key fob within 10 seconds.

Memory Position Recall

NOTE:

If a recall is attempted when the vehicle is not in PARK, a message will display in the instrument cluster display.

To recall the memory settings for driver one or two, push the desired memory button number (1 or 2) or the unlock button on the key fob linked to the desired memory position.

A recall can be canceled by pushing any of the memory buttons (S, 1, or 2) during a recall. When a recall is canceled, the driver seat will stop moving. A delay of one second will occur before another recall can be selected.

SEATS

Seats are a part of the Occupant Restraint system of the vehicle.

WARNING!

- It is dangerous to ride in a cargo area, inside or outside of a vehicle. In a collision, people riding in these areas are more likely to be seriously injured or killed.
- Do not allow people to ride in any area of your vehicle that is not equipped with seats and seat belts. In a collision, people riding in these areas are more likely to be seriously injured or killed.
- Be sure everyone in your vehicle is in a seat and using a seat belt properly.

MANUAL ADJUSTMENT FRONT SEATS — IF EQUIPPED

Manual Front Seat Forward/Rearward Adjustment

Both front seats are adjustable forward or rearward. The manual seat adjustment handle is located under the seat cushion at the front edge of each seat.

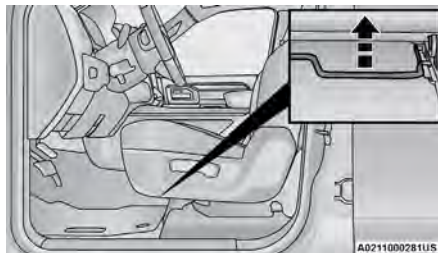

Manual Seat Adjustment Bar

While sitting in the seat, pull up on the handle and slide the seat forward or rearward. Release the bar once you have reached the desired position. Then, using body pressure, move forward and rearward on the seat to be sure that the seat adjusters have latched.

WARNING!

- Adjusting a seat while driving may be dangerous. Moving a seat while driving could result in loss of control which could cause a collision and serious injury or death.
- Seats should be adjusted before fastening the seat belts and while the vehicle is parked. Serious injury or death could result from a poorly adjusted seat belt.

Manual Front Seat Recline Adjustment

The recline lever is located on the outboard side of the seat. To recline the seat, lean forward slightly, lift the lever, lean back to the desired position and release the lever. To return the seatback to its normal upright position, lean forward and lift the lever. Release the lever once the seatback is in the upright position.

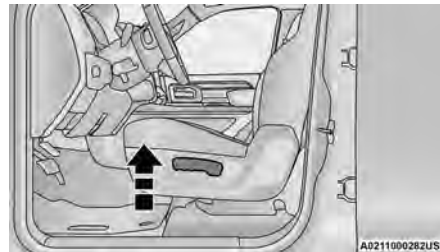

Manual Recline Lever

WARNING!

- Do not stand or lean in front of the seat while actuating the handle. The seatback may swing forward and hit you causing injury.
- To avoid injury, place your hand on the seatback and actuate the handle, then position the seatback in the desired position.

40-20-40 Front Bench Seat — If Equipped

The seat is divided into three segments. The outboard seat portions are each 40% of the total width of the seat. If equipped, the back of the center portion (20%) easily folds down to provide an armrest/center storage compartment.

MANUAL ADJUSTMENT REAR SEATS

WARNING!

Do not place luggage or cargo higher than the top of the seatback. This could impair visibility or become a dangerous projectile in a sudden stop or collision.

Second Row Bench Fold Flat Seat

To provide additional storage area, each rear seat can be folded flat. This allows for extended cargo space and still maintains some rear seating room.

NOTE:

Prior to folding the rear seat, it may be necessary to position the front seat to its mid-track position. Also, be sure that the front seats are fully upright and positioned forward. This will allow the rear seat to fold down easily. To lower the seatback, pull upward on the recline lever located on the outboard side of the seat, and let the seatback fold forward automatically.



Second Row Bench Seat Folded Flat

To raise the seatback, fold the seatback up into its original position and lock it into place.

WARNING!

Be certain that the seatback is securely locked into position. If the seatback is not securely locked into position the seat will not provide the proper stability for child seats and/or passengers. An improperly latched seat could cause serious injury.

POWER ADJUSTMENT FRONT SEATS — IF EQUIPPED

Some models may be equipped with eight-way power driver and passenger seats. The power seat switches are located on the outboard side of the driver and passenger seat cushions. There are two power seat switches that are used to control the movement of the seat cushion and the seatback.



Power Seat Switches

- 1 — Power Seat Switch
- 2 — Power Seatback Switch

Adjusting The Seat Forward Or Rearward

The seat can be adjusted both forward and rearward by using the power seat switch. The seat will move in the direction of the switch. Release the switch when the desired position has been reached.

Adjusting The Seat Up Or Down

The height of the seats can be adjusted up or down by using the power seat switch. The seat will move in the direction of the switch. Release the switch when the desired position has been reached.

Tilting The Seat Up Or Down

The angle of the seat cushion can be adjusted up or down using the power seat switch. The front of the seat cushion will move in the direction of the switch. Release the switch when the desired position has been reached.

Reclining The Seatback

The angle of the seatback can be adjusted forward or rearward by using the power seat switch. The seat will move in the direction of the switch. Release the switch when the desired position is reached.

WARNING!

- Adjusting a seat while driving may be dangerous. Moving a seat while driving could result in loss of control which could cause a collision and serious injury or death.
- Seats should be adjusted before fastening the seat belts and while the vehicle is parked. Serious injury or death could result from a poorly adjusted seat belt.
- Do not ride with the seatback reclined so that the shoulder belt is no longer resting against your chest. In a collision you could slide under the seat belt, which could result in serious injury or death.

CAUTION!

Do not place any article under a power seat or impede its ability to move as it may cause damage to the seat controls. Seat travel may become limited if movement is stopped by an obstruction in the seat's path.

Power Lumbar — If Equipped

Vehicles equipped with power driver or passenger seats may also be equipped with power lumbar. The power lumbar switch is located on the outboard side of the power seat. Push the switch forward to increase the lumbar support. Push the switch rearward to decrease the lumbar support.

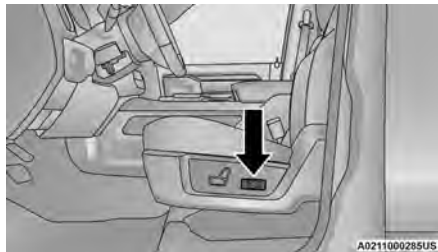

Lumbar Control Switch

Easy Entry/Exit Seat

This feature provides automatic driver's seat positioning to enhance driver mobility when entering and exiting the vehicle.

The distance the driver's seat moves depends on where you have the driver's seat positioned when you place the ignition in the OFF position.

- When you place the vehicle's ignition in the OFF position, the driver's seat will move about 2.4 inches (6 cm) rearward if the driver's seat position is greater than or equal to 2.7 inches (6.77 cm) forward of the rear stop. The seat will return to its previously set position when you place the ignition into the ACC or ON/RUN position.

- When you remove the key fob from the ignition, the driver's seat will move to a position 0.3 inches (0.77 cm) forward of the rear stop if the driver's seat position is between 0.9 inches and 2.7 inches (2.27 cm and 6.77 cm) forward of the rear stop. The seat will return to its previously set position when you place the ignition to the ACC or ON/RUN position.
- The Easy Entry/Easy Exit feature is disabled when the driver's seat position is less than 0.9 inches (2.27 cm) forward of the rear stop. At this position, there is no benefit to the driver by moving the seat for Easy Exit or Easy Entry.

When enabled in Uconnect Settings, Easy Entry and Easy Exit positions are stored in each memory setting profile ↩ page 31.

NOTE:

The Easy Entry/Exit feature is enabled or disabled through the programmable features in the Uconnect system ↩ page 209.

HEATED SEATS — IF EQUIPPED

On some models, the front and rear seats may be equipped with heaters located in the seat cushions and seatbacks.

WARNING!

- Persons who are unable to feel pain to the skin because of advanced age, chronic illness, diabetes, spinal cord injury, medication, alcohol use, exhaustion or other physical condition must exercise care when using the seat heater. It may cause burns even at low temperatures, especially if used for long periods of time.

(Continued)

WARNING!

- Do not place anything on the seat or seatback that insulates against heat, such as a blanket or cushion. This may cause the seat heater to overheat. Sitting in a seat that has been overheated could cause serious burns due to the increased surface temperature of the seat.

Front Heated Seats

The heated seats control buttons are located on the center instrument panel below the touchscreen, or located within the Climate or Comfort screen of the touchscreen.

NOTE:

If the vehicle is equipped with a 12-inch radio, there will only be control buttons through the touchscreen.

- Press the heated seat button once to turn the HI setting on.
- Press the heated seat button a second time to turn the MED setting on.
- Press the heated seat button a third time to turn the LO setting on.
- Press the heated seat button a fourth time to turn the heating elements off.

NOTE:

- The engine must be running for the heated seats to operate.
- The level of heat selected will stay on until the operator changes it.

For information on use with the Remote Start system, see page 23.

Rear Heated Seats

On some models, the two outboard rear seats are equipped with heated seats. The heated seat switches for these seats are located on the rear of the center console.

There are two heated seat switches that allow the rear passengers to operate the seats independently. You can choose from HI, MED, LO, or OFF heat settings. Amber indicator lights in each switch indicate the level of heat in use.

- Push the heated seat button once to turn the HI setting on.
- Push the heated seat button a second time to turn the MED setting on.
- Push the heated seat button a third time to turn the LO setting on.
- Push the heated seat button a fourth time to turn the heating elements off.

NOTE:

- The level of heat selected will stay on until the operator changes it.
- Once a heat setting is selected, heat will be felt within two to five minutes.
- The engine must be running for the heated seats to operate.

VENTILATED SEATS – IF EQUIPPED**Front Ventilated Seats**

Located in the seat cushion are small fans that draw the air from the passenger compartment and move air through fine perforations in the seat cover to help keep the driver and front passenger cooler in higher ambient temperatures. The fans operate at three speeds: HI, MED and LO.

The front ventilated seats control buttons are located on the center instrument panel below the touchscreen, and are also located within the Climate or Comfort screen of the touchscreen.

NOTE:

If the vehicle is equipped with a 12-inch radio, there will only be control buttons through the touchscreen.

- Press the ventilated seat button once to choose HI.
- Press the ventilated seat button a second time to choose MED.
- Press the ventilated seat button a third time to choose LO.
- Press the ventilated seat button a fourth time to turn the ventilation off.

NOTE:

The engine must be running for the ventilated seats to operate.

For information on use with the Remote Start system, see page 23.

HEAD RESTRAINTS

Head restraints are designed to reduce the risk of injury by restricting head movement in the event of a rear impact. Head restraints should be adjusted so that the top of the head restraint is located above the top of your ear.

WARNING!

- All occupants, including the driver, should not operate a vehicle or sit in a vehicle's seat until the head restraints are placed in their proper positions in order to minimize the risk of neck injury in the event of a crash.
- Head restraints should never be adjusted while the vehicle is in motion. Driving a vehicle with the head restraints improperly adjusted or removed could cause serious injury or death in the event of a collision.

NOTE:

Do not reverse the head restraints (making the rear of the head restraint face forward) in an attempt to gain additional clearance to the back of your head.

Front Head Restraints

Four-Way Head Restraints — If Equipped

Your vehicle may be equipped with front four-way driver and passenger head restraints.

To raise the head restraint, pull upward on the head restraint. To lower the head restraint, push the adjustment button, located at the base of the head restraint, and push downward on the head restraint.

To adjust the head restraint forward, pull the top of the head restraint toward the front of the vehicle as desired and release. To adjust the head restraint rearward, pull the top of the head restraint to the forward most position and release. The head restraint will return to the rear most position.



Forward Adjustment

NOTE:

Four-way head restraints have seven tilt/locking positions. When pulling fully forward, the head restraint will spring back to the untilted, rearward most position when released.

Two-Way Head Restraints — If Equipped

Your vehicle may be equipped with front two-way driver and passenger head restraints.

To raise the head restraint, pull upward on the head restraint. To lower the head restraint, push the adjustment button, located at the base of head restraint, and push downward on the head restraint.

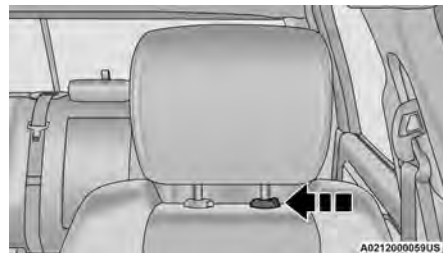

Head Restraint Adjustment Button Location

NOTE:

If your vehicle is equipped with a front bench seat, the center head restraint is not adjustable or removable.

WARNING!

- All occupants, including the driver, should not operate a vehicle or sit in a vehicle's seat until the head restraints are placed in their proper positions in order to minimize the risk of neck injury in the event of a crash.
- Head restraints should never be adjusted while the vehicle is in motion. Driving a vehicle with the head restraints improperly adjusted or removed could cause serious injury or death in the event of a collision.

Front Head Restraint Removal

Two-Way Head Restraints — If Equipped

To remove the head restraint, push the adjustment button and the release button while pulling upward on the whole assembly. To reinstall the head restraint, put the head restraint posts into the holes and adjust it to the appropriate height.

Four-Way Head Restraints — If Equipped

The head restraints should only be removed by qualified technicians, for service purposes only. If either of the head restraints require removal, see an authorized dealer.

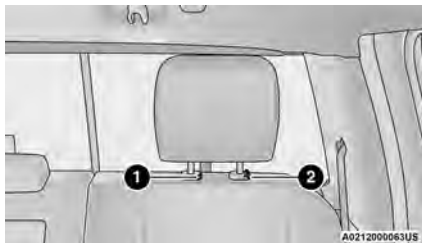

Release/Adjustment Buttons

- 1 — Release Button
2 — Adjustment Button

NOTE:

- The rear center head restraint (Crew Cab) has only one adjustment position that is used to aid in the routing of a tether → page 286.
- Do not reposition the head restraint 180 degrees to the incorrect position in an attempt to gain additional clearance to the back of the head.

Rear Head Restraint Removal

To remove the head restraint, push the adjustment button and the release button while pulling upward on the whole assembly. To reinstall the head restraint, put the head restraint posts into the holes and adjust it to the appropriate height.

NOTE:

To remove outboard restraints, the rear seat bottom must be folded up.

WARNING!

- A loose head restraint thrown forward in a collision or hard stop could cause serious injury or death to occupants of the vehicle. Always securely stow removed head restraints in a location outside the occupant compartment.
- ALL the head restraints MUST be reinstalled in the vehicle to properly protect the occupants. Follow the reinstallation instructions prior to operating the vehicle or occupying a seat.

WARNING!

- A loose head restraint thrown forward in a collision or hard stop could cause serious injury or death to occupants of the vehicle. Always securely stow removed head restraints in a location outside the occupant compartment.
- ALL the head restraints MUST be reinstalled in the vehicle to properly protect the occupants. Follow the reinstallation instructions prior to operating the vehicle or occupying a seat.

Rear Head Restraint Adjustment

The rear seats are equipped with adjustable and removable head restraints. To raise the head restraint, pull upward on the head restraint. To lower the head restraint, push the adjustment button located on the base of the head restraint and push downward on the head restraint.

DRIVER ADJUSTABLE PEDALS — IF EQUIPPED

The adjustable pedals system is designed to allow a greater range of driver comfort for steering wheel tilt and seat position. This feature allows the brake and accelerator pedals to move toward or away from the driver to provide improved position with the steering wheel.

The adjustable pedal switch is located to the left side of the steering column.



Adjustable Pedals Switch

The pedals **cannot** be adjusted when the vehicle is in REVERSE or when the Cruise Control system is on. If there is an attempt to adjust the pedals when the system is locked out, one of the following messages will appear (on vehicles equipped with an instrument cluster display):

- Adjustable Pedal Disabled — Cruise Control Engaged
- Adjustable Pedal Disabled — Vehicle In Reverse

NOTE:

- Always adjust the pedals to a position that allows full movement of the pedal.
- Further small adjustments may be necessary to find the best possible seat/pedal position.
- For vehicles equipped with Driver Memory Settings, you can use your remote keyless entry key fob or the memory switch on the driver's door trim panel to return the adjustable pedals to saved positions
↪ page 31.

WARNING!

Do not adjust the pedals while the vehicle is moving. You could lose control and have an accident. Always adjust the pedals while the vehicle is parked.

CAUTION!

Do not place any article under the adjustable pedals or impede its ability to move, as it may cause damage to the pedal controls. Pedal travel may become limited if movement is stopped by an obstruction in the adjustable pedal's path.

MIRRORS

INSIDE REARVIEW MIRROR

Manual Mirror — If Equipped

The mirror head can be adjusted up, down, left, and right. The mirror should be adjusted to center on the view through the rear window.

Headlight glare from vehicles behind you can be reduced by moving the small control under the mirror to the night position (toward the rear of the vehicle). The mirror should be adjusted while set in the day position (toward the windshield).

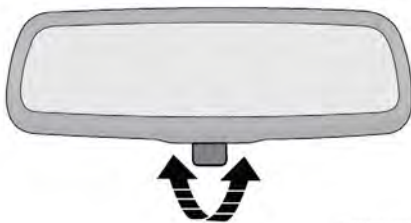

A0215000117US

Adjusting Rearview Mirror

Automatic Dimming Mirror — If Equipped

The rearview mirror can be adjusted up, down, left, and right. The mirror should be adjusted to center on the view through the rear window.

This mirror automatically adjusts for headlight glare from vehicles behind you.

NOTE:

The Automatic Dimming Mirror feature is disabled when the vehicle is in REVERSE to improve the driver's rear view.

The Automatic Dimming feature can be turned on or off through the touchscreen.



A0215000115US

Automatic Dimming Mirror

CAUTION!

To avoid damage to the mirror during cleaning, never spray any cleaning solution directly onto the mirror. Apply the solution onto a clean cloth and wipe the mirror clean.

Digital Rearview Mirror — If Equipped

The Digital Rearview Mirror provides a high definition, wide and unobstructed view of the road and traffic behind the vehicle, as well as a trailer when Tow Mode Camera is equipped, while driving forward (not recommended for use as a Back Up Camera).

Position the mirror in the regular Automatic Dimming Mirror mode, then activate the Digital Rearview Mirror mode.

To activate the Digital Rearview Mirror, pull the on/off control lever on the bottom of the mirror rearward toward the driver.

When Digital Rearview Mode is not in use, push the on/off control lever forward toward the windshield to return the mirror to the regular Automatic Dimming Mirror.

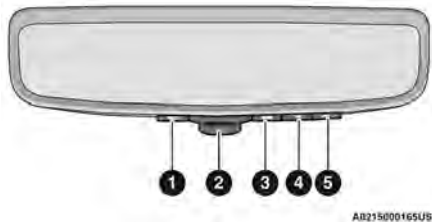

Digital Rearview Mirror

- 1 — View Button
- 2 — On/Off Control Lever
- 3 — Menu Button
- 4 — Left Scroll Button
- 5 — Right Scroll Button

Push the View button to the left of the on/off control to access the following view options.

NOTE:

View button is only available when a trailer coax cable is plugged into the two camera system.

Rearview Camera (Back Of Vehicle)

This is the default view of the Digital Rearview Camera. It displays a wide screen view of the back of the vehicle.

Split Screen Tow Mode — If Equipped

The Split Screen Tow Mode will display the left and right sides of the back of the vehicle using the outside mirror cameras.

Tri-View Tow Mode — If Equipped

The Tri-View Tow Mode will display the left and right sides of the back of the vehicle using the outside mirror cameras and the back of the trailer using an auxiliary camera.

Tow Mode (Back Of Trailer) — If Equipped

The Tow Mode will display a wide screen view of the back of the trailer using an auxiliary camera.

Push the Menu button next to the on/off control to access the following mirror adjustment options:

- Tilt (up/down)
- Pan (left/right)
- Rotate
- Zoom
- Brightness

Options can be customized for each camera by pressing the View button until desired camera is highlighted.

Push the Menu button to scroll through the menu options and use left and right scroll buttons to change settings.

The menu will lockout when vehicle is traveling above 8 mph (12 km/h). Once this happens, the menu options cannot be changed (view can still be changed).

NOTE:

The Digital Rearview Mirror is not as effective during nighttime driving in low light applications due to low ambient light levels. In the event that it provides the user with less than expected vision, the mirror can be reverted to a normal reflective Automatic Dimming Mirror by pushing the on/off control lever toward the windshield and putting the mirror into Automatic Dimming Mirror mode.

Tow Mode — If Equipped

Your vehicle may be equipped with an additional auxiliary trailer camera to be mounted on the rear of a trailer. When the camera is connected, the display in the Digital Rearview Mirror automatically switches to the trailer camera. Your vehicle may also include additional cameras in the outside mirrors, which will allow you to use Split Screen and Tri-View Tow Mode views.

To return to the Rearview Camera display toggle through the menu options using the control buttons on the mirror.

The following indications may be displayed on the Digital Rearview Mirror:

Digital Mode



This indication will appear when the Rearview Camera is utilizing the cameras on the vehicle.

Tow Mode



This indication will appear when the Rearview Camera is utilizing an auxiliary camera attached to the trailer.

View Switching In Progress

This indication will appear when camera view switching is in progress.

Camera Signal Lost (Single View)

This indication will appear when the Rearview Camera has lost its signal.

Camera Signal Lost (Multi-View)

This indication will appear when the camera affected has lost its signal in either Split Screen or Tri-View.

Communication Lost

This indication will appear when the Digital Rearview Camera has lost communication with the vehicle.

If a camera signal is lost, switch to Automatic Dimming Mirror mode.

For more information on trailer camera options, see [page 184](#).

WARNING!

The Digital Rearview Mirror mode has a limited view. Portions of the road, vehicles, and other objects may not be seen, especially while backing up.

ILLUMINATED VANITY MIRROR — IF EQUIPPED

To access an illuminated vanity mirror, flip down one of the visors and lift the cover.

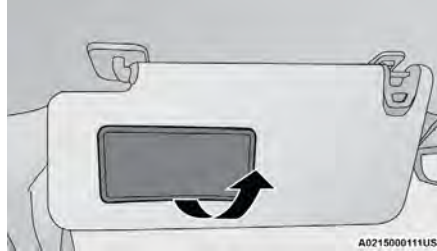
**Lift Cover For Illuminated Mirror****Slide-On-Rod Feature Of Sun Visor — If Equipped**

The sun visor Slide-On-Rod feature allows for additional flexibility in positioning the sun visor to block out the sun.

1. Fold down the sun visor.
2. Unclip the visor from the corner clip.
3. Pivot the sun visor toward the side window.
4. Extend the sun visor for additional sun blockage.

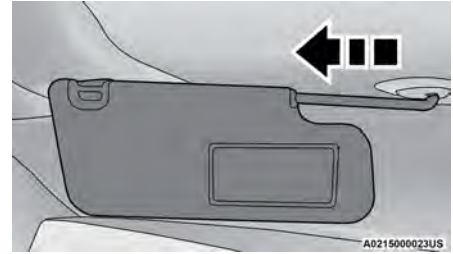
**Slide-On-Rod Extender****NOTE:**

The sun visor can also be extended while the sun visor is against the windshield for additional sun blockage through the front of the vehicle.

OUTSIDE MIRRORS

The outside mirror(s) can be adjusted to the center of the adjacent lane of traffic to achieve the optimal view.

NOTE:

If your vehicle is equipped with puddle lamps under the outside mirrors, they can be turned off through the Uconnect system [page 209](#).

WARNING!

Vehicles and other objects seen in the driver or passenger side convex mirror (bottom mirror) will look smaller and farther away than they really are. Relying only on the convex mirror could cause you to collide with another vehicle or other object. Use the top portion of your outside mirrors and/or your inside mirror when judging the size or distance of a vehicle seen in the convex mirror.

Trailer Tow Telescoping Mirrors

Your vehicle may be equipped with manual or power trailer telescoping mirrors. These mirrors are designed with an adjustable mirror head that can be extended when trailering to provide a greater vision range when towing extra-wide loads.

Power Telescoping Mirrors

The Power Telescoping Mirror Switch is located on the door trim panel, above the power mirror controls. The switch enables the driver to extend or retract the mirror head.

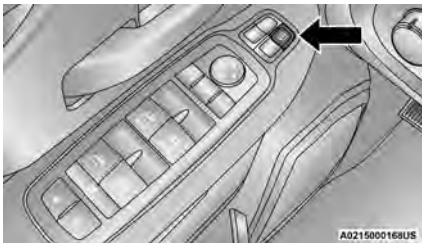
**Power Telescoping Mirror Switch**

To adjust the outside mirrors, push the Telescoping Mirror Switch. Use the left and right arrows on the directional button to move both driver's and passenger mirrors outward or inward to desired position.

**Power Telescoping Mirror (Extended Position)**

To return the control to the large mirror, push the Power Telescoping Mirror Switch a second time.

Manual Telescoping Mirrors

To extend the Manual Telescoping Mirrors pull the mirror outward to desired position. To return to normal position, push the mirror inward all the way.

**Manual Telescoping Mirror (Extended Position)****NOTE:**

Return the trailer towing mirrors to normal driving position or fold the mirrors prior to entering an automated car wash.

Outside Mirrors Folding Feature

All outside mirrors are designed to be able to be manually folded both forward and rearward to prevent damage.

**Folding Mirror**

CAUTION!

It is recommended to fold the mirrors into the full rearward position to resist damage when entering a car wash or a narrow location.

Outside Mirrors With Turn Signal And Approach Lighting — If Equipped

Driver and passenger outside mirrors with turn signal and approach lighting contain LEDs, which are located in the lower outer corner of each mirror.

The outer LEDs are turn signal indicators, which flash with the corresponding turn signal lights in the front and rear of the vehicle. Turning on the Hazard Warning flashers will also activate these LEDs.

The approach lighting, which turns on in both mirrors when you use the key fob or open any door is located on the underside of the mirror.

The illuminated entry lighting fades to off after about 30 seconds or it will fade to off immediately once the ignition is placed in the ON/RUN position.

NOTE:

The approach lighting will not function when the gear selector is moved out of the PARK position.

OUTSIDE AUTOMATIC DIMMING MIRROR — IF EQUIPPED

The exterior mirrors will automatically adjust for glare from vehicles behind you. This feature is controlled by the inside automatic dimming mirror. The mirror will automatically adjust for headlight glare when the inside mirror adjusts.

POWER MIRRORS — IF EQUIPPED

The controls for the power mirrors are located on the driver's door trim panel.

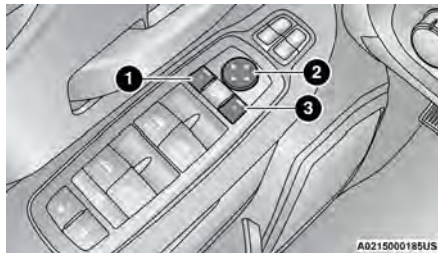

Power Mirror Controls

- 1 — Left Mirror Selection
- 2 — Mirror Direction Control
- 3 — Right Mirror Selection

The power mirror controls consist of mirror select buttons and a four-way mirror control switch.

To adjust a mirror, push either the L (left) or R (right) button to select the mirror that you want to adjust.

Using the mirror control switch, push on any of the four arrows for the direction that you want the mirror to move.

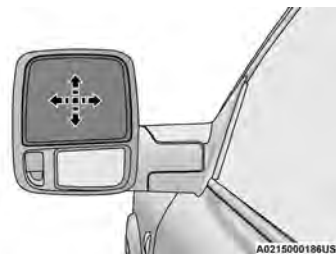

Power Mirror Movement

POWER FOLDING OUTSIDE MIRRORS — IF EQUIPPED

The power folding mirrors can be folded rearward and unfolded into the normal driving position.

The switch for the power folding mirrors is located between the power mirror switches L (left) and R (right). Push the switch once and the mirrors will fold in, push the switch a second time and the mirrors will return to the normal driving position.

If the mirror is manually folded after a powered cycle, a potential extra button push is required to get the mirrors back to the normal driving position. If the mirror does not fold automatically, check for ice or dirt buildup at the pivot area, which can cause excessive drag.

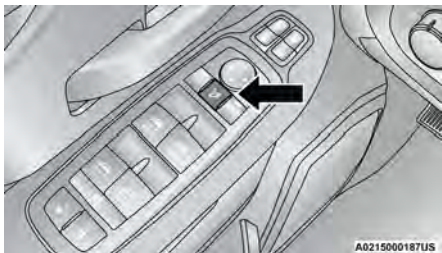
**Power Folding Mirror Switch****Resetting The Power Folding Outside Mirrors**

You may need to reset the power folding mirrors if the following occurs:

- The mirrors are accidentally blocked while folding.
- The mirrors are accidentally manually folded/unfolded (by hand or by pushing the power folding mirror switch).
- The mirrors come out of the unfolded position.
- The mirrors shake and vibrate at normal driving speeds.

To reset the power folding mirrors: Fold and unfold them by pushing the button (this may require multiple attempts). This resets them to their normal driving position.

AUTOMATIC POWER FOLDING MIRRORS — IF EQUIPPED

When enabled within Uconnect Settings ↗ page 209, the exterior mirrors will automatically fold when the vehicle's ignition is placed in the OFF position, and after the doors are locked and closed.

The exterior mirrors will auto-fold in the following situations after the ignition is placed in the OFF position:

- Pushing the lock button on the door panel before the door is opened.

NOTE:

If the doors are already locked, push the lock button again.

- Opening the door, then pushing the lock button on the door panel, followed by closing the door.
- After exiting the vehicle, close the doors then push the lock button on the key fob.
- After exiting the vehicle, close the doors then touch the lock icon on the Passive Entry door handle.

If the exterior mirrors were folded automatically, they will unfold when the ignition is placed in the ON/RUN position.

NOTE:

If the mirrors were folded manually (pushing the mirror head inward by hand), OR by using the power folding mirror switch on the driver's door panel, they will not automatically unfold.

TILT SIDE MIRRORS IN REVERSE — IF EQUIPPED

This feature provides automatic outside mirror positioning which will assist with the driver's ground visibility. The outside mirrors will move slightly downward from the present position when the vehicle is shifted into REVERSE. The outside mirrors will then return to the original position when the vehicle is shifted out of REVERSE. If the vehicle is equipped with Driver Memory Settings, this feature will be linked to the programmable settings.

NOTE:

The Tilt Side Mirrors In Reverse feature can be turned on and off using the Uconnect system ↗ page 209.

POWER CONVEX MIRROR SWITCH — IF EQUIPPED

The Power Convex Mirror Switch is located on the door trim panel, above the power mirror controls. The switch enables the movement of the convex portion of both the driver and passenger outside mirrors.

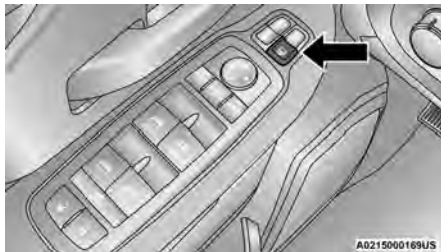
**Power Convex Mirror Switch**

To adjust the convex portion of the outside mirrors, push the Power Convex Mirror Switch. Then, select the mirror you want to adjust by using the L (left) or R (right) buttons. Using the mirror control switch, push any of the four arrows for the direction you want the mirror to move.

To return the control to the large mirror, push the Power Convex Mirror Switch a second time.



Trailer Tow Power Convex Mirror

NOTE:

If the Power Convex Mirror Switch is not pushed a second time, the switch will automatically default back to the larger portion of the outside mirrors after a period of time.

FORWARD UTILITY LIGHTS AND REAR GUIDANCE LIGHTS – IF EQUIPPED

The forward utility lights and reverse guidance lights switches are located on the drivers door trim panel, above the power mirror controls. These switches enable the forward or reverse lights located on the driver and passenger outside mirrors.

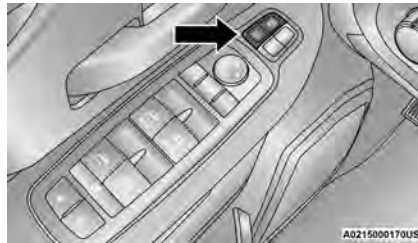

Forward and Reverse Light Switches

When either button is pressed the corresponding light on the outside mirror will remain on for ten minutes. The vehicle must be in the ON/RUN or ACC position. When the light is active, the switch on the door panel will illuminate. Pushing the switch a second time will turn the lights off.

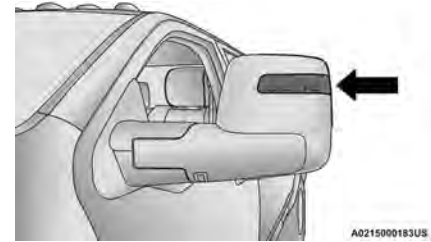

Forward Utility Light



Reverse Guidance Light

When the lights are activated using the switch on the door panel, the reverse guidance lights will illuminate when the vehicle transmission is in PARK, NEUTRAL, or REVERSE and the forward utility lights will illuminate in all ignition positions. The rear guidance lights will turn off when the vehicle transmission is placed in DRIVE. The rear guidance lights will also illuminate when the cargo light switch is pressed on the headlight switch panel. This feature is programmable through the Uconnect system ↪ page 209

HEATED MIRRORS — IF EQUIPPED



These mirrors are heated to melt frost or ice. This feature will be activated whenever you turn on the rear window defroster (if equipped) → page 56.

Universal Garage Door Opener (HomeLink®) — If Equipped

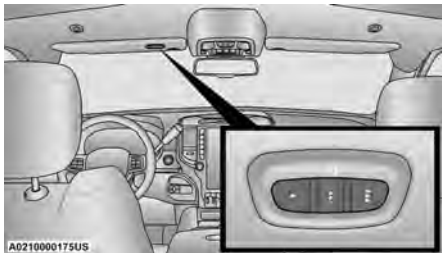

HomeLink® Buttons

Use this QR code to access your digital experience.



- HomeLink® replaces up to three hand-held transmitters that operate devices such as garage door openers, motorized gates, lighting, or home security systems. The HomeLink® unit is powered by your vehicle's 12 Volt battery.

- The HomeLink® buttons that are located in the overhead console or sun visor designate the three different HomeLink® channels.
- To operate HomeLink®, push and release any of the programmed HomeLink® buttons. These buttons will activate the devices they are programmed to with each press of the corresponding HomeLink® button.
- The HomeLink® indicator light is located above the center button.

NOTE:

HomeLink® is disabled when the Vehicle Security system is active → page 404.

BEFORE YOU BEGIN PROGRAMMING HOMELINK®

For efficient programming and accurate transmission of the Radio Frequency (RF) signal, it is recommended that a new battery be placed in the hand-held transmitter of the device that is being programmed to the HomeLink® system. Make sure your hand-held transmitter is programmed to activate the device you are trying to program your HomeLink® button to.

Ensure that your vehicle is parked outside of the garage before you begin programming.

It is recommended that you erase all the channels of your HomeLink® before you use it for the first time.

ERASING ALL THE HOMELINK® CHANNELS

To erase the channels, follow this procedure:

1. Place the ignition switch in the ON/RUN position.
2. Push and hold the two outside HomeLink® buttons (I and III) for up to 20 seconds, or until the HomeLink® indicator light flashes.

NOTE:

Erasing all channels should only be performed when programming HomeLink® for the first time. Do not erase channels when programming additional buttons.

IDENTIFYING WHETHER YOU HAVE A ROLLING CODE OR NON-ROLLING CODE DEVICE

Before programming a device to one of your HomeLink® buttons, you must determine whether the device has a rolling code or non-rolling code.

Rolling Code Devices

To determine if your device has a rolling code, a good indicator is its manufacturing date. Typically, devices manufactured after 1995 have rolling codes. A device with a rolling code will also have a "LEARN" or "TRAIN" button located where the antenna is attached to the device. The button may not be immediately visible when looking at the device. The name and color of the button may vary slightly by manufacturer.

NOTE:

The "LEARN" or "TRAIN" button is not the button you normally use to operate the device.

Non-rolling Code Devices

Most devices manufactured before 1995 will not have a rolling code. These devices will also not have a "LEARN" or "TRAIN" button.

PROGRAMMING HOMELINK® TO A GARAGE DOOR OPENER

To program any of the HomeLink® buttons to activate your garage door opener motor, refer to the following steps:

NOTE:

All HomeLink® buttons are programmed using this procedure. You do not need to erase all channels when programming additional buttons.

1. Place the ignition switch in the ON/RUN position.
2. Place the garage door opener transmitter 1 to 3 inches (3 to 8 cm) away from the HomeLink® button you wish to program, while keeping the HomeLink® indicator light in view.
3. Push and hold the HomeLink® button you want to program while you push and hold the garage door opener transmitter button you are trying to replicate.
4. Continue to hold both buttons and observe the HomeLink® indicator light. The HomeLink® indicator light will flash slowly and then rapidly. Once this happens, release both buttons.

NOTE:

Make sure the garage door opener motor is plugged in before moving on to the rolling code/non-rolling code final steps.

Rolling Code Garage Door Opener Final Steps**NOTE:**

You have 30 seconds in which to initiate rolling code final step 2, after completing rolling code final step 1.

1. At the garage door opener motor (in the garage), locate the "LEARN" or "TRAIN" button. This can usually be found where the hanging antenna wire is attached to the garage door opener motor. Firmly push and release the "LEARN" or "TRAIN" button.
2. Return to the vehicle and push the programmed HomeLink® button three times (holding the button for two seconds each time). If the garage door opener motor operates, programming is complete.
3. Push the programmed HomeLink® button to confirm that the garage door opener motor operates. If the garage door opener motor does not operate, repeat the final steps for the rolling code procedure.

Non-Rolling Code Garage Door Opener Final Steps

1. Push and hold the programmed HomeLink® button and observe the HomeLink® indicator light. If the HomeLink® indicator light stays on constantly, programming is complete.
2. Push the programmed HomeLink® button to confirm that the garage door opener motor operates. If the garage door opener motor does not operate, repeat the steps from the beginning.

WARNING!

- Your motorized door or gate will open and close while you are programming the universal transmitter. Do not program the transmitter if people or pets are in the path of the door or gate.
- Do not run your vehicle in a closed garage or confined area while programming the transmitter. Exhaust gas from your vehicle contains carbon monoxide which is odorless and colorless. Carbon monoxide is poisonous when inhaled and can cause you and others to be severely injured or killed.

2

PROGRAMMING HOMELINK® TO A MISCELLANEOUS DEVICE

The procedure on how to program HomeLink® to a miscellaneous device follows the same procedure as programming to a garage door opener ➔ page 47. Be sure to determine if the device has a rolling code or non-rolling code before beginning the programming process.

NOTE:

Canadian Radio Frequency (RF) laws require transmitter signals to time-out (or quit) after several seconds of transmission, which may not be long enough for HomeLink® to pick up the signal during programming. Similar to this Canadian law, some U.S. gate operators are designed to time-out in the same manner. The procedure may need to be performed multiple times to successfully pair the device to your HomeLink® buttons.

REPROGRAMMING A SINGLE HOMELINK® BUTTON

To reprogram a single HomeLink® button that has been previously trained, without erasing all the channels, proceed as follows. Be sure to determine whether the new device you want to program the HomeLink® button to has a rolling code, or non-rolling code.

1. Place the ignition in the ON/RUN position, without starting the engine.
2. Push and hold the desired HomeLink® button until the HomeLink® indicator light begins to flash after 20 seconds. **Do not release the button.**
3. **Without releasing the button**, proceed with Step 2 in “Programming HomeLink® To A Garage Door Opener” and follow all remaining steps.

CANADIAN/GATE OPERATOR PROGRAMMING

For programming transmitters in Canada/United States that require the transmitter signals to “time-out” after several seconds of transmission:

Canadian Radio Frequency (RF) laws require transmitter signals to time-out (or quit) after several seconds of transmission, which may not be long enough for HomeLink® to pick up the signal during programming. Similar to this Canadian law, some U.S. gate operators are designed to time-out in the same manner.

It may be helpful to unplug the device during the cycling process to prevent possible overheating of the garage door or gate motor.

1. Place the ignition in the ON/RUN position.

NOTE:

For vehicles equipped with Keyless Enter ‘n Go™, place the ignition in the RUN position. Make sure while programming HomeLink® with the engine on that your vehicle is outside of your garage, or that the garage door remains open at all times.

2. Place the hand-held transmitter 1 to 3 inches (3 to 8 cm) away from the HomeLink® button you wish to program while keeping the HomeLink® indicator light in view.
3. Continue to push and hold the HomeLink® button while you push and release (cycle) your hand-held transmitter every two seconds until HomeLink® has successfully accepted the frequency signal. The indicator light will flash slowly and then rapidly when fully trained.
4. Watch for the HomeLink® indicator to change flash rates. When it changes, it is programmed. It may take up to 30 seconds or longer in rare cases. The garage door may open and close while you are programming.
5. Push and hold the programmed HomeLink® button and observe the indicator light.

NOTE:

- If the indicator light stays on constantly, programming is complete and the garage door/device should activate when the HomeLink® button is pushed.
- To program the two remaining HomeLink® buttons, repeat each step for each remaining button. **DO NOT** erase the channels.

If you unplugged the garage door opener/device for programming, plug it back in at this time.

Reprogramming A Single HomeLink® Button (Canadian/Gate Operator)

To reprogram a channel that has been previously trained, follow these steps:

1. Place the ignition in the ON/RUN position.
2. Press and hold the desired HomeLink® button until the indicator light begins to flash after 20 seconds. Do not release the button.
3. Without releasing the button, proceed with “Canadian/Gate Operator Programming” Step 2 and follow all remaining steps.

SECURITY

It is advised to erase all channels before you sell or turn in your vehicle.

To do this, push and hold the two outside buttons for 20 seconds until the indicator flashes. Note that all channels will be erased. Individual channels cannot be erased.

The HomeLink® universal transmitter is disabled when the Vehicle Security system is active.

TROUBLESHOOTING TIPS

If you are having trouble programming HomeLink®, here are some of the most common solutions:

- Replace the battery in the garage door opener hand-held transmitter.
- Push the LEARN button on the garage door opener to complete the training for a rolling code.
- Did you unplug the device for programming and remember to plug it back in?

If you have any problems, or require assistance, please call toll-free 1-800-355-3515 or visit HomeLink.com for information or assistance.

WARNING!

- Vehicle exhaust contains carbon monoxide, a dangerous gas. Do not run your vehicle in the garage while programming the transmitter. Exhaust gas can cause serious injury or death.
- Your motorized door or gate will open and close while you are programming the universal transmitter. Do not program the transmitter if people, pets or other objects are in the path of the door or gate. Only use this transmitter with a garage door opener that has a “stop and reverse” feature as required by Federal safety standards. This includes most garage door opener models manufactured after 1982. Do not use a garage door opener without these safety features.

EXTERIOR LIGHTS

HEADLIGHT SWITCH

The headlight switch is located on the left side of the instrument panel. This switch controls the operation of the headlights, parking lights, automatic headlights (if equipped), instrument panel light dimming, cargo light, rear guidance lights (if equipped), and fog lights (if equipped).

NOTE:

The forward utility lights and rear guidance lights can also be controlled from the switch on the drivers door trim panel → page 45.

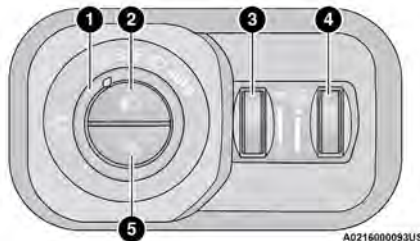

Headlight Switch

- 1 – Rotate Headlight Control
- 2 – Push Fog Light Switch
- 3 – Ambient Light Dimmer Control
- 4 – Instrument Panel Dimmer Control
- 5 – Push Cargo Light Switch

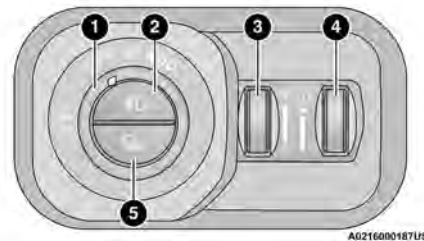

Headlight Switch (Vehicles Sold In Canada)

- 1 – Rotate Headlight Control
- 2 – Push Fog Light Switch
- 3 – Ambient Light Dimmer Control
- 4 – Instrument Panel Dimmer Control
- 5 – Push Cargo Light Switch

NOTE:

Vehicles sold in Canada are equipped with a headlight switch with an AUTO and ON detent but without an OFF detent. Headlights will be deactivated when the headlight switch is placed in the parking lights position. However, the Daytime Running Lights (DRLs) will be activated along with the front and rear marker lights. The DRLs may be deactivated when the parking brake is engaged.

To turn on the headlights, rotate the headlight switch clockwise. When the headlight switch is on, the parking lights, taillights, license plate light and instrument panel lights are also turned on. To turn off the headlights, rotate the headlight switch back to the O (off) position.

NOTE:

For vehicles sold in Canada, rotate the headlight switch clockwise from the parking lights and instrument panel lights position to the first detent to turn on headlights, parking lights, and instrument panel lights. Rotate the headlight switch to the second detent for the AUTO position.

MULTIFUNCTION LEVER

The multifunction lever is located on the left side of the steering column.



Multifunction Lever

**DAYTIME RUNNING LIGHTS (DRLS)
— IF EQUIPPED**

The Daytime Running Lights (DRLs) come on whenever the engine is running, and the low beams are not on. The lights will remain on until the ignition is placed in the OFF or ACC position, or the parking brake is engaged.

NOTE:

- For vehicles sold in Canada, the Daytime Running Lights will automatically deactivate when the front fog lights are turned on.
- If allowed by law in the country in which the vehicle was purchased, the Daytime Running Lights can be turned on and off using the Uconnect system
↪ page 209.

- On some vehicles, the Daytime Running Lights may deactivate, or reduce intensity, on one side of the vehicle (when a turn signal is activated on that side), or on both sides of the vehicle (when the hazard warning lights are activated).

HIGH/LOW BEAM SWITCH

Push the multifunction lever toward the instrument panel to switch the headlights to high beams. Pulling the multifunction lever back will turn the low beams on.

**AUTOMATIC HIGH BEAM
HEADLAMP CONTROL —
IF EQUIPPED**

The Automatic High Beam Headlamp Control system provides increased forward lighting at night by automating high beam control through the use of a camera mounted on the inside rearview mirror or a windshield mounted camera. These cameras detect vehicle specific light and automatically switch from high beams to low beams until the approaching vehicle is out of view.

NOTE:

- The Automatic High Beam Headlamp Control can be turned on or off by selecting “ON” under “Auto Dim High Beams” within your Uconnect Settings
↪ page 209, as well as turning the headlight switch to the AUTO position.
- Broken, muddy, or obstructed headlights and tail-lights of vehicles in the field of view will cause headlights to remain on longer (closer to the vehicle). Also, dirt, film, and other obstructions on the windshield or camera lens will cause the system to function improperly.

- If the windshield or Automatic High Beam Headlamp Control mirror is replaced, the mirror must be re-aimed to ensure proper performance. See a local authorized dealer.
- The Automatic High Beams will not activate until the vehicle is at or above 15 mph (24 km/h). To opt out of the Automatic High-Beam Sensitivity Control (default) and enter Reduced High-Beam Sensitivity Control (not recommended), toggle the multifunction lever six full on/off cycles within 10 seconds of ignition ON. The system will return to the default setting when the ignition is placed in the OFF position.

FLASH-TO-PASS

You can signal another vehicle with your headlights by lightly pulling the multifunction lever toward you. This will cause the high beam headlights to turn on, and remain on, until the lever is released.

**AUTOMATIC HEADLIGHTS —
IF EQUIPPED**

This system automatically turns the headlights on or off according to ambient light levels. To turn the system on, rotate the headlight switch to the AUTO position.

When the system is on, the Headlight Delay feature is also on. This means the headlights will stay on for up to 90 seconds after you place the ignition into the OFF position. To turn the automatic headlights off, turn the headlight switch out of the AUTO position.

NOTE:

The engine must be running before the headlights will turn on in the Automatic Mode.

DIRECTIONAL LED HEADLAMP SYSTEM — IF EQUIPPED

This is a system consisting of LED (low/high beam) headlights that incorporate dynamic cornering with 5-degree inboard/15-degree outboard swivel. The headlights continuously and automatically adapt to the driving conditions around bends or when cornering based on steering wheel angle.

The system directs the headlights to light up the road in the best way, taking into account the speed of the vehicle and the bend or corner angle, as well as the speed of the vehicle while the steering wheel is being turned.

The adaptive lights are automatically activated when the vehicle is traveling above approximately 5 mph (8 km/h).

This system can be turned on/off through the Uconnect Settings under “Steering Directed Lights”  page 209.

PARKING LIGHTS AND PANEL LIGHTS

To turn on the parking lights and instrument panel lights, rotate the headlight switch clockwise. To turn off the parking lights, rotate the headlight switch back to the 0 (off) position.

NOTE:

- For vehicles sold in Canada, the first headlight switch position is the parking lights and instrument panel lights position (instead of the OFF position).
- Vehicles sold in Canada are equipped with a headlight switch with an AUTO and ON detent but without an OFF detent. Headlights will be deactivated when the headlight switch is placed in the parking lights position. However, the Daytime Running Lights (DRLs) will be activated along with the front and rear marker lights. The DRLs may be deactivated when the parking brake is engaged.

AUTOMATIC HEADLIGHTS WITH WIPERS

If your vehicle is equipped with Automatic Headlights, it also has this customer-programmable feature. When your headlights are in the automatic mode and the engine is running, they will automatically turn on when the wiper system is on. This feature is programmable through the Uconnect system  page 209.

If your vehicle is equipped with the Rain Sensing Wiper system  page 56, and it is activated, the headlights will automatically turn on after the wipers complete five wipe cycles within approximately one minute, and they will turn off approximately four minutes after the wipers completely stop.

NOTE:

When your headlights come on during the daytime, the instrument panel lights will automatically dim to the lower nighttime intensity.

HEADLIGHT ILLUMINATION ON APPROACH

When enabled, the headlights, exterior door handle pocket lights (if equipped), and interior lights will illuminate when the unlock button on the key fob is pushed as the operator is approaching the vehicle. This feature can be turned on/off, and the length of time the headlights stay on can be programmed for up to 90 seconds within Uconnect Settings  page 209.

HEADLIGHT DELAY

To assist when exiting the vehicle, the headlight delay feature will leave the headlights on for up to 90 seconds. This delay is initiated when the ignition is placed in the OFF position while the headlight switch is on, and then the headlight switch is cycled off. Headlight delay can be canceled by either turning the headlight switch on then off, or by placing the ignition in the ON position.

NOTE:

- This feature can be programmed through the Uconnect system  page 209.
- The headlight delay feature is automatically activated if the headlight switch is left in the AUTO position when the ignition is placed in the OFF position.

LIGHTS-ON REMINDER

If the headlights, parking lights, or cargo lights are left on after the ignition is placed in the OFF position, a chime will sound and a message will appear in the instrument cluster display when the driver’s door is opened.

FRONT FOG LIGHTS — IF EQUIPPED

To activate the front fog lights, turn on the parking lights or low beam headlights and push the fog light switch located within the headlight switch. Pushing the fog light switch a second time will turn the front fog lights off.

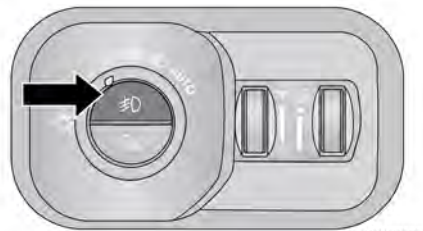

Fog Light Switch

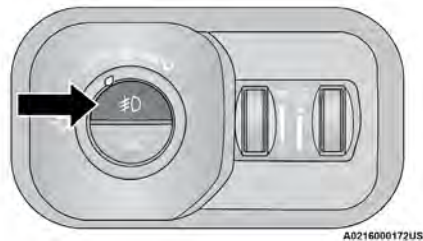

Fog Light Switch (Vehicles Sold In Canada Only)

TURN SIGNALS

Move the multifunction lever up or down to activate the turn signals. The arrows on each side of the instrument cluster flash to show proper operation.

NOTE:

If either light remains on and does not flash, or there is a very fast flash rate, check for a defective outside light bulb.

LANE CHANGE ASSIST — IF EQUIPPED

Lightly push the multifunction lever up or down, without moving beyond the detent, and the turn signal will flash three times then automatically turn off.

NOTE:

For information on Turn Signal Activated Blind Spot Assist, see  page 178.

CARGO LIGHTS/TRAILER SPOTTER LIGHTS/TRAILER HITCH LIGHT WITH BED LIGHTS — IF EQUIPPED

The cargo light, bed lights, trailer spotter lights, and trailer hitch light are turned on by pushing the cargo light button located on the lower half of the headlight switch.

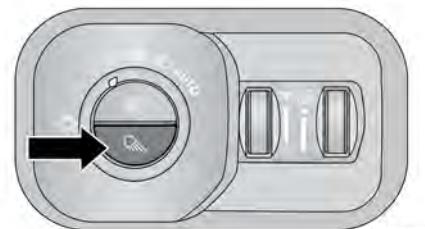

Cargo/Bed Lights Button On Headlight Switch

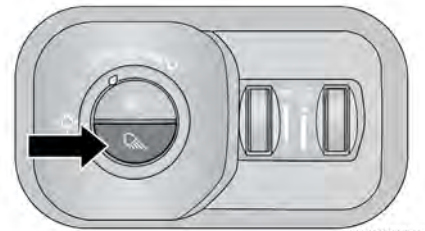

Cargo/Bed Lights Button On Headlight Switch (Vehicles Sold In Canada)

When the vehicle is stationary, these lights can also be turned on using the switch located just inside the pickup box, on the lower part of the bed light lens. A telltale will illuminate in the instrument cluster display when these lights are on. Pushing the switch a second time will turn the lights off.

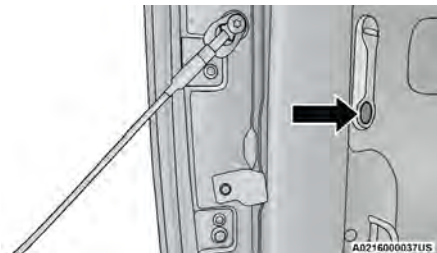

Bed Light Switch (Without RamBox)

The cargo light and bed lights (if equipped) will turn on for approximately 60 seconds when a key fob unlock button is pushed, as part of the Illuminated Entry feature.

When these lights are activated using the button on the headlight switch, the cargo lights, trailer spotter lights, and trailer hitch light will remain illuminated when the vehicle transmission is in PARK, NEUTRAL, or REVERSE. The lights will turn off when the vehicle transmission is placed in DRIVE.

When the vehicle is placed in the REVERSE position, the trailer hitch light will turn on automatically. The trailer hitch light will turn off when the vehicle is placed in the DRIVE position.

NOTE:

For vehicles shipped to or sold in the states of California or Mississippi, the cargo, bed, and mirror spotter lights will not work while the vehicle is in motion. In every other state, the cargo and mirror spotter lights will turn off when the vehicle is in motion, but the bed light will remain on. In all states, including California and Mississippi, if a bed camera is deactivated, the bed lights will turn back on.

BATTERY SAVER

Timers are set to both the interior and exterior lights to protect the life of your vehicle's battery.

If the ignition is in the OFF position, the interior lights will automatically turn off when:

- Any door is left ajar for 10 minutes.
- The Dome Defeat button is pushed.
- The cargo, bed, and spotter lights are manually activated by either the headlight switch or the truck bed switch.

NOTE:

Battery saver mode is canceled if the ignition is in the ON/RUN position.

If the headlights remain on while the ignition is placed in the OFF position, the exterior lights will automatically turn off after eight minutes. If the headlights are turned on and left on for eight minutes while the ignition is in the OFF position, the exterior lights will automatically turn off.

INTERIOR LIGHTS

COURTESY LIGHTS

The courtesy, dome, cargo, and bed lights are turned on when any door is opened. The courtesy and dome lights are turned on when the Dome On button is pushed on the overhead console. Also, if your vehicle is equipped with Remote Keyless Entry, and the unlock button is pushed on the key fob, the courtesy, dome, cargo, and bed lights will turn on.

Courtesy/Reading Lights

The overhead console lights can also be operated individually as reading lights by pushing the corresponding buttons.

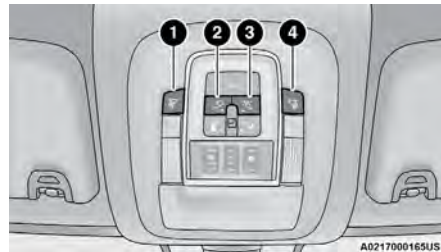

Front Courtesy/Reading Lights

- 1 — Driver's Reading Light On/Off Button
- 2 — Dome Defeat Button
- 3 — Dome On Button
- 4 — Passenger's Reading Light On/Off Button

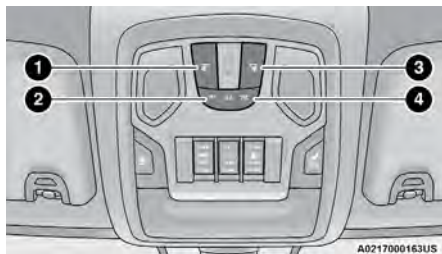

Front Courtesy/Reading Lights

- 1 – Driver's Reading Light On/Off Button
- 2 – Dome Defeat Button
- 3 – Passenger's Reading Light On/Off Button
- 4 – Dome On Button

NOTE:

On vehicles equipped with an LED overhead console, if both the Dome On and Dome Defeat buttons are pushed, the Illuminated Entry with door ajar feature will be disabled, but the dome lights inside the vehicle will turn on.

Three types of rear courtesy/reading lights are available for your vehicle:

- Push button on/off
- Push lens on/off
- No on/off button, only courtesy light

NOTE:

The rear courtesy/reading lights will remain on until the switch is pushed a second time, so be sure they have been turned off before exiting the vehicle. If the interior lights are left on after the ignition is placed in the OFF position, they will automatically turn off after 10 minutes.

Dimmer Controls

The dimmer controls are inboard and adjacent to the headlight switch located on the left side of the instrument panel.

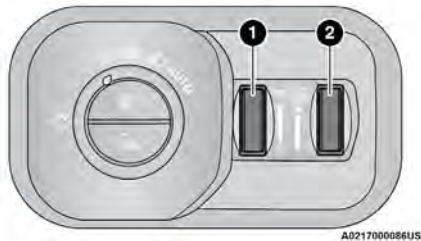

Dimmer Controls

- 1 – Ambient Light Control (If Equipped)
- 2 – Instrument Panel Dimmer Control

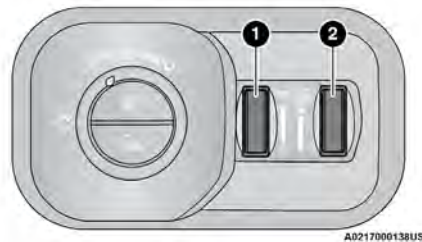

Dimmer Controls (Vehicles Sold In Canada Only)

- 1 – Ambient Light Control (If Equipped)
- 2 – Instrument Panel Dimmer Control

With the parking lights or headlights on, rotating the instrument panel dimmer control upward will increase the brightness of the instrument panel lights. Rotating the ambient dimmer control will adjust the interior and ambient light levels when the headlights are on.

Dimming Of The Uconnect Touchscreen

The brightness of the Uconnect touchscreen can be dimmed using the instrument panel dimmer control when the parking lights or headlights are on.

When Display Mode is set to Auto within the Uconnect system, the brightness will automatically adjust from daytime intensity to nighttime intensity (and vice versa) based on ambient light levels outside of the vehicle.

NOTE:

The brightness of the Uconnect touchscreen cannot be adjusted when the instrument panel dimmer control is rotated to the upper most detent, even when Display Mode is set to Auto within the Uconnect Settings.

When Display Mode is set to Manual, the brightness of the Uconnect touchscreen will adjust to the set brightness (1 - 6) when the headlights are either on or off. For more information on these Uconnect Settings, see [page 209](#).

ILLUMINATED ENTRY

The courtesy lights will turn on when you use the key fob to unlock the doors or open any door.

This feature also turns on the approach lamps located beneath the outside mirrors (if equipped).

The lights will fade to off after approximately 30 seconds, or they will immediately fade to off once the ignition switch is placed in the ON/RUN position from the OFF position.

The front courtesy overhead console and door courtesy lights will not turn off if the Dome On button on the overhead console is pushed. The overhead and door courtesy lights will turn off after 10 minutes to protect the battery.

The illuminated entry system will not operate if the Dome Defeat button on the overhead console is pushed.

NOTE:

If your vehicle is equipped with Illuminated Approach lights under the outside mirrors, they will also be turned off by pushing the Dome Defeat button.

WINDSHIELD WIPERS AND WASHERS

The windshield wiper/washer controls are located on the multifunction lever on the left side of the steering column. The front wipers are operated by rotating a switch, located on the end of the lever.

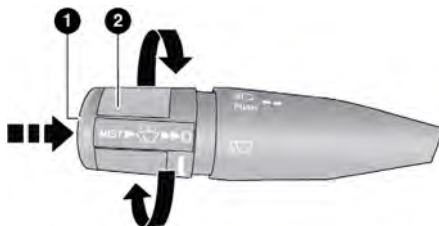

Windshield Wiper/Washer Lever

1 — Push End Inward (Hold For Washer Or Short Press For Mist)

2 — Rotate For Front Wiper Operation

WINDSHIELD WIPER OPERATION**Intermittent Wipers**

The intermittent feature of this system was designed for use when weather conditions make a single wiping cycle, with a variable pause between cycles, desirable. For maximum delay between cycles, rotate the control knob upward to the first detent.

The delay interval decreases as you rotate the knob until it enters the low continual speed position.

The delay can be regulated from a maximum of about 18 seconds between cycles, to a cycle every one second. The delay intervals will double in duration when the vehicle speed is 10 mph (16 km/h) or less.

Windshield Washers

To use the windshield washer, push the washer knob, located on the end of the multifunction lever, inward and hold. Washer fluid will be sprayed and the wipers will operate for two to three cycles after the washer knob is released.

If the washer knob is pushed while in the delay range, the wipers will operate for several seconds after the washer knob is released. The wipers will then resume the intermittent interval previously selected. If the washer knob is pushed while in the off position, the wipers will turn on and cycle approximately three times after the washer knob is released.

To prevent freeze-up of your windshield washer system in cold weather, select a solution or mixture that meets or exceeds the temperature range of your climate. This rating information can be found on most washer fluid containers.

WARNING!

Sudden loss of visibility through the windshield could lead to a collision. You might not see other vehicles or other obstacles. To avoid sudden icing of the windshield during freezing weather, warm the windshield with the defroster before and during windshield washer use.

Mist

When a single wipe to clear off road mist or spray from a passing vehicle is needed, push the washer knob, located on the end of the multifunction lever, inward briefly and release. The wipers will cycle one time and automatically shut off.

NOTE:

The mist feature does not activate the washer pump; therefore, no washer fluid will be sprayed on the windshield. The washer function must be used in order to spray the windshield with washer fluid.

For information on wiper care and replacement, see [page 351](#).

RAIN SENSING WIPERS — IF EQUIPPED

This feature senses rain or snowfall on the windshield and automatically activates the wipers. Rotate the end of the multifunction lever to one of five detent positions to activate this feature.

The sensitivity of the system can be adjusted with the multifunction lever. Wiper delay position 1 is the least sensitive, and wiper delay position 5 is the most sensitive. Position 3 should be used for normal rain conditions. Positions 1 and 2 can be used if the driver desires less wiper sensitivity. Positions 4 and 5 can be used if the driver desires more sensitivity. Place the wiper switch in the 0 (off) position when not using the system.

NOTE:

- The Rain Sensing feature will not operate when the wiper switch is in the low or high-speed position.
- The Rain Sensing feature may not function properly when ice, or dried salt water is present on the windshield.
- Use of products containing wax or silicone may reduce Rain Sensing performance.
- The Rain Sensing feature can be turned on and off using the Uconnect system [page 209](#).

The Rain Sensing system has protection features for the wiper blades and arms, and will not operate under the following conditions:

- **Low Ambient Temperature** — When the ignition is first placed in the ON position, the Rain Sensing system will not operate until the wiper switch is moved, vehicle speed is greater than 0 mph (0 km/h), or the outside temperature is greater than 32 °F (0 °C).
- **Transmission In NEUTRAL Position** — When the ignition is ON, and the transmission is in the NEUTRAL position, the Rain Sensing system will not operate until the wiper switch is moved, vehicle speed is greater than 5 mph (8 km/h), or the gear selector is moved out of the NEUTRAL position.
- **Remote Start Mode Inhibit** — On vehicles equipped with the Remote Start system, Rain Sensing wipers are not operational when the vehicle is in the Remote Start mode. Once the operator is in the vehicle and has placed the ignition switch in the RUN position, Rain Sensing wiper operation can resume, if it has been selected, and no other inhibit conditions (mentioned previously) exist.

CLIMATE CONTROLS

The Climate Control system allows you to regulate the temperature, air flow, and direction of air circulating throughout the vehicle. The controls are located on the touchscreen, on the sides of the touchscreen (if equipped), or on the instrument panel below the radio.

AUTOMATIC CLIMATE CONTROL DESCRIPTIONS AND FUNCTIONS



**Uconnect 5 or 5 NAV With 8.4-inch Display Automatic
Temperature Controls**



Uconnect 5 NAV With 12-inch Display Automatic Temperature Controls

NOTE:

Icons and descriptions can vary based upon vehicle equipment.

MAX A/C Button



Press and release the MAX A/C button on the touchscreen to change the current setting to the coldest output of air. The MAX A/C indicator illuminates when MAX A/C is on.

Pressing the button again will cause the MAX A/C operation to exit. Pressing other settings will also cause MAX A/C to exit.

NOTE:

- The MAX A/C sets the control for maximum cooling performance.
- The MAX A/C button is only available on the touchscreen.

A/C Button



Press and release this button on the touchscreen, or push the button on the faceplate to change the current setting. The A/C indicator illuminates when A/C is on.

Recirculation Button



Press and release this button on the touchscreen, or push the button on the faceplate, to change the system between Recirculation mode and outside air mode. The Recirculation indicator and the A/C indicator illuminate when the Recirculation button is pressed. Recirculation can be used when outside conditions, such as smoke, odors, dust, or high humidity are present. Recirculation can be used in all modes. Recirculation may be unavailable (button on the touchscreen greyed out) if conditions exist that could create fogging on the inside of the windshield. The A/C can be deselected manually without disturbing the mode control selection. Continuous use of the Recirculation mode may make the inside air stuffy and window fogging may occur. Extended use of this mode is not recommended. Recirculation mode may automatically adjust to optimize customer experience for warming, cooling, dehumidification, etc.

In cold weather, use of Recirculation mode may lead to excessive window fogging. The Recirculation feature may be unavailable if conditions exist that could create fogging on the inside of the windshield.

Auto Button



Set your desired temperature and press AUTO. AUTO will achieve and maintain your desired temperature by automatically adjusting the blower speed and air distribution. Air Conditioning (A/C) may be active during AUTO operation to improve performance. AUTO mode is highly recommended for efficiency.

You can turn AUTO on in one of two ways:

- Press and release this button on the touchscreen.
- Push the button on the faceplate.

toggling this function will cause the system to switch between manual mode and automatic mode

↩ page 61.

Front Defrost Button



Press and release the Front Defrost button on the touchscreen, or push and release the button on the faceplate, to change the current airflow setting to Defrost mode. The Front Defrost indicator illuminates when Front Defrost is on. Air comes from the windshield and side window demist outlets. When the defrost button is selected, the blower level may increase. Use Defrost mode with maximum temperature settings for best windshield and side window defrosting and defogging. When toggling the front defrost mode button, the climate system will return to the previous setting.

Rear Defrost Button



Press and release the Rear Defrost button on the touchscreen, or push and release the button on the faceplate, to turn on the rear window defroster and the heated outside mirrors (if equipped). The Rear Defrost indicator illuminates when the rear window defroster is on. The rear window defroster automatically turns off after 10 minutes.

CAUTION!

Failure to follow these cautions can cause damage to the heating elements:

- Use care when washing the inside of the rear window. Do not use abrasive window cleaners on the interior surface of the window. Use a soft cloth and a mild washing solution, wiping parallel to the heating elements. Labels can be peeled off after soaking with warm water.
- Do not use scrapers, sharp instruments, or abrasive window cleaners on the interior surface of the window.
- Keep all objects a safe distance from the window.

Driver And Passenger Temperature Up And Down Buttons

These buttons provide the driver and passenger with independent temperature control.



Push the red button (or rotate knob if equipped) on the faceplate or touchscreen, or press and slide the temperature bar towards the red arrow button on the touchscreen for warmer temperature settings.



Push the blue button (or rotate knob if equipped) on the faceplate or touchscreen, or press and slide the temperature bar towards the blue arrow button on the touchscreen for cooler temperature settings.

NOTE:

- The numbers within the temperature display will only appear if the system is equipped with an automatic climate control system.
- Up and down buttons are only available on vehicles equipped with a 12-inch display.

SYNC Button



Press the SYNC button on the touchscreen to toggle the SYNC feature on/off. The SYNC indicator illuminates when SYNC is on. SYNC synchronizes the passenger temperature setting with the driver temperature setting. Changing the passenger's temperature setting while in SYNC will automatically exit this feature.

NOTE:

The SYNC button is only available on the touchscreen.

Blower Control



Blower Control regulates the amount of air forced through the climate control system.

There are seven blower speeds available. Adjusting the blower will cause automatic mode to switch to manual operation. The speeds can be selected using either the blower control knob on the faceplate or the buttons on the touchscreen.

Faceplate

The blower speed increases as you turn the blower control knob clockwise from the lowest blower setting. The blower speed decreases as you turn the blower control knob counterclockwise.

Touchscreen

Use the small blower icon to reduce the blower setting and the large blower icon to increase the blower setting. Blower can also be selected by pressing the blower bar area between the icons.

Mode Control



Select Mode by pressing one of the mode buttons on the touchscreen, or pushing the MODE button on the faceplate, to change the airflow distribution mode. The airflow distribution mode can be adjusted so air comes from the instrument panel outlets, floor outlets, defrost outlets, and demist outlets.

Faceplate

Push the MODE button to change the airflow distribution mode.

Touchscreen

Press one of the mode buttons to change the airflow distribution mode. The airflow distribution mode can be adjusted so air comes from the instrument panel outlets, floor outlets, defrost outlets and demist outlets.

Panel Mode



Air comes from the outlets in the instrument panel. Each of these outlets can be individually adjusted to direct the flow of air. The air vanes of the center outlets and outboard outlets can be moved up and down or side to side to regulate airflow direction. There is a shut-off wheel located below the air vanes to shut off or adjust the amount of airflow from these outlets.

Bi-Level Mode



Air comes from the instrument panel outlets and floor outlets. A slight amount of air is directed through the defrost and side window demister outlets.

NOTE:

Bi-Level mode is designed under comfort conditions to provide cooler air out of the panel outlets and warmer air from the floor outlets.

Floor Mode



Air comes from the floor outlets. A slight amount of air is directed through the defrost and side window demister outlets.

Mix Mode



Air is directed through the floor, defrost, and side window demister outlets. This setting works best in cold or snowy conditions that require extra heat to the windshield. This setting is good for maintaining comfort while reducing moisture on the windshield.

Climate Control OFF Button



Press and release the OFF button on the touchscreen, or push the OFF button on the faceplate (if equipped) to turn the Climate Control system on/off.

MANUAL CLIMATE CONTROL DESCRIPTIONS AND FUNCTIONS

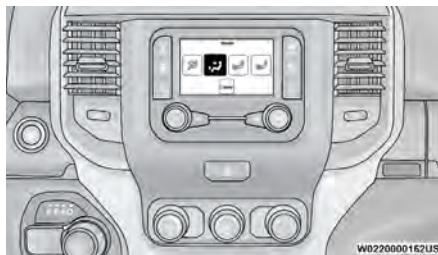

Uconnect 3 With 5-inch Display Manual Temperature Controls



Uconnect 5 With 8.4-inch Display Manual Temperature Controls

MAX A/C Setting



Set the temperature control knob to the MAX A/C setting to change the current setting to the coldest output of air. Moving the temperature control knob away from the MAX A/C setting causes the MAX A/C operation to exit.

A/C Button



Push the A/C button to engage the Air Conditioning (A/C). The A/C indicator illuminates when A/C is on.

Recirculation Button



Push the Recirculation button to change the system between recirculation mode and outside air mode. The Recirculation indicator and the A/C indicator illuminate when the Recirculation button is pressed. Recirculation can be used when outside conditions, such as smoke, odors, dust, or humidity are present. Recirculation can be used in all modes except for Defrost. Recirculation may be unavailable if conditions exist that could create fogging on the inside of the windshield. The A/C can be deselected manually without disturbing the mode control selection. Continuous use of the Recirculation mode may make the inside air stuffy and window fogging may occur. Extended use of this mode is not recommended.

On vehicles equipped with Manual Climate controls, the Recirculation mode is not allowed in Defrost mode to improve window clearing operation. Recirculation is disabled automatically if this mode is selected. Attempting to use Recirculation while in this mode causes the LED in the control button to blink and then turn off.

Front Defrost Setting



Turn the mode control knob to the Front Defrost mode setting. Air comes from the windshield and side window demist outlets. When the defrost button is selected, the blower level may increase. Use Defrost mode with maximum temperature settings for best windshield and side window defrosting and defogging.

Rear Defrost Button



Push and release the Rear Defrost Control button to turn on the rear window defroster and the heated outside mirrors (if equipped). The Rear Defrost indicator illuminates when the rear window defroster is on. The rear window defroster automatically turns off after 10 minutes.

CAUTION!

Failure to follow these cautions can cause damage to the heating elements:

- Use care when washing the inside of the rear window. Do not use abrasive window cleaners on the interior surface of the window. Use a soft cloth and a mild washing solution, wiping parallel to the heating elements. Labels can be peeled off after soaking with warm water.
- Do not use scrapers, sharp instruments, or abrasive window cleaners on the interior surface of the window.
- Keep all objects a safe distance from the window.

Temperature Control

Temperature Control regulates the temperature of the air forced through the climate system.



The temperature increases as you turn the temperature control knob clockwise.



The temperature decreases as you turn the temperature control knob counterclockwise.

Blower Control



Blower Control regulates the amount of air forced through the climate control system. There are seven blower speeds available. The blower speed increases as you turn the blower control knob clockwise from the lowest blower setting. The blower speed decreases as you turn the blower control knob counterclockwise.

Mode Control



Turn the mode control knob to adjust airflow distribution. The airflow distribution mode can be adjusted so air comes from the instrument panel outlets, floor outlets, defrost outlets and demist outlets.

Panel Mode



Air comes from the outlets in the instrument panel. Each of these outlets can be individually adjusted to direct the flow of air. The air vanes of the center outlets and outboard outlets can be moved up and down or side to side to regulate airflow direction. There is a shut-off wheel located below the air vanes to shut off or adjust the amount of airflow from these outlets.

Bi-Level Mode



Air comes from the instrument panel outlets and floor outlets. A slight amount of air is directed through the defrost and side window demister outlets.

NOTE:

Bi-Level mode is designed under comfort conditions to provide cooler air out of the panel outlets and warmer air from the floor outlets.

Floor Mode



Air comes from the floor outlets. A slight amount of air is directed through the defrost and side window demister outlets.

Mix Mode



Air is directed through the floor, defrost, and side window demister outlets. This setting works best in cold or snowy conditions that require extra heat to the windshield. This setting is good for maintaining comfort while reducing moisture on the windshield.

AUTOMATIC TEMPERATURE CONTROL (ATC)

Automatic Operation

1. Push the AUTO button on the faceplate, or the AUTO button on the touchscreen on the Automatic Temperature Control (ATC) Panel.
2. Next, adjust the temperature you would like the system to maintain by adjusting the driver and passenger temperature control buttons. Once the desired temperature is displayed, the system will achieve and automatically maintain that comfort level.
3. When the system is set up for your comfort level, it is not necessary to change the settings. You will experience the greatest efficiency by simply allowing the system to function automatically.

NOTE:

- It is not necessary to move the temperature settings for cold or hot vehicles. The system automatically adjusts the temperature, mode, and blower speed to provide comfort as quickly as possible.
- The temperature can be displayed in U.S. or Metric units by selecting the U.S./Metric customer-programmable feature within the Uconnect Settings  page 209.

To provide you with maximum comfort in the Automatic mode during cold start-ups, the blower fan will remain on low until the engine warms up. The blower will increase in speed and transition into Auto mode.

Manual Operation Override

This system offers a full complement of manual override features. The AUTO symbol in the front ATC display will be turned off when the system is being used in the manual mode.

CLIMATE VOICE RECOGNITION — IF EQUIPPED

Adjust vehicle temperatures hands-free and keep every-one comfortable while you keep moving ahead.

Push the VR button on the steering wheel. After the beep, say one of the following commands:

- “Set driver temperature to 70 degrees”
- “Set passenger temperature to 70 degrees”

Did you know: Voice Command for Climate may only be used to adjust the interior temperature of your vehicle. Voice Command will not work to adjust the heated seats or steering wheel if equipped.

OPERATING TIPS

Refer to the chart at the end of this section for suggested control settings for various weather conditions.

Summer Operation

The engine cooling system must be protected with a high-quality antifreeze coolant to provide proper corrosion protection and to protect against engine overheating. OAT coolant (conforming to MS.90032) is recommended.

Winter Operation

To ensure the best possible heater and defroster performance, make sure the engine cooling system is functioning properly and the proper amount, type, and concentration of coolant is used. Use of the Air Recirculation mode during Winter months is not recommended, because it may cause window fogging.

Vacation/Storage

For information on maintaining the Climate Control system when the vehicle is being stored for an extended period of time, see  page 388.

Window Fogging

Vehicle windows tend to fog on the inside in mild, rainy, and/or humid weather. To clear the windows, select Defrost or Mix mode and increase the front blower speed. Do not use the Recirculation mode without A/C for long periods, as fogging may occur.







Outside Air Intake

Make sure the air intake, located directly in front of the windshield, is free of obstructions, such as leaves. Leaves collected in the air intake may reduce airflow, and if they enter the air distribution box, they could plug the water drains. In Winter months, make sure the air intake is clear of ice, slush, and snow.

Cabin Air Filter

The Climate Control system filters out dust and pollen from the air. Contact an authorized dealer to service your cabin air filter, and to have it replaced when needed.

Operating Tips Chart

WEATHER	CONTROL SETTINGS
Hot Weather And Vehicle Interior Is Very Hot	Set the mode control to  (Panel Mode), A/C (A/C) on, and blower on high. Roll down the windows for a minute to flush out the hot air. Adjust the controls as needed to achieve comfort.
Warm Weather	Turn A/C (A/C) on and set the mode control to  .
Cool Sunny	Operate in  (Bi-Level Mode).
Cool & Humid Conditions	Set the mode control to  (Mix Mode) and turn A/C (A/C) on to keep windows clear.
Cold Weather	Set the mode control to  (Floor Mode). If windshield fogging starts to occur, move the control to  (Mix Mode).

INTERIOR STORAGE AND EQUIPMENT

STORAGE

Glove Compartment

The glove compartment is located on the passenger side of the instrument panel and features both an upper and lower storage area.

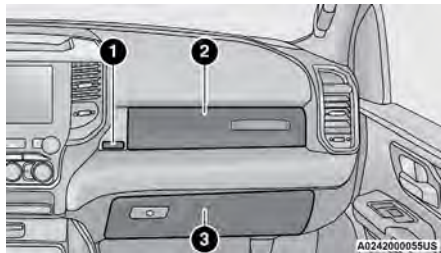

Glove Compartment

- 1 — Upper Glove Compartment Release Button (If Equipped)
- 2 — Upper Glove Compartment
- 3 — Lower Glove Compartment

If equipped with a covered upper glove compartment, push the release button to open.

To open the lower glove compartment, pull the release handle.

WARNING!

Do not operate this vehicle with a glove compartment in the open position. Driving with the glove compartment open may result in injury in a collision.

Door Storage

Front Door Storage — If Equipped

Storage areas are located in the door trim panels.

Rear Door Storage — If Equipped

Storage compartments are located in both the driver and passenger rear door trim panels.

Center Storage Compartment — If Equipped

The center storage compartment is located between the driver and passenger seats. The storage compartment provides an armrest and contains both an upper and lower storage area.



Center Storage Compartment

WARNING!

- This armrest is not a seat. Anyone seated on the armrest could be seriously injured during vehicle operation, or a collision.
- In a collision, the latch may open if the total weight of the items stored exceeds about 10 lb (4.5 kg). These items could be thrown about endangering occupants of the vehicle. Items stored should not exceed a total of 10 lb (4.5 kg).

Pull the upper handle on the front of the armrest to raise the cover.

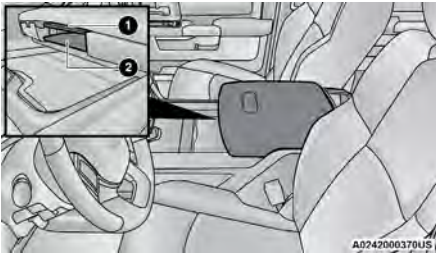
**Center Storage Compartment**

- 1 — Upper Console Handle
- 2 — Lower Console Handle

With the upper lid closed, pull the lower handle to open the lower storage bin. The lower bin contains a power inverter. There is also a fill line located along the **rear** inside wall of the lower bin. Contents above the fill line may interfere with cupholder placement if equipped with a premium center console.

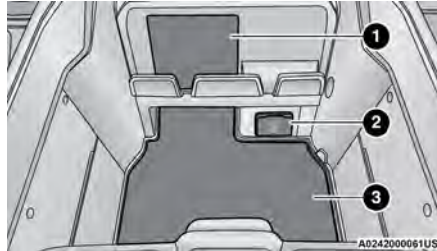
**Forward Portion Of Lower Storage Bin**

- 1 — Wireless Charging Pad
- 2 — Power Inverter
- 3 — Storage Area

WARNING!

Do not operate this vehicle with a console compartment lid in the open position. Driving with the console compartment lid open may result in injury in a collision.

Premium Center Console — If Equipped

The premium center console is equipped with two front storage bins located in front of the center storage compartment. These storage bins may be equipped with tandem doors. Push the front bin to access the cupholders, or push the rear bin to access the coin holder/small storage bin.

**Center Console Tandem Doors— If Equipped**

- 1 — Push Front Bin Access
- 2 — Push Rear Bin Access

**Tandem Doors Open Position**

- 1 — Front Bin Open
- 2 — Rear Bin Open

Push the release button at the front of the cupholder bin to slide tray rearward to access the front lower storage bin, or forward to access the rear lower storage bin.

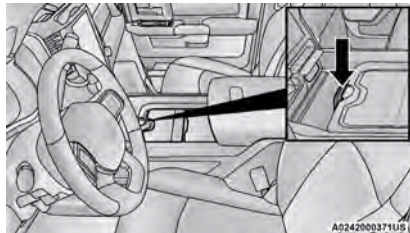

Push Release Button To Slide Tray

Overhead Sunglass Storage

At the front of the overhead console, a compartment is provided for the storage of one pair of sunglasses.

From the closed position, push the door latch to open the compartment.



Overhead Sunglass Door

Front Bench Seat Storage — If Equipped

If your vehicle is equipped with a front bench seat, storage can be found by folding down the center seatback. A console storage area and cupholders are available.



Front Bench Seat Storage Location

With the seatback in the upright position, lift the center seat bottom to access additional storage underneath the seat.

Seatback Storage — If Equipped

Located in the back of both the driver and passenger front seats are pockets that can be used for storage.

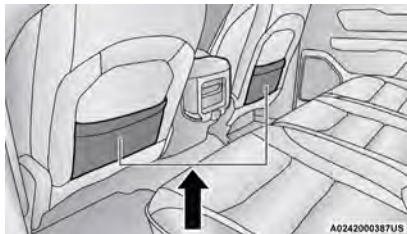

Seatback Storage

Second Row In-Floor Storage Bin — If Equipped

In-floor storage bins are located in front of the second row seats and can be used for extra storage. The storage bins have removable liners that can be easily removed for cleaning.

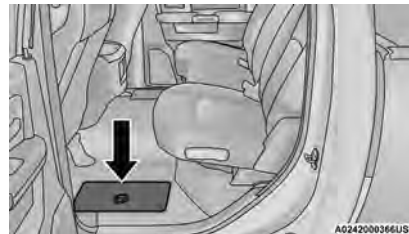

In-Floor Storage Bin And Latch

To open in-floor storage bin, remove the floor mat (if equipped), and lift upward on the handle of the latch and open the lid.

NOTE:

The front seat may have to be moved forward to fully open the lid.

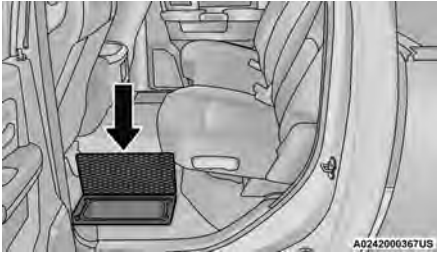
**Opened Storage Bin****Storage Bin (Regular Cab) — If Equipped**

The storage bin is located behind the front seats and runs the length of the cab.

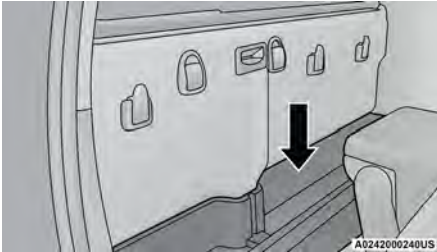
**Storage Bin****Fold Flat Load Floor — If Equipped**

Crew Cab models with a 60/40 rear seat may be equipped with a folding load floor.

WARNING!

Do not operate the vehicle with loose items stored on the load floor. While driving or in an accident you may experience abrupt stopping, rapid acceleration, or sharp turns. Loose objects stored on the load floor may move around with force and strike occupants, resulting in serious or fatal injury.

Unfolding The Load Floor/Crew Cab

1. Lift the 60/40 seat cushion(s) to the upward position.

**Load Floor Legs In Stowed Position**

2. Unfold both the legs using the straps.

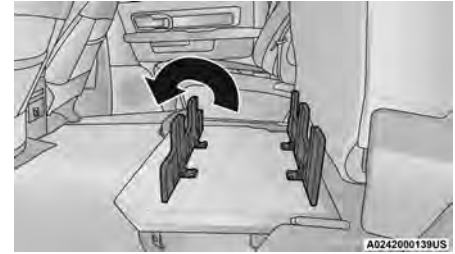
**Load Floor Legs In Opened Position**

3. Lift the front panel until the load floor unfolds into position.

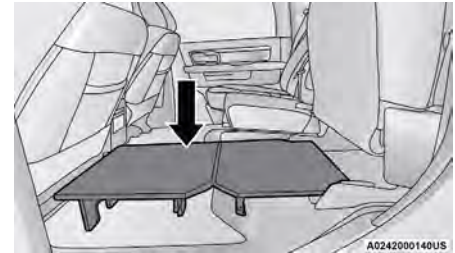
**Load Floor In Open Position**

4. Reverse the procedure to store the load floor.

Positioning The Load Floor For Storage Access Under The Seat

1. Lift the 60/40 seat cushion(s) to the upward position.
2. Unsnap the securing snap located at either side of the load floor.
3. Lift the load floor up to access storage under the load floor.

WARNING!

Do not drive with the load floor in the up position. When stopping fast or in an accident, the load floor could move to the down position causing serious injury.



Load Floor Securing Straps/ Crew Cab

4. Reverse the procedure to put the load floor back in the secured down position before you operate the vehicle.

Below Rear Seat Storage (Crew Cab) — If Equipped

The Crew Cab models provide additional storage under the rear seats. Lift the seats to access the storage compartment.

If equipped with a fold flat load floor, unsnap the securing snap located at either side of the load floor and lift upward on the fold flat lid to open the storage compartments → page 65.

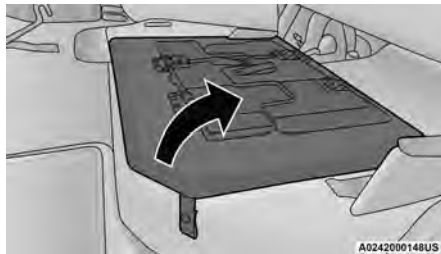

Crew Cab Storage

USB/AUX CONTROL

Located on the center stack, just below the instrument panel, is the main media hub. There are four total USB ports: Two Mini-USBs (Type C) and two Standard USBs (Type A). There is also an AUX port located in the middle of the USB ports.

Plugging in a smartphone device to a USB port may activate Android Auto™ or Apple CarPlay® features, if equipped. For further information, refer to “Android Auto™” or “Apple CarPlay®” in the Uconnect Radio Instruction Manual.

NOTE:

Two devices can be plugged in at the same time, and both ports will provide charging capabilities. Only one port can transfer data to the system at a time. A pop-up will appear and allow you to select the device transferring data.

For example, if a device is plugged into the Type A USB port and another device is plugged into the Type C USB port, a message will appear and allow you to select which device to use.

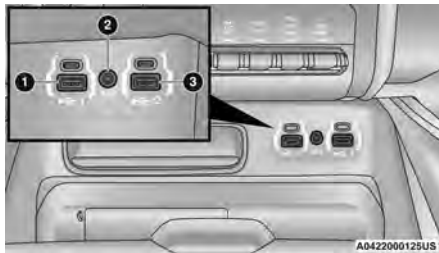

Center Stack USB/AUX Media Hub

- 1 — Standard USB Type A Port #1
- 2 — AUX Port
- 3 — Standard USB Type A Port #2

The third and fourth USB ports are located behind the center console, above the power inverter. These USB ports are charge only.

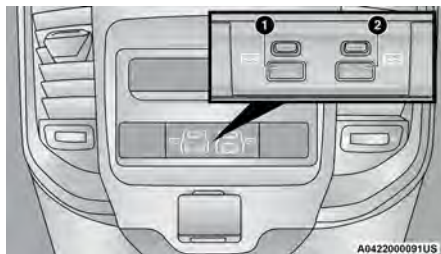

Rear Center Console Mini-USB (Type C) USB Ports

- 1 – Rear Charge Only USB Ports 1
- 2 – Rear Charge Only USB Ports 2

Applicable to only Uconnect 5/5 NAV With 8.4-inch Display and Uconnect 5 NAV With 12-inch Display radios: different scenarios are listed as follows when a non-phone device is plugged into the smaller and larger USB ports, and when a phone device is plugged into the smaller and larger USB ports:

- “A new device is now connected. Previous connection was lost.”
- “(Phone Name) now connected. Previous connection was lost.”
- “Another device is in use through the same USB port. Please disconnect the first device to use the second device.”

NOTE:

Charge unsupported devices with the Charge Only USB ports. If an unsupported device is plugged into a Media USB port, a message will display on the touchscreen that the device is not supported by the system.

Plugging in a phone or another USB device may cause the connection to a previous device to be lost.

If equipped, there is also a charge-only USB port located in the center console of the vehicle.

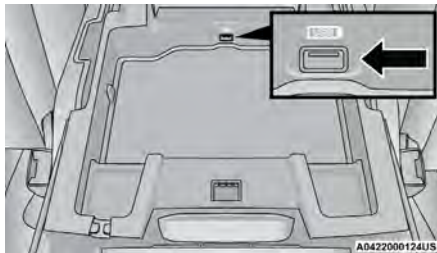

Center Console Charge-Only USB Port

If equipped, two Mini-USB ports (Type C), two Standard USB ports (Type A), and one AUX port may be located to the left of the center stack, just below the climate controls.

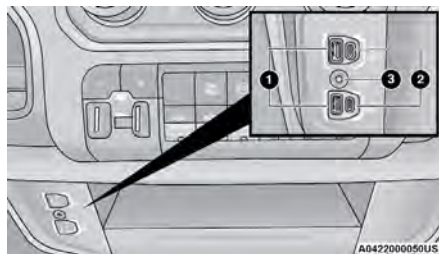

USB/AUX Media Hub

- 1 – Standard USB Type A Ports
- 2 – Mini-USB Type C Ports
- 3 – AUX Port

Some USB ports support media and charging. You can use features, such as Apple CarPlay®, Android Auto™, Pandora®, and others while charging your phone.

NOTE:

Plugging in a phone or another USB device may cause the connection to a previous device to be lost.

For further information, refer to the Uconnect Radio Instruction Manual or visit UconnectPhone.com.

ELECTRICAL POWER OUTLETS

The auxiliary 12 Volt (13 Amp) power outlet can provide power for in-cab accessories designed for use with the standard “cigar lighter” style plug. The 12 Volt power outlets and 5 Volt (2.5 Amp) USB port (Charge Only) have a cap attached to the outlet indicating “12 V DC”, together with either a key symbol, battery symbol, or USB symbol.

A key symbol indicates that the key must be in the ON/RUN or ACC position for the outlet to provide power. The battery symbol indicates that the outlet is connected to the battery, and can provide power at all times.

CAUTION!

- Do not exceed the maximum power of 160 Watts (13 Amps) at 12 Volts. If the 160 Watts (13 Amps) power rating is exceeded, the fuse protecting the system will need to be replaced.
- Power outlets are designed for accessory plugs only. Do not insert any other object in the power outlets as this will damage the outlet and blow the fuse. Improper use of the power outlet can cause damage not covered by your New Vehicle Limited Warranty.

An auxiliary power outlet can be found in the tray on top of the center stack. This power outlet works when the ignition is in the ON/RUN, ACC, or OFF position.

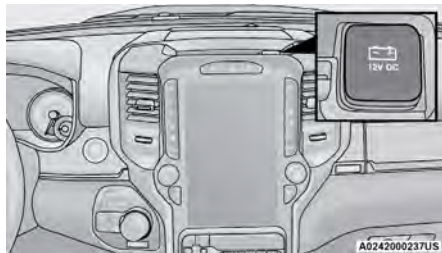

Power Outlet – Top Of Center Stack

Power Outlet Fuse Locations:

- F104 Fuse 20 A Yellow UCI Port/ USB Rear Center Console
- F90 Fuse 20 A Yellow Instrument Panel Power Outlet Battery Fed (If Equipped)
- F91 Fuse 20 A Yellow Instrument Panel Power Outlet Ignition Fed (If Equipped)
- F93 Fuse 20 A Yellow Cigar Lighter/ Instrument Panel Power Outlet (If Equipped)

When the vehicle is turned off, be sure to unplug any equipment as to not drain the battery of the vehicle. All accessories connected to the outlet(s) should be removed or turned off when the vehicle is not in use to protect the battery against discharge.

WARNING!

To avoid serious injury or death:

- Only devices designed for use in this type of outlet should be inserted into any 12 Volt outlet.
- Do not touch with wet hands.
- Close the lid when not in use and while driving the vehicle.
- If this outlet is mishandled, it may cause an electric shock and failure.

CAUTION!

- Many accessories that can be plugged in draw power from the vehicle's battery, even when not in use (i.e., cellular phones, etc.). Eventually, if plugged in long enough, the vehicle's battery will discharge sufficiently to degrade battery life and/or prevent the engine from starting.

(Continued)

CAUTION!

- Accessories that draw higher power (i.e., coolers, vacuum cleaners, lights, etc.), will discharge the battery even more quickly. Only use these intermittently and with greater caution.
- After the use of high power draw accessories, or long periods of the vehicle not being started (with accessories still plugged in), the vehicle must be driven a sufficient length of time to allow the generator to recharge the vehicle's battery.

POWER INVERTER — IF EQUIPPED**Interior Power Inverters**

If equipped, 115 Volt (400 Watts maximum) power inverters may be located inside the vehicle. These inverters can power cellular phones, electronics and other low power devices requiring power up to 400 Watts. Certain video game consoles exceed this power limit, as will most power tools.

All power inverters are designed with built-in overload protection. If the power rating of 400 Watts is exceeded, the power inverter shuts down. Once the electrical device has been removed from the outlet the inverter should reset.

The front power inverter is located in center console toward the right hand side, just under the Wireless Charging Pad (if equipped).

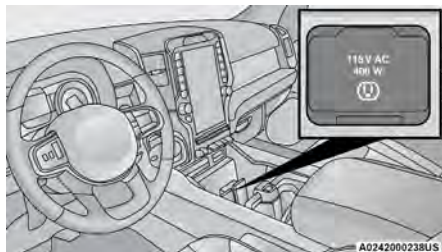

Center Console Power Inverter Outlet (If Equipped)

There is also a second 115 Volt (400 Watts maximum) power inverter located on the rear of the center console.



Rear Center Console Power Inverter Outlet (If Equipped)

NOTE:

400 Watts is the maximum for the inverter, not each outlet. If three outlets are in use, 400 Watts is shared among the devices plugged in.

If equipped with a front bench seat, the inverter is located to the right of the center stack, just below the climate controls.

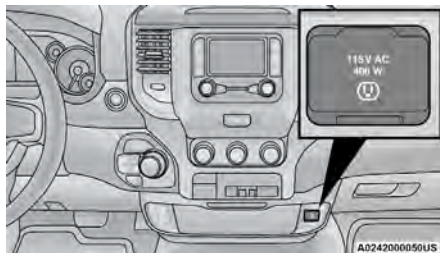

Center Stack Power Inverter (If Equipped)

Exterior Power Inverter — If Equipped

Vehicles not equipped with a RamBox may be equipped with a 115 Volt (400 Watts maximum) power inverter located just inside the truck bed.

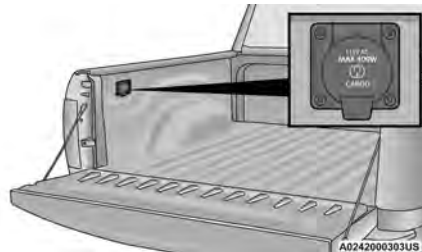

Exterior Power Inverter (If Equipped)

The Instrument Panel Power Inverter switch is only found on vehicles equipped with an exterior power inverter. The switch only controls on/off operation of the power outlet in the truck bed or, if equipped, the RamBox. It does not control on/off operation of the power outlets located inside the cabin of the vehicle.

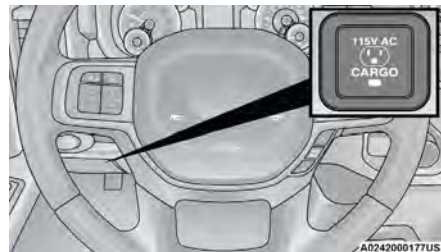

Instrument Panel Power Inverter Switch

For information on the outlet found inside the RamBox, see [page 80](#).

To turn on the power outlet, simply plug in a device. The outlet turns off when the device is unplugged.

NOTE:

- The power inverter only turns on if the ignition is in the ACC or ON/RUN position.
- Due to built-in overload protection, the power inverter shuts down if the power rating is exceeded.

WARNING!

To avoid serious injury or death:

- Do not insert any objects into the receptacles.
- Do not touch with wet hands.
- Close the lid when not in use.
- If this outlet is mishandled, it may cause an electric shock and failure.

WIRELESS CHARGING PAD — IF EQUIPPED



Wireless Charging Pad

Your vehicle may be equipped with a 15W 3A Qi® wireless charging pad located below the center stack, within the storage compartment. This charging pad is designed to wirelessly charge your Qi® enabled mobile phone. Qi® is a standard that allows wireless charging of your mobile phone.

Your mobile phone must be designed for Qi® wireless charging. If the phone is not equipped with Qi® wireless charging functionality, an aftermarket sleeve or a specialized back plate can be purchased from your mobile phone provider or a local electronics retailer. Please see your phone's Owner's Manual for further information.

The wireless charging pad is equipped with an anti-slip mat to hold your mobile phone in place, and an LED indicator light.

Place the device inside the prepared area delimited in the mat as shown in the image. Incorrect positioning will prevent the phone from charging.

NOTE:

If your vehicle comes with a Wireless Charging pad, you'll notice a clear indication on the rubber mat with the text "Wireless Charger" and accompanying phone and charging icon graphics. The charger is available for the left side only.

Alternatively, if you have a phone holder in your vehicle, it has a rubber surface with textured grip for secure placement, and a designated slot for your charging cord.

LED Indicator Status:

- No Light: Charging pad is idle or searching for a device. Device may not be compatible with the Qi® standard.
- Blue Light: Device is detected and is charging.
- Red Light/Flashing: Internal error, or foreign object is detected.
- Green Light: Device has completed battery charging (if device is equipped to transmit this information).

Important Notes Regarding This Vehicle's Wireless Charging Pad:

- The presence of the Near-Field Communication (NFC) function active on a smartphone could signal malfunction anomalies.
- The ignition must be in the ON/RUN position in order for the phone to charge.
- To avoid interference with the key fob search, the wireless charging pad will stop charging when any door or liftgate is opened, even if the engine is running.
- Be sure to place the mobile device correctly (display facing upward, and phone not covering the LED) on the wireless charging pad.
- If the phone moves on the pad causing the red light to illuminate, the phone will have to be picked up and placed back on the charging pad to resume charging.
- Wireless charging is not as fast as when the phone is connected to a wired charger.
- The phone's protective case must be removed when placed on the wireless charging pad.
- iPhone® 12 (including iPod®) is equipped with software to protect the device from overheating. When the software is active, the rate of charge is slowed down to protect the device.
- Phones must always be placed on the wireless charging pad within the outline shown on the pad so that its charging parts connect with the charging coils of the system. Movement of the phone during charging may prevent or slow the rate of charge.
- Having multiple applications open on the phone while charging will reduce the charging efficiency, and may even shut down an application that is actively running (i.e. Apple CarPlay®). This may also cause the phone to overheat.

- Wireless chargers may implement certain methods to prevent the phone from overheating during charging such as slowing down the rate of charge. In certain instances, the device may shut down for a brief period of time (when the device reaches a certain temperature). If this happens, it does not mean there is a fault with the wireless charging pad. This may just be a protective measure to prevent damage to the phone.
- The use of multiple wireless functions at the same time (wireless charging, Apple CarPlay®, Android Auto™) could cause the device to overheat, resulting in limitation of the functions or it turning off. In this case, it is recommended to connect the system using the USB port.
- Do not place the key fob or any other type of metal/magnetized object inside the mobile phone housing or near the wireless charging pad.
- With a compatible device placed on the charging pad, and the ignition is cycled to the OFF position, a reminder message may appear on the instrument cluster display to warn the driver.

CAUTION!

The key fob should not be placed on the charging pad or within 6 inches (15 cm) of it. Doing so can cause excessive heat buildup and damage to the fob. Placing the fob in close proximity of the charging pad blocks the fob from being detected by the vehicle and prevents the vehicle from starting.

WINDOWS

POWER WINDOWS

The window controls on the driver's door control all the door windows.

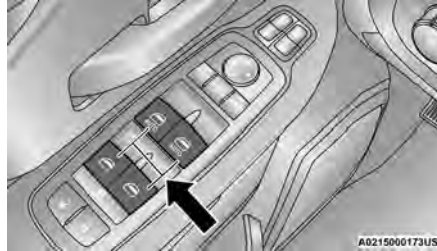

Power Window Switches

The passenger door windows can also be operated by using the single window controls on the passenger door trim panel. The window controls will operate only when the ignition is in the ACC or ON/RUN position.

To open the window part way (manually), push the window switch down briefly and release.

NOTE:

The power window switches will remain active for up to 10 minutes after the ignition is placed in the OFF position. Opening either front door will cancel this feature. The timing is programmable within Uconnect Settings [↔](#) page 209.

WARNING!

Never leave children unattended in a vehicle. Do not leave the key fob in or near the vehicle or in a location accessible to children, and do not leave the Keyless Enter 'n Go™ Ignition in the ACC or ON/RUN position. Occupants, particularly unattended children, can become entrapped by the windows while operating the power window switches. Such entrapment may result in serious injury or death.

2

AUTOMATIC WINDOW FEATURES

Auto-Down Feature

The driver and front passenger door power window switches have an Auto-Down feature. Push the window switch down briefly, then release, and the window will go down automatically.

To stop the window from going all the way down during the Auto-Down operation, pull up or push down on the switch briefly.

Auto-Up Feature With Anti-Pinch Protection — If Equipped

Lift the window switch up briefly and release; the window will go up automatically.

To stop the window from going all the way up during the Auto-Up operation, push down on the switch briefly.

To close the window part way, lift the window switch briefly and release it when you want the window to stop. If the window runs into any obstacle during auto-closure, it will reverse direction and then go back down. Remove the obstacle and use the window switch again to close the window.

NOTE:

Any impact due to rough road conditions may trigger the auto-reverse function unexpectedly during auto-closure. If this happens, pull the switch lightly and hold to close the window manually.

WARNING!

There is no anti-pinch protection when the window is almost closed. To avoid personal injury be sure to clear your arms, hands, fingers and all objects from the window path before closing.

RESET AUTO-UP — IF EQUIPPED

Should the Auto-Up feature stop working, the window probably needs to be reset. To reset Auto-Up:

1. Pull the window switch up to close the window completely and continue to hold the switch up for an additional two seconds after the window is closed.
2. Push the window switch down firmly to open the window completely and continue to hold the switch down for an additional two seconds after the window is fully open.

WINDOW LOCKOUT SWITCH

The window lockout switch on the driver's door trim panel allows you to disable the window controls on the rear passenger doors. To disable the window controls, push and release the window lockout button (the indicator light on the button will turn on). To enable the window controls, push and release the window lockout button again (the indicator light on the button will turn off).

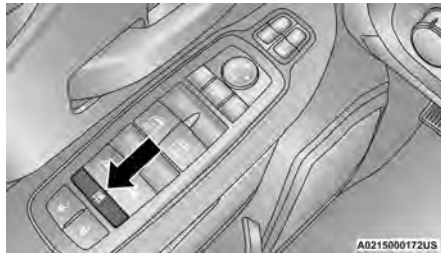
**Window Lockout Switch****POWER SLIDING REAR WINDOW — IF EQUIPPED**

The switch for the power sliding rear window is located on the overhead console. Push the switch rearward to open the glass. Pull the switch forward to close the glass.

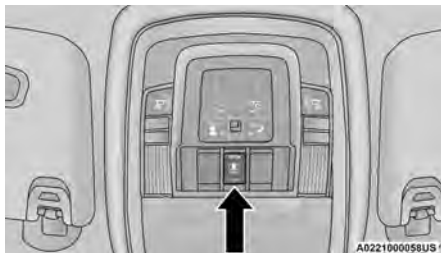
**Power Sliding Rear Window Switch****MANUAL SLIDING REAR WINDOW — IF EQUIPPED**

A locking device in the center of the window helps to prevent entry from the rear of the vehicle. Squeeze the lock to release the window.

WIND BUFFETING

Wind buffeting can be described as the perception of pressure on the ears or a helicopter-type sound in the ears. Your vehicle may exhibit wind buffeting with the windows down, or the sunroof (if equipped) in certain open or partially open positions. This is a normal occurrence and can be minimized. If the buffeting occurs with the rear windows open, open the front and rear windows together to minimize the buffeting. If the buffeting occurs with the sunroof open, adjust the sunroof opening to minimize the buffeting or open any window.

POWER SUNROOF — IF EQUIPPED

SINGLE PANE POWER SUNROOF

The power sunroof switches are located on the overhead console between the courtesy/reading lights.

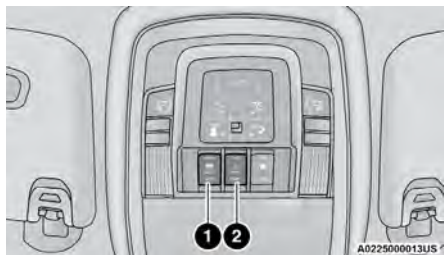

Power Sunroof Switches

- 1 — Opening/Closing Sunroof
2 — Venting Sunroof

WARNING!

- Never leave children unattended in a vehicle, or with access to an unlocked vehicle. Never leave the key fob in or near the vehicle, or in a location accessible to children. Do not leave the Keyless Enter 'n Go™ Ignition in the ACC or ON/RUN position. Occupants, particularly unattended children, can become entrapped by the power sunroof while operating the power sunroof switch. Such entrapment may result in serious injury or death.

(Continued)

WARNING!

- In a collision, there is a greater risk of being thrown from a vehicle with an open sunroof. You could also be seriously injured or killed. Always fasten your seat belt properly and make sure all passengers are also properly secured.
- Do not allow small children to operate the sunroof. Never allow your fingers, other body parts, or any object, to project through the sunroof opening. Injury may result.

Opening Sunroof

Express Open/Close

To open the sunroof, push OPEN on the sunroof switch and release it within one-half second. The sunroof will open automatically from any position and stop at full open.

To close the sunroof, push CLOSE on the sunroof switch and release it within one-half second. The sunroof will close automatically from any position.

During Express Open or Express Close operation, any other actuation of the sunroof switch will stop the sunroof.

Manual Open/Close

To open the sunroof, push and hold OPEN on the sunroof switch.

To close the sunroof, push and hold CLOSE on the sunroof switch.

Any release of the switch during open or close operation will stop the sunroof movement. The sunroof will remain in a partially opened position until the switch is operated and held again.

NOTE:

If the sunshade is in the closed position when Express or Manual Open operation is initiated, the sunshade will automatically open with the sunroof.

Express Venting Sunroof

To vent open the sunroof, push TILT on the vent switch and release within one-half second. To close the sunroof from the vent position, push DOWN on the vent switch and release within one-half second.

Pinch Protect Feature

This feature will detect an obstruction in the closing of the sunroof during the Express Close operation. If an obstruction in the path of the sunroof is detected, the sunroof will automatically retract. Remove the obstruction if this occurs.

NOTE:

If three consecutive sunroof close attempts result in Pinch Protect reversals, Pinch Protect will disable and the sunroof must be closed in Manual Mode.

Sunshade Operation

The sunshade can be opened manually. However, the sunshade will open automatically as the sunroof opens.

NOTE:

The sunshade cannot be closed if the sunroof is open.

Ignition Off Operation

The power sunroof switch will remain active for up to approximately 10 minutes after the ignition switch is placed in the OFF position. Opening either front door will cancel this feature.

NOTE:

Ignition Off timing is programmable through the Uconnect system → page 209.

Sunroof Maintenance

Use only a non-abrasive cleaner and a soft cloth to clean the glass panel. Periodically check for and clear out any debris that may have collected in the tracks.

HOOD**TO OPEN THE HOOD**

To open the hood, two latches must be released.

1. Pull the hood release lever located below the steering wheel at the base of the instrument panel.

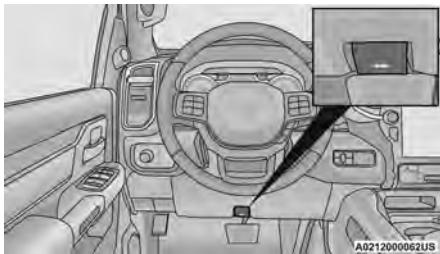
**Hood Release**

2. Reach into the opening beneath the center of the hood and push the safety latch lever to the left to release it, before raising the hood.

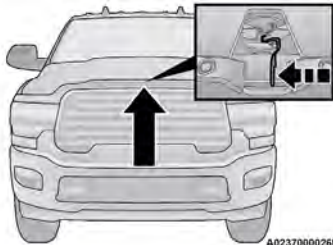
**Safety Latch Location****NOTE:**

- Vehicle must be at a stop and the gear selector must be in PARK.
- While lifting the hood, use both hands.
- Before lifting the hood, check that the wiper arms are not in motion and not in the lifted position.

TO CLOSE THE HOOD

In one continuous motion, pull down on the front edge of the hood with moderate force until the angle is below the crossover point (where the gas props are no longer resisting) and let the hood continue to fall closed from its own inertia.

WARNING!

Be sure the hood is fully latched before driving your vehicle. If the hood is not fully latched, it could open when the vehicle is in motion and block your vision. Failure to follow this warning could result in serious injury or death.

CAUTION!

To prevent possible damage, do not slam the hood to close it. Use a firm downward push at the front center of the hood to ensure that both latches engage.

TAILGATE**OPENING**

The power tailgate may be opened by pushing the tailgate release pad located on the tailgate door.

The tailgate damper strut will lower the tailgate to the open position (if equipped).

Electronic Tailgate Release — If Equipped

The key fob may be equipped with an electronic release feature for the tailgate, allowing hands-free tailgate opening. To activate, push and release the Tailgate Release button on the key fob twice within five seconds. The tailgate door will unlatch, and slowly lower into the open position.

If equipped, a button on the center overhead console inside the vehicle can be used to release the tailgate. An indicator light may also signal when the tailgate is open.

For the tailgate to lower, the vehicle must be stationary and in PARK or NEUTRAL.

NOTE:

The optional Tri-Fold Tonneau Cover ↪ page 83 may prevent electronic tailgate release. The Tonneau Cover must be removed or folded up before releasing the tailgate.

CLOSING

To close the tailgate, push it upward until both sides are latched. After closing the tailgate, pull it back to be sure it is latched securely.

The tailgate can be locked using the key fob lock button.

TAILGATE REMOVAL

NOTE:

Removing the tailgate will disable the rearview camera function.

To remove the tailgate, refer to the following instructions:

1. Disconnect the wiring harness for the rear camera and or power locks (if equipped) ↪ page 75.
2. Unlatch the tailgate and remove the support cables by releasing the lock tang from the pivot.

NOTE:

Make sure tailgate is supported when removing support cables.

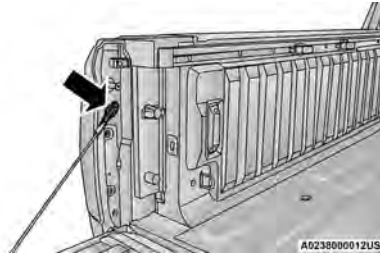

Locking Tang

3. Position the tailgate on a 45 degree angle.
4. Raise the right side of the tailgate until the right side pivot clears the hanger bracket.
5. Slide the entire tailgate to the right to free the left side pivot.
6. Remove the tailgate from the vehicle.

NOTE:

Do not carry the tailgate loose in the truck pickup box.

WARNING!

To avoid inhaling carbon monoxide, which is deadly, the exhaust system on vehicles equipped with "Cap or Slide-In Campers" should extend beyond the overhanging camper compartment and be free of leaks.

Disconnecting The Rear Camera And Remote Keyless Entry

1. Open the tailgate to access the rear camera or Remote Keyless Entry connector bracket located on the rear sill.

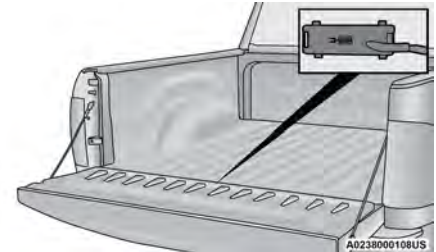

Connector Bracket

2. Remove the connector bracket from the sill by pushing inward in the locking tab.

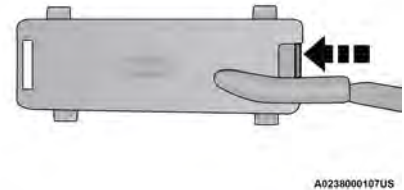

Locking Tab

3. Disconnect the chassis wiring harness, ensuring the connector bracket does not fall into the sill.

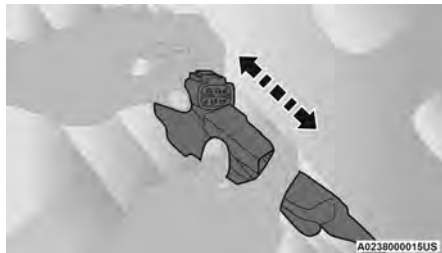

Disconnected Harness

4. Connect the chassis plug and bracket (provided in the glove compartment) to the chassis wiring harness and insert the bracket back into the sill.

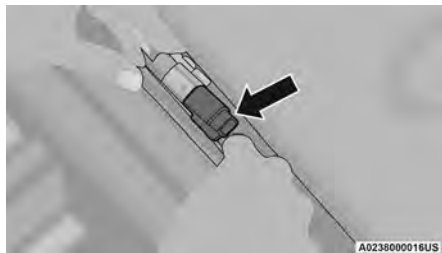

Chassis Wiring Harness

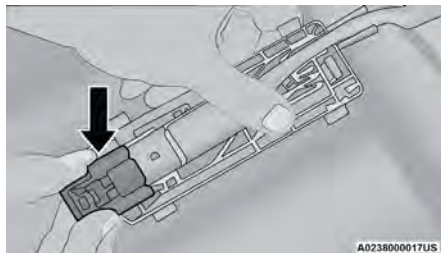

Chassis Plug

5. Connect the tailgate plug (provided in the glove compartment) to the tailgate wiring harness to ensure that the terminals do not corrode.

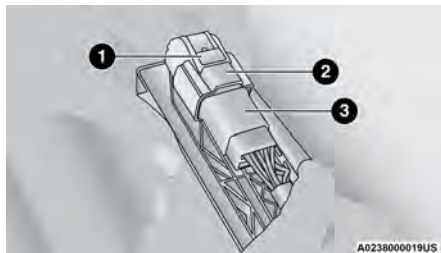

Wire Harness Bracket

- 1 – Tailgate Plug Release
2 – Tailgate Plug
3 – Tailgate Harness

6. Tape the tailgate harness and bracket against the forward-facing surface of the tailgate. This will prevent damaging the connector and bracket when storing or reinstalling the tailgate.

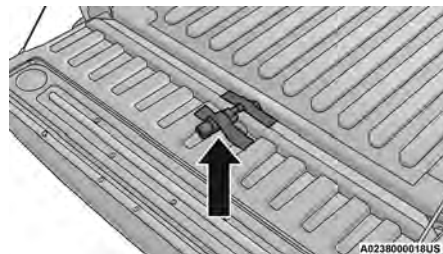

Taped Tailgate Harness

BED STEP – IF EQUIPPED

Your vehicle may be equipped with an extendable bed step on the driver's side of the tailgate to provide easier entry and exit into the truck bed.

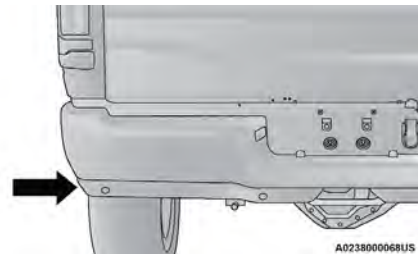

Bed Step Location

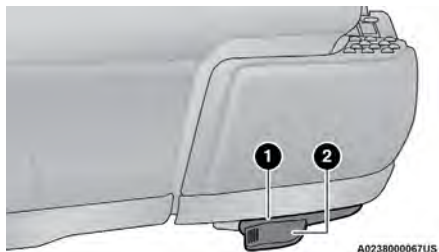
**Bed Step Components**

- 1 – Bed Step
- 2 – Foot Tab

To extend the bed step, place your foot on the protruding foot tab located on the left edge of the bed step, and push rearward. A small amount of force will release the spring load, and extend the bed step out and away from the tailgate.

NOTE:

Once the spring load is overcome, the bed step will extend out quickly, so be sure to stand in a position that will avoid coming into contact with the step as it extends.

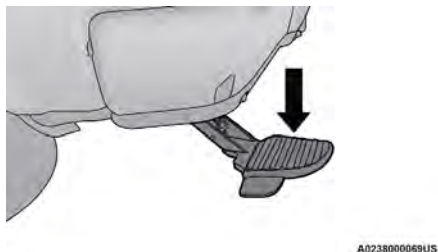
**Bed Step (Extended)**

To stow the bed step back under the tailgate, push the bed step forward with your foot until the bed step is retracted by the spring load.

WARNING!

Do not attempt to stow the bed step with your hands. The low clearance space between the bed step and the rear bumper as the bed step returns to the stowed position could result in injury to your hands or fingers.

PICKUP BOX

The pickup box has many features designed for utility and convenience.

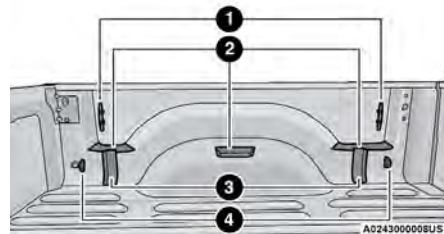
**Pickup Box Features**

- 1 – Cleats
- 2 – Upper Load Floor Indents
- 3 – Bulk Head Dividers
- 4 – Anchors

NOTE:

If you are installing a toolbox, ladder rack or headache rack at the front of the pickup box, you must use Mopar® Box Reinforcement Brackets that are available from an authorized dealer.

You can carry wide building materials (sheets of plywood, etc.) by building a raised load floor. Place lumber across the box in the indentations provided above the wheel housings and in the bulkhead dividers to form the floor.

WARNING!

- The pickup box is intended for load carrying purposes only, not for passengers, who should sit in seats and use seat belts.
- Care should always be exercised when operating a vehicle with unrestrained cargo. Vehicle speeds may need to be reduced. Severe turns or rough roads may cause shifting or bouncing of the cargo that may result in vehicle damage. If wide building materials are to be frequently carried, the installation of a support is recommended. This will restrain the cargo and transfer the load to the pickup box floor.
- If you wish to carry more than 600 lb (272 kg) of material suspended above the wheelhouse, supports must be installed to transfer the weight of the load to the pickup box floor or vehicle damage may result. The use of proper supports will permit loading up to the rated payload.
- Unrestrained cargo may be thrown forward in an accident causing serious or fatal injury.

There are stampings in the sheet metal on the inner side bulkheads of the box in front of and behind both wheel housings. Place wooden boards across the box from side to side to create separate load compartments in the pickup box.

There are four tie-down cleats bolted to the lower sides of the pickup box that can sustain loads up to 1,000 lb (450 kg) total.

CARGO CAMERA — IF EQUIPPED

Your vehicle may be equipped with the Cargo Camera that allows you to see an image of the inside of the pickup box. The image will be displayed in the Uconnect screen.

The Cargo Camera is located in the bottom center area of the Center High Mounted Stop Lamp (CHMSL).



A touchscreen button to indicate the current active camera image being displayed is made available whenever the Cargo Camera image is displayed.



A touchscreen button to switch the display to rear view camera image is made available whenever the Cargo Camera image is displayed.

A touchscreen X button to disable display of the camera image is made available when the vehicle is not in REVERSE gear.

A display timer is initiated when the Cargo Camera image is displayed. The image will continue to be displayed until the display timer exceeds 10 seconds and the vehicle speed is above 8 mph (13 km/h) or the touchscreen X button to disable display of the Cargo Camera image is pressed.

Cargo Camera With Dynamic Centerline (Available With Surround View Camera Only) — If Equipped

The Dynamic Centerline feature provides an overlay on the Cargo Camera display screen that aligns to the center of the pickup box to aid in hooking up a fifth wheel camper or gooseneck trailer. The centerline auto aligns to the center of the pickup box, and can also be manually adjusted. The centerline will adjust in response to steering angle inputs, and will not obstruct the gooseneck receiver or an approaching trailer gooseneck in the camera feed.

Activation

The Dynamic Centerline feature can be activated through the Uconnect Settings by pressing the Cargo Camera button, followed by the Adjust Centerline button on the touchscreen.

If the Dynamic Centerline feature is turned on, the overlay will display anytime the Cargo Camera image is displayed.

Adjusting Centerline

Refer to the following steps to manually adjust the centerline:

1. Press the Adjust Centerline button located in the bottom right corner of the Cargo Camera display.
2. Use the arrows on the bottom left corner of the Cargo Camera display to adjust the centerline horizontally or vertically.
3. Once the desired position is achieved, press the Accept button to set the centerline to the newly specified position.

Deactivation

The Dynamic Centerline feature will automatically be deactivated whenever the Cargo Camera display is deactivated. It can also be manually deactivated through the Uconnect Settings → page 209.

NOTE:

- If the vehicle speed remains below 8 mph (13 km/h), the Cargo Camera image will be displayed continuously until the touchscreen X button to disable display of the Cargo Camera image is pressed.

- The touchscreen X button to disable the display of the camera image is made available ONLY when the vehicle is not in reverse.
- If snow, ice, mud, or any foreign substance builds up on the camera lens, clean the lens, rinse with water, and dry with a soft cloth. Do not cover the lens.

Turning Cargo Camera On Or Off — With Uconnect 5/5 NAV

1. Press the Controls button located on the bottom of the Uconnect display.
2. Press the Cargo Camera button  to turn the Cargo Camera system on.

NOTE:

Once initiated by the Cargo Camera button, the Cargo Camera image will be displayed until the vehicle speed remains below 8 mph (13 km/h) and the 10 second timer runs out. The image may be deactivated by pressing the touchscreen X button, placing the ignition in the OFF position, placing the gear selector in PARK, or pressing the touchscreen X button. On deactivation, the previous selected screen will appear.

BED RAIL TIE-DOWN SYSTEM — IF EQUIPPED

CAUTION!

The maximum load per cleat should not exceed 250 lb (113 kg) and the angle of the load on each cleat should not exceed 45 degrees above horizontal, or damage to the cleat or cleat rail may occur.

NOTE:

This feature is only available for vehicles equipped with a RamBox.

There are two adjustable cleats on each side of the bed that can be used to assist in securing cargo.

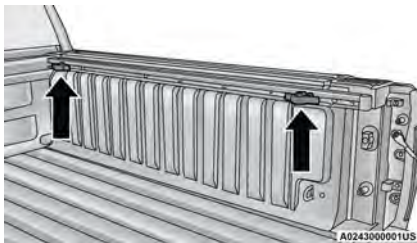

Adjustable Cleats

Each cleat must be located and tightened down in one of the detents, along either rail, in order to keep cargo properly secure.

To move the cleat to any position on the rail, turn the nut counterclockwise several turns. Then pull out on the cleat and slide it to the detent nearest the desired location. Make sure the cleat is seated in the detent and tighten the nut.

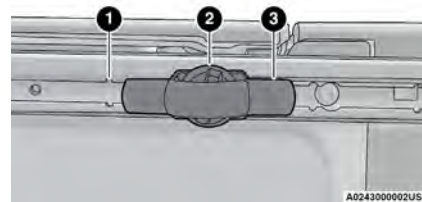

Adjustable Cleat Assembly

- 1 — Utility Rail Detent
- 2 — Cleat Retainer Nut
- 3 — Utility Rail Cleat

Cleat Removal (With Tonneau Cover)

To remove the cleats from the utility rail, remove the end cap screw located in the center of the end cap, using a #T30 Torx head driver. Remove the end cap and slide the cleat off the end of the rail.

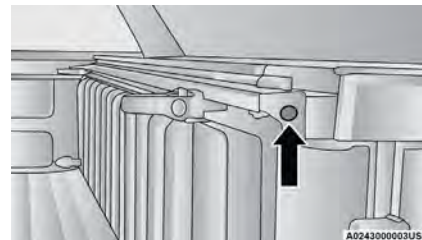

End Cap Screw Location With Tonneau Cover

Cleat Removal (Without Tonneau Cover)

Remove the end cap by pushing upward on the release button located beneath the end cap while pulling the cap away from the rail. The cleat can now be removed by sliding it off the end of the rail.

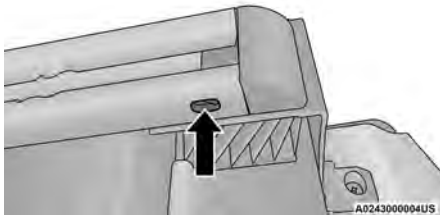
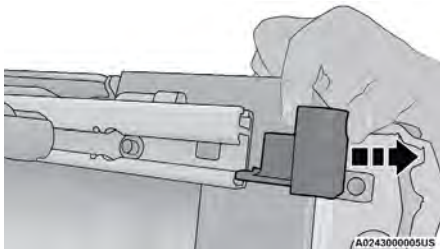
**End Cap Release Button Without Tonneau Cover****Pull End Cap Away From Rail****RAMBOX — IF EQUIPPED**

The RamBox system is an integrated pickup box storage and cargo management system consisting of up to three features:

- Integrated box side storage bins
- Cargo divider (if equipped)

LOCKING AND UNLOCKING RAMBOX

Push and release the lock or unlock button on the key fob to lock and unlock all doors, the tailgate and the RamBox ↪ page 18. The RamBox storage bins can be locked using the vehicle key. To lock and unlock the storage bin, insert the key into the keyhole on the push button and turn clockwise to lock or counterclockwise to unlock. Always return the key to the upright (vertical) position before removing the key from the push button.

CAUTION!

- Ensure cargo bin lids are closed and latched before moving or driving vehicle.
- Loads applied to the top of the bin lid should be minimized to prevent damage to the lid and latching/hinging mechanisms.
- Damage to the RamBox bin may occur due to heavy/sharp objects placed in bin that shift due to vehicle motion. In order to minimize potential for damage, secure all cargo to prevent movement and protect inside surfaces of bin from heavy/sharp objects with appropriate padding.

RAMBOX CARGO STORAGE BINS

Cargo storage bins are located on both sides of the pickup box. The cargo storage bins provide watertight, lockable, illuminated storage for up to 300 lb (136 kg) of evenly distributed cargo.

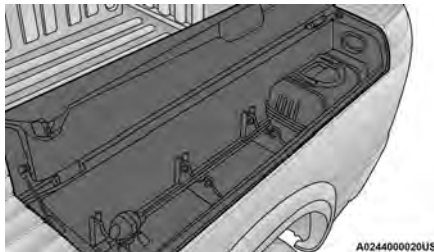
**RamBox Cargo Storage Bins****CAUTION!**

Failure to follow the following items could cause damage to the vehicle:

- Ensure that all cargo inside the storage bins is properly secured.
- Do not exceed cargo weight rating of 300 lb (136 kg) for 2500 and 3500 series vehicles per bin.

To open a storage bin with the RamBox unlocked, push and release the button located on the lid. The RamBox lid will open upward to allow hand access. Lift the lid to fully open.

NOTE:

The RamBox will not open when the button is pushed if the RamBox is locked.

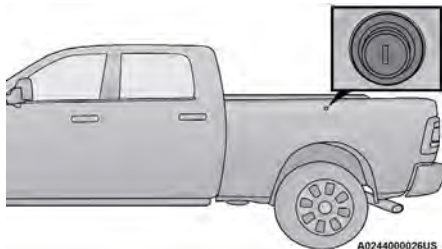

RamBox Pushbutton And Lock

CAUTION!

Leaving the lid open for extended periods of time could cause the vehicle battery to discharge. If the lid is required to stay open for extended periods of time, it is recommended that the bin lights be turned off manually using the on/off switch.

The interior of the RamBox will automatically illuminate when the lid is opened. In addition to the automatic illumination, there is a manual on/off switch located at the rear of each storage bin. Pushing the switch once will turn off the bin lights, pushing the switch again will turn the lights back on.

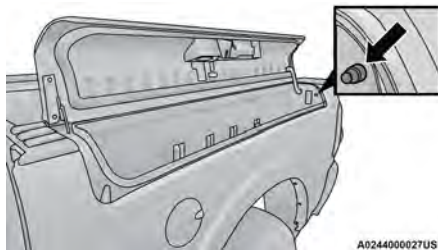

RamBox Light Switch

Cargo bins feature two removable drain plugs (to allow water to drain from bins). To remove a plug, pull up on the edge. To install, push the plug downward into the drain hole.

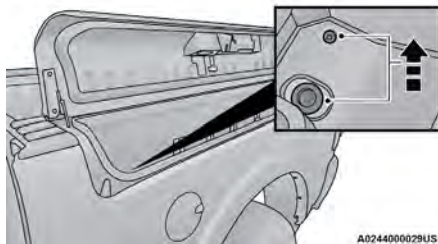

RamBox Drain Plug Removal

NOTE:

Provisions are provided in the bins for cargo dividers and shelf supports. These accessories (in addition to other RamBox accessories) are available from Mopar®. If equipped, a 115 Volt (400 W maximum) inverter may be located inside the RamBox of your vehicle. The inverter can be turned on by the Instrument Panel Power Inverter switch located to the left of the steering wheel. The RamBox inverter can power cellular phones, electronics and other low power devices requiring power up to 400 W. Certain video game consoles exceed this power limit, as will most power tools.

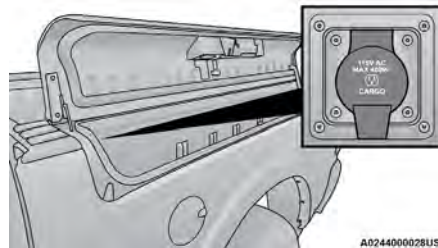

RamBox Power Inverter

The Instrument Panel Power Inverter switch is only found on vehicles equipped with an exterior power inverter inside the RamBox or truck bed. The switch only controls on/off operation of the exterior power inverter; it does not control on/off operation of the power outlets located inside the cabin of the vehicle.

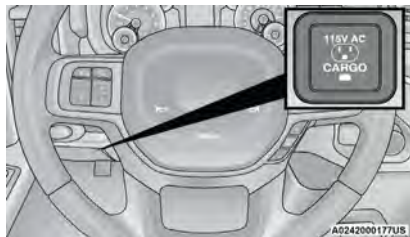

Instrument Panel Power Inverter Switch

RAMBOX SAFETY WARNING

Carefully follow these warnings to help prevent personal injury or damage to your vehicle:

WARNING!

- Always close the storage bin covers when your vehicle is unattended.
- Do not allow children to have access to the storage bins. Once in the storage bin, young children may not be able to escape. If trapped in the storage bin, children can die from suffocation or heat stroke.
- In an accident, serious injury could result if the storage bin covers are not properly latched.
- Do not drive the vehicle with the storage bin covers open.
- Keep the storage bin covers closed and latched while the vehicle is in motion.
- Do not use a storage bin latch as a tie-down.

RamBox Emergency Release Lever

As a security measure, an Emergency Release Lever is built into the storage bin cover latching mechanism. In the event of an individual being locked inside the storage bin, the storage bin cover can be opened from inside of the bin by pulling on the glow-in-the-dark lever attached to the storage bin cover latching mechanism.

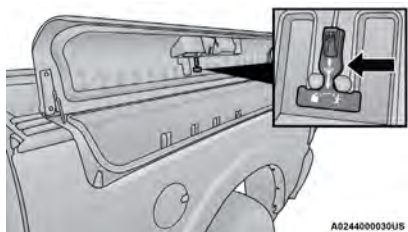

Emergency Release Lever

BED DIVIDER — IF EQUIPPED

The bed divider has two functional positions:

- Divider Position
- Storage Position

Divider Position

The divider position is intended for managing your cargo and assisting in keeping cargo from moving around the bed. There are 11 divider slots along the bed inner panels which allow for various positions to assist in managing your cargo.

To install the bed divider into a divider position, perform the following:

1. Make sure the center handle is unlocked using the vehicle key and rotate the center handle vertically to release the divider side gates.

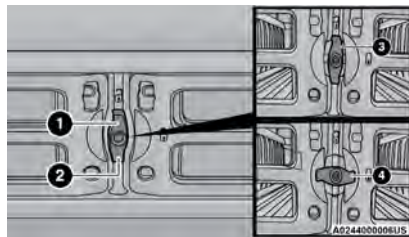

Center Handle And Lock

- 1 — Center Handle Lock
- 2 — Handle
- 3 — Unlocked Position
- 4 — Locked Position

2. With the side gates open, position the divider so the outboard ends align with the intended slots in the sides of the bed.

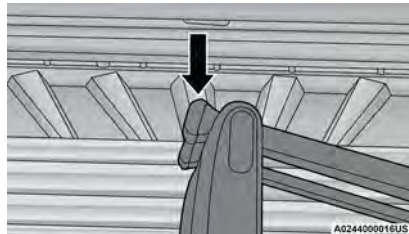

Aligning Gate To Slots

3. Rotate the side gates closed so that the outboard ends are secured into the intended slots of the bed.
4. Rotate the center handle horizontally to secure the side gates in the closed position.

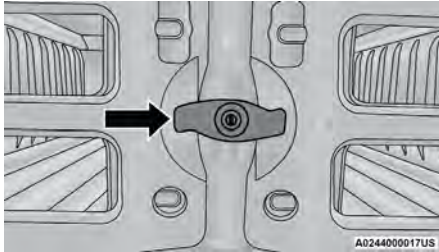
**Side Gates Closed**

5. Lock the center handle to secure the panel into place.

Storage Position

The storage position for the bed divider is at the front of the truck bed which maximizes the bed cargo area when not in use.

To install the bed divider into the storage position, perform the same steps as you would for the divider position, except position the divider fully forward in the bed against the front panel.

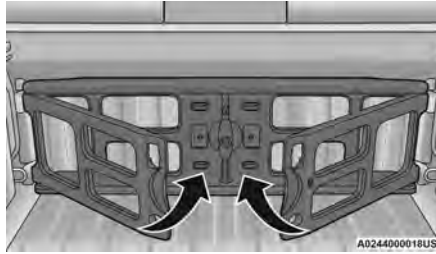
**Storage Position**

The outboard ends should be positioned in front of the cargo tie-down loops.

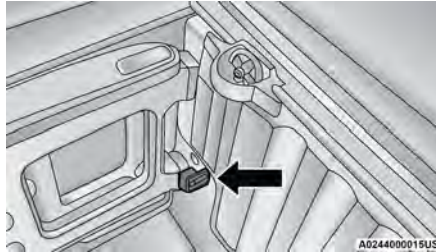
**Cargo Tie-Down Loop**

TRI-FOLD TONNEAU COVER — IF EQUIPPED

The Tri-Fold Tonneau Cover can be installed on the truck bed to protect your gear and cargo.

TRI-FOLD TONNEAU COVER REMOVAL

To remove the Tonneau Cover, use the following steps:

1. Open the tailgate to gain access to the rear pair of Tonneau Cover clamps located on the underside of the cover.

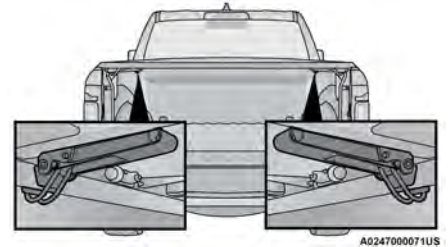
**Location Of Rear Latches**

NOTE:

If clamp wire is damaged replace immediately.

2. Pull both clamp handles down to release the Tonneau Cover's rear panel.



Released Position

3. From the Released Position, send the clamps to the Stowed Position by pushing from the yellow bumper upward. Listen for a "clicking" sound to confirm the clamp has been stowed properly.

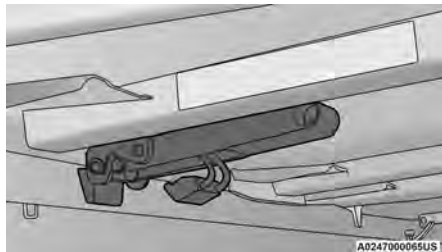

Stowed Position

CAUTION!

Make sure the Tonneau Cover clamp and clamp wire are in the proper stowed position. If the clamp and clamp wire are not properly stowed, damage to the Tonneau Cover material will result.

4. Fold the rear panel up onto the center panel (Intermediate Position).



Folded Rear Panel (Intermediate Position)

NOTE:

The vehicle cannot be driven when the Tonneau Cover is in this position.

5. Fold the rear and center panels up onto the front panel (Tri-Folded Position).



Tri-Folded Position

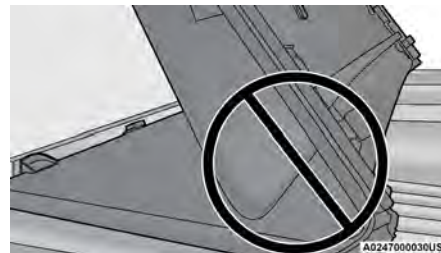

Incorrect Folding – Will Cause Damage

**Correct Folding – Hold Panels Together****NOTE:**

- When folding the center and rear panels, the sections **MUST** be held together to avoid damage to the cover material.
 - Fold the panels gently. It is not recommended to allow the panels to drop under their own weight.
6. Clip both stowage straps to prevent the Tonneau Cover panels from unfolding.

CAUTION!

The folded Tonneau Cover must be latched by both front latches and both front stowage straps or damage to the Tonneau Cover or vehicle may occur.

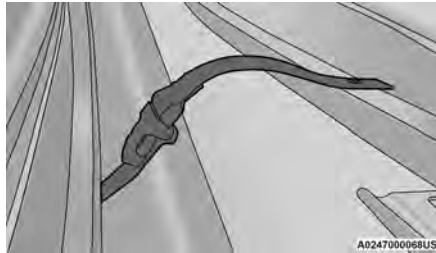
**Stowage Strap**

7. Once in the Tri-Folded Position, pull both front clamp handles down to the Released Position.

**Released Position**

8. From the Released Position, send the clamps to the Stowed Position by pushing the yellow bumper upward. Listen for a “clicking” sound to confirm the clamp has been properly stowed.

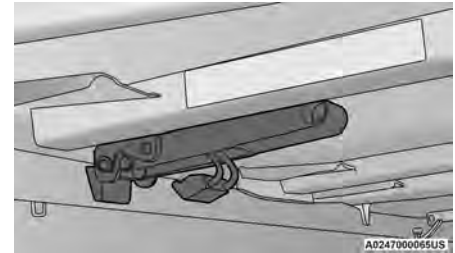
**Stowed Position**

9. Utilizing two people, remove the Tonneau Cover.

NOTE:

Be sure the Tonneau Cover has been folded completely, and the stowage straps are engaged, before removing the cover from the vehicle.

TRI-FOLD TONNEAU COVER INSTALLATION

To install the Tonneau Cover follow these steps:

1. Position the folded Tonneau Cover on the truck bed and push the cover forward against the front of the truck bed. The Tonneau Cover centers itself when placed on the vehicle.

NOTE:

Make sure to always push the Tonneau Cover all the way forward on the truck bed. Failure to do so might prevent proper clamp engagement, or interfere with the electronic tailgate release function (if equipped).

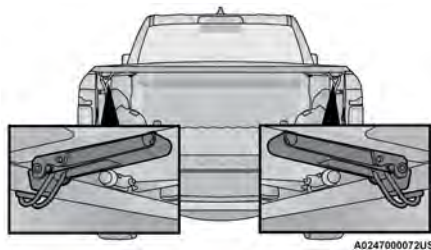

Location Of Front Latches

2. Pull down on the first set of clamp handles to release the clamps from the Stowed Position.

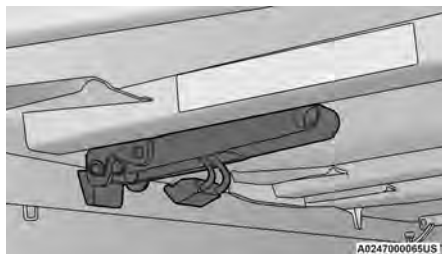

Stowed Position

3. Push clamp wires up and under the flange of the box (or flange of the RamBox rail, if equipped) to the Semi-Clamped Position.



Semi Clamped Position

4. Push clamp handles upward to the clamped position to properly engage the clamps.

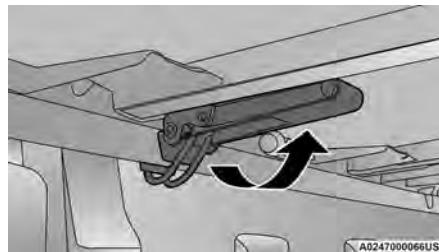

Clamped Position

NOTE:

Once clamped, be sure the clamps are not improperly attached to the truck bed flange.



Improper Clamp Position

5. Disengage the stowage straps.
6. Unfold the center and rear panels to the Intermediate Position.



Intermediate Position (Vehicle Cannot Be Driven)

NOTE:

When folding the center and rear panels, the sections **MUST** be held together to avoid damage to the cover material.

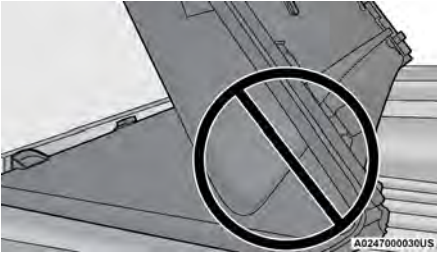
**Incorrect Folding – Will Cause Damage****Correct Folding – Hold Panels Together**

7. Completely unfold the Tonneau Cover.

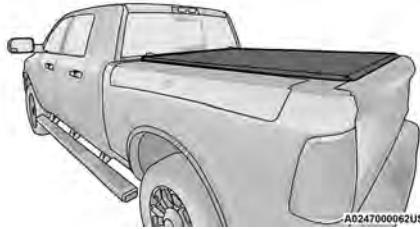
**Fully Unfolded Position**

8. Pull the rear clamp handles down into the Released Position.

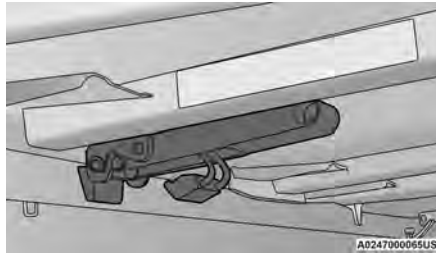
**Stowed Position**

9. Push clamp wires up and under the flange of box (or flange of RamBox rail, if equipped) to the Semi Clamped Position.

**Semi Clamped Position**

10. Push clamp handles upward to the clamped position to properly engage the clamps.

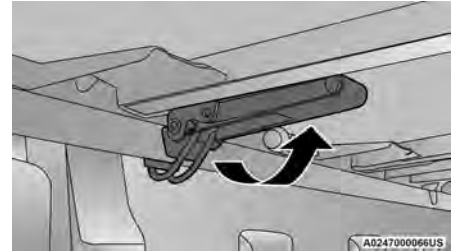
**Clamped Position**



Improper Clamp Position

NOTE:

Once clamped, be sure the clamps are not partially clamped to the truck bed flange.

The Tonneau Cover clamps can be locked when in the clamped position by placing a lock through the locking hole.

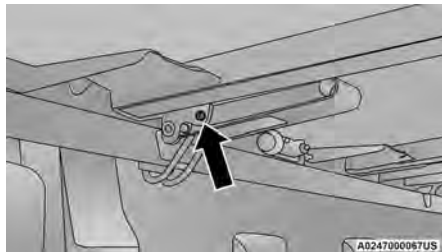

Locking Hole

WARNING!

You must ensure the Tonneau Cover is properly installed on the vehicle before driving. An unsecured Tonneau Cover can fly off of the vehicle while in motion, resulting in a collision, personal injury, and death. Failure to follow this procedure can also damage the vehicle and the Tonneau Cover.

CAUTION!

It is the driver's responsibility to ensure the Tonneau Cover is properly installed on the vehicle. Failure to follow this procedure can result in detachment of the Tonneau Cover from the vehicle and/or damage to the vehicle/Tonneau Cover.

TRI-FOLD TONNEAU COVER CLEANING

For proper cleaning of the Tonneau Cover, use Mopar® Whitewall & Vinyl Top Cleaner and Mopar® Leather & Vinyl Conditioner/Protectant.

GETTING TO KNOW YOUR INSTRUMENT PANEL

MIDLINE INSTRUMENT CLUSTER — GAS ENGINE

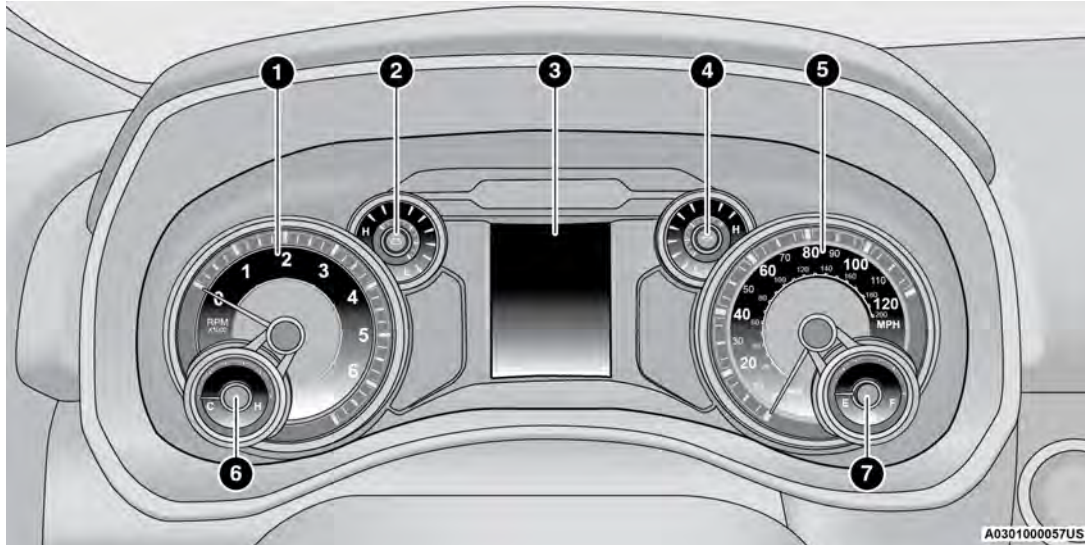

Use this QR code to access your digital experience.



MIDLINE INSTRUMENT CLUSTER DESCRIPTIONS — GAS ENGINE

1. Tachometer

- Indicates the engine speed in revolutions per minute (RPM x 1000).

2. Voltmeter

- When the vehicle is in the RUN state, the gauge indicates the electrical system voltage. The pointer should stay within the normal range if the battery is charged. If the pointer moves to either extreme left or right and remains there during normal driving, the electrical system should be serviced.

3. Instrument Cluster Display

- When the appropriate conditions exist, this display shows the instrument cluster display messages → page 101.
- The display always shows one of the main menu item after ignition is placed on.

4. Oil Pressure Gauge

- The pointer should always indicate the oil pressure when the engine is running. A continuous high or low reading under normal driving conditions may indicate a lubrication system malfunction. Immediate service should be obtained from an authorized dealer.

5. Speedometer

- Indicates vehicle speed.

6. Temperature Gauge

- The gauge pointer shows engine coolant temperature. The pointer positioned within the normal range indicates that the engine cooling system is operating satisfactorily.
- The gauge pointer will likely indicate a higher temperature when driving in hot weather, up mountain grades, or when towing a trailer. It should not be allowed to exceed the upper limits of the normal operating range.

WARNING!

A hot engine cooling system is dangerous. You or others could be badly burned by steam or boiling coolant. It is recommended to call an authorized dealer for service if your vehicle overheats.

CAUTION!

Driving with a hot engine cooling system could damage your vehicle. If the temperature gauge reads "H," pull over and stop the vehicle. Idle the vehicle with the air conditioner turned off until the pointer drops back into the normal range. If the pointer remains on the "H," turn the engine off immediately and call an authorized dealer for service.

7. Fuel Gauge

- The pointer shows the level of fuel in the fuel tank when the ignition is in the ON/RUN position.
- The fuel pump symbol points to the side of the vehicle where the fuel door is located.



HIGHLINE INSTRUMENT CLUSTER — GAS ENGINE

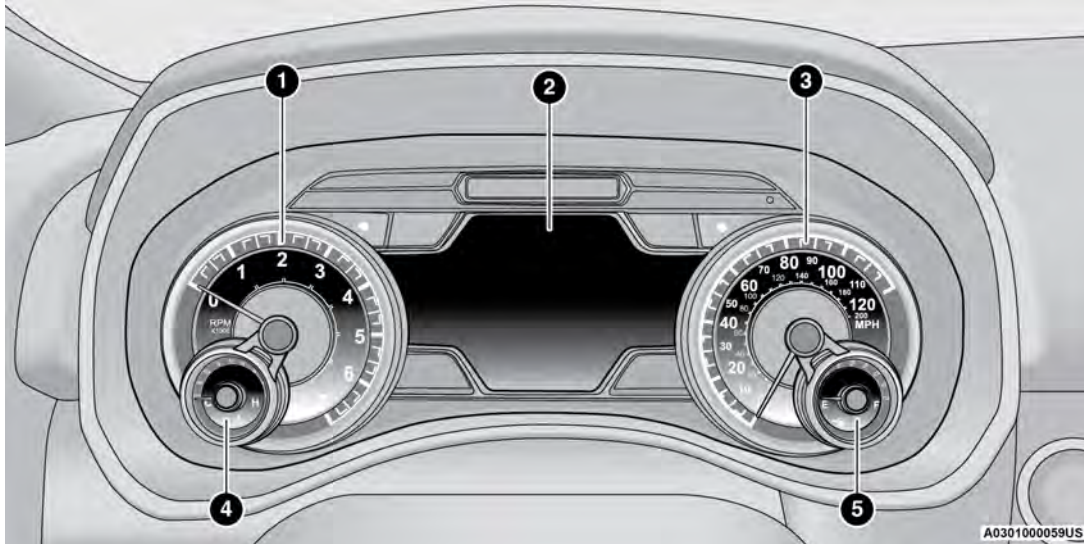

HIGHLINE INSTRUMENT CLUSTER DESCRIPTIONS — GAS ENGINE

1. Tachometer

- Indicates the engine speed in revolutions per minute (RPM x 1000).

2. Instrument Cluster Display

- When the appropriate conditions exist, this display shows the instrument cluster display messages → page 101.
- The display always shows one of the main menu item after ignition is placed on.

3. Speedometer

- Indicates vehicle speed.

4. Temperature Gauge

- The gauge pointer shows engine coolant temperature. The pointer positioned within the normal range indicates that the engine cooling system is operating satisfactorily.
- The gauge pointer will likely indicate a higher temperature when driving in hot weather, up mountain grades, or when towing a trailer. It should not be allowed to exceed the upper limits of the normal operating range.

WARNING!

A hot engine cooling system is dangerous. You or others could be badly burned by steam or boiling coolant. It is recommended to call an authorized dealer for service if your vehicle overheats.

CAUTION!

Driving with a hot engine cooling system could damage your vehicle. If the temperature gauge reads "H," pull over and stop the vehicle. Idle the vehicle with the air conditioner turned off until the pointer drops back into the normal range. If the pointer remains on the "H," turn the engine off immediately and call an authorized dealer for service.

5. Fuel Gauge

- The pointer shows the level of fuel in the fuel tank when the ignition is in the ON/RUN position.
- The fuel pump symbol points to the side of the vehicle where the fuel door is located.



PREMIUM INSTRUMENT CLUSTER — GASOLINE

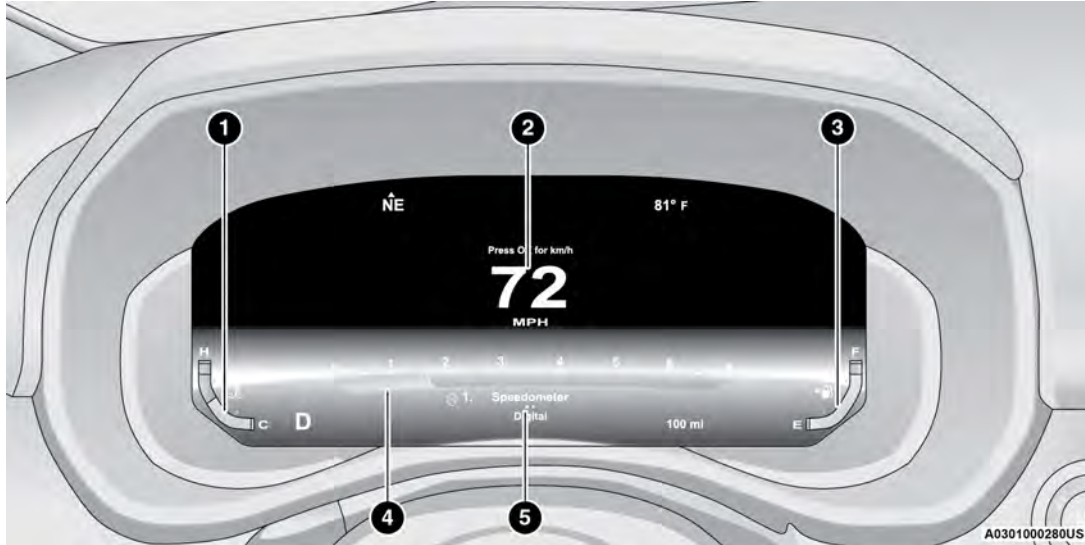

Holding the **OK** button on the Instrument Cluster Display controls located on the steering wheel will allow you to change your display from Digital to Analog.

PREMIUM INSTRUMENT CLUSTER DESCRIPTIONS — GASOLINE

1. Temperature Gauge

- The temperature gauge shows engine coolant temperature. Any reading within 203°F - 230°F (95°C - 110°C) indicates that the engine cooling system is operating satisfactorily.
- The pointer will likely indicate a higher temperature when driving in hot weather, up mountain grades, or when towing a trailer. It should not be allowed to exceed the upper limits of the normal operating range.

WARNING!

A hot engine cooling system is dangerous. You or others could be badly burned by steam or boiling coolant. It is recommended to call an authorized dealer for service if your vehicle overheats.

CAUTION!

Driving with a hot engine cooling system could damage your vehicle. If the temperature gauge reads "H," pull over and stop the vehicle. Idle the vehicle with the air conditioner turned off until the pointer drops back into the normal range. If the pointer remains on the "H," turn the engine off immediately and call an authorized dealer for service.

2. Speedometer

- Indicates vehicle speed.

3. Fuel Gauge

- The pointer shows the level of fuel in the fuel tank when the Keyless Push Button Ignition is in the ON/RUN position.
- The fuel pump symbol points to the side of the vehicle where the fuel door is located.



4. Tachometer

- Indicates the engine speed in revolutions per minute (RPM x 1000).

5. Instrument Cluster Display

- The instrument cluster display features a driver interactive display → page 101.

NOTE:

The hard telltales will illuminate for a bulb check when the ignition is first cycled.

MIDLINE INSTRUMENT CLUSTER — DIESEL ENGINE

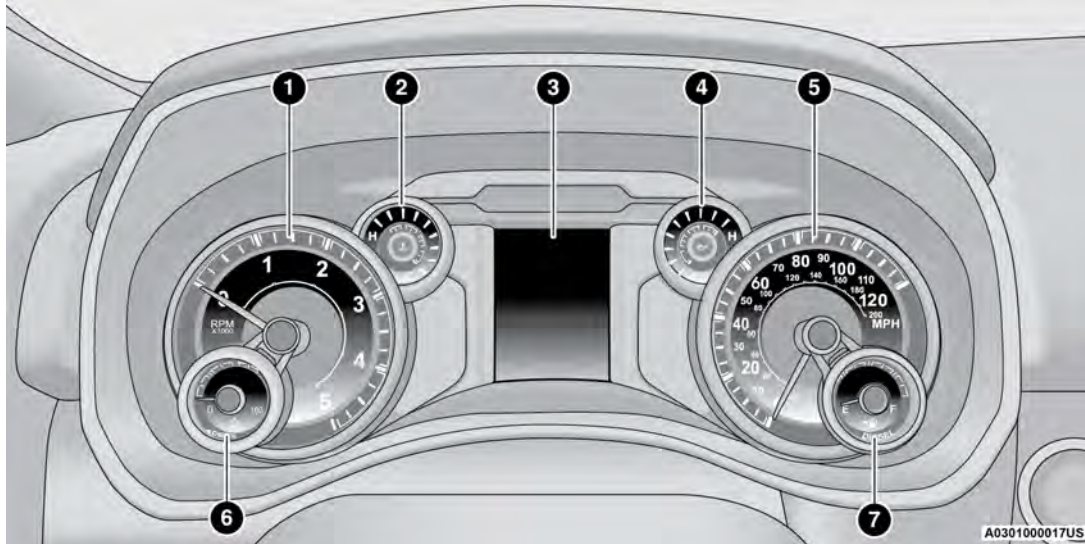

MIDLINE INSTRUMENT CLUSTER DESCRIPTIONS — DIESEL ENGINE

1. Tachometer

- Indicates the engine speed in revolutions per minute (RPM x 1000).

2. Engine Coolant Temperature

- This gauge shows the engine coolant temperature. The gauge pointer will likely show higher temperatures when driving in hot weather, up mountain grades, or in heavy stop and go traffic. If the red Warning Light turns on while driving, safely bring the vehicle to a stop, and turn off the engine. DO NOT operate the vehicle until the cause is corrected.

WARNING!

A hot engine cooling system is dangerous. You or others could be badly burned by steam or boiling coolant. It is recommended to call an authorized dealer for service if your vehicle overheats.

CAUTION!

Driving with a hot engine cooling system could damage your vehicle. If the temperature gauge reads greater "H," pull over and stop the vehicle. Idle the vehicle with the air conditioner turned off until the pointer drops back into the normal range. If the pointer remains on the "H," turn the engine off immediately and call an authorized dealer for service.

3. Instrument Cluster Display

- When the appropriate conditions exist, this display shows the instrument cluster display messages ⇄ page 101.
- The display always shows one of the main menu item after ignition is placed on.

4. Oil Pressure Gauge

- The pointer should always indicate some oil pressure when the engine is running. A continuous high or low reading under normal driving conditions may indicate a lubrication system malfunction. Immediate service should be obtained from an authorized dealer.

5. Speedometer

- Indicates vehicle speed.

6. Diesel Exhaust Fluid (DEF) Gauge

- The DEF Gauge displays the actual level of Diesel Exhaust Fluid in the DEF tank. DEF is required to maintain normal vehicle operation and emissions compliance. If something is wrong with the gauge, a DEF Warning Message or Malfunction Indicator Light (MIL) will be displayed. More information is available in the instrument cluster display section under the heading of DEF Warning Messages.

NOTE:

- The gauge may take up to five seconds to update after adding a gallon or more of DEF to the DEF tank. If you have a fault related to the DEF system, the gauge may not update to the new level. See an authorized dealer for service.

- The DEF gauge may also not immediately update after a refill if the temperature of the DEF fluid is below 39°F (4°C). The DEF tank heater will warm up the DEF fluid and allow the gauge to update after a period of run time. Under very cold conditions, it is possible that the gauge may not reflect the new fill level for several drives.

7. Fuel Gauge

- The pointer shows the level of fuel in the fuel tank when the ignition switch is in the ON/RUN position.
- The fuel pump symbol points to the side of the vehicle where the fuel filler door is located.



HIGHLINE INSTRUMENT CLUSTER — DIESEL ENGINE

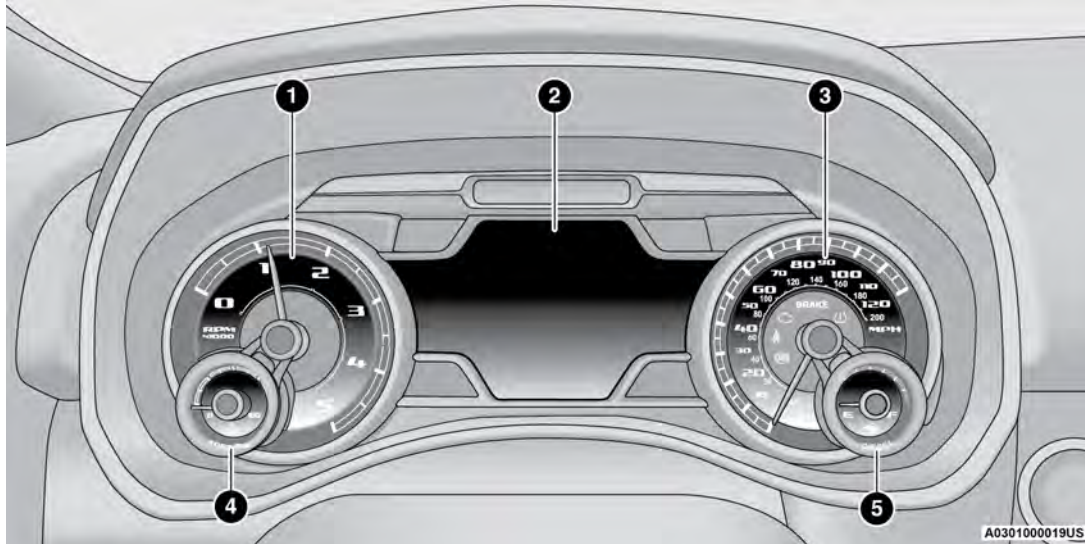

HIGHLINE INSTRUMENT CLUSTER DESCRIPTIONS — DIESEL ENGINE

1. Tachometer

- Indicates the engine speed in revolutions per minute (RPM x 1000).

2. Instrument Cluster Display

- When the appropriate conditions exist, this display shows the instrument cluster display messages → page 101.
- The display always shows one of the main menu item after ignition is placed on.

3. Speedometer

- Indicates vehicle speed.

4. Diesel Exhaust Fluid (DEF) Gauge

- The DEF Gauge displays the actual level of Diesel Exhaust Fluid in the DEF tank. DEF is required to maintain normal vehicle operation and emissions compliance. If something is wrong with the gauge, a DEF Warning Message or Malfunction Indicator Light (MIL) will be displayed. More information is available in the instrument cluster display section under the heading of DEF Warning Messages.

NOTE:

- The DEF tank on these vehicles is designed with a large amount of full reserve. So the level sensor will indicate a full reading even before the tank is completely full. To put it another way, there's additional storage capacity in the tank above the Full mark that's not represented in the gauge. You may not see any movement in the reading – even after driving up to 200 miles (322 kilometers) in some cases.

- The gauge may take up to five seconds to update after adding a gallon or more of DEF to the DEF tank. If you have a fault related to the DEF system, the gauge may not update to the new level. See an authorized dealer for service.
- The DEF gauge may also not immediately update after a refill if the temperature of the DEF fluid is below 39°F (4°C). The DEF tank heater will warm up the DEF fluid and allow the gauge to update after a period of run time. Under very cold conditions, it is possible that the gauge may not reflect the new fill level for several drives.

5. Fuel Gauge

- The pointer shows the level of fuel in the fuel tank when the ignition switch is in the ON/RUN position.
- The fuel pump symbol points to the side of the vehicle where the fuel filler door is located.



PREMIUM INSTRUMENT CLUSTER — DIESEL

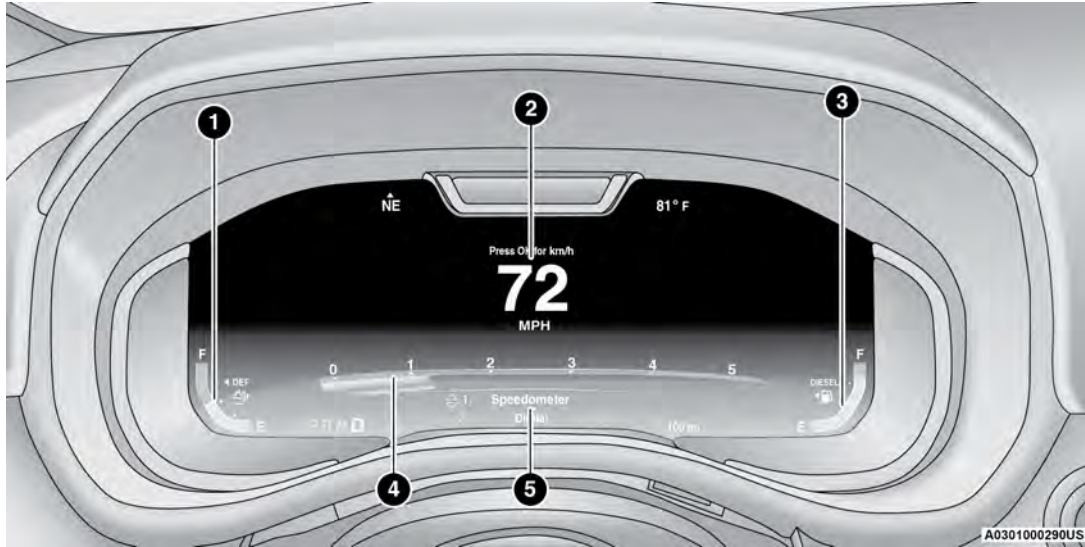

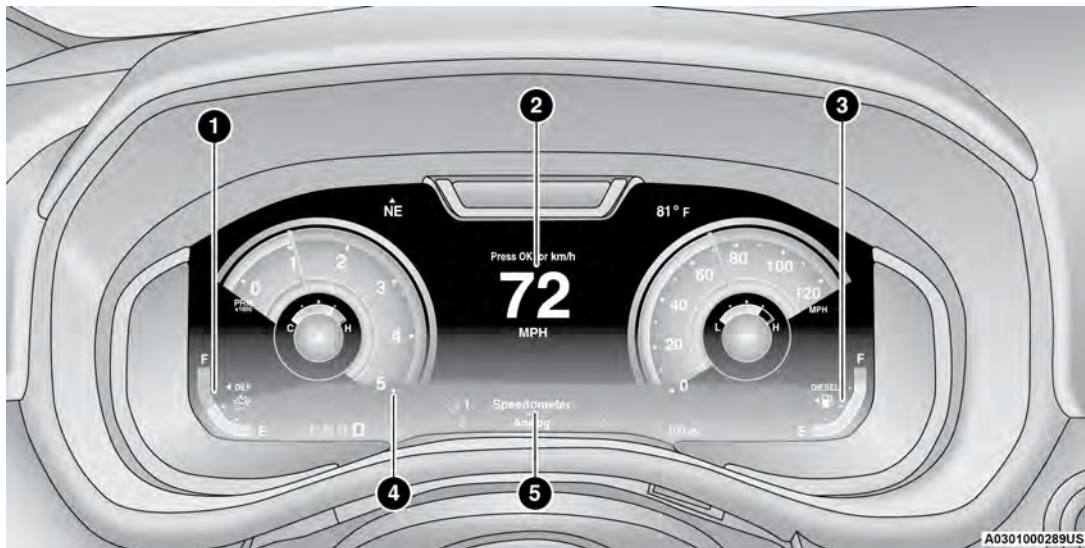

Holding the **OK** button on the Instrument Cluster Display controls located on the steering wheel will allow you to change your display from Analog to Digital.

PREMIUM INSTRUMENT CLUSTER DESCRIPTIONS — DIESEL

1. Diesel Exhaust Fluid (DEF) Gauge

- The DEF Gauge displays the actual level of Diesel Exhaust Fluid in the DEF tank. DEF is required to maintain normal vehicle operation and emissions compliance. If something is wrong with the gauge, a DEF Warning Message or Malfunction Indicator Light (MIL) will be displayed. More information is available in the instrument cluster display section under the heading of DEF Warning Messages.

NOTE:

- The DEF tank on these vehicles is designed with a large amount of full reserve. So the level sensor will indicate a full reading even before the tank is completely full. To put it another way, there's additional storage capacity in the tank above the Full mark that's not represented in the gauge. You may not see any movement in the reading – even after driving up to 200 miles (322 kilometers) in some cases.
- The gauge may take up to five seconds to update after adding a gallon or more of DEF to the DEF tank. If you have a fault related to the DEF system, the gauge may not update to the new level. See an authorized dealer for service.

- The DEF gauge may also not immediately update after a refill if the temperature of the DEF fluid is below 39°F (4°C). The DEF tank heater will warm up the DEF fluid and allow the gauge to update after a period of run time. Under very cold conditions, it is possible that the gauge may not reflect the new fill level for several drives.
- Speedometer
 - Indicates vehicle speed.
 - Fuel Gauge
 - The pointer shows the level of fuel in the fuel tank when the Keyless Push Button Ignition is in the ON/RUN position.
 - The fuel pump symbol points to the side of the vehicle where the fuel door is located.
 - Tachometer
 - Indicates the engine speed in revolutions per minute (RPM x 1000).
 - Instrument Cluster Display
 - The instrument cluster display features a driver interactive display ↪ page 101.



NOTE:

The hard telltales will illuminate for a bulb check when the ignition is first cycled.

INSTRUMENT CLUSTER DISPLAY

Your vehicle is equipped with an instrument cluster display, which offers useful information to the driver. With the ignition in the OFF mode, opening/closing of a door will activate the display for viewing, and display the total miles, or kilometers, in the odometer. Your instrument cluster display is designed to display important information about your vehicle's systems and features. Using a driver interactive display located on the instrument panel, your instrument cluster display can show you how systems are working and give you warnings when they are not. The steering wheel mounted controls allow you to scroll through the main menus and submenus. You can access the specific information you want and make selections and adjustments.

3

INSTRUMENT CLUSTER DISPLAY LOCATION AND CONTROLS

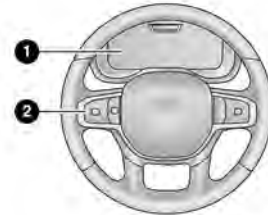

A6302000212US

Instrument Cluster Display/Controls Location

- 1 - Instrument Cluster Display Screen
- 2 - Instrument Cluster Display Controls

The system allows the driver to select information by pushing the following instrument cluster display control buttons located on the left side of the steering wheel.

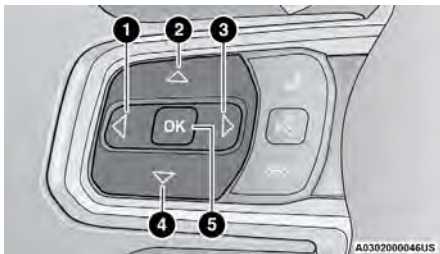

Base/Midline Instrument Cluster Display Control Buttons

- 1 – Left Arrow Button
- 2 – Up Arrow Button
- 3 – Right Arrow Button
- 4 – Down Arrow Button
- 5 – OK Button



Premium Instrument Cluster Display Control Buttons

- 1 – Left Arrow Button
- 2 – Up Arrow Button
- 3 – Right Arrow Button
- 4 – Down Arrow Button
- 5 – OK Button
- 6 – Menu Button

Up Δ And Down ∇ Arrow Buttons:

Using the **up Δ** or **down ∇** arrow button allows you to cycle through the Main Menu Items.

Left \triangleleft And Right \triangleright Arrow Buttons:

Using the **left \triangleleft** or **right \triangleright** arrow button allows you to cycle through the submenu items of the Main menu item.

NOTE:

- Holding the **up Δ / down ∇** or **left \triangleleft / right \triangleright** arrow button will loop the user through the currently selected menu or options presented on the screen.
- Main menu and submenus wrap for continuous scrolling.

- Upon returning to a main menu, the last submenu screen viewed within that main menu will be displayed.

OK Button:

For Digital Speedometer:

- Pushing the **OK** button changes units (mph or km/h).

Menu Button

- Press Menu button for Home Screen display.
- Navigate **left \triangleleft** or **right \triangleright** to highlight desired tile. Press **OK** to select desired. Once **OK** is pressed, cluster will navigate to selected submenu (e.g. "Audio").

NOTE:

Exiting Home Screen Speed Limit tile and Navigation tile with no Ethernet navigates to Speedometer submenu.

- Press **up Δ** or **down ∇** to select different screen within selected category.
- If Menu button is pressed while in this view, cluster will return to previously displayed screen.
- Press and hold **OK** button to enter edit mode.
 - Instruction text may overlay lower tachometer

For Screen Setup:

- **OK** button allows user to enter menu and submenus.
- Within each submenu layer, the **up Δ** and **down ∇** arrow buttons will allow the user to select the item of interest.
- Pushing the **OK** button makes the selection and a confirmation screen will appear (returning the user to the first page of the submenu).
- Pushing the **left \triangleleft** arrow button will exit each submenu layer and return to the main menu.

Custom Tile Configuration — If Equipped

To customize the instrument cluster further, you are able to select up to five tiles to display information based on your needs.

- Press the **MENU** button for the Home Screen display
- Navigate **Left** ◀ or **Right** ▶ to highlight desired tile
- Press **OK** to select the tile and navigate to the selected submenu and press **OK** again to add your selection to your tile view
- The main menu options of the home screen are Driver Info, Vehicle Info, Navigation — If Equipped, Audio, and Off Road



Custom Tile Screen Example

You can customize your Instrument Cluster Display with up to five tiles that may consist of the following:

NOTE:

These options may vary based on your vehicle trim level.

- **Navigation**
 - Route Set / Route Not Set
 - Trip A / Trip B

- **Vehicle Info**
 - Coolant Temp
 - Trans Temp
 - Oil Temp
 - Oil Pressure
 - Battery Voltage
 - Oil Life
 - Tire Pressure
 - Fuel Economy
 - Air Suspension
- **Driver Info**
 - Driver Assist
- **Audio**
 - Audio Info
- **Off Road**
 - Selec-Terrain / Air Suspension Status
 - Steering Angle
 - Pitch
 - Roll
- **Trailer Tow**
 - Trailer Trip
 - Trailer Brake
 - Trailer Tire Pressure Monitor

OIL LIFE RESET

Use this QR code to access your digital experience.

Your vehicle is equipped with an engine oil change indicator system. The “Oil Change Required” message will display in the instrument cluster display after a single chime has sounded, to indicate the next scheduled oil change interval. The engine oil change indicator system is duty cycle based, which means the engine oil change interval may fluctuate, dependent upon your personal driving style.



NOTE:

Use the steering wheel instrument cluster display controls for the following procedure.

Oil Life Reset Procedure

1. Without pushing the brake pedal, push the ENGINE START/STOP button and place the ignition to the ON/RUN position (do not start the engine).
2. Push and release the **down** ▼ arrow button to scroll downward through the main menu to “Vehicle Info.”
3. Push and release the **right** ▶ arrow button to access the “Vehicle Info” screen, then scroll up or down to select “Oil Life.”
4. Push and hold the **right** ▶ arrow button to select “Reset”.
5. Push and release the **down** ▼ arrow button to select “Yes,” then push and release the **right** ▶ arrow button to reset the Oil Life to 100%.
6. Push and release the **up** ▲ arrow button to exit the instrument cluster display screen.

Secondary Method Of Resetting Engine Oil Life

1. Without pressing the brake pedal, push the ENGINE START/STOP button and place the ignition to the ON/RUN position (do not start the engine).
2. Fully press the accelerator pedal, slowly, three times within ten seconds.
3. Without pushing the brake pedal, push the ENGINE START/STOP button once to return the ignition to the OFF position.

NOTE:

If the indicator message illuminates when you start the vehicle, the oil change indicator system did not reset. If necessary, repeat this procedure.

DISPLAY MENU ITEMS

Push and release the **up** \triangle or **down** ∇ arrow button until the desired selectable menu icon is highlighted in the instrument cluster display.

Speedometer

Push and release the **up** \triangle or **down** ∇ arrow button until the speedometer menu item is highlighted in the instrument cluster display. Push and release the **right** \triangleright arrow button to cycle the display between mph and km/h.

Driver Assist — If Equipped

The Driver Assist menu displays the status of the Adaptive Cruise Control (ACC) and LaneSense systems.

Push and release the **up** \triangle or **down** ∇ arrow button until the Driver Assist menu is displayed in the instrument cluster display.

Adaptive Cruise Control (ACC) Feature

The instrument cluster display displays the current ACC system settings. The information displayed depends on ACC system status.

Push the ACC on/off button (located on the steering wheel) until one of the following displays in the instrument cluster display:

Adaptive Cruise Control Off

When ACC is deactivated, the display will read "Adaptive Cruise Control Off."

Adaptive Cruise Control Ready

When ACC is activated but the vehicle speed setting has not been selected, the display will read "Adaptive Cruise Control Ready."

Push the SET + or the SET- button (located on the steering wheel) and the following will display in the instrument cluster display:

ACC SET

When ACC is set, the set speed will display in the instrument cluster \rightarrow page 112.

The ACC screen may display once again if any ACC activity occurs, which may include any of the following:

- Distance Setting Change
- System Cancel
- Driver Override
- System Off
- ACC Proximity Warning
- ACC Unavailable Warning

LaneSense — If Equipped

The instrument cluster display displays the current LaneSense system settings. The information displayed depends on LaneSense system status and the conditions that need to be met.

Vehicle Info

Push and release the **up** \triangle or **down** ∇ arrow button until the Vehicle Info menu item is highlighted in the instrument cluster display. Push and release the **right** \triangleright arrow button to enter the submenus items of Vehicle Info. Follow the directional prompts to access or reset any of the following Vehicle Info submenu items:

MIDLINE OR HIGHLINE CLUSTER

- Tire Pressure Monitor System
- Coolant Temperature — If Equipped
- Trans Temperature — If Equipped
- Oil Temperature
- Oil Pressure
- Exhaust Brake — If Equipped
- Boost Pressure — If Equipped
- Diesel Particulate Filter
- Oil Life
- Fuel Filter Life — If Equipped
- Battery Voltage — If Equipped
- Gauge Summary — If Equipped
 - Coolant Temp
 - Trans Temp
 - Oil Temp
 - Oil Pressure
- Engine Hours — If Equipped

PREMIUM CLUSTER

- Fuel Economy
 - Average
 - Current
 - Range to Empty
- Gauge Summary
 - Coolant Temperature — If Equipped
 - Battery Voltage — If Equipped
 - Trans Temperature
- Oil Summary
 - Oil Temperature
 - Oil Life
 - Oil Pressure — If Equipped

- Tire Pressure Monitor System
- Diesel Summary
 - Exhaust Brake — If Equipped
 - Boost Pressure — If Equipped
- Fuel Filter Life — If Equipped
- Engine Hours — If Equipped

Off Road

Push and release the **up** \triangle or **down** ∇ arrow button until the Off Road menu icon is displayed in the instrument cluster display. Push and release the **left** \triangleleft or **right** \triangleright arrow button to scroll through the information submenus.

- Drivetrain
 - Front Wheel Angle: displays the graphical and numerical value of calculated average front wheel angle from the steering wheel orientation.
 - Transfer Case Lock Status: displays “Lock” graphic only during 4WD High, 4WD High Part Time, 4WD Low status.
 - Axle Lock And Sway Bar Status (If Equipped): displays front and rear or rear only axle locker graphic, and sway bar connection graphic with text message (connected or disconnected).
- Pitch And Roll
 - Displays the pitch and roll of the vehicle in the graphic with the angle number on the screen.

NOTE:

When vehicle speed becomes too high to display the pitch and roll, “-” will display in place of the numbers, and the graphic will be grayed out. A message indicating the necessary speed for the feature to become available will also display.

Fuel Economy — If Equipped

Push and release the **up** \triangle or **down** ∇ arrow button until the Fuel Economy menu item is highlighted in the instrument cluster display. Push and hold the **right** \triangleright arrow button to reset Average Fuel Economy.

- Current Fuel Economy Gauge
- Average Fuel Economy Value
- Range To Empty

Trip A/Trip B

Push and release the **up** \triangle or **down** ∇ arrow button until the Trip menu item is highlighted in the instrument cluster display. Push and release the **right** \triangleright arrow button to enter the submenus of Trip A and Trip B. The Trip A or Trip B information will display the following:

- Distance
- Average Fuel Economy
- Elapsed Time

Push and hold the **right** \triangleright arrow button to reset all information.

Navigation — If Equipped

Push and release the **up** \triangle or **down** ∇ arrow button until the Navigation display title is highlighted in the instrument cluster display, “Hold **OK** to Start Route” will display when no active route is set. “Hold **OK** to Cancel Route” will display when active route is set. Use the **left** \triangleleft or **right** \triangleright arrow button to zoom in or out on the display \rightarrow page 217.

Trailer Tow

Push and release the **up** \triangle or **down** ∇ arrow button until the Trailer Tow menu item is highlighted in the instrument cluster display. Push and release the **right** \triangleright or **left** \triangleleft arrow button to cycle through the following trailer tow information:

- **Trip (trailer specific) Distance:** Push and hold the **OK** button to reset the distance.
- **Integrated Trailer Brake Module (ITBM):**
 - Braking Output
 - Trailer Type
 - ITBM Gain
- **Trailer Light Check:** Push and hold the **OK** button to begin the Trailer Light Test sequence \rightarrow page 201.
- **Trailer Tire Pressure Monitoring:** The Instrument Cluster Display will display the Trailer Tire Pressure for a connected trailer with sensors that match the active trailer profile. When a low tire is present, the low tire value will be displayed in red, and the affected low tire will have a red glow. “Trailer Tire Low” will be displayed on the center bottom of the Instrument Cluster Display screen.

Audio

Push and release the **up** \triangle or **down** ∇ arrow button until the Audio Menu icon/title is highlighted in the instrument cluster display. This menu will display the audio source information, including the Song name, Artist name, and audio source with an accompanying graphic.

Phone Call Status

When a call is incoming, a Phone Call Status pop-up will display on the screen. The pop-up will remain until the phone is answered or ignored.

NOTE:

The call status will temporarily replace the previous media source information displayed on the screen. When the pop-up is no longer displayed, the display will return to the last used screen.

Messages

Push and release the **up** ▲ or **down** ▼ arrow button until the Messages Menu item is highlighted. This feature shows the number of stored warning messages. Push and release the **right** ► or **left** ◄ arrow button to cycle through stored messages.

Settings — If Equipped

Personal Settings allows the driver to set and recall features when the transmission is in PARK.

Push and release the **up** ▲ or **down** ▼ arrow button until Settings displays in the instrument cluster display. Follow the prompts to display and set any of the following Vehicle Settings.

NOTE:

Your vehicle may be equipped with the following settings.

- If equipped with a base radio (Non-Touchscreen) Vehicle Settings will be included in the instrument cluster display.
- If equipped with a Touchscreen radio, the Vehicle Settings will be included in the radio head unit.

MIDLINE OR HIGHLINE CLUSTER

Upper Left or Right		
None	Time	Current Econ
Compass	Range	Trip A Distance
Outside Temp	Average Econ	Trip B Distance
Trailer Trip – If Equipped	Trailer Brake	Oil Pressure
Coolant Temp	Oil Temp	Battery Voltage
Trans Temp	Oil Life	Exhaust Brake – If Equipped
Boost Pressure – If Equipped	Fuel Filter Life – If Equipped	

Upper Center		
None	Compass	Outside Temp
Time	Range To Empty	Average Econ
Current Econ	Trip A Distance	Trip B Distance
Trailer Trip	Audio (show/hide)	Speedometer
Menu Title		

Left or Right		
None	Range To Empty	Average Econ
Menu Icon	Coolant Temp	Oil Temp
Trans Temp	Oil Life	Fuel Filter Life – If Equipped

Lower Left or Right		
None	Time	Current Econ
Compass	Range	Trip A Distance
Outside Temp	Average Econ	Trip B Distance
Trailer Trip – If Equipped	Trailer Brake	Oil Pressure
Coolant Temp	Oil Temp	Battery Voltage
Trans Temp	Oil Life	Exhaust Brake – If Equipped
Boost Pressure – If Equipped	Fuel Filter Life – If Equipped	

Favorite Menus		
Speedometer	Vehicle Info	Driver Assist
Fuel Economy	Trip Info	Trailer Tow – If Equipped (show/hide)
Audio (show/hide)	Messages	Screen Setup
Commercial Settings		

Current Gear

- Off
- On

Odometer

- No Decimal Point
- Decimal Point

Defaults (Restores All Settings To Default Settings)

- Cancel
- Restore

PREMIUM CLUSTER**Display Style**

- Modern
- Traditional

Upper Left or Right		
None	Time	Current Econ
Compass	Range	Trip A Distance
Outside Temp	Average Econ	Trip B Distance
Trailer Trip – If Equipped		

Upper Center		
None	Badge	Compass
Outside Temp	Time	Range To Empty
Average Econ	Current Econ	Trip A Distance
Trip B Distance	Trailer Trip	Audio (show/hide)

Current Gear

- Off
- On

Odometer

- No Decimal Point
- Decimal Point
- Hide

Fuel Gauge

- Hide Range
- Show Range

Favorite Menus		
Trip Info	Navigation	Off Road
Trailer Tow – If Equipped (show/hide)	Audio (show/hide)	

Defaults (Restores All Settings To Default Settings)

- Restore
- Cancel

Commercial Settings – If Equipped

Commercial Settings allows the driver to set and recall additional features when the transmission is in PARK (P). Push and release the **up** Δ or **down** ∇ arrow button until Commercial Settings displays in the instrument cluster display.

Follow the prompts to enter the required PIN and enter the Commercial Settings submenu.

Commercial Settings allows you to access the following features (if equipped):

- Backup Alarm
- ParkSense
- Aux Switches
- PIN Setup

NOTE:

If the vehicle's PIN is forgotten or not known, see an authorized dealer to have the PIN reset. If the PIN is known, you may enter the PIN and restore to the factory settings. The Default PIN will be "0000".

DIESEL MESSAGES AND WARNINGS – 6.7L CUMMINS® DIESEL ENGINE**Diesel Particulate Filter (DPF) Messages**

The Cummins® diesel engine meets all diesel emissions standards, resulting in one of the lowest emitting diesel engines ever produced. To achieve these emissions standards, your vehicle is equipped with a state-of-the-art engine and exhaust system. These systems are seamlessly integrated into your vehicle and managed by the Powertrain Control Module (PCM). The PCM manages engine combustion to allow the exhaust system's catalyst to trap and burn Particulate Matter (PM) pollutants, with no input or interaction on your part.

WARNING!

A malfunctioning catalytic converter can reach higher temperatures than in normal operating conditions. This can cause a fire if you drive slowly or park over flammable substances such as dry plants, wood, cardboard, etc. This could result in death or serious injury to the driver, occupants or others.

Your vehicle has the ability to alert you to additional maintenance required on your vehicle or engine. The following messages may display in your instrument cluster display:

- **Perform Service** — Your vehicle will require emissions maintenance at a set interval. To help remind you when this maintenance is due, the instrument cluster display will display "Perform Service". When the "Perform Service" message is displayed in the instrument cluster display it is necessary to have the

emissions maintenance performed. Emissions maintenance may include replacing the Closed Crankcase Ventilation (CCV) filter element. The procedure for clearing and resetting the "Perform Service" indicator message is located in the appropriate Service Information.

- **Exhaust System — Regeneration Required Now** — "Exhaust Filter XX% Full Safely Drive at Highway Speeds to Remedy" will be displayed in the instrument cluster display if the exhaust particulate filter reaches 80% of its maximum storage capacity. Under conditions of exclusive short duration and low speed driving cycles, your Cummins® diesel engine and exhaust after-treatment system may never reach the conditions required to remove the trapped Particulate Matter (PM). If this occurs, the "Exhaust Filter XX% Full Safely Drive at Highway Speeds to Remedy" message will be displayed in the instrument cluster display. If this message is displayed, you will hear one chime to assist in alerting you of this condition

By simply driving your vehicle at highway speeds for as little as 45 minutes, you can remedy the condition in the particulate filter system and allow your Cummins® diesel engine and exhaust after-treatment system to remove the trapped Particulate Matter (PM) and restore the system to normal operating condition.

- **Exhaust System — Regeneration In Process Exhaust Filter XX% Full** — Indicates that the DPF is self-cleaning. Maintain your current driving condition until regeneration is completed.
- **Exhaust System — Regeneration Completed** — This message indicates that the DPF self-cleaning is completed. If this message is displayed, you will hear one chime to assist in alerting you of this condition.

- **Exhaust Service Required — See Dealer Now** — This message indicates regeneration has been disabled due to a system malfunction. At this point the engine Powertrain Control Module (PCM) will register a fault code, the instrument panel will display a MIL light.

CAUTION!

See an authorized dealer, as damage to the exhaust system could occur soon with continued operation.
--

- **Exhaust Filter Full — Power Reduced See Dealer** — This message indicates the PCM has derated the engine to limit the likelihood of permanent damage to the after-treatment system. If this condition is not corrected and a dealer service is not performed, extensive exhaust after-treatment damage can occur. To correct this condition it will be necessary to have your vehicle serviced by your local authorized dealer.

NOTE:

Failing to follow the oil change indicator, changing your oil and resetting the oil change indicator by 0 miles remaining will prevent the diesel exhaust filter from performing its cleaning routine. This will shortly result in a Malfunction Indicator Light (MIL) and reduced engine power. Only an authorized dealer will be able to correct this condition.

CAUTION!

See an authorized dealer, as damage to the exhaust system could occur soon with continued operation.
--

Cold Ambient Derate Mode Messages

The vehicle will display messages when a derate (engine power reduction) is activated to protect the engine during start-up in cold ambient temperatures.

- **Engine Power Reduced During Warm-up** — This message will display during start-up when the ambient temperature is between 10 °F (-12 °C) and -10 °F (-23 °C).
- **Engine Power Reduced Up To 30 Sec (Seconds) During Warm-up** — This message will display during start-up when the ambient temperature is between -10 °F (-23 °C) and -25 °F (-32 °C).
- **Engine Power Reduced Up To 2 Min (Minutes) During Warm-up** — This message will display during start-up when the ambient temperature is -25 °F (-32 °C) and below.

Your vehicle is equipped with an engine warm up protection feature that may limit engine performance after cold starting at low ambient temperatures. The length of time engine speed is limited is dependent upon engine coolant temperature. Engine speed may be briefly limited to 1,000 RPM after starting with coolant temperature below freezing conditions, and may be limited to 1,000 RPM for up to approximately two minutes under more severe cold conditions.

- **Coolant Low** — This telltale will turn on to indicate the vehicle coolant level is low → page 342.

Diesel Exhaust Fluid (DEF) Warning Messages

There are four different messages which are displayed if the vehicle detects that the DEF system has been filled with a fluid other than DEF, has experienced component failures, or when tampering has been detected. The vehicle may be limited to a maximum speed of 5 mph (8 km/h) if the DEF system is not serviced within less than 200 miles (322 km) of the fault being detected.

When the DEF system needs to be serviced the following warnings will display:

- **DEF Low Refill Soon** — This message will display when the low level is reached, during vehicle start-up, and with increased frequency during vehicle operation. It will be accompanied by a single chime. Approximately 5 gallons (19 Liters) of DEF is required to refill the tank when this message is initially displayed. on pickup applications, and approximately 7 gallons (26 Liters) are required on chassis-cab applications.
- **Speed Limited to 5 MPH in XXX mi Refill DEF** — This message will continuously display if the “DEF Low Refill Soon” message is ignored, and the frequency of occurrence of the chime will increase unless up to 2 gallons (7.5 Liters) of DEF is added to the tank.
- **5 MPH Max Speed on Restart, Long Idle or Refuel Refill DEF** — This message will continuously display when the counter reaches zero, and will be accompanied by a periodic chime.

The vehicle will only be capable of a maximum speed of 5 mph upon the first of the following conditions to occur:

- If the vehicle is shut off and restarted.
- If the vehicle is idled for an extended period of time, approximately one hour or greater.

- If the system detects that the level of fuel in the tank has increased.

Add a minimum of 2 gallons (7.5 Liters) of DEF to the tank in order to avoid vehicle operation at a maximum speed of 5 mph (8 km/h).

NOTE:

A minimum of 2 gallons (7.5 Liters) may be required to restore normal vehicle operation. Although the vehicle will start normally and can be placed in gear after this message has been initially displayed, extreme caution should be utilized since the vehicle will only be capable of maneuvering at a maximum speed of 5 mph (8 km/h).

Diesel Exhaust Fluid (DEF) Fault Warning Messages

There are five different messages which are displayed if the vehicle detects that the DEF system has been filled with a fluid other than DEF, has experienced component failures, or when tampering has been detected. The vehicle may be limited to a maximum speed of 5 mph (8 km/h) if the DEF system is not serviced within less than 200 miles (322 km) of the fault being detected.

When the DEF system needs to be serviced the following warnings will display:

- **Service DEF System See Dealer** — This message will display when the fault is initially detected, each time the vehicle is started, and periodically during driving. The message will be accompanied by a single chime. Drive to your nearest authorized dealer and have your vehicle serviced as soon as possible.
- **5 MPH Max Speed in 150 mi Service DEF System See Dealer** — This message will display if the DEF system has not been serviced after the “Service DEF System – See Dealer” message is displayed. This message will continuously display until the

mileage counter reaches zero, and will be accompanied by a periodic chime. The message will continue to countdown until it reaches zero unless the vehicle is serviced. Drive to your nearest authorized dealer and have your vehicle serviced immediately.

NOTE:

Under some circumstances this mileage counter may start with a value of less than 150 miles (241 km). For example, if recurring faults are detected in a time interval of less than 40 hours, the counter may restart at the value where it stopped when a previous fault was temporarily remedied, or at a minimum of 50 miles (80 km).

- **5 MPH Max Speed on Restart, Long Idle or Refuel Service DEF See Dealer** — This message will continuously display when the mileage counter reaches zero, and will be accompanied by a periodic chime. The vehicle will only be capable of a maximum speed of 5 mph upon the first of the following conditions to occur:
 - If the vehicle is shut off and restarted.
 - If the vehicle is idled for an extended period of time, approximately one hour or greater.
 - If the system detects that the level of fuel in the tank has increased.
- **5 MPH Max Speed Service DEF System See Dealer** — This message will continuously display, and will be accompanied by a periodic chime. Although the vehicle can be started and placed in gear, the vehicle will only operate at a maximum speed of 5 mph. Your vehicle will require towing, see an authorized dealer for service.

NOTE:

When this message is displayed, the engine can still be started. However, the vehicle will only operate at a maximum speed of 5 mph.

- **Incorrect DEF Detected See Dealer** — This message will display when the fault is initially detected, each time the vehicle is started, and periodically during driving. The message will be accompanied by a single chime. Drive to your nearest authorized dealer and have your vehicle serviced as soon as possible.

BATTERY SAVER ON/BATTERY SAVER MODE MESSAGE — ELECTRICAL LOAD REDUCTION ACTIONS — IF EQUIPPED

This vehicle is equipped with an Intelligent Battery Sensor (IBS) to perform additional monitoring of the electrical system and status of the vehicle battery.

In cases when the IBS detects charging system failure, or the vehicle battery conditions are deteriorating, electrical load reduction actions will take place to extend the driving time and distance of the vehicle. This is done by reducing power to or turning off non-essential electrical loads.

Load reduction is only active when the engine is running. It will display a message if there is a risk of battery depletion to the point where the vehicle may stall due to lack of electrical supply, or will not restart after the current drive cycle.

When load reduction is activated, the message “Battery Saver On Some Systems May Have Reduced Power” will appear in the instrument cluster.

These messages indicate the vehicle battery has a low state of charge and continues to lose electrical charge at a rate that the charging system cannot sustain.

NOTE:

- The charging system is independent from load reduction. The charging system performs a diagnostic on the charging system continuously.
- If the Battery Charge Warning Light is on it may indicate a problem with the charging system
➔ page 111.

The electrical loads that may be switched off (if equipped), and vehicle functions which can be affected by load reduction:

- Heated Seats/Vented Seats/Heated Wheel
- Rear Defroster And Heated Mirrors
- HVAC System
- 115 Volts AC Power Inverter System
- Audio and Telematics System

Loss of the battery charge may indicate one or more of the following conditions:

- The charging system cannot deliver enough electrical power to the vehicle system because the electrical loads are larger than the capability of charging system. The charging system is still functioning properly.
- Turning on all possible vehicle electrical loads (e.g. HVAC to max settings, exterior and interior lights, overloaded power outlets +12 Volts, 115 Volts AC, USB ports) during certain driving conditions (city driving, towing, frequent stopping).
- Installing options like additional lights, upfitter electrical accessories, audio systems, alarms and similar devices.
- Unusual driving cycles (short trips separated by long parking periods).

- The vehicle was parked for an extended period of time (weeks, months).
- The battery was recently replaced and was not charged completely.
- The battery was discharged by an electrical load left on when the vehicle was parked.
- The battery was used for an extended period with the engine not running to supply radio, lights, chargers, +12 Volts portable appliances like vacuum cleaners, game consoles and similar devices.

What to do when an electrical load reduction action message is present (“Battery Saver On” or “Battery Saver Mode”)

During a trip:

- Reduce power to unnecessary loads if possible:
 - Turn off redundant lights (interior or exterior).
 - Check what may be plugged in to power outlets +12 Volts, 115 Volts AC, USB ports.
 - Check HVAC settings (blower, temperature).
 - Check the audio settings (volume).

After a trip:

- Check if any aftermarket equipment was installed (additional lights, upfitter electrical accessories, audio systems, alarms) and review specifications if any (load and Ignition Off Draw currents).
- Evaluate the latest driving cycles (distance, driving time and parking time).
- The vehicle should have service performed if the message is still present during consecutive trips and the evaluation of the vehicle and driving pattern did not help to identify the cause.

WARNING LIGHTS AND MESSAGES

The warning/indicator lights will illuminate in the instrument panel together with a dedicated message and/or acoustic signal when applicable. These indications are indicative and precautionary and as such must not be considered as exhaustive. Always refer to the information in this chapter in the event of a failure indication. All active telltales will display first if applicable. The system check menu may appear different based upon equipment options and current vehicle status. Some telltales are optional and may not appear.

RED WARNING LIGHTS

Air Bag Warning Light



This warning light will illuminate to indicate a fault with the air bag, and will turn on for four to eight seconds as a bulb check when the ignition is placed in the ON/RUN or ACC/ON/RUN position. This light will illuminate with a single chime when a fault with the air bag has been detected, it will stay on until the fault is cleared. If the light is either not on during startup, stays on, or turns on while driving, have the system inspected at an authorized dealer as soon as possible.

Brake Warning Light



This warning light monitors various brake functions, including brake fluid level and parking brake application. If the brake light turns on it may indicate that the parking brake is applied, that the brake fluid level is low, or that there is a problem with the Anti-Lock Brake System reservoir.

If the light remains on when the parking brake has been disengaged, and the fluid level is at the full mark on the master cylinder reservoir, it indicates a possible brake hydraulic system malfunction or that a problem with the Brake Booster has been detected by the Anti-Lock Brake System (ABS) / Electronic Stability Control (ESC) system. In this case, the light will remain on until the condition has been corrected. If the problem is related to the brake booster, the ABS pump will run when applying the brake, and a brake pedal pulsation may be felt during each stop.

The dual brake system provides a reserve braking capacity in the event of a failure to a portion of the hydraulic system. A leak in either half of the dual brake system is indicated by the Brake Warning Light, which will turn on when the brake fluid level in the master cylinder has dropped below a specified level.

The light will remain on until the cause is corrected.

NOTE:

The light may flash momentarily during sharp cornering maneuvers, which change fluid level conditions. The vehicle should have service performed, and the brake fluid level checked.

If brake failure is indicated, immediate repair is necessary.

WARNING!

Driving a vehicle with the red brake light on is dangerous. Part of the brake system may have failed. It will take longer to stop the vehicle. You could have a collision. Have the vehicle checked immediately.

Vehicles equipped with the Anti-Lock Brake System (ABS) are also equipped with Electronic Brake Force Distribution (EBD). In the event of an EBD failure, the Brake Warning Light will turn on along with the ABS Light. Immediate repair to the ABS system is required.

Operation of the Brake Warning Light can be checked by turning the ignition switch from the OFF position to the ON/RUN position. The light should illuminate for approximately two seconds. The light should then turn off unless the parking brake is applied or a brake fault is detected. If the light does not illuminate, have the light inspected by an authorized dealer.

The light also will turn on when the parking brake is applied with the ignition switch in the ON/RUN position.

NOTE:

This light shows only that the parking brake is applied. It does not show the degree of brake application.

Battery Charge Warning Light



This warning light will illuminate when the battery is not charging properly. If it stays on while the engine is running, there may be a malfunction with the charging system. Contact an authorized dealer as soon as possible.

This indicates a possible problem with the electrical system or a related component.

Door Open Warning Light



This indicator will illuminate when a door is ajar/open and not fully closed.

NOTE:

If the vehicle is moving there will also be a single chime.

Electronic Throttle Control (ETC) Warning Light



This warning light will illuminate to indicate a problem with the ETC system. If a problem is detected while the vehicle is running, the light will either stay on or flash depending on the nature of the problem. Cycle the ignition when the vehicle is safely and completely stopped and the transmission is placed in the PARK (P) position. The light should turn off. If the light remains on with the vehicle running, your vehicle will usually be drivable; however, see an authorized dealer for service as soon as possible.

NOTE:

This light may turn on if the accelerator and brake pedals are pressed at the same time.

If the light continues to flash when the vehicle is running, immediate service is required and you may experience reduced performance, an elevated/rough idle, or engine stall and your vehicle may require towing. The light will come on when the ignition is placed in the ON/RUN or ACC/ON/RUN position and remain on briefly as a bulb check. If the light does not come on during starting, have the system checked by an authorized dealer.

Engine Coolant Temperature Warning Light



This warning light warns of an overheated engine condition. If the engine coolant temperature is too high, this indicator will illuminate and a single chime will sound. If the temperature reaches the upper limit, a continuous chime will sound for four minutes or until the engine is able to cool; whichever comes first.

If the light turns on while driving, safely pull over and stop the vehicle. If the Air Conditioning (A/C) system is on, turn it off. Also, shift the transmission into NEUTRAL and idle the vehicle. If the temperature reading does not return to normal, turn the engine off immediately and call for service → page 328.

Hood Open Warning Light



This warning light will illuminate when the hood is ajar/open and not fully closed.

NOTE:

If the vehicle is moving, there will also be a single chime.

Oil Pressure Warning Light



This warning light will illuminate to indicate low engine oil pressure. If the light turns on while driving, stop the vehicle, shut off the engine as soon as possible, and contact an authorized dealer. A chime will sound when this light turns on.

Do not operate the vehicle until the cause is corrected. This light does not indicate how much oil is in the engine. The engine oil level must be checked under the hood.

Oil Temperature Warning Light



This warning light will illuminate to indicate the engine oil temperature is high. If the light turns on while driving, stop the vehicle and shut off the engine as soon as possible. Wait for oil temperature to return to normal levels.

Seat Belt Reminder Warning Light



This warning light indicates when the driver or passenger seat belt is unbuckled. When the ignition is first placed in the ON/RUN or ACC/ON/RUN position and if the driver's seat belt is unbuckled, a chime will sound and the light will turn on. When driving, if the driver or front passenger seat belt remains unbuckled, the Seat Belt Reminder Light will flash or remain on continuously and a chime will sound → page 286.

Tailgate Open Warning Light



This warning light will illuminate when the tailgate is open.

NOTE:

If the vehicle is moving, there will also be a single chime.

Trailer Brake Disconnected Warning Light



This warning light will illuminate when the Trailer Brake has been disconnected.

Transmission Temperature Warning Light



This warning light will illuminate to warn of a high transmission fluid temperature. This may occur with strenuous usage such as trailer towing. If this light turns on, stop the vehicle and run the engine at idle or slightly faster, with the transmission in PARK (P) or NEUTRAL (N), until the light turns off. Once the light turns off, you may continue to drive normally.

WARNING!

If you continue operating the vehicle when the Transmission Temperature Warning Light is illuminated you could cause the fluid to boil over, come in contact with hot engine or exhaust components and cause a fire.

CAUTION!

Continuous driving with the Transmission Temperature Warning Light illuminated will eventually cause severe transmission damage or transmission failure.

Vehicle Security Warning Light — If Equipped



This light will flash at a fast rate for approximately 15 seconds when the vehicle security system is arming, and then will flash slowly until the vehicle is disarmed.

YELLOW WARNING LIGHTS

Adaptive Cruise Control (ACC) Fault Warning Light — If Equipped



This warning light will illuminate to indicate a fault in the ACC system. Contact a local authorized dealer for service → page 165.

Air Suspension Fault Warning Light — If Equipped



This light will illuminate when a fault is detected with the air suspension system.

Anti-Lock Brake System (ABS) Warning Light



This warning light monitors the ABS. The light will turn on when the ignition is placed in the ON/RUN or ACC/ON/RUN position and may stay on for as long as four seconds.

If the ABS light remains on or turns on while driving, then the Anti-Lock portion of the brake system is not functioning and service is required as soon as possible. However, the conventional brake system will continue to operate normally, assuming the Brake Warning Light is not also on.

If the ABS light does not turn on when the ignition is placed in the ON/RUN or ACC/ON/RUN position, have the brake system inspected by an authorized dealer.

Electronic Stability Control (ESC) Active Warning Light — If Equipped



This warning light will indicate when the ESC system is Active. The ESC Indicator Light in the instrument cluster will come on when the ignition is placed in the ON/RUN or ACC/ON/RUN position, and when ESC is activated. It should go out with the engine running. If the ESC Indicator Light comes on continuously with the engine running, a malfunction has been detected in the ESC system. If this warning light remains on after several ignition cycles, and the vehicle has been driven several miles (kilometers) at speeds greater than 30 mph (48 km/h), see an authorized dealer as soon as possible to have the problem diagnosed and corrected.

- The ESC OFF Indicator Light and the ESC Indicator Light come on momentarily each time the ignition is placed in the ON/RUN or ACC/ON/RUN position.

- The ESC system will make buzzing or clicking sounds when it is active. This is normal; the sounds will stop when ESC becomes inactive.
- This light will come on when the vehicle is in an ESC event.

Electronic Stability Control (ESC) OFF Warning Light — If Equipped



This warning light indicates the ESC is off.

Each time the ignition is turned to ON/RUN or ACC/ON/RUN, the ESC system will be on, even if it was turned off previously.

LaneSense Warning Light — If Equipped



The LaneSense system provides the driver with visual and steering torque warnings when the vehicle starts to drift out of its lane unintentionally without the use of a turn signal.

- When the LaneSense system senses a lane drift situation, the LaneSense indicator changes from solid green to solid yellow.
- When the LaneSense system senses the lane has been approached and is in a lane departure situation, the LaneSense indicator changes from solid white/green to flashing yellow → page 176.

Low Washer Fluid Warning Light



This warning light will illuminate when the windshield washer fluid is low.

Low Fuel Warning Light



When the fuel level reaches approximately 3.2 gal (12 L) this light will turn on, and remain on until fuel is added.

A single warning chime will sound with Low Fuel Warning.

Low Coolant Level Warning Light



This telltale will turn on to indicate the vehicle coolant level is low.

Loose Fuel Filler Cap Warning Light — If Equipped



This warning light will illuminate when the fuel filler cap is loose. Properly close the filler cap to disengage the light. If the light does not turn off, please see an authorized dealer.

Engine Check/Malfunction Indicator Warning Light (MIL)



The Engine Check/Malfunction Indicator Light (MIL) is a part of an Onboard Diagnostic System called OBD II that monitors engine and automatic transmission control systems. This warning light will illuminate when the ignition is in the ON/RUN position before engine start. If the bulb does not come on when turning the ignition switch from OFF to ON/RUN, have the condition checked promptly.

Certain conditions, such as a loose or missing gas cap, poor quality fuel, etc., may illuminate the light after engine start. The vehicle should be serviced if the light stays on through several typical driving styles. In most situations, the vehicle will drive normally and will not require towing.

When the engine is running, the MIL may flash to alert serious conditions that could lead to immediate loss of power or severe catalytic converter damage. The vehicle should be serviced by an authorized dealer as soon as possible if this occurs.

WARNING!

A malfunctioning catalytic converter can reach higher temperatures than in normal operating conditions. This can cause a fire if you drive slowly or park over flammable substances such as dry plants, wood, cardboard, etc. This could result in death or serious injury to the driver, occupants or others.

CAUTION!

Prolonged driving with the Malfunction Indicator Light (MIL) on could cause damage to the vehicle control system. It also could affect fuel economy and drivability. If the MIL is flashing, severe catalytic converter damage and power loss will soon occur. Immediate service is required.

Rear Axle Locker Fault Warning Light — If Equipped



This warning light will illuminate to indicate when a rear axle locker fault has been detected.

Service Forward Collision (FCW) or Pedestrian Emergency Braking (PEB) Warning Light — If Equipped



This warning light will illuminate to indicate a fault in the Forward Collision Warning (FCW) or Pedestrian Emergency Braking (PEB) System. Contact an authorized dealer for service. [↩](#) page 278.

Service LaneSense Warning Light — If Equipped



This warning light will illuminate when the LaneSense system is not operating and requires service. Please see an authorized dealer.

Service 4WD Warning Light — If Equipped



This warning light will illuminate to signal a fault with the 4WD system. If the light stays on or comes on during driving, it means that the 4WD system is not functioning properly and that service is required. Drive to the nearest service center and have the vehicle serviced immediately.

Cruise Control Fault Warning Light



This warning light will illuminate to indicate the Cruise Control System is not functioning properly and service is required. Contact an authorized dealer.

Sway Bar Fault Warning Light



This light will illuminate when there is a fault in the sway bar disconnect system.

Tire Pressure Monitoring System (TPMS) Warning Light



The warning light switches on and a message is displayed to indicate that the tire pressure is lower than the recommended value and/or that slow pressure loss is

occurring. In these cases, optimal tire duration and fuel consumption may not be guaranteed.

Should one or more tires be in the condition previously mentioned, the display will show the indications corresponding to each tire.

CAUTION!

Do not continue driving with one or more flat tires as handling may be compromised. Stop the vehicle, avoiding sharp braking and steering. If a tire puncture occurs, repair immediately using the dedicated tire repair kit and contact an authorized dealer as soon as possible.

Each tire, including the spare (if provided), should be checked monthly when cold and inflated to the inflation pressure recommended by the vehicle manufacturer on the vehicle placard or tire inflation pressure label. If your vehicle has tires of a different size than the size indicated on the vehicle placard or tire inflation pressure label, you should determine the proper tire inflation pressure for those tires.

As an added safety feature, your vehicle has been equipped with a TPMS that illuminates a low tire pressure telltale when one or more of your tires is significantly underinflated. Accordingly, when the low tire pressure telltale illuminates, you should stop and check your tires as soon as possible, and inflate them to the proper pressure. Driving on a significantly underinflated tire causes the tire to overheat and can lead to tire failure. Underinflation also reduces fuel efficiency and tire tread life, and may affect the vehicle's handling and stopping ability.

Please note that the TPMS is not a substitute for proper tire maintenance, and it is the driver's responsibility to maintain correct tire pressure, even if underinflation has not reached the level to trigger illumination of the TPMS low tire pressure telltale.

Your vehicle has also been equipped with a TPMS malfunction indicator to indicate when the system is not operating properly. The TPMS malfunction indicator is combined with the low tire pressure telltale. When the system detects a malfunction, the telltale will flash for approximately one minute and then remain continuously illuminated. This sequence will continue upon subsequent vehicle start-ups as long as the malfunction exists. When the malfunction indicator is illuminated, the system may not be able to detect or signal low tire pressure as intended. TPMS malfunctions may occur for a variety of reasons, including the installation of replacement or alternate tires or wheels on the vehicle that prevent the TPMS from functioning properly. Always check the TPMS malfunction telltale after replacing one or more tires or wheels on your vehicle to ensure that the replacement or alternate tires and wheels allow the TPMS to continue to function properly.

CAUTION!

The TPMS has been optimized for the original equipment tires and wheels. TPMS pressures and warning have been established for the tire size equipped on your vehicle. Undesirable system operation or sensor damage may result when using replacement equipment that is not of the same size, type, and/or style. Aftermarket wheels can cause sensor damage. Using aftermarket tire sealants may cause the Tire Pressure Monitoring System (TPMS) sensor to become inoperable. After using an aftermarket tire sealant it is recommended that you take your vehicle to an authorized dealer to have your sensor function checked.

3

YELLOW INDICATOR LIGHTS

Air Suspension Alternate Trailer Height Indicator Light — If Equipped



This light will illuminate when the air suspension system is set to the Alternate Trailer Height setting → page 146.

Air Suspension Bed Lowering Mode Indicator Light — If Equipped



This light will illuminate when the Bed Lowering mode procedure is complete → page 146.

Air Suspension Payload Protection Indicator Light — If Equipped



This indicator light will illuminate to indicate that the maximum payload may have been exceeded or load leveling cannot be achieved at its current ride height. Protection mode will automatically be selected in order to “protect” the air suspension system, air suspension adjustment is limited due to payload.

Air Suspension Ride Height Raising Indicator Light — If Equipped



This light will blink and alert the driver that the vehicle is changing to a higher ride height ↪ page 146.

Air Suspension Ride Height Lowering Indicator Light — If Equipped



This light will blink and alert the driver that the vehicle is changing to a lower ride height ↪ page 146.

Cargo Indicator Light — If Equipped



This indicator light will illuminate when the cargo light is activated by pushing the cargo light button on the headlight switch.

Cold Ambient Derate Mode Indicator Light — If Equipped



This indicator light will illuminate when a derate (engine power reduction) is activated for protection of the turbocharger in cold ambient temperatures.

Diesel Exhaust Brake Indicator Light — If Equipped



This indicator light will illuminate when the Diesel Exhaust Brake has been activated, and is in full strength mode ↪ page 132.

Forward Collision Warning (FCW) or Pedestrian Emergency Braking (PEB) Off Indicator Light — If Equipped



This indicator light illuminates to indicate that Forward Collision Warning (FCW) or Pedestrian Emergency Braking (PEB) is off.

Front And Rear Axle Lock Indicator Light



This light indicates when the front, rear, or both axles have been locked. The telltale will display the lock icon on the front and rear axles to indicate the current lock status.

Low Diesel Exhaust Fluid (DEF) Indicator Light — If Equipped



The Low DEF Indicator will illuminate if the vehicle is low on DEF ↪ page 350.

NEUTRAL Indicator Light — If Equipped



This light alerts the driver that the 4WD power transfer case is in the NEUTRAL mode and the front and rear driveshafts are disengaged from the powertrain.

Rear Axle Lock Indicator Light



This light indicates when the rear axle lock has been activated ↪ page 140.

4WD Lock Indicator Light



This light alerts the driver that the vehicle is in the 4WD Lock mode. The front and rear driveshafts are mechanically locked together, forcing the front and rear wheels to rotate at the same speed ↪ page 140.

4WD Low Indicator Light — If Equipped



This light alerts the driver that the vehicle is in the 4WD Low mode. The front and rear driveshafts are mechanically locked together forcing the front and rear wheels to rotate at the same speed. Low range provides a greater gear reduction ratio to provide increased torque at the wheels ↪ page 140.

4WD High Indicator Light — If Equipped



This light alerts the driver that the vehicle is in the 4WD High mode. The front and rear driveshafts are mechanically locked together forcing the front and rear wheels to rotate at the same speed.

Snowplow Mode Indicator Light — If Equipped



This indicator light will illuminate when Snowplow mode has been activated ↪ page 203.

Sway Bar Indicator Light — If Equipped

This indicator light will illuminate when the front sway bar is disconnected.

TOW/HAUL Indicator Light

This indicator light will illuminate when TOW/HAUL mode is selected.

Trailer Merge Assist Indicator Light — If Equipped

This indicator light will illuminate to indicate when Trailer Merge Assist has been activated → page 273.

Water In Fuel Indicator Light — If Equipped

The Water In Fuel Indicator Light will illuminate when there is water detected in the fuel filter. If this light remains on, DO NOT start the vehicle before you drain the water from the fuel filter to prevent engine damage.

Wait To Start Indicator Light — If Equipped

This indicator light will illuminate for approximately two seconds when the ignition is turned to the RUN position. Its duration may be longer based on colder operating conditions. Vehicle will not initiate start until telltale is no longer displayed → page 123.

NOTE:

The Wait To Start telltale may not illuminate if the intake manifold temperature is warm enough.

GREEN INDICATOR LIGHTS**Adaptive Cruise Control (ACC) Set With Target Indicator Light — If Equipped**

This will display when the ACC is set and a vehicle in front is detected → page 165.

Adaptive Cruise Control (ACC) Set With No Target Detected Indicator Light — If Equipped

This light will turn on when the Adaptive Cruise Control is SET and there is no vehicle in front detected → page 165.

Cruise Control Set Indicator Light — If Equipped

This indicator light will illuminate when the cruise control is set to the desired speed → page 163.

Automatic Diesel Exhaust Brake Indicator Light — If Equipped

This indicator light will illuminate when the Diesel Exhaust Brake has been activated, and has switched to Automatic mode → page 132.

ECO Mode Indicator Light — If Equipped

This light will turn on when ECO mode is active.

Front Fog Indicator Light — If Equipped

This indicator light will illuminate when the front fog lights are on.

LaneSense Indicator Light — If Equipped

The LaneSense indicator light illuminates solid green when both lane markings have been detected and the system is armed and ready to provide visual and torque warnings if an unintentional lane departure occurs → page 176.

Parking/Headlights On Indicator Light

This indicator light will illuminate when the parking lights or headlights are turned on.

Turn Signal Indicator Lights

When the left or right turn signal is activated, the turn signal indicator will flash independently and the corresponding exterior turn signal lamps will flash. Turn signals can be activated when the multifunction lever is moved down (left) or up (right).

NOTE:

- A continuous chime will sound if the vehicle is driven more than 1 mile (1.6 km) with either turn signal on.
- Check for an inoperative outside light bulb if either indicator flashes at a rapid rate.
- If equipped with fog lamps, the fog lamp on the side of the activated turn signal will also illuminate to provide additional light when turning.

WHITE INDICATOR LIGHTS**Adaptive Cruise Control (ACC) Ready Indicator Light — If Equipped**

This light will illuminate when the vehicle equipped with ACC has been turned on but not set → page 165.

Cruise Control Ready Indicator Light

This indicator light will illuminate when the cruise control is ready, but not set → page 163.

Hill Descent Control (HDC) Indicator Light — If Equipped

This indicator shows when the HDC feature is turned on. The light will be on solid when HDC is armed. HDC can only be armed when the transfer case is in the 4WD Low position and the vehicle speed is less than 20 mph (32 km/h). If these conditions are not met while attempting to use the HDC feature, the HDC indicator light will flash on/off.

LaneSense Indicator Light — If Equipped

When the LaneSense system is ON, but not armed, the LaneSense indicator light illuminates solid white. This occurs when only left, right, or neither lane line has been detected.

If a single lane line is detected, the system is ready to provide only visual warnings if an unintentional lane departure occurs on the detected lane line → page 176.

BLUE INDICATOR LIGHTS**High Beam Indicator Light**

This indicator light will illuminate to indicate that the high beam headlights are on. With the low beams activated, push the multifunction lever forward (toward the front of the vehicle) to turn on the high beams. Pull the multifunction lever rearward (toward the rear of the vehicle) to turn off the high beams. If the high beams are off, pull the lever toward you for a temporary high beam on, "flash to pass" scenario.

ONBOARD DIAGNOSTIC SYSTEM — OBD II

Your vehicle is equipped with a sophisticated Onboard Diagnostic system called OBD II. This system monitors the performance of the emissions, engine, and transmission control systems. When these systems are operating properly, your vehicle will provide excellent performance and fuel economy, as well as engine emissions well within current government regulations.

If any of these systems require service, the OBD II system will turn on the Malfunction Indicator Light (MIL). It will also store diagnostic codes and other information to assist your service technician in making repairs. Although your vehicle will usually be drivable and not need towing, see an authorized dealer for service as soon as possible.

CAUTION!

- Prolonged driving with the MIL on could cause further damage to the emission control system. It could also affect fuel economy and driveability. The vehicle must be serviced before any emissions tests can be performed.
- If the MIL is flashing while the vehicle is running, severe catalytic converter damage and power loss will soon occur. Immediate service is required.

ONBOARD DIAGNOSTIC SYSTEM (OBD II) CYBERSECURITY

Your vehicle is required to have an OBD II and a connection port to allow access to information related to the performance of your emissions controls. Authorized service technicians may need to access this information to assist with the diagnosis and service of your vehicle and emissions system → page 209.

WARNING!

- ONLY an authorized service technician should connect equipment to the OBD II connection port in order to read the VIN, diagnose, or service your vehicle.
- If unauthorized equipment is connected to the OBD II connection port, such as a driver-behavior tracking device, it may:
 - Be possible that vehicle systems, including safety related systems, could be impaired or a loss of vehicle control could occur that may result in an accident involving serious injury or death.
 - Access, or allow others to access, information stored in your vehicle systems, including personal information.

EMISSIONS INSPECTION AND MAINTENANCE PROGRAMS

In some localities, it may be a legal requirement to pass an inspection of your vehicle's emissions control system. Failure to pass could prevent vehicle registration.



For states that require an Inspection and Maintenance (I/M), this check verifies the Malfunction Indicator Light (MIL) is functioning and is not on when the engine is running, and that the OBD II system is ready for testing.

Normally, the OBD II system will be ready. The OBD II system may **not** be ready if your vehicle was recently serviced, recently had a depleted battery or a battery replacement. If the OBD II system should be determined not ready for the I/M test, your vehicle may fail the test.

Your vehicle has a simple ignition actuated test, which you can use prior to going to the test station. To check if your vehicle's OBD II system is ready, you must do the following:

1. Cycle the ignition switch to the ON position, but do not crank or start the engine.

NOTE:

If you crank or start the engine, you will have to start this test over.

2. As soon as you cycle the ignition switch to the ON position, you will see the Malfunction Indicator Light (MIL) symbol come on as part of a normal bulb check.
3. Approximately 15 seconds later, one of two things will happen:
 - The MIL will flash for about 10 seconds and then return to being fully illuminated until you turn OFF the ignition or start the engine. This means that your vehicle's OBD II system is **not ready** and you should **not** proceed to the I/M station.
 - The MIL will not flash at all and will remain fully illuminated until you place the ignition in the off position or start the engine. This means that your vehicle's OBD II system is **ready** and you can proceed to the I/M station.

If your OBD II system is **not ready**, you should see an authorized dealer or repair facility. If your vehicle was recently serviced or had a battery failure or replacement, you may need to do nothing more than drive your vehicle as you normally would in order for your OBD II system to update. A recheck with the previous mentioned test routine may then indicate that the system is **now ready**.

Regardless of whether your vehicle's OBD II system is ready or not, if the MIL is illuminated during normal vehicle operation you should have your vehicle serviced before going to the I/M station. The I/M station can fail your vehicle because the MIL is on with the engine running.

STARTING AND OPERATING

STARTING THE ENGINE — GASOLINE ENGINE

Before starting your vehicle, adjust your seat, adjust both inside and outside mirrors, and fasten your seat belts.

The starter should not be operated for more than 10-second intervals. Waiting 10 - 15 seconds between such intervals will protect the starter from overheating.

WARNING!

- When leaving the vehicle, always make sure the keyless ignition node is in the OFF position, remove the key fob from the vehicle and lock the vehicle.
- Never leave children alone in a vehicle, or with access to an unlocked vehicle. Allowing children to be in a vehicle unattended is dangerous for a number of reasons. A child or others could be seriously or fatally injured. Children should be warned not to touch the parking brake, brake pedal or the gear selector.
- Do not leave the key fob in or near the vehicle, or in a location accessible to children, and do not leave the ignition of a vehicle equipped with Keyless Enter 'n Go™ in the ACC or ON/RUN position. A child could operate power windows, other controls, or move the vehicle.
- Do not leave children or animals inside parked vehicles in hot weather. Interior heat buildup may cause serious injury or death.

AUTOMATIC TRANSMISSION

Start the engine with the transmission in PARK position. Apply the brake before shifting into any driving range.

NOTE:

- This vehicle is equipped with a transmission shift interlocking system. The brake pedal must be pressed to shift out of PARK.
- If equipped with an 8-speed transmission, starting the vehicle in NEUTRAL is not possible unless the Manual Park Release has been activated
 page 327.
- The brake pedal needs to be pressed to allow the vehicle to stay running.

TIP START FEATURE

Do not press the accelerator. Place the ignition switch briefly to the START position and release it. The starter motor will continue to run and will automatically disengage when the engine is running.

KEYLESS ENTER 'N GO™ — IGNITION

This feature allows the driver to operate the ignition switch with the push of a button, as long as the Remote Start/Keyless Enter 'n Go™ key fob is in the passenger compartment.

NORMAL STARTING USING ENGINE START/STOP BUTTON

To Turn On The Engine Using The ENGINE START/STOP Button

1. The transmission must be in PARK.
2. Press and hold the brake pedal while pushing the ENGINE START/STOP button once.
3. The system takes over and attempts to start the vehicle. If the vehicle fails to start, the starter will disengage automatically after 10 seconds.
4. If you wish to stop the cranking of the engine prior to the engine starting, push the ENGINE START/STOP button again.

NOTE:

Normal starting of either a cold or a warm engine is obtained without pumping or pressing the accelerator pedal.

To Turn Off The Engine Using The ENGINE START/STOP Button

1. Place the gear selector in PARK, then push and release the ENGINE START/STOP button.
2. The ignition will return to the OFF position.
3. If the gear selector is not in PARK, the ENGINE START/STOP button must be held for two seconds or three short pushes in a row with the vehicle speed above 5 mph (8 km/h) before the engine will shut off. The ignition will remain in the ACC position until the gear selector is in PARK and the button is pushed twice to the OFF position.

4. If the gear selector is not in PARK and the ENGINE START/STOP button is pushed once with the vehicle speed above 5 mph (8 km/h), the instrument cluster will display a “**Vehicle Not In Park**” message and the engine will remain running. Never leave a vehicle out of the PARK position, or it could roll.

NOTE:

If the gear selector is not in PARK, and the ENGINE START/STOP button is pushed once with the vehicle speed below 5 mph (8 km/h), the engine will shut off and the ignition will remain in the ACC position. If vehicle speed drops below 1.2 mph (1.9 km/h), the vehicle may AutoPark → page 121.

ENGINE START/STOP Button Functions — With Driver's Foot Off The Brake Pedal (In PARK Or NEUTRAL Position)

The ENGINE START/STOP button operates similar to an ignition switch. It has three positions: OFF, ACC, and ON/RUN. To change the ignition positions without starting the vehicle and use the accessories, follow these directions:

1. Start with the ignition in the OFF position.
2. Push the ENGINE START/STOP button once to place the ignition to the ACC position.
3. Push the ENGINE START/STOP button a second time to place the ignition to the ON/RUN position.
4. Push the ENGINE START/STOP button a third time to return the ignition to the OFF position.

AUTOPARK — ROTARY SHIFTER AND 8-SPEED TRANSMISSION ONLY

AutoPark is a supplemental feature to assist with placing the vehicle in PARK should the situations on the following pages occur. It is a back-up system and should not be relied upon as the primary method by which the driver shifts the vehicle into PARK.

The conditions under which AutoPark will engage are outlined on the following pages.

WARNING!

- Driver inattention could lead to failure to place the vehicle in PARK. ALWAYS DO A VISUAL CHECK that your vehicle is in PARK by verifying that a solid (not blinking) “P” is indicated in the instrument cluster display and near the gear selector. If the “P” indicator is blinking, your vehicle is not in PARK. As an added precaution, always apply the parking brake when exiting the vehicle.
- AutoPark is a supplemental feature. It is not designed to replace the need to shift your vehicle into PARK. It is a back-up system and should not be relied upon as the primary method by which the driver shifts the vehicle into PARK.

If the vehicle is not in PARK and the driver turns off the engine, the vehicle may AutoPark.

AutoPark will engage when all of these conditions are met:

- Vehicle is equipped with a rotary shifter and an 8-speed transmission
- Vehicle is not in PARK
- Vehicle speed is 1.2 mph (1.9 km/h) or less
- Ignition is switched from ON/RUN to ACC

NOTE:

For Keyless Enter 'n Go™ equipped vehicles, the engine will turn off and the ignition switch will change to ACC position. After 30 minutes the ignition switches to OFF automatically, unless the driver turns the ignition switch off.

If the vehicle is not in PARK and the driver exits the vehicle with the engine running, the vehicle may AutoPark.

AutoPark will engage when all of these conditions are met:

- Vehicle is equipped with a rotary shifter and an 8-speed transmission
- Vehicle is not in PARK
- Vehicle speed is 1.2 mph (1.9 km/h) or less
- Driver's seat belt is unbuckled
- Driver's door is ajar
- Brake pedal is not pressed

The message “**AutoPark Engaged Shift To P Then Shift To Gear**” will display in the instrument cluster.

NOTE:

In some cases the ParkSense graphic will be displayed in the instrument cluster, causing the “**AutoPark Engaged Shift To P Then Shift To Gear**” to not be seen. In these cases, the shifter must be returned to “P” to select desired gear.

If the driver shifts into PARK while moving, the vehicle may AutoPark.

AutoPark will engage **ONLY** when vehicle speed is 1.2 mph (1.9 km/h) or less.

The message “**Vehicle Speed Is Too High To Shift To P**” will be displayed in the instrument cluster if vehicle speed is above 1.2 mph (1.9 km/h).

WARNING!

If vehicle speed is above 1.2 mph (1.9 km/h), the transmission will default to NEUTRAL until the vehicle speed drops below 1.2 mph (1.9 km/h). A vehicle left in the NEUTRAL position can roll. As an added precaution, always apply the parking brake when exiting the vehicle.

4WD Low — If Equipped

AutoPark will be disabled when operating the vehicle in 4WD Low.

The message “AutoPark Disabled” will be displayed in the instrument cluster.

Additional customer warnings will be given when all of these conditions are met:

- Vehicle is not in PARK
- Driver’s door is ajar
- Vehicle is in 4WD Low range

The message “AutoPark Not Engaged” will be displayed in the instrument cluster. A warning chime will continue until you shift the vehicle into PARK or the driver’s door is closed.

ALWAYS DO A VISUAL CHECK that your vehicle is in PARK by looking for the “P” in the instrument cluster display and near the shifter. As an added precaution, always apply the parking brake when exiting the vehicle.

EXTENDED PARK STARTING**NOTE:**

Extended Park condition occurs when the vehicle has not been started or driven for at least 30 days.

1. Install a battery charger or jumper cables to the battery to ensure a full battery charge during the crank cycle.
2. Place the ignition to the START position and release it when the engine starts. For Keyless Enter ‘n Go™ ignition systems, press and hold the brake pedal while pushing the ENGINE START/STOP button once.
3. If the engine fails to start within 10 seconds, wait 10 to 15 seconds to allow the starter to cool, then repeat the Extended Park Starting procedure.
4. If the engine fails to start after eight attempts, allow the starter to cool for at least 10 minutes, then repeat the Extended Park Starting procedure.

CAUTION!

To prevent damage to the starter, do not crank continuously for more than 10 seconds at a time. Wait 10 to 15 seconds before trying again.

IF ENGINE FAILS TO START

If the engine fails to start after you have followed the “Normal Starting” procedure and the vehicle has not experienced an Extended Park condition as previously defined, it may be flooded. Push the accelerator pedal all the way to the floor and hold it there while the engine is cranking. This should clear any excess fuel in case the engine is flooded.

The starter motor will engage automatically, run for 10 seconds, and then disengage. Once this occurs, release the accelerator pedal and the brake pedal, wait 10 to 15 seconds, then repeat the “Normal Starting” procedure.

WARNING!

- Never pour fuel or other flammable liquid into the throttle body air inlet opening in an attempt to start the vehicle. This could result in flash fire causing serious personal injury.
- Do not attempt to push or tow your vehicle to get it started. Vehicles equipped with an automatic transmission cannot be started this way. Unburned fuel could enter the catalytic converter and once the engine has started, ignite and damage the converter and vehicle.
- If the vehicle has a discharged battery, booster cables may be used to obtain a start from a booster battery or the battery in another vehicle. This type of start can be dangerous if done improperly → page 326.

CAUTION!

To prevent damage to the starter, do not crank the engine for more than 10 seconds at a time. Wait 10 to 15 seconds before trying again.

If the engine has been flooded, it may start to run, but not have enough power to continue running when the ignition button/key is released. If this occurs, continue cranking with the accelerator pedal pushed all the way to the floor. Release the accelerator pedal and the ignition button/key once the engine is running smoothly.

If the engine shows no sign of starting after a 10 second period of engine cranking with the accelerator pedal held to the floor, wait 10 to 15 seconds, then repeat the “Normal Starting” procedure.

COLD WEATHER OPERATION (BELOW -22°F OR -30°C)

To ensure reliable starting at these temperatures, use of an externally powered electric engine block heater (available from an authorized dealer) is recommended.

AFTER STARTING

The idle speed is controlled automatically, and it will decrease as the engine warms up.

STARTING THE ENGINE — DIESEL ENGINE

Before starting your vehicle, adjust your seat, adjust both inside and outside mirrors, and fasten your seat belts.

The starter should not be operated for more than 25-second intervals. Waiting two minutes between such intervals will protect the starter from overheating.

WARNING!

- Do not leave children or animals inside parked vehicles in hot weather. Interior heat buildup may cause serious injury or death.
- When leaving the vehicle, always make sure the keyless ignition node is in the OFF position, remove the key fob from the vehicle and lock the vehicle.
- Never leave children alone in a vehicle, or with access to an unlocked vehicle. Allowing children to be in a vehicle unattended is dangerous for a number of reasons. A child or others could be seriously or fatally injured. Children should be warned not to touch the parking brake, brake pedal or the gear selector.

(Continued)

WARNING!

- Do not leave the key fob in or near the vehicle, or in a location accessible to children, and do not leave the ignition of a vehicle equipped with Keyless Enter 'n Go™ in the ACC or ON/RUN position. A child could operate power windows, other controls, or move the vehicle.

AUTOMATIC TRANSMISSION

Start the engine with the transmission in the NEUTRAL or PARK position. Apply the brake before shifting to any driving range.

Tip Start Feature

Do not press the accelerator. Place the ignition switch briefly to the START position and release it. The starter motor will continue to run and will automatically disengage when the engine is running.

KEYLESS ENTER 'N GO™ — IGNITION

This feature allows the driver to operate the ignition switch with the push of a button, as long as the Remote Start/Keyless Enter 'n Go™ key fob is in the passenger compartment.

Normal Starting

USING THE ENGINE START/STOP BUTTON

- The transmission must be in PARK or NEUTRAL.
- Press and hold the brake pedal while pushing the ENGINE START/STOP button once.
- The system takes over and attempts to start the vehicle. If the vehicle fails to start, the starter will disengage automatically after 25 seconds.

- If you wish to stop the cranking of the engine prior to the engine starting, remove your foot from the brake pedal and push the ENGINE START/STOP button again.

NOTE:

- Normal starting of either a cold or a warm engine is obtained without pumping or pressing the accelerator pedal.
- Under cold weather conditions, the engine may not immediately crank if the Wait To Start Indicator Light is illuminated. This is normal operation. For vehicles equipped with Keyless Enter 'n Go™, the vehicle will automatically crank when the Wait To Start time has elapsed  page 124.

TO TURN OFF THE ENGINE USING ENGINE START/STOP BUTTON

- Place the gear selector in PARK, then push and release the ENGINE START/STOP button.
- The ignition will return to the OFF position.
- If the gear selector is not in PARK and the ENGINE START/STOP button is pushed once, the instrument cluster will display a "Vehicle Not In Park" message and the engine will remain running. Never leave a vehicle out of the PARK position, or it could roll.
- If the gear selector is in NEUTRAL, and the vehicle speed below 5 mph (8 km/h), pushing the ENGINE START/STOP button once will turn the engine off. The ignition will remain in the ACC position.
- If the vehicle speed is above 5 mph (8 km/h), the ENGINE START/STOP button must be held for two seconds (or three short pushes in a row) to turn the engine off. The ignition will remain in the ACC position (NOT the OFF position) if the engine is turned off when the transmission is not in PARK.

NOTE:

If the ignition is left in the ACC or ON/RUN (engine not running) position and the transmission is in PARK, the system will automatically time out after 30 minutes of inactivity and the ignition return to the OFF position.

ENGINE START/STOP BUTTON FUNCTIONS — WITH DRIVER'S FOOT OFF THE BRAKE PEDAL (IN PARK OR NEUTRAL POSITION)

The ENGINE START/STOP button operates similar to an ignition switch. It has three positions, OFF, ACC, and ON/RUN. To change the ignition switch positions without starting the vehicle and use the accessories follow these steps:

1. Start with the ignition in the OFF position.
2. Push the ENGINE START/STOP button once to change the ignition to the ACC position.
3. Push the ENGINE START/STOP button a second time to change the ignition to the ON/RUN position.
4. Push the ENGINE START/STOP button a third time to return the ignition to the OFF position.

Keyless Enter 'n Go™ Starting Procedure — Engine Manifold Air Temperature 0° F To 66° F (-18° C to 19° C)

NOTE:

The temperature displayed in the instrument cluster does not necessarily reflect the engine manifold air temperature → page 101. When engine temperatures fall below 66° F (19° C) the Wait To Start Indicator Light will remain on indicating the intake air heater system is active.

Follow the steps in the “Normal Starting” procedure except:

1. Pushing the ENGINE START/STOP button with the driver's foot on the brake will move the ignition from OFF or ACC to ON/RUN, and will illuminate the Wait To Start Indicator Light. The engine will not immediately crank, this is normal operation.
2. The Wait To Start Indicator Light will remain on for a period of time that varies depending on the engine temperature.
3. While the Wait To Start Indicator Light is on, the instrument cluster will additionally display a gauge or bar whose initial length represents the full Wait to Start time period. Its length will decrease until it disappears when the Wait to Start time has elapsed.

CAUTION!

If the Water in Fuel Indicator Light remains on, DO NOT START the engine before you drain the water from the fuel filters to avoid engine damage.

4. After the engine Wait To Start Indicator Light goes off, the engine will automatically crank.

CAUTION!

Do not crank the engine for more than 25 seconds at a time or starter motor damage may result. Turn the ignition switch to the OFF position and wait at least two minutes for the starter to cool before repeating start procedure.

5. After engine start-up, check to see that there is oil pressure.
6. Release the parking brake and drive.

NOTE:

- Engine idle speed will automatically increase to 1,000 RPM and engage the Variable Geometry Turbocharger at low coolant temperatures to improve engine warm-up.
- The engine will not automatically crank after the engine Wait To Start Indicator Light goes off if a door or the hood is ajar.
- If the engine stalls, or if the ignition switch is left ON for more than two minutes after the Wait To Start Indicator Light goes out, reset the intake air heater by turning the ignition switch to the OFF position for at least five seconds and then back ON. Repeat steps 1 through 6 of “Keyless Enter 'n Go™ Starting Procedure – Engine Manifold Air Temperature 0° F To 66° F (-18° C to 19° C).”

EXTREME COLD WEATHER

The Cummins® Turbo Diesel engine is equipped with several features designed to assist cold weather starting and operation:

- The engine block heater is a resistance heater installed in the water jacket of the engine just above and behind the oil filter. It requires a 110-115 Volt AC electrical outlet with a grounded, three-wire extension cord.

NOTE:

The engine block heater cord is a factory installed option. If your vehicle is not equipped, heater cords are available from an authorized Mopar® dealer.

- A 12 Volt heater built into the fuel filter housings aids in preventing fuel gelling. It is controlled by a built-in thermostat.
- An intake air heater system both improves engine starting and reduces the amount of white smoke generated by a warming engine.

NORMAL STARTING PROCEDURE — ENGINE MANIFOLD AIR TEMPERATURE ABOVE 66° F (19° C)

Observe the instrument panel cluster lights when starting the engine.

1. Always apply the parking brake.
2. Shift into PARK for an automatic transmission.
3. Place the ignition switch in the ON/RUN position and watch the instrument panel cluster lights.

CAUTION!

If the Water in Fuel Indicator Light remains on, DO NOT START the engine before you drain the water from the fuel filters to avoid engine damage.

4. Place the ignition switch in the START position and crank the engine. Do not press the accelerator during starting.

CAUTION!

Do not crank the engine for more than 25 seconds at a time or starter motor damage may result. Turn the ignition switch to the OFF position and wait at least two minutes for the starter to cool before repeating start procedure.

5. Check that the Oil Pressure Warning Light has turned off.
6. Release the parking brake.

STARTING PROCEDURE — ENGINE MANIFOLD AIR TEMPERATURE 0° F TO 66° F (-18° C TO 19° C)

NOTE:

The temperature displayed in the instrument cluster does not necessarily reflect the engine manifold air temperature ↪ page 101. When engine temperatures fall below 66° F (19° C) the Wait To Start Indicator Light will remain on indicating the intake air heater system is active.

Follow the steps in the "Normal Starting" procedure except:

1. The Wait To Start Indicator Light will remain on for a period of time that varies depending on the engine temperature.
2. While the Wait To Start Indicator Light is on, the instrument cluster will additionally display a gauge or bar whose initial length represents the full Wait To Start time period. Its length will decrease until it disappears when the Wait To Start time has elapsed.

CAUTION!

If the Water in Fuel Indicator Light remains on, DO NOT START the engine before you drain the water from the fuel filters to avoid engine damage.

3. After the Wait To Start Indicator Light goes off, place the ignition switch in the START position. Do not press the accelerator during starting.

CAUTION!

Do not crank the engine for more than 25 seconds at a time or starter motor damage may result. Turn the ignition switch to the OFF position and wait at least two minutes for the starter to cool before repeating start procedure.

4. After engine start-up, check that the Oil Pressure Warning Light has turned off.
5. Release the parking brake and drive.

NOTE:

- Engine idle speed will automatically increase to 1,000 RPM and engage the Variable Geometry Turbocharger at low coolant temperatures to improve engine warm-up.
- Automatic equipped vehicles with optional Keyless Enter 'n Go™ – If the start button is pushed once while in PARK with the ignition off and driver's foot on the brake pedal, the vehicle will automatically crank and start after the Wait to Start time has elapsed. If it is desired to abort the start process before it completes, the driver's foot should be fully removed from the brake pedal prior to pushing the start button again in order for the ignition to move directly to off.
- If the engine stalls, or if the ignition switch is left ON for more than two minutes after the Wait To Start Indicator Light goes out, reset the intake air heater by turning the ignition switch to the OFF position for at least five seconds and then back ON. Repeat steps 1 through 5 of "Starting Procedure – Engine Manifold Air Temperature 0° F To 66° F (-18° C to 19° C)."

STARTING PROCEDURE — ENGINE MANIFOLD AIR TEMPERATURE BELOW 0 °F (-18 °C)

In extremely cold weather below 0 °F (-18 °C) it may be beneficial to cycle the intake air heater twice before attempting to start the engine. This can be accomplished by turning the ignition off for at least 5 seconds and then back to the ON/RUN position after the Wait To Start Indicator Light has turned off, but before the engine is started. However, excessive cycling of the intake air heater will result in damage to the heater elements or reduced battery voltage.

NOTE:

If multiple pre-heat cycles are used before starting, additional engine run time may be required to maintain battery state of charge at a satisfactory level.

1. If the engine stalls after the initial start, the ignition must be turned to the OFF position for at least five seconds and then to the ON/RUN position to recycle the intake air heater.

NOTE:

Excessive white smoke and poor engine performance will result if intake air heater is not recycled.

2. Heat generated by the intake air heater dissipates rapidly in a cold engine. If more than two minutes pass between the time the Wait To Start Indicator Light turns off and the engine is started, recycle the intake air heater by turning the ignition switch to the OFF position for at least five seconds and then back to the ON/RUN position.

3. If the vehicle is driven and vehicle speed exceeds 19 mph (31 km/h) before the intake air heater post-heat (after start) cycle is complete, the intake air heater will shut off.
4. If the engine is cranked for more than 10 seconds, the post-heat cycle will turn off.

NOTE:

- Engine idle speed will automatically increase to 1,000 RPM and engage the Variable Geometry Turbocharger at low coolant temperatures to improve engine warm-up.
- When a diesel engine is allowed to run out of fuel or the fuel gels at low temperatures, air is pulled into the fuel system. If your engine has run out of fuel → page 349.
- If the engine stalls, or if the ignition switch is left ON for more than two minutes after the Wait To Start Indicator Light goes out, reset the intake air heater by turning the ignition switch to the OFF position for at least five seconds and then back ON. Repeat steps 1 through 5 of "Starting Procedure – Engine Manifold Air Temperature 0 °F to 66 °F (-18 °C to 19 °C)" → page 124.

STARTING FLUIDS

WARNING!

Starting fluids or flammable liquids must never be used in the Cummins® diesel engine (see Warning label). Never pour diesel fuel, flammable liquid, starting fluids (ether) into the air cleaner canister, air intake piping, or turbocharger inlet in an attempt to start the vehicle. This could result in a flash fire and explosion causing serious personal injury and engine damage.

The engine is equipped with an automatic electric air preheating system. If the instructions in this manual are followed, the engine should start in all conditions.

WARNING!

- Do not leave children or animals inside parked vehicles in hot weather. Interior heat buildup may cause serious injury or death.
- When leaving the vehicle, always make sure the keyless ignition node is in the OFF position, remove the key fob from the vehicle and lock the vehicle.
- Never leave children alone in a vehicle, or with access to an unlocked vehicle. Allowing children to be in a vehicle unattended is dangerous for a number of reasons. A child or others could be seriously or fatally injured. Children should be warned not to touch the parking brake, brake pedal or the gear selector.
- Do not leave the key fob in or near the vehicle, or in a location accessible to children, and do not leave the ignition of a vehicle equipped with Keyless Enter 'n Go™ in the ACC or ON/RUN position. A child could operate power windows, other controls, or move the vehicle.

NORMAL OPERATION — DIESEL ENGINE

Observe the following when the engine is operating:

- All message center lights are off.
- Malfunction Indicator Light (MIL) is off.
- Engine oil pressure is above 10 psi (69 kPa) at idle.
- Voltmeter operation:

The voltmeter may show a gauge fluctuation at various engine temperatures. This cycling operation is caused by the post-heat cycle of the intake manifold heater system. The number of cycles and the length of the cycling operation is controlled by the engine control module. Post-heat operation can run for several minutes, and then the electrical system and voltmeter needle will stabilize.

The cycling action will cause temporary dimming of the headlamps, interior lamps, and also a noticeable reduction in blower motor speed.

COLD WEATHER PRECAUTIONS

Operation in ambient temperature below 32°F (0°C) may require special considerations. The following charts suggest these options:

Fuel Operating Range

NOTE:

Use Ultra Low Sulfur Diesel (ULSD) Fuels **ONLY**.

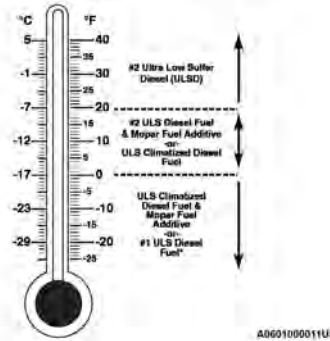

Fuel Operating Range Chart

*Number 1 Ultra Low Sulfur Diesel Fuel should only be used where extended arctic conditions (0°F/-18°C) exist.

NOTE:

- Use of Climatized Ultra Low Sulfur Diesel Fuel or Number 1 Ultra Low Sulfur Diesel Fuel results in a noticeable decrease in fuel economy.
- Climatized Ultra Low Sulfur Diesel Fuel is a blend of Number 2 Ultra Low Sulfur and Number 1 Ultra Low Sulfur Diesel Fuels which reduces the temperature at which wax crystals form in fuel.
- The fuel grade should be clearly marked on the pump at the fuel station.
- The engine requires the use of Ultra Low Sulfur Diesel Fuel. Use of incorrect fuel could result in engine and exhaust system damage → page 395.

- If Climatized or Diesel Number 1 ULSD fuel is not available, and you are operating below (20°F/-6°C), in sustained arctic conditions, Mopar® Premium Diesel Fuel Treatment (or equivalent) is recommended to avoid gelling (see Fuel Operating Range Chart).
- Under some circumstances increased engine noise may be audible in the seconds following a cold start. This is most likely to occur when using fuel that isn't blended for the ambient temperature present. This may occur on an unseasonably cold day or when a truck is fueled in a warmer climate and driven to a colder climate. The noise can typically be prevented by using Mopar® Premium Diesel Fuel Treatment as recommended (see Fuel Operating Range Chart).

Engine Oil Usage

For the correct engine oil viscosity → page 342.

Winter Front Cover Usage

A Winter front or cold weather cover is to be used in ambient temperatures below 32°F (0°C), especially during extended idle conditions. This cover is equipped with four flaps for managing total grille opening in varying ambient temperatures. If a Winter front or cold weather cover is to be used the flaps should be left in the full open position to allow air flow to the charge air cooler and automatic transmission oil cooler. When ambient temperatures drop below 0°F (-17°C) the four flaps need to be closed. A suitable cold weather cover is available from your Mopar® dealer.

Battery Blanket Usage

A battery loses 60% of its cranking power as the battery temperature decreases to 0 °F (-18 °C). For the same decrease in temperature, the engine requires twice as much power to crank at the same RPM. The use of 120 Volt AC powered battery blankets will greatly increase starting capability at low temperatures. Suitable battery blankets are available from an authorized Mopar® dealer.

Engine Warm-Up

Avoid full throttle operation when the engine is cold. When starting a cold engine, bring the engine up to operating speed slowly to allow the oil pressure to stabilize as the engine warms up.

NOTE:

High-speed, no-load running of a cold engine can result in excessive white smoke and poor engine performance. No-load engine speeds should be kept under 1,000 RPM during the warm-up period, especially in cold ambient temperature conditions.

Your vehicle is equipped with an engine warm-up protection feature that may limit engine performance after cold starting at low ambient temperatures. The length of time engine speed is limited is dependent upon engine coolant temperature. Engine speed may be briefly limited to 1,000 RPM after starting with coolant temperature below freezing conditions, and may be limited to 1,000 RPM for up to approximately two minutes under more severe cold conditions.

NOTE:

If ambient temperatures are low and the coolant temperature is below 180 °F (82 °C), the engine idle speed will slowly increase to 1,000 RPM after two minutes of idle, if the following conditions are met:

- Foot is off brake pedal and accelerator pedal.
- Automatic transmission is in PARK.
- Vehicle speed is 0 mph (0 km/h).
- Applying the accelerator pedal will cancel fast idle.
- Operating the exhaust brake at idle will greatly improve warm-up rate and will help keep the engine close to operating temperature during extended idle.

ENGINE IDLING

Avoid prolonged idling. Long periods of idling may be harmful to your engine because combustion chamber temperatures can drop so low that the fuel may not burn completely. Incomplete combustion allows carbon and varnish to form on piston rings, engine valves, and injector nozzles. Also, the unburned fuel can enter the crankcase, diluting the oil and causing rapid wear to the engine.

If the engine is allowed to idle or the truck is driven on low engine speed drive cycles for more than two hours, the system will automatically enter an emissions operating mode that will increase the engine idle speed to 900 RPM. While in this mode, which is designed to help maintain the diesel particulate filter, the engine idle speed will return to normal when the brake pedal is applied. A small change in engine tone or a slight change in engine performance while accelerating may also be noticeable at speeds below 20 mph (32 km/h). This operating mode may last for up to an hour of idle time, or around 20 minutes of driving time.

Your truck may have been ordered with an optional voltage monitoring Idle-Up feature. If a load is placed on the electrical system while the truck is in park, this feature will attempt to maintain normal system voltage by automatically increasing engine idle speed. You may notice several consecutive increases in idle speed, up to a maximum of 1,450 RPM, as the system will attempt to utilize the smallest increase in idle speed necessary to maintain normal system voltage. The idle speed will return to normal when either the electrical load is removed, or when the brake pedal is applied.

NOTE:

For instrument cluster display messages related to the vehicle's exhaust system → page 101.

Idle-Up Feature

The driver-controlled high idle speed feature will help increase cylinder temperatures and provide additional cab heat, however, excessive idling may still cause the exhaust aftertreatment system to not properly regenerate. Extended periods of idle time should be avoided.

The Idle-Up feature uses the Cruise Control buttons to increase engine idle speed and quickly warm the vehicle's interior.

1. With the transmission in PARK, the parking brake applied, and the engine running, push the On/Off button to the ON position, then push the SET (-) button.
2. The engine RPM will go up to 1,100 RPM. To increase the RPM, push and hold the RES (+) button and the idle speed will increase to approximately 1,500 RPM. To decrease the RPM, push and hold the SET (-) button and the idle speed will decrease to approximately 1,100 RPM.
3. To cancel the Idle-Up feature, either push the CANCEL button, push the On/Off button, or press the brake pedal.

NOISE

Diesel engines can create noises that may seem concerning. The nature of a diesel engine is compression ignition where compressed air and fuel are mixed and ignited. Weather, barometric pressure, altitude, and temperature will affect how fuel is ignited in the engine. Engines will sound different from day to day or previous model years. Clicking, ticking, or light knocking is normal and will change from day to day, as the engine breaks in, and can vary with changes in ambient temperature. Clicking sound from under the hood shortly after vehicle shutdown is normal as actuators such as the EGR valve are cycled.

Fuel pump noise may increase during low speed/light load conditions when ambient temperature is above 100 °F (38 °C), and when fuel tank level is below 10% which is a normal condition of the fuel system and controls strategy. Diesel equipped vehicles also have an exhaust after-treatment system to reduce emissions utilizing a Diesel Particulate Filter (DPF) and a Selective Reduction Catalyst (SCR). The SCR reduces Nitrogen Oxides (NOx) using the Diesel Exhaust Fluid (DEF) system. DEF is injected directly into the SCR through a dosing module. This process will create a clicking sound and at times, will make noise even with the vehicle shut off. This is normal as the DEF dosing module is purging DEF. If at any time the Check Engine Light is on, please visit an authorized dealer.

STOPPING THE ENGINE

Idle the engine a few minutes before routine shutdown. After full load operation, idle the engine three to five minutes before shutting it down. This idle period will allow the lubricating oil and coolant to carry excess heat away from the combustion chamber, bearings, internal components, and turbocharger. This is especially important for turbocharged, charge air-cooled engines. Refer to the following chart for proper engine shutdown:

Driving Condition	Load	Turbocharger Temperature	Idle Time (min.) Before Engine Shutdown
Stop and Go	Empty	Cool	Less than One
Stop and Go	Medium	-	One
Highway Speeds	Medium	Warm	Two
City Traffic	Maximum GCWR	-	Three
Highway Speeds	Maximum GCWR	-	Four
Uphill Grade	Maximum GCWR	Hot	Five

IDLE SHUTDOWN

This feature can be enabled so that the truck will automatically shutdown when the truck has been idling for a set period of time when the engine is at operating temperature. Idle time can be set in 5 minute increments between 5 and 60 minutes. See an authorized dealer to enable this feature.

NOTE:

The idle shutdown timer is disabled while the Power Take Off (PTO) is active.

PROGRAMMABLE MAXIMUM VEHICLE SPEED

This feature allows the owner to set a maximum vehicle speed for the vehicle. The 2500 and 3500 Series maximum vehicle speed can be set between 40 mph (64 km/h) and 87 mph (140 km/h).

NOTE:

DO NOT set the maximum vehicle speed to a value greater than what the vehicle tires are rated for.

OPERATING PRECAUTIONS

Avoid Overheating The Engine

The temperature of the engine coolant (antifreeze) (a mixture of 50% ethylene-glycol and 50% water) must not exceed the normal range of the temperature gauge 240 °F (116 °C) with a 21 psi (145 kPa) coolant pressure cap.

Usually the engine coolant (antifreeze) temperature indicated during operation will be to the left of center in the normal range of the gauge.

Avoid Low Coolant Temperature Operation

Continual operation at low engine coolant (antifreeze) temperature below the normal range on the gauge 140°F (60°C) can be harmful to the engine. Low engine coolant (antifreeze) temperature can cause incomplete combustion which allows carbon and varnish to form on piston rings and injector nozzles. Also, the unburned fuel can enter the crankcase, diluting the lubricating oil and causing rapid wear to the engine.

COOLING SYSTEM TIPS

To reduce potential for engine and transmission overheating in high ambient temperature conditions, take the following actions:

- City Driving — When stopped, shift the transmission into NEUTRAL and increase engine idle speed.
- Highway Driving — Reduce your speed.
- Up Steep Hills — Select a lower transmission gear.
- Air Conditioning — Turn it off temporarily.

Do Not Operate The Engine With Low Oil Pressure

When the engine is at normal operating temperature, the minimum oil pressures required are:

Idle 700 to 800 RPM	10 psi (69 kPa)
Full speed and load	30 psi (207 kPa)

CAUTION!

If oil pressure falls to less than normal readings, shut the engine off immediately. Failure to do so could result in immediate and severe engine damage.

Do Not Operate The Engine With Failed Parts

All engine failures give some warning before the parts fail. Be on the alert for changes in performance, sounds, and visual evidence that the engine requires service. Some important clues are:

- Engine misfiring or vibrating severely.
- Sudden loss of power.
- Unusual engine noises.
- Fuel, oil or coolant leaks.
- Sudden change, outside the normal operating range, in the engine operating temperature.
- Excessive smoke.
- Oil pressure drop.

ENGINE BLOCK HEATER — IF EQUIPPED

The engine block heater warms the engine, and permits quicker starts in cold weather. Connect the cord to a standard 110-115 Volt AC electrical outlet with a grounded, three-wire extension cord.

The engine block heater cord is routed behind the front bumper and accessible through the right hole of the air dam.

The engine block heater must be plugged in at least one hour to have an adequate warming effect on the engine.

It includes a removable cap that is secured by a tethered strap. It also has a c-clip that is used for storage when not in use for the Winter months. During Winter months, remove the heater cord wiring assembly from itself on the c-clip.

NOTE:

The block heater will require 110 Volt AC and 6.5 Amps to activate the heater element.

Block Heater Usage

For ambient temperatures below 0°F (-18°C), engine block heater usage is recommended.

For ambient temperatures below -20°F (-29°C), engine block heater usage is required.

ENGINE BREAK-IN RECOMMENDATIONS — GASOLINE ENGINE

A long break-in period is not required for the engine and drivetrain (transmission and axle) in your vehicle.

Drive moderately during the first 300 miles (500 km). After the initial 60 miles (100 km), speeds up to 50 or 55 mph (80 or 90 km/h) are desirable.

While cruising, brief full-throttle acceleration within the limits of local traffic laws contributes to a good break-in. Wide-open throttle acceleration in low gear can be detrimental and should be avoided.

The engine oil installed in the engine at the factory is a high-quality energy conserving type lubricant. Oil changes should be consistent with anticipated climate conditions under which vehicle operations will occur. For the recommended viscosity and quality grades  page 398.

CAUTION!

Never use Non-Detergent Oil or Straight Mineral Oil in the engine or damage may result.

NOTE:

A new engine may consume some oil during its first few thousand miles (kilometers) of operation. This should be considered a normal part of the break-in and not interpreted as a problem. Please check your oil level with the engine oil indicator often during the break in period. Add oil as required.

ENGINE BREAK-IN RECOMMENDATIONS — DIESEL ENGINE

The Cummins® Turbo Diesel engine does not require a break-in period due to its construction. Normal operation is allowed, providing the following recommendations are followed:

- Warm up the engine before placing it under load.
- Do not operate the engine at idle for prolonged periods.
- Use the appropriate transmission gear to prevent engine lugging.
- Observe vehicle oil pressure and temperature indicators.
- Check the coolant and oil levels frequently.
- Vary throttle position at highway speeds when carrying or towing significant weight.

NOTE:

Light duty operation such as light trailer towing or no load operation will extend the time before the engine is at full efficiency. Reduced fuel economy and power may be seen at this time.

For additional vehicle break-in requirements

↪ page 198.

Because of the construction of the Cummins® Turbo Diesel engine, engine run-in is enhanced by loaded operating conditions which allow the engine parts to achieve final finish and fit during the first 6,000 miles (10,000 km).

PARKING BRAKE

Before leaving the vehicle, make sure that the parking brake is fully applied. Also, be certain to leave the transmission in PARK.

The foot-operated parking brake is located below the lower left corner of the instrument panel. To apply the parking brake, firmly push the parking brake pedal fully. Vehicle should be completely stopped before the parking brake is applied. To release the parking brake, pull the parking brake release handle.

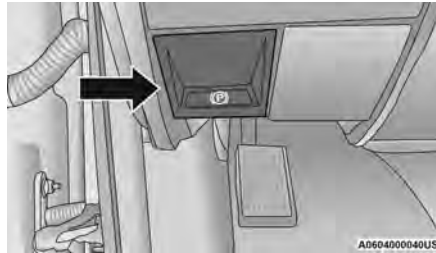

Parking Brake Release

When the parking brake is applied with the ignition switch ON, the Brake Warning Light in the instrument cluster will illuminate.

NOTE:

- When the parking brake is applied and the transmission is placed in gear, the Brake Warning Light will flash if vehicle speed is detected. A chime will sound if the vehicle speed is over 5 mph (8 km/h) to alert the driver. Fully release the parking brake before attempting to move the vehicle.
- This light only shows that the parking brake is applied. It does not show the degree of brake application.

When parking on a hill, it is important to turn the front wheels toward the curb on a downhill grade and away from the curb on an uphill grade. Apply the parking brake before placing the gear selector in PARK, otherwise the load on the transmission locking mechanism may make it difficult to move the gear selector out of PARK. The parking brake should always be applied whenever the driver is not in the vehicle.

4

WARNING!

- Never use the PARK position as a substitute for the parking brake. Always apply the parking brake fully when parked to guard against vehicle movement and possible injury or damage.
- Never leave children alone in a vehicle, or with access to an unlocked vehicle. Leaving unattended children in a vehicle is dangerous for a number of reasons. A child or others could be seriously or fatally injured.
- Do not leave the key fob in or near the vehicle, or in a location accessible to children, and do not leave a vehicle equipped with Keyless Enter 'n Go™ in the ACC or ON/RUN position. A child could operate power windows, other controls, or move the vehicle.

(Continued)

WARNING!

- Be sure the parking brake is fully disengaged before driving; failure to do so can lead to brake failure and a collision.
- Always fully apply the parking brake when leaving your vehicle or it may roll and cause damage or injury. Also, be certain to leave the transmission in PARK. Failure to do so may cause the vehicle to roll and cause damage or injury.

CAUTION!

If the Brake Warning Light remains on with the parking brake released, a brake system malfunction is indicated. Have the brake system serviced by an authorized dealer immediately.

DIESEL EXHAUST BRAKE — ENGINE BRAKING (IF EQUIPPED)

The purpose of the exhaust brake (engine braking) feature is to supply negative (braking) torque from the engine. Typically, the engine braking is used for, but not limited to, vehicle towing applications where vehicle braking can be achieved by the internal engine power, thereby sparing the mechanical brakes of the vehicle.

Benefits of the exhaust brake are:

- Vehicle driving control.
- Reduced brake fade.
- Longer brake life.
- Faster cab warm-up.

The exhaust brake feature will only function when the driver toggles it on by pushing the exhaust brake button until the Exhaust Brake Indicator is illuminated. Normal (Full Strength) exhaust brake mode is indicated by a yellow Exhaust Brake Indicator.

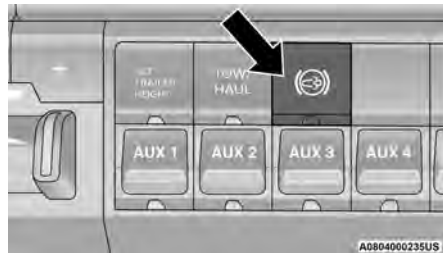

Exhaust Brake Switch

Once the Exhaust Brake Indicator is illuminated and the vehicle is moving faster than 5 mph (8 km/h), the exhaust brake will automatically operate when the driver removes pressure from the accelerator pedal. Exhaust braking is most effective when the engine RPM is higher. The automatic transmission will downshift more aggressively in TOW/HAUL mode when the exhaust brake is enabled to increase brake performance.

WARNING!

Do not use the exhaust brake feature when driving in icy or slippery conditions as the increased engine braking can cause the rear wheels to slide and the vehicle to swing around with the possible loss of vehicle control, which may cause an accident possibly resulting in personal injury or death.

CAUTION!

Use of aftermarket exhaust brakes is not recommended and could lead to engine damage.

NOTE:

For optimum braking power it is recommended to use the exhaust brake while in TOW/HAUL mode.

The exhaust brake feature can also be used to reduce the engine warm-up time. To use the exhaust brake as a warm-up device, the vehicle must be stopped or moving less than 5 mph (8 km/h), the Exhaust Brake Indicator must be on, and the coolant temperature must be below 180°F (82°C) and ambient temperature below 60°F (16°C).

Automatic “Smart” Exhaust Brake

Automatic “Smart” Exhaust Brake technology delivers smoother, less aggressive exhaust braking characteristics during downhill descents. Although it can apply full exhaust braking force if needed, Automatic “Smart” Exhaust Brake may not apply obvious braking if the vehicle speed is not increasing. Automatic “Smart” Exhaust Brake is intended to maintain vehicle speed, while Full Exhaust Brake is intended to reduce vehicle speed.

Automatic “Smart” Exhaust Brake can be enabled by pushing the exhaust brake button (on the center stack) again anytime after the normal Full Exhaust Brake has been turned on. The Exhaust Brake Indicator in the instrument cluster display will change from Yellow to Green when Automatic “Smart” Exhaust Brake is enabled. Pushing the exhaust brake button again will toggle the exhaust brake mode to off.

AUTOMATIC TRANSMISSION

You must press and hold the brake pedal while shifting out of PARK.

WARNING!

- Never use the PARK position as a substitute for the parking brake. Always apply the parking brake fully when exiting the vehicle to guard against vehicle movement and possible injury or damage.
- Your vehicle could move and injure you and others if it is not in PARK. Check by trying to move the transmission gear selector out of PARK with the brake pedal released. Make sure the transmission is in PARK before exiting the vehicle.
- The transmission may not engage PARK if the vehicle is moving. Always bring the vehicle to a complete stop before shifting to PARK, and verify that the transmission gear position indicator solidly indicates PARK (P) without blinking. Ensure that the vehicle is completely stopped, and the PARK position is properly indicated, before exiting the vehicle.
- It is dangerous to shift out of PARK or NEUTRAL if the engine speed is higher than idle speed. If your foot is not firmly pressing the brake pedal, the vehicle could accelerate quickly forward or in reverse. You could lose control of the vehicle and hit someone or something. Only shift into gear when the engine is idling normally and your foot is firmly pressing the brake pedal.

(Continued)

WARNING!

- Unintended movement of a vehicle could injure those in or near the vehicle. As with all vehicles, you should never exit a vehicle while the engine is running. Before exiting a vehicle, always come to a complete stop, then apply the parking brake, shift the transmission into PARK, and turn the ignition OFF. When the ignition is in the OFF position, the transmission is locked in PARK, securing the vehicle against unwanted movement.
- When exiting the vehicle, always make sure the ignition is in the OFF position, remove the key fob from the vehicle, and lock the vehicle.
- Never leave children alone in a vehicle, or with access to an unlocked vehicle. Allowing children to be in a vehicle unattended is dangerous for a number of reasons. A child or others could be seriously or fatally injured. Children should be warned not to touch the parking brake, brake pedal or the transmission gear selector.
- Do not leave the key fob in or near the vehicle (or in a location accessible to children), and do not leave the ignition in the ACC or ON/RUN position. A child could operate power windows, other controls, or move the vehicle.

CAUTION!

- Damage to the transmission may occur if the following precautions are not observed:
- Shift into or out of PARK or REVERSE only after the vehicle has come to a complete stop.

(Continued)

CAUTION!

- Do not shift between PARK, REVERSE, NEUTRAL, or DRIVE when the engine is above idle speed.
- Before shifting into any gear, make sure your foot is firmly pressing the brake pedal.

IGNITION PARK INTERLOCK

This vehicle is equipped with an Ignition Park Interlock which requires the transmission to be in PARK before the ignition can be turned to the OFF position. This helps the driver avoid inadvertently leaving the vehicle without placing the transmission in PARK. This system also locks the transmission in PARK whenever the ignition is in the OFF position.

NOTE:

The transmission is NOT locked in PARK when the ignition is in the ACC position (even though the engine will be off). Ensure that the transmission is in PARK, and the ignition is OFF (not in ACC position) before exiting the vehicle.

BRAKE/TRANSMISSION SHIFT INTERLOCK (BTSI) SYSTEM

This vehicle is equipped with a BTSI system that holds the transmission gear selector in PARK unless the brakes are applied. To shift the transmission out of PARK, the engine must be running and the brake pedal must be pressed.

The brake pedal must also be pressed to shift from NEUTRAL into DRIVE or REVERSE when the vehicle is stopped or moving at low speeds.

8-SPEED AUTOMATIC TRANSMISSION — IF EQUIPPED

The transmission is controlled using a rotary electronic gear selector located on the instrument panel. The transmission gear range (PRND) is displayed both above the gear selector and in the instrument cluster. To select a gear range, simply rotate the gear selector. You must press the brake pedal to shift the transmission out of PARK (or NEUTRAL, when the vehicle is stopped or moving at low speeds). To shift past multiple gear ranges at once (such as PARK to DRIVE), simply rotate the gear selector to the appropriate detent. Select the DRIVE range for normal driving.

NOTE:

In the event of a mismatch between the gear selector position and the actual transmission gear (for example, driver selects PARK while driving), the position indicator will blink continuously until the selector is returned to the proper position, or the requested shift can be completed.

The electronically controlled transmission adapts its shift schedule based on driver inputs, along with environmental and road conditions. The transmission electronics are self-calibrating; therefore, the first few shifts on a new vehicle may be somewhat abrupt. This is a normal condition, and precision shifts will develop within a few hundred miles (kilometers).

Only shift from DRIVE to PARK or REVERSE when the accelerator pedal is released and the vehicle is stopped. Be sure to keep your foot on the brake pedal when shifting between these gears.

The transmission gear selector has only PARK, REVERSE, NEUTRAL, and DRIVE positions. Manual downshifts can be made using the Electronic Range Select (ERS) shift control. Pushing the GEAR "+"/GEAR

"+" switches (on the steering wheel) while in the DRIVE position will select the highest available transmission gear, and will display that gear limit in the instrument cluster as 1, 2, 3, etc. ↪ page 135. Some models will display both the selected gear limit, and the actual current gear, while in ERS mode.

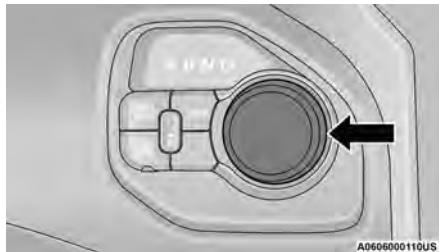

Electronic Transmission Gear Selector

Gear Ranges

Do not press the accelerator pedal when shifting from PARK or NEUTRAL into another gear range.

NOTE:

After selecting any gear range, wait a moment to allow the selected gear to engage before accelerating. This is especially important when the engine is cold.

PARK (P)

This range supplements the parking brake by locking the transmission. The engine can be started in this range. Never attempt to use PARK while the vehicle is in motion. Apply the parking brake when exiting the vehicle in this range.

When parking on a hill, apply the parking brake before shifting the transmission to PARK. As an added precaution, turn the front wheels toward the curb on a downhill grade and away from the curb on an uphill grade.

NOTE:

On four-wheel drive vehicles be sure that the transfer case is in a drive position.

When exiting the vehicle, always:

- Apply the parking brake.
- Shift the transmission into PARK.
- Turn the engine off.
- Remove the key fob.

CAUTION!

- DO NOT race the engine when shifting from PARK or NEUTRAL into another gear range, as this can damage the drivetrain.
- Before moving the transmission gear selector out of PARK, you must start the engine, and also press the brake pedal. Otherwise, damage to the gear selector could result.

The following indicators should be used to ensure that you have properly engaged the transmission into the PARK position:

- Look at the transmission gear position display and verify that it indicates the PARK position (P), and is not blinking.
- With the brake pedal released, verify that the gear selector will not move out of PARK.

REVERSE (R)

This range is for moving the vehicle backward. Shift into REVERSE only after the vehicle has come to a complete stop.

NEUTRAL (N)

Use this range when the vehicle is standing for prolonged periods with the engine running. Apply the parking brake and shift the transmission into PARK if you must exit the vehicle.

WARNING!

Do not coast in NEUTRAL and never turn off the ignition to coast down a hill. These are unsafe practices that limit your response to changing traffic or road conditions. You might lose control of the vehicle and have a collision.

CAUTION!

Towing the vehicle, coasting, or driving for any other reason with the transmission in NEUTRAL can cause severe transmission damage.

For Recreational Towing ↗ page 204.

For Towing A Disabled Vehicle ↗ page 329.

DRIVE (D)

This range should be used for most city and highway driving. It provides the smoothest upshifts and downshifts, and the best fuel economy. The transmission automatically upshifts through all forward gears.

When frequent transmission shifting occurs (such as when operating the vehicle under heavy loading conditions, in hilly terrain, traveling into strong head winds, or while towing a heavy trailer), select TOW/HAUL mode or use the Electronic Range Select (ERS) shift control to select a lower gear range ↗ page 135. Under these conditions, using a lower gear range will improve performance and extend transmission life by reducing excessive shifting and heat buildup.

During extremely cold temperatures (-22°F [-30°C] or below), transmission operation may be modified depending on engine and transmission temperature as well as vehicle speed. Normal operation will resume once the transmission temperature has risen to a suitable level.

Transmission Limp Home Mode

Transmission function is monitored electronically for abnormal conditions. If a condition is detected that could result in transmission damage, Transmission Limp Home mode is activated. In this mode, the transmission may operate only in certain gears, or may not shift at all. Vehicle performance may be severely degraded and the engine may stall. In some situations, the transmission may not re-engage if the engine is turned off and restarted. The Malfunction Indicator Light (MIL) may be illuminated. A message in the instrument cluster will inform the driver of the more serious conditions, and indicate what actions may be necessary.

In the event of a momentary problem, the transmission can be reset to regain all forward gears by performing the following steps:

NOTE:

In cases where the instrument cluster message indicates the transmission may not re-engage after engine shutdown, perform this procedure only in a desired location (preferably, at an authorized dealer).

1. Stop the vehicle.
2. Shift the transmission into PARK, if possible. If not, shift the transmission to NEUTRAL.
3. Push and hold the ignition switch until the engine turns off.

4. Wait approximately 30 seconds.
5. Restart the engine.
6. Shift into the desired gear range. If the problem is no longer detected, the transmission will return to normal operation.

NOTE:

Even if the transmission can be reset, we recommend that you visit an authorized dealer at your earliest possible convenience. An authorized dealer has diagnostic equipment to assess the condition of your transmission. If the transmission cannot be reset, authorized dealer service is required.

Electronic Range Select (ERS) Operation

The ERS shift control allows the driver to limit the highest available gear when the transmission is in DRIVE. For example, if you set the transmission gear limit to FOURTH gear, the transmission will not shift above FOURTH gear, but will shift through the lower gears normally.

You can switch between DRIVE and ERS mode at any vehicle speed. When the transmission gear selector is in DRIVE, the transmission will operate automatically, shifting between all available gears. Tapping the GEAR “-” switch (on the steering wheel) will activate ERS mode, display the current gear in the instrument cluster, and set that gear as the top available gear. Once in ERS mode, tapping the GEAR “-” or GEAR “+” switch will change the top available gear.

**ERS Control**

- 1 – GEAR “+” Switch
- 2 – GEAR “-” Switch

To exit ERS mode, simply push and hold the GEAR “+” switch until the gear limit display disappears from the instrument cluster.

WARNING!

Do not downshift for additional engine braking on a slippery surface. The drive wheels could lose their grip and the vehicle could skid, causing a collision or personal injury.

When to Use TOW/HAUL Mode

When driving in hilly areas, towing a trailer, carrying a heavy load, etc., and frequent transmission shifting occurs, push the TOW/HAUL switch to activate TOW/HAUL mode. This will improve performance and reduce the potential for transmission overheating or failure due to excessive shifting.

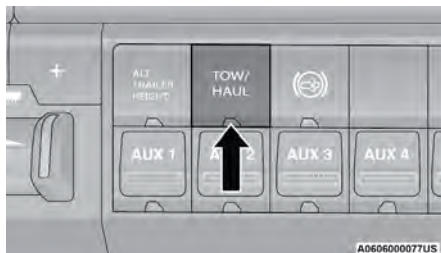
**TOW/HAUL Switch**

The TOW/HAUL Indicator Light will illuminate in the instrument cluster to indicate that TOW/HAUL mode has been activated. Pushing the switch a second time restores normal operation. Normal operation is always the default at engine start-up. If TOW/HAUL mode is desired, the switch must be pushed each time the engine is started.

WARNING!

Do not use the TOW/HAUL feature when driving in icy or slippery conditions. The increased engine braking can cause the rear wheels to slide, and the vehicle to swing around with the possible loss of vehicle control, which may cause an accident possibly resulting in personal injury or death.

6-SPEED AUTOMATIC TRANSMISSION – IF EQUIPPED

Pickup models may use either AS69RC transmission, or the 68RFE transmission (which has no PTO access cover).

The transmission gear position display (located in the instrument cluster) indicates the transmission gear range. The gear selector is mounted on the right side of the steering column. You must press the brake pedal to move the gear selector out of PARK or NEUTRAL to the DRIVE position. To drive, move the gear selector from PARK or NEUTRAL to the DRIVE position. Pull the gear selector toward you when shifting into REVERSE or PARK, or when shifting out of PARK.

The electronically controlled transmission provides a precise shift schedule. The transmission electronics are self-calibrating; therefore, the first few shifts on a new vehicle may be somewhat abrupt. This is a normal condition, and precision shifts will develop within a few hundred miles (kilometers).

Only shift from DRIVE to PARK or REVERSE when the accelerator pedal is released and the vehicle is stopped. Be sure to keep your foot on the brake pedal when shifting between these gears.

The transmission gear selector has only PARK, REVERSE, NEUTRAL, and DRIVE shift positions. Manual downshifts can be made using the Electronic Range Select (ERS) shift control. Pushing the GEAR “-”/GEAR “+” switches (on the steering wheel) while in the DRIVE position will select the highest available transmission gear, and will display that gear limit in the instrument cluster as 1, 2, 3, etc. ⇨ page 135. Some models will display both the selected gear limit, and the actual current gear, while in ERS mode.

Gear Ranges

Do not press the accelerator pedal when shifting from PARK or NEUTRAL into another gear range.

NOTE:

After selecting any gear range, wait a moment to allow the selected gear to engage before accelerating. This is especially important when the engine is cold.

PARK (P)

This range supplements the parking brake by locking the transmission. The engine can be started in this range. Never attempt to use PARK while the vehicle is in motion. Apply the parking brake when exiting the vehicle in this range.

When parking on a hill, apply the parking brake before shifting the transmission to PARK, otherwise the load on the transmission locking mechanism may make it difficult to move the gear selector out of PARK. As an added precaution, turn the front wheels toward the curb on a downhill grade and away from the curb on an uphill grade.

When exiting the vehicle, always:

- Apply the parking brake.
- Shift the transmission into PARK.
- Turn the engine off.
- Remove the key fob.

NOTE:

On four-wheel drive vehicles be sure that the transfer case is in a drive position.

CAUTION!

- Before moving the transmission gear selector out of PARK, you must turn the ignition to the ON/RUN position, and also press the brake pedal. Otherwise, damage to the gear selector could result.
- DO NOT race the engine when shifting from PARK or NEUTRAL into another gear range, as this can damage the drivetrain.

The following indicators should be used to ensure that you have properly engaged the transmission into the PARK position:

- When shifting into PARK, pull the gear selector toward you and move it all the way counterclockwise until it stops.
- Release the gear selector and make sure it is fully seated in the PARK gate.
- Look at the transmission gear position display and verify that it indicates the PARK position (P).
- With the brake pedal released, verify that the gear selector will not move out of PARK.

REVERSE (R)

This range is for moving the vehicle backward. Shift into REVERSE only after the vehicle has come to a complete stop.

NEUTRAL (N)

Use this range when the vehicle is standing for prolonged periods with the engine running. The engine may be started in this range. Apply the parking brake and shift the transmission into PARK if you must exit the vehicle.

WARNING!

Do not coast in NEUTRAL and never turn off the ignition to coast down a hill. These are unsafe practices that limit your response to changing traffic or road conditions. You might lose control of the vehicle and have a collision.

CAUTION!

Towing the vehicle, coasting, or driving for any other reason with the transmission in NEUTRAL can cause severe transmission damage.

For Recreational Towing ↪ page 204.

For Towing A Disabled Vehicle ↪ page 329.

DRIVE (D)

This range should be used for most city and highway driving. It provides the smoothest upshifts and downshifts, and the best fuel economy. The transmission automatically upshifts through all forward gears.

When frequent transmission shifting occurs (such as when operating the vehicle under heavy loading conditions, in hilly terrain, traveling into strong head winds, or while towing a heavy trailer), select TOW/HAUL mode or use the Electronic Range Select (ERS) shift control to select a lower gear range ↪ page 135. Under these conditions, using a lower gear range will improve performance and extend transmission life by reducing excessive shifting and heat buildup.

If the transmission temperature exceeds normal operating limits, the powertrain controller will modify the transmission shift schedule and expand the range of torque converter clutch engagement. This is done to prevent transmission damage due to overheating.

If the transmission becomes extremely hot or is in danger of overheating, the Transmission Temperature Warning Light may illuminate and the transmission may operate differently until the transmission cools down.

NOTE:

Use caution when operating a heavily loaded vehicle at low speeds (such as towing a trailer up a steep grade, or in stop-and-go traffic) during hot weather. In these conditions, torque converter slip can impose a significant additional heat load on the cooling system. Downshifting the transmission to the lowest possible gear (when climbing a grade), or shifting to NEUTRAL (when stopped in heavy traffic) can help to reduce this excess heat generation.

During cold temperatures, transmission operation may be modified depending on engine and transmission temperature as well as vehicle speed. This feature improves warm-up time of the engine and transmission to achieve maximum efficiency. Engagement of the torque converter clutch is inhibited until the transmission fluid is warm → page 139. On Pickup models with 68RFE transmission, top overdrive gear is also inhibited until the transmission fluid is warm, and during extremely cold temperatures (-16°F [-27°C] or below), operation may briefly be limited to first and direct gears only. On trucks with AS69RC transmission, FIFTH and SIXTH gears may be inhibited briefly on cold starts below 41°F (5°C), and during very cold temperatures (-4°F [-20°C] or below), operation may briefly be limited to third gear only. During this condition, the ability of the vehicle to accelerate under heavily loaded conditions may be reduced. In all cases, normal operation will resume once the transmission temperature has risen to a suitable level.

Transmission Limp Home Mode

Transmission function is monitored electronically for abnormal conditions. If a condition is detected that could result in transmission damage, Transmission Limp Home mode is activated. In this mode, the transmission remains in FOURTH gear (for 68RFE transmission) or THIRD gear (for AS69RC transmission) regardless of which forward gear is selected. If an AS69RC-equipped truck enters Limp Home mode at highway speeds, it will initially engage FIFTH gear, until the vehicle slows to a speed where third gear can be engaged. PARK, REVERSE, and NEUTRAL will continue to operate. The Malfunction Indicator Light (MIL) may be illuminated. Limp Home mode allows the vehicle to be driven to an authorized dealer for service without damaging the transmission.

In the event of a momentary problem, the transmission can be reset to regain all forward gears by performing the following steps:

1. Stop the vehicle.
2. Shift the transmission into PARK.
3. Turn the ignition OFF.
4. Wait approximately 10 seconds.
5. Restart the engine.
6. Shift into the desired gear range. If the problem is no longer detected, the transmission will return to normal operation.

NOTE:

Even if the transmission can be reset, we recommend that you visit an authorized dealer at your earliest possible convenience. An authorized dealer has diagnostic equipment to assess the condition of your transmission. If the transmission cannot be reset, authorized dealer service is required.

Electronic Range Select (ERS) Operation

The ERS shift control allows the driver to limit the highest available gear when the transmission is in DRIVE. For example, if you set the transmission gear limit to FOURTH gear, the transmission will not shift above FOURTH gear, but will shift through the lower gears normally.

You can switch between DRIVE and ERS mode at any vehicle speed. When the gear selector is in the DRIVE position, the transmission will operate automatically, shifting between all available gears. Tapping the GEAR “-” switch will activate ERS mode, display the current gear in the instrument cluster, and set that gear as the top available gear. Once in ERS mode, tapping the GEAR “-” or GEAR “+” switch will change the top available gear.



Electronic Range Select

- 1 — GEAR “+” Switch
2 — GEAR “-” Switch

To exit ERS mode, simply push and hold the GEAR “+” switch until the gear limit display disappears from the instrument cluster.

WARNING!

Do not downshift for additional engine braking on a slippery surface. The drive wheels could lose their grip and the vehicle could skid, causing a collision or personal injury.

Gear Limit Display	1	2	3	4	5	6	D
Actual Gear(s) Allowed	1	1-2	1-3	1-4	1-5	1-6	1-6

NOTE:

To select the proper gear position for maximum deceleration (engine braking), simply push and hold the GEAR “-” switch. The transmission will shift to the range from which the vehicle can best be slowed down.

CAUTION!

When using ERS for engine braking while descending steep grades, be careful not to overspeed the engine. Apply the brakes as needed to prevent engine overspeed.

Overdrive Operation

The automatic transmission includes an electronically controlled Overdrive (FIFTH and SIXTH gears). The transmission will automatically shift into Overdrive if the following conditions are present:

- The gear selector is in the DRIVE position.
- The transmission fluid has reached an adequate temperature.
- The engine coolant has reached an adequate temperature.
- The vehicle speed is sufficiently high.
- The driver is not heavily pressing the accelerator.

When To Use TOW/HAUL Mode

When driving in hilly areas, towing a trailer, carrying a heavy load, etc., and frequent transmission shifting occurs, push the TOW/HAUL switch to activate TOW/HAUL mode. This will improve performance and reduce the potential for transmission overheating or failure due to excessive shifting. When operating in TOW/HAUL mode, transmission upshifts are delayed, and the transmission will automatically downshift (for engine braking) when the throttle is closed and/or during steady braking maneuvers.

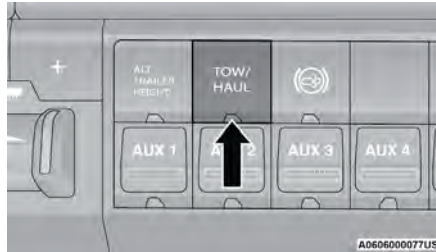
**TOW/HAUL Switch**

The TOW/HAUL Indicator Light will illuminate in the instrument cluster to indicate that TOW/HAUL mode has been activated. Pushing the switch a second time restores normal operation. Normal operation is always the default at engine start-up. If TOW/HAUL mode is desired, the switch must be pushed each time the engine is started.

WARNING!

Do not use the TOW/HAUL feature when driving in icy or slippery conditions. The increased engine braking can cause the rear wheels to slide, and the vehicle to swing around with the possible loss of vehicle control, which may cause an accident possibly resulting in personal injury or death.

Torque Converter Clutch

A feature designed to improve fuel economy has been included in the automatic transmission on your vehicle. A clutch within the torque converter engages automatically at calibrated speeds. This may result in a slightly different feeling or response during normal operation in the upper gears. When the vehicle speed drops or during some accelerations, the clutch automatically disengages.

NOTE:

- The torque converter clutch will not engage, until the transmission fluid and engine coolant are warm (usually after 1 to 3 miles [2 to 5 km] of driving). Because engine speed is higher when the torque converter clutch is not engaged, it may seem as if the transmission is not shifting properly when cold. This is normal. Using the Electronic Range Select (ERS) shift control, when the transmission is sufficiently warm, will demonstrate that the transmission is able to shift into and out of Overdrive.
- If the vehicle has not been driven for several days, the first few seconds of operation after shifting the transmission into gear may seem sluggish. This is due to the fluid partially draining from the torque converter into the transmission. This condition is normal and will not cause damage to the transmission. The torque converter will refill within five seconds after starting the engine.

AUXILIARY SWITCHES — IF EQUIPPED

There can be up to six auxiliary switches located in the lower switch bank of the instrument panel which can be used to power various electronic devices and Power Take Off (PTO). If equipped, it will take the place of the sixth auxiliary switch. Connections to the switches are found under the hood in the connectors attached to the auxiliary Power Distribution Center.

You have the ability to configure the functionality of the auxiliary switches via the instrument cluster display. All switches can now be configured for setting the switch type operation to latching or momentary, power source of either battery or ignition, and ability to hold last state across key cycles.

NOTE:

Holding last state conditions are met when switch type is set to latching and power source is set to ignition.

For further information on using the auxiliary switches, please refer to the Ram Body Builder's Guide by accessing

<https://www.ramtrucks.com/ram-commercial/body-builders-guide.html> and choosing the appropriate links.

ACTIVE NOISE CANCELLATION

Your vehicle is equipped with an Active Noise Cancellation system that cannot be turned off. This system is designed to address exhaust and engine noise. The system relies on four microphones embedded in the headliner, which monitor exhaust and engine noise, and assists an onboard frequency generator, which creates counteracting sound waves in the audio system's speakers. This helps keep the vehicle quiet at idle and during drive. The system is deactivated when the windows are rolled down.

FOUR-WHEEL DRIVE OPERATION — IF EQUIPPED

Four-wheel drive trucks are equipped with either a manually shifted transfer case or an electronically shifted transfer case.

ELECTRONICALLY SHIFTED TRANSFER CASE (8-SPEED TRANSMISSION) — IF EQUIPPED

This is an electronically shifted transfer case and is operated by the 4WD Control Switch (Transfer Case Switch), which is located on the instrument panel.

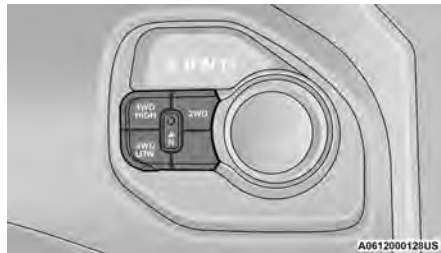

Four-Position Transfer Case

This electronically shifted transfer case provides four positions:

- Two-Wheel Drive High Range (2WD)
- Four-Wheel Drive High Range (4WD HIGH)
- Four-Wheel Drive Low Range (4WD LOW)
- N (Neutral)

For additional information on the appropriate use of each transfer case position, see the following information:

2WD

Two-Wheel Drive High Range — This range is for normal street and highway driving on dry, hard surfaced roads.

4WD HIGH

Four-Wheel Drive High Range — This range provides torque to the front driveshaft (engages four-wheel drive) which allows front and rear wheels to spin at the same speed. This provides additional traction for loose, slippery road surfaces only.

4WD LOW

Four-Wheel Drive Low Range — This range provides low speed four-wheel drive. It maximizes torque (increased torque over 4WD HIGH) to the front wheels, allowing front and rear wheels to rotate at the same speed. This range provides additional traction and maximum pulling power for loose, slippery road surfaces only. Do not exceed 25 mph (40 km/h) in this range.

N (Neutral)

N (Neutral) — This range disengages both the front and rear driveshafts from the powertrain. To be used for flat towing behind another vehicle ⇨ page 204.

WARNING!

- You or others could be injured or killed if you leave the vehicle unattended with the transfer case in the N (Neutral) position without first fully engaging the parking brake. The transfer case N (Neutral) position disengages both the front and rear drive shaft from the powertrain, and will allow the vehicle to roll, even if the transmission is in PARK. The parking brake should always be applied when the driver is not in the vehicle.
- The transmission may not engage PARK if the vehicle is moving. Always bring the vehicle to a complete stop before shifting to PARK, and verify that the transmission gear position indicator solidly indicates PARK (P) without blinking. Ensure that the vehicle is completely stopped, and the PARK position is properly indicated, before exiting the vehicle.

This electronically shifted transfer case is designed to be driven in the two-wheel drive position (2WD) for normal street and highway conditions on dry, hard surfaced roads. Driving the vehicle in two-wheel drive will have greater fuel economy benefits as the front axle is not engaged in two-wheel drive.

When additional traction is required, the transfer case 4WD HIGH and 4WD LOW positions can be used to maximize torque to the front driveshaft, forcing the front and rear wheels to rotate at the same speed. This is accomplished by pushing the desired position on the four-wheel drive control switch.

For specific shifting instructions ⇨ page 142.

The 4WD HIGH and 4WD LOW positions are designed for loose, slippery road surfaces only. Driving in the 4WD HIGH and 4WD LOW positions on dry hard surfaced roads may cause increased tire wear and damage to the driveline components.

NOTE:

The transfer case NEUTRAL button is located in the center of the four-wheel drive Control Switch and is pushed by using a ballpoint pen or similar object. The transfer case NEUTRAL position is to be used for recreational towing only ⇨ page 204.

Transfer Case Position Indicator Lights

The Transfer Case Position Indicator Lights (4WD and 4WD LOW) are located in the instrument cluster and indicate the current and desired transfer case selection. When you select a different transfer case position, the indicator lights will do the following:

If All Of The Following Shift Conditions Are Met:

1. The current position indicator light will turn off.
2. The selected position indicator light will flash until the transfer case completes the shift.
3. When the shift is complete, the indicator light for the selected position will stop flashing and remain on.

If One Or More Of The Following Shift Conditions Are Not Met:

1. The indicator light for the current position will remain on.
2. The newly selected position indicator light will continue to flash.
3. The transfer case **will not** shift.

NOTE:

Before retrying a selection, make certain that all the necessary requirements for selecting a new transfer case position have been met. To retry the selection, push the current position, wait five seconds, and retry selection. To find the shift requirements ⇨ page 142.

The SERV 4WD Warning Light monitors the electronic shift four-wheel drive system. If this light remains on after engine start-up or illuminates during driving, it means that the four-wheel drive system is not functioning properly and that service is required.

WARNING!

Always engage the parking brake when powering down the vehicle if the SERV 4WD Warning Light is illuminated. Not engaging the parking brake may allow the vehicle to roll which may cause personal injury or death.

NOTE:

Do not attempt to make a shift while only the front or rear wheels are spinning. This could cause damage to driveline components.

When operating your vehicle in 4WD LOW, the engine speed is approximately three times that of the two-wheel drive or 4WD HIGH positions at a given road speed. Take care not to overspeed the engine and do not exceed 25 mph (40 km/h).

Proper operation of four-wheel drive vehicles depends on tires of equal size, type and circumference on each wheel. Any difference in tire size can cause damage to the drivetrain.

Because four-wheel drive provides improved traction, there is a tendency to exceed safe turning and stopping speeds. Do not go faster than road conditions permit.

Shifting Procedure

NOTE:

- If any of the requirements to select a new transfer case position have not been met, the transfer case will not shift. The position indicator light for the previous position will remain on and the newly selected position indicator light will continue to flash until all the requirements for the selected position have been met.
- If all the requirements to select a new transfer case position have been met, the current position indicator light will turn off, the selected position indicator light will flash until the transfer case completes the shift. When the shift is complete, the position indicator light for the selected position will stop flashing and remain on.

2WD TO 4WD HIGH

Push the desired position on the four-wheel drive control switch to shift the transfer case. Shifts between two-wheel drive and 4WD HIGH can be done with the vehicle stopped or in motion. With the vehicle in motion, the transfer case will engage/disengage faster if you momentarily release the accelerator pedal after turning the control switch. If the vehicle is stopped, the ignition switch must be in the ON/RUN position with the engine either running or off. This shift cannot be completed if the ignition switch is in the ACC position.

NOTE:

The four-wheel drive system will not allow shifts between 2WD/4WD HIGH if the front and/or rear wheels are spinning (no traction). In this situation, the selected position indicator light will flash and the original position indicator light will remain on. At this time, reduce speed and stop spinning the wheels to complete the shift.

2WD OR 4WD HIGH TO 4WD LOW

NOTE:

When shifting into or out of 4WD LOW some gear noise may be heard. This noise is normal and is not detrimental to the vehicle or occupants.

Shifting can be performed with the vehicle rolling 2 to 3 mph (3 to 5 km/h) or completely stopped. You can use either of the following procedures:

Preferred Procedure

1. With the engine running, slow the vehicle to 2 to 3 mph (3 to 5 km/h).
2. Shift the transmission into NEUTRAL.

3. While still rolling, push the desired position on the transfer case control switch.

4. After the desired position indicator light is on (not flashing), shift the transmission back into gear.

Alternate Procedure

1. Bring the vehicle to a complete stop.

2. With the ignition switch in the ON/RUN position and the engine running, shift the transmission into NEUTRAL.

3. Push the desired position on the transfer case control switch.

4. After the desired position indicator light is on (not flashing), shift the transmission back into gear.

NOTE:

- If Steps 1 or 2 of either the Preferred or Alternate Procedure are not satisfied prior to attempting the shift, then the desired position indicator light will flash continuously while the original position indicator light is on, until all requirements have been met.
- The ignition switch must be in the ON/RUN position for a shift to take place and for the position indicator lights to be operable. If the ignition switch is not in the ON/RUN position, the shift will not take place and no position indicator lights will be on or flashing.

ELECTRONICALLY SHIFTED TRANSFER CASE (6-SPEED TRANSMISSION) — IF EQUIPPED

The electronic shift transfer case is operated by the 4WD Control Switch (Transfer Case Switch), which is located on the instrument panel.



Four-Position/Part-Time Transfer Case

This electronically shifted transfer case provides four positions:

- Two-Wheel Drive High Range (2WD)
- Four-Wheel Drive High Range (4WD HIGH)
- Four-Wheel Drive Low Range (4WD LOW)
- N (NEUTRAL)

For additional information on the appropriate use of each transfer case position, see the following information:

2WD

Two-Wheel Drive High Range — This range is for normal street and highway driving on dry, hard surfaced roads.

4WD HIGH

Four-Wheel Drive High Range — This range maximizes torque to the front driveshaft, forcing the front and rear wheels to rotate at the same speed. This range provides additional traction for loose, slippery road surfaces only.

4WD LOW

Four-Wheel Drive Low Range — This range provides low speed four-wheel drive. It maximizes torque to the front wheels, forcing the front and rear wheels to rotate at the same speed. This range provides additional traction and maximum pulling power for loose, slippery road surfaces only. Do not exceed 25 mph (40 km/h).

N (Neutral)

N (Neutral) — This range disengages both the front and rear driveshafts from the powertrain. To be used for flat towing behind another vehicle → page 204.

WARNING!

You or others could be injured or killed if you leave the vehicle unattended with the transfer case in the N (Neutral) position without first fully engaging the parking brake. The transfer case N (Neutral) position disengages both the front and rear drive shafts from the powertrain and will allow the vehicle to roll, even if the transmission is in PARK. The parking brake should always be applied when the driver is not in the vehicle.

This electronically shifted transfer case is designed to be driven in the two-wheel drive position (two-wheel drive) for normal street and highway conditions on dry, hard surfaced roads.

When additional traction is required, the transfer case 4WD HIGH and 4WD LOW positions can be used to maximize torque to the front driveshaft, forcing the front and rear wheels to rotate at the same speed.

This is accomplished by rotating the four-wheel drive Control Switch to the desired position.

For specific shifting instructions → page 144.

The 4WD HIGH and 4WD LOW positions are designed for loose, slippery road surfaces only. Driving in the 4WD HIGH and 4WD LOW positions on dry hard surfaced roads may cause increased tire wear and damage to the driveline components.

NOTE:

The transfer case NEUTRAL button is located on the lower left hand corner of the 4WD Control Switch. The transfer case NEUTRAL position is to be used for recreational towing only → page 204.

Transfer Case Position Indicator Lights

The Transfer Case Position Indicator Lights (4WD and 4WD LOW) are located in the instrument cluster and indicate the current and desired transfer case selection. When you select a different transfer case position, the indicator lights will do the following:

If All Of The Following Shift Conditions Are Met:

1. The current position indicator light will turn OFF.
2. The selected position indicator light will flash until the transfer case completes the shift.
3. When the shift is complete, the indicator light for the selected position will stop flashing and remain ON.

If One Or More Of The Following Shift Conditions Are Not Met:

1. The indicator light for the current position will remain ON.
2. The newly selected position indicator light will continue to flash.
3. The transfer case **will not** shift.

NOTE:

Before retrying a selection, make certain that all the necessary requirements for selecting a new transfer case position have been met. To retry the selection, turn the control switch back to the current position, wait five seconds, and retry selection. To find the shift requirements → page 144.

The SERV 4WD Warning Light monitors the electronic shift four-wheel drive system. If this light remains on after engine start-up or illuminates during driving, it means that the four-wheel drive system is not functioning properly and that service is required.

WARNING!

Always engage the parking brake when powering down the vehicle if the SERV 4WD Warning Light is illuminated. Not engaging the parking brake may allow the vehicle to roll, which may cause personal injury.

NOTE:

Do not attempt to make a shift while only the front or rear wheels are spinning, as this can cause damage to driveline components.

When operating your vehicle in 4WD LOW, the engine speed is approximately three times that of the two-wheel drive or 4WD HIGH positions at a given road speed. Take care not to overspeed the engine and do not exceed 25 mph (40 km/h).

Proper operation of four-wheel drive vehicles depends on tires of equal size, type and circumference on each wheel. Any difference in tire size can cause damage to the drivetrain.

Because four-wheel drive provides improved traction, there is a tendency to exceed safe turning and stopping speeds. Do not go faster than road conditions permit.

Shifting Procedure**NOTE:**

- If any of the requirements to select a new transfer case position have not been met, the transfer case will not shift. The position indicator light for the previous position will remain ON and the newly selected position indicator light will continue to flash until all the requirements for the selected position have been met. To retry a shift: return the control switch back to the original position, make certain all shift requirements have been met, wait five seconds and try the shift again.
- If all the requirements to select a new transfer case position have been met, the current position indicator light will turn OFF, the selected position indicator light will flash until the transfer case completes the shift. When the shift is complete, the position indicator light for the selected position will stop flashing and remain ON.

2WD TO 4WD HIGH

Push the desired position on the four-wheel drive control switch to shift the transfer case. Shifts between two-wheel drive and 4WD HIGH can be done with the vehicle stopped or in motion. With the vehicle in motion, the transfer case will engage/disengage faster if you momentarily release the accelerator pedal after turning the control switch. If the vehicle is stopped, the ignition switch must be in the ON/RUN position with the engine either running or off. This shift cannot be completed if the ignition switch is in the ACC position.

NOTE:

The four-wheel drive system will not allow shifts between 2WD/4WD HIGH if the front and/or rear wheels are spinning (no traction). In this situation, the selected position indicator light will flash and the original position indicator light will remain on. At this time, reduce speed and stop spinning the wheels to complete the shift.

2WD OR 4WD HIGH TO 4WD LOW**NOTE:**

When shifting into or out of 4WD LOW some gear noise may be heard. This noise is normal and is not detrimental to the vehicle or occupants.

Shifting can be performed with the vehicle rolling 2 to 3 mph (3 to 5 km/h) or completely stopped. You can use either of the following procedures:

Preferred Procedure

1. With the engine running, slow the vehicle to 2 to 3 mph (3 to 5 km/h).
2. Shift the transmission into NEUTRAL.
3. While still rolling, push the desired position on the transfer case control switch.
4. After the desired position indicator light is on (not flashing), shift the transmission back into gear.

Alternate Procedure

1. Bring the vehicle to a complete stop.
2. With the ignition switch in the ON/RUN position and the engine running, shift the transmission into NEUTRAL.
3. Push the desired position on the transfer case control switch.
4. After the desired position indicator light is on (not flashing), shift the transmission back into gear.

NOTE:

- If Steps 1 or 2 of either the Preferred or Alternate Procedure are not satisfied prior to attempting the shift, then the desired position indicator light will flash continuously while the original position indicator light is on, until all requirements have been met.
- The ignition switch must be in the ON/RUN position for a shift to take place and for the position indicator lights to be operable. If the ignition switch is not in the ON/RUN position, the shift will not take place and no position indicator lights will be on or flashing.

MANUALLY SHIFTED TRANSFER CASE — IF EQUIPPED

The transfer case provides four positions:

- Two-Wheel Drive High Range (2H)
- Four-Wheel Drive Lock High Range (4H)
- N (Neutral)
- Four-Wheel Drive Low Range (4L)

For additional information on the appropriate use of each transfer case position, see the following information:

2H

Two-Wheel Drive High Range — This range is for normal street and highway driving on dry, hard surfaced roads.

4H

Four-Wheel Drive Lock High Range — This range locks the front and rear driveshafts together forcing the front and rear wheels to rotate at the same speed. Additional traction for loose, slippery road surfaces only.

N (Neutral)

N (Neutral) — This range disengages both the front and rear driveshafts from the powertrain. To be used for flat towing behind another vehicle ↪ page 204.

4L

Four-Wheel Drive Low Range — This range locks the front and rear driveshafts together forcing the front and rear wheels to rotate at the same speed. Additional traction and maximum pulling power for loose, slippery road surfaces only. Do not exceed 25 mph (40 km/h).

This transfer case is intended to be driven in the 2H position for normal street and highway conditions such as dry, hard surfaced roads.

When additional traction is required, the 4H and 4L positions can be used to lock the front and rear driveshafts together and force the front and rear wheels to rotate at the same speed. This is accomplished by simply moving the gear selector to the desired positions once the appropriate speed and gear requirements are met. ↪ page 146 for further information.

The 4H and 4L positions are intended for loose, slippery road surfaces only. Driving in the 4H and 4L positions on dry, hard surfaced roads may cause increased tire wear and damage to the driveline components.

The Transfer Case Position Indicator Light in the instrument cluster will alert the driver that the vehicle is in four-wheel drive and that the front and rear driveshafts are locked together. This light will illuminate when the transfer case is shifted into either the 4H or 4L position. There is no light for the 2H or N (Neutral) positions on some models.

When operating your vehicle in 4L, the engine speed is approximately three times that of the 2H or 4H positions at a given road speed. Take care not to overspeed the engine and do not exceed 25 mph (40 km/h).

Proper operation of four-wheel drive vehicles depends on tires of equal size, type and circumference on each wheel. Any difference will adversely affect shifting and can cause damage to the drivetrain.

NOTE:

Do not attempt to make a shift while only the front or rear wheels are spinning, as this can cause damage to driveline components.

Because four-wheel drive provides improved traction, there is a tendency to exceed safe turning and stopping speeds. Do not go faster than road conditions permit.

NOTE:

Delayed shifts out of four-wheel drive may be experienced due to uneven tire wear, low or uneven tire pressures, excessive vehicle loading, or cold temperatures.

WARNING!

You or others could be injured or killed if you leave the vehicle unattended with the transfer case in the N (Neutral) position without first fully engaging the parking brake. The transfer case N (Neutral) position disengages both the front and rear drive shafts from the powertrain and will allow the vehicle to roll, even if the transmission is in PARK. The parking brake should always be applied when the driver is not in the vehicle.

Shifting Procedure — Manually Shifted Transfer Case

2H TO 4H

Shifting between 2H and 4H can be made with the vehicle stopped or in motion. If the vehicle is in motion, shifts can be made up to 55 mph (88 km/h). With the vehicle in motion, the transfer case will engage/disengage faster if you momentarily release the accelerator pedal after completing the shift. Apply a constant force when shifting the transfer case lever.

2H OR 4H TO 4L

NOTE:

When shifting into or out of 4L some gear noise may be heard. This noise is normal and is not detrimental to the vehicle or occupants.

With the vehicle rolling at 2 to 3 mph (3 to 5 km/h), shift the transmission into NEUTRAL. While the vehicle is coasting at 2 to 3 mph (3 to 5 km/h), shift the transfer case lever firmly to the desired position. Do not pause in transfer case Neutral.

NOTE:

- Pausing in transfer case N (Neutral) in vehicles equipped with an automatic transmission may require shutting the engine off to avoid gear clash while completing the shift. If difficulty occurs, shift the transmission into N (Neutral), hold your foot on the brake, and turn the engine off. Complete the range shift to the desired position.

- Shifting into or out of 4L is possible with the vehicle completely stopped, however difficulty may occur due to the mating teeth not being properly aligned. Several attempts may be required for teeth alignment and shift completion to occur. The preferred method is with the vehicle rolling 2 to 3 mph (3 to 5 km/h). Avoid attempting to engage or disengage 4L with the vehicle moving faster than 2 to 3 mph (3 to 5 km/h).
- Do not attempt to shift into or out of 4L while the transmission is in gear.

Transfer Case Position Indicator Light

The Transfer Case Position Indicator Light in the instrument cluster is used to alert the driver that the front axle is fully engaged and all four wheels are driving.

AIR SUSPENSION SYSTEM — IF EQUIPPED

DESCRIPTION

This air suspension system is a rear leveling ride height system. The main purpose of this system is to maintain the truck's rear ride height level. There are two selectable heights that can be chosen based on your operating conditions.

The system requires that the ignition be in the ON/RUN position or the engine running.

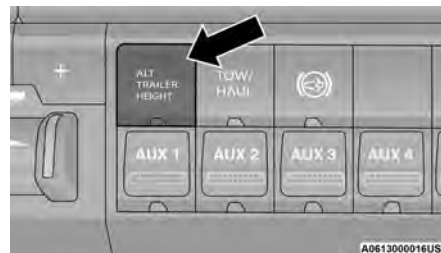

Rear Leveling Ride Height Switch

Standard Ride Height (SRH) – This is the standard position of the suspension and is meant for normal driving. It will automatically adjust to maintain the rear ride height as conditions change.

Alternate Trailer Height (ATH) – Lowers the vehicle approximately 1 inch (25 mm) for a level truck, to be used as required while trailer towing. It will automatically adjust to maintain the rear ride height as conditions change.

NOTE:

If lightly loaded, 3500 models will lower as close to 1 inch (25 mm) as possible.

Trailer Decoupling/Unloading – The air suspension system will continue to load level after the vehicle has been turned off for 5 minutes without compressor activation. This allows for easy removal of a trailer and/or load from the back of the truck by maintaining the ride height. After 5 minutes you will need to turn the ignition to the ON/RUN position for the air suspension to re-level due to addition/removal of load in the vehicle. If the air suspension system is disabled using the settings menu (Tire Jack Mode, Transport Mode, Alignment

Mode, or Bed Lowering Mode) the system will remain disabled when the vehicle is turned off. Reactivating the air suspension can be accomplished via the settings menu or driving the vehicle above 5 mph (8 km/h) for Tire Jack Mode, Alignment Mode, Transport Mode and Bed Lowering Mode.

NOTE:

- Most 3500 models will not lower to Alternate Trailer Height (ATH) when unloaded.
- For further information ↪ page 192.

WARNING!

The air suspension system uses a high pressure volume of air to operate the system. To avoid personal injury or damage to the system, see an authorized dealer for service.

AIR SUSPENSION MODES

The air suspension system has multiple modes to protect the system in unique situations:

Tire/Jack Mode

To assist with changing a tire, the air suspension system has a feature which allows the automatic leveling to be disabled ↪ page 101 or ↪ page 209.

NOTE:

This mode is intended to be enabled with the engine running.

Transport Mode

For towing your vehicle with four wheels off the road, the air suspension system has a feature which will put the vehicle into Bed Lowering Mode and disable the automatic load leveling system ↪ page 101 or ↪ page 209.

NOTE:

This mode is intended to be enabled with the engine running.

Wheel Alignment Mode

Before performing a wheel alignment, this mode must be enabled ↪ page 101 or ↪ page 209.

NOTE:

This mode is intended to be enabled with the engine running.

Bed Lowering Mode

While at zero vehicle speed, this setting is used to lower the rear suspension to the lowest possible height and disable the air suspension system. It enables easier loading/unloading of the truck and makes it easier to hook up trailers ↪ page 101 or ↪ page 209.

Protection Strategy

In order to protect the air suspension system, the vehicle will disable load leveling as required (suspension overloaded, battery charge low, etc.). Load leveling will automatically resume as soon as system operation requirements are met. See an authorized dealer if system does not resume.

INSTRUMENT CLUSTER DISPLAY MESSAGES

When the appropriate conditions exist, a message will appear in the instrument cluster display ↪ page 101.

An audible chime will be heard whenever a system error has been detected.

See an authorized dealer for system service if normal operation does not resume.

OPERATION

Pushing the Alternate Trailer Height (ATH) button once while at Standard Ride Height (SRH), will lower the vehicle to Alternate Trailer Height (ATH) and will illuminate the LED.

NOTE:

The LED will continuously blink until vehicle Alternate Trailer Height (ATH) has been achieved and the LED will turn on.

Pushing the Alternate Trailer Height (ATH) again will raise the vehicle to Standard Ride Height (SRH).

NOTE:

The LED will continuously blink until Standard Ride Height (SRH) has been achieved and the LED will turn off.

- Transport Mode – No indicator lamps will be illuminated. Transport Mode is disabled by driving the vehicle, or deselecting the mode via the interface.
- Tire/Jack Mode – No indicator lamps will be illuminated. Tire/Jack Mode is disabled by driving the vehicle, or by deselecting the mode via the interface.
- Wheel Alignment Mode – No indicator lamps will be illuminated. Wheel Alignment Mode is disabled by driving the vehicle, or by deselecting the mode via the interface.
- Bed Lowering Mode – Telltale on the cluster will be illuminated. Bed Lowering Mode is disabled by driving the vehicle, deselecting the mode via the interface, or by pushing the Alternate Trailer Height (ATH) button.

AXLE LOCKER SYSTEM —IF EQUIPPED

This vehicle is equipped with an electronically locking rear differential. Power Wagon also includes a locking front differential. These differentials, when engaged, mechanically lock together the axle shafts forcing the wheels to spin at an equal rate. This allows the vehicle to maintain its momentum and prevents it from becoming stuck. The locking differentials, rear or front, should only be engaged during low-speed, extreme off-road situations where one wheel is likely to not be in contact with the ground. It is not recommended to drive the vehicle with one or both of the differentials locked on pavement due to the reduced ability to turn and speed limitations.

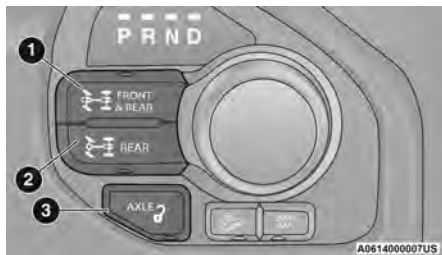

AXLE Lock Selector

- 1 — FRONT/REAR LOCK – the front and rear axles are locked (Power Wagon Only)
- 2 — REAR LOCK – the rear axle is locked
- 3 — AXLE UNLOCK – the front and rear axles are unlocked (Rear only if equipped)

CAUTION!

- Do not lock the front or rear axle on hard surfaced roads. The ability to steer the vehicle is reduced and damage to the drivetrain may occur when the axles are locked on hard surfaced roads.
- Do not try to lock the rear axle if the vehicle is stuck and the tires are spinning. You can damage drivetrain components. Lock the rear axle before attempting situations or navigating terrain, which could possibly cause the vehicle to become stuck.

The locking axles are controlled by the axle lock buttons.

Under normal driving conditions, the vehicle should be left in the AXLE UNLOCK position.

NOTE:

Even when the axles are in the AXLE UNLOCK position, the limited slip differential in the rear axle still provides torque biasing capability for moderate low traction environments.

During the command to lock the axle, the indicator light will flash until the axle is locked. After the lock command has been successfully executed, the light will remain on solid.

To lock the rear axle, place the vehicle in 4WD LOW, 4WD HIGH or two-wheel drive ⇄ page 140. Push the REAR LOCK button while traveling less than 10 mph (16 km/h). The REAR LOCK indicator light will remain on when the rear axle is locked.

NOTE:

Left to right wheel speed difference may be necessary to allow the axle to fully lock. If the indicator light is flashing after placing the vehicle in the REAR LOCK or FRONT/REAR LOCK position, drive the vehicle in a turn or on loose gravel to expedite the locking action.

WARNING!

Do not use the locked axle position for normal driving. A locked front axle is intended for off-road driving only. Locking the front axle during on-road driving will reduce the steering ability. This could cause a collision and you may be seriously injured.

To lock the front axle, if equipped, push the FRONT/REAR LOCK button while traveling less than 10 mph (16 km/h) in 4WD LOW. The FRONT/REAR LOCK indicator light will be solid when the front axle is locked.

NOTE:

The rear axle must be locked before the front axle will lock.

When both the axles are locked, to unlock the front axle, push the REAR LOCK button while in 4WD LOW. The FRONT/REAR LOCK indicator light will go out when the axle is unlocked.

NOTE:

The axle lockers could be torque locked due to side to side loads on the axle. Driving slowly while turning the steering wheel from a left hand turn to a right hand turn or driving in REVERSE for a short distance may be required to release the torque lock and unlock the axles.

To unlock the rear axle, push the AXLE UNLOCK button. The REAR LOCK indicator light will go out when the rear axle is unlocked.

STABILIZER/SWAY BAR SYSTEM — POWER WAGON ONLY

Your vehicle is equipped with an electronic disconnecting stabilizer/sway bar. This system allows greater front suspension travel in off-road situations.

Due to the use of taller springs, this vehicle has an increased ride height of approximately 1.9 inches (48.3 mm) in the front and 1.5 inches (38.1 mm) in the rear. A major advantage to increasing ride height is the positive effect it has on approach/departure and break over angles.

This system is controlled by the electronic control sway bar switch located below the instrument panel.

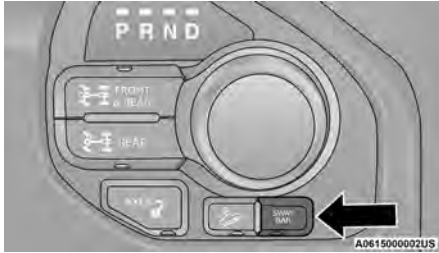

SWAY BAR Disconnect Button

Push the SWAY BAR switch to activate the system. Push the switch again to deactivate the system. The Sway Bar Indicator Light (located in the instrument cluster) will illuminate when the bar is disconnected. The Sway Bar Indicator Light will flash during activation transition, or when activation conditions are not met. The stabilizer/sway bar should remain in On-Road mode during normal driving conditions.

WARNING!

Do not disconnect the stabilizer bar and drive on hard surfaced roads or at speeds above 18 mph (29 km/h), you may lose control of the vehicle, which could result in serious injury or death. The front stabilizer bar enhances vehicle stability and assists in maintaining control of the vehicle. The system monitors vehicle speed and will attempt to reconnect the stabilizer bar at speeds over 18 mph (29 km/h). This is indicated by a flashing off road light and solid on road light. Once vehicle speed is reduced below 14 mph (22 km/h), the system will attempt to return to the Off-Road mode.

To disconnect the stabilizer/sway bar, shift to either 4WD HIGH or 4WD LOW and push the SWAY BAR button to obtain the Off-Road position → page 140. The Sway Bar Indicator Light will flash until the stabilizer/sway bar has been fully disconnected.

NOTE:

The stabilizer/sway bar may be torque locked due to left and right suspension height differences. This condition is due to driving surface differences or vehicle loading. In order for the stabilizer/sway bar to disconnect/reconnect, the right and left halves of the bar must be aligned. This alignment may require that the vehicle be driven onto level ground or rocked from side to side.

To return to the On-Road mode, push the SWAY BAR button again.

WARNING!

If the stabilizer/sway bar will not return to On-Road mode, vehicle stability is reduced. Do not attempt to drive the vehicle over 18 mph (29 km/h). Driving faster than 18 mph (29 km/h) may cause loss of control of the vehicle, which could result in serious injury or death. Contact your local service center for assistance.

SAFE OFF-ROAD DRIVING — POWER WAGON, REBEL OR OFF-ROAD PACKAGE EQUIPPED ONLY

OFF-ROAD DRIVING TIPS AND VEHICLE CHARACTERISTICS

Your vehicle has excellent on and off-road capabilities. These off-road capabilities will allow you to explore those wilderness trails where few travel, providing a source of exciting and satisfying recreation. Before you venture out, you should contact your local governmental agency to determine the designated Off-Road Vehicle (ORV) trails or recreation areas. You should always tread lightly and only use established roads, trails or ORV recreational areas.

The National Forest Service, Bureau of Land Management, or local Department of Natural Resources are a wealth of information and usually have maps with marked trails.

Skid Plates And Underbody Protection

Steel skid plates protect the major driveline components of the truck including the fuel tank, transfer case and steering damper. In addition, this vehicle is equipped with boxed cross members and fore/aft rails. This additional protection allows the vehicle to be utilized in severe off-road situations that would be considered impassable by a normal truck.

Ramp Travel Index (RTI)

The RTI is the distance, in inches, that you can drive your vehicle with one wheel on a 20-degree ramp without lifting any other wheel off the ground. This distance up the ramp divided by the wheelbase of the vehicle and multiplied by 1,000 is the RTI. This vehicle has an RTI of 429 (connected sway bar) or an RTI of 538 (disconnected sway bar), which means you can articulate one front wheel 22 inches (56 cm) or 27.5 inches (70cm) in the air while the other three wheels remain in contact with the ground.

Water Forging Characteristics

Water fording characteristic is the vehicle's ability to cross a body of still water, where the powertrain and drivetrain are safe from water ingestion. This vehicle has high water fording characteristics with the ability to cross a pool of water, without stopping, 24 inches (60 cm) deep at a maximum speed of 10 mph (16 km/h) and a pool of water 30 inches (76 cm) deep at a maximum speed of 5 mph (8 km/h), both with an entrance ramp angle of 1.3 degrees.

CAUTION!

The door sill height is 25 inches (63.5 cm). Water may intrude into the interior of the vehicle at greater depths.

Simultaneous Brake And Throttle Operation

Many off-road driving conditions require the simultaneous use of the brake and throttle (two footed driving). When climbing rocks, logs, or other stepped objects, using light brake pressure with light throttle will keep the vehicle from jerking or lurching. This technique is also used when you need to stop and restart a vehicle on a steep incline.

The Basics Of Off-Road Driving

You will encounter many types of terrain driving off-road. You should be familiar with the terrain and area before proceeding. There are many types of surface conditions: hard packed dirt, gravel, rocks, grass, sand, mud, snow and ice. Every surface has a different effect on your vehicle's steering, handling and traction. Controlling your vehicle is one of the keys to successful off-road driving, so always keep a firm grip on the steering wheel and maintain a good driving posture. Avoid sudden accelerations, turns or braking. In most cases there are no road signs, posted speed limits or signal lights. Therefore you will need to use your own good judgment on what is safe and what isn't. When on a trail you should always be looking ahead for surface obstacles and changes in terrain. The key is to plan your future driving route while remembering what you are currently driving over.

WARNING!

Always wear your seat belt and firmly tie down cargo. Unsecured cargo can become projectiles in an off-road situation.

CAUTION!

Never park your vehicle over dry grass or other combustible materials. The heat from your vehicle exhaust system could cause a fire.

When To Use Low Range

When driving off-road, shift into 4WD LOW for additional traction or to improve handling and control on slippery or difficult terrain. Due to the lower gearing, low range will allow the engine to operate in a higher power range. This will allow you to idle over obstacles and down hills, with improved control and less effort. Also, use 4WD LOW in rain, ice, snow, mud, and sand to get heavy loads rolling, improve traction, or whenever 4WD HIGH traction will not do the job.

DRIVING IN SNOW, MUD AND SAND

There is a drastic reduction in traction when driving in snow, mud or sand. The vehicle will be less responsive to steering, acceleration and braking inputs. Therefore you should accelerate slowly, leave greater stopping distances and avoid abrupt vehicle maneuvers. You want to keep a slow constant steady pace. The key is to maintain the vehicle's momentum.

- **Snow** – In heavy snow or for additional control and traction at slower speeds, shift the transmission to a low gear and shift the transfer case to 4WD LOW if necessary. Do not shift to a lower gear than necessary to maintain headway. Over-revving the engine can spin the wheels and traction will be lost. If you start to slow to a stop, try turning your steering wheel no more than a quarter turn quickly back and forth, while still applying throttle. This will allow the tires to get a fresh traction and help maintain your momentum.

CAUTION!

On icy or slippery roads, do not downshift at high engine RPMs or vehicle speeds because engine braking may cause skidding and loss of control.

- **Mud** – Deep mud creates a great deal of suction around the tires and is very difficult to get through. You should use 4WD LOW with a gear low enough to maintain your momentum without shifting. If you start to slow to a stop, try turning your steering wheel no more than a quarter turn quickly back and forth for additional traction. Mud holes pose an increased threat of vehicle damage and getting stuck. They are normally full of debris from previous vehicles getting stuck. As a good practice before entering any mud hole, get out and determine how deep it is, if there are any hidden obstacles and if the vehicle can be safely recovered if stuck.
- **Sand** – Soft sand is very difficult to travel through with full tire pressure. When crossing soft sandy spots in a trail, maintain your vehicle's momentum and do not stop. The key to driving in soft sand is using the appropriate tire pressure, accelerating slowly, avoiding abrupt maneuvers and maintaining the vehicle's momentum. If you are going to be driving on large soft sandy areas or dunes, reduce your tire pressure to a minimum of 15 psi (103 kPa) to allow for a greater tire surface area. Reduced tire pressure will drastically improve your traction and handling, while driving on the soft sand, but you must return the tires to normal air pressure before driving on pavement or other hard surfaces. Be sure you have a way to air the tires back up prior to reducing the pressure.

CAUTION!

Reduced tire pressures may cause tire unseating and total loss of air pressure. To reduce the risk of tire unseating, while at a reduced tire pressure, reduce your speed and avoid sharp turns or abrupt maneuvers.

CROSSING OBSTACLES (ROCKS AND OTHER HIGH POINTS)

While driving off road, you will encounter many types of terrain. These varying types of terrain bring different types of obstacles. Before proceeding review the path ahead to determine the correct approach and your ability to safely recover the vehicle if something goes wrong. Keeping a firm grip on the steering wheel, bring the vehicle to a complete stop and then inch the vehicle forward until it makes contact with the object. Apply the throttle lightly while holding a light brake pressure and ease the vehicle up and over the object.

WARNING!

Crossing obstacles can cause abrupt steering system loading which could cause you to lose control of your vehicle.

Using A Spotter

There are many times where it is hard to see the obstacle or determine the correct path. Determining the correct path can be extremely difficult when you are confronting many obstacles. In these cases have someone guide you over, through, or around the obstacle. Have the person stand a safe distance in front of you where they can see the obstacle, watch your tires and undercarriage, and guide you through.

Crossing Large Rocks

When approaching large rocks, choose a path which ensures you drive over the largest with your tires. This will lift your undercarriage over the obstacle. The tread of the tire is tougher and thicker than the side wall and is designed to take the abuse. Always look ahead and make every effort to cross the large rocks with your tires.

CAUTION!

- Never attempt to straddle a rock that is large enough to strike your axles or undercarriage.
- Never attempt to drive over a rock which is large enough to contact the door sills.

Crossing A Ravine, Gully, Ditch, Washout Or Rut

When crossing a ravine, gully, ditch, washout or a large rut, the angled approach is the key to maintaining your vehicle's mobility. Approach these obstacles at a 45-degree angle and let each tire go through the obstacle independently. You need to use caution when crossing large obstacles with steep sides. Do not attempt to cross any large obstacle with steep sides at an angle great enough to put the vehicle at risk of a rollover. If you get caught in a rut, dig a small trench to the right or left at a 45-degree angle ahead of the front tires. Use the removed dirt to fill the rut ahead of the turnout you just created. You should now be able to drive out following the trench you just created at a 45-degree angle.

WARNING!

There is an increased risk of rollover when crossing an obstacle, at any angle, with steep sides.

Crossing Logs

To cross a log, approach it at a slight angle (approximately 10 to 15 degrees). This allows one front tire to be on top of the log while the other just starts to climb the log. While climbing the log, modulate your brake and accelerator to avoid spinning the log out from under your tires. Then ease the vehicle off the log using your brakes.

CAUTION!

Do not attempt to cross a log with a greater diameter than the running ground clearance or the vehicle will become high centered.

Getting High Centered

If you get hung up or high centered on an object, get out of the vehicle and try to determine what the vehicle is hung up on, where it is contacting the underbody and what is the best direction to recover the vehicle. Depending on what you are in contact with, jack the vehicle up and place a few rocks under the tires so the weight is off of the high point when you let the vehicle down. You can also try rocking the vehicle or winching the vehicle off the object.

CAUTION!

Winching or rocking the vehicle off hard objects increases the risk of underbody damage.

HILL CLIMBING

Hill climbing requires good judgment and a good understanding of your abilities and your vehicle's limitations. Hills can cause serious problems. Some are just too steep to climb and should not be attempted. You should always feel confident with the vehicle and your abilities. You should always climb hills straight up and down. Never attempt to climb a hill on an angle.

- Before Climbing A Steep Hill** – As you approach a hill consider its grade or steepness. Determine if it is too steep. Look to see what the traction is on the hill side trail. Is the trail straight up and down? What is on top and the other side? Are there ruts, rocks, branches or other obstacles on the path? Can you safely recover the vehicle if something goes wrong? If everything looks good and you feel confident, then change transmission into a lower gear, shift the transfer case into 4WD LOW and proceed with caution. You should use first gear and 4WD LOW for very steep hills.
- Driving Uphill** – Once you have determined your ability to proceed and have shifted into the appropriate gear, line your vehicle up for the straightest possible run. Accelerate with an easy constant throttle and apply more power as you start up the hill. Do not race forward into a steep grade, the abrupt change of grade could cause you to lose control. If the front end begins to bounce, ease off the throttle slightly to bring all four tires back on the ground. As you approach the crest of the hill ease off the throttle and slowly proceed over the top. If the wheels start to slip as you approach the crest of a hill, ease off the accelerator and maintain headway by turning the steering wheel no more than a quarter turn quickly back and forth. This will provide a fresh traction into the surface and will usually provide enough

traction to complete the climb. If you do not make it to the top, place the vehicle in REVERSE and back straight down the grade using engine resistance along with the vehicle brakes.

WARNING!

Never attempt to climb a hill at an angle or turn around on a steep grade. Driving across an incline increases the risk of a roll over, which may result in severe injury or death.

- Driving Downhill** – Before driving down a steep hill you need to determine if it is too steep for a safe descent. What is the surface traction? Is the grade too steep to maintain a slow controlled descent? Are there obstacles? Is it a straight descent? Is there plenty of distance at the base of the hill to regain control if the vehicle descends too fast? If you feel confident in your ability to proceed then make sure you are in 4WD LOW with the transmission in FIRST gear (manually select FIRST gear on automatic transmissions) and proceed with caution. Allow engine braking to control the descent and apply your brakes if necessary, but do not allow the tires to lock.

WARNING!

Do not descend a steep grade in NEUTRAL. Use vehicle brakes in conjunction with engine braking. Descending a grade too fast could cause you to lose control and be seriously injured or killed.

- **Driving Across An Incline** – If at all possible avoid driving across an incline. If it is necessary, know your vehicle's abilities. Driving across an incline places more weight on the downhill wheels, which increases the possibilities of a downhill slide or rollover. Make sure the surface has good traction with firm and stable soils. If possible transverse the incline at an angle heading slightly up or down.

WARNING!

Driving across an incline increases the risk of a rollover, which may result in severe injury.

- **If You Stall Or Begin To Lose Headway** – If you stall or begin to lose headway while climbing a steep hill, allow your vehicle to come to a stop and immediately apply the brake. Restart the engine and shift into REVERSE. Back slowly down the hill allowing the compression braking of the engine and transmission to help regulate your speed. If the brakes are required to control vehicle speed, apply them lightly and avoid locking or skidding the tires.

WARNING!

If the engine stalls or you lose headway or cannot make it to the top of a steep hill or grade, never attempt to turn around. To do so may result in tipping and rolling the vehicle, which may result in severe injury. Always back carefully straight down a hill in REVERSE. Never back down a hill in NEUTRAL using only the vehicle brakes. Never drive diagonally across a hill, always drive straight up or down.

DRIVING THROUGH WATER

Extreme care should be taken crossing any type of water. Water crossings should be avoided if possible and only be attempted when necessary, in a safe responsible manner. You should only drive through areas which are designated and approved. You should tread lightly and avoid damage to the environment. You should know your vehicle's abilities and be able to recover it if something goes wrong. You should never stop or shut a vehicle off when crossing deep water unless you ingested water into the engine air intake. If the engine stalls do not attempt to restart it. Determine if it has ingested water first. The key to any crossing is low and slow. You want to use FIRST gear in 4WD LOW and proceed very slowly with a constant slow speed (3-5 mph [5-8 km/h] maximum) and light throttle. Keep the vehicle moving; do not try to accelerate through the crossing. After crossing any water higher than the bottom of the axle differentials, you should inspect all of the vehicle fluids for signs of water ingestion.

CAUTION!

Water ingestion into the axles, transmission, transfer case, engine or vehicle interior can occur if you drive too fast or through too deep of water. Water can cause permanent damage to engine, driveline or other vehicle components and your brakes will be less effective once wet and/or muddy.

- **Before You Cross Any Type Of Water** – As you approach any type of water you need to determine if you can cross it safely and responsibly. If necessary, get out and walk through the water or probe it with a stick. You need to be sure of its depth, approach

angle, current and bottom condition. Be careful of murky or muddy waters, check for hidden obstacles. Make sure you will not be intruding on any wildlife and you can recover the vehicle if necessary. The key to a safe crossing is the water depth, current and bottom conditions. On soft bottoms the vehicle will sink in, effectively increasing the water level on the vehicle. Be sure to consider this when determining the depth and the ability to safely cross.

- **Crossing Puddles, Pools, Flooded Areas Or Other Standing Water** – Puddles, pools, flooded or other standing water areas normally contain murky or muddy waters. These water types normally contain hidden obstacles and make it difficult to determine an accurate water depth, approach angle, and bottom condition. Murky or muddy water holes are where you want to hook up tow straps prior to entering. This makes for a faster, cleaner and easier vehicle recovery. If you are able to determine you can safely cross, than proceed using the low and slow method.

CAUTION!

Muddy waters can reduce the cooling system effectiveness by depositing debris onto the radiator.

- **Crossing Ditches, Streams, Shallow Rivers Or Other Flowing Water** – Flowing water can be extremely dangerous. Never attempt to cross a fast running stream or river even in shallow water. Fast moving water can easily push your vehicle downstream sweeping it out of control. Even in very shallow water, a high current can still wash the dirt out from around your tires putting you and your vehicle in jeopardy. There is still a high risk of personal injury and vehicle damage with slower water currents in depths greater than the vehicle's running

ground clearance. You should never attempt to cross flowing water which is deeper than the vehicle's running ground clearance. Even the slowest current can push the heaviest vehicle downstream out of control if the water is deep enough to push on the large surface area of the vehicle's body. Before you proceed determine the speed of the current, the water's depth, approach angle, bottom condition and if there are any obstacles, then cross at an angle heading slightly upstream using the low and slow technique.

WARNING!

Never drive through fast moving deep water. It can push your vehicle downstream, sweeping it out of control. This could put you and your passengers at risk of injury or drowning.

AIRING DOWN FOR OFF-ROAD DRIVING

Running lower tire pressure off-road can improve your ride comfort and vehicle traction. Reducing the tire air pressure allows the tire to bulge slightly, improving its surface area for better flotation and ability to mold or form to the ground contour. Different terrain, tires, and vehicles require different tire pressure. Hard surfaces like rock and heavier vehicles require higher pressures than softer surfaces such as sand and lighter vehicles. You will need to experiment to determine what is right for your situation. It is easier and faster to let air out than it is to replace it. Start high and lower it as required. Remember you must return the tires to normal air pressure before driving on road or at highway conditions. Be sure you have a way to return the tires to their normal on road air pressure.

CAUTION!

Reduced tire pressure increases the risk of tire damage and may cause tire unseating with total loss of air pressure. To reduce the risk of tire unseating, while at a reduced tire pressure, drive at slower speeds and avoid sharp turns or abrupt maneuvers.

VEHICLE RECOVERY

If you drive off-road, you may encounter a situation where you will need to recover your vehicle. Vehicle recovery should always be given consideration before attempting a questionable obstacle. You should never go off-road driving without the ability to recover your vehicle from a situation. Having another vehicle with you usually works best for most situations. The first thing to do is assess the situation. Why are you stuck? Are you hung up on something? Would it be easier to go forward or to go backward? Can you still move the vehicle? Is there an anchor point to winch to? Are you alone or do you have another vehicle to help? Is there high risk of vehicle damage during the recovery process? Answering these questions will help you determine the best method of recovery. If you can still move the vehicle slightly and the only issue is slick ground, then rock cycling your vehicle would be the first choice. If you have ample room, an additional vehicle and there is low risk of vehicle impact on the surroundings, then using a tow strap to the vehicle tow hooks would be fast and easy. If the vehicle is severely hung up or in a situation where great care needs to be taken during the recovery, then nothing can do the job better than a winch. If you are severely hung up on something you should jack the vehicle up and stack something under the wheels to allow the vehicle to roll off the object without causing further damage. This should be tried before attempting any recovery method.

CAUTION!

Pulling the vehicle off an obstacle, without first clearing the object, may result in additional underbody damage.

- Rock Cycling Your Vehicle** – Rock cycling your vehicle is one of the easiest, fastest and most commonly used methods. This simply involves shifting your vehicle from DRIVE to REVERSE, while applying throttle after each shift. During this process, for additional traction, try turning your steering wheel quickly left and right no more than a quarter turn. If you are stuck in mud, sand, or snow try spinning your tires during this process to clean the debris from the tread and improve the traction. You want to create a rocking motion with the vehicle. This helps build vehicle momentum, which hopefully gets you out. Remember to ease off and on the accelerator before and after the shift. If after a few rock cycles your vehicle is not free, stop and try another method of recovery. Continuous rock cycling will only cause unnecessary damage to your vehicle and the environment.

CAUTION!

Damage can occur when spinning your tires at an excessive high speed. Do not spin your tires faster than an indicated 30 mph (48 km/h).

- Using The Tow Hooks With A Tow Strap** – Tow straps are a quick and easy way to recover your vehicle from minor situations if you have a secondary vehicle which is not stuck. The tow hooks on your vehicle are designed to take the abusive force generated during vehicle recovery. Do not use the bumper or any other vehicle component as an attachment point. Using tow

straps requires coordination between the two drivers. Good communication and line of sight are required for a safe recovery. First connect the tow strap to the correct attachment points on both vehicles. There should be a least 20 to 30 feet (6 to 9 meters) between the vehicles to allow for a safe recovery. If necessary join two tow straps together using a 1.5 inch hard wood dowel. This will keep the straps from becoming knotted and is safer than using a clevis pin if the strap breaks. Next have the tow vehicle back-up, leaving two to three feet worth of slack in the strap. Then the tow vehicle, using light throttle, should accelerate tightening the strap providing the pulling force needed to free the vehicle. The vehicle being recovered should assist in the recovery, at the time of the snap, by slowly spinning the tires in the same direction as the pulling vehicle. After the vehicle becomes free, the driver of the previously stuck vehicle should signal they are free and should hit their brakes stopping both vehicles. The driver of the pulling vehicle should let off the throttle without using the brakes, once signaled by the other driver. This sequence is important to avoid having the recovered vehicle hit the pulling vehicle.

WARNING!

Never use tow straps with end hooks or link two straps with a clevis pin. These heavy metal objects could become projectiles if a strap breaks, which could cause severe injury. Never leave more than 2 to 3 feet (0.60 to 1 meter) of slack in the strap. More slack than this greatly increases the risk of injury and vehicle damage. Always keep everyone at least 30 feet (9 meters) away from a strapping or winching situation.

● Winching (Refer To "Winch Operation"

↪ **page 156**) – Winching is most commonly used in the following situations: there is no support vehicle available, a high controlled force is required to recover the vehicle, there is a high risk of environmental or vehicle damage, or where nothing else seems to work. A winch can deliver a high pulling force with a great deal of control. It allows you to walk the vehicle out of the situation in a slow controlled manner. This control works well for avoiding further vehicle damage. Once you decide it is time to use the winch look for a good anchor point. It needs to be strong enough to hold more than the vehicle's weight and provide a direction of pull as straight as possible. Use block and tackle if necessary to improve the angle of pull or increase the winch's pulling force. If the anchor point is a tree use a strap around its base and hook the cable to the strap. If it is another vehicle, then place that vehicle in PARK and block the front tires. If you cannot find an anchor point within reach try using your spare tire by burying it. Once you have determined an anchor point hook up the cable, ensuring there are a least five wraps of cable left on the drum, and place a floor mat or something else over the strung out cable. Placing something over the strung out cable helps keep the cable on the ground if it breaks. Next, place the vehicle in FIRST gear and apply a very light throttle as you power the winch in. Be careful not to allow slack in the cable as you recover the vehicle. Do not try to guide the cable into the drum. If it starts to bunch up on one end, let it. You can re-spool the cable afterwards. Never use a winch cable as a tow strap and always stand back while winching.

WARNING!

Winch cables are under high tension when in use and can become a projectile if they fail. Never stand over or straddle the winch cable. Never jerk or overload the winch cable. Never stand in front of the vehicle while winching. Failure to follow these instructions can result in serious or fatal injury.

AFTER DRIVING OFF-ROAD

Off-road operation puts more stress on your vehicle than does most on-road driving. After going off-road, it is always a good idea to check for damage. That way you can get any problems taken care of right away and have your vehicle ready when you need it.

- Completely inspect the underbody of your vehicle. Check tires, body structure, steering, suspension, and exhaust system for damage.
- Inspect the radiator for mud and debris and clean as required.
- Check threaded fasteners for looseness, particularly on the chassis, drivetrain components, steering, and suspension. Retighten them, if required, and torque to the values specified in the Service Manual.
- Check for accumulations of plants or brush. These things could be a fire hazard. They might hide damage to fuel lines, brake hoses, axle pinion seals, and propeller shafts.
- After extended operation in mud, sand, water, or similar dirty conditions, have the radiator, fan, brake rotors, wheels, brake linings, and axle yokes inspected and cleaned as soon as possible.

WARNING!

Abrasive material in any part of the brakes may cause excessive wear or unpredictable braking. You might not have full braking power when you need it to prevent a collision. If you have been operating your vehicle in dirty conditions, get your brakes checked and cleaned as necessary.

- If you experience unusual vibration after driving in mud, slush or similar conditions, check the wheels for impacted material. Impacted material can cause a wheel imbalance and freeing the wheels of it will correct the situation.

LIMITED-SLIP DIFFERENTIAL

The limited-slip differential provides additional traction on snow, ice, mud, sand and gravel, particularly when there is a difference between the traction characteristics of the surface under the right and left rear wheels. During normal driving and cornering, the limited-slip unit performs similarly to a conventional differential. On slippery surfaces, however, the differential delivers more of the driving effort to the rear wheel having the better traction.

The limited-slip differential is especially helpful during slippery driving conditions. With both rear wheels on a slippery surface, a slight application of the accelerator will supply maximum traction. When starting with only one rear wheel on an excessively slippery surface, slight momentary application of the parking brake may be necessary to gain maximum traction.

WARNING!

On vehicles equipped with a limited-slip differential never run the engine with one rear wheel off the ground since the vehicle may drive through the rear wheel remaining on the ground. You could lose control of the vehicle.

Care should be taken to avoid sudden accelerations when both rear wheels are on a slippery surface. This could cause both rear wheels to spin, and allow the vehicle to slide sideways on the crowned surface of a road or in a turn.

WINCH USAGE — IF EQUIPPED**THINGS TO KNOW BEFORE USING YOUR WINCH****General Winch Information**

Your vehicle is equipped with an electric vehicle recovery winch. This winch uses the electrical power from the vehicle charging system to power a motor that winds the winch rope onto the winch drum via planetary gear reduction. By nature, a winch is capable of generating very high forces and should be used with care. Do not operate the winch without reading and understanding the complete winch owner's manual.

Tensioning The Winch Rope

The winch rope must be properly tensioned before use. Follow the instructions listed to tension the rope:

1. Un-spool the rope leaving five wraps of rope on the winch drum.
2. Attach the hook to a suitable anchor point.

CAUTION!

Be certain the anchor will withstand the load required to tension the winch rope.

3. Apply at least 1,000 lb (454 kg) of tension to the rope while winding the rope. Always use care to ensure the rope does not pile up on one side of the drum and is neatly wound onto the drum.

CAUTION!

The winch rope must spool on the winch drum in the direction indicated on the drum rotation decal on the winch.

Low Voltage Interrupt

Your winch is equipped with a device that will interrupt winch function if the vehicle charging system voltage drops to a low level. The winch will not power-in or out for 30 seconds if this device is tripped. If the interrupt is tripped, the vehicle should be operated at high idle for a few minutes to allow the vehicle charging system to recover before continuing to winch.

UNDERSTANDING THE FEATURES OF YOUR WINCH

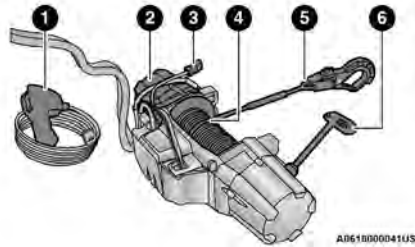

Winch Components

- 1. Remote Control:** The remote control provides the interface between the winch operator and the winch. The remote control provides the ability to power the winch in, out, and stop the winch. To operate the winch, the toggle switch is pushed down to power the winch in and up to power the winch out. The winch will stop if the switch is left in the neutral (center) position.
- 2. Motor:** The winch motor is powered by the vehicle charging system.
- 3. Remote Socket:** The remote socket (which will be located on the bumper assembly) allows the remote control to be attached to the control pack to allow the winch to function.

- 4. Winch Drum With Integral Brake:** The winch drum allows the rope to be stored on the winch and transmits force to the rope. The winch is equipped with an integral brake that will stop rotation of the winch drum if the winch motor is stopped.
- 5. Synthetic Rope:** The synthetic rope allows the winch to be connected to an anchor to provide a pulling force. This synthetic rope is highly flexible, lightweight, and it floats.
- 6. Clutch Lever:** The clutch lever allows the winch drum to be disconnected from the winch motor to allow the rope to be pulled from the winch by hand.

CAUTION!

If not installed, the hook strap must be placed on the hook.

Fairlead: The hawse fairlead acts as a guide for the synthetic rope and minimizes damage to the rope.

WINCH ACCESSORIES

The following accessories are necessary to attach the winch to anchors, change direction of pull, and for safe winching.



Gloves: It is extremely important to wear protective gloves while operating the winch or handling the winch rope. Avoid loose fitting clothes or anything that could become entangled in the rope and other moving parts.



Snatch/Block Pulley: Used properly, the multi-purpose snatch block allows you to (1) increase the winch's pulling power; and (2) change your pulling direction without damaging the winch rope. Proper use of the snatch block is covered in "Before You Pull."



Clevis/D-Shackles: The D-Shackle is a safe means of connecting the looped ends of cables, straps and snatch blocks. The shackle's pin is threaded to allow easy removal.



Tree Trunk Protector: Typically made of tough, high-quality nylon, it provides the operator an attachment point for the winch rope to a wide variety of anchor points and objects, as well as protects living trees.

Abrasion Sleeve: The abrasion sleeve is provided with the synthetic rope and must be used with the synthetic rope at all times to protect the rope from potential abrasion wear. The sleeve has a loose fit so it can easily be positioned along the synthetic rope to protect from rough surfaces and sharp corners.

OPERATING YOUR WINCH

WARNING!

Failure to observe any of these warnings regarding proper winch usage may result in severe injury.

- Always use supplied hook strap to hold the hook when spooling wire rope in or out.
- Never use as a hoist.
- Never use to move persons.
- Never exceed winch or synthetic rope rated capacity.

(Continued)

WARNING!

- Always wear heavy leather gloves when handling the synthetic rope.
- Never touch synthetic rope or hook while in tension or under load.
- Never engage or disengage clutch if winch is under load, synthetic rope is in tension, or rope drum is moving.
- Always stand clear of synthetic rope and load and keep others away during winching.
- Always keep hands and clothing clear of the synthetic rope, hook and fairlead opening during operation and when spooling.
- Never wrap synthetic rope back onto itself. Always use a choker chain, wire choker rope or tree trunk protector on the anchor.
- Never attach a recovery strap to the winch hook to increase the length of a pull.
- Never attempt to tow a vehicle with the recovery strap attached directly to the winch hook.
- Never use bungee or kinetic straps that develop tremendous and potentially dangerous amounts of force when stretched.
- Always disconnect the remote control when not in use.
- Never winch when there are less than 10 wraps of synthetic rope around the winch drum.
- Always pass remote control through a window to avoid pinching lead in door, when using remote inside a vehicle.
- Never leave the remote control plugged into the winch while free spooling, rigging or sitting idle.

General Information

Practice using your winch before you get stuck. Some key points to remember when using your winch are:

- Always take your time to assess the situation and plan your pull carefully.
- Always take your time when using a winch.
- Use the right equipment for the situation.
- Always wear leather gloves and do not allow the synthetic rope to slip through your hands when handling the rope.
- Only the operator should handle the synthetic rope and remote control.
- Think safety at all times.

Vehicle Recovery Using The Winch**CAUTION!**

- Always know your winch: Take the time to fully read and understand the included Installation and Operations Guide and Basic Guide to Winching Techniques, in order to understand your winch and the winching operation.
- Always inspect winch installation and synthetic rope condition before operating the winch. Frayed, kinked or damaged rope must be replaced immediately. Loose or damaged winch installation must be corrected immediately.
- Always be sure any element which can interfere with safe winching operations is removed prior to initiating winching.

(Continued)

CAUTION!

- Always keep remote control lead clear of the drum, synthetic rope and rigging.
- Inspect for cracks, pinches, frayed rope, or loose connections. Replace if damaged.
- Be careful not to pull the winch rope collar through the rollers. Watch and listen to winch for proper snugness.
- Never power hook through fairlead. Could cause damage.

1. Inspect the winch, winch mount, and synthetic rope for damage. Do not use the winch if the mount is loose or rope shows excessive wear, frays, or damage.

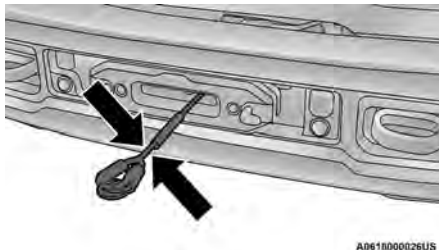

Winch Rope

2. Put on gloves.

3. Disengage the clutch to allow free spooling of the winch drum, rotate the clutch lever on the winch to disengage. Freespooling conserves battery power.

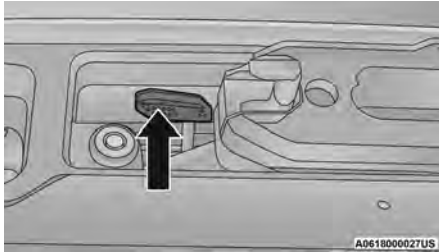

Free Spool Lever

4. Free the winch hook and attach the hook strap. Free the winch hook from its anchor point. Attach the hook strap to the hook (if not attached).

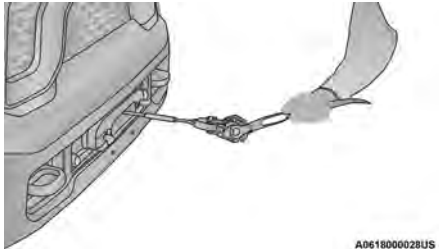

Hook Strap

WARNING!

- Never touch winch rope or hook while someone else is at the control switch or during winching operation.
- Never touch winch rope or hook while under tension or under load.

5. Pull the wire to the anchor point. Pull out enough wire rope to reach your anchor point. To prevent losing the end, hold the hook strap while you work.



Pulling Synthetic Rope

6. Secure to the anchor point. Once you have established your anchor point, secure the tree-trunk protector or choker-chain around the object.



Tree Trunk Protector

CAUTION!

Always be certain the anchor you select will withstand the load.

NOTE:

How to choose an anchor point: A secure anchor is critical to winching operations. An anchor must be strong enough to hold while winching. Natural anchors include trees, stumps and rocks. Hook the cable as low as possible. If no natural anchors are available when recovering another vehicle, your vehicle becomes the anchor point. In this case, be sure to put the transmission in NEUTRAL, apply the hand brake and block its wheels to prevent your vehicle from moving. Ideally, you'll want an anchor point that will enable you to pull straight in the direction the vehicle will move. This allows the synthetic rope to wind tightly and evenly onto the spooling drum. An anchor point as far away as possible will provide the winch with its greatest pulling power.

7. Attach the Clevis/D-Shackle and Tree Trunk Protector. Attach the shackle to the two ends of the strap or chain and through the hook, being careful not to over tighten (tighten and back-off 1/2 turn).



Clevis/D-Shackles

A0618000031US

8. Lock the clutch. Lock the winch drum by rotating the clutch lever on the winch to engage.

NOTE:

Always ensure the clutch is fully engaged or disengaged.

9. Connect the remote control to the winch control box, located on the front fascia/bumper. Be careful not to let the remote control cord dangle in front of the winch. If you choose to control the winch from inside your vehicle, always pass the remote through a window to avoid pinching the cord in the door. Always disconnect the remote control when not in use.

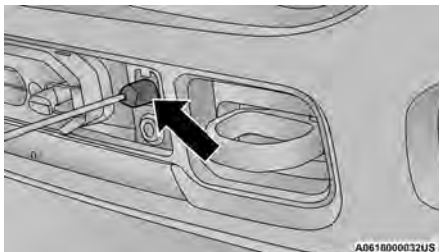

Winch Box Remote Control Connector

A0618000032US

10. Put synthetic rope under tension. Using the remote control switch, slowly wind the rope until no slack remains. Once the rope is under tension, stand well clear of it and never step over it.



Pulling Synthetic Rope Under Tension

A0618000033US

11. Check your anchor. Make sure all connections are secured and free of debris before continuing with the winching procedure.

12. Check synthetic rope. The rope should be neatly wound around the spooling drum. Improper winding can cause damage to the synthetic rope.

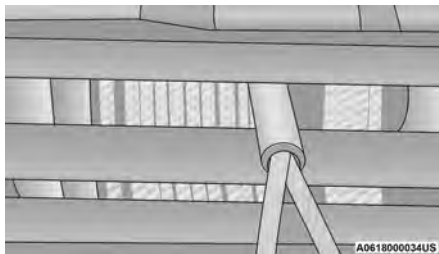

Synthetic Rope Neatly Wound Around The Spooling Drum

A0618000034US

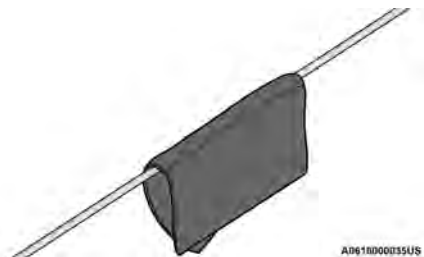

Heavy Blanket Over Rope

A0618000035US

In certain situations you may decide to throw a heavy blanket or similar object over the rope. A heavy blanket can absorb energy should the synthetic rope break. Place it on the rope midway between the winch and the anchor point. Do this before the rope is put under tension. Do not approach or move the blanket once tension is applied. Do not allow it to get pulled into the fairlead. If it is necessary to move or remove the blanket, slack the tension on the rope first.

13. **Establish "no people" zones:** Make your intentions clear. Be sure that everyone in the immediate vicinity surrounding the winching operation is completely aware of your intentions before you pull. **Declare where the spectators should not stand — never behind or in front of the vehicle and never near the synthetic rope or snatch block.** Your situation may have other "no people" zones.

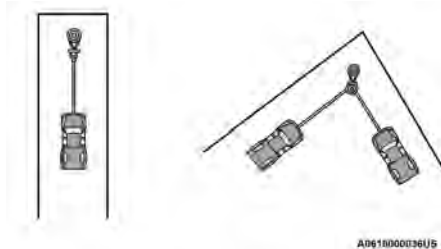

No People Zones

14. Begin winching. With the winching vehicle's engine on and light tension already on the synthetic rope, begin winching slowly and steadily. Be sure that the rope is winding evenly and tightly around the spooling drum. For additional assistance, the

winched vehicle can be slowly driven while being pulled by the winch. Continue pulling until the vehicle is on stable ground. If you are able to move the vehicle, the winching operation is complete.



Using The Remote Control

NOTE:

- Avoid overheating the winch motor. For extended winching, stop at reasonable intervals to allow the winch motor to cool down.
- **What to look for under load:** The synthetic rope must always spool onto the drum as indicated by the drum rotation decal on the winch. As you power-in, make sure the synthetic rope winds evenly and tightly on the drum. This prevents the outer rope wraps from drawing into the inner wraps, binding and damaging the synthetic rope. Avoid shock loads by using the control switch intermittently to take up rope slack. Shock loads can momentarily far exceed the winch and synthetic rope ratings. During side pulls the synthetic rope tends to stack up at one end of the drum. This stack can become large enough to cause serious damage to the winch. So, line up pulls as straight ahead as possible and stop

winching if the synthetic rope comes close to the tie rods or mounting plate. To fix an uneven stack, spool out that section of the rope and reposition it to the opposite end of the drum, which will free up space for continued winching.

15. Secure the vehicle. Once recovery of the vehicle is complete, be sure to secure the vehicle's brakes and shift the transmission to PARK. Release tension in the synthetic rope.
16. Disconnect the synthetic rope, and disconnect from the anchor.
17. Rewind the synthetic rope. The person handling the synthetic rope should walk the rope in and not let it slide through the hand, control the winch at all times.



Rewinding The Synthetic Rope

WARNING!

To prevent serious injury, NEVER put your fingers inside the hook area as you are powering-in.

NOTE:

How to spool under no load: Arrange the remote control lead so it cannot be caught in the winch. Arrange the synthetic rope so it will not kink or tangle when spooled. Be sure any synthetic rope already on the spooling drum is wound tightly and evenly layered. Tighten and straighten the layer if necessary. Keep the synthetic rope under light tension and spool the rope back and onto the winch drum in even layers. Stop frequently to tighten and straighten the layers as necessary. Repeat this process until the winch hook is the same distance as the full length of the remote control from the winch. Pinch the hook between your thumb and forefinger and attach the hook strap. Hold the hook strap between the thumb and forefinger to keep tension on the synthetic rope. Walk the synthetic rope towards the fairlead, carefully spooling in the remaining rope by pulsing the remote control switch.

18. Store the hook on the most outboard loop of the hawse fairlead.

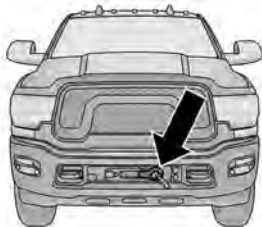

AD618000038US

Hook In Stored Position

19. Disconnect the remote control. Disconnect the remote control cord from the control box and store in a clean and dry place. Winching operations are now complete. Put the cap on the solenoid plug-in.

NOTE:

Always store the remote control in a protected, clean, dry area.

RIGGING TECHNIQUES

Various winching situations will require application of other winching techniques. These could range from too little distance to achieve maximum pull using straight line rigging, simply increasing pulling power, or maintaining a straight-line pulling situation. You will have to assess what technique is correct for your situation. Think "safety" at all times.

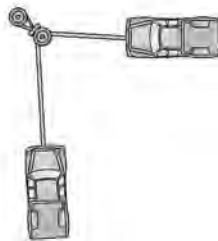
How To Change The Pulling Direction

AD618000039US

Change Pulling Directions

All winching operations should have a straight line from the winch to the object being pulled. This minimizes the synthetic rope collecting on one side of the drum affecting pulling efficiency and damaging synthetic rope. A snatch block, secured to a point directly in front of the vehicle will enable you to change your pulling direction while still allowing the synthetic rope to be at 90° to wind properly onto the spooling drum.

Increasing Pulling Power

In some cases, you may find yourself needing more pulling power. The use of snatch blocks increases mechanical advantage and that increases your pulling power.

Double Line

AD618000040US

Wire Rope Routing

Because pulling power decreases with the number of layers of synthetic rope on the winch drum, you can use a snatch block to double line out more rope. This decreases the number of layers of synthetic rope on the drum, and increases pulling power. Start by feeding out enough synthetic rope to free the winch hook. Attach

the hook to your vehicle's frame/tow hook and run the rope through a snatch block. Disengage the clutch and, using the snatch block, pull out enough synthetic rope to reach your anchor point. Do not attach the hook to the mounting kit. Secure to the anchor point with a tree trunk protector or choker chain. Attach the clevis/shackle. Attach the shackle to the two ends of the strap/chain, being careful not to over tighten (tighten and back-off 1/2 turn).

HYDRAULIC POWER STEERING

The standard power steering system will provide increased vehicle response and maneuverability in tight spaces. The system will provide mechanical steering capability if power assist is lost.

If for some reason the power assist is interrupted, it will still be possible to steer your vehicle. Under these conditions, you will observe a substantial increase in steering effort, especially at very low vehicle speeds and during parking maneuvers.

NOTE:

- Increased noise levels at the end of the steering wheel travel are considered normal and do not indicate that there is a problem with the power steering system.
- Upon initial start-up in cold weather, the power steering pump may make noise for a short amount of time. This is due to the cold, thick fluid in the steering system. This noise should be considered normal, and it does not in any way damage the steering system.

CAUTION!

Prolonged operation of the steering system at the end of the steering wheel travel will increase the steering fluid temperature and it should be avoided when possible. Damage to the power steering pump may occur.

HYDRAULIC POWER STEERING FLUID CHECK

Checking the power steering fluid level at a defined service interval is not required. The fluid should only be checked if a leak is suspected, abnormal noises are apparent, and/or the system is not functioning as anticipated. Check fluid level when the engine is cold and off. Coordinate inspection efforts through an authorized dealer.

WARNING!

Fluid level should be checked on a level surface and with the engine off to prevent injury from moving parts and to ensure accurate fluid level reading. Do not overfill. Use only manufacturer's recommended power steering fluid.

CAUTION!

Do not use chemical flushes in your power steering system as the chemicals can damage your power steering components. Such damage is not covered by the New Vehicle Limited Warranty.

If necessary, add fluid to restore to the proper indicated level. With a clean cloth, wipe any spilled fluid from all surfaces → page 400.

CRUISE CONTROL SYSTEMS — IF EQUIPPED

Your vehicle may be equipped with the Cruise Control system, or the Adaptive Cruise Control (ACC) system:

- Cruise Control will keep your vehicle at a constant preset speed.
- Adaptive Cruise Control (ACC) will adjust the vehicle speed up to the preset speed to maintain a distance with the vehicle ahead.

NOTE:

- In vehicles equipped with ACC, if ACC is not enabled, Fixed Speed Cruise Control will not detect vehicles directly ahead of you. Always be aware of the feature selected.
- Only one Cruise Control feature can operate at a time. For example, if Fixed Speed Cruise Control is enabled, Adaptive Cruise Control will be unavailable, and vice versa.

CRUISE CONTROL

When engaged, the Cruise Control takes over accelerator operations at speeds greater than 20 mph (32 km/h).

The Cruise Control buttons are located on the right side of the steering wheel.

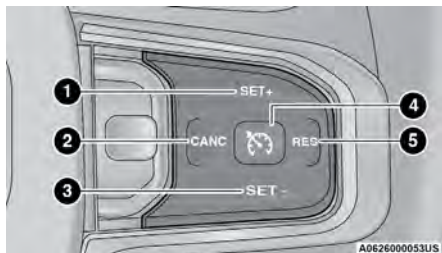

Cruise Control Buttons

- 1 – SET (+)/Accel
- 2 – CANC/Cancel
- 3 – SET (-)/Decel
- 4 – On/Off
- 5 – RES/Resume

To Activate

Push the on/off button to activate the Cruise Control. The cruise indicator light in the instrument cluster display will illuminate. To turn the system off, push the on/off button a second time. The cruise indicator light will turn off. The system should be turned off when not in use.

WARNING!

Leaving the Cruise Control system on when not in use is dangerous. You could accidentally set the system or cause it to go faster than you want. You could lose control and have an accident. Always ensure the system is off when you are not using it.

To Set A Desired Speed

Turn the Cruise Control on.

When the vehicle has reached the desired speed, push the SET (+) or SET (-) button and release. Release the accelerator and the vehicle will operate at the selected speed.

NOTE:

The vehicle should be traveling at a steady speed and on level ground before pushing the SET (+) or SET (-) button.

To Vary The Speed Setting

To Increase Or Decrease The Set Speed

After setting a speed, you can increase the set speed by pushing the SET (+) button, or decrease speed by pushing the SET (-) button.

U.S. Speed (mph)

- Pushing the SET (+), or SET (-) button once will result in a 1 mph speed adjustment. Each subsequent tap of the button results in an adjustment of 1 mph.
- If the button is continually pushed, the set speed will continue to adjust in 5 mph increments until the button is released. The new set speed is reflected in the instrument cluster display.

Metric Speed (km/h)

- Pushing the SET (+), or SET (-) button once will result in a 1 km/h speed adjustment. Each subsequent tap of the button results in an adjustment of 1 km/h.
- If the button is continually pushed, the set speed will continue to adjust in 10 km/h increments until the button is released. The new set speed is reflected in the instrument cluster display.

NOTE:

When you override and push the SET (+) or SET (-) button, the new set speed will be the current speed of the vehicle.

To Accelerate For Passing

While the Cruise Control is set, press the accelerator to pass as you would normally. When the pedal is released, the vehicle will return to the set speed.

USING CRUISE CONTROL ON HILLS

The transmission may downshift on hills to maintain the vehicle set speed.

The Cruise Control system maintains speed up and down hills. A slight speed change on moderate hills is normal. On steep hills, a greater speed loss or gain may occur so it may be preferable to drive without Cruise Control.

WARNING!

Cruise Control can be dangerous where the system cannot maintain a constant speed. Your vehicle could go too fast for the conditions, and you could lose control and have an accident. Do not use Cruise Control in heavy traffic or on roads that are winding, icy, snow-covered or slippery.

To Resume Speed

To resume a previously set speed, push the RES button and release. Resume can be used at any speed above 20 mph (32 km/h).

To Deactivate

A tap on the brake pedal, pushing the CANC (cancel) button, or normal brake pressure while slowing the vehicle will deactivate the Cruise Control system without erasing the set speed from memory.

The following conditions will also deactivate the Cruise Control system without erasing the set speed from memory:

- Vehicle parking brake is applied
- Stability event occurs
- Gear selector is moved out of DRIVE
- Engine overspeed occurs

Pushing the on/off button or placing the ignition in the OFF position, erases the set speed from memory.

ADAPTIVE CRUISE CONTROL (ACC)

Adaptive Cruise Control (ACC) increases the driving convenience provided by Cruise Control while traveling on highways and major roadways. However, it is not a safety system and not designed to prevent collisions.

The Cruise Control function performs differently
 ⇨ page 163.

ACC will allow you to keep Cruise Control engaged in light to moderate traffic conditions without the constant need to reset your speed. ACC utilizes a radar sensor and a forward facing camera designed to detect a vehicle directly ahead of you to maintain a set speed.

NOTE:

- If the ACC sensor detects a vehicle ahead, ACC will apply limited braking or acceleration (not to exceed the original set speed) automatically to maintain a preset following distance, while matching the speed of the vehicle ahead.

- Any chassis/suspension or tire size modifications to the vehicle will affect the performance of the Adaptive Cruise Control and Forward Collision Warning system.
- Fixed Speed Cruise Control (ACC not enabled) will not detect vehicles directly ahead of you. Always be aware of the feature selected ⇨ page 404.

WARNING!

- Adaptive Cruise Control (ACC) is a convenience system. It is not a substitute for active driver involvement. It is always the driver's responsibility to be attentive of road, traffic, and weather conditions, vehicle speed, distance to the vehicle ahead and, most importantly, brake operation to ensure safe operation of the vehicle under all road conditions. Your complete attention is always required while driving to maintain safe control of your vehicle. Failure to follow these warnings can result in a collision and death or serious personal injury.
- The ACC system:
 - Does not react to pedestrians, oncoming vehicles, and stationary objects (e.g., a stopped vehicle in a traffic jam or a disabled vehicle).
 - Cannot take street, traffic, and weather conditions into account, and may be limited upon adverse sight distance conditions.
 - Does not always fully recognize complex driving conditions, which can result in wrong or missing distance warnings.

(Continued)

WARNING!

- Will bring the vehicle to a complete stop while following a vehicle ahead and hold the vehicle for approximately two seconds in the stop position. At this point, there will be an "ACC May Cancel Soon" chime and warning to the driver. When ACC is canceled, the system will release the brakes and the driver must take over braking. The system can be resumed when the vehicle ahead drives off by releasing the brake and pushing the resume button on the steering wheel.

You should switch off the ACC system:

- When driving in fog, heavy rain, heavy snow, sleet, heavy traffic, and complex driving situations (i.e., in highway construction zones).
- When entering a turn lane or highway off-ramp; when driving on roads that are winding, icy, snow-covered, slippery, or have steep uphill or downhill slopes.
- When towing a trailer up or down steep slopes.
- When circumstances do not allow safe driving at a constant speed.

Adaptive Cruise Control (ACC) Operation

The buttons on the right side of the steering wheel operate the Adaptive Cruise Control system.

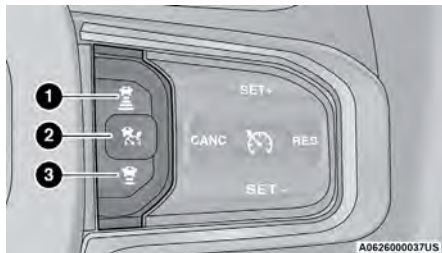

Adaptive Cruise Control Buttons

- 1 — Distance Setting Increase
- 2 — Adaptive Cruise Control (ACC) On/Off
- 3 — Distance Setting Decrease

Adaptive Cruise Control (ACC) Menu

The instrument cluster display will show the current ACC system settings. The information it displays depends on ACC system status.

Push the Adaptive Cruise Control (ACC) on/off button until one of the following appears in the instrument cluster display:

Adaptive Cruise Control Off

When ACC is deactivated, the display will read "Adaptive Cruise Control Off."

Adaptive Cruise Control Ready

When ACC is activated, but the vehicle speed setting has not been selected, the display will read "Adaptive Cruise Control Ready."

Adaptive Cruise Control Set

When the SET (+) or the SET (-) button is pushed, the display will read "ACC SET."

When ACC is set, the set speed will show in the instrument cluster display.

The ACC screen may display once again if any of the following ACC activity occurs:

- System Cancel
- Driver Override
- System Off
- ACC Proximity Warning
- ACC Unavailable Warning

The instrument cluster display will return to the last display selected after five seconds of no ACC display activity.

Activating Adaptive Cruise Control (ACC)

The minimum set speed for the ACC system is 20 mph (32 km/h).

When the system is turned on and in the ready state, the instrument cluster display will read "ACC Ready."

When the system is off, the instrument cluster display will read "Adaptive Cruise Control (ACC) Off."

NOTE:

You cannot engage ACC under the following conditions:

- When in 4WD Low
- When the brakes are applied
- When the parking brake is applied

- When the automatic transmission is in PARK, REVERSE or NEUTRAL
- When the vehicle speed is below the minimum speed range
- When the brakes are overheated
- When the driver's door is open at low speeds
- When the driver's seat belt is unbuckled at low speeds
- When there is a stationary vehicle in front of your vehicle in close proximity
- When Electronic Stability Control (ESC) Full Off mode is active

To Activate/Deactivate

Push and release the Adaptive Cruise Control (ACC) on/off button. The ACC menu in the instrument cluster displays "ACC Ready."

To turn the system off, push and release the Adaptive Cruise Control (ACC) on/off button again. At this time, the system will turn off and the instrument cluster display will show "Adaptive Cruise Control (ACC) Off."

WARNING!

Leaving the Adaptive Cruise Control (ACC) system on when not in use is dangerous. You could accidentally set the system or cause it to go faster than you want. You could lose control and have a collision. Always leave the system off when you are not using it.

To Set A Desired ACC Speed

When the vehicle reaches the speed desired, push the SET (+) button or the SET (-) button and release. The instrument cluster display will show the set speed.

NOTE:

Fixed Speed Cruise Control can be used without ACC enabled. To change between the different modes, push the ACC on/off button which turns the ACC and the Fixed Speed Cruise Control off. Pushing the Fixed Speed Cruise Control on/off button will result in turning on (changing to) Fixed Speed Cruise Control mode.

WARNING!

In Fixed Speed Cruise Control mode, the system will not react to vehicles ahead. In addition, the proximity warning does not activate and no alarm will sound even if you are too close to the vehicle ahead since neither the presence of the vehicle ahead nor the vehicle-to-vehicle distance is detected. Be sure to maintain a safe distance between your vehicle and the vehicle ahead. Always be aware which mode is selected.

If ACC is set when the vehicle speed is **below** 20 mph (32 km/h), the set speed will default to 20 mph (32 km/h).

NOTE:

Fixed Speed Cruise Control cannot be set below 20 mph (32 km/h).

If either system is set when the vehicle speed is **above** 20 mph (32 km/h), the set speed shall be the current speed of the vehicle.

NOTE:

- Keeping your foot on the accelerator pedal can cause the vehicle to continue to accelerate beyond the set speed. If this occurs, the message "ACC Driver Override" will display in the instrument cluster display.
- If you continue to accelerate beyond the set speed while ACC is enabled, the system will not control the distance between your vehicle and the vehicle ahead. The vehicle speed will only be determined by the position of the accelerator pedal.

To Cancel

The following conditions cancel the ACC or Fixed Speed Cruise Control systems:

- The brake pedal is applied
- The CANC (cancel) button is pushed
- The Anti-Lock Brake System (ABS) activates
- The trailer brake is applied manually (if equipped)
- The gear selector is removed from the DRIVE position
- The Electronic Stability Control/Traction Control System (ESC/TCS) activates
- The vehicle parking brake is applied
- The Trailer Sway Control (TSC) activates
- The driver switches ESC to Full Off mode
- The braking temperature exceeds normal range (overheated)

The following conditions will only cancel the ACC system:

- Driver seat belt is unbuckled at low speeds
- Driver door is opened at low speeds

To Turn Off

The system will turn off and clear the set speed in memory if:

- The Adaptive Cruise Control (ACC) on/off button is pushed
- The Fixed Speed Cruise Control on/off button is pushed
- The ignition is placed in the OFF position
- 4WD Low is engaged

To Resume

If there is a set speed in memory, push the RES (resume) button and then remove your foot from the accelerator pedal. The instrument cluster display will show the last set speed.

Resume can be used at any speed above 20 mph (32 km/h) when only Fixed Speed Cruise Control is being used.

Resume can be used at any speed above 0 mph (0 km/h) when ACC is active.

NOTE:

- While in ACC mode, when the vehicle comes to a complete stop longer than two seconds, the system will cancel. The driver will have to apply the brakes to keep the vehicle at a standstill.
- ACC cannot be resumed if there is a stationary vehicle in front of your vehicle in close proximity.

WARNING!

The Resume function should only be used if traffic and road conditions permit. Resuming a set speed that is too high or too low for prevailing traffic and road conditions could cause the vehicle to accelerate or decelerate too sharply for safe operation. Failure to follow these warnings can result in a collision and death or serious personal injury.

To Vary The Speed Setting**To Increase Or Decrease The Set Speed**

After setting a speed, you can increase the set speed by pushing the SET (+) button, or decrease speed by pushing the SET (-) button.

U.S. Speed (mph)

- Pushing the SET (+), or SET (-) button once will result in a 1 mph speed adjustment. Each subsequent tap of the button results in an adjustment of 1 mph.
- If the button is continually pushed, the set speed will continue to adjust in 5 mph increments until the button is released. The new set speed is reflected in the instrument cluster display.

Metric Speed (km/h)

- Pushing the SET (+), or SET (-) button once will result in a 1 km/h speed adjustment. Each subsequent tap of the button results in an adjustment of 1 km/h.
- If the button is continually pushed, the set speed will continue to adjust in 10 km/h increments until the button is released. The new set speed is reflected in the instrument cluster display.

NOTE:

When you override and push the SET (+) button or SET (-) buttons, the new set speed will be the current speed of the vehicle.

When ACC Is Active

- When you use the SET (-) button to decelerate, if the engine's braking power does not slow the vehicle sufficiently to reach the set speed, the brake system will automatically slow the vehicle.
- The ACC system applies the brake down to a full stop when following a vehicle in front. If your vehicle follows the vehicle in front to a standstill, your vehicle will release the brakes two seconds after coming to a full stop.
- The ACC system maintains set speed when driving uphill and downhill. However, a slight speed change on moderate hills is normal. In addition, downshifting may occur while climbing uphill or descending downhill. This is normal operation and necessary to maintain set speed. When driving uphill and downhill, the ACC system will cancel if the braking temperature exceeds normal range (overheated).

Setting The Following Distance In ACC

The specified following distance for Adaptive Cruise Control (ACC) can be set by varying the distance setting between four bars (longest), three bars (long), two bars (medium) and one bar (short). Using this distance setting and the vehicle speed, ACC calculates and sets the distance to the vehicle ahead. This distance setting displays in the instrument cluster display.

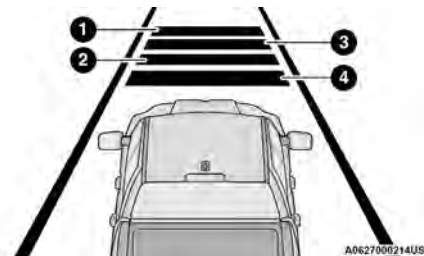
**Distance Settings**

- 1 — Longest Distance Setting (Four Bars)
- 2 — Medium Distance Setting (Two Bars)
- 3 — Long Distance Setting (Three Bars)
- 4 — Short Distance Setting (One Bar)

To increase the distance setting, push the Distance Increase button and release. Each time the button is pushed, the distance setting increases by one bar (longer).

To decrease the distance setting, push the Distance Decrease button and release. Each time the button is pushed, the distance setting decreases by one bar (shorter).

If there is no vehicle ahead, the vehicle will maintain the set speed. If a slower moving vehicle is detected in the same lane, the instrument cluster displays the ACC Set With Target Detected Indicator Light, and the system adjusts vehicle speed automatically to maintain the distance setting, regardless of the set speed.

The vehicle will then maintain the set distance until:

- The vehicle ahead accelerates to a speed above the set speed.
- The vehicle ahead moves out of your lane or view of the sensor.
- The distance setting is changed.
- The system disengages.

The maximum braking applied by ACC is limited; however, the driver can always apply the brakes manually, if necessary.

NOTE:

The brake lights will illuminate whenever the ACC system applies the brakes.

A Proximity Warning will alert the driver if ACC predicts that its maximum braking level is not sufficient to maintain the set distance. If this occurs, a visual alert “BRAKE!” will flash in the instrument cluster display and a chime will sound while ACC continues to apply its maximum braking capacity.

NOTE:

The “BRAKE!” screen in the instrument cluster display is a warning for the driver to take action and does not mean that the Forward Collision Warning system is applying the brakes autonomously.

Overtake Aid

When driving with ACC engaged and following a vehicle, the system will provide an additional acceleration up to the ACC set speed to assist in passing the vehicle. This additional acceleration is triggered when the driver utilizes the left turn signal and will only be active when passing on the left hand side.

ACC Operation At Stop

If the ACC system brings your vehicle to a standstill while following a vehicle ahead, your vehicle will resume motion, without any driver interaction, if the vehicle ahead starts moving within two seconds of your vehicle coming to a standstill.

If the vehicle in front does not start moving within two seconds of your vehicle coming to a standstill, the ACC with Stop system will cancel and the brakes will release. A cancel message will display on the instrument cluster display and produce a warning chime. The driver must now manually operate the vehicle’s accelerator and brakes.

While ACC with Stop is holding your vehicle at a standstill, if the driver seat belt is unbuckled or the driver door is opened, the ACC with Stop system will cancel and the brakes will release. A cancel message will display on the instrument cluster display and produce a warning chime. The driver must now manually operate the vehicle’s accelerator and brakes.

WARNING!

When the ACC system is resumed, the driver must ensure that there are no pedestrians, vehicles or objects in the path of the vehicle. Failure to follow these warnings can result in a collision and death or serious personal injury.

Display Warnings And Maintenance

“WIPE FRONT RADAR SENSOR IN FRONT OF VEHICLE” WARNING

The “ACC/FCW Unavailable Wipe Front Radar Sensor” warning will display and a chime will sound when conditions temporarily limit system performance.

This most often occurs at times of poor visibility, such as in snow or heavy rain. The ACC system may also become temporarily blinded due to obstructions, such as mud, dirt or ice. In these cases, the instrument cluster display will display “ACC/FCW Unavailable Wipe Front Radar Sensor” and the system will deactivate.

This message can sometimes be displayed while driving in highly reflective areas (i.e. ice and snow, or tunnels with reflective tiles). The ACC system will recover after the vehicle has left these areas. Under rare conditions, when the radar is not tracking any vehicles or objects in its path this warning may temporarily occur.

NOTE:

If the “ACC/FCW Unavailable Wipe Front Radar Sensor” warning is active, Fixed Speed Cruise Control is still available.

If weather conditions are not a factor, the driver should examine the sensor. It may require cleaning or removal of an obstruction. The sensor is located in the camera in the center of the windshield, on the forward side of the rearview mirror.

To keep the ACC system operating properly, it is important to note the following maintenance items:

- Always keep the sensor clean. Carefully clear the windshield.
- Do not remove any screws from the sensor. Doing so could cause an ACC system malfunction or failure and require a sensor realignment.
- Do not attach or install any accessories near the sensor, including transparent material or aftermarket grilles. Doing so could cause an ACC system failure or malfunction.

When the condition that deactivated the system is no longer present, the system will return to the “Adaptive Cruise Control Off” state and will resume function by simply reactivating it.

NOTE:

- If the “ACC/FCW Unavailable Wipe Front Radar Sensor” message occurs frequently (e.g. more than once on every trip) without any snow, rain, mud, or other obstructions, have the radar sensor realigned at an authorized dealer.
- Installing a snowplow, front-end protector, an aftermarket grille or modifying the grille is not recommended. Doing so may block the sensor and inhibit ACC/FCW operation.

“CLEAN FRONT WINDSHIELD” WARNING

The “ACC/FCW Limited Functionality Clean Front Windshield” warning will display and a chime will sound when conditions temporarily limit system performance. This most often occurs at times of poor visibility, such as in snow or heavy rain and fog. The ACC system may also become temporarily blinded due to obstructions, such as mud, dirt, or ice on windshield, driving directly into the sun and fog on the inside of glass. In these

cases, the instrument cluster display will show “ACC/FCW Limited Functionality Clean Front Windshield” and the system will have degraded performance.

This message can sometimes be displayed while driving in adverse weather conditions. The ACC/FCW system will recover after the vehicle has left these areas. Under rare conditions, when the camera is not tracking any vehicles or objects in its path this warning may temporarily occur.

If weather conditions are not a factor, the driver should examine the windshield and the camera located on the back side of the inside rearview mirror. They may require cleaning or removal of an obstruction.

When the condition that created limited functionality is no longer present, the system will return to full functionality.

NOTE:

If the “ACC/FCW Limited Functionality Clean Front Windshield” message occurs frequently (e.g. more than once on every trip) without any snow, rain, mud, or other obstructions, have the windshield and forward facing camera inspected at an authorized dealer.

SERVICE ACC/FCW WARNING

If the system turns off, and the instrument cluster displays “ACC/FCW Unavailable Service Required” or “Cruise/FCW Unavailable Service Required”, there may be an internal system fault or a temporary malfunction that limits ACC functionality. Although the vehicle is still drivable under normal conditions, ACC will be temporarily unavailable. If this occurs, try activating ACC again later, following an ignition cycle. If the problem persists, see an authorized dealer.

Precautions While Driving With ACC

NOTE:

- Aftermarket add-ons such as snowplows, lift kits, and brush/grille bars can hinder module performance. Ensure the radar/camera has no obstructions in the field of view.
- Height modifications can limit module performance and functionality.
- Do not put stickers or easy passes over the camera/radar field of view.
- Any modifications to the vehicle that may obstruct the field of view of the radar/camera are not recommended.

In certain driving situations, ACC may have detection issues. In these cases, ACC may brake late or unexpectedly. The driver needs to stay alert and may need to intervene. The following are examples of these types of situations:

TOWING A TRAILER

ACC while towing a trailer is recommended only with an Integrated Trailer Brake Controller. Aftermarket trailer brake controllers will not activate the trailer brakes when ACC is braking.

OFFSET DRIVING

ACC may not detect a vehicle in the same lane that is offset from your direct line of travel, or a vehicle merging in from a side lane. There may not be sufficient distance to the vehicle ahead. The offset vehicle may move in and out of the line of travel, which can cause your vehicle to brake or accelerate unexpectedly.

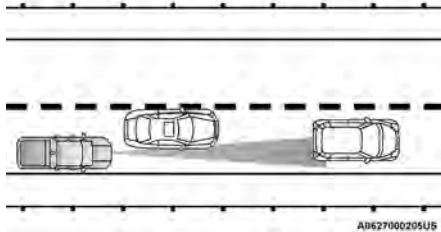

Offset Driving Condition Example

TURNS AND BENDS

When driving on a curve with ACC engaged, the system may increase or decrease the vehicle speed for stability, with no vehicle ahead detected. Once the vehicle is out of the curve, the system will resume your original set speed. This is a part of normal ACC system functionality.

NOTE:

On tight turns ACC performance may be limited.

USING ACC ON HILLS

ACC performance may be limited when driving on hills. ACC may not detect a vehicle in your lane depending on the speed, vehicle load, traffic conditions, and the steepness of the hill.

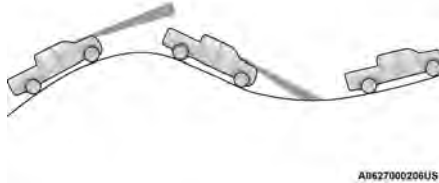

ACC Hill Example

LANE CHANGING

ACC may not detect a vehicle until it is completely in the lane in which you are traveling. In the following lane changing example, ACC has not yet detected the vehicle changing lanes and it may not detect the vehicle until it's too late for the ACC system to take action. ACC may not detect a vehicle until it is completely in the lane. There may not be sufficient distance to the lane-changing vehicle. Always be attentive and ready to apply the brakes if necessary.

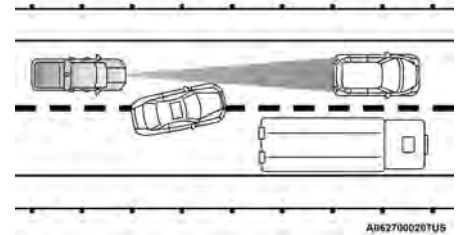

Lane Changing Example

NARROW VEHICLES

Some narrow vehicles traveling near the outer edges of the lane or edging into the lane are not detected until they have moved fully into the lane. There may not be sufficient distance to the vehicle ahead.

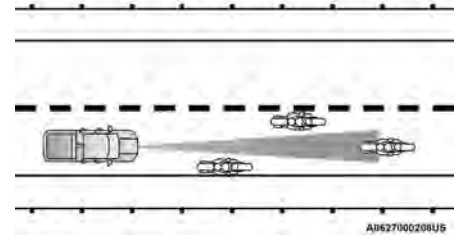

Narrow Vehicle Example

STATIONARY OBJECTS AND VEHICLES

ACC does not react to stationary objects or vehicles. For example, ACC will not react in situations where the vehicle you are following exits your lane and the vehicle ahead is stopped in your lane. It will consider this stopped vehicle a stationary object as it did not previously detect movement from it. Always be attentive and ready to apply the brakes if necessary.

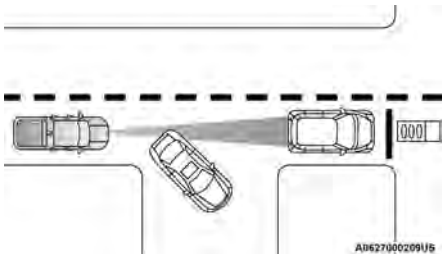

Stationary Object And Stationary Vehicle Example

PARKSENSE FRONT/REAR PARK ASSIST — IF EQUIPPED

The ParkSense Park Assist system provides visual and audible indications of the distance between the rear, and/or front fascia/bumper, and a detected obstacle when backing up or moving forward (e.g. during a parking maneuver).

For limitations of this system and recommendations, see ↪ page 175.

ParkSense will retain the system state (enabled or disabled) from the previous ignition cycle when the ignition is placed in the ON/RUN position.

ParkSense can be active only when the gear selector is in REVERSE or DRIVE. If ParkSense is enabled at one of these gear selector positions, the system will remain active until the vehicle speed is increased to approximately 7 mph (11 km/h) or above. A warning will appear in the instrument cluster display when the vehicle is in REVERSE, indicating the vehicle is above ParkSense operating speed. The system will become active again if the vehicle speed is decreased to less than approximately 6 mph (9 km/h).

PARKSENSE SENSORS

The four ParkSense sensors, located in the rear fascia/bumper, monitor the area behind the vehicle that is within the sensors' field of view.

The sensors can detect obstacles from approximately 12 inches (30 cm) up to 79 inches (200 cm) from the rear fascia/bumper in the horizontal direction, depending on the location, type and orientation of the obstacle.

NOTE:

If equipped as a dually, the ParkSense system has six rear sensors to assist in detection around the dually flares.

The six ParkSense sensors, located in the front fascia/bumper, monitor the area in front of the vehicle that is within the sensors' field of view. The sensors can detect obstacles from approximately 12 inches (30 cm) up to 47 inches (120 cm) from the front fascia/bumper in the horizontal direction, depending on the location, type and orientation of the obstacle.

NOTE:

The dually flares are only protected when the vehicle is in REVERSE. There is no detection for the flares when the vehicle is moving forward.

PARKSENSE WARNING DISPLAY

The ParkSense Warning screen is located within the instrument cluster display. It provides visual warnings to indicate the distance between the rear fascia/bumper and/or front fascia/bumper and the detected obstacle.

NOTE:

If equipped, when Trailer Reverse Steering Control (TRSC) is active, ParkSense warnings in the instrument cluster display are suppressed to allow for TRSC warnings ↪ page 195.

PARKSENSE DISPLAY

The warning display will turn on indicating the system status when the vehicle is in REVERSE or when the vehicle is in DRIVE and an obstacle has been detected.

The system will indicate a detected obstacle by showing a single arc in the left and/or right rear regions based on the obstacle's distance and location relative to the vehicle.

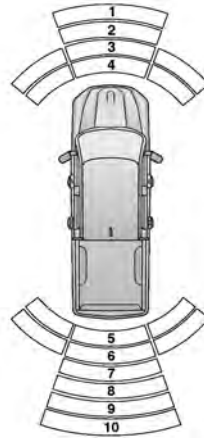

A0629000255US

Front/Rear ParkSense Arcs

- 1 – No Tone/Solid Arc
- 2 – No Tone/Flashing Arc
- 3 – Fast Tone/Flashing Arc
- 4 – Continuous Tone/Flashing Arc
- 5 – Continuous Tone/Flashing Arc

- 6 – Fast Tone/Flashing Arc
- 7 – Fast Tone/Flashing Arc
- 8 – Slow Tone/Solid Arc
- 9 – Slow Tone/Solid Arc
- 10 – Single 1/2 Second Tone/Solid Arc

If an obstacle is detected in the left and/or right rear region, the display will show a single arc in the left and/or right rear region and the system will produce a tone. As the vehicle moves closer to the obstacle, the display will show the single arc moving closer to the vehicle and the tone will change from a single 1/2 second tone to slow, to fast, to continuous.

The vehicle is close to the obstacle when the display shows one flashing arc and sounds a continuous tone. The following chart shows the warning alert operation when the system is detecting an obstacle:

WARNING ALERTS FOR REAR							
Rear Distance (inches/cm)	Greater than 79 inches (200 cm)	79-59 inches (200-150 cm)	59-47 inches (150-120 cm)	47-39 inches (120-100 cm)	39-25 inches (100-65 cm)	25-12 inches (65-30 cm)	Less than 12 inches (30 cm)
Audible Alert Chime	None	Single 1/2 Second Tone	Slow	Slow	Fast	Fast	Continuous
Arcs-Left	None	None	None	None	None	6th Flashing	5th Flashing
Arcs-Center	None	10th Solid	9th Solid	8th Solid	7th Flashing	6th Flashing	5th Flashing
Arcs-Right	None	None	None	None	None	6th Flashing	5th Flashing
Radio Volume Reduced	No	Yes	Yes	Yes	Yes	Yes	Yes

WARNING ALERTS FOR FRONT					
Front Distance (inches/cm)	Greater than 47 inches (120 cm)	47-39 inches (120-100 cm)	39-25 inches (100-65 cm)	25-12 inches (65-30 cm)	Less than 12 inches (30 cm)
Audible Alert Chime	None	None	None	Fast	Continuous
Arcs-Left	None	None	None	3rd Flashing	4th Flashing
Arcs-Center	None	1st Solid	2nd Flashing	3rd Flashing	4th Flashing
Arcs-Right	None	None	None	3rd Flashing	4th Flashing
Radio Volume Reduced	No	No	No	Yes	Yes

NOTE:

ParkSense will reduce the volume of the radio, if on, when the system is sounding an audio tone.

ParkSense Camera Activation

If the ParkSense system detects an obstacle, a camera image will display in the radio. The camera will continue to display as long as the ParkSense system continues to detect an object. This can be turned on or off in the Uconnect system ↗ page 209.

Front Park Assist Audible Alerts

ParkSense will turn off the Front Park Assist audible alert (chime) after approximately three seconds when an obstacle has been detected, the vehicle is stationary, and brake pedal is applied.

Adjustable Chime Volume Settings

The Front and Rear chime volume settings are programmable through the Uconnect system ↗ page 209.

The chime volume settings include low, medium, and high. The factory default volume is medium.

ENABLING AND DISABLING FRONT AND/OR REAR PARKSENSE



Front ParkSense can be enabled and disabled with the Front ParkSense switch.

Rear ParkSense can be enabled and disabled with the Rear ParkSense switch.

When the gear selector is moved to REVERSE and the Front or Rear system is disabled, the instrument cluster display will show a vehicle graphic with an "Off" message overlay over the system that is off (Front or Rear system). This vehicle graphic will be displayed for as long as the vehicle is in REVERSE.

The Front or Rear ParkSense switch LED will be on when Front or Rear ParkSense is disabled or requires service. The Front or Rear ParkSense switch LED will be off when the Front or Rear system is enabled. If the Front or Rear ParkSense switch is pushed, and the system requires service, the Front or Rear ParkSense switch LED will blink momentarily, and then the LED will be on.

SERVICE THE PARKSENSE FRONT/REAR PARK ASSIST SYSTEM

During vehicle start up, when the Front/Rear ParkSense System has detected a faulted condition, the instrument cluster display will show the "Front/Rear ParkSense Unavailable Service Required" or the "Front/Rear ParkSense Unavailable Wipe Sensors" message.

When the gear selector is moved into REVERSE, a vehicle graphic will show in the instrument cluster display, along with the display overlay "Wipe Sensors." If the system needs service, the display overlay will read "Service." Under this condition, ParkSense will not operate.

If "Front/Rear ParkSense Unavailable Wipe Sensors" appears in the instrument cluster display make sure the outer surface and the underside of the rear fascia/bumper is clean and clear of snow, ice, mud, dirt or other obstructions, and then cycle the ignition. If the message continues to appear, see an authorized dealer.

If "Front/Rear ParkSense Unavailable Service Required" appears in the instrument cluster display, see an authorized dealer.

CLEANING THE PARKSENSE SYSTEM

Clean the ParkSense sensors with water, car wash soap and a soft cloth. Do not use rough or hard cloths. Do not scratch or poke the sensors. Otherwise, you could damage the sensors.

PARKSENSE SYSTEM USAGE PRECAUTIONS

NOTE:

- Ensure that the front and rear fascias/bumpers are free of snow, ice, mud, dirt and debris to keep the ParkSense system operating properly.
- Jackhammers, large trucks, and other vibrations could affect the performance of ParkSense.
- When you move the gear selector to the REVERSE position and Front or Rear ParkSense is turned off, the instrument cluster display will show "Off" on the vehicle graphic arcs. This vehicle graphic will be displayed for as long as the vehicle is in REVERSE.
- ParkSense, when on, will reduce the volume of the radio when it is sounding a tone.
- Clean the ParkSense sensors regularly, taking care not to scratch or damage them. The sensors must not be covered with ice, snow, slush, mud, dirt or debris. Failure to do so can result in the system not working properly. The ParkSense system might not detect an obstacle behind or in front of the fascia/bumper, or it could provide a false indication that an obstacle is behind or in front of the fascia/bumper.
- Use the ParkSense switch to turn the ParkSense system off if obstacles such as bicycle carriers, trailer hitches, etc. are placed within 18 inches (45 cm) from the rear fascia/bumper. Failure to do so can result in the system misinterpreting a close obstacle as a sensor problem, causing the "Front/Rear ParkSense Unavailable Service Required" message to appear in the instrument cluster display.

- On vehicles equipped with a tailgate, ParkSense should be disabled when the tailgate is in the lowered or open position. A lowered tailgate could provide a false indication that an obstacle is behind the vehicle.

WARNING!

- Drivers must be careful when backing up even when using ParkSense. Always check carefully behind your vehicle, look behind you, and be sure to check for pedestrians, animals, other vehicles, obstructions, and blind spots before backing up. You are responsible for safety and must continue to pay attention to your surroundings. Failure to do so can result in serious injury or death.
- Before using ParkSense, it is strongly recommended that the ball mount and hitch ball assembly be disconnected from the vehicle when the vehicle is not used for towing. Failure to do so can result in injury or damage to vehicles or obstacles because the hitch ball will be much closer to the obstacle than the rear fascia/bumper when the vehicle sounds the continuous tone. Also, the sensors could detect the ball mount and hitch ball assembly, depending on its size and shape, giving a false indication that an obstacle is behind the vehicle.

CAUTION!

- ParkSense is only a parking aid and it is unable to recognize every obstacle, including small obstacles. Parking curbs might be temporarily detected or not detected at all. Obstacles located above or below the sensors will not be detected when they are in close proximity.

*(Continued)***CAUTION!**

- The vehicle must be driven slowly when using ParkSense in order to be able to stop in time when an obstacle is detected. It is recommended that the driver looks over his/her shoulder when using ParkSense.

LANESENSE — IF EQUIPPED**LANESENSE OPERATION**

The LaneSense system is operational at speeds above 37 mph (60 km/h) and below 112 mph (180 km/h). It uses a forward-looking camera to detect lane markings and measure vehicle position within the lane boundaries. When both lane markings are detected and the driver unintentionally drifts out of the lane while no turn signal has been applied OR the driver departs the lane on the opposite side of the applied turn signal (if the left turn signal is applied and the vehicle departs to the right), the LaneSense system provides a haptic warning in the form of torque applied to the steering wheel to prompt the driver to remain within the lane boundaries. The LaneSense system will also provide a visual warning through the instrument cluster display to prompt the driver to remain within the lane boundaries.

The driver may manually override the haptic warning by applying torque to the steering wheel at any time.

When only a single lane marking is detected and the driver unintentionally drifts across that lane marking (no turn signal applied), the LaneSense system provides a visual warning through the instrument cluster display to prompt the driver to remain within the lane. When only a single lane marking is detected, a haptic (torque) warning will not be provided.

NOTE:

When operating conditions have been met, the LaneSense system will monitor if the driver's hands are on the steering wheel and provides an audible and visual warning to the driver when the driver's hands are not detected on the steering wheel. The system will cancel if the driver does not return their hands to the wheel.

TURNING LANESENSE ON OR OFF

The LaneSense button is located on the switch panel below the Uconnect display.

NOTE:

If your vehicle is equipped with a 12-inch Uconnect Display screen, the LaneSense button is located above the display.

To turn the LaneSense system on, push the LaneSense button (LED turns off). A "LaneSense On" message is shown in the instrument cluster display.

To turn the LaneSense system off, push the LaneSense button again (LED turns on).

NOTE:

The LaneSense system will retain the last system state (on or off) from the last ignition cycle when the ignition is placed in the ON/RUN position.

LANESENSE WARNING MESSAGE



The LaneSense system will indicate the current lane drift condition through the instrument cluster display.

When the LaneSense system is on, the lane lines are gray when both of the lane boundaries have not been detected and the LaneSense telltale  is solid white.



System ON (Gray Lines) With White Telltale

Left Lane Departure — Only Left Lane Detected

- When the LaneSense system is on, the LaneSense Telltale  is solid white when only the left lane marking has been detected and the system is ready to provide visual warnings in the instrument cluster display if an unintentional lane departure occurs on the left side.
- When the LaneSense system senses the lane has been approached and is in a lane departure situation, the visual warning in the instrument cluster display will show the left lane line flashing yellow (on/off). The LaneSense telltale  changes from solid white to flashing yellow.



Lane Crossed (Flashing Yellow Lane Line) With Yellow Telltale

NOTE:

The LaneSense system operates with similar behavior for a right lane departure when only the right lane marking has been detected.

Left Lane Departure — Both Lane Lines Detected

- When the LaneSense system is on and both the lane markings have been detected, the system is ready to provide visual warnings in the instrument cluster display and a torque warning in the steering wheel if an unintentional lane departure occurs. The lane lines turn from gray to white and the LaneSense telltale  is solid green.



Lanes Sensed (White Lines) With Green Telltale

- When the LaneSense system senses a lane drift situation, the left lane line turns solid yellow. The LaneSense telltale  changes from solid green to solid yellow. At this time torque is applied to the steering wheel in the opposite direction of the lane boundary. For example: If approaching the left side of the lane the steering wheel will turn to the right.

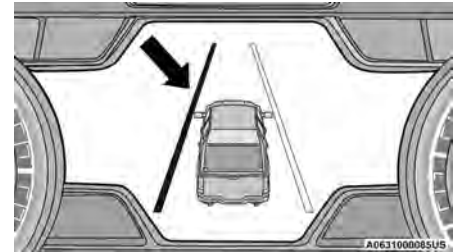

Lane Approached (Solid Yellow Lane Line) With Solid Yellow Telltale

- When the LaneSense system senses the lane has been approached and is in a lane departure situation, the left lane line flashes yellow (on/off). The LaneSense telltale  changes from solid yellow to flashing yellow. At this time torque is applied to the steering wheel in the opposite direction of the lane boundary.

For example: If approaching the left side of the lane the steering wheel will turn to the right.

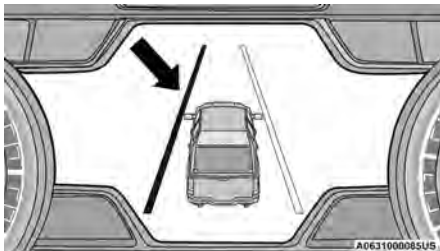

Lane Crossed (Flashing Yellow Lane Line) With Flashing Yellow Telltale

NOTE:

The LaneSense system operates with similar behavior for a right lane departure.

CHANGING LANESENSE STATUS

The LaneSense system has settings to adjust the intensity of the torque warning and the warning zone sensitivity (Early/Medium/Late) that you can configure through the Uconnect system  page 209.

NOTE:

- When enabled the system operates above 37 mph (60 km/h) and below 112 mph (180 km/h).
- Use of the turn signal suppresses the warnings.
- The system will not apply torque to the steering wheel whenever a safety system engages (Anti-Lock Brakes, Traction Control System, Electronic Stability Control, Forward Collision Warning, etc.).

TURN SIGNAL ACTIVATED BLIND SPOT ASSIST – IF EQUIPPED

When enabled in the Uconnect system and a turn signal is activated, the corresponding side view mirror camera will display in the radio. The camera will continue to display as long as the turn signal is engaged. If "Only With Trailer" is selected (if equipped), the camera will only display when a trailer is connected to the vehicle  page 209.

WARNING!

Blind Spot Assist is only an aid to help detect objects in the blind spot zones and may not provide alerts when changing lanes under all driving conditions. Even if your vehicle is equipped with the BSA system, always check your vehicle's mirrors, glance over your shoulder, and use turn signals before changing lanes. Failure to do so can result in serious injury or death.

PARKVIEW REAR BACK UP CAMERA

The ParkView Rear Back Up Camera allows you to see an on-screen image of the rear surroundings of your vehicle whenever the gear selector is put into REVERSE. The image will be displayed on the Uconnect display along with a caution note to "Check Entire Surroundings" across the top of the screen. After five seconds this note will disappear. The ParkView Camera is located in the center of the tailgate handle.

NOTE:

Removing the tailgate will disable the Rear View Camera function.



Manual Activation Of The Rear View Camera

- Press the Vehicle button located on the bottom of the Uconnect display and then select the Controls menu.
- Press the Back Up Camera icon to turn the Rear View Camera system on.

When the vehicle is shifted out of REVERSE with Camera delay turned off, the rear Camera mode is exited and the previous screen appears again.

When the vehicle is shifted out of REVERSE with Camera delay turned on, the rear Camera image will be displayed for up to 10 seconds after shifting to another gear, unless the vehicle speed exceeds 8 mph (13 km/h), the transmission is shifted into PARK, the ignition is placed in the OFF position, or the touchscreen X button to disable display of the Rear View Camera image is pressed.

Whenever the Rear View Camera image is activated through the Back Up Camera button in the Controls menu, and the vehicle speed is greater than, or equal to, 8 mph (13 km/h), a display timer for the image is initiated. The image will continue to be displayed until the display timer exceeds 10 seconds.

NOTE:

- If the vehicle speed remains below 8 mph (13 km/h), the Rear View Camera image will be displayed continuously until deactivated via the touchscreen X button, the transmission is shifted into PARK, or the ignition is placed in the OFF position.
- The touchscreen X button to disable display of the camera image is made available **ONLY** when the vehicle is not in REVERSE.

Cargo Camera Icons — If Equipped



Back Up Camera Touchscreen Button



Cargo Camera Touchscreen Button



AUX Camera Touchscreen Button

If equipped with a Cargo Camera, a touchscreen button is made available to indicate the current active Camera image being displayed whenever the Rear View Camera image is displayed.

If equipped with a Cargo Camera, a touchscreen button to switch the display to Cargo Camera image is made available whenever the Rear View Camera image is displayed.

A touchscreen X button to disable display of the camera image is made available when the vehicle is not in REVERSE gear.

When enabled, active guidelines are overlaid on the Back Up camera image to illustrate the width of the vehicle and its projected back up path based on the steering wheel position. The active guidelines will show separate zones that will help indicate the distance to the rear of the vehicle. The corresponding settings can be adjusted within Uconnect Settings → page 209.

A dashed centerline overlay indicates the center of the vehicle to assist with parking or aligning to a hitch/receiver. The following table shows the approximate distances for each zone:

Zones	Distance To The Rear Of The Vehicle
Red	0 - 1 ft (0 - 30 cm)
Yellow	1 ft - 6.5 ft (30 cm - 2m)
Green	6.5 ft or greater (2 m or greater)

WARNING!

Drivers must be careful when backing up even when using the ParkView Rear Back Up Camera. Always check carefully behind your vehicle, and be sure to check for pedestrians, animals, other vehicles, obstructions, or blind spots before backing up. You are responsible for the safety of your surroundings and must continue to pay attention while backing up. Failure to do so can result in serious injury or death.

CAUTION!

- To avoid vehicle damage, ParkView should only be used as a parking aid. The ParkView camera is unable to view every obstacle or object in your drive path.
- To avoid vehicle damage, the vehicle must be driven slowly when using ParkView to be able to stop in time when an obstacle is seen. It is recommended that the driver look frequently over his/her shoulder when using ParkView.

The ParkView Rear Back Up Camera is located in the center of the tailgate handle.

NOTE:

If snow, ice, mud, or any foreign substance builds up on the camera lens, clean the lens, rinse with water, and dry with a soft cloth. Do not cover the lens.

Zoom View

When the Rear View Camera image is being displayed, and the vehicle speed is below 8 mph (13 km/h) while in any gear selector position, Zoom View is available. By pressing the “magnifying glass” icon in the upper left of the display screen, the image will zoom in to four times the standard view. Pressing the icon a second time will return the view to the standard Back Up Camera display.

When Zoom View is selected while the vehicle is in REVERSE, then shifted to DRIVE, the camera delay view will display the standard Back Up Camera view. If the vehicle is then returned to REVERSE gear from DRIVE, the Zoom View selection will automatically resume.

Shifting to NEUTRAL from any gear will maintain the selected view (Zoom or Standard) as long as the vehicle speed is below 8 mph (13 km/h).

If the vehicle is in PARK, Zoom View is available until the gear selector is placed in DRIVE or REVERSE.

NOTE:

- If the vehicle is in DRIVE, NEUTRAL, or REVERSE, and speed is greater than or equal to 8 mph (13 km/h), Zoom View is unavailable and the icon will appear gray.
- While in Zoom View, the guidelines will not be visible.

For information on Auxiliary Cameras (if equipped), see page 187.

**SURROUND VIEW CAMERA SYSTEM —
IF EQUIPPED**

The Surround View Camera system allows you to see an on-screen image of the surroundings and the Top View of your vehicle. This occurs whenever the gear selector is in REVERSE or when enabled through the Uconnect system. The Top View of the vehicle will also show if any doors are open. The image will be displayed on the Uconnect display along with a caution note “Check Entire Surroundings”. After five seconds, this note will disappear. The Surround View Camera system is comprised of four cameras located in the front grille, rear tailgate and side mirrors.

NOTE:

- Removing the tailgate will disable the Rear View Camera function.
- The Surround View Camera system has programmable settings that may be selected through the Uconnect system page 209.



Press this button on the touchscreen to enter the Surround View Camera menu in the Uconnect system.

When the vehicle is shifted into REVERSE, the Rear View and Top View is the default view of the system.

If the camera delay is turned on, the camera image will display for up to 10 seconds after shifting out of REVERSE. The camera image will not display for 10 seconds if the vehicle speed exceeds 8 mph (13 km/h), the vehicle is shifted into PARK, or the ignition is placed in the OFF position. The touchscreen X button disables the display of the camera image.

If the camera delay is turned off, the camera image will close and display the previous screen after shifting out of REVERSE.

If active guidelines are enabled, the lines are overlaid on the image in the Rear View to illustrate the width of the vehicle. The view will also include the side view mirrors and its projected back up path based on the steering wheel position.

There are different colored zones to indicate the distance to the rear of the vehicle. Refer to the following chart:

Zone	Distance To The Rear Of The Vehicle
Red	0 - 1 ft (0 - 30 cm)
Yellow	1 ft - 6.5 ft (30 cm - 2 m)
Green	6.5 ft or greater (2 m or greater)

Modes Of Operation

Standard Rear View can be manually activated by selecting “Back Up Camera” through the Controls menu within the Uconnect system.

Top View

The Top View will show in the Uconnect system with Rear View and Front View in a split screen display. There are integrated ParkSense arcs in the image at the front and rear of the vehicle. The arcs will change color from yellow to red corresponding the distance zones to the oncoming object.

The fifth button of the ParkSense Camera View screen will change based on vehicle options. If not equipped with a Cargo Camera or Trailer Reverse Guidance, the Back Up Camera button will be displayed. If equipped with a Cargo Camera but no Trailer Reverse Guidance,

the Cargo Camera button will be displayed. If equipped with both a Cargo Camera and Trailer Reverse Guidance, the Cargo/Trailer Reverse Guidance button will be displayed.

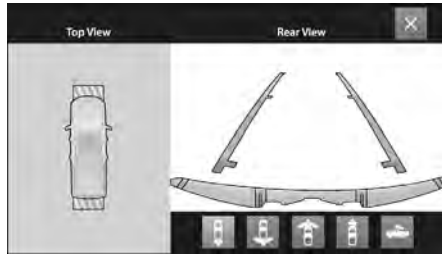

ParkSense Camera View

NOTE:

- Front tires will display on the image when the tires are turned.
- Due to wide angle cameras in mirrors, the image will appear distorted.
- Top View will show which doors are open.
- Open front doors will cancel the outside image.

Top View Plus Rear View



This is the default view of the system in REVERSE and is always paired with the Top View of the vehicle with optional active guidelines for the projected path when enabled.

Rear Cross Path View



The Rear Cross Path will give the driver a wider angle view of the Back Up Camera system. The Top View will be disabled when this is selected.

Top View Plus Front View



The Front View will show what is immediately in front of the vehicle and is always paired with the Top View of the vehicle.

Front Cross Path View



The Front Cross Path will give the driver a wider angle view of the front camera system. The Top View will be disabled when this is selected.

Back Up Camera View



The Back Up Camera will provide a full screen rear view with Zoom View.

NOTE:

If the Back Up Camera view was selected through the Surround View Camera menu, exiting out of the Rear View screen will return to the Surround View menu. If the Back Up Camera was manually activated through the Controls menu of the Uconnect system, exiting out of the display screen will return to the Controls menu.

Cargo Camera



The Cargo Camera will provide a full screen view of the cargo area.

NOTE:

If the Cargo Camera view was selected through the Surround View screen, exiting out of the Cargo Camera screen will return to the Surround View screen. If the Cargo Camera was manually activated through the Controls menu of the Uconnect display, exiting out of the display screen will return to the Controls menu.

Trailer Reverse Guidance



The Trailer Reverse Guidance will provide a full screen view of the cargo area and trailer.



Pressing the Left & Right Tow Mirror Split Screen View button within the Trailer Reverse Guidance screen will display a split screen to allow the driver to see both sides of the trailer at the same time. This view allows the driver to pan left/right to better frame the trailer in the image.

NOTE:

Trailer Reverse Guidance can only be selected through the Surround View screen; exiting out of the Trailer Reverse Guidance screen will return to the Surround View screen.

Zoom View

When the Rear View Camera image is being displayed, and the vehicle speed is below 8 mph (13 km/h) while in any gear, Zoom View is available. By pressing the "magnifying glass" icon in the upper left of the display screen, the image will zoom in to four times the standard view. Pressing the icon a second time will return the view to the standard Back Up Camera display.

When Zoom View is selected while the vehicle is in REVERSE, then shifted to DRIVE, the camera delay view will display the standard Back Up Camera view. If the vehicle is then returned to REVERSE gear from DRIVE, the Zoom View selection will automatically resume.

Shifting to NEUTRAL from any gear will maintain the selected view (Zoom or Standard) as long as the vehicle is below 8 mph (13 km/h).

If the vehicle is in PARK, Zoom View is available until the gear selector is placed in DRIVE or REVERSE and speeds are at or above 8 mph (13 km/h).

NOTE:

- If the vehicle is in DRIVE, NEUTRAL, or REVERSE, and speed is greater than or equal to 8 mph (13 km/h), Zoom View is unavailable and the icon will appear gray.
- While in Zoom View, the guidelines will not be visible.

Deactivation

The system is deactivated in the following conditions if it was activated **automatically**:

- When the vehicle is shifted out of REVERSE with camera delay turned on, the camera image will continue to be displayed for up to 10 seconds, unless the vehicle speed exceeds 8 mph (13 km/h), the vehicle is shifted into PARK or the ignition is placed in the OFF position. There is a touchscreen X button to disable the display of the camera image.
- When the vehicle is shifted out of REVERSE with camera delay turned off, the Surround View Camera mode is exited and the last known screen appears again.

The system is deactivated in the following conditions if it was activated **manually** from the Uconnect controls menu via the Surround View button, Back Up Camera button, Cargo Camera button or Forward Facing Camera button:

- The touchscreen X button on the display is pressed
- Vehicle is shifted into PARK
- Ignition is placed in the OFF position
- Vehicle speed is over 8 mph (13 km/h) for 10 seconds

NOTE:

If the Surround View Camera, Cargo Camera, Back Up Camera, or Forward Facing Camera is activated manually, and the vehicle is shifted into REVERSE, deactivation methods for automatic activation are assumed.

The camera delay system is turned off manually through the Uconnect Settings menu  page 209.

NOTE:

- If snow, ice, mud, or any foreign substance builds up on the camera lenses, clean the lenses, rinse with water, and dry with a soft cloth. Do not cover the lenses.
- If a malfunction with the system has occurred, see an authorized dealer.

Cargo Camera With Dynamic Centerline — If Equipped

The Dynamic Centerline feature provides an overlay on the Cargo Camera display screen that aligns to the center of the pickup box to aid in hooking up a fifth-wheel camper or gooseneck trailer. The centerline auto aligns to the center of the pickup box, and can also be manually adjusted. The centerline will adjust in response to steering angle inputs, and will not obstruct the gooseneck receiver or an approaching trailer gooseneck in the camera feed.

Activation

The Dynamic Centerline feature can be activated through the Uconnect settings by pressing the Cargo Camera button, followed by the Dynamic Centerline button on the touchscreen.

If the Dynamic Centerline feature is turned on, the overlay will display any time the Cargo Camera image is displayed.

Adjusting Centerline

To manually adjust the centerline, proceed as follows:

1. Press the Adjust Centerline button located in the bottom right corner of the Cargo Camera display.
2. Use the arrows on the bottom left corner of the Cargo Camera display to adjust the centerline horizontally or vertically.
3. Once the desired position is achieved, press the Accept button to set the centerline to the newly specified position.

Deactivation

The Dynamic Centerline feature will automatically be deactivated whenever the Cargo Camera display is deactivated. It can also be manually deactivated through the Uconnect Settings.

Cargo Camera Zoom View



When the Cargo Camera image is being displayed, and the vehicle speed is below 8 mph (13 km/h) while in any gear selector position, Zoom View is available. By pressing the “magnifying glass” icon in the upper left of the display screen, the image will zoom in to four times the standard view. Pressing the icon a second time will return the view to the standard Cargo Camera display.

When Zoom View is selected while the vehicle is in REVERSE, then shifted to DRIVE, the camera delay view will display the standard Cargo Camera view. If the vehicle is then returned to REVERSE gear from DRIVE, the Zoom View selection will automatically resume.

Shifting to NEUTRAL from any gear will maintain the selected view (Zoom or Standard) as long as the vehicle is below 8 mph (13 km/h).

Zoom View is available until the gear selector is placed in DRIVE or REVERSE and speeds are at or above 8 mph (13 km/h).

NOTE:

- If the vehicle is in DRIVE, NEUTRAL, or REVERSE, and speed is greater than or equal to 8 mph (13 km/h), Zoom View is unavailable and the icon will appear gray.
- While in Zoom View, the dynamic centerline will not be visible.

Forward Facing Camera With Tire Lines — If Equipped

The Forward Facing Camera displays a front view image of the road ahead, along with tire lines to guide the driver when driving on narrow roads. Tire lines can be activated/deactivated through the Uconnect Settings.

Activation

The Forward Facing Camera can be activated in the following ways:

- Pressing the Forward Facing Camera button in the Controls screen or Apps menu
- Pressing the Forward Facing Camera button located in the upper left corner of the Back Up camera display

Once activated, the camera image will remain on as long as the vehicle speed is below 8 mph (13 km/h).

Deactivation

The Forward Facing Camera is deactivated in the following conditions:

- The vehicle exceeds 8 mph (13 km/h), except when vehicle is in 4WD Low.
- The touchscreen X button on the display is pressed.
- The vehicle is shifted into PARK.
- The ignition is placed in the OFF position.

NOTE:

If the vehicle is in 4WD Low, the Forward Facing Camera image will be displayed until the touchscreen X button is pressed or the ignition is placed in the OFF position.

Trailer Reverse Guidance — If Equipped

The Trailer Reverse Guidance feature assists the driver in backing up a trailer by providing adjustable camera views of the trailer and surrounding area. The cameras are mounted on the side mirrors and the images will be displayed side-by-side on the touchscreen. Left and right camera images are swapped and mirrored on the touchscreen to show the equivalent area behind the vehicle as though the driver is using the side mirrors.

Activation

The Trailer Reverse Guidance feature can be activated by pressing the Trailer Reverse Guidance button on the Back Up/Cargo Camera Display.

Deactivation

When the vehicle is shifted out of REVERSE with camera delay turned on, the camera image will continue to be displayed for up to 10 seconds unless the vehicle speed exceeds 8 mph (13 km/h), the vehicle is shifted into PARK, or the ignition is placed in the OFF position. There is a touchscreen X button to disable the display of the camera image.

If Trailer Reverse Guidance is selected through manually activated Surround View, Back Up Camera, or Cargo Camera, the following deactivation conditions apply:

- The touchscreen X button on the display is pressed
- The vehicle is shifted into PARK
- The ignition is placed in the OFF position
- The vehicle speed is over 8 mph (13 km/h) for 10 seconds

Blind Spot Assist Cameras — If Equipped

There are cameras located in the exterior mirrors to assist in blind spot detection by providing a wide camera view of the selected side of the vehicle. The blind spot cameras will work in the ON/RUN or ignition ON position. Press the touchscreen X button or the More Cams button to exit the screen. The Blind Spot Assist Cameras can also be activated with Turn Signal engagement, see  page 178 for more information.

Activation

Press the Driver Blind Spot or Passenger Blind Spot buttons by locating the Vehicle screen, then Cameras screen.

Driver Blind Spot

Pressing the Driver's Blind Spot button will provide a full screen view of the driver's outside mirror camera.

Passenger Blind Spot

Pressing the Passenger's Blind Spot button will provide a full screen view of the passenger's outside mirror camera.

WARNING!

Drivers must be careful when backing up even when using the Surround View Camera. Always check carefully behind your vehicle, and be sure to check for pedestrians, animals, other vehicles, obstructions, or blind spots before backing up. You are responsible for the safety of your surroundings and must continue to pay attention while backing up. Failure to do so can result in serious injury or death.

CAUTION!

- To avoid vehicle damage, Surround View should only be used as a parking aid. The Surround View Camera is unable to view every obstacle or object in your drive path.
- To avoid vehicle damage, the vehicle must be driven slowly when using Surround View to be able to stop in time when an obstacle is seen. It is recommended that the driver look frequently over his/her shoulder when using Surround View.

NOTE:

If the vehicle is not equipped with a Pickup Box:

- The bottom wedge of the Top View will be displayed in black.
- The Rear Cross Path button will be grayed out.
- The guidelines will not be overlaid on Top View/Rear View and Full Screen of Back Up Camera view.

- Black video will be displayed for the right side of the Top and Rear View, and full screen of the Back Up Camera view when the Rear View Camera is not connected.

To access all camera options when the vehicle is in REVERSE, select the More Cams button on the surround view screen.

For information on Auxiliary Cameras (if equipped), see  page 187.

TRAILER CAMERAS — IF EQUIPPED

TRAILER SURROUND VIEW CAMERA SYSTEM

The Trailer Surround View Camera system allows you to see an on-screen image of the surroundings and the Top View of a trailer using four mountable cameras. This occurs whenever the More Cams button is selected, or when enabled through the Uconnect system. The image will be displayed on the Uconnect display along with a caution note “Check Entire Surroundings”. After five seconds, this note will disappear.

NOTE:

- Trailer Surround View Camera kit is only available for vehicles equipped with the Surround View Camera system.
- The Trailer Surround View Camera system has programmable settings that may be selected through the Uconnect system  page 209.

Set Up

The Trailer Surround View Camera system includes an installation kit with a Trailer Surround View Module and four Trailer Surround View Cameras that must be installed on your trailer prior to connecting to your vehicle. See the installation instructions included with the Trailer Surround View installation kit for more information.

NOTE:

The trailer will be connected to the vehicle via the 12-way connector, and the installation location varies for Conventional or Gooseneck trailers.

For Conventional trailers, the connection from the rear fascia goes to the receptacle in the bumper.

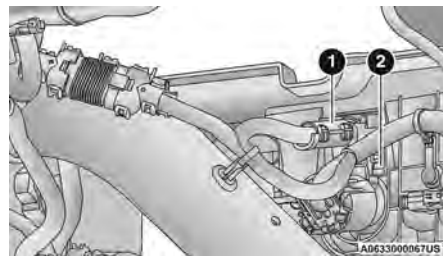
**Conventional Trailer Connection**

- 1 — Rear Fascia Connector
2 — Receptacle

For Gooseneck trailers, the connection from the rear fascia goes to the rear chassis inline.

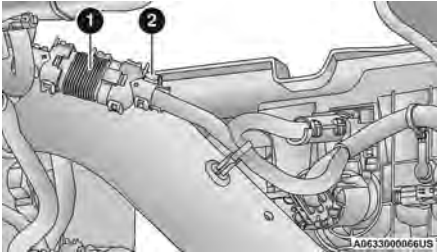

Gooseneck Trailer Connection

- 1 – Rear Chassis Inline
2 – Rear Fascia Connector

NOTE:

- When the 12-way connector goes to the rear chassis, there is a black cap on the bumper receptacle for protection.
- In order to make the connection from the rear chassis to the bumper, the cap must be unplugged from the bumper and put on the rear chassis after making the 12-way connection and vice versa.

Once the Trailer Surround View Module and cameras are installed and the trailer is connected to the vehicle via the 12-way connector, the Trailer Surround Camera settings can be accessed. The Trailer Surround Camera settings can be accessed through Uconnect Settings by pressing the Trailer button in the Trailer Settings or the Camera Settings. The system requires input of the trailer dimensions prior to use of the system.

NOTE:

- If a trailer is connected but the trailer dimensions have not been entered in the Trailer Surround settings page, the system will default to the settings page.
- If a trailer is not connected and any button is selected, a message will appear: "Connect Trailer Equipped With Trailer Surround View System".

Inputting Trailer Values

For the Trailer Surround View Camera system to function, all fields must be entered. When a value is needed the screen will display "Required".

Setting	Description
Trailer Length	Input the total length of the trailer
Trailer Width	Input the total width of the trailer
Camera Height	Input the height of the mounted camera
Trailer Type	Choose the trailer type from menu

When the Trailer Type button is selected two options are available: Conventional or Gooseneck/Fifth Wheel.

Activation

The Trailer Surround Camera can be activated through the Uconnect system when the vehicle is in PARK, NEUTRAL, or DRIVE.

When the vehicle is shifted into REVERSE, Surround View Camera showing the Top View and Back Up Camera is the default view of the system. Press the More Cams button and press the Trailer tab to access the Trailer Cameras. Press Trailer Surround Camera button to access Top View and Rear View of the trailer.

If the camera delay is turned on, the camera image will display for up to 10 seconds after shifting out of REVERSE. The camera image will not display for 10 seconds if the vehicle speed exceeds 8 mph (13 km/h),

the vehicle is shifted into PARK, or the ignition is placed in the OFF position. The touchscreen X button disables the display of the camera image.

If the camera delay is turned off, the camera image will close and display the previous screen after shifting out of REVERSE.

Modes Of Operation

The Trailer Surround View Camera system offers two different camera displays:

- Top View split screen with one selected mounted camera
- Full screen view of a selected mounted camera

Press the More Cams button on the Surround View screen and select the Trailer tab to access the Trailer Cameras. Press Trailer Surround Camera button to access the default Top View and Rear View of the trailer.

Top View

The Trailer Top View will show in the Uconnect system with Top View and Rear View in a split screen display.

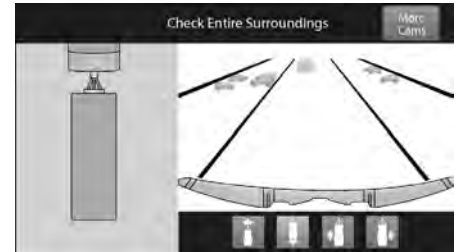

Trailer Top and Rear Camera View

NOTE:

Due to wide angle cameras, the image will appear distorted.

Rear View

Pressing the Rear View button will show the Top View and Rear View in a split screen display.

Front View

Pressing the Front View button will show you what is immediately in front of the trailer and is paired with the Top View of the trailer.

Left View

Pressing the Left View button will give the driver a wider angle view of the left side trailer camera and is paired with the Top View of the trailer.

Right View

Pressing the Right View button will give the driver a wider angle view of the right side trailer camera and is paired with the Top View of the trailer.

Full Screen Camera View

To display a full screen image of the Trailer Surround View mounted cameras, select one of the following options from the Trailer Cameras screen: Trailer Left, Trailer Right, Trailer Front or Trailer Rear. Exiting out of the full screen view will return the system to the previous screen.

NOTE:

If the Trailer Surround Camera was selected through the More Cameras menu, an option to return to the More Cameras menu will display. If the Trailer Surround Camera was manually activated through the Controls menu of the Uconnect system, exiting out of the display screen will return to the Controls menu.

Deactivation

The system is deactivated in the following conditions if it was activated **automatically**:

- When the vehicle is shifted out of REVERSE with camera delay turned on, the camera image will continue to be displayed for up to 10 seconds, unless the vehicle speed exceeds 8 mph (13 km/h), the vehicle is shifted into PARK or the ignition is placed in the OFF position. There is a touchscreen X button to disable the display of the camera image.
- When the vehicle is shifted out of REVERSE with camera delay turned off, the Trailer Surround View Camera mode is exited and the last known screen appears again.

The system is deactivated in the following conditions if it was activated **manually** from the Uconnect controls menu via the Trailer Surround Camera button:

- The touchscreen X button on the display is pressed
- Vehicle is shifted into PARK
- Ignition is placed in the OFF position
- Vehicle speed is over 8 mph (13 km/h) for 10 seconds

NOTE:

If the Trailer Surround Camera is activated manually, and the vehicle is shifted into REVERSE, deactivation methods for automatic activation are assumed.

The camera delay system is turned off manually through the Uconnect system ↩ page 209.

NOTE:

- If snow, ice, mud, or any foreign substance builds up on the camera lenses, clean the lenses, rinse with water, and dry with a soft cloth. Do not cover the lenses.
- If a malfunction with the system has occurred, see an authorized dealer.

WARNING!

Drivers must be careful when backing up even when using the Trailer Surround View Camera. Always check carefully behind your vehicle, and be sure to check for pedestrians, animals, other vehicles, obstructions, or blind spots before backing up. You are responsible for the safety of your surroundings and must continue to pay attention while backing up. Failure to do so can result in serious injury or death.

CAUTION!

- To avoid vehicle damage, Trailer Surround View should only be used as a parking aid. The Trailer Surround View Camera is unable to view every obstacle or object in your drive path.
- To avoid vehicle damage, the vehicle must be driven slowly when using Trailer Surround View to be able to stop in time when an obstacle is seen. It is recommended that the driver look frequently over his/her shoulder when using Trailer Surround View.

AUX CAMERA

Your vehicle may be equipped with one or two AUX Cameras, which display rear view and side view images from the trailer on the touchscreen.

NOTE:

Two Aux Cameras are only available on vehicles with NAV equipped radios if the vehicle is not equipped with a Center High Mounted Stop Lamp (CHMSL) and Surround View Camera system.

Activation

The AUX Camera is activated by first pressing the Back Up Camera or Cargo Camera (if equipped) button on the touchscreen, followed by the AUX button located in the upper left corner of the rearview display. On vehicles with Surround View Camera (if equipped), the AUX Camera can be activated when the vehicle is in REVERSE by first pressing the More Cams button in the Surround view screen, followed by the AUX tab. The AUX camera can also be activated when the vehicle is in REVERSE by pressing the AUX button.

If equipped with two AUX Cameras, you can switch between each camera by pressing the AUX 1 or AUX 2 buttons on the Trailer Camera display.



AUX 1 Camera Button



AUX 2 Camera Button

Deactivation

The AUX Camera is deactivated by pressing the touchscreen X button in the upper right corner of the touchscreen. This will return the display back to the previously displayed screen.

NOTE:

- If the AUX button is pressed and no AUX Camera is connected, the touchscreen will display a blue screen along with the message "Camera System Unavailable." The screen can be exited out by pressing the touchscreen X button in the upper right hand corner. This will return the display back to the previously displayed screen.
- Zoom View is not available with the AUX Camera feature.
- The display will always default to the Trailer Camera display AUX 1.

ENGINE RUNAWAY — DIESEL ENGINE

Diesel engine runaway is a rare condition affecting diesel engines, where the engine consumes its own lubrication oil and runs at higher and higher RPM until it overspeeds to a point where it destroys itself due to either mechanical failure or engine seizure through lack of lubrication.

WARNING!

In case of engine runaway due to flammable fumes from fuel spills or turbocharger oil leaks being sucked into the engine, do the following to help avoid personal injury and/or vehicle damage:

- Turn the ignition switch to the OFF position.
- Using a CO2 or dry chemical type fire extinguisher, direct the spray from the fire extinguisher into the grille on the driver side so that the spray enters the engine air intake.

The inlet for the engine air intake is located behind the driver's side headlamp and receives air through the grille.

4

REFUELING THE VEHICLE — GASOLINE ENGINE

The fuel filler cap (gas cap) is located behind the fuel filler door, on the left side of the vehicle. Open the fuel door and remove the fuel filler cap by turning it counter-clockwise.

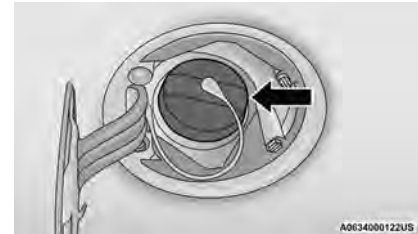

Fuel Filler Cap

1. Fully insert the gasoline nozzle into the filler pipe.
2. Fill the vehicle with fuel.
3. Remove gasoline nozzle, reinstall fuel cap and close fuel filler door.

NOTE:

- When removing the fuel filler cap, lay the cap tether in the hook, located on the fuel filler door.
- When the fuel nozzle “clicks” or shuts off, the fuel tank is full.
- Tighten the gas cap until you hear a “clicking” sound. This is an indication that the gas cap is tightened properly. The MIL in the instrument cluster may turn on if the gas cap is not secured properly. Make sure that the gas cap is tightened each time the vehicle is refueled.

WARNING!

Static electricity can cause an ignition of flammable liquid, vapor or gas in any vehicle or trailer. To reduce risk of serious injury or death when filling containers:

- Always place container on the ground before filling.
- Keep the pump nozzle in contact with the container when you are filling it.
- Use only approved containers for flammable liquid.
- Do not leave container unattended while filling.
- A static electric charge could cause a spark and fire hazard.

WARNING!

- Never have any smoking materials lit in or near the vehicle when the gas cap is removed or the tank is being filled.
- Never add fuel to the vehicle when the engine is running.
- A fire may result if gasoline is pumped into a portable container that is inside of a vehicle. You could be burned. Always place gas containers on the ground while filling.

CAUTION!

- Damage to the fuel system or emissions control system could result from using an improper fuel tank filler tube cap.
- A poorly fitting fuel filler cap could let impurities into the fuel system.
- A poorly fitting fuel filler cap may cause the Malfunction Indicator Light (MIL) to turn on.
- To avoid fuel spillage and overfilling, do not “top off” the fuel tank after filling. When the fuel nozzle “clicks” or shuts off, the fuel tank is full.

LOOSE FUEL FILLER CAP MESSAGE

If the vehicle diagnostic system determines that the fuel filler cap is loose, improperly installed, or damaged, a loose gASCAP indicator will display in the instrument cluster telltale display area  page 101. Tighten the fuel filler cap properly and push the RIGHT button to turn off the message. If the problem continues, the message will appear the next time the vehicle is started.

REFUELING THE VEHICLE — DIESEL ENGINE

1. Open the fuel filler door.

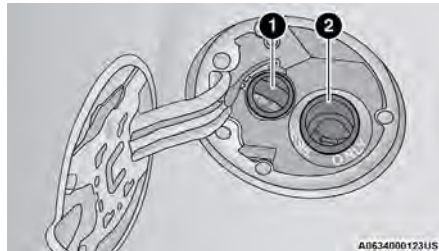
**Fill Locations**

- 1 — Diesel Exhaust Fluid (DEF) Fill Location
- 2 — Diesel Fuel Fill Location

NOTE:

There is no fuel filler cap. A flapper door inside the filler pipe seals the system.

2. Insert the fuel nozzle fully into the filler pipe – the nozzle opens and holds the flapper door while refueling.
3. Fill the vehicle with fuel – when the fuel nozzle “clicks” or shuts off the fuel tank is full.
4. Remove the fuel nozzle and close the fuel door.

NOTE:

In the event that you run the vehicle out of fuel, once refueled, place the ignition in the ON position for 30 seconds, then turn the ignition OFF and wait 30 seconds. Repeat this procedure three times, prior to cranking the engine.

WARNING!

- Never have any smoking materials lit in or near the vehicle when the fuel door is open or the tank is being filled.
- Never add fuel when the engine is running. This is in violation of most state and federal fire regulations and may cause the Malfunction Indicator Light to turn on.
- A fire may result if fuel is pumped into a portable container that is inside of a vehicle. You could be burned. Always place fuel containers on the ground while filling.

CAUTION!

To avoid fuel spillage and overfilling, do not "top off" the fuel tank after filling.

DIESEL EXHAUST FLUID

Your vehicle is equipped with a Selective Catalytic Reduction (SCR) system to meet the very stringent diesel emissions standards required by the Environmental Protection Agency.

The purpose of the SCR system is to reduce levels of NOx (oxides of nitrogen emitted from engines) that are harmful to our health and the environment to a near-zero level. A small quantity of Diesel Exhaust Fluid

(DEF) is injected into the exhaust upstream of a catalyst where, when vaporized, it converts smog-forming nitrogen oxides (NOx) into harmless nitrogen (N₂) and water vapor (H₂O), two natural components of the air we breathe. You can operate with the comfort that your vehicle is contributing to a cleaner, healthier world environment for this and generations to come.

System Overview

This vehicle is equipped with a Diesel Exhaust Fluid (DEF) injection system and a Selective Catalytic Reduction (SCR) catalyst to meet the emission requirements.

The DEF injection system consists of the following components:

- DEF tank
- DEF pump
- DEF injector
- Electronically-heated DEF lines
- DEF control module
- NOx sensors
- Temperature sensors
- SCR catalyst
- UQS Sensor

For system messages and warnings ⇨ page 101.

NOTE:

- Your vehicle is equipped with a DEF injection system. You may occasionally hear an audible clicking noise. This is normal operation.
- The DEF pump will run for a period of time after engine shutdown to purge the DEF system. This is normal operation.

Diesel Exhaust Fluid Storage

Diesel Exhaust Fluid (DEF) is considered a very stable product with a long shelf life. If DEF is kept in temperatures between 10°F and 90°F (-12°C and 32°C), it will last a minimum of one year.

DEF is subject to freezing at the lowest temperatures. For example, DEF may freeze at temperatures at or below 12°F (-11°C). The system has been designed to operate in this environment.

NOTE:

When working with DEF, it is important to know that:

- Any containers or parts that come into contact with DEF must be DEF compatible (plastic or stainless steel). Copper, brass, aluminum, iron or non-stainless steel should be avoided as they are subject to corrosion by DEF.
- If DEF is spilled, it should be wiped up completely.

Adding Diesel Exhaust Fluid

The DEF gauge (located on the instrument cluster) will display the level of DEF remaining in the tank
⇨ page 101.

NOTE:

- Driving conditions (altitude, vehicle speed, load, etc.) will affect the amount of DEF that is used in your vehicle.
- Another factor is that outside temperature can affect DEF consumption. In cold conditions, 12°F (-11°C) and below, the DEF gauge needle can stay on a fixed position and may not move for extended periods of time. This is a normal function of the system.

- There is an electric heater inside the DEF tank that automatically works when necessary. If the DEF supply does freeze, the truck will operate normally until it thaws.

DEF FILL PROCEDURE

NOTE:

For the correct fluid type ↪ page 398.

Remove cap from DEF tank (located on drivers side of the vehicle or in fuel door).

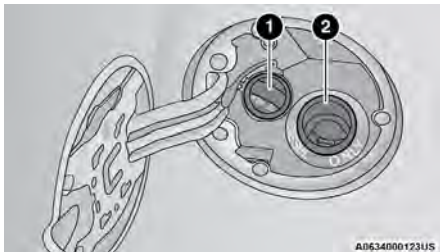

Fill Locations

- 1 – Diesel Exhaust Fluid (DEF) Fill Location
2 – Diesel Fuel Fill Location

NOTE:

- The DEF gauge may take up to five seconds to update after adding a gallon or more of DEF to the DEF tank. If you have a fault related to the DEF system, the gauge may not update to the new level. See an authorized dealer for service.
- The DEF gauge may also not immediately update after a refill if the temperature of the DEF fluid is below 12°F (-11°C). The DEF tank heater will possibly warm up the DEF fluid and allow the gauge to update after a period of run time. Under very cold conditions, it is possible that the gauge may not reflect the new fill level for several drives.
- At 40°F (4°C) you could see some increase in the DEF gauge due to the tank thawing. The gauge and level sensor are working properly and are just updating with proper thawed DEF.
- Excessive overfilling of the DEF tank can result in a MIL lamp/fault code and inaccurate level readings.

Refilling With Nozzles

You can fill up at any DEF distributor.

Proceed as follows:

- Insert the DEF nozzle in the filler tube, start refilling and stop refilling at the first shut-off (the shut-off indicates that the DEF tank is full). DO NOT proceed with the refilling, to prevent spillage of DEF.
- Extract the nozzle.

Refilling With Containers

Proceed as follows:

- Check the expiration date.
- Read the advice for use on the label before pouring the content of the bottle into the DEF tank.
- After the indication appears on the instrument cluster display ↪ page 101 fill the DEF tank with no more than 4 gallons (15 liters).

CAUTION!

- To avoid DEF spillage, and possible damage to the DEF tank from overfilling, do not “top off” the DEF tank after filling.
- DO NOT OVERFILL. DEF will freeze below 12°F (-11°C). The DEF system is designed to work in temperatures below the DEF freezing point, however, if the tank is overfilled and freezes, the system could be damaged.
- When DEF is spilled, clean the area immediately with water and use an absorbent material to soak up the spills on the ground.
- Do not attempt to start your engine if DEF is accidentally added to the diesel fuel tank as it can result in severe damage to your engine, including but not limited to failure of the fuel pump and injectors.
- Never add anything other than DEF to the tank – especially any form of hydrocarbon such as diesel fuel, fuel system additives, gasoline, or any other petroleum-based product. Even a very small amount of these, less than 100 parts per million or less than 1 oz. per 78 gallons (295 liters) will contaminate the entire DEF system and will require replacement. If owners use a container, funnel or nozzle when refilling the tank, it should either be new or one that has only been used for adding DEF. Mopar® provides an attachable nozzle with its DEF for this purpose.

Stop filling the DEF tank immediately if DEF splashes or wells back in the filler neck.

Reinstall cap onto DEF filler tube.

Filling The Def Tank In Cold Climates

Since DEF will begin to freeze at 12 °F (-11 °C), your vehicle is equipped with an automatic DEF heating system. This allows the DEF injection system to operate properly at temperatures below 12 °F (-11 °C). If your vehicle is not in operation for an extended period of time with temperatures below 12 °F (-11 °C), the DEF in the tank may freeze. If the tank is overfilled and freezes, it could be damaged. Therefore, do not overfill the DEF tank.

Extra care should be taken when filling with portable containers to avoid overfilling. Note the level of the DEF gauge in your instrument cluster. You may safely add a maximum of 2 gallons (7.5 liters) of DEF from portable containers when your DEF gauge is reading ½ full.

VEHICLE LOADING

GROSS VEHICLE WEIGHT RATING (GVWR)

The GVWR is the total permissible weight of your vehicle including driver, passengers, vehicle, options and cargo. The label also specifies maximum capacities of front and rear axle systems (GAWR). Total load must be limited so GVWR and front and rear GAWR are not exceeded.

PAYLOAD

The payload of a vehicle is defined as the allowable load weight a truck can carry, including the weight of the driver, all passengers, options and cargo.

GROSS AXLE WEIGHT RATING (GAWR)

The GAWR is the maximum permissible load on the front and rear axles. The load must be distributed in the cargo area so that the GAWR of each axle is not exceeded.

Each axle GAWR is determined by the components in the system with the lowest load carrying capacity (axle, springs, tires or wheels). Heavier axles or suspension components sometimes specified by purchasers for increased durability do not necessarily increase the vehicle's GVWR.

TIRE SIZE

The tire size on the Vehicle Certification Label represents the actual tire size on your vehicle. Replacement tires must be equal to the load capacity of this tire size.

RIM SIZE

This is the rim size that is appropriate for the tire size listed.

INFLATION PRESSURE

This is the cold tire inflation pressure for your vehicle for all loading conditions up to full GAWR.

CURB WEIGHT

The curb weight of a vehicle is defined as the total weight of the vehicle with all fluids, including vehicle fuel, at full capacity conditions, and with no occupants or cargo loaded into the vehicle. The front and rear curb weight values are determined by weighing your vehicle on a commercial scale before any occupants or cargo are added.

LOADING

The actual total weight and the weight of the front and rear of your vehicle at the ground can best be determined by weighing it when it is loaded and ready for operation.

The entire vehicle should first be weighed on a commercial scale to ensure that the GVWR has not been exceeded. The weight on the front and rear of the vehicle should then be determined separately to be sure that the load is properly distributed over the front and rear axles. Weighing the vehicle may show that the GAWR of either the front or rear axle has been exceeded but the total load is within the specified GVWR. If so, weight must be shifted from front to rear or rear to front as appropriate until the specified weight limitations are met. Store the heavier items down low and be sure that the weight is distributed equally. Stow all loose items securely before driving.

Improper weight distributions can have an adverse effect on the way your vehicle steers and handles and the way the brakes operate.

WARNING!

Do not load your vehicle any heavier than the GVWR, maximum Payload or the maximum front and rear GAWR. If you do, parts on your vehicle can break, or it can change the way your vehicle handles. This could cause you to lose control. Overloading can shorten the life of your vehicle.

TRAILER TOWING

In this section you will find safety tips and information on limits to the type of towing you can reasonably do with your vehicle. Before towing a trailer, carefully review this information to tow your load as efficiently and safely as possible.

To maintain the New Vehicle Limited Warranty coverage, follow the requirements and recommendations in this manual concerning vehicles used for trailer towing.

COMMON TOWING DEFINITIONS

The following trailer towing-related definitions will assist you in understanding the following information:

Gross Vehicle Weight Rating (GVWR)

The GVWR is the total allowable weight of your vehicle. This includes driver, passengers, cargo and tongue weight. The total load must be limited so that you do not exceed the GVWR ↪ page 191.

Gross Trailer Weight (GTW)

The GTW is the weight of the trailer plus the weight of all cargo, consumables and equipment (permanent or temporary) loaded in or on the trailer in its "loaded and ready for operation" condition.

The recommended way to measure GTW is to put your fully loaded trailer on a vehicle scale. The entire weight of the trailer must be supported by the scale.

WARNING!

If the gross trailer weight is 5,000 lb (2,267 kg) or more, it is recommended to use a weight-distributing hitch to ensure stable handling of your vehicle. If you use a standard weight-carrying hitch, you could lose control of your vehicle and cause a collision.

Gross Combination Weight Rating (GCWR)

The GCWR is the total allowable weight of your vehicle and trailer when weighed in combination.

Gross Axle Weight Rating (GAWR)

The GAWR is the maximum capacity of the front and rear axles. Distribute the load over the front and rear axles evenly. Make sure that you do not exceed either front or rear GAWR ↪ page 191.

WARNING!

It is important that you do not exceed the maximum front or rear GAWR. A dangerous driving condition can result if either rating is exceeded. You could lose control of the vehicle and have a collision.

Tongue Weight (TW)

The TW is the downward force exerted on the hitch ball by the trailer. You must consider this as part of the load on your vehicle.

Trailer Frontal Area

The frontal area is the maximum height multiplied by the maximum width of the front of a trailer.

Trailer Sway Control (TSC)

The TSC can be a mechanical telescoping link that can be installed between the hitch receiver and the trailer tongue that typically provides adjustable friction associated with the telescoping motion to dampen any unwanted trailer swaying motions while traveling.

If equipped, the electronic TSC recognizes a swaying trailer and automatically applies individual wheel brakes and/or reduces engine power to attempt to eliminate the trailer sway.

Weight-Carrying Hitch

A weight-carrying hitch supports the trailer tongue weight, just as if it were luggage located at a hitch ball or some other connecting point of the vehicle. These kinds of hitches are commonly used to tow small and medium sized trailers.

Weight-Distributing Hitch

A weight-distributing system works by applying leverage through spring (load) bars. They are typically used for heavier loads to distribute trailer tongue weight to the tow vehicle's front axle and the trailer axle(s). When used in accordance with the manufacturer's directions, it provides for a more level ride, offering more consistent steering and brake control, thereby enhancing towing safety. The addition of a friction/hydraulic sway control also dampens sway caused by traffic and crosswinds and contributes positively to tow vehicle and trailer stability. Trailer Sway Control (TSC) and a weight-distributing (load equalizing) hitch are recommended for heavier Tongue Weights (TW) and may be required depending on vehicle and trailer configuration/loading to comply with GAWR requirements.

WARNING!

- An improperly adjusted weight-distributing hitch system may reduce handling, stability and braking performance and could result in a collision.
- Weight-distributing systems may not be compatible with surge brake couplers. Consult with your hitch and trailer manufacturer or a reputable Recreational Vehicle dealer for additional information.



A0636000053U5

Improper Adjustment Of Weight-Distributing Hitch (Incorrect)**RECOMMENDED DISTRIBUTION HITCH ADJUSTMENT****Towing With 2500/3500 Air Suspension**

1. Position the truck to be ready to connect to the trailer (do not connect the trailer).

NOTE:

Standard Ride Height (SRH) or Alternate Trailer Height (ATH) can be used. The vehicle must remain in the engine running position while attaching a trailer for proper leveling of the air suspension system. It may not be possible to enter Alternate Trailer Height (ATH) while lightly loaded.

2. Measure the height from the top of the front wheel opening on the fender to the ground, this is height H1.



A0636000054U5

Measuring Height (H)

3. Attach the trailer to the vehicle without the weight distribution bars connected.
4. Measure the height from the top of the front wheel opening on the fender to the ground, this is height H2.
5. Install and adjust the tension in the weight distributing bars per the manufacturers' recommendations so that the height of the front fender is approximately $(H2-H1)/2+H1$ (about 1/2 the difference between H2 and H1 above Standard Ride Height [H1]).
6. Perform a visual inspection of the trailer and weight distributing hitch to confirm manufacturer's recommendations have been met.



A0636000052U5

With Weight-Distributing Hitch (Correct)

A0636000055U5

Without Weight-Distributing Hitch (Incorrect)

Measurement Example	Example 2500/ 3500 Height (mm)
H1	1030
H2	1058
H2-H1	28
(H2-H1)/2	14
(H2-H1)/2 + H1	1044

NOTE:

For all towing conditions, we recommend towing with TOW/HAUL mode engaged.

Towing With All Other 2500/3500 (Non-Air Suspension)

1. Position the truck to be ready to connect to the trailer (do not connect the trailer).
2. Measure the height of the top of the front wheel opening on the fender to ground, this is height H1.
3. Attach the trailer to the vehicle without the weight distribution bars connected.

4. Measure the height of the top of the front wheel opening on the fender to ground, this is height H2.
5. Install and adjust the tension in the weight distributing bars per the manufacturer's recommendations so that the height of the front fender is approximately $(H2-H1)/2+H1$ (about 1/2 the difference between H2 and H1 above Standard Ride Height [H1]).
6. Perform a visual inspection of the trailer and weight-distributing hitch to confirm manufacturer's recommendations have been met.

Measurement Example	Example 2500/ 3500 Height (mm)
H1	1030
H2	1058
H2-H1	28
(H2-H1)/2	14
(H2-H1)/2 + H1	1044

NOTE:

For all towing conditions, we recommend towing with TOW/HAUL mode engaged.

Fifth-Wheel Hitch

The fifth-wheel hitch is a special high platform with a coupling that mounts over the rear axle of the tow vehicle in the truck bed. It connects a vehicle and fifth-wheel trailer with a coupling king pin.

Your truck may be equipped with a fifth-wheel hitch option. Refer to the separately provided fifth-wheel hitch safety, care, assembly, and operating instructions.

Gooseneck Hitch

The gooseneck hitch employs a pivoted coupling arm which attaches to a ball mounted in the bed of a pickup truck. The coupling arm connects to the hitch mounted over the rear axle in the truck bed.

TRAILER HITCH TYPE AND MAXIMUM TRAILER WEIGHT

The following chart provides the maximum trailer weight a given factory equipped trailer hitch type can tow and should be used to assist you in selecting the correct trailer hitch for your intended towing condition.

Trailer Hitch Type and Maximum Trailer Weight	
Hitch Type	Max. Trailer Weight / Max. Tongue Weight
Class V - 2500 Models	20,000 lb (9,071 kg) / 2,000 lb (907 kg)
Class V - 3500 Models	23,000 lb (10,432 kg) / 2,300 lb (1,043 kg)
Fifth-Wheel - 2500 Models	25,000 lb (11,339 kg) / 3,750 lb (1,700 kg)
Fifth-Wheel - 3500 Models	30,000 lb (13,607 kg) / 4,500 lb (2,041 kg)

Trailer Hitch Type and Maximum Trailer Weight	
Gooseneck - 2500 Models	20,000 lb (9,071 kg) / 3,000 lb (1,360 kg)
Gooseneck - 3500 Models	37,100 lb (16,828 kg) / 5,565 lb (2,524 kg)
Refer to the "Trailer Towing Weights (Maximum Trailer Weight Ratings)" for the Maximum Gross Trailer Weight (GTW) towable for your given drivetrain.	

All trailer hitches should be professionally installed on your vehicle.

TRAILER TOWING WEIGHTS (MAXIMUM TRAILER WEIGHT RATINGS)

NOTE:

For trailer towing information (maximum trailer weight ratings) refer to the following website addresses:

- ramtrucks.com/towing/towing-guide
- ramtruck.ca (Canada)
- rambodybuilder.com

TRAILER AND TONGUE WEIGHT

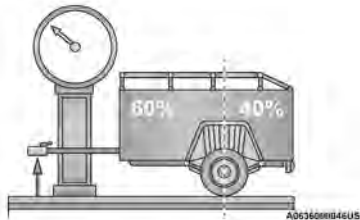

Weight Distribution

Consider the following items when computing the weight on the rear axle of the vehicle:

- The tongue weight of the trailer.
- The weight of any other type of cargo or equipment put in or on your vehicle.
- The weight of the driver and all passengers.

NOTE:

Remember that everything put into or on the trailer adds to the load on your vehicle. Also, additional factory-installed options or dealer-installed options must be considered as part of the total load on your vehicle. For the maximum combined weight of occupants and cargo for your vehicle → page 375.

TRAILER REVERSE STEERING CONTROL — IF EQUIPPED

Feature Overview

Trailer Reverse Steering Control (TRSC) is a feature that will assist the driver when backing up a trailer. Use the TRSC knob, located on the center stack, to more accurately control the direction of the trailer.

The driver controls the accelerator and brake while using the TRSC knob to steer. The trailer is steered according to the direction the knob is turned.

This feature will also allow the driver to back up a vehicle and trailer in a straight line when the knob is in the center position.

Minimal setup is required to use this feature.

Set Up:

To use the system, attach your trailer to the truck and ensure all electrical wiring is connected → page 201. Make sure that the cable is secured out of the camera view and does not interfere with any part of the rear-view image as it may impact system performance.

During normal forward driving, the system will automatically calibrate the attached trailer provided that the driving incorporates calibration maneuvers such as going straight and 90-degree turns. If the vehicle has not had enough time to automatically calibrate after connecting a trailer, you will see a "Calibrate Trailer" message in the instrument cluster when pressing the TRSC button to activate the system. The TRSC button is located above the TRSC knob. If this is the case, perform the following maneuver to calibrate the trailer:

Drive forward at least 100 ft (30 m), perform a 90 degree turn and return to a straight position for at least another 100 ft (30 m). Perform another 90 degree turn, followed by another straight drive of at least 100 ft (30 m). Check that the system has calibrated by pushing the TRSC button.

NOTE:

The 90 degree turns could be in either the left or right direction.

When the vehicle is not in Reverse, press the TRSC button while at a standstill. A “Calibrate Trailer” message will display.

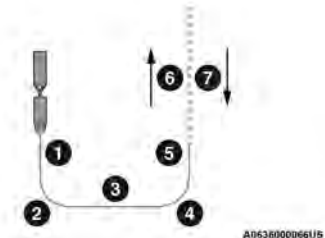
**Trailer Reverse Steering Control Calibration**

1. Drive straight 100 ft (30 m). A “Calibrating Trailer” message will display when vehicle is in motion.
2. Perform intersection turn with radius 50-65 ft (15-20 m) in either direction.
3. Drive straight 100 ft (30 m).
4. Perform intersection turn with radius 50-65 ft (15-20 m) in either direction.
5. Drive straight 100 ft (30 m).
6. Drive straight 100 ft (30 m), making sure to align vehicle/trailer to path center line.
7. Once calibration is complete, feature will be available for use. For calibration runs under 30 mph (48 km/h) a “To Enable Trailer Steering Shift to P” message will appear to indicate calibration completion.



Turn Signal Activated Blind Spot Assist will be unavailable if the trsc button is pressed and no trailer is connected, system will continue to attempt to locate trailer until ignition is cycled. Turn signal activated blindspot message will come up speeds less than 30 mph (48 km/h) during the calibration procedure. Instead of the Blind Spot camera view, an image showing the unavailable feature will display on the radio screen when the turn signal is used.

NOTE:

Turn Signal Activated Blind Spot Assist will function normally during automatic calibration.

Using TRSC**CAUTION!**

Always observe the position of the trailer and surroundings using the camera and mirrors to avoid damage to the truck or trailer.

**Trailer Reverse Steering Control Knob**

To use the system, place the gear selector in PARK. Push the TRSC button located above the TRSC knob in the center stack. The LED on the button will glow solid and the instrument cluster display will direct you to shift to REVERSE. Once in REVERSE the system is active. Remove hands from the steering wheel and slowly back up while turning the TRSC knob in the direction you want the trailer to go. A trajectory line will show the intended path of the trailer on the radio display. Turning the knob clockwise will cause the trailer to turn right. Turning the knob counter-clockwise will cause the trailer to turn left. If you release the knob, it will return to its center position, and the trailer will back up in a straight line.

Continue to control the accelerator and brake while backing the trailer up. The following graphics will display on the radio screen to warn the user if the trailer is approaching a jackknife angle. Left or right zones in the graphic will change color based on which side the event occurs.



An orange arch will display when approaching a jackknife angle.



A red arch will display when reaching the jackknife angle.

CAUTION!

Continuing after the red warning may lead to damage to the vehicle and/or trailer.

NOTE:

While active, TRSC will automatically disable the Rear Park Assist system if it was previously enabled.

The TRSC system will limit the top speed your vehicle can travel in REVERSE while using the feature. If needed, you can shift to DRIVE or NEUTRAL to pull forward to get more room or straighten out the trailer, and shift back to REVERSE without the need to reactivate the feature.

The feature will cancel after 30 seconds in DRIVE or when the vehicle speed reaches 8 mph (12 km/h).

To cancel out of the feature, come to a stop and shift to PARK, or push the TRSC activation button.

Instrument Cluster Messages:

- “Calibrate Trailer” will display when a trailer is not calibrated and the vehicle is at a standstill while the button is pushed.
- “Calibrating Trailer” will display when the trailer is not calibrated and the vehicle is moving while the button is pushed.
- “To Enable Trailer Steering Shift To P” will display when the trailer is calibrated successfully, the TRSC activation button is pushed, vehicle speed is less than 30 mph (48 km/h) and the vehicle is not in PARK. This message will also display if calibration maneuver is performed successfully under 30 mph (48 km/h).
- “Press Trailer Steering To Begin” will display if the vehicle is shifted to PARK from any other gear within 5 seconds of the “To Enable Trailer Steering Shift To P” message appearing.
- “Trailer Steering Ready Shift To R And Use Knob To Steer Trailer” will display when the trailer is calibrated, the vehicle is in PARK and the TRSC activation button is pushed. The message may also appear when the feature is active and the vehicle is shifted to DRIVE/NEUTRAL from REVERSE.

- “Trailer Steering Active Check Surrounding Backup Slowly” will display after the driver shifts to REVERSE and indicates the feature is active.
- “Calibration Failed See User Manual” will display when calibration has failed during an active calibration attempt.
- “Trailer Steering Unavailable” will display if there is a fault in the system preventing activation or the driver’s door is open with the driver’s seat belt unbuckled.
- “Trailer Steering Unavailable Trailer Angle Too Steep” will display when trailer is calibrated, the TRSC button is pressed and the trailer is at a jack-knife angle.
- “Trailer Steering Canceled Hands On Wheel Detected” will display when driver overrides steering wheel input.
- “Trailer Steering Canceled Trailer Not Found” will display when sufficient trailer data cannot be estimated using camera for TRSC to continue functioning.
- “Trailer Steering Canceled Vehicle Speed Too High” will display when vehicle speed goes over 8 mph (12 km/h) while the feature is active in REVERSE. System will limit the speed in REVERSE and prevent feature cancellation due to this event.

“Trailer Steering Canceled” will display when the maneuver is canceled due to any of the following reasons:

- Trailer tracking is lost.
- TRSC button is pushed while active.
- Vehicle speed goes over 8 mph (12 km/h) in DRIVE.
- Driver door is open and seat belt is unbuckled.
- Transmission is shifted to PARK.

Trailer Memory

The trailer steering system will automatically retain the calibration of the previous five trailers connected, so recalibration will not be necessary when hooking up a previously calibrated trailer.

To store a trailer to memory, calibrate the trailer and then allow the vehicle to be off for a minimum of 2 minutes. The next time the vehicle is started the trailer system will attempt to identify the attached trailer. If successful, the TRSC system can then be activated.

NOTE:

- If the trailer is not identified, drive forward to align the trailer to the vehicle in a straight line, 0 degree trailer angle, and shift to PARK. Ensure that there is no camera feed displayed on the radio screen and wait for up to 10 seconds for the system to attempt to identify the trailer. Press TRSC button to activate the feature.
- Trailers may look different during day and night conditions. In such cases, the trailer may need to recalibrate.
- Some trailers (such as boat trailers) will need to recalibrate while loaded and unloaded.
- The system may not detect a trailer in low light conditions. In sunny conditions, the performance may be degraded as shadows pass over the trailer.
- The driver is always responsible for safe operation of truck and trailer.
- The driver is always in control of the truck as well as the trailer and is responsible for controlling the accelerator and brakes.
- The system may not function when the camera lens is blocked, blurred (covered with water, snow, ice, dirt, etc) and will not work unless the tailgate is upright and fully latched.

Trailer Sticker

As there are many variations of trailers on the market you may encounter one that is particularly difficult to use with the TRSC. High-contrast stickers have been provided to be placed on the trailer for when this scenario is encountered. By applying these stickers to your trailer, it aids the vision system with learning the trailer by providing high contrast features to track in the rear camera image. The following are guidelines for attaching the stickers to your trailer:

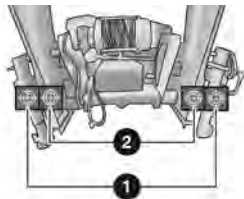

Gooseneck Trailer

AD636000117US

- 1 – 1st Option Decal Placement
2 – 2nd Option Decal Placement

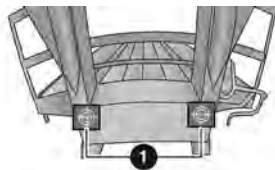

Gooseneck Trailer

AD636000118US

- 1 – Decal Placement

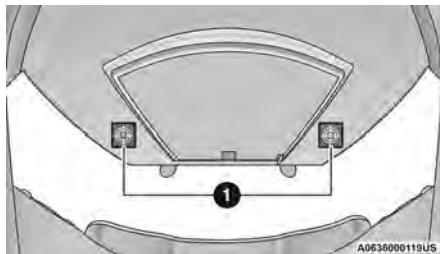

Enclosed Gooseneck Trailer

AD636000119US

- 1 – Decal Placement

- TRAILER SURFACE:** Surface temperature should be between 70 °F and 90 °F during decal application to ensure proper adhesive bond.
- ALCOHOL WIPE:** Wipe the body surface with a clean, lint-free cloth moistened with isopropyl alcohol to remove contaminants.
- LINER REMOVAL:** Use tab on decal to remove the liner exposing the adhesive.
- LOCATING THE DECALS:** Use photos to determine the style of trailer. Place one decal on both sides of the trailer as shown. To get ideal functionality, place decals at the same height of the camera and at each vertical edge of the trailer without going over.
- PRESSURIZING THE DECAL:** Use firm hand pressure over entire decal starting at the center and fanning out to the edges trying not to trap air.
- POST APPLICATION:** Do not power wash decal area for 72 hours.

TOWING REQUIREMENTS

To promote proper break-in of your new vehicle drivetrain components, the following guidelines are recommended.

CAUTION!

- Do not tow a trailer at all during the first 500 miles (805 km) the new vehicle is driven. The engine, axle or other parts could be damaged.
- Then, during the first 500 miles (805 km) that a trailer is towed, do not drive over 50 mph (80 km/h) and do not make starts at full throttle. This helps the engine and other parts of the vehicle wear in at the heavier loads.

Perform the maintenance listed in the “Scheduled Servicing” ⇨ page 332. When towing a trailer, never exceed the GAWR or GCWR ratings.

WARNING!

Improper towing can lead to a collision. Follow these guidelines to make your trailer towing as safe as possible:

- Make certain that the load is secured in the trailer and will not shift during travel. When trailering cargo that is not fully secured, dynamic load shifts can occur that may be difficult for the driver to control. You could lose control of your vehicle and have a collision.
- When hauling cargo or towing a trailer, do not overload your vehicle or trailer. Overloading can cause a loss of control, poor performance or damage to brakes, axle, engine, transmission, steering, suspension, chassis structure or tires.
- Safety chains must always be used between your vehicle and trailer. Always connect the chains to the hook retainers of the vehicle hitch. Cross the chains under the trailer tongue and allow enough slack for turning corners.
- Vehicles with trailers should not be parked on a grade. When parking, apply the parking brake on the tow vehicle. Put the tow vehicle transmission in PARK. For four-wheel drive vehicles, make sure the transfer case is not in NEUTRAL. Always, block or “chock” the trailer wheels.
- GCWR must not be exceeded.

(Continued)

WARNING!

- **Total weight must be distributed between the tow vehicle and the trailer such that the following four ratings are not exceeded:**
 - GVWR
 - GTW
 - GAWR
 - Tongue weight rating for the trailer hitch utilized

Towing Requirements — Tires

- Do not attempt to tow a trailer while using a compact spare tire.
- Do not drive more than 50 mph (80 km/h) when towing while using a full size spare tire.
- Proper tire inflation pressures are essential to the safe and satisfactory operation of your vehicle ⇨ page 372.
- Check the trailer tires for proper tire inflation pressures before trailer usage.
- Check for signs of tire wear or visible tire damage before towing a trailer ⇨ page 372.
- For the proper tire replacement procedures ⇨ page 372. Replacing tires with a higher load carrying capacity will not increase the vehicle’s GVWR and GAWR limits.

Towing Requirements — Trailer Brakes

- Do **not** interconnect the hydraulic brake system or vacuum system of your vehicle with that of the trailer. This could cause inadequate braking and possible personal injury.

- An electronically actuated trailer brake controller is required when towing a trailer with electronically actuated brakes. When towing a trailer equipped with a hydraulic surge actuated brake system, an electronic brake controller is not required.
- Trailer brakes are recommended for trailers over 1,000 lb (453 kg) and required for trailers in excess of 2,000 lb (907 kg).

WARNING!

- Do not connect trailer brakes to your vehicle’s hydraulic brake lines. It can overload your brake system and cause it to fail. You might not have brakes when you need them and could have an accident.
- Towing any trailer will increase your stopping distance. When towing, you should allow for additional space between your vehicle and the vehicle in front of you. Failure to do so could result in an accident.

CAUTION!

If the trailer weighs more than 1,000 lb (453 kg) loaded, it should have its own brakes and they should be of adequate capacity. Failure to do this could lead to accelerated brake lining wear, higher brake pedal effort, and longer stopping distances.

Integrated Trailer Brake Module (ITBM) — If Equipped

Your vehicle may have an ITBM for Electric and Electric Over Hydraulic (EOH) trailer brakes.

NOTE:

This module has been designed and verified with electric trailer brakes and new electric over hydraulic systems. Some previous EOH systems may not be compatible with ITBM.

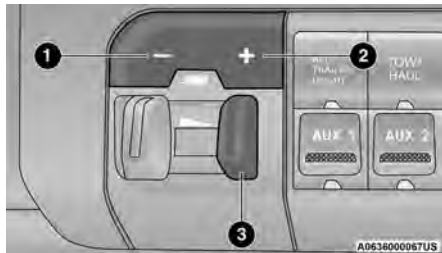

Integrated Trailer Brake Module (ITBM)

- 1 — GAIN Adjustment “-” Button
- 2 — GAIN Adjustment “+” Button
- 3 — Manual Brake Control Lever

The user interface consists of the following:

Manual Brake Control Lever

Slide the manual brake control lever to the left to activate power to the trailer’s electric brakes independent of the tow vehicle’s brakes. If the manual brake control lever is activated while the brake is also applied, the greater of the two inputs determines the power sent to the trailer brakes.

The trailer and the vehicle’s stop lamps will come on when braking normally with the vehicle brake pedal. Only the trailer stop lamps will come on when the manual brake control lever is applied.

Trailer Brake Status Indicator Light

This light indicates the trailer electrical connection status.

If no electrical connection is detected after the ignition is turned on, pushing the GAIN adjustment button or sliding the manual brake control lever will display the GAIN setting for 10 seconds and the Trailer Brake Disconnected Warning Light will not be displayed.

If a fault is detected in the trailer wiring or the ITBM, the Trailer Brake Disconnected Warning Light will flash.

GAIN Adjustment Buttons (+/-)

Pushing these buttons will adjust the brake control power output to the trailer brakes in 0.5 increments. The GAIN setting can be increased to a maximum of 10 or decreased to a minimum of 0 (no trailer braking).

GAIN

The GAIN setting is used to set the trailer brake control for the specific towing condition and should be changed as towing conditions change. Changes to towing conditions include trailer load, vehicle load, road conditions and weather.

Adjusting GAIN

NOTE:

This should only be performed in a traffic free environment at speeds of approximately 20–25 mph (30–40 km/h).

1. Make sure the trailer brakes are in good working condition, functioning normally and properly adjusted. See your trailer dealer if necessary.
2. Hook up the trailer and make the electrical connections according to the trailer manufacturer’s instructions.

3. When a trailer with electric/EOH brakes is plugged in, the trailer connected message should appear in the instrument cluster display (if the connection is not recognized by the ITBM, braking functions will not be available), the GAIN setting will illuminate and the correct type of trailer must be selected from the instrument cluster display options.
 4. Push the UP or DOWN button on the steering wheel until “TRAILER TOW” appears on the screen.
 5. Push the RIGHT arrow on the steering wheel to enter “TRAILER TOW”.
 6. Push the UP or DOWN buttons until the Trailer Brake Type appears on the screen.
 7. Push the RIGHT arrow and then push the UP or DOWN buttons until the proper Trailer Brake Type appears on the screen.
 8. In a traffic-free environment, tow the trailer on a dry, level surface at a speed of 20–25 mph (30–40 km/h) and squeeze the manual brake control lever completely.
 9. If the trailer wheels lockup (indicated by squealing tires), reduce the GAIN setting; if the trailer wheels turn freely, increase the GAIN setting.
- Repeat steps 8 and 9 until the GAIN setting is at a point just below trailer wheel lockup. If towing a heavier trailer, trailer wheel lockup may not be attainable even with the maximum GAIN setting of 10.

	Light Electric	Heavy Electric	Light EOH	Heavy EOH
Type of Trailer Brakes	Electric Trailer Brakes	Electric Trailer Brakes	Electric Over Hydraulic Trailer Brakes	Electric Over Hydraulic Trailer Brakes
Load	*Under 10,000 lb (4,536 kg)	*Above 10,000 lb (4,536 kg)	*Under 10,000 lb (4,536 kg)	*Above 10,000 lb (4,536 kg)

* The suggested selection depends and may change depending on the customer preferences for braking performance. Condition of the trailer brakes, driving and road state may also affect the selection.

Display Messages

The trailer brake control interacts with the instrument cluster display. Display messages, along with a single chime, will be displayed when a malfunction is determined in the trailer connection, trailer brake control, or on the trailer ↩ page 101.

WARNING!

Connecting a trailer that is not compatible with the ITBM system may result in reduced or complete loss of trailer braking. There may be an increase in stopping distance or trailer instability which could result in personal injury.

CAUTION!

Connecting a trailer that is not compatible with the ITBM system may result in reduced or complete loss of trailer braking. There may be an increase in stopping distance or trailer instability which could result in damage to your vehicle, trailer, or other property.

NOTE:

- An aftermarket controller may be available for use with trailers with air or EOH trailer brake systems. To determine the type of brakes on your trailer and the availability of controllers, check with your trailer manufacturer or dealer.
- Removal of the ITBM will cause errors and it may cause damage to the electrical system and electronic modules of the vehicle. See an authorized dealer if an aftermarket module is to be installed.

Towing Requirements — Trailer Lights And Wiring

Whenever you pull a trailer, regardless of the trailer size, stop lights and turn signals on the trailer are required for motoring safety.

The Trailer Tow Package may include a four- and seven-pin wiring harness. Use a factory approved trailer harness and connector.

NOTE:

Do not cut or splice wiring into the vehicle's wiring harness.

The electrical connections are all complete to the vehicle but you must mate the harness to a trailer connector. Refer to the following illustrations.

NOTE:

- Disconnect the trailer wiring connector from the vehicle (or any other device plugged into vehicle's electrical connectors) before launching a boat into water.
- Be sure to reconnect once clear from water area.

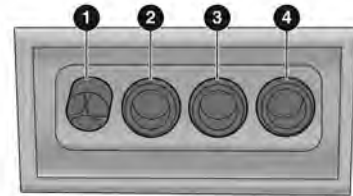

M063600043US

Four-Pin Connector

- 1 — Ground
- 2 — Park
- 3 — Left Stop/Turn
- 4 — Right Stop/Turn

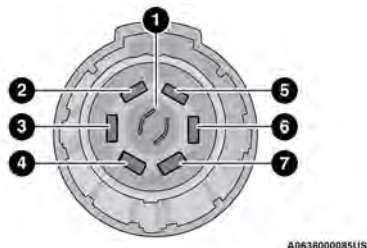

Seven-Pin Connector

- 1 – Backup Lamps
- 2 – Running Lamps
- 3 – Left Stop/Turn
- 4 – Ground
- 5 – Battery
- 6 – Right Stop/Turn
- 7 – Electric Brakes

Trailer Light Check

This feature will run the trailer lights through a sequence to check the trailer light function. It is available in the instrument cluster under the Trailer Tow menu for 3 and 7 inch clusters, for the 12 inch the feature will be in the tow page on the radio  page 105.

When activated the feature will enable all of the exterior lights sequentially for up to five minutes for time to walk around and verify functionality. The following exterior lights will remain on for the entirety of the sequence:

- Park/Running Lamps
 - Side Marker Lamps (if equipped)
 - License Lamp
 - Signature Lamp (if equipped)
 - Low Beams
 - Fog Lamps (if equipped)
 - Daytime Running Lamps
- During this time the following lights will sequence, each activating for three seconds:
1. Brake and CHMSL (third brake light)
 2. Left turn signal
 3. Right turn signal
 4. Reverse Lamps
 5. High Beam
- This light check sequence will continue for a total of five minutes.
- The sequence will only activate if the following conditions are met:
- Vehicle is equipped with the Trailer Tow Package
 - Vehicle is in PARK
 - Vehicle is not in motion
 - Ignition in ACC or RUN
 - Remote start is inactive
 - Brakes are not applied
 - Left turn signal is not applied
 - Right turn signal not applied
 - Hazard switch is not applied
- The sequence will cancel if any of the following conditions occur:
- Brakes are applied
 - Vehicle is shifted from PARK
 - Vehicle is no longer stationary
 - Left turn signal activated from stalk
 - Right turn signal is activated from stalk
 - Hazard switch is activated
 - Any button on the key fob is pushed
 - Ignition button is pushed
 - High Beam stalk position is changed
 - Sequence is canceled in the instrument cluster

TOWING TIPS

Before setting out on a trip, practice turning, stopping, and backing up the trailer in an area located away from heavy traffic.

Automatic Transmission

The DRIVE range can be selected when towing. The transmission controls include a drive strategy to avoid frequent shifting when towing. However, if frequent shifting does occur while in DRIVE, select TOW/HAUL mode or select a lower gear range (using the Electronic Range Select [ERS] shift control).

NOTE:

Using TOW/HAUL mode or selecting a lower gear range (using the ERS shift control) while operating the vehicle under heavy loading conditions will improve performance and extend transmission life by reducing excessive shifting and heat build up. This action will also provide better engine braking.

Tow/Haul Mode

To reduce potential for automatic transmission overheating, activate TOW/HAUL mode when driving in hilly areas, or select a lower gear range (using the Electronic Range Select [ERS] shift control) on more severe grades.

Cruise Control — If Equipped

- Do not use on hilly terrain or with heavy loads.
- When using the Cruise Control, if you experience speed drops greater than 10 mph (16 km/h), disengage until you can get back to cruising speed.
- Use Cruise Control in flat terrain and with light loads to maximize fuel efficiency.

Air Suspension System

To aid in attaching/detaching the trailer from the vehicle, the air suspension system can be used  page 146.

NOTE:

The vehicle must remain in the engine running position while attaching a trailer for proper leveling of the air suspension system.

SNOWPLOW

Snowplow Prep Packages are available as a factory installed option. These packages include components necessary to equip your vehicle with a snowplow.

NOTE:

Before installation of a snowplow it is highly recommended that the owner/installer obtain and follow the recommendations contained within the current Body Builder's Guide. See an authorized dealer, installer or snowplow manufacturer for this information. There are unique electrical systems that must be connected to properly ensure operator safety and prevent overloading vehicle systems.

WARNING!

Attaching a snowplow to this vehicle could adversely affect performance of the airbag system in a collision. Do not expect that the airbag will perform as described earlier in this manual.

CAUTION!

The "Lamp Out" indicator could illuminate if exterior lamps are not properly installed.

BEFORE PLOWING

- Check the hydraulic system for leaks and proper fluid level.
- Check the mounting bolts and nuts for proper tightness.
- Check the runners and cutting edge for excessive wear. The cutting edge should be $\frac{1}{4}$ to $\frac{1}{2}$ inches (6 cm to 1.2 cm) above ground in snow plowing position.
- Check that snowplow lighting is connected and functioning properly.

SNOWPLOW PREP PACKAGE MODEL AVAILABILITY

For Information about snowplow applications visit www.ramtrucks.com or refer to the current Body Builder's Guide.

1. The maximum number of occupants in the truck should not exceed two.
2. The total GVWR or the Front GAWR or the Rear GAWR should never be exceeded.
3. Cargo capacity will be reduced by the addition of options or passengers, etc.

The loaded vehicle weight, including the snowplow system, all aftermarket accessories, driver, passengers, options, and cargo, must not exceed either the Gross Vehicle Weight Rating (GVWR) or Gross Axle Weight Rating (GAWR). These weights are specified on the Safety Compliance Certification Label on the driver's side door opening.

NOTE:

Detach the snowplow when transporting passengers.

Vehicle front end wheel alignment was set to specifications at the factory without consideration for the weight of the plow. Front end toe-in should be checked and reset if necessary at the beginning and end of the snowplow season. This will help prevent uneven tire wear.

The blade should be lowered whenever the vehicle is parked.

Maintain and operate your vehicle and snowplow equipment following the recommendations provided by the specific snowplow manufacturer.

OVER THE ROAD OPERATION WITH SNOWPLOW ATTACHED

The blade restricts air flow to the radiator and causes the engine to operate at higher than normal temperatures. Therefore, when transporting the plow, angle the blade completely and position it as low as road or surface conditions permit. Do not exceed 40 mph (64 km/h). The operator should always maintain a safe stopping distance and allow adequate passing clearance.

OPERATING TIPS

Under ideal snow plowing conditions, 20 mph (32 km/h) should be maximum operating speed. The operator should be familiar with the area and surface to be cleaned. Reduce speed and use extreme caution when plowing unfamiliar areas or under poor visibility.

GENERAL MAINTENANCE

Snowplows should be maintained in accordance with the plow manufacturer's instructions.

Keep all snowplow electrical connections and battery terminals clean and free of corrosion.

When plowing snow, to avoid transmission and drivetrain damage, the following precautions should be observed.

- Operate with transfer case in 4WD LOW when plowing small or congested areas where speeds are not likely to exceed 15 mph (24 km/h). At higher speeds operate in 4WD HIGH.
- Vehicles with automatic transmissions should use 4WD LOW when plowing deep or heavy snow for extended periods of time to avoid transmission overheating.
- Do not shift the transmission unless the engine has returned to idle and wheels have stopped. Make a practice of stepping on the brake pedal while shifting the transmission.

RECREATIONAL TOWING (BEHIND MOTORHOME)

TOWING THIS VEHICLE BEHIND ANOTHER VEHICLE

Towing Condition	Wheels OFF The Ground	Two-Wheel Drive Models	Four-Wheel Drive Models
Flat Tow	NONE	NOT ALLOWED	See Instructions <ul style="list-style-type: none"> • Automatic transmission in PARK • Transfer case in N (Neutral) • Tow in forward direction
Dolly Tow	Front	NOT ALLOWED	NOT ALLOWED
	Rear	OK	NOT ALLOWED
On Trailer	ALL	OK	OK

NOTE:

- When towing your vehicle, always follow applicable state and provincial laws. Contact state and provincial Highway Safety offices for additional details.
- Vehicles equipped with air suspension must be placed in Transport mode before tying them down (from the body) on a trailer or flatbed truck  page 146. If the vehicle cannot be placed in Transport mode (for example, engine will not run), tie-downs must be fastened to the axles (not to the body). Failure to follow these instructions may cause fault codes to be set and/or cause loss of proper tie-down tension.

RECREATIONAL TOWING — TWO-WHEEL DRIVE MODELS

DO NOT flat tow this vehicle. Damage to the drivetrain will result.

Recreational towing (for two-wheel drive models) is allowed **ONLY** if the rear wheels are **OFF** the ground. This may be accomplished using a tow dolly or vehicle trailer. If using a tow dolly, follow this procedure:

NOTE:

If vehicle is equipped with air suspension, ensure the vehicle is set to Standard Ride Height.

1. Properly secure the dolly to the tow vehicle, following the dolly manufacturer's instructions.
2. Drive the rear wheels onto the tow dolly.
3. Firmly apply the parking brake. Place automatic transmission in PARK.
4. Properly secure the rear wheels to the dolly, following the dolly manufacturer's instructions.

5. Turn the ignition OFF and remove the key fob.
6. Install a suitable clamping device, designed for towing, to secure the front wheels in the straight position.

CAUTION!

- Towing with the rear wheels on the ground will cause severe transmission damage. Damage from improper towing is not covered under the New Vehicle Limited Warranty.
- Do not disconnect the driveshaft because fluid may leak from the transmission, causing damage to internal parts.

RECREATIONAL TOWING — FOUR-WHEEL DRIVE MODELS

NOTE:

Both the manual shift and electronic shift transfer cases must be shifted into N (Neutral) for recreational towing. Automatic transmissions must be shifted into PARK for recreational towing. Refer to the following for the proper transfer case N (Neutral) shifting procedure for your vehicle.

CAUTION!

- **DO NOT** dolly tow any 4WD vehicle. Towing with only one set of wheels on the ground (front or rear) will cause severe transmission and/or transfer case damage. Tow with all four wheels either **ON** the ground, or **OFF** the ground (using a vehicle trailer).

(Continued)

CAUTION!

- Tow only in the forward direction. Towing this vehicle backwards can cause severe damage to the transfer case.
- Before recreational towing, the transfer case must be in N (Neutral). To be certain the transfer case is fully in N (Neutral), perform the procedure outlined under "Shifting Into N (Neutral)". Internal transmission damage will result, if the transfer case is not in N (Neutral) during towing.
- The transmission must be placed in PARK for recreational towing.
- Towing this vehicle in violation of the previously listed requirements can cause severe transmission and/or transfer case damage. Damage from improper towing is not covered under the New Vehicle Limited Warranty.
- Do not disconnect the rear driveshaft because fluid will leak from the transfer case, causing damage to internal parts.
- Do not use a bumper-mounted clamp-on tow bar on your vehicle. The bumper face bar will be damaged.

Shifting Into N (Neutral)

Use the following procedure to prepare your vehicle for recreational towing.

WARNING!

You or others could be injured or killed if you leave the vehicle unattended with the transfer case in the N (Neutral) position without first fully engaging the parking brake. The transfer case N (Neutral) position disengages both the front and rear driveshafts from the powertrain, and will allow the vehicle to roll, even if the automatic transmission is in PARK. The parking brake should always be applied when the driver is not in the vehicle.

CAUTION!

It is necessary to follow these steps to be certain that the transfer case is fully in N (Neutral) before recreational towing to prevent damage to internal parts.

1. Bring the vehicle to a complete stop on level ground, with the engine running. Firmly apply the parking brake.
2. Shift the transmission to NEUTRAL.

NOTE:

If vehicle is equipped with air suspension, ensure the vehicle is set to Standard Ride Height.

3. Press and hold the brake pedal.
4. Shift the transfer case into N (Neutral):
 - With manual shift transfer case, shift the transfer case lever into N (Neutral).

- With electronic shift transfer case, push and hold the transfer case N (Neutral) button. Some models have a small, recessed "N" button (at the center of the transfer case switches) that must be pushed using a ballpoint pen or similar object. Other models have a rectangular N (Neutral) switch, below the rotary transfer case control knob. The N (Neutral) indicator light will blink while the shift is in progress. The light will stop blinking (stay on solid) when the shift to N (Neutral) is complete. After the shift is completed and the N (Neutral) light stays on, release the N (Neutral) button.

5. Release the parking brake.
6. Shift the transmission into REVERSE.
7. Release the brake pedal for five seconds and ensure that there is no vehicle movement.
8. Repeat steps 6 and 7 with automatic transmission in DRIVE.
9. Shift the transmission to NEUTRAL. Firmly apply the parking brake. Turn off the engine. For vehicles with Keyless Enter 'n Go™, push and hold the ENGINE START/STOP button until the engine shuts off.
10. Shift the transmission into PARK. On 8-speed transmissions the shifter will automatically select PARK when the engine is turned off.
11. Turn the ignition to the OFF mode, then cycle the ignition to the RUN mode and back to the OFF mode. Remove the key fob from the ignition.
12. Attach the vehicle to the tow vehicle using a suitable tow bar.
13. Release the parking brake.

NOTE:

With electronic shift transfer case:

- Steps 2 through 3 are requirements that must be met before pushing the N (Neutral) button, and must continue to be met until the shift has been completed. If any of these requirements are not met before pushing the N (Neutral) button or are no longer met during the shift, the N (Neutral) indicator light will flash continuously until all requirements are met or until the N (Neutral) button is released.
- The ignition must be in the ON/RUN mode for a shift to take place and for the position indicator lights to be operable. If the ignition is not in the ON/RUN mode, the shift will not take place and no position indicator lights will be on or flashing.
- A flashing N (Neutral) position indicator light indicates that shift requirements have not been met.
- If the vehicle is equipped with air suspension, the engine should be started and left running for a minimum of 60 seconds (with all the doors closed) at least once every 24 hours. This process allows the air suspension to adjust the vehicle's ride height to compensate for temperature effects.

Shifting Out Of N (Neutral)

Use the following procedure to prepare your vehicle for normal usage:

1. Bring the vehicle to a complete stop, leaving it connected to the tow vehicle.
2. Firmly apply the parking brake.
3. Press and hold the brake pedal.

4. Start the engine. Shift the transmission into NEUTRAL.
 - With manual shift transfer case, shift the transfer case lever to the desired position.
 - With electronic shift transfer case with rotary selector switch, push and hold the transfer case N (Neutral) button until the N (Neutral) indicator light turns off. After the N (Neutral) indicator light turns off, release the N (Neutral) button. After the N (Neutral) button has been released, the transfer case will shift to the position indicated by the selector switch.
 - With electronic shift transfer case with push button selector switch, push and hold the switch for the desired transfer case position, until the N (Neutral) indicator light turns off and the desired position indicator light turns on.

NOTE:

When shifting out of transfer case N (Neutral), turning the engine off is not required, but may be helpful to avoid gear clash. With the 8-speed automatic transmission, the engine must remain running, since turning the engine off will shift the transmission to PARK (and the transmission must be in NEUTRAL for the transfer case to shift out of NEUTRAL).

5. Turn the engine off. Shift automatic transmission into PARK. On 8-speed transmissions the shifter will automatically select PARK when the engine is turned off.
6. Release the brake pedal.
7. Disconnect vehicle from the tow vehicle.
8. Start the engine.
9. Press and hold the brake pedal.

10. Release the parking brake.
11. Shift the transmission into gear, release the brake pedal, and check that the vehicle operates normally.

NOTE:

With electronic shift transfer case:

- Steps 3 and 4 are requirements that must be met before pushing the button to shift out of N (Neutral), and must continue to be met until the shift has been completed. If any of these requirements are not met before pushing the button or are no longer met during the shift, the N (Neutral) indicator light will flash continuously until all requirements are met or until the button is released.
- The ignition must be in the ON/RUN mode for a shift to take place and for the position indicator lights to be operable. If the ignition is not in the ON/RUN mode, the shift will not take place and no position indicator lights will be on or flashing.
- A flashing N (Neutral) position indicator light indicates that shift requirements have not been met.

DRIVING TIPS**DRIVING ON SLIPPERY SURFACES****Acceleration**

Rapid acceleration on snow covered, wet, or other slippery surfaces may cause the driving wheels to pull erratically to the right or left. This phenomenon occurs when there is a difference in the surface traction under the rear (driving) wheels.

WARNING!

Rapid acceleration on slippery surfaces is dangerous. Unequal traction can cause sudden pulling of the rear wheels. You could lose control of the vehicle and possibly have a collision. Accelerate slowly and carefully whenever there is likely to be poor traction (ice, snow, wet, mud, loose sand, etc.).

DRIVING THROUGH WATER

Driving through water more than a few inches/centimeters deep will require extra caution to ensure safety and prevent damage to your vehicle.

Flowing/Rising Water**WARNING!**

Do not drive on or across a road or path where water is flowing and/or rising (as in storm run-off). Flowing water can wear away the road or path's surface and cause your vehicle to sink into deeper water. Furthermore, flowing and/or rising water can carry your vehicle away swiftly. Failure to follow this warning may result in injuries that are serious or fatal to you, your passengers, and others around you.

Shallow Standing Water

Although your vehicle is capable of driving through shallow standing water, consider the following Cautions and Warnings before doing so.

WARNING!

- Driving through standing water limits your vehicle's traction capabilities. Do not exceed 5 mph (8 km/h) when driving through standing water.
- Driving through standing water limits your vehicle's braking capabilities, which increases stopping distances. Therefore, after driving through standing water, drive slowly and lightly press on the brake pedal several times to dry the brakes.
- Failure to follow these warnings may result in injuries that are serious or fatal to you, your passengers, and others around you.

CAUTION!

- Always check the depth of the standing water before driving through it. Never drive through standing water that is deeper than the bottom of the tire rims mounted on the vehicle.
- Determine the condition of the road or the path that is under water and if there are any obstacles in the way before driving through the standing water.
- Do not exceed 5 mph (8 km/h) when driving through standing water. This will minimize wave effects.

(Continued)

CAUTION!

- Driving through standing water may cause damage to your vehicle's drivetrain components. Always inspect your vehicle's fluids (i.e., engine oil, transmission, axle, etc.) for signs of contamination (i.e., fluid that is milky or foamy in appearance) after driving through standing water. Do not continue to operate the vehicle if any fluid appears contaminated, as this may result in further damage. Such damage is not covered by the New Vehicle Limited Warranty.
- Getting water inside your vehicle's engine can cause it to lock up and stall out, and cause serious internal damage to the engine. Such damage is not covered by the New Vehicle Limited Warranty.

OFF-ROAD DRIVING TIPS

Care should be taken when attempting to climb steep hills or driving diagonally across a hill or slope. If natural obstacles force you to travel diagonally up or down a hill, choose a mild angle and keep as little side tilt as possible. Keep the vehicle moving and make turns slowly and cautiously.

If you must back down a hill, back straight down using REVERSE gear. Never back down in NEUTRAL or diagonally across the hill.

When driving over sand, mud, and other soft terrain, shift to low gear and drive steadily. Apply the accelerator slowly to avoid spinning the wheels.

Do not reduce the tire pressures for this type of driving.

After Driving Off-Road

Off-road operation puts more stress on your vehicle than does most on-road driving. After going off-road, it is always a good idea to check for damage. That way you can get any problems taken care of right away and have your vehicle ready when you need it.

- Completely inspect the underbody of your vehicle. Check tires, body structure, steering, suspension, and exhaust system for damage.
- Inspect the radiator for mud and debris and clean as required.
- Check threaded fasteners for looseness, particularly on the chassis, drivetrain components, steering, and suspension. Retighten them, if required, and torque to the values specified in the Service Manual.
- Check for accumulations of plants or brush. These things could be a fire hazard. They might hide damage to fuel lines, brake hoses, axle pinion seals, and propeller shafts.
- After extended operation in mud, sand, water, or similar dirty conditions, have the radiator, fan, brake rotors, wheels, brake linings, and axle yokes inspected and cleaned as soon as possible.

WARNING!

Abrasive material in any part of the brakes may cause excessive wear or unpredictable braking. You might not have full braking power when you need it to prevent a collision. If you have been operating your vehicle in dirty conditions, get your brakes checked and cleaned as necessary.

- If you experience unusual vibration after driving in mud, slush or similar conditions, check the wheels for impacted material. Impacted material can cause a wheel imbalance and freeing the wheels of it will correct the situation.

MULTIMEDIA

UCONNECT SYSTEMS

For detailed information about your Uconnect 5/5 NAV With 8.4-inch Display system or your Uconnect 5 NAV With 12-inch Display system, refer to your Uconnect Radio Instruction Manual.

NOTE:

Uconnect screen images are for illustration purposes only and may not reflect exact software for your vehicle.

CYBERSECURITY

Depending on applicability, your vehicle may be able to send or receive information from a wired or wireless network. This information allows systems and features in your vehicle to function properly.

Your vehicle may be equipped with certain security features to reduce the risk of unauthorized and unlawful access to vehicle systems and wireless communications. Vehicle software technology continues to evolve over time and FCA US LLC, working with its suppliers, evaluates and takes appropriate steps as needed. As always, if you experience unusual behavior, contact an authorized dealer immediately, ↗ page 401, or refer to your Uconnect Radio Instruction Manual for additional contact information.

The risk of unauthorized and unlawful access to your vehicle systems may still exist, even if the most recent version of vehicle software (such as Uconnect software) is installed.

WARNING!

- ONLY insert trusted media devices/components into your vehicle. Media of unknown origin could possibly contain malicious software, and if installed in your vehicle, it may increase the possibility for vehicle systems to be breached.
- As always, if you experience unusual vehicle behavior, contact an authorized dealer immediately.

NOTE:

To help further improve user experience, features, stability, etc., and minimize the potential risk of a security breach, vehicle owners should routinely check www.driveuconnect.com (US Residents) or www.driveuconnect.ca (Canadian Residents) to learn about available Uconnect software updates.

UCONNECT SETTINGS

The Uconnect system uses a combination of buttons on the touchscreen and buttons on the faceplate located on the center of the instrument panel. These buttons allow you to access and change the Customer Programmable Features. Many features can vary by vehicle.

Buttons on the faceplate are located below and/or beside the Uconnect system in the center of the instrument panel. In addition, there is a SCROLL/ENTER control knob located on the right side. Turn the control knob to scroll through menus and change settings. Push the center of the control knob one or more times to select or change a setting.

Your Uconnect system may also have SCREEN OFF and MUTE buttons on the faceplate.

Push the SCREEN OFF button on the faceplate to turn off the Uconnect screen. Push the button again or tap the screen to turn the screen on.

Press the Back Arrow button to exit out of a Menu or certain option on the Uconnect system.

For the Uconnect 5 systems, push and hold the Power button on the radio's faceplate for a minimum of 15 seconds to reset the radio.

CUSTOMER PROGRAMMABLE FEATURES

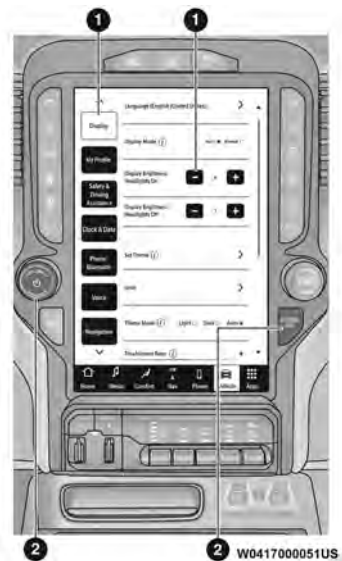

Uconnect 5 NAV With 12-inch Display Touchscreen And Faceplate Buttons

1 – Uconnect Buttons On The Touchscreen

2 – Uconnect Buttons On The Faceplate

For The Uconnect 3 With 5-inch Display, The Uconnect 5/5 NAV With 8.4-inch Display, And The Uconnect 5 NAV With 12-inch Display

For Uconnect 3, push the **SETTINGS** button on the side of the faceplate. In this menu, the Uconnect system allows you to access all of the available programmable features.

For Uconnect 5, press the **Vehicle** button on the touchscreen, then press the **Settings** tab on the top of the touchscreen. In this menu, the Uconnect system allows you to access all of the available programmable features.

NOTE:

- Only one touchscreen area may be selected at a time.
- Depending on the vehicle's options, feature settings may vary.

When making a selection, press the button on the touchscreen to enter the desired menu. Once in the desired menu, press and release the preferred setting option until a check mark appears next to the setting, showing that setting has been selected. Once the setting is complete, press the **Vehicle** button to exit to the screen. Pressing the **Up** or **Down Arrow** button on the right side of the screen will allow you to toggle up or down through the available settings.

Display

When the Display button is pressed on the touchscreen, the system will display the options related to the theme (if equipped), brightness, and color of the touchscreen. The available settings are:

NOTE:

Depending on the vehicle's options, feature settings may vary.

Setting Name	Description
Language	This setting will change the language of the Uconnect system and Instrument Cluster Display. The available languages are English (United States), Español (Mexico), Italiano (Italy), and Français (Canada).
Display Mode	This setting will allow you to set the brightness manually or have the system set it automatically. The "Auto" setting has the system automatically adjust the display brightness. The "Manual" setting will allow the user to adjust the brightness of the display.
Display Brightness With Headlights ON/Display Brightness Nighttime	This setting will allow you to set the brightness when the headlights are on. To access this setting, Display Mode must be set to "Manual", the headlights must be on, and the dimmer wheel must be in the lowest position. The "+" setting will increase the brightness; the "-" will decrease the brightness.
Display Brightness With Headlights OFF/Display Brightness Daytime	This setting will allow you to set the brightness when the headlights are off. To access this setting, Display Mode must be set to "Manual". The "+" setting will increase the brightness; the "-" will decrease the brightness.
Set Theme	This setting will allow you to change the display theme.
Units	This setting will allow you to change the units to "US", "Metric", or "Custom". The available options within Custom are "Speed" (MPH or km/h), "Distance" (mi or km), "Current Consumption" (MPG [US], MPG [UK], L/100 km, or km/L), "Pressure" (psi, kPa, or bar), "Temperature" (°C or °F), "Power" (HP [US], Gal HP [UK], or kW), and "Torque" (lb-ft or Nm) units of measurement independently.
Keyboard	This setting will change the keyboard type on the display. The selectable keyboards are "ABCDEF Keyboard", "QWERTY Keyboard", and "AZERTY Keyboard".
Theme Mode	This setting will allow you to adjust the brightness of your theme. Setting options are "Light", "Dark" and "Auto". Select to show themes in Light or Dark mode. "Auto" changes the theme with the headlights.
Touchscreen Beep	This setting will allow you to turn the touchscreen beep on or off.
Control Screen Timeout	This setting allows you to set the Control Screen to turn off automatically after five seconds or stay open until manually closed.
Navigation Next Turn-by-Turn Displayed in Cluster	This setting will display navigation prompts in the Instrument Cluster Display.
Phone Pop-ups Displayed In Cluster	This setting will display incoming calls in the Instrument Cluster Display.

Setting Name	Description
Fuel Saver Display	This setting will enable fuel saver mode in the Instrument Cluster Display.
Ready To Drive Pop-ups	This setting will enable the Ready To Drive Pop-ups in the Instrument Cluster Display.
Show Main Category Bar Labels	This setting will allow you to turn the bottom main category bar labels on or off.

My Profile

When the My Profile button is pressed on the touchscreen, the system displays options related to the vehicle's profiles.

NOTE:

Depending on the vehicle's options, feature settings may vary.

Setting Name	Description
Language	This setting will change the language of the Uconnect system and Instrument Cluster Display. The available languages are English (United States), Español (Mexico), Italiano (Italy), and Français (Canada).
Display Mode	This setting will adjust the display brightness for the radio to "Auto" or "Manual". "Manual" allows for more customization with the radio display brightness.
Display Brightness Headlights On/Display Brightness Nighttime	This setting will allow you to set the brightness when the headlights are on. To access this setting, Display Mode must be set to "Manual", the headlights must be on, and the dimmer wheel must be in the lowest position. The "+" setting will increase the brightness; the "-" will decrease the brightness.
Display Brightness Headlights Off/Display Brightness Daytime	This setting will allow you to set the brightness when the headlights are off. To access this setting, Display Mode must be set to "Manual". The "+" setting will increase the brightness; the "-" will decrease the brightness.
Set Theme	This setting will allow you to change the display theme.
Units	This setting will allow you to change the units to "US", "Metric", or "Custom". The available options within Custom are "Speed" (MPH or km/h), "Distance" (mi or km), "Current Consumption" (MPG [US], MPG [UK], L/100 km, or km/L), "Pressure" (psi, kPa, or bar), "Temperature" (°C or °F), "Power" (HP [US], Gal HP [UK], or kW), and "Torque" (lb-ft or Nm) units of measurement independently.
Theme Mode	This setting will allow you to adjust the brightness of your theme. Setting options are "Light", "Dark" and "Auto". Select to show themes in Light or Dark mode. "Auto" changes the theme with the headlights.
Touchscreen Beep	This setting will allow you to turn the touchscreen beep on or off.

Setting Name	Description
Navigation Turn-by-Turn Displayed in Cluster	This setting will display navigation prompts in the Instrument Cluster Display.
Phone Pop-ups Displayed In Cluster	This setting will display incoming calls in the Instrument Cluster Display.
Time Format	This setting will allow you to set the time format (AM/PM). Sync Time With GPS must be "Off" for this setting to be available. The "12 hrs" setting will set the time to a 12-hour format. The "24 hrs" setting will set the time to a 24-hour format.
Voice Options	This setting will allow you to change the voice options for the radio to "Male" or "Female".
"Wake Up" Word	This setting will allow you to set the system "Wake Up" word. The available options are "Off", "Hey, Uconnect", and "Hey, Ram".
Voice Barge-in	This setting will allow Voice Barge-in to be turned on or off.
Show Command List	This setting will allow the Command List to be shown. The options are "On" and "Off".
Key Off Power Delay	This setting will keep certain electrical features running after the engine is turned off. When any door is opened, the electronics will deactivate. The available settings are "0 sec" and "45 sec".
Auto-On Driver Heated/Ventilated Seat & Heated Steering Wheel	This setting will activate the vehicle's comfort system and heated seats or heated steering wheel when the vehicle is remote started or ignition is started. The "Off" setting will not activate the comfort systems. The "Remote Start" setting will only activate the comfort systems when using Remote Start. The "All Start" setting will activate the comfort systems whenever the vehicle is started.
Radio Power Off	This setting will keep certain electrical features running after the engine is turned off. When any door is opened, the electronics will deactivate. The available settings are "0 sec", "45 sec", "5 min", and "10 min".
Radio Off With Door	This setting will allow you to determine if the radio shuts off when any of the doors are opened.
App Drawer Favoriting Popups	This setting will allow you to favorite app drawer pop-ups with "On" and "Off" options.
App Drawer Unfavoritings Popups	This setting will allow you to unfavorit app drawer pop-ups with "On" and "Off" options.
New Text Message Popups	This setting will allow you to have pop-up notifications for new text messages. Setting options are "On" and "Off".
Missed Calls Message	This setting will allow you to have pop-up notifications for missed calls. Setting options are "On" and "Off".
Navigation Popups	This setting will allow you to have pop-up notifications for Navigation. Setting options are "On" and "Off".
Navigation Settings	This setting will redirect to the list of Navigation settings. Refer to your Uconnect Radio Instruction Manual for further information.
Audio Settings	This setting will open the submenu, containing the audio settings  page 223.
Reset App Drawer to Default Order	This setting will reset the app drawer to its factory default layout.
Restore Settings to Default	This setting will return all the previously changed settings to their factory defaults.
More Profile Options	This setting will give access to more profile options.

Safety/Driving Assistance

When the Safety/Driving Assistance button is selected on the touchscreen, the system displays the options related to the vehicle's safety settings. These options will differ depending on the features equipped on the vehicle. The settings may display in list form or within subfolders on the screen. To access a subfolder, select the desired folder; the available options related to that feature will then display on the screen.

NOTE:

Depending on the vehicle's options, feature settings may vary.

Setting Name	Description
Forward Collision Warning Sensitivity — Located In Automatic Emergency Braking Submenu	This setting will change the distance at which the Forward Collision Warning (FCW) alert sounds. The "Medium" setting will have the FCW system signal when an object is in view, and the possibility of a collision is detected. The "Near" setting will have the FCW system signal when the object is closer to the vehicle. The "Far" setting will have the FCW system signal when an object is at a far distance from the vehicle.
Forward Collision Warning — Located In Automatic Emergency Braking Submenu	This setting will turn the Forward Collision Warning system on or off. The "Off" setting will deactivate the FCW system. The "Warning Only" setting will provide only an audible chime when a collision is detected. The "Warning + Active Braking" setting will provide an audible chime and apply some brake pressure when a collision is detected.
Pedestrian Emergency Braking — Located In Automatic Emergency Braking Submenu	This setting will turn the Pedestrian Emergency Braking system on or off. This setting is located in Automatic Emergency Braking.
LaneSense Warning — Located In LaneSense Submenu	This setting will change the distance at which the steering wheel will provide lane departure feedback. The available settings are "Early", "Medium", and "Late".
LaneSense Strength — Located In LaneSense Submenu	This setting will change the strength of the steering wheel feedback during a lane departure. The available settings are "Low", "Medium", and "High".
ParkSense	This setting will change the type of ParkSense alert when a close object is detected and can provide both an audible chime and a visual display.
Front ParkSense Volume	This setting adjusts the volume of the Front ParkSense system. The available settings are "Low", "Medium", and "High".
Rear ParkSense Volume	This setting adjusts the volume of the Rear ParkSense system. The available settings are "Low", "Medium", and "High".
Blind Spot Alert	This setting will change the type of alert provided when an object is detected in a vehicle's blind spot. The "Off" setting will turn off Blind Spot Alert. The "Lights" setting will activate the Blind Spot Alert lights on the outside mirrors. The "Lights & Chime" setting will activate both the lights on the outside mirrors and an audible chime.
Trailer Length For Blind Spot Alert	This setting will auto detect the length of an attached trailer. The "Auto" setting will have the system automatically set the trailer length. The "Max" setting will always set the length to the maximum 39.5 ft (12 m).
Hill Start Assist	This setting will turn the Hill Start Assist system on or off.

Setting Name	Description
ParkView Backup Camera Delay	This setting will add a timed delay to the ParkView Backup Camera when shifting out of REVERSE.
ParkView Backup Camera Active Guidelines	This setting will turn the ParkView Backup Camera Active Guidelines on or off.
ParkView Backup Camera Fixed Guidelines	This setting will turn the ParkView Backup Camera Fixed Guidelines on or off.
Tire Fill Assist	This setting will turn Tire Fill Assist on or off.
Power Side Steps	This setting will raise and lower or stow the Power Side Steps. The available options are "Automatic" to raise and lower the Power Side Steps and "Stow" to deactivate the Power Side Steps.
Rear Seat Alert	When this setting is turned on and the rear doors are opened while the engine is running, or if the engine is turned on within 10 minutes of the door opening, a message will appear to check the rear seat when the vehicle is powered OFF.
Front ParkSense Camera Activation	This setting will allow you to enable or disable the front camera when an obstacle is detected.

Clock & Date

5

When the Clock & Date button is pressed on the touchscreen, the system displays the different options related to the vehicle's internal clock.

NOTE:

Depending on the vehicle's options, feature settings may vary.

Setting Name	Description
Sync Time With GPS	This setting will sync the time to the GPS receiver in the system. The system will control the time via the GPS location.
Set Time	This setting will allow you to set the hours and minutes. Sync Time With GPS must be off for this setting to be available. The "+" setting will increase the hours or minutes. The "-" setting will decrease the hours or minutes.
Time Format	This setting will allow you to set the time format (AM/PM). Sync Time With GPS must be off for this setting to be available. The "12 hrs" setting will set the time to a 12-hour format. The "24 hrs" setting will set the time to a 24-hour format.
Set Date	This setting will allow you to set the day, month and year. Using "+" or "-", you can scroll through the available days, months, and years.
Show Time in Status Bar	This setting will place the time in the radio's status bar.
Show Time and Date During Screen Off	This setting will allow you to show the time and date while the screen is off. Available options are "On" and "Off".

Phone/Bluetooth®

When the Phone/Bluetooth® button is pressed on the touchscreen, the system displays the options related to Bluetooth® connectivity from an external audio device or smart-phone. The list of paired audio devices or smartphones can be accessed from this menu.

NOTE:

Depending on the vehicle's options, feature settings may vary.

Setting Name	Description
Device Manager	This setting will open the Device Manager main screen.
Do Not Disturb All	This setting will open the Do Not Disturb All Settings menu. The available options are "On" and "Off".
Enable Two Active Phones	This setting will enable or disable two active phones within the vehicle. The setting options are "On" and "Off".
Phone Pop-Ups Displayed In Cluster	This setting will display incoming calls in the Instrument Cluster Display.

Voice

When the Voice button is pressed on the touchscreen, the system displays the options related to the vehicle's Voice Recognition feature.

NOTE:

Depending on the vehicle's options, feature settings may vary.

Setting Name	Description
Voice Options	This setting will allow you to change the system's voice to either "Male" or "Female".
Wake Up Word	This setting will allow you to set the system's "Wake Up" word. The available options are "Off", "Hey, Uconnect", and "Hey, Ram".
Voice Barge-In	This setting allows you to respond to a Voice Response before the statement is completed by the system. The available options are "On" and "Off".
Show Command List	This setting will allow you to turn the Command List on or off. The "Always" setting will always show the Command List. The "With Help" setting will show the Command List and provide a brief description of what the command does. The "Never" setting will turn the Command List off.

Navigation — If Equipped

When the Navigation button is pressed on the touchscreen, the system displays options related to the vehicle's built-in Navigation system. These settings can change which icons display on the map, how "time to arrival is calculated", and route types.

For more information on Navigation and settings, refer to your Uconnect Radio Instruction Manual.

Trailer Brake/Trailer — If Equipped

When the Trailer Brake/Trailer button is pressed on the touchscreen, the system will display settings related to trailer towing.

NOTE:

Depending on the vehicle's options, feature settings may vary.

Setting Name	Description
Trailer 1	Options for each trailer are "Use This Trailer", "Braking" (Light Electric, Heavy Electric, Light Electric Over Hydraulic, and Heavy Electric Over Hydraulic), "Trailer Name", and "Tire Pressure" (Setup All Tires, Replace Single Tire, Set Target Tire Pressure, and Delete Tire Settings).
Trailer 2	Options for each trailer are "Use This Trailer", "Braking" (Light Electric, Heavy Electric, Light Electric Over Hydraulic, and Heavy Electric Over Hydraulic), "Trailer Name", and "Tire Pressure" (Setup All Tires, Replace Single Tire, Set Target Tire Pressure, and Delete Tire Settings).
Trailer 3	Options for each trailer are "Use This Trailer", "Braking" (Light Electric, Heavy Electric, Light Electric Over Hydraulic, and Heavy Electric Over Hydraulic), "Trailer Name", and "Tire Pressure" (Setup All Tires, Replace Single Tire, Set Target Tire Pressure, and Delete Tire Settings).
Trailer 4	Options for each trailer are "Use This Trailer", "Braking" (Light Electric, Heavy Electric, Light Electric Over Hydraulic, and Heavy Electric Over Hydraulic), "Trailer Name", and "Tire Pressure" (Setup All Tires, Replace Single Tire, Set Target Tire Pressure, and Delete Tire Settings).
Trailer Surround Camera	This setting will let you access options related to the Trailer Surround Camera.
Trailer Select	Select from "Trailer 1", "Trailer 2", "Trailer 3", and "Trailer 4". These trailer designations can be used to save different trailer settings.

Setting Name	Description
Trailer Brake Type	This setting will set the system to a specific trailer type. The available options are "Light Electric", "Heavy Electric", "Light Electric Over Hydraulic", and "Heavy Electric Over Hydraulic".
Trailer Name	This setting will personalize the trailer name depending on the type of trailer you are hauling. Select the trailer name from the following list: trailer, boat, car, cargo, dump, equipment, flatbed, gooseneck, horse, livestock, motorcycle, snowmobile, travel, utility, and 5th wheel.

Camera

When the Camera button is pressed on the touchscreen, the system displays the options related to the vehicle's camera features.

NOTE:

Depending on the vehicle's options, feature settings may vary.

Setting Name	Description
Surround View Camera Delay	This setting will add a timed delay to the Surround View Camera when shifting out of REVERSE.
Surround View Camera Guidelines	This setting will turn the Surround View Camera Guidelines on or off.
ParkView Backup Camera Delay	This setting will add a timed delay to the ParkView Backup Camera when shifting out of REVERSE.
ParkView Backup Camera Active Guidelines	This setting will turn the ParkView Backup Camera Active Guidelines on or off.
ParkView Backup Camera Fixed Guidelines	This setting will turn the ParkView Backup Camera Fixed Guidelines on or off.
Turn Signal Activated Blind Spot View	For vehicles not equipped with towing, this setting will allow you to enable or disable the turn signal blind spot view. For vehicles equipped with towing, the selectable options are "Off", "On", and "Only with Trailer".
Aux Cameras	This setting will allow you to edit the settings for the aux camera.
Cargo Camera Dynamic Centerline	This setting will turn the Cargo Camera Dynamic Centerline on or off.
Trailer Surround Camera	This setting will allow you to see the trailer camera surround view.
Turn Signal Activated Blind Spot View	For vehicles not equipped with towing, this setting will allow you to enable or disable the turn signal blind spot view. For vehicles equipped with towing, the selectable options are "Off", "On", or "Only with Trailer".

Mirrors & Wipers

When the Mirrors & Wipers button is pressed on the touchscreen, the system displays the options related to the vehicle's mirrors and wipers.

NOTE:

Depending on the vehicle's options, feature settings may vary.

Setting Name	Description
Tilt Side Mirrors In Reverse	This setting will tilt the outside side-view mirrors when the ignition is in the ON/RUN position and the transmission gear selector is in the REVERSE position. The mirrors will move back to their previous position when the transmission is shifted out of REVERSE. The available settings are "On" and "Off".
Rain Sensing Auto Wipers	This setting will turn the Rain Sensing Auto Wipers on or off.
Headlights With Wipers	This setting will turn the headlights on when the wipers are activated.
Auto Folding Side Mirrors	This setting will automatically fold and unfold the side-view mirrors when the vehicle is turned off, the doors are locked, or the key fob button is pushed. The available options are "On" and "Off".

5

Lights

When the Lights button is pressed on the touchscreen, the system displays the options related to the vehicle's exterior and interior lights.

NOTE:

- When the "Daytime Running Lights" feature is selected, the daytime running lights can be turned on or off. This feature is only allowed by law in the country of the vehicle purchase.
- Depending on the vehicle's options, feature settings may vary.

Setting Name	Description
Headlight Off Delay	This setting will allow you to set the amount of time it takes for the headlights to shut off after the vehicle is turned off. The available settings are "0 sec", "30 sec", "60 sec", and "90 sec".
Headlight Illumination On Approach	This setting will allow you to set the amount of time it takes for the headlights to shut off after the vehicle is unlocked. The available settings are "0 sec", "30 sec", "60 sec", and "90 sec".
Headlights with Wipers	This setting will turn the headlights on when the wipers are activated.
Daytime Running Lights	This setting will allow you to turn the Daytime Running Lights on or off.

Setting Name	Description
Flash Lights With Lock	This setting will allow you to turn the flashing of the lights when the Lock button is pushed on the key fob on or off.
Auto Dim High Beams	This setting will allow you to turn the Auto Dim High Beams on or off.
Steering Directed Lights	This setting will turn the headlights with the steering wheel. The available options are "On" and "Off".
Rear Guidance Lights w/ Cargo Lights	This setting will turn the Rear Guidance Lights on when Cargo Lights are activated.

Brakes

After pressing the Brakes button on the touchscreen, the following setting will be available:

NOTE:

Depending on the vehicle's options, feature settings may vary.

Setting Name	Description
Brake Service	This setting will allow you to retract the brakes for servicing.

Doors & Locks

When the Doors & Locks button is pressed on the touchscreen, the system displays the options related to locking and unlocking the vehicle's doors.

NOTE:

Depending on the vehicle's options, feature settings may vary.

Setting Name	Description
Auto Door Locks	This setting will allow you to change if the doors lock automatically when the vehicle reaches 15 mph (24 km/h).
Auto Unlock On Exit	This setting will unlock the doors when any of the doors are opened from the inside.
Flash Lights With Lock	This setting will allow you to turn the flashing of the lights when the Lock button is pushed on the key fob on or off.

Setting Name	Description
Sound Horn With Lock	This setting will sound the horn when the Lock button is pushed on the key fob. The "Off" setting will not sound the horn when the Lock button is pushed. The "1st Press" setting will sound the horn when the Lock button is pushed once. The "2nd Press" setting will sound the horn when the Lock button is pushed twice.
Sound Horn With Remote Start	This setting will sound the horn when the remote start is activated from the key fob.
Remote Door Unlock, Door Lock/1st Press Of Key Fob Unlocks	This setting will change how many pushes of the Unlock button on the key fob are needed to unlock all the doors. The "Driver Door" setting will only unlock the driver door on the first push on the Unlock button. The "All Doors" setting will unlock all doors with only one push of the Unlock button.
Passive Entry	This setting will allow you to turn the Passive Entry feature (Keyless Enter 'n Go™) on or off.
Personal Settings Linked To Key Fob	This setting will recall preset radio stations and driver seat position that have been linked to the key fob.

Seats & Comfort/Auto-On Comfort Systems

When the Seats & Comfort/Auto-On Comfort Systems button is pressed on the touchscreen, the system displays the options related to the vehicle's comfort systems when remote start has been activated or the vehicle has been started.

NOTE:

Depending on the vehicle's options, feature settings may vary.

Setting Name	Description
Auto-On Driver Heated/Ventilated Seat & Heated Steering Wheel With Vehicle Start	This setting will activate the vehicle's comfort systems and heated seats or heated steering wheel when the vehicle is remote started or ignition is started. The "Off" setting will not activate the comfort systems. The "Remote Start" setting will only activate the comfort systems when using Remote Start. The "All Start" setting will activate the comfort systems whenever the vehicle is started.
Easy Exit Seats	This setting will automatically move the driver seat rearward when the engine is shut off. The available settings are "On" and "Off".

Key Off Options/Engine Off Options

When the Key Off Options/Engine Off Options button is pressed on the touchscreen, the system displays the options related to vehicle shutoff. These settings will only activate when the ignition is set to OFF.

NOTE:

Depending on the vehicle's options, feature settings may vary.

Setting Name	Description
Easy Exit Seat	This setting adjusts the seats to make exiting the vehicle easier.
Key Off Power Delay/Engine Off Power Delay	This setting will keep certain electrical features running after the engine is turned off. When any door is opened, the electronics will deactivate. The available settings are "0 sec", "45 sec", "5 min", and "10 min".
Headlight Off Delay	This setting will allow you to set the amount of time the headlights remain on after the vehicle has been turned off. The "+" will increase the amount of time. The "-" will decrease the amount of time.

Suspension/Air Suspension

When the Suspension/Air Suspension button is pressed on the touchscreen, the system will display settings related to the vehicle's air suspension.

NOTE:

Depending on the vehicle's options, feature settings may vary.

Setting Name	Description
Display Suspension Messages	This setting will display suspension messages in the Instrument Cluster Display. The "All" setting will display all available messages. The "Warnings Only" setting will only display warning messages.
Tire Jack Mode	This setting will disable the Air Suspension system to assist in changing a spare tire.
Transport Mode	This setting will disable the Air Suspension system for flat towing.
Wheel Alignment Mode	This setting must be activated before performing a wheel alignment. Contact an authorized dealer for further information.

Audio

When the Audio button is pressed on the touchscreen, the system displays options related to the vehicle's sound system. These settings can change the audio location within the vehicle, adjust the bass or treble levels, and auto-play settings from an audio device or smartphone.

NOTE:

Depending on the vehicle's options, feature settings may vary.

Setting Name	Description
Balance/Fade — Located In the Audio Settings Submenu	This setting will adjust audio levels from specific speakers in the front/back and left/right of the vehicle. The Speaker icon can be moved to set audio location.
Equalizer — Located In the Audio Settings Submenu	This setting will adjust the "Bass", "Mid", and "Treble" ranges of the audio.
Speed Adjusted Volume — Located In the Audio Settings Submenu	This setting will adjust audio volume as speeds increase. At a higher setting, the volume will increase more as the vehicle speeds up. The available settings are "Off", "1", "2", and "3".
Surround Sound — Located In the Audio Settings Submenu	This setting will turn the Surround Sound system on or off.
AUX Volume Offset — Located In the Audio Settings Submenu	This setting will tune the audio levels from a device connected through the AUX port. The available settings are "+" and "-".
Auto Play — Located In the Audio Settings Submenu	This setting will automatically begin playing audio from a connected device.
Auto-On Radio — Located In the Audio Settings Submenu	This setting will automatically turn the radio on when the vehicle is started. The available settings are "Off", "On", and "Recall Last". With "Recall Last", the system resumes the previous task before vehicle shut off.
Volume Adjustment — Located In the Audio Settings Submenu	This setting will allow you to set the audio volume levels for each option (Media, Phone, Navigation, etc.). You can set the volume between 0 and 38.
Loudness — Located In the Audio Settings Submenu	This setting will improve audio quality at lower volumes.

Notifications

When the Notifications button is pressed on the touchscreen, the system displays the options related to Notifications for the system.

NOTE:

Depending on the vehicle's options, feature settings may vary.

Setting Name	Description
Notification Sounds	This setting will turn off the Notification chime that plays when a new notification is sent. The options are "On" and "Off".
App Drawer Favoriting Popups	This setting turns the App Favorited pop-up on or off.
App Drawer Unfavoriting Popups	This setting turns the App Unfavorited pop-up on or off.
New Text Message Popups	This setting turns receiving/storing a pop-up for new text messages from any connected phone on or off.
Missed Calls Message	This setting turns receiving/storing a pop-up for missed calls from any connected phone on or off.
Navigation Popups	This setting turns receiving/storing predictive Navigation Pop-Ups on or off.

SiriusXM® Setup

When the SiriusXM® Setup button is pressed on the touchscreen, the system displays options related to SiriusXM® satellite radio. These settings can be used to skip specific radio channels and restart favorite songs from the beginning.

NOTE:

- A subscription to SiriusXM® satellite radio is required for these settings to be functional.
- Depending on the vehicle's options, feature settings may vary.

Setting Name	Description
Tune Start	This setting will play the current song from the beginning when you tune to a music channel using one of the 12 presets.
Channel Skip	This setting allows you to set channels that you wish to skip. A channel list will display of the skipped channels.
Subscription Information	This menu provides SiriusXM® subscription information. SiriusXM® Travel Link is a separate subscription.
SiriusXM® Account, Profile, And Settings	This setting will redirect you to the SiriusXM® Settings menu within the SiriusXM® menu.
Block Explicit	This setting will skip over content labeled as explicit. The available settings are "On" and "Off".

Software Updates — If Equipped

When the Software Updates button is pressed on the touchscreen, the system will display the setting related to updating the Uconnect software.

NOTE:

Depending on the vehicle's options, feature settings may vary.

Setting Name	Description
Software Downloads over Wi-Fi	This setting will allow software updates to happen over Wi-Fi. Selectable options for the setting are "On" and "Off".

System Information

After pressing the System Information button on the touchscreen, the following settings will be available:

NOTE:

Depending on the vehicle's options, feature settings may vary.

Setting Name	Description
Version Information	When this feature is selected, a Version Information screen will appear, displaying information about the version of your radio.
License Information	When this feature is selected, a License Information screen will appear, displaying the licensing information of your radio.

Reset

When the Reset button is pressed on the touchscreen, the system displays the options related to resetting the Uconnect system back to its default settings. These settings can clear personal data and reset selected settings from other menus.

NOTE:

Depending on the vehicle's options, feature settings may vary.

Setting Name	Description
Restart Radio	This setting will reboot the radio.
Reset Apps Drawer To Default Order	This setting will return the apps drawer to the default order. The available options are "Yes" and "Cancel". The X button can also be pressed to cancel the screen.
Restore Settings to Default	This setting will return all the previously changed settings to their factory defaults.
Clear Personal Data	This setting will display a pop-up that gives you the option to clear all personal data from the system, including Bluetooth® devices and presets.
Reset Wi-Fi Password For Projection	This setting will allow you to reset the vehicle's Wi-Fi password for smartphone projection. The available options are "Yes" and "Cancel". The X button can also be pressed to cancel the screen.
Reset Performance Values	This setting will reset the performance values for your vehicle.
Factory Reset	This setting will restore the radio to its factory default settings.

UCONNECT INTRODUCTION

SYSTEM OVERVIEW







Uconnect 3 With 5-inch Display

- 1 – RADIO Button
- 2 – MEDIA Button
- 3 – PHONE Button
- 4 – VOLUME & On/Off Button
- 5 – MUTE Button

- 6 – COMPASS Button
- 7 – SETTINGS Button
- 8 – MORE Button
- 9 – ENTER/BROWSE & TUNE/SCROLL Knob
- 10 – SCREEN OFF Button

NOTE:

Uconnect screen images are for illustration purposes only and may not reflect exact software for your vehicle.

Feature	Description
Radio/Media	Press/Push the Radio button or Media button to enter Radio Mode/Media Mode and access the radio functions and external audio sources ↩ page 229.
Phone	Press/Push the Phone button to enter Phone Mode and access the hands-free phone system ↩ page 238.
Settings	Press/Push the Settings button to access the Uconnect Settings ↩ 209.
	Push the ENTER/BROWSE button on the faceplate to accept a highlighted selection on the screen. Rotate the TUNE/SCROLL rotary knob to scroll through a list or tune a radio station.
	Push the SCREEN OFF button on the faceplate to turn the screen on or off.
	Push the MUTE button on the faceplate to turn the audio of the radio system off. Push it again to turn the audio back on.
	<p>Rotate the rotary knob to adjust the volume. Push the VOLUME & On/Off button on the faceplate to turn the system on or off.</p> <p>NOTE: Push and hold the VOLUME & On/Off button for approximately 10 seconds to reset the radio manually. Doing this can also recover the radio screen from freezing.</p>
BACK	Push the BACK button on the faceplate to go back to a previous screen in the headunit.
MUTE/VOLUME	Rotate the rotary knob to adjust the volume. Push the MUTE/VOLUME button on the faceplate to mute or unmute the system.

Feature	Description
Compass	Push the COMPASS button on the faceplate to access the vehicle's compass.
More	Push the MORE button on the faceplate to access additional options.

SAFETY AND GENERAL INFORMATION

Safety Guidelines

WARNING!

ALWAYS obey traffic laws and pay attention to the road. Your complete attention is always required while driving to maintain safe control of your vehicle. Only use and interact with the features and applications when it is safe to do so. Failure to follow these warnings can result in a collision and death or serious personal injury.

Please read this manual carefully before using the system. It contains instructions on how to use the system in a safe and effective manner.

Do NOT attach any object to the touchscreen. Doing so can result in damage to the touchscreen.

Please read and follow these safety precautions. Failure to do so may result in injury or property damage.

- Become familiar with the Uconnect features and applications in this vehicle before you drive on the roadway so using Uconnect will be more intuitive and will not require prolonged viewing of the screen while you are driving.
- When driving, looking at the touchscreen should only be done by a glance when safe to do so. If prolonged viewing of the screen is required, choose a safe and secure location where you can pull over and park safely to do so.

- Stop use immediately if a problem occurs. Failure to do so may cause injury or damage to the product. See an authorized dealer for repair.
- Ensure the volume level of the system is set to a level that still allows you to hear outside traffic and emergency vehicles.

Safe Usage Of The Uconnect System

- The Uconnect system is a sophisticated electronic device. Do not let young children use the system.
- Permanent hearing loss may occur if you play your music or sound system at loud volumes. Exercise caution when setting the volume on the system.
- Keep drinks, rain and other sources of moisture away from the system. Besides damage to the system, moisture can cause electric shocks as with any electronic device.

NOTE:

Many features of this system are speed dependent. For your own safety, it is not possible to use some of the touchscreen features while the vehicle is in motion.

Care And Maintenance

- Do not press the touchscreen with any hard or sharp objects (pen, USB stick, jewelry, etc.), which could scratch the surface.
- Do not spray any liquid or chemicals directly on the screen! Use a clean and dry microfiber lens cleaning cloth in order to clean the touchscreen.

- If necessary, use a lint-free cloth dampened with a cleaning solution, such as isopropyl alcohol or an isopropyl alcohol and water solution ratio of 50:50. Be sure to follow the solvent manufacturer's precautions and directions ↗ page 404.

UCONNECT MODES

STEERING WHEEL AUDIO CONTROLS

The remote sound system controls are located on the rear surface of the steering wheel at the three and nine o'clock positions.



A042000007U5

Remote Sound System Controls

The right-hand control is a rocker-type switch with a push button in the center and controls the volume and mode of the sound system. Pushing the top of the rocker switch will increase the volume, and pushing the bottom of the rocker switch will decrease the volume.

Pushing the right-hand control's center button will make the radio switch between the various modes available (AM/FM/SXM or Media, etc.).

The left-hand control is a rocker-type switch with a push button in the center. The function of the left-hand control is different depending on which mode you are in.

The following describes the left-hand control operation in each mode:

Radio Operation

Pushing the top of the switch will seek up for the next available station and pushing the bottom of the switch will seek down for the next available station.

The button located in the center of the left-hand control will tune to the next preset station that you have programmed in the radio presets.

Media Mode

Pushing the top of the switch skips to the next track on the selected media (AUX/USB/Bluetooth®). Pushing the switch up twice will go forward two tracks. Pushing the bottom switch goes to the beginning of the current track, or the beginning of the previous track if it is within eight seconds after the current track begins to play. Double pressing the bottom button switch will skip to the previous track if it is after eight seconds into the current track.

RADIO MODE

Radio Controls

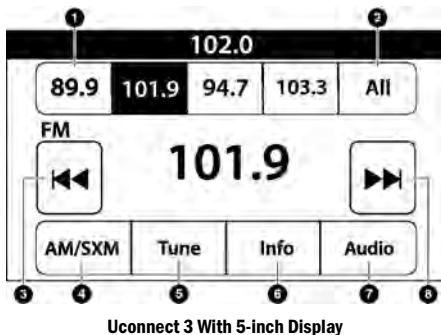

- 1 — Preset Radio Stations
- 2 — All Preset Radio Stations
- 3 — Seek Down ◀◀
- 4 — Radio Band (AM/FM)
- 5 — Tune
- 6 — Station Info
- 7 — Audio Settings
- 8 — Seek Up ▶▶

The radio is equipped with the following modes:

- AM
- FM
- SiriusXM® Satellite Radio (If Equipped)

Press the Radio button on the touchscreen to enter the Radio Mode. The different tuner modes, AM, FM, and SXM, can then be selected by pressing the corresponding button in Radio Mode.

Volume & On/Off Control

Push the VOLUME & On/Off control knob to turn on and off the Uconnect system.

The electronic volume control turns continuously (360 degrees) in either direction, without stopping. Turning the VOLUME & On/Off control knob clockwise increases the volume, and counterclockwise decreases it.

When the audio system is turned on, the sound will be set at the same volume level as last played.

Mute Button

Push the MUTE button to mute or unmute the system.

Tune/Scroll Control

Turn the rotary TUNE/SCROLL control knob clockwise to increase or counterclockwise to decrease the radio station frequency. Push the ENTER/BROWSE button to choose a selection.

Seek

The Seek Up and Down functions are activated by pressing the double arrow buttons on the touchscreen to the right and left of the radio station display or by pushing the left steering wheel audio control button up or down.

Seek Up ▶▶ and Seek Down ◀◀

Press and release the Seek Up ▶▶ or Seek Down ◀◀ button to tune the radio to the next available station or channel. During a Seek Up/Down function, if the radio reaches the starting station after passing through the entire band two times, the radio will stop at the station where it began.

Fast Seek Up ▶▶ and Fast Seek Down ◀◀

Press and hold, and then release the Seek Up ▶▶ or Seek Down ◀◀ button to advance the radio through the available stations or channels at a faster rate. The radio stops at the next available station or channel when the button on the touchscreen is released.

NOTE:

Pressing and holding either the Seek Up ▶▶ or Seek Down ◀◀ button will scan the different frequency bands at a slower rate.

Info — If Equipped

Press the Info button to display information related to the currently playing song and radio station.

Direct Tune

Press the Tune button located at the bottom of the radio screen to directly tune to a desired radio station or channel.

Press the available number button on the touchscreen to begin selecting a desired station. Once a number has been entered, any numbers that are no longer possible (stations that cannot be reached) will become deactivated/grayed out.

Undo

You can backspace an entry by pressing the Back ⌫ button on the touchscreen.

GO

Once the last digit of a station has been entered, press “Ok”. The Direct Tune screen will close, and the system will automatically tune to that station.

RADIO VOICE COMMANDS

Use your voice to quickly get to the AM, FM, or SiriusXM® Satellite Radio stations you would like to hear. (Subscription or included SiriusXM® Satellite Radio trial required.)

Push the VR button  on the steering wheel and wait for the beep to say a command. See an example:

- “ Tune to ninety-five-point-five FM”
- “ Tune to Satellite Channel Hits 1”

Did You Know: At any time, if you are not sure of what to say or want to learn a Voice Command, push the VR button  and say “ Help”. The system provides you with a list of commands.

SiriusXM® Satellite Radio Mode — If Equipped

Uconnect 3 With 5-inch Display Changing To SiriusXM®

NOTE:

Some SiriusXM® features are not supported by all SiriusXM® channels or content, for example song and artist favorites, sport game notifications, tune start, and others.

SiriusXM® Satellite Radio uses direct satellite-to-receiver broadcasting technology to provide clear, coast-to-coast radio content. SiriusXM® is a subscription-based service.

Visit <https://www.siriusxm.com/phx/getlogin> or review your SiriusXM® Radio pamphlet in your Owner's Manual kit for more information.

SiriusXM® services require subscriptions, sold separately after the trial included with the new vehicle purchase. If you decide to continue your service at the end of your trial subscription, the plan you choose will automatically renew and bill at then-current rates until you call SiriusXM® at 866-635-2349 to cancel. See SiriusXM® Customer Agreement for complete terms at www.siriusxm.com (US) or www.siriusxm.ca (Canada).

All fees and programming subject to change. SiriusXM® satellite service is available only to those at least 18 and older in the 48 contiguous US and D.C. Our SiriusXM® satellite service is also available in Canada and Puerto Rico (with coverage limitations). SiriusXM® Internet radio service is available throughout their satellite service area and in AK. © 2023 SiriusXM® Radio Inc. SiriusXM® and all related marks and logos are trademarks of SiriusXM® Radio Inc.

This functionality is only available for radios equipped with a Satellite receiver. In order to receive satellite radio, the vehicle needs to be outside with a clear view to the sky.

If the screen shows “Acquiring Signal”, you might have to change the vehicle’s position in order to receive a signal. In most cases, the satellite radio does not receive a signal in underground parking garages or tunnels.

No Subscription

Radios equipped with a Satellite receiver require a subscription to the SiriusXM® Service. When the radio does not have the necessary subscription, the radio is able to receive the Preview channel only.

Acquiring SiriusXM® Subscription

To activate the SiriusXM® Satellite Radio subscription, US residents visit

<https://www.siriusxm.com/phx/getlogin> or call: 1-800-643-2112

Canadian residents visit <https://www.siriusxm.ca/> or call: 1-888-539-7474.

NOTE:

You will need to provide the SiriusXM® ID (RID) located at the bottom of the Channel 0 screen.

The Satellite Mode is activated by a press of the SXM button on the touchscreen.

When in Satellite Mode:

- The SXM button on the touchscreen is highlighted.
- The SiriusXM® Presets are displayed at the top of the screen.
- The SiriusXM® Channel Number is displayed in the center.
- The Program Information is displayed at the bottom of the Channel Number.
- The SiriusXM® function buttons are displayed below the Program Information.

Tuning is done by operating the Tune Knob or by Direct Tune, similar to other Radio Bands.

In addition to the tuning operation functions common to all radio modes, the Replay, Traffic/Weather button, and Favorite button functions are available in SiriusXM® Mode.

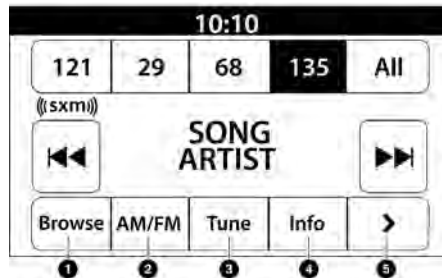

Uconnect 3 With 5-inch Display SiriusXM® Satellite Radio





- 1 – Browse
- 2 – Radio Bands
- 3 – Direct Tune
- 4 – Info Button
- 5 – Next Button

REPLAY

Replay provides a means to store and replay up to 22 minutes of music audio and 48 minutes of talk radio. Once the channel is switched, content in replay memory is lost.

Press the Replay button on the touchscreen. The Play/Pause, Rewind/Forward and Live buttons will display at the top of the screen, along with the replay time.

You can exit by pressing the Replay button on the touchscreen any time during the Replay Mode.

Play/Pause		Press the Pause/Play button on the touchscreen to pause the playing of live or rewind content at any time. Play can be resumed by pressing the Pause/Play button again on the touchscreen.
Rewind		Press the Rewind button on the touchscreen to rewind the content in steps of five seconds. Pressing the Rewind button on the touchscreen for more than two seconds rewinds the content. The radio begins playing the content at the point at which the press is released.
Forward		Each press of the Forward button on the touchscreen forwards the content in steps of five seconds. Forwarding of the content can only be done when the content is previously rewound, and therefore, cannot be done for live content. A continuous press of the Forward button on the touchscreen also forwards the content. The radio begins playing the content at the point at which the press is released.
Live		Press the Live button on the touchscreen to resume the playing of live content.

FAVORITES

Press the Favorites button on the touchscreen to activate the favorites menu, which will time out within 20 seconds in absence of user interaction.

You can exit the Favorites Menu by a press of the X button.

The Favorites feature enables you to set a favorite artist or song that is currently playing. The radio then uses this information to alert you when either the favorite artist or song is being played at any time by any of the SiriusXM® Channels.

The maximum number of favorites that can be stored in the Radio is 50.

Favorite Artist: While the song is playing, to set a favorite artist, press the Favorites button on the touchscreen and then the Favorite Artist button on the touchscreen.

Favorite Song: While the song is playing, to set a favorite song, press the Favorites button on the touchscreen and then the Favorite Song button on the touchscreen.

BROWSE IN SXM

Press the Browse button on the touchscreen to edit Presets, Favorites, Game Zone, and Jump settings, along with providing the SiriusXM® Channel List.

This Screen contains many submenus. You can exit submenus to return to a parent menu by pressing the Back arrow.

All

Press the All button on the Browse Screen. When pressing the All button, the following categories become available:

- **Channel List:** Press the Channel List to display all the SiriusXM® Channel Numbers. You can scroll the Channel List by pressing the Up and Down arrows, located on the right side of the screen. Scrolling can also be done by operating the TUNE/SCROLL knob.
- **Genre List:** Press the Genre button on the touchscreen to display a list of Genres. You can select any desired Genre by pressing the Genre List. The radio tunes to a channel with the content in the selected Genre.

Favorites

Press the Favorites button on the Browse screen.

The Favorites menu provides a means to edit the Favorites list and to configure the Alert Settings, along with providing a list of Channels currently airing any of the items in the Favorites list.

You can scroll the Favorites list by pressing the Up and Down arrows located at the right side of the screen. Scrolling can also be done by operating the TUNE/SCROLL knob as well.

Remove Favorites

Press the Remove Favorites tab at the top of the screen. Press the Delete All button on the touchscreen to delete all of the Favorites or press the Trash Can icon next to the Favorite to be deleted.

Alert Settings

Press the Alert Settings tab at the top of the Favorites screen. The Alert Settings menu allows you to choose from a visual alert or audible and visual alert when one of your favorites is airing on any of the SiriusXM® channels.

Game Zone

Press the Game Zone button, located at the left of the Browse screen. This feature provides you with the ability to select teams, edit the selection, and set alerts.

On-Air

Press the On-Air tab at the top of the screen. The On-Air list provides a list of Channels currently airing any of the items in the Selections list, and pressing any of the items in the list tunes the radio to that channel.

Add/Delete — If Equipped

Press the Add/Delete button on the touchscreen to activate the League Scroll list. Press the chosen league and a scroll list of all teams within the league will appear, then you can select a team by pressing the corresponding box. A check mark appears for all teams that are chosen.

Remove Selection/Trash Can Icon

Press the Remove Selection tab at the top of the screen. Press the Delete All button on the touchscreen to delete all of the selections or press the Trash Can icon next to the selection to be deleted.

Alert Settings

Press the Alert Setting tab at the top of the screen. The Alert Settings menu allows you to choose from “Alert me to on-air games upon start” or “Alert upon score update” or both when one or more of your selections is airing on any of the SiriusXM® channels.

Tune Start

Tune Start begins playing the current song from the beginning when you tune to a music channel using one of the 12 presets. This feature occurs the first time the preset is selected during that current song.

Setting Presets

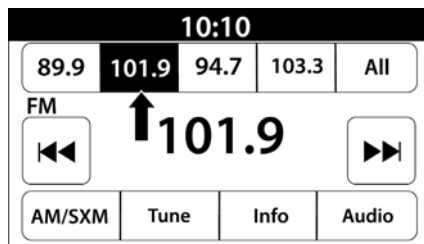

Uconnect 3 With 5-inch Display Radio Presets

The Presets are available for all Radio Modes, and are activated by pressing any of the Preset buttons, located at the top of the screen.

When you are on a station that you wish to save as a preset, press and hold the numbered button on the touchscreen for more than two seconds.

The Radio stores up to 12 presets in each of the Radio Modes.

For the Uconnect 3 With 5-inch Display

A set of four presets will appear on the screen. Press the All button to view all saved presets. To remove a saved preset, a new preset must be saved over the old one.

Audio Settings

Press the Audio button within the settings main menu to activate the Audio Settings screen.



Uconnect 3 With 5-inch Display

Audio Setting	Description
Balance/Fade	Press the Balance/Fade button on the touchscreen to balance audio between the front speakers or fade the audio between the rear and front speakers. Press the Front, Rear, Left or Right button or press and drag the red Speaker icon to adjust the Balance/Fade.
Equalizer	Press the + or - button or press and drag the level bar to increase or decrease each of the equalizer bands. The level value, which spans between plus or minus nine, is displayed at the top of each of the bands.
Speed Adjusted Volume	The Speed Adjusted Volume is adjusted by selecting from "Off", "1", "2", and "3". This alters the automatic adjustment of the audio volume with variation to vehicle speed. Volume increases automatically as speed increases to compensate for normal road noise.
Surround Sound	When Surround Sound is on, you can hear audio coming from every direction as in a movie theatre or home theatre system.
Loudness	When Loudness is on, the sound quality at lower volumes improves.
AUX Volume Offset	The AUX Volume Offset is adjusted by pressing + and - buttons. This alters the AUX input audio volume. The level value, which spans between plus or minus three, is displayed above the adjustment bar.
Radio Off With Door	The Radio Off With Door feature, when activated, keeps the radio on until the driver or passenger door is opened or until the "Radio Off Delay" selected time has expired.

MEDIA MODE

Operating Media Mode

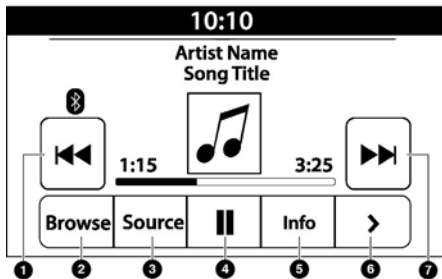

Uconnect 3 With 5-inch Display Operating Media Mode

- 1 — Seek Down ◀◀
- 2 — Browse
- 3 — Source
- 4 — Pause/Play
- 5 — Info
- 6 — More Options
- 7 — Seek Up ▶▶

Media Mode is entered by pushing the MEDIA button located on the faceplate.

Audio Source Selection

Once in Media Mode, press the Source or Source Select button on the touchscreen and the desired mode button on the touchscreen. USB, AUX, and Bluetooth® are the Media sources available. When available, you can select the Browse button on the touchscreen to be given these options:

- Now Playing
- Artists
- Albums
- Genres
- Songs
- Playlists
- Folders

For the Uconnect 3 With 5-inch Display, Media Mode is entered by pushing the MEDIA button located on the faceplate.

Types of Media Modes

USB MODE

Overview

USB Mode is entered by inserting a USB device into the USB port. Another way is by pushing the MEDIA button on the faceplate and then selecting the USB button.

On the Uconnect 3 With 5-inch Display, if you insert a USB device with the ignition in ON/RUN, the unit will switch to USB Mode and begin to play. The display will show the track number and index time in minutes and seconds. Play will begin at the start of track 1.

BLUETOOTH® MODE

Overview

Bluetooth® Streaming Audio or Bluetooth® Mode is entered by pairing a Bluetooth® device, containing music, to the Uconnect system.

Before proceeding, the Bluetooth® device must be paired to the Uconnect Phone to communicate with the Uconnect system.

On the Uconnect 3 With 5-inch Display, push the MEDIA button located on the faceplate. Once in Media Mode, press the Source button on the touchscreen and select the Bluetooth® button ↵ page 238.

To access Bluetooth® Mode, press the Bluetooth® button on the left side of the touchscreen or under the Source Select/Select Source button (if equipped).

AUX MODE

Overview

Auxiliary Mode (AUX) is entered by inserting an AUX device using a cable with a 3.5 mm audio jack into the AUX port. Another way is by pushing the MEDIA button on the faceplate, selecting the Source button and then the AUX button.



To insert an Auxiliary device, gently insert the Auxiliary device cable into the AUX port. If you insert an Auxiliary device with the ignition and the radio on, the unit will switch to AUX Mode and begin to play.

Controlling The Auxiliary Device

Auxiliary Mode (AUX) is entered by inserting an AUX device using a cable with a 3.5 mm audio jack into the AUX port. Another way is by pushing the MEDIA button on the faceplate, selecting the Source button, and then the AUX button.

NOTE:

The radio unit is acting as the amplifier for audio output from the Auxiliary device. Therefore, if the volume control on the Auxiliary device is set too low, there will be insufficient audio signal for the radio unit to play the music on the device.

Seek Up  **/Seek Down** 

In USB Mode, press the Seek Up button on the touchscreen for the next selection on the USB device. Press and release the Seek Down button on the touchscreen to return to the beginning of the current selection, or to return to the beginning of the previous selection if the USB device is within the first three seconds of the current selection.

In Bluetooth® Mode, press and release the Seek Up button on the touchscreen for the next selection on the Bluetooth® device. Press and release the Seek Down button on the touchscreen to return to the beginning of the current selection, or return to the beginning of the previous selection if the Bluetooth® device is within the first second of the current selection.

Browse

In USB Mode, press the Browse button on the touchscreen to display the browse window. In USB Mode, the left side of the browse window displays a list of ways you can browse through the contents of the USB device. If supported by the device, you can browse by Folder, Artist, Playlist, Album, Song, etc. Press the desired button on the touchscreen on the left side of the screen. The center of the browse window shows items and their sub-functions, which can be scrolled through by pressing the Up and Down buttons to the right. The TUNE/SCROLL knob can also be used to scroll.

On the Uconnect 3 With 5-inch Display, rotate the ENTER/BROWSE button on the faceplate or press the Browse button on the touchscreen to scroll through and

select a desired track on the device. Press the Exit button on the touchscreen if you wish to cancel the Browse function.

Media Mode

In USB Mode, press the Media button on the touchscreen to select the desired audio source: USB.

In Bluetooth® Mode, press the Media button on the touchscreen to select the desired audio source: Bluetooth®.

In AUX Mode, press the Media button on the touchscreen to select the desired audio source: AUX.

Repeat

In USB Mode, press the Repeat button on the touchscreen to toggle the repeat functionality. The Repeat button on the touchscreen is highlighted when active. The Radio will continue to play the current track, repeatedly, as long as the repeat is active. Press the Repeat button again to enter Repeat All. The radio will continue to play all the current tracks, repeatedly, as long as the repeat function is active. To cancel Repeat, press the Repeat button a third time.

Shuffle

In USB Mode, press the Shuffle button on the touchscreen to play the selections on the USB device in random order to provide an interesting change of pace. Press the Shuffle button on the touchscreen a second time to turn this feature off.

Audio

Audio settings can be accessed by pressing the Audio button  page 236.

Info

In USB Mode, press the Info button on the touchscreen to display the current track information. Press the Info or X button on the touchscreen a second time to cancel this feature.

Tracks

In USB Mode, press the Tracks button on the touchscreen to display a pop-up with the Song List. The song currently playing is indicated by an arrow and lines above and below the song title. When in the Tracks List screen you can rotate the TUNE/SCROLL knob to highlight a track (indicated by the line above and below the track name) and then push the ENTER/BROWSE knob to start playing that track.

In Bluetooth® Mode, if the Bluetooth® device supports this feature, press the Tracks button on the touchscreen to display a pop-up with the Song List. The currently playing song is indicated by a red arrow and lines above and below the song title.

Pressing the Tracks button on the touchscreen while the pop-up is displayed will close the pop-up.

MEDIA VOICE COMMANDS

Uconnect offers connections via USB, Bluetooth®, and auxiliary (AUX) ports. Voice operation is only available for connected USB and AUX devices.

Push the VR button  located on the steering wheel. After the beep, say one of the following commands and follow the prompts to switch your media source or choose an artist:

- “ **Change source** to Bluetooth®”
- “ **Change source** to AUX”
- “ **Change source** to USB”
- “ **Play artist** Beethoven”; “ **Play album** Greatest Hits”; “ **Play song** Moonlight Sonata”; “ **Play genre** Classical”

Did You Know: Press the Browse button on the touchscreen to see all of the music on your USB device. Your Voice Command must match exactly how the artist, album, song, and genre information is displayed.

PHONE MODE

Overview

Uconnect Phone is a voice-activated, hands-free, in-vehicle communications system. It allows you to dial a phone number with your mobile phone.

The feature supports the following:

Voice Activated Features

- Hands-Free dialing via Voice (“Call John Smith Mobile” or “Dial 248-555-1212”).
- Hands-Free text-to-speech listening of your incoming SMS messages.
- Hands-Free Text Message Replying: Forward one of 18 predefined SMS messages to incoming calls/text messages.
- Redialing last dialed numbers (“Redial”).
- Calling Back the last incoming call number (“Call Back”).
- Viewing call logs on screen (“Show Incoming Calls,” “Show Outgoing Calls,” “Show Missed Calls,” or “Show Recent Calls”).
- Searching Contacts phone number (“Search for John Smith Mobile”).

Screen Activated Features

- Dialing via Keypad using touchscreen.
- Viewing and Calling contacts from Phonebooks displayed on the touchscreen.
- Setting Favorite Contact phone numbers so they are easily accessible on the Main Phone screen.
- Viewing and Calling contacts from Recent Call logs.
- Reviewing your recent Incoming SMS Messages.
- Pairing up to 10 phones/audio devices for easy access to connect to them quickly.

NOTE:

Your phone must be capable of SMS messaging via Bluetooth® for messaging features to work properly.

Your mobile phone’s audio is transmitted through your vehicle’s audio system; the system will automatically mute your radio when using the Uconnect Phone.

For Uconnect customer support:

- US visit UconnectPhone.com or call 877-855-8400
- Canada visit UconnectPhone.com or call 800-465-2001 (English) or (French) call 800-387-9983

Uconnect Phone allows you to transfer calls between the system and your mobile phone as you enter or exit your vehicle and enables you to mute the system’s microphone for private conversation.

WARNING!

ALWAYS drive safely with your hands on the steering wheel. You have full responsibility and assume all risks related to the use of the Uconnect features and applications in this vehicle. Only use Uconnect when it is safe to do so. Failure to do so may result in an accident involving serious injury or death.

The Phone feature is driven through your Bluetooth® “Hands-Free Profile” mobile phone. Uconnect features Bluetooth® technology – the global standard that enables different electronic devices to connect to each other without wires or a docking station. Ensure your phone is turned on with Bluetooth® active and has been paired to the Uconnect system. Up to 10 mobile phones or audio devices are allowed to be linked to the system. Only one linked (or paired) mobile phone and one audio device can be used with the system at a time.

Phone Button



The Phone button on your steering wheel is used to get into the Phone Mode and make calls, show recent, incoming or outgoing calls, view phonebook, etc. When you push the button you will hear a BEEP. The BEEP is your signal to give a command.

Voice Command Button



The Voice Command button on your steering wheel is only used for “barge in” and when you are already in a call or want to make another call.

The button on your steering wheel is also used to access the Voice Commands for the Uconnect Voice Command features if your vehicle is equipped.

Phone Operation

OPERATION

Voice commands can be used to operate the Uconnect Phone and to navigate its menu structure. Voice commands are required after most Uconnect Phone prompts. There are two general methods for how Voice Command works:

1. Say compound commands like “Call John Smith mobile”.
2. Say the individual commands and allow the system to guide you to complete the task.

You will be prompted for a specific command and then guided through the available options.

- Prior to giving a voice command, one must wait for the beep, which follows the “Listen” prompt or another prompt.

- For certain operations, compound commands can be used. For example, instead of saying “Call” and then “John Smith” and then “mobile”, the following compound command can be said: “Call John Smith mobile.”
- For each feature explanation in this section, only the compound command form of the voice command is given. You can also break the commands into parts and say each part of the command when you are asked for it. For example, you can use the compound command form voice command “Search for John Smith,” or you can break the compound command form into two voice commands: “Search Contacts” and when asked, “John Smith.” Please remember, the Uconnect Phone works best when you talk in a normal conversational tone, as if speaking to someone sitting a few feet/meters away from you.

NATURAL SPEECH

Your Uconnect Phone Voice system uses a Natural Language Voice Recognition (VR) engine.

Natural speech allows the user to speak commands in phrases or complete sentences. The system filters out certain non-word utterances and sounds such as “ah” and “eh.” The system handles fill-in words such as “I would like to”.

The system handles multiple inputs in the same phrase or sentence such as “make a phone call” and “to Kelly Smith”. For multiple inputs in the same phrase or sentence, the system identifies the topic or context and provides the associated follow-up prompt such as “Who do you want to call?” in the case where a phone call was requested but the specific name was not recognized.

The system utilizes continuous dialog. When the system requires more information from the user, it will ask a question to which the user can respond without pushing the Voice Command button on the steering wheel.

HELP COMMAND

If you need assistance at any prompt, or if you want to know your options at any prompt, say “Help” following the beep.

To activate the Uconnect Phone from idle, simply push the Phone button (if active) on your steering wheel and say a command or say “Help”. All Phone sessions begin with a push of the VR button or the Phone button.

CANCEL COMMAND

At any prompt, after the beep, you can say “Cancel” and you will be returned to the main menu.

You can also push the VR button or Phone button on your steering wheel when the system is listening for a command and be returned to the main or previous menu.

PAIR (LINK) UCONNECT PHONE TO A MOBILE PHONE

Use this QR code to access your digital experience.



To begin using your Uconnect Phone, you must pair your compatible Bluetooth®-enabled mobile phone. Mobile phone pairing is the process of establishing a wireless connection between a cellular phone and the Uconnect system.

To complete the pairing process, you will need to reference your mobile phone’s manual. Please visit UconnectPhone.com for complete mobile phone compatibility information.

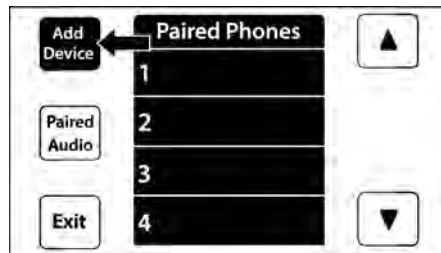

Uconnect 3 With 5-inch Display

NOTE:

- You must have Bluetooth® enabled on your phone to complete this procedure.
 - The vehicle must be in PARK or at a standstill.
- Follow these steps to pair your phone:

1. Place the ignition in the ACC or ON/RUN position.
2. Press the Phone button.

NOTE:

- If there are no phones currently connected with the system, a pop-up will appear asking if you would like to pair a mobile phone.
 - This pop-up only appears when the user enters Phone Mode and no other device(s) have previously been paired. If the system has a phone previously paired, even if no phone is currently connected with the system, this pop-up will not appear.
3. Select “Yes” to begin the pairing process.

4. Search for available devices on your Bluetooth®-enabled mobile phone.
 - Press the Settings button on your mobile phone.
 - Select “Bluetooth®” and ensure it is enabled. Once enabled, the mobile phone will begin to search for Bluetooth® connections.

NOTE:

During the pairing procedure, you may receive a pop-up on your touchscreen asking you to make sure the PIN on the touchscreen matches the PIN from the pop-up on your mobile phone.

5. If “No” is selected, and you still would like to pair a mobile phone, press the Phone Pairing or Settings button from the Uconnect Phone main screen.
 - Press the Paired Phones button or the Add Device button.
 - Search for available devices on your Bluetooth®-enabled mobile phone. When prompted on the phone, select “Uconnect” and accept the connection request.
6. Uconnect Phone will display an in-progress screen while the system is connecting.
7. When your mobile phone finds the Uconnect system, select “Uconnect.”
8. When prompted on the mobile phone, accept the connection request from Uconnect.
9. When the pairing process has successfully completed, the system will prompt you to choose whether or not this is your favorite phone. Selecting “Yes” will make this phone the highest priority. This phone will take precedence over other paired phones within range and will connect to the Uconnect system automatically when entering the

vehicle. Only one mobile phone and/or one Bluetooth® audio device can be connected to the Uconnect system at a time. If “No” is selected, simply select “Uconnect” from the mobile phone/audio device Bluetooth® screen, and the Uconnect system will reconnect to the Bluetooth® device.

NOTE:

For phones which are not made a favorite, the phone priority is determined by the order in which it was paired. The most recent phone paired will have the higher priority.

NOTE:

During the pairing procedure, you may receive a pop-up on your mobile phone for the Uconnect system to access your “messages” and “contacts”. Selecting “Ok” or “Allow” will sync your contacts with the Uconnect system.

You can also use the VR command “Show Paired Phones” to bring up the Paired Phone screen from any screen on the radio.

NOTE:

Software updates on your phone or the Uconnect system may interfere with the Bluetooth® connection. If this happens, simply repeat the pairing process. However, first make sure to delete the device from the list of phones on your Uconnect system. Next, be sure to remove Uconnect from the list of devices in your phone’s Bluetooth® settings.

CONNECTING TO A PARTICULAR MOBILE PHONE OR AUDIO DEVICE AFTER PAIRING

Uconnect Phone will automatically connect to the highest priority paired phone and/or Audio Device within range. If you need to choose a particular phone or audio device follow these steps:

1. Press the Settings button on the touchscreen.
2. Press the Paired Phones or Audio Sources button.
3. Press to select the particular phone or the particular audio device. A pop-up menu will appear; press “Connect Phone”.
4. Press the X to exit out of the Settings screen.

DISCONNECTING OR DELETING A PHONE OR AUDIO DEVICE

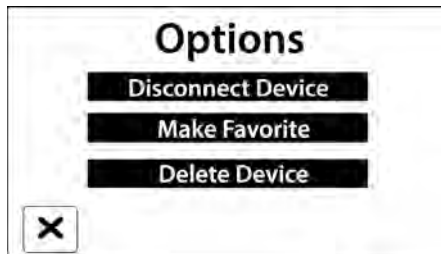

Uconnect 3 With 5-inch Display

1. Press the Uconnect Phone Pairing or Settings button.
2. Press the Paired Phones or Audio Sources button.
3. Press the Settings button located to the right of the device name for a different phone or audio device than the currently connected device or press the preferred Connected Phone from the list.
4. The option’s pop-up will be displayed.

5. Press the Disconnect Device or the Delete Device button on the touchscreen.
6. Press the X to exit out of the Settings screen.

MAKING A PHONE OR AUDIO DEVICE A FAVORITE

1. On the Paired Phone/Audio Sources screen, press the Settings button located to the right of the device name for a different phone or audio device than the currently connected device or press the preferred “Connected Phone” from the list.
2. The option’s pop-up will be displayed.
3. Press the Make Favorite button on the touchscreen; you will see the chosen device move to the top of the list.
4. Press the X to exit out of the Settings screen.

PHONEBOOK DOWNLOAD (AUTOMATIC PHONEBOOK TRANSFER FROM MOBILE PHONE) — IF EQUIPPED

If supported by your phone, Uconnect Phone has the ability to download contact names and number entries from the mobile phone’s phonebook. Specific Bluetooth® Phones with Phonebook Access Profile may support this feature. Your mobile phone may receive a pop-up asking for permission for the Uconnect system to access your messages and contacts. Selecting “Ok” or “Allow” will sync your contacts with the Uconnect system.

See the Uconnect website, UconnectPhone.com, for supported phones.

- To call a name from a downloaded mobile phonebook ↩ page 242.
- Automatic download and update of a phonebook, if supported, begins as soon as the Bluetooth® wireless phone connection is made to the Uconnect Phone, for example, after you start the vehicle.
- A maximum of 5,000 contact names with four numbers per contact will be downloaded and updated every time a phone is connected to the Uconnect Phone.
- Depending on the maximum number of entries downloaded, there may be a short delay before the latest downloaded names can be used. Until then, if available, the previously downloaded phonebook is available for use.
- Only the phonebook of the currently connected mobile phone is accessible.
- This downloaded phonebook cannot be edited or deleted on the Uconnect Phone. These can only be edited on the mobile phone. The changes are transferred and updated to Uconnect Phone on the next phone connection.

MANAGING YOUR FAVORITES — IF EQUIPPED

There are two ways you can add an entry to your favorites:

1. After loading the mobile phonebook, press the Favorites button on the touchscreen, and then press one of the +Add Favorite Contact buttons that appears on the list.
2. After loading the mobile phonebook, select “Contacts” from the Phone main screen, and then select the appropriate number. Press the Down Arrow button or the Settings Gear button next to the selected number to display the option’s pop-up. In the pop-up, select “Add to Favorites”.

NOTE:

If the Favorites list is full, you will be asked to remove an existing favorite.

TO REMOVE A FAVORITE — IF EQUIPPED

1. To remove a Favorite, select “Favorites” from the Phone main screen.
2. Next, select the Down Arrow icon or the Settings Gear icon next to the contact you want to remove from your favorites. This will bring up the options for that Favorite contact.
3. Deselect the Star icon to delete the Favorite.

Phone Call Features

The following features can be accessed through the Uconnect Phone if the feature(s) are available and supported by Bluetooth® on your mobile service plan. For example, if your mobile service plan provides three-way calling, this feature can be accessed through the Uconnect Phone. Check with your mobile service provider for the features that you have.

Here are the phone options with Uconnect:

- Redial
- Dial by pressing in the number
- Voice Commands (Dial by Saying a Name, Call by Saying a Phonebook Name, Redial or Call Back)
- Favorites
- Mobile Phonebook
- Recent Call Log
- SMS Message Viewer

CALL CONTROLS

The touchscreen allows you to control the following call features:



Uconnect 3 With 5-inch Display

- 1 – Answer
- 2 – Mute/Unmute
- 3 – Ignore
- 4 – Transfer

Other phone call features include:

- End Call
- Hold/Unhold/Resume
- Swap two active calls

KEY PAD NUMBER ENTRY

1. Press the Phone button.
2. Press the Dial/Keypad button on the touchscreen.
3. The Touch-Tone screen will be displayed.
4. Use the numbered buttons on the touchscreens to enter the number and press “Dial/Call”.

RECENT CALLS — IF EQUIPPED

You may browse a list of the most recent of each of the following call types:

- All Calls
- Incoming Calls or Calls Received
- Outgoing Calls or Calls Made
- Missed Calls

These can be accessed by pressing the Recent Calls button on the phone main screen.

You can also push the VR button on your steering wheel and perform the operation. For example, say “Show my incoming calls”.

ANSWER OR IGNORE AN INCOMING CALL — NO CALL CURRENTLY IN PROGRESS

When you receive a call on your mobile phone, the Uconnect Phone will interrupt the vehicle audio system. Push the Phone button on the steering wheel, press the Answer button on the touchscreen.



Uconnect 3 With 5-inch Display

- 1 – Answer Button
- 2 – Caller ID Box

ANSWER OR IGNORE AN INCOMING CALL — CALL CURRENTLY IN PROGRESS

If a call is currently in progress and you have another incoming call, you will hear the same network tones for call waiting that you normally hear when using your mobile phone. Push the Phone button on the steering wheel, press the Answer button on the touchscreen, or press the Caller ID box to place the current call on hold and answer the incoming call.

NOTE:

Phones that are compatible with the Uconnect system in the market today do not support rejecting an incoming call when another call is in progress. Therefore, the user can only answer an incoming call or ignore it.

DO NOT DISTURB

With Do Not Disturb, you can disable notifications from incoming calls and texts, allowing you to keep your eyes on the road and hands on the wheel. For your convenience, there is a counter display to keep track of your missed calls and text messages while Do Not Disturb is active.

Do Not Disturb can automatically reply with a text message, a call, or both when declining an incoming call and send it to voicemail.

Automatic reply messages can be:

- “I am driving right now, I will get back to you shortly”.
- Create a custom auto reply message up to 160 characters.

NOTE:

Only the first 25 characters can be seen on the touchscreen while typing a custom message.

While in Do Not Disturb, “Conference Call” can be selected so you can still place a second call without being interrupted by incoming calls.

NOTE:

- Reply with text message is not compatible with iPhone® devices.
- Auto reply with text message is only available on phones that support Bluetooth® Message Access Profile (MAP).

PLACE/RETRIEVE A CALL FROM HOLD

During an active call, press the Hold or Call On Hold button on the Phone main screen.

MAKING A SECOND CALL WHILE CURRENT CALL IS IN PROGRESS

You can place a call on hold by pressing the Hold button on the Phone main screen, then dial a number from the keypad (if supported by your mobile phone), recent calls, SMS Inbox or from the phonebooks.

TOGGLING BETWEEN CALLS



Uconnect 3 With 5-inch Display

If two calls are in progress (one active and one on hold), press the Swap Calls button on the phone main screen. Only one call can be placed on hold at a time.

You can also push the Phone button to toggle between the active and held phone call.

JOIN CALLS

When two calls are in progress (one active and one on hold), press the Join/Merge Calls button on the Phone main screen to combine all calls into a conference call.

CALL TERMINATION

To end a call in progress, momentarily press the End Call button on the touchscreen or the Phone End button on the steering wheel. Only the active call(s) will be terminated and if there is a call on hold, it will become the new active call.

REDIAL



Push the VR button and after the “Listening” prompt and the following beep, say “Redial.” The Uconnect Phone will call the last number that was dialed from your mobile phone.

CALL CONTINUATION

Call continuation is the progression of a phone call on the Uconnect Phone after the vehicle ignition has been switched to OFF.

NOTE:

The call will remain within the vehicle audio system until the phone becomes out of range for the Bluetooth® connection. It is recommended to press the Transfer button on the touchscreen when leaving the vehicle.

Advanced Phone Connectivity

TRANSFER CALL TO AND FROM MOBILE PHONE

The Uconnect Phone allows ongoing calls to be transferred from your mobile phone without terminating the call. To transfer an ongoing call from your connected mobile phone to the Uconnect Phone or vice versa, press the Transfer button on the Phone main screen.

Things You Should Know About Uconnect Phone

VOICE COMMAND

For the best performance:

- Always wait for the beep before speaking
- Speak normally, without pausing, just as you would speak to a person sitting a few feet/meters away from you
- Ensure that no one other than you is speaking during a voice command period
- Low-To-Medium Blower Setting
- Low-To-Medium Vehicle Speed
- Low Road Noise
- Smooth Road Surface
- Fully Closed Windows
- Dry Weather Conditions

WARNING!

ALWAYS drive safely with your hands on the wheel. You have full responsibility and assume all risks related to the use of the Uconnect features and applications in this vehicle. Only use Uconnect when it is safe to do so. Failure to do so may result in an accident involving serious injury or death.

Even though the system is designed for many languages and accents, the system may not always work for some.

NOTE:

It is recommended that you do not store names in your Favorites phonebook while the vehicle is in motion.

Number and name recognition rate is optimized when the entries are not similar. You can say "0" (letter "O") for "0" (zero).

Even though international dialing for most number combinations is supported, some shortcut dialing number combinations may not be supported.

Audio Performance

Audio quality is maximized under:

- Low-To-Medium Blower Setting
- Low-To-Medium Vehicle Speed
- Low Road Noise
- Smooth Road Surface
- Fully Closed Windows
- Dry Weather Conditions
- Operation From The Driver's Seat

Performance such as audio clarity, echo, and loudness to a large degree rely on the phone and network, and not the Uconnect Phone.

Echo at the far end can sometimes be reduced by lowering the in-vehicle audio volume.

Phone Voice Commands

Making and answering hands-free phone calls is easy with Uconnect. When the Phonebook button is illuminated on your touchscreen, your system is ready. Check UconnectPhone.com for mobile phone compatibility and pairing instructions.



Push the Phone button  and wait for the beep to say a command. Here are some examples:

- " **Call** John Smith"
- " **Dial** 123 456 7890"

- " **Redial**" (call previous outgoing phone number)
- " **Call back**" (call previously answered incoming phone number)

Did You Know: When providing a Voice Command, push the Phone button  and say " **Call**", then pronounce the name **exactly** as it appears in your phonebook. When a contact has multiple phone numbers, you can say " **Call** John Smith **work**".

Voice Text Reply — If Equipped

Uconnect can announce **incoming** text messages. Push the VR button  or Phone button  and say:

1. " **Listen**" to have the system read an incoming text message. (Must have compatible mobile phone paired to Uconnect system.)
2. " **Reply**" after an incoming text message has been read.

Listen to the Uconnect prompts. After the beep, repeat one of the predefined messages and follow the system prompts.

PRE-DEFINED VOICE TEXT REPLY RESPONSES

Yes.	Stuck in traffic.	See you later.
No.	Start without me.	I'll be late.
Okay.	Where are you?	I will be 5 <or 10, 15, 20, 25, 30, 45, 60> minutes late.
Call me.	Are you there yet?	
I'll call you later.	I need directions.	See you in 5 <or 10, 15, 20, 25, 30, 45, 60> minutes.
I'm on my way.	Can't talk right now.	
I'm lost.		Thanks.

NOTE:

Only use the numbering listed in the provided table. Otherwise, the system will not transpose the message.

Did You Know: Your mobile phone must have the full implementation of the **Message Access Profile (MAP)** to take advantage of this feature. For details about MAP, visit UconnectPhone.com.

Apple® iPhone® iOS 5 or later supports reading **incoming** text messages only. For further information on how to enable this feature on your Apple® iPhone®, refer to your iPhone® “User Manual”.

Did You Know: Voice Text Reply is not compatible with iPhone®, but if your vehicle is equipped with Siri® Eyes Free, you can use your voice to send a text message.

Siri® Eyes Free — If Equipped

When used with your Apple® iPhone® connected to your vehicle via Bluetooth®, Siri lets you use your voice to send text messages, select media, place phone calls and much more. Siri uses your natural language to understand what you mean and responds back to confirm your requests. The system is designed to keep your eyes on the road and your hands on the wheel by letting Siri help you perform useful tasks.

To enable Siri, push and hold, then release the Uconnect Voice Recognition (VR) button on the steering wheel. After you hear a double beep, you can ask Siri to play podcasts and music, get directions, read text messages, and many other useful requests.

BLUETOOTH® COMMUNICATION LINK

Mobile phones may lose connection to the Uconnect Phone. When this happens, the connection can generally be re-established by restarting the mobile phone. Your mobile phone is recommended to remain in Bluetooth® ON Mode.

POWER-UP

After switching the ignition key from OFF to either the ON/RUN or ACC position, or after a language change, you must wait at least 15 seconds prior to using the system ↪ page 404.

**CONNECTED VEHICLE SERVICES —
IF EQUIPPED****IS MY VEHICLE CONNECTED?**

If equipped, vehicles with an ASSIST and an SOS button are connected vehicles. These buttons will be located on either the rearview mirror or overhead console, depending on the vehicle. If these buttons are present in your vehicle, you have a connected radio and can take advantage of the many connected vehicle features.

For further information about the ASSIST and SOS buttons ↪ page 314.

**INTRODUCTION TO CONNECTED
VEHICLE SERVICES**

One of the many benefits of your vehicle's Uconnect system is that you can now take advantage of SiriusXM Guardian™ connected services. To unlock the full potential of SiriusXM Guardian™ in your vehicle, you first need to activate SiriusXM Guardian™ connected services.

WARNING!

ALWAYS obey traffic laws and pay attention to the road. Your complete attention is always required while driving to maintain safe control of your vehicle. Only use and interact with the features and applications when it is safe to do so. Failure to follow these warnings can result in a collision and death or serious personal injury.

NOTE:

SiriusXM Guardian™ involves the collection, transmission and use of data from your vehicle ↪ page 258.

**SiriusXM Guardian™ Contact
Information****SiriusXM Guardian™/Care**

- US residents visit: <https://www.driveuconnect.com/sirius-xm-guardian.html> or call 1-844-796-4827
- Canadian residents visit: <https://www.driveuconnect.ca/en/sirius-xm-guardian> or call 1-877-324-9091

What Is SiriusXM Guardian™?

SiriusXM Guardian™ uses an embedded device in the Uconnect system installed in your vehicle, which receives GPS signals and communicates with the SiriusXM Guardian™ Customer Care center via wireless and landline communications networks. Depending on the type of device in your vehicle, some SiriusXM Guardian™ connected services require an operable LTE (voice/data) or 4G (data) network compatible with your device. SiriusXM Guardian™ is available only on equipped vehicles purchased within the continental United States, Alaska, Hawaii, Puerto Rico and Canada.

NOTE:

- Certain SiriusXM Guardian™ connected services are dependent upon an operative telematics device, a cellular connection, navigation map data, and GPS satellite signal reception, which can limit the ability to reach the response center or reach emergency support.
- Not all features of SiriusXM Guardian™ are available everywhere at all times, particularly in remote or enclosed areas.
- Other factors outside the control of SiriusXM Guardian™ that may limit or prevent service delivery are hills, structures, buildings, tunnels, weather, damage to the electrical system or other important parts of your vehicle, network congestion, civil disturbances, actions of third parties or the government, Internet failure, and/or the physical location of your vehicle, such as in an underground parking structure or under a bridge.

Not all SiriusXM Guardian™ features are available for all models.

SiriusXM Guardian™ provides:

- The ability to remotely lock/unlock and remote start your vehicle from virtually anywhere by using the Vehicle Branded App or your computer.
- If equipped — Send & Go capability with the Vehicle Branded App. Use the Vehicle Branded App to easily search, map and send your locations directly to your Uconnect Navigation.
- The ability to locate your vehicle, when you forget where you parked, using the Vehicle Finder function of the Vehicle Branded App.

Before you drive, familiarize yourself with the easy-to-use Uconnect system and SiriusXM Guardian™ connected services.

The ASSIST and SOS Call Buttons On Your Rearview Mirror Or Overhead Console

If equipped, the ASSIST Button is used for contacting Roadside Assistance, Vehicle Care, Uconnect Care, and SiriusXM Guardian™ Customer Care. The SOS Call button connects you directly to SiriusXM Guardian™ Customer Care for assistance in an emergency.

Activation — If Equipped

To unlock the full potential of SiriusXM Guardian™ in your vehicle, you must activate your SiriusXM Guardian™ connected services.

1. Press the Apps icon on the bottom of your in-vehicle touchscreen.
2. Select the Activate Services icon from your list of apps.
3. **For customers in the United States**, select “Customer Care” to speak with a SiriusXM Guardian™ Customer Care agent who will activate services in your vehicle, or select “Enter Email” to activate on the web.

For customers in Canada, enter your email address to activate services in your vehicle.

Included Trial Period For New Vehicles

Your new vehicle may come with an included trial* period for use of SiriusXM Guardian™ connected services starting on the date of vehicle purchase. To get started with your trial, enrollment in SiriusXM Guardian™ is required.

* Included trial applies to new vehicles only.

Features And Packages

After the trial period, you must purchase a subscription to continue your services by calling a SiriusXM Guardian™ Customer Care agent.

GETTING STARTED WITH CONNECTED VEHICLE SERVICES

Download The Vehicle Branded App

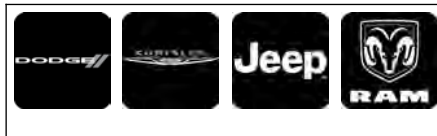

Once you have activated your services, you're only a few steps away from using connected services.

- Download the Vehicle Branded App to your mobile device.
- Use your Owner Account login and password to open the app and then set up a PIN.



- For customers in the United States, if your vehicle is not registered at the dealership, you will have to call the Customer Care call center from inside your vehicle or press the in-vehicle registration button. From there, you will be able to register your vehicle and add your vehicle's VIN to your account.
- For customers in Canada, register your account via your vehicle.
 - a. Press the Apps button in the bottom menu bar.
 - b. Press the Activate Services button from the apps list.
 - c. Enter your email and press "OK". A confirmation email will be sent to the provided email address.
 - d. Press "Continue Activation" from the confirmation email. It may take a short time before remote services will be available, but you will be able to log into the Vehicle Branded App and the Owner's Site.
- Once on the Remote screen and you have set up your four-digit PIN, you can begin using Remote Door Lock/Unlock, Remote Vehicle Start, and activate your horn and lights remotely, if equipped.
- Press the Location button on the bottom menu bar of the app to bring up a map to locate your vehicle or send a location to your Mobile Navigation, if equipped.
- Press the Settings side menu in the upper left corner of the app to bring up app settings and access the Assist Call Centers.

Using Your Owner's Site

Your Owner's Site website

<https://www.mopar.com/en-us.html> (US Residents), or www.mopar.ca (Canadian Residents) provides you with all the information you need, all in one place. You can track your service history, find recommended accessories for your vehicle, watch videos about your vehicle's features, and easily access your manuals. It is also where you can manage your SiriusXM Guardian™ account. This section will familiarize you with the key elements of the website that will help you get the most of your SiriusXM Guardian™ connected services.

For customers in the United States, press the Sign In/Register button and enter your email address and password.

For customers in Canada, press the My Vehicle button. Select from "Dashboard", "Vehicle Health Report", and "Recalls". The website will then prompt you to log in using your email address and password.

- **Edit/Edit Profile:**

To manage the details of your SiriusXM Guardian™ account, such as your contact information, password and SiriusXM Guardian™ PIN, click on the Edit/Edit Profile button to access the details of your account.

- **Connected Services Status:**

This statement will indicate your SiriusXM Guardian™-equipped vehicle.

- **Remote Commands:**

For vehicles with an active SiriusXM Guardian™ subscription, press one of these icons and enter your four-digit SiriusXM Guardian™ Security PIN to remotely start (if equipped), lock/unlock doors or sound the horn and flash the lights.

Editing Your Notifications

Notifications are an important element of your SiriusXM Guardian™ account. For example, any time you use your remote services (such as Remote Door Unlock), you can elect to receive a text message, push notification, and/or E-mail to notify you of the event. To set up the notifications, please follow these instructions.

1. Log on to your Owner's Account at <https://www.mopar.com/en-us.html> (US Residents) and select "Dashboard", or www.mopar.ca (Canadian Residents), select "My Vehicle" and then "Dashboard".
2. Click the Edit/Edit Profile button.
3. Once there, select "SiriusXM Guardian™" where you can edit Notification Preferences.
4. You can enter a mobile phone and/or email address to notify you, and you can customize the types of messages.

USING SIRIUSXM GUARDIAN™

SOS Call — If Equipped

WARNING!

Some SiriusXM Guardian™ connected services, including SOS Call and Roadside Assistance Call, will NOT work without a network connection compatible with your device.

Access To Emergency Services At The Push Of A Button

Center Light Status	Description
Off	No call activated
Green	Active call in progress
Red	System error

SiriusXM Guardian™ In-Vehicle Assistance Features

With SiriusXM Guardian™, your vehicle has onboard assistance features located on the rearview mirror or overhead console designed to enhance your driving experience if you should ever need assistance or support.

Description

SOS Call offers a convenient way to get in contact with a SiriusXM Guardian™ Customer Care agent in the event of an emergency. When the connection between the vehicle and the live agent is made, your vehicle will automatically transmit location information. In the event of a minor collision, medical or any other emergency, press the SOS button to be connected to a call center agent who can send emergency assistance to your vehicle's location.

NOTE:

Certain SiriusXM Guardian™ connected services are dependent on an operational Uconnect system, cellular network availability that is compatible with the device in your vehicle, and GPS network availability. Not all features of SiriusXM Guardian™ are available everywhere at all times, particularly in remote or enclosed areas.

How It Works

1. Push the SOS Call button; the indicator light will turn green indicating a call has been placed.

NOTE:

- In case the SOS Call button is accidentally pushed, there is a 10-second delay before the SOS call is placed. The system will verbally alert you that a call is about to be made. To cancel the SOS Call connection, push the SOS Call button on the rearview mirror or overhead console or press the Cancel button on the touchscreen within 10 seconds.
 - During an SOS Call, the Bluetooth®-paired phone is disconnected so incoming or outgoing calls will go through your mobile device versus the hands-free system which is not available due to the SOS Call.
2. Once a connection between the vehicle and a SiriusXM Guardian™ Customer Care agent is made, the agent will stay on the line with you.

NOTE:

Calls between the vehicle occupants and the SiriusXM Guardian™ Customer Care center may be recorded or monitored for quality assurance purposes. Through your enrollment in and use of the SiriusXM Guardian™ connected services, you consent to being recorded.

SOS Call System Limitations

Vehicles that have been purchased in the US and that travel into Mexico and Canada may have limited services. In particular, responses to SOS calls or other emergency services may be unavailable or very limited. Vehicles purchased outside the United States and Canada are unable to receive SiriusXM Guardian™ connected services.

If the SOS Call system detects a malfunction, any of the following may occur at the time the malfunction is detected:

- The light will continuously be illuminated red.
- The screen will display the following message "Vehicle phone requires service. Please contact your dealer."
- An in-vehicle audio message will state "Vehicle phone requires service. Please contact your dealer."

Even if the SOS Call system is fully functional, factors beyond FCA US LLC's control may prevent or stop SOS Call system operation. These include, but are not limited to, the following factors:

- The ignition key is in OFF position.
- The vehicle's electrical systems are not intact.
- The vehicle battery loses power or becomes disconnected during a vehicle crash.
- The SOS Call system software and/or hardware is damaged during a vehicle crash.
- LTE (voice/data) or 4G (data) coverage and/or GPS signals are unavailable or obstructed.
- Network congestion.
- Weather conditions.
- Buildings, structures, geographic terrain, or tunnels.

If your vehicle loses battery power for any reason (including during or after an accident), the SOS Call system, among other vehicle systems, will not operate.

Requirements

- This feature is available only on vehicles sold in the US or Canada.
- Vehicle must be properly equipped with the SiriusXM Guardian™ connected services. Vehicle must be registered with SiriusXM Guardian™ and have an active subscription that includes the applicable feature.

- Vehicle must have an operable LTE (voice/data) or 4G (data) network connection compatible with your device.
- Vehicle must be powered in the ON/RUN or ACC (Accessory) position with a properly functioning electrical system.

WARNING!

- Never place anything on or near the vehicle's LTE (voice/data) or 4G (data) and GPS antennas. You could prevent LTE (voice/data) or 4G (data) and GPS signal reception, which can prevent your vehicle from placing an emergency call.
- Do not add any aftermarket electrical equipment to the vehicle's electrical system. This may prevent your vehicle from sending a signal to initiate an emergency call. To avoid interference that can cause the SOS Call system to fail, never add aftermarket equipment (e.g., two-way mobile radio, CB radio, data recorder, etc.) to your vehicle's electrical system or modify the antennas on your vehicle. IF YOUR VEHICLE LOSES POWER FOR ANY REASON (INCLUDING DURING OR AFTER AN ACCIDENT), NEITHER THE VEHICLE BRANDED APPS NOR THE SIRIUSXM GUARDIAN™ CONNECTED SERVICES WILL OPERATE.
- The Occupant Restraint Controller (ORC) turns on the Air Bag Warning Light on the instrument panel if a malfunction in any part of the air bag system is detected. If the Air Bag Warning Light is illuminated, the air bag system may not be working properly and the SOS Call system may not be able to send a signal to the SiriusXM Guardian™ Customer Care center. If the Air Bag Warning Light is illuminated, have an authorized dealer service your vehicle immediately.

*(Continued)***WARNING!**

- Ignoring the Rearview Mirror Light could mean you will not have SOS Call services if needed. If the Rearview Mirror Light is illuminated, have an authorized dealer service the SOS Call system immediately.
- If anyone in the vehicle could be in danger (e.g., fire or smoke is visible, dangerous road conditions or location), do not wait for voice contact from a SiriusXM Guardian™ Customer Care agent. All occupants should exit the vehicle immediately and move to a safe location.
- Failure to perform scheduled maintenance and regular inspection of your vehicle may result in vehicle damage, accident or injury.

Automatic SOS — If Equipped

Automatic SOS is a hands-free safety service that can immediately connect you with help in the event that your vehicle's airbags deploy. After an accident, a live agent will contact you through the Uconnect system and alert emergency services.

NOTE:

An active SiriusXM Guardian™ subscription is required for this feature to function.

After a crash where the airbags deploy:

1. Automatic SOS will initiate a call with an agent.
2. An agent will receive the call and confirm the location of the emergency.
3. If needed, the agent will request the assistance of emergency services.
4. First responders will arrive on scene. The agent will remain on the call until emergency services arrive.

NOTE:

- Agents are available 24/7 to assist you in the case of an emergency.
- On your behalf, agents are able to notify family members about the collision.
- Agents can brief first responders of the situation before they arrive on scene.
- In the event vehicle occupants are unable to speak, emergency services will be dispatched based on the last known GPS coordinates.
- SiriusXM Guardian™ connected services are dependent upon an operative telematics device, a cellular connection, navigation map data, and GPS satellite reception, which can limit the ability to reach the response center or reach emergency support.
- Terms of service of the Uconnect and the SiriusXM Guardian™ subscriber agreement apply. See terms of services for complete service limitation.

Remote Commands

On the Remote Commands screen, you have access to several vehicle features that can be controlled remotely from your mobile device. These features include locking/unlocking, remote starting, and activating the horn and lights of the vehicle.

Lock	Press this button to lock your vehicle.
Vehicle Start	Press this button to start your vehicle.
Horn & Lights	Press this button to sound the horn and activate your lights.
Unlock	Press this button to unlock your vehicle.
Cancel Vehicle Start	Press this button to cancel remote start.

Remote Commands lets you send a request to your vehicle in one of three ways:

- Anywhere using your mobile device and Vehicle Branded App
- From your computer on the Owner's Site (not available on all functions)
- Contacting SiriusXM Guardian™ Customer Care (not available on all functions)

Using A Remote Command Through Your Mobile Device And The Vehicle Branded App

1. Press the desired Remote Command icon on your mobile device.
2. A pop-up screen will appear asking for your SiriusXM Guardian™ Security PIN (this is the same four-digit code established when you activated your SiriusXM Guardian™ connected services). Enter the SiriusXM Guardian™ Security PIN on the keypad.
3. It may take 30 seconds or more for the command to go through to your vehicle.
4. A message will let you know if the command was received by your vehicle.

Using A Remote Command Through Your Owner's Site

1. Log on to your Owner's Site using the username and password you used when activating your SiriusXM Guardian™ connected services in your vehicle.

NOTE:

If you forgot your username or password, links are provided on the website to help you retrieve them.

2. If you have more than one vehicle registered into your Owner's Site, select the vehicle you want to send the command to by clicking on its image along the top.

3. On your dashboard, you will see remote commands. Press the desired icon to activate that feature.
4. You will then be asked to enter your SiriusXM Guardian™ Security PIN (this is the same four-digit code established when you activated your SiriusXM Guardian™ connected services). Please enter your SiriusXM Guardian™ Security PIN.
5. A message will appear on the screen to let you know if the command was received by your vehicle.

Contacting SiriusXM Guardian™ Customer Care (for example, in case of an accidental lock-out):

1. Contact SiriusXM Guardian™ Customer Care if you are unable to lock your vehicle through the Vehicle Branded App or your key fob.
2. For security purposes, the SiriusXM Guardian™ Customer Care agent will verify your identity by asking for your four-digit SiriusXM Guardian™ Security PIN.
3. After providing your SiriusXM Guardian™ Security PIN, you can ask them to perform a remote command.

NOTE:

Anyone with access to your PIN may request Remote Door Lock/Unlock. It is your responsibility to protect your PIN appropriately.

Remote Door Lock/Unlock

Description

The Remote Door Lock/Unlock feature provides you the ability to lock or unlock the door on your vehicle without the keys and from virtually any distance.

Working Vehicle Conditions

- The vehicle must be in PARK or at a standstill.
- The vehicle must be in an open area with cell tower reception.
- Your mobile device must have a cellular or Wi-Fi connection.

Requirements

- Vehicle must be properly equipped with SiriusXM Guardian™.
- Vehicle must have an operable LTE (voice/data) or 4G (data) network connection. If using the Vehicle Branded App to command your vehicle, your device must be compatible and be connected to an operable LTE (voice/data) or 4G (data) network connection.
- Vehicle must be registered with SiriusXM Guardian™ and have an active subscription that includes the applicable feature.
- An ignition cycle is required for some remote commands, such as Remote Vehicle Start and Remote Door Lock/Unlock if following a Remote Horn & Lights activation.
- Your Remote Door Lock/Unlock request will not be processed if the vehicle is in motion, the ignition key is on or during an emergency call.

NOTE:

All other remote services should be performed via your Owner's Site or through the Vehicle Branded App on your compatible device.

Remote Vehicle Start

Description

The Remote Vehicle Start feature provides you with the ability to start the engine on your vehicle without the keys and from virtually any distance. Once started, the preset climate controls in your vehicle can warm up or cool down the interior.

You can also send a command to turn off an engine that has been started using Remote Vehicle Start. After 15 minutes, if you have not entered your vehicle with the key, the engine will shut off automatically.

This remote function requires your vehicle to be equipped with a factory-installed Remote Start system.

You can set up push notifications every time a command is sent to activate or cancel Remote Start.

Working Vehicle Conditions

- The vehicle must be off or in ACC mode.
- The vehicle has been started with the key fob within the last 14 days.
- The vehicle must be in PARK or at a standstill.
- The vehicle's security system has been armed and not triggered since the last vehicle start.
- The doors, hood, and trunk/liftgate are closed.
- The vehicle's check engine light must be off.
- The vehicle must have at least a quarter tank of fuel, along with oil and battery power.
- The vehicle's hazard lights must be off.
- If equipped, the vehicle must have an automatic transmission.
- The vehicle must be in an open area with cell tower reception.

- Your mobile device must have a cellular or Wi-Fi connection.
- If the Panic button has been pressed, the vehicle must be started at least once after alarming the system.

NOTE:

The SiriusXM Guardian™ Customer Care agents are not authorized for Remote Vehicle Start services. Contact the Uconnect Care Team for assistance.

Remote Horn & Lights

Description

It is easy to locate a vehicle in a dark, crowded or noisy parking area by activating the horn and lights. It may also help if you need to draw attention to your vehicle for any reason.

If you want, you can set up push notifications every time a command is sent to turn on the horn and lights.

Working Vehicle Conditions

- The vehicle must be in PARK or at a standstill.
- The vehicle must be in an open area with cell tower reception.
- Your mobile device must have a cellular or Wi-Fi connection.

NOTE:

The Remote Horn & Lights feature is designed to be loud and get noticed. Please keep in mind the surroundings when using this feature. You are responsible for compliance with local laws, rules and ordinances in the location of your vehicle when using Remote Horn & Lights.

Assist — If Equipped

Description

Vehicles equipped with the SiriusXM Guardian™ connected services feature may contain an ASSIST button in the vehicle. Once your SiriusXM Guardian™ connected services have been activated, the ASSIST button can connect you directly to the Customer Care call center (if equipped). You will be directed to one of the following four services:

- **Roadside Assistance** — If you get a flat tire or need a tow, you'll be connected to someone who can help anytime.
- **Connected Services** — Contact the SiriusXM Guardian™ Customer Care call center to activate your services, renew after your trial has expired, for in-vehicle support for your SiriusXM Guardian™ connected services, or help answering any general questions surrounding your connected services.
- **Uconnect Care** — In-vehicle support for all non-connected Uconnect system features, such as radio and Bluetooth® connections.
- **Vehicle Care** — Total support for your vehicle.

SiriusXM Guardian™ In-Vehicle Assistance Features — If Equipped

With SiriusXM Guardian™, your vehicle has onboard assistance features located on the rearview mirror or overhead console designed to enhance your driving experience if you should ever need assistance or support.

How It Works

Simply push the ASSIST button in the vehicle and you will be presented with your ASSIST options on the touchscreen. Make your selection by pressing the touchscreen.

Requirements

- This feature is available only on vehicles sold in the US and Canada.
- Vehicle must be properly equipped with the SiriusXM Guardian™ connected services.
- Vehicle must have an operable LTE (voice/data) or 4G (data) network connection.
- Vehicle must be registered with SiriusXM Guardian™ and have an active subscription that includes the applicable feature.
- Vehicle must be powered in the ON/RUN or ACC (Accessory) position with a properly functioning electrical system.

Disclaimers

If Roadside Assistance Call is provided to your vehicle, you agree to be responsible for any additional roadside assistance service costs that you may incur. In order to provide SiriusXM Guardian™ connected services to you, we may record and monitor your conversations with Roadside Assistance Call, Vehicle Care, Uconnect Care, or SiriusXM Guardian™ Customer Care, whether such conversations are initiated through the SiriusXM Guardian™ connected services in your vehicle, or via a land-line or mobile device, and may share information obtained through such recording and monitoring in accordance with regulatory requirements. You acknowledge, agree and consent to any recording, monitoring or sharing of information obtained through any such call recordings.

Send & Go — If Equipped

Description

The Send & Go feature allows you to search for a destination on your mobile device, and then send the route to your vehicle's Navigation system.

How It Works

1. There are multiple ways to find a destination. After selecting the Location tab at the bottom of the App, browse through one of the categories provided, or type the name or keyword in the search box. You can also select categories such as "Favorites" or "Contact List".
2. Select your destination from the list that appears. Location information will then be displayed on the map.
From this screen, you will be able to:
 - View the location on a map.
 - See the distance from your current location.
 - Send the destination to the vehicle (Send & Go).
3. Send the destination to the Uconnect Navigation in your vehicle. You can also call the destination by pressing the Call button.
4. Confirm your destination in the vehicle through a notification or in the Navigation system.

Requirements

- Vehicle must have an operable LTE (voice/data) or 4G (data) network connection compatible with your device.
- Vehicle must have an active subscription that includes the applicable feature.

Vehicle Finder

Description

The Vehicle Finder feature allows you to find the location of your vehicle.

You can also sound the horn and flash the lights to make finding your vehicle even easier.

How It Works

Select the Vehicle Finder function within the Vehicle Branded App and select the Location tab at the bottom of the App. Then, press the Vehicle icon to find your vehicle.

Requirements

- Vehicle must be properly equipped with the Uconnect system.
- Vehicle must have an operable LTE (voice/data) or 4G (data) network connection compatible with your device.
- Vehicle must have an active subscription that includes the applicable feature.
- Vehicle ignition must have been turned on within 14 days.

4G Wi-Fi Hotspot — If Equipped

Description

4G Wi-Fi Hotspot is an in-vehicle service that connects your device to an LTE (voice/data) or 4G (data) network that is ready to go wherever you are. After you've made your purchase, turn on your device's Wi-Fi and connect your devices.

- Enables all your passengers to be simultaneously connected to the web.
- Connect several devices at one time.
- Any Wi-Fi-enabled device — such as a laptop or any other portable-enabled media — can connect over your private in-vehicle network.
- A high-speed, secured connection lets anyone on your private network access the Web — great for working and relaxing.

WARNING!

The driver should NEVER use the 4G Wi-Fi Hotspot while driving the vehicle as doing so may result in an accident involving serious injury or death.

Create A 4G Wi-Fi Hotspot For Use In Your Vehicle**How it Works**

The 4G Wi-Fi Hotspot feature provides the vehicle passengers with an internet access hotspot in the vehicle, using the radio as an access point. The hotspot will allow Wi-Fi-enabled in-vehicle devices (such as a laptop or any other portable-enabled media device) to wirelessly connect to the internet. Uconnect offers a complimentary 3-month trial period that includes 1GB of total data. The trial can be activated any time within the first year of new vehicle ownership.

Use one of these three ways to purchase a subscription to the 4G Wi-Fi Hotspot:

1. From your vehicle's touchscreen, select the 4G Wi-Fi Hotspot App, and press the How To Purchase button and follow the instructions.
2. Log onto your Owner's Site and click the link to the AT&T portal to get set up.
3. **For existing Connected Car customers:** Push the ASSIST button to be routed to an AT&T Customer Care agent who will assist you.

Once the 4G Wi-Fi Hotspot is purchased, you can change its name and the password by selecting the Wi-Fi Hotspot App and pressing the Setup Wi-Fi Hotspot button. You can also view the connected devices from the app screen by pressing the View Connected Devices button.

NOTE:

A SiriusXM Guardian™ subscription is not required in order to purchase and use 4G Wi-Fi Hotspot. For more information on setting up a Wi-Fi connection, visit <https://myvehicle.att.com>.

WARNING!

Always drive safely with your hands on the steering wheel and obey all applicable laws. You have full responsibility and assume all risks related to the use of the features and applications in this vehicle. Only use the features and applications in this vehicle when it is safe to do so. Failure to comply may result in an accident involving serious injury or death.

Stolen Vehicle Assistance — If Equipped**Description**

If your vehicle is stolen, the SiriusXM Guardian™ Customer Care agent may be able to locate the stolen vehicle and work with law enforcement to help recover it.

How It Works

1. If your vehicle is stolen, contact local law enforcement as soon as possible. They will work with you to file a stolen vehicle report.
2. Next, inform SiriusXM Guardian™ Customer Care that your vehicle has been stolen.

The SiriusXM Guardian™ Customer Care Agent will ask for the stolen vehicle report number (as issued by your local law enforcement). If you have downloaded the Vehicle Branded App, you can push the Settings menu button on your device, select "Help", and then select "SiriusXM Guardian™ Customer Care" to make the call.

3. SiriusXM Guardian™ Customer Care will authenticate that you are the owner of the vehicle and contact the law enforcement with whom you filed the stolen vehicle report.
4. SiriusXM Guardian™ Customer Care will work with your local law enforcement to locate the vehicle. You will be contacted by law enforcement if your vehicle is recovered. While the investigation is ongoing, you should also contact your insurance company to inform it of the situation.

Requirements

- Vehicle must be properly equipped with the Uconnect system.
- Vehicle must have an operable LTE (voice/data) or 4G (data) network connection compatible with your device.
- Vehicle must be registered with SiriusXM Guardian™ and have an active subscription that includes the applicable feature.

NOTE:

Not all features of SiriusXM Guardian™ are available everywhere at all times, particularly in remote or enclosed areas.

Monthly Vehicle Health Report — If Equipped**Description**

Monthly Vehicle Health Report is a Uconnect service through which a summary of the performance of your vehicle's key systems will be sent to you every month so you can stay on top of your vehicle's maintenance needs. This is provided as a convenience to you and does not substitute for regular maintenance to your vehicle.

In order to provide the Monthly Vehicle Health Report, the Uconnect system in your vehicle may collect and transmit vehicle data to SiriusXM Guardian™ and to FCA, such as your vehicle's health and performance, your vehicle's location, your utilization of the features in your vehicle, and other data.

This data collection and transmission begins when you enroll in SiriusXM Guardian™ and will continue even if you cancel your SiriusXM Guardian™ subscription unless you call SiriusXM Guardian™ Customer Care and tell them to deactivate your connected services.

Please see the Uconnect Privacy Policy for more information, located at www.driveuconnect.com/connectedservices/privacy.html (US Residents) or www.driveuconnect.ca (Canadian Residents).

For more information on SiriusXM Guardian™ private policy, see <https://siriusxm cvs.com/privacy-policy>.

NOTE:

Your vehicle must be enrolled in an active subscription with connected services. If you have concerns about the operation, function or performance of your vehicle, please take it to an authorized dealer. This report does not replace regularly scheduled maintenance. Check the instrument cluster warning lights and cautions in your vehicle for the most accurate vehicle health information.

Vehicle Health Alert —If Equipped

Description

Your vehicle will send you an email alert if it senses a problem with one of your vehicle's key systems. For further information, go to your Owner's website.

NOTE:

Vehicle Health Alert emails require you to register and activate services. During this process you will be asked to provide an email address to which the reports will be sent.

In-Vehicle Notifications — If Equipped

Description

Your vehicle will send you notifications to remind you when services are needed, or to alert you of other important information, such as recall notices. When you receive a notification through your touchscreen, press OK to dismiss the message, or press Call Care to speak with a SiriusXM Guardian™ Customer Care agent.

NOTE:

Pressing "OK" or the X button on the pop-up screen will dismiss or close the pop-up, and the In-Vehicle Messages mailbox will display. In the Mailbox, you can reopen messages or delete messages.

Amazon Alexa Skill — If Equipped

Enjoy the convenience of using your voice to command your vehicle with Amazon Alexa!

With Amazon Alexa, you can connect to your vehicle and remotely access key services and features.

If your vehicle is equipped with Uconnect Navigation, you can send a destination directly to your vehicle using Alexa.

If you need assistance, you can always ask Alexa for help, or complete a list of commands by saying: "Alexa, ask <brand name> for help with my car."

Here are a few of the many questions you can ask Alexa:

- "Alexa, ask <vehicle brand> to start my <vehicle name> with your Voice Code."
- "Alexa, ask <vehicle brand> to lock my <vehicle name> with your Voice Code."
- "Alexa, ask <vehicle brand> to send 1000 Chrysler Drive, Auburn Hills, Michigan to my <vehicle name>."
- "Alexa, ask <vehicle brand> what is the fuel level of my <vehicle name>."

An active subscription to SiriusXM Guardian™ is required. To use Amazon Alexa, first, register for SiriusXM Guardian™ ➔ page 246.

Next, link the Uconnect system on your vehicle to Amazon Alexa:

1. Download the Amazon Alexa app on your mobile device (Apple® or Android™).
2. Once in the app, tap MENU and go to SKILLS.
3. Search for <vehicle brand> skill, then tap Enable.
4. Tap SAVE SETTINGS when prompted.
5. Link the vehicle brand name to the <vehicle brand> Skill by tapping LINK ACCOUNT.
6. Log in using your Owner Account credentials. This will be the same user name and password you used when registering for SiriusXM Guardian™ connected services. There will be additional settings to confirm on the following screen.
7. AUTHORIZE the account to return to the <vehicle brand> Skill.

You can now begin using the <vehicle brand> Skill on Alexa!

Family Drive Alerts — If Equipped

Description

Family Drive Alerts help promote safer driving and give you peace of mind when your loved ones are out on the road. You can set boundary limits, monitor driving speed, and pinpoint your vehicle's location any time, any place. Use the Vehicle Branded App to set alerts:

- **Boundary Alert**

Receive a notification the moment your vehicle is driven either out of or into a geographic boundary that you set.

- **Curfew Alert**

Receive a notification when your car is being driven outside of the curfew time.

- **Speed Alert**

Receive a notification whenever your car exceeds a speed limit you set.

- **Valet Alert**

Receive a notification if and when your vehicle is driven outside a quarter-mile radius of a valet drop-off zone.

SmartWatch Integration — If Equipped

Description

SmartWatch Integration puts the Vehicle Branded App right on your Apple® Watch or Android™ Wear. To get started, follow these steps:

1. Download the Vehicle Branded App from the App Store® or Google Play.
2. Log onto the app from your smartphone using the username and password you created when you first set up your account.

3. Make sure your watch and smartphone are connected through Bluetooth®.
4. The Vehicle Branded App should appear on your SmartWatch.

Once the app is downloaded on your SmartWatch, you can enjoy these features:

- Lock or unlock your vehicle by tapping the remote lock button in the app and entering your security PIN.
- Remote start or stop your vehicle.
- View important vehicle stats, such as fuel level, vehicle location, tire pressure warning, and more.

MANAGE MY SIRIUSXM GUARDIAN™ ACCOUNT

To manage your SiriusXM Guardian™ account, press the ASSIST button in your vehicle, or call SiriusXM Guardian™ Customer Care.

NOTE:

It is recommended, when selling your vehicle, or turning in your lease, to call SiriusXM Guardian™ Care to remove your personal data.

CONNECTED SERVICES FAQs

For additional information about SiriusXM Guardian™, active subscribers can push the ASSIST button (if equipped) and then select SiriusXM Guardian™ Call on your in-vehicle touchscreen to contact SiriusXM Guardian™. Your call will be directed to a SiriusXM Guardian™ agent or held in a queue until an agent is available. If you do not have an active subscription, push the ASSIST button and press the Activate button on the touchscreen to activate services.

CONNECTED SERVICES SOS FAQs — IF EQUIPPED

1. **What happens if I accidentally push the SOS Call button on the mirror or overhead console?** You have 10 seconds after pushing the SOS Call button to cancel the call. To cancel the call, either push the SOS Call button again, or press the Cancel button on the in-vehicle touchscreen.
2. **What type of information is sent when I use the SOS Call button from my vehicle?** Certain vehicle information, such as make and model, is transmitted along with the last known GPS location.
3. **When could I use the SOS Call button?** You can use the SOS Call button to make a call if you or someone else needs emergency assistance.

CONNECTED SERVICES REMOTE DOOR LOCK/UNLOCK FAQs

1. **How long does it take to unlock or lock the door?** Depending on various conditions, it can take up to three minutes or more for the request to get to your vehicle.
2. **Which is faster, my key fob or the Vehicle Branded App?** Your key fob will lock/unlock the door more quickly, however its range is limited and your Vehicle Branded App comes in handy for these and other situations.
3. **Will my vehicle be safe if I lose my device?** People sometimes lose their mobile devices, which is why security measures have been engineered into the Vehicle Branded App. Asking for your username, password and SiriusXM Guardian™ Security PIN are

required for the activation of Remote services through your mobile device. It is your responsibility to protect your passwords and PINs.

4. **Why can't all mobile devices use the Vehicle Branded App?** The Vehicle Branded App is compatible with most devices with the Apple® and Android™ operating systems. The capabilities of these devices allow us to remotely command your vehicle. Other operating systems may be supported in the future.
5. **Why is the Vehicle Branded App running slow?** The Vehicle Branded App relies on a mobile network connection from your device to send commands to your vehicle which must have an operable LTE (voice/data), 4G (data), or 5G (data) network connection. If either your device or your vehicle is in an area with below average coverage, it may take longer to log in and send commands.

CONNECTED SERVICES ROADSIDE ASSISTANCE FAQs

1. **What is the phone number for roadside assistance call?** The phone number is:
 - US: 1-800-521-2779
 - Canada: 1-800-363-4869
2. **If I am subscribed to SiriusXM Guardian™, does it cover towing or other expenses incurred by using roadside assistance?** No, however your new vehicle may include Roadside Assistance Call services.

CONNECTED SERVICES SEND & GO FAQs — IF EQUIPPED

1. **How long does it take to send the route and destination to my vehicle?** Depending on various conditions, it can take up to three minutes for the request to get through to your vehicle.
2. **Can I cancel a route I sent to my vehicle?** Yes, once you enter your vehicle, and start the engine, the pop-up message stating that you have a new route will appear. There is an exit button on the pop-up that will cancel the route if selected.
3. **Can I select a different route than the most recent one I sent to my vehicle?** Yes, once you enter the vehicle, and start the engine, the pop-up message offers a "Locations" option. Once "Locations" is selected, you can choose from a list of recently sent destinations.

CONNECTED SERVICES VEHICLE FINDER FAQs

1. **Can someone else locate my vehicle?** Your vehicle may be located by anyone who has your PIN and access to your account. It is your responsibility to guard your PIN accordingly. See the Uconnect and SiriusXM Guardian™ terms of service for more information.
2. **How long does it take to sound my horn and flash the lights?** Depending on various conditions, it can take three minutes or more for the request to get through to your vehicle.
3. **How do I turn off the horn and lights after I turn them on?** If you are close enough to the vehicle, you can use the key fob to turn off the horn and lights by pushing the red Panic button.

CONNECTED SERVICES STOLEN VEHICLE ASSISTANCE FAQs — IF EQUIPPED

1. **Can someone locate my vehicle?** To enhance your privacy, and the privacy of others using your vehicle, a stolen vehicle police report is required for you to activate this service. You must involve local law enforcement to have SiriusXM Guardian™ locate your vehicle. We may also locate the vehicle for other law enforcement or government agencies, subject to a valid court order telling SiriusXM Guardian™ to do so. We will also provide the service for FCA entities to locate a vehicle that you have purchased through them.
2. **How will I know if my vehicle is recovered?** After you provide the SiriusXM Guardian™ Customer Care agent with the stolen vehicle report, the agent will work together with law enforcement to try to locate your vehicle. If your vehicle is recovered, you will be contacted by law enforcement.
3. **Can SiriusXM Guardian™ lower my insurance rates?** Some insurance providers offer lower rates on vehicles equipped with systems that can deter auto theft. When shopping for insurance, be sure to inform the insurance provider of your SiriusXM Guardian™ connected services subscription to find out if the insurance provider can offer you a lower rate.

NOTE:

Neither FCA nor SiriusXM® are insurance companies, and SiriusXM Guardian™ is not an insurance product. You are responsible for obtaining insurance coverage for your vehicle and yourself.

CONNECTED SERVICES REMOTE VEHICLE START FAQs

- 1. How long does it take to remotely start my vehicle?** Depending on various conditions, it can take three minutes or more for the request to get through to your vehicle.
- 2. Which is faster, my key fob or the Vehicle Branded App?** Your key fob will remotely start your vehicle more quickly. However its range is limited. For example, when you are leaving the stadium after the game, you can use the Vehicle Branded App to remotely start your vehicle and have the inside of your vehicle comfortable by the time you get to it.
- 3. Will my vehicle be safe if I lose my wireless device?** People sometimes lose their wireless devices, which is why security measures have been engineered into the Vehicle Branded App. Asking for your username, password and SiriusXM Guardian™ Security PIN help to ensure that nobody can start your vehicle if they happen to find your device.
- 4. Can someone drive off with my vehicle using the App?** No. Driving your vehicle still requires the keys to be in the vehicle. The Remote Start feature simply starts the engine to warm up or cool down the interior before you arrive.
- 5. Can I stop a vehicle that is being driven with the cancel Remote Vehicle Start command?** No. If the vehicle is in motion, the cancel Remote Vehicle Start button will not stop the vehicle.

- 6. Why can't all mobile devices use the Vehicle Branded App?** The Vehicle Branded App has been designed to work on most devices with the Apple® and Android™ operating systems. The capabilities of these devices allow us to remotely command your vehicle. Other operating systems may be supported in the future.

CONNECTED SERVICES REMOTE HORN & LIGHTS FAQs

- 1. How long does it take to sound my horn and flash the lights?** Depending on various conditions, it can take three minutes or more for the request to get through to your vehicle.
- 2. Which is faster, my key fob or the Vehicle Branded App?** Your key fob will sound the horn and flash the lights quicker; however, its range is limited.
- 3. How do I turn off the horn and lights after I turn them on?** If you are close enough to the vehicle, you can use the key fob to turn off the horn and lights by pressing the red Panic button. Otherwise, Remote Horn & Lights will continue for a maximum of three minutes.
- 4. Why can't all mobile devices use the Vehicle Branded App?** The Vehicle Branded App has been designed to work on most devices with the Apple® and Android™ operating systems. The capabilities of these devices allow us to remotely command your vehicle. Other operating systems may be supported in the future.

CONNECTED SERVICES ACCOUNT FAQs — IF EQUIPPED

- 1. How do I register for my SiriusXM Guardian™ account?** There are three ways that you can register your SiriusXM Guardian™ Account:
 - Push the ASSIST button. A call will be placed to an agent who can assist in registering your new account.
 - Press the Activate Services icon in the Apps menu. Select the button to speak with an agent, who can assist in registering your new account.
 - Press the Activate Services icon in the Apps menu. Enter your email on the touchscreen and then follow the prompts from the provided email. You will receive an email with an activation link that will be good for 72 hours. Once you click the activation link, you will be prompted to fill out your information and accept Terms and Conditions. Then, you will be directed to the SiriusXM Guardian™ home page to complete your profile and demo the remote services.
- 2. Why do I need an email address?** Without an email address, customers cannot register for SiriusXM Guardian™. Customers need to register so they can subscribe to receive additional services and create a SiriusXM Guardian™ Security PIN for remote command requests.
- 3. How do I create a SiriusXM Guardian™ security PIN?** Set up your SiriusXM Guardian™ Security PIN during the registration process. The SiriusXM Guardian™ Security PIN will be required to authenticate you when accessing your account via SiriusXM Guardian™ Call or performing any remote services, such as Remote Door Lock/Unlock, Remote Horn & Lights, or Remote Vehicle Start.

4. **What if I forgot my SiriusXM Guardian™ security PIN?** If you've already activated services and forgot your SiriusXM Guardian™ Security PIN, you can reset the PIN by selecting Edit Profile on your Owner's Site.
5. **How do I update my SiriusXM Guardian™ payment account address?** Your SiriusXM Guardian™ Payment Account address can be updated online, or by calling SiriusXM Guardian™ Customer Care from ASSIST in your vehicle. To update online: login to your Owner's Site, and select Edit Profile > SiriusXM Guardian™ Payment Account.
6. **How do I update my SiriusXM Guardian™ profile?** Your name, home address, phone number, email address and SiriusXM Guardian™ Security PIN can be updated online on your Owner's Site. Log in to your Owner's Site then select Edit Profile to edit your personal information. Make your edits and click Save.
7. **Can I try features or packages before I buy them?** Your new vehicle purchase may have come with an included trial period for certain Apps and services.
8. **Can I access every App and service while driving?** No, some applications and services are not available while driving. For your own safety, it is not possible to use some of the touchscreen features while the vehicle is in motion (e.g. key pad).
9. **What happens when my subscription comes up for renewal?** If you have added a credit card to your account information, your subscription will be automatically renewed for a term length in accordance with the service plan that you have selected at the then current subscription rate and on every renewal date thereafter, unless you cancel your subscription by calling SiriusXM Guardian™ Care. If you have not

added a credit card to your account, SiriusXM Guardian™ will send you an email or letter in advance of your expiration date to remind you that your subscription is ending soon.

10. **How do I manage my SiriusXM Guardian™ notification preferences?** Contact SiriusXM Guardian™ Customer Care, or go to your Owner's Site and then update your preferences on the SiriusXM Guardian™ customer web portal.
11. **How do I purchase a subscription?** Contact SiriusXM Guardian™ Customer Care by pushing the ASSIST button on your rearview mirror or overhead console.
12. **How do I update my credit card information?** Login to your Owner's Site, and select Edit Profile, then select SiriusXM Guardian™ Payment Account.
13. **How do I find out how much longer I have on my subscription?** Contact SiriusXM Guardian™ Customer Care.
You also can visit your Owner's Site and choose a subscription to view its expiration date. When your subscription is about to expire, you will receive an email or letter of notification.
14. **Can I get a refund if I have not used the entire subscription?** Prorated refunds are provided from the date of cancellation for annual plans or longer. Please see the Uconnect and SiriusXM Guardian™ Terms & Conditions for refunds related to billing plans of other lengths and other circumstances.
15. **Can I cancel a subscription before it expires?** Yes. If you have an annual subscription, your subscription will be canceled the day you cancel. If you have a monthly subscription, your subscription will be canceled on the last day of the month in which you choose to cancel.

16. **What should I do if I want to sell my vehicle?** Before your vehicle is sold to a new owner, you'll want to remove your account information. This process removes all personal information, returns the Uconnect system to its original factory settings, removes all SiriusXM Guardian™ connected services and account information. To remove your account information from the Uconnect system, contact SiriusXM Guardian™ Customer Care.
17. **What if I forgot to remove my account information before I returned my lease vehicle or sold it?** Contact SiriusXM Guardian™ Customer Care.
18. **What will happen if an operable LTE (voice/data), 4G (data), or 5G (data) network connection compatible with my device is temporarily unavailable?** The SOS Call and ASSIST buttons will NOT function if you are not connected to an operable LTE (voice/data) or 4G (data), 5G (data) network. Services that required your smartphone only direct calls to Roadside Assistance Call may be functioning if you have an operable network.

DATA COLLECTION & PRIVACY

The Uconnect system collects and transmits data which may include information about your vehicle, your vehicle's health and performance, your vehicle's location, your utilization of the features in your vehicle, and other data. The collection, use and sharing of this information is required to provide the SiriusXM Guardian™ connected services and is further described by the Uconnect Privacy Policy, which can be found at www.driveuconnect.com/connectedservices/privacy.html (US Residents) or www.driveuconnect.ca (Canadian Residents). This information may be collected by SiriusXM® Connected Vehicle Services Inc. and shared with FCA US LLC for the purposes stated in

the Uconnect Privacy Policy. Vehicle health and diagnostic information including location data may be used by Uconnect to provide a Vehicle Health Report to you.

Even if you cancel your SiriusXM Guardian™ subscription, this vehicle diagnostic health information, including location data, may still be transmitted from your vehicle and you may still have a Vehicle Health Report sent to you.

Use of any of the connected services including SiriusXM Guardian™ is deemed to be your consent to the collection, use and disclosure of this information in accordance with the Uconnect Privacy Policy. If you do not want this information to be collected, used, or shared, you must cancel your Uconnect services in their entirety by contacting us as referenced in the Uconnect Privacy Policy.

RADIO OPERATION AND MOBILE PHONES

Under certain conditions, the mobile phone being on in your vehicle can cause erratic or noisy performance from your radio. This condition may be lessened or eliminated by repositioning the mobile phone within the vehicle. This condition is not harmful to the radio. If your radio performance does not satisfactorily improve from repositioning the mobile phone, it is recommended that the volume be turned down or off during mobile phone operation when not using the Uconnect system.

REGULATORY AND SAFETY INFORMATION

US/CANADA

Exposure to Radio Frequency Radiation

The radiated output power of the internal wireless radio is far below the FCC and IC radio frequency exposure limits. Nevertheless, the wireless radio will be used in such a manner that the radio is 8 inches (20 cm) or further from the human body.

The radiated output power of the internal wireless radio is far below the FCC and IC radio frequency exposure limits. Nevertheless, the wireless radio will be used in such a manner that the radio is 20 cm (8 in) or further from the human body.

The radiated output power of the internal wireless radio is far below the FCC and IC radio frequency exposure limits. Nevertheless, the wireless radio will be used in such a manner that the radio is 20 cm or further from the human body.

The internal wireless radio operates within guidelines found in radio frequency safety standards and recommendations, which reflect the consensus of the scientific community.

The radio manufacturer believes the internal wireless radio is safe for use by consumers. The level of energy emitted is far less than the electromagnetic energy emitted by wireless devices such as mobile phones. However, the use of wireless radios may be restricted in some situations or environments, such as aboard airplanes. If you are unsure of restrictions, you are encouraged to ask for authorization before turning on the wireless radio ↩ page 404.

OFF-ROAD PAGES — IF EQUIPPED

Your vehicle may be equipped with Off-Road Pages which display vehicle information related to the drive-train, transfer case, and coolant/oil gauges.

To access Off-Road Pages, press the Vehicle button on the touchscreen, select the Offroad tab, and then select the OFF ROAD button on the main screen. Off-Road Pages can also be accessed through the app drawer.



OFF ROAD Button

OFF-ROAD PAGES STATUS BAR

The Off-Road Pages Status Bar is located along the bottom of Off-Road Pages and is present in each of the selectable page options. It provides information for the following items:

1. Transfer Case Status
2. Latitude/Longitude
3. Altitude of the vehicle
4. Status of Hill Descent Control and Target Speed in mph (km/h)

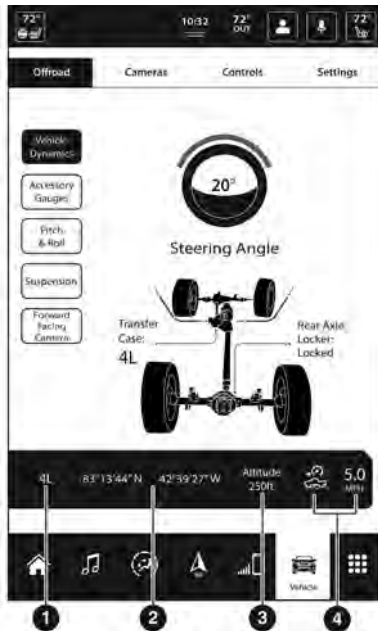

Status Bar 2WD/4WD

- 1 – Transfer Case Status
- 2 – Latitude/Longitude
- 3 – Altitude
- 4 – Hill Descent Control Status And Target Speed

VEHICLE DYNAMICS

The Vehicle Dynamics page displays information concerning the vehicle's transfer case and steering angle. The following information is displayed:

1. Status of Transfer Case
2. Status of Front Axles
3. Status of the Rear Axles
4. Steering angle in degrees

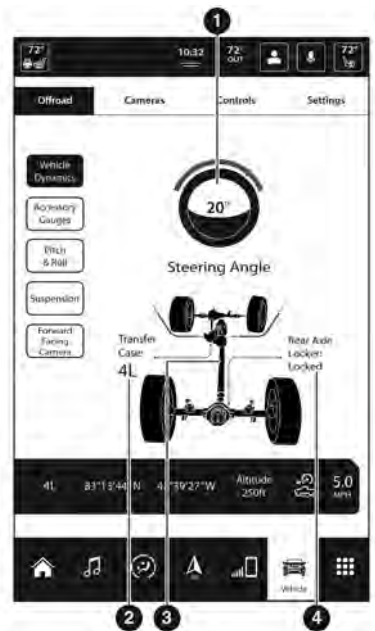

Drivetrain Menu 2WD/4WD

- 1 – Steering Angle
- 2 – Transfer Case Status
- 3 – Rear Axle
- 4 – Rear Axle Locker Status

ACCESSORY GAUGE

The Accessory Gauge page displays the current status of the vehicle's Coolant Temperature, Oil Temperature, Oil Pressure, Transmission Temperature, and Battery Voltage.

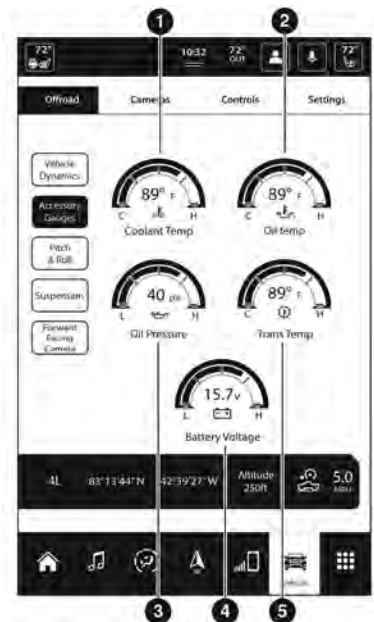

Accessory Gauge Menu 2WD/4WD

- 1 – Coolant Temperature
- 2 – Oil Temperature
- 3 – Oil Pressure
- 4 – Battery Voltage
- 5 – Transmission Temperature

PITCH & ROLL

The Pitch & Roll page displays the vehicle's current pitch (angle up and down) and roll (angle side to side) in degrees. The Pitch & Roll gauges provide a visualization of the current vehicle angle.

NOTE:

Pitch & Roll values may show upon startup. These numbers will update once the vehicle is driven.

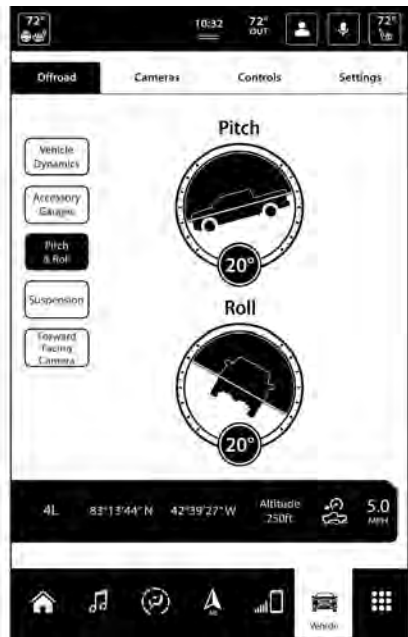

Pitch & Roll Menu

SUSPENSION

The Suspension page displays the current status of the vehicle's suspension system and the current ride height of the vehicle. The Suspension page will also indicate when the vehicle's height changes.

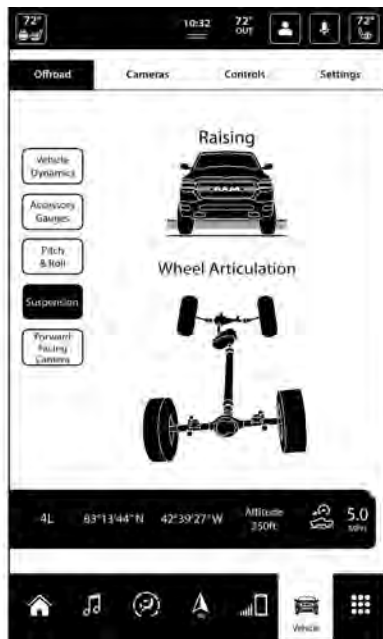

Suspension Menu

NOTE:

Wheel articulation will only be present if the vehicle is equipped with air suspension.

FORWARD FACING CAMERA

Your vehicle may be equipped with a Forward Facing Camera that allows you to see an on-screen image of the front view of your vehicle. The image will be displayed on the touchscreen along with a caution note "Check Entire Surroundings" across the top of the screen.

To activate, press the Forward Facing Camera button on the touchscreen.

TRAILER TOW — IF EQUIPPED

If your vehicle is equipped with Trailer Tow Pages, you will be able to view and edit different trailer settings for each of your unique trailers.

To access Trailer Tow Pages, press on the Vehicle icon in the lower menu bar on the touchscreen. From the Dashboard tab select "Towing & Trailers".



Towing & Trailers Button

TRAILER INFO

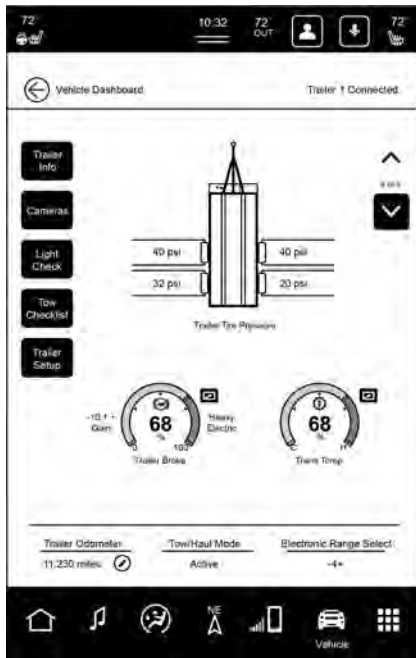

Trailer Tow Pages Info Tab

The Trailer Info main page displays your trailer's tire pressure, odometer, electric range select, and view of your trailer's Tow/Haul mode status.

Displayed in the Trailer Info tab are the following gauges that show information for each separate trailer:

- Trailer Brake
- Transmission Temperature
- Coolant Temperature
- Oil Temperature
- Oil Pressure
- Battery Voltage

NOTE:

Press the Up and Down arrows on the right-hand side of your touchscreen to toggle between gauges, as only up to five will be displayed at a time.

The upper right-hand corner of each gauge will give you the option to maximize each gauge, which will show you the Gauge Detail View page that will show specific gauge information and a status graph of the gauge over time. To get back to the Trailer Info page, select the same icon located at the top right.

NOTE:

If any gauge reaches a critical condition, the fill bar, numerical readout, and icon will be displayed in bright red.

CAMERAS

Selecting the Camera tab within "Trailer Tow Pages" will redirect you to the Trailer tab in the More Cams section of the Camera app.

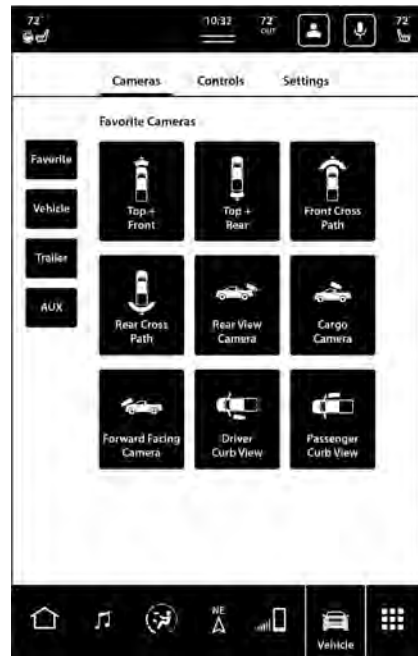

Trailer Tow Pages Camera Tab

After selecting your desired trailer camera view, selecting the More Cams button will take you back to the previous screen.

In order for the camera's features to be accessible, the Surround View Camera settings have to be enabled [↗](#) page 209.

LIGHT CHECK

Pressing the Light Check tab will open the Light Check Ready page. A box will appear with the text "Activate Light Check", which will allow you to check your trailer's brake lights.



Trailer Tow Pages Light Check Tab

Once selected, the screen will change to "Light Check in Progress". The box will turn red and the text will read "Cancel Light Check", which will then turn the trailer's brake lights back off.

Checking "Auto Trailer Light Check" in the "Trailer Brake/Trailer" Uconnect Settings will automatically turn on your trailer's lights once the trailer is attached to the vehicle. For more information [↗](#) page 209.

NOTE:

After two minutes, if "Cancel Light Check" is not selected, the screen will automatically revert back to the Activate Light Check screen.

SETUP

After selecting your trailer of choice, selecting the Setup tab will redirect to the Uconnect Settings “Trailer Brake/Trailer” feature, ↪ page 209.



Trailer Tow Pages Setup Tab

NOTE:

Make sure that “Use this Trailer” is selected in order to make any settings changes to that selected trailer.

SAFETY

SAFETY FEATURES

ANTI-LOCK BRAKE SYSTEM (ABS)

The ABS provides increased vehicle stability and brake performance under most braking conditions. The system automatically prevents wheel lock and enhances vehicle control during braking.

The ABS performs a self-check cycle to ensure that the ABS is working properly each time the vehicle is started and driven. During this self-check, you may hear a slight clicking sound as well as some related motor noises.

The ABS is activated during braking when the system detects one or more wheels are beginning to lock. Road conditions such as ice, snow, gravel, bumps, railroad tracks, loose debris, or panic stops may increase the likelihood of ABS activation(s).

You also may experience the following normal characteristics when the ABS activates:

- ABS motor noise or clicking sounds (you may continue to hear for a short time after the stop)
- Brake pedal pulsations
- A slight drop of the brake pedal at the end of the stop

The ABS is designed to function with the Original Equipment Manufacturer (OEM) tires. Modification may result in degraded ABS performance.

WARNING!

- The ABS contains sophisticated electronic equipment that may be susceptible to interference caused by improperly installed or high output radio transmitting equipment. This interference can cause possible loss of anti-lock braking capability. Installation of such equipment should be performed by qualified professionals.
- Pumping of the Anti-Lock Brakes will diminish their effectiveness and may lead to a collision. Pumping makes the stopping distance longer. Just press firmly on your brake pedal when you need to slow down or stop.
- The ABS cannot prevent the natural laws of physics from acting on the vehicle, nor can it increase braking or steering efficiency beyond that afforded by the condition of the vehicle brakes and tires or the traction afforded.
- The ABS cannot prevent collisions, including those resulting from excessive speed in turns, following another vehicle too closely, or hydroplaning.
- The capabilities of an ABS equipped vehicle must never be exploited in a reckless or dangerous manner that could jeopardize the user's safety or the safety of others.

Anti-Lock Brake System (ABS) Warning Light

The yellow ABS Warning Light will turn on when the ignition is placed in the ON/RUN mode and may stay on for as long as four seconds.

If the ABS Warning Light remains on or comes on while driving, it indicates that the anti-lock portion of the brake system is not functioning and that service is required. However, the conventional brake system will continue to operate normally if the ABS Warning Light is on.

If the ABS Warning Light is on, the brake system should be serviced as soon as possible to restore the benefits of Anti-Lock Brakes. If the ABS Warning Light does not come on when the ignition is placed in the ON/RUN mode, have the light repaired as soon as possible.

REAR SEAT REMINDER ALERT (RSRA)

RSRA alerts you of the possible presence of an object, passenger, or pet in the rear seats through a visual and auditory notification. The system will activate automatically if a rear door was opened within 10 minutes of the ignition being placed in the ON/RUN position. RSRA does not directly detect objects, passengers, or pets in the rear seats. When the previous conditions are met, RSRA displays the message "Check Rear Seat" on the instrument cluster display and sounds an auditory alert upon the driver placing the ignition in the OFF position to exit the vehicle.

To enable or disable RSRA, see  page 209.

WARNING!

- Before exiting a vehicle, always come to a complete stop, then shift the automatic transmission into PARK and apply the parking brake.
- Always make sure the keyless ignition node is in the OFF position, key fob is removed from the vehicle and vehicle is locked.
- Never leave children alone in a vehicle, or with access to an unlocked vehicle. Leaving children in a vehicle unattended is dangerous for a number of reasons. A child or others could be seriously or fatally injured. Children should be warned not to touch the parking brake, brake pedal or the gear selector.
- Do not leave children or animals inside parked vehicles in hot weather. Interior heat buildup may cause serious injury or death.

ELECTRONIC BRAKE CONTROL (EBC) SYSTEM

Your vehicle is equipped with an advanced Electronic Brake Control (EBC) system. This system includes Anti-Lock Brake System (ABS), Brake Assist System (BAS), Electronic Brake Force Distribution (EBD), Electronic Roll Mitigation (ERM), Electronic Stability Control (ESC), Hill Start Assist (HSA), and Traction Control System (TCS). These systems work together to enhance both vehicle stability and control in various driving conditions.

Your vehicle may also be equipped with Trailer Sway Control (TSC) and Hill Descent Control (HDC).

Brake Assist System (BAS)

The BAS is designed to optimize the vehicle's braking capability during emergency braking maneuvers. The system detects an emergency braking situation by sensing the rate and amount of brake application and then applies optimum pressure to the brakes. This can help reduce braking distances. The BAS complements the Anti-Lock Brake System (ABS). Applying the brakes very quickly results in the best BAS assistance. To receive the benefit of the system, you must apply continuous braking pressure during the stopping sequence (do not "pump" the brakes). Do not reduce brake pedal pressure unless braking is no longer desired. Once the brake pedal is released, the BAS is deactivated.

WARNING!

The Brake Assist System (BAS) cannot prevent the natural laws of physics from acting on the vehicle, nor can it increase the traction afforded by prevailing road conditions. BAS cannot prevent collisions, including those resulting from excessive speed in turns, driving on very slippery surfaces, or hydroplaning. The capabilities of a BAS-equipped vehicle must never be exploited in a reckless or dangerous manner, which could jeopardize the user's safety or the safety of others.

Brake System Warning Light

The red Brake System Warning Light will turn on when the ignition is placed in the ON/RUN mode and may stay on for as long as four seconds.

If the Brake System Warning Light remains on or comes on while driving, it indicates that the brake system is not functioning properly and that immediate service is required. If the Brake System Warning Light does not come on when the ignition is placed in the ON/RUN mode, have the light repaired as soon as possible.

Electronic Brake Force Distribution (EBD)

EBD manages the distribution of the braking torque between the front and rear axles by limiting braking pressure to the rear axle. This is done to prevent over-slip of the rear wheels to avoid vehicle instability, and to prevent the rear axle from entering Anti-Lock Brake System (ABS) before the front axle.

Electronic Roll Mitigation (ERM)

ERM anticipates the potential for wheel lift by monitoring the driver's steering wheel input and the speed of the vehicle. When Electronic Roll Mitigation (ERM) determines that the rate of change of the steering wheel angle and vehicle's speed are sufficient to potentially cause wheel lift, it then applies the appropriate brake and may also reduce engine power to lessen the chance that wheel lift will occur. ERM can only reduce the chance of wheel lift occurring during severe or evasive driving maneuvers; it cannot prevent wheel lift due to other factors, such as road conditions, leaving the roadway, or striking objects or other vehicles.

NOTE:

ERM is disabled any time the ESC is in "Full Off" mode (if equipped). For a complete explanation of the available ESC modes, see [↔](#) page 269.

WARNING!

Many factors, such as vehicle loading, road conditions and driving conditions, influence the chance that wheel lift or rollover may occur. ERM cannot prevent all wheel lift or rollovers, especially those that involve leaving the roadway or striking objects or other vehicles. The capabilities of an ERM-equipped vehicle must never be exploited in a reckless or dangerous manner which could jeopardize the user's safety or the safety of others.

Electronic Stability Control (ESC)

ESC enhances directional control and stability of the vehicle under various driving conditions. Electronic Stability Control (ESC) corrects for oversteering or understeering of the vehicle by applying the brake of the appropriate wheel(s) to counteract these conditions. Engine power may also be reduced to help the vehicle maintain the desired path.

- Oversteer — when the vehicle is turning more than appropriate for the steering wheel position.
- Understeer — when the vehicle is turning less than appropriate for the steering wheel position.

ESC uses sensors in the vehicle to determine the vehicle path intended by the driver and compares it to the actual path of the vehicle. When the actual path does not match the intended path, ESC applies the brake of the appropriate wheel to assist in counteracting the oversteer or understeer condition.

The ESC Activation/Malfunction Indicator Light located in the instrument cluster will start to flash as soon as the ESC system becomes active. The ESC Activation/Malfunction Indicator Light also flashes when the TCS is active. If the ESC Activation/Malfunction Indicator Light

begins to flash during acceleration, ease up on the accelerator and apply as little throttle as possible. Be sure to adapt your speed and driving to the prevailing road conditions.

WARNING!

- Electronic Stability Control (ESC) cannot prevent the natural laws of physics from acting on the vehicle, nor can it increase the traction afforded by prevailing road conditions. ESC cannot prevent accidents, including those resulting from excessive speed in turns, driving on very slippery surfaces, or hydroplaning. ESC also cannot prevent accidents resulting from loss of vehicle control due to inappropriate driver input for the conditions. Only a safe, attentive, and skillful driver can prevent accidents. The capabilities of an ESC equipped vehicle must never be exploited in a reckless or dangerous manner which could jeopardize the user's safety or the safety of others.
- Vehicle modifications, or failure to properly maintain your vehicle, may change the handling characteristics of your vehicle, and may negatively affect the performance of the ESC system. Changes to the steering system, suspension, braking system, tire type and size or wheel size may adversely affect ESC performance. Improperly inflated and unevenly worn tires may also degrade ESC performance. Any vehicle modification or poor vehicle maintenance that reduces the effectiveness of the ESC system can increase the risk of loss of vehicle control, vehicle rollover, personal injury and death.

ESC Operating Modes

Depending upon model and mode of operation, the ESC system may have multiple operating modes.

ESC On

This is the normal operating mode for the ESC. Whenever the vehicle is started, the ESC system will be in this mode. This mode should be used for most driving conditions. Alternate ESC modes should only be used for specific reasons as noted in the following paragraphs.

Partial Off

This mode may be useful if the vehicle becomes stuck. This mode may modify TCS and ESC thresholds for activation, which allows for more wheel spin than normally allowed.

To enter the "Partial Off" mode, momentarily push the ESC OFF button and the ESC OFF Indicator Light will illuminate. To turn the ESC on again, momentarily push the ESC OFF button and the ESC OFF Indicator Light will turn off.

NOTE:

For vehicles with multiple partial ESC modes, the push and release of the button will toggle the ESC modes. Multiple attempts may be required to return to "ESC On" mode.

WARNING!

- When in “Partial Off” mode, the TCS functionality of ESC, except for the limited slip feature described in the TCS section, has been disabled and the ESC OFF Indicator Light will be illuminated. When in “Partial Off” mode, the engine power reduction feature of TCS is disabled, and the enhanced vehicle stability offered by the ESC system is reduced.
- Trailer Sway Control (TSC) is disabled when the ESC system is in the “Partial Off” mode.

Full Off — If Equipped

This mode is intended for off-highway or off-road use only and should not be used on any public roadways. In this mode, TCS and ESC features are turned off. To enter the “Full Off” mode, push and hold the ESC OFF button for five seconds while the vehicle is stopped with the engine running. After five seconds, a chime will sound, the ESC OFF Indicator Light will illuminate, and the “ESC OFF” message will display in the instrument cluster. To turn ESC on again, momentarily push the ESC OFF button.

NOTE:

System may switch from ESC “Full Off” to “Partial Off” mode when vehicle exceeds a predetermined speed. When the vehicle speed slows below the predetermined speed the system will return to ESC “Full Off”.

ESC modes may also be affected by drive modes (if equipped).

WARNING!

- In the ESC “Full Off” mode, the engine torque reduction and stability features are disabled. Therefore, enhanced vehicle stability offered by the ESC system is unavailable. In an emergency evasive maneuver, the ESC system will not engage to assist in maintaining stability. ESC “Full Off” mode is intended for off-highway or off-road use only.
- The Electronic Stability Control (ESC) cannot prevent the natural laws of physics from acting on the vehicle, nor can it increase the traction afforded by prevailing road conditions. ESC cannot prevent all accidents, including those resulting from excessive speed in turns, driving on very slippery surfaces, or hydroplaning. ESC also cannot prevent collisions.

ESC Activation/Malfunction Indicator Light And ESC OFF Indicator Light

The ESC Activation/Malfunction Indicator Light in the instrument cluster will come on when the ignition is placed in the ON/RUN mode. It should go out with the engine running. If the ESC Activation/Malfunction Indicator Light comes on continuously with the engine running, a malfunction has been detected in the ESC system. If this light remains on after several ignition cycles, and the vehicle has been driven several miles (kilometers) at speeds greater than 30 mph (48 km/h), see an authorized dealer as soon as possible to have the problem diagnosed and corrected.

The ESC Activation/Malfunction Indicator Light (located in the instrument cluster) starts to flash as soon as the tires lose traction and the ESC system becomes active.

The ESC Activation/Malfunction Indicator Light also flashes when TCS is active. If the ESC Activation/Malfunction Indicator Light begins to flash during acceleration, ease up on the accelerator and apply as little throttle as possible. Be sure to adapt your speed and driving to the prevailing road conditions.



The ESC OFF Indicator Light indicates that the Electronic Stability Control (ESC) is in a reduced mode.

NOTE:

- The ESC Activation/Malfunction Indicator Light and the ESC OFF Indicator Light come on momentarily each time the ignition is placed in the ON position.
- Each time the ignition is placed in the ON position, the ESC system will be on even if it was turned off previously.
- The ESC system will make buzzing or clicking sounds when it is active. This is normal; the sounds will stop when ESC becomes inactive following the maneuver that caused the ESC activation.

Hill Descent Control (HDC) — If Equipped

HDC is intended for low speed off-road driving while in 4WD Low. HDC maintains vehicle speed while descending hills during various driving situations. HDC controls vehicle speed by actively controlling the brakes.

HDC Has Three States:

1. Off (feature is not enabled and will not activate).
2. Enabled (feature is enabled and ready but activation conditions are not met, or driver is actively overriding with brake or throttle application).
3. Active (feature is enabled and actively controlling vehicle speed).

Enabling HDC

HDC is enabled by pushing the HDC switch, but the following conditions must also be met to enable HDC:

- The driveline is in 4WD Low.
- The vehicle speed is below 5 mph (8 km/h).
- The parking brake is released.
- The driver door is closed.

Activating HDC

Once HDC is enabled it will activate automatically if driven down a grade of sufficient magnitude. The set speed for HDC is selectable by the driver, and can be adjusted by using the gear shift +/- . The following summarizes the HDC set speeds:

HDC Target Set Speeds

- P = No set speed. HDC may be enabled but will not activate.
- R = 0.6 mph (1 km/h)
- N = 1.2 mph (2 km/h)
- D = 0.6 mph (1 km/h)
- 1st = 0.6 mph (1 km/h)
- 2nd = 1.2 mph (2 km/h)
- 3rd = 1.8 mph (3 km/h)
- 4th = 2.5 mph (4 km/h)
- 5th = 3.1 mph (5 km/h)
- 6th = 3.7 mph (6 km/h)
- 7th = 4.3 mph (7 km/h)
- 8th = 5.0 mph (8 km/h)
- 9th = 5.6 mph (9 km/h) – If Equipped

NOTE:

During HDC the +/- shifter input is used for HDC target speed selection, but will not affect the gear chosen by the transmission. When actively controlling HDC the transmission will shift appropriately for the driver-selected set speed and corresponding driving conditions.

Driver Override

The driver may override HDC activation with throttle or brake application at any time.

Deactivating HDC

HDC will be deactivated but remain available if any of the following conditions occur:

- Driver overrides HDC set speed with throttle or brake application.
- Vehicle speed exceeds 20 mph (32 km/h) but remains below 40 mph (64 km/h).
- Vehicle is on a downhill grade of insufficient magnitude, is on level ground, or is on an uphill grade.
- Vehicle is shifted to PARK.

Disabling HDC

HDC will be deactivated and disabled if any of the following conditions occur:

- The driver pushes the HDC switch.
- The driveline is shifted out of 4WD Low.
- The parking brake is applied.
- The driver door opens.
- The vehicle is driven greater than 20 mph (32 km/h) for greater than 70 seconds.
- The vehicle is driven greater than 40 mph (64 km/h) (HDC exits immediately).
- HDC detects excessive brake temperature.

Feedback To The Driver

The instrument cluster has an HDC icon and the HDC switch has an LED icon, which offers feedback to the driver about the state HDC is in.

- The cluster icon and switch light will illuminate and remain on solid when HDC is enabled or activated. This is the normal operating condition for HDC.
- The cluster icon and switch light will flash for several seconds then extinguish when the driver pushes the HDC switch but enable conditions are not met.
- The cluster icon and switch light will flash for several seconds then extinguish when HDC disables due to excess speed.
- The cluster icon and switch light will flash when HDC deactivates due to overheated brakes. The flashing will stop and HDC will activate again once the brakes have cooled sufficiently.

WARNING!

HDC is only intended to assist the driver in controlling vehicle speed when descending hills. The driver must remain attentive to the driving conditions and is responsible for maintaining a safe vehicle speed.

Hill Start Assist (HSA)

HSA is designed to mitigate roll back from a complete stop while on an incline. If the driver releases the brake while stopped on an incline, HSA will continue to hold the brake pressure for a short period. If the driver does not apply the throttle before this time expires, the system will release brake pressure and the vehicle will roll down the hill as normal.

The following conditions must be met in order for HSA to activate:

- The feature must be enabled.
- The vehicle must be stopped.
- The parking brake must be off.
- The driver door must be closed.
- The vehicle must be on a sufficient grade.
- The gear selection must match vehicle uphill direction (i.e., vehicle facing uphill is in forward gear; vehicle backing uphill is in REVERSE gear).
- HSA will work in REVERSE gear and all forward gears. The system will not activate if the transmission is in PARK or NEUTRAL. For vehicles equipped with a manual transmission, if the clutch is pressed, HSA will remain active.

WARNING!

There may be situations where the Hill Start Assist (HSA) will not activate and slight rolling may occur, such as on minor hills or with a loaded vehicle, or while pulling a trailer. HSA is not a substitute for active driving involvement. It is always the driver's responsibility to be attentive to distance to other vehicles, people, and objects, and most importantly brake operation to ensure safe operation of the vehicle under all road conditions. Your complete attention is always required while driving to maintain safe control of your vehicle. Failure to follow these warnings can result in a collision or serious personal injury.

Disabling And Enabling HSA

This feature can be turned on or turned off. To change the current setting, proceed as follows:

- If disabling HSA using your instrument cluster display, see [↪ page 101](#).
- If disabling HSA using Uconnect Settings, see [↪ page 209](#).

Towing With HSA

HSA will also provide assistance to mitigate roll back while towing a trailer.

WARNING!

- If you use a trailer brake controller with your trailer, the trailer brakes may be activated and deactivated with the brake switch. If so, there may not be enough brake pressure to hold both the vehicle and the trailer on a hill when the brake pedal is released. In order to avoid rolling down an incline while resuming acceleration, manually activate the trailer brake or apply more vehicle brake pressure prior to releasing the brake pedal.
- HSA is not a parking brake. Always apply the parking brake fully when exiting your vehicle. Also, be certain to place the transmission in PARK.
- Failure to follow these warnings can result in a collision or serious personal injury.

Ready Alert Braking (RAB)

RAB may reduce the time required to reach full braking during emergency braking situations. It anticipates when an emergency braking situation may occur by monitoring how fast the throttle is released by the driver. The Electronic Brake Control system will prepare the brake system for a panic stop.

Traction Control System (TCS)

The TCS monitors the amount of wheel spin of each of the driven wheels. If wheel spin is detected, the Traction Control System (TCS) may apply brake pressure to the spinning wheel(s) and/or reduce engine power to provide enhanced acceleration and stability. A feature of the TCS, Brake Limited Differential (BLD) functions similarly to a limited slip differential and controls the wheel spin across a driven axle. If one wheel on a driven axle is spinning faster than the other, the system will apply the brake of the spinning wheel. This will allow more engine power to be applied to the wheel that is not spinning. BLD may remain enabled even if TCS and Electronic Stability Control (ESC) are in reduced modes.

Trailer Sway Control (TSC)

TSC uses sensors in the vehicle to recognize an excessively swaying trailer and will take the appropriate actions to attempt to stop the sway.

NOTE:

TSC cannot stop all trailers from swaying. Always use caution when towing a trailer and follow the trailer tongue weight recommendations [↪ page 192](#).

When TSC is functioning, the ESC Activation/Malfunction Indicator Light will flash, the engine power may be reduced and you may feel the brakes being applied to individual wheels to attempt to stop the trailer from swaying. TSC is disabled when the ESC system is in the "Partial Off" or "Full Off" modes.

WARNING!

If TSC activates while driving, slow the vehicle down, stop at the nearest safe location, and adjust the trailer load to eliminate trailer sway.

AUXILIARY DRIVING SYSTEMS**BLIND SPOT MONITORING (BSM) — IF EQUIPPED**

BSM uses two radar sensors, located inside the taillights, to detect highway licensable vehicles (automobiles, trucks, motorcycles, etc.) that enter the blind spot zones from the rear/front/side of the vehicle.

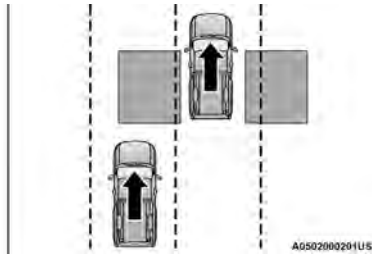
**Rear Detection Zones**

When the vehicle is started, the BSM Warning Light will momentarily illuminate in both outside rearview mirrors to let the driver know that the system is operational. The BSM system sensors operate when the vehicle is in any forward gear and enters standby mode when the vehicle is in PARK.

The BSM detection zone covers approximately one lane width on both sides of the vehicle 12 ft (3.8 m). The zone length starts at the outside rearview mirror and extends approximately 10 ft (3 m) beyond the rear fascia/bumper of the vehicle. The BSM system monitors the detection zones on both sides of the vehicle when the vehicle speed reaches approximately 6 mph (10 km/h) or higher and will alert the driver of vehicles in these areas.

NOTE:

- The BSM system DOES NOT alert the driver about rapidly approaching vehicles that are outside the detection zones.
- The BSM system may experience dropouts (blinking on and off) of the side mirror warning indicator lights when a motorcycle or any small object remains at the side of the vehicle for extended periods of time (more than a couple of seconds).

The vehicle's taillights, where the radar sensors are located, must remain free of snow, ice, and dirt/road contamination so that the BSM system can function properly. Do not block the taillights with foreign objects (bumper stickers, bicycle racks, etc.).

The system may also detect blockage if the vehicle is operated in areas with extremely low radar returns such as a desert or parallel to a large elevation drop. If blockage is detected, a "Blind Spot Temporarily Unavailable, Wipe Rear Corners" message will display in the cluster,

both mirror lights will illuminate, and BSM and RCP alerts will not occur. This is normal operation. The system will automatically recover and resume function when the condition clears.

**Radar Sensor Locations**

If the system detects degraded performance due to contamination or foreign objects, a message will warn you of a blocked sensor and the warning indicators in the side view mirrors will be on. The warning indicators will remain illuminated until blockage clearing conditions are met. First clear the taillights around the sensors of the blockage. After removing the blockage, cycle the ignition from ON to OFF and then back ON.

If the blockage message is still present after cycling the ignition and driving in traffic, check again for a blockage.

The BSM system notifies the driver of objects in the detection zones by illuminating the BSM Warning Light located in the outside mirrors in addition to sounding an audible (chime) alert and reducing the radio volume
 ⇨ page 275.

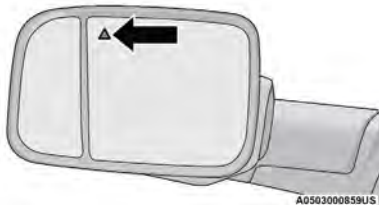

Warning Light Location

The BSM system monitors the detection zone from three different entry points (side, rear, front) while driving to see if an alert is necessary. The BSM system will issue an alert during these types of zone entries.

Entering From The Side

Vehicles that move into your adjacent lanes from either side of the vehicle.

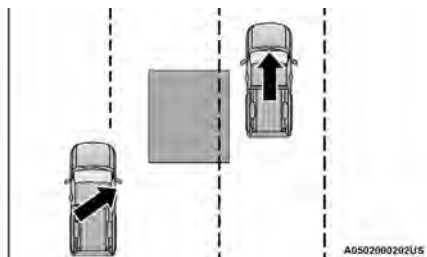

Side Monitoring

Entering From The Rear

Vehicles that come up from behind your vehicle on either side and enter the rear detection zone with a relative speed of less than 30 mph (48 km/h).

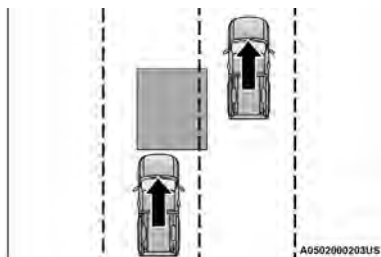

Rear Monitoring

Overtaking Traffic

If you pass another vehicle slowly with a relative speed less than 15 mph (24 km/h) and the vehicle remains in the blind spot for approximately 1.5 seconds, the warning light will be illuminated. If the difference in speed between the two vehicles is greater than 15 mph (24 km/h), the warning light will not illuminate.

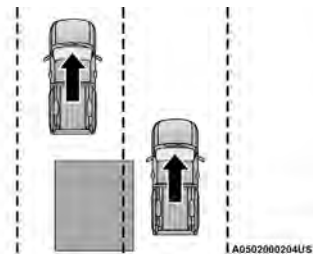

Overtaking/Approaching

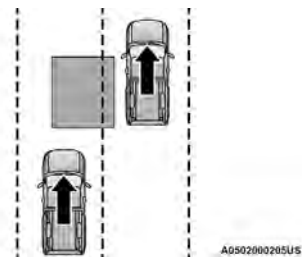

Overtaking/Passing

The BSM system is designed not to issue an alert on stationary objects such as guardrails, posts, walls, foliage, berms, snow banks, car washes, etc. However, occasionally the system may alert on such objects. This is normal operation and your vehicle does not require service.

The BSM system will not alert you of objects that are traveling in the opposite direction of the vehicle in adjacent lanes ↪ page 404.

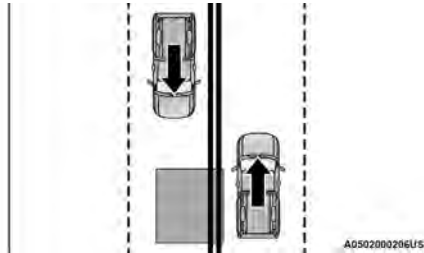

Opposing Traffic

WARNING!

The Blind Spot Monitoring system is only an aid to help detect objects in the blind spot zones. The BSM system is not designed to detect pedestrians, bicyclists, or animals. Even if your vehicle is equipped with the BSM system, always check your vehicle's mirrors, glance over your shoulder, and use your turn signal before changing lanes. Failure to do so can result in serious injury or death.

Rear Cross Path (RCP)

RCP is intended to aid the driver when backing out of parking spaces where their vision of oncoming vehicles may be blocked. Proceed slowly and cautiously out of the parking space until the rear end of the vehicle is exposed. The RCP system will then have a clear view of the cross traffic and if an oncoming vehicle is detected, alert the driver.

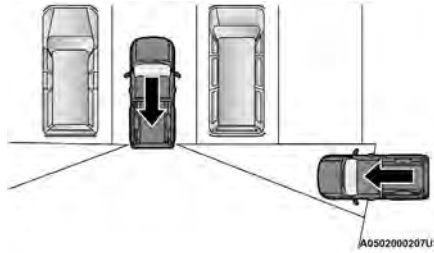

RCP Detection Zones

RCP monitors the rear detection zones on both sides of the vehicle, for objects that are moving toward the side of the vehicle with a minimum speed of approximately 3 mph (5 km/h), to objects moving a maximum of approximately 20 mph (32 km/h), such as in parking lot situations.

When RCP is on and the vehicle is in REVERSE, the driver is alerted using both the visual and audible alarms, including reducing the radio volume.

NOTE:

In a parking lot situation, oncoming vehicles can be blocked by vehicles parked on either side. If the sensors are blocked by other structures or vehicles, the system will not be able to alert the driver.

WARNING!

Rear Cross Path Detection (RCP) is not a backup aid system. It is intended to be used to help a driver detect an oncoming vehicle in a parking lot situation. Drivers must be careful when backing up, even when using RCP. Always check carefully behind your vehicle, look behind you, and be sure to check for pedestrians, animals, other vehicles, obstructions, and blind spots before backing up. Failure to do so can result in serious injury or death.

Blind Spot Modes

Blind Spot Alert has three selectable modes of operation that are available in the Uconnect system.

For further information, see ↪ page 209.

Blind Spot Alert Lights Only

When operating in Blind Spot Alert Lights Only mode, the BSM system will provide a visual alert in the appropriate side view mirror based on a detected object. However, when the system is operating in Rear Cross Path (RCP) mode, the system will respond with both visual and audible alerts when a detected object is present. Whenever an audible alert is requested, the radio is muted.

Blind Spot Alert Lights/Chime

When operating in Blind Spot Alert Lights/Chime mode, the BSM system will provide a visual alert in the appropriate side view mirror based on a detected object. If the turn signal is then activated, and it corresponds to an alert present on that side of the vehicle, an audible chime will also be sounded. Whenever a turn signal and detected object are present on the same side at the same time, both the visual and audible alerts will be issued. In addition to the audible alert the radio (if on) will also be muted.

NOTE:

Whenever an audible alert is requested by the BSM system, the radio is also muted.

When the system is in RCP, the system shall respond with both visual and audible alerts when a detected object is present. Whenever an audible alert is requested, the radio is also muted. Turn/hazard signal status is ignored; the RCP state always requests the chime.

Blind Spot Alert Off

When the BSM system is turned off there will be no visual or audible alerts from either the BSM or RCP systems.

NOTE:

The BSM system will store the current operating mode when the vehicle is shut off. Each time the vehicle is started the previously stored mode will be recalled and used.

Blind Spot Assist Cameras

There are cameras located in the exterior mirrors to assist in blind spot detection. Refer to [page 178](#) to learn more about how the cameras function with turn signal engagement or refer to [page 180](#) to learn how to activate the cameras through the camera's screen.

Trailer Merge Assist

NOTE:

When Trailer Merge Assist is activated, Rear Cross Path is disabled.

NOTE:

When a trailer with an electric brake is connected to the vehicle, the instrument cluster display will provide a menu to allow a selection of the trailer type. There will be two options provided: Conventional and Goose/Fifth Wheel. Goose/Fifth Wheel Trailer is incompatible and when selected, the BSM system will disable until the trailer is disconnected. If the wrong option is selected, the system can be reset by either disconnecting and reconnecting the trailer harness connector or disabling then re-enabling the Blind Spot Monitoring system in the customer settings in the Uconnect system. This will prompt the trailer selection menu again to allow for the correct selection.

Trailer Merge Assist is a function of the Blind Spot Monitoring (BSM) system that extends the blind spot zone to work while pulling a trailer. Trailer Merge Assist consists of three sub functions:

- Automatic Trailer Detection
- Trailer Length Detection
- Trailer Merge Warning

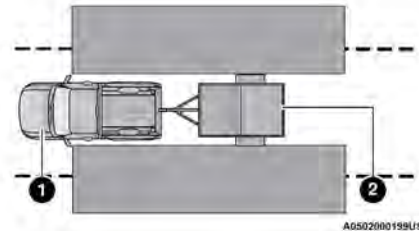



Blind Spot Zones With Trailer Merge Assist

- 1 – Vehicle
2 – Trailer

Automatic Trailer Detection

There are two modes of operation for the detection of the trailer length:

- *Automatic Mode* – When “Auto Mode” is selected, the system will use the blind spot sensors to automatically determine the presence and length of a trailer. The presence of a trailer will be detected using the blind spot radar within 90 seconds of forward movement of the vehicle. The vehicle must be moving above 6 mph (10 km/h) to activate the feature. Once the trailer has been detected, the system will default to the maximum blind spot zone until the length has been verified. You will see “Auto” in the instrument panel cluster .
- *Maximum Mode* – When “Max Mode” is selected, the system will default to the maximum blind spot zone regardless of what size trailer is attached .

NOTE:

Selected setting is stored when the ignition is placed in the OFF position. To change this setting, it must be selected through the Uconnect Settings ➔ page 209.

Trailer Length Detection

Once the trailer presence has been established, the trailer length will be established (by making a 90 degree turn) and then the trailer length category (e.g. 10-20 ft (3 m to 6 m)) will be displayed. This can take up to 30 seconds after completing the turn.

NOTE:

During the same ignition cycle, if the vehicle is at a standstill for a minimum of 90 seconds, a new “trailer detection request” is enabled by the system once the vehicle resumes motion.

Maximum length supported by the Trailer Merge Assist feature is 39.5 ft (12 m). Trailer length is considered the forward most portion of the trailer hitch to the rearward most portion of the body, fascia/bumper, or ramp of the trailer.

Maximum width supported by the Trailer Merge Assist feature is 8.5 ft (2.59 m). Trailer width is measured at the widest portion of the trailer and may include wheels, tires, finders, or rails.

NOTE:

Fifth wheel or gooseneck trailers are not supported by Trailer Merge Assist.

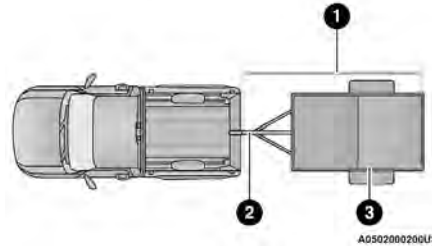

Trailer Length Detection

- 1 – Trailer Length
2 – Trailer Hitch
3 – Trailer Width

Trailer length will be identified and placed into one of the following categories:

- Trailer length up to 10 ft (3 m) – Blind Spot zone will be adjusted to 10 ft (3 m) 🚗 🚗 .
- Trailer length between 10 ft to 20 ft (3 m to 6 m) – Blind Spot zone will be adjusted to 20 ft (6 m) 🚗 🚗 .
- Trailer length between 20 ft to 30 ft (6 m to 9 m) – Blind Spot zone will be adjusted to 30 ft (9 m) 🚗 🚗 .
- Trailer length between 30 ft and 39.5 ft (9 m to 12 m) – Blind Spot zone will be adjusted to Max distance 🚗 .

NOTE:

Trailer length is determined within +/- 3 ft (1 m) of actual length. Trailers that are the same size as the category limit, 10/20/30 ft (3/6/9 m), could be subject to being placed in the category above or below the correct one.

Trailer Merge Warning

Trailer Merge Warning is the extension of the blind spot function to cover the length of the trailer, plus a safety margin, to warn the driver when there is a vehicle in the adjacent lane. The driver is alerted by the illumination of the BSM Warning Light located in the outside mirror on the side the other vehicle is detected on. In addition, an audible (chime) alert will be heard and radio volume reduced ➔ page 275.

NOTE:

- The Trailer Merge Alert system DOES NOT alert the driver about rapidly approaching vehicles that are outside the detection zones.
- The BSM system may experience dropouts (blinking on and off) of the side mirror warning indicator lights when a motorcycle or any small object remains at the side of the vehicle for extended periods of time (more than a couple of seconds).
- Crowded areas such as parking lots, neighborhoods, etc. may lead to an increased amount of false alerts. This is normal operation.

WARNING!

The Blind Spot Monitoring system is only an aid to help detect objects in the blind spot zones. The BSM system is not designed to detect pedestrians, bicyclists, or animals. Even if your vehicle is equipped with the BSM system, always check your vehicle's mirrors, glance over your shoulder, and use your turn signal before changing lanes. Failure to do so can result in serious injury or death.

FORWARD COLLISION WARNING (FCW) WITH MITIGATION — IF EQUIPPED

FCW with Mitigation provides the driver with audible warnings, visual warnings (within the instrument cluster display), and may apply a haptic warning in the form of a brake jerk, to warn the driver when it detects a potential frontal collision. The warnings are intended to provide the driver with enough time to react, avoid or mitigate the potential collision.

NOTE:

FCW monitors the information from the forward looking sensors as well as the Electronic Brake Controller (EBC), to calculate the probability of a forward collision. When the system determines that a forward collision is probable, the driver will be provided with audible and visual warnings as well as a possible haptic warning in the form of a brake jerk.

If the driver does not take action based upon these progressive warnings, then the system will provide a limited level of active braking to help slow the vehicle and mitigate the potential forward collision. If the driver reacts to the warnings by braking and the system determines that the driver intends to avoid the collision by braking but has not applied sufficient brake force, the system will compensate and provide additional brake force as required. When towing a trailer, the system will also respond to activate the trailer brakes (if equipped).

If an FCW with Mitigation event begins at a speed below 32 mph (52 km/h), the system may provide the maximum braking possible to mitigate the potential forward collision. If the Forward Collision Warning with Mitigation event stops the vehicle completely, the system will hold the vehicle at standstill for two seconds and then release the brakes.



FCW Message

When the system determines a collision with the vehicle in front of you is no longer probable, the warning message will be deactivated ↵ page 404.

NOTE:

- The minimum speed for FCW activation is 3 mph (5 km/h).
- The FCW alerts may be triggered on objects other than vehicles such as guardrails or sign posts based on the course prediction. This is expected and is a part of normal FCW activation and functionality.
- It is unsafe to test the FCW system. To prevent such misuse of the system, after four Active Braking events within a key cycle, the Active Braking portion of FCW will be deactivated until the next key cycle.
- The FCW system is intended for on-road use only. If the vehicle is taken off-road, the FCW system should be deactivated to prevent unnecessary warnings to the surroundings.
- FCW may not react to irrelevant objects such as overhead objects, ground reflections, objects not in the path of the vehicle, stationary objects that are far away, oncoming traffic, or leading vehicles with the same or higher rate of speed.
- FCW will be disabled like ACC, with the unavailable screens.
- During an FCW event when towing a trailer, your Electronic Brake system will respond by activating the trailer brakes (if equipped).

WARNING!

Forward Collision Warning (FCW) is not intended to avoid a collision on its own, nor can FCW detect every type of potential collision. The driver has the responsibility to avoid a collision by controlling the vehicle via braking and steering. Failure to follow this warning could lead to serious injury or death.

Turning FCW On Or Off

The FCW button is located in the Uconnect display in the control settings. For further information, see [page 209](#).

- To turn the FCW system on, press the Forward Collision button once.
- To turn the FCW system off, press the Forward Collision button once.

NOTE:

- When the FCW is "on", this allows the system to warn the driver of a possible collision with the vehicle in front.
- When the FCW is "off", this prevents the system from warning the driver of a possible collision with the vehicle in front. If the FCW is set to "off", "FCW OFF" will be displayed in the instrument cluster display.
- When FCW status is set to "Only Warning", this prevents the system from providing limited Active Braking, or additional brake support if the driver is not braking adequately in the event of a potential frontal collision.

- When FCW status is set to "Warning and Braking", this allows the system to warn the driver of a possible collision with the vehicle in front using audible/visual warnings and it applies autonomous braking.
- The FCW system state is defaulted to "Full On" from one ignition cycle to the next. If the system is turned off, it will reset to "Full On" when the vehicle is restarted.

FCW Braking Status And Sensitivity

The FCW Sensitivity and Active Braking status are programmable through the Uconnect system [page 209](#).

The default sensitivity of FCW is the "Medium" setting and the system status is "Warning & Braking". This allows the system to warn the driver of a possible collision with the vehicle in front using audible/visual warnings and it applies autonomous braking.

By changing the FCW status setting to "Far", the system provides possible collision warnings on objects farther away. This results in earlier warnings and provides the most reaction time to avoid possible collisions.

NOTE:

The "Far" setting may result in a greater number of FCW possible collision warnings experienced.

By changing the FCW status setting to "Near", the system provides possible collision warnings on objects closer to the vehicle. This results in later warnings and provides less reaction time than the "Far" and "Medium" settings, which allows for a more dynamic driving experience.

NOTE:

The "Near" setting may result in a lesser number of FCW possible collision warnings experienced.

NOTE:

- Changing the FCW status to "Only Warning" prevents the system from providing limited active braking, or additional brake support if the driver is not braking adequately in the event of a potential frontal collision, but maintains the audible and visual warnings.
- Changing the FCW status to "Off" prevents the system from providing autonomous braking, or additional brake support if the driver is not braking adequately in the event of a potential frontal collision.
- The system will retain the last setting selected by the driver after ignition shut down.
- FCW may not react to irrelevant objects such as overhead objects, ground reflections, objects not in the path of the vehicle, stationary objects that are far away, oncoming traffic, or leading vehicles with the same or higher rates of speed.
- FCW will be disabled like ACC, with the unavailable screens.

FCW Limited Warning

If the instrument cluster displays "ACC/FCW Limited Functionality" or "ACC/FCW Limited Functionality Clean Front Windshield" momentarily, there may be a condition that limits FCW functionality. Although the vehicle is still drivable under normal conditions, Active Braking may not be fully available. Once the condition that limited the system performance is no longer present, the system will return to its full performance state. If the problem persists, see an authorized dealer.

Service FCW Warning

If the system turns off, and the instrument cluster displays:

- ACC/FCW Unavailable Service Required
- Cruise/FCW Unavailable Service Required

This indicates there is an internal system fault. Although the vehicle is still drivable under normal conditions, have the system checked by an authorized dealer.

Pedestrian Emergency Braking (PEB) — If Equipped

PEB is a subsystem of the Forward Collision Warning (FCW) system which provides the driver with audible warnings and visual warnings, in the instrument cluster display. It may apply limited automatic braking when it detects a potential frontal collision with a pedestrian/cyclist.

If a PEB event begins at a speed below 39 mph (62 km/h), the system may provide maximum braking to mitigate the potential collision with a pedestrian/cyclist. If the PEB event stops the vehicle completely, the system will hold the vehicle at a standstill for two seconds and then release the brakes. When the system determines a collision with the pedestrian/cyclist in front of you is no longer probable, the warning message will be deactivated.

The minimum speed for PEB activation is 3 mph (5 km/h).

WARNING!

Pedestrian Emergency Braking (PEB) is not intended to avoid a collision on its own, nor can PEB detect every type of potential collision with a pedestrian/cyclist. The driver has the responsibility to avoid a collision by controlling the vehicle via braking and steering. Failure to follow this warning could lead to serious injury or death.

Turning PEB On Or Off

NOTE:

The default status of PEB is “On.” This allows the system to warn you of a possible frontal collision with the pedestrian/cyclist.

The PEB button is located in the Uconnect display in the Control settings ↪ page 209.

To turn the PEB system off, push the Pedestrian Emergency Braking button.

To turn the PEB system back on, push the Warning Active Braking button.

Changing the PEB status to “Off” deactivates the system, so no warning or active braking will be available in case of a possible frontal collision with the pedestrian/cyclist.

NOTE:

The PEB system will retain the last setting selected by the driver after ignition shut down. The system will not reset to the default setting when the vehicle is restarted.

TIRE PRESSURE MONITORING SYSTEM (TPMS)

The Tire Pressure Monitoring System (TPMS) will warn the driver of a low tire pressure based on the vehicle recommended cold placard pressure.

NOTE:

The TPMS Warning Light will illuminate in the instrument cluster and a chime will sound when tire pressure is low in one or more of the four active road tires. In addition, the instrument cluster will display a graphic showing the pressure values of each tire with the low tire pressure values in a different color, or the Uconnect radio will display a TPMS message. When this occurs you must increase the tire pressure to the recommended cold placard pressure in order for the TPMS Warning Light to turn off.

The tire pressure will vary with temperature by about 1 psi (7 kPa) for every 12 °F (6.5 °C). This means that when the outside temperature decreases, the tire pressure will decrease. Tire pressure should always be set based on cold inflation tire pressure. This is defined as the tire pressure after the vehicle has not been driven for at least three hours, or driven less than 1 mile (1.6 km) after a three hour period. The cold tire inflation pressure must not exceed the maximum inflation pressure molded into the tire sidewall. The tire pressure will also increase as the vehicle is driven — this is normal and there should be no adjustment for this increased pressure.

See ↪ page 372 on how to properly inflate the vehicle's tires.

The TPMS will warn the driver of a low tire pressure if the tire pressure falls below the low-pressure warning limit for any reason, including low temperature effects and natural pressure loss through the tire.

The TPMS will continue to warn the driver of low tire pressure as long as the condition exists, and will not turn off until the tire pressure is at or above the recommended cold placard pressure. Once the low TPMS Warning Light illuminates, you must increase the tire pressure to the recommended cold placard pressure in order for the TPMS Warning Light to turn off. The system will automatically update and the TPMS Warning Light will turn off once the system receives the updated tire pressures. The vehicle may need to be driven for up to 20 minutes above 15 mph (24 km/h) in order for the TPMS to receive this information.

NOTE:

When filling warm tires, the tire pressure may need to be increased up to an additional 4 psi (28 kPa) above the recommended cold placard pressure in order to turn the TPMS Warning Light off.

For example, your vehicle may have a recommended cold (parked for more than three hours) placard pressure of 30 psi (207 kPa). If the ambient temperature is 68 °F (20 °C) and the measured tire pressure is 27 psi (186 kPa), a temperature drop to 20 °F (-7 °C) will decrease the tire pressure to approximately 23 psi (158 kPa). This tire pressure is sufficiently low enough to turn on the TPMS Warning Light. Driving the vehicle may cause the tire pressure to rise to approximately 27 psi (186 kPa), but the TPMS Warning Light will still be on. In this situation, the TPMS Warning Light will turn off only after the tires are inflated to the vehicle's recommended cold placard pressure value.

CAUTION!

- The TPMS has been optimized for the original equipment tires and wheels. TPMS pressures and warning have been established for the tire size equipped on your vehicle. Undesirable system operation or sensor damage may result when using replacement equipment that is not of the same size, type, and/or style. Aftermarket wheels can cause sensor damage.
- Using aftermarket tire sealants may cause the Tire Pressure Monitoring System (TPMS) sensor to become inoperable. After using an aftermarket tire sealant it is recommended that you take your vehicle to an authorized dealership to have your sensor function checked.
- After inspecting or adjusting the tire pressure always reinstall the valve stem cap. This will prevent moisture and dirt from entering the valve stem, which could damage the TPMS sensor.

NOTE:

- The TPMS is not intended to replace normal tire care and maintenance or to provide warning of a tire failure or condition.
- If your vehicle is not equipped with the Tire Fill Alert feature the TPMS should not be used as a tire pressure gauge while adjusting your tire pressure.
- Driving on a significantly underinflated tire causes the tire to overheat and can lead to tire failure. Underinflation also reduces fuel efficiency and tire tread life, and may affect the vehicle's handling and stopping ability.

- The TPMS is not a substitute for proper tire maintenance, and it is the driver's responsibility to maintain correct tire pressure using an accurate tire pressure gauge, even if underinflation has not reached the level to trigger illumination of the TPMS Warning Light.
- Seasonal temperature changes will affect tire pressure, and the TPMS will monitor the actual tire pressure in the tire.

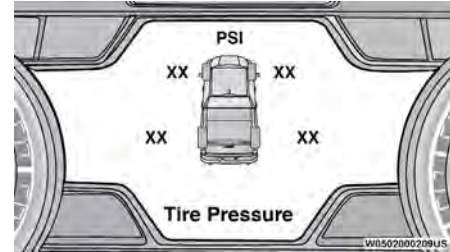

Example: Tire Pressure Monitoring System Display

The TPMS uses wireless technology with wheel rim mounted electronic sensors to monitor tire pressure levels. Sensors, mounted to each wheel as part of the valve stem, transmit tire pressure readings to the receiver module.

NOTE:

It is particularly important for you to check the tire pressure in all of the tires on your vehicle monthly and to maintain the proper pressure.

The TPMS consists of the following components:

- Receiver module
- Four TPMS sensors
- Various TPMS messages, which display in the instrument cluster
- TPMS Warning Light

Tire Pressure Monitoring System Low Pressure Warnings



The Tire Pressure Monitoring System Warning Light will illuminate in the instrument cluster when tire pressure is low in one or more of the four active road tires. In addition, the instrument cluster will display a graphic showing the pressure values of each tire with the low tire pressure values in a different color. An "Inflate to XX" message will also be displayed.

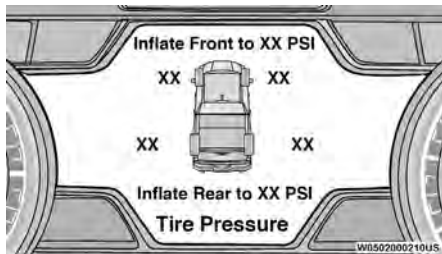

Example: Low Tire Pressure Display

Should this occur, you should stop as soon as possible and inflate the tires with a low pressure condition (those in a different color in the instrument cluster graphic) to the vehicle's recommended cold placard pressure inflation value as shown in the "Inflate to XX" message. Once the system receives the updated tire pressures, the system will automatically update, the graphic display in the instrument cluster will return to its original color, and the Tire Pressure Monitoring System Warning Light will turn off. The vehicle may need to be driven for up to 20 minutes above 15 mph (24 km/h) in order for the TPMS to receive this information.

NOTE:

When filling warm tires, the tire pressure may need to be increased up to an additional 4 psi (28 kPa) above the recommended cold placard pressure in order to turn the Tire Pressure Monitoring System Warning Light off.

Service TPMS Warning

If a system fault is detected, the TPMS Warning Light will flash on and off for 75 seconds and then remain on solid. In addition, the instrument cluster will display a "SERVICE TPM SYSTEM" message for a minimum of five seconds and then display dashes (-) in place of the pressure value to indicate which sensor is not being received.

If the ignition switch is cycled, this sequence will repeat, providing the system fault still exists. If the system fault no longer exists, the TPMS Warning Light will no longer flash, and the "SERVICE TPM SYSTEM" message will no longer display, and a pressure value will display in place of the dashes. A system fault can occur due to any of the following:

- Signal interference due to electronic devices or driving next to facilities emitting the same radio frequencies as the TPMS sensors.
- Installing aftermarket window tinting that contains materials that may block radio wave signals.
- Accumulation of snow or ice around the wheels or wheel housings.
- Using tire chains on the vehicle.
- Using wheels/tires not equipped with TPMS sensors.

A system fault may occur due to an incorrect TPMS sensor location condition. When a system fault occurs due to an incorrect TPMS sensor location, the TPMS Warning Light will flash on and off for 75 seconds and then remain on solid. The system fault will also sound a chime. In addition, the instrument cluster will display a "Tire Pressure Temporarily Unavailable" message in place of the tire pressure display screen. If the ignition switch is cycled, this sequence will repeat, providing the system fault still exists. If the system fault no longer exists, the TPMS Warning Light will no longer flash and the tire pressure display screen will be displayed showing the tire pressure values in the correct locations.

Vehicles With Non-Matching Full Size Spare Or Compact Spare

- The non-matching full size spare or compact spare tire does not have a TPMS sensor. Therefore, the TPMS will not monitor the pressure in the non-matching full size spare or compact spare tire.
- If you install the non-matching full size spare or compact spare tire in place of a road tire that has a pressure below the low-pressure warning limit, upon the next ignition switch cycle, the TPMS Warning Light and a "LOW TIRE" message will remain on and a chime will sound. In addition, the graphic in the instrument cluster will still display a pressure value in a different color and an "Inflate to XX" message.

- After driving the vehicle for up to 20 minutes above 15 mph (24 km/h), the TPMS Warning Light will flash on and off for 75 seconds and then remain on solid. In addition, the instrument cluster will display a "SERVICE TPM SYSTEM" message for a minimum of five seconds and then display dashes (- -) in place of the pressure value.
- For each subsequent ignition switch cycle, a chime will sound, the TPMS Warning Light will flash on and off for 75 seconds and then remain on solid, and the instrument cluster will display a "SERVICE TPM SYSTEM" message for a minimum of five seconds and then display dashes (- -) in place of the pressure value.
- Once you repair or replace the original road tire and reinstall it on the vehicle in place of the non-matching full size spare or compact spare, the TPMS will update automatically. In addition, the TPMS Warning Light will turn off and the graphic in the instrument cluster will display a new pressure value instead of dashes (- -), as long as no tire pressure is below the low-pressure warning limit in any of the four active road tires. The vehicle may need to be driven for up to 20 minutes above 15 mph (24 km/h) in order for the TPMS to receive this information.

Trailer Tire Pressure Monitoring System (TTPMS) — If Equipped

The Trailer Tire Pressure Monitoring System (TTPMS) is a feature that displays the trailer tire pressure values and warns the driver of a low tire pressure event based on the drivers set target tire pressure value, through the TTPMS settings found in the radio.

The TTPMS monitors the pressure of each tire and warns the driver through the instrument cluster, when either a low tire pressure condition falls below 25% of the drivers set pressure or if a system malfunction occurs. The instrument cluster will display the actual tire pressure or dashes for each of the trailer tires in the correct trailer position, based on trailer configuration. The TTPMS can support up to 12 trailer tires per configured trailer on up to four configurable trailers
 ↪ page 209.

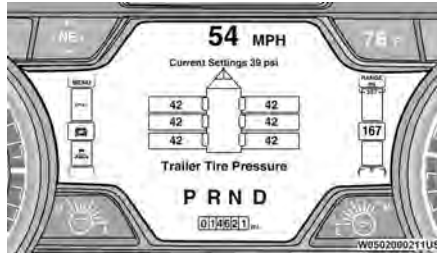

Trailer Tire Pressure Monitoring System

Trailer Tire Pressure Sensor Pairing

In order use this feature, the provided tire pressure sensors must be installed in the desired trailer tires and the sensors must be paired to the truck. If the target trailer requires more than the provided four sensors, additional sensors can be purchased at an authorized Ram dealership.

With the sensors installed and the trailer near or connected to your Ram truck, initiate the pairing process by entering the settings menu in the radio and selecting trailer. Select the desired trailer profile to pair to, open the "Tire Pressure" menu, and hit "Setup All Tires"
 ↪ page 209.

NOTE:

The vehicle may not be driven until the pairing process is complete.



Trailer Tire Pressure Settings



Trailer Tire Pressure Pairing

Follow the on screen prompts to select the number of axles (1 - 3), the number of trailer tires (2, 4, 6, 8, or 12), and the set trailer tire pressure. The range is selectable anywhere between 25-125 psi (172-862 kPa).

Once psi (kPa) is programmed, the pairing screen appears. Tire sensors must be paired in order shown. Starting with Tire 1, deflate tire by 5 psi (34 kPa) and wait for a horn chirp. It may take up to three minutes for the chirp to occur, indicating that the sensor has paired. Repeat process on each tire, in order, until complete. Do not exit the pairing screen until process is complete. If pairing was unsuccessful, a double horn chirp will sound, and a prompt on the touchscreen will allow you to retry the procedure; "Retry" will only appear when setup fails. Each tire must be successfully paired during a single pairing process to receive the success screen.

NOTE:

If the pairing process times out after three minutes of no communication with a sensor, a double horn chirp will occur indicating the pairing has failed and a message will display on the radio indicating the process was unsuccessful. Under certain circumstances, the double horn chirp may continue to happen every three minutes indicating the failed pairing. If this happens, the horn chirping may be canceled by cycling the ignition button OFF and then back to RUN position.

Trailer Tire Pressure Monitoring System Low Pressure Warnings

When a tire pressure low in one or more of the active road tires is detected, the instrument cluster will display a message stating "Trailer Tire Pressure Low". The instrument cluster will then display the TTPMS graphic showing the pressure values of each tire with the low tire pressure values in a different color.

Should this occur, you should stop as soon as possible and inflate the tires with a low pressure condition (those in a different color in the instrument cluster graphic) to the customer programmed target tire pressure value as shown at the top of the TTPMS instrument cluster graphic. Once the tire(s) are inflated, the system will automatically update the graphic display in the instrument cluster, returning to its original color. The vehicle may need to be driven for up to 10 minutes above 15 mph (24 km/h) in order for the TTPMS to receive the updated information.

Service TTPMS Warning

If a system fault is detected, the instrument cluster will display a "Trailer Tire Pressure System Service Required" message for a minimum of five seconds.

Once the system fault is corrected the "Trailer Tire Pressure System Service Required" message will no longer be displayed. The vehicle may need to be driven for up to 10 minutes above 15 mph (24 km/h) in order for the TTPMS to receive the trailer tire pressure information.

Trailer Tire Pressure Monitoring System Not Configured

A "Trailer Tire Pressure System Not Configured" message will be displayed in the instrument cluster on the TTPMS instrument cluster graphic when a trailer number is selected that has not had trailer tire pressure sensors paired. To correct this condition, see  page 209.

Trailer Sensors Detected Do Not Match Active Trailer

The "Trailer Sensors Detected Do Not Match Active Trailer" message will be displayed in the instrument cluster when the trailer sensors being received by the TTPMS module do not match the trailer sensors paired to the current trailer number selected. This message will be displayed when the sensors being received completely match the sensors paired to another trailer number configured in the TTPMS module.

To correct this condition, the correct trailer number must be selected in the radio  page 209.

System Limitations

The TTPMS may have difficulty transmitting through steel-walled tires or on trailers longer than 30 ft. It is recommended to use standard tires and trailers less than 30 ft long to avoid dropouts or difficulty when pairing.

NOTE:

The vehicle may not be driven until the pairing process is complete.

Tire Fill Alert

This feature notifies the user when the placard tire pressure is attained while inflating or deflating the tire. The customer may choose to disable or enable the Tire Fill Alert feature through use of the customer settings in the radio.

NOTE:

- Only one tire can be filled at a time when using the Tire Fill Alert system.
- The Tire Fill Alert feature cannot be entered if an existing TPMS fault is set to "active" or if the system is in deactivation mode (if equipped).

The system will be activated when the system detects an increase of tire pressure, while filling the tire. The ignition must be in the RUN mode, with the transmission in PARK (P).

NOTE:

It is not required to have the engine running to enter Tire Fill Alert mode.

The hazard lamps will come on to confirm the vehicle is in Tire Fill Alert mode.

If the hazard lamps do not come on while inflating the tire, the TPMS sensor may be in an inoperative position, preventing the TPMS sensor signal from being received. In this case, the vehicle may need to be moved slightly forward or backward.

When Tire Fill Alert mode is entered, the tire pressure display screen will be displayed in the instrument cluster.

Operation:

- The horn will chirp once to let the user know when to stop filling the tire, when it reaches recommended pressure.
- The horn will chirp three times if the tire is overfilled and will continue to chirp every five seconds if the user continues to inflate the tire.
- The horn will chirp once again when enough air is let out to reach proper inflation level.
- The horn will also chirp three times if the tire is then underinflated and will continue to chirp every five seconds if the user continues to deflate the tire.

NOTE:

After use, the TFA feature will NOT remain active after ignition shut down. The feature will need to be re-enabled when the vehicle is restarted ↪ page 209.

SELECTABLE TIRE FILL ALERT (STFA)

The Selectable Tire Fill Alert (STFA) system is an optional feature that is included as part of the normal Tire Fill Alert system. The system is designed to allow the customer to select a pressure to inflate or deflate the vehicle's front and rear axle tires to and to provide feedback to the customer while inflating or deflating the vehicle's tires.

In the Selectable Tire Fill Alert application, which is located in the apps menu of the Uconnect system, the customer will be able to select a pressure setting for both the front and rear axle tire pressures by scrolling through a pressure range from XX to 15 psi in 1 psi increments for each axle setting. XX = the vehicle's cold placard pressure values for the front and rear axles as shown on the vehicle placard pressure label.

NOTE:

The Tire Fill Alert feature disables every time the ignition is placed in the OFF position. The feature must be re-enabled through the radio each time the ignition is placed back in the ON/RUN position ↪ page 209.

The customer may also store the pressure values chosen for each axle in the radio as a preset pressure. The customer will be allowed to store up to two sets of preset values in the radio for the front and rear axle pressure values.

Once the customer selects the tire pressures for the front and rear axles that they want to inflate or deflate to, they can begin inflating or deflating one tire at a time.

NOTE:

The STFA system will only support inflating or deflating one tire at a time.

The customer may choose to disable or enable the STFA feature through use of the TFA settings in the radio. If STFA appears grayed out it must be turned on prior to selecting.

In order to use STFA, the Tire Fill Alert feature must be enabled through the radio ↪ page 209.

The system will be activated when the TPMS receiver module detects a change in tire pressure. The ignition must be in the RUN mode, with the transmission in PARK (P).

The Hazard Warning flashers will come on to confirm the vehicle is in Tire Fill Alert mode.

If the Hazard Warning flashers do not come on while inflating or deflating the tire, the TPMS sensor may be in an inoperative position, preventing the TPMS sensor signal from being received. In this case, the vehicle may need to be moved slightly forward or backward.

When Tire Fill Alert mode is entered, the tire pressure display screen will be displayed in the instrument cluster.

Operation:

- The horn will chirp once when the selected pressure is reached to let the user know when to stop inflating or deflating the tire.
- The horn will chirp three times if the tire is overinflated or over deflated and will continue to chirp every five seconds if the user continues to inflate or deflate the tire.
- The horn will chirp once again when enough air is added or removed to reach proper selected pressure level.

Tire Pressure Information System (TPIS) 3500 Series Trucks

Your vehicle may be equipped with a TPIS.

The TPIS uses wireless technology with wheel rim mounted electronic sensors to transmit tire pressure levels. Sensors mounted to each wheel as part of the valve stem transmit tire pressure readings to the receiver module.

NOTE:

It is particularly important for you to check the tire pressure in all of the tires on your vehicle monthly and to maintain the proper pressure.

The TPIS consists of the following components:

- Receiver module
- Four TPMS sensors (Single Rear Wheel (SRW) applications)
- Six TPMS sensors (Dual Rear Wheel (DRW) applications)
- Pressure display in the instrument cluster

The TPIS will display all four (Single Rear Wheel (SRW) applications) or six (Dual Rear Wheel (DRW) applications) tire pressure values in the instrument cluster display.

If a system fault is detected, the instrument cluster will display a "SERVICE TPM SYSTEM" message for a minimum of five seconds and then display dashes (- -) in place of the pressure value to indicate which sensor is not being received.

If the ignition switch is cycled, this sequence will repeat, providing the system fault still exists. If the system fault no longer exists, the "SERVICE TPM SYSTEM" message will no longer be displayed, and a pressure value will display in place of the dashes. A system fault can occur due to any of the following:

- Signal interference due to electronic devices or driving next to facilities emitting the same radio frequencies as the TPMS sensors.
- Installing aftermarket window tinting that contains materials that may block radio wave signals.
- Accumulation of snow or ice around the wheels or wheel housings.
- Using tire chains on the vehicle.
- Using wheels/tires not equipped with TPMS sensors.

OCCUPANT RESTRAINT SYSTEMS

Some of the most important safety features in your vehicle are the restraint systems:

OCCUPANT RESTRAINT SYSTEMS FEATURES

- Seat Belt Systems
- Supplemental Restraint Systems (SRS) Air Bags
- Child Restraints

Some of the safety features described in this section may be standard equipment on some models, or may be optional equipment on others. If you are not sure, ask an authorized dealer.

IMPORTANT SAFETY PRECAUTIONS

Please pay close attention to the information in this section. It tells you how to use your restraint system properly, to keep you and your passengers as safe as possible.

Here are some simple steps you can take to minimize the risk of harm from a deploying air bag:

1. Children 12 years old and under should always ride buckled up in the rear seat of a vehicle with a rear seat.
2. A child who is not big enough to wear the vehicle seat belt properly must be secured in the appropriate child restraint or belt-positioning booster seat in a rear seating position ↪ page 299.
3. If a child from 2 to 12 years old (not in a rear-facing child restraint) must ride in the front passenger seat, move the seat as far back as possible and use the proper child restraint ↪ page 299.

4. Never allow children to slide the shoulder belt behind them or under their arm.
5. You should read the instructions provided with your child restraint to make sure that you are using it properly.
6. All occupants should always wear their lap and shoulder belts properly.
7. The driver and front passenger seats should be moved back as far as practical to allow the front air bags room to inflate.
8. Do not lean against the door or window. If your vehicle has side air bags, and deployment occurs, the side air bags will inflate forcefully into the space between occupants and the door and occupants could be injured.
9. If the air bag system in this vehicle needs to be modified to accommodate a disabled person, see ↪ page 401 for customer service contact information.

WARNING!

- Never place a rear-facing child restraint in front of an air bag. A deploying passenger front air bag can cause death or serious injury to a child 12 years or younger, including a child in a rear-facing child restraint.
- Never install a rear-facing child restraint in the front seat of a vehicle. Only use a rear-facing child restraint in the rear seat. If the vehicle does not have a rear seat, do not transport a rear-facing child restraint in that vehicle.

SEAT BELT SYSTEMS

Buckle up even though you are an excellent driver, even on short trips. Someone on the road may be a poor driver and could cause a collision that includes you. This can happen far away from home or on your own street.

Research has shown that seat belts save lives, and they can reduce the seriousness of injuries in a collision. Some of the worst injuries happen when people are thrown from the vehicle. Seat belts reduce the possibility of ejection and the risk of injury caused by striking the inside of the vehicle. Everyone in a motor vehicle should be belted at all times.

Enhanced Seat Belt Use Reminder System (BeltAlert)

Driver And Passenger BeltAlert — If Equipped



BeltAlert is a feature intended to remind the driver and outboard front seat passenger (if equipped with outboard front passenger seat BeltAlert) to buckle their seat belts. The BeltAlert feature is active whenever the ignition switch is in the START or ON/RUN position.

The BeltAlert feature is active whenever the ignition switch is in the START or ON/RUN position.

Initial Indication

If the driver is unbuckled when the ignition switch is first in the START or ON/RUN position, a chime will signal for a few seconds. If the driver or outboard front seat passenger (if equipped with outboard front passenger seat BeltAlert) is unbuckled when the ignition switch is first in the START or ON/RUN position the Seat Belt Reminder Light will turn on and remain on until both outboard front seat belts are buckled. The outboard front passenger seat BeltAlert is not active when an outboard front passenger seat is unoccupied.

BeltAlert Warning Sequence

The BeltAlert warning sequence is activated when the vehicle is moving above a specified vehicle speed range and the driver or outboard front seat passenger is unbuckled (if equipped with outboard front passenger seat BeltAlert) (the outboard front passenger seat BeltAlert is not active when the outboard front passenger seat is unoccupied). The BeltAlert warning sequence starts by blinking the Seat Belt Reminder Light and sounding an intermittent chime. Once the BeltAlert warning sequence has completed, the Seat Belt Reminder Light will remain on until the seat belts are buckled. The BeltAlert warning sequence may repeat based on vehicle speed until the driver and occupied outboard front seat passenger seat belts are buckled. The driver should instruct all occupants to buckle their seat belts.

Change Of Status

If the driver or outboard front seat passenger (if equipped with outboard front passenger seat BeltAlert) unbuckles their seat belt while the vehicle is traveling, the BeltAlert warning sequence will begin until the seat belts are buckled again.

The outboard front passenger seat BeltAlert is not active when the outboard front passenger seat is unoccupied. BeltAlert may be triggered when an animal or other items are placed on the outboard front passenger seat or when the seat is folded flat (if equipped). It is recommended that pets be restrained in the rear seat (if equipped) in pet harnesses or pet carriers that are secured by seat belts, and cargo is properly stowed.

BeltAlert can be activated or deactivated by an authorized dealer. FCA US LLC does not recommend deactivating BeltAlert.

NOTE:

If BeltAlert has been deactivated and the driver or outboard front seat passenger (if equipped with outboard front passenger seat BeltAlert) is unbuckled the Seat Belt Reminder Light will turn on and remain on until the driver and outboard front seat passenger seat belts are buckled.

Lap/Shoulder Belts

All seating positions except the Mega Cab and Crew Cab front center seating position have combination lap/shoulder belts.

The seat belt webbing retractor will lock only during very sudden stops or collisions. This feature allows the shoulder part of the seat belt to move freely with you under normal conditions. However, in a collision the seat belt will lock and reduce your risk of striking the inside of the vehicle or being thrown out of the vehicle.

WARNING!

- Relying on the air bags alone could lead to more severe injuries in a collision. The air bags work with your seat belt to restrain you properly. In some collisions, the air bags won't deploy at all. Always wear your seat belt even though you have air bags.
- In a collision, you and your passengers can suffer much greater injuries if you are not properly buckled up. You can strike the interior of your vehicle or other passengers, or you can be thrown out of the vehicle. Always be sure you and others in your vehicle are buckled up properly.
- It is dangerous to ride in a cargo area, inside or outside of a vehicle. In a collision, people riding in these areas are more likely to be seriously injured or killed.

(Continued)

WARNING!

- Do not allow people to ride in any area of your vehicle that is not equipped with seats and seat belts.
- Be sure everyone in your vehicle is in a seat and using a seat belt properly. Occupants, including the driver, should always wear their seat belts whether or not an air bag is also provided at their seating position to minimize the risk of severe injury or death in the event of a crash.
- Wearing your seat belt incorrectly could make your injuries in a collision much worse. You might suffer internal injuries, or you could even slide out of the seat belt. Follow these instructions to wear your seat belt safely and to keep your passengers safe, too.
- Two people should never be belted into a single seat belt. People belted together can crash into one another in a collision, hurting one another badly. Never use a lap/shoulder belt or a lap belt for more than one person, no matter what their size.

WARNING!

- A lap belt worn too high can increase the risk of injury in a collision. The seat belt forces won't be at the strong hip and pelvic bones, but across your abdomen. Always wear the lap part of your seat belt as low as possible and keep it snug.

*(Continued)***WARNING!**

- A twisted seat belt may not protect you properly. In a collision, it could even cut into you. Be sure the seat belt is flat against your body, without twists. If you can't straighten a seat belt in your vehicle, take it to an authorized dealer immediately and have it fixed.
- A seat belt that is buckled into the wrong buckle will not protect you properly. The lap portion could ride too high on your body, possibly causing internal injuries. Always buckle your seat belt into the buckle nearest you.
- A seat belt that is too loose will not protect you properly. In a sudden stop, you could move too far forward, increasing the possibility of injury. Wear your seat belt snugly.
- A seat belt that is worn under your arm is dangerous. Your body could strike the inside surfaces of the vehicle in a collision, increasing head and neck injury. A seat belt worn under the arm can cause internal injuries. Ribs aren't as strong as shoulder bones. Wear the seat belt over your shoulder so that your strongest bones will take the force in a collision.
- A shoulder belt placed behind you will not protect you from injury during a collision. You are more likely to hit your head in a collision if you do not wear your shoulder belt. The lap and shoulder belt are meant to be used together.

*(Continued)***WARNING!**

- A frayed or torn seat belt could rip apart in a collision and leave you with no protection. Inspect the seat belt system periodically, checking for cuts, frays, or loose parts. Damaged parts must be replaced immediately. Do not disassemble or modify the seat belt system. If your vehicle is involved in a collision, or if you have questions regarding seat belt or retractor conditions, take your vehicle to an authorized FCA dealer or authorized FCA Certified Collision Care Program facility for inspection.

Lap/Shoulder Belt Operating Instructions

1. Enter the vehicle and close the door. Sit back and adjust the seat.
2. The seat belt latch plate is above the back of the front seat, and next to your arm in the rear seat (for vehicles equipped with a rear seat). Grab the latch plate and pull out the seat belt. Slide the latch plate up the webbing as far as necessary to allow the seat belt to go around your lap.

**Pulling Out The Latch Plate**

- When the seat belt is long enough to fit, insert the latch plate into the buckle until you hear a “click.”



Inserting Latch Plate Into Buckle

- Position the lap belt so that it is snug and lies low across your hips, below your abdomen. To remove slack in the lap belt portion, pull up on the shoulder belt. To loosen the lap belt if it is too tight, tilt the latch plate and pull on the lap belt. A snug seat belt reduces the risk of sliding under the seat belt in a collision.

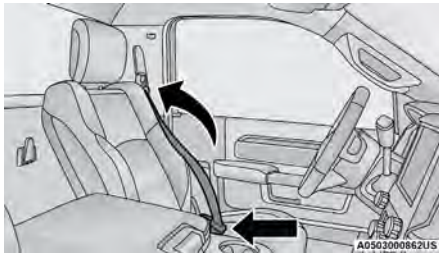

Positioning The Lap Belt

- Position the shoulder belt across the shoulder and chest with minimal, if any slack so that it is comfortable and not resting on your neck. The retractor will withdraw any slack in the shoulder belt.
- To release the seat belt, push the red button on the buckle. The seat belt will automatically retract to its stowed position. If necessary, slide the latch plate down the webbing to allow the seat belt to retract fully.

Lap/Shoulder Belt Untwisting Procedure

Use the following procedure to untwist a twisted lap/shoulder belt.

- Position the latch plate as close as possible to the anchor point.
- At about 6 to 12 inches (15 to 30 cm) above the latch plate, grab and twist the seat belt webbing 180 degrees to create a fold that begins immediately above the latch plate.
- Slide the latch plate upward over the folded webbing. The folded webbing must enter the slot at the top of the latch plate.
- Continue to slide the latch plate up until it clears the folded webbing and the seat belt is no longer twisted.

Adjustable Upper Shoulder Belt Anchorage

In the driver and outboard front passenger seats, the top of the shoulder belt can be adjusted upward or downward to position the seat belt away from your neck. Push or squeeze the anchorage button to release the anchorage, and move it up or down to the position that serves you best.

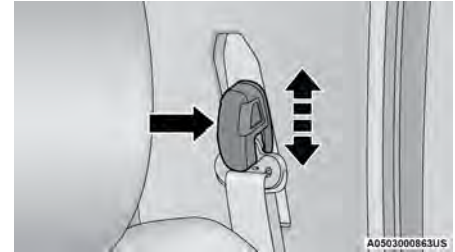

Adjustable Anchorage

As a guide, if you are shorter than average, you will prefer the shoulder belt anchorage in a lower position, and if you are taller than average, you will prefer the shoulder belt anchorage in a higher position. After you release the anchorage button, try to move it up or down to make sure that it is locked in position.

NOTE:

The adjustable upper shoulder belt anchorage is equipped with an Easy Up feature. This feature allows the shoulder belt anchorage to be adjusted in the upward position without pushing or squeezing the release button. To verify the shoulder belt anchorage is latched, pull downward on the shoulder belt anchorage until it is locked into position.

WARNING!

- Wearing your seat belt incorrectly could make your injuries in a collision much worse. You might suffer internal injuries, or you could even slide out of the seat belt. Follow these instructions to wear your seat belt safely and to keep your passengers safe, too.
- Position the shoulder belt across the shoulder and chest with minimal, if any slack so that it is comfortable and not resting on your neck. The retractor will withdraw any slack in the shoulder belt.
- Misadjustment of the seat belt could reduce the effectiveness of the safety belt in a crash.
- Always make all seat belt height adjustments when the vehicle is stationary.

First Row Center Seat Belt Operating Instructions (Regular Cab Only)

The first row center seat belt (Regular Cab only) features a seat belt with a mini-latch plate and buckle, which allows the seat belt to detach from the lower anchor when the seat is folded. The mini-latch plate and regular latch plate can then be stored out of the way in the seat for added convenience to open up utilization of the storage areas behind the front seats when the seat is not occupied.

1. Remove the mini-latch plate and regular latch plate from its stowed position on the seat.

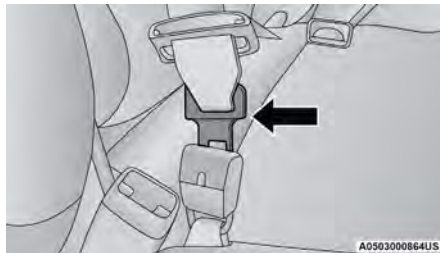

Connect Mini-Latch To Mini-Buckle

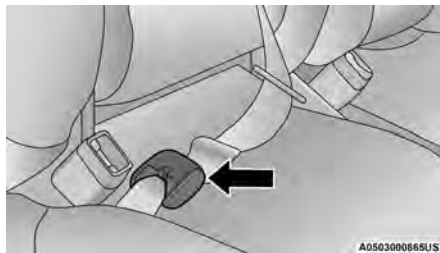

Mini-Latch And Mini-Buckle Connected

2. Grab the mini-latch plate and pull the seat belt over the seat.
3. Route the shoulder belt to the inside of the right head restraint.
4. When the seat belt is long enough to fit, insert the mini-latch plate into the mini-buckle until you hear a "click."
5. Sit back in seat. Slide the regular latch plate up the webbing as far as necessary to allow the seat belt to go around your lap.
6. When the seat belt is long enough to fit, insert the latch plate into the buckle until you hear a "click."
7. Position the lap belt so that it is snug and lies low across your hips, below your abdomen. To remove slack in the lap belt portion, pull up on the shoulder belt. To loosen the lap belt if it is too tight, pull on the lap belt. A snug seat belt reduces the risk of sliding under the seat belt in a collision.
8. Position the shoulder belt on your chest so that it is comfortable and not resting on your neck. The retractor will withdraw any slack in the seat belt.
9. To release the seat belt, push the red button on the buckle.
10. To disengage the mini-latch plate from the mini-buckle for storage, insert the regular latch plate into the center red slot on the mini-buckle. The seat belt will automatically retract to its stowed position. If necessary, slide the latch plate down the webbing to allow the seat belt to retract fully. Insert the mini-latch plate and regular latch plate into its stowed position.



Detaching Mini-Buckle With Seat Belt Tongue

WARNING!

- If the mini-latch plate and mini-buckle are not properly connected when the seat belt is used by an occupant, the seat belt will not be able to provide proper restraint and will increase the risk of injury in a collision.
- When reattaching the mini-latch plate and mini-buckle, ensure the seat belt webbing is not twisted. If the webbing is twisted, follow the preceding procedure to detach the mini-latch plate and mini-buckle, untwist the webbing, and reattach the mini-latch plate and mini-buckle.

First Row Center Lap Belt Operating Instructions — If Equipped

The center seating position for the Mega Cab and Crew Cab front seat has a lap belt only. To buckle the lap belt, slide the latch plate into the buckle until you hear a "click." To lengthen the lap belt, tilt the latch plate and pull.

To remove slack, pull the loose end of the webbing. Wear the lap belt snug against the hips. Sit back and upright in the seat, then adjust the seat belt as tightly as is comfortable.

Seat Belt Extender

If a seat belt is not long enough to fit properly, even when the webbing is fully extended and the adjustable upper shoulder belt anchorage (if equipped) is in its lowest position, an authorized dealer can provide you with a Seat Belt Extender. The Seat Belt Extender should be used only if the existing seat belt is not long enough. When the Seat Belt Extender is not required for a different occupant, it must be removed.

WARNING!

- **ONLY** use a Seat Belt Extender if it is physically required in order to properly fit the original seat belt system. **DO NOT USE** the Seat Belt Extender if, when worn, the distance between the front edge of the Seat Belt Extender buckle and the center of the occupant's body is **LESS** than 6 inches.
- Using a Seat Belt Extender when not needed can increase the risk of serious injury or death in a collision. Only use the Seat Belt Extender when the lap belt is not long enough and only use in the recommended seating positions. Remove and store the Seat Belt Extender when not needed.

Seat Belts And Pregnant Women



Seat Belts And Pregnant Women

Seat belts must be worn by all occupants including pregnant women: the risk of injury in the event of an accident is reduced for the mother and the unborn child if they are wearing a seat belt.

Position the lap belt snug and low below the abdomen and across the strong bones of the hips. Place the shoulder belt across the chest and away from the neck. Never place the shoulder belt behind the back or under the arm.

Seat Belt Pretensioner

The front outboard seat belt system is equipped with pretensioning devices that are designed to remove slack from the seat belt in the event of a collision. These devices may improve the performance of the seat belt by removing slack from the seat belt early in a collision. Pretensioners work for all size occupants, including those in child restraints.

NOTE:

These devices are not a substitute for proper seat belt placement by the occupant. The seat belt still must be worn snugly and positioned properly.

The pretensioners are triggered by the Occupant Restraint Controller (ORC). Like the air bags, the pretensioners are single use items. A deployed pretensioner or a deployed air bag must be replaced immediately.

Energy Management Feature

The front outboard seat belt system is equipped with an Energy Management feature that may help further reduce the risk of injury in the event of a collision. The seat belt system has a retractor assembly that is designed to release webbing in a controlled manner.

Switchable Automatic Locking Retractors (ALR) — If Equipped

The seat belts in the passenger seating positions may be equipped with a Switchable Automatic Locking Retractor (ALR) which is used to secure a child restraint system → page 306.

The figure below illustrates the locking feature for each seating position.

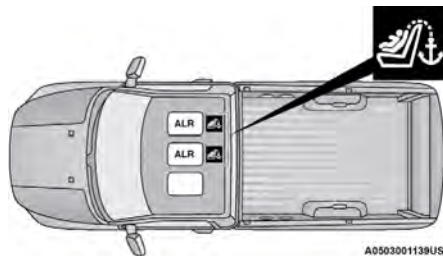

Regular Cab Automatic Locking Retractor (ALR) Locations

ALR — Switchable Automatic Locking Retractor

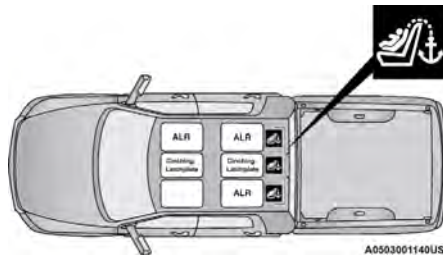

Mega Cab/Crew Cab Automatic Locking Retractor (ALR) Locations

ALR — Switchable Automatic Locking Retractor

If the passenger seating position is equipped with an ALR and is being used for normal usage, only pull the seat belt webbing out far enough to comfortably wrap around the occupant's mid-section so as to not activate the ALR. If the ALR is activated, you will hear a clicking sound as the seat belt retracts. Allow the webbing to retract completely in this case and then carefully pull out only the amount of webbing necessary to comfortably wrap around the occupant's mid-section. Slide the latch plate into the buckle until you hear a "click."

In Automatic Locking Mode, the shoulder belt is automatically pre-locked. The seat belt will still retract to remove any slack in the shoulder belt. Use the Automatic Locking Mode anytime a child restraint is installed in a seating position that has a seat belt with this feature. Children 12 years old and under should always be properly restrained in the rear seat of a vehicle with a rear seat.

WARNING!

- Never place a rear-facing child restraint in front of an air bag. A deploying passenger front air bag can cause death or serious injury to a child 12 years or younger, including a child in a rear-facing child restraint.
- Never install a rear-facing child restraint in the front seat of a vehicle. Only use a rear-facing child restraint in the rear seat. If the vehicle does not have a rear seat, do not transport a rear-facing child restraint in that vehicle.

How To Engage The Automatic Locking Mode

1. Buckle the combination lap and shoulder belt.
2. Grab the shoulder portion and pull downward until the entire seat belt is extracted.
3. Allow the seat belt to retract. As the seat belt retracts, you will hear a clicking sound. This indicates the seat belt is now in the Automatic Locking Mode.

How To Disengage The Automatic Locking Mode

Unbuckle the combination lap/shoulder belt and allow it to retract completely to disengage the Automatic Locking Mode and activate the vehicle sensitive (emergency) locking mode.

WARNING!

- The seat belt assembly must be replaced if the switchable Automatic Locking Retractor (ALR) feature or any other seat belt function is not working properly when checked according to the procedures in the Service Manual.
- Failure to replace the seat belt assembly could increase the risk of injury in collisions.
- Do not use the Automatic Locking Mode to restrain occupants who are wearing the seat belt or children who are using booster seats. The locked mode is only used to install rear-facing or forward-facing child restraints that have a harness for restraining the child.

SUPPLEMENTAL RESTRAINT SYSTEMS (SRS)

Some of the safety features described in this section may be standard equipment on some models, or may be optional equipment on others. If you are not sure, ask an authorized dealer.

The air bag system must be ready to protect you in a collision. The Occupant Restraint Controller (ORC) monitors the internal circuits and interconnecting wiring associated with the electrical Air Bag System Components. Your vehicle may be equipped with the following Air Bag System Components:

Air Bag System Components

- Occupant Restraint Controller (ORC)
- Air Bag Warning Light 
- Steering Wheel and Column
- Instrument Panel
- Knee Impact Bolsters
- Driver and Front Passenger Air Bags
- Seat Belt Buckle Switch
- Supplemental Side Air Bags
- Front and Side Impact Sensors — If Equipped
- Seat Belt Pretensioners
- Seat Track Position Sensors — If Equipped

Air Bag Warning Light



The Occupant Restraint Controller (ORC) monitors the readiness of the electronic parts of the air bag system whenever the ignition switch is in the START or ON/RUN position. If the ignition switch is in the OFF position or in the ACC position, the air bag system is not on and the air bags will not inflate.

The ORC contains a backup power supply system that may deploy the air bag system even if the battery loses power or it becomes disconnected prior to deployment.

The ORC turns on the Air Bag Warning Light in the instrument panel for approximately four to eight seconds for a self-check when the ignition switch is first in the ON/RUN position. After the self-check, the Air Bag Warning Light will turn off. If the ORC detects a malfunction in any part of the system, it turns on the Air Bag Warning Light, either momentarily or continuously. A single chime will sound to alert you if the light comes on again after initial startup.

The ORC also includes diagnostics that will illuminate the instrument panel Air Bag Warning Light if a malfunction is detected that could affect the air bag system. The diagnostics also record the nature of the malfunction. While the air bag system is designed to be maintenance free, if any of the following occurs, have an authorized dealer service the air bag system immediately.

- The Air Bag Warning Light does not come on during the four to eight seconds when the ignition switch is first in the ON/RUN position.
- The Air Bag Warning Light remains on after the four to eight-second interval.
- The Air Bag Warning Light comes on intermittently or remains on while driving.

NOTE:

If the speedometer, tachometer, or any engine related gauges are not working, the Occupant Restraint Controller (ORC) may also be disabled. In this condition the air bags may not be ready to inflate for your protection. Have an authorized dealer service the air bag system immediately.

WARNING!

Ignoring the Air Bag Warning Light in your instrument panel could mean you won't have the air bag system to protect you in a collision. If the light does not come on as a bulb check when the ignition is first turned on, stays on after you start the vehicle, or if it comes on as you drive, have an authorized dealer service the air bag system immediately.

Redundant Air Bag Warning Light

If a fault with the Air Bag Warning Light is detected, which could affect the Supplemental Restraint System (SRS), the Redundant Air Bag Warning Light will illuminate on the instrument panel. The Redundant Air Bag Warning Light will stay on until the fault is cleared. In addition, a single chime will sound to alert you that the Redundant Air Bag Warning Light has come on and a fault has been detected. If the Redundant Air Bag Warning Light comes on intermittently or remains on while driving have an authorized dealer service the vehicle immediately.

For additional information regarding the Redundant Air Bag Warning Light, see ⇨ page 111.

Front Air Bags

This vehicle has front air bags and lap/shoulder belts for both the driver and front passenger. The front air bags are a supplement to the seat belt restraint systems. The driver front air bag is mounted in the center of the steering wheel. The passenger front air bag is mounted in the instrument panel, above the glove compartment. The words "SRS AIRBAG" or "AIRBAG" are embossed on the air bag covers.

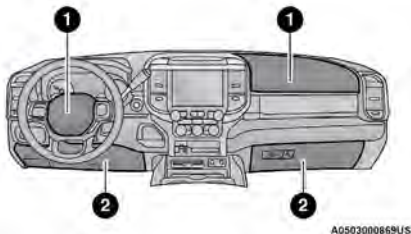

Front Air Bag/Knee Bolster Locations

- 1 — Driver And Passenger Front Air Bags
2 — Driver And Passenger Knee Impact Bolsters

WARNING!

- Being too close to the steering wheel or instrument panel during front air bag deployment could cause serious injury, including death. Air bags need room to inflate. Sit back, comfortably extending your arms to reach the steering wheel or instrument panel.
- Never place a rear-facing child restraint in front of an air bag. A deploying passenger front air bag can cause death or serious injury to a child 12 years or younger, including a child in a rear-facing child restraint.
- Never install a rear-facing child restraint in the front seat of a vehicle. Only use a rear-facing child restraint in the rear seat. If the vehicle does not have a rear seat, do not transport a rear-facing child restraint in that vehicle.

Driver And Passenger Front Air Bag Features**2500 Series Truck**

The Advanced Front Air Bag system has multistage driver and front passenger air bags. This system provides output appropriate to the severity and type of collision as determined by the Occupant Restraint Controller (ORC), which may receive information from the front impact sensors (if equipped) or other system components.

The first stage inflator is triggered immediately during an impact that requires air bag deployment. A low energy output is used in less severe collisions. A higher energy output is used for more severe collisions.

This vehicle may be equipped with a driver and/or front passenger seat belt buckle switch that detects whether the driver or front passenger seat belt is buckled. The seat belt buckle switch may adjust the inflation rate of the Advanced Front Air Bags.

This vehicle may be equipped with driver and/or front passenger seat track position sensors that may adjust the inflation rate of the Advanced Front Air Bags based upon seat position.

3500 Series Truck

The Advanced Front Air Bag system has multistage driver and front passenger air bags. This system provides output appropriate to the severity and type of collision as determined by the Occupant Restraint Controller (ORC), which may receive information from the front impact sensors (if equipped) or other system components.

The first stage inflator is triggered immediately during an impact that requires air bag deployment. A low energy output is used in less severe collisions. A higher energy output is used for more severe collisions.

This vehicle may be equipped with a driver and/or front passenger seat belt buckle switch that detects whether the driver or front passenger seat belt is buckled. The seat belt buckle switch may adjust the inflation rate of the Advanced Front Air Bags.

WARNING!

- No objects should be placed over or near the air bag on the instrument panel or steering wheel because any such objects could cause harm if the vehicle is in a collision severe enough to cause the air bag to inflate.

(Continued)

WARNING!

- Do not put anything on or around the air bag covers or attempt to open them manually. You may damage the air bags and you could be injured because the air bags may no longer be functional. The protective covers for the air bag cushions are designed to open only when the air bags are inflating.
- Relying on the air bags alone could lead to more severe injuries in a collision. The air bags work with your seat belt to restrain you properly. In some collisions, air bags won't deploy at all. Always wear your seat belts even though you have air bags.

Front Air Bag Operation

Front Air Bags are designed to provide additional protection by supplementing the seat belts. Front air bags are not expected to reduce the risk of injury in rear, side, or rollover collisions. The front air bags will not deploy in all frontal collisions, including some that may produce substantial vehicle damage — for example, some pole collisions, truck underrides, and angle offset collisions.

On the other hand, depending on the type and location of impact, front air bags may deploy in crashes with little vehicle front-end damage but that produce a severe initial deceleration.

Because air bag sensors measure vehicle deceleration over time, vehicle speed and damage by themselves are not good indicators of whether or not an air bag should have deployed.

Seat belts are necessary for your protection in all collisions, and also are needed to help keep you in position, away from an inflating air bag.

When the Occupant Restraint Controller (ORC) detects a collision requiring the front air bags, it signals the inflator units. A large quantity of non-toxic gas is generated to inflate the front air bags.

The steering wheel hub trim cover and the upper passenger side of the instrument panel separate and fold out of the way as the air bags inflate to their full size. The front air bags fully inflate in less time than it takes to blink your eyes. The front air bags then quickly deflate while helping to restrain the driver and front passenger.

Knee Impact Bolsters

The Knee Impact Bolsters help protect the knees of the driver and front passenger, and position the front occupants for improved interaction with the front air bags.

WARNING!

- Do not drill, cut, or tamper with the knee impact bolsters in any way.
- Do not mount any accessories to the knee impact bolsters such as alarm lights, stereos, citizen band radios, etc.

Supplemental Side Air Bags

Supplemental Seat-Mounted Side Air Bags (SABs)

This vehicle is equipped with Supplemental Seat-Mounted Side Air Bags (SABs).

Supplemental Seat-Mounted Side Air Bags (SABs) are located in the outboard side of the front seats. The SABs are marked with "SRS AIRBAG" or "AIRBAG" on a label or on the seat trim on the outboard side of the seats.

The SABs may help to reduce the risk of occupant injury during certain side impacts, in addition to the injury reduction potential provided by the seat belts and body structure.



Supplemental Seat-Mounted Side Air Bag Label

When the SAB deploys, it opens the seam on the outboard side of the seatback's trim cover. The inflating SAB deploys through the seat seam into the space between the occupant and the door. The SAB moves at a very high speed and with such a high force that it could injure occupants if they are not seated properly, or if items are positioned in the area where the SAB inflates. Children are at an even greater risk of injury from a deploying air bag.

WARNING!

Do not use accessory seat covers or place objects between you and the Side Air Bags; the performance could be adversely affected and/or objects could be pushed into you, causing serious injury.

Supplemental Side Air Bag Inflatable Curtains (SABICs)

This vehicle is equipped with Supplemental Side Air Bag Inflatable Curtains (SABICs).

Supplemental Side Air Bag Inflatable Curtains (SABICs) are located above the side windows. The trim covering the SABICs is labeled "SRS AIRBAG" or "AIRBAG."

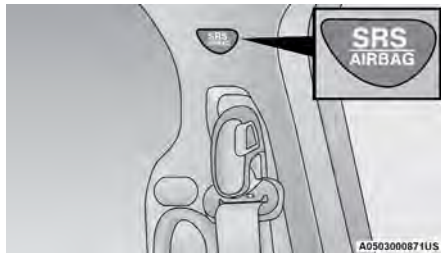

Supplemental Side Air Bag Inflatable Curtain (SABIC) Label Location

SABICs may help reduce the risk of head and other injuries to front and rear seat outboard occupants in certain side impacts, in addition to the injury reduction potential provided by the seat belts and body structure.

The SABIC deploys downward, covering the side windows. An inflating SABIC pushes the outside edge of the headliner out of the way and covers the window. The SABICs inflate with enough force to injure occupants if they are not belted and seated properly, or if items are positioned in the area where the SABICs inflate. Children are at an even greater risk of injury from a deploying air bag.

The SABICs may help reduce the risk of partial or complete ejection of vehicle occupants through side windows in certain side impact events.

WARNING!

- Do not mount equipment, or stack luggage or other cargo up high enough to block the deployment of the SABICs. The trim covering above the side windows where the SABIC and its deployment path are located should remain free from any obstructions.
- In order for the SABICs to work as intended, do not install any accessory items in your vehicle which could alter the roof. Do not add an aftermarket sunroof to your vehicle. Do not add roof racks that require permanent attachments (bolts or screws) for installation on the vehicle roof. Do not drill into the roof of the vehicle for any reason.

Side Impacts

The Side Air Bags are designed to activate in certain side impacts. The Occupant Restraint Controller (ORC) determines whether the deployment of the Side Air Bags in a particular impact event is appropriate, based on the severity and type of collision. The side impact sensors aid the ORC in determining the appropriate response to impact events. The system is calibrated to deploy the Side Air Bags on the impact side of the vehicle during impacts that require Side Air Bag occupant protection. In side impacts, the Side Air Bags deploy independently; a left side impact deploys the left Side Air Bags only and a right-side impact deploys the right Side Air Bags only. Vehicle damage by itself is not a good indicator of whether or not Side Air Bags should have deployed.

The Side Air Bags will not deploy in all side collisions, including some collisions at certain angles, or some side collisions that do not impact the area of the passenger compartment. The Side Air Bags may deploy during angled or offset frontal collisions where the front air bags deploy.

Side Air Bags are a supplement to the seat belt restraint system. Side Air Bags deploy in less time than it takes to blink your eyes.

WARNING!

- Occupants, including children, who are up against or very close to Side Air Bags can be seriously injured or killed. Occupants, including children, should never lean on or sleep against the door, side windows, or area where the side air bags inflate, even if they are in an infant or child restraint.
- Seat belts (and child restraints where appropriate) are necessary for your protection in all collisions. They also help keep you in position, away from an inflating Side Air Bag. To get the best protection from the Side Air Bags, occupants must wear their seat belts properly and sit upright with their backs against the seats. Children must be properly restrained in a child restraint or booster seat that is appropriate for the size of the child.

WARNING!

- Side Air Bags need room to inflate. Do not lean against the door or window. Sit upright in the center of the seat.

(Continued)

WARNING!

- Being too close to the Side Air Bags during deployment could cause you to be severely injured or killed.
- Relying on the Side Air Bags alone could lead to more severe injuries in a collision. The Side Air Bags work with your seat belt to restrain you properly. In some collisions, Side Air Bags won't deploy at all. Always wear your seat belt even though you have Side Air Bags.

NOTE:

Air bag covers may not be obvious in the interior trim, but they will open during air bag deployment.

Rollover Events

Side Air Bags and seat belt pretensioners are designed to activate in certain rollover events. The Occupant Restraint Controller (ORC) determines whether deployment in a particular rollover event is appropriate, based on the severity and type of collision. Vehicle damage by itself is not a good indicator of whether or not Side Air Bags and seat belt pretensioners should have deployed.

The Side Air Bags and seat belt pretensioners will not deploy in all rollover events. The rollover sensing system determines if a rollover event may be in progress and whether deployment is appropriate. In the event the vehicle experiences a rollover or near rollover event, and deployment is appropriate, the rollover sensing system will deploy the side air bags and seat belt pretensioners on both sides of the vehicle.

The SABICs may help reduce the risk of partial or complete ejection of vehicle occupants through side windows in certain rollover or side impact events.

Air Bag System Components

NOTE:

The Occupant Restraint Controller (ORC) monitors the internal circuits and interconnecting wiring associated with electrical Air Bag System Components listed below:

- Occupant Restraint Controller (ORC)
- Air Bag Warning Light 
- Steering Wheel and Column
- Instrument Panel
- Knee Impact Bolsters
- Driver and Front Passenger Air Bags
- Seat Belt Buckle Switch
- Supplemental Side Air Bags
- Front and Side Impact Sensors – If Equipped
- Seat Belt Pretensioners
- Seat Track Position Sensors – If Equipped

If A Deployment Occurs

The front air bags are designed to deflate immediately after deployment.

NOTE:

Front and/or side air bags will not deploy in all collisions. This does not mean something is wrong with the air bag system.

If you do have a collision which deploys the air bags, any or all of the following may occur:

- The air bag material may sometimes cause abrasions and/or skin reddening to the occupants as the air bags deploy and unfold. The abrasions are similar to friction rope burns or those you might get sliding along a carpet or gymnasium floor. They are not caused by contact with chemicals. They are not permanent and normally heal quickly. However, if you haven't healed significantly within a few days, or if you have any blistering, see your doctor immediately.
- As the air bags deflate, you may see some smoke-like particles. The particles are a normal by-product of the process that generates the non-toxic gas used for air bag inflation. These airborne particles may irritate the skin, eyes, nose, or throat. If you have skin or eye irritation, rinse the area with cool water. For nose or throat irritation, move to fresh air. If the irritation continues, see your doctor. If these particles settle on your clothing, follow the garment manufacturer's instructions for cleaning.

Do not drive your vehicle after the air bags have deployed. If you are involved in another collision, the air bags will not be in place to protect you.

WARNING!

Deployed air bags and seat belt pretensioners cannot protect you in another collision. Have the air bags, seat belt pretensioners, and the seat belt retractor assemblies replaced by an authorized dealer immediately. Also, have the Occupant Restraint Controller System serviced as well.

NOTE:

- Air bag covers may not be obvious in the interior trim, but they will open during air bag deployment.
- After any collision, the vehicle should be taken to an authorized dealer immediately.

Enhanced Accident Response System

In the event of an impact, if the communication network remains intact, and the power remains intact, depending on the nature of the event, the Occupant Restraint Controller (ORC) will determine whether to have the Enhanced Accident Response System perform the following functions:

- Cut off fuel to the engine (if equipped)
- Cut off battery power to the electric motor (if equipped)
- Flash hazard lights as long as the battery has power
- Turn on the interior lights, which remain on as long as the battery has power or for 15 minutes from the intervention of the Enhanced Accident Response System
- Unlock the power door locks

Your vehicle may also be designed to perform any of these other functions in response to the Enhanced Accident Response System:

- Turn off the Fuel Filter Heater, Turn off the HVAC Blower Motor, Close the HVAC Circulation Door
- Cut off battery power to the:
 - Engine
 - Electric Motor (if equipped)
 - Electric power steering
 - Brake booster
 - Electric park brake
 - Automatic transmission gear selector
 - Horn
 - Front wiper

NOTE:

After an accident, remember to cycle the ignition to the STOP (OFF/LOCK) position and remove the key from the ignition switch to avoid draining the battery. Carefully check the vehicle for fuel leaks in the engine compartment and on the ground near the engine compartment and fuel tank before resetting the system and starting the engine. If there are no fuel leaks or damage to the vehicle electrical devices (e.g. headlights) after an accident, reset the system by following the procedure described below. If you have any doubt, contact an authorized dealer.

Enhanced Accident Response System Reset Procedure

In order to reset the Enhanced Accident Response System functions after an event, the ignition switch must be changed from ignition START or ON/RUN to ignition OFF. Carefully check the vehicle for fuel leaks in the engine compartment and on the ground near the engine compartment and fuel tank before resetting the system and starting the engine.

After an accident, if the vehicle will not start after performing the reset procedure, the vehicle must be towed to an authorized dealer to be inspected and to have the Enhanced Accident Response System reset.

Maintaining Your Air Bag System

WARNING!

- Modifications to any part of the air bag system could cause it to fail when you need it. You could be injured if the air bag system is not there to protect you. Do not modify the components or wiring, including adding any kind of badges or stickers to the steering wheel hub trim cover or the upper pas-

(Continued)

WARNING!

senger side of the instrument panel. Do not modify the front fascia/bumper, vehicle body structure, or add aftermarket side steps or running boards.

- It is dangerous to try to repair any part of the air bag system yourself. Be sure to tell anyone who works on your vehicle that it has an air bag system.
- Do not attempt to modify any part of your air bag system. The air bag may inflate accidentally or may not function properly if modifications are made. Take your vehicle to an authorized dealer for any air bag system service. If your seat, including your trim cover and cushion, needs to be serviced in any way (including removal or loosening/tightening of seat attachment bolts), take the vehicle to an authorized dealer. Only manufacturer approved seat accessories may be used. If it is necessary to modify the air bag system for persons with disabilities, contact an authorized dealer.

Event Data Recorder (EDR)

This vehicle is equipped with an event data recorder (EDR). The main purpose of an EDR is to record, in certain crash or near crash-like situations, such as an air bag deployment or hitting a road obstacle, data that will assist in understanding how a vehicle's systems performed. The EDR is designed to record data related to vehicle dynamics and safety systems for a short period of time, typically 30 seconds or less. The EDR in this vehicle is designed to record such data as:

- How various systems in your vehicle were operating;
- Whether or not the driver and passenger safety belts were buckled/fastened;

- How far (if at all) the driver was depressing the accelerator and/or brake pedal; and,
- How fast the vehicle was traveling.

These data can help provide a better understanding of the circumstances in which crashes and injuries occur.

NOTE:

EDR data are recorded by your vehicle only if a non-trivial crash situation occurs; no data are recorded by the EDR under normal driving conditions and no personal data (e.g., name, gender, age, and crash location) are recorded. However, other parties, such as law enforcement, could combine the EDR data with the type of personally identifying data routinely acquired during a crash investigation.

To read data recorded by an EDR, special equipment is required, and access to the vehicle or the EDR is needed. In addition to the vehicle manufacturer, other parties, such as law enforcement, that have the special equipment, can read the information if they have access to the vehicle or the EDR.

CHILD RESTRAINTS

Everyone in your vehicle needs to be buckled up at all times, including babies and children. Every state in the United States, and every Canadian province, requires that small children ride in proper restraint systems. This is the law, and you can be prosecuted for ignoring it. Children 12 years or younger should ride properly buckled up in a rear seat, if available. According to crash statistics, children are safer when properly restrained in the rear seats rather than in the front.

WARNING!

In a collision, an unrestrained child can become a projectile inside the vehicle. The force required to hold even an infant on your lap could become so great that you could not hold the child, no matter how strong you are. The child and others could be badly injured or killed. Any child riding in your vehicle should be in a proper restraint for the child's size.

There are different sizes and types of restraints for children from newborn size to the child almost large enough for an adult safety belt. Always check the child seat Owner's Manual to make sure you have the correct seat for your child. Carefully read and follow all the instructions and warnings in the child restraint Owner's Manual and on all the labels attached to the child restraint.

Before buying any restraint system, make sure that it has a label certifying that it meets all applicable Safety Standards. You should also make sure that you can install it in the vehicle where you will use it.

NOTE:

- For additional information, refer to <http://www.nhtsa.gov/parents-and-caregivers> or call: 1-888-327-4236
- Canadian residents should refer to Transport Canada's website for additional information: <https://tc.canada.ca/en/road-transportation/child-car-seat-safety>

Summary Of Recommendations For Restraining Children In Vehicles

	Child Size, Height, Weight Or Age	Recommended Type Of Child Restraint
Infants and Toddlers	Children who are two years old or younger and who have not reached the height or weight limits of their child restraint	Either an Infant Carrier or a Convertible Child Restraint, facing rearward in a rear seat of the vehicle
Small Children	Children who are at least two years old or who have outgrown the height or weight limit of their rear-facing child restraint	Forward-Facing Child Restraint with a five-point Harness, facing forward in a rear seat of the vehicle
Larger Children	Children who have outgrown their forward-facing child restraint, but are too small to properly fit the vehicle's seat belt	Belt Positioning Booster Seat and the vehicle seat belt, seated in a rear seat of the vehicle
Children Too Large for Child Restraints	Children 12 years old or younger, who have outgrown the height or weight limit of their booster seat	Vehicle Seat Belt, seated in a rear seat of the vehicle

Infant And Child Restraints

Safety experts recommend that children ride rear-facing in the vehicle until they are two years old or until they reach either the height or weight limit of their rear-facing child restraint. Two types of child restraints can be used rear-facing: infant carriers and convertible child seats.

The infant carrier is only used rear-facing in the vehicle. It is recommended for children from birth until they reach the weight or height limit of the infant carrier. Convertible child seats can be used either rear-facing or forward-facing in the vehicle. Convertible child seats often have a higher weight limit in the rear-facing direction than infant carriers do, so they can be used rear-facing by children who have outgrown their infant carrier but are still less than at least two years old. Children should remain rear-facing until they reach the highest weight or height allowed by their convertible child seat.

WARNING!

- Never place a rear-facing child restraint in front of an air bag. A deploying passenger front air bag can cause death or serious injury to a child 12 years or younger, including a child in a rear-facing child restraint.
- Never install a rear-facing child restraint in the front seat of a vehicle. Only use a rear-facing child restraint in the rear seat. If the vehicle does not have a rear seat, do not transport a rear-facing child restraint in that vehicle.

WARNING!

Do not install a rear-facing car seat using a rear support leg in this vehicle. The floor of this vehicle is not designed to manage the crash forces of this type of car seat. In a crash, the support leg may not function as it was designed by the car seat manufacturer, and your child may be more severely injured as a result.



9226047161

Older Children And Child Restraints

Children who are two years old or who have outgrown their rear-facing convertible child seat can ride forward-facing in the vehicle. Forward-facing child seats and convertible child seats used in the forward-facing direction are for children who are over two years old or who have outgrown the rear-facing weight or height limit of their rear-facing convertible child seat. Children should remain in a forward-facing child seat with a harness for as long as possible, up to the highest weight or height allowed by the child seat.

All children whose weight or height is above the forward-facing limit for the child seat should use a belt-positioning booster seat until the vehicle's seat belts fit properly. If the child cannot sit with knees bent over the vehicle's seat cushion while the child's back is against the seatback, they should use a belt-positioning booster seat. The child and belt-positioning booster seat are held in the vehicle by the seat belt.

WARNING!

- Improper installation can lead to failure of an infant or child restraint. It could come loose in a collision. The child could be badly injured or killed. Follow the child restraint manufacturer's directions exactly when installing an infant or child restraint.
- After a child restraint is installed in the vehicle, do not move the vehicle seat forward or rearward because it can loosen the child restraint attachments. Remove the child restraint before adjusting the vehicle seat position. When the vehicle seat has been adjusted, reinstall the child restraint.

(Continued)

WARNING!

- When your child restraint is not in use, secure it in the vehicle with the seat belt or LATCH anchorages, or remove it from the vehicle. Do not leave it loose in the vehicle. In a sudden stop or accident, it could strike the occupants or seatbacks and cause serious personal injury.

Children Too Large For Booster Seats

Children who are large enough to wear the shoulder belt comfortably, and whose legs are long enough to bend over the front of the seat when their back is against the seatback, should use the seat belt in a rear seat. Use this simple 5-step test to decide whether the child can use the vehicle's seat belt alone:

1. Can the child sit all the way back against the back of the vehicle seat?
2. Do the child's knees bend comfortably over the front of the vehicle seat while the child is still sitting all the way back?
3. Does the shoulder belt cross the child's shoulder between the neck and arm?
4. Is the lap part of the belt as low as possible, touching the child's thighs and not the stomach?
5. Can the child stay seated like this for the whole trip?

If the answer to any of these questions was "no," then the child still needs to use a booster seat in this vehicle. If the child is using the lap/shoulder belt, check seat belt fit periodically and make sure the seat belt buckle is latched. A child's squirming or slouching can move the belt out of position. If the shoulder belt contacts the face or neck, move the child closer to the center of the vehicle, or use a booster seat to position the seat belt on the child correctly.

WARNING!

Never allow a child to put the shoulder belt under an arm or behind their back. In a crash, the shoulder belt will not protect a child properly, which may result in serious injury or death. A child must always wear both the lap and shoulder portions of the seat belt correctly.

Recommendations For Attaching Child Restraints

Restraint Type	Combined Weight of the Child + Child Restraint	Use Any Attachment Method Shown With An "X" Below			
		LATCH – Lower Anchors Only	Seat Belt Only	LATCH – Lower Anchors + Top Tether Anchor	Seat Belt + Top Tether Anchor
Rear-Facing Child Restraint	Up to 65 lb (29.5 kg)	X	X		
Rear-Facing Child Restraint	More than 65 lb (29.5 kg)		X		
Forward-Facing Child Restraint	Up to 65 lb (29.5 kg)			X	X
Forward-Facing Child Restraint	More than 65 lb (29.5 kg)				X

Lower Anchors And Tethers For Children (LATCH) Restraint System



LATCH Label

Your vehicle is equipped with the child restraint anchorage system called LATCH, which stands for Lower Anchors and Tethers for Children. The LATCH system has three vehicle anchor points for installing LATCH-equipped child seats. There are two lower anchorages located at the back of the seat cushion where it meets the seatback and one top tether anchorage located behind the seating position. These anchorages are used to install LATCH-equipped child seats without using the vehicle's seat belts. Some seating positions may have a top tether anchorage but no lower anchorages. In these seating positions, the seat belt must be used with the top tether anchorage to install the child restraint. Please see the following table for more information.

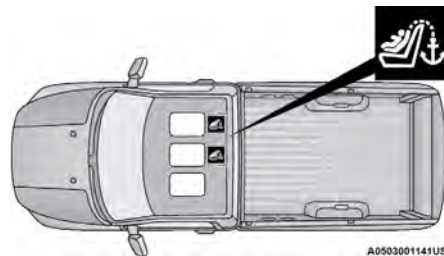

LATCH Positions For Installing Child Restraints In This Vehicle



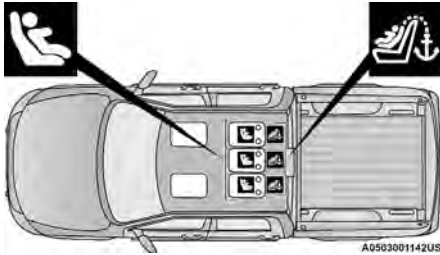

Regular Cab LATCH Positions

 Top Tether Anchorage Symbol

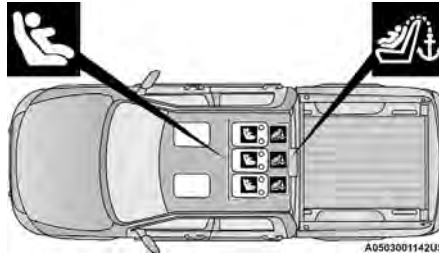

**Crew Cab 60/40 Split Bench LATCH Positions**

 Top Tether Anchorage Symbol
 Lower Anchorage Symbol (2 Anchorages Per Seating Position)

**Mega Cab LATCH Positions**

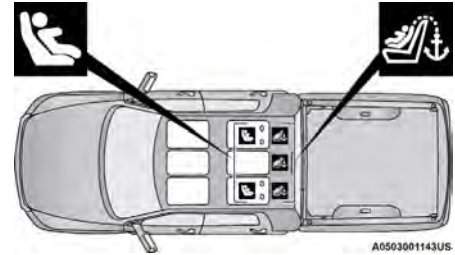
 Top Tether Anchorage Symbol
 Lower Anchorage Symbol (2 Anchorages Per Seating Position)

**Crew Cab Full Bench LATCH Positions**

 Top Tether Anchorage Symbol
 Lower Anchorage Symbol (2 Anchorages Per Seating Position)

Frequently Asked Questions About Installing Child Restraints With LATCH

What is the weight limit (child's weight + weight of the child restraint) for using the LATCH anchorage system to attach the child restraint?	65 lb (29.5 kg)	Use the LATCH anchorage system until the combined weight of the child and the child restraint is 65 lb (29.5 kg). Use the seat belt and tether anchor instead of the LATCH system once the combined weight is more than 65 lb (29.5 kg).
Can the LATCH anchorages and the seat belt be used together to attach a rear-facing or forward-facing child restraint?	No	Do not use the seat belt when you use the LATCH anchorage system to attach a rear-facing or forward-facing child restraint. Booster seats may be attached to the LATCH anchorages if allowed by the booster seat manufacturer. See your booster seat owner's manual for more information.
Can a child seat be installed in the center position using the inner LATCH lower anchorages from the outboard seating positions?	N/A – Regular Cab/Mega Cab/ Crew Cab Split Bench No – Crew Cab Full Bench rear seat	Regular Cab Front / Crew Cab with full bench rear seat: Use the seat belt and tether anchor to install a child seat in the center seating position. Crew Cab with split bench rear seat / Mega Cab: Child restraints can be installed using the supplied lower anchorages for the center seating position.
Can two child restraints be attached using a common lower LATCH anchorage?	No	Never "share" a LATCH anchorage with two or more child restraints. If the center position does not have dedicated LATCH lower anchorages, use the seat belt to install a child seat in the center position next to a child seat using the LATCH anchorages in an outboard position.

Frequently Asked Questions About Installing Child Restraints With LATCH

Can the rear-facing child restraint touch the back of the front passenger seat?	Yes	The child seat may touch the back of the front passenger seat if the child restraint manufacturer also allows contact. See your child restraint owner's manual for more information.
Can the rear head restraints be removed?	Yes	The head restraints can be removed in every rear seating position if they interfere with the installation of the child restraint ↪ page 37.

Locating The LATCH Anchorages



The lower anchorages are round bars that are found at the rear of the seat cushion where it meets the seatback. They are just visible when you lean into the rear seat to install the child restraint. You will easily feel them if you run your finger along the gap between the seatback and seat cushion.

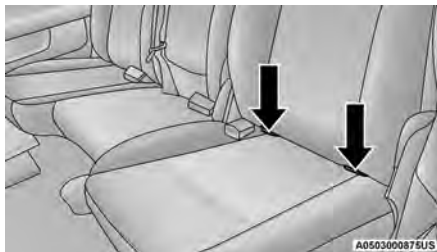

Mega Cab/Crew Cab Rear Outboard Seats (Driver Side)

Locating The Upper Tether Anchorages



Regular Cab models have tether strap anchorages behind the front center and right seats. Mega Cab and Crew Cab models have tether strap anchorages located behind each of the rear seats.

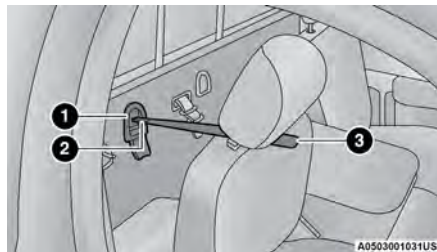

Regular Cab Tether Anchorages (Behind Covers)

- 1 – Tether Anchor
- 2 – Tether Strap Hook
- 3 – Tether Strap To Child Restraint

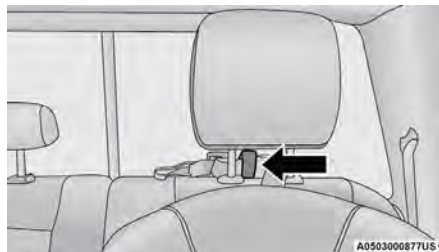

Crew Cab Outboard Tether Anchorage

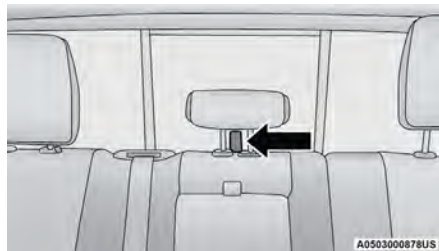

Crew Cab Center Tether Anchorage With Head Restraint In Raised Position

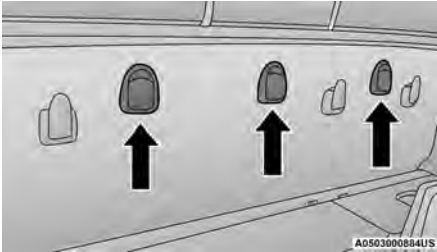

Mega Cab Tether Anchorages (Behind Covers)

LATCH-compatible child restraint systems will be equipped with a rigid bar or a flexible strap on each side. Each will have a hook or connector to attach to the lower anchorage and a way to tighten the connection to the anchorage. Forward-facing child restraints and some rear-facing child restraints will also be equipped with a tether strap. The tether strap will have a hook at the end to attach to the top tether anchorage and a way to tighten the strap after it is attached to the anchorage.

Center Seat LATCH

Regular Cab Or Crew Cab Full Bench Rear Seat: No Lower Center LATCH Anchorages Available

WARNING!

- Do not install a child restraint in the center position using the LATCH system. This position is not approved for installing child seats using the LATCH attachments. You must use the seat belt and tether anchor to install a child seat in the center seating position.

(Continued)

WARNING!

- Never use the same lower anchorage to attach more than one child restraint. For typical installation instructions, see ↪ page 305.

Crew Cab Split Bench Rear Seat Or Mega Cab Rear Seat: Center LATCH Anchorages Available

If a child restraint installed in the center position blocks the seat belt webbing or buckle for the outboard position, do not use that outboard position. If a child seat in the center position blocks the outboard LATCH anchors or seat belt, do not install a child seat in that outboard position.

WARNING!

- Never use the same lower anchorage to attach more than one child restraint. For typical installation instructions, see ↪ page 305.

Always follow the directions of the child restraint manufacturer when installing your child restraint. Not all child restraint systems will be installed as described here.

To Install A LATCH-Compatible Child Restraint

If the selected seating position has a Switchable Automatic Locking Retractor (ALR) seat belt, stow the seat belt, following the instructions below. See ↪ page 306 to check what type of seat belt each seating position has.

- Loosen the adjusters on the lower straps and on the tether strap of the child seat so that you can more easily attach the hooks or connectors to the vehicle anchorages.

- Place the child seat between the lower anchorages for that seating position. If the second row seat can be reclined, you may recline the seat and/or raise the head restraint (if adjustable) to get a better fit. If the rear seat can be moved forward and rearward in the vehicle, you may wish to move it to its rear-most position to make room for the child seat. You may also move the front seat forward to allow more room for the child seat.
- Attach the lower hooks or connectors of the child restraint to the lower anchorages in the selected seating position.
- If the child restraint has a tether strap, connect it to the top tether anchorage. See ↪ page 308 for directions to attach a tether anchor.
- Tighten all of the straps as you push the child restraint rearward and downward into the seat. Remove slack in the straps according to the child restraint manufacturer's instructions.
- Test that the child restraint is installed tightly by pulling back and forth on the child seat at the belt path. It should not move more than 1 inch (25.4 mm) in any direction.

How To Stow An Unused Switchable-ALR (ALR) Seat Belt:

When using the LATCH attaching system to install a child restraint, stow all ALR seat belts that are not being used by other occupants or being used to secure child restraints. An unused belt could injure a child if they play with it and accidentally lock the seat belt retractor. Before installing a child restraint using the LATCH system, buckle the seat belt behind the child restraint and out of the child's reach. If the buckled seat belt interferes with the child restraint installation, instead of buckling it behind the child

restraint, route the seat belt through the child restraint belt path and then buckle it. Do not lock the seat belt. Remind all children in the vehicle that the seat belts are not toys and that they should not play with them.

WARNING!

- Improper installation of a child restraint to the LATCH anchorages can lead to failure of the restraint. The child could be badly injured or killed. Follow the child restraint manufacturer's directions exactly when installing an infant or child restraint.
- Child restraint anchorages are designed to withstand only those loads imposed by correctly-fitted child restraints. Under no circumstances are they to be used for adult seat belts, harnesses, or for attaching other items or equipment to the vehicle.

Installing Child Restraints Using The Vehicle Seat Belt

Child restraint systems are designed to be secured in vehicle seats by lap belts or the lap belt portion of a lap/shoulder belt.

WARNING!

- Improper installation or failure to properly secure a child restraint can lead to failure of the restraint. The child could be badly injured or killed.
- Follow the child restraint manufacturer's directions exactly when installing an infant or child restraint.

Regular Cab

The seat belts in the passenger seating positions are equipped with a Switchable Automatic Locking Retractor (ALR) that is designed to keep the lap portion of the seat belt tight around the child restraint so that it is not necessary to use a locking clip. The ALR retractor can be "switched" into a locked mode by pulling all of the webbing out of the retractor and then letting the webbing retract back into the retractor. If it is locked, the ALR will make a clicking noise while the webbing is pulled back into the retractor. See the "Automatic Locking Mode" description ↗ page 292 for additional information on ALR.

Crew Cab And Mega Cab

The seat belts in the passenger seating positions are equipped with either a Switchable Automatic Locking Retractor (ALR) or a cinching latch plate or both. Both types of seat belts are designed to keep the lap portion of the seat belt tight around the child restraint so that it is not necessary to use a locking clip. The ALR retractor can be "switched" into a locked mode by pulling all of the webbing out of the retractor and then letting the webbing retract back into the retractor. If it is locked, the ALR will make a clicking noise while the webbing is pulled back into the retractor. See the "Automatic Locking Mode" description ↗ page 292 for additional information on ALR. The cinching latch plate is designed to hold the lap portion of the seat belt tight when webbing is pulled tight and straight through a child restraint's belt path.

Please see the table below and the following sections for more information.

Lap/Shoulder Belt Systems For Installing Child Restraints In This Vehicle

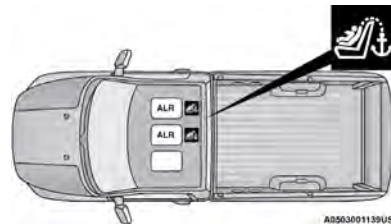

Regular Cab Automatic Locking Retractor (ALR) Locations

ALR — Switchable Automatic Locking Retractor
 Top Tether Anchorage Symbol

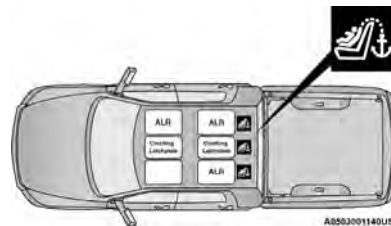

Mega Cab/Crew Cab Automatic Locking Retractor (ALR) Locations

Cinching Latch plate — Cinching Latch plate
 ALR — Switchable Automatic Locking Retractor
 Top Tether Anchorage Symbol

Frequently Asked Questions About Installing Child Restraints With Seat Belts

What is the weight limit (child's weight + weight of the child restraint) for using the Tether Anchor with the seat belt to attach a forward-facing child restraint?	Weight limit of the Child Restraint	Always use the tether anchor when using the seat belt to install a forward-facing child restraint, up to the recommended weight limit of the child restraint.
Can the rear-facing child restraint touch the back of the front passenger seat?	Yes	Contact between the front passenger seat and the child restraint is allowed, if the child restraint manufacturer also allows contact.
Can the rear head restraints be removed?	Yes	The head restraints can be removed in every rear seating position if they interfere with the installation of the child restraint → page 37.
Can the buckle stalk be twisted to tighten the seat belt against the belt path of the child restraint?	Yes – Cinching Latch Plate No – ALR	In positions with cinching latch plates (CINCH), the buckle stalk may be twisted up to 3 full turns. Do not twist the buckle stalk in a seating position with an ALR retractor.

Installing A Child Restraint With A Switchable Automatic Locking Retractor (ALR):

Child restraint systems are designed to be secured in vehicle seats by lap belts or the lap belt portion of a lap/shoulder belt.

WARNING!

- Improper installation or failure to properly secure a child restraint can lead to failure of the restraint. The child could be badly injured or killed.
- Follow the child restraint manufacturer's directions exactly when installing an infant or child restraint.

1. For Mega And Crew Cab Models

Place the child seat in the center of the seating position. If the second row seat can be reclined, you may recline the seat and/or raise the head restraint (if adjustable) to get a better fit. If the rear seat can be moved forward and rearward in the vehicle, you may wish to move it to its rear-most position to make room for the child seat. You may also move the front seat forward to allow more room for the child seat.

For Regular Cab Models

Place the child seat in the center of the seating position. Move the vehicle seat as far rearward as possible to keep the child as far from the passenger air bag as possible.

2. Pull enough of the seat belt webbing from the retractor to pass it through the belt path of the child restraint. Do not twist the belt webbing in the belt path.

3. Slide the latch plate into the buckle until you hear a "click."
4. Pull on the webbing to make the lap portion tight against the child seat.
5. To lock the seat belt, pull down on the shoulder part of the belt until you have pulled all the seat belt webbing out of the retractor. Then, allow the webbing to retract back into the retractor. As the webbing retracts, you will hear a clicking sound. This means the seat belt is now in the Automatic Locking mode.
6. Try to pull the webbing out of the retractor. If it is locked, you should not be able to pull out any webbing. If the retractor is not locked, repeat step 5.
7. Finally, pull up on any excess webbing to tighten the lap portion around the child restraint while you push the child restraint rearward and downward into the vehicle seat.

- If the child restraint has a top tether strap and the seating position has a top tether anchorage, connect the tether strap to the anchorage and tighten the tether strap. For directions to attach a tether anchor, see ⇨ page 308.
- Test that the child restraint is installed tightly by pulling back and forth on the child seat at the belt path. It should not move more than 1 inch (25.4 mm) in any direction.

Any seat belt system will loosen with time, so check the belt occasionally, and pull it tight if necessary.

Installing A Child Restraint With A Cinching Latch Plate (CINCH) — If Equipped:

Child restraint systems are designed to be secured in vehicle seats by lap belts or the lap belt portion of a lap/shoulder belt.

WARNING!

- Improper installation or failure to properly secure a child restraint can lead to failure of the restraint. The child could be badly injured or killed.
- Follow the child restraint manufacturer's directions exactly when installing an infant or child restraint.

- Place the child seat in the center of the seating position. If the second row seat can be reclined, you may recline the seat and/or raise the head restraint (if adjustable) to get a better fit. If the rear seat can be moved forward and rearward in the vehicle, you may wish to move it to its rear-most position to make room for the child seat. You may also move the front seat forward to allow more room for the child seat.

- Next, pull enough of the seat belt webbing from the retractor to pass it through the belt path of the child restraint. Do not twist the belt webbing in the belt path.
- Slide the latch plate into the buckle until you hear a "click."
- Finally, pull up on any excess webbing to tighten the lap portion around the child restraint while you push the child restraint rearward and downward into the vehicle seat.
- If the child restraint has a top tether strap and the seating position has a top tether anchorage, connect the tether strap to the anchorage and tighten the tether strap. See ⇨ page 308 for directions to attach a tether anchor.
- Test that the child restraint is installed tightly by pulling back and forth on the child seat at the belt path. It should not move more than 1 inch (25.4 mm) in any direction.

Any seat belt system will loosen with time, so check the belt occasionally, and pull it tight if necessary.

If the buckle or the cinching latch plate is too close to the belt path opening of the child restraint, you may have trouble tightening the seat belt. If this happens, disconnect the latch plate from the buckle and twist the short buckle-end belt up to three full turns to shorten it. Insert the latch plate into the buckle with the release button facing out, away from the child restraint. Repeat steps 4 to 6, above, to complete the installation of the child restraint.

If the belt still cannot be tightened after you shorten the buckle, disconnect the latch plate from the buckle, turn the buckle around one half turn, and insert the latch plate into the buckle again. If you still cannot make the child restraint installation tight, try a different seating position.

Installing Child Restraints Using The Top Tether Anchorage

WARNING!

Do not attach a tether strap for a rear-facing car seat to any location in front of the car seat, including the seat frame or a tether anchorage. Only attach the tether strap of a rear-facing car seat to the tether anchorage that is approved for that seating position, located behind the top of the vehicle seat. For the location of approved tether anchorages in your vehicle, see ⇨ page 302.



Regular And Mega Cab Trucks:



In the regular cab truck, the top tether anchorages are located behind the center and right passenger seats. In the mega cab truck, the top tether anchorages are located behind each rear seating position. There is a plastic cover over each anchorage. To attach the tether strap of the child restraint:

- Place the child restraint on the seat and adjust the tether strap so that it will reach over the seat back, under the head restraint and to the tether anchor directly behind the seat.

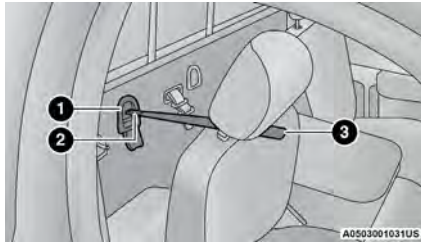

Regular Cab Tether Anchorages

- 1 – Tether Anchor
- 2 – Tether Strap Hook
- 3 – Tether Strap To Child Restraint

2. Route the tether strap to provide the most direct path between the anchorage and the child seat. The tether strap should go between the head restraint posts underneath the head restraint. You may need to adjust the head restraint to the upward position to pass the tether strap underneath the head restraint and between its posts.
3. Lift the cover (if so equipped), and attach the hook to the square opening in the sheet metal. Tighten the tether strap according to the child seat manufacturer's instructions.

WARNING!

Never place a rear-facing child restraint in front of an air bag. A deploying Passenger Front Air Bag can cause death or serious injury to a child 12 years or younger, including a child in a rear-facing child restraint.



Crew Cab Trucks:

The top tether anchorages in this vehicle are tether strap loops located between the rear glass and the back of the rear seat. There is a tether strap loop located behind each seating position. Follow the steps below to attach the tether strap of the child restraint.

Right Or Left Outboard Seats:

1. Raise the head restraint and reach between the rear seat and rear glass to access the tether strap loop.

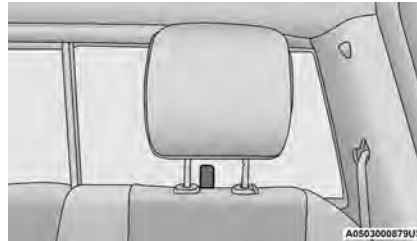

Head Restraint In Raised Position

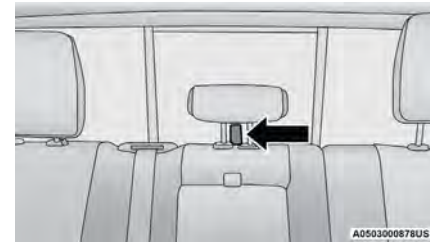

Tether Strap Loop With Center Head Restraint In Raised Position

2. Place a child restraint on the seat and adjust the tether strap so that it will reach over the seat back, under the head restraint, through the tether strap loop behind the seat and over to the tether strap loop behind the center seat.
3. Pass the tether strap hook under the head restraint behind the child seat, through the tether strap loop behind the seat and over to the center tether strap loop.

6

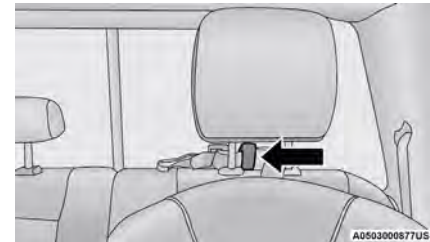

Tether Strap Through Outboard Tether Strap Loop

- Attach the hook to the center tether strap loop (see diagram). Tighten the tether strap according to the child seat manufacturer's instructions.

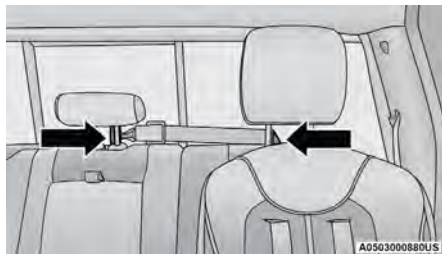

Tether Strap Through Outboard Tether Strap Loop And Attached To Center Tether Strap Loop

NOTE:

If there are child seats in both of the outboard (left and right) seating positions, the tether strap hooks of both child seats should be connected to the center tether strap loop. This is the correct way to tether two outboard child seats.

Center Seat:

- Raise the head restraint and reach between the rear seat and rear glass to access the tether strap loop.

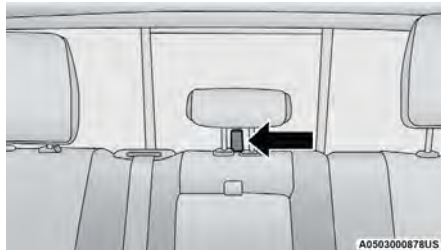

Tether Strap Loop With Head Restraint In Raised Position

- Place a child restraint on the seat and adjust the tether strap so that it will reach over the seat back, under the head restraint, through the tether strap loop behind the seat and over to the tether strap loop behind either the right or left outboard seat.
- Pass the tether strap hook under the head restraint behind the child seat, through the tether strap loop behind the seat and over to the right or left outboard tether strap loop.

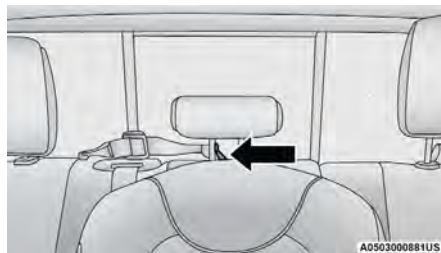

Tether Strap Through Center Tether Strap Loop

- Attach the hook to the outboard tether strap loop (see diagram). Tighten the tether strap according to the child seat manufacturer's instructions.

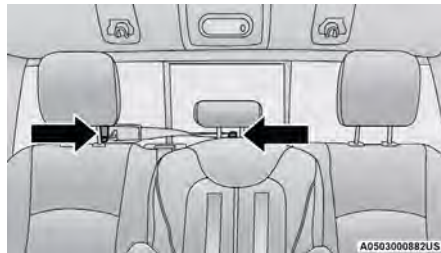

Tether Strap Through Center Tether Strap Loop And Attached To Outboard Tether Strap Loop

Installing Three Child Restraints:

1. Place a child restraint on each outboard rear seat. Route the tether straps following the directions for right and left seating positions, above.
2. Attach both hooks to the center tether strap loop, but do not tighten the straps yet.
3. Place a child restraint on the center rear seat. Route the tether strap following the directions for the center seating position, above.
4. Attach the hook to the outboard tether strap loop.
5. Tighten the tether straps according to the child seat manufacturer's instructions, tightening the right and left tether straps before the center tether strap.

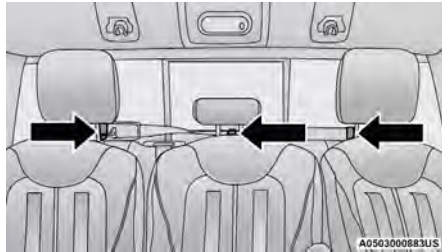
**Outboard And Center Seating Positions Shown****WARNING!**

- An incorrectly anchored tether strap could lead to increased head motion and possible injury to the child. Use only the anchorage position directly behind the child seat to secure a child restraint top tether strap.
- If your vehicle is equipped with a split rear seat, make sure the tether strap does not slip into the opening between the seatbacks as you remove slack in the strap.

SAFETY TIPS**TRANSPORTING PASSENGERS**

NEVER TRANSPORT PASSENGERS IN THE CARGO AREA.

WARNING!

- Do not leave children or animals inside parked vehicles in hot weather. Interior heat buildup may cause serious injury or death.
- It is extremely dangerous to ride in a cargo area, inside or outside of a vehicle. In a collision, people riding in these areas are more likely to be seriously injured or killed.
- Do not allow people to ride in any area of your vehicle that is not equipped with seats and seat belts.
- Be sure everyone in your vehicle is in a seat and using a seat belt properly.

TRANSPORTING PETS

Air Bags deploying in the front seat could harm your pet. An unrestrained pet will be thrown about and possibly injured, or injure a passenger during panic braking or in a collision.

Pets should be restrained in the rear seat (if equipped) in pet harnesses or pet carriers that are secured by seat belts.

CONNECTED VEHICLES

Privacy of any wireless and wired communications cannot be ensured. Third parties may unlawfully intercept information and private communications without your consent. For further information, refer to "Data Collection & Privacy" in your Uconnect Radio Instruction Manual or "Onboard Diagnostic System (OBD II) Cybersecurity" ↗ page 118.

WARNING!

It is not possible to know or to predict all of the possible outcomes if your vehicle's systems are breached. It may be possible that vehicle systems, including safety related systems, could be impaired or a loss of vehicle control could occur that may result in an accident involving serious injury or death.

SAFETY CHECKS YOU SHOULD MAKE INSIDE THE VEHICLE

Seat Belts

Inspect the seat belt system periodically, checking for cuts, frays, and loose parts. Damaged parts must be replaced immediately. Do not disassemble or modify the system.

If your vehicle is involved in a collision, or if you have questions regarding the seat belt or retractor conditions, take your vehicle to an authorized FCA dealer or authorized FCA Certified Collision Care Program facility for inspection.

Air Bag Warning Light



The Air Bag Warning Light will turn on for four to eight seconds as a bulb check when the ignition switch is first placed in the ON/RUN mode. If the light is either not on during starting, stays on, or turns on while driving, have the system inspected at an authorized dealer as soon as possible. After the bulb check, this light will illuminate with a single chime when a fault with the Air Bag System has been detected. It will stay on until the fault is removed. If the light comes on intermittently or remains on while driving, have an authorized dealer service the vehicle immediately → page 286.

Defroster



Check operation by selecting the defrost mode and place the blower control on high speed. You should be able to feel the air directed against the windshield. See an authorized dealer for service if your defroster is inoperable.

Floor Mat Safety Information

Always use floor mats designed to fit your vehicle. Only use a floor mat that does not interfere with the operation of the accelerator, brake or clutch pedals. Only use a floor mat that is securely attached using the floor mat fasteners so it cannot slip out of position and interfere with the accelerator, brake or clutch pedals or impair safe operation of your vehicle in other ways.

WARNING!

An improperly attached, damaged, folded, or stacked floor mat, or damaged floor mat fasteners may cause your floor mat to interfere with the accelerator, brake, or clutch pedals and cause a loss of vehicle control. To prevent SERIOUS INJURY or DEATH:

- ALWAYS securely attach your floor mat using the floor mat fasteners. DO NOT install your floor mat upside down or turn your floor mat over. Lightly pull to confirm mat is secured using the floor mat fasteners on a regular basis. 
- ALWAYS REMOVE THE EXISTING FLOOR MAT FROM THE VEHICLE before installing any other floor mat. NEVER install or stack an additional floor mat on top of an existing floor mat. 
- ONLY install floor mats designed to fit your vehicle. NEVER install a floor mat that cannot be properly attached and secured to your vehicle. If a floor mat needs to be replaced, only use a FCA approved floor mat for the specific make, model, and year of your vehicle.

(Continued)

WARNING!

- ONLY use the driver's side floor mat on the driver's side floor area. To check for interference, with the vehicle properly parked with the engine off, fully depress the accelerator, the brake, and the clutch pedal (if present) to check for interference. If your floor mat interferes with the operation of any pedal, or is not secure to the floor, remove the floor mat from the vehicle and place the floor mat in your trunk.
- ONLY use the passenger's side floor mat on the passenger's side floor area.
- ALWAYS make sure objects cannot fall or slide into the driver's side floor area when the vehicle is moving. Objects can become trapped under accelerator, brake, or clutch pedals and could cause a loss of vehicle control.
- NEVER place any objects under the floor mat (e.g., towels, keys, etc.). These objects could change the position of the floor mat and may cause interference with the accelerator, brake, or clutch pedals.
- If the vehicle carpet has been removed and re-installed, always properly attach carpet to the floor and check the floor mat fasteners are secure to the vehicle carpet. Fully depress each pedal to check for interference with the accelerator, brake, or clutch pedals then re-install the floor mats.
- It is recommended to only use mild soap and water to clean your floor mats. After cleaning, always check your floor mat has been properly installed and is secured to your vehicle using the floor mat fasteners by lightly pulling mat.

PERIODIC SAFETY CHECKS YOU SHOULD MAKE OUTSIDE THE VEHICLE

Tires

Examine tires for excessive tread wear and uneven wear patterns. Check for stones, nails, glass, or other objects lodged in the tread or sidewall. Inspect the tread for cuts and cracks. Inspect sidewalls for cuts, cracks, and bulges. Check the lug nuts/bolt torque for tightness. Check the tires (including spare) for proper cold inflation pressure.

Lights

Have someone observe the operation of brake lights and exterior lights while you work the controls. Check turn signal and high beam indicator lights on the instrument panel.

Door Latches

Check for proper closing, latching, and locking.

Fluid Leaks

Check area under the vehicle after overnight parking for fuel, coolant, oil, or other fluid leaks. Also, if gasoline fumes are detected or if fuel or brake fluid leaks are suspected, the cause should be located and corrected immediately.

EXHAUST GAS

WARNING!

Exhaust gases can injure or kill. They contain carbon monoxide (CO), which is colorless and odorless. Breathing it can make you unconscious and can eventually poison you. To avoid breathing (CO), follow these safety tips:

- Do not run the engine in a closed garage or in confined areas any longer than needed to move your vehicle in or out of the area.
- If you are required to drive with the trunk/liftgate/rear doors open, make sure that all windows are closed and the climate control BLOWER switch is set at high speed. DO NOT use the recirculation mode.
- If it is necessary to sit in a parked vehicle with the engine running, adjust your heating or cooling controls to force outside air into the vehicle. Set the blower at high speed.

The best protection against carbon monoxide entry into the vehicle body is a properly maintained engine exhaust system.

Whenever a change is noticed in the sound of the exhaust system, when exhaust fumes can be detected inside the vehicle, or when the underside or rear of the vehicle is damaged, have an authorized dealer inspect the complete exhaust system and adjacent body areas for broken, damaged, deteriorated, or mispositioned parts. Open seams or loose connections could permit exhaust fumes to seep into the passenger compartment. In addition, inspect the exhaust system each time the vehicle is raised for lubrication or oil change. Replace as required.

CARBON MONOXIDE WARNINGS

WARNING!

Carbon monoxide (CO) in exhaust gases is deadly. Follow the precautions provided to prevent carbon monoxide poisoning:

- Do not inhale exhaust gases. They contain carbon monoxide, a colorless and odorless gas, which can kill. Never run the engine in a closed area, such as a garage, and never sit in a parked vehicle with the engine running for an extended period. If the vehicle is stopped in an open area with the engine running for more than a short period, adjust the ventilation system to force fresh, outside air into the vehicle.
- Guard against carbon monoxide with proper maintenance. Have the exhaust system inspected every time the vehicle is raised. Have any abnormal conditions repaired promptly. Until repaired, drive with all side windows fully open.

IN CASE OF EMERGENCY

HAZARD WARNING FLASHERS

The Hazard Warning Flashers button is located on the upper switch bank just below the radio.

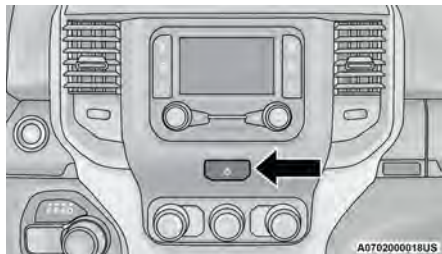

Hazard Warning Flashers Button

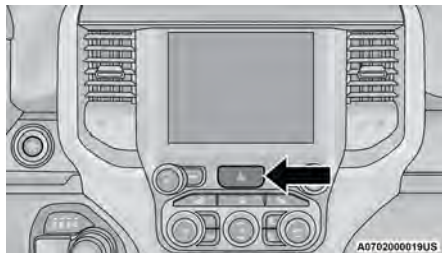

Hazard Warning Flashers Button

NOTE:

If your vehicle is equipped with a 12-inch Uconnect display, the Hazard Warning Flashers button is located above the display.

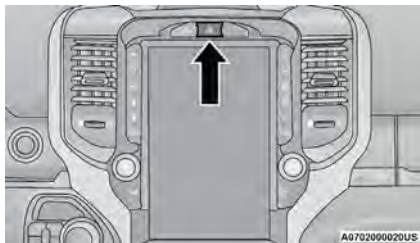

Hazard Warning Flashers Button

Push the button to turn on the Hazard Warning Flashers. When the button is activated, all directional turn signals will flash on and off to warn oncoming traffic of an emergency. Push the button a second time to turn off the Hazard Warning Flashers.

This is an emergency warning system and it should not be used when the vehicle is in motion. Use only when your vehicle is disabled or signaling a safety hazard warning for other motorists.

When you must leave the vehicle to seek assistance, the Hazard Warning Flashers will continue to operate even though the ignition is placed in the OFF position.

NOTE:

With extended use the Hazard Warning Flashers may wear down your battery.

ASSIST AND SOS SYSTEM — IF EQUIPPED

If equipped, the overhead console may contain an ASSIST and an SOS button. Depending on the vehicles trim level, the overhead console may vary.

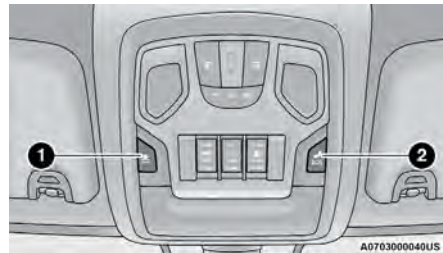

Assist And SOS Buttons

- 1 — ASSIST Button
- 2 — SOS Button

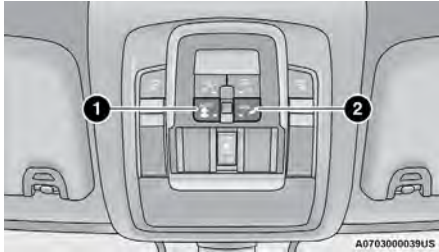

Assist And SOS Buttons

- 1 – ASSIST Button
2 – SOS Button

WARNING!

ALWAYS obey traffic laws and pay attention to the road. ALWAYS drive safely with your hands on the steering wheel. You have full responsibility and assume all risks related to the use of the features and applications in this vehicle. Only use the features and applications when it is safe to do so. Failure to do so may result in an accident involving serious injury or death.

NOTE:

- The SOS and ASSIST buttons will only function if you are connected to an operable 4G (data) network, which comes as a built-in feature. Other services will only be operable if your SiriusXM Guardian™ or Ram Connect service is active and you are connected to an operable 4G (data) network.

ASSIST Call

The ASSIST button is used to automatically connect you to any one of the following support centers:

- Roadside Assistance – If you get a flat tire, or need a tow, just push the ASSIST button to connect to someone who can help. Roadside Assistance will know what vehicle you're driving and its location. Additional fees may apply for roadside assistance.
- SiriusXM Guardian™ Customer Care – In-vehicle support for SiriusXM Guardian™ (if equipped).
- Vehicle Customer Care – Total support for all other vehicle issues.
- Ram Connect Customer Care (if equipped) – Total support for Radio, Phone and NAV issues.

SOS Call

1. Push the SOS Call button on the overhead console.

NOTE:

In case the SOS Call button is pushed in error, there will be a 10 second delay before the SOS Call system initiates a call to an SOS operator. To cancel the SOS Call connection, push the SOS Call button on the overhead console or press the cancellation button on the Device Screen. Termination of the SOS Call will turn off the green LED light on the overhead console.

2. The LED light located within the ASSIST and SOS buttons on the overhead console will turn green once a connection to an SOS operator has been made.
3. Once a connection between the vehicle and an SOS operator is made, the SOS Call system may transmit the following important vehicle information to an SOS operator:

- Indication that the occupant placed an SOS Call.
 - The vehicle brand.
 - The last known GPS coordinates of the vehicle.
4. You should be able to speak with the SOS operator through the vehicle audio system to determine if additional help is needed.

WARNING!

ALWAYS obey traffic laws and pay attention to the road. ALWAYS drive safely with your hands on the steering wheel. You have full responsibility and assume all risks related to the use of the features and applications in this vehicle. Only use the features and applications when it is safe to do so. Failure to do so may result in an accident involving serious injury or death.

NOTE:

- Your vehicle may be transmitting data as authorized by the subscriber.
- Once a connection is made between the vehicle's SOS Call system and the SOS operator, the SOS operator may be able to open a voice connection with the vehicle to determine if additional help is needed. Once the SOS operator opens a voice connection with the vehicle's SOS Call system, the operator should be able to speak with you or other vehicle occupants and hear sounds occurring in the vehicle. The vehicle's SOS Call system will attempt to remain connected with the SOS operator until the SOS operator terminates the connection.

5. The SOS operator may attempt to contact appropriate emergency responders and provide them with important vehicle information and GPS coordinates.

WARNING!

- If anyone in the vehicle could be in danger (e.g., fire or smoke is visible, dangerous road conditions or location), do not wait for voice contact from an Emergency Services Agent. All occupants should exit the vehicle immediately and move to a safe location.
- Never place anything on or near the vehicle's operable network and GPS antennas. You could prevent operable network and GPS signal reception, which can prevent your vehicle from placing an emergency call. An operable network and GPS signal reception is required for the SOS Call system to function properly.
- The SOS Call system is embedded into the vehicle's electrical system. Do not add aftermarket electrical equipment to the vehicle's electrical system. This may prevent your vehicle from sending a signal to initiate an emergency call. To avoid interference that can cause the SOS Call system to fail, never add aftermarket equipment (e.g., two-way mobile radio, CB radio, data recorder, etc.) to your vehicle's electrical system or modify the antennas on your vehicle. IF YOUR VEHICLE LOSES BATTERY POWER FOR ANY REASON (INCLUDING DURING OR AFTER AN ACCIDENT), THE UCONNECT OR RAM CONNECT FEATURES, APPS AND SERVICES, AMONG OTHERS, WILL NOT OPERATE.
- Modifications to any part of the SOS Call system could cause the air bag system to fail when you need it. You could be injured if the air bag system is not there to help protect you.

SOS Call System Limitations

Vehicles sold in Mexico **DO NOT** have SOS Call system capabilities.

SOS or other emergency line operators in Mexico may not answer or respond to SOS system calls.

If the SOS Call system detects a malfunction, any of the following may occur at the time the malfunction is detected, and at the beginning of each ignition cycle:

- The overhead console light located within the ASSIST and SOS buttons will continuously illuminate red.
- The Device Screen will display the following message: "Vehicle Device Requires Service. Please Contact An Authorized Dealer."
- An in-vehicle audio message will state "Vehicle device requires service. Please contact an authorized dealer."

WARNING!

- Ignoring the overhead console light could mean you will not have SOS Call services. If the overhead console light is illuminated, have an authorized dealer service the SOS Call system immediately.
- The Occupant Restraint Control module turns on the Air Bag Warning Light on the instrument panel if a malfunction in any part of the system is detected. If the Air Bag Warning Light is illuminated, have an authorized dealer service the Occupant Restraint Control system immediately.

Even if the SOS Call system is fully functional, factors beyond FCA US LLC's control may prevent or stop the SOS Call system operation. These include, but are not limited to, the following factors:

- The ignition is in the OFF position.
- The vehicle's electrical systems are not intact.
- The SOS Call system software and/or hardware are damaged during a crash.
- The vehicle battery loses power or becomes disconnected during a vehicle crash.
- 4G (data) network and/or Global Positioning Satellite signals are unavailable or obstructed.
- Equipment malfunction at the SOS operator facility.
- Operator error by the SOS operator.
- 4G (data) network congestion.
- Weather.
- Buildings, structures, geographic terrain, or tunnels.

WARNING!

ALWAYS obey traffic laws and pay attention to the road. ALWAYS drive safely with your hands on the steering wheel. You have full responsibility and assume all risks related to the use of the features and applications in this vehicle. Only use the features and applications when it is safe to do so. Failure to do so may result in an accident involving serious injury or death.

NOTE:

- Your vehicle may be transmitting data as authorized by the subscriber.
- Never place anything on or near the vehicle's 4G (data) and GPS antennas. You could prevent 4G (data) and GPS signal reception, which can prevent your vehicle from placing an emergency call. An operable 4G (data) network connection and a GPS signal is required for the SOS Call system to function properly.

Automatic SOS — If Equipped

Automatic SOS is a hands-free safety service that can immediately connect you with help in the event that your vehicle's air bags deploy. Please refer to your provided radio supplement for complete information.

JACKING AND TIRE CHANGING

Use this QR code to access your digital experience.

**WARNING!**

- Do not attempt to change a tire on the side of the vehicle close to moving traffic. Pull far enough off the road to avoid the danger of being hit when operating the jack or changing the wheel.

(Continued)

WARNING!

- Being under a jacked-up vehicle is dangerous. The vehicle could slip off the jack and fall on you. You could be crushed. Never put any part of your body under a vehicle that is on a jack. If you need to get under a raised vehicle, take it to a service center where it can be raised on a lift.
- Never start or run the engine while the vehicle is on a jack.
- The jack is designed to be used as a tool for changing tires only. The jack should not be used to lift the vehicle for service purposes. The vehicle should be jacked on a firm level surface only. Avoid ice or slippery areas.
- The jack should be used on level firm ground whenever possible.
- It is recommended that the wheels of the vehicle be chocked, and that no person should remain in a vehicle that is being jacked.
- No person should place any portion of their body under a vehicle that is supported by a jack.

NOTE:

If your vehicle is equipped with an air suspension system, there is a feature which allows the automatic leveling to be disabled to assist with changing a tire.

This feature can be activated through the Uconnect system → page 222.

PREPARATIONS FOR JACKING

1. Park the vehicle on a firm, level surface. Avoid ice or slippery areas.

WARNING!

Do not attempt to change a tire on the side of the vehicle close to moving traffic. Pull far enough off the road to avoid being hit when operating the jack or changing the wheel.

2. Turn on the Hazard Warning Flashers.
3. Apply the parking brake.
4. Shift the transmission into PARK (P).
5. Turn the ignition OFF.
6. Block both front and rear of the wheel diagonally opposite of the jacking position. For example, if the driver's front wheel is being changed, block the passenger's rear wheel.

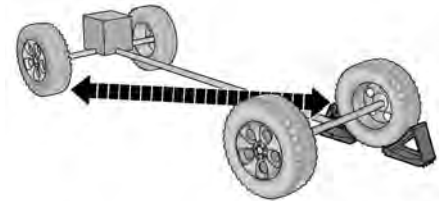

A0797001133U5

Wheel Blocked Example

NOTE:

Passengers should not remain in the vehicle when the vehicle is being raised or lifted.

JACK LOCATION

The jack and tools are stored under the front passenger seat.

REMOVAL OF JACK AND TOOLS

To access the jack and tools, you must remove the plastic access cover located on the side of the front passenger's seat. To remove the cover, pull the front part of the cover (closest to the front of the seat) toward you to release a locking tab. Once the front of the cover is loose, slide the cover toward the front of the seat until it is free from the seat frame.

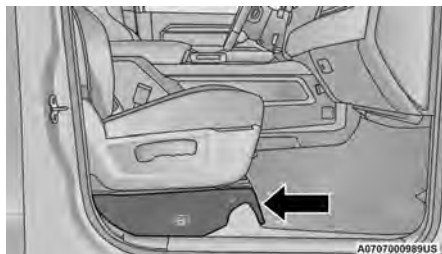
**Jack Access Cover**

Remove the jack and tools by turning the wing bolt counterclockwise, remove the wing bolt and then slide the assembly out from under the seat.

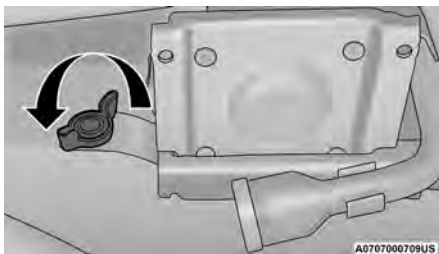
**Wing Bolt/Jack And Tools**

Remove the jack and tools from the bracket assembly. Turn the jack turn-screw counterclockwise to release jack from bracket assembly.

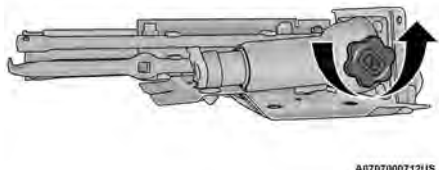
**Jack And Tools Bracket Assembly****Jacking Tools**

There are two ways to assemble the tools:
Assembled For Spare Tire Lowering/Raising

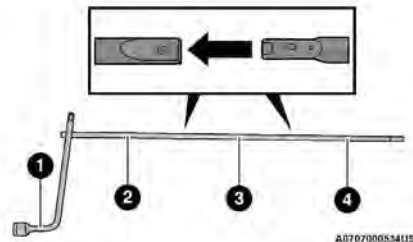
**Assembled For Spare Tire Lowering/Raising**

- 1 – Lug Wrench
- 2 – Extension 2
- 3 – Extension 3
- 4 – Extension 4

CAUTION!

- The lug wrench can only be attached to extension two (2).
- When attaching the tool to the winch mechanism be sure the large flared end opening on extension four (4) is positioned correctly over the winch mechanism adjusting nut.
- Damage to the lug wrench, extensions and winch mechanism may occur from improper tool assembly.

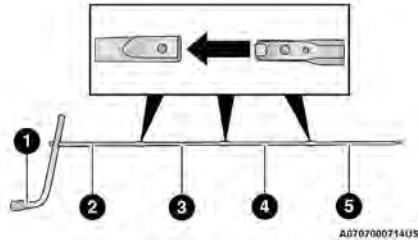
Assembled For Jack Operation**Assembled For Jack Operation**

- 1 – Lug Wrench
2 – Extension 2
3 – Extension 3
4 – Extension 4
5 – Jack Driver

WARNING!

After using the jack and tools, always reinstall them in the original carrier and location. While driving you may experience abrupt stopping, rapid acceleration or sharp turns. A loose jack, tools, bracket or other objects in the vehicle may move around with force, resulting in serious injury.

REMOVING THE SPARE TIRE

1. Remove the spare tire before attempting to jack up the truck. Attach the lug wrench to the extension tubes with the curved angle facing away from the vehicle. Insert the extension tubes through the access hole between the lower tailgate and the top of the fascia/bumper and into the winch mechanism tube.

**Winch Mechanism Tube****Inserting The Extension Tubes Into The Access Hole**

2. Rotate the lug wrench handle counterclockwise until the spare tire is on the ground with enough cable slack to allow you to pull it out from under the vehicle.

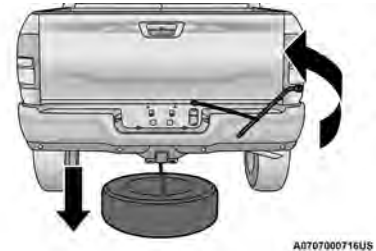
**Pulling The Spare Tire Out**

3. Pull the spare tire out from under the vehicle to gain access to the spare tire retainer.

4. Lift the spare tire with one hand to give clearance to tilt the retainer at the end of the cable.

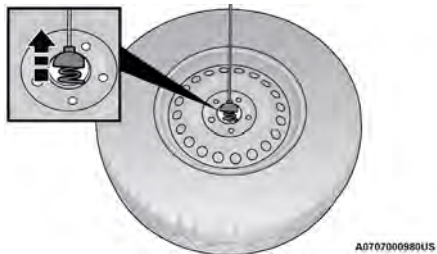

Removing The Retainer

5. Pull the retainer through the center of the wheel.

NOTE:

The winch mechanism is designed for use with the extension tubes only. Use of an air wrench or other power tools is not recommended and can damage the winch.

JACKING INSTRUCTIONS

WARNING!

Carefully follow these tire changing warnings to help prevent personal injury or damage to your vehicle:

- Always park on a firm, level surface as far from the edge of the roadway as possible before raising the vehicle.

(Continued)

WARNING!

- Turn on the Hazard Warning Flashers.
- Apply the parking brake firmly and set the transmission in PARK.
- Block the wheel diagonally opposite the wheel to be raised.
- Never start or run the engine with the vehicle on a jack.
- Do not let anyone sit in the vehicle when it is on a jack.
- Do not get under the vehicle when it is on a jack. If you need to get under a raised vehicle, take it to a service center where it can be raised on a lift.
- Only use the jack in the positions indicated and for lifting this vehicle during a tire change.
- If working on or near a roadway, be extremely careful of motor traffic.
- To assure that spare tires, flat or inflated, are securely stowed, spares must be stowed with the valve stem facing the ground.
- The jack should be used on level firm ground wherever possible.
- It is recommended that the wheels of the vehicle be chocked, and that no person should be remain in a vehicle that is being jacked.
- No person should place any portion of their body under a vehicle that is supported by a jack.



00000714

Jack Warning Label

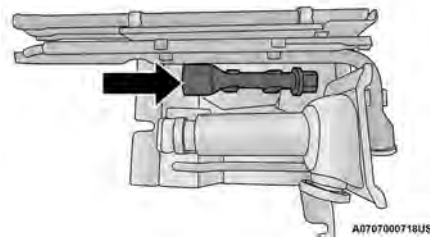

Lug Wrench Adapter Location

See the following steps for proper jacking and tire removal:

1. Remove the spare wheel, jack, and tools from storage.
2. Using the lug wrench, loosen, but do not remove, the wheel nuts by turning them counterclockwise one turn while the wheel is still on the ground. Changing a dually tire requires the lug wrench adapter.

NOTE:

If your vehicle is equipped with hub caps/wheel covers they must be removed before raising the vehicle off the ground → page 324.

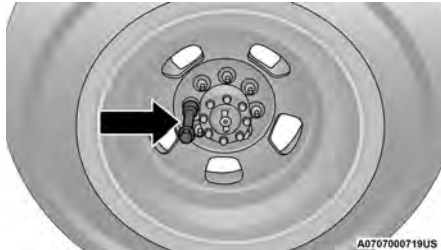

Lug Wrench Adapter

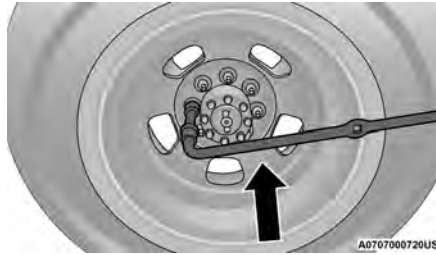

Lug Wrench Adapter And Wrench

3. Place the assembled jack and tools into the jacking position.

NOTE:

Placement for the front and rear jacking locations are critical. Keep the jack and tools aligned while raising the vehicle to prevent tool damage. See the following images for proper jacking locations.



Jack / Extensions Placement

CAUTION!
Do not attempt to raise the vehicle by jacking on locations other than those indicated in the Jacking Instructions for this vehicle.

Front Jacking Location

When changing the front wheel, assemble the jack driver to the jack and connect the jack driver to the extension tubes. Place the jack under the axle as close to the tire as possible with the extension tubes extending to the front. Connect the extension tubes and lug wrench.

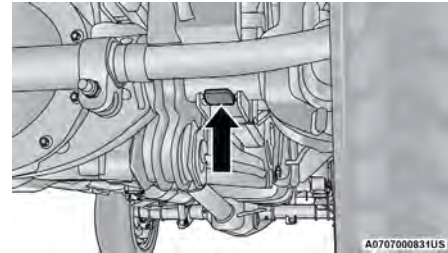

Front Lifting Point

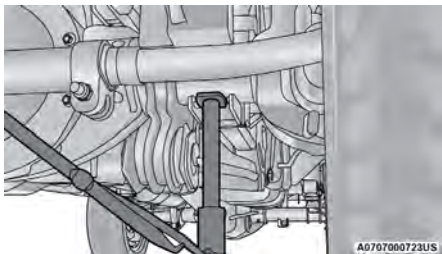
**Front Jacking Location****Rear Jacking Location**

When changing a rear wheel, assemble the jack driver to the jack and connect the jack driver to the extension tubes. Place the jack under the axle between the spring and the shock absorber with the extension tubes extending to the rear.

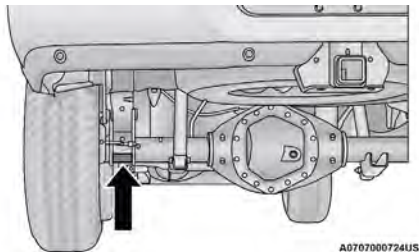
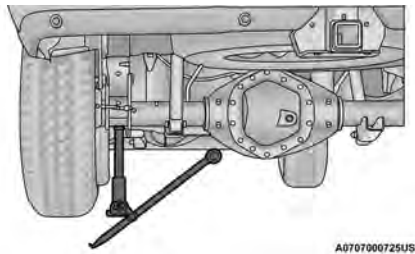
**Rear Lifting Point****Rear Jacking Location****CAUTION!**

Before raising the wheel off the ground, make sure that the jack will not damage surrounding truck parts and adjust the jack position as required.

4. Connect the extension tubes and lug wrench.
5. By rotating the lug wrench clockwise, raise the vehicle until the wheel just clears the surface.

WARNING!

Raising the vehicle higher than necessary can make the vehicle less stable. It could slip off the jack and hurt someone near it. Raise the vehicle only enough to remove the tire.

6. Remove the lug nuts and pull the wheel off. On Single Rear Wheel (SRW) trucks, install the spare wheel and lug nuts with the cone shaped end of the wheel nuts toward the wheel. On 3500 Dual Rear Wheel (DRW) trucks, if the outer tire is being replaced then leave the inner wheel on the vehicle. If the inner wheel is being replaced remove the outer wheel and replace the inner wheel. The wheel nuts are a two-piece assembly with a flat face. Lightly tighten the lug nuts. To avoid the risk of forcing the vehicle off the jack, do not fully tighten the lug nuts until the vehicle has been lowered.

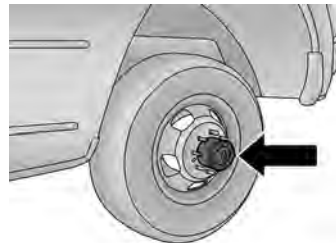
**Rear Inner Wheel Proper Placement (Dual Rear Wheel Equipped)**

A0707000727US

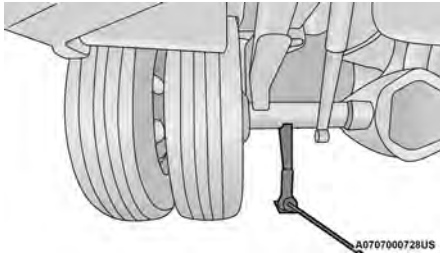

Dual Rear Wheel Jack Placement

7. Finish tightening the lug nuts. Push down on the lug wrench at the end of the handle for increased leverage. Tighten the lug nuts in a star pattern until each nut has been tightened twice ↪ page 392. If in doubt about the correct tightness, have them checked with a torque wrench by an authorized dealer or service station.

WARNING!

A loose tire or jack thrown forward in a collision or hard stop, could endanger the occupants of the vehicle. Always stow the jack parts and the spare tire in the places provided.

8. Install the wheel center cap and remove the wheel blocks. Do not install chrome or aluminum wheel center caps on the spare wheel. This may result in cap damage.
9. Lower the jack to its fully closed position. Stow the replaced tire, jack, and tools as previously described.

NOTE:

The bottle jack will not lower by turning the dial (thumbwheel) by hand, it may be necessary to use the jack driver in order to lower the jack.

10. Adjust the tire pressure when possible.

NOTE:

Do not oil wheel studs. For chrome wheels, do not substitute with chrome plated lug nuts.

TO STOW THE FLAT OR SPARE

1. Lift the spare tire with one hand to give clearance to tilt the retainer at the end of the cable and position it properly across the wheel opening.
2. Position the wheel behind the rear fascia/bumper facing outward. Push the end of the winch's cable, spring and steel sleeve through the back of the road wheel. Making sure the valve stem is facing the ground when the wheel is stowed.

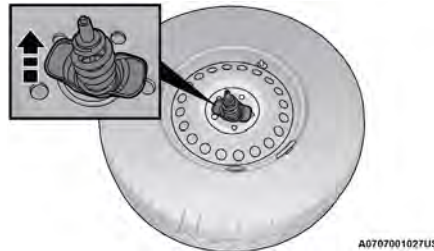

Reinstalling The Retainer

3. Lay the wheel flat after the retainer is installed.

4. Attach the lug wrench to the extension tubes with the curved angle facing away from the vehicle. Insert the extensions through the access hole between the lower tailgate and the top of the fascia/bumper and into the winch mechanism tube.

CAUTION!

The winch mechanism is designed for use with the jack extension tube only. Use of an air wrench or other power tools is not recommended and can damage the winch.



Stowing The Flat Or Spare

5. Rotate the lug wrench handle clockwise until the wheel is drawn into place against the underside of the vehicle. Continue to rotate until you feel the winch mechanism slip, or click three or four times. It cannot be overtightened. Push against the tire several times to ensure it is firmly in place.

NOTE:

Have the flat tire repaired or replaced immediately.

WARNING!

A loose tire or jack thrown forward in a collision or hard stop could endanger the occupants of the vehicle. Always stow the jack parts and the spare tire in the places provided. Have the deflated (flat) tire repaired or replaced immediately.

REINSTALLING THE JACK AND TOOLS

1. Tighten the jack all the way down by turning the jack turn-screw counterclockwise until the jack is snug.
2. Position the jack and tools into bracket assembly. Make sure the lug wrench is under the jack near the jack turn-screw. Snap tools into bracket assembly clips. Install the jack into bracket assembly and turn the jack turn-screw clockwise until jack is snug into bracket assembly.

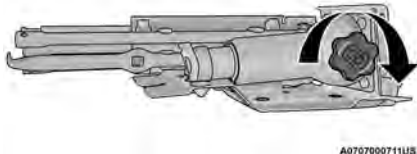

Jack And Tools Bracket Assembly

3. Place the jack and tool bracket assembly in the storage position holding the jack by the jack turn-screw, slip the jack and tools under the seat so that the bottom slot engages into the fastener on the floor.

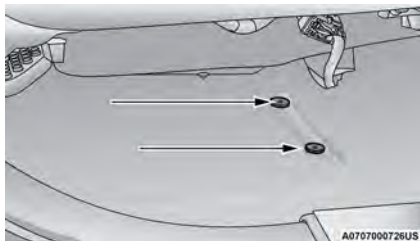

Jack Hold Down Fastener

NOTE:

Ensure that the jack and tool bracket assembly slides into the front hold down location.

4. Turn the wing bolt clockwise to secure to the floor pan. Reinstall the plastic cover.

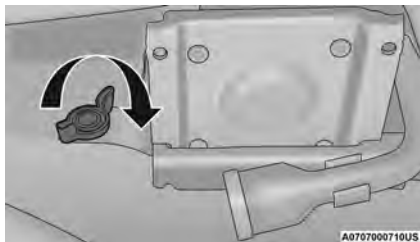

Wing Bolt/Jack And Tools

HUB CAPS/WHEEL COVERS — IF EQUIPPED

The hub caps must be removed before raising the vehicle off the ground.

CAUTION!

Use extreme caution when removing the front and rear wheel covers. Damage can occur to the center cap and/or the wheel if screwdriver type tools are used. A pulling motion, not a pry off motion, is recommended to remove the caps.

For 2500/3500 Single Rear Wheel (SRW) models, use the flat end of the lug wrench to hook and pull off the hub cap. Find the opening in the hub cap, insert the lug wrench, and pull off the cap. If you need to pry against the wheel, protect the wheel surface.

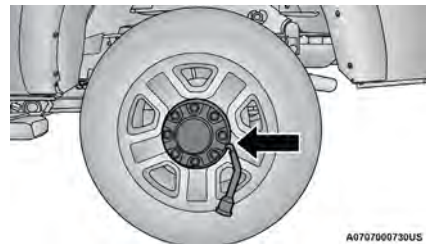

Lug Wrench Insertion Location — Hub Cap

On 3500 models with Dual Rear Wheels (DRW), you must first remove the hub caps, use the procedure noted for the single rear wheel. For the wheel covers (wheel skins), insert the flat end of the lug wrench between the outer edge of the wheel cover and the wheel. Pry against the wheel to remove the wheel cover. Repeat this procedure around the wheel until the cover pops off.

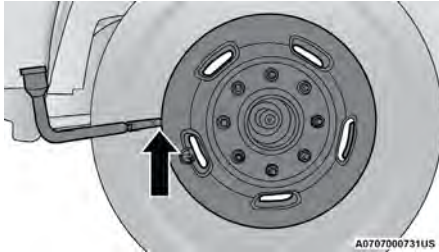

Lug Wrench Insertion Location – Wheel Cover

CAUTION!

- Use a pulling motion to remove the hub cap. Do not use a twisting motion when removing the hub cap, damage to the hub cap finish may occur.
- The rear hub caps on the dual rear wheel have two pull off notches. Make sure that the hook of the jack driver is located squarely in the cap notch before attempting to pull off.

Replace the wheel covers using a rubber mallet to ease the installation. Align the wheel cover vent holes to the wheel vent holes. Tap on the wheel cover as needed to firmly seat it evenly around the wheel.

JUMP STARTING

If your vehicle has a discharged battery, it can be jump started using a set of jumper cables and a battery in another vehicle, or by using a portable battery booster pack. Jump starting can be dangerous if done improperly, so please follow the procedures in this section carefully.

WARNING!

Do not attempt jump starting if the battery is frozen. It could rupture or explode and cause personal injury.

CAUTION!

Do not use a portable battery booster pack or any other booster source with a system voltage greater than 12 Volts or damage to the battery, starter motor, alternator or electrical system may occur.

NOTE:

When using a portable battery booster pack, follow the manufacturer's operating instructions and precautions.

PREPARATIONS FOR JUMP START

The battery in your vehicle is located in the front of the engine compartment, behind the driver side headlight assembly.

If you have a diesel engine, you may have two batteries, jump start off the driver side battery.

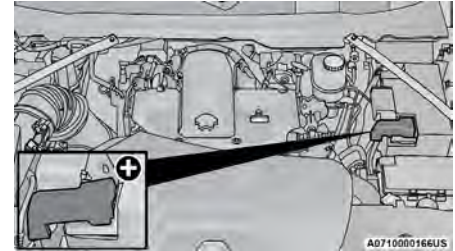

Battery Location

If equipped, the positive battery post may be covered with a protective cap. Lift up on the cap to gain access to the positive battery post. Do not jump off fuses. Only jump directly off positive post which has a positive (+) symbol on or around the post.

1. Apply the parking brake, shift the automatic transmission into PARK and turn the ignition OFF.
2. Turn off the heater, radio, and all electrical accessories.
3. If using another vehicle to jump start the battery, park the vehicle within the jumper cables reach apply the parking brake, make sure the ignition is OFF.

WARNING!

- Take care to avoid the radiator cooling fan whenever the hood is raised. It can start anytime the ignition switch is ON. You can be injured by moving fan blades.
- Remove any metal jewelry such as rings, watch bands and bracelets that could make an inadvertent electrical contact. You could be seriously injured.
- Batteries contain sulfuric acid that can burn your skin or eyes and generate hydrogen gas which is flammable and explosive. Keep open flames or sparks away from the battery.
- Do not allow vehicles to touch each other as this could establish a ground connection and personal injury could result.

JUMP STARTING PROCEDURE**WARNING!**

Failure to follow this jump starting procedure could result in personal injury or property damage due to battery explosion.

CAUTION!

Failure to follow these procedures could result in damage to the charging system of the booster vehicle or the discharged vehicle.

Connecting The Jumper Cables

1. Connect the positive (+) end of the jumper cable to the positive (+) post of the discharged vehicle.

NOTE:

Do not jump off fuses. Only jump directly off positive post.

2. Connect the opposite end of the positive (+) jumper cable to the positive (+) post of the booster battery.
3. Connect the negative (-) end of the jumper cable to the negative (-) post of the booster battery.
4. Connect the opposite end of the negative (-) jumper cable to a good engine ground. A "ground" is an exposed metallic/unpainted part of the engine, frame or chassis, such as an accessory bracket or large bolt. The ground must be away from the battery and the fuel injection system.

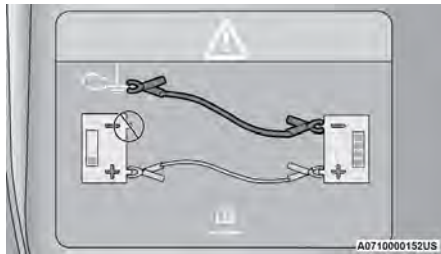
**Jump Starting Label****WARNING!**

Do not connect the jumper cable to the negative (-) post of the discharged battery. The resulting electrical spark could cause the battery to explode and could result in personal injury.

5. Start the engine in the vehicle that has the booster battery, let the engine idle a few minutes, and then start the engine in the vehicle with the discharged battery.

CAUTION!

Do not connect jumper cable to any of the fuses on the positive battery terminal. The resulting electrical current will blow the fuse.

6. Once the engine is started, see the following disconnection procedure.

Disconnecting The Jumper Cables

1. Disconnect the negative (-) end of the jumper cable from the engine ground of the vehicle with the discharged battery.
2. Disconnect the opposite end of the negative (-) jumper cable from the negative (-) post of the booster battery.
3. Disconnect the positive (+) end of the jumper cable from the positive (+) post of the booster battery.
4. Disconnect the opposite end of the positive (+) jumper cable from the positive (+) post of the vehicle with the discharged battery, and reinstall the protective cap over the positive (+) post.

If frequent jump starting is required to start your vehicle you should have the battery and charging system inspected at an authorized dealer.

CAUTION!

Accessories plugged into the vehicle power outlets draw power from the vehicle's battery, even when not in use (i.e., cellular devices, etc.). Eventually, if plugged in long enough without engine operation, the vehicle's battery will discharge sufficiently to degrade battery life and/or prevent the engine from starting.

GEAR SELECTOR OVERRIDE**6-SPEED TRANSMISSION**

If a malfunction occurs and the gear selector cannot be moved out of the PARK position, you can use the following procedure to temporarily move the gear selector:

1. Turn the engine OFF.
2. Firmly apply the parking brake.
3. Tilt the steering wheel to the full up position.
4. Press and maintain firm pressure on the brake pedal.
5. Insert a screwdriver or similar tool into the access port (ringed circle) on the bottom of the steering column, and push and hold the override release lever up.

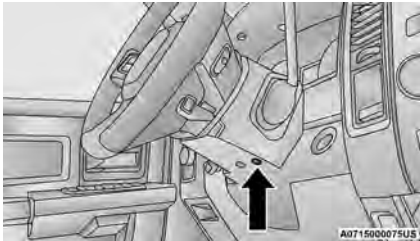
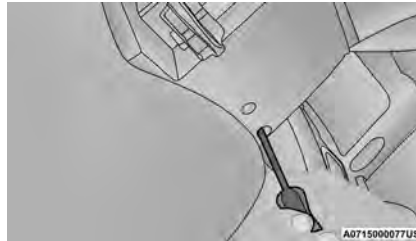
**Gear Selector Override Access Port Location****Gear Selector Override Access Port****Engaging The Access Port**

6. Move the gear selector to the NEUTRAL position.
7. The vehicle may then be started in NEUTRAL.

MANUAL PARK RELEASE**8-SPEED TRANSMISSION**

In order to push or tow the vehicle in cases where the transmission will not shift out of PARK (such as a depleted battery), a Manual Park Release is available.

WARNING!

Always secure your vehicle by fully applying the parking brake before activating the Manual Park Release. In addition, you should be seated in the driver's seat with your foot firmly on the brake pedal when activating the Manual Park Release. Activating the Manual Park Release will allow your vehicle to roll away if it is not secured by the parking brake, or by proper connection to a tow vehicle. Activating the Manual Park Release on an unsecured vehicle could lead to serious injury or death for those in or around the vehicle.

See the following steps to use the Manual Park Release:

1. Firmly apply the parking brake.
2. Using a small screwdriver or similar tool, remove the Manual Park Release access cover, which is just above the parking brake release handle, below and to the left of the steering column.

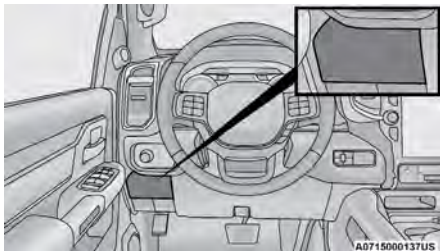
**Manual Park Release Access Cover**

- Using the screwdriver or similar tool, push the Manual Park Release lever locking tab (just below the middle of the lever) to the right.
- While holding the locking tab in the disengaged position, pull the tether strap to rotate the lever rearward, until it locks in place pointing towards the driver's seat. Release the locking tab and verify that the Manual Park Release lever is locked in the released position.

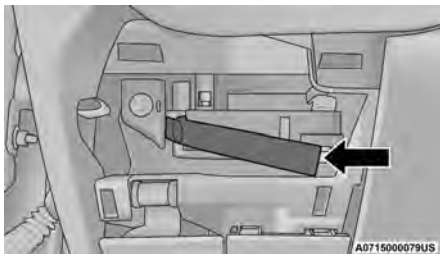
**Manual Park Release Tether**

- The vehicle is now out of PARK and can be towed. Release the parking brake only when the vehicle is securely connected to a tow vehicle.

To Reset The Manual Park Release:

- Push the locking tab to the right, to unlock the lever.
- Rotate the Manual Park Release lever forward to its original position, until the locking tab snaps into place to secure the lever.
- Pull gently on the tether strap to confirm that the lever is locked in its stowed position.

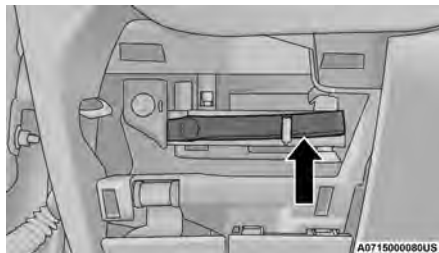
**Manual Park Release Tether In Stowed Position**

- Reinstall the access cover.

IF YOUR ENGINE OVERHEATS

If the vehicle is overheating, it will need to be serviced by an authorized dealer.

Potential signs of vehicle overheating:

- Temperature gauge is at HOT (H)
- Strong smell of coolant
- White smoke coming from engine or exhaust
- Coolant bottle coolant has bubbles present

WARNING!

You or others can be badly burned by hot engine coolant (antifreeze) or steam from your radiator. If you see or hear steam coming from under the hood, do not open the hood until the radiator has had time to cool. Never try to open a cooling system pressure cap when the radiator or coolant bottle is hot.

If the temperature gauge is moving towards or close to the HOT (H) position, you can reduce the potential for overheating by taking the appropriate action.

- On highways — slow down.
- In city traffic — while stopped, place the transmission in NEUTRAL (N), but do not increase the engine idle speed while preventing vehicle motion with the brakes.
- Turn off the A/C. The A/C system adds heat to the engine cooling system and turning the A/C off can help remove this heat.
- Turn the temperature control to maximum heat, the mode control to floor and the blower control to high. This allows the heater core to act as a supplement to the radiator and aids in removing heat from the engine cooling system.

CAUTION!

Driving with a hot cooling system could damage your vehicle. If the temperature gauge reads HOT (H), pull over and stop the vehicle. Idle the vehicle with the air conditioner turned off until the pointer drops back into the normal range. If the pointer remains on HOT (H), and you hear continuous chimes, turn the engine off immediately and call for service.

FREEDING A STUCK VEHICLE

If your vehicle becomes stuck in mud, sand, or snow, it can often be moved using a rocking motion. Turn the steering wheel right and left to clear the area around the front wheels. Then shift back and forth between DRIVE (D) and REVERSE (R), while gently pressing the accelerator. Use the least amount of accelerator pedal pressure that will maintain the rocking motion, without spinning the wheels or racing the engine.

NOTE:

- For trucks equipped with an 8-speed transmission, shifts between DRIVE and REVERSE can only be achieved at wheel speeds of 5 mph (8 km/h) or less. Whenever the transmission remains in NEUTRAL (N) for more than two seconds, you must press the brake pedal to engage DRIVE or REVERSE.
- Push the ESC OFF button to place the Electronic Stability Control (ESC) system in “Partial OFF” mode, before rocking the vehicle → page 269. Once the vehicle has been freed, push the ESC OFF button again to restore “ESC On” mode.

WARNING!

Fast spinning tires can be dangerous. Forces generated by excessive wheel speeds may cause damage, or even failure, of the axle and tires. A tire could explode and injure someone. Do not spin your vehicle's wheels faster than 30 mph (48 km/h) or for longer than 30 seconds continuously without stopping when you are stuck and do not let anyone near a spinning wheel, no matter what the speed.

CAUTION!

- Racing the engine or spinning the wheels may lead to transmission overheating and failure. Allow the engine to idle with the transmission in NEUTRAL for at least one minute after every five rocking-motion cycles. This will minimize overheating and reduce the risk of transmission failure during prolonged efforts to free a stuck vehicle.
- When “rocking” a stuck vehicle by shifting between DRIVE and REVERSE, do not spin the wheels faster than 15 mph (24 km/h), or drivetrain damage may result.
- Revving the engine or spinning the wheels too fast may lead to transmission overheating and failure. It can also damage the tires. Do not spin the wheels above 30 mph (48 km/h) while in gear (no transmission shifting occurring).

TOWING A DISABLED VEHICLE

This section describes procedures for towing a disabled vehicle using a commercial towing service.

If the transmission and drivetrain are operable, disabled vehicles may also be towed as described on → page 204.

NOTE:

Vehicles equipped with the Air Suspension System → page 146 must be placed in Transport mode, before tying them down (from the body) on a trailer or flatbed truck. If the vehicle cannot be placed in Transport mode (for example, engine will not run), tie-downs must be fastened to the axles (not to the body). Failure to follow these instructions may cause fault codes to be set and/or cause loss of proper tie-down tension.

Towing Condition	Wheels OFF The Ground	Two-Wheel Drive Models	Four-Wheel Drive Models
Flat Tow	NONE	NOT ALLOWED	<p>See Instructions</p> <ul style="list-style-type: none"> • Automatic transmission in PARK • Transfer case in N (Neutral) • Tow in forward direction
Dolly Tow	Front	NOT ALLOWED	NOT ALLOWED
	Rear	OK	NOT ALLOWED
On Trailer	ALL	OK	OK

Proper towing or lifting equipment is required to prevent damage to your vehicle. Use only tow bars and other equipment designed for this purpose, following equipment manufacturer's instructions. Use of safety chains is mandatory. Attach a tow bar or other towing device to main structural members of the vehicle, not to fascia/bumpers or associated brackets. State and local laws regarding vehicles under tow must be observed.

If you must use the accessories (wipers, defrosters, etc.) while being towed, the ignition must be in the ON/RUN mode, not the ACC mode.

If the key fob is unavailable or the vehicle's battery is discharged, find Instructions on shifting the transmission out of PARK ↪ page 327.

CAUTION!

- Do not use sling type equipment when towing. Vehicle damage may occur.
- When securing the vehicle to a flat bed truck, do not attach to front or rear suspension components. Damage to your vehicle may result from improper towing.

TWO-WHEEL DRIVE MODELS

FCA US LLC recommends towing your vehicle with all four wheels **OFF** the ground using a flatbed.

If flatbed equipment is not available, and the transmission is operable, the vehicle may be towed (with rear wheels **OFF** the ground) under the following conditions:

- The transmission must be in NEUTRAL (N). Instructions on shifting the transmission to NEUTRAL (N) when the engine is off ↪ page 327.
- The towing speed must not exceed 30 mph (48 km/h).
- The towing distance must not exceed 30 miles (48 km) for 8-speed transmission.
- The towing distance must not exceed 15 miles (24 km) for 6-speed transmission.

If the transmission is not operable, or the vehicle must be towed faster than 30 mph (48 km/h) or farther than 15 miles (24 km) for 6-speed transmission, or 30 miles (48 km) for 8-speed transmission, tow with the rear wheels **OFF** the ground. Acceptable methods to tow the vehicle on a flatbed are as follows:

- The front wheels raised and the rear wheels on a towing dolly
- Using a suitable steering wheel stabilizer to hold the front wheels in the straight position with the rear wheels raised when and the front wheels **ON** the ground.

CAUTION!

Towing this vehicle in violation of the approved requirements can cause severe transmission damage. Damage from improper towing is not covered under the New Vehicle Limited Warranty.

FOUR-WHEEL DRIVE MODELS

FCA US LLC recommends towing with all wheels **OFF** the ground. Acceptable methods are to tow the vehicle on a flatbed or with one end of vehicle raised and the opposite end on a towing dolly.

CAUTION!

- Front or rear wheel lifts must not be used (if the remaining wheels are on the ground). Internal damage to the transmission or transfer case will occur if a front or rear wheel lift is used when towing.
- Towing this vehicle in violation of the approved requirements can cause severe transmission and/or transfer case damage. Damage from improper towing is not covered under the New Vehicle Limited Warranty.

EMERGENCY TOW HOOKS — IF EQUIPPED

If your vehicle is equipped with tow hooks, they are mounted in the front fascia/bumpers.

NOTE:

For off-road recovery, it is recommended to use both of the front tow hooks to minimize the risk of damage to the vehicle. Always use an appropriately rated tow strap.

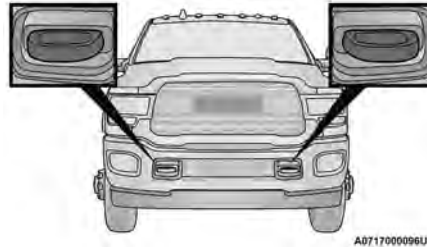

Front Tow Hooks

WARNING!

- Do not use a chain for freeing a stuck vehicle. Chains may break, causing serious injury or death.
- Stand clear of vehicles when pulling with tow hooks. Tow straps may become disengaged, causing serious injury.

CAUTION!

Tow hooks are for emergency use only, to rescue a vehicle stranded off-road. Do not use tow hooks for tow truck hookup or highway towing. You could damage your vehicle.

ENHANCED ACCIDENT RESPONSE SYSTEM (EARS)

This vehicle is equipped with an Enhanced Accident Response System.

This feature is a communication network that takes effect in the event of an impact → page 298.

EVENT DATA RECORDER (EDR)

This vehicle is equipped with an Event Data Recorder (EDR). The main purpose of an EDR is to record data that will assist in understanding how a vehicle's systems performed under certain crash or near crash-like situations, such as an air bag deployment or hitting a road obstacle → page 299.

SERVICING AND MAINTENANCE

SCHEDULED SERVICING

CAUTION!

Failure to perform the required maintenance items may result in damage to the vehicle.

Your vehicle is equipped with an engine oil change indicator system. This system will alert you when it is time to change your engine oil by displaying the words “Oil Change Due” in your instrument cluster display. The engine oil change indicator system is duty cycle based, which means the engine oil change interval may fluctuate depending on your personal driving style. Failure to change the engine oil per the maintenance schedule can result in internal engine damage.

An authorized dealer will reset the oil change indicator message after completing the scheduled oil change. If a scheduled oil change is performed by someone other than an authorized dealer, the message can be reset by referring to the steps described under instrument cluster display → page 101.

For Gasoline Engines, under no circumstances should oil change intervals exceed 8,000 miles (13,000 km), 12 months or 350 hours of engine run time, whichever comes first. The 350 hours of engine run or idle time is generally only a concern for fleet customers.

For Diesel Engines, under no circumstances should oil change intervals exceed 15,000 miles (24,000 km) or 12 months, whichever comes first or sooner if prompted by the oil change indicator system.

NOTE:

- It is recommended that every 3,000 miles (4,800 km), check the engine oil level at least 30 minutes after a fully warmed engine is shut off. Checking the oil level while the vehicle is on level ground will improve the accuracy of the oil level reading. Add oil only when the level is at or below the ADD or MIN mark.
- Severe service (high ambient temperature, short trips, heavy loading, trailer towing, off-road, or law enforcement use) may reduce oil change intervals.
- For Diesel Engines, see the Fuel Requirements section for more information regarding operation with biodiesel blend (B6-B20) fuel meeting ASTM specification D-7467.

Perform Service Indicator — Diesel Engine

Your vehicle will require emissions maintenance at a set interval. To help remind you when this maintenance is due, the instrument cluster will display “Perform Service”. When the “Perform Service” message is displayed on the instrument cluster it is necessary to have the emissions maintenance performed. Emissions maintenance may include replacing the Closed Crankcase Ventilation (CCV) filter element. The procedure for clearing and resetting the “Perform Service” indicator message is located in the appropriate Service Information.

Once A Month Or Before A Long Trip:

- Check engine oil level.
- Rotate tires at the first sign of irregular wear, even if it occurs before the oil indicator system turns on.
- Check windshield washer fluid level.
- Check the fluid levels of the coolant reservoir, brake master cylinder and power steering and fill as needed.
- Check function of all interior and exterior lights.

At Each Oil Change

- Change the engine oil and filter.
- Inspect the exhaust system.
- Check tire pressure and look for unusual wear or damage. Rotate tires at the first sign of irregular wear, even if it occurs before the oil indicator system turns on.
- Inspect the batteries, and clean and tighten the terminals as required.
- Inspect the CV/Universal joints.
- Inspect brake pads, shoes, rotors, drums, hoses and parking brake.
- Inspect engine cooling system protection and hoses.
- Inspect front end, and lubricate — If equipped with serviceable fittings.

- Deploy power side steps and clean linkages with high pressure car wash wand to remove any foreign debris. Apply MOPAR Spray White Lithium Grease to the pivot points.
- Inspect engine air cleaner filter if using in dusty or off-road conditions. If required, replace engine air cleaner filter.

- Inspect and replace the Evaporative System Fresh Air Filter as necessary, replacement may be more frequent if vehicle is operated in extreme dusty conditions.

Inspection and service should also be performed any-time a malfunction is observed or suspected. Retain all receipts.

NOTE:

Using white lithium grease, lubricate the door hinge pivot joints twice a year to prevent premature wear.

MAINTENANCE PLAN – GASOLINE ENGINE

Mileage Or Time Passed (Whichever Comes First):	20,000	30,000	40,000	50,000	60,000	70,000	80,000	90,000	100,000	110,000	120,000	130,000	140,000	150,000
Or Years:	2	3	4	5	6	7	8	9	10	11	12	13	14	15
Or Kilometers:	32,000	48,000	64,000	80,000	96,000	112,000	128,000	144,000	160,000	176,000	192,000	208,000	224,000	240,000
Change engine oil.	Under no circumstances should oil change intervals exceed 8,000 miles (13,000 km), 12 months or 350 hours of engine run time, whichever comes first.													
Additional Inspections														
Rotate the tires.	X	X	X	X	X	X	X	X	X	X	X	X	X	X
Inspect the CV/Universal joints.	X	X	X	X	X	X	X	X	X	X	X	X	X	X
Inspect front suspension, tie rod ends, and replace if necessary.	X		X		X		X		X		X		X	
Inspect the front and rear axle surfaces. If gear oil leakage is suspected, check the fluid level. If using your vehicle for police, taxi, fleet, off-road or frequent trailer towing, change axle fluid.	X		X		X		X		X		X		X	
Inspect the brake linings, replace as necessary.	X		X		X		X		X		X		X	

Mileage Or Time Passed (Whichever Comes First):	20,000	30,000	40,000	50,000	60,000	70,000	80,000	90,000	100,000	110,000	120,000	130,000	140,000	150,000
Or Years:	2	3	4	5	6	7	8	9	10	11	12	13	14	15
Or Kilometers:	32,000	48,000	64,000	80,000	96,000	112,000	128,000	144,000	160,000	176,000	192,000	208,000	224,000	240,000
Adjust parking brake as necessary.	X		X		X		X		X		X		X	
Inspect transfer case fluid.		X						X						X
Additional Maintenance														
Replace the cabin air filter.	To be replaced every 12,000 miles (19,000 km).													
Replace the engine air cleaner filter.		X			X			X			X			X
Replace spark plugs. **									X					
Flush and replace the engine coolant at 10 years or 150,000 miles (240,000 km) whichever comes first.									X					X
Inspect the transfer case fluid, change for any of the following: police, taxi, fleet, or frequent trailer towing.					X						X			
Change the transfer case fluid.											X			
Inspect and replace PCV valve if necessary.									X					

** The spark plug change interval is mileage based only, yearly intervals do not apply.

WARNING!

- You can be badly injured working on or around a motor vehicle. Do only service work for which you have the knowledge and the right equipment. If you have any doubt about your ability to perform a service job, take your vehicle to a competent mechanic.
- Failure to properly inspect and maintain your vehicle could result in a component malfunction and affect vehicle handling and performance. This could cause an accident.

MAINTENANCE PLAN – DIESEL ENGINE

Mileage Or Time Passed (Whichever Comes First):	7,500	15,000	22,500	30,000	37,500	45,000	52,500	60,000	67,500	75,000	82,500	90,000	97,500	105,000	112,500	120,000	127,500	135,000	142,500	150,000
Or Months:	6	12	18	24	30	36	42	48	54	60	66	72	78	84	90	96	102	108	114	120
Or Kilometers:	12,000	24,000	36,000	48,000	60,000	72,000	84,000	96,000	108,000	120,000	132,000	144,000	156,000	168,000	180,000	192,000	204,000	216,000	228,000	240,000
Change engine oil every 15,000 miles (24,000 km) or 12 months or 500 Hours or sooner if prompted by the oil change indicator system, whichever comes first.		X		X		X		X		X		X		X		X		X		X
Additional Inspections																				
Check the Diesel Exhaust Fluid (DEF) tank, refill if necessary.	X	X	X	X	X	X	X	X	X	X	X	X	X	X	X	X	X	X	X	X
Rotate the tires.	X	X	X	X	X	X	X	X	X	X	X	X	X	X	X	X	X	X	X	X
Inspect front end, and lubricate – If equipped with serviceable fittings.	X	X	X	X	X	X	X	X	X	X	X	X	X	X	X	X	X	X	X	X
Inspect engine air cleaner filter, replace if necessary. ****		X		X		X		X		X		X		X		X		X		X
Inspect the CV/Universal joints.	X	X	X	X	X	X	X	X	X	X	X	X	X	X	X	X	X	X	X	X
Inspect the front suspension, tie rod ends and boot seals for cracks or leaks and all parts for damage, wear, improper looseness or end play; replace if necessary.		X		X		X		X		X		X		X		X		X		X

**** Under no circumstances should the engine air cleaner filter exceed 30,000 miles (48,000 km) or 24 months, whichever comes first.

Mileage Or Time Passed (Whichever Comes First):	7,500	15,000	22,500	30,000	37,500	45,000	52,500	60,000	67,500	75,000	82,500	90,000	97,500	105,000	112,500	120,000	127,500	135,000	142,500	150,000
Or Months:	6	12	18	24	30	36	42	48	54	60	66	72	78	84	90	96	102	108	114	120
Or Kilometers:	12,000	24,000	36,000	48,000	60,000	72,000	84,000	96,000	108,000	120,000	132,000	144,000	156,000	168,000	180,000	192,000	204,000	216,000	228,000	240,000
Inspect the brake linings.			X			X			X			X			X			X		
Inspect and adjust parking brake.			X			X			X			X			X			X		
Inspect drive belt; replace as necessary.			X			X			X			X			X			X		
Inspect wheel bearings.				X				X				X				X				X
Additional Maintenance																				
Replace the cabin air filter.	To be replaced every 12,000 miles (19,000 km).																			
Replace the engine fuel filter.		X		X		X		X		X		X		X		X		X		X
Replace the chassis mounted fuel filter.		X		X		X		X		X		X		X		X		X		X
Inspect the front and rear axle surfaces. If gear oil leakage is suspected, check the fluid level. If using your vehicle for police, taxi, fleet, off-road or frequent trailer towing change the axle fluid.			X			X			X			X			X			X		
Inspect the transfer case fluid (4x4), change for any of the following: police, taxi, fleet, or frequent trailer towing.				X				X				X				X				X
Change the transfer case fluid (4x4).								X								X				
Change automatic transmission fluid (AS69RC transmission only).				X				X				X				X				
Change automatic transmission fluid and sump filter (AS69RC transmission only).								X								X				

Mileage Or Time Passed (Whichever Comes First):	7,500	15,000	22,500	30,000	37,500	45,000	52,500	60,000	67,500	75,000	82,500	90,000	97,500	105,000	112,500	120,000	127,500	135,000	142,500	150,000
Or Months:	6	12	18	24	30	36	42	48	54	60	66	72	78	84	90	96	102	108	114	120
Or Kilometers:	12,000	24,000	36,000	48,000	60,000	72,000	84,000	96,000	108,000	120,000	132,000	144,000	156,000	168,000	180,000	192,000	204,000	216,000	228,000	240,000
Change automatic transmission fluid and filter(s) if using your vehicle for any of the following: police, fleet, or frequent trailer towing (68RFE transmission only).								X								X				
Change automatic transmission fluid and filter(s).																X				
Replace Crankcase Ventilation Filter (CCV).										X										X
Flush and replace power steering fluid.													X							
Flush and replace engine coolant. ***																				X

WARNING!

- You can be badly injured working on or around a motor vehicle. Do only service work for which you have the knowledge and the right equipment. If you have any doubt about your ability to perform a service job, take your vehicle to a competent mechanic.
- Failure to properly inspect and maintain your vehicle could result in a component malfunction and affect vehicle handling and performance. This could cause an accident.

CAUTION!

***The manufacturer highly recommends that all cooling system service, maintenance, and repairs be performed by your local authorized dealer.

ENGINE COMPARTMENT

6.4L GASOLINE ENGINE

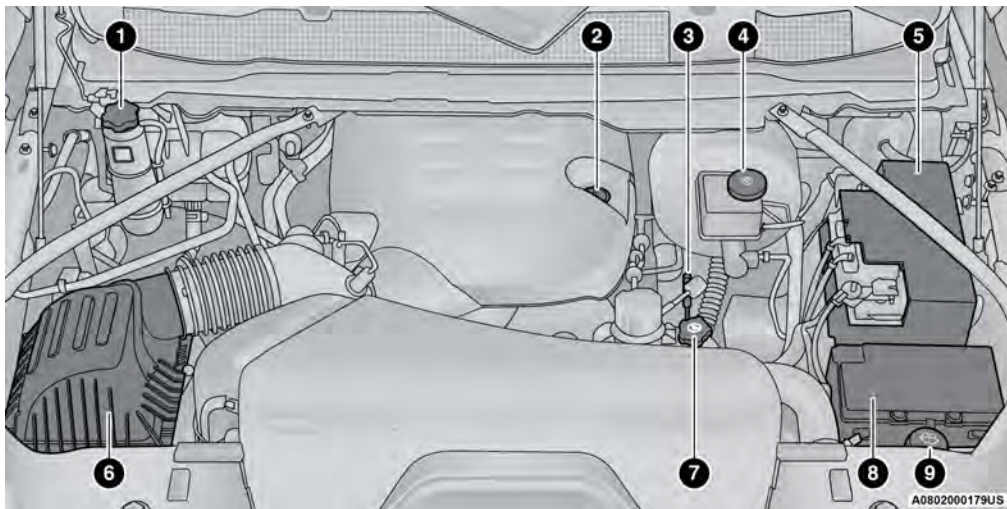

- 1 – Engine Coolant Pressure Cap
- 2 – Engine Oil Fill
- 3 – Engine Oil Dipstick
- 4 – Brake Fluid Reservoir Cap
- 5 – Battery

- 6 – Engine Air Cleaner, Filter
 - 7 – Power Steering Reservoir Cap
 - 8 – Power Distribution Center (Fuses)
 - 9 – Washer Fluid Reservoir Cap
-

6.7L DIESEL ENGINE – 6-SPEED 68RFE

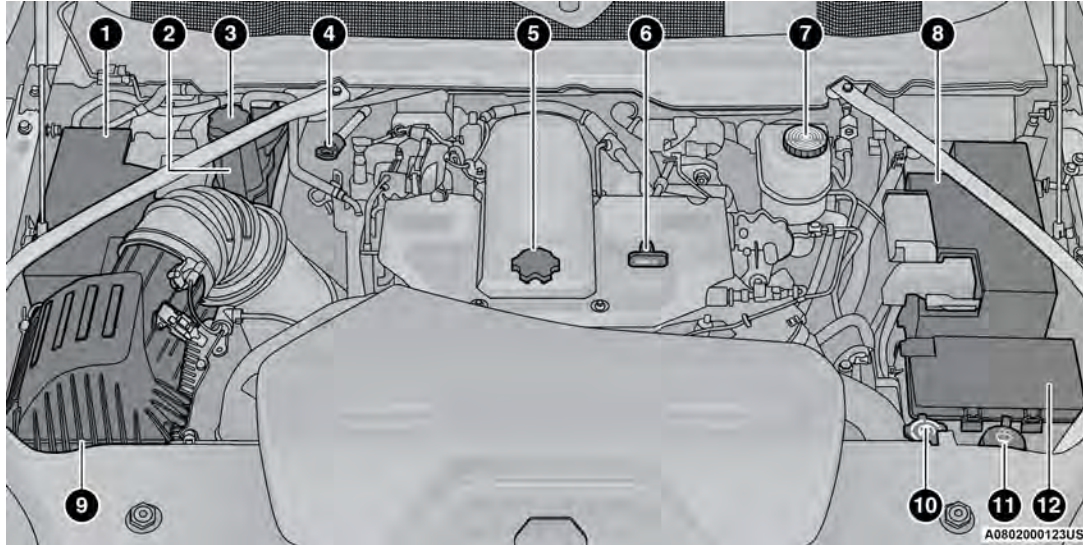

- 1 – Battery
- 2 – Engine Coolant Pressure Reservoir
- 3 – Engine Coolant Reservoir Cap
- 4 – Automatic Transmission Dipstick
- 5 – Engine Oil Fill
- 6 – Engine Oil Dipstick

- 7 – Brake Fluid Reservoir Cap
- 8 – Battery
- 9 – Engine Air Cleaner, Filter
- 10 – Power Steering Reservoir Cap
- 11 – Washer Fluid Reservoir Cap
- 12 – Power Distribution Center (Fuses)

6.7L DIESEL ENGINE

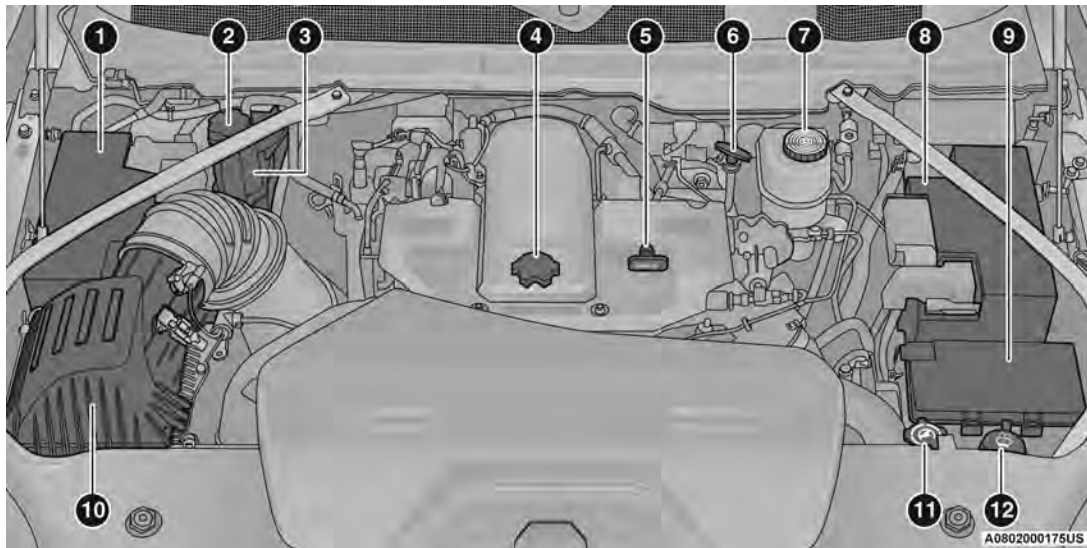

- 1 – Battery
- 2 – Engine Coolant Pressure Cap
- 3 – Engine Coolant Pressure Reservoir
- 4 – Engine Oil Fill
- 5 – Engine Oil Dipstick
- 6 – Automatic Transmission Dipstick

- 7 – Brake Fluid Reservoir Cap
- 8 – Battery
- 9 – Power Distribution Center (Fuses)
- 10 – Engine Air Cleaner, Filter
- 11 – Power Steering Reservoir Cap
- 12 – Washer Fluid Reservoir Cap

CHECKING OIL LEVEL

To ensure proper engine lubrication, the engine oil must be maintained at the correct level. Check the oil level at regular intervals, such as every fuel stop. The best time to check the engine oil level is about five minutes after a fully warmed up engine is shut off.

Checking the oil while the vehicle is on level ground will improve the accuracy of the oil level readings.

There are four possible dipstick types:

- Crosshatched zone.
- Crosshatched zone marked SAFE.
- Crosshatched zone marked with MIN at the low end of the range and MAX at the high end of the range.
- Crosshatched zone marked with dimples at the MIN and the MAX ends of the range.

NOTE:

Always maintain the oil level within the crosshatch markings on the dipstick.

Adding 1 qt (1 L) of oil when the reading is at the low end of the dipstick range will raise the oil level to the high end of the range marking.

CAUTION!

Overfilling or underfilling the crankcase will cause oil aeration or loss of oil pressure. This could damage your engine.

ADDING WASHER FLUID

The fluid reservoir is located under the hood and the fluid level should be checked at regular intervals. Fill the reservoir with windshield washer solvent only (not radiator antifreeze). When refilling the washer fluid reservoir, take some washer fluid and apply it to a cloth or towel and wipe the wiper blades clean. This will help blade performance.

To prevent freeze-up of your windshield washer system in cold weather, select a solution or mixture that meets or exceeds the temperature range of your climate. This rating information can be found on most washer fluid containers.

WARNING!

Commercially available windshield washer solvents are flammable. They could ignite and burn you. Care must be exercised when filling or working around the washer solution.

After the engine has warmed up, operate the defroster for a few minutes to reduce the possibility of smearing or freezing the fluid on the cold windshield. Windshield washer solution used with water as directed on the container, aids cleaning action, reduces the freezing point to avoid line clogging, and is not harmful to paint or trim.

MAINTENANCE-FREE BATTERY

Your vehicle is equipped with a maintenance-free battery. You will never have to add water, and periodic maintenance is not required.

WARNING!

- Battery fluid is a corrosive acid solution and can burn or even blind you. Do not allow battery fluid to contact your eyes, skin, or clothing. Do not lean over a battery when attaching clamps. If acid splashes in eyes or on skin, flush the area immediately with large amounts of water → page 326.
- Battery gas is flammable and explosive. Keep flame or sparks away from the battery. Do not use a booster battery or any other booster source with an output greater than 12 Volts. Do not allow cable clamps to touch each other.
- Battery posts, terminals, and related accessories contain lead and lead compounds. Wash hands after handling.

CAUTION!

- It is essential when replacing the cables on the battery that the positive cable is attached to the positive post and the negative cable is attached to the negative post. Battery posts are marked positive (+) and negative (-) and are identified on the battery case. Cable clamps should be tight on the terminal posts and free of corrosion.
- If a "fast charger" is used while the battery is in the vehicle, disconnect both vehicle battery cables before connecting the charger to the battery. Do not use a "fast charger" to provide starting voltage.

PRESSURE WASHING

Cleaning the engine compartment with a high pressure washer is not recommended.

CAUTION!

Precautions have been taken to safeguard all parts and connections however, the pressure generated by these machines is such that complete protection against water ingress cannot be guaranteed.

VEHICLE MAINTENANCE

An authorized dealer has the qualified service personnel, special tools, and equipment to perform all service operations in an expert manner. Service Manuals are available which include detailed service information for your vehicle. Refer to these Service Manuals before attempting any procedure yourself.

NOTE:

Intentional tampering with emissions control systems may void your warranty and could result in civil penalties being assessed against you.

WARNING!

You can be badly injured working on or around a motor vehicle. Only do service work for which you have the knowledge and the proper equipment. If you have any doubt about your ability to perform a service job, take your vehicle to a competent mechanic.

ENGINE OIL

Engine Oil Selection — Gasoline Engine

Use only the manufacturer's recommended fluid
↪ page 398.

NOTE:

Hemi engines (6.4L) at times can tick right after startup and then quiet down after approximately 30 seconds. This is normal and will not harm the engine. This characteristic can be caused by short drive cycles. For example, if the vehicle is started then shut off after driving a short distance. Upon restarting, you may experience a ticking sound. Other causes could be if the vehicle is unused for an extended period of time, incorrect oil, extended oil changes or extended idling. If the engine continues to tick or if the Malfunction Indicator Light (MIL) comes on, see the nearest authorized dealer.

Engine Oil Selection — Diesel Engine

Use only the manufacturer's recommended fluid
↪ page 398.

American Petroleum Institute (API) Approved Engine Oil

These symbols mean that the oil has been certified by the API. The manufacturer only recommends API trademark oils.



The API Starburst trademark certifies 0W-20, 0W-30 and 5W-30 engine oils.



The API Donut trademark certifies 0W-40 and 5W-40 engine oil.

For diesel engines, oils with a high ash content may produce damaging deposits on cylinder head valves and/or after treatment system damage. A maximum sulfated ash content of 1.00 mass % is recommended for all oil used in the engine.

The same oil change interval is to be followed for synthetic oil as for petroleum-based oil. Also, synthetic oil must meet the same performance specifications as petroleum oil.

CAUTION!

Do not use chemical flushes in your engine oil as the chemicals can damage your engine. Such damage is not covered by the New Vehicle Limited Warranty.

Synthetic Engine Oils

Your engine was designed for synthetic engine oils, only use synthetic API approved engine oils.

Synthetic engine oils which do not have both the correct API trademark and the correct SAE viscosity grade numbers should not be used.

Materials Added To Engine Oil

The manufacturer strongly recommends against the addition of any additives (other than leak detection dyes) to the engine oil. Engine oil is an engineered product and its performance may be impaired by supplemental additives.

Disposing Of Used Engine Oil And Oil Filters

Care should be taken in disposing of used engine oil and oil filters from your vehicle. Used oil and oil filters, indiscriminately discarded, can present a problem to the environment. Contact an authorized dealer, service station or governmental agency for advice on how and where used oil and oil filters can be safely discarded in your area.

ENGINE OIL FILTER

The engine oil filter should be replaced with a new filter at every engine oil change.

Engine Oil Filter Selection

A full-flow type disposable oil filter should be used for replacement. The quality of replacement filters varies considerably. Only high quality Mopar® certified filters should be used. If a Mopar® Engine Oil Filter is unavailable, only use filters that meet or exceed SAE/USCAR-36 Filter Performance Requirements.

ENGINE AIR CLEANER FILTER

For the proper maintenance intervals ⇨ page 332.

WARNING!

The air induction system (air cleaner, hoses, etc.) can provide a measure of protection in the case of engine backfire. Do not remove the air induction system (air cleaner, hoses, etc.) unless such removal is necessary for repair or maintenance. Make sure that no one is near the engine compartment before starting the vehicle with the air induction system (air cleaner, hoses, etc.) removed. Failure to do so can result in serious personal injury.

Engine Air Cleaner Filter Selection

The quality of replacement engine air cleaner filters varies considerably. Only high quality filters should be used to ensure most efficient service. Mopar® engine air cleaners are a high quality filter and are recommended.

Engine Air Cleaner Filter Inspection And Replacement — Gasoline Engine

NOTE:

When replacing the engine air cleaner filter on vehicles equipped with a 6.4L gasoline engine, replace with a dry (non-oiled) filter only.

Engine Air Cleaner Filter Removal

1. With suitable tool fully loosen (six) fasteners on engine air cleaner filter cover.

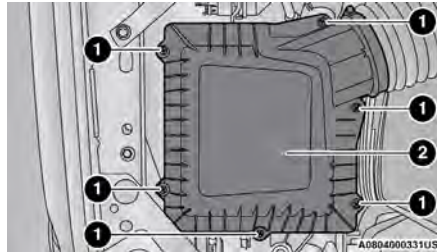

Engine Air Cleaner Filter

- 1 — Fasteners
- 2 — Engine Air Cleaner Filter Cover

2. Lift the engine air cleaner filter cover to access the engine air cleaner filter.
3. Remove the engine air cleaner filter from the housing assembly.

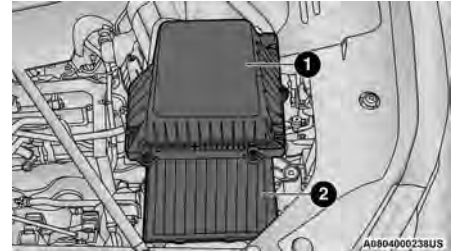

Engine Air Cleaner Filter Assembly

- 1 — Engine Air Cleaner Filter Cover
- 2 — Engine Air Cleaner Filter

Engine Air Cleaner Filter Installation

NOTE:

Inspect and clean the housing if significant dirt or debris is present before replacing the engine air cleaner filter.

1. Install the engine air cleaner filter into the housing assembly with the engine air cleaner filter inspection surface facing downward.
2. Install the engine air cleaner filter cover onto the housing assembly.

3. Tighten the fasteners (six) on the engine air cleaner filter assembly.

CAUTION!

Do not overtighten the engine air cleaner filter cover lid screws or damage may result.

Engine Air Cleaner Filter Inspection and Replacement — Diesel Engine

Engine Air Cleaner Filter Removal

1. Using a suitable tool, fully loosen (six) fasteners on engine air cleaner filter cover.

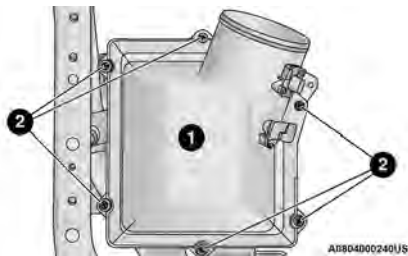

Engine Air Cleaner Filter Cover

- 1 — Engine Air Cleaner Filter Cover
- 2 — Screws

2. Lift the engine air cleaner filter cover to access the engine air cleaner filter.

3. Remove the engine air cleaner filter from the housing assembly.

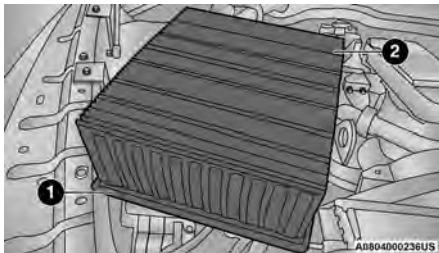

Engine Air Cleaner Filter

- 1 — Engine Air Cleaner Filter
- 2 — Engine Air Cleaner Filter Inspection Surface

Engine Air Cleaner Filter Installation

NOTE:

Inspect and clean the housing if significant dirt or debris is present before replacing the engine air cleaner filter.

1. Install the engine air cleaner into the housing assembly with the engine air cleaner filter inspection surface facing downward.
2. Install the engine air cleaner filter cover onto the housing assembly locating tabs.
3. Tighten (6) screws to secure the engine air cleaner filter cover to the housing assembly.

CAUTION!

Always observe the position of the trailer and surroundings using the camera and mirrors to avoid damage to the truck or trailer.

AIR CONDITIONER MAINTENANCE

For best possible performance, your air conditioner should be checked and serviced by an authorized dealer at the start of each warm season. This service should include cleaning of the condenser fins and a performance test. Drive belt tension should also be checked at this time.

WARNING!

- Use only refrigerants and compressor lubricants approved by the manufacturer for your air conditioning system. Some unapproved refrigerants are flammable and can explode, injuring you. Other unapproved refrigerants or lubricants can cause the system to fail, requiring costly repairs. Refer to Warranty Information Book, for further warranty information.
- The air conditioning system contains refrigerant under high pressure. To avoid risk of personal injury or damage to the system, adding refrigerant or any repair requiring lines to be disconnected should be done by an experienced technician.

CAUTION!

Do not use chemical flushes in your air conditioning system as the chemicals can damage your air conditioning components. Such damage is not covered by the New Vehicle Limited Warranty.

Refrigerant Recovery And Recycling – R-134a – (If Equipped)

R-134a Air Conditioning Refrigerant is a Hydrofluorocarbon (HFC) that is an ozone-friendly substance. The manufacturer recommends that air conditioning service be performed by an authorized dealer or other service facilities using recovery and recycling equipment.

NOTE:

Use only manufacturer approved A/C system PAG compressor oil and refrigerants.

Refrigerant Recovery And Recycling – R-1234yf – (If Equipped)

R-1234yf Air Conditioning Refrigerant is a Hydrofluorolefin (HFO) that is endorsed by the Environmental Protection Agency and is an ozone-friendly substance with a low global-warming potential. The manufacturer recommends that air conditioning service be performed by an authorized dealer using recovery and recycling equipment.

NOTE:

Use only manufacturer approved A/C system PAG compressor oil, and refrigerants.

Cabin Air Filter Replacement

For the proper maintenance intervals → page 332.

WARNING!

Do not remove the cabin air filter while the vehicle is running, or while the ignition is in the ACC or ON/RUN mode. With the cabin air filter removed and the blower operating, the blower can contact hands and may propel dirt and debris into your eyes, resulting in personal injury.

The cabin air filter is located in the fresh air inlet behind the glove compartment. Perform the following procedure to replace the filter:

1. Open the glove compartment and remove all contents.
2. With the glove compartment door open, remove the glove compartment tension tether and tether clip by sliding the clip toward the face of the glove compartment door. Lift the clip out of glove compartment door and release into dash panel.

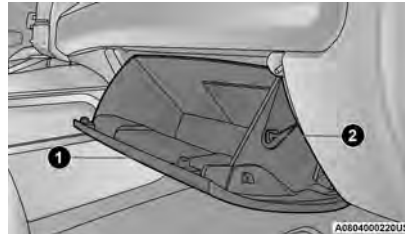

Right Side Of Glove Compartment

- 1 – Glove Compartment Door
- 2 – Glove Compartment Tension Tether

3. There are travel stops on both sides of the glove compartment. Push inward on right side of the glove compartment travel stop to disengage the stop. Then pull the right of the glove compartment outward (away from the hinge) to disengage the right side of the compartment from the hinge. Continue by removing the left side from the hinge by slightly lowering the compartment while pulling outward until it is completely disengaged from the hinge.

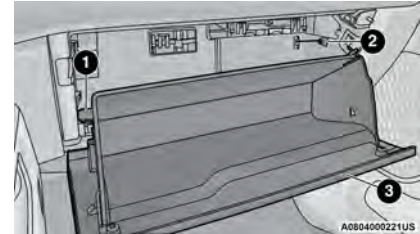

Glove Compartment

- 1 – Glove Compartment Travel Stop
- 2 – Glove Compartment Tension Tether
- 3 – Glove Compartment Door

4. Remove the filter cover by pushing in on the finger tabs on each end of the filter cover.

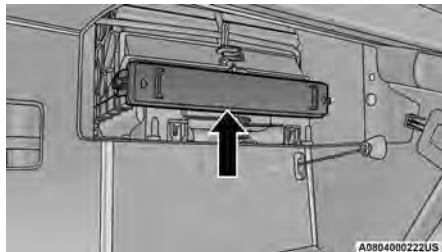

Filter Cover

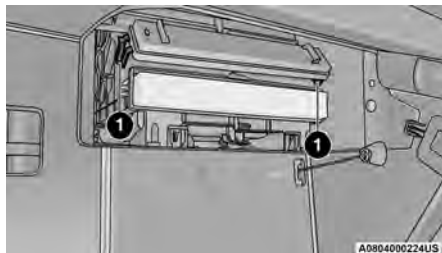

Filter Cover Removal

1 – Finger Tabs

5. Remove the cabin air filter by pulling it straight out of the housing.

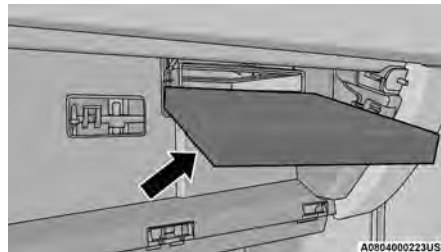

Cabin Air Filter

6. Install the cabin air filter with the arrow on the filter pointing toward the floor. When installing the filter cover, press on each end until you hear an audible click.

CAUTION!

The cabin air filter is identified with an arrow to indicate airflow direction through the filter. Failure to properly install the filter will result in the need to replace it more often.

7. Reinstall the glove compartment on the hinges.
8. Pull the tension tether outward and reinstall the glove compartment past the travel stops by pushing in on the glove compartment sides.

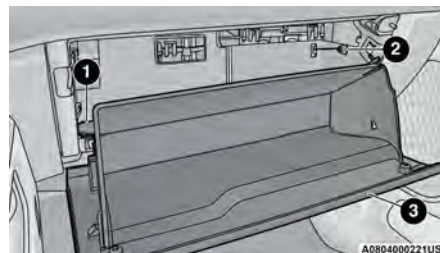

Glove Compartment

- 1 – Glove Compartment Travel Stop
2 – Glove Compartment Tension Tether
3 – Glove Compartment Door

NOTE:

Ensure the glove compartment door hinges and glove compartment travel stops are fully engaged.

9. Reattach the glove compartment tension tether by inserting the tether clip in the glove compartment and sliding the clip away from the face of the glove compartment door.

ACCESSORY DRIVE BELT INSPECTION

WARNING!

- Do not attempt to inspect an accessory drive belt with vehicle running.
- When working near the radiator cooling fan, disconnect the fan motor lead. The fan is temperature controlled and can start at any time regardless of ignition mode. You could be injured by the moving fan blades.
- You can be badly injured working on or around a motor vehicle. Only do service work for which you have the knowledge and the proper equipment. If you have any doubt about your ability to perform a service job, take your vehicle to a competent mechanic.

When inspecting accessory drive belts, small cracks that run across ribbed surface of belt from rib to rib, are considered normal. These are not a reason to replace belt. However, cracks running along a rib (not across) are not normal. Any belt with cracks running along a rib must be replaced. Also have the belt replaced if it has excessive wear, frayed cords or severe glazing.

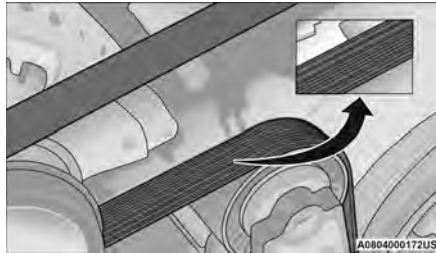

Accessory Belt (Serpentine Belt)

Conditions that would require replacement:

- Rib chunking (one or more ribs has separated from belt body)
- Rib or belt wear
- Longitudinal belt cracking (cracks between two ribs)
- Belt slips
- Groove jumping (belt does not maintain correct position on pulley)
- Belt broken (identify and correct problem before new belt is installed)
- Noise (objectionable squeal, squeak, or rumble is heard or felt while drive belt is in operation)

Some conditions can be caused by a faulty component such as a belt pulley. Belt pulleys should be carefully inspected for damage and proper alignment.

Belt replacement on some models requires the use of special tools, we recommend having your vehicle serviced at an authorized dealer.

DRAINING FUEL/WATER SEPARATOR FILTER – DIESEL ENGINE

There are two fuel filter assemblies. One is located on the driver's side of the engine. The best access to this water drain valve is from under the hood. The second one is on the under body, located in front of the rear axle above the drive shaft. The best access to this water drain valve is from under the vehicle.

CAUTION!

- Do not drain the fuel/water separator filter when the engine is running.
- Diesel fuel will damage blacktop paving surfaces. Drain the filter into an appropriate container.

If water is detected in the water separator while the engine is running, or while the ignition switch is in the ON position, the Water In Fuel Indicator Light will illuminate and an audible chime will be heard five times. At this point you should stop the engine and drain the water from both of the filters.

CAUTION!

If the Water In Fuel Indicator Light remains on, DO NOT START the engine before you drain water from the fuel filters to avoid engine damage.

If the Water In Fuel Indicator Light comes on and a single chime is heard while you are driving, or with the ignition switch in the ON position, there may be a problem with your water separator wiring or sensor. See an authorized dealer for service.

Upon proper draining of the water from both fuel filters, the Water In Fuel Indicator Light will remain illuminated for approximately 10 seconds. If the water was drained while the engine was running, the Water In Fuel Indicator Light may remain on for approximately three minutes.

NOTE:

Care should be taken in disposing of used fluids from your vehicle. Used fluids, indiscriminately discarded, can present a problem to the environment. Contact an authorized dealer, service station, or government agency for advice on recycling programs and for where used fluids and filters can be properly disposed of in your area.

Drain the fuel/water separator filters when the Water In Fuel Indicator Light is ON. Within 10 minutes of vehicle shutdown, turn the engine mounted filter drain valve (located on the side of the filter assembly) counterclockwise 1/4 turn, and turn the under body mounted filter drain valve (located on the bottom of the filter assembly) counterclockwise 1 full turn. Then turn the ignition switch to the ON position, and allow any accumulated water to drain. Leave the drain valve open until all water and contaminants have been removed. When clean fuel is visible, close the drain valve following these guidelines:

1. Rotate the drain clockwise to close until you feel resistance from the internal seal.
2. Continue turning the drain 1/2 of a turn to properly compress the seal.

NOTE:

Over-compression of the seal due to over-tightening of the drain will damage the seal, cause a leak, and require the entire sensor to be replaced.

3. Turn the ignition switch to OFF.

The sensor drain should not be over-tightened during normal service operations to avoid internal damage and future fuel leaks. The drain should be closed and secured without the use of tools.

If more than a couple ounces/milliliters of fuel have been drained, follow the directions  page 349.

ENGINE MOUNTED FUEL FILTER REPLACEMENT – DIESEL ENGINE

NOTE:

- Using a fuel filter that does not meet the manufacturer's filtration and water separating requirements can severely impact fuel system life and reliability.
- The engine mounted filter housing is equipped with a No-Filter-No-Run (NFNR) feature. Engine will not run if:
 - No filter is installed.
 - Inferior/Non-approved filter is used. Use of OEM filter is required to ensure vehicle will run.



Engine Mounted Fuel Filter Assembly

1 — Drain Valve

CAUTION!

- Diesel fuel will damage blacktop paving surfaces. Drain the filter into an appropriate container.
- Do not prefill the fuel filter when installing a new fuel filter. There is a possibility debris could be introduced into the fuel filter during this action. It is best to install the filter dry and allow the in-tank lift pump to prime the fuel system.

1. Ensure engine is turned off.
2. Place drain pan under the fuel filter drain hose.
3. Open the water drain valve a quarter turn counterclockwise and completely drain fuel and water into the approved container.
4. Close the water drain valve.
5. Remove lid using a socket or strap wrench. Rotate counterclockwise for removal. Remove used o-ring and discard it.
6. Remove the used filter cartridge from the housing and dispose of according to your local regulations.
7. Wipe clean the sealing surfaces of the lid and housing.
8. Install new o-ring back into ring groove on the filter housing and lubricate with clean engine oil.
9. Remove new filter cartridge from plastic bag and install into housing.

NOTE:

Do not remove cartridge from bag until you reach this step in order to keep cartridge clean.

10. Push down on the cartridge to ensure it is properly seated. **Do not pre-fill the filter housing with fuel.**
11. Install lid onto housing and tighten to 22.5 ft-lb (30.5 Nm). Do not overtighten the lid.
12. Prime the engine, then start the engine and confirm there are no leaks ↪ page 349.

UNDERBODY MOUNTED FUEL FILTER REPLACEMENT – DIESEL ENGINE

NOTE:

- Using a fuel filter that does not meet the manufacturer's filtration and water separating requirements can severely impact fuel system life and reliability.
- The underbody mounted filter housing will cause the engine not to run if no filter is installed.



Underbody Mounted Fuel Filter Assembly

1 – Drain Valve

CAUTION!

- Diesel fuel will damage blacktop paving surfaces. Drain the filter into an appropriate container.
- Do not prefill the fuel filter when installing a new fuel filter. There is a possibility debris could be introduced into the fuel filter during this action. It is best to install the filter dry and allow the in-tank lift pump to prime the fuel system.

1. Ensure engine is turned off.
2. Place drain pan under the fuel filter drain hose.
3. Open the water drain valve one full turn counterclockwise and completely drain fuel and water into the approved container.
4. Close the water drain valve.
5. Remove lid using a socket or strap wrench. Rotate counterclockwise for removal. Remove used o-ring and discard it.
6. Remove the used filter cartridge from the housing and dispose of according to your local regulations.
7. Wipe clean the sealing surfaces of the lid and housing.
8. Install new o-ring back into ring groove on the filter housing and lubricate with clean engine oil.

NOTE:

Water In Fuel (WIF) sensor is reusable. Service kit comes with new o-ring for filter canister and WIF sensor.

PRIMING IF THE ENGINE HAS RUN OUT OF FUEL – DIESEL ENGINE

WARNING!

Do not open the high pressure fuel system with the engine running. Engine operation causes high fuel pressure. High pressure fuel spray can cause serious injury or death.

1. Add a substantial amount of fuel to the tank, approximately 2 to 5 gal (8 L to 19 L).
2. Three priming cycles must be completed. Turn ignition to the RUN position and wait approximately 30 seconds. This will activate the in tank fuel pump. Turn the ignition switch to the off position, and leave off for at least 30 seconds. Repeat this procedure three times before cranking the engine.
3. Start the engine using the “Normal Starting” procedure ↪ page 123.
4. Once the engine starts, allow the engine to idle for a minimum of 30 seconds.

CAUTION!

Do not engage the starter motor for more than 15 seconds at a time. Allow two minutes between the cranking intervals.

NOTE:

The engine may run rough until the air is forced from all the fuel lines.

WARNING!

Do not use alcohol or gasoline as a fuel blending agent. They can be unstable under certain conditions and be hazardous or explosive when mixed with diesel fuel.

CAUTION!

Due to lack of lubricants in alcohol or gasoline, the use of these fuels can cause damage to the fuel system.

NOTE:

- A maximum blend of 5% biodiesel, meeting ASTM specification D-975 may be used with your Cummins® diesel engine.
- A maximum blend of 20% biodiesel, meeting ASTM specification D-7467 may be used with your Cummins® diesel engine.
- Use of biodiesel mixture in excess of 20% can negatively impact the fuel filter's ability to separate water from the fuel, resulting in high pressure fuel system corrosion or damage.
- Ethanol blends are not recommended or approved for use with your Cummins® diesel engine.
- In addition, commercially available fuel additives are not necessary for the proper operation of your Cummins® diesel engine.

INTERVENTION REGENERATION STRATEGY — MESSAGE PROCESS FLOW

The Cummins® diesel engine meets all Environmental Protection Agency (EPA) Heavy Duty Diesel Engine Emissions Standards, resulting in one of the lowest emitting diesel engines ever produced.

To achieve these emissions standards, your vehicle is equipped with a state-of-the-art engine and exhaust system. The engine and exhaust after-treatment system work together to achieve the EPA Heavy Duty Diesel Engine Emissions Standards. These systems are seamlessly integrated into your vehicle and managed by the Cummins® Powertrain Control Module (PCM). The PCM manages engine combustion to allow the exhaust system's catalyst to trap and burn Particulate Matter (PM) pollutants, with no input or interaction on your part.

If the engine is allowed to idle or the truck is driven on low engine speed drive cycles for more than two hours, the system will automatically enter an emissions operating mode that will increase the engine idle speed to 900 RPM. While in this mode, which is designed to help maintain the Diesel Particulate Filter, the engine idle speed will return to normal when the brake pedal is applied. A small change in engine tone or a slight change in engine performance while accelerating may also be noticeable at speeds below 20 mph (32 km/h). This operating mode may last for up to an hour of idle time, or around 20 minutes of driving time.

Additionally, your vehicle has the ability to alert you to additional maintenance required on your truck or engine → page 101.

WARNING!

A hot exhaust system can start a fire if you park over materials that can burn. Such materials might be grass or leaves coming into contact with your exhaust system. Do not park or operate your vehicle in areas where your exhaust system can contact anything that can burn.

DIESEL EXHAUST FLUID (DEF)

DEF sometimes known simply by the name of its active component, UREA, is a key component of Selective Catalytic Reduction (SCR) systems, which help diesel vehicles meet stringent emission regulations. DEF is a liquid reducing agent that reacts with engine exhaust in the presence of a catalyst to convert smog-forming Nitrogen Oxides (NOx) into harmless nitrogen and water vapor → page 398.

You can receive assistance in locating DEF by contacting an authorized dealer.

BODY LUBRICATION

Locks and all body pivot points, including such items as seat tracks, door hinge pivot points and rollers, liftgate, tailgate, decklid, sliding doors and hood hinges, should be lubricated periodically with a lithium-based grease, such as Mopar® Spray White Lube to ensure quiet, easy operation and to protect against rust and wear. Prior to the application of any lubricant, the parts concerned should be wiped clean to remove dust and grit; after lubricating, excess oil and grease should be removed. Particular attention should also be given to

hood latching components to ensure proper function. When performing other underhood services, the hood latch, release mechanism and safety catch should be cleaned and lubricated.

The external lock cylinders should be lubricated twice a year, preferably in the Autumn and Spring. Apply a small amount of a high quality lubricant, such as Mopar® Lock Cylinder Lubricant directly into the lock cylinder.

WINDSHIELD WIPER BLADES

Clean the rubber edges of the wiper blades and the windshield periodically with a sponge or soft cloth and a mild nonabrasive cleaner. This will remove accumulations of salt or road film.

Operation of the wipers on dry glass for long periods may cause deterioration of the wiper blades. Always use washer fluid when using the wipers to remove salt or dirt from a dry windshield.

Avoid using the wiper blades to remove frost or ice from the windshield. Keep the blade rubber out of contact with petroleum products such as engine oil, gasoline, etc.

NOTE:

Life expectancy of wiper blades varies depending on geographical area and frequency of use. Poor performance of blades may be present with chattering, marks, water lines or wet spots. If any of these conditions are present, clean the wiper blades or replace as necessary.

The wiper blades and wiper arms should be inspected periodically, not just when wiper performance problems are experienced. This inspection should include the following points:

- Wear or uneven edges
- Foreign material

- Hardening or cracking
- Deformation or fatigue

If a wiper blade or wiper arm is damaged, replace the affected wiper arm or blade with a new unit. Do not attempt to repair a wiper arm or blade that is damaged.

Wiper Blade Removal/Installation

CAUTION!

Do not allow the wiper arm to spring back against the glass without the wiper blade in place or the glass may be damaged.

1. Lift the wiper arm to raise the wiper blade off of the glass, until the wiper arm is in the full up position.

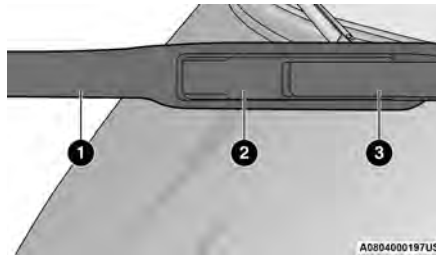

Windshield Wiper Arm And Blade

- 1 – Wiper
- 2 – Locking Tab
- 3 – Wiper Arm

2. To disengage the wiper blade from the wiper arm, flip up the locking tab.

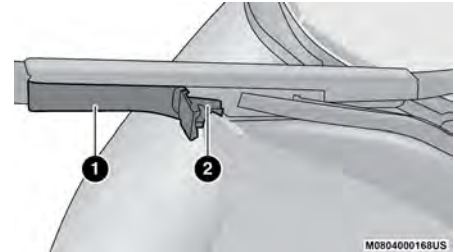

Wiper Locking Assembly

- 1 – Wiper
- 2 – Locking Tab

- Tilt the lower end of the wiper blade away from the arm and with one finger, push the release tab toward the wiper arm.

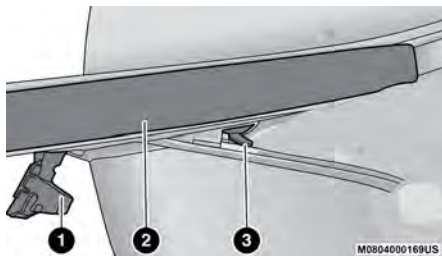
**Wiper Disengaging**

- Locking Tab
- Wiper
- Release Tab

- Slide the wiper blade down towards the base of the wiper arm.
- With the wiper blade disengaged, remove the wiper blade from the wiper arm by holding the wiper arm with one hand and separating the wiper blade from the wiper arm with the other hand (move the wiper blade down toward the base of the wiper arm and away from the J hook in the end of the wiper arm).

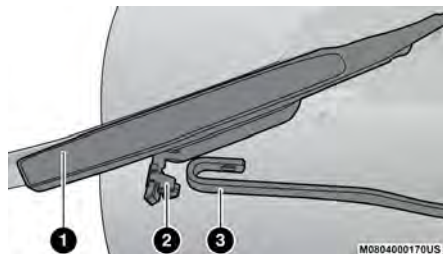
**Removing Wiper From Wiper Arm**

- Wiper
- Locking Tab
- Wiper Arm J Hook

- Gently lower the wiper arm onto the glass.

Installing The Front Wipers

- Lift the wiper arm off of the glass, until the wiper arm is in the full up position.
- Position the wiper blade under the hook on the tip of the wiper arm with the wiper locking tab open.
- Insert the receiver bracket on the wiper assembly into the hook on the tip of the arm through the opening in the wiper blade under the locking tab.
- Slide the wiper blade up into the hook on the wiper arm until it is latched (engagement will be accompanied by an audible click). Fold down the latch release tab and snap it into its locked position.
- Gently lower the wiper blade onto the glass.

EXHAUST SYSTEM

The best protection against carbon monoxide entry into the vehicle body is a properly maintained engine exhaust system.

If you notice a change in the sound of the exhaust system; or if exhaust fumes can be detected inside the vehicle; or when the underside or rear of the vehicle is damaged; have an authorized technician inspect the complete exhaust system and adjacent body areas for broken, damaged, deteriorated, or mispositioned parts. Open seams or loose connections could permit exhaust fumes to seep into the passenger compartment. In addition, have the exhaust system inspected each time the vehicle is raised for lubrication or oil changes. Replace as required.

WARNING!

- Exhaust gases can injure or kill. They contain Carbon Monoxide (CO), which is colorless and odorless. Breathing it can make you unconscious and can eventually poison you → page 313.
- A hot exhaust system can start a fire if you park over materials that can burn. Such materials might be grass or leaves coming into contact with your exhaust system. Do not park or operate your vehicle in areas where your exhaust system can contact anything that can burn.

CAUTION!

- The catalytic converter requires the use of unleaded fuel only. Leaded gasoline will destroy the effectiveness of the catalyst as an emissions control device and may seriously reduce engine performance and cause serious damage to the engine.
- Damage to the catalytic converter can result if your vehicle is not kept in proper operating condition. In the event of engine malfunction, particularly involving engine misfire or other apparent loss of performance, have your vehicle serviced promptly. Continued operation of your vehicle with a severe malfunction could cause the converter to overheat, resulting in possible damage to the converter and vehicle.

Under normal operating conditions, the catalytic converter will not require maintenance. However, it is important to keep the engine properly tuned to ensure proper catalyst operation and prevent possible catalyst damage.

NOTE:

Intentional tampering with emissions control systems can result in civil penalties being assessed against you. In unusual situations involving grossly malfunctioning engine operation, a scorching odor may suggest severe and abnormal catalyst overheating. If this occurs, stop the vehicle, turn off the engine and allow it to cool. Service, including a tune-up to manufacturer's specifications, should be obtained immediately.

To minimize the possibility of catalytic converter damage:

- Do not interrupt the ignition when the transmission is in gear and the vehicle is in motion.
- Do not try to start the vehicle by pushing or towing the vehicle.
- Do not idle the engine with any ignition components disconnected or removed, such as during diagnostic testing, or for prolonged periods during very rough idle or malfunctioning operating conditions.

COOLING SYSTEM**WARNING!**

- You or others can be badly burned by hot engine coolant (antifreeze) or steam from your radiator. If you see or hear steam coming from under the hood, do not open the hood until the radiator has had time to cool. Never open a cooling system pressure cap when the radiator or coolant bottle is hot.
- Keep hands, tools, clothing, and jewelry away from the radiator cooling fan when the hood is raised. The fan starts automatically and may start at any time, whether the engine is running or not.
- When working near the radiator cooling fan, disconnect the fan motor lead or turn the ignition to the OFF mode. The fan is temperature controlled and can start at any time the ignition is in the ON mode.

Engine Coolant Checks

Check the engine coolant (antifreeze) protection every 12 months (before the onset of freezing weather, where applicable). If the engine coolant is dirty or rusty in appearance, the system should be drained, flushed and refilled with fresh coolant. Check the front of the A/C condenser or radiator for any accumulation of bugs, leaves, etc. If dirty, clean by gently spraying water from a garden hose vertically down the face of the A/C condenser or the back of the radiator core.

Check the engine cooling system hoses for brittle rubber, cracking, tears, cuts and tightness of the connection at the coolant recovery bottle and radiator. Inspect the entire system for leaks.

DO NOT REMOVE THE COOLANT PRESSURE CAP WHEN THE COOLING SYSTEM IS HOT.

Cooling System — Drain, Flush And Refill**NOTE:**

Some vehicles require special tools to add coolant properly. Failure to fill these systems properly could lead to severe internal engine damage. If any coolant is needed to be added to the system please contact an authorized dealer.

If the engine coolant (antifreeze) is dirty or contains visible sediment, have an authorized dealer clean and flush with Organic Additive Technology (OAT) coolant (conforming to MS.90032).

For the proper maintenance intervals → page 332.

Selection Of Coolant

For further information ↗ page 398.

NOTE:

- Mixing of engine coolant (antifreeze) other than specified Organic Additive Technology (OAT) engine coolant, may result in engine damage and may decrease corrosion protection. OAT engine coolant is different and should not be mixed with Hybrid Organic Additive Technology (HOAT) engine coolant or any “globally compatible” coolant. If a non-OAT engine coolant is introduced into the cooling system in an emergency, the cooling system will need to be drained, flushed, and refilled with fresh OAT coolant (conforming to MS.90032), by an authorized dealer as soon as possible.
- Do not use water alone or alcohol-based engine coolant products. Do not use additional rust inhibitors or antirust products, as they may not be compatible with the radiator engine coolant and may plug the radiator.
- This vehicle has not been designed for use with propylene glycol-based engine coolant. Use of propylene glycol-based engine coolant is not recommended.
- Some vehicles require special tools to add coolant properly. Failure to fill these systems properly could lead to severe internal engine damage. If any coolant is needed to be added to the system please contact an authorized dealer.

Adding Coolant

Your vehicle has been built with an improved engine coolant (OAT coolant conforming to MS.90032) that allows extended maintenance intervals. This engine coolant (antifreeze) can be used up to ten years or 150,000 miles (240,000 km) before replacement. To prevent reducing this extended maintenance period, it is important to use the same engine coolant (OAT coolant conforming to MS.90032) throughout the life of your vehicle.

Please review these recommendations for using Organic Additive Technology (OAT) engine coolant that meets the requirements of the manufacturer Material Standard MS.90032. When adding engine coolant:

- We recommend using Mopar® Antifreeze/Coolant 10 Year/150,000 Mile (240,000 km) Formula OAT that meets the requirements of the manufacturer Material Standard MS.90032.
- Mix a minimum solution of 50% OAT engine coolant that meets the requirements of the manufacturer Material Standard MS.90032 and distilled water. Use higher concentrations (not to exceed 70%) if temperatures below -34°F (-37°C) are anticipated. Please contact an authorized dealer for assistance.
- Use only high purity water such as distilled or deionized water when mixing the water/engine coolant (antifreeze) solution. The use of lower quality water will reduce the amount of corrosion protection in the engine cooling system.

NOTE:

- It is the owner's responsibility to maintain the proper level of protection against freezing according to the temperatures occurring in the area where the vehicle is operated.

- Some vehicles require special tools to add coolant properly. Failure to fill these systems properly could lead to severe internal engine damage. If any coolant is needed to be added to the system, please contact a local authorized dealer.
- Mixing engine coolant types is not recommended and can result in cooling system damage. If HOAT and OAT coolant are mixed in an emergency, have an authorized dealer drain, flush, and refill with OAT coolant (conforming to MS.90032) as soon as possible.

Cooling System Pressure Cap

The cap must be fully tightened to prevent loss of engine coolant (antifreeze), and to ensure that engine coolant will return to the radiator from the coolant expansion bottle/recovery tank if so equipped.

The cap should be inspected and cleaned if there is any accumulation of foreign material on the sealing surfaces.

WARNING!

- Do not open a hot engine cooling system. Never add engine coolant (antifreeze) when the engine is overheated. Do not loosen or remove the cap to cool an overheated engine. Heat causes pressure to build up in the cooling system. To prevent scalding or injury, do not remove the pressure cap while the system is hot or under pressure.
- Do not use a pressure cap other than the one specified for your vehicle. Personal injury or engine damage may result.

Disposal Of Used Coolant

Used ethylene glycol-based coolant (antifreeze) is a regulated substance requiring proper disposal. Check with your local authorities to determine the disposal rules for your community. To prevent ingestion by animals or children, do not store ethylene glycol-based coolant in open containers or allow it to remain in puddles on the ground. If ingested by a child or pet, seek emergency assistance immediately. Clean up any ground spills immediately.

Checking Coolant Level — 6.4L Engine

The level of the coolant in the pressurized coolant bottle should be between the “MIN” and “MAX” range on the bottle when the engine is cold.

The radiator normally remains completely full, so there is no need to remove the cap unless checking for coolant freeze point or replacing engine coolant (antifreeze). Advise your service attendant of this. As long as the engine operating temperature is satisfactory, the coolant bottle need only be checked once a month. When additional engine coolant is needed to maintain the proper level, it should be added to the coolant bottle. Do not overfill.

Cooling System Notes

NOTE:

When the vehicle is stopped after a few miles/kilometers of operation, you may observe vapor coming from the front of the engine compartment. This is normally a result of moisture from rain, snow, or high humidity accumulating on the radiator and being vaporized when the thermostat opens, allowing hot engine coolant (antifreeze) to enter the radiator.

If an examination of your engine compartment shows no evidence of radiator or hose leaks, the vehicle may be safely driven. The vapor will soon dissipate.

- Do not overfill the coolant expansion bottle.
- Check the coolant freeze point in the radiator and in the coolant expansion bottle. If engine coolant needs to be added, the contents of the coolant expansion bottle must also be protected against freezing.
- If frequent engine coolant additions are required, the cooling system should be pressure tested for leaks.
- Maintain engine coolant concentration at a minimum of 50% OAT coolant (conforming to MS.90032) and distilled water for proper corrosion protection of your engine which contains aluminum components.
- Make sure that the coolant expansion bottle overflow hoses are not kinked or obstructed.
- Keep the front of the radiator clean. If your vehicle is equipped with air conditioning, keep the front of the condenser clean.
- Do not change the thermostat for Summer or Winter operation. If replacement is ever necessary, install ONLY the correct type thermostat. Other designs may result in unsatisfactory engine cooling performance, poor gas mileage, and increased emissions.

CHARGE AIR COOLER — INTER-COOLER

The charge air cooler is positioned below the radiator and the air conditioner condenser. Air enters the engine through the air cleaner and passes through the turbocharger, where it is pressurized. This pressurized air rapidly reaches high temperature. The air is then directed through a hose to the charge air cooler and through another hose to the intake manifold of the engine. The air entering the engine has been cooled by about 50° to 100°F (10° to 38°C). This cooling process enables more efficient burning of fuel resulting in fewer emissions.

To guarantee optimum performance of the system, keep the surfaces of the charge air cooler, condenser and radiator clean and free of debris. Periodically check the hoses leading to and from the charge air cooler for cracks or loose clamps resulting in loss of pressure and reduced engine performance.

BRAKE SYSTEM

In order to ensure brake system performance, all brake system components should be inspected periodically  page 332.

WARNING!

Riding the brakes can lead to brake failure and possibly a collision. Driving with your foot resting or riding on the brake pedal can result in abnormally high brake temperatures, excessive lining wear, and possible brake damage. You would not have your full braking capacity in an emergency.

Fluid Level Check — Brake Master Cylinder

The fluid level of the master cylinder should be checked when performing under the hood service or immediately if the Brake System Warning Light indicates system failure.

If necessary, add fluid to bring level within the designated marks on the side of the reservoir of the brake master cylinder. Be sure to clean the top of the master cylinder area before removing cap.

With disc brakes the fluid level can be expected to fall as the brake linings wear. However, an unexpected drop in fluid level may be caused by a leak and a system check should be conducted.

For further information ↗ page 400.

WARNING!

- Use only manufacturer's recommended brake fluid ↗ page 400. Using the wrong type of brake fluid can severely damage your brake system and/or impair its performance. The proper type of brake fluid for your vehicle is also identified on the original factory installed hydraulic master cylinder reservoir.
- To avoid contamination from foreign matter or moisture, use only new brake fluid or fluid that has been in a tightly closed container. Keep the master cylinder reservoir cap secured at all times. Brake fluid in an open container absorbs moisture from the air resulting in a lower boiling point. This may cause it to boil unexpectedly during hard or prolonged braking, resulting in sudden brake failure. This could result in a collision.

(Continued)

WARNING!

- Overfilling the brake fluid reservoir can result in spilling brake fluid on hot engine parts, causing the brake fluid to catch fire. Brake fluid can also damage painted and vinyl surfaces, care should be taken to avoid its contact with these surfaces.
- Do not allow petroleum based fluid to contaminate the brake fluid. Brake seal components could be damaged, causing partial or complete brake failure. This could result in a collision.

AUTOMATIC TRANSMISSION

Special Additives

The manufacturer strongly recommends against using any special additives in the transmission. Automatic Transmission Fluid (ATF) is an engineered product and its performance may be impaired by supplemental additives. Therefore, do not add any fluid additives to the transmission. The only exception to this policy is the use of special dyes for diagnosing fluid leaks in transmissions. Avoid using transmission sealers as they may adversely affect seals.

CAUTION!

Do not use chemical flushes in your transmission as the chemicals can damage your transmission components. Such damage is not covered by the New Vehicle Limited Warranty.

Fluid Level Check — 8-Speed Transmission

The fluid level is preset at the factory and does not require adjustment under normal operating conditions. Routine fluid level checks are not required, therefore the transmission has no dipstick. An authorized dealer can check your transmission fluid level using special service tools.

If you notice fluid leakage or transmission malfunction, visit an authorized dealer immediately to have the transmission fluid level checked. Operating the vehicle with an improper fluid level can cause severe transmission damage.

CAUTION!

If a transmission fluid leak occurs, visit an authorized dealer immediately. Severe transmission damage may occur. An authorized dealer has the proper tools to adjust the fluid level accurately.

Fluid Level Check — 6-Speed Transmission

It is best to check the fluid level when the transmission is at normal operating temperature (158-176 °F / 70-80 °C). This normally occurs after at least 15 miles (25 km) of driving. At normal operating temperature the fluid cannot be held comfortably between the fingertips. You can read the transmission sump temperature in the instrument cluster screen ↗ page 101.

Use the following procedure to check the transmission fluid level properly:

1. Monitor the transmission temperature using the instrument cluster display, and operate the vehicle as required to reach the normal operating temperature. If the transmission is not functioning properly, or the vehicle cannot be driven, see the following Note and Caution about checking the fluid level at colder temperatures.
2. Park the vehicle on level ground.
3. Run the engine at normal idle speed for at least 60 seconds, and leave the engine running for the rest of this procedure.
4. Fully apply the parking brake, and press the brake pedal.
5. Place the gear selector momentarily into each gear position (allowing time for the transmission to fully engage in each position), ending with the transmission in PARK.
6. Remove the dipstick by unlocking the cap, wipe it clean and reinsert it until seated.
7. Remove the dipstick again and note the fluid level on both sides. The fluid level reading is only valid if there is a solid coating of oil on both sides of the dipstick. Note that the holes in the dipstick will be full of fluid if the actual level is at or above the hole. The fluid level should be between the "HOT" (upper) reference holes on the dipstick at normal operating temperature. If the fluid level is low, add fluid through the dipstick tube to bring it to the proper level. **Do not overfill.** Use ONLY the specified fluid  page 400. After adding any quantity of fluid through the dipstick tube, wait a minimum of two minutes for the fluid to fully drain into the transmission before rechecking the fluid level.



Dipstick

NOTE:

If it is necessary to check the transmission below the operating temperature, the fluid level should be between the two "COLD" (lower) holes on the dipstick with the fluid at 60-70 °F / 16-21 °C. Only use the COLD region of the dipstick as a rough reference when setting the fluid level after a transmission service or fluid change. Recheck the fluid level, and adjust as required, once the transmission reaches normal operating temperature.

CAUTION!

If the fluid temperature is below 50 °F (10 °C) it may not register on the dipstick. Do not add fluid until the temperature is elevated enough to produce an accurate reading. Run the engine at idle, in PARK, to warm the fluid.

8. Reinsert the dipstick until fully seated and lock it down. The bending of the blade will orient the cap in the correct position. Do not force or rotate the cap into another position. Check for leaks. Release the parking brake.

Fluid And Filter Changes — 8-Speed Transmission

Under normal operating conditions, the fluid installed at the factory will provide satisfactory lubrication for the life of the vehicle.

Routine fluid and filter changes are not required. However, change the fluid and filter if the fluid becomes contaminated (with water, etc.), or if the transmission is disassembled for any reason.

Fluid And Filter Changes — 6-Speed Transmission

For the proper maintenance intervals  page 332.

In addition, change the fluid and filters if the fluid becomes contaminated (with water, etc.), or if the transmission is disassembled for any reason.

Selection Of Lubricant

It is important to use the proper transmission fluid to ensure optimum transmission performance and life. Use only the manufacturer's specified transmission fluid  page 400. It is important to maintain the transmission fluid at the correct level using the recommended fluid. No chemical flushes should be used in any transmission; only the approved lubricant should be used.

CAUTION!

Using a transmission fluid other than the manufacturer's recommended fluid may cause deterioration in transmission shift quality and/or torque converter shudder, and will require more frequent fluid and filter changes ↪ page 400.

REAR AXLE AND 4X4 FRONT DRIVING AXLE FLUID LEVEL

For normal service, periodic fluid level checks are not required. When the vehicle is serviced for other reasons the exterior surfaces of the axle assembly should be inspected. If gear oil leakage is suspected inspect the fluid level ↪ page 400. This inspection should be made with the vehicle in a level position.

To check the axle fluid, park the vehicle on a level surface. Take a piece of wire (or zip tie) and make a 90 degree bend two inches from the end of the wire. Insert the wire into the fill plug hole and use it like a dipstick. Remove the wire and measure from the 90 degree bend to the oil level.

For the 2500 (Non-Power Wagon) axles, the fluid level should be $4/5$ in \pm $1/4$ in (20.3 mm \pm 6.4 mm) below the fill hole for the rear axle and it should be $1/4$ in \pm $1/4$ in (6.4 mm \pm 6.4 mm) below the fill hole on the front axle.

For the 2500 Power Wagon and all 3500 model axles, the fluid level should be $1/4$ in \pm $1/4$ in (6.4 mm \pm 6.4 mm) below the fill hole on the 9.25 in front, 11.5 in rear axle, and 12.0 in rear axle.

Drain And Refill

For the proper maintenance intervals ↪ page 332.

Lubricant Selection

For further information ↪ page 400.

NOTE:

The presence of water in the gear lubricant will result in corrosion and possible failure of differential components. Operation of the vehicle in water, as may be encountered in some off-highway types of service, will require draining and refilling the axle to avoid damage.

Limited-Slip Differentials **DO REQUIRE** limited slip oil additive (friction modifiers).

NOTE:

Slight noise and mild shuddering may be evident while turning a vehicle with limited slip differential on concrete or dry pavement. These conditions should be considered normal operation of the limited slip differential.

TRANSFER CASE

Fluid Level Check

This fluid level can be checked by removing the filler plug. The fluid level should be to the bottom edge of the filler plug hole with the vehicle in a level position.

Drain And Refill

For the proper maintenance intervals ↪ page 332.

Selection Of Lubricant

Use only the manufacturer's recommended fluid ↪ page 400.

NOISE CONTROL SYSTEM REQUIRED MAINTENANCE & WARRANTY

All vehicles built over 10,000 lb (4,535 kg) Gross Vehicle Weight Rating and manufactured for sale and use in the United States are required to comply with the Federal Government's Exterior Noise Regulations. These vehicles can be identified by the Noise Emission Control Label located in the operator's compartment.

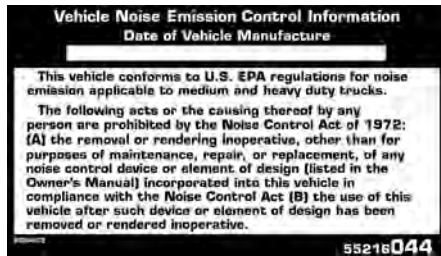

Required Maintenance For Noise Control Systems

The following maintenance services must be performed every six months or 7,500 miles (12,000 km) whichever comes first, to ensure proper operation of the noise control systems. In addition, inspection and service should be performed anytime a malfunction is observed or suspected. Proper maintenance of the entire vehicle will help the effectiveness of the noise control systems.

Exhaust System

Inspect the entire exhaust system for leaks and damaged parts. Devices such as hangers, clamps, and U-bolts should be tight and in good condition. Damaged components, burned or blown out mufflers, burned or rusted out exhaust pipes should be replaced according to the procedures and specifications outlined in the appropriate service manual.

Air Cleaner Assembly

Inspect air cleaner housing for proper assembly and fit. Make certain that the air cleaner is properly positioned and that the cover is tight. Check all hoses leading to the air cleaner for tightness. The air filter element must also be clean and serviced according to the instructions outlined in the Scheduled Maintenance section of this manual.

Maintenance Log and Service Chart (Diesel Engines)

Noise Systems Maintenance Chart and Service Log — Insert Month, Day, Year under column mileage closest to the mileage at which service was performed.								
MILES	7,500	15,000	22,500	30,000	37,500	45,000	52,500	60,000
KILOMETERS	12,000	24,000	36,000	48,000	60,000	72,000	84,000	96,000
Exhaust system-inspect								
Air cleaner assembly-inspect								
ODOMETER READING								
PERFORMED BY								
PERFORMED AT								

Tampering With Noise Control System Prohibited

Federal law prohibits the following acts or the causing thereof: (1) the removal or rendering inoperative by any person, other than for purposes of maintenance, repair, or replacement, of any device or element of design incorporated into any new vehicle for the purpose of noise control prior to its sale or delivery to the ultimate purchaser or while it is in use, or (2) the use of the vehicle after such device or element of design has been removed or rendered inoperative by any person.

Among those acts presumed to constitute tampering are the following:

AIR CLEANER

- Removal of the air cleaner.
- Removal of the air cleaner filter element from the air cleaner housing.
- Removal of the air ducting.

EXHAUST SYSTEM

- Removal of, or rendering inoperative exhaust system components including the muffler or tailpipe.

ENGINE COOLING SYSTEM

- Removal of, or rendering inoperative the fan clutch.
- Removal of the fan shroud.

Noise Emission Warranty

The manufacturer warrants that this vehicle as manufactured by the manufacturer, was designed, built and equipped to conform at the time it left the manufacturer's control with all applicable US EPA Noise Control Regulations.

This warranty covers this vehicle as designed, built and equipped by the manufacturer, and is not limited to any particular part, component or system of the vehicle manufactured by the manufacturer. Defects in design, assembly or in any part, component or system of the vehicle as manufactured by the manufacturer, which, at the time it left the manufacturer's control, caused noise emissions to exceed Federal standards, are covered by this warranty for the life of the vehicle.

Noise Systems Maintenance Chart and Service Log — Insert Month, Day, Year under column mileage closest to the mileage at which service was performed.

MILES	67,500	75,000	82,500	90,000	97,500	105,000	112,500	120,000
KILOMETERS	108,000	120,000	132,000	144,000	156,000	168,000	180,000	192,000
Exhaust system-inspect								
Air cleaner assembly-inspect								
ODOMETER READING								
PERFORMED BY								
PERFORMED AT								

FUSES

General Information

WARNING!

- When replacing a blown fuse, always use an appropriate replacement fuse with the same amp rating as the original fuse. Never replace a fuse with another fuse of higher amp rating. The use of a fuse with a rating other than indicated may result in a dangerous electrical system overload. If a properly rated fuse continues to blow, it indicates a problem in the circuit that must be corrected. Never replace a blown fuse with metal wires or any other material. Do not place a fuse inside a circuit breaker cavity or vice versa. Failure to use proper fuses may result in serious personal injury, fire and/or property damage.
- Before replacing a fuse, make sure that the ignition is off and that all the other services are switched off and/or disengaged.

(Continued)

WARNING!

- If the replaced fuse blows again, contact an authorized dealer.
- If a general protection fuse for safety systems (air bag system, braking system), power unit systems (engine system, transmission system) or steering system blows, contact an authorized dealer.

CAUTION!

If it is necessary to wash the engine compartment, take care not to directly hit the fuse box, and the windshield wiper motors with water.

The fuses protect electrical systems against excessive current.

When a device does not work, you must check the fuse element inside the blade fuse for a break/melt.

Also, please be aware that using power outlets for extended periods of time with the engine off may result in vehicle battery discharge.

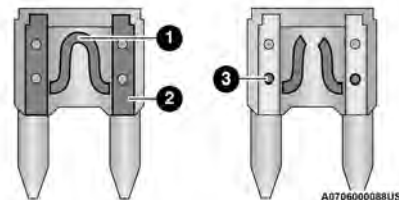

Blade Fuses

- 1 — Fuse Element
- 2 — Blade Fuse with a good/functional fuse element
- 3 — Blade Fuse with a bad/not functional fuse element (blown fuse)

Power Distribution Center

The Power Distribution Center is located in the engine compartment near the battery. This center contains cartridge fuses, micro fuses, relays, and circuit breakers. A description of each fuse and component may be stamped on the inside cover, otherwise the cavity number of each fuse is stamped on the inside cover that corresponds to the following chart.

CAUTION!

- When installing the power distribution center cover, it is important to ensure the cover is properly positioned and fully latched. Failure to do so may allow water to get into the power distribution center and possibly result in an electrical system failure.
- If it is necessary to wash the engine compartment, take care not to directly hit the fuse box, and the windshield wiper motor with water.

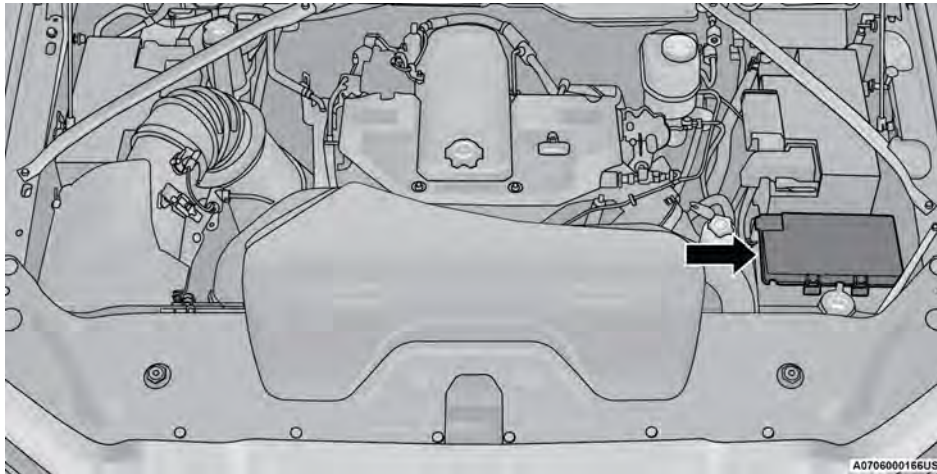

Power Distribution Center Location

Cavity	Cartridge Fuse	Micro Fuse	Description
* If Equipped			
F01	-	-	Spare
F02	60 Amp Yellow	-	ABS Pump Mtr
F03	60 Amp Yellow	-	Rad Fan HI / Lo *
F04	50 Amp Red	-	400W Inverter
F05	50 Amp Red	-	Air Suspension Comp
F06	40 Amp Green	-	STOM
F07	40 Amp Green	-	Starter Solenoid
F08	20 Amp Blue	-	NOX Sensor *
F09	30 Amp Pink	-	Gas - Brake Vacuum Pump *
	40 Amp Green		Diesel - Fuel Heater *
F10	40 Amp Green	-	CBC #2 / Ext Lights
F11	40 Amp Green	-	Brake SYS MOD ECU & Valves
F12	40 Amp Green	-	CBC #3 / Pwr Locks
F13	40 Amp Green	-	HVAC Blwr Mtr
F14	40 Amp Green	-	CBC #4 / Ext Light
F15	30 Amp Pink	-	Power Side Step *
F16	30 Amp Pink	-	Smart - Bar Module *
F17	30 Amp Pink	-	Winch *
F18	-	-	Spare
F19	30 Amp Pink	-	Diesel SCR Feed *
F20	30 Amp Pink	-	Passenger Door Mod
F21	30 Amp Pink	-	DTCM
F22	20 Amp Blue	-	Gas - ECM *
	25 Amp White		Diesel - PCM *
F23	30 Amp Pink	-	CBC #1 / Int Light

Cavity	Cartridge Fuse	Micro Fuse * If Equipped	Description
F24	30 Amp Pink	-	Driver Door Mod
F25	30 Amp Pink	-	FT Wiper
F26	-	-	Spare
F27	-	-	Spare
F28	20 Amp Blue	-	TRLR Tow B / U
F29	20 Amp Blue	-	TRLR Tow Park
F30	30 Amp Pink	-	TRLR Tow
F31	-	-	Spare
F32	-	-	Spare
F33	20 Amp Blue	-	Trans Control Mod *
F34	30 Amp Pink	-	VSIM #2 *
F35	30 Amp Pink	-	Sunroof *
F36	30 Amp Pink	-	Rear Defroster (EBL) *
F37	30 Amp Pink	-	Diesel Frame / Fuel HTR *
F38	30 Amp Pink	-	ITBM *
F39	-	-	Spare
F40	-	10 Amp Red	Vented Seats *
F41	-	10 Amp Red	Act Grille Shutter / Dam *
F42	-	20 Amp Yellow	Horn
F43	-	15 Amp Blue	Heated Strng Wheel *
F44	-	10 Amp Red	Diagnostic Port
F45	-	-	Spare
F46	-	10 Amp Red	Upfitters Relay Coils *
F47	-	-	Spare
F48	-	-	Spare

Cavity	Cartridge Fuse	Micro Fuse	Description
		* If Equipped	
F49	-	15 Amp Blue	IP Cluster / CSG
F50	-	20 Amp Yellow	Air Suspension Mod *
F51	-	10 Amp Red	IGN Mod / KINMod / RFHub
F52	-	5 Amp Tan	Batt Snsr
F53	-	20 Amp Yellow	TRLR Tow - Lt Turn/Stop
F54	-	20 Amp Yellow	Non-Memory Adj Pedals *
F55	-	10 Amp Red	Fwd Utility Lamps
F56	-	10 Amp Red	VBV
F57	-	20 Amp Yellow	TCM / PCM / Trans PRSR SW
F58	-	10 Amp Red	Bed Lighting
F59	-	-	Spare
F60	-	-	Spare
F61	-	10 Amp Red	NH3 Sensor / PM Sensor *
F62	-	10 Amp Red	A/C Clutch
F63	-	20 Amp Yellow	Ignition Coils / CAPS
F64	-	25 Amp Clear	Fuel Injectors / PCM *
F65	-	10 Amp Red	RVDMP / MOD BLE *
F66	-	10 Amp Red	Sunroof / USB RR * / RR Mirror/ Passenger Wind SW
F67	-	10 Amp Red	UCI / TRLR 360 Cam/ Tach *
F68	-	10 Amp Red	AEB RACAM HTR *
F69	-	15 Amp Blue	SCR Mod 12 Volt *
F70	-	30 Amp Green	Fuel Pump Mtr / Fuel Htr RLY
F71	-	25 Amp Clear	Amp / Act Noise Cnsl
F72	-	-	Spare
F73	-	20 Amp Yellow	Fuel Transfer Pump *

Cavity	Cartridge Fuse	Micro Fuse	Description
* If Equipped			
F74	-	10 Amp Red	Backup Alarm
F75	-	10 Amp Red	SCR RLY / ATMM *
F76	-	10 Amp Red	Electronic Stability Control (ESC) *
F77	-	10 Amp Red	DTCM / TCM / FAD MOD / STOM
F78	-	15 Amp Blue	ECM / PCM / IRCM / AUX Relay Feed / HRLS
F79	-	15 Amp Blue	ID / Clearance Lt
F80	-	10 Amp Red	Ovrhd Con / Assist / 911
F81	-	20 Amp Yellow	TRLR Tow RT Turn / Stop
F82	-	10 Amp Red	SCCM / Cruise Control
F83	-	10 Amp Red	TLR AST / TLR RVS CTL / TLR KNB
F84	-	15 Amp Blue	ASBM / HVAC / ICS / R Heated Seats SW
F85	-	10 Amp Red	ORC (Airbag)
F86	-	10 Amp Red	ORC (Airbag)
F87	-	10 Amp Red	Air Susp / ITBM / SCCM / TLR TPM
F88	-	15 Amp Blue	IP Cluster
F89	-	-	Spare
F90	-	20 Amp Yellow	Power Outlet / Batt
F91	-	-	Power Outlet / Acc
F92	-	10 Amp Red	Invertor MOD / USB-IP / WCPM *
F93	-	-	Spare

Cavity	Cartridge Fuse	Micro Fuse	Description
* If Equipped			
F94	-	10 Amp Red	SBW / TCASE SW / TRL TPM - GTWY
F95	-	10 Amp Red	RR CAM / PRKTRNX/ CHMSL Cam / Bld SPT SNR / SVUE CAM *
F96	-	10 Amp Red	TRL Cam *
F97	-	20 Amp Yellow	Front HTD ST PSGR *
F98	-	20 Amp Yellow	Front HTD ST DRIVER *
F99	-	10 Amp Red	HVAC / IN-CARTS / CSG / TRL CWY MOD */ TACH
F100	-	10 Amp Red	Upfitter Box Feed *
F101	-	20 Amp Yellow	RR HTD ST Right *
F102	-	20 Amp Yellow	RR HTD ST Left / Run RLY #3 *
F103	-	10 Amp Red	HeadLamp AFLS *
F104	-	20 Amp Yellow	UCI Port / USB Rear

BULB REPLACEMENT

Replacement Bulbs, Names, And Part Numbers

In the instance a bulb needs to be replaced, this section includes bulb description and replacement part numbers. All of the inside bulbs are brass or glass-wedge base. Aluminum base bulbs are not approved.

NOTE:

Please see an authorized dealer for LED replacement

Interior Bulbs	
Bulb Name	Bulb Number
Overhead Console Lamps	TS 212-9
Dome Lamp	7679
For lighted switches, see an authorized dealer for replacement instructions.	

Exterior Bulbs	
Bulb Name	Bulb Number
Low Beam (Halogen Reflector Headlamp)	H11LL
High Beam (Halogen Reflector Headlamp)	9005LL
Low & High Beam	LED
Turn Signal / Front Position (Halogen Reflector Headlamp)	7444NA
Turn Signal	LED
Front Position (LED Headlamps)	LED
Front Side Marker (Headlamps)	LED
Front Fog Lamps (Halogen Reflector Headlamp)	H11LL
Front Fog Lamps (LED Headlamps)	LED
Side Indicators (Front And Side View Mirror)	LED
Base Rear Tail/Turn and Stop Lamp	3157K
Premium Rear Tail/Turn and Stop Lamp	LED
Base Tail/Backup Lamp	W21/5W
Center High Mounted Stop Lamp (CHMSL)	921
Cab Roof Marker Lamps	LED
Rear Lamp Bar ID Marker Lamp	LED
Side Marker Lamps (Dual Rear Wheels)	LED
Base Turn/Tail Lamp	PWY24W
Rear License Plate Lamp	LED

Replacing Exterior Bulbs

BASE QUAD: LOW BEAM HEADLAMP, HIGH BEAM HEADLAMP, FRONT PARK AND TURN — IF EQUIPPED

Low Beam

See the following steps to replace:

1. Open the hood.
2. Disconnect and isolate the negative battery cable.
3. Reach into the front wheel house ahead of the front wheel, remove the fastener, and lift the cover over the access hole in the front of the wheel house splash shield. Access to the rear of the lamp can be gained through this access hole.

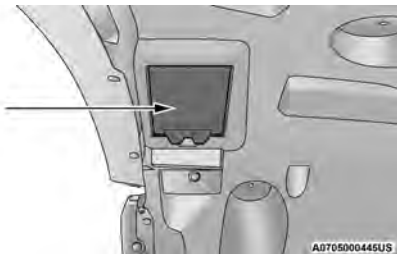

Splash Shield Access Cover

4. Reach through the access hole of the wheel house splash shield and disengage the bulb access cover by rotating counterclockwise.

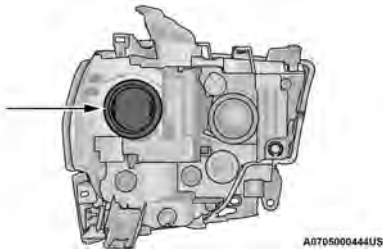

Bulb Access Cover

5. Disconnect the internal lamp wiring harness connector from the low beam bulb.

CAUTION!

- Do not contaminate the bulb glass by touching it with your fingers or by allowing it to contact other oily surfaces. Shortened bulb life will result.
- Always use the correct bulb size and type for replacement. An incorrect bulb size or type may overheat and cause damage to the lamp, the bulb socket, or the lamp wiring.

6. Rotate the bulb counterclockwise a quarter turn to unlock the bulb from the lamp.
7. Pull the bulb straight out from the housing.
8. Reverse the procedure for installation of new bulb and covers.

High Beam

See the following steps to replace:

1. Open the hood.
2. Disconnect and isolate the negative battery cable.

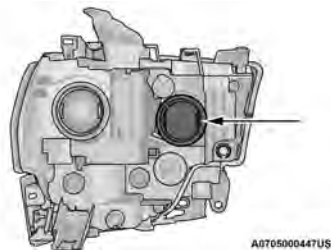

Bulb Access Cover

3. Look under the hood and behind the headlamp to find the high beam bulb access cover.
4. Reach behind the headlamp and disengage the access cover by rotating counterclockwise.
5. Disconnect the internal lamp wiring harness connector from the high beam bulb.

CAUTION!

- Do not contaminate the bulb glass by touching it with your fingers or by allowing it to contact other oily surfaces. Shortened bulb life will result.
- Always use the correct bulb size and type for replacement. An incorrect bulb size or type may overheat and cause damage to the lamp, the bulb socket, or the lamp wiring.

6. Rotate the bulb counterclockwise a quarter turn to unlock the bulb from the lamp.
7. Pull the bulb straight out from the housing.
8. Reverse the procedure for installation of new bulb and covers.

Outer Front Park And Turn

See the following steps to replace:

1. Open the hood.
2. Disconnect and isolate the negative battery cable.
3. Reach into the front wheel house ahead of the front wheel, remove the fastener, and lift the cover over the access hole in the front of the wheel house splash shield. Access to the rear of the lamp can be gained through this access hole.

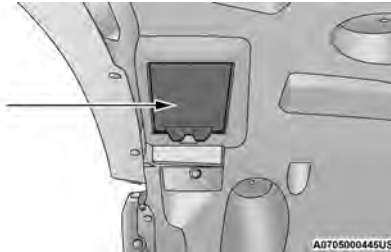
**Splash Shield Access Cover**

4. Reach through the access hole of the wheel house splash shield and disengage the side marker socket by rotating counterclockwise a quarter turn.

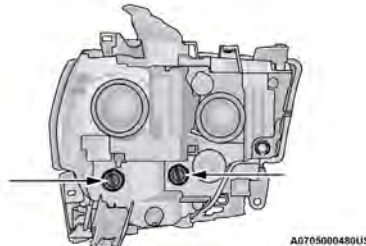
**Park And Turn Sockets**

5. Pull the socket and bulb straight out from the housing.
6. Separate the bulb from the socket without twisting.
7. Reverse the procedure for installation of new bulb and covers.

FOG LAMPS — IF EQUIPPED

Please see an authorized dealer for service on LED and Halogen front fog lamps.

Halogen

See the following steps to replace:

1. Reach under and behind the front fascia/bumper to access the back of the front fog lamp housing.
2. Disconnect the fog lamp wiring harness connector from the fog lamp bulb.
3. Rotate the bulb counterclockwise a quarter turn to unlock the bulb from the housing.

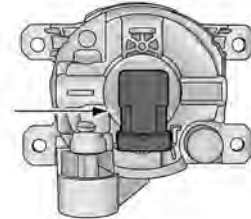
**Fog Lamp Bulb**

4. Pull the bulb straight out from the housing.

CAUTION!

Do not contaminate the bulb glass by touching it with your fingers or by allowing it to contact other oily surfaces. Shortened bulb life will result.

REAR TAIL/STOP, TURN SIGNAL AND BACKUP LAMPS

See the following steps to replace:

1. Remove the two screws and pushpins that pass through the bed sheet metal.

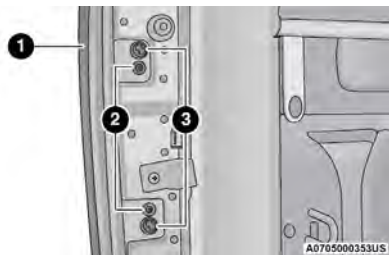

Tail Lamp Locations

- 1 – Tail Lamp
2 – Screws
3 – Fasteners

2. Pull the outboard side of the lamp rearward far enough to unsnap the two receptacles on the outboard side of the lamp housing from the two plastic snap post retainers in the outer box side panel.

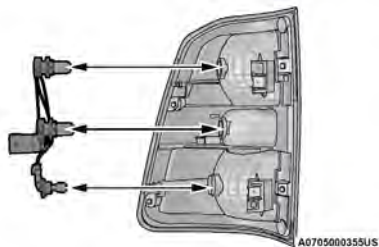

Tail Lamp Removed

3. Disconnect the wiring harness connectors from the bulb socket.
4. Rotate the bulb socket counterclockwise a quarter turn to unlock it from the housing.
5. Pull the bulb straight out of the socket.

CAUTION!

Do not contaminate the bulb glass by touching it with your fingers or by allowing it to contact other oily surfaces. Shortened bulb life will result.

6. Reverse the procedure to install the bulb and housing.

CENTER HIGH MOUNTED STOP LAMP (CHMSL) WITH CARGO LAMP

See the following steps to replace:

1. Remove the two screws holding the housing/lens to the body as shown.

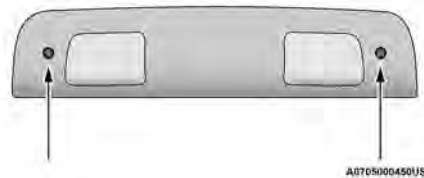

CHMSL Mounting Screw Locations

2. Separate the connector holding the housing and wiring harness to the body.
3. Turn the desired bulb socket a quarter turn and remove the socket and bulb from housing.

- Pull the desired bulb straight from the socket.

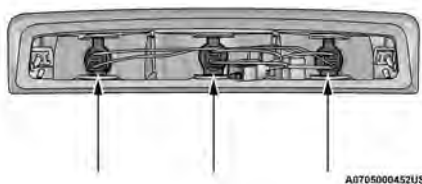

CHMSL Bulb And Socket

CAUTION!

Do not contaminate the bulb glass by touching it with your fingers or by allowing it to contact other oily surfaces. Shortened bulb life will result.

- Outside Bulbs: Cargo Lamps
 - Inside Bulb: Center High Mounted Stop Lamp
- Reverse the procedure for installation of bulbs and housing.

CAB TOP CLEARANCE LAMPS — IF EQUIPPED

See the following steps to replace:

- Remove the screws from the top of the lamp.

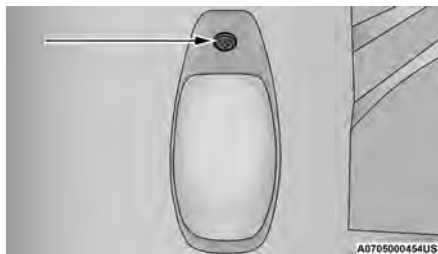

Screw Location From Clearance Lamp

- Rotate the bulb socket a quarter turn and pull it from the lamp assembly.

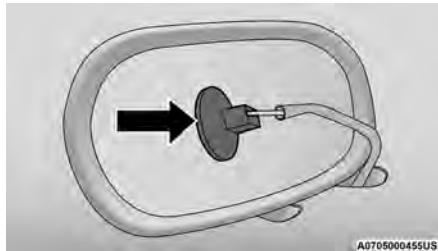

Removing Bulb Socket From Clearance Lamp

- Pull the bulb straight from it's socket and replace.

REAR LAMP BAR ID MARKER (DUAL REAR WHEELS) — IF EQUIPPED

See the following steps to replace:

- Loosen the two screws and the housing to gain access to the bulb sockets.

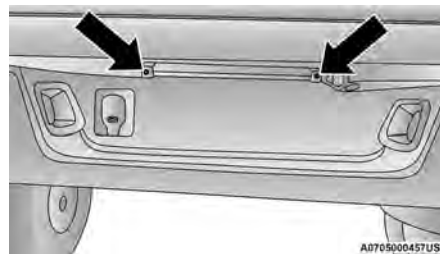

Screw Locations

- Turn the socket a quarter turn counterclockwise to access the bulb.
- Pull the bulb straight out from the socket.
- Reverse the procedure for installation of the bulbs and housing.

TIRE SIZING CHART

EXAMPLE:
Example Size Designation: P215/65R15XL 95H, 215/65R15 96H, LT235/85R16C, T145/80D18 103M, 31x10.5 R15 LT
<p>P = Passenger car tire size based on US design standards, or "...blank..." = Passenger car tire based on European design standards, or LT = Light truck tire based on US design standards, or T or S = Temporary spare tire or 31 = Overall diameter in inches (in) 215, 235, 145 = Section width in millimeters (mm) 65, 85, 80 = Aspect ratio in percent (%)</p> <ul style="list-style-type: none"> ● Ratio of section height to section width of tire, or <p>10.5 = Section width in inches (in)</p>
<p>R = Construction code</p> <ul style="list-style-type: none"> ● "R" means radial construction, or ● "D" means diagonal or bias construction
15, 16, 18 = Rim diameter in inches (in)
Service Description:
<p>95 = Load Index</p> <ul style="list-style-type: none"> ● A numerical code associated with the maximum load a tire can carry
<p>H = Speed Symbol</p> <ul style="list-style-type: none"> ● A symbol indicating the range of speeds at which a tire can carry a load corresponding to its load index under certain operating conditions ● The maximum speed corresponding to the speed symbol should only be achieved under specified operating conditions (i.e., tire pressure, vehicle loading, road conditions, and posted speed limits)
<p>Load Identification: Absence of the following load identification symbols on the sidewall of the tire indicates a Standard Load (SL) tire:</p> <ul style="list-style-type: none"> ● XL = Extra load (or reinforced) tire, or ● LL = Light load tire or ● C, D, E, F, G = Load range associated with the maximum load a tire can carry at a specified pressure
Maximum Load - Maximum load indicates the maximum load this tire is designed to carry
Maximum Pressure - Maximum pressure indicates the maximum permissible cold tire inflation pressure for this tire

Tire Identification Number (TIN)

The TIN may be found on one or both sides of the tire; however, the date code may only be on one side. Tires with white sidewalls will have the full TIN, including the date code, located on the white sidewall side of the tire. Look for the TIN on the outboard side of black sidewall tires as mounted on the vehicle. If the TIN is not found on the outboard side, then you will find it on the inboard side of the tire.

EXAMPLE:
DOT MA L9 ABCD 0301
DOT = Department of Transportation <ul style="list-style-type: none"> ● This symbol certifies that the tire is in compliance with the US Department of Transportation tire safety standards and is approved for highway use
MA = Code representing the tire manufacturing location (two digits)
L9 = Code representing the tire size (two digits)
ABCD = Code used by the tire manufacturer (one to four digits)
03 = Number representing the week in which the tire was manufactured (two digits) <ul style="list-style-type: none"> ● 03 means the 3rd week
01 = Number representing the year in which the tire was manufactured (two digits) <ul style="list-style-type: none"> ● 01 means the year 2001 ● Prior to July 2000, tire manufacturers were only required to have one number to represent the year in which the tire was manufactured. Example: 031 could represent the 3rd week of 1981 or 1991

Tire Terminology And Definitions

Term	Definition
B-pillar	The vehicle B-pillar is the structural member of the body located behind the front door.
Cold Tire Inflation Pressure	Cold tire inflation pressure is defined as the tire pressure after the vehicle has not been driven for at least three hours, or driven less than 1 mile (1.6 km) after sitting for a minimum of three hours. Inflation pressure is measured in units of psi (pounds per square inch) or kPa (kilopascals).
Maximum Inflation Pressure	The maximum inflation pressure is the maximum permissible cold tire inflation pressure for this tire. The maximum inflation pressure is molded into the sidewall.
Recommended Cold Tire Inflation Pressure	Vehicle manufacturer's recommended cold tire inflation pressure as shown on the tire placard.
Tire Placard	A label permanently attached to the vehicle describing the vehicle's loading capacity, the original equipment tire sizes and the recommended cold tire inflation pressures.

Tire Loading And Tire Pressure

NOTE:

The proper cold tire inflation pressure is listed on the driver's side B-pillar or the rear edge of the driver's side door.

Check the inflation pressure of each tire, including the spare tire (if equipped), at least monthly and inflate to the recommended pressure for your vehicle.

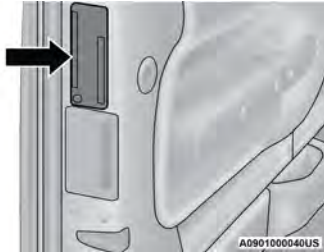

Example Tire Placard Location (Door)

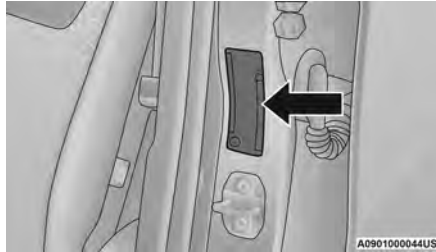

Example Tire Placard Location (B-pillar)

Tire And Loading Information Placard

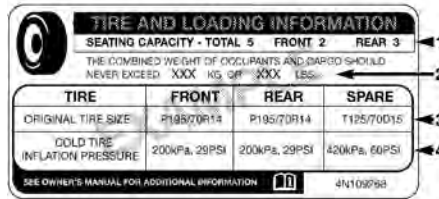

Tire And Loading Information Placard

This placard tells you important information about the:

1. Number of people that can be carried in the vehicle.
2. Total weight your vehicle can carry.
3. Tire size designed for your vehicle.
4. Cold tire inflation pressures for the front, rear, and spare tires.

Loading

The vehicle maximum load on the tire must not exceed the load carrying capacity of the tire on your vehicle. You will not exceed the tire's load carrying capacity if you adhere to the loading conditions, tire size, and cold tire inflation pressures specified on the Tire And Loading Information Placard ↪ page 191.

NOTE:

Under a maximum loaded vehicle condition, gross axle weight ratings (GAWRs) for the front and rear axles must not be exceeded.

For further information on GAWRs, vehicle loading, and trailer towing ↪ page 191.

To determine the maximum loading conditions of your vehicle, locate the statement "The combined weight of occupants and cargo should never exceed XXX kg or XXX lbs" on the Tire And Loading Information Placard. The combined weight of occupants, cargo/luggage and trailer tongue weight (if applicable) should never exceed the weight referenced here.

Steps For Determining Correct Load Limit—

(1) Locate the statement “The combined weight of occupants and cargo should never exceed XXX kg or XXX lbs.” on your vehicle’s placard.

(2) Determine the combined weight of the driver and passengers that will be riding in your vehicle.

(3) Subtract the combined weight of the driver and passengers from XXX kg or XXX lbs.

(4) The resulting figure equals the available amount of cargo and luggage load capacity. For example, if “XXX” amount equals 1400 lbs. and there will be five 150 lb passengers in your vehicle, the amount of available cargo and luggage load capacity is 650 lbs. (1400-750 (5x150) = 650 lbs.)

(5) Determine the combined weight of luggage and cargo being loaded on the vehicle. That weight may not safely exceed the available cargo and luggage load capacity calculated in Step 4.

(6) If your vehicle will be towing a trailer, load from your trailer will be transferred to your vehicle. Consult this manual to determine how this reduces the available cargo and luggage load capacity of your vehicle.

Metric Example For Load Limit

For example, if “XXX” amount equals 635 kg and there will be five 68 kg passengers in your vehicle, the amount of available cargo and luggage load capacity is 295 kg (635-340 (5x68) = 295 kg) as shown in step 4.

NOTE:

- If your vehicle will be towing a trailer, load from your trailer will be transferred to your vehicle. The following table shows examples on how to calculate total load, cargo/luggage, and towing capacities of your vehicle with varying seating configurations and number and size of occupants. This table is for illustration purposes only and may not be accurate for the seating and load carry capacity of your vehicle.
- For the following example, the combined weight of occupants and cargo should never exceed 865 lbs (392 kg).

Occupants			Combined weight of occupants and cargo from Tire Placard	MINUS	Combined Occupant's weight	=	AVAILABLE Cargo/Luggage and Trailer Tongue Weight
TOTAL	FRONT	REAR					
EXAMPLE 1			865 lbs	minus	670 lbs	=	195 lbs
5	2	3					
EXAMPLE 2			865 lbs	minus	540 lbs	=	325 lbs
3	2	1					
EXAMPLE 3			865 lbs	minus	400 lbs	=	465 lbs
2	2	0					

811a4d11

WARNING!

Overloading of your tires is dangerous. Overloading can cause tire failure, affect vehicle handling, and increase your stopping distance. Use tires of the recommended load capacity for your vehicle. Never overload them.

TIRES — GENERAL INFORMATION

Tire Pressure

Proper tire inflation pressure is essential to the safe and satisfactory operation of your vehicle. Four primary areas are affected by improper tire pressure:

- Safety
- Fuel Economy
- Tread Wear
- Ride Comfort and Vehicle Stability

Safety

WARNING!

- Improperly inflated tires are dangerous and can cause collisions.
- Underinflation increases tire flexing and can result in overheating and tire failure.
- Overinflation reduces a tire's ability to cushion shock. Objects on the road and chuckholes can cause damage that result in tire failure.
- Overinflated or underinflated tires can affect vehicle handling and can fail suddenly, resulting in loss of vehicle control.
- Unequal tire pressures can cause steering problems. You could lose control of your vehicle.
- Unequal tire pressures from one side of the vehicle to the other can cause the vehicle to drift to the right or left.
- Always drive with each tire inflated to the recommended cold tire inflation pressure.

Both underinflation and overinflation affect the stability of the vehicle and can produce a feeling of sluggish response or over responsiveness in the steering.

NOTE:

- Unequal tire pressures from side to side may cause erratic and unpredictable steering response.
- Unequal tire pressure from side to side may cause the vehicle to drift left or right.

Fuel Economy

Underinflated tires will increase tire rolling resistance resulting in higher fuel consumption.

Tread Wear

Improper cold tire inflation pressures can cause abnormal wear patterns and reduced tread life, resulting in the need for earlier tire replacement.

Ride Comfort And Vehicle Stability

Proper tire inflation contributes to a comfortable ride. Overinflation produces a jarring and uncomfortable ride.

Tire Inflation Pressures

The proper cold tire inflation pressure is listed on the driver's side B-pillar or rear edge of the driver's side door.

At least once a month:

- Check and adjust tire pressure with a good quality pocket-type pressure gauge. Do not make a visual judgement when determining proper inflation. Tires may look properly inflated even when they are underinflated.
- Inspect tires for signs of tire wear or visible damage.

CAUTION!

After inspecting or adjusting the tire pressure, always reinstall the valve stem cap. This will prevent moisture and dirt from entering the valve stem, which could damage the valve stem.

Inflation pressures specified on the placard are always "cold tire inflation pressure". Cold tire inflation pressure is defined as the tire pressure after the vehicle has not been driven for at least three hours, or driven less than 1 mile (1.6 km) after sitting for a minimum of three hours. The cold tire inflation pressure must not exceed the maximum inflation pressure molded into the tire sidewall.

Check tire pressures more often if subject to a wide range of outdoor temperatures, as tire pressures vary with temperature changes.

Tire pressures change by approximately 1 psi (7 kPa) per 12°F (7°C) of air temperature change. Keep this in mind when checking tire pressure inside a garage, especially in the Winter.

Example: If garage temperature = 68°F (20°C) and the outside temperature = 32°F (0°C) then the cold tire inflation pressure should be increased by 3 psi (21 kPa), which equals 1 psi (7 kPa) for every 12°F (7°C) for this outside temperature condition.

Tire pressure may increase from 2 to 6 psi (13 to 40 kPa) during operation. DO NOT reduce this normal pressure build up or your tire pressure will be too low.

Tire Pressures For High Speed Operation

The manufacturer advocates driving at safe speeds and within posted speed limits. Where speed limits or conditions are such that the vehicle can be driven at high speeds, maintaining correct tire inflation pressure is very important. Increased tire pressure and reduced vehicle loading may be required for high-speed vehicle operation. Refer to an authorized tire dealer or original equipment vehicle dealer for recommended safe operating speeds, loading and cold tire inflation pressures.

WARNING!

High speed driving with your vehicle under maximum load is dangerous. The added strain on your tires could cause them to fail. You could have a serious collision. Do not drive a vehicle loaded to the maximum capacity at continuous speeds above 75 mph (120 km/h).

Radial Ply Tires

WARNING!

Combining radial ply tires with other types of tires on your vehicle will cause your vehicle to handle poorly. The instability could cause a collision. Always use radial ply tires in sets of four. Never combine them with other types of tires.

Tire Repair

If your tire becomes damaged, it may be repaired if it meets the following criteria:

- The tire has not been driven on when flat.
- The damage is only on the tread section of your tire (sidewall damage is not repairable).
- The puncture is no greater than $\frac{1}{4}$ of an inch (6 mm).

Consult an authorized tire dealer for tire repairs and additional information.

Damaged Run Flat tires, or Run Flat tires that have experienced a loss of pressure should be replaced immediately with another Run Flat tire of identical size and service description (Load Index and Speed Symbol). Replace the tire pressure sensor as well as it is not designed to be reused.

Run Flat Tires — If Equipped

Run Flat tires allow you the capability to drive 50 miles (80 km) at 50 mph (80 km/h) after a rapid loss of inflation pressure. This rapid loss of inflation is referred to as the Run Flat mode. A Run Flat mode occurs when the tire inflation pressure is of/or below 14 psi (96 kPa). Once a Run Flat tire reaches the Run Flat mode it has limited driving capabilities and needs to be replaced immediately. A Run Flat tire is not repairable. When a Run Flat tire is changed after being driven under a Run Flat mode 14 psi (96 kPa) condition, please replace the TPMS sensor as it is not designed to be reused.

NOTE:

TPMS sensor must be replaced after driving the vehicle on a flat tire condition.

It is not recommended driving a vehicle loaded at full capacity or to tow a trailer while a tire is in the Run Flat mode ↪ page 280.

Tire Spinning

When stuck in mud, sand, snow, or ice conditions, do not spin your vehicle's wheels above 30 mph (48 km/h) or for longer than 30 seconds continuously without stopping.

For further information ↪ page 329.

WARNING!

Fast spinning tires can be dangerous. Forces generated by excessive wheel speeds may cause tire damage or failure. A tire could explode and injure someone. Do not spin your vehicle's wheels faster than 30 mph (48 km/h) for more than 30 seconds continuously when you are stuck, and do not let anyone near a spinning wheel, no matter what the speed.

Tread Wear Indicators

Tread wear indicators are in the original equipment tires to help you in determining when your tires should be replaced.

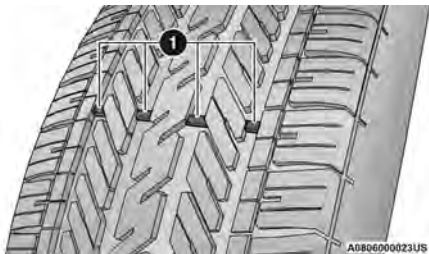

Tire Tread

1 — Tread Wear Indicators

These indicators are molded into the bottom of the tread grooves. They will appear as bands when the tread depth becomes 1/16 of an inch (1.6 mm). When the tread is worn to the tread wear indicators, the tire should be replaced.

Life Of Tire

The service life of a tire is dependent upon varying factors including, but not limited to:

- Driving style.
- Tire pressure - Improper cold tire inflation pressures can cause uneven wear patterns to develop across the tire tread. These abnormal wear patterns will reduce tread life, resulting in the need for earlier tire replacement.

- Distance driven.
- Performance tires, tires with a speed rating of V or higher, and Summer tires typically have a reduced tread life. Rotation of these tires per the vehicle scheduled maintenance is highly recommended.

WARNING!

Tires and the spare tire should be replaced after six years, regardless of the remaining tread. Failure to follow this warning can result in sudden tire failure. You could lose control and have a collision resulting in serious injury or death.

NOTE:

Wheel valve stem must be replaced as well when installing new tires due to wear and tear in existing tires.

Keep dismantled tires in a cool, dry place with as little exposure to light as possible. Protect tires from contact with oil, grease, and gasoline.

Replacement Tires

The tires on your new vehicle provide a balance of many characteristics. They should be inspected regularly for wear and correct cold tire inflation pressures. The manufacturer strongly recommends using tires equivalent to the originals in size, quality and performance when replacement is needed ↪ page 380. Refer to the Tire And Loading Information Placard or the Vehicle Certification Label for the size designation of your tire. The Load Index and Speed Symbol for your tire will be found on the original equipment tire sidewall.

See the Tire Sizing Chart example for more information relating to the Load Index and Speed Symbol of a tire ↪ page 372.

It is recommended to replace the two front tires or two rear tires as a pair. Replacing just one tire can seriously affect your vehicle's handling. If you ever replace a wheel, make sure that the wheel's specifications match those of the original wheels.

It is recommended you contact an authorized tire dealer or original equipment dealer with any questions you may have on tire specifications or capability. Failure to use equivalent replacement tires may adversely affect the safety, handling, and ride of your vehicle.

WARNING!

- Do not use a tire, wheel size, load rating, or speed rating other than that specified for your vehicle. Some combinations of unapproved tires and wheels may change suspension dimensions and performance characteristics, resulting in changes to steering, handling, and braking of your vehicle. This can cause unpredictable handling and stress to steering and suspension components. You could lose control and have a collision resulting in serious injury or death. Use only the tire and wheel sizes with load ratings approved for your vehicle.
- Never use a tire with a smaller load index or capacity, other than what was originally equipped on your vehicle. Using a tire with a smaller load index could result in tire overloading and failure. You could lose control and have a collision.
- Failure to equip your vehicle with tires having adequate speed capability can result in sudden tire failure and loss of vehicle control.

CAUTION!

Replacing original tires with tires of a different size may result in false speedometer and odometer readings.

WARNING!

Do not use Summer tires in snow/ice conditions. You could lose vehicle control, resulting in severe injury or death. Driving too fast for conditions also creates the possibility of loss of vehicle control.

TIRE TYPES

All Season Tires — If Equipped

All Season tires provide traction for all seasons (Spring, Summer, Autumn, and Winter). Traction levels may vary between different all season tires. All season tires can be identified by the M+S, M&S, M/S or MS designation on the tire sidewall. Use all season tires only in sets of four; failure to do so may adversely affect the safety and handling of your vehicle.

Summer Or Three Season Tires — If Equipped

Summer tires provide traction in both wet and dry conditions, and are not intended to be driven in snow or on ice. If your vehicle is equipped with Summer tires, be aware these tires are not designed for Winter or cold driving conditions. Install Winter tires on your vehicle when ambient temperatures are less than 40°F (5°C) or if roads are covered with ice or snow. For more information, contact an authorized dealer.

Summer tires do not contain the all season designation or mountain/snowflake symbol on the tire sidewall. Use Summer tires only in sets of four; failure to do so may adversely affect the safety and handling of your vehicle.

Snow Tires



Some areas of the country require the use of snow tires during the Winter. Snow tires can be identified by a "mountain/snowflake" symbol on the tire sidewall.

If you need snow tires, select tires equivalent in size and type to the original equipment tires. Use snow tires only in sets of four; failure to do so may adversely affect the safety and handling of your vehicle.

Snow tires generally have lower speed ratings than what was originally equipped with your vehicle and should not be operated at sustained speeds over 75 mph (120 km/h). For speeds above 75 mph (120 km/h) refer to original equipment or an authorized tire dealer for recommended safe operating speeds, loading and cold tire inflation pressures.

While studded tires improve performance on ice, skid and traction capability on wet or dry surfaces may be poorer than that of non-studded tires. Some states prohibit studded tires; therefore, local laws should be checked before using these tire types.

SPARE TIRES — IF EQUIPPED

CAUTION!

Because of the reduced ground clearance, do not take your vehicle through an automatic car wash with a compact or limited use temporary spare installed. Damage to the vehicle may result.

For restrictions when towing with a spare tire designated for temporary emergency use → page 199.

Spare Tire Matching Original Equipped Tire And Wheel — If Equipped

Your vehicle may be equipped with a spare tire and wheel equivalent in look and function to the original equipment tire and wheel found on the front or rear axle of your vehicle. This spare tire may be used in the tire rotation for your vehicle. If your vehicle has this option, refer to an authorized tire dealer for the recommended tire rotation pattern.

Compact Spare Tire — If Equipped

The compact spare is for temporary emergency use only. You can identify if your vehicle is equipped with a compact spare by looking at the spare tire description on the Tire And Loading Information Placard located on the driver's side door opening or on the sidewall of the tire. Compact spare tire descriptions begin with the letter "T" or "S" preceding the size designation. Example: T145/80D18 103M.

T, S = Temporary Spare Tire

Since this tire has limited tread life, the original equipment tire should be repaired (or replaced) and reinstalled on your vehicle at the first opportunity.

Do not install a wheel cover or attempt to mount a conventional tire on the compact spare wheel, since the wheel is designed specifically for the compact spare tire. Do not install more than one compact spare tire and wheel on the vehicle at any given time.

WARNING!

Compact and collapsible spares are for temporary emergency use only. With these spares, do not drive more than 50 mph (80 km/h). Temporary use spares have limited tread life. When the tread is worn to the tread wear indicators, the temporary use spare tire needs to be replaced. Be sure to follow the warnings, which apply to your spare. Failure to do so could result in spare tire failure and loss of vehicle control.

Collapsible Spare Tire — If Equipped

The collapsible spare is for temporary emergency use only. You can identify if your vehicle is equipped with a collapsible spare by looking at the spare tire description on the Tire And Loading Information Placard located on the driver's side door opening or on the sidewall of the tire.

Collapsible spare tire description example:
165/80-17 101P.

Since this tire has limited tread life, the original equipment tire should be repaired (or replaced) and reinstalled on your vehicle at the first opportunity.

Inflate collapsible tire only after the wheel is properly installed to the vehicle. Inflate the collapsible tire using the electric air pump before lowering the vehicle.

Do not install a wheel cover or attempt to mount a conventional tire on the collapsible spare wheel, since the wheel is designed specifically for the collapsible spare tire.

WARNING!

Compact and Collapsible spares are for temporary emergency use only. With these spares, do not drive more than 50 mph (80 km/h). Temporary use spares have limited tread life. When the tread is worn to the tread wear indicators, the temporary use spare tire needs to be replaced. Be sure to follow the warnings, which apply to your spare. Failure to do so could result in spare tire failure and loss of vehicle control.

Full Size Spare — If Equipped

The full size spare is for temporary emergency use only. This tire may look like the originally equipped tire on the front or rear axle of your vehicle, but it is not. This spare tire may have limited tread life. When the tread is worn to the tread wear indicators, the temporary use full size spare tire needs to be replaced. Since it is not the same as your original equipment tire, replace (or repair) the original equipment tire and reinstall on the vehicle at the first opportunity.

Limited Use Spare — If Equipped

The limited use spare tire is for temporary emergency use only. This tire is identified by a label located on the limited use spare wheel. This label contains the driving limitations for this spare. This tire may look like the original equipped tire on the front or rear axle of your vehicle, but it is not. Installation of this limited use

spare tire affects vehicle handling. Since it is not the same as your original equipment tire, replace (or repair) the original equipment tire and reinstall on the vehicle at the first opportunity.

WARNING!

Limited use spares are for emergency use only. Installation of this limited use spare tire affects vehicle handling. With this tire, do not drive more than the speed listed on the limited use spare wheel. Keep inflated to the cold tire inflation pressures listed on your Tire And Loading Information Placard located on the driver's side B-pillar or the rear edge of the driver's side door. Replace (or repair) the original equipment tire at the first opportunity and reinstall it on your vehicle. Failure to do so could result in loss of vehicle control.

WHEEL AND WHEEL TRIM CARE

All wheels and wheel trim, especially aluminum and chrome plated wheels, should be cleaned regularly using mild (neutral Ph) soap and water to maintain their luster and to prevent corrosion. Wash wheels with the same soap solution recommended for the body of the vehicle and remember to always wash when the surfaces are not hot to the touch.

Your wheels are susceptible to deterioration caused by salt, sodium chloride, magnesium chloride, calcium chloride, etc., and other road chemicals used to melt ice or control dust on dirt roads. Use a soft cloth or sponge and mild soap to wipe away promptly. Do not use harsh chemicals or a stiff brush. They can damage the wheel's protective coating that helps keep them from corroding and tarnishing.

CAUTION!

Avoid products or automatic car washes that use acidic solutions or strong alkaline additives or harsh brushes. Many aftermarket wheel cleaners and automatic car washes may damage the wheel's protective finish. Such damage is not covered by the New Vehicle Limited Warranty. Only car wash soap, Mopar® Wheel Cleaner or equivalent is recommended.

When cleaning extremely dirty wheels including excessive brake dust, care must be taken in the selection of tire and wheel cleaning chemicals and equipment to prevent damage to the wheels. Mopar® Wheel Treatment or Mopar® Chrome Cleaner or their equivalent is recommended or select a non-abrasive, non-acidic cleaner for aluminum or chrome wheels.

CAUTION!

Do not use scouring pads, steel wool, a bristle brush, metal polishes or oven cleaner. These products may damage the wheel's protective finish. Such damage is not covered by the New Vehicle Limited Warranty. Only car wash soap, Mopar® Wheel Cleaner or equivalent is recommended.

NOTE:

If you intend parking or storing your vehicle for an extended period after cleaning the wheels with wheel cleaner, drive your vehicle and apply the brakes to remove the water droplets from the brake components. This activity will remove the red rust on the brake rotors and prevent vehicle vibration when braking.

Dark Vapor Chrome, Black Satin Chrome, or Low Gloss Clear Coat Wheels**CAUTION!**

If your vehicle is equipped with these specialty wheels, DO NOT USE wheel cleaners, abrasives, or polishing compounds. They will permanently damage this finish and such damage is not covered by the New Vehicle Limited Warranty. HAND WASH ONLY USING MILD SOAP AND WATER WITH A SOFT CLOTH. Used on a regular basis; this is all that is required to maintain this finish.

SNOW TRACTION DEVICES

Use of traction devices require sufficient tire-to-body clearance. Due to limited clearance, the following snow traction devices are recommended. Follow these recommendations to guard against damage:

- Snow traction device must be of proper size for the tire, as recommended by the snow traction device manufacturer.
- No other tire sizes are recommended for use with the snow traction device.
- Please see the following table for the recommended tire size, axle and snow traction device:

2500 4x2 (2WD) Trim Level	Axle	Tire/Wheel Size	Snow Traction Device (Maximum Pro- jection Beyond Tire Profile Or Equivalent)
Tradesman	Rear	LT245/70R17E LT275/70R18E	U Class
Bighorn Laramie Longhorn		LT275/70R18E LT285/60R20E	
Limited		LT285/60R20E	

2500 4x4 (4WD) Trim Level	Axle	Tire/Wheel Size	Snow Traction Device (Maximum Pro- jection Beyond Tire Profile Or Equivalent)
Tradesman	Rear	LT245/70R17E LT285/70R17D LT275/70R18E	U Class
Bighorn Laramie Limited Longhorn		LT275/70R18E LT285/60R20E	
Power Wagon		LT285/70R17D LT275/70R18E LT285/60R20E	

3500 SRW 4x2 (2WD) & 4x4 (4WD) Trim Level	Axle	Tire/Wheel Size	Snow Traction Device (Maximum Pro- jection Beyond Tire Profile Or Equivalent)
Tradesman	Rear	LT275/70R18E	U Class
Bighorn Limited Laramie Longhorn		LT275/70R18E LT285/60R20E	

3500 DRW 4x2 (2WD) Trim Level	Axle	Tire/Wheel Size	Snow Traction Device (Maximum Pro- jection Beyond Tire Profile Or Equivalent)
Tradesman Bighorn	Rear	LT235/80R17E	U Class
Limited Laramie Longhorn	Front/Rear	LT235/80R17E	U Class

3500 DRW 4x4 (4WD) Trim Level	Axle	Tire/Wheel Size	Snow Traction Device (Maximum Pro- jection Beyond Tire Profile Or Equivalent)
Tradesman Bighorn Limited Laramie Longhorn	Front/Rear	LT235/80R17E	U Class

WARNING!

Using tires of different size and type (M+S, Snow) between front and rear axles can cause unpredictable handling. You could lose control and have a collision.

CAUTION!

To avoid damage to your vehicle or tires, observe the following precautions:

- Because of restricted traction device clearance between tires and other suspension components, it is important that only traction devices in good condition are used. Broken devices can cause serious damage. Stop the vehicle immediately if noise occurs that could indicate device breakage. Remove the damaged parts of the device before further use.
- Install device as tightly as possible and then retighten after driving about ½ mile (0.8 km). Autosock traction devices do not require retightening.
- Do not exceed 30 mph (48 km/h).
- Drive cautiously and avoid severe turns and large bumps, especially with a loaded vehicle.
- Do not drive for a prolonged period on dry pavement.
- Observe the traction device manufacturer's instructions on the method of installation, operating speed, and conditions for use. Always use the suggested operating speed of the device manufacturer's if it is less than 30 mph (48 km/h).
- Do not use traction devices on a compact spare tire.

TIRE ROTATION RECOMMENDATIONS

Tires on the front and rear axles of vehicles operate at different loads and perform different steering, driving, and braking functions. For these reasons, they wear at unequal rates.

These effects can be reduced by timely rotation of tires. The benefits of rotation are especially worthwhile with aggressive tread designs such as those on all season type tires. Rotation will increase tread life, help to maintain mud, snow and wet traction levels and contribute to a smooth, quiet ride.

For the proper maintenance intervals ⇨ page 332. More frequent rotation is permissible if desired. The reasons for any rapid or unusual wear should be corrected prior to rotation being performed.

The suggested rotation method is the "rearward cross" shown in the following diagram. This rotation pattern does not apply to some directional tires that must not be reversed.

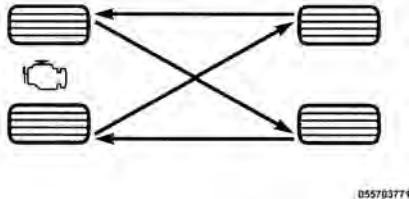

Tire Rotation (Rearward Cross)

Dual Rear Wheels — If Equipped

The tires used on dual wheel assemblies should be matched for wear to prevent overloading one tire in a set. To check if tires are even, lay a straight edge across all four tires. The straight edge should touch all the tires.

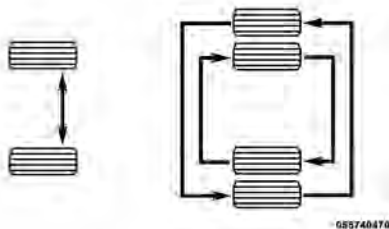

Tire Rotation

NOTE:

If your vehicle is equipped with a Tire Pressure Information System (TPIS):

- The Tire Pressure Information System (TPIS) uses unique sensors in the inner rear wheels to help identify them from the outer rear wheels, because of this, the inner and outer wheel locations can't be switched.
- After a tire rotation is completed, as shown, the system can auto learn the locations of each sensor ID. Auto learning/localization occurs when the vehicle ignition status is changed from Off to On and speeds of greater than 5 mph (8km/h) are obtained and remain over 5 mph (8km/h) for at about a 15 minute period. You may need to drive for 20 minutes to account slower speeds and stops.

- If the tires are rotated incorrectly, The auto localization of the TPIS sensors will fail to locate correctly resulting in incorrect locations for the pressure values displayed in the instrument cluster.

CAUTION!

- 3500 Dual Rear Tires may only have one approved direction of rotation. This is to accommodate the asymmetrical design (tread pattern) of the On/Off-Road tire and the use of Outline White Letter (OWL) tires.
- When replacing a flat, the spare tire may have to be remounted on the rim, or installed at a different location, to maintain the correct placement of the tire on the wheel relative to the tire/wheel position on the truck. For example, if the spare is used to replace an outer rear tire it will have to be remounted on the rim so that the wheel is dished inward. That way the tread design of asymmetrical tires and the white writing of the OWL tires will maintain proper position.

DEPARTMENT OF TRANSPORTATION UNIFORM TIRE QUALITY GRADES

The following tire grading categories were established by the National Highway Traffic Safety Administration. The specific grade rating assigned by the tire's manufacturer in each category is shown on the sidewall of the tires on your vehicle.

All passenger vehicle tires must conform to Federal safety requirements in addition to these grades.

TREADWEAR

The Treadwear grade is a comparative rating, based on the wear rate of the tire when tested under controlled conditions on a specified government test course. For example, a tire graded 150 would wear one and one-half times as well on the government course as a tire graded 100. The relative performance of tires depends upon the actual conditions of their use, however, and may depart significantly from the norm due to variations in driving habits, service practices, and differences in road characteristics and climate.

TRACTION GRADES

The Traction grades, from highest to lowest, are AA, A, B, and C. These grades represent the tire's ability to stop on wet pavement, as measured under controlled conditions on specified government test surfaces of asphalt and concrete. A tire marked C may have poor traction performance.

WARNING!

The traction grade assigned to this tire is based on straight-ahead braking traction tests, and does not include acceleration, cornering, hydroplaning, or peak traction characteristics.

TEMPERATURE GRADES

The Temperature grades are A (the highest), B, and C, representing the tire's resistance to the generation of heat and its ability to dissipate heat, when tested under controlled conditions on a specified indoor laboratory test wheel.

Sustained high temperature can cause the material of the tire to degenerate and reduce tire life, and excessive temperature can lead to sudden tire failure. The grade C corresponds to a level of performance, which all passenger vehicle tires must meet under the Federal Motor Vehicle Safety Standard No. 109. Grades B and A represent higher levels of performance on the laboratory test wheel, than the minimum required by law.

WARNING!

The temperature grade for this tire is established for a tire that is properly inflated and not overloaded. Excessive speed, underinflation, or excessive loading, either separately or in combination, can cause heat build-up and possible tire failure.

STORING THE VEHICLE

If you are storing your vehicle for more than three weeks, we recommend that you take the following steps to minimize the drain on your vehicle's battery:

- Disconnect the negative cable from battery.
- Any time you store your vehicle or keep it out of service (i.e., vacation) for two weeks or more, run the air conditioning system at idle for about five minutes in the fresh air and high blower setting. This will ensure adequate system lubrication to minimize the possibility of compressor damage when the system is started again.

BODYWORK

PROTECTION FROM ATMOSPHERIC AGENTS

Vehicle body care requirements vary according to geographic locations and usage. Chemicals that make roads passable in snow and ice and those that are sprayed on trees and road surfaces during other seasons are highly corrosive to the metal in your vehicle. Outside parking, which exposes your vehicle to airborne contaminants, road surfaces on which the vehicle is operated, extreme hot or cold weather and other extreme conditions will have an adverse effect on paint, metal trim, and underbody protection.

The following maintenance recommendations will enable you to obtain maximum benefit from the corrosion resistance built into your vehicle.

What Causes Corrosion?

Corrosion is the result of deterioration or removal of paint and protective coatings from your vehicle.

The most common causes are:

- Road salt, dirt and moisture accumulation.
- Stone and gravel impact.
- Insects, tree sap and tar.
- Salt in the air near seacoast localities.
- Atmospheric fallout/industrial pollutants.

BODY AND UNDERBODY MAINTENANCE

Cleaning Headlights

Your vehicle is equipped with plastic headlights and fog lights that are lighter and less susceptible to stone breakage than glass headlights.

Plastic is not as scratch resistant as glass and therefore different lens cleaning procedures must be followed.

To minimize the possibility of scratching the lenses and reducing light output, avoid wiping with a dry cloth. To remove road dirt, wash with a mild soap solution followed by rinsing.

Do not use abrasive cleaning components, solvents, steel wool or other aggressive material to clean the lenses.

Tri-Fold Soft Tonneau Cover Care — If Equipped

For cleaning and protecting the vinyl Tri-Fold Tonneau cover, use Mopar® Whitewall & Vinyl Top Cleaner and Mopar® Leather and Vinyl Conditioner/Protectant.

PRESERVING THE BODYWORK

Washing

- Wash your vehicle regularly. Always wash your vehicle in the shade using Mopar® Car Wash, or a mild car wash soap, and rinse the panels completely with water.
- If insects, tar, or other similar deposits have accumulated on your vehicle, use Mopar® Super Kleen Bug and Tar Remover to remove.
- Use a high quality cleaner wax, such as Mopar® Cleaner Wax to remove road film, stains and to protect your paint finish. Use precautions to not scratch the paint.
- Avoid using abrasive compounds and power buffing that may diminish the gloss or thin out the paint finish.

CAUTION!

- Do not use abrasive or strong cleaning materials such as steel wool or scouring powder that will scratch metal and painted surfaces.
- Use of power washers exceeding 1,200 psi (8,274 kPa) can result in damage or removal of paint and decals.

Fascia/Bumper Care

The customer is responsible to clean and maintain the chrome components of the vehicle. Washing away road debris and salt using an automotive soap. Fascia/bumpers should be cleaned regularly using mild (neutral Ph) soap and water to maintain their luster and to prevent corrosion.

Your fascia/bumpers are susceptible to deterioration caused by salt, sodium chloride, magnesium chloride, calcium chloride, etc., and other road chemicals used to melt ice or control dust on dirt roads. Do not use harsh chemicals or a stiff brush. They can stain or damage the protective coating that helps keep them from corroding and tarnishing.

CAUTION!

Do not use scouring pads, steel wool, a bristle brush, metal polishes, or oven cleaner. These products may damage the fascia/bumper's protective finish. Such damage is not covered by the New Vehicle Limited Warranty. Only car wash soap, Mopar® Chrome Cleaner, or equivalent is recommended.

Avoid products or automatic car washes that use acidic solutions, strong alkaline additives, or harsh brushes. Many aftermarket cleaners and automatic car washes may damage the fascia/bumper's protective finish. Such damage is not covered by the New Vehicle Limited Warranty. Only car wash soap, Mopar® Chrome Cleaner, or equivalent is recommended.

Special Care

- If you drive on salted or dusty roads or if you drive near the ocean, hose off the undercarriage at least once a month.
- It is important that the drain holes in the lower edges of the doors, rocker panels, and trunk be kept clear and open.
- If you detect any stone chips or scratches in the paint, touch them up immediately.

- If your vehicle is damaged due to a collision or similar cause that destroys the paint and protective coating, have your vehicle repaired as soon as possible.
- If you carry special cargo such as chemicals, fertilizers, de-icer salt, etc., be sure that such materials are well packaged and sealed.
- If a lot of driving is done on gravel roads, consider mud or stone shields behind each wheel.
- Use Mopar® Touch Up Paint on scratches as soon as possible. An authorized dealer has touch up paint to match the color of your vehicle.

Spray-On Bedliner – If Equipped

During ownership, the shine and luster of the Spray-On Bedliner can fade from oxidation, road dirt, heavy-duty hauling and hard water stains. Weathering and UV exposure will lead to fading, dulling, and loss of gloss over time.

To help maintain the appearance of your Spray-On Bedliner, the manufacturer recommends you periodically rinse all loose dirt from your truck bed and clean your truck at least twice per year using the Mopar® Spray-On Bedliner Conditioner available at a local authorized dealer.

To Help Maintain The Appearance Of Your Spray-On Bedliner:

1. Rinse your truck bed out with water to remove any loose dirt and debris.
2. Mix a mild soap or detergent with water with a soft cloth or brush.
3. Rinse bedliner with water.
4. Once dry, apply a small amount of Mopar® Spray-On Bedliner Conditioner to a moist towel or sponge and wipe over the entire surface of the truck bedliner.

WARNING!

Do not use silicon-based protection products to clean your bedliner. Silicon-based products can become slippery and may result in personal injury.

Spray-On Bedliners are chemically-resistant to many different types of chemicals (including gasoline, oil, hydraulic fluids) for short periods of time. If a spill occurs on your Spray-On Bedliner, rinse the truck out as soon as possible to avoid permanent damage.

Repairing The Spray-On Bedliner

While extremely tough, it is possible to damage a Spray-On Bedliner. One common condition is when loading a heavy pallet and dragging that pallet across the floor of the bed. If a nail or sharp point is exposed under the weight of the pallet a scratch or tear is possible. While not covered by your new vehicle warranty, a cosmetic fix to cover the metal exposed by the scratch is required. To repair a tear or gouge, follow the directions provided in the Mopar® Quick Repair Kit.

INTERIORS**SEATS AND FABRIC PARTS**

Use Mopar® Total Clean to clean fabric upholstery and carpeting.

WARNING!

Do not use volatile solvents for cleaning purposes. Many are potentially flammable, and if used in closed areas they may cause respiratory harm.

Stain Repel Fabric Cleaning Procedure — If Equipped

Stain Repel seats may be cleaned in the following manner:

- Remove as much of the stain as possible by blotting with a clean, dry towel.
- Blot any remaining stain with a clean, damp towel.
- For tough stains, apply Mopar® Total Clean, or a mild soap solution to a clean, damp cloth and remove stain. Use a fresh, damp towel to remove soap residue.
- For grease stains, apply Mopar® Multi-Purpose Cleaner to a clean, damp cloth and remove stain. Use a fresh, damp towel to remove soap residue.
- Do not use any harsh solvents or any other form of protectants on Stain Repel products.

Seat Belt Maintenance

Do not bleach, dye or clean the belts with chemical solvents or abrasive cleaners. This will weaken the fabric.

If the belts need cleaning, use a mild soap solution or lukewarm water. Do not remove the belts from the vehicle to wash them. Dry with a soft cloth.

Sun damage can also weaken the fabric. Replace the belts if they appear frayed or worn or if the buckles do not work properly.

NOTE:

If the belts retract slowly, inspect the upper turning loop for soiling. If soiling is present, clean with a wet soft cloth until all residue is removed.

WARNING!

A frayed or torn seat belt could rip apart in a collision and leave you with no protection. Inspect the seat belt system periodically, checking for cuts, frays, or loose parts. Damaged parts must be replaced immediately. Do not disassemble or modify the seat belt system. If your vehicle is involved in a collision, or if you have questions regarding seat belt or retractor conditions, take your vehicle to an authorized FCA dealer or authorized FCA Certified Collision Care Program facility for inspection.

PLASTIC AND COATED PARTS

Use Mopar® Total Clean to clean vinyl upholstery.

CAUTION!

- Direct contact of air fresheners, insect repellents, suntan lotions, or hand sanitizers to the plastic, painted, or decorated surfaces of the interior may cause permanent damage. Wipe away immediately.
- Damage caused by these type of products may not be covered by your New Vehicle Limited Warranty.

Cleaning Plastic Instrument Cluster Lenses

The lenses in front of the instruments in this vehicle are molded in clear plastic. When cleaning the lenses, care must be taken to avoid scratching the plastic.

Clean with a wet soft cloth. A mild soap solution may be used, but do not use high alcohol content or abrasive cleaners. If soap is used, wipe clean with a clean damp cloth. Dry with a soft cloth.

LEATHER SURFACES

Mopar® Total Clean is specifically recommended for leather upholstery.

Your leather upholstery can be best preserved by regular cleaning with a damp soft cloth. Small particles of dirt can act as an abrasive and damage the leather upholstery and should be removed promptly with a damp cloth. Stubborn soils can be removed easily with a soft cloth and Mopar® Total Clean. Care should be taken to avoid soaking your leather upholstery with any liquid. Please do not use polishes, oils, cleaning fluids, solvents, detergents, or ammonia-based cleaners to clean your leather upholstery.

NOTE:

If equipped with light colored leather, it tends to show any foreign material, dirt, and fabric dye transfer more so than darker colors. The leather is designed for easy cleaning, and FCA recommends Mopar® total care leather cleaner applied on a cloth to clean the leather seats as needed.

CAUTION!

Do not use alcohol and alcohol-based and/or ketone-based cleaning products to clean leather upholstery, as damage to the upholstery may result.

GLASS SURFACES

All glass surfaces should be cleaned on a regular basis with Mopar® Glass Cleaner, or any commercial household-type glass cleaner. Never use an abrasive type cleaner. Use caution when cleaning the inside rear window equipped with electric defrosters or windows equipped with radio antennas. Do not use scrapers or other sharp instruments that may scratch the elements.

When cleaning the rearview mirror, spray cleaner on the towel or cloth that you are using. Do not spray cleaner directly on the mirror.

TECHNICAL SPECIFICATIONS

VEHICLE IDENTIFICATION NUMBER (VIN)

The VIN is found on the left front corner of the instrument panel, visible through the windshield.

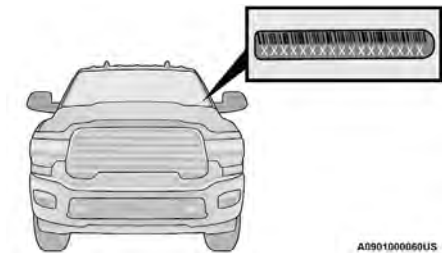

Vehicle Identification Number

NOTE:

It is illegal to remove or alter the VIN.

BRAKE SYSTEM

If power assist is lost for any reason (for example, repeated brake applications with the engine off), the brakes will still function. However, you will experience a substantial increase in braking effort to stop the vehicle.

If either the front or rear hydraulic system loses normal braking capability, the remaining system will still function with some loss of overall braking effectiveness. This will be evident by increased pedal travel during

application, greater pedal force required to slow or stop, and activation of the Brake Warning Light and/or the Anti-Lock Brake System (ABS) Warning Light during brake use.

HYDRAULIC BRAKE ASSIST – IF EQUIPPED

The brake system power assist is provided by a hydro-boost unit which shares fluid with the power steering system. You may experience some clicking or hissing noises from the hydro-boost system during hard braking conditions.

NOTE:

Under cold temperatures, pedal effort will be higher than normal until the power steering fluid reaches operating temperature.

WHEEL AND TIRE TORQUE SPECIFICATIONS

Proper lug nut/bolt torque is very important to ensure that the wheel is properly mounted to the vehicle. Any time a wheel has been removed and reinstalled on the vehicle, the lug nuts/bolts should be torqued using a properly calibrated torque wrench using a six-sided (hex) deep wall socket.

TORQUE SPECIFICATIONS

Lug Nut/ Bolt Torque	Lug Nut/ Bolt Type	**Lug Nut/ Bolt Size	Lug Nut/ Bolt Socket Size
130 ft-lb (176 N-m)	Cone	M14 x 1.50	22 mm
129 ft-lb (175 N-m)	Flanged		

**Use only authorized dealer recommended lug nuts/bolts and clean or remove any dirt or oil before tightening.

NOTE:

Dual wheels are flat mounted, center piloted. The lug nuts are a two-piece assembly. When the tires are being rotated or replaced, clean these lug nuts at the interface between the lug nut/bolt and the washer. **Do not oil wheel studs.**

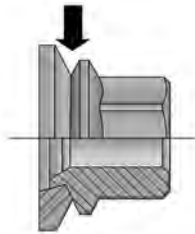

0322116841US

Two-Piece Lug Nut

Inspect the wheel mounting surface prior to mounting the tire and remove any corrosion or loose particles.

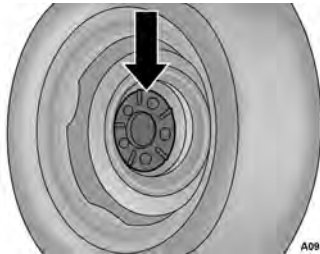

A091000006US

Wheel Mounting Surface

Retighten the wheel nuts, in the same pattern, to the torques listed in the Torque Specifications table. Go through the sequence a second time to verify that the specific torque has been achieved. Retighten to specifications after 25 miles (40 km) and check the lug nut/bolt torque to be sure that all the lug nuts/bolts are properly tightened.

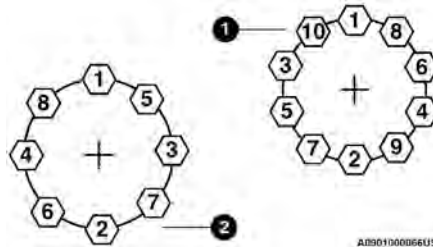

A0901000066US

8 / 10 Lug Nuts/Bolts Torque Patterns

- 1 – 10 Bolt Pattern
- 2 – 8 Bolt Pattern

It is recommended that wheel stud nuts be kept torqued to specifications at all times. Torque wheel stud nuts to specifications at each lubrication interval.

All wheel nuts should be tightened occasionally to eliminate the possibility of wheel studs being sheared or the bolt holes in the wheels becoming elongated. This is especially important during the first few hundred miles/kilometers of operation to allow the wheel nuts to become properly set. All wheel nuts should first be firmly seated against the wheel. The wheel nuts should then be tightened to recommended torque. Tighten the wheel nuts to final torque in increments. Progress around the bolt circle, tightening the wheel nut opposite to the wheel nut just previously tightened until final torque is achieved.

WARNING!

To avoid the risk of forcing the vehicle off the jack, do not tighten the lug nuts/bolts fully until the vehicle has been lowered. Failure to follow this warning may result in personal injury.

FUEL REQUIREMENTS — GASOLINE ENGINE

While operating on gasoline with the required octane number, hearing a light knocking sound from the engine is not a cause for concern. However, if the engine is heard making a heavy knocking sound, see a dealer immediately. Use of gasoline with a lower than recommended octane number can cause engine failure and may void or not be covered by the New Vehicle Limited Warranty.

Poor quality gasoline can cause problems such as hard starting, stalling, and hesitations. If you experience these symptoms, try another brand of gasoline before considering service for the vehicle.

6.4L ENGINE

Do not use E-85 flex fuel or ethanol blends greater than 15% in this engine.



This engine is designed to meet all emissions regulations and provide satisfactory fuel economy and performance when using high quality unleaded gasoline having a posted octane number of 87 as specified by the (R+M)/2 method.

REFORMULATED GASOLINE

Many areas of the country require the use of cleaner burning gasoline referred to as "reformulated gasoline". Reformulated gasoline contains oxygenates and are specifically blended to reduce vehicle emissions and improve air quality.

The use of reformulated gasoline is recommended. Properly blended reformulated gasoline will provide improved performance and durability of engine and fuel system components.

MATERIALS ADDED TO FUEL

Besides using unleaded gasoline with the proper octane rating, gasolines that contain detergents, corrosion and stability additives are recommended. Using gasolines that have these additives will help improve fuel economy, reduce emissions, and maintain vehicle performance.



Designated TOP TIER Detergent Gasoline contains a higher level of detergents to further aid in minimizing engine and fuel system deposits. When available, the usage of TOP TIER Detergent gasoline is recommended. Visit www.toptiergas.com for a list of TOP TIER Detergent Gasoline retailers.

Indiscriminate use of fuel system cleaning agents should be avoided. Many of these materials intended for gum and varnish removal may contain active solvents or similar ingredients. These can harm fuel system gasket and diaphragm materials.

GASOLINE/OXYGENATE BLENDS

Some fuel suppliers blend unleaded gasoline with oxygenates such as ethanol.

CAUTION!

DO NOT use E-85, gasoline containing methanol, or gasoline containing more than 15% ethanol (E-15). Use of these blends may result in starting and drivability problems, damage critical fuel system components, cause emissions to exceed the applicable standard, and/or cause the Malfunction Indicator Light to illuminate. Please observe pump labels as they should clearly communicate if a fuel contains greater than 15% ethanol (E-15).

Problems that result from using gasoline containing more than 15% ethanol (E-15) or gasoline containing methanol are not the responsibility of the manufacturer and may void or not be covered under New Vehicle Limited Warranty.

DO NOT USE E-85 IN NON-FLEX FUEL VEHICLES

Non-Flex Fuel Vehicles (FFV) are compatible with gasoline containing up to 15% ethanol (E-15). Use of gasoline with higher ethanol content may void the New Vehicle Limited Warranty.

If a Non-FFV vehicle is inadvertently fueled with E-85 fuel, the engine will have some or all of these symptoms:

- Operate in a lean mode.
- OBD II Malfunction Indicator Light on.
- Poor engine performance.
- Poor cold start and cold drivability.
- Increased risk for fuel system component corrosion.

CNG AND LP FUEL SYSTEM MODIFICATIONS

Modifications that allow the engine to run on Compressed Natural Gas (CNG) or Liquid Propane (LP) may result in damage to the engine, emissions, and fuel system components. Problems that result from running CNG or LP are not the responsibility of the manufacturer and may void or not be covered under the New Vehicle Limited Warranty.

METHYLCYCLOPENTADIENYL MANGANESE TRICARBONYL (MMT) IN GASOLINE

MMT is a manganese-containing metallic additive that is blended into some gasolines to increase octane. Gasoline blended with MMT provides no performance advantage beyond gasoline of the same octane number without MMT. Gasoline blended with MMT reduces spark plug life and reduces emissions system performance in some vehicles. The manufacturer recommends that gasoline without MMT be used in your vehicle. The MMT content of gasoline may not be indicated on the gasoline pump; therefore, you should ask your gasoline retailer whether the gasoline contains MMT. MMT is prohibited in Federal and California reformulated gasoline.

FUEL SYSTEM CAUTIONS

CAUTION!

Follow these guidelines to maintain your vehicle's performance:

- The use of leaded gasoline is prohibited by Federal law. Using leaded gasoline can impair engine performance and damage the emissions control system.
- An out-of-tune engine or certain fuel or ignition malfunctions can cause the catalytic converter to overheat. If you notice a pungent burning odor or some light smoke, your engine may be out of tune or malfunctioning and may require immediate service. Contact an authorized dealer for service assistance.
- The use of fuel additives, which are now being sold as octane enhancers, is not recommended. Most of these products contain high concentrations of methanol. Fuel system damage or vehicle performance problems resulting from the use of such fuels or additives is not the responsibility of the manufacturer and may void or not be covered under the New Vehicle Limited Warranty.

NOTE:

Intentional tampering with the emissions control system can result in civil penalties being assessed against you.

FUEL REQUIREMENTS – DIESEL ENGINE

Use good quality diesel fuel from a reputable supplier in your vehicle. Federal law requires that you must fuel this vehicle with Ultra Low Sulfur Highway Diesel fuel (15 ppm Sulfur maximum) and prohibits the use of Low Sulfur Highway Diesel fuel (500 ppm Sulfur maximum) to avoid damage to the emissions control system.

For most year-round service, Number 2 Diesel Fuel meeting ASTM (formerly known as the American Society for Testing and Materials) specification D-975 Grade S15 will provide good performance. If the vehicle is exposed to extreme cold (below 20 °F or -7 °C), or is required to operate at colder-than-normal conditions for prolonged periods, use Climatized Number 2 Diesel Fuel or dilute the No. 2 diesel fuel with 50% Number 1 Diesel Fuel. This will provide better protection from fuel gelling or wax-plugging of the fuel filters.

WARNING!

Do not use alcohol or gasoline as a fuel blending agent. They can be unstable under certain conditions and hazardous or explosive when mixed with diesel fuel.

Diesel fuel is seldom completely free of water. To prevent fuel system trouble, drain the accumulated water from the fuel/water separator using the fuel/water separator drain provided on both fuel filters. If you buy good quality fuel and follow the cold weather advice above, fuel conditioners should not be required in your vehicle. If available in your area, a high cetane "premium" diesel fuel may offer improved cold-starting and warm-up performance.

CAUTION!

If the Water in Fuel Indicator Light remains on, DO NOT START engine before you drain the water from the fuel filter(s) to avoid engine damage
 page 347.

FUEL SPECIFICATIONS

The Cummins® Turbo Diesel engine has been developed to take advantage of the high energy content and generally lower cost Number 2 Ultra Low Sulfur Diesel Fuel or Number 2 Ultra Low Sulfur Climatized Diesel Fuels. Experience has shown that it also operates on Number 1 Ultra Low Sulfur Diesel Fuels or other fuels within specification.

NOTE:

- If you accidentally fill the fuel tank with gasoline on your diesel vehicle, do not start the vehicle. If you restart your vehicle you risk damaging the engine and fuel system. Please call an authorized dealer for service.
- A maximum blend of 20% biodiesel meeting ASTM specification D-7467 may be used with your Cummins® diesel engine. (Models configured with B20 Capability.)
- In addition, commercially available fuel additives are not necessary for the proper operation of your Cummins® diesel engine. However, if seasonably adjusted fuel is not available and you are operating below 20 °F (-6 °C), Mopar® Premium Diesel Fuel Treatment (or equivalent) may be beneficial to avoid fuel gelling.
- Number 1 Ultra Low Sulfur Diesel Fuel should only be used where extended arctic conditions (0 °F or -18 °C) exist.

BIODIESEL FUEL REQUIREMENTS

Pickup Models

Your vehicle has been validated and approved for the use of biodiesel in blends up to 20% (B20) provided that you comply with the requirements outlined below. It is important that you understand and comply with these requirements. Failure to comply with Oil Change requirements for vehicles operating on biodiesel blends up to B20 will result in premature engine wear. Such wear is not covered by the New Vehicle Limited Warranty.

Biodiesel is a fuel produced from renewable resources typically derived from animal fat, rapeseed oil (Rapeseed Methyl Ester (RME) base), or soybean oil (Soy Methyl Ester (SME or SOME) base). Biodiesel fuel has inherent limitations which require that you understand and adhere to the following requirements if you use blends of biodiesel greater than 5% but not greater than 20% (B6-B20). There are no unique restrictions for the use of B5. Use of blends greater than 20% is not approved. Use of blends greater than 20% can result in engine damage. Such damage is not covered by the New Vehicle Limited Warranty.

Fuel Quality — Must Comply With ASTM Standards

The quality of biodiesel fuel may vary widely. Only fuel produced by a BQ9000 supplier to the following specifications may be blended to meet biodiesel blend (B6–B20) fuel meeting ASTM specification D-7467:

- Petrodiesel fuel meeting ASTM specification D-975 and biodiesel fuel (B100) meeting ASTM specification D-6751.

Fuel Oxidation Stability — Must Use Fuel Within Six Months Of Manufacture

Biodiesel fuel has poor oxidation stability which can result in long term storage problems. Fuel produced to approved ASTM standards, if stored properly, provides for protection against fuel oxidation for up to six months.

Fuel Water Separation — Must Use Mopar®/Cummins® Approved Fuel Filter Elements

You must use Mopar®/Cummins® approved fuel filter elements in both your engine mounted filter and frame mounted filter.

Biodiesel fuel has a natural affinity to water and water accelerates microbial growth. Your Mopar®/Cummins® filtration system is designed to provide adequate fuel water separation capabilities.

Biodiesel Fuel Properties — Low Ambient Temperatures

Biodiesel fuel may gel or solidify at low ambient temperatures, which may pose problems for both storage and operation. Precautions can be necessary at low ambient temperatures, such as storing the fuel in a heated building or a heated storage tank, or using cold temperature additives.

Fuel In Oil Dilution — Must Adhere To Required Oil Change Interval

Fuel dilution of lubricating oil has been observed with the use of biodiesel fuel. Fuel in oil must not exceed 5%. To ensure this limit is met your oil change interval must be maintained to the following schedule:

Ram PickUp 2500/3500 Only — 15,000 miles (24,000 km) or 500 hours whichever comes first*

(*unless otherwise notified with an oil service message.)

CAUTION!

- Under no circumstances should oil change intervals exceed 15,000 miles (24,000 km) or 500 hours whichever comes first if operation occurs with greater than 5% biodiesel blends. Oil change intervals should not exceed 6 months in either case. Failure to comply with these oil change requirements for vehicles operating on biodiesel blends up to B20 may result in premature engine wear. Such wear is not covered by the New Vehicle Limited Warranty.
- B20 Biodiesel capable: The engine may suffer severe damage if operated with concentrations of biodiesel higher than 20%.

FLUID CAPACITIES

6.4L GASOLINE ENGINE

	US	Metric
Fuel (Approximate)		
2500/3500 Shortbed Models	31 gal	117 L
2500/3500 Longbed Models	32 gal	121 L
2500/3500 Crew Cab Longbed Models – If Equipped	50 gal	189 L
Engine Oil With Filter		
6.4L Engine	7 qt	6.6 L
Cooling System		
6.4L Engine	18.5 qt	17.5 L

6.7L DIESEL ENGINE

	US	Metric
Fuel (Approximate)		
2500/3500 Standard Cab Longbed Models	28 gal	106 L
2500/3500 Crew/Mega Cab Shortbed Models	31 gal	117 L
2500/3500 Crew Cab Longbed Models	32 gal	121 L
2500/3500 Crew Cab Longbed Models – If Equipped	50 gal	189 L
Diesel Exhaust Fluid Tank	5.7 gal	21 L
Engine Oil With Filter		
6.7L Engine	12 qt	11.4 L
Cooling System		
6.7L Engine	22 qt	20.8 L

ENGINE FLUIDS AND LUBRICANTS

6.4L GASOLINE ENGINE

Component	Fluid, Lubricant, or Genuine Part
Engine Coolant	We recommend using Mopar® Antifreeze/Coolant 10 Year/150,000 Mile (240,000 km) Formula OAT (Organic Additive Technology).
Engine Oil	We recommend using Mopar® API Certified SAE 0W-40 Full Synthetic Engine Oil which meets the requirements of the manufacturer Material Standard MS-A0921. Equivalent full synthetic SAE 0W-40 engine oil can be used but must have the API Donut trademark → page 342.
Fuel Selection	87 Octane (R+M)/2 Method, 0-15% Ethanol (Do not use E-85).

6.7L DIESEL ENGINE

Component	Fluid, Lubricant, or Genuine Part
Engine Coolant	We recommend using Mopar® Antifreeze/Coolant 10 Year/150,000 Mile (240,000 km) Formula OAT (Organic Additive Technology).
Engine Oil	In ambient temperatures above 0°F (-18°C), we recommend using 10W-30 engine oil such as Mopar®, Shell Rotella and Shell Rimula that meets the manufacturer Material Standard MS-10902 and the API CK-4 engine oil category is required. Products meeting Cummins® CES 20081 may also be used. The identification of these engine oils is typically located on the back of the oil container. In ambient temperatures below 0°F (-18°C), we recommend using 5W-40 synthetic engine oil such as Mopar®, Shell Rotella and Shell Rimula that meets the manufacturer Material Standard MS-10902 and the API CK-4 engine oil category is required.
Fuel Filters	We recommend using Mopar® Fuel Filter. Must meet 3 micron rating (engine mounted filter). Must meet 5 micron rating (chassis mounted filter). Using a fuel filter that does not meet the manufacturer's filtration and water separating requirements can severely impact fuel system life and reliability.
Crankcase Ventilation Filter	We recommend using Mopar® CCV Filter.

Component	Fluid, Lubricant, or Genuine Part
Fuel Selection	<p>Use good quality diesel fuel from a reputable supplier in your vehicle. Federal law requires that you must fuel this vehicle with Ultra Low Sulfur Highway Diesel fuel (15 ppm Sulfur maximum) and prohibits the use of Low Sulfur Highway Diesel fuel (500 ppm Sulfur maximum) to avoid damage to the emissions control system.</p> <p>For most year-round service, Number 2 Diesel fuel meeting ASTM specification D-975 Grade S15 will provide good performance.</p> <p>If climatized or diesel Number 1 ULSD fuel is not available, and you are operating below (20°F/-6°C), in sustained arctic conditions, Mopar® Premium Diesel Fuel Treatment (or equivalent) is recommended to avoid gelling.</p> <p>This vehicle is fully compatible with biodiesel blends up to 5% biodiesel meeting ASTM specification D-975. Pickup models are additionally compatible with 20% biodiesel meeting ASTM specification D-7467.</p>
Diesel Exhaust Fluid	<p>Mopar® Diesel Exhaust Fluid (DEF) (API Certified) or equivalent that has been API Certified to the ISO 22241 standard. Use of fluids not API Certified to ISO 22241 may result in system damage. You can receive assistance in locating DEF in the United States by calling 866-RAM-INFO (866-726-4636). In Canada call 1-800-465-2001 (English) or 1-800-387-9983 (French).</p>

CAUTION!
<ul style="list-style-type: none"> ● Mixing of engine coolant (antifreeze) other than specified Organic Additive Technology (OAT) engine coolant (antifreeze), may result in engine damage and may decrease corrosion protection. Organic Additive Technology (OAT) engine coolant is different and should not be mixed with Hybrid Organic Additive Technology (HOAT) engine coolant (antifreeze) or any "globally compatible" coolant (antifreeze). If a non-OAT engine coolant (antifreeze) is introduced into the cooling system in an emergency, the cooling system will need to be drained, flushed, and refilled with fresh OAT coolant (conforming to MS.90032), by an authorized dealer as soon as possible. ● Do not use water alone or alcohol-based engine coolant (antifreeze) products. Do not use additional rust inhibitors or antirust products, as they may not be compatible with the radiator engine coolant and may plug the radiator. ● This vehicle has not been designed for use with propylene glycol-based engine coolant (antifreeze). Use of propylene glycol-based engine coolant (antifreeze) is not recommended.

CHASSIS FLUIDS AND LUBRICANTS

6.4L GASOLINE ENGINE

Component	Fluid, Lubricant, or Genuine Part
Automatic Transmission – 8-Speed Automatic	Use only Mopar® ZF 8 & 9 Speed ATF Automatic Transmission Fluid, or equivalent. Failure to use the correct fluid may affect the function or performance of your transmission.
Transfer Case	We recommend using Mopar® Transfer Case Lubricant for Borg Warner 44-44 and 44-45.
Front and Rear Axle	We recommend using SAE 75W-85 HD Ram GL-5 Synthetic Axle Lubricant. Limited slip additive is required for limited slip axles. If the axle fluid is not pre-mixed with limited slip additive we recommend using Mopar® MS-10111 Limited Slip Additive.
Brake Master Cylinder	We recommend using Mopar® DOT 3 and SAE J1703.
Power Steering Reservoir	We recommend using Mopar® Power Steering Fluid +4 or Mopar® ATF+4 Automatic Transmission Fluid.

6.7L DIESEL ENGINE

Component	Fluid, Lubricant, or Genuine Part
Automatic Transmission – 68RFE	Only use ATF+4 Automatic Transmission Fluid. Failure to use ATF+4 fluid may affect the function or performance of your transmission. We recommend Mopar® ATF+4 fluid.
Automatic Transmission – AS69RC	Only use Mopar® ASRC Automatic Transmission Fluid or equivalent. Failure to use the proper fluid may affect the function or performance of your transmission.
Transfer Case	We recommend using Mopar® BW44–44 Transfer Case Fluid.
Front and Rear Axle Fluid	We recommend using SAE 75W-85 HD Ram GL-5 Synthetic Axle Lubricant in 9.25 Front, 11.5 and 12.0 (Single Rear Wheel) Rear Axles. Limited slip additive is required for limited slip axles. We recommend using the pre-mixed Mopar® lubricant and limited slip additive. If the axle fluid is not pre-mixed with limited slip additive we recommend using Mopar® MS-10111 Limited Slip Additive.
Brake Master Cylinder	We recommend using Mopar® DOT 3 and SAE J1703.

CUSTOMER ASSISTANCE

SUGGESTIONS FOR OBTAINING SERVICE FOR YOUR VEHICLE

PREPARE FOR THE APPOINTMENT

All work to be performed may not be covered by the warranty. Discuss additional charges with the service manager. Keep a maintenance log of your vehicle's service history. This can often provide a clue to the current problem.

PREPARE A LIST

Make a written list of your vehicle's problems or the specific work you want done. If you've had an accident or work done that is not on your maintenance log, let the service advisor know.

BE REASONABLE WITH REQUESTS

If you list a number of items and you must have your vehicle by the end of the day, discuss the situation with the service advisor and list the items in order of priority. At many authorized dealers, you may obtain a rental vehicle (additional charges may apply). If you need a rental, it is advisable to make these arrangements when you call for an appointment.

IF YOU NEED ASSISTANCE

FCA US LLC and its authorized dealers are vitally interested in your satisfaction. We want you to be happy with our products and services.

Warranty service must be done by an authorized dealer. We strongly recommend that you take the vehicle to an authorized dealer. They know your vehicle the best, and are most concerned that you get prompt and high quality service. FCA US LLC's authorized dealers have the facilities, factory-trained technicians, special tools, and the latest information to ensure the vehicle is fixed correctly and in a timely manner.

This is why you should always talk to an authorized dealer service manager first. If for some reason you are still not satisfied, talk to the general manager or owner of the authorized dealer. They want to know if you need assistance. If an authorized dealer is unable to resolve the concern, you may contact FCA US LLC's Customer Assistance center.

Any communication to FCA US LLC's customer center should include the following information:

- Owner's name and address
- Owner's telephone number (home, mobile, and office)
- Authorized dealer name
- Vehicle Identification Number (VIN)
- Vehicle delivery date and mileage

ROADSIDE ASSISTANCE

Available 24 hours, 7 days a week.

Call 1-800-521-2779 or visit [chrysler.rsahelp.com\(USA\)](http://chrysler.rsahelp.com(USA))

Call 1-800-363-4869 or visit fca.roadsideaid.com (Canada)

Who is Covered

You are covered by Roadside Assistance services if you are a purchaser for use of the vehicle. Roadside Assistance services last for five years or 60,000 miles on the odometer, whichever occurs first, calculated from the start date of the Basic Limited Warranty, as set forth in your Warranty Information book.¹

1. Towing services provided through Cross Country Motor Club, Inc., 400 River's Edge Drive, Medford, MA 02155, except in AK, CA, HI, OR, WI, and WY, where services are provided by Cross Country Motor Club of California, Inc., 275 East Hillcrest Drive, Suite 165, Thousand Oaks, CA 91360

What to Do

If your vehicle requires jump start assistance, out of gas/fuel delivery, tire service, lockout service or towing as a result of a mechanical breakdown, dial toll-free: USA: 1-800-521-2779/Canada: 1-800-363-4869. Provide your name, Vehicle Identification Number (VIN) required for covered services, license plate number, and your location, including the telephone number from which you are calling. Briefly describe the nature of the problem and answer a few simple questions. You will be given the name of the service provider and an estimated time of arrival. If you feel you are in an unsafe situation, please let us know. With your consent, we will contact local police or safety authorities.

If Unable to Contact Roadside Assistance

If you are unable to contact Roadside Assistance or unable to provide a valid Vehicle Identification Number (VIN), and you obtain towing services on your own, you may submit your original receipts from the licensed towing or service facility, for services rendered within 30 days of the occurrence. Be sure to include your VIN, odometer mileage at the time of service, and current mailing address. We will process the claim based on vehicle and service eligibility. If eligible, we will reimburse you for the reasonable amount actually paid, based on the usual and customary charges for that service in the area where they were provided. FCA US LLC's determination relating to reimbursement is final. Correspondence should be mailed to:

FCA US LLC Customer Assistance

P.O. Box 9145

Medford, MA 02155

Attention Claims Department

FCA US LLC reserves the right to modify the terms or discontinue the Roadside Assistance Program at any time. The Roadside Assistance program is subject to restrictions and conditions of use, which are determined solely by FCA US LLC.

Flat Tire Service

If you are inconvenienced by a flat tire, we will dispatch a service provider to use your vehicle's temporary spare tire (if equipped) as recommended in your Owner's Manual. This is not a permanent flat tire repair.

Out of Gas/Fuel Delivery

Drivers cannot always count on a gas station being nearby, especially when traveling away from home. We will dispatch a service provider to deliver a small amount of fuel (maximum two gallons) to get you to a nearby station. This service is limited to two occurrences in a 12-month period.

Battery Jump Assistance

No time is a good time for a depleted battery. With Roadside Assistance, you do not have to worry about being stranded. We will dispatch a service provider to provide you with a battery jump anytime, day or night.

Lockout Service

Whether the keys are locked in your vehicle or frozen locks are keeping you from getting on your way, help is just a phone call away. This service is limited to providing access to the vehicle's seating area. It does not cover the cost of replacement keys.

Towing Service

Our towing service gives you peace of mind and confidence. If your vehicle becomes disabled as a result of a mechanical breakdown, Roadside Assistance will dispatch a towing service to transport your vehicle to the closest authorized Chrysler, Dodge, Jeep®, or Ram dealer. If you choose to go to another dealer, you will be responsible for the cost of the extra distance.

FCA US LLC CUSTOMER ASSISTANCE CENTER

P.O. Box 21-8004

Auburn Hills, MI 48321-8004

Phone: (866) 726-4636

FCA CANADA CUSTOMER CARE

P.O. Box 1621

Windsor, Ontario N9A 4H6

Phone: (800) 465-2001 English / (800) 387-9983 French

MEXICO**Customer relations Office**

Av. Prolongacion Paseo de la Reforma, 1240

Sante Fe C.P. 05109

Mexico, D.F.

In Mexico City: 800-505-1300

Outside Mexico City: +(52) 55 50817568

PUERTO RICO AND US VIRGIN ISLANDS**FCA Caribbean LLC Customer Service**

P.O. Box 191857

San Juan 00919-1857

Phone: (866) 726-4636

CUSTOMER ASSISTANCE FOR THE HEARING OR SPEECH IMPAIRED (TDD/TTY)

To assist customers who have hearing difficulties, FCA US LLC has installed special TDD (Telecommunication Devices for the Deaf) equipment at its customer center. Any hearing or speech impaired customer, who has access to a TDD or a conventional teletypewriter (TTY) in the United States, can communicate with FCA US LLC by dialing 1-800-380-2479.

Canadian residents with hearing difficulties that require assistance can use the special needs relay service offered by Bell Canada. For TTY teletypewriter users, dial 711 and for Voice callers, dial 1-800-855-0511 to connect with a Bell Relay Service operator.

SERVICE CONTRACT

You may have purchased a service contract for a vehicle to help protect you from the high cost of unexpected repairs after FCA US LLC's New Vehicle Limited Warranty expires. The Mopar® Vehicle Protection plans are the ONLY vehicle extended protection plans authorized, endorsed and backed by FCA US LLC to provide additional protection beyond your vehicle's warranty. If you purchased a Mopar® Vehicle Protection Plan, you will receive Plan Provisions and an Owner Identification Card in the mail within three weeks of the vehicle delivery date. If you have any questions about the service contract, call FCA US LLC's Service Contract National Customer Hotline at 1-800-521-9922 (Canadian residents, call (800) 465-2001 English / (800) 387-9983 French).

FCA US LLC is not responsible for any service contract you may have purchased from another manufacturer. If you require service after the FCA US LLC New Vehicle Limited Warranty expires, please refer to the contract documents, and contact the person listed in those documents.

We appreciate that you have made a major investment when you purchased the vehicle. An authorized dealer has also made a major investment in facilities, tools, and training to ensure that you are absolutely delighted with the ownership experience.

WARNING!

Engine exhaust (internal combustion engines only), some of its constituents, and certain vehicle components contain, or emit, chemicals known to the State of California to cause cancer and birth defects, or other reproductive harm. In addition, certain fluids contained in vehicles and certain products of component wear contain, or emit, chemicals known to the State of California to cause cancer and birth defects, or other reproductive harm.

WARRANTY INFORMATION

See the Warranty Information for the terms and provisions of FCA US LLC warranties applicable to this vehicle and market. Refer to www.mopar.com/om for further information.

See the Warranty Information for the terms and provisions of FCA Canada Inc. warranties applicable to this vehicle and market.

Use this QR code to access your digital experience.



MOPAR® PARTS

Mopar® original equipment parts & accessories and factory filled fluids are available from an authorized dealer. They are recommended for your vehicle to keep it operating at its best and maintain its original condition.

REPORTING SAFETY DEFECTS

IN THE 50 UNITED STATES AND WASHINGTON, D.C.

If you believe that your vehicle has a defect that could cause a crash or cause injury or death, you should immediately inform the National Highway Traffic Safety Administration (NHTSA) in addition to notifying FCA US LLC.

If NHTSA receives similar complaints, it may open an investigation, and if it finds that a safety defect exists in a group of vehicles, it may order a recall and remedy campaign. However, NHTSA cannot become involved in individual problems between you, an authorized dealer or FCA US LLC.

To contact NHTSA, you may call the Vehicle Safety Hotline toll free at 1-888-327-4236 (TTY: 1-800-424-9153); or go to <http://www.safercar.gov>; or write to: Administrator, NHTSA, 1200 New Jersey Avenue, SE., West Building, Washington, D.C. 20590. You can also obtain other information about motor vehicle safety from <http://www.safercar.gov>.

IN CANADA

If you believe that your vehicle has a safety defect, you should contact the Customer Service Department immediately. Canadian customers who wish to report a safety defect to the Canadian government should contact Transport

Canada, Motor Vehicle Defect Investigations and Recalls at
1-800-333-0510 or go to
[wwwapps.tc.gc.ca/Saf-Sec-Sur/7/
PCDB-BDPP](http://wwwapps.tc.gc.ca/Saf-Sec-Sur/7/PCDB-BDPP).

PUBLICATION ORDER FORMS

To order the following manuals, you may use either the website or the phone numbers listed below.

Service Manuals

These comprehensive Service Manuals provide a complete working knowledge of the vehicle, system, and/or components and is written in straightforward language with illustrations, diagrams, and charts.

Diagnostic Procedure Manuals

Diagnostic Procedure Manuals are filled with diagrams, charts and detailed illustrations. These manuals make it easy to find and fix problems on computer-controlled vehicle systems and features. They show exactly how to find and correct problems, using step-by-step troubleshooting and drivability procedures, proven diagnostic tests and a complete list of all tools and equipment.

To order a digital copy of your Service or Diagnostic Procedure manuals, visit:

www.techauthority.com (US and Canada).

Owner's Manuals

These Owner's Manuals have been prepared with the assistance of service and engineering specialists to acquaint you with specific FCA US LLC vehicles.

To access your Owner's Information online, visit www.mopar.com/om (US) or www.owners.mopar.ca (Canada).

Or visit:

www.techauthority.com to order physical copies of Owner's Manuals (US).

Owner's Manuals, Radio Manuals and Warranty Information Books can be ordered through Archway at:

- 1-800-387-1143 (Canada)

Change Of Ownership Or Address

*If you have purchased this vehicle used or have changed your address, please provide the following information and mail to:

FCA US LLC

P.O. Box 21-8008

Auburn Hills, MI 48321-8004

Make sure to include the following:

- Date of Sale (mm/dd/yy)
- Vehicle Identification Number (17 Character ID located on top left of the instrument panel)
- Exact Odometer Reading
- First and Last Name
- Phone Number
- Street Address, City, State and Zip Code
- Email Address

*Applies to US residents only.

GENERAL INFORMATION

The following regulatory statement applies to all Radio Frequency (RF) devices equipped in this vehicle:

This device complies with Part 15 of the FCC Rules and with Innovation, Science and Economic Development Canada license-exempt RSS standard(s). Operation is subject to the following two conditions:

1. This device may not cause harmful interference, and
2. This device must accept any interference received, including interference that may cause undesired operation.

Le présent appareil est conforme aux CNR d'Innovation, Science et Economic Development applicables aux appareils radio exempts de licence. L'exploitation est autorisée aux deux conditions suivantes:

1. l'appareil ne doit pas produire de brouillage, et
2. l'utilisateur de l'appareil doit accepter tout brouillage radioélectrique subi, même si le brouillage est susceptible d'en compromettre le fonctionnement.

La operación de este equipo está sujeta a las siguientes dos condiciones:

1. es posible que este equipo o dispositivo no cause interferencia perjudicial y
2. este equipo o dispositivo debe aceptar cualquier interferencia, incluyendo la que pueda causar su operación no deseada.

NOTE:

Changes or modifications not expressly approved by the party responsible for compliance could void the user's authority to operate the equipment.

INDEX

A

Adaptive Cruise Control (ACC) (Cruise Control)	.163, 165
Adding Engine Coolant (Antifreeze)	.354
Adding Fuel	.187, 188
Additives, Fuel	.394
Adjust	
Down	.34
Forward	.34
Rearward	.34
Up	.34
Adjustable Pedals	.38
Advance Phone Connectivity	.243
Air Bag	
Air Bag Operation	.295
Air Bag Warning Light	.293
Enhanced Accident Response	.298, 331
Event Data Recorder (EDR)	.331
If Deployment Occurs	.297
Knee Impact Bolsters	.295
Maintaining Your Air Bag System	.298
Maintenance	.298
Redundant Air Bag Warning Light	.294
Transporting Pets	.311
Air Bag Light	.111, 293, 312
Air Cleaner, Engine (Engine Air Cleaner Filter)	.343, 358
Air Conditioner Maintenance	.344
Air Conditioner Refrigerant	.344, 345
Air Conditioner System	.344
Air Conditioning	.59
Air Conditioning Filter	.61, 345
Air Conditioning, Operating Tips	.61
Air Conditioning System	.61
Air Filter	.343

Air Pressure	
Tires	.378
Alarm	
Panic	.19
Security Alarm	.25, 113
Alterations/Modifications	
Vehicle	.12
Antifreeze (Engine Coolant)	.354, 397
Disposal	.355
Anti-Lock Brake System (ABS)	.267
Anti-Lock Warning Light	.113
Assist, Hill Start	.271
Audio Settings	.235
Audio Systems (Radio)	.209
Auto Down Power Windows	.71
Automatic Door Locks	.28
Automatic Folding Mirrors	.44
Automatic Headlights	.50
Automatic Tailgate Release	.74
Automatic Temperature Control (ATC)	.61
Automatic Transmission	.134, 357
Adding Fluid	.357
Fluid And Filter Change	.357
Fluid Change	.357
Fluid Level Check	.356
Fluid Type	.357, 400
Shifting	.136
Special Additives	.356
Automatic Transmission Limp Home Mode	.135
AutoPark	.121
AUX Camera	.184
Auxiliary Driving Systems	.273
Axle Fluid	.358, 400
Axle Lubrication	.358

B

Back Up Camera	.178
Bar, Stabilizer/Sway System	.149
Battery	.111, 341
Blanket	.128
Charging System Light	.111
Keyless Key Fob Replacement	.19
Battery Saver Feature	.53
Bed Divider	.82
Bed Step	.76
Belts, Seat	.312
Blind Spot Monitoring	.273
Bluetooth	
Connecting To A Particular Mobile Phone Or	
Audio Device After Pairing	.240
Body Builders Guide	.10
Body Mechanism Lubrication	.350
B-Pillar Location	.375
Brake Assist System	.268
Brake Control System	.268
Brake Fluid	.356, 400
Brake System	.355, 392
Fluid Check	.356
Master Cylinder	.356
Parking	.131
Warning Light	.111
Brake/Transmission Interlock	.133
Bulb Replacement	.366
Bulbs, Light	.313, 366

C

Cab Top Clearance Lights371
Camera178
Camera, AUX184
Camera, Rear178, 180
Camera, Trailer Surround View184
Capacities, Fluid.397
Caps, Filler	
Oil (Engine)338
Power Steering163
Radiator (Coolant Pressure)354
Carbon Monoxide Warning313
Cargo Light52
Car Washes389
CD236
Cellular Phone259
Center High Mounted Stop Light370
Center Seat Storage Compartment62
Charge Air Cooler355
Chart, Tire Sizing373
Check Engine Light (Malfunction Indicator Light)119
Checking Your Vehicle For Safety311
Checks, Safety311
Child Restraint299
Child Restraints	
Booster Seats301
Child Seat Installation306, 307
How To Stow An unused ALR Seat Belt305
Infant And Child Restraints300
Locating The LATCH Anchorages304
Lower Anchors And Tethers For Children302
Older Children And Child Restraints301
Seating Positions302
Clean Air Gasoline.394
Cleaning	
Wheels382
Climate Control56
Automatic56
Manual59
Cold Weather Operation123
Compact Spare Tire381
Connected Services245, 246, 247, 255
Contract, Service403
Controls.230
Cooling Pressure Cap (Radiator Cap)354
Cooling System353
Adding Coolant (Antifreeze)354
Coolant Level353, 355
Cooling Capacity397
Disposal Of Used Coolant355
Drain, Flush, And Refill353
Inspection355
Points To Remember355
Pressure Cap354
Radiator Cap354
Selection Of Coolant (Antifreeze)354, 397, 398
Corrosion Protection.388
Cruise Control (Speed Control)163, 165
Cruise Light117, 118
Customer Assistance401
Cybersecurity209

D

Daytime Running Lights50
Dealer Service342
Defroster, Rear Window59
Defroster, Windshield59, 312
Deleting A Phone240
Diagnostic System, Onboard118
Diesel Exhaust Brake132
Diesel Fuel395
Diesel Fuel Requirements395

Diesel Fuel System, Re-Priming349
Differential, Limited Slip156
Dimmer Controls54
Dipsticks	
Power Steering163
Disabled Vehicle Towing329
Disc Drive236
Disconnecting.240
Disposal	
Antifreeze (Engine Coolant)355
Disturb243
Door Ajar111, 112
Door Ajar Light111, 112
Door Locks	
Automatic28
Doors26
Draining Fuel/Water Separator Filter347
Driver Memory Presets235
Driver's Seat Back Tilt33
Driving	
Off-Pavement149
Off-Road149
Through Flowing, Rising, Or Shallow Standing Water207
Dual Rear Wheels386, 392

E

Electrical Power Outlets67
Electric Brake Control System268
Anti-Lock Brake System267
Electronic Roll Mitigation268, 272
Electronically Shifted Transfer Case140, 143
Electronic Range Select (ERS)135, 138
Electronic Stability Control (ESC)269
Electronic Throttle Control Warning Light112
Emergency Braking.131, 280

- Emergency, In Case Of
 Freeing Vehicle When Stuck329
 Hazard Warning Flasher314
 Jump Starting325
 Emission Control System Maintenance119
 Engine338, 339, 340
 Air Cleaner343
 Block Heater124, 130
 Break-In Recommendations130, 131
 Compartment339, 340
 Compartment Identification338
 Coolant (Antifreeze)398
 Exhaust Gas Caution313
 Fails To Start122
 Flooded, Starting122
 Fuel Requirements393
 Identification339, 340
 Idling128
 Jump Starting325
 Oil342, 397, 398
 Oil Filler Cap338
 Oil Filter343
 Oil Reset103
 Oil Selection342, 397
 Oil Synthetic342
 Overheating328
 Runaway187
 Starting120
 Enhanced Accident Response Feature298, 331
 Entry System, Illuminated55
 Ethanol394
 Exhaust Brake132
 Exhaust Gas Cautions313
 Exhaust System313, 352, 358
 Exterior Lighting49
 Exterior Lights49, 313
- F**
 Family Alerts255
 FAQ255
 Features247
 Filters
 Air Cleaner343
 Air Conditioning61, 345
 Engine Fuel347
 Engine Oil343, 398
 Engine Oil Disposal343
 Flashers
 Turn Signals52, 117, 313
 Flash-To-Pass50
 Flat Tire Stowage323
 Fluid, Brake400
 Fluid Capacities397
 Fluid Leaks313
 Fluid Level Checks
 Brake356
 Power Steering163
 Fog Lights52, 369
 Fold Flat Load Floor65
 Fold-Flat Seats33
 Forward Collision Warning278
 Four-Way Hazard Flasher314
 Four Wheel Drive140
 Freeing A Stuck Vehicle329
 Front And Rear ParkSense System172
 Front Axle (Differential)358
 Fuel393, 395
 Adding187, 188
 Additives394
 Clean Air394
 Diesel395
 Ethanol394
 Filler Cap (Gas Cap)188
 Filter347
 Gasoline393
 Light114
 Materials Added394
 Methanol394
 Octane Rating393, 398
 Requirements393, 395
 Specifications395
 Tank Capacity397
 Fueling188
 Fuses360
- G**
 Garage Door Opener (HomeLink®)46
 Gas Cap (Fuel Filler Cap)188
 Gasoline, Clean Air394
 Gasoline, Reformulated394
 Gauges
 Voltage127
 Gear Ranges137
 Gear Selector Override327
 Getting Started246
 Glass Cleaning391
 Gross Axle Weight Rating192
 Gross Vehicle Weight Rating192
 Guide
 Body Builders10
 GVWR191
- H**
 Hazard
 Driving Through Flowing, Rising, Or
 Shallow Standing Water207
 Hazard Warning Flashers314
 Headlights368
 Automatic High Beam50

Cleaning388	Instrument Panel Lens Cleaning391	Lights313
High Beam50	Integrated Trailer Brake Control200	Air Bag111, 293, 312
Lights On Reminder51	Interior Appearance Care390	Automatic High Beam50
Passing50	Interior Lights53	Brake Assist Warning270
Switch49	Intervention Regeneration Strategy107, 350	Brake Warning111
Head Restraints37	Introduction245	Bulb Replacement366
Head Rests37	Inverter Outlet (115V).68	Cab Top Clearance371
Heated Mirrors46	iPod/USB/MP3 Control.66	Cargo52, 116
Heated Seats.35			Center Mounted Stop370
Heater, Engine Block130			Courtesy/Reading53
Hill Descent Control270	J		Cruise117, 118
Hill Descent Control Indicator270	Jacking And Tire Changing 317	Daytime Running50
Hill Start Assist271	Jack Location317	ECO117
Hitches		Jump Starting325	Electronic Stability Program(ESP) Indicator112
Trailer Towing194			Exterior49, 313
HomeLink® (Garage Door Opener)46			Fog117, 369
Hood Prop74	K		Four Wheel Drive Indicator146
Hood Release.74	Key Fob		Hazard Warning Flasher314
Hub Caps324	Panic Alarm19	Headlights49, 50
		Programming Additional Key Fobs20	High Beam50
I		Key Fob Battery Service (Remote Keyless Entry)19	Hill Descent Control Indicator270
Idle-Up Feature128	Key Fob Programming (Remote Keyless Entry)20	Illuminated Entry55
Ignition.21	Keyless Enter 'n Go™.27, 120, 123	Interior53
Switch21	Passive Entry27	LaneSense113, 114, 117, 118
Illuminated Entry55	Keys18	Lights On Reminder51
Inside Rearview Mirror39, 314			Low Fuel114
Instrument Cluster94, 95, 96, 97, 98, 101	L		Malfunction Indicator (Check Engine)114
Display101	Lane Change And Turn Signals52	NEUTRAL116
Engine Oil Reset103	Lane Change Assist.52	Park117
Instrument Cluster Display		LaneSense176	Passing50
Driver Assist104	Latches313	Seat Belt Reminder112
Fuel Economy105	Hood74	Security Alarm113
Off Road105	Lead Free Gasoline393	Service366
Speedometer104	Leaks, Fluid313	Side Marker372
Trip105	Life Of Tires380	Snowplow116
Vehicle Info104	Light Bulbs.313, 366	Traction Control270

Turn Signals52, 117, 313, 368, 370
Warning Instrument Cluster Descriptions112
Limited-Slip Differential156, 358
Loading Vehicle191
Tires375
Load Shed Battery Saver Mode110
Load Shed Battery Saver On110
Load Shed Electrical Load Reduction110
Load Shed Intelligent Battery Sensor110
Locks	
Automatic Door28
Child Protection28
Power Door26
Low Tire Pressure System280
Lubrication, Body350
Lug Nuts/Bolts392

M

Maintenance74
Maintenance Free Battery341
Maintenance Plan335
Maintenance Schedule332, 335
Malfunction Indicator Light (Check Engine)114, 119
Manage My Account255
Manual	
Park Release327
Service404
Media Hub66
Media Mode236
Memory Seat31
Memory Settings31
Methanol394
Mirror, Digital Rearview40
Mirror, Digital Trailer Camera40

Mirrors39
Electric Powered43
Heated46
Memory31
Outside41
Rearview39, 314
Trailer Towing42
Mobile App246
Modifications/Alterations	
Vehicle12
Monitor, Tire Pressure System280
Mopar Parts403
MP3 Control66
Multi-Function Control Lever50

N

New Vehicle Break-In Period130, 131
Noise Control	
Maintenance358
Tampering Prohibited359
Noise Emission Warranty358, 359

O

Occupant Restraints286
Octane Rating, Gasoline (Fuel)393
Off-Pavement Driving (Off-Road)149, 208
Off-Road Driving (Off-Pavement)149, 208
Oil, Engine342, 398
Capacity397
Dipstick341
Disposal343
Filter343, 398
Filter Disposal343
Identification Logo342
Materials Added To342

Pressure Warning Light112
Recommendation342, 397
Synthetic342
Viscosity397
Oil Filter, Change343
Oil Filter, Selection343
Oil Life Reset 103
Oil Pressure Light112
Oil Reset103
Onboard Diagnostic System118
Operating Precautions118
Operator Manual	
Owner's Manual404
Outside Rearview Mirrors41
Overdrive139
Overdrive OFF Switch139
Overheating, Engine328

P

Paint Care388
Pair (Link) Uconnect Phone To A Mobile Phone 239
Panic Alarm19
Parking Brake131
ParkSense System, Rear172
Passive Entry27
Pedals, Adjustable38
Pedestrian Warning System280
Pets311
Phone Mode238
Pickup Box77
Pinch Protection73
Placard, Tire And Loading Information375
Power	
Distribution Center (Fuses)361
Door Locks26
Folding Mirrors43

Mirrors43
Outlet (Auxiliary Electrical Outlet)67, 68
Outside Mirror Lights45
Seats34
Side Steps27
Sliding Rear Window72
Steering43, 163
Sunroof73
Windows71
Power Seats	
Down34
Forward34
Rearward34
Recline35
Tilt34
Up34
Power Steering Fluid400
Pregnant Women And Seat Belts291
Presets235
Pretensioners	
Seat Belts292
Profile Settings212
Programmable Features209
R	
Radial Ply Tires379
Radiator Cap (Coolant Pressure Cap)353, 354
Radio	
Presets235
Settings209
Radio Controls230
Radio Mode230
Radio Operation230, 259
Radio Remote Controls229
Rain Sensitive Wiper System56

RamBox Cargo Storage80
Ramp Travel Index150
Rear Axle (Differential)358
Rear Camera180
Rear Cargo Area Utility Rails79
Rear Cross Path275
Rear ParkSense System172
Rear Seat Reminder Alert267
Rear Window, Sliding72
Recreational Towing204
Shifting Into Transfer Case Neutral (N)206
Shifting Out Of Transfer Case Neutral (N)206
Reformulated Gasoline394
Refrigerant345
Registering SiriusXM Guardian246
Release, Hood74
Release, Tailgate74
Reminder, Seat Belt287
Remote Features, Door Lock/Unlock250, 255
Remote Features, Horn And Lights251
Remote Features, Starting251, 257
Remote Keyless Entry	
Panic Alarm19
Programming Additional Key Fobs20
Remote Sound System (Radio) Control229
Remote Start (Diesel)24
Remote Start (Gasoline)22
Remote Starting	
Exit Remote Start Mode23
Replacement Bulbs366
Replacement Tires380
Reporting Safety Defects403
Restraints, Child299
Restraints, Head37
Roadside Assistance251, 256
Rotation, Tires386

S



Safety229
Safety Checks Inside Vehicle312
Safety Checks Outside Vehicle313
Safety Defects, Reporting403
Safety, Exhaust Gas313
Safety Features229
Safety Information, Tire372
Safety Tips311
Satellite Radio231
Saved Radio Stations235
Schedule, Maintenance332
Seat Belt Reminder112
Seat Belts287, 312
Adjustable Shoulder Belt289
Adjustable Upper Shoulder Anchorage289
Adjustable Upper Shoulder Belt Anchorage289
Automatic Locking Retractor (ALR)292
Child Restraints299
Energy Management Feature292
Extender291
Front Seat287, 288
Inspection312
Lap/Shoulder Belt Operation288
Lap/Shoulder Belt Untwisting289
Operating Instructions288
Pregnant Women291
Pretensioners292
Reminder287
Seat Belt Extender291
Seat Belt Pretensioner292
Seat Belt Reminder287
Untwisting Procedure289
Seat Belts Maintenance390
Seats33, 34
Adjustment33, 34
Easy Entry35

Folding Floor65
Head Restraints37
Memory31
Power34
Rear Folding33
Tilting33
Security Alarm.25, 113
Selection Of Coolant (Antifreeze)398
Send & Go252, 256
Sentry Key (Immobilizer)21
Service Assistance401
Service Contract403
Service Manuals404
Settings, Audio235
Shifting133
Automatic Transmission134, 136
Transfer Case146
Transfer Case, Shifting Into Transfer Case Neutral (N)206
Transfer Case, Shifting Out Of Transfer Case Neutral (N)206
Shift Lever Override327
Side Steps, Power27
Signals, Turn52, 117, 313
Sirius Satellite Radio231
Favorites234
Replay232
SiriusXM Satellite Radio	
Browse in SXM234
Favorites234
Replay232
Sliding Rear Window, Power72
Smart Watch255
Snow Chains (Tire Chains)383
Snow Plow203
Snow Tires381
SOS Call247, 255
Spare Tires381, 382

Speed Control	
Accel/Decel164
Cancel165
Resume164
Speed Control (Cruise Control)163, 165
Stabilizer/Sway Bar System149
Starting120, 123
Automatic Transmission120, 123
Button21
Cold Weather123
Engine Block Heater124
Engine Fails To Start122
Starting And Operating120
Starting Procedures120, 123
Starting Procedures (Diesel Engines)123
Starting Procedures (Gas Engines)120
Steering	
Power163
Tilt Column29
Wheel, Heated29
Wheel, Tilt29
Steering Wheel Audio Controls229
Steering Wheel Mounted Sound System229
Steps, Power Side27
Stolen Vehicle Assistance253, 256
Storage62
In Floor64
Storage Compartment, Center Seat62
Storage, Vehicle61, 388
Store Radio Presets235
Storing Your Vehicle388
Sunglasses Storage64
Sun Roof73, 74
Sunshade Operation73
Surround View Camera180
Sway Control, Trailer272
Synthetic Engine Oil342

T

Tailgate, Electronic Lowering74
Tailgate Removal75
Telescoping Steering Column29
Temperature Control, Automatic (ATC)61
Tilt	
Down34
Up34
Tilt Steering Column29
Tip Start120, 123
Tire And Loading Information Placard375
Tire Markings372
Tires313, 378, 381, 387
Aging (Life Of Tires)380
Air Pressure378
Chains383
Compact Spare381
Dual386, 392
General Information378, 381
High Speed379
Inflation Pressure378
Life Of Tires380
Load Capacity375
Pressure Monitoring System (TPMS)115, 280
Quality Grading387
Radial379
Replacement380
Rotation386
Safety372, 378
Sizes373
Snow Tires381
Spare Tires381, 382
Spinning379
Trailer Towing199
Tread Wear Indicators380
Wheel Nut Torque392
Tire Safety Information372

Tongue Weight/Trailer Weight195	U	Uconnect Settings209
Tonneau Cover83, 388	Uconnect	Customer Programmable Features27
Tonneau Cover Cleaning388	Phone Call Features	Passive Entry Programming27
To Open Hood74	Things You Should Know About Your Uconnect Phone	Uconnect System227
Torque Converter Clutch139		Uconnect Voice Command30
Towing192, 329	Uconnect Phone	Uniform Tire Quality Grades387
Disabled Vehicle329	Answer Or Ignore An Incoming Call — Call Currently In Progress	Universal Garage Door Opener (HomeLink®) If Equipped 46
Guide195	Answer Or Ignore An Incoming Call — No Call Currently In Progress	Unleaded Gasoline393
Recreational204	Bluetooth Communication Link	Untwisting Procedure, Seat Belt289
Weight195	Call Continuation	USB66
Towing Behind A Motorhome204	Call Controls	Utility Rails, Rear Cargo Area79
Traction207	Call Termination		
Traction Control272	Cancel Command	V	
Trailer Reverse Steering Control195	Connecting To A Particular Mobile Phone Or Audio Device After Pairing	Vehicle Finder252, 256
Trailer Sway Control (TSC)272	Help Command	Vehicle Health Alert254
Trailer Towing192	Join Calls	Vehicle Health Report253
Hitches194	Making A Phone Or Audio Device A Favorite	Vehicle Identification Number (VIN)392
Minimum Requirements198	Making A Second Call While Current Call Is In Progress	Vehicle Loading191, 375
Mirrors42	Managing Your Favorites	Vehicle Maintenance342
Tips202	Natural Speech	Vehicle Modifications/Alterations12
Trailer And Tongue Weight195	Operation	Vehicle Notifications254
Wiring201	Overview	Vehicle Settings209
Trailer Towing Guide195	Pair (Link) Uconnect Phone To A Mobile Phone	Vehicle Storage61, 388
Trailer Tow Pages263	Phonebook Download	Ventilated Seats36
Trailer Weight195	Place/Retrieve A Call From Hold	Voice Recognition System (VR)30
Transfer Case358	Power-Up	Voltmeter127
Electronically Shifted140, 143	Recent Calls		
Fluid400	Redial	W	
Transmission134	Toggling Between Calls	Warning Lights (Instrument Cluster Descriptions)113
Automatic134, 136, 356	To Remove A Favorite	Warranty Information 403
Fluid400	Touch-Tone Number Entry	Washers, Windshield341
Maintenance356	Transfer Call To And From Mobile Phone	Washing Vehicle389
Shifting133	Voice Command	Water	
Transporting Pets311		Driving Through207
Tread Wear Indicators380			
Turn Signals52, 117, 368, 370			

Water Separator	
Diesel Fuel	.347
Wheel And Wheel Tire Care	.382
Wheel And Wheel Tire Trim	.382
Wheel Covers	.324
Wi-Fi	.252
Winch	.156
Accessories	.157
Operation	.157
Rigging Techniques	.162
Usage	.156
Wind Buffeting	.72
Window Fogging	.61
Windows	.71
Power	.71
Rear Sliding	.72
Reset Auto-Up	.72
Windshield Defroster	.312
Windshield Washers	.55, 341
Fluid	.341
Windshield Wiper Blades	.351
Windshield Wipers	.55
Wipers Blade Replacement	.351
Wipers, Rain Sensitive	.56
Wireless Charging Pad	.70

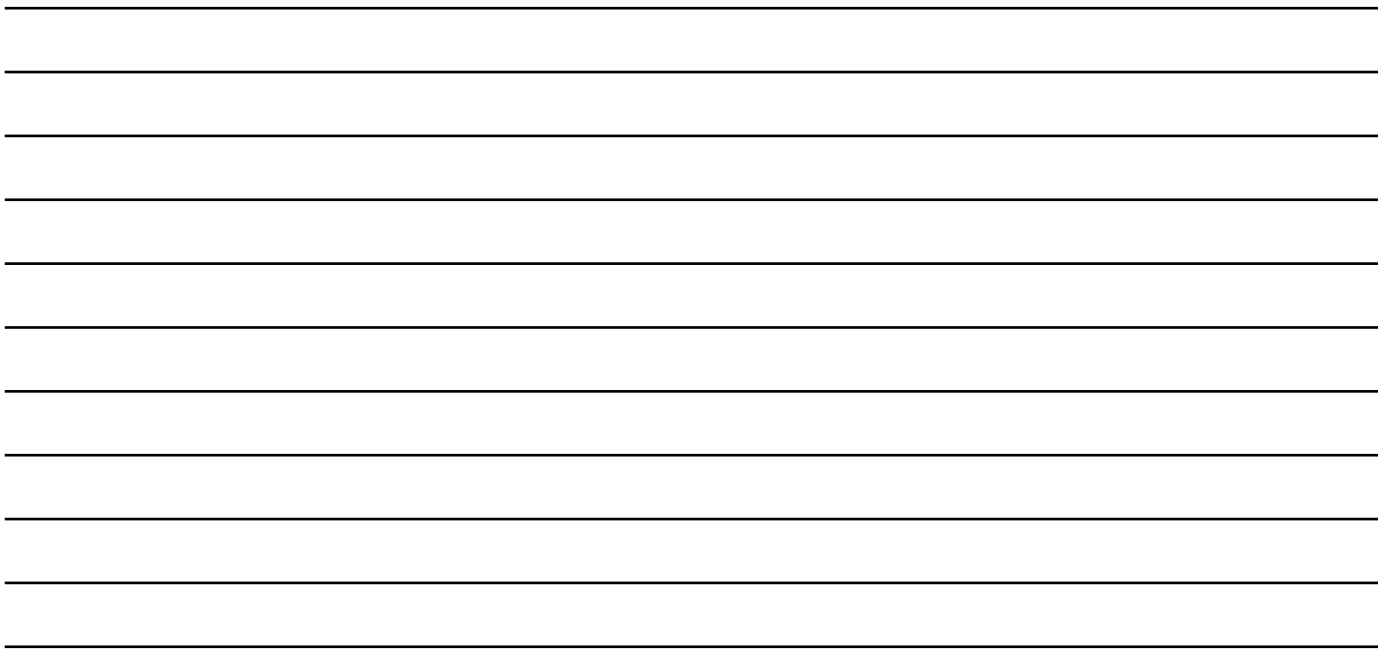

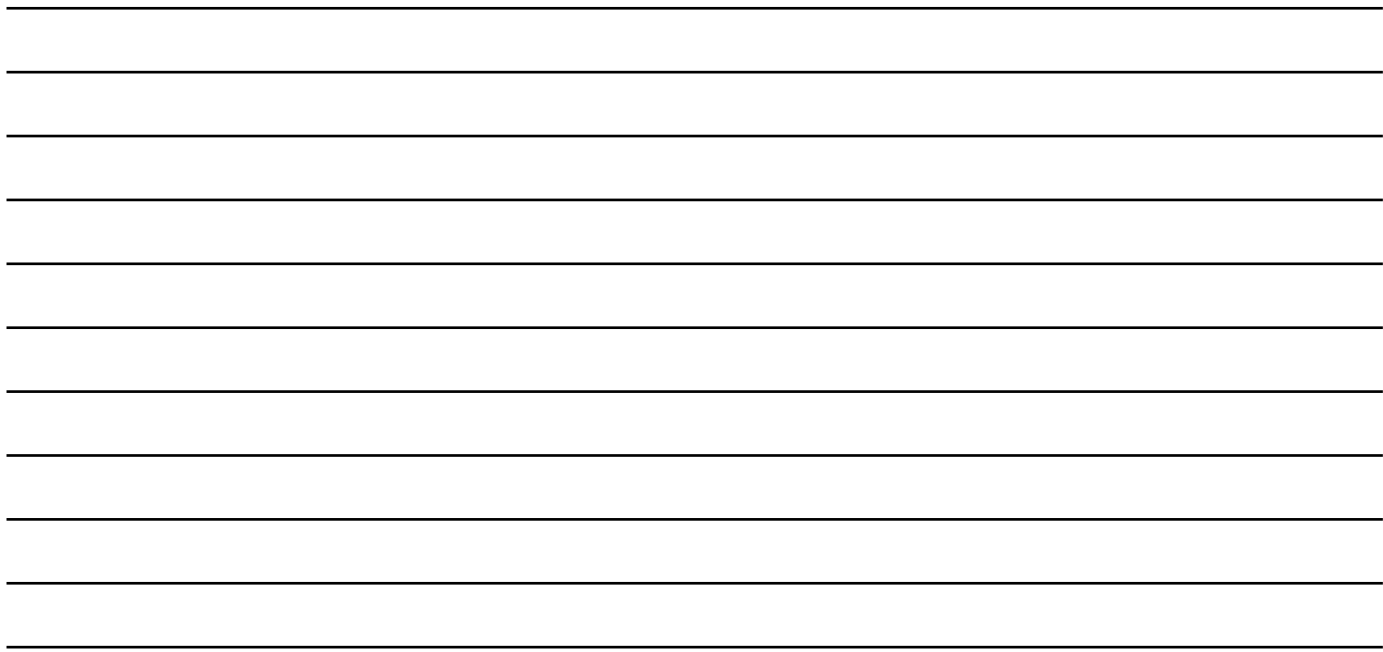

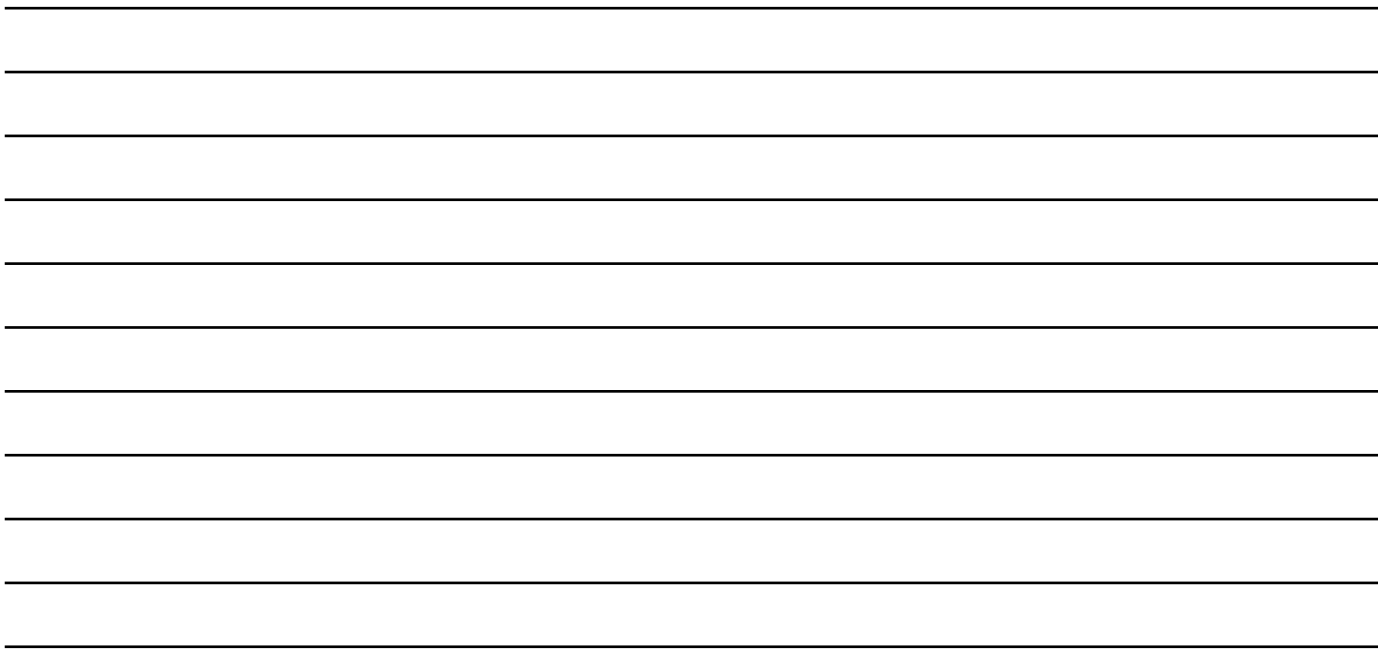

DRIVING AND ALCOHOL

Drunk driving is one of the most frequent causes of accidents. Your driving ability can be seriously impaired with blood alcohol levels far below the legal minimum. If you are drinking, don't drive. Ride with a designated non-drinking driver, call a cab, a friend or use public transportation.



WARNING

Driving after drinking can lead to an accident. Your perceptions are less sharp, your reflexes are slower and your judgment is impaired when you have been drinking. Never drink and then drive.

The driver's primary responsibility is the safe operation of the vehicle. Driving while distracted can result in loss of vehicle control, resulting in an accident and personal injury. FCA US LLC strongly recommends that the driver use extreme caution when using any device or feature that may take their attention off the road. Use of any electrical devices, such as cellular telephones, computers, portable radios, vehicle navigation or other devices, by the driver while the vehicle is moving is dangerous and could lead to a serious accident. Texting while driving is also dangerous and should never be done while the vehicle is moving. If you find yourself unable to devote your full attention to vehicle operation, pull off the road to a safe location and stop your vehicle. Some states or provinces prohibit the use of cellular telephones or texting while driving. It is always the driver's responsibility to comply with all local laws.

This Owner's Manual has been prepared to help you get acquainted with your new Ram brand vehicle and to provide a convenient reference for common questions.

Not all features shown in this manual may apply to your vehicle. For additional information on accessories to help personalize your vehicle, visit mopar.com/om (USA), owners.mopar.ca (Canada) or your local Ram brand dealer.

This Owner's Manual is intended to familiarize you with the important features of your vehicle. Your most up-to-date Owner's Manual, Radio Instruction Manual and Warranty Booklet can be found by visiting the website on the back cover.

U.S. Residents: If you are the first registered retail owner of your vehicle, you may obtain a complimentary printed copy of the Warranty Booklet by calling **1-866-726-4636** or by contacting your dealer. Replacement kits can be purchased by visiting www.techauthority.com.

Canadian Residents: If you are the first registered retail owner of your vehicle, you may obtain a complimentary printed copy of the Warranty Booklet or purchase a replacement kit by calling **1-800-387-1143** or by contacting your dealer.



Whether it is providing information about specific product features, taking a tour through your vehicle's heritage, knowing what steps to take following an accident or scheduling your next appointment, we know you will find the app an important extension of your Ram vehicle. Simply download the app, select your make and model and enjoy the ride. To get this app, go directly to the App Store® or Google Play® Store and enter the search keyword "ram toolbox" (U.S. residents only).

**DOWNLOAD THE MOST UP-TO-DATE OWNER'S MANUAL,
RADIO AND WARRANTY BOOKS**

US



[MOPAR.COM/OM](https://mopar.com/om)

CANADA



[OWNERS.MOPAR.CA](https://owners.mopar.ca)