



Maintenance and Service Guide

SUMMARY

This guide provides information about spare parts, removal and replacement of parts, security, backing up, and more.

Legal information

© Copyright 2022 HP Development Company, L.P.

AMD is a trademark of Advanced Micro Devices, Inc. Bluetooth is a trademark owned by its proprietor and used by HP Inc. under license. Bluetooth is a trademark owned by its proprietor and used by HP Inc. under license. Intel, Core, Iris, Thunderbolt, vPro, and XMM are trademarks of Intel Corporation or its subsidiaries in the U.S. and/or other countries. Microsoft and Windows are either registered trademarks or trademarks of Microsoft Corporation in the United States and/or other countries. NVIDIA and GeForce are trademarks and/or registered trademarks of NVIDIA Corporation in the U.S. and other countries. TILE and the TILE design are trademarks of Tile, Inc. USB Type-C and USB-C are registered trademarks of USB Implementers Forum. DisplayPort™ and the DisplayPort™ logo are trademarks owned by the Video Electronics Standards Association (VESA®) in the United States and other countries. Miracast and Wi-Fi are registered trademarks of Wi-Fi Alliance.

The information contained herein is subject to change without notice. The only warranties for HP products and services are set forth in the express warranty statements accompanying such products and services. Nothing herein should be construed as constituting an additional warranty. HP shall not be liable for technical or editorial errors or omissions contained herein.

First Edition: March 2022

Document Part Number: N03559-001

Product notice

This guide describes features that are common to most models. Some features may not be available on your computer.

Not all features are available in all editions or versions of Windows. Systems may require upgraded and/or separately purchased hardware, drivers, software or BIOS update to take full advantage of Windows functionality. Windows is automatically updated, which is always enabled. High-speed internet and Microsoft account required. ISP fees may apply and additional requirements may apply over time for updates. See <http://www.windows.com>. **If your product ships with Windows in S Mode:** Windows in S Mode works exclusively with apps from the Microsoft Store within Windows. Certain default settings, features, and apps cannot be changed. Some accessories and apps that are compatible with Windows may not work (including some antivirus, PDF writers, driver utilities, and accessibility apps), and performance may vary, even if you switch out of S Mode. If you switch to Windows, you cannot switch back to S Mode. Learn more at [Windows.com/SmodeFAQ](https://windows.com/SmodeFAQ).

To access the latest user guides, go to <http://www.hp.com/support>, and follow the instructions to find your product. Then select **Manuals**.

Software terms

By installing, copying, downloading, or otherwise using any software product preinstalled on this computer, you agree to be bound by the terms of the HP End User License Agreement (EULA). If you do not accept these license terms, your sole remedy is to return the entire unused product (hardware and software) within 14 days for a full refund subject to the refund policy of your seller.

For any further information or to request a full refund of the price of the computer, please contact your seller.

Safety warning notice

Reduce the possibility of heat-related injuries or of overheating the computer by following the practices described.

⚠ WARNING! To reduce the possibility of heat-related injuries or of overheating the computer, do not place the computer directly on your lap or obstruct the computer air vents. Use the computer only on a hard, flat surface. Do not allow another hard surface, such as an adjoining optional printer, or a soft surface, such as pillows or rugs or clothing, to block airflow. Also, do not allow the AC adapter to come into contact with the skin or a soft surface, such as pillows or rugs or clothing, during operation. The computer and the AC adapter comply with the user-accessible surface temperature limits defined by applicable safety standards.

Important notice about Customer Self-Repair parts

Your computer includes Customer Self-Repair parts and parts that should be accessed by only an authorized service provider.



IMPORTANT: See "Removal and replacement procedures for Customer Self-Repair parts" for details.

Accessing parts described in "Removal and replacement procedures for authorized service provider parts" can damage the computer or void your warranty.

Table of contents

1 Product description	1
2 Components	6
Right	6
Left	8
Display	9
Low blue light mode (select products only)	9
Keyboard area	10
Touchpad	10
Touchpad settings	10
Adjusting touchpad settings	10
Turning on the touchpad	10
Touchpad components	11
Lights	11
Button, speakers, and fingerprint reader	13
Special keys	14
Bottom	15
Rear	16
Labels	17
HP Tamper Lock	18
Using Tile (select products only)	18
3 Illustrated parts catalog	19
Computer major components	19
Display assembly subcomponents	23
Cable Kit	25
Miscellaneous parts	26
4 Removal and replacement procedures preliminary requirements	32
Tools required	32
Service considerations	32
Plastic parts	32
Cables and connectors	32
Drive handling	32
Electrostatic discharge information	33
Generating static electricity	33
Preventing electrostatic damage to equipment	34
Personal grounding methods and equipment	34
Grounding the work area	35
Recommended materials and equipment	35

Cleaning your computer	36
Enabling HP Easy Clean (select products only)	36
Removing dirt and debris from your computer.....	36
Cleaning your computer with a disinfectant	37
Caring for wood veneer (select products only)	38
Packaging and transporting guidelines	38
Accessing support information	38
5 Removal and replacement procedures for Customer Self-Repair parts.....	41
Component replacement procedures.....	41
Preparation for disassembly	41
Bottom cover	41
Using a SIM card (select products only).....	42
Determining the correct SIM card size for your computer	43
Inserting a SIM card in an external slot	43
Memory modules	43
WLAN module	45
WWAN module	47
Solid-state drive	48
6 Removal and replacement procedures for authorized service provider parts.....	51
Component replacement procedures.....	51
Preparation for disassembly	51
Battery	51
RTC battery	52
I/O board	53
Touchpad	54
NFC module.....	55
Smart card reader	56
Fan	57
Fingerprint reader board	58
Heat sink	59
System board.....	60
Speakers	63
Power connector cable	64
Display assembly	65
Top cover with keyboard (includes smart card board)	73
7 Computer Setup (BIOS), TPM, and HP Sure Start.....	75
Using Computer Setup.....	75
Navigating and selecting in Computer Setup	75
Restoring factory settings in Computer Setup	75
Updating the BIOS.....	76
Determining the BIOS version	76
Preparing for a BIOS update	76
Downloading a BIOS update	77
Installing a BIOS update	77
Changing the boot order using the f9 prompt	77

TPM BIOS settings (select products only)	78
Using HP Sure Start (select products only)	78
8 Backing up, restoring, and recovering	79
Backing up information and creating recovery media	79
Using Windows tools for backing up	79
Using the HP Cloud Recovery Download Tool to create recovery media (select products only)	79
Restoring and recovering your system	79
Creating a system restore	80
Restoring and recovery methods	80
Recovering using HP Recovery media	80
Changing the computer boot order	81
Using HP Sure Recover (select products only)	81
9 Using HP PC Hardware Diagnostics	82
Using HP PC Hardware Diagnostics Windows (select products only)	82
Using an HP PC Hardware Diagnostics Windows hardware failure ID code	82
Accessing HP PC Hardware Diagnostics Windows	82
Accessing HP PC Hardware Diagnostics Windows from HP Help and Support (select products only)	82
Accessing HP PC Hardware Diagnostics Windows from HP Support Assistant	83
Accessing HP PC Hardware Diagnostics Windows from the Start menu (select products only)	83
Downloading HP PC Hardware Diagnostics Windows	83
Downloading the latest HP PC Hardware Diagnostics Windows version from HP	83
Downloading the HP PC Hardware Diagnostics Windows from the Microsoft Store	83
Downloading HP Hardware Diagnostics Windows by product name or number (select products only)	84
Installing HP PC Hardware Diagnostics Windows	84
Using HP PC Hardware Diagnostics UEFI	84
Using an HP PC Hardware Diagnostics UEFI hardware failure ID code	84
Starting HP PC Hardware Diagnostics UEFI	85
Downloading HP PC Hardware Diagnostics UEFI to a USB flash drive	85
Downloading the latest HP PC Hardware Diagnostics UEFI version	85
Downloading HP PC Hardware Diagnostics UEFI by product name or number (select products only)	86
Using Remote HP PC Hardware Diagnostics UEFI settings (select products only)	86
Downloading Remote HP PC Hardware Diagnostics UEFI	86
Downloading the latest Remote HP PC Hardware Diagnostics UEFI version	86
Downloading Remote HP PC Hardware Diagnostics UEFI by product name or number	86
Customizing Remote HP PC Hardware Diagnostics UEFI settings	86
10 Specifications	88
Computer specifications	88
35.6 cm (14.0 in) display specifications	88
Solid-state drive specifications	89
11 Statement of memory volatility	91
Current BIOS steps	91
Nonvolatile memory usage	93
Questions and answers	95

Using HP Sure Start (select products only)	97
12 Power cord set requirements	98
Requirements for all countries	98
Requirements for specific countries and regions	98
13 Recycling	100
Index	101

1 Product description

This table provides detailed product information.

Table 1-1 Product components and their descriptions

Category	Description
Product Name	HP EliteBook 650 15.6 inch G9 Notebook PC
Processors	Intel® processors Intel Core® i7 1270P (1.6 GHz base frequency, 18 MB cache, 12 cores, 28 W) Intel Core i7 1265U (1.8 GHz base frequency, 12 MB cache, 10 cores, 15 W) Intel Core i7 1255U (1.7 GHz base frequency, 12 MB cache, 10 cores, 15 W) Intel Core i5 1250P (1.7 GHz base frequency, 18 MB cache, 12 cores, 28 W) Intel Core i5 1245U (1.6 GHz base frequency, 12 MB cache, 10 cores, 15 W) Intel Core i5 1235U (1.3 GHz base frequency, 12 MB cache, 10 cores, 15 W) Intel Core i3 1215U (1.2 GHz base frequency, 10 MB cache, 6 cores, 15 W)
Graphics	Internal graphics memory Intel Iris® Xe Graphics Discrete graphics memory NVIDIA® GeForce® MX570 graphics processor
Display	39.6 cm (15.6 in), full high definition (FHD) (1920 × 1080), narrow bezel, UWVA, antiglare, bent, camera privacy cover 250 nits, 45% CG, eDP 1.2 without PSR, no camera, nontouch 250 nits, 45% CG, eDP 1.2 without PSR, HD camera, touch or nontouch 250 nits, 45% CG, eDP 1.2 without PSR, HD + IR camera, nontouch 250 nits, 45% CG, eDP 1.2 without PSR, HD camera, nontouch, WWAN 250 nits, 45% CG, eDP 1.2 without PSR, HD + IR camera, touch or nontouch, WWAN 400 nits, sRGB 100, eDP 1.4 + PSR2, low power, HD + IR camera, nontouch, WWAN 400 nits, sRGB 100, eDP 1.4 + PSR2, low power, HD camera, nontouch 35.6 cm (14.0 in), high definition (HD) (1366 × 768), narrow bezel, SVA, antiglare, bent, eDP 1.2 without PSR, 250 nits No camera HD camera
Memory	Two customer-accessible (by IT or self-maintainers only) memory module slots supporting up to 64 GB of RAM DDR4-3200 dual-channel support Supports the following configurations:

Table 1-1 Product components and their descriptions (continued)

Category	Description
	<ul style="list-style-type: none"> • 64 GB (32 × 2) • 32 GB (16 × 2) or (32 × 1) • 16 GB (8 × 2) or (16 × 1) • 8 GB (8 × 1 or 4 × 2)
Primary storage	<p>Solid-state drives, PCIe, NVMe</p> <p>1 TB, PCIe-4 × 4, Three Layer Cell (TLC), M.2 2280</p> <p>512 GB, value, M.2 2280</p> <p>512 GB, PCIe-4 × 4, TLC, M.2 2280</p> <p>512 GB, PCIe-4 × 4, TLC, self-encrypted OPAL2, M.2 2280</p> <p>256 GB, PCIe-4 × 4, TLC, M.2 2280</p> <p>256 GB, PCIe-4 × 4, TLC, self-encrypted OPAL2, M.2 2280</p> <p>256 GB, value, M.2 2280</p> <p>256 GB, M.2 2230 (2nd solid-state drive, only available on models without WWAN)</p> <p>128 GB, M.2 2230 (2nd solid-state drive, only available on models without WWAN)</p>
Audio and video	<p>Camera, HD 720p, with Temporal Noise Reduction (select products only)</p> <p>Camera, HD 720p + IR (infrared), with Temporal Noise Reduction (select products only)</p> <p>Camera privacy cover</p> <p>Stereo speakers (2)</p> <p>Microphone (dual array)</p> <p>Supports WDR (wide dynamic range)</p>
RJ-45 (network) jack	<p>Intel Ethernet Connection I219-LM (vPro®)</p> <p>Intel Ethernet Connection I219-V (non-vPro)</p>
Wireless	<p>Wireless Local Area Network (WLAN) (select products only)</p> <p>Intel AX211 Wi-Fi® 6e Bluetooth® 5.2 WLAN</p> <p>Intel AX211 Wi-Fi 6E Bluetooth 5.2 vPro WLAN</p> <p>Compatible with Miracast® devices</p> <p>Supports HP Connection Optimizer (with data analytics)</p> <p>Supports HP LAN-Wireless Protection (WLAN/LAN/WWAN switching)</p> <p>Supports UEFI Wi-Fi</p> <p>Supports Indonesia New Band</p> <p>Supports Dynamic Antenna gain (EU only)</p> <p>Supports Bluetooth Audio Offload for A2DP</p> <p>Supports BT PLDR</p> <p>Supports WLAN PLDR</p>

Table 1-1 Product components and their descriptions (continued)

Category	Description
	Wireless Wide Area Network (WWAN) (select products only)
	Intel XMM™ 7560 R + LTE-Advanced Pro WWAN (Cat 16)
	Two antennas integrated at top of display
	eSIM support
	LTE CAT16: Fibocom LTE/HSPA + with GPS
	Global Series support
	NFC module (select products only)
	NFC Mirage WNC XRAV-1 (NXP NPC300 I2C 10 mm × 17 mm).
Ports	HDMI 2.0
	Audio-out (headphone)/Audio-in (microphone) combo jack
	(3) USB 3.1 Gen 1 Type-A port
	Thunderbolt™ 4 with USB4 Type-C® 40 Gbps signaling rate (USB Power Delivery, DisplayPort™ 1.4)
	RJ-45 (network) jack
	AC Smart Pin adapter plug, 4.5 mm
	Nano SIM slot for WWAN
Sensors	Hall sensor
Keyboard/pointing devices	Keyboard
	Backlit with numeric keypad, spill resistant
	Not backlit, with numeric keypad, spill resistant
	Clickpad
	Microsoft® precision touchpad default gestures support
	No hybrid mode support
	Firmware PTP
Power requirements	Battery
	3 cell, 51.3 Whr, HP Long Life
	3 cell, 42.75 Whr, HP Long Life
	HP fast charge technology
	Long life
	Smart AC adapters
	65 W, right angle, nPFC, 4.5 mm, 1.8 m (6 ft)
	65 W, right angle, nPFC, 4.5 mm, 1.8 m (6 ft) (LA MERC0)
	65 W, nPFC, 4.5 mm, EM
	65 W, straight, nPFC, USB Type-C®, 1.8 m (6 ft)
	45 W, right angle, nPFC, 4.5 mm, 1.8 m (6 ft)

Table 1-1 Product components and their descriptions (continued)

Category	Description
	45 W, right angle, nPFC, 4.5 mm, 1.8 m (6 ft) (LA MERCO)
	45 W, nPFC, standard C8, two prong, 4.5 mm (for use in Japan)
	45 W, straight, nPFC, USB Type-C, 1.8 m (6 ft)
	Power cord
	C7, 1.0 m (3.3 ft) conventional
	C5, 1.0 m (3.3 ft) conventional
	C5, 1.0 m (3.3 ft), sticker, conventional, straight, HF
Security	Fingerprint sensor (select products only)
	Camera privacy cover
	Nano security cable slot
	Active SmartCard (select products only)
	HP Tamper Lock (select products only)
Operating system	Windows® 10 Enterprise 64
	Windows 10 Enterprise 64 LTSC 2109 (21H2)
	Windows 11 Enterprise 64
	Windows 11 Home 64
	Windows 11 Home 64 Advanced
	Windows 11 Home 64 Advanced Single Language
	Windows 11 Home 64 Chinese Market CPPP
	Windows 11 Home 64 High-End Chinese Market CPPP
	Windows 11 Home 64 Plus
	Windows 11 Home 64 Plus Single Language
	Windows 11 Home 64 Plus Single Language Africa Market PPP
	Windows 11 Home 64 Plus Single Language APAC EM PPP
	Windows 11 Home 64 Plus Single Language India Market PPP
	Windows 11 Home 64 Plus Single Language Indonesia Market PPP
	Windows 11 Home 64 Single Language
	Windows 11 Home 64 Single Language Africa Market PPP
	Windows 11 Home 64 Single Language APAC EM PPP
	Windows 11 Home 64 Single Language India Market PPP
	Windows 11 Home 64 Single Language Indonesia Market PPP
	Windows 11 Pro 64
	Windows 11 Pro 64 Chinese Market
	Windows 11 Pro 64 Downgrade Win 10 Pro 64

Table 1-1 Product components and their descriptions (continued)

Category	Description
	Windows 11 Pro 64 Downgrade Win 10 Pro 64 Chinese Market
	Windows 11 Pro 64 Downgrade Win 10 Pro 64 StF MSNA Standard
	Windows 11 Pro 64 StF MSNA Standard
	FreeDOS 3.0
	Restore media
	Windows 10 Professional 64 bit OS DVD
	Windows 10 Professional 64 bit OS USB
Serviceability	End user replaceable parts
	AC adapter

2 Components

Your computer features top-rated components. This chapter provides details about your components, where they are located, and how they work.

Right

Use the illustration and table to identify the components on the right side of the computer.

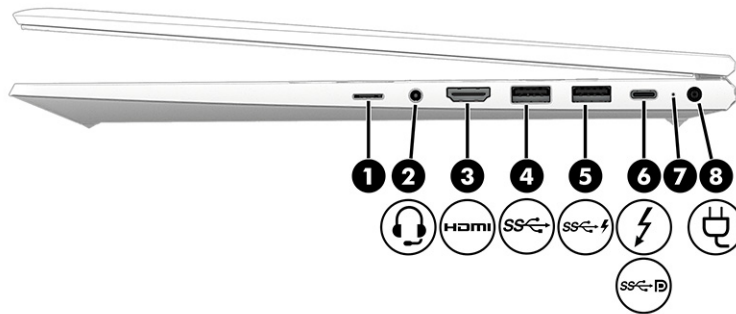

Table 2-1 Right-side components and their descriptions



Component	Description
(1)	<p>SIM card slot (select products only)</p> <p>Supports a wireless subscriber identity module (SIM) card.</p> <p>For SIM card installation steps, see Using a SIM card (select products only) on page 42.</p> <p>NOTE: Models without WWAN have a permanent insert installed.</p>
(2)	<p> Audio-out (headphone)/Audio-in (microphone) combo jack</p> <p>Connects optional powered stereo speakers, headphones, earbuds, a headset, or a television audio cable. Also connects an optional headset microphone. This jack does not support optional standalone microphones.</p> <p>WARNING! To reduce the risk of personal injury, adjust the volume before putting on headphones, earbuds, or a headset. For additional safety information, see the <i>Regulatory, Safety, and Environmental Notices</i>.</p> <p>To access this guide:</p> <ul style="list-style-type: none"> ▲ Select the Search icon (select products only) in the taskbar, type HP Documentation in the search box, and then select HP Documentation. <p>NOTE: When a device is connected to the jack, the computer speakers are disabled.</p>
(3)	<p> HDMI port</p> <p>Connects an optional video or audio device, such as a high-definition television, any compatible digital or audio component, or a high-speed High Definition Multimedia Interface (HDMI) device.</p>

Table 2-1 Right-side components and their descriptions (continued)





Component	Description
(4)  USB SuperSpeed 5 Gbps port	<p>Connects a USB device, provides high-speed data transfer, and (for select products) charges small devices (such as a smartphone) when the computer is on or in Sleep mode.</p> <p>NOTE: Use a standard USB Type-A charging cable or cable adapter (purchased separately) when charging a small external device.</p>
(5)  USB SuperSpeed 5 Gbps port with HP Sleep and Charge	<p>Connects a USB device, provides high-speed data transfer, and charges small devices (such as a smartphone), even when the computer is off.</p> <p>NOTE: Use a standard USB Type-A charging cable or cable adapter (purchased separately) when charging a small external device.</p>
(6)  USB Type-C® power connector port, SuperSpeed 10 Gbps port, and Thunderbolt™ port with HP Sleep and Charge	<p>Connects an AC adapter that has a USB Type-C connector, supplying power to the computer and, if needed, charging the computer battery.</p> <p>– and –</p> <p>Connects a USB device, provides high-speed data transfer, and charges small devices (such as a smartphone), even when the computer is off.</p> <p>NOTE: Use a standard USB Type-C charging cable or cable adapter (purchased separately) when charging a small external device.</p> <p>– and –</p> <p>Connects a display device that has a USB Type-C connector, providing DisplayPort output.</p> <p>NOTE: Your computer might also support a Thunderbolt docking station.</p>
 USB Type-C power connector port, SuperSpeed 10 Gbps port, and DisplayPort™ output	<p>Connects an AC adapter that has a USB Type-C connector, supplying power to the computer and, if needed, charging the computer battery.</p> <p>– and –</p> <p>Connects a USB device, provides high-speed data transfer, and (for select products) charges small devices (such as a smartphone) when the computer is on or in Sleep mode.</p> <p>NOTE: Use a standard USB Type-C charging cable or cable adapter (purchased separately) when charging a small external device.</p> <p>– and –</p> <p>Connects a display device that has a USB Type-C connector, providing DisplayPort output.</p>
(7) Battery light	<p>When AC power is connected:</p> <ul style="list-style-type: none"> ● White: The battery charge is greater than 90%. ● Amber: The battery charge is from 0 to 90%. ● Off: The battery is not charging. <p>When AC power is disconnected (battery not charging):</p>

Table 2-1 Right-side components and their descriptions (continued)

Component	Description
	<ul style="list-style-type: none"> Blinking amber: The battery has reached a low battery level. When the battery has reached a critical battery level, the battery light begins blinking rapidly. Off: The battery is not charging.
(8)  Power connector	Connects an AC adapter.

Left

Use the illustration and table to identify the components on the left side of the computer.

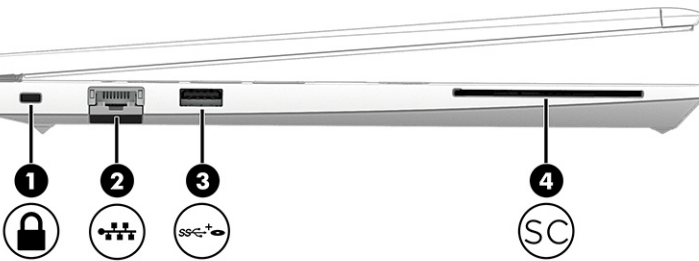





Table 2-2 Left-side components and their descriptions

Component	Description
(1)  Security cable slot	Attaches an optional security cable to the computer. NOTE: The security cable is designed to act as a deterrent, but it might not prevent the computer from being mishandled or stolen.
(2)  RJ-45 (network) jack/status lights	Connects a network cable. <ul style="list-style-type: none"> Green (left): The network is connected. Amber (right): Activity is occurring on the network.
(3)  USB SuperSpeed 5 Gbps powered port	Connects and supplies power to a USB device, provides high-speed data transfer, and (for select products) charges small devices (such as a smartphone) when the computer is on or in Sleep mode. NOTE: Use a standard USB Type-A charging cable or cable adapter (purchased separately) when charging a small external device.
(4)  Smart card reader (select products only)	Supports optional smart cards.

Display

Use the illustration and table to identify the display components.

Low blue light mode (select products only)

Your computer display is shipped from the factory in low blue light mode for improved eye comfort and safety. Also, blue light mode automatically adjusts blue light emissions when you are using the computer at night or for reading.

⚠ WARNING! To reduce the risk of serious injury, read the *Safety & Comfort Guide*. It describes proper workstation setup and proper posture, health, and work habits for computer users. The *Safety & Comfort Guide* also provides important electrical and mechanical safety information. The *Safety & Comfort Guide* is available on the web at <http://www.hp.com/ergo>.

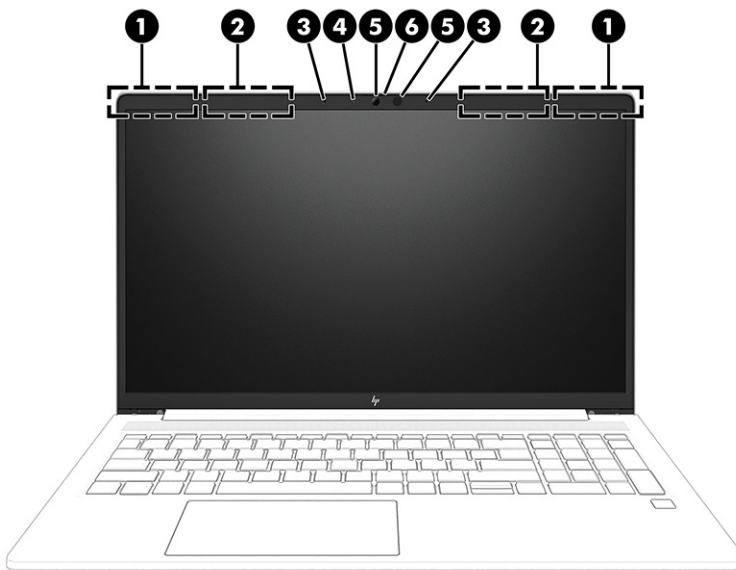

Table 2-3 Display components and their descriptions

Component	Description
(1) WLAN antennas* (select products only)	Send and receive wireless signals to communicate with wireless local area networks (WLANs).
(2) WWAN antennas* (select products only)	Send and receive wireless signals to communicate with wireless wide area networks (WWANs).
(3) Internal microphones	Record sound.
(4) Camera light (select products only)	On: The camera is in use.
(5) Camera(s) (select products only)	Allow(s) you to video chat, record video, and record still images. Some cameras also allow a facial recognition logon to Windows, instead of a password logon. NOTE: Camera functions vary depending on the camera hardware and software installed on your product.
(6) Camera privacy cover (select products only)	By default, the camera lens is uncovered, but you can slide the camera privacy cover to block the camera's view. To use the camera,

Table 2-3 Display components and their descriptions (continued)

Component	Description
	Slide the camera privacy cover in the opposite direction to reveal the lens. NOTE: If you have both front-facing and rear-facing cameras, when one camera lens is revealed and ready to use, the other is concealed.
*The antennas are not visible from the outside of the computer. For optimal transmission, keep the areas immediately around the antennas free from obstructions. For wireless regulatory notices, see the section of the <i>Regulatory, Safety, and Environmental Notices</i> that applies to your country or region. To access this guide: ▲ Select the Search icon (select products only) in the taskbar, type <code>HP Documentation</code> in the search box, and then select HP Documentation .	

Keyboard area

Keyboards can vary by language.



NOTE: The keyboard, including the function keys and power key (select products only), is disabled in stand, tent, and tablet modes. To enable the keyboard, including the power key, change to the clamshell mode.

Touchpad

The touchpad settings and components are described here.

Touchpad settings

You learn how to adjust the touchpad settings and components here.

Adjusting touchpad settings

Use these steps to adjust touchpad settings and gestures.

1. Select the **Search** icon (select products only) in the taskbar, type `touchpad settings` in the search box, and then press `enter`.
2. Choose a setting.

Turning on the touchpad

Follow these steps to turn on the touchpad.

1. Select the **Search** icon (select products only) in the taskbar, type `touchpad settings` in the search box, and then press `enter`.
2. Using an external mouse, click the **Touchpad** button.

If you are not using an external mouse, press the `Tab` key repeatedly until the pointer rests on the **touchpad** button. Then press the `spacebar` to select the button.

Touchpad components

Use the illustration and table to identify the touchpad components.

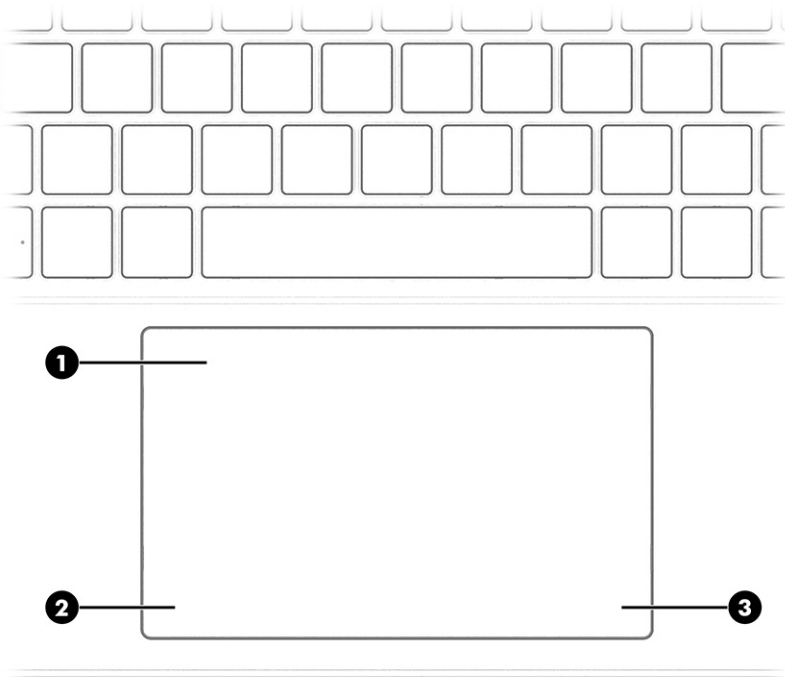

Table 2-4 Touchpad components and their descriptions

Component	Description
(1) Touchpad zone	Reads your finger gestures to move the pointer or activate items on the screen.
(2) Left control zone	Textured area that allows you to perform additional gestures.
(3) Right control zone	Textured area that allows you to perform additional gestures.

Lights

Use the illustration and table to identify the lights on the computer.

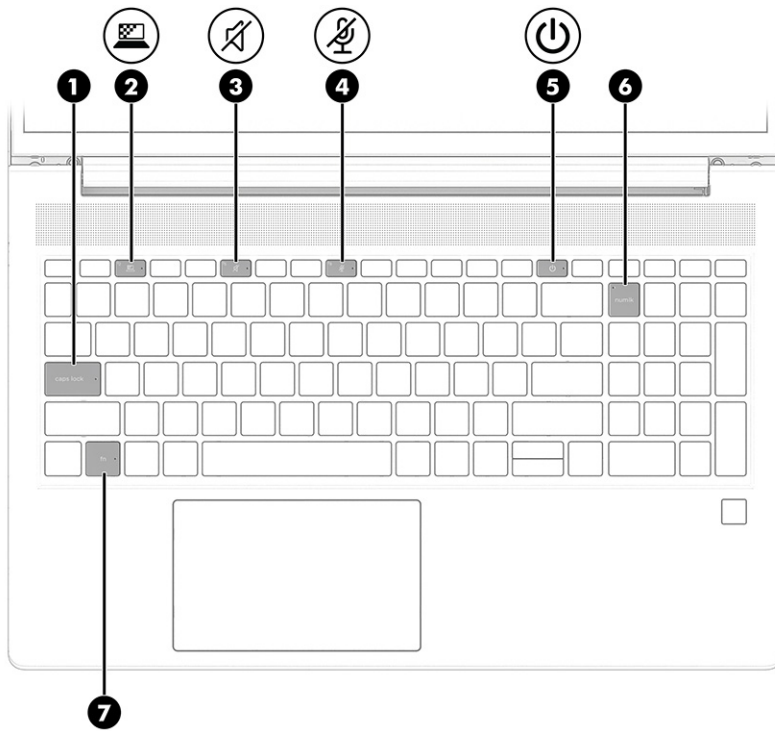







Table 2-5 Lights and their descriptions

Component	Description
(1) Caps lock light	On: Caps lock is on, which switches the key input to all capital letters.
(2)  Privacy key light	On: Privacy screen is on, which helps prevent side-angle viewing.
(3)  Mute light	<ul style="list-style-type: none"> On: Computer sound is off. Off: Computer sound is on.
(4)  Microphone mute light	<ul style="list-style-type: none"> On: Microphone is off. Off: Microphone is on.
(5)  Power light	<ul style="list-style-type: none"> On: The computer is on. Blinking (select products only): The computer is in the Sleep state, a power-saving state. The computer shuts off power to the display and other unnecessary components. Off: Depending on your computer model, the computer is off, in Hibernation, or in Sleep. Hibernation is the power-saving state that uses the least amount of power.
(6) Num lk light	On: Num lk is on.
(7) Fn lock light	On: The fn key is locked.

Button, speakers, and fingerprint reader

Fingerprint readers can be located on the touchpad, on a side panel of the computer, or on the top cover below the keyboard.

 **IMPORTANT:** To verify that your computer supports fingerprint reader sign-in, select the Search icon (select products only) in the taskbar, type `Sign-in options` in the search box, and then follow the on-screen instructions. If **Fingerprint reader** is not listed as an option, then your notebook does not include a fingerprint reader.

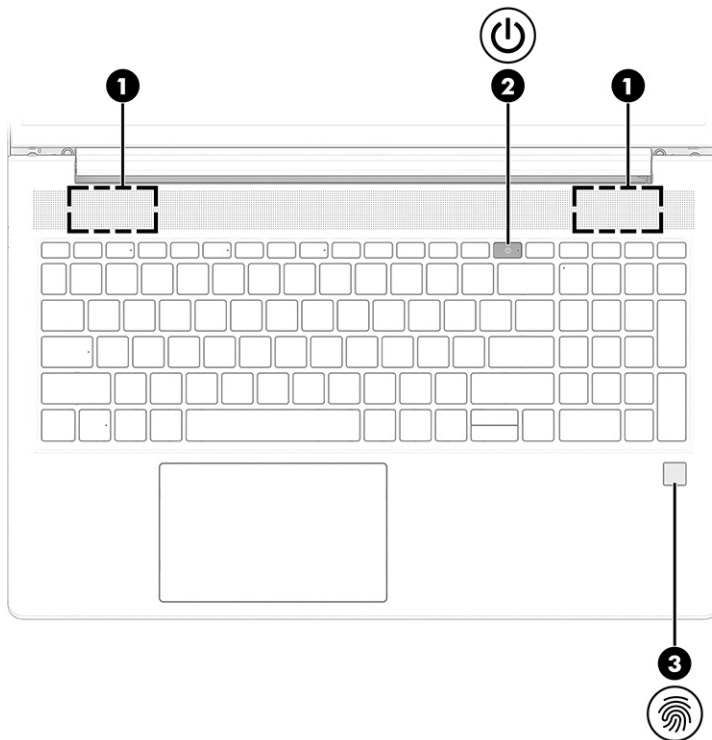

Table 2-6 Button, speakers, and fingerprint reader and their descriptions



Component	Description
(1) Speakers	Produce sound.
(2)  Power button	<ul style="list-style-type: none"> When the computer is off, press the button briefly to turn on the computer. When the computer is on, press the button briefly to initiate Sleep. When the computer is in the Sleep state, press the button briefly to exit Sleep (select products only). When the computer is in Hibernation, press the button briefly to exit Hibernation. <p>IMPORTANT: Pressing and holding down the power button results in the loss of unsaved information.</p> <p>If the computer has stopped responding and shutdown procedures are ineffective, press and hold the power button for at least 4 seconds to turn off the computer.</p> <p>To learn more about your power settings, use the Power icon.</p>
(3) 	

Table 2-6 Button, speakers, and fingerprint reader and their descriptions (continued)

Component	Description
	<ul style="list-style-type: none"> Right-click the Power icon  and then, depending on your product, select Power and sleep settings or Power Options.
(3) Fingerprint reader (select products only)	<p>Allows a fingerprint logon to Windows, instead of a password logon.</p> <ul style="list-style-type: none"> ▲ Swipe down across the fingerprint reader. <p>IMPORTANT: To prevent fingerprint logon issues, make sure when you register your fingerprint that all sides of your finger are registered by the fingerprint reader.</p>

Special keys

Use the illustration and table to identify the special keys.

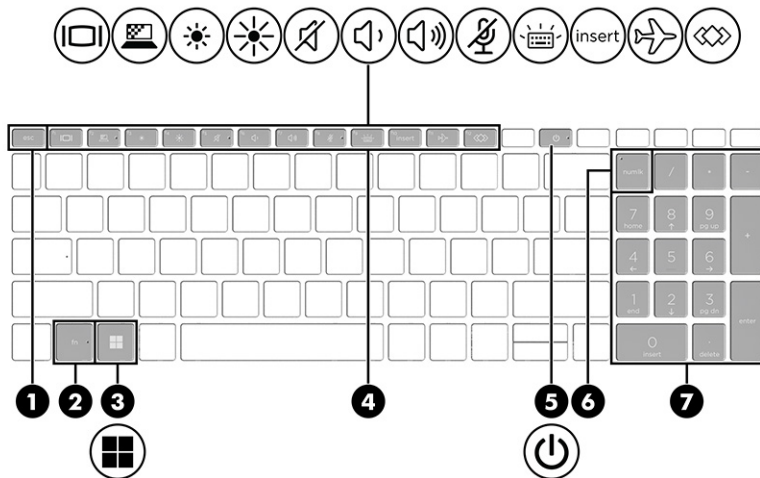

Table 2-7 Special keys and their descriptions



Component	Description
(1) <code>esc</code> key	Displays system information when pressed in combination with the <code>fn</code> key.
(2) <code>fn</code> key	Executes frequently used system functions when pressed in combination with another key. Such key combinations are called <i>hot keys</i> .
(3)  Windows key	<p>Opens the Start menu.</p> <p>NOTE: Pressing the Windows key again will close the Start menu.</p>
(4) Action keys	Execute frequently used system functions.
(5)  Power button	<ul style="list-style-type: none"> When the computer is off, press the button briefly to turn on the computer. When the computer is on, press the button briefly to initiate Sleep.

Table 2-7 Special keys and their descriptions (continued)

Component	Description
	<ul style="list-style-type: none"> When the computer is in the Sleep state, press the button briefly to exit Sleep (select products only). When the computer is in Hibernation, press the button briefly to exit Hibernation. <p>IMPORTANT: Pressing and holding down the power button results in the loss of unsaved information.</p> <p>If the computer has stopped responding and shutdown procedures are ineffective, press and hold the power button for at least 4 seconds to turn off the computer.</p> <p>To learn more about your power settings, use the Power icon.</p> <ul style="list-style-type: none"> Right-click the Power icon  and then, depending on your product, select Power and sleep settings or Power Options.
(6)	<p><code>num lk</code> key</p> <p>Turns the embedded numeric keypad on and off when pressed in combination with the <code>fn</code> key.</p> <p>– or –</p> <p>Turns the embedded numeric keypad on and off.</p> <p>– or –</p> <p>Alternates between the navigational and numeric functions on the integrated numeric keypad.</p>
(7)	<p>Integrated numeric keypad</p> <p>A separate keypad to the right of the alphabet keyboard. When <code>num lk</code> is pressed, the integrated keypad can be used like an external numeric keypad.</p> <p>NOTE: If the keypad function is active when the computer is turned off, that function is reinstated when the computer is turned back on.</p>

Bottom

Use the illustration and table to identify the bottom component.

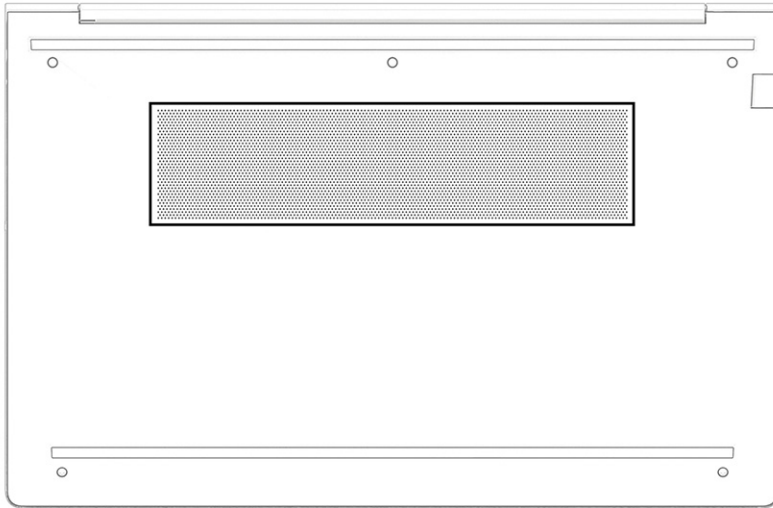

Table 2-8 Bottom component and description

Component	Description
Vent	Enables airflow to cool internal components. NOTE: The computer fan starts up automatically to cool internal components and prevent overheating. It is normal for the internal fan to cycle on and off during routine operation.

Rear

Use the illustration and table to identify the rear component.



Table 2-9 Rear component and description

Component	Description
Vent	Enables airflow to cool internal components. NOTE: The computer fan starts up automatically to cool internal components and prevent overheating. It is normal for the internal fan to cycle on and off during routine operation.

Labels

The labels affixed to the computer provide information you might need when you troubleshoot system problems or travel internationally with the computer. Labels might be in paper form or imprinted on the product.

 **IMPORTANT:** Check the following locations for the labels described in this section: the bottom of the computer, inside the battery bay, under the service door, on the back of the display, or on the bottom of a tablet kickstand.

- Service label—Provides important information to identify your computer. When contacting support, you might be asked for the serial number, the product number, or the model number. Locate this information before you contact support.

Your service label will resemble one of the following examples. Refer to the illustration that most closely matches the service label on your computer.

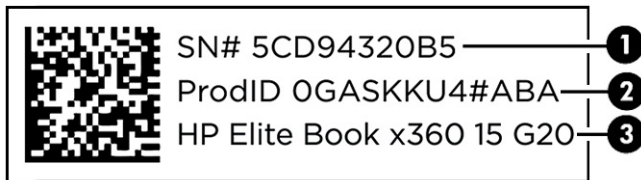

Table 2-10 Service label components

Component
(1) Serial number
(2) Product ID
(3) HP product name

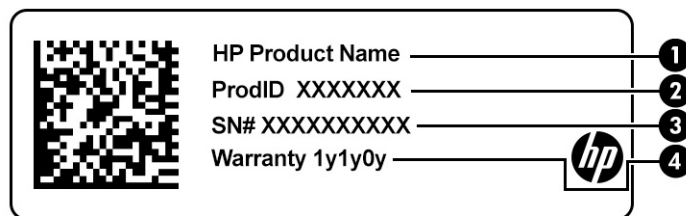

Table 2-11 Service label components

Component
(1) HP product name
(2) Product ID
(3) Serial number
(4) Warranty period

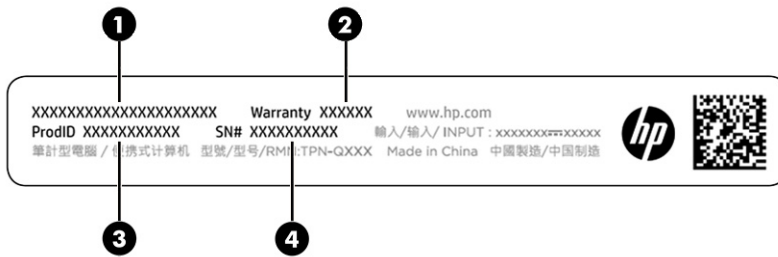

Table 2-12 Service label components

Component	
(1)	HP product name
(2)	Warranty period
(3)	Product ID
(4)	Serial number

- Regulatory labels—Provide regulatory information about the computer.
- Wireless certification labels—Provide information about optional wireless devices and the approval markings for the countries or regions in which the devices have been approved for use.

HP Tamper Lock

HP Tamper Lock offers an extra level of business protection by notifying you when your computer has been tampered with or the bottom cover has been removed.

HP Tamper Lock uses tamper detection sensors located on the bottom cover and internal storage. If a sensor is triggered, you must enter an admin password to unlock the computer. This feature is disabled by default. Configuration settings are available in Computer Setup (BIOS).

 **NOTE:** HP Tamper Lock must be configured at the factory and requires that you set an admin password before use.

 **IMPORTANT:** Be sure to disable tamper detection before sending the computer in for repair.

For more information about HP Tamper Lock, see www.hp.com.

Using Tile (select products only)

Some computers include a Tile™ Bluetooth® device that can help find your computer even when it is off or in the Sleep state. The Tile device operates in combination with the Tile software on your computer.

 **NOTE:** The limit of the Tile Bluetooth signal is approximately 76 m (250 feet).

To use the Tile features on your computer:



1. Select the **Start** button, select **All apps**, and then select the **Tile** app.
2. Follow the on-screen instructions to create a Tile account and activate your Tile features.

3 Illustrated parts catalog

Use this table to determine the spare parts that are available for the computer.

Computer major components

To identify the computer major components, use this illustration and table.

-
-  **NOTE:** HP continually improves and changes product parts. For complete and current information about supported parts for your computer, go to <http://partsurfer.hp.com>, select your country or region, and then follow the on-screen instructions.
 -  **NOTE:** Details about your computer, including model, serial number, product key, and length of warranty, are on the service tag at the bottom of your computer.
-

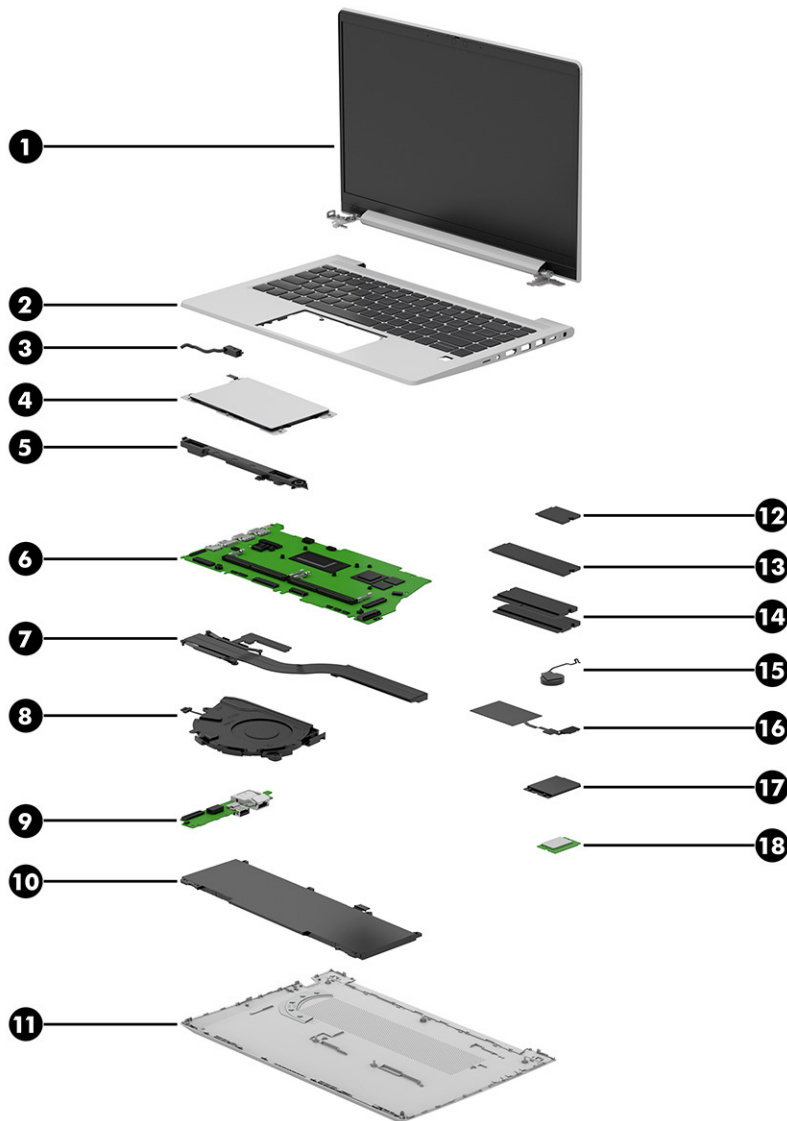

Table 3-1 Computer major component descriptions and part numbers

Item	Component	Spare part number
(1)	Display assembly NOTE: Display spare parts are available only as subcomponents. For spare part information, see Display assembly subcomponents on page 23 .	not available as a spare part
(2)	Top cover with keyboard (includes smart card reader) NOTE: For a detailed list of country codes, see Top cover with keyboard (includes smart card board) on page 73 .	
	Backlit	N17712-001
	Not backlit	N17713-001
(3)	Power connector cable	M21725-001
(4)	Touchpad NOTE: The touchpad cable is available in the Cable Kit as spare part number N03218-001.	

Table 3-1 Computer major component descriptions and part numbers (continued)

Item	Component	Spare part number
	Models with NFC (includes NFC antenna)	M22000-001
	Models without NFC	N14647-001
(5)	Speaker	M21723-001
(6)	System board (includes integrated processor)	
	NOTE: All system board spare part kits include replacement thermal material.	
	All system boards use the following part numbers:	
	xxxxxx-001: Non-Windows operating systems	
	xxxxxx-601: Windows operating system	
	Models with integrated unified memory architecture (UMA) graphics memory	
	<ul style="list-style-type: none"> Intel Core i7-1270P processor, models with WWAN 	N21920-xx1
	<ul style="list-style-type: none"> Intel Core i7-1265U processor 	N21918-xx1
	<ul style="list-style-type: none"> Intel Core i7-1265U processor, models with WWAN 	N21919-xx1
	<ul style="list-style-type: none"> Intel Core i7-1255U processor 	N21916-xx1
	<ul style="list-style-type: none"> Intel Core i7-1255U processor, models with WWAN 	N21917-xx1
	<ul style="list-style-type: none"> Intel Core i5-1250P processor, models with WWAN 	N21915-xx1
	<ul style="list-style-type: none"> Intel Core i5-1245U processor 	N21913-xx1
	<ul style="list-style-type: none"> Intel Core i7-1245U processor, models with WWAN 	N21914-xx1
	<ul style="list-style-type: none"> Intel Core i5-1245U processor (Realtek PD USB-C) 	N22180-xx1
	<ul style="list-style-type: none"> Intel Core i5-1235U processor 	N21911-xx1
	<ul style="list-style-type: none"> Intel Core i5-1235U processor, models with WWAN 	N21912-xx1
	<ul style="list-style-type: none"> Intel Core i5-1235U processor (Realtek PD USB-C) 	N22179-xx1
	<ul style="list-style-type: none"> Intel Core i3-1215U processor 	N21909-xx1
	<ul style="list-style-type: none"> Intel Core i3-1215U processor, models with WWAN 	N21910-xx1
	Models with discrete graphics memory	
	<ul style="list-style-type: none"> Intel Core i7-1265U processor, models with WWAN 	N21908-xx1
	<ul style="list-style-type: none"> Intel Core i5-1255U processor 	N21907-xx1
	<ul style="list-style-type: none"> Intel Core i5-1255U processor, models with WWAN 	N21921-xx1
	<ul style="list-style-type: none"> Intel Core i5-1245U processor, models with WWAN 	N21906-xx1
	<ul style="list-style-type: none"> Intel Core i5-1235U processor 	N21905-xx1
(7)	Heat sink (includes replacement thermal material)	
	For use in models with 15 W processors	M47406-001
	For use in models with 28 W processors	N15764-001
(8)	Fan	
	For use in 42 W, UMA models	M21718-001

Table 3-1 Computer major component descriptions and part numbers (continued)

Item	Component	Spare part number
	For use in models with discrete graphics	M21719-001
	For use in 51 W, UMA models	N00095-001
(9)	I/O board	
	NOTE: The I/O board cables are available in the Cable Kit as spare part number N03218-001. The RJ-45 (network) jack door is available as spare part number M21994-001.	
	For use in vPro models	M48790-001
	For use in non-vPro models	N01502-001
(10)	Battery	
	3 cell, 51 Wh	M73472-005
	3 cell, 42 Wh	M75599-005
(11)	Bottom cover	
	For use in models with a 51 Wh battery	N00121-001
	For use in models with a 42 Wh battery	M21720-001
(12)	Solid-state drive (M2, 2230)	
	NOTE: The solid-state drive support kit is available as spare part number N00354-001. It includes 2nd SSD holder, bracket, and rubber.	
	256 GB, PCIe, value, 2230	M11042-001
	128 GB, PCIe, value, 2230	M11040-001
(13)	Solid-state drive (M2, 2280)	
	NOTE: The solid-state drive support kit is available as spare part number N00354-001.	
	1 TB, PCIe, TLC, 2280	M16560-001
	512 GB, PCIe-4 × 4, TLC, 2280	M17436-001
	512 GB, PCIe-4 × 4, TLC, self-encrypting drive, 2280	M52031-001
	512 GB, PCIe, value, 2280	L85364-001
	256 GB, PCIe-4 × 4, TLC, 2280	M52025-001
	256 GB, PCIe-4 × 4, TLC, self-encrypting drive, 2280	M52029-001
	256 GB, PCIe, value, 2280	L85354-001
(14)	Memory modules (DDR4, PC-3200)	
	32 GB	M09713-001
	16 GB	L67710-001
	8 GB	L46598-001
	4 GB	L83673-001
(15)	Real-time clock (RTC) battery	M34737-001

Table 3-1 Computer major component descriptions and part numbers (continued)

Item	Component	Spare part number
(16)	NFC module NOTE: The NFC module spare part kit does not include the antenna. The antenna is included in the touchpad spare part kit.	M27890-001
(17)	WWAN module Intel XMM 7560 R + LTE-Advanced Pro WWAN (Cat 16)	M52040-001
(18)	WLAN module NOTE: WLAN module protective tape is available as spare part number N02047-001.	
	Intel AX211 Wi-Fi 6e Bluetooth 5.2 vPro WLAN	M53363-001
	Intel AX211 Wi-Fi 6e Bluetooth 5.2 WLAN	M53366-001
	Fingerprint reader (not illustrated)	N00879-001
	NOTE: The fingerprint reader cable is available in the Cable Kit as spare part number N03218-001. The fingerprint reader bracket is available in the Bracket Kit as spare part number M21997-001.	
	Smart card reader (not illustrated)	M21398-001
	NOTE: The smart card reader cable is available as spare part number N27591-001. The smart card reader bracket is available as spare part number N21997-001	

Display assembly subcomponents

To identify the display assembly subcomponents, use this illustration and table.

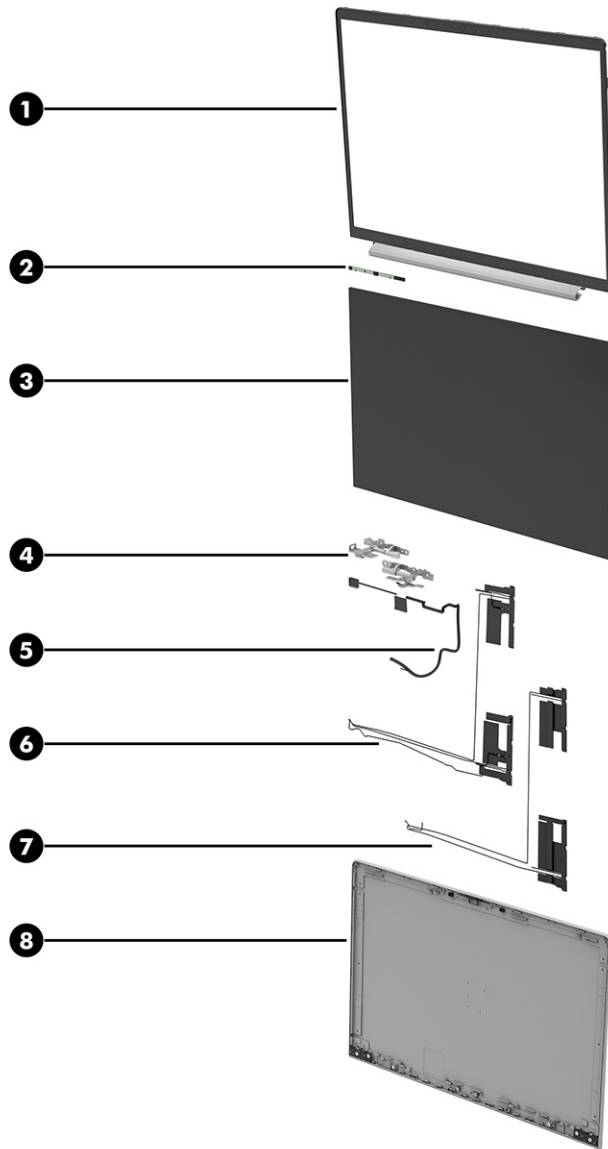

Table 3-2 Display component descriptions and part numbers

Item	Component	Spare part number
(1)	Display bezel	
	For use in models with an FHD display without a camera	N03215-001
	For use in models with an FHD display with an HD camera	N03213-001
	For use in models with an FHD display with an HD + IR camera	N03214-001
	For use in models with an HD display without a camera	N07342-001
	For use in models with an HD display with an HD camera	N07341-001
(2)	Camera module	
	HD camera	N05869-001

Table 3-2 Display component descriptions and part numbers (continued)

Item	Component	Spare part number
	IR camera	N05870-001
	Microphone module	N05863-001
(3)	Display panel (includes cover and bezel adhesive)	
	NOTE: Display panel tape is available as spare part number N00351-001.	
	FHD, 400 nits	N00086-001
	FHD, 250 nits	N00084-001
	FHD, 250 nits, touch screen	N00085-001
	HD, 250 nits	N00087-001
(4)	Hinges (left and right; includes bezel trim pieces, bezel trim protective shielding, display panel adhesive, and bezel adhesive)	M21732-001
(5)	Display/camera cable (includes cover and bezel adhesive)	N03217-001
(6)	WLAN antennas and cables (includes camera, cover, and bezel adhesive)	N03219-001
(7)	WWAN antennas and cables (includes cover and bezel adhesive)	
	400 nit displays	N03220-001
	250 nit displays	N03221-001
(8)	Display back cover (includes bezel adhesive)	
	Models with a 400 nit panel, without WWAN	N03209-001
	Models with 400 nit panel, with WWAN	N03210-001
	Models with a 250 nit panel, without WWAN	N03211-001
	Models with 250 nit panel, with WWAN	N03212-001

Cable Kit

To identify the contents of the Cable Kit, use this table.

Table 3-3 Cable Kit content descriptions and part number

Component	Spare part number
Cable Kit , includes:	N03218-001
I/O board cable	
I/O board cable (USB 3.0)	
Touchpad cable	
Fingerprint reader board cable	
NFC board cable	
Smart card reader board cable	

Miscellaneous parts

To identify the miscellaneous parts, use this table.

Table 3-4 Miscellaneous part descriptions and part numbers

Component	Spare part number
AC adapters	
280 W, PFC, 7.4 mm	M52952-001
120 W, PFC, 7.4 mm	L89695-001
120 W, PFC, 7.4 mm	L57117-001
120 W, PFC, 4.5 mm	M95377-001
65 W, nPFC, USB-C, 1.8 m (6.0 ft)	L67440-001
65 W, nPFC, 3 pin, 4.5 mm	710412-001
65 W, nPFC, 4.5 mm, EM	913691-850
65 W, nPFC, USB-C, travel adapter	L21487-001
65 W, nPFC, USB-C, straight, 1.8 m (6 ft)	L04650-850
65 W, nPFC, USB-C, RC, 1.8 m (6 ft)	L32392-001
45 W, nPFC, SMART, RC, 4.5 mm, nonslim	741727-001
45 W, nPFC, 3 pin, USB-C, 1.8 m (6.0 ft)	L43407-001
45 W, nPFC, 2 pin, 4.5 mm	742436-001
45 W, nPFC, USB-C, wall mount	860210-850
45 W, nPFC, USB-C, wall mount, 1.8 m (6 ft)	L32390-001
Smart AC adapter, 7.4 mm	734734-001
USB-C-to-DisplayPort adapter	831753-001
USB-C-to-HDMI 2.0 adapter	935325-001
USB-C-to-VGA adapter	831751-001
USB-C-to-USB-A adapter	L65254-001
USB-C (male)-to-USB-C (male) adapter	L65253-001
HDMI-toVGA adapter	701943-001
HDMI-to-DVI-D adapter	691227-001
USB-C travel hub	L72056-001
USB-C-to-USB-A hub	916838-001
WLAN protective tape	N02047-001
Bracket Kit (includes smart card bracket and fingerprint reader bracket)	M21997-001
Screw Kit (for use with HP TB Dock 120W G2)	L15820-001
Screw Kit (for use with HP USB-C Dock G5)	L64089-001

Table 3-4 Miscellaneous part descriptions and part numbers (continued)

Component	Spare part number
Screw Kit (for use in product component removal and replacement)	N00353-001
Bottom case (for use with HP TB Dock 120W G2)	L15814-001
Top cap (for use with HP TB Dock 120W G2)	L15815-001
Plastics Kit (includes fingerprint reader insert, cable holder, SIM card insert, and smart card insert)	M21393-001
Bluetooth travel mouse	L62043-001
USB mouse	L95713-001
HP Wireless Premium Mouse	923947-001
HP 128 Laser Wired Mouse	M27885-001
HP 435 wireless mouse	M62277-001
HP 125 wired keyboard	M27881-001
Nano lock	918431-001
Sure Key cable lock	L65088-001
External optical drive	747080-001
External optical drive	754895-001
Thunderbolt™ 120 W G4 dock (with cable)	M97105-001
Thunderbolt 120 W G4 dock (with cable) (TAA)	N17490-001
Thunderbolt 280 W G4 dock (with cable)	M97106-001
Thunderbolt 280 W G4 dock (with cable) (TAA)	N17491-001
USB-C mini dock	935327-001
Thunderbolt dock 120 W (with cable)	L15809-001
Thunderbolt dock 230 W (with cable)	L24855-001
USB-C dock (with cable)	L64086-001
USB-C/A universal dock (with cable)	L64087-001
Bottom case for USB-C/A universal doc	L64088-001
Bottom case for USB-C dock	L65256-001
Cable kit for use with 120W docking station	L15812-002
Cable kit for use with Thunderbolt 120 W G4 dock	M88058-001
Cable kit for use with Thunderbolt 120 W G4 dock (TAA)	N17492-001
Cable kit for use with Thunderbolt 280 W G4 dock	M88059-001
Cable kit for use with Thunderbolt 280 W G4 dock (TAA)	N17493-001
Thunderbolt combo cable, 0.7 m (2.3 ft)	L15938-002
HP Dock audio module	L15811-001
HP Prelude Pro 15.6 top load case	M03618-001
HP Prelude Pro 15.6 backpack	M03617-001

Table 3-4 Miscellaneous part descriptions and part numbers (continued)

Component	Spare part number
HP Business 14.1 laptop bag	M55007-001
HP Business 17.3 laptop bag	M55004-001
Power cord (C13, premium, 1.0 m [3.3 ft])	
Argentina	L32029-001
Brazil	L32030-001
Italy	L32031-001
Power cord (C7, conventional, 1.0 m [3.3 ft])	
Japan	L19375-001
Power adapter, duckhead	
Japan	L33157-001
Power cord (C5, conventional, 1.0 m [3.3 ft], HF)	
Denmark	M79264-001
Europe (Austria, Belgium, Finland, France, Germany, the Netherlands, Norway, and Sweden)	M79266-001
Switzerland	M79265-001
Power cord (C5, conventional, 1.0 m [3.3 ft])	
Argentina	L19357-001
Australia	L19358-001
Brazil	L19359-001
Denmark	L19360-001
Europe (Austria, Belgium, Finland, France, Germany, the Netherlands, Norway, and Sweden)	L19361-001
India	L19363-001
Israel	L19362-001
Italy	L19364-001
Japan	L19365-001
North America	L19367-001
People's Republic of China	L19368-001
South Africa	L19369-001
South Korea	L19366-001
Switzerland	L19370-001
Taiwan	L19372-001
Thailand	L19371-001
Thailand (ADP + cord)	M85418-001
The United Kingdom	L19373-001
Power cord (C5, conventional, 1.8 m [6.0 ft])	

Table 3-4 Miscellaneous part descriptions and part numbers (continued)

Component	Spare part number
Argentina	L19357-002
Australia	L19358-002
Brazil	L19359-002
Denmark	L19360-002
Europe (Austria, Belgium, Finland, France, Germany, the Netherlands, Norway, and Sweden)	L19361-002
India	L19363-002
Israel	L19362-002
Italy	L19364-002
Japan	L19365-002
North America	L19367-002
People's Republic of China	L19368-002
South Africa	L19369-002
South Korea	L19366-002
Switzerland	L19370-002
Taiwan	L19372-002
Thailand	L19371-002
The United Kingdom	L19373-002
Power cord (C13, premium, 1.0 m [3.3 ft])	
Argentina	401328-018
Australia	100661-021
Denmark	130627-014
Europe (Austria, Belgium, Finland, France, Germany, the Netherlands, Norway, and Sweden)	100614-016
India	403440-008
Israel	398062-011
Italy	109197-012
Japan	653326-005
North America	121565-023
People's Republic of China	286496-024
South Africa	187487-012
South Korea	231216-015
Switzerland	150304-015
Taiwan	393312-008
Thailand	285052-013
United Kingdom	100613-021

Table 3-4 Miscellaneous part descriptions and part numbers (continued)

Component	Spare part number
Power cord (C5, premium, duckhead, 1.0 m [3.3 ft])	
Argentina	L36815-001
Australia	L36816-001
Denmark	L36817-001
Thailand	M85416-001
Europe (Austria, Belgium, Finland, France, Germany, the Netherlands, Norway, and Sweden)	L36818-001
India	L36820-001
Israel	L36819-001
Italy	L44788-001
North America	L36822-001
People's Republic of China	L36823-001
South Africa	L36824-001
Switzerland	L36825-001
Taiwan	L36827-001
Thailand	L36826-001
United Kingdom	L36828-001
Duckhead power cord (C5)	
South Korea	L50816-001
Europe	854703-001
Duckhead power cord (C5NS)	
South Korea	L50818-001
North America	L50818-002
65 W USB-C AC adapter + 1.8 m (6.0 ft) power cord	
Argentina	L43180-001
Australia	L43180-002
Brazil	L43180-003
Denmark	L43180-004
Europe (Austria, Belgium, Finland, France, Germany, the Netherlands, Norway, and Sweden)	L43180-005
India	L43180-007
Israel	L43180-006
Italy	L43180-008
North America	L43180-010
People's Republic of China	L43180-011
South Africa	L43180-012

Table 3-4 Miscellaneous part descriptions and part numbers (continued)

Component	Spare part number
South Korea	L43181-001
Switzerland	L43180-013
Taiwan	L43180-015
Thailand	L43180-014
United Kingdom	L43180-016
45 W USB-C AC adapter + 1.8 m (6.0 ft) power cord	
Argentina	L43182-001
Australia	L43182-002
Brazil	L43182-003
Denmark	L43182-004
Europe (Austria, Belgium, Finland, France, Germany, the Netherlands, Norway, and Sweden)	L43182-005
India	L43182-007
Israel	L43182-006
Italy	L43182-008
North America	L43182-010
People's Republic of China	L43182-011
South Africa	L43182-012
South Korea	L43183-001
Switzerland	L43182-013
Thailand	L43182-014
Taiwan	L43182-015
United Kingdom	L43182-016

4 Removal and replacement procedures preliminary requirements

Use this information to properly prepare to disassemble and reassemble the computer.

Tools required

You need the following tools to complete the removal and replacement procedures:

- Tweezers
- Nonconductive, nonmarking pry tool
- Magnetic Phillips P1 screwdriver

Service considerations

The following sections include some of the considerations that you must keep in mind during disassembly and assembly procedures.

 **NOTE:** As you remove each subassembly from the computer, place the subassembly (and all accompanying screws) away from the work area to prevent damage.

Plastic parts

Using excessive force during disassembly and reassembly can damage plastic parts.

Cables and connectors

Handle cables with extreme care to avoid damage.

 **IMPORTANT:** When servicing the computer, be sure that cables are placed in their proper locations during the reassembly process. Improper cable placement can damage the computer.

Apply only the tension required to unseat or seat the cables during removal and insertion. Handle cables by the connector whenever possible. In all cases, avoid bending, twisting, or tearing cables. Be sure that cables are routed so that they cannot be caught or snagged as you remove or replace parts. Handle flex cables with extreme care; these cables tear easily.

Drive handling

Note the following guidelines when handling drives.

 **IMPORTANT:** Drives are fragile components. Handle them with care. To prevent damage to the computer, damage to a drive, or loss of information, observe these precautions:

Before removing or inserting a hard drive, shut down the computer. If you are unsure whether the computer is off or in Hibernation, turn the computer on, and then shut it down through the operating system.

Before handling a drive, be sure that you are discharged of static electricity. While handling a drive, avoid touching the connector.

Before removing an optical drive, be sure that a disc is not in the drive, and be sure that the optical drive tray is closed.

Handle drives on surfaces covered with at least 2.54 cm (1 inch) of shock-proof foam.

Avoid dropping drives from any height onto any surface.

After removing a hard drive or an optical drive, place it in a static-proof bag.

Avoid exposing an internal hard drive to products that have magnetic fields, such as monitors or speakers.

Avoid exposing a drive to temperature extremes or liquids.

If a drive must be mailed, place the drive in a bubble pack mailer or other suitable form of protective packaging, and label the package "FRAGILE."

Electrostatic discharge information

A sudden discharge of static electricity from your finger or other conductor can destroy static-sensitive devices or microcircuitry. Often the spark is neither felt nor heard, but damage occurs. An electronic device exposed to electrostatic discharge (ESD) might not appear to be affected at all and can work perfectly throughout a normal cycle. The device might function normally for a while, but it has been degraded in the internal layers, reducing its life expectancy.

Networks built into many integrated circuits provide some protection, but in many cases, the discharge contains enough power to alter device parameters or melt silicon junctions.



IMPORTANT: To prevent damage to the device when you remove or install internal components, observe these precautions:

Keep components in their electrostatic-safe containers until you are ready to install them.

Before touching an electronic component, discharge static electricity by using the guidelines described [Personal grounding methods and equipment on page 34](#).

Avoid touching pins, leads, and circuitry. Handle electronic components as little as possible.

If you remove a component, place it in an electrostatic-safe container.

Generating static electricity

Follow these static electricity guidelines.

- Different activities generate different amounts of static electricity.
- Static electricity increases as humidity decreases.

Table 4-1 Static electricity occurrence based on activity and humidity

Event	Relative humidity		
	55%	40%	10%
Walking across carpet	7,500 V	15,000 V	35,000 V
Walking across vinyl floor	3,000 V	5,000 V	12,000 V

Table 4-1 Static electricity occurrence based on activity and humidity (continued)

Event	Relative humidity		
	55%	40%	10%
Motions of bench worker	400 V	800 V	6,000 V
Removing DIPs (dual in-line packages) from plastic tube	400 V	700 V	2,000 V
Removing DIPs from vinyl tray	2,000 V	4,000 V	11,500 V
Removing DIPs from polystyrene foam	3,500 V	5,000 V	14,500 V
Removing bubble pack from PCB (printed circuit board)	7,000 V	20,000 V	26,500 V
Packing PCBs in foam-lined box	5,000 V	11,000 V	21,000 V
Multiple electric components can be packaged together in plastic tubes, trays, or polystyrene foam.			

 **NOTE:** As little as 700 V can degrade a product.

Preventing electrostatic damage to equipment

Many electronic components are sensitive to ESD. Circuitry design and structure determine the degree of sensitivity. The following packaging and grounding precautions are necessary to prevent static electricity damage to electronic components.

- To avoid hand contact, transport products in static-safe containers such as tubes, bags, or boxes.
- Protect all electrostatic parts and assemblies with conductive or approved containers or packaging.
- Keep electrostatic-sensitive parts in their containers until they arrive at static-free stations.
- Place items on a grounded surface before removing them from their container.
- Always be properly grounded when touching a sensitive component or assembly.
- Avoid contact with pins, leads, or circuitry.
- Place reusable electrostatic-sensitive parts from assemblies in protective packaging or conductive foam.

Personal grounding methods and equipment

Using certain equipment can prevent static electricity damage to electronic components.

- **Wrist straps** are flexible straps with a maximum of 1 M Ω \pm 10% resistance in the ground cords. To provide proper ground, a strap must be worn snug against bare skin. The ground cord must be connected and fit snugly into the banana plug connector on the grounding mat or workstation.
- **Heel straps/Toe straps/Boot straps** can be used at standing workstations and are compatible with most types of shoes or boots. On conductive floors or dissipative floor mats, use them on both feet with a maximum of 1 M Ω \pm 10% resistance between the operator and ground.

Table 4-2 Static shielding protection levels

Static shielding protection levels	
Method	Voltage
Antistatic plastic	1,500

Table 4-2 Static shielding protection levels (continued)

Static shielding protection levels	
Carbon-loaded plastic	7,500
Metallized laminate	15,000

Grounding the work area

To prevent static damage at the work area, follow these precautions.

- Cover the work surface with approved static-dissipative material.
- Use a wrist strap connected to a properly grounded work surface and use properly grounded tools and equipment.
- Use static-dissipative mats, foot straps, or air ionizers to give added protection.
- Handle electrostatic sensitive components, parts, and assemblies by the case or PCB laminate. Handle them only at static-free work areas.
- Turn off power and input signals before inserting and removing connectors or test equipment.
- Use fixtures made of static-safe materials when fixtures must directly contact dissipative surfaces.
- Keep the work area free of nonconductive materials, such as ordinary plastic assembly aids and polystyrene foam.
- Use conductive field service tools, such as cutters, screwdrivers, and vacuums.
- Avoid contact with pins, leads, or circuitry.

Recommended materials and equipment

HP recommends certain materials and equipment to prevent static electricity.

- Antistatic tape
- Antistatic smocks, aprons, or sleeve protectors
- Conductive bins and other assembly or soldering aids
- Conductive foam
- Conductive tabletop workstations with ground cord of $1\text{ M}\Omega \pm 10\%$ resistance
- Static-dissipative table or floor mats with hard tie to ground
- Field service kits
- Static awareness labels
- Wrist straps and footwear straps providing $1\text{ M}\Omega \pm 10\%$ resistance
- Material handling packages
- Conductive plastic bags

- Conductive plastic tubes
- Conductive tote boxes
- Opaque shielding bags
- Transparent metallized shielding bags
- Transparent shielding tubes

Cleaning your computer

Cleaning your computer regularly removes dirt and debris so that your device continues to operate at its best. Use the following information to safely clean the external surfaces of your computer.

Enabling HP Easy Clean (select products only)

HP Easy Clean helps you to avoid accidental input while you clean the computer surfaces. This software disables devices such as the keyboard, touch screen, and touchpad for a preset amount of time so that you can clean all computer surfaces.

1. Start HP Easy Clean in one of the following ways:
 - Select the **Start** menu, and then select **HP Easy Clean**.
– or –
 - Select the **HP Easy Clean** icon in the taskbar.
– or –
 - Select **Start**, and then select the **HP Easy Clean** tile.
2. Now that your device is disabled for a short period, see [Removing dirt and debris from your computer on page 36](#) for the recommended steps to clean the high-touch, external surfaces on your computer. After you remove the dirt and debris, you can also clean the surfaces with a disinfectant. See [Cleaning your computer with a disinfectant on page 37](#) for guidelines to help prevent the spread of harmful bacteria and viruses.

Removing dirt and debris from your computer

Here are the recommended steps to clean dirt and debris from your computer.

For computers with wood veneer, see [Caring for wood veneer \(select products only\) on page 38](#).

1. Wear disposable gloves made of latex (or nitrile gloves, if you are latex-sensitive) when cleaning the surfaces.
2. Turn off your device and unplug the power cord and other connected external devices. Remove any installed batteries from items such as wireless keyboards.

 **CAUTION:** To prevent electric shock or damage to components, never clean a product while it is turned on or plugged in.

3. Moisten a microfiber cloth with water. The cloth should be moist, but not dripping wet.

 **IMPORTANT:** To avoid damaging the surface, avoid abrasive cloths, towels, and paper towels.

4. Wipe the exterior of the product gently with the moistened cloth.

 **IMPORTANT:** Keep liquids away from the product. Avoid getting moisture in any openings. If liquid makes its way inside your HP product, it can cause damage to the product. Do not spray liquids directly on the product. Do not use aerosol sprays, solvents, abrasives, or cleaners containing hydrogen peroxide or bleach that might damage the finish.

5. Start with the display (if applicable). Wipe carefully in one direction, and move from the top of the display to the bottom. Finish with any flexible cables, like power cord, keyboard cable, and USB cables.
6. Be sure that surfaces have completely air-dried before turning the device on after cleaning.
7. Discard the gloves after each cleaning. Clean your hands immediately after you remove the gloves.

See [Cleaning your computer with a disinfectant on page 37](#) for recommended steps to clean the high-touch, external surfaces on your computer to help prevent the spread of harmful bacteria and viruses.

Cleaning your computer with a disinfectant

The World Health Organization (WHO) recommends cleaning surfaces, followed by disinfection, as a best practice for preventing the spread of viral respiratory illnesses and harmful bacteria.

After cleaning the external surfaces of your computer using the steps in [Removing dirt and debris from your computer on page 36](#), [Caring for wood veneer \(select products only\) on page 38](#), or both, you might also choose to clean the surfaces with a disinfectant. A disinfectant that is within HP's cleaning guidelines is an alcohol solution consisting of 70% isopropyl alcohol and 30% water. This solution is also known as rubbing alcohol and is sold in most stores.

Follow these steps when disinfecting high-touch, external surfaces on your computer:

1. Wear disposable gloves made of latex (or nitrile gloves, if you are latex-sensitive) when cleaning the surfaces.
2. Turn off your device and unplug the power cord and other connected external devices. Remove any installed batteries from items such as wireless keyboards.

 **CAUTION:** To prevent electric shock or damage to components, never clean a product while it is turned on or plugged in.

3. Moisten a microfiber cloth with a mixture of 70% isopropyl alcohol and 30% water. The cloth should be moist, but not dripping wet.

 **CAUTION:** Do not use any of the following chemicals or any solutions that contain them, including spray-based surface cleaners: bleach, peroxides (including hydrogen peroxide), acetone, ammonia, ethyl alcohol, methylene chloride, or any petroleum-based materials, such as gasoline, paint thinner, benzene, or toluene.

 **IMPORTANT:** To avoid damaging the surface, avoid abrasive cloths, towels, and paper towels.

4. Wipe the exterior of the product gently with the moistened cloth.

 **IMPORTANT:** Keep liquids away from the product. Avoid getting moisture in any openings. If liquid makes its way inside your HP product, it can cause damage to the product. Do not spray liquids directly on the product. Do not use aerosol sprays, solvents, abrasives, or cleaners containing hydrogen peroxide or bleach that might damage the finish.

5. Start with the display (if applicable). Wipe carefully in one direction, and move from the top of the display to the bottom. Finish with any flexible cables, like power cord, keyboard cable, and USB cables.
6. Be sure that surfaces have completely air-dried before turning the device on after cleaning.
7. Discard the gloves after each cleaning. Clean your hands immediately after you remove the gloves.

Caring for wood veneer (select products only)

Your product might feature high-quality wood veneer. As with all natural wood products, proper care is important for best results over the life of the product. Because of the nature of natural wood, you might see unique variations in the grain pattern or subtle variations in color, which are normal.

- Clean the wood with a dry, static-free microfiber cloth or chamois.
- Avoid cleaning products containing substances such as ammonia, methylene chloride, acetone, turpentine, or other petroleum-based solvents.
- Do not expose the wood to sun or moisture for long periods of time.
- If the wood becomes wet, dry it by dabbing with an absorbent, lint-free cloth.
- Avoid contact with any substance that might dye or discolor the wood.
- Avoid contact with sharp objects or rough surfaces that might scratch the wood.

See [Removing dirt and debris from your computer on page 36](#) for the recommended steps to clean the high-touch, external surfaces on your computer. After you remove the dirt and debris, you can also clean the surfaces with a disinfectant. See [Cleaning your computer with a disinfectant on page 37](#) for sanitizing guidelines to help prevent the spread of harmful bacteria and viruses.

Packaging and transporting guidelines

Follow these grounding guidelines when packaging and transporting equipment.

- To avoid hand contact, transport products in static-safe tubes, bags, or boxes.
- Protect ESD-sensitive parts and assemblies with conductive or approved containers or packaging.
- Keep ESD-sensitive parts in their containers until the parts arrive at static-free workstations.
- Place items on a grounded surface before removing items from their containers.
- Always be properly grounded when touching a component or assembly.
- Store reusable ESD-sensitive parts from assemblies in protective packaging or nonconductive foam.
- Use transporters and conveyors made of antistatic belts and roller bushings. Be sure that mechanized equipment used for moving materials is wired to ground and that proper materials are selected to avoid static charging. When grounding is not possible, use an ionizer to dissipate electric charges.

Accessing support information

Use this information to find the HP support that you need.

Table 4-3 Support information locations



Service consideration	Path to access information
Records of reported failure incidents stored on the computer	<p>Windows:</p> <p>Pre-operating system failures are logged in the BIOS Event Log. To view the BIOS Event Log:</p> <ol style="list-style-type: none">1. Press the power button.2. Immediately and repeatedly press esc when the power button light turns white. <p>NOTE: If you do not press esc at the appropriate time, you must restart the computer and again repeatedly press esc when the power button light turns white to access the utility.</p> <ol style="list-style-type: none">3. Press f10 to enter the BIOS setup.4. (On commercial products) Under the Main tab, select BIOS event log, and then select View BIOS Event Log. <p>- or -</p> <p>(On consumer products) Under the Main tab, select System Log.</p> <p>Post-operating system failures are logged in the Event Viewer.</p> <ol style="list-style-type: none">1. Turn on the computer and allow the operating system to open.2. Select the search icon  in the taskbar.3. Type <code>Event Viewer</code>, and then press enter.4. Select the log from the left panel. Details display in the right panel. <p>Chrome:</p> <ol style="list-style-type: none">1. Go to support.google.com/chrome.2. Search <code>collect Chrome device logs</code>.
Technical bulletins	<p>To locate technical bulletins:</p> <ol style="list-style-type: none">1. Go to www.hp.com.2. Place the cursor over Problem solving to display more options.3. Select Support & Troubleshooting.4. Type the serial number, product number, or product name to go to the product support page.5. Select Advisories to view technical bulletins.
Repair professionals	<p>To locate repair professionals:</p> <ol style="list-style-type: none">1. Go to www.hp.com.2. Place the cursor over Support resources to display more options.3. Select Authorized service providers.
Component and diagnosis information, failure detection, and required action	<p>To locate diagnosis information and actions:</p> <ol style="list-style-type: none">1. Go to http://www.hp.com/go/techcenter/pcdiags.2. Select Get Support.

Table 4-3 Support information locations (continued)

Service consideration	Path to access information
	<ol style="list-style-type: none"><li data-bbox="679 247 1439 304">3. Near the bottom of the window, select Notebook PCs, and then select your location.

5 Removal and replacement procedures for Customer Self-Repair parts

This chapter provides removal and replacement procedures for Customer Self-Repair parts.

 **NOTE:** The Customer Self-Repair program is not available in all locations. Installing a part that is not supported by the Customer Self-Repair program can void your warranty. Check your warranty to determine whether Customer Self-Repair is supported in your location.

Component replacement procedures

To remove and replace computer components, use these procedures.

 **NOTE:** Details about your computer, including model, serial number, product key, and length of warranty, are on the service tag at the bottom of your computer.

 **NOTE:** HP continually improves and changes product parts. For complete and current information about supported parts for your computer, go to <http://partsurfer.hp.com>, select your country or region, and then follow the on-screen instructions.

Make special note of each screw size and location during removal and replacement.

Preparation for disassembly

To remove and replace computer components, use these procedures.

See [Removal and replacement procedures preliminary requirements on page 32](#) for initial safety procedures.

1. Turn off the computer. If you are unsure whether the computer is off or in Hibernation, turn the computer on, and then shut it down through the operating system.
2. Disconnect the power from the computer by unplugging the power cord from the computer.
3. Disconnect all external devices from the computer.

Bottom cover

To remove the bottom cover, use this procedure and illustration.

Table 5-1 Bottom cover description and part number

Description	Spare part number
Bottom cover for use in models with a 51 Wh battery	N00121-001
Bottom cover for use in models with a 42 Wh battery	M21720-001

Before removing the bottom cover, prepare the computer for disassembly (see [Preparation for disassembly on page 41](#)).

Remove the bottom cover:

1. Loosen the three captive Phillips screws (1) and remove the two Phillips M2.0 × 4.0 screws (2) that secure the bottom cover to the computer.

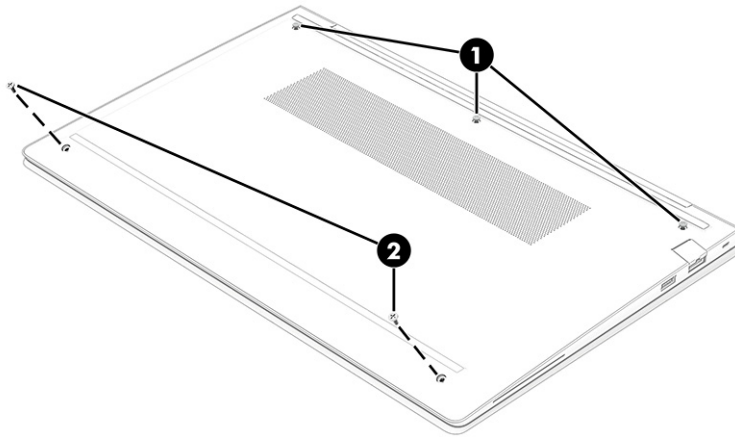

2. Starting near the hinges, use a nonmarking, nonconductive tool (1) to release the edges of the bottom cover from the computer (2).
3. Remove the bottom cover from the computer (3).

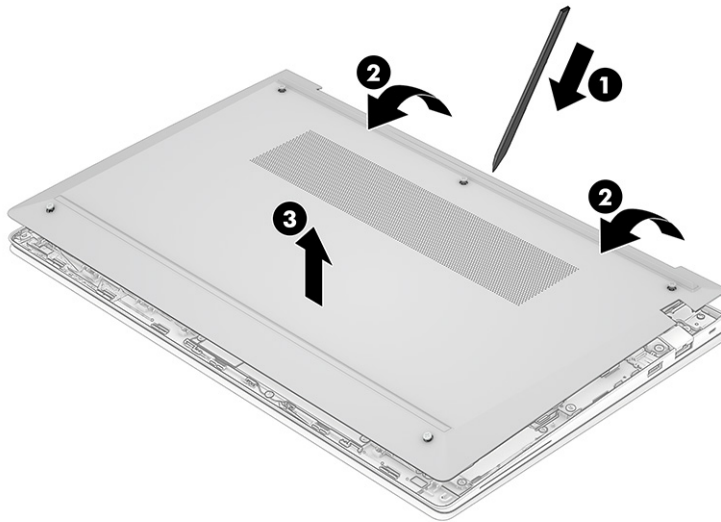

To replace the bottom cover, reverse the removal procedures.

Using a SIM card (select products only)

Use these instructions to insert a SIM card.

 **IMPORTANT:** You can damage the SIM card if you insert the wrong size card or insert it or the SIM card tray in the wrong direction. The card might also become stuck in the slot. Do not use SIM card adapters. To prevent damage to the SIM card or connectors, use minimal force when inserting or removing a SIM card.

Determining the correct SIM card size for your computer

Before purchasing a SIM card, follow these instructions to determine the correct SIM card size for your computer.

1. Go to <http://www.hp.com/support>, and then search for your computer by product name or number.
2. Select **Product Information**.
3. Refer to the listed options to determine which card to purchase.

Inserting a SIM card in an external slot

To insert a SIM card in an external slot, follow these steps.

1. Turn off the computer by using the Shut down command.
2. Insert the SIM card into the SIM card slot, and then press in on the SIM card until it is firmly seated.



NOTE: Your SIM card or the SIM card slot in your computer might look different from the illustration in this section.

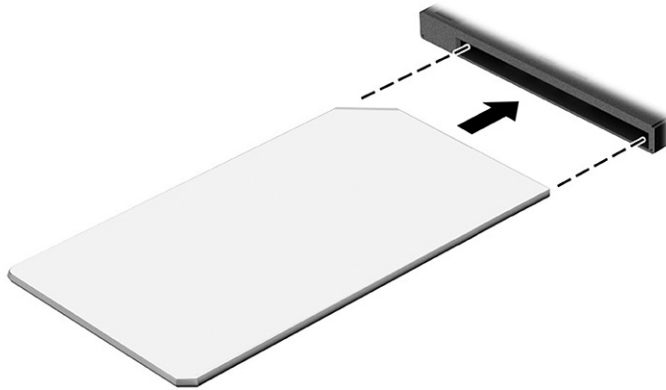

To remove the SIM card, press in gently on the card to disengage the SIM lock, and then remove it from the slot.

Memory modules

To remove the memory modules, use this procedure and illustration.

Table 5-2 Memory module descriptions and part numbers

Description	Spare part number
32 GB, DDR4-3200	M09713-001
16 GB, DDR4-3200	L67710-001
8 GB, DDR4-3200	L46598-001
4 GB, DDR4-3200	L83673-001

Before removing the memory, follow these steps:

1. Prepare the computer for disassembly (see [Preparation for disassembly on page 41](#)).

2. Remove the bottom cover (see [Bottom cover on page 41](#)).
3. Disconnect the battery cable from the system board (see [Battery on page 51](#)).

If you are replacing a memory module, remove the existing memory module:

1. Pull the protective shielding up from the top and toward you to access the memory modules.
2. Spread the two retention clips outward **(1)** until the memory module tilts up at a 45° angle, and then remove the module **(2)**. Use the same procedure to remove all memory modules.

 **IMPORTANT:** To prevent damage to the memory module, hold the memory module by the edges only. Do not touch the components on the memory module.

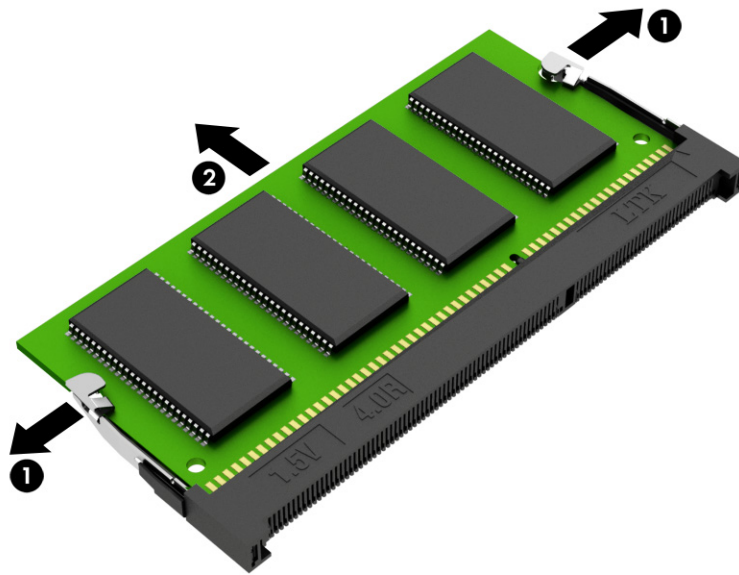

To protect a memory module after removal, place it in an electrostatic-safe container.

To install a memory module:

1. Align the notched edge of the module with the tab in the slot **(1)**, and then press the module into the slot at an angle until it is seated **(2)**.

2. Press down on the module until the side retention clips snap into place (3).

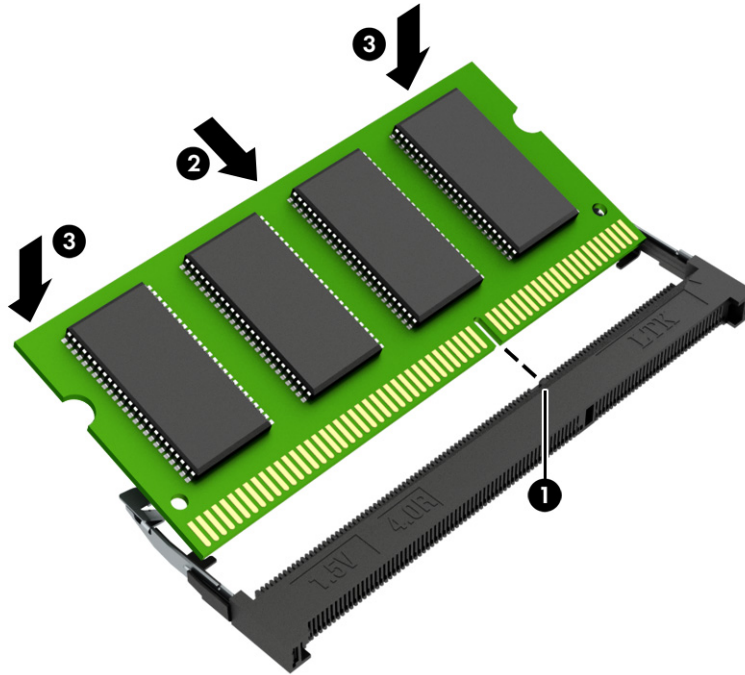

WLAN module

To remove the WLAN module, use this procedure and illustration.

Table 5-3 WLAN module descriptions and part numbers

Description	Spare part number
Intel AX211 Wi-Fi 6e Bluetooth 5.2 vPro WLAN	M53363-001
Intel AX211 Wi-Fi 6e Bluetooth 5.2 WLAN	M53366-001
WLAN module protective tape	N02047-001

IMPORTANT: To prevent an unresponsive system, replace the wireless module only with a wireless module authorized for use in the computer by the governmental agency that regulates wireless devices in your country or region. If you replace the module and then receive a warning message, remove the module to restore device functionality, and then contact technical support.

Before removing the WLAN module, follow these steps:

1. Prepare the computer for disassembly (see [Preparation for disassembly on page 41](#)).
2. Remove the bottom cover (see [Bottom cover on page 41](#)).
3. Disconnect the battery cable from the system board (see [Battery on page 51](#)).

Remove the WLAN module:

1. Remove the plastic that covers the antennas.
2. Carefully disconnect the two antenna cables from the module (1).

3. Remove the Phillips M2.0 × 2.5 screw (2), and then remove the WLAN module (3).

 **NOTE:** Models have either one or two WLAN antennas. On models with two antennas, the #1 white WLAN antenna cable connects to the WLAN module #1 Main terminal. The #2 black WLAN antenna cable connects to the WLAN module #1 Aux terminal.

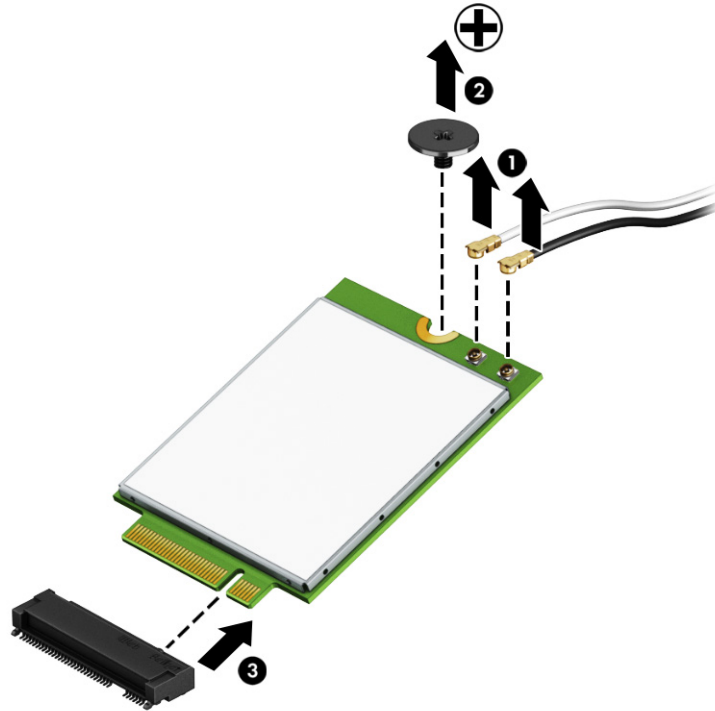

4. If the WLAN antenna is not connected to the terminal on the WLAN module, install a protective sleeve on the antenna connector, as shown in the following illustration.

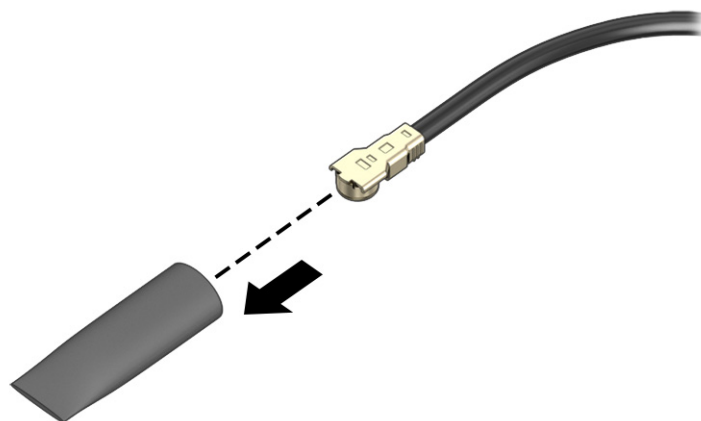

Reverse this procedure to install the WLAN module.

WWAN module

To remove the WWAN module, use this procedure and illustration.

Table 5-4 WWAN module descriptions and part numbers

Description	Spare part number
Intel XMM 7560 R + LTE-Advanced Pro WWAN (Cat 16)	M52040-001

 **IMPORTANT:** To prevent an unresponsive system, replace the wireless module only with a wireless module authorized for use in the computer by the governmental agency that regulates wireless devices in your country or region. If you replace the module and then receive a warning message, remove the module to restore device functionality, and then contact technical support.

Before removing the WWAN module, follow these steps:

1. Prepare the computer for disassembly (see [Preparation for disassembly on page 41](#)).
2. Remove the bottom cover (see [Bottom cover on page 41](#)).
3. Disconnect the battery cable from the system board (see [Battery on page 51](#)).

Remove the WWAN module:

1. Remove the plastic that covers the antennas.
2. Disconnect the WWAN antenna cables **(1)** from the terminals on the WWAN module. The number of antenna cables can vary.
3. Remove the Phillips M2.0 × 2.5 screw **(2)** that secures the WWAN module to the bottom cover. (The WWAN module tilts up.)
4. Remove the WWAN module **(3)** by pulling the module away from the slot at an angle.

 **NOTE:** When you look at the antenna terminals from the top of the module, the white WWAN antenna cable connects to the terminal to the left of the black WWAN antenna cables.

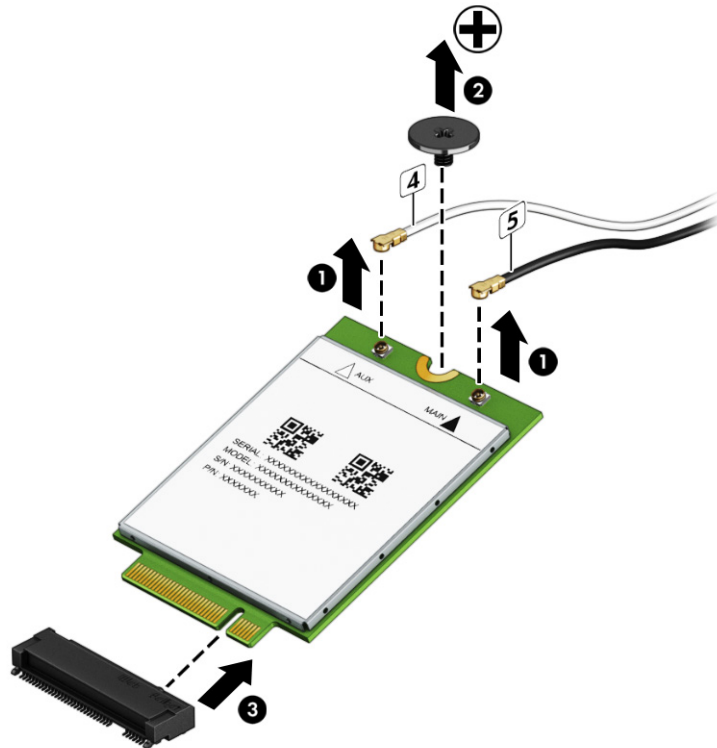

5. If the WWAN antenna is not connected to the terminal on the WWAN module, a protective sleeve must be installed on the antenna connector, as shown in the following illustration.

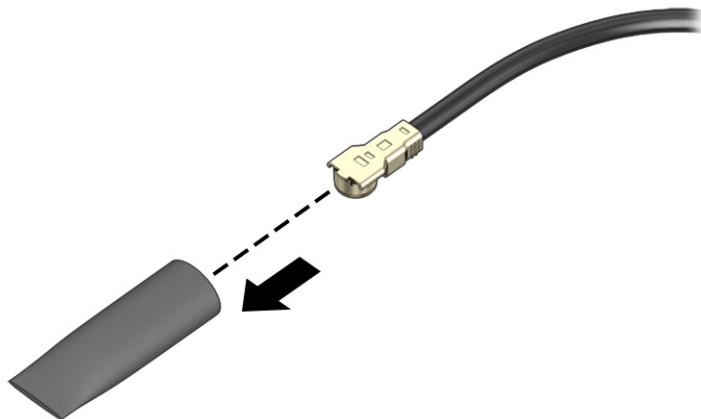

Reverse this procedure to install the WWAN module.

Solid-state drive

To remove the solid-state drive, use these procedures and illustrations. The primary solid-state drive is installed in the main solid-state drive connector. The secondary solid-state drive is installed in the same connector as the WWAN module—you can use one or the other, but not both.

Table 5-5 Solid-state drive descriptions and part numbers

Description	Spare part number
Primary solid-state drives (M.2 2280)	
1 TB, PCIe, TLC, 2280	M16560-001
512 GB, PCIe-4 × 4, TLC, 2280	M17436-001
512 GB, PCIe, value, 2280	L89745-001
512 GB, PCIe-4 × 4, TLC, self-encrypting drive, 2280	M52031-001
512 GB, PCIe, value, 2280	L85364-001
256 GB, PCIe-4 × 4, TLC, 2280	M52025-001
256 GB, PCIe-4 × 4, TLC, self-encrypting drive, 2280	M52029-001
256 GB, PCIe, value, 2280	L85354-001
Secondary solid-state drives (M.2 2230)	
256 GB, PCIe, value, 2230	M11042-001
128 GB, PCIe, value, 2230	M11040-001
Solid-state drive support kit (includes 2nd SSD holder, bracket, and rubber)	N00354-001

Before removing the solid-state drive, follow these steps:

1. Prepare the computer for disassembly (see [Preparation for disassembly on page 41](#)).
2. Remove the bottom cover (see [Bottom cover on page 41](#)).
3. Disconnect the battery cable from the system board (see [Battery on page 51](#)).

Remove the solid-state drive:

1. The primary solid-state drive is installed in the main solid-state drive connector. Remove the Phillips M2.0 × 2.5 screw **(1)** that secures the drive to the computer.
2. Pull the drive away from the socket to remove it **(2)**.

 **NOTE:** Some models do not include a bracket under the drive.

Primary M.2 2280 solid-state drive

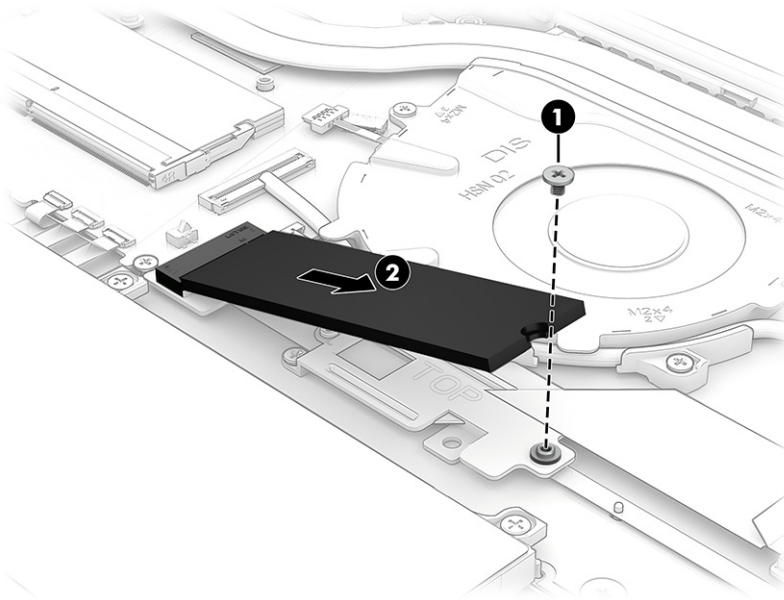

Secondary M.2 2230 solid-state drives are installed in the

3. The secondary solid-state drive is installed in the same connector as the WWAN module. You can use one or the other, but not both. Remove the Phillips M2.0 × 2.5 screw (1) that secures the drive to the computer.
4. Pull the drive away from the socket to remove it (2).

Secondary M.2 2230 solid-state drive

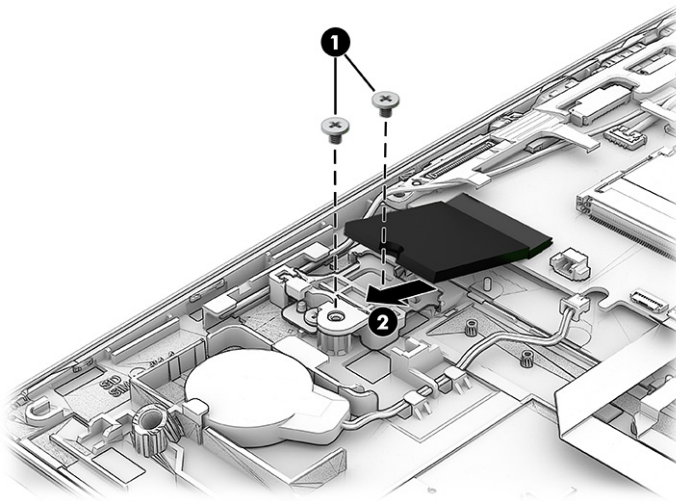

To install the solid-state drive, reverse the removal procedures.



NOTE: Solid-state drives are designed with a notch to prevent incorrect insertion.

6 Removal and replacement procedures for authorized service provider parts

This chapter provides removal and replacement procedures for authorized service provider parts.

 **IMPORTANT:** Components described in this chapter should be accessed only by an authorized service provider. Accessing these parts can damage the computer or void the warranty.

 **NOTE:** Details about your computer, including model, serial number, product key, and length of warranty, are on the service tag at the bottom of your computer.

Component replacement procedures

To remove and replace computer components, use these procedures.

 **NOTE:** HP continually improves and changes product parts. For complete and current information about supported parts for your computer, go to <http://partsurfer.hp.com>, select your country or region, and then follow the on-screen instructions.

You must remove, replace, or loosen as many as 53 screws when you service the parts described in this chapter. Make special note of each screw size and location during removal and replacement.

Preparation for disassembly

To remove and replace computer components, use these procedures.

See [Removal and replacement procedures preliminary requirements on page 32](#) for initial safety procedures.

1. Turn off the computer. If you are unsure whether the computer is off or in Hibernation, turn the computer on, and then shut it down through the operating system.
2. Disconnect the power from the computer by unplugging the power cord from the computer.
3. Disconnect all external devices from the computer.

Battery

To remove the battery, use this procedure and illustration.

Table 6-1 Battery description and part number

Description	Spare part number
Battery, 3 cell, 42 Whr	M75599-005
Battery, 3 cell, 51 Whr	M73472-005

 **WARNING!** To avoid personal injury and damage to the product:

- Do *not* puncture, twist, or crack the battery.

- Do *not* cause an external puncture or rupture to the battery. They can cause a short inside the battery, which can result in battery thermal runaway.
- Do *not* handle or touch the battery enclosure with sharp objects such as tweezers or pliers, which might puncture the battery.
- Do *not* compress or squeeze the battery case with tools or heavy objects stacked on top of the case. These actions can apply undue force on the battery.
- Do *not* touch the connectors with any metallic surface or object, such as metal tools, screws, or coins, which can cause shorting across the connectors.

Before removing the battery, follow these steps:

1. Prepare the computer for disassembly (see [Preparation for disassembly on page 41](#)).
2. Remove the bottom cover (see [Bottom cover on page 41](#)).

⚠ WARNING! To reduce potential safety issues, use only the user-replaceable battery provided with the computer, a replacement battery provided by HP, or a compatible battery purchased from HP.

📌 IMPORTANT: Removing a battery that is the sole power source for the computer can cause loss of information. To prevent loss of information, save your work or shut down the computer through Windows before you remove the battery.

Remove the battery:

1. Disconnect the battery cable from the system board (1).
2. Remove the six Phillips M2.0 × 4.0 screws (2) that secure the battery to the computer.
3. Remove the battery from the computer (3).

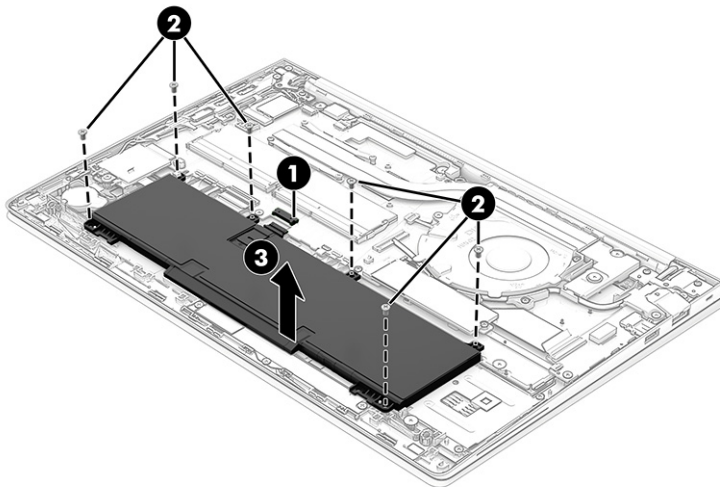

To insert the battery, reverse the removal procedures.

RTC battery

To remove the RTC battery, use this procedure and illustration.

Table 6-2 RTC battery description and part number

Description	Spare part number
RTC battery	M34737-001

Before removing the RTC battery, follow these steps:

1. Prepare the computer for disassembly (see [Preparation for disassembly on page 41](#)).
2. Remove the bottom cover (see [Bottom cover on page 41](#)).
3. Disconnect the battery cable from the system board (see [Battery on page 51](#)).

Remove the RTC battery:

1. Disconnect the battery cable from the system board (1).
2. Remove the cable from the clips in the computer chassis (2).
3. Use a tool to release the battery from the computer (3).

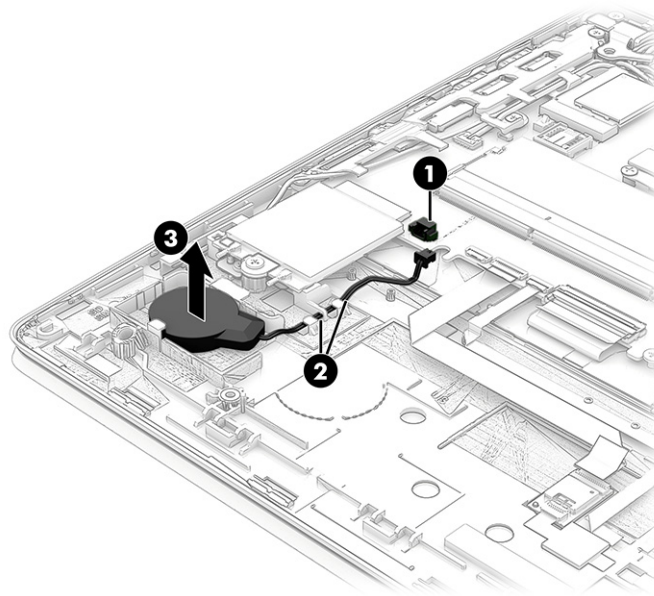

Reverse this procedure to install the RTC battery.

I/O board

To remove the I/O board, use this procedure and illustration.

Table 6-3 I/O board description and part number

Description	Spare part number
I/O board for use in vPro models	M48790-001
I/O board for use in non-vPro models	N01502-001
I/O board cables (included in Cable Kit)	N03218-001

Table 6-3 I/O board description and part number (continued)

Description	Spare part number
RJ-45 (network) jack door	M21994-001

Before removing the I/O board, follow these steps:

1. Prepare the computer for disassembly (see [Preparation for disassembly on page 41](#)).
2. Remove the bottom cover (see [Bottom cover on page 41](#)).
3. Disconnect the battery cable from the system board (see [Battery on page 51](#)).

Remove the I/O board:

1. Disconnect the cable from the larger ZIF connector (1) and smaller ZIF connector (2) on the I/O board.
2. Remove the three Phillips M2.0 × 4.0 screws (3) that secure the board to the computer, and then remove the network jack door from the board (4).
3. Remove the board from the computer (5).

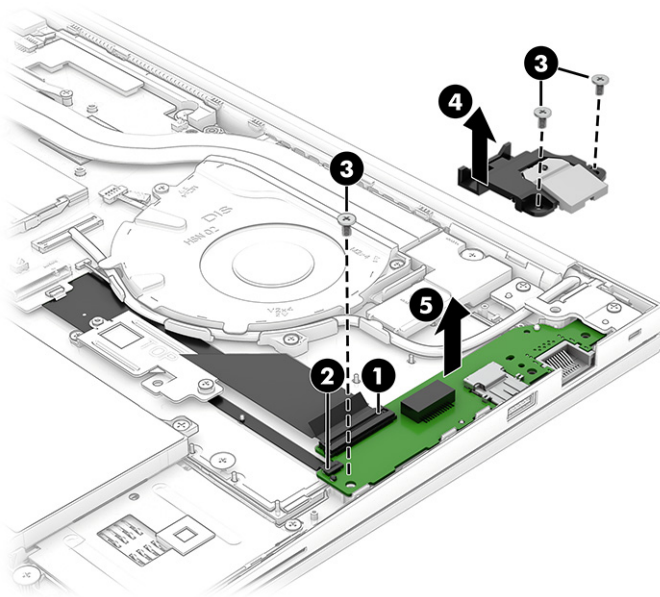

Reverse this procedure to install the I/O board.

Touchpad

To remove the touchpad, use this procedure and illustration.

Table 6-4 Touchpad description and part number

Description	Spare part number
Touchpad for use in models without NFC	N14647-001
Touchpad for use in models with NFC (includes NFC antenna)	M22000-001
Touchpad cable (included in Cable Kit)	N03218-001

Before removing the touchpad, follow these steps:

1. Prepare the computer for disassembly (see [Preparation for disassembly on page 41](#)).
2. Remove the bottom cover (see [Bottom cover on page 41](#)).
3. Remove the battery (see [Battery on page 51](#)).

Remove the touchpad:

1. Disconnect the system board cable from the ZIF connector on the touchpad (1).
2. (Select models only) Disconnect the cable from the ZIF connector on the NFC module (2).
3. Remove the four Phillips M2.0× 2.0 screws (3) that secure the touchpad to the computer.
4. Remove the two Phillips M1.6 × 2.0 screws (4) that secure the touchpad to the computer.
5. Remove the touchpad from the computer (5).

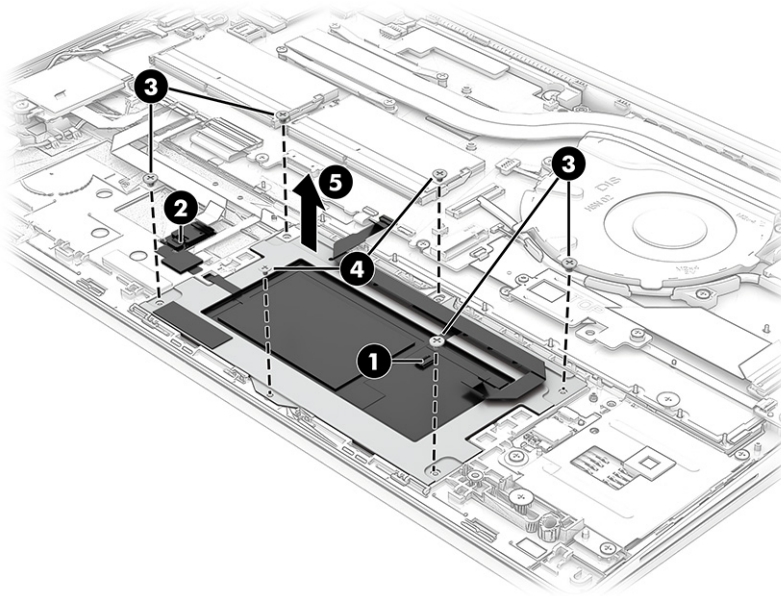

Reverse this procedure to install the touchpad.

NFC module

To remove the NFC module, use this procedure and illustration.

Table 6-5 NFC module description and part number

Description	Spare part number
NFC module	M27890-001
NOTE: The NFC module spare part kit does not include the antenna. The antenna is included in the touchpad spare part kit.	
NFC module cable (included in Cable Kit)	N03218-001

Before removing the NFC module, follow these steps:

1. Prepare the computer for disassembly (see [Preparation for disassembly on page 41](#)).
2. Remove the bottom cover (see [Bottom cover on page 41](#)).
3. Remove the battery (see [Battery on page 51](#)).

Remove the NFC module:

1. Remove any protective tape covering the module and reuse during replacement.
2. Disconnect the antenna cable from the ZIF connector on the NFC module (1).
3. Disconnect the system board cable from the ZIF connector on the NFC module (2).
4. Use a tool to release the module from the computer (3). The NFC module is secured with adhesive.
5. Remove the NFC module from the computer (4).

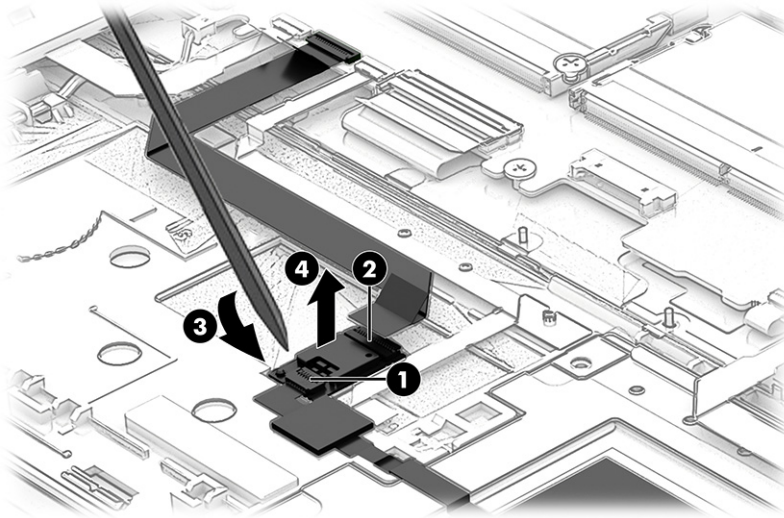

Reverse this procedure to install the NFC module.

Smart card reader

To remove the smart card reader from the top cover, use this procedure and illustration.

Table 6-6 Smart card reader description and part number

Description	Spare part number
Smart card reader	M21398-001
Smart card reader cable	N27591-001
Smart card reader bracket (available in the Bracket Kit)	N21997-001

Before removing the smart card reader, follow these steps:

1. Prepare the computer for disassembly (see [Preparation for disassembly on page 41](#)).

2. Remove the bottom cover (see [Bottom cover on page 41](#)).
3. Remove the battery (see [Battery on page 51](#)).

Remove the smart card reader:

1. Remove the four Phillips M2.0 × 2.0 screws (1) from the metal bracket covering the card reader board.
2. Disconnect the cable from the card reader (2).
3. Lift the smart card reader straight up to remove it (3).

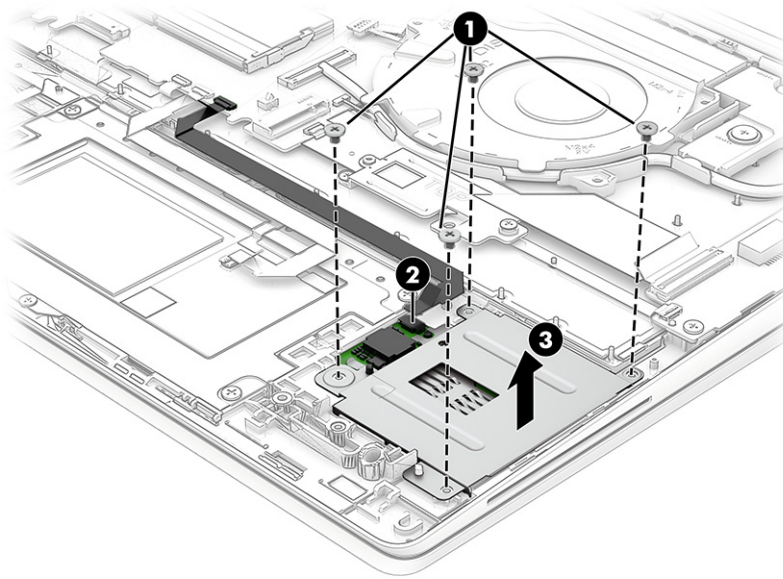

Reverse this procedure to install the smart card reader.

Fan

To remove the fan, use this procedure and illustration.

Table 6-7 Fan description and part number

Description	Spare part number
Fan for use in 42 W, UMA models	M21718-001
Fan for use in models with discrete graphics	M21719-001
Fan for use in 51 W, UMA models	N00095-001

Before removing the fan, follow these steps:

1. Prepare the computer for disassembly (see [Preparation for disassembly on page 41](#)).
2. Remove the bottom cover (see [Bottom cover on page 41](#)).
3. Disconnect the battery cable from the system board (see [Battery on page 51](#)).

Remove the fan assembly:

1. Remove display cable from the clips on the side of the fan (1).
2. Remove the three Phillips 2.0 × 4.0 screws (2) that secure the fan to the computer.
3. Disconnect the fan cable from the system board (3).
4. Remove the fan from the computer (4).

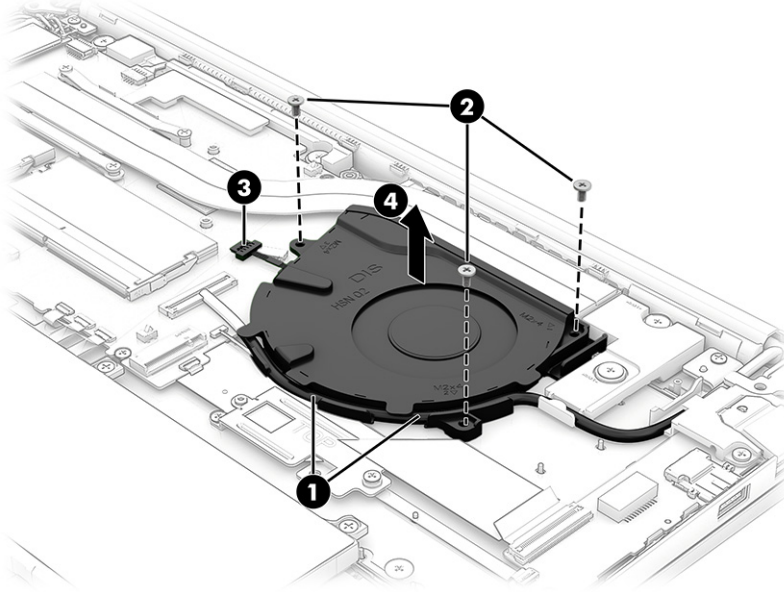

Reverse this procedure to install the fan assembly.

Fingerprint reader board

To remove the fingerprint reader board, use this procedure and illustration.

Table 6-8 Fingerprint reader board description and part number

Description	Spare part number
Fingerprint reader board	N00879-001
Fingerprint reader board cable (included in Cable Kit)	N03218-001
Fingerprint reader board bracket (included in Bracket Kit)	M21997-001

Before removing the fingerprint reader board, follow these steps:

1. Prepare the computer for disassembly (see [Preparation for disassembly on page 41](#)).
2. Remove the bottom cover (see [Bottom cover on page 41](#)).
3. Disconnect the battery cable from the system board (see [Battery on page 51](#)).
4. (Select products only) Remove the WWAN module (see [WWAN module on page 47](#)).

Remove the fingerprint reader board:

1. Disconnect the cable from the ZIF connector on the fingerprint reader board (1).

2. Remove the Phillips M2.0 × 2.5 screw (2) that secures the fingerprint reader bracket to the computer, and then remove the bracket (3).
3. Remove the fingerprint reader board from the computer (4).

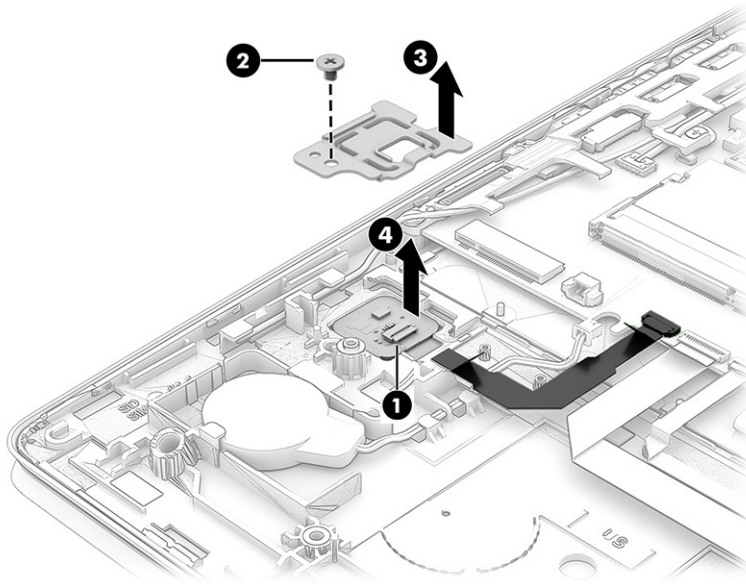

Reverse this procedure to install the fingerprint reader board.

Heat sink

To remove the heat sink, use these procedures and illustrations.

Table 6-9 Heat sink descriptions and part numbers

Description	Spare part number
Heat sink for use in models with 15 W processors	M47406-001
Heat sink for use in models with 28 W processors	N15764-001

Before removing the heat sink, follow these steps:

1. Prepare the computer for disassembly (see [Preparation for disassembly on page 41](#)).
2. Remove the bottom cover (see [Bottom cover on page 41](#)).
3. Disconnect the battery cable from the system board (see [Battery on page 51](#)).

Remove the heat sink:

1. In the order indicated on the heat sink, loosen the four captive Phillips screws (1) that secure the heat sink to the computer.

2. Remove the heat sink from the computer (2).

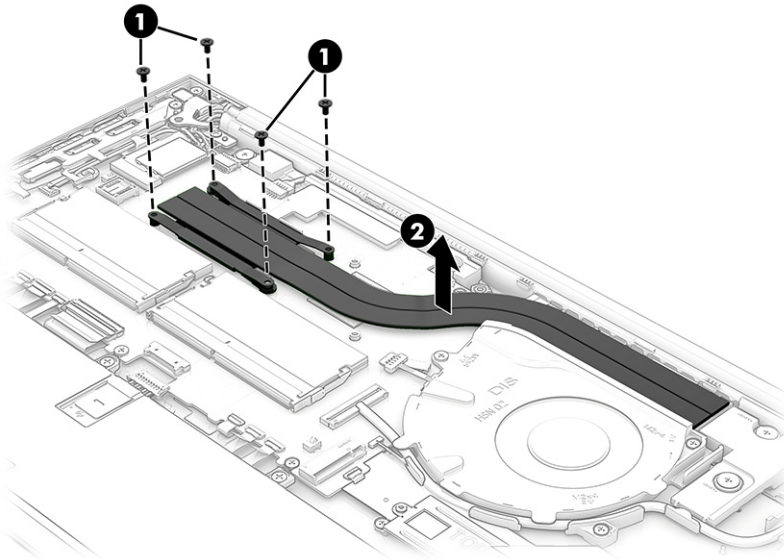

3. Thoroughly clean the thermal material from the surfaces of the heat sink and the system board components each time the heat sink is removed. Replacement thermal material is included with the heat sink and system board spare part kits. The following illustration shows the replacement thermal material locations.

Thermal material is used on the heat sink (1) and associated system board component (2).

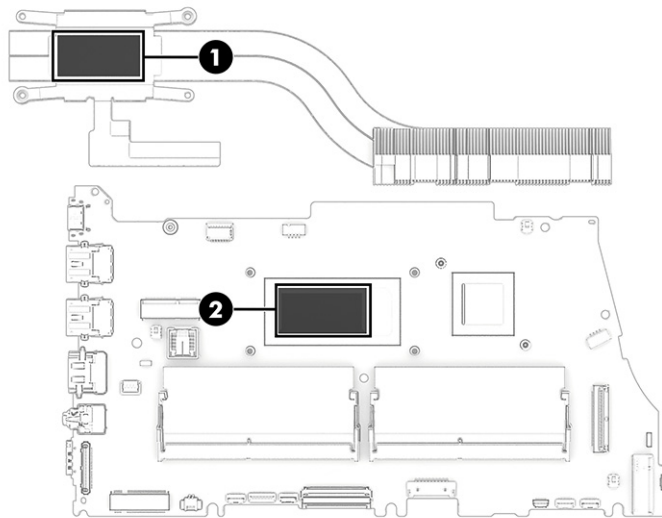

Reverse this procedure to install the heat sink.

System board

To remove the system board, use these procedures and illustrations.

Table 6-10 System board descriptions and part numbers

Description	Spare part number
System board (includes integrated processor)	
All system boards use the following part numbers:	
xxxxxx-001: Non-Windows operating systems	
xxxxxx-601: Windows operating system	
• Intel Core i7-1270P processor, models with WWAN	N21920-xx1
• Intel Core i7-1265U processor	N21918-xx1
• Intel Core i7-1265U processor, models with WWAN	N21919-xx1
• Intel Core i7-1255U processor	N21916-xx1
• Intel Core i7-1255U processor, models with WWAN	N21917-xx1
• Intel Core i5-1250P processor, models with WWAN	N21915-xx1
• Intel Core i5-1245U processor	N21913-xx1
• Intel Core i7-1245U processor, models with WWAN	N21914-xx1
• Intel Core i5-1245U processor (Realtek PD USB-C)	N22180-xx1
• Intel Core i5-1235U processor	N21911-xx1
• Intel Core i5-1235U processor, models with WWAN	N21912-xx1
• Intel Core i5-1235U processor (Realtek PD USB-C)	N22179-xx1
• Intel Core i3-1215U processor	N21909-xx1
• Intel Core i3-1215U processor, models with WWAN	N21910-xx1
Models with discrete graphics memory	
• Intel Core i7-1265U processor, models with WWAN	N21908-xx1
• Intel Core i5-1255U processor	N21907-xx1
• Intel Core i5-1255U processor, models with WWAN	N21921-xx1
• Intel Core i5-1245U processor, models with WWAN	N21906-xx1
• Intel Core i5-1235U processor	N21905-xx1

Before removing the system board, follow these steps:

1. Prepare the computer for disassembly (see [Preparation for disassembly on page 41](#)).
2. Remove the bottom cover (see [Bottom cover on page 41](#)).
3. Remove the battery (see [Battery on page 51](#)).
4. Remove the fan (see [Fan on page 57](#)).

When you replace the system board, be sure to remove the following components (as applicable) from the defective system board and install them on the replacement system board:

- Memory modules (see [Memory modules on page 43](#)).

- WLAN module (see [WLAN module on page 45](#)).
- WWAN module (see [WWAN module on page 47](#)).
- Solid-state drive (see [Solid-state drive on page 48](#)).
- Heat sink (see [Heat sink on page 59](#)).

Remove the system board:

1. Disconnect the following cables from the system board:



NOTE: You should never disconnect the RTC battery cable from the system board.

- Antenna cables from the WLAN module (select products only) **(1)**
- Power connector cable **(2)**
- Speaker cable **(3)**
- Display cable **(4)**
- USB cable (ZIF) from USB board **(5)**
- USB cable (ZIF) from system board **(6)**
- Touchpad cable (ZIF) **(7)**
- Keyboard backlight cable (ZIF) (select products only) **(8)**
- Keyboard cable (ZIF) **(9)**
- Fingerprint reader cable (ZIF) (select products only) **(10)**
- **Important: Do not disconnect** the RTC battery cable **(11)**
- Antenna cables from the WWAN module (select products only) **(12)**

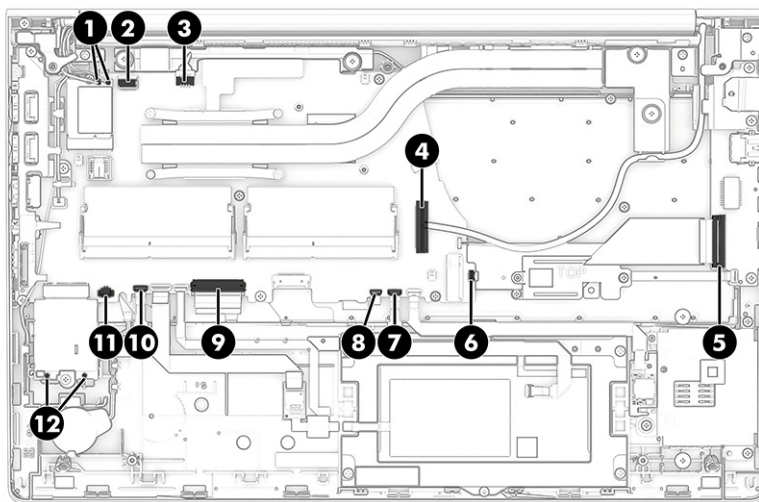

2. Remove the port bracket (1) by removing the three Phillips M2.0 × 4.0 screws (2) that secure the bracket to the system board and then removing the bracket (3).
3. Remove the four Phillips M2.0 × 2.5 screws (4) that secure the system board to the computer.
4. Lift the side of the system board upward (5), and then pull the system board away from the connectors on the side of the computer to remove it (6).

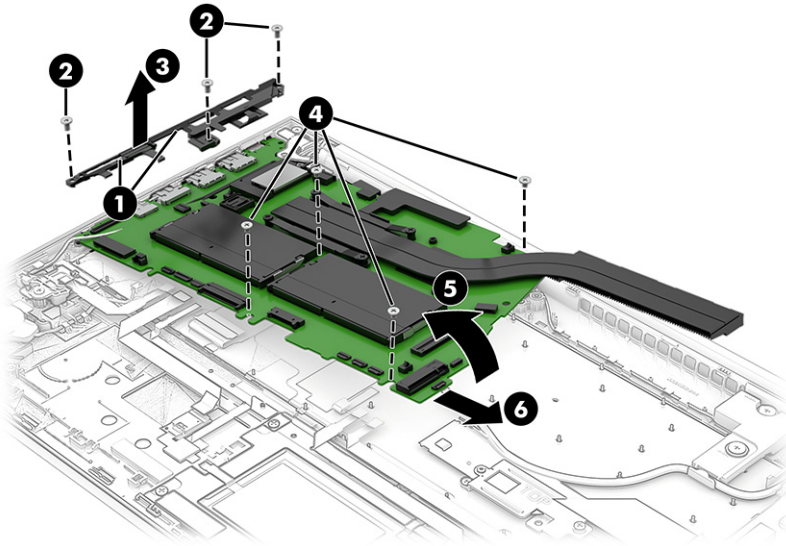

5. When installing a new system board, be sure to remove the thermal pad from the bottom of the old board and install it onto the bottom of the new board.

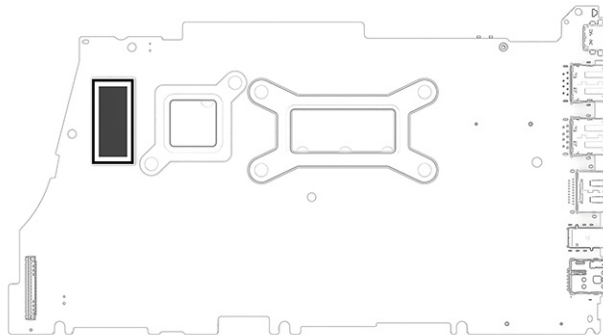

Reverse this procedure to install the system board.

Speakers

To remove the speakers, use this procedure and illustration.

Table 6-11 Speakers description and part number

Description	Spare part number
Speakers	M21723-001

Before removing the speakers, follow these steps:

1. Prepare the computer for disassembly (see [Preparation for disassembly on page 41](#)).
2. Remove the bottom cover (see [Bottom cover on page 41](#)).
3. Remove the battery (see [Battery on page 51](#)).
4. Remove the system board (see [System board on page 60](#)).

 **NOTE:** Be sure that the RTC battery remains connected to the system board.

Remove the speakers:

1. Remove the four Phillips M2.0 × 2.0 screws (1) that secure the speakers to the computer.
2. Lift the speakers straight up to remove them (2).

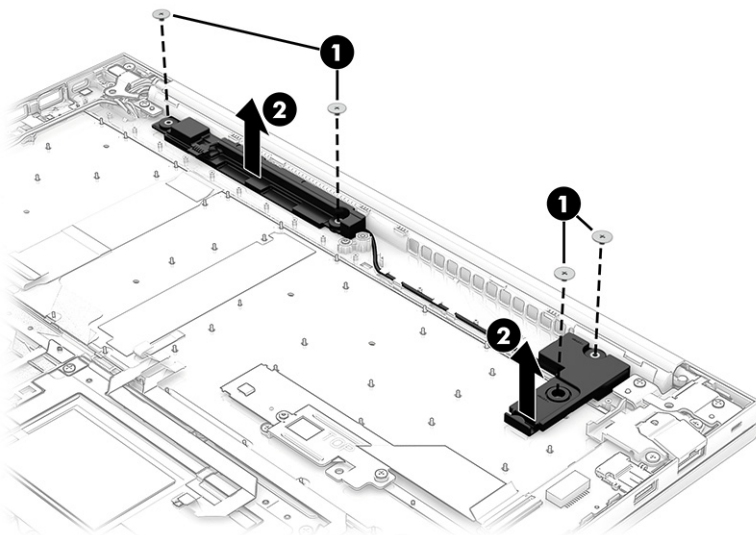

Reverse this procedure to install the speakers.

Power connector cable

To remove the power connector cable, use this procedure and illustration.

Table 6-12 Power connector cable description and part number

Description	Spare part number
Power connector cable	M21725-001

Before removing the power connector cable, follow these steps:

1. Prepare the computer for disassembly (see [Preparation for disassembly on page 41](#)).
2. Remove the bottom cover (see [Bottom cover on page 41](#)).

3. Disconnect the battery cable from the system board (see [Battery on page 51](#)).

Remove the power connector cable:

1. Remove the antenna cables that route over the screws (1).
2. Remove the three Phillips M2.5 × 4.0 screws (2) that secure the right display hinge to the computer, and then rotate the hinge off the power connector (3).
3. Disconnect the cable from the system board (4).
4. Remove the power connector cable from the computer (5).

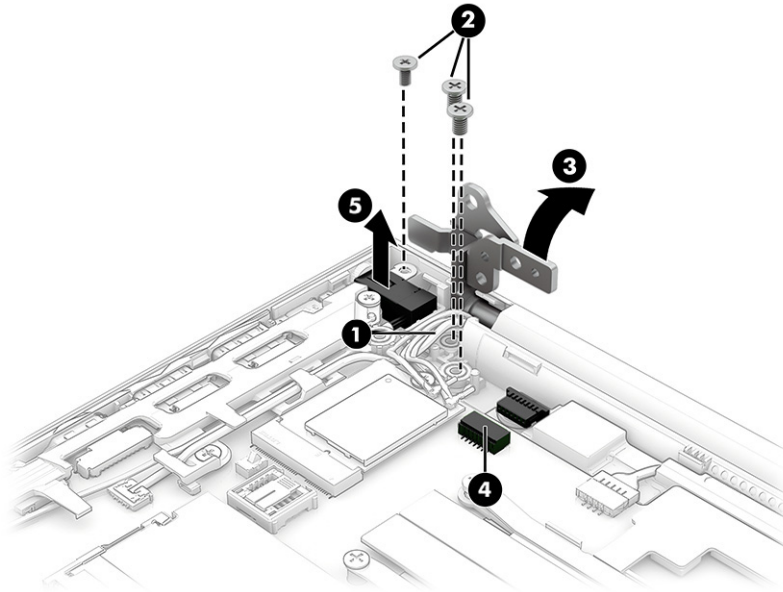

Reverse this procedure to install the power connector cable.

Display assembly

To remove and disassemble the display assembly, use these procedures and illustrations.

Full hinge-up displays are not available as spare parts. Spare parts for displays are available only at the subcomponent level.

Before removing the display panel, follow these steps:

1. Prepare the computer for disassembly (see [Preparation for disassembly on page 41](#)).
2. Remove the bottom cover (see [Bottom cover on page 41](#)).
3. Disconnect the battery cable from the system board (see [Battery on page 51](#)).
4. Remove the power connector cable (see [Power connector cable on page 64](#)).

Remove the display assembly:

1. Disconnect the display cable (1), and then remove the cable from the clips around the fan (2).
2. Disconnect the antenna cables from the WLAN module (3).

3. (Select models only) Disconnect the antenna cables from the WWAN module (4), and then remove the cables from the clips (5).

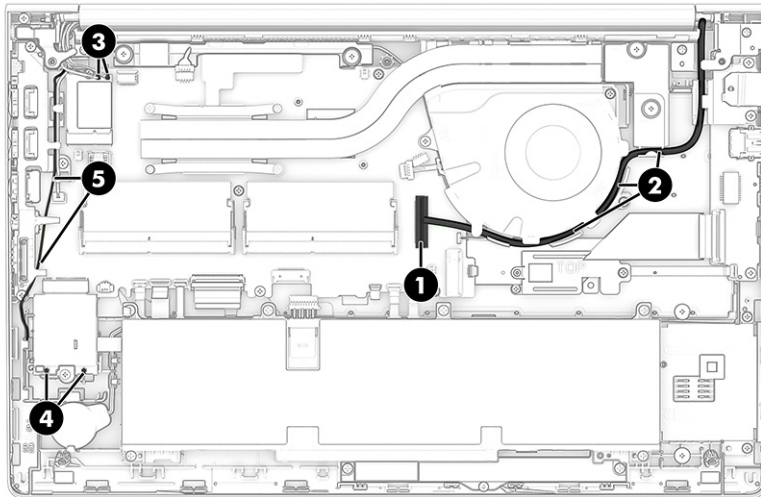

4. Remove the four Phillips M2.5 × 4.0 screws (1) that secure the display assembly to the computer.
5. Rotate the display to open the hinges (2).
6. Separate the display assembly from the computer (3).

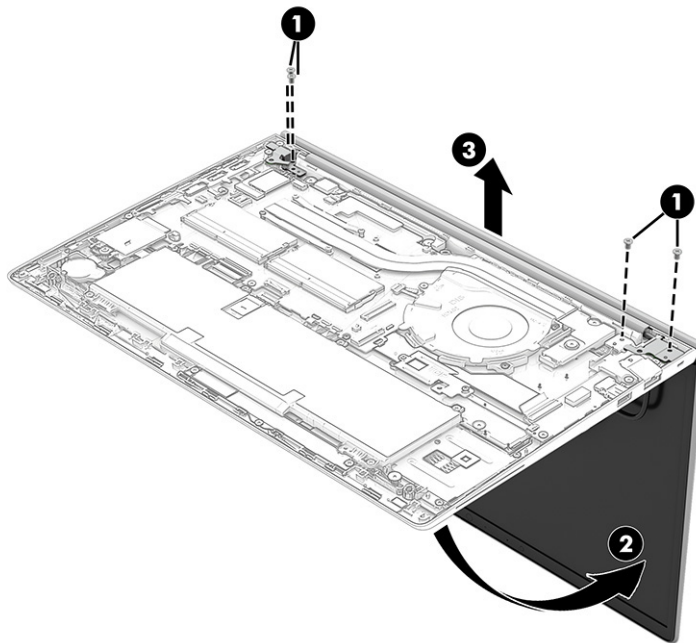

7. If you need to remove the bezel:
 - a. Flex the top (1), the left and right sides (2), and then the bottom of the bezel (3) to release it.
 - b. Remove the bezel from the display (4).

The display bezel is available as the following spare part numbers:

N03215-001: Models with an FHD display without a camera

N03213-001 Models with an FHD display with an HD camera

N03214-001: Models with an FHD display with an HD + IR camera

N07342-001: Models with an HD display without a camera

N07341-001 Models with an HD display with an HD camera

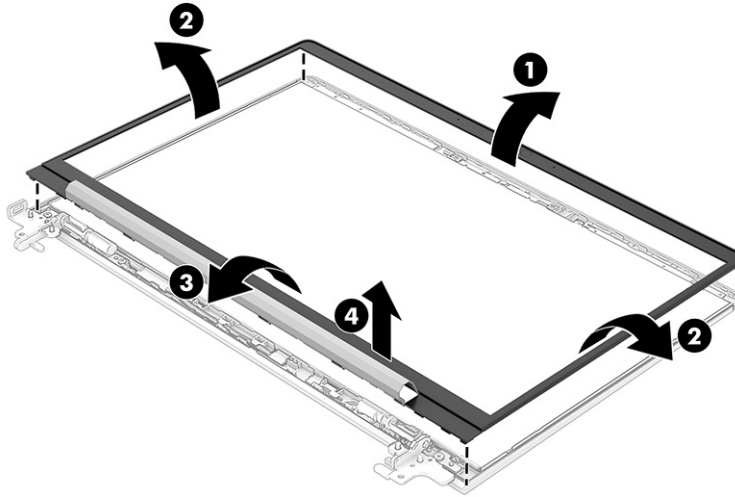

8. If you need to remove the display panel:

- a. The display panel is secured to the display enclosure with tape that is installed under the left and right sides of the panel. You have to pull the tape out from behind the panel from all four corners of the panel. To remove the panel, use tweezers to grasp and pull the end of the tape out from behind the panel **(1)**. While turning the tweezers, wrap the tape around the tweezers **(2)** as you continue to pull the tape out from behind the display panel. You must pull the tape multiple times before it is completely removed.
- b. Rotate the display panel over and place it next to the display enclosure **(3)**.

Display panels are available as the following spare part numbers:

N00086-001: FHD, 400 nit panel

N00084-001: FHD, 250 nit panel

N00085-001: FHD, 250 nit panel, touch screen

N00087-001: HD, 250 nit panel

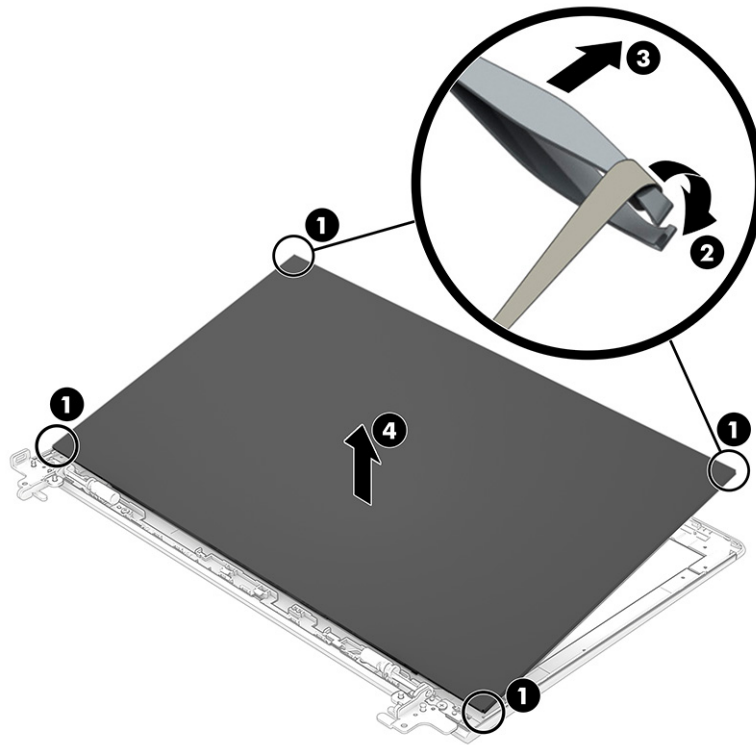

- c. Lift the tape from the connector on the display panel (1), and then disconnect the cable from the panel (2).

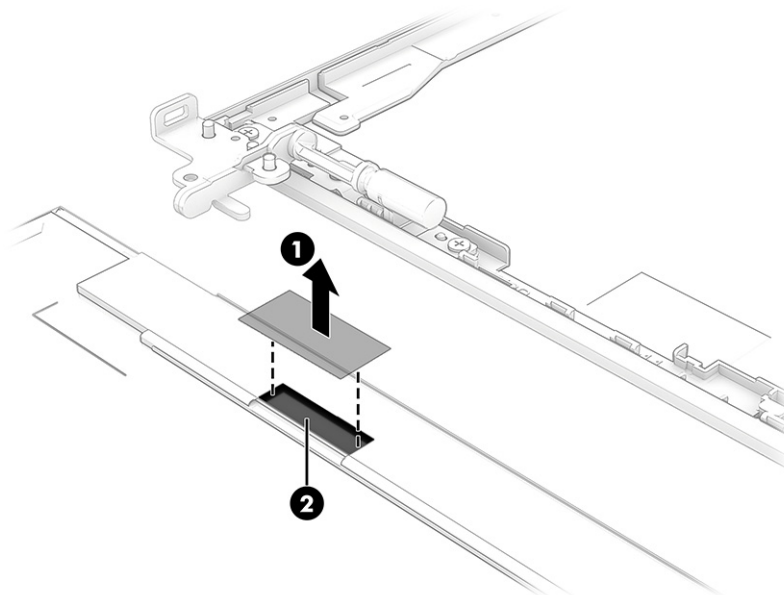

- 9. When replacing the display panel, follow these steps:

 **IMPORTANT:** Before installing the display panel, be sure to install the display cable to the back of the panel.

- a. Peel the protective layer from the bottom of the adhesive strips (1).

- b. Starting near the bottom of the inside of the display back cover (2), install the adhesive strips on both the left and right sides by aligning them with the groove on the edge of cover (3).
- c. Peel the protective layer from the top of the adhesive strips (4).
- d. Align the top left of the panel with the top left of the display rear cover (5), and then place the panel onto the cover (6).

The double-sided adhesive strips are available as spare part number N00351-001.

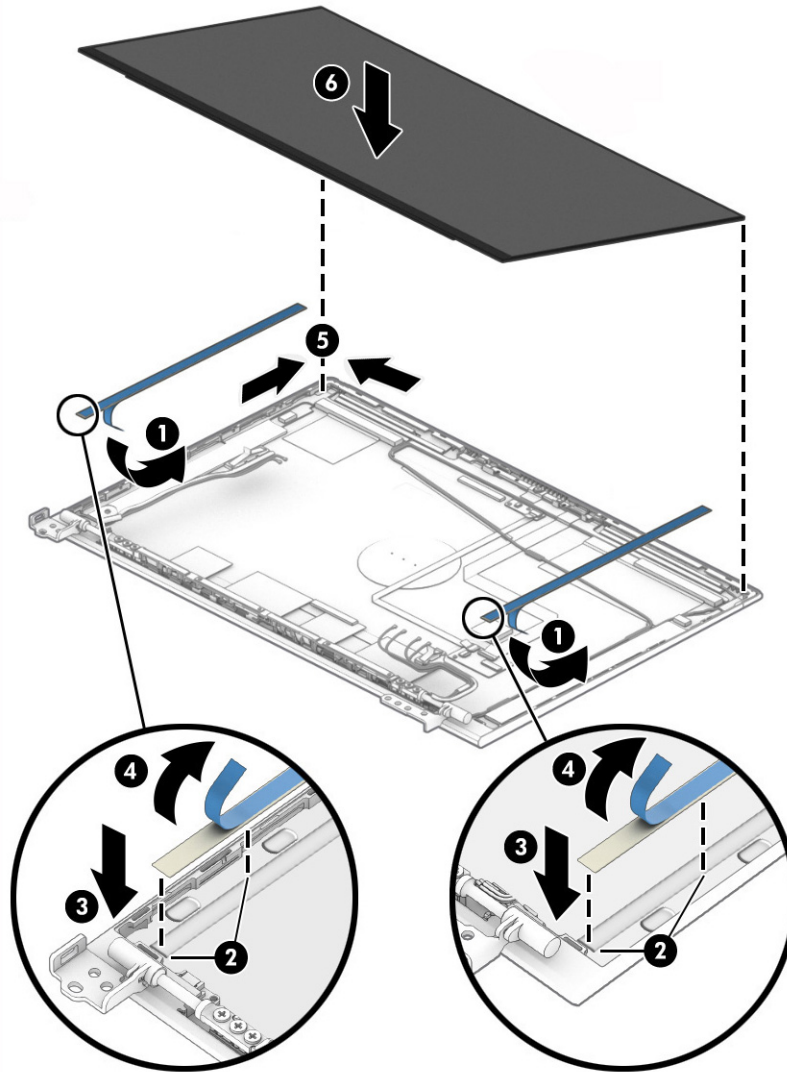

- e. Replace the bezel by pressing along the bottom, sides, and then top of the bezel to snap it into place.
- f. Position the computer upside down on a table.

- g. Leave the computer upside down on the table for 20 minutes to allow the adhesive to set.

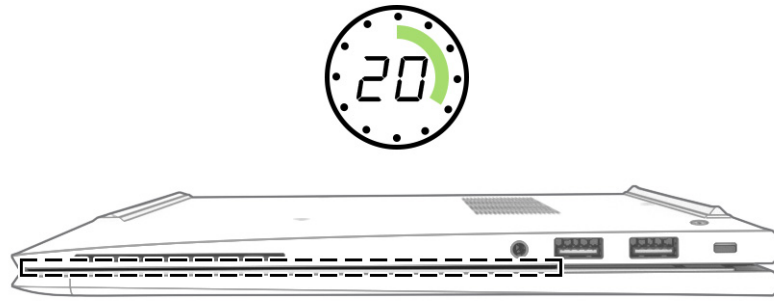

- h. Position the computer upright on a table.
- i. Leave the computer upright on the table for 10 minutes to be sure that the panel sits correctly in the display.

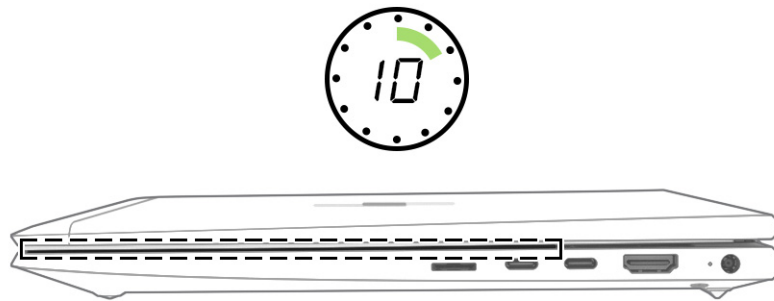

10. If you need to remove the camera module:

- ▲ Use a tool to lift up evenly across the module and peel the module up from the display back cover (1), and then disconnect the cable or cables from the reverse ZIF connector on the module (2). The camera module is available as spare part number N05869-001 for HD cameras and N05870-001 for IR cameras. The microphone module is available as spare part number N05863-001.



NOTE: For installation, note that the cable routes under the camera module before it connects to the module.

HD camera shown in the following illustration.

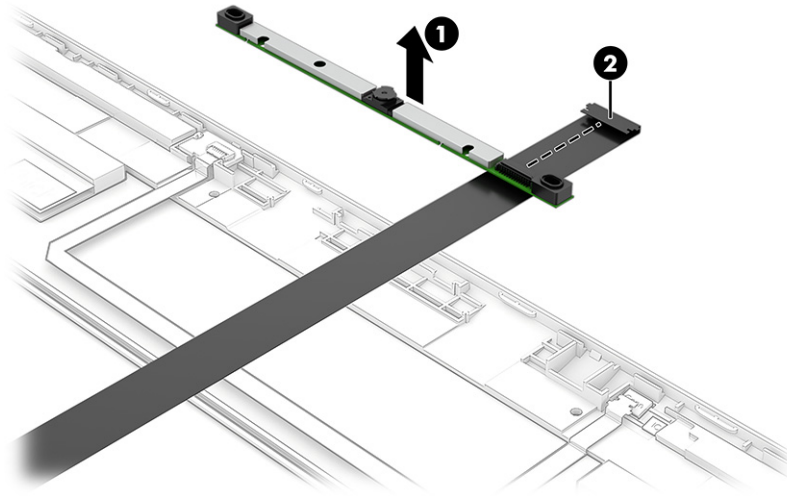

11. If you need to remove the hinges from the display enclosure:

- a. Remove the trim pieces **(1)**.
- b. Remove the two Phillips M2.5 × 2.5 screws **(2)** from each hinge.
- c. Remove the Phillips M2.5 × 4.0 screw **(3)** from each hinge.
- d. Remove the hinges from the display **(4)**.

The hinges and associated parts are available in the Hinge Kit as spare part number M21732-001.

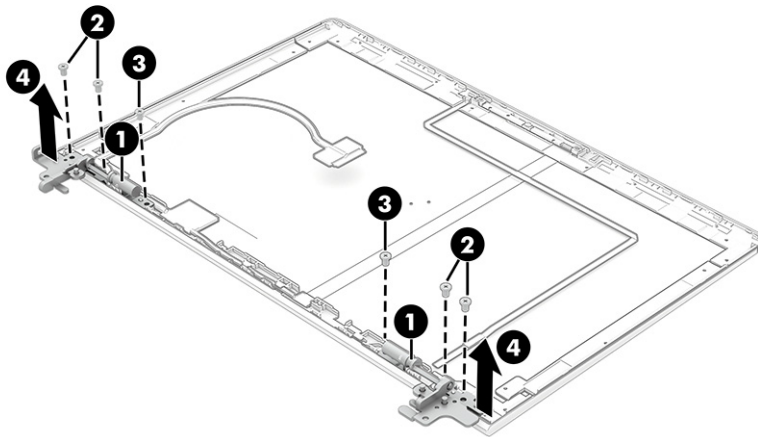

12. If you need to remove the display panel/camera cable, peel the cable up off the inside of the display rear cover.

The display panel/camera cable is available as spare part number N03217-001.

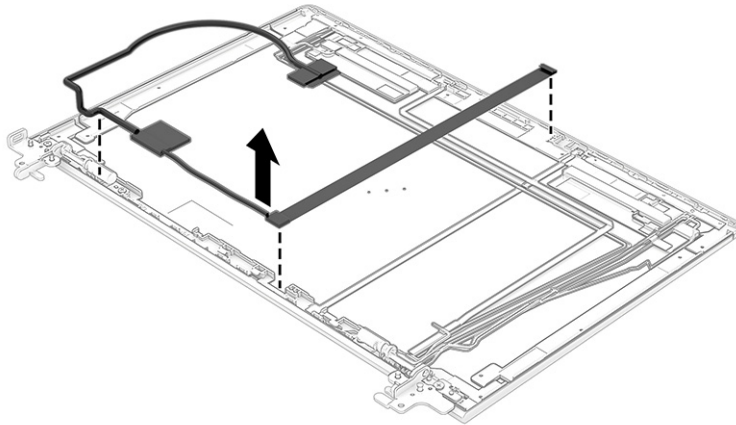

- 13.** If you need to remove the WLAN antennas and cables, remove the cables from the plastic clips at the bottom-right and the clips on the inside of the display rear cover **(1)**, and then peel the antennas off the cover **(2)**. The WLAN antennas and cables are available as spare part number N03219-001.

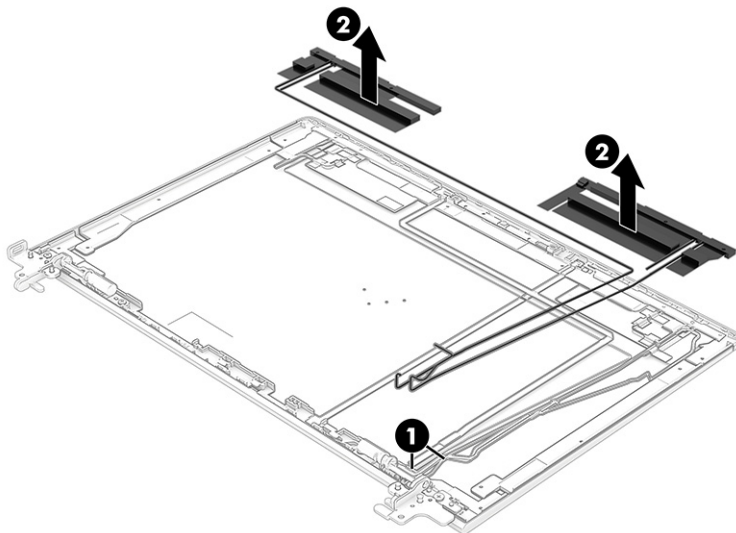

- 14.** If you need to remove the WWAN antennas and cables, remove the cables **(1)** from the inside of the display rear cover **(2)**, and then peel the antennas off the cover **(3)**. The WWAN antennas and cables

are available as spare part number N03220-001 for models with 400 nit displays and N03221-001 for models with 250 nit displays.

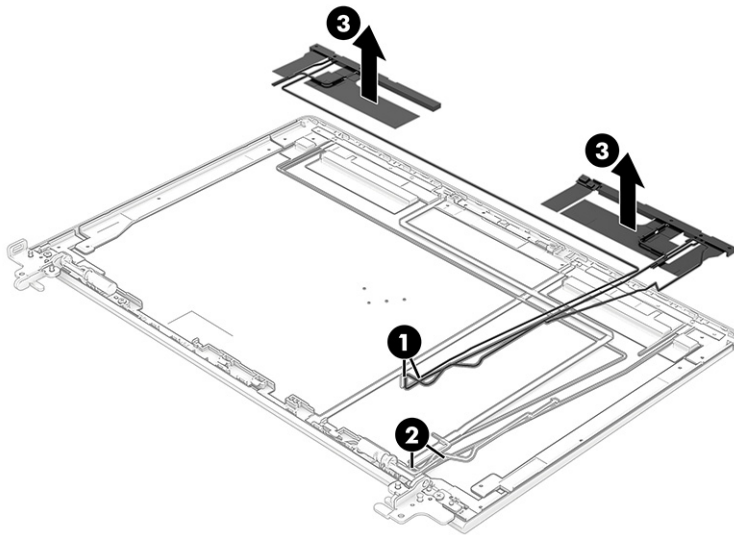

Display rear covers are available as the following spare part numbers:

N03209-001: Models with a 400 nit panel, without WWAN

N03210-001: Models with a 400 nit panel, with WWAN

N03211-001: Models with a 250 nit panel, without WWAN

N03212-001: Models with a 250 nit panel, with WWAN

Reverse this procedure to reassemble and replace the display assembly.

Top cover with keyboard (includes smart card board)

The top cover with keyboard remains after removing all other spare parts from the computer. In this section, the first table provides the main spare part number for the top cover/keyboards. The second table provides the country codes.

 **NOTE:** If replacing the smart card board, be sure to reinstall the smart card brackets.

Table 6-13 Top cover with keyboard descriptions and part numbers

Description	Spare part number
Top cover with keyboard, backlit	N17712-001
Top cover with keyboard, not backlit	N17713-001

Table 6-14 Spare part country codes

For use in country or region	Spare part number	For use in country or region	Spare part number	For use in country or region	Spare part number
Belgium	-A41	Hungary	-211	Saudi Arabia	-171
Brazil	-201	Iceland	-DD1	Slovenia	-BA1

Table 6-14 Spare part country codes (continued)

For use in country or region	Spare part number	For use in country or region	Spare part number	For use in country or region	Spare part number
Bulgaria	-261	India	-D61	South Korea	-AD1
Chile	-161	Israel	-BB1	Spain	-071
Czech Republic/Slovakia	-FL1	Italy	-061	Switzerland	-BG1
Denmark	-081	Japan	-291	Taiwan	-AB1
Denmark, Finland, and Norway	-DH1	The Netherlands	-B31	Thailand	-281
French Canada	-DB1	Northern Africa	-FP1	Turkey	-141
Finland/Sweden	-B71	Norway	-091	Turkey-F	-541
France	-051	Portugal	-131	Ukraine	-BD1
Germany	-041	Romania	-271	United Kingdom	-031
Greece	-151	Russia	-251	United States	-001

7 Computer Setup (BIOS), TPM, and HP Sure Start

HP provides several tools to help set up and protect your computer.

Using Computer Setup

Computer Setup, or Basic Input/Output System (BIOS), controls communication between all the input and output devices on the system (such as hard drives, display, keyboard, mouse, and printer). Computer Setup includes settings for types of devices installed, the startup sequence of the computer, and amount of system and extended memory.

 **NOTE:** Use extreme care when making changes in Computer Setup. Errors can prevent the computer from operating properly.

To start Computer Setup, turn on or restart the computer, and when the HP logo appears, press **f10** to enter Computer Setup.

Navigating and selecting in Computer Setup

You can navigate and select in Computer Setup using one or more methods.

- To select a menu or a menu item, use the **tab** key and the keyboard arrow keys and then press **enter**, or use a pointing device to select the item.
- To scroll up and down, select the up arrow or the down arrow in the upper-right corner of the screen, or use the up arrow key or the down arrow key on the keyboard.
- To close open dialog boxes and return to the main Computer Setup screen, press **esc**, and then follow the on-screen instructions.

To exit Computer Setup, choose one of the following methods:

- To exit Computer Setup menus without saving your changes, select **Main**, select **Ignore Changes and Exit**, and then select **Yes**.

 **NOTE:** If you are using arrow keys to highlight your choice, you must then press **enter**.

- To save your changes and exit Computer Setup menus, select **Main**, select **Save Changes and Exit**, and then select **Yes**.

 **NOTE:** If you are using arrow keys to highlight your choice, you must then press **enter**.

Your changes go into effect when the computer restarts.

Restoring factory settings in Computer Setup

To return all settings in Computer Setup to the values that were set at the factory, follow these steps.

 **NOTE:** Restoring defaults will not change the hard drive mode.

1. Start Computer Setup. See [Using Computer Setup on page 75](#).
2. Select **Main**, select **Apply Factory Defaults and Exit**, and then select **Yes**.

 **NOTE:** If you are using arrow keys to highlight your choice, you must then press **enter**.

 **NOTE:** On select products, the selections might display **Restore Defaults** instead of **Apply Factory Defaults and Exit**.

Your changes go into effect when the computer restarts.

 **NOTE:** Your password settings and security settings are not changed when you restore the factory settings.

Updating the BIOS

Updated versions of the BIOS might be available on the HP website. Most BIOS updates on the HP website are packaged in compressed files called *SoftPaqs*.

Some download packages contain a file named *Readme.txt*, which contains information regarding installing and troubleshooting the file.

Determining the BIOS version

To decide whether you need to update Computer Setup (BIOS), first determine the BIOS version on your computer.

If you are already in Windows, you can access BIOS version information (also known as *ROM date* and *System BIOS*) by pressing **fn+esc** (select products only). Or you can use Computer Setup.

1. Start Computer Setup. See [Using Computer Setup on page 75](#).
2. Select **Main**, and then select **System Information**.
3. To exit Computer Setup menus without saving your changes, select **Main**, select **Ignore Changes and Exit**, and then select **Yes**.

 **NOTE:** If you are using arrow keys to highlight your choice, you must then press **enter**.

To check for later BIOS versions, see [Preparing for a BIOS update on page 76](#).

Preparing for a BIOS update

Be sure to follow all prerequisites before downloading and installing a BIOS update.

 **IMPORTANT:** To reduce the risk of damage to the computer or an unsuccessful installation, download and install a BIOS update only when the computer is connected to reliable external power using the AC adapter. Do not download or install a BIOS update while the computer is running on battery power, docked in an optional docking device, or connected to an optional power source. During the download and installation, follow these instructions:

Do not disconnect power on the computer by unplugging the power cord from the AC outlet.

Do not shut down the computer or initiate Sleep.

Do not insert, remove, connect, or disconnect any device, cable, or cord.

Downloading a BIOS update

After you review the prerequisites, you can check for and download BIOS updates.

1. Select the **Search** icon (select products only) from the taskbar, type `support`, and then select the HP Support Assistant app.
– or –
Select the question mark icon (select products only) in the taskbar.
2. Select **Updates**, and then select **Check for updates and messages**.
3. Follow the on-screen instructions.
4. At the download area, follow these steps:
 - a. Identify the most recent BIOS update and compare it to the BIOS version currently installed on your computer. Make a note of the date, name, or other identifier. You might need this information to locate the update later, after it has been downloaded to your hard drive.
 - b. Follow the on-screen instructions to download your selection to the hard drive.

Make a note of the path to the location on your hard drive where the BIOS update is downloaded. You will need to access this path when you are ready to install the update.



NOTE: If you connect your computer to a network, consult the network administrator before installing any software updates, especially system BIOS updates.

Installing a BIOS update

BIOS installation procedures vary. Follow any instructions that are displayed on the screen after the download is complete. If no instructions are displayed, follow these steps.

1. Select the **Search** icon (select products only) from the taskbar, type `file`, and then select **File Explorer**.
2. Select your hard drive designation. The hard drive designation is typically Local Disk (C:).
3. Using the hard drive path you recorded earlier, open the folder that contains the update.
4. Double-click the file that has an `.exe` extension (for example, `filename.exe`).

The BIOS installation begins.
5. Complete the installation by following the on-screen instructions.



NOTE: After a message on the screen reports a successful installation, you can delete the downloaded file from your hard drive.

Changing the boot order using the f9 prompt

To dynamically choose a boot device for the current startup sequence, follow these steps.

1. Access the Boot Device Options menu:
 - Turn on or restart the computer, and when the HP logo appears, press **f9** to enter the Boot Device Options menu.
2. Select a boot device, press `enter`, and then follow the on-screen instructions.

TPM BIOS settings (select products only)

TPM provides additional security for your computer. You can modify the TPM settings in Computer Setup (BIOS).

 **IMPORTANT:** Before enabling Trusted Platform Module (TPM) functionality on this system, you must ensure that your intended use of TPM complies with relevant local laws, regulations and policies, and approvals or licenses must be obtained if applicable. For any compliance issues arising from your operation or usage of TPM that violates the previously mentioned requirement, you shall bear all the liabilities wholly and solely. HP will not be responsible for any related liabilities.

 **NOTE:** If you change the TPM setting to Hidden, TPM is not visible in the operating system.

To access TPM settings in Computer Setup:

1. Start Computer Setup. See [Using Computer Setup on page 75](#).
2. Select **Security**, select **TPM Embedded Security**, and then follow the on-screen instructions.

Using HP Sure Start (select products only)

Select computer models are configured with HP Sure Start, a technology that monitors the computer's BIOS for attacks or corruption. If the BIOS becomes corrupted or is attacked, HP Sure Start automatically restores the BIOS to its previously safe state, without user intervention.

HP Sure Start is configured and already enabled so that most users can use the HP Sure Start default configuration. Advanced users can customize the default configuration.

To access the latest documentation on HP Sure Start, go to <http://www.hp.com/support>. Select **Find your product**, and then follow the on-screen instructions.

8 Backing up, restoring, and recovering

You can use Windows tools or HP software to back up your information, create a restore point, reset your computer, create recovery media, or restore your computer to its factory state. Performing these standard procedures can return your computer to a working state faster.

 **IMPORTANT:** If you will be performing recovery procedures on a tablet, the tablet battery must be at least 70% charged before you start the recovery process.

 **IMPORTANT:** For a tablet with a detachable keyboard, connect the tablet to the keyboard base before beginning any recovery process.

Backing up information and creating recovery media

These methods of creating recovery media and backups are available on select products only.

Using Windows tools for backing up

HP recommends that you back up your information immediately after initial setup. You can do this task either using Windows Backup locally with an external USB drive or using online tools.

 **IMPORTANT:** Windows is the only option that allows you to back up your personal information. Schedule regular backups to avoid information loss.

 **NOTE:** If computer storage is 32 GB or less, Microsoft® System Restore is disabled by default.

Using the HP Cloud Recovery Download Tool to create recovery media (select products only)

You can use the HP Cloud Recovery Download Tool to create HP Recovery media on a bootable USB flash drive.

For details:

▲ Go to <http://www.hp.com>, search for HP Cloud Recovery, and then select the result that matches the type of computer that you have.

 **NOTE:** If you cannot create recovery media yourself, contact support to obtain recovery discs. Go to <http://www.hp.com/support>, select your country or region, and then follow the on-screen instructions.

 **IMPORTANT:** HP recommends that you follow the [Restoring and recovery methods on page 80](#) to restore your computer before you obtain and use the HP recovery discs. Using a recent backup can return your machine to a working state sooner than using the HP recovery discs. After the system is restored, reinstalling all the operating system software released since your initial purchase can be a lengthy process.

Restoring and recovering your system

You have several tools available to recover your system both within and outside of Windows if the desktop cannot load.

HP recommends that you attempt to restore your system using the [Restoring and recovery methods on page 80](#).

Creating a system restore

System Restore is available in Windows. The System Restore software can automatically or manually create restore points, or snapshots, of the system files and settings on the computer at a particular point.

When you use System Restore, it returns your computer to its state at the time you made the restore point. Your personal files and documents should not be affected.

Restoring and recovery methods

After you run the first method, test to see whether the issue still exists before you proceed to the next method, which might now be unnecessary.

1. Run a Microsoft System Restore.
2. Run Reset this PC.



NOTE: The options **Remove everything** and then **Fully clean the drive** can take several hours to complete and leave no information on your computer. It is the safest way to reset your computer before you recycle it.

3. Recover using HP Recovery media. For more information, see [Recovering using HP Recovery media on page 80](#).

For more information about the first two methods, see the Get Help app:

Select the **Start** button, select **All apps** (select products only), select the **Get Help** app, and then enter the task you want to perform.



NOTE: You must be connected to the internet to access the Get Help app.

Recovering using HP Recovery media

You can use HP Recovery media to recover the original operating system and software programs that were installed at the factory. On select products, it can be created on a bootable USB flash drive using the HP Cloud Recovery Download Tool.

For details, see [Using the HP Cloud Recovery Download Tool to create recovery media \(select products only\) on page 79](#).



NOTE: If you cannot create recovery media yourself, contact support to obtain recovery discs. Go to <http://www.hp.com/support>, select your country or region, and then follow the on-screen instructions.

To recover your system:

- ▲ Insert the HP Recovery media, and then restart the computer.



NOTE: HP recommends that you follow the [Restoring and recovery methods on page 80](#) to restore your computer before you obtain and use the HP recovery discs. Using a recent backup can return your machine to a working state sooner than using the HP recovery discs. After the system is restored, reinstalling all the operating system software released since your initial purchase can be a lengthy process.

Changing the computer boot order

If your computer does not restart using the HP Recovery media, you can change the computer boot order, the order of devices listed in BIOS for startup information. You can select an optical drive or a USB flash drive, depending on the location of your HP Recovery media.

 **IMPORTANT:** For a tablet with a detachable keyboard, connect the tablet to the keyboard base before beginning these steps.

To change the boot order:

1. Insert the HP Recovery media.
2. Access the system **Startup** menu.
 - For computers or tablets with keyboards attached, turn on or restart the computer or tablet, quickly press **esc**, and then press **f9** for boot options.
 - For tablets without keyboards, turn on or restart the tablet, quickly press and hold the volume up button, and then select **f9**.

– or –

Turn on or restart the tablet, quickly press and hold the volume down button, and then select **f9**.
3. Select the optical drive or USB flash drive from which you want to boot, and then follow the on-screen instructions.

Using HP Sure Recover (select products only)

Select computer models are configured with HP Sure Recover, a PC operating system (OS) recovery solution built into the hardware and software. HP Sure Recover can fully restore the HP OS image without installed recovery software.

Using HP Sure Recover, an administrator or user can restore the system and install:

- Latest version of the operating system
- Platform-specific device drivers
- Software applications, in the case of a custom image

To access the latest documentation for HP Sure Recover, go to <http://www.hp.com/support>. Follow the on-screen instructions to find your product and locate your documentation.

9 Using HP PC Hardware Diagnostics

You can use the HP PC Hardware Diagnostics utility to determine whether your computer hardware is running properly. The three versions are HP PC Hardware Diagnostics Windows, HP PC Hardware Diagnostics UEFI (Unified Extensible Firmware Interface), and (for select products only) Remote HP PC Hardware Diagnostics UEFI, a firmware feature.

Using HP PC Hardware Diagnostics Windows (select products only)

HP PC Hardware Diagnostics Windows is a Windows-based utility that allows you to run diagnostic tests to determine whether the computer hardware is functioning properly. The tool runs within the Windows operating system to diagnose hardware failures.

If HP PC Hardware Diagnostics Windows is not installed on your computer, first you must download and install it. To download HP PC Hardware Diagnostics Windows, see [Downloading HP PC Hardware Diagnostics Windows on page 83](#).

Using an HP PC Hardware Diagnostics Windows hardware failure ID code

When HP PC Hardware Diagnostics Windows detects a failure that requires hardware replacement, a 24-digit failure ID code is generated for select component tests. For interactive tests, such as keyboard, mouse, or audio and video palette, you must perform troubleshooting steps before you can receive a failure ID.

- ▲ You have several options after you receive a failure ID:
 - Select **Next** to open the Event Automation Service (EAS) page, where you can log the case.
– or –
 - Scan the QR code with your mobile device, which takes you to the EAS page, where you can log the case.
– or –
 - Select the box next to the 24-digit failure ID to copy your failure code and send it to support.

Accessing HP PC Hardware Diagnostics Windows

After HP PC Hardware Diagnostics Windows is installed, you can access it from HP Support Assistant or the Start menu.

Accessing HP PC Hardware Diagnostics Windows from HP Help and Support (select products only)

After HP PC Hardware Diagnostics Windows is installed, follow these steps to access it from HP Help and Support.

1. Select the **Start** button, and then select **HP Help and Support**.
2. Select **HP PC Hardware Diagnostics Windows**.
3. When the tool opens, select the type of diagnostic test that you want to run, and then follow the on-screen instructions.



NOTE: To stop a diagnostic test, select **Cancel**.

Accessing HP PC Hardware Diagnostics Windows from HP Support Assistant

After HP PC Hardware Diagnostics Windows is installed, follow these steps to access it from HP Support Assistant.

1. Select the **Search** icon (select products only) from the taskbar, type `support`, and then select **HP Support Assistant**.

– or –
Select the question mark icon (select products only) in the taskbar.
2. Select **Troubleshooting and fixes** (select products only) or **Fixes & Diagnostics**.
3. Select **Diagnostics**, and then select **HP PC Hardware Diagnostics Windows**.
4. When the tool opens, select the type of diagnostic test that you want to run, and then follow the on-screen instructions.



NOTE: To stop a diagnostic test, select **Cancel**.

Accessing HP PC Hardware Diagnostics Windows from the Start menu (select products only)

After HP PC Hardware Diagnostics Windows is installed, follow these steps to access it from the Start menu.

1. Select the **Start** button, and then select **All apps** (select products only).
2. Select **HP PC Hardware Diagnostics Windows**.
3. When the tool opens, select the type of diagnostic test that you want to run, and then follow the on-screen instructions.



NOTE: To stop a diagnostic test, select **Cancel**.

Downloading HP PC Hardware Diagnostics Windows

The HP PC Hardware Diagnostics Windows downloading instructions are provided in English only. You must use a Windows computer to download this tool because only .exe files are provided.

Downloading the latest HP PC Hardware Diagnostics Windows version from HP

To download HP PC Hardware Diagnostics Windows from HP, follow these steps.

1. Go to <http://www.hp.com/go/techcenter/pcdiags>. The HP PC Diagnostics home page is displayed.
2. Select **Download HP Diagnostics Windows**, and then select the specific Windows diagnostics version to download to your computer or a USB flash drive.

The tool downloads to the selected location.

Downloading the HP PC Hardware Diagnostics Windows from the Microsoft Store

You can download the HP PC Hardware Diagnostics Windows from the Microsoft Store.

1. Select the Microsoft Store app on your desktop.
– or –
Select the **Search** icon (select products only) in the taskbar, and then type `Microsoft Store`.
2. Enter `HP PC Hardware Diagnostics Windows` in the **Microsoft Store** search box.
3. Follow the on-screen directions.

The tool downloads to the selected location.

Downloading HP Hardware Diagnostics Windows by product name or number (select products only)

You can download HP PC Hardware Diagnostics Windows by product name or number.



NOTE: For some products, you might have to download the software to a USB flash drive by using the product name or number.

1. Go to <http://www.hp.com/support>.
2. Select **Software and Drivers**, select your type of product, and then enter the product name or number in the search box that is displayed.
3. In the **Diagnostics** section, select **Download**, and then follow the on-screen instructions to select the specific Windows diagnostics version to be downloaded to your computer or USB flash drive.

The tool downloads to the selected location.

Installing HP PC Hardware Diagnostics Windows

To install HP PC Hardware Diagnostics Windows, navigate to the folder on your computer or the USB flash drive where the .exe file downloaded, double-click the .exe file, and then follow the on-screen instructions.

Using HP PC Hardware Diagnostics UEFI

HP PC Hardware Diagnostics UEFI (Unified Extensible Firmware Interface) allows you to run diagnostic tests to determine whether the computer hardware is functioning properly. The tool runs outside the operating system so that it can isolate hardware failures from issues that are caused by the operating system or other software components.



NOTE: For some products, you must use a Windows computer and a USB flash drive to download and create the HP UEFI support environment because only .exe files are provided. For more information, see [Downloading HP PC Hardware Diagnostics UEFI to a USB flash drive on page 85](#).

If your PC does not start in Windows, you can use HP PC Hardware Diagnostics UEFI to diagnose hardware issues.

Using an HP PC Hardware Diagnostics UEFI hardware failure ID code

When HP PC Hardware Diagnostics UEFI detects a failure that requires hardware replacement, a 24-digit failure ID code is generated.

For assistance in solving the problem:

- ▲ Select **Contact HP**, accept the HP privacy disclaimer, and then use a mobile device to scan the failure ID code that appears on the next screen. The HP Customer Support - Service Center page appears with your failure ID and product number automatically filled in. Follow the on-screen instructions.

– or –

Contact support, and provide the failure ID code.

 **NOTE:** To start diagnostics on a convertible computer, your computer must be in notebook mode, and you must use the attached keyboard.

 **NOTE:** If you need to stop a diagnostic test, press `esc`.

Starting HP PC Hardware Diagnostics UEFI

To start HP PC Hardware Diagnostics UEFI, follow this procedure.

1. Turn on or restart the computer, and quickly press `esc`.
2. Press `f2`.

The BIOS searches three places for the diagnostic tools, in the following order:

- a. Connected USB flash drive

 **NOTE:** To download the HP PC Hardware Diagnostics UEFI tool to a USB flash drive, see [Downloading the latest HP PC Hardware Diagnostics UEFI version on page 85](#).

- b. Hard drive

- c. BIOS

3. When the diagnostic tool opens, select a language, select the type of diagnostic test you want to run, and then follow the on-screen instructions.

Downloading HP PC Hardware Diagnostics UEFI to a USB flash drive

Downloading HP PC Hardware Diagnostics UEFI to a USB flash drive can be useful in some situations.

- HP PC Hardware Diagnostics UEFI is not included in the preinstallation image.
- HP PC Hardware Diagnostics UEFI is not included in the HP Tool partition.
- The hard drive is damaged.

 **NOTE:** The HP PC Hardware Diagnostics UEFI downloading instructions are provided in English only, and you must use a Windows computer to download and create the HP UEFI support environment because only `.exe` files are provided.

Downloading the latest HP PC Hardware Diagnostics UEFI version

To download the latest HP PC Hardware Diagnostics UEFI version to a USB flash drive, follow this procedure.

1. Go to <http://www.hp.com/go/techcenter/pcdiags>. The HP PC Diagnostics home page is displayed.
2. Select **Download HP Diagnostics UEFI**, and then select **Run**.

Downloading HP PC Hardware Diagnostics UEFI by product name or number (select products only)

You can download HP PC Hardware Diagnostics UEFI by product name or number (select products only) to a USB flash drive.

 **NOTE:** For some products, you might have to download the software to a USB flash drive by using the product name or number.

1. Go to <http://www.hp.com/support>.
2. Enter the product name or number, select your computer, and then select your operating system.
3. In the **Diagnostics** section, follow the on-screen instructions to select and download the specific UEFI Diagnostics version for your computer.

Using Remote HP PC Hardware Diagnostics UEFI settings (select products only)

Remote HP PC Hardware Diagnostics UEFI is a firmware (BIOS) feature that downloads HP PC Hardware Diagnostics UEFI to your computer. It can then execute the diagnostics on your computer, and it might upload results to a preconfigured server.

For more information about Remote HP PC Hardware Diagnostics UEFI, go to <http://www.hp.com/go/techcenter/pcdiags>, and then select **Find out more**.

Downloading Remote HP PC Hardware Diagnostics UEFI

HP Remote PC Hardware Diagnostics UEFI is also available as a SoftPaq that you can download to a server.

Downloading the latest Remote HP PC Hardware Diagnostics UEFI version

You can download the latest HP PC Hardware Diagnostics UEFI version to a USB flash drive.

1. Go to <http://www.hp.com/go/techcenter/pcdiags>. The HP PC Diagnostics home page is displayed.
2. Select **Download Remote Diagnostics**, and then select **Run**.

Downloading Remote HP PC Hardware Diagnostics UEFI by product name or number

You can download HP Remote PC Hardware Diagnostics UEFI by product name or number.

 **NOTE:** For some products, you might have to download the software by using the product name or number.

1. Go to <http://www.hp.com/support>.
2. Select **Software and Drivers**, select your type of product, enter the product name or number in the search box that is displayed, select your computer, and then select your operating system.
3. In the **Diagnostics** section, follow the on-screen instructions to select and download the **Remote UEFI** version for the product.

Customizing Remote HP PC Hardware Diagnostics UEFI settings

Using the Remote HP PC Hardware Diagnostics setting in Computer Setup (BIOS), you can perform several customizations.

- Set a schedule for running diagnostics unattended. You can also start diagnostics immediately in interactive mode by selecting **Execute Remote HP PC Hardware Diagnostics**.
- Set the location for downloading the diagnostic tools. This feature provides access to the tools from the HP website or from a server that has been preconfigured for use. Your computer does not require the traditional local storage (such as a hard drive or USB flash drive) to run remote diagnostics.
- Set a location for storing the test results. You can also set the user name and password that you use for uploads.
- Display status information about the diagnostics run previously.

To customize Remote HP PC Hardware Diagnostics UEFI settings, follow these steps:

1. Turn on or restart the computer, and when the HP logo appears, press **f10** to enter Computer Setup.
2. Select **Advanced**, and then select **Settings**.
3. Make your customization selections.
4. Select **Main**, and then **Save Changes and Exit** to save your settings.

Your changes take effect when the computer restarts.

10 Specifications

This chapter provides specifications for your computer.

Computer specifications

This section provides specifications for your computer. When traveling with your computer, the computer dimensions and weights, as well as input power ratings and operating specifications, provide helpful information.

Table 10-1 Computer specifications

	Metric	U.S.
Dimensions		
Width	321.9 mm	12.67 in
Depth	213.9 mm	8.42 in
Height	19.95 mm	0.79 in
Weight	1.38 kg	3.04 lbs
Input power		
Operating voltage and current	19.5 V dc @ 2.31 A – 45 W	
	19.5 V dc @ 3.33 A – 65 W	
Temperature		
Operating	5°C to 35°C	41°F to 95°F
Nonoperating	–20°C to 60°C	–4°F to 140°F
Relative humidity (noncondensing)		
Operating	10% to 90%	
Nonoperating	5% to 95%	
Maximum altitude (unpressurized)		
Operating	–15 m to 3,048 m	–50 ft to 10,000 ft
Nonoperating	–15 m to 12,192 m	–50 ft to 40,000 ft
NOTE: Applicable product safety standards specify thermal limits for plastic surfaces. The device operates well within this range of temperatures.		

35.6 cm (14.0 in) display specifications

This section provides specifications for your display.

Table 10-2 Display specifications

	Metric	U.S.
Active diagonal size	39.6 cm	15.6 in
Resolution	1366 × 768 1920 × 1080	
Surface treatment	Antiglare	
Brightness	250 nits (45% CG panels) 400 nits (sRGB, 72% CG panels)	
Viewing angle	UWVA	
Backlight	LED	
Display panel interface	eDP	

Solid-state drive specifications

This section provides specifications for your solid-state drives.

Table 10-3 Solid-state drive specifications

	256 GB*	512 GB*	1 TB*
Dimensions			
Height	1.0 mm	1.0 mm	1.0 mm
Length	50.8 mm	50.8 mm	50.8 mm
Width	28.9 mm	28.9 mm	28.9 mm
Weight	< 10 g	< 10 g	< 10 g
Interface type			
Ready time, maximum (to not busy)	1.0 ms	< 1.0 ms	1.0 ms
Access times, logical	0.1 ms	0.1 ms	0.1 ms
Transfer rate			
Sequential read	up to 2150 MB/s	up to 2150 MB/s	up to 2150 MB/s
Random read	Up to 300,000 IOPs	Up to 300,000 IOPs	Up to 300,000 IOPs
Sequential write	up to 1550 MB/s	up to 1550 MB/s	up to 1550 MB/s
Random write	Up to 100,000 IOPs	Up to 100,000 IOPs	Up to 100,000 IOPs
Total logical sectors	468,883,296	1,000,215,216	1,500,336,388
Operating temperature	0°C to 70°C (32°F to 158°F)		
*1 GB = 1 billion bytes when referring to hard drive storage capacity. Actual accessible capacity is less. Actual drive specifications might differ slightly.			
NOTE: Certain restrictions and exclusions apply. Contact support for details.			

11 Statement of memory volatility

For general information regarding nonvolatile memory in HP business computers, and to restore nonvolatile memory that can contain personal data after the system has been turned off and the hard drive has been removed, use these instructions.

HP business computer products that use Intel®-based or AMD®-based system boards contain volatile DDR memory. The amount of nonvolatile memory present in the system depends upon the system configuration. Intel-based and AMD-based system boards contain nonvolatile memory subcomponents as originally shipped from HP, with the following assumptions:

- No subsequent modifications were made to the system.
- No applications, features, or functionality were added to or installed on the system.

Following system shutdown and removal of all power sources from an HP business computer system, personal data can remain on volatile system memory (DIMMs) for a finite period of time and also remains in nonvolatile memory. Use the following steps to remove personal data from the computer, including the nonvolatile memory found in Intel-based and AMD-based system boards.

 **NOTE:** If your tablet has a keyboard base, connect to the keyboard base before beginning steps in this chapter.

Current BIOS steps

Use these instructions to restore nonvolatile memory.

1. Follow these steps to restore the nonvolatile memory that can contain personal data. Restoring or reprogramming nonvolatile memory that does not store personal data is neither necessary nor recommended.
 - a. Turn on or restart the computer, and then quickly press **esc**.

 **NOTE:** If the system has a BIOS administrator password, type the password at the prompt.

 - b. Select **Main**, select **Apply Factory Defaults and Exit**, and then select **Yes** to load defaults. The computer restarts.
 - c. During the restart, press **esc** while the "Press the ESC key for Startup Menu" message is displayed at the bottom of the screen.

 **NOTE:** If the system has a BIOS administrator password, type the password at the prompt.

 - d. Select the **Security** menu, select **Restore Security Settings to Factory Defaults**, and then select **Yes** to restore security level defaults. The computer reboots.
 - e. During the reboot, press **esc** while the "Press the ESC key for Startup Menu" message is displayed at the bottom of the screen.

 **NOTE:** If the system has a BIOS administrator password, type the password at the prompt.

- f. If an asset or ownership tag is set, select the **Security** menu and scroll down to the **Utilities** menu. Select **System IDs**, and then select **Asset Tracking Number**. Clear the tag, and then make the selection to return to the prior menu.
- g. If a DriveLock password is set, select the **Security** menu, and scroll down to **Hard Drive Utilities** under the **Utilities** menu. Select **Hard Drive Utilities**, select **DriveLock**, and then clear the check box for **DriveLock password on restart**. Select **OK** to proceed.
- h. Select the **Main** menu, and then select **Reset BIOS Security to factory default**. Select **Yes** at the warning message. The computer reboots.
- i. During the reboot, press **esc** while the "Press the ESC key for Startup Menu" message is displayed at the bottom of the screen.



NOTE: If the system has a BIOS administrator password, type the password at the prompt.

- j. Select the **Main** menu, select **Apply Factory Defaults and Exit**, select **Yes** to save changes and exit, and then select **Shutdown**.
 - k. Reboot the system. If the system has a Trusted Platform Module (TPM), fingerprint reader, or both, one or two prompts will appear—one to clear the TPM and the other to Reset Fingerprint Sensor. Press or tap **f1** to accept or **f2** to reject.
 - l. Remove all power and system batteries for at least 24 hours.
2. Complete one of the following:
- Remove and retain the storage drive.
– or –
 - Clear the drive contents by using a third-party utility designed to erase data from an SSD.
– or –
 - Clear the contents of the drive by using the following BIOS Setup Secure Erase command option steps:



NOTE: If you clear data using Secure Erase, you cannot recover it.

- a. Turn on or restart the computer, and then quickly press **esc**.
- b. Select the **Security** menu and scroll down to the **esc** menu.
- c. Select **Hard Drive Utilities**.
- d. Under **Utilities**, select **Secure Erase**, select the hard drive storing the data you want to clear, and then follow the on-screen instructions to continue.

– or –

Clear the contents of the drive using the following Disk Sanitizer commands steps:

- i. Turn on or restart the computer, and then quickly press **esc**.
- ii. Select the **Security** menu and scroll down to the **Utilities** menu.
- iii. Select **Hard Drive Utilities**.

- iv. Under **Utilities**, select **Disk Sanitizer**, select the hard drive with the data that you want to clear, and then follow the on-screen instructions to continue.

 **NOTE:** The amount of time it takes for Disk Sanitizer to run can take several hours. Plug the computer into an AC outlet before starting.

Nonvolatile memory usage

Use this table to troubleshooting nonvolatile memory usage.

Table 11-1 Troubleshooting steps for nonvolatile memory usage

Nonvolatile memory type	Amount (Size)	Does this memory store customer data?	Does this memory retain data when power is removed?	What is the purpose of this memory?	How is data entered into this memory?	How is this memory write-protected?
HP Sure Start flash (select models only)	8 MB	No	Yes	Provides protected backup of critical System BIOS code, EC firmware, and critical computer configuration data for select platforms that support HP Sure Start. For more information, see Using HP Sure Start (select products only) on page 97 .	Data cannot be written to this device via the host processor. The content is managed solely by the HP Sure Start Embedded Controller.	This memory is protected by the HP Sure Start Embedded Controller.
Real Time Clock (RTC) battery backed-up CMOS configuration memory	256 bytes	No	Yes	Stores system date and time and noncritical data.	RTC battery backed-up CMOS is programmed using Computer Setup (BIOS), or by changing the Windows date & time.	This memory is not write-protected.
Controller (NIC) EEPROM	64 KB (not customer accessible)	No	Yes	Stores NIC configuration and NIC firmware.	NIC EEPROM is programmed using a utility from the NIC vendor that can be run from DOS.	A utility must be used to write data to this memory and is available from the NIC vendor. Writing data to this ROM in an inappropriate manner will render the NIC nonfunctional.
DIMM Serial Presence Detect (SPD) configuration data	256 bytes per memory module, 128 bytes programmabl	No	Yes	Stores memory module information.	DIMM SPD is programmed by the memory vendor.	Data cannot be written to this memory when the module is installed in a computer. The specific

Table 11-1 Troubleshooting steps for nonvolatile memory usage (continued)

Nonvolatile memory type	Amount (Size)	Does this memory store customer data?	Does this memory retain data when power is removed?	What is the purpose of this memory?	How is data entered into this memory?	How is this memory write-protected?
						write-protection method varies by memory vendor.
System BIOS	9 MB	Yes	Yes	Stores system BIOS code and computer configuration data.	System BIOS code is programmed at the factory. Code is updated when the system BIOS is updated. Configuration data and settings are entered using the Computer Setup (BIOS) or a custom utility.	<p>NOTE: Writing data to this ROM in an inappropriate manner can render the computer nonfunctional.</p> <p>A utility must be used for writing data to this memory and is available on the HP website; go to http://www.hp.com/support. Select Find your product, and then follow the on-screen instructions.</p>
Intel Management Engine Firmware (present only in select Elite or Z models. For more information, go to http://www.hp.com/support . Select Identify your product for manuals and specific product information , and then follow the on-screen instructions.)	1.5 MB or 7 MB	Yes	Yes	Stores Management Engine Code, Settings, Provisioning Data and iAMT third-party data store.	Management Engine Code is programmed at the factory. Code is updated via Intel secure firmware update utility. Unique Provisioning Data can be entered at the factory or by an administrator using the Management Engine (MEBx) setup utility. The third-party data store contents can be populated by a remote management console or local applications that have been registered by an administrator to have access to the space.	The Intel chipset is configured to enforce hardware protection to block all direct read-write access to this area. An Intel utility must be used for updating the firmware. Only firmware updates digitally signed by Intel can be applied using this utility.
Bluetooth flash (select products only)	2 megabits	No	Yes	Stores Bluetooth configuration and firmware.	Bluetooth flash is programmed at the factory. Tools for writing data to this memory are not publicly available but can be obtained from the silicon vendor.	A utility must be used for writing data to this memory and is made available through newer versions of the driver whenever the flash requires an upgrade.
802.11 WLAN EEPROM	4 kilobits to 8 kilobits	No	Yes	Stores configuration and calibration data.	802.11 WLAN EEPROM is programmed at the factory. Tools for writing data to this memory are not made public.	A utility must be used for writing data to this memory and is typically not made available to the public unless a firmware upgrade is necessary to address a unique issue.

Table 11-1 Troubleshooting steps for nonvolatile memory usage (continued)

Nonvolatile memory type	Amount (Size)	Does this memory store customer data?	Does this memory retain data when power is removed?	What is the purpose of this memory?	How is data entered into this memory?	How is this memory write-protected?
Camera (select products only)	64 kilobits	No	Yes	Stores camera configuration and firmware.	Camera memory is programmed using a utility from the device manufacturer that can be run from Windows.	A utility must be used for writing data to this memory and is typically not made available to the public unless a firmware upgrade is necessary to address a unique issue.
Fingerprint reader (select products only)	512 KB flash	Yes	Yes	Stores fingerprint templates.	Fingerprint reader memory is programmed by user enrollment in HP ProtectTools Security Manager.	Only a digitally signed application can make the call to write to the flash.

Questions and answers

Use this section to answer your questions about nonvolatile memory.

1. How can the BIOS settings be restored (returned to factory settings)?

 **IMPORTANT:** The restore defaults feature does not securely erase any information on your hard drive. See question and answer 6 for steps to securely erase information.

The restore defaults feature does not reset the Custom Secure Boot keys. See question and answer 7 for information about resetting the keys.

- Turn on or restart the computer, and then quickly press *esc*.
- Select **Main**, and then select **Apply Factory Defaults and Exit**.
- Follow the on-screen instructions.
- Select **Main**, select **Save Changes and Exit**, and then follow the on-screen instructions.

2. What is a UEFI BIOS, and how is it different from a legacy BIOS?

The Unified Extensible Firmware Interface (UEFI) BIOS is an industry-standard software interface between the platform firmware and an operating system (OS). It replaces the older BIOS architecture but supports much of the legacy BIOS functionality.

Like the legacy BIOS, the UEFI BIOS provides an interface to display the system information and configuration settings and to change the configuration of your computer before an OS is loaded. BIOS provides a secure runtime environment that supports a Graphic User Interface (GUI). In this environment, you can use either a pointing device (touch screen, touchpad, pointing stick, or USB mouse) or the keyboard to navigate and make menu and configuration selections. The UEFI BIOS also contains basic system diagnostics.

The UEFI BIOS provides functionality beyond that of the legacy BIOS. In addition, the UEFI BIOS works to initialize the computer's hardware before loading and executing the OS; the runtime environment allows the loading and execution of software programs from storage devices to provide more functionality, such as advanced hardware diagnostics (with the ability to display more detailed system information) and advanced firmware management and recovery software.

HP has provided options in Computer Setup (BIOS) to allow you to run in legacy BIOS, if required by the operating system. Examples of this requirement would be if you upgrade or downgrade the OS.

3. Where is the UEFI BIOS located?

The UEFI BIOS is located on a flash memory chip. You must use a utility to write to the chip.

4. What kind of configuration data is stored on the DIMM Serial Presence Detect (SPD) memory module? How would this data be written?

The DIMM SPD memory contains information about the memory module, such as size, serial number, data width, speed and timing, voltage, and thermal information. This information is written by the module manufacturer and stored on an EEPROM. You cannot write to this EEPROM when the memory module is installed in a computer. Third-party tools do exist that can write to the EEPROM when the memory module is not installed in a computer. Various third-party tools are available to read SPD memory.

5. What is meant by “Restore the nonvolatile memory found in Intel-based system boards”?

This message relates to clearing the Real Time Clock (RTC) CMOS memory that contains computer configuration data.

6. How can the BIOS security be reset to factory defaults and erase the data?



IMPORTANT: Resetting results in the loss of information.

These steps do not reset Custom Secure Boot Keys. See question and answer 7 for information about resetting the keys.

- a. Turn on or restart the computer, and then quickly press **esc**.
- b. Select **Main**, and then select **Reset Security to Factory Defaults**.
- c. Follow the on-screen instructions.
- d. Select **Main**, select **Save Changes and Exit**, and then follow the on-screen instructions.

7. How can the Custom Secure Boot Keys be reset?

Secure Boot is a feature to ensure that only authenticated code can start on a platform. If you enabled Secure Boot and created Custom Secure Boot Keys, disabling Secure Boot does not clear the keys. You must also select to clear the Custom Secure Boot Keys. Use the same Secure Boot access procedure that you used to create the Custom Secure Boot Keys, but select to clear or delete all Secure Boot Keys.

- a. Turn on or restart the computer, and then quickly press **esc**.
- b. Select the **Security** menu, select **Secure Boot Configuration**, and then follow the on-screen instructions.
- c. At the **Secure Boot Configuration** window, select **Secure Boot**, select **Clear Secure Boot Keys**, and then follow the on-screen instructions to continue.

Using HP Sure Start (select products only)

Select computer models are configured with HP Sure Start, a technology that continuously monitors your computer's BIOS for attacks or corruption.

If the BIOS becomes corrupted or is attacked, HP Sure Start restores the BIOS to its previously safe state, without user intervention. Those select computer models ship with HP Sure Start configured and enabled. HP Sure Start is configured and already enabled so that most users can use the HP Sure Start default configuration. Advanced users can customize the default configuration.

To access the latest documentation on HP Sure Start, go to <http://www.hp.com/support>.

12 Power cord set requirements

This chapter provides power cord requirements for countries and regions.

The wide-range input feature of the computer permits it to operate from any line voltage from 100 V ac to 120 V ac, or from 220 V ac to 240 V ac.

The three-conductor power cord set included with the computer meets the requirements for use in the country or region where the equipment is purchased.

Power cord sets for use in other countries or regions must meet the requirements of the country and region where the computer is used.

Requirements for all countries

These power cord requirements are applicable to all countries and regions.

- The length of the power cord set must be at least **1.0 m** (3.3 ft) and no more than **2.0 m** (6.5 ft).
- All power cord sets must be approved by an acceptable accredited agency responsible for evaluation in the country or region where the power cord set will be used.
- The power cord sets must have a minimum current capacity of 10 A and a nominal voltage rating of 125 V ac or 250 V ac, as required by the power system of each country or region.
- The appliance coupler must meet the mechanical configuration of an EN 60 320/IEC 320 Standard Sheet C13 connector for mating with the appliance inlet on the back of the computer.

Requirements for specific countries and regions

To determine power cord requirements for specific countries and regions, use this table.

Table 12-1 Power cord requirements for specific countries and regions

Country/region	Accredited agency	Applicable note number
Argentina	IRAM	1
Australia	SAA	1
Austria	OVE	1
Belgium	CEBEC	1
Brazil	ABNT	1
Canada	CSA	2
Chile	IMQ	1
Denmark	DEMKO	1
Finland	FIMKO	1
France	UTE	1
Germany	VDE	1

Table 12-1 Power cord requirements for specific countries and regions (continued)

Country/region	Accredited agency	Applicable note number
India	BIS	1
Israel	SII	1
Italy	IMQ	1
Japan	JIS	3
Netherlands	KEMA	1
New Zealand	SANZ	1
Norway	NEMKO	1
People's Republic of China	CCC	4
Saudi Arabia	SASO	7
Singapore	PSB	1
South Africa	SABS	1
South Korea	KTL	5
Sweden	SEMKO	1
Switzerland	SEV	1
Taiwan	BSMI	6
Thailand	TISI	1
United Kingdom	ASTA	1
United States	UL	2

1. The flexible cord must be Type H05VV-F, three-conductor, 0.75 mm² conductor size. Power cord set fittings (appliance coupler and wall plug) must bear the certification mark of the agency responsible for evaluation in the country or region where it will be used.
2. The flexible cord must be Type SVT/SJT or equivalent, No. 18 AWG, three-conductor. The wall plug must be a two-pole grounding type with a NEMA 5-15P (15 A, 125 V ac) or NEMA 6-15P (15 A, 250 V ac) configuration. CSA or C-UL mark. UL file number must be on each element.
3. The appliance coupler, flexible cord, and wall plug must bear a T mark and registration number in accordance with the Japanese Dentori Law. The flexible cord must be Type VCTF, three-conductor, 0.75 mm² or 1.25 mm² conductor size. The wall plug must be a two-pole grounding type with a Japanese Industrial Standard C8303 (7 A, 125 V ac) configuration.
4. The flexible cord must be Type RVV, three-conductor, 0.75 mm² conductor size. Power cord set fittings (appliance coupler and wall plug) must bear the CCC certification mark.
5. The flexible cord must be Type H05VV-F three-conductor, 0.75 mm² conductor size. KTL logo and individual approval number must be on each element. Approval number and logo must be printed on a flag label.
6. The flexible cord must be Type HVCTF three-conductor, 1.25 mm² conductor size. Power cord set fittings (appliance coupler, cable, and wall plug) must bear the BSMI certification mark.
7. For 127 V ac, the flexible cord must be Type SVT or SJT 3-conductor, 18 AWG, with plug NEMA 5-15P (15 A, 125 V ac), with UL and CSA or C-UL marks. For 240 V ac, the flexible cord must be Type H05VV-F three-conductor, 0.75 mm² or 1.00 mm² conductor size, with plug BS 1363/A with BSI or ASTA marks.

13 Recycling

When a nonrechargeable or rechargeable battery has reached the end of its useful life, do not dispose of the battery in general household waste. Follow the local laws and regulations in your area for battery disposal.

HP encourages customers to recycle used electronic hardware, HP original print cartridges, and rechargeable batteries. For more information about recycling programs, see the HP website at <http://www.hp.com/recycle>.

Index

A

- AC adapters, spare part numbers 26
- audio-out (headphone)/audio-in (microphone) combo jack, identifying 6, 8
- audio, product description 2

B

- backup, creating 79
- backups 79
- battery
 - illustrated 22
 - spare part number 22
- battery light 7
- BIOS
 - determining version 76
 - downloading an update 76, 77
 - updating 76
- Bluetooth label 17
- boot order
 - changing using the f9 prompt 77
- boot order, changing 81
- bottom cover
 - illustrated 22
 - removal 41
 - spare part number 22, 41
- buttons
 - power 13, 14

C

- Cable Kit
 - spare part number 25
- camera 9
 - identifying 9
- camera light, identifying 9
- camera privacy cover, identifying 9
- caps lock light, identifying 11
- caring for your computer 36
- cautions
 - electrostatic discharge 32, 33
- cleaning your computer 36
 - caring for wood veneer 38
 - disinfecting 37
 - HP Easy Clean 36
 - removing dirt and debris 36

- components
 - bottom 15
 - display 9
 - keyboard area 10
 - left side 8
 - rear 16
 - right side 6
- computer major components 19
- Computer Setup
 - navigating and selecting 75
 - restoring factory settings 75
 - starting 75
- computer specifications 88
- connector, power 7, 8
- control zone 11

D

- display
 - specifications 88
- display assembly
 - subcomponents 23
- display back cover
 - illustrated 23, 25
 - spare part number 23, 25
- display bezel
 - illustrated 23, 24
 - spare part number 23, 24
- display cable
 - illustrated 23, 25
 - spare part number 23, 25
- display components 9
- display panel
 - illustrated 23, 25
 - product description 1
 - spare part number 23, 25

E

- electrostatic discharge (ESD) 32, 33
 - preventing damage 32-34
- esc key, identifying 14

F

- fan
 - illustrated 21
 - removal 57
 - spare part number 21, 57

- fingerprint reader
 - illustrated 23
 - spare part number 23
- fingerprint reader board
 - removal 58
 - spare part numbers 58
- fingerprint reader, identifying 14
- fn key, identifying 14
- fn lock light, identifying 11

G

- graphics, product description 1
- grounding methods 32-34
- guidelines
 - packaging 32, 38
 - transporting 32, 38
 - workstation 32

H

- hard drive
 - product description 2
 - specifications 88
- heat sink
 - removal 59
 - spare part numbers 59
- hinge
 - illustrated 23, 25
 - spare part number 23, 25
- HP PC Hardware Diagnostics UEFI
 - downloading 85
 - failure ID code 84
 - starting 85
 - using 84
- HP PC Hardware Diagnostics Windows
 - accessing 82, 83
 - downloading 83
 - failure ID code 82
 - installing 84
 - using 82
- HP Recovery media
 - recovery 80
- HP Sure Recover 81
- HP Sure Start 91, 97
- HP Tamper Lock 18

- I**
- I/O board
 - illustrated 22
 - removal 53
 - spare part number 22, 53
- illustrated parts catalog 19
- integrated numeric keypad, identifying 15
- internal microphones, identifying 9
- J**
- jacks
 - audio-out (headphone)/audio-in (microphone) combo 6, 8
 - network 8
 - RJ-45 (network) 8
- K**
- keyboard
 - product description 3
- keypad
 - integrated numeric 15
- keys
 - esc 14
 - fn 14
 - num lk 15
 - Windows 14
- L**
- labels
 - Bluetooth 17
 - regulatory 17
 - serial number 17
 - service 17
 - wireless certification 17
 - WLAN 17
- left control zone, identifying 11
- left side components 8
- lights
 - AC adapter and battery 7
 - battery 7
 - camera 9
 - caps lock 11
 - fn lock 11
 - microphone mute 11
 - num lk 11
 - power 11
 - privacy key 11
 - RJ-45 (network) 8
- low blue light mode 9
- M**
- memory
 - nonvolatile 91
 - volatile 91
- memory module
 - illustrated 22
 - product description 1
 - spare part number 22
- memory modules
 - removal 43
 - spare part numbers 43
- microphone
 - product description 2
- microphone mute light, identifying 11
- model name 1
- N**
- network jack, identifying 8
- NFC module
 - removal 55
 - spare part number 55
- nonvolatile memory 91
- num lk light 11
- O**
- operating system, product description 4
- P**
- packaging guidelines 32, 38
- Plastics Kit, spare part number 26, 27
- pointing device, product description 3
- ports
 - product description 3
 - USB SuperSpeed 5 Gbps 7, 8
 - USB SuperSpeed 5 Gbps port with HP Sleep and Charge 7
 - USB SuperSpeed Plus 8
 - USB Type-C DisplayPort 7
 - USB Type-C power connector 7
 - USB Type-C power connector and Thunderbolt port with HP Sleep and Charge 7
 - USB Type-C SuperSpeed 10 Gbps 7
- power button, identifying 13, 14
- power connector
 - identifying 7, 8
 - identifying USB Type-C 7
- power connector cable
 - illustrated 20
 - removal 64
 - spare part number 20, 64
- power cord
 - requirements for all countries 98
 - requirements for specific countries and regions 98
 - set requirements 98
- power cords, spare part numbers 26, 28, 31
- power lights 11
- power requirements, product description 3
- primary storage
 - product description 2
- privacy key light 11
- processor
 - product description 1
- product description
 - audio 2
 - display panel 1
 - graphics 1
 - hard drive 2
 - keyboard 3
 - memory module 1
 - microphone 2
 - operating system 4
 - pointing device 3
 - ports 3
 - power requirements 3
 - primary storage 2
 - processors 1
 - product name 1
 - RJ-45 (network) jack 2
 - security 4
 - sensors 3
 - serviceability 5
 - solid-state drive 2
 - video 2
 - wireless 2
- product name 1
- product name and number, computer 17
- R**
- recovery 79
 - discs 80
 - media 80
 - USB flash drive 80
- recovery media 79
 - creating using HP Cloud Recovery Download Tool 79

- creating using Windows
 - tools 79
- regulatory information
 - regulatory label 17
 - wireless certification labels 17
- Remote HP PC Hardware Diagnostics
 - UEFI settings
 - customizing 86
 - using 86
- removal and replacement
 - procedures 41, 51
 - solid-state drive 48
- removing personal data from
 - volatile system memory 91
- restoring 79
- restoring and recovery methods 80
- right control zone, identifying 11
- right side components 6
- RJ-45 (network) jack, identifying 8
- RJ-45 (network) jack, product
 - description 2
- RJ-45 (network) lights,
 - identifying 8
- RTC battery
 - illustrated 22
 - spare part number 22
- Rubber Kit, spare part number 26

S

- Screw Kit, spare part number 26
- security cable slot, identifying 8
- security, product description 4
- sensors
 - product description 3
- serial number, computer 17
- service labels, locating 17
- serviceability, product
 - description 5
- setup utility
 - navigating and selecting 75
 - restoring factory settings 75
- SIM card, correct size 43
- SIM card, inserting 42, 43
- SIM slot, identifying 6
- slots
 - security cable 8
 - SIM card 6
 - smart card 8
- smart card reader
 - removal 56
 - spare part numbers 56
- smart card slot, identifying 8
- solid-state drive
 - illustrated 22

- product description 2
- removal and replacement 48
- spare part number 22
- specifications 89
- spare part country codes 73
- speaker
 - illustrated 21
 - spare part number 21
- speakers
 - removal 63
 - spare part numbers 63
- speakers, identifying 13
- special keys, using 14
- specifications
 - computer 88
 - display 88
 - hard drive 88
 - solid-state drive 89
- static electricity 32, 33
- support information 38
- Sure Start
 - using 78
- system board
 - illustrated 21
 - removal 60
 - spare part number 21
 - spare part numbers 60
- system memory, removing personal
 - data from volatile 91
- system restore 80
- system restore point, creating 79

T

- Tile 18
- top cover with keyboard
 - illustrated 20
 - spare part numbers 20, 73
- touchpad
 - illustrated 20
 - removal 54
 - settings 10
 - spare part number 20, 54
- touchpad zone, identifying 11
- TPM settings 78
- transporting guidelines 32, 38
- traveling with the computer 17

U

- USB SuperSpeed 5 Gbps port with HP
 - Sleep and Charge, identifying 7
- USB SuperSpeed 5 Gbps port,
 - identifying 7
- USB SuperSpeed 5 Gbps powered
 - port, identifying 8

- USB SuperSpeed Plus port,
 - identifying 8
- USB SuperSpeed powered port,
 - identifying 8
- USB Type-C power connector and
 - Thunderbolt port with HP Sleep
 - and Charge, identifying 7
- USB Type-C power connector port,
 - identifying 7
- USB Type-C SuperSpeed 10 Gbps
 - port, identifying 7

V

- vents, identifying 16
- video, product description 2

W

- Windows
 - backup 79
 - recovery media 79
 - system restore point 79
- Windows key, identifying 14
- Windows tools, using 79
- wireless antennas
 - illustrated 23, 25
 - spare part number 23, 25
- wireless antennas, identifying 9
- wireless certification label 17
- wireless, product description 2
- WLAN antennas, identifying 9
- WLAN device 17
- WLAN label 17
- WLAN module
 - illustrated 23
 - removal 45
 - spare part number 23
 - spare part numbers 45
- workstation guidelines 32
- WWAN antennas, identifying 9
- WWAN module
 - removal 47
 - spare part numbers 47