

# TC52x/TC57x 触发开关把手 安装指南

## 功能

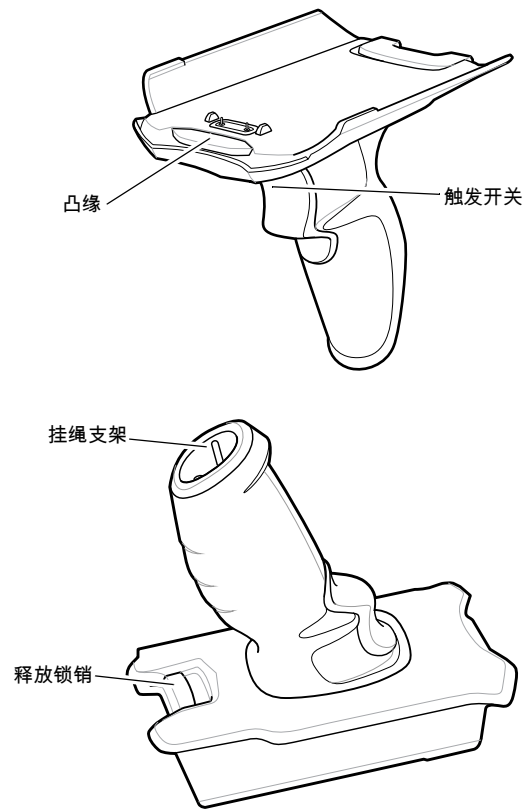

## 坚固橡胶套安装



注意：如果安装了手提带，请在安装橡胶套前先将手提带拆下。

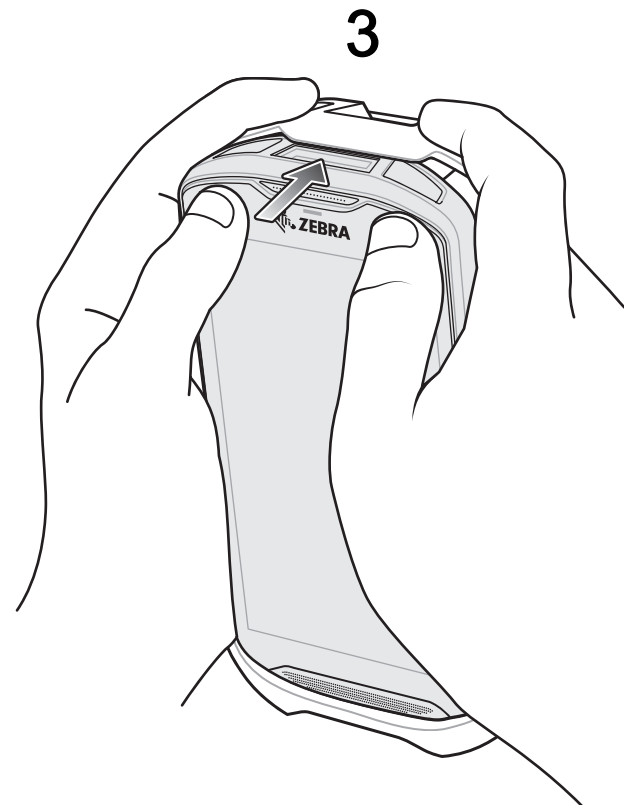
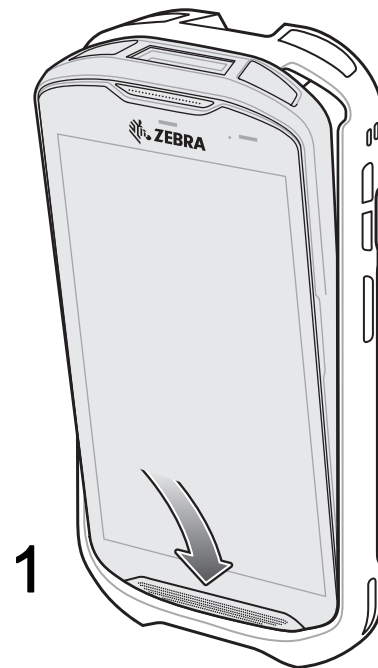

MN-004007-01ZHCN — 2020 年 7 月 28 日

Zebra Technologies | 3 Overlook Point | Lincolnshire, IL 60069 USA  
www.zebra.com

ZEBRA 和标志性的 Zebra 斑马头像是 Zebra Technologies Corp. 在全球许多司法管辖区内注册的商标。所有其他商标均为其各自所有者的财产。© 2020 Zebra Technologies Corp. 和/或其子公司。保留所有权利。



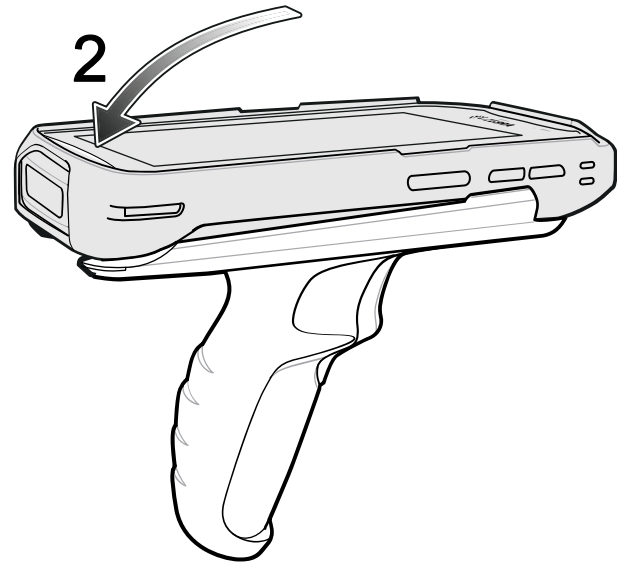
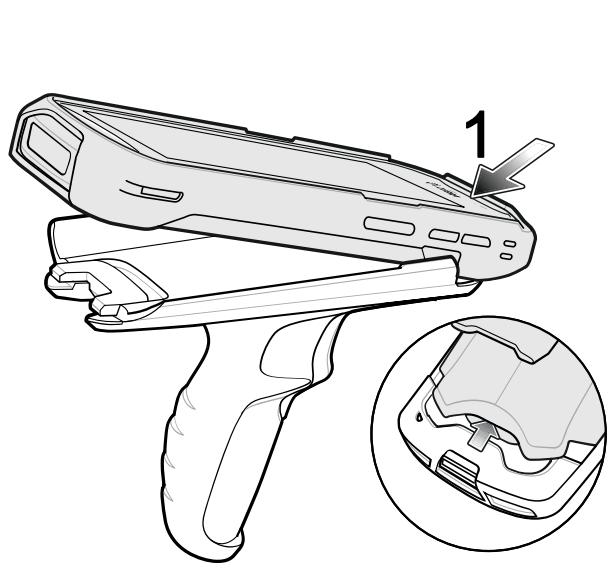

### 设备安装



### 充电



 注意：在安装到设备上之前，先将电缆杯中的垫片拆下。

 注意：在安装到设备上之前，先将通讯座杯中的垫片拆下。

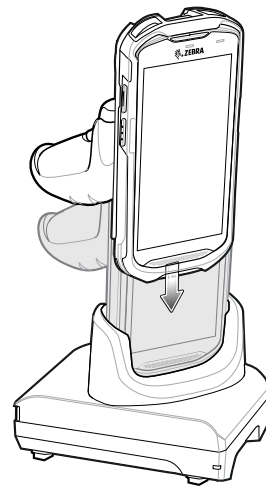

### 可选挂绳安装

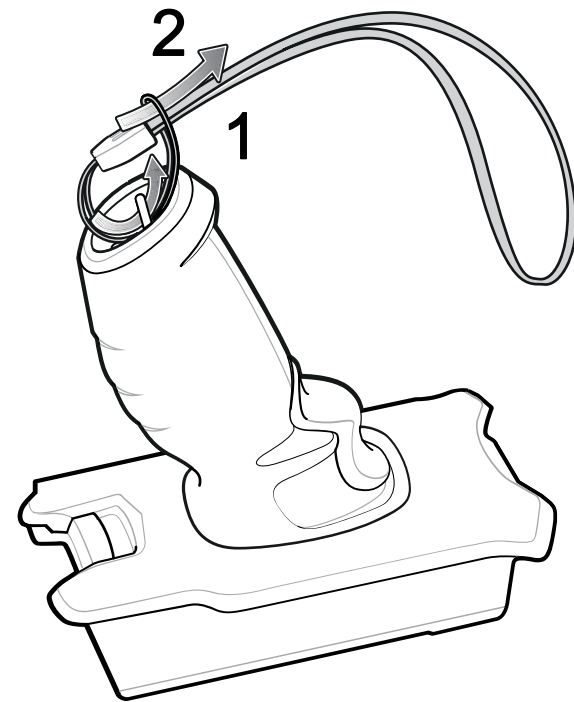

### 取下

