



FCC RADIO TEST REPORT

FCC ID : UZ7TC210K
Equipment : Touch computer
Brand Name : Zebra
Model Name : TC210K
Applicant : Zebra Technologies Corporation
1 Zebra Plaza, Holtsville, NY 11742
Manufacturer : Zebra Technologies Corporation
1 Zebra Plaza, Holtsville, NY 11742
Standard : FCC Part 15 Subpart E §15.407

The product was received on Jan. 20, 2020 and testing was started from Jan. 22, 2020 and completed on Feb. 28, 2020. We, SPORTON INTERNATIONAL INC., EMC & Wireless Communications Laboratory, would like to declare that the tested sample has been evaluated in accordance with the test procedures and has been in compliance with the applicable technical standards.

The report must not be used by the client to claim product certification, approval, or endorsement by TAF or any agency of government.

The test results in this report apply exclusively to the tested model / sample. Without written approval of SPORTON INTERNATIONAL INC. EMC & Wireless Communications Laboratory, the test report shall not be reproduced except in full.

Louis Wu

Approved by: Louis Wu

SPORTON INTERNATIONAL INC. EMC & Wireless Communications Laboratory

No. 52, Huaya 1st Rd., Guishan Dist., Taoyuan City, Taiwan (R.O.C.)



Table of Contents

History of this test report.....	3
Summary of Test Result.....	4
1 General Description	5
1.1 Product Feature of Equipment Under Test.....	5
1.2 Product Specification of Equipment Under Test.....	6
1.3 Modification of EUT	6
1.4 Testing Location	7
1.5 Applicable Standards.....	7
2 Test Configuration of Equipment Under Test	8
2.1 Carrier Frequency and Channel	8
2.2 Test Mode.....	9
2.3 Connection Diagram of Test System.....	11
2.4 Support Unit used in test configuration and system	12
2.5 EUT Operation Test Setup	13
2.6 Measurement Results Explanation Example.....	13
3 Test Result	14
3.1 6dB and 26dB and 99% Occupied Bandwidth Measurement	14
3.2 Maximum Conducted Output Power Measurement	18
3.3 Power Spectral Density Measurement	20
3.4 Unwanted Emissions Measurement.....	22
3.5 AC Conducted Emission Measurement.....	27
3.6 Automatically Discontinue Transmission	29
3.7 Antenna Requirements.....	30
4 List of Measuring Equipment.....	31
5 Uncertainty of Evaluation.....	33
Appendix A. AC Conducted Emission Test Result	
Appendix B. Radiated Spurious Emission	
Appendix C. Radiated Spurious Emission Plots	
Appendix D. Duty Cycle Plots	
Appendix E. Setup Photographs	



History of this test report

Report No.	Version	Description	Issued Date
FR010732F	01	Initial issue of report	Mar. 03, 2020



Summary of Test Result

Report Clause	Ref Std. Clause	Test Items	Result (PASS/FAIL)	Remark
3.1	15.403 (i)	6dB & 26dB Bandwidth	Pass	-
3.1	2.1049	99% Occupied Bandwidth	Reporting only	-
3.2	15.407 (a)	Maximum Conducted Output Power	Pass	-
3.3	15.407 (a)	Power Spectral Density	Pass	-
3.4	15.407(b)	Unwanted Emissions	Pass	Under limit 3.14 dB at 11570.000 MHz
3.5	15.207	AC Conducted Emission	Pass	Under limit 17.24 dB at 0.567 MHz
3.6	15.407 (c)	Automatically Discontinue Transmission	Pass	-
3.7	15.203 & 15.407 (a)	Antenna Requirement	Pass	-

Declaration of Conformity: The test results with all measurement uncertainty excluded are presented in accordance with the regulation limits or requirements declared by manufacturers.
Comments and Explanations: The declared of product specification for EUT presented in the report are provided by the manufacturer, and the manufacturer takes all the responsibilities for the accuracy of product specification.

Reviewed by: Wii Chang
Report Producer: Celery Wei



1 General Description

1.1 Product Feature of Equipment Under Test

Product Specification subjective to this standard	
Equipment	Touch computer
Brand Name	Zebra
Model Name	TC210K
FCC ID	UZ7TC210K
Sample 1	WLAN, GMS, SE4710, NFC, 3G/32GB, Rear camera, 2-pin connector
Sample 2	WLAN, GMS, No scanner, NFC, 3G/32GB, Front & Rear camera, 2-pin connector
EUT supports Radios application	NFC WLAN 11a/b/g/n HT20/HT40 WLAN 11ac VHT20/VHT40/VHT80 Bluetooth BR/EDR
HW Version	Meteor_EV1_MB_V11
OS Version	Android version 10
SW Version	FUSION_QA_2_1.0.0.007_Q
FW Version	Zebra/TC21MG/TC21:10/03-08-17.00-QG-U00-PRD/88:userdebug/release-keys
MFD	27DEC19
EUT Stage	Engineering Sample

Remark: The above EUT's information was declared by manufacturer.

Specification of Accessories				
AC Adapter	Brand Name	Zebra	Part Number	PWR-WUA5V12W0US
Battery 1	Brand Name	Zebra	Part Number	BT-000409-00
Battery 2	Brand Name	Zebra	Part Number	BT-000410-50
Battery 3	Brand Name	Zebra	Part Number	BT-000411-08
USB Cable (TypeA plug to TypeC plug)	Brand Name	Zebra	Part Number	CBL-TC5X-USBC2A-01
Adapter Cable PTT headset(3.5mm to 3.5mm)	Brand Name	Zebra	Part Number	CBL-TC51-HDST35-01
Headset 3.5mm type with PTT/micassy	Brand Name	Zebra	Part Number	HDST-35MM-PTVP-01
Snap on Trigger handle	Brand Name	Zebra	Part Number	TRG-TC2Y-SNP1-01
Belt Holster	Brand Name	Zebra	Part Number	SG-TC2Y-HLSTR1-01
Wearable Arm Mount	Brand Name	Zebra	Part Number	SG-TC2Y-ARMNT-01

Support Unit used in test configuration and system				
Type C to 3.5mm headset adaptor	Trade Name	Google	Model name	Pixel-2-2XL



1.2 Product Specification of Equipment Under Test

Standards-related Product Specification	
Tx/Rx Frequency Range	5725 MHz ~ 5850 MHz
Maximum Output Power to Antenna	<5745 MHz ~ 5775 MHz> 802.11a : 19.30 dBm / 0.0851 W 802.11n HT20 : 19.20 dBm / 0.0832 W 802.11n HT40 : 18.20 dBm / 0.0661 W 802.11ac VHT20: 19.30 dBm / 0.0851 W 802.11ac VHT40: 18.30 dBm / 0.0676 W 802.11ac VHT80: 18.90 dBm / 0.0776 W
99% Occupied Bandwidth	802.11a : 17.58 MHz 802.11ac VHT20 : 18.78 MHz 802.11ac VHT40 : 36.66 MHz 802.11ac VHT80 : 76.96 MHz
Type of Modulation	802.11a/n : OFDM (BPSK / QPSK / 16QAM / 64QAM) 802.11ac : OFDM (BPSK / QPSK / 16QAM / 64QAM / 256QAM)
Antenna Gain / Gain	PIFA Antenna with gain 2.3 dBi

1.3 Modification of EUT

No modifications are made to the EUT during all test items.



1.4 Testing Location

Test Site	SPORTON INTERNATIONAL INC. EMC & Wireless Communications Laboratory	
Test Site Location	No.52, Huaya 1st Rd., Guishan Dist., Taoyuan City, Taiwan (R.O.C.) TEL: +886-3-327-3456 FAX: +886-3-328-4978	
Test Site No.	Sporton Site No.	
	TH05-HY	CO05-HY

Note: The test site complies with ANSI C63.4 2014 requirement.

Test Site	SPORTON INTERNATIONAL INC. EMC & Wireless Communications Laboratory	
Test Site Location	No.58, Aly. 75, Ln. 564, Wenhua 3rd, Rd., Guishan Dist., Taoyuan City, Taiwan (R.O.C.) TEL: +886-3-327-0868 FAX: +886-3-327-0855	
Test Site No.	Sporton Site No.	
	03CH15-HY	

Note: The test site complies with ANSI C63.4 2014 requirement.

FCC designation No.: TW1190 and TW0007

1.5 Applicable Standards

According to the specifications of the manufacturer, the EUT must comply with the requirements of the following standards:

- ♦ FCC Part 15 Subpart E
- ♦ FCC KDB 789033 D02 General UNII Test Procedures New Rules v02r01.
- ♦ FCC KDB 414788 D01 Radiated Test Site v01r01.
- ♦ ANSI C63.10-2013

Remark:

1. All test items were verified and recorded according to the standards and without any deviation during the test.
2. This EUT has also been tested and complied with the requirements of FCC Part 15, Subpart B, recorded in a separate test report.



2 Test Configuration of Equipment Under Test

- a. The EUT has been associated with peripherals and configuration operated in a manner tended to maximize its emission characteristics in a typical application. Frequency range investigated: conduction emission (150 kHz to 30 MHz), radiation emission (9 kHz to the 10th harmonic of the highest fundamental frequency or to 40 GHz, whichever is lower). For radiated measurement, pre-scanned in three orthogonal panels, X, Y, Z. The worst cases (Z plane) were recorded in this report.

- b. AC power line Conducted Emission was tested under maximum output power.

2.1 Carrier Frequency and Channel

Frequency Band	Channel	Freq. (MHz)	Channel	Freq. (MHz)
5725-5850 MHz Band 4 (U-NII-3)	149	5745	157	5785
	151*	5755	159*	5795
	153	5765	161	5805
	155#	5775	165	5825

Note:

- 1. The above Frequency and Channel in "*" were 802.11n HT40 and 802.11ac VHT40.
- 2. The above Frequency and Channel in "#n" were 802.11ac VHT80.

2.2 Test Mode

Final test modes are considering the modulation and worse data rates as below table.

Modulation	Data Rate
802.11a	6 Mbps
802.11n HT20 (Covered by VHT20)	MCS0
802.11n HT40 (Covered by VHT40)	MCS0
802.11ac VHT20	MCS0
802.11ac VHT40	MCS0
802.11ac VHT80	MCS0

Test Cases	
AC Conducted Emission	Mode 1 : WLAN (5GHz) Link + NFC On + Bluetooth Link + USB cable (CBL-TC5X-USBC2A-01) + AC adapter (PWR-WUA5V12W0US) + Battery 1_1X (BT-000409-00) for Sample 1

Ch. #	Band IV : 5725-5850 MHz			
	802.11a	802.11ac VHT20	802.11ac VHT40	802.11ac VHT80
L Low	149	149	151	-
M Middle	157	157	-	155
H High	165	165	159	-

Remark: For radiation spurious emission, the final modulation and the worst data rate was reference the max RF conducted power.



802.11a RF Output Power (dBm)										
Power vs. Channel			Power vs Data Rate							
Channel	Frequency (MHz)	Data Rate (bps)	Channel	Data Rate (bps)						
		6M		9M	12M	18M	24M	36M	48M	54M
Duty Cycle (%)		95.15		94.40	92.80	89.80	87.20	82.30	78.20	76.40
CH 149	5745	17.50	CH 157	19.20	19.20	19.10	19.20	18.90	18.80	18.80
CH 157	5785	19.30								
CH 165	5825	19.20								

802.11n HT20 RF Output Power (dBm)										
Power vs. Channel			Power vs Data Rate							
Channel	Frequency (MHz)	MCS Index	Channel	MCS Index						
		MCS0		MCS1	MCS2	MCS3	MCS4	MCS5	MCS6	MCS7
Duty Cycle (%)		94.80		92.20	89.10	86.50	81.80	77.70	76.10	74.40
CH 149	5745	19.20	CH 149	19.10	19.00	19.00	18.70	18.70	18.70	18.70
CH 157	5785	17.70								
CH 165	5825	19.10								

802.11n HT40 RF Output Power (dBm)										
Power vs. Channel			Power vs Data Rate							
Channel	Frequency (MHz)	MCS Index	Channel	MCS Index						
		MCS0		MCS1	MCS2	MCS3	MCS4	MCS5	MCS6	MCS7
Duty Cycle (%)		90.34		86.00	81.10	77.10	71.10	65.90	64.10	62.50
CH 151	5755	18.10	CH 159	18.1	18.1	18.1	17.9	17.8	17.8	17.8
CH 159	5795	18.20								

802.11ac VHT20 RF Output Power (dBm)											
Power vs. Channel			Power vs Data Rate								
Channel	Frequency (MHz)	MCS Index	Channel	MCS Index							
		MCS0		MCS1	MCS2	MCS3	MCS4	MCS5	MCS6	MCS7	MCS8
Duty Cycle (%)		95.78		92.30	89.30	86.70	81.90	78.10	76.40	74.90	71.90
CH 149	5745	19.30	CH 149	19.20	19.20	19.20	19.10	19.10	19.20	19.20	19.20
CH 157	5785	17.80									
CH 165	5825	19.20									

802.11ac VHT40 RF Output Power (dBm)												
Power vs. Channel			Power vs Data Rate									
Channel	Frequency (MHz)	MCS Index	Channel	MCS Index								
		MCS0		MCS1	MCS2	MCS3	MCS4	MCS5	MCS6	MCS7	MCS8	MCS9
Duty Cycle (%)		91.35		86.10	81.20	77.30	71.30	66.70	64.70	63.50	60.40	58.90
CH 151	5755	18.20	CH 159	18.2	18.2	18.2	18.1	18.1	18.1	18.1	18.1	18.1
CH 159	5795	18.30										

802.11ac VHT80 RF Output Power (dBm)												
Power vs. Channel			Power vs Data Rate									
Channel	Frequency (MHz)	MCS Index	Channel	MCS Index								
		MCS0		MCS1	MCS2	MCS3	MCS4	MCS5	MCS6	MCS7	MCS8	MCS9
Duty Cycle (%)		85.93		76.30	70.00	65.30	59.40	54.80	53.40	52.50	49.90	48.70
CH 155	5775	18.90	CH 155	18.80	18.80	18.80	18.40	18.40	18.40	18.40	18.30	18.40

2.3 Connection Diagram of Test System

< AC Conducted Emission Mode >

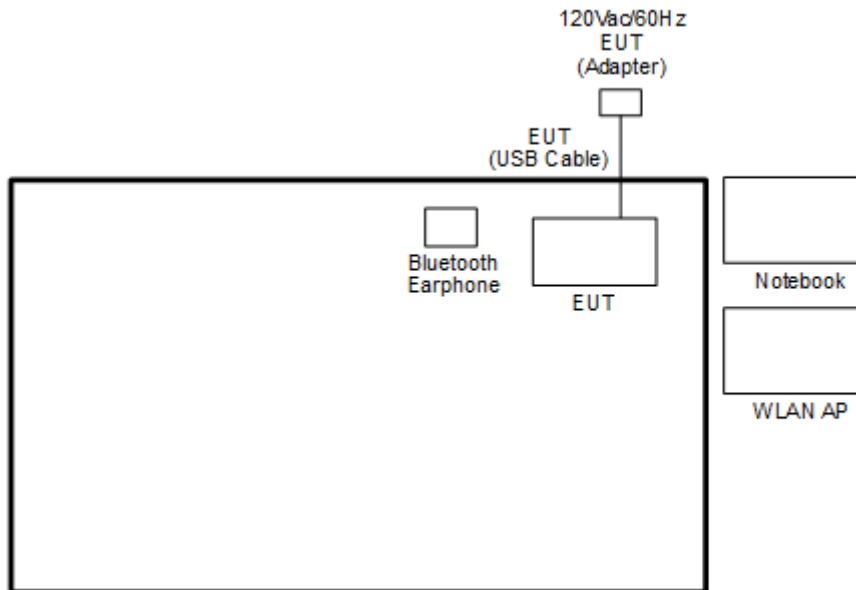

<For WLAN Tx Mode>

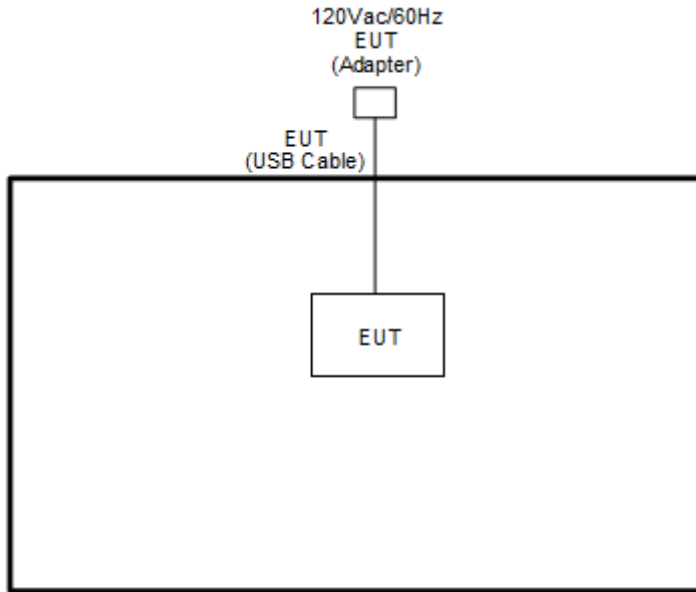

2.4 Support Unit used in test configuration and system

Item	Equipment	Trade Name	Model Name	FCC ID	Data Cable	Power Cord
1.	Bluetooth Earphone	Sony Ericsson	MW600	PY7DDA-2029	N/A	N/A
2.	WLAN AP	ASUS	RT-AC66U	MSQ-RTAC66U	N/A	Unshielded, 1.8 m
3.	Notebook	Dell	Latitude 3400	FCC DoC	N/A	AC I/P : Unshielded, 1.2m DC O/P : Shielded, 1.8m
4.	SD Card	SanDisk	MicroSD HC	FCC DoC	N/A	N/A



2.5 EUT Operation Test Setup

The RF test items, utility “QRCT V4.0.00142.0” was installed in Notebook which was programmed in order to make the EUT get into the engineering modes to provide channel selection, power level, data rate and the application type and for continuous transmitting signals.

2.6 Measurement Results Explanation Example

For all conducted test items:

The offset level is set in the spectrum analyzer to compensate the RF cable loss and attenuator factor between EUT conducted output port and spectrum analyzer. With the offset compensation, the spectrum analyzer reading level is exactly the EUT RF output level.

Example :

The spectrum analyzer offset is derived from RF cable loss and attenuator factor.

Offset = RF cable loss + attenuator factor.

Following shows an offset computation example with cable loss 4.2 dB and 10dB attenuator.

$$\begin{aligned} \text{Offset(dB)} &= \text{RF cable loss(dB)} + \text{attenuator factor(dB)}. \\ &= 4.2 + 10 = 14.2 \text{ (dB)} \end{aligned}$$

3 Test Result

3.1 6dB and 26dB and 99% Occupied Bandwidth Measurement

3.1.1 Description of 6dB and 26dB and 99% Occupied Bandwidth

The minimum 6 dB bandwidth shall be at least 500 kHz.

26dB and 99% Occupied bandwidth are reporting only.

3.1.2 Measuring Instruments

See list of measuring equipment of this test report.

3.1.3 Test Procedures

1. The testing follows FCC KDB 789033 D02 General UNII Test Procedures New Rules v02r01. Section C) Emission bandwidth for the band 5.725-5.85GHz
2. Set RBW = 100kHz.
3. Set the VBW $\geq 3 \times$ RBW.
4. Detector = Peak.
5. Trace mode = max hold
6. Measure the maximum width of the emission that is 6 dB down from the peak of the emission.
7. Measure and record the results in the test report.

3.1.4 Test Setup

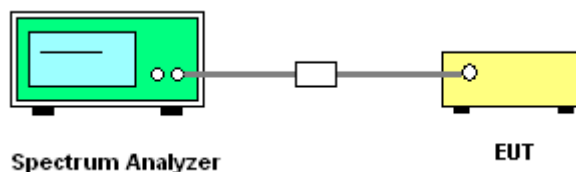



3.1.5 Test Result of 6dB and 26dB and 99% Occupied Bandwidth

Test Engineer :	AnAn Wu and Luffy Lin	Temperature :	21~25°C
		Relative Humidity :	51~54%

Band IV												
Mod.	Data Rate	NTX	CH.	Freq. (MHz)	99% Bandwidth (MHz)		26dB Bandwidth (MHz)		6 dB Bandwidth (MHz)		6 dB Bandwidth Min. Limit (MHz)	Pass/Fail
					Ant 1	Ant 2	Ant 1	Ant 2	Ant 1	Ant 2		
11a	6Mbps	1	149	5745	17.03	-	27.17	-	16.33	-	0.5	Pass
11a	6Mbps	1	157	5785	17.33	-	28.82	-	15.53	-	0.5	Pass
11a	6Mbps	1	165	5825	17.58	-	30.22	-	16.03	-	0.5	Pass
VHT20	MCS0	1	149	5745	18.78	-	31.37	-	16.23	-	0.5	Pass
VHT20	MCS0	1	157	5785	18.13	-	27.62	-	16.38	-	0.5	Pass
VHT20	MCS0	1	165	5825	18.58	-	30.97	-	16.23	-	0.5	Pass
VHT40	MCS0	1	151	5755	36.66	-	42.44	-	35.60	-	0.5	Pass
VHT40	MCS0	1	159	5795	36.66	-	42.80	-	35.87	-	0.5	Pass
VHT80	MCS0	1	155	5775	76.96	-	87.91	-	75.12	-	0.5	Pass

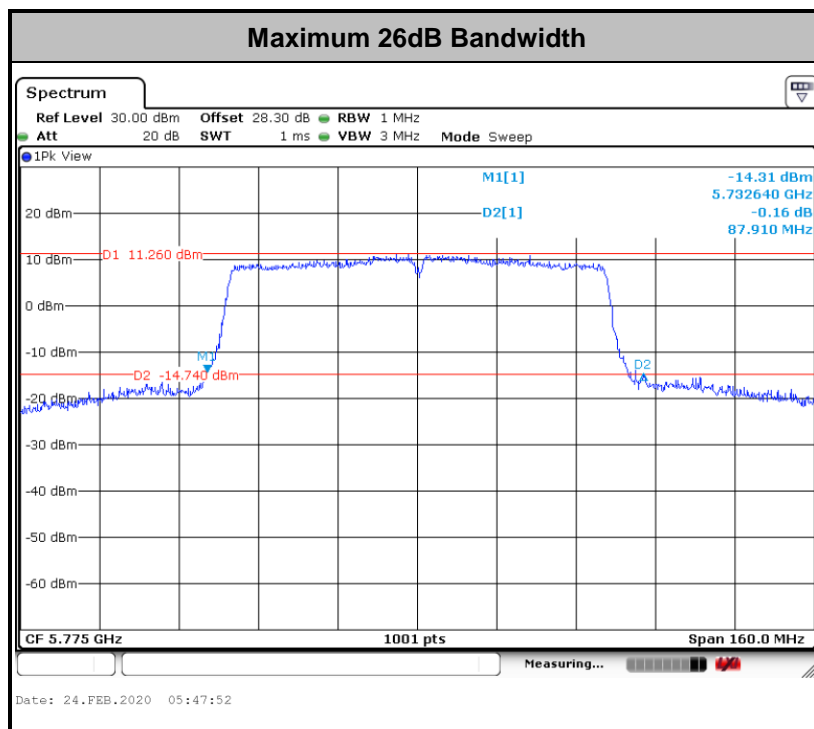
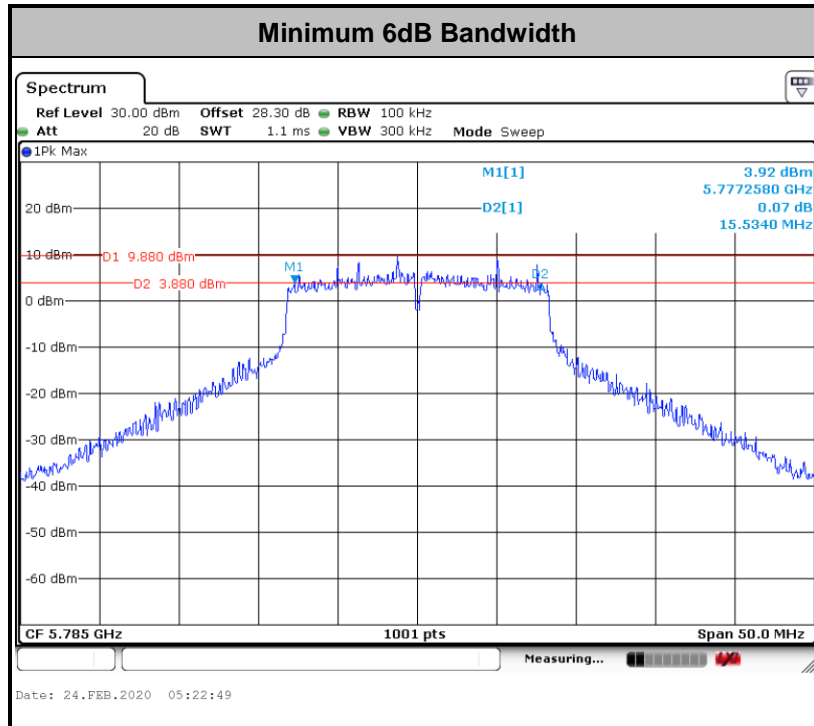

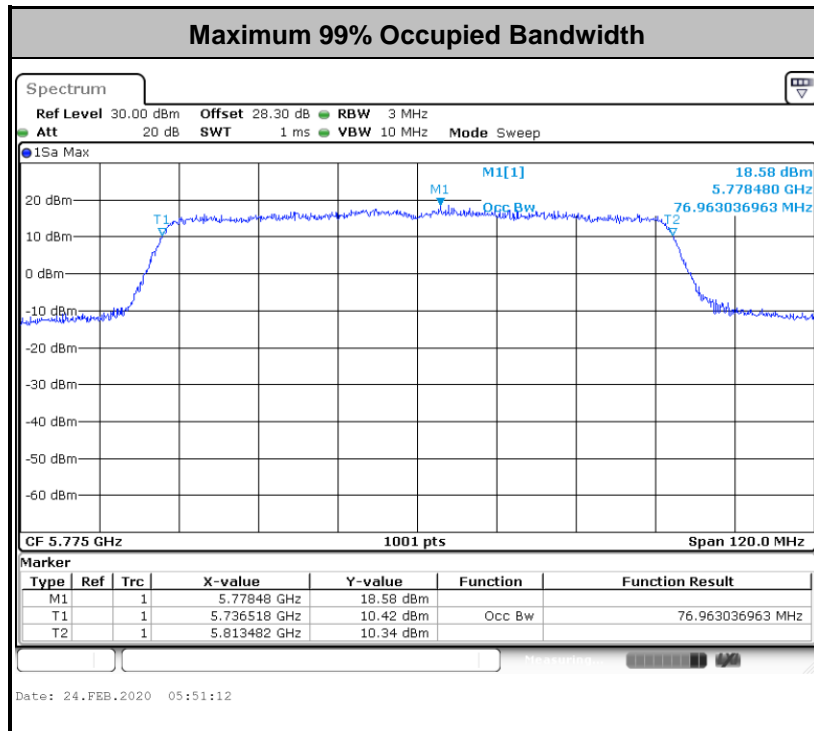

Note: The occupied channel bandwidth is maintained within the band of operation for all of the modulations.

3.2 Maximum Conducted Output Power Measurement

3.2.1 Limit of Maximum Conducted Output Power

For the band 5.725–5.85 GHz, the maximum conducted output power over the frequency band of operation shall not exceed 1 W.

If transmitting antennas of directional gain greater than 6 dBi are used, the peak output power shall be reduced by the amount in dB that the directional gain of the antenna exceeds 6 dBi.

3.2.2 Measuring Instruments

See list of measuring equipment of this test report.

3.2.3 Test Procedures

The testing follows Method PM-G of FCC KDB 789033 D02 General UNII Test Procedures New Rules v02r01.

Method PM-G (Measurement using a gated RF average power meter):

1. Measurement is performed using a wideband RF power meter.
2. The EUT is configured to transmit at its maximum power control level.
3. Measure the average power of the transmitter
4. Since the measurement is made only during the ON time of the transmitter, no duty cycle correction factor is required.

3.2.4 Test Setup

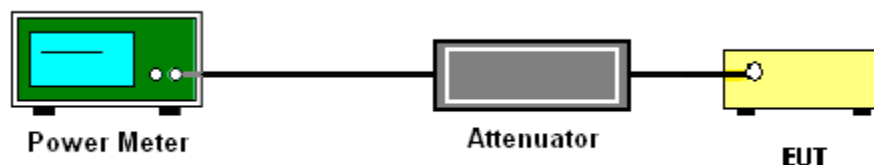



3.2.5 Test Result of Maximum Conducted Output Power

Test Engineer :	AnAn Wu and Luffy Lin	Temperature :	21~25°C
		Relative Humidity :	51~54%

Band IV												
Mod.	Data Rate	NTX	CH.	Freq. (MHz)	Average Conducted Power (dBm)			FCC Conducted Power Limit (dBm)		DG (dBi)		Pass/Fail
					Ant 1	Ant 2	SUM	Ant 1	Ant 2	Ant 1	Ant 2	
11a	6Mbps	1	149	5745	17.50	-	-	30.00	-	2.30	-	Pass
11a	6Mbps	1	157	5785	19.30	-	-	30.00	-	2.30	-	Pass
11a	6Mbps	1	165	5825	19.20	-	-	30.00	-	2.30	-	Pass
HT20	MCS0	1	149	5745	19.20	-	-	30.00	-	2.30	-	Pass
HT20	MCS0	1	157	5785	17.70	-	-	30.00	-	2.30	-	Pass
HT20	MCS0	1	165	5825	19.10	-	-	30.00	-	2.30	-	Pass
HT40	MCS0	1	151	5755	18.10	-	-	30.00	-	2.30	-	Pass
HT40	MCS0	1	159	5795	18.20	-	-	30.00	-	2.30	-	Pass
VHT20	MCS0	1	149	5745	19.30	-	-	30.00	-	2.30	-	Pass
VHT20	MCS0	1	157	5785	17.80	-	-	30.00	-	2.30	-	Pass
VHT20	MCS0	1	165	5825	19.20	-	-	30.00	-	2.30	-	Pass
VHT40	MCS0	1	151	5755	18.20	-	-	30.00	-	2.30	-	Pass
VHT40	MCS0	1	159	5795	18.30	-	-	30.00	-	2.30	-	Pass
VHT80	MCS0	1	155	5775	18.90	-	-	30.00	-	2.30	-	Pass

3.3 Power Spectral Density Measurement

3.3.1 Limit of Power Spectral Density

For the band 5.725–5.85 GHz, the maximum power spectral density shall not exceed 30 dBm in any 500-kHz band.

If transmitting antennas of directional gain greater than 6 dBi are used, the peak output power shall be reduced by the amount in dB that the directional gain of the antenna exceeds 6 dBi.

3.3.2 Measuring Instruments

See list of measuring equipment of this test report.

3.3.3 Test Procedures

The testing follows FCC KDB 789033 D02 General UNII Test Procedures New Rules v02r01. Section F) Maximum power spectral density.

Method SA-3

(power averaging (rms) detection with max hold):

- Set span to encompass the entire emission bandwidth (EBW) of the signal.
- Set RBW = 300 kHz.
- Set VBW \geq 1 MHz.
- Number of points in sweep \geq 2 Span / RBW.
- Sweep time \leq (number of points in sweep) \times T, when duty cycle is less than 98 percent where T is the minimum transmission duration over which the transmitter is on and is transmitting at its maximum power control level for the tested mode of operation.
- Detector = power averaging (rms).
- Trace mode = max hold.
- Allow max hold to run for at least 60 seconds, or longer as needed to allow the trace to stabilize.

3.3.4 Test Setup

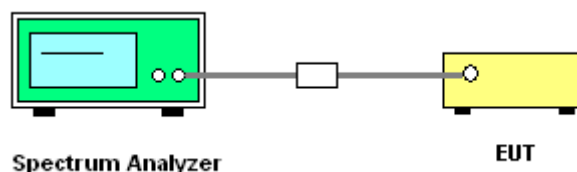



3.3.5 Test Result of Power Spectral Density

Test Engineer :	AnAn Wu and Luffy Lin	Temperature :	21~25°C
		Relative Humidity :	51~54%

Band IV														
Mod.	Data Rate	NTX	CH.	Freq. (MHz)	10log (500kHz /RBW) Factor (dB)		Average Power Density (dBm/500kHz)			Average PSD Limit (dBm/500kHz)		DG (dBi)		Pass /Fail
					Ant 1	Ant 2	Ant 1	Ant 2	SUM	Ant 1	Ant 2	Ant 1	Ant 2	
					11a	6Mbps	1	149	5745	2.22	-	7.56	-	
11a	6Mbps	1	157	5785	2.22	-	10.28	-	-	30.00	-	2.30	-	Pass
11a	6Mbps	1	165	5825	2.22	-	10.42	-	-	30.00	-	2.30	-	Pass
VHT20	MCS0	1	149	5745	2.22	-	10.06	-	-	30.00	-	2.30	-	Pass
VHT20	MCS0	1	157	5785	2.22	-	8.57	-	-	30.00	-	2.30	-	Pass
VHT20	MCS0	1	165	5825	2.22	-	9.80	-	-	30.00	-	2.30	-	Pass
VHT40	MCS0	1	151	5755	2.22	-	4.69	-	-	30.00	-	2.30	-	Pass
VHT40	MCS0	1	159	5795	2.22	-	5.07	-	-	30.00	-	2.30	-	Pass
VHT80	MCS0	1	155	5775	2.22	-	3.73	-	-	30.00	-	2.30	-	Pass

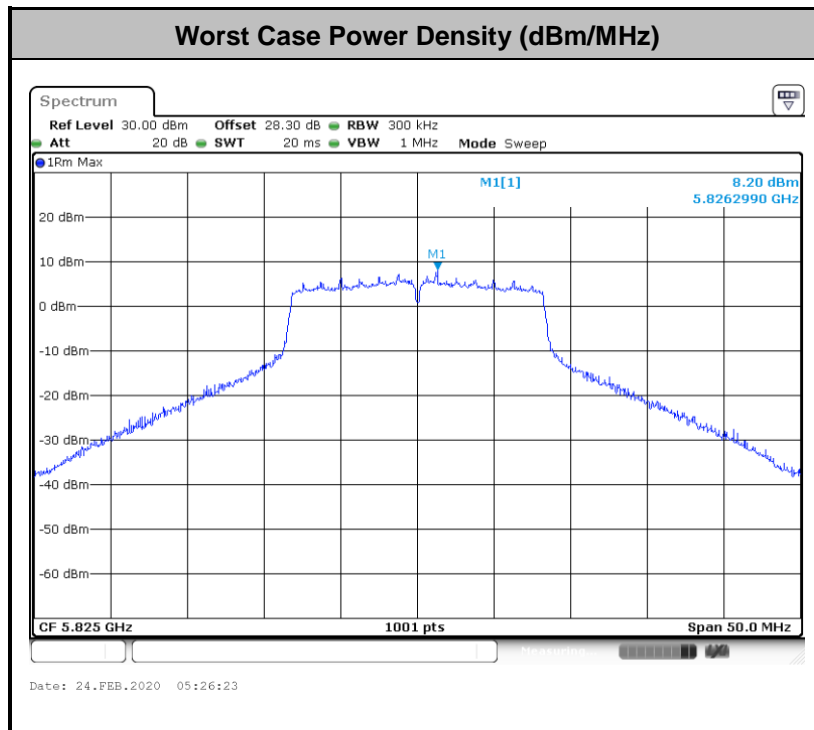



3.4 Unwanted Emissions Measurement

This section is to measure unwanted emissions through radiated measurement for band edge spurious emissions and out of band emissions measurement.

3.4.1 Limit of Unwanted Emissions

(1) For transmitters operating in the 5.725-5.85 GHz band:

15.407(b)(4)(i) All emissions shall be limited to a level of -27 dBm/MHz at 75 MHz or more above or below the band edge increasing linearly to 10 dBm/MHz at 25 MHz above or below the band edge, and from 25 MHz above or below the band edge increasing linearly to a level of 15.6 dBm/MHz at 5 MHz above or below the band edge, and from 5 MHz above or below the band edge increasing linearly to a level of 27 dBm/MHz at the band edge.

(2) Unwanted spurious emissions fallen in restricted bands shall comply with the general field strength limits as below table,

Frequency (MHz)	Field Strength (microvolts/meter)	Measurement Distance (meters)
0.009 – 0.490	2400/F(kHz)	300
0.490 – 1.705	24000/F(kHz)	30
1.705 – 30.0	30	30
30 – 88	100	3
88 – 216	150	3
216 - 960	200	3
Above 960	500	3

Note: The following formula is used to convert the EIRP to field strength.

$$E = \frac{1000000\sqrt{30P}}{3} \mu\text{V/m, where P is the eirp (Watts)}$$



EIRP (dBm)	Field Strength at 3m (dBμV/m)
- 27	68.3

(3) KDB789033 D02 v02r01 G)2)c)

- (i) Sections 15.407(b)(1-3) specifies the unwanted emissions limit for the U-NII-1 and U-NII-2 bands. As specified, emissions above 1000 MHz that are outside of the restricted bands are subject to a peak emission limit of -27 dBm/MHz.
- (ii) Section 15.407(b)(4) specifies the unwanted emissions limit for the U-NII-3 band. A band emissions mask is specified in Section 15.407(b)(4)(i). The emission limits are based on the use of a peak detector.

3.4.2 Measuring Instruments

See list of measuring equipment of this test report.

3.4.3 Test Procedures

1. The testing follows FCC KDB 789033 D02 General UNII Test Procedures New Rules v02r01. Section G) Unwanted emissions measurement.

(1) Procedure for Unwanted Emissions Measurements Below 1000MHz

- RBW = 120 kHz
- VBW = 300 kHz
- Detector = Peak
- Trace mode = max hold

(2) Procedure for Peak Unwanted Emissions Measurements Above 1000 MHz

- RBW = 1 MHz
- VBW ≥ 3 MHz
- Detector = Peak
- Sweep time = auto
- Trace mode = max hold

(3) Procedures for Average Unwanted Emissions Measurements Above 1000MHz

- RBW = 1 MHz
- VBW = 10 Hz, when duty cycle is no less than 98 percent.
- VBW ≥ 1/T, when duty cycle is less than 98 percent where T is the minimum transmission duration over which the transmitter is on and is transmitting at its maximum power control level for the tested mode of operation.



2. The EUT was placed on a turntable with 0.8 meter for frequency below 1GHz and 1.5 meter for frequency above 1GHz respectively above ground.
3. The EUT was set 3 meters from the interference receiving antenna which was mounted on the top of a variable height antenna tower.
4. The antenna is a broadband antenna and its height is adjusted between one meter and four meters above ground to find the maximum value of the field strength for both horizontal polarization and vertical polarization of the antenna.
5. For each suspected emission, the EUT was arranged to its worst case and then adjust the antenna tower (from 1 m to 4 m) and turntable (from 0 degree to 360 degrees) to find the maximum reading.
6. For testing below 1GHz, if the emission level of the EUT in peak mode was 3 dB lower than the limit specified, then peak values of EUT will be reported, otherwise, the emissions will be repeated one by one using the CISPR quasi-peak method and reported.
7. For testing above 1GHz, the emission level of the EUT in peak mode was 20dB lower than average limit (that means the emission level in average mode also complies with the limit in average mode), then peak values of EUT will be reported, otherwise, the emissions will be measured in average mode again and reported.

3.4.4 Test Setup

For radiated emissions below 30MHz

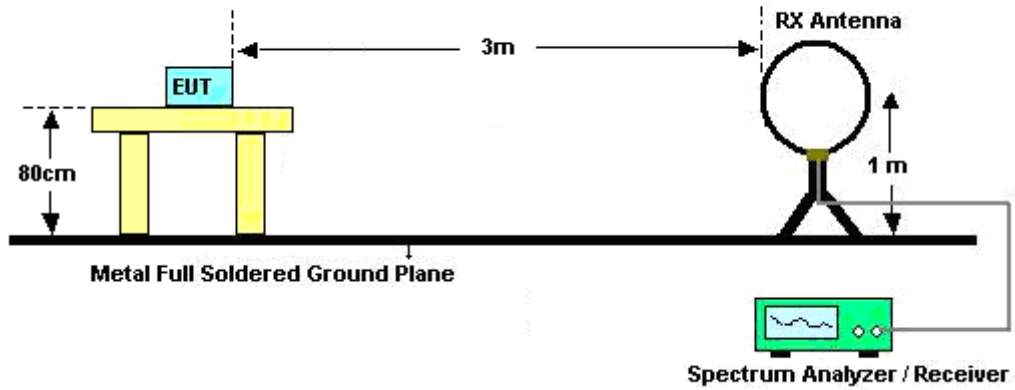

For radiated emissions from 30MHz to 1GHz

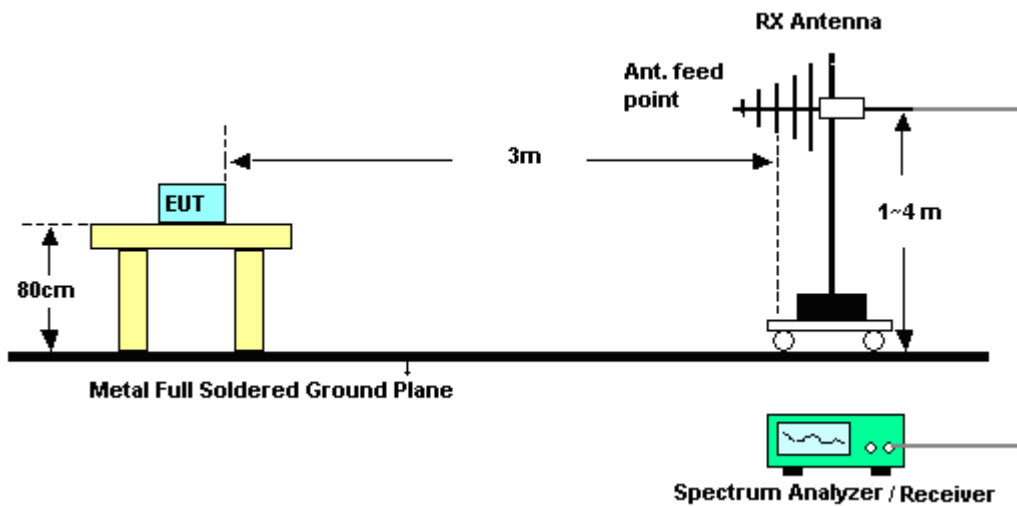

For radiated emissions above 1GHz

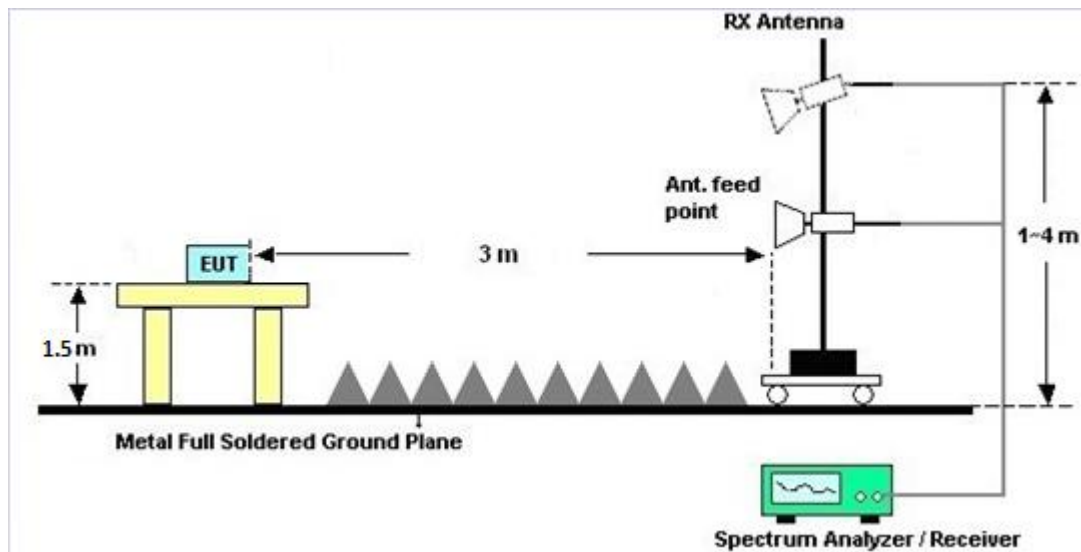

3.4.5 Test Results of Radiated Emissions (9 kHz ~ 30 MHz)

The low frequency, which started from 9 kHz to 30MHz, was pre-scanned and the result which was 20dB lower than the limit line was not reported.

There is a comparison data of both open-field test site and alternative test site - semi-Anechoic chamber according to 414788 D01 Radiated Test Site v01r01, and the result came out very similar.

3.4.6 Test Result of Radiated Band Edges

Please refer to Appendix B and C.

3.4.7 Duty Cycle

Please refer to Appendix D.

3.4.8 Test Result of Unwanted Radiated Emission (30MHz ~ 10th Harmonic)

Please refer to Appendix B and C.



3.5 AC Conducted Emission Measurement

3.5.1 Limit of AC Conducted Emission

For equipment that is designed to be connected to the public utility (AC) power line, the radio frequency voltage that is conducted back onto the AC power line on any frequency or frequencies within the band 150 kHz to 30 MHz shall not exceed the limits in the following table.

Frequency of emission (MHz)	Conducted limit (dB μ V)	
	Quasi-peak	Average
0.15-0.5	66 to 56*	56 to 46*
0.5-5	56	46
5-30	60	50

*Decreases with the logarithm of the frequency.

3.5.2 Measuring Instruments

See list of measuring equipment of this test report.

3.5.3 Test Procedures

1. The EUT was placed 0.4 meter from the conducting wall of the shielding room was kept at least 80 centimeters from any other grounded conducting surface.
2. Connect EUT to the power mains through a line impedance stabilization network (LISN).
3. All the support units are connecting to the other LISN.
4. The LISN provides 50 ohm coupling impedance for the measuring instrument.
5. The FCC states that a 50 ohm, 50 microhenry LISN should be used.
6. Both sides of AC line were checked for maximum conducted interference.
7. The frequency range from 150 kHz to 30 MHz was searched.
8. Set the test-receiver system to Peak Detect Function and specified bandwidth with Maximum Hold Mode.

3.5.4 Test Setup



3.5.5 Test Result of AC Conducted Emission

Please refer to Appendix A.



3.6 Automatically Discontinue Transmission

3.6.1 Limit of Automatically Discontinue Transmission

The device shall automatically discontinue transmission in case of either absence of information to transmit or operational failure. These provisions are not intended to preclude the transmission of control or signaling information or the use of repetitive codes used by certain digital technologies to complete frame or burst intervals. Applicants shall include in their application for equipment authorization to describe how this requirement is met.

3.6.2 Measuring Instruments

See list of measuring equipment of this test report.

3.6.3 Test Result of Automatically Discontinue Transmission

While the EUT is not transmitting any information, the EUT can automatically discontinue transmission and become standby mode for power saving. The EUT can detect the controlling signal of ACK message transmitting from remote device and verify whether it shall resend or discontinue transmission.



3.7 Antenna Requirements

3.7.1 Standard Applicable

If transmitting antenna directional gain is greater than 6 dBi, both the peak transmit power and the peak power spectral density shall be reduced by the amount in dB that the directional gain of the antenna exceeds 6 dBi.

3.7.2 Antenna Anti-Replacement Construction

An embedded-in antenna design is used.

3.7.3 Antenna Gain

The antenna peak gain of EUT is less than 6 dBi. Therefore, it is not necessary to reduce maximum peak output power limit.



4 List of Measuring Equipment

Instrument	Manufacturer	Model No.	Serial No.	Characteristics	Calibration Date	Test Date	Due Date	Remark
Loop Antenna	Rohde & Schwarz	HFH2-Z2	100488	9 kHz~30 MHz	Jan. 09, 2020	Feb. 01, 2020~ Feb. 28, 2020	Jan. 08, 2021	Radiation (03CH15-HY)
Bilog Antenna	TESEQ	CBL 6111D & 00800N1D01 N-06	37059 & 01	30MHz~1GHz	Oct. 12, 2019	Feb. 01, 2020~ Feb. 28, 2020	Oct. 11, 2020	Radiation (03CH15-HY)
Horn Antenna	SCHWARZBE CK	BBHA 9120 D	9120D-211 4	1-18GHz	Jul. 31, 2019	Feb. 01, 2020~ Feb. 28, 2020	Jul. 30, 2020	Radiation (03CH15-HY)
SHF-EHF Horn Antenna	SCHWARZBE CK	BBHA 9170	BBHA9170 584	18GHz- 40GHz	Dec. 10, 2019	Feb. 01, 2020~ Feb. 28, 2020	Dec. 09, 2020	Radiation (03CH15-HY)
Amplifier	SONOMA	310N	363440	9kHz~1GHz	Dec. 27, 2019	Feb. 01, 2020~ Feb. 28, 2020	Dec. 26, 2020	Radiation (03CH15-HY)
Preamplifier	Jet-Power	JPA0118-55-3 03	171000180 0055007	1GHz~18GHz	Apr. 01, 2019	Feb. 01, 2020~ Feb. 28, 2020	May 31, 2020	Radiation (03CH15-HY)
Preamplifier	Keysight	83017A	MY532701 95	1GHz~26.5GHz	Aug. 23, 2019	Feb. 01, 2020~ Feb. 28, 2020	Aug. 22, 2020	Radiation (03CH15-HY)
Preamplifier	EMEC	EM18G40G	060715	18GHz ~ 40GHz	Dec. 13, 2019	Feb. 01, 2020~ Feb. 28, 2020	Dec. 12, 2020	Radiation (03CH15-HY)
EMI Test Receiver	Keysight	N9038A (MXE)	MY554201 70	20MHz~8.4GHz	Mar. 08, 2019	Feb. 01, 2020~ Feb. 28, 2020	Mar. 07, 2020	Radiation (03CH15-HY)
Spectrum Analyzer	Agilent	E4446A	MY501801 36	3Hz~44GHz	Apr. 29, 2019	Feb. 01, 2020~ Feb. 28, 2020	Apr. 28, 2020	Radiation (03CH15-HY)
Antenna Mast	ChainTek	MBS-520-1	N/A	1m~4m	N/A	Feb. 01, 2020~ Feb. 28, 2020	N/A	Radiation (03CH15-HY)
Turn Table	ChainTek	T-200-S-1	N/A	0~360 Degree	N/A	Feb. 01, 2020~ Feb. 28, 2020	N/A	Radiation (03CH15-HY)
Software	Audix	E3 6.2009-8-24 (k5)	RK-00045 1	N/A	N/A	Feb. 01, 2020~ Feb. 28, 2020	N/A	Radiation (03CH15-HY)
RF Cable	HUBER + SUHNER	SUCOFLEX 104	MY36980/ 4	30M-18G	Apr. 15, 2019	Feb. 01, 2020~ Feb. 28, 2020	Apr. 14, 2020	Radiation (03CH15-HY)
RF Cable	HUBER + SUHNER	SUCOFLEX 104	MY9838/4 PE	30M-18G	Apr. 15, 2019	Feb. 01, 2020~ Feb. 28, 2020	Apr. 14, 2020	Radiation (03CH15-HY)
RF Cable	HUBER + SUHNER	SUCOFLEX 104	MY802430 /4	30M~18GHz	May 13, 2019	Feb. 01, 2020~ Feb. 28, 2020	May 12, 2020	Radiation (03CH15-HY)
RF Cable	HUBER + SUHNER	SUCOFLEX 102	505134/2	30MHz-40GHz	Feb. 26, 2019	Feb. 01, 2020~ Feb. 28, 2020	Feb. 25, 2020	Radiation (03CH15-HY)
RF Cable	HUBER + SUHNER	SUCOFLEX 102	800740/2	30MHz-40GHz	Feb. 26, 2019	Feb. 01, 2020~ Feb. 28, 2020	Feb. 25, 2020	Radiation (03CH15-HY)
Filter	Wainwright	WLK4-1000-1 530-8000-40S S	SN4	1.53G Low Pass	Jul. 04, 2019	Feb. 01, 2020~ Feb. 28, 2020	Jul. 03, 2020	Radiation (03CH15-HY)
Filter	Wainwright	WHKX8-5872. 5-6750-18000 -40ST	SN6	6.75GHz High Pass Filter	Jul. 02, 2019	Feb. 01, 2020~ Feb. 28, 2020	Jul. 01, 2020	Radiation (03CH15-HY)



Instrument	Manufacturer	Model No.	Serial No.	Characteristics	Calibration Date	Test Date	Due Date	Remark
AC Power Source	ChainTek	APC-1000W	N/A	N/A	N/A	Feb. 14, 2020	N/A	Conduction (CO05-HY)
EMI Test Receiver	Rohde & Schwarz	ESR3	102388	9kHz~3.6GHz	Nov. 15, 2019	Feb. 14, 2020	Nov. 14, 2020	Conduction (CO05-HY)
Hygrometer	Testo	608-H1	34913912	N/A	Mar. 19, 2019	Feb. 14, 2020	Mar. 18, 2020	Conduction (CO05-HY)
LISN	Rohde & Schwarz	ENV216	100080	9kHz~30MHz	Nov. 20, 2019	Feb. 14, 2020	Nov. 19, 2020	Conduction (CO05-HY)
Software	Rohde & Schwarz	EMC32 V10.30	N/A	N/A	N/A	Feb. 14, 2020	N/A	Conduction (CO05-HY)
LF Cable	HUBER + SUHNER	RG-214/U	LF01	N/A	Jan. 02, 2020	Feb. 14, 2020	Jan. 01, 2021	Conduction (CO05-HY)
Pulse Limiter	Rohde & Schwarz	ESH3-Z2	100851	N/A	Jan. 02, 2020	Feb. 14, 2020	Jan. 01, 2021	Conduction (CO05-HY)
Hygrometer	Testo	608-H2	41410069	N/A	Jun. 17, 2019	Jan. 22, 2020~ Feb. 25, 2020	Jun. 16, 2020	Conducted (TH05-HY)
Power Sensor	DARE	RPR3006W	16I00054S NO10	10MHz~6GHz	Dec. 23, 2019	Jan. 22, 2020~ Feb. 25, 2020	Dec. 22, 2020	Conducted (TH05-HY)
Signal Analyzer	Rohde & Schwarz	FSV40	101566	10Hz~40GHz	Jul. 15, 2019	Jan. 22, 2020~ Feb. 25, 2020	Jul. 14, 2020	Conducted (TH05-HY)
Spectrum Analyzer	Rohde & Schwarz	FSP40	100055	9kHz~40GHz	Aug. 14, 2019	Jan. 22, 2020~ Feb. 25, 2020	Aug. 13, 2020	Conducted (TH05-HY)
Switch Box & RF Cable	Burgeon	ETF-058	EC120838 2	N/A	Mar. 27, 2019	Jan. 22, 2020~ Feb. 25, 2020	Mar. 26, 2020	Conducted (TH05-HY)



5 Uncertainty of Evaluation

Uncertainty of Conducted Emission Measurement (150kHz ~ 30MHz)

Measuring Uncertainty for a Level of Confidence of 95% ($U = 2Uc(y)$)	2.0
---	-----

Uncertainty of Radiated Emission Measurement (30 MHz ~ 1000 MHz)

Measuring Uncertainty for a Level of Confidence of 95% ($U = 2Uc(y)$)	5.0
---	-----

Uncertainty of Radiated Emission Measurement (1000 MHz ~ 18000 MHz)

Measuring Uncertainty for a Level of Confidence of 95% ($U = 2Uc(y)$)	5.4
---	-----

Uncertainty of Radiated Emission Measurement (18000 MHz ~ 40000 MHz)

Measuring Uncertainty for a Level of Confidence of 95% ($U = 2Uc(y)$)	5.0
---	-----



Appendix A. AC Conducted Emission Test Results

Test Engineer :	Tom Lee	Temperature :	21~25°C
		Relative Humidity :	41~52%
Test Voltage :	120Vac / 60Hz	Phase :	Line
Remark :	All emissions not reported here are more than 10 dB below the prescribed limit.		

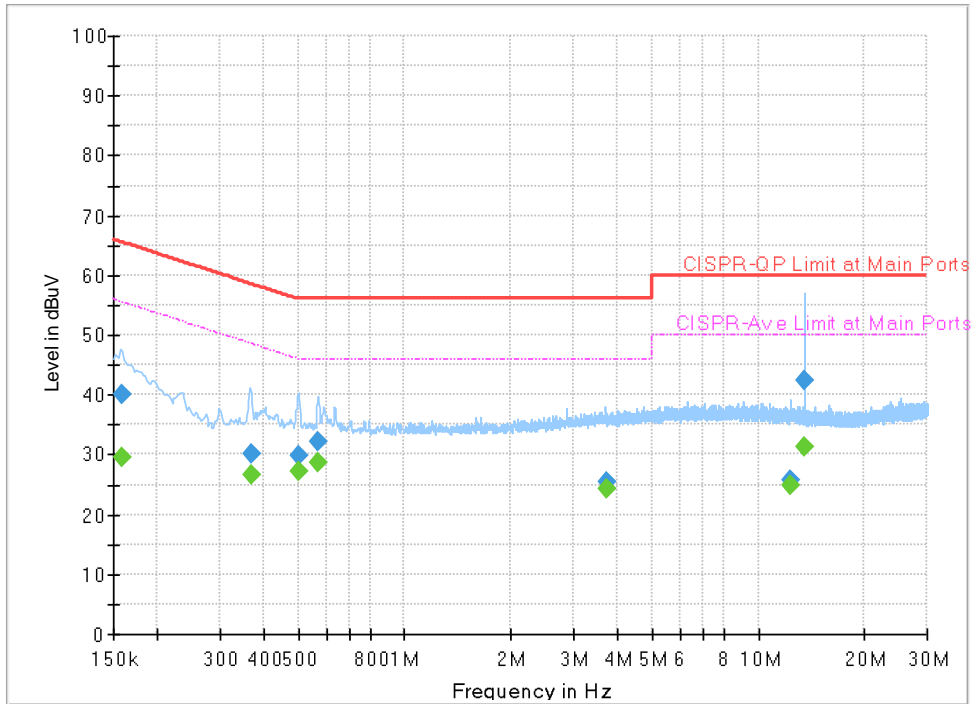

Final Result

Frequency (MHz)	QuasiPeak (dBuV)	CAverage (dBuV)	Limit (dBuV)	Margin (dB)	Line	Filter	Corr. (dB)
0.159630	---	29.55	55.48	25.93	L1	OFF	19.5
0.159630	40.11	---	65.48	25.37	L1	OFF	19.5
0.368700	---	26.73	48.53	21.80	L1	OFF	19.5
0.368700	30.22	---	58.53	28.31	L1	OFF	19.5
0.500730	---	27.29	46.00	18.71	L1	OFF	19.5
0.500730	29.75	---	56.00	26.25	L1	OFF	19.5
0.567240	---	28.76	46.00	17.24	L1	OFF	19.5
0.567240	32.05	---	56.00	23.95	L1	OFF	19.5
3.709500	---	24.30	46.00	21.70	L1	OFF	19.7
3.709500	25.41	---	56.00	30.59	L1	OFF	19.7
12.295320	---	24.75	50.00	25.25	L1	OFF	20.1
12.295320	25.74	---	60.00	34.26	L1	OFF	20.1
13.560000	---	31.29	50.00	18.71	L1	OFF	20.1
13.560000	42.27	---	60.00	17.73	L1	OFF	20.1



Test Engineer :	Tom Lee	Temperature :	21~25°C
		Relative Humidity :	41~52%
Test Voltage :	120Vac / 60Hz	Phase :	Neutral
Remark :	All emissions not reported here are more than 10 dB below the prescribed limit.		

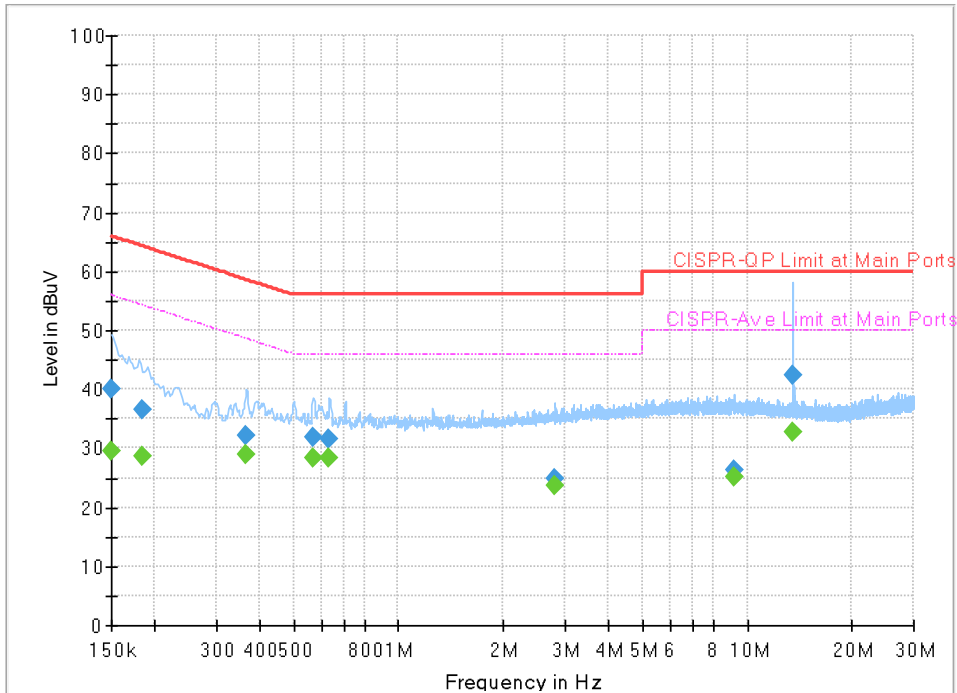

Final Result

Frequency (MHz)	QuasiPeak (dBuV)	CAverage (dBuV)	Limit (dBuV)	Margin (dB)	Line	Filter	Corr. (dB)
0.150000	---	29.67	56.00	26.33	N	OFF	19.6
0.150000	39.93	---	66.00	26.07	N	OFF	19.6
0.183750	---	28.77	54.31	25.54	N	OFF	19.6
0.183750	36.49	---	64.31	27.82	N	OFF	19.6
0.365910	---	29.05	48.59	19.54	N	OFF	19.6
0.365910	32.16	---	58.59	26.43	N	OFF	19.6
0.567330	---	28.46	46.00	17.54	N	OFF	19.6
0.567330	32.00	---	56.00	24.00	N	OFF	19.6
0.633210	---	28.45	46.00	17.55	N	OFF	19.6
0.633210	31.50	---	56.00	24.50	N	OFF	19.6
2.818950	---	23.71	46.00	22.29	N	OFF	19.6
2.818950	24.72	---	56.00	31.28	N	OFF	19.6
9.125250	---	25.27	50.00	24.73	N	OFF	20.0
9.125250	26.39	---	60.00	33.61	N	OFF	20.0
13.560000	---	32.72	50.00	17.28	N	OFF	20.1
13.560000	42.51	---	60.00	17.49	N	OFF	20.1



Appendix B. Radiated Spurious Emission

Test Engineer :	Leo Lee, Mancy Chou and Bigshow Wang	Temperature :	23.9~25.2°C
		Relative Humidity :	53~60%

Band 4 - 5725~5850MHz

WIFI 802.11a (Band Edge @ 3m)

WIFI Ant.	Note	Frequency (MHz)	Level (dBμV/m)	Over Limit (dB)	Limit Line (dBμV/m)	Read Level (dBμV)	Antenna Factor (dB/m)	Path Loss (dB)	Preamp Factor (dB)	Ant Pos (cm)	Table Pos (deg)	Peak Avg. (P/A)	Pol. (H/V)	
802.11a CH 149 5745MHz		5610.8	50.99	-17.21	68.2	39.76	31.88	9.85	30.5	203	252	P	H	
		5690.8	53.69	-44.73	98.42	42.42	31.96	9.86	30.55	203	252	P	H	
		5719.8	54.4	-56.34	110.74	43.11	32	9.86	30.57	203	252	P	H	
		5725	64.27	-57.93	122.2	52.98	32	9.86	30.57	203	252	P	H	
	*	5745	108.87	-	-	97.59	32	9.86	30.58	203	252	P	H	
	*	5745	101.09	-	-	89.81	32	9.86	30.58	203	252	A	H	
														H
														H
			5610	51.68	-16.52	68.2	40.45	31.88	9.85	30.5	378	345	P	V
			5692.4	55.07	-44.53	99.6	43.79	31.97	9.86	30.55	378	345	P	V
			5718.4	58.8	-51.55	110.35	47.51	32	9.86	30.57	378	345	P	V
			5724.4	68.12	-52.71	120.83	56.83	32	9.86	30.57	378	345	P	V
	*		5745	111.65	-	-	100.37	32	9.86	30.58	378	345	P	V
	*		5745	104.23	-	-	92.95	32	9.86	30.58	378	345	A	V
													V	
													V	



WIFI Ant. 1	Note	Frequency (MHz)	Level (dBμV/m)	Over Limit (dB)	Limit Line (dBμV/m)	Read Level (dBμV)	Antenna Factor (dB/m)	Path Loss (dB)	Preamp Factor (dB)	Ant Pos (cm)	Table Pos (deg)	Peak Avg. (P/A)	Pol. (H/V)
		5649.6	51.05	-17.15	68.2	39.92	31.8	9.85	30.52	400	298	P	H
		5687.2	51.57	-44.19	95.76	40.31	31.95	9.86	30.55	400	298	P	H
		5709.4	52.19	-55.64	107.83	40.89	32	9.86	30.56	400	298	P	H
		5722.8	51.43	-65.75	117.18	40.14	32	9.86	30.57	400	298	P	H
	*	5785	110.07	-	-	98.67	32.14	9.87	30.61	400	298	P	H
	*	5785	102.78	-	-	91.38	32.14	9.87	30.61	400	298	A	H
		5852.8	52.36	-63.46	115.82	40.86	32.21	9.94	30.65	400	298	P	H
		5856	51.53	-58.99	110.52	40.02	32.22	9.94	30.65	400	298	P	H
		5889.8	52.05	-42.17	94.22	40.38	32.36	9.98	30.67	400	298	P	H
		5926.6	51.32	-16.88	68.2	39.53	32.45	10.03	30.69	400	298	P	H
													H
													H
802.11a													
CH 157													
5785MHz		5616.4	51.11	-17.09	68.2	39.89	31.87	9.85	30.5	330	321	P	V
		5670.2	51.63	-31.56	83.19	40.43	31.88	9.86	30.54	330	321	P	V
		5714.2	52.64	-56.54	109.18	41.34	32	9.86	30.56	330	321	P	V
		5724.2	52.99	-67.39	120.38	41.7	32	9.86	30.57	330	321	P	V
	*	5785	113.93	-	-	102.53	32.14	9.87	30.61	330	321	P	V
	*	5785	106.4	-	-	95	32.14	9.87	30.61	330	321	A	V
		5853.6	52.78	-61.21	113.99	41.28	32.21	9.94	30.65	330	321	P	V
		5857	52.8	-57.44	110.24	41.28	32.23	9.94	30.65	330	321	P	V
		5875.2	53.3	-51.75	105.05	41.7	32.3	9.96	30.66	330	321	P	V
		5931.8	52.22	-15.98	68.2	40.43	32.46	10.03	30.7	330	321	P	V
													V
													V



WiFi Ant. 1	Note	Frequency (MHz)	Level (dBμV/m)	Over Limit (dB)	Limit Line (dBμV/m)	Read Level (dBμV)	Antenna Factor (dB/m)	Path Loss (dB)	Preamp Factor (dB)	Ant Pos (cm)	Table Pos (deg)	Peak Avg. (P/A)	Pol. (H/V)	
802.11a CH 165 5825MHz	*	5825	110.41	-	-	98.94	32.2	9.9	30.63	215	262	P	H	
	*	5825	102.41	-	-	90.94	32.2	9.9	30.63	215	262	A	H	
		5850.6	61.55	-59.28	120.83	50.07	32.2	9.93	30.65	215	262	P	H	
		5855	54.56	-56.24	110.8	43.05	32.22	9.94	30.65	215	262	P	H	
		5891.2	53.38	-39.8	93.18	41.71	32.36	9.98	30.67	215	262	P	H	
		5927.2	51.49	-16.71	68.2	39.7	32.45	10.03	30.69	215	262	P	H	
														H
														H
	*	5825	112.82	-	-	101.35	32.2	9.9	30.63	305	353	P	V	
	*	5825	105.51	-	-	94.04	32.2	9.9	30.63	305	353	A	V	
		5850.6	62.98	-57.85	120.83	51.5	32.2	9.93	30.65	305	353	P	V	
		5855.8	55.98	-54.6	110.58	44.47	32.22	9.94	30.65	305	353	P	V	
		5892	52.8	-39.78	92.58	41.12	32.37	9.98	30.67	305	353	P	V	
		5926.2	51.13	-17.07	68.2	39.34	32.45	10.03	30.69	305	353	P	V	
														V
														V
													V	
Remark	1. No other spurious found. 2. All results are PASS against Peak and Average limit line.													



Band 4 5725~5850MHz

WIFI 802.11a (Harmonic @ 3m)

WIFI Ant. 1	Note	Frequency (MHz)	Level (dBμV/m)	Over Limit (dB)	Limit Line (dBμV/m)	Read Level (dBμV)	Antenna Factor (dB/m)	Path Loss (dB)	Preamp Factor (dB)	Ant Pos (cm)	Table Pos (deg)	Peak Avg. (P/A)	Pol. (H/V)
802.11a CH 149 5745MHz		11490	59.66	-14.34	74	66.87	40.48	14.5	62.19	191	11	P	H
		11490	50.77	-3.23	54	57.98	40.48	14.5	62.19	191	11	A	H
		17235	47.3	-20.9	68.2	46.93	40.94	18.51	59.08	100	0	P	H
													H
		11490	48.78	-25.22	74	55.99	40.48	14.5	62.19	100	0	P	V
		17235	46.97	-21.23	68.2	46.6	40.94	18.51	59.08	100	0	P	V
802.11a CH 157 5785MHz		11570	59.2	-14.8	74	66.61	40.29	14.56	62.26	191	332	P	H
		11570	49.64	-4.36	54	57.05	40.29	14.56	62.26	191	332	A	H
		17355	49.54	-18.66	68.2	47.89	41.75	18.72	58.82	100	0	P	H
													H
		11570	58.67	-15.33	74	66.08	40.29	14.56	62.26	200	308	P	V
		11570	49.44	-4.56	54	56.85	40.29	14.56	62.26	200	308	A	V
		17355	49.22	-18.98	68.2	47.57	41.75	18.72	58.82	100	0	P	V
802.11a CH 165 5825MHz		11650	58.12	-15.88	74	65.97	39.85	14.62	62.32	192	26	P	H
		11650	49.26	-4.74	54	57.11	39.85	14.62	62.32	192	26	A	H
		17475	49.79	-18.41	68.2	46.97	42.5	18.88	58.56	100	0	P	H
													H
		11650	58.75	-15.25	74	66.6	39.85	14.62	62.32	203	311	P	V
		11650	48.61	-5.39	54	56.46	39.85	14.62	62.32	203	311	A	V
		17475	49.38	-18.82	68.2	46.56	42.5	18.88	58.56	100	0	P	V
													V
Remark	1. No other spurious found. 2. All results are PASS against Peak and Average limit line.												



Band 4 5725~5850MHz

WIFI 802.11ac VHT20 (Band Edge @ 3m)

WIFI Ant. 1	Note	Frequency (MHz)	Level (dBμV/m)	Over Limit (dB)	Limit Line (dBμV/m)	Read Level (dBμV)	Antenna Factor (dB/m)	Path Loss (dB)	Preamp Factor (dB)	Ant Pos (cm)	Table Pos (deg)	Peak Avg. (P/A)	Pol. (H/V)	
802.11ac VHT20 CH 149 5745MHz		5631.2	51.94	-16.26	68.2	40.76	31.84	9.85	30.51	354	304	P	H	
		5697.2	53.58	-49.56	103.14	42.28	31.99	9.86	30.55	354	304	P	H	
		5720	63.99	-46.81	110.8	52.7	32	9.86	30.57	354	304	P	H	
		5724.8	75.98	-45.76	121.74	64.69	32	9.86	30.57	354	304	P	H	
	*	5745	111.42	-	-	100.14	32	9.86	30.58	354	304	P	H	
	*	5745	103.09	-	-	91.81	32	9.86	30.58	354	304	A	H	
														H
														H
			5648.6	53.34	-14.86	68.2	42.21	31.8	9.85	30.52	301	354	P	V
			5686.4	61.18	-33.99	95.17	49.92	31.95	9.86	30.55	301	354	P	V
			5720	70.97	-39.83	110.8	59.68	32	9.86	30.57	301	354	P	V
			5725	79.95	-42.25	122.2	68.66	32	9.86	30.57	301	354	P	V
	*		5745	113.78	-	-	102.5	32	9.86	30.58	301	354	P	V
	*		5745	105.8	-	-	94.52	32	9.86	30.58	301	354	A	V
														V
													V	



WIFI Ant. 1	Note	Frequency (MHz)	Level (dBμV/m)	Over Limit (dB)	Limit Line (dBμV/m)	Read Level (dBμV)	Antenna Factor (dB/m)	Path Loss (dB)	Preamp Factor (dB)	Ant Pos (cm)	Table Pos (deg)	Peak Avg. (P/A)	Pol. (H/V)
		5644.8	51.52	-16.68	68.2	40.38	31.81	9.85	30.52	202	253	P	H
		5693.2	51.11	-49.08	100.19	39.83	31.97	9.86	30.55	202	253	P	H
		5710.2	51.28	-56.78	108.06	39.98	32	9.86	30.56	202	253	P	H
		5721.4	51.69	-62.3	113.99	40.4	32	9.86	30.57	202	253	P	H
	*	5785	108.44	-	-	97.04	32.14	9.87	30.61	202	253	P	H
	*	5785	100.75	-	-	89.35	32.14	9.87	30.61	202	253	A	H
		5851.8	52.02	-66.08	118.1	40.53	32.21	9.93	30.65	202	253	P	H
		5859	51.98	-57.7	109.68	40.45	32.24	9.94	30.65	202	253	P	H
		5906	51.63	-30.59	82.22	39.9	32.41	10	30.68	202	253	P	H
		5943.4	51.2	-17	68.2	39.36	32.49	10.05	30.7	202	253	P	H
802.11ac													H
VHT20													H
CH 157		5613.2	50.7	-17.5	68.2	39.48	31.87	9.85	30.5	307	345	P	V
5785MHz		5673	51.85	-33.41	85.26	40.64	31.89	9.86	30.54	307	345	P	V
		5719.2	52.46	-58.12	110.58	41.17	32	9.86	30.57	307	345	P	V
		5723.6	52.64	-66.37	119.01	41.35	32	9.86	30.57	307	345	P	V
	*	5785	111.72	-	-	100.32	32.14	9.87	30.61	307	345	P	V
	*	5785	104.19	-	-	92.79	32.14	9.87	30.61	307	345	A	V
		5852	52.93	-64.71	117.64	41.44	32.21	9.93	30.65	307	345	P	V
		5855.6	52.25	-58.38	110.63	40.74	32.22	9.94	30.65	307	345	P	V
		5906.4	53.45	-28.48	81.93	41.72	32.41	10	30.68	307	345	P	V
		5934.4	51.87	-16.33	68.2	40.06	32.47	10.04	30.7	307	345	P	V
													V
													V



WIFI Ant. 1	Note	Frequency (MHz)	Level (dBμV/m)	Over Limit (dB)	Limit Line (dBμV/m)	Read Level (dBμV)	Antenna Factor (dB/m)	Path Loss (dB)	Preamp Factor (dB)	Ant Pos (cm)	Table Pos (deg)	Peak Avg. (P/A)	Pol. (H/V)	
802.11ac VHT20 CH 165 5825MHz	*	5825	109.93	-	-	98.46	32.2	9.9	30.63	400	299	P	H	
	*	5825	102.23	-	-	90.76	32.2	9.9	30.63	400	299	A	H	
		5850	68.96	-53.24	122.2	57.48	32.2	9.93	30.65	400	299	P	H	
		5855.4	55.19	-55.5	110.69	43.68	32.22	9.94	30.65	400	299	P	H	
		5882.8	53.41	-46	99.41	41.78	32.33	9.97	30.67	400	299	P	H	
		5935.4	52.69	-15.51	68.2	40.88	32.47	10.04	30.7	400	299	P	H	
														H
														H
	*	5825	113.49	-	-	102.02	32.2	9.9	30.63	309	352	P	V	
	*	5825	105.82	-	-	94.35	32.2	9.9	30.63	309	352	A	V	
		5850	73.9	-48.3	122.2	62.42	32.2	9.93	30.65	309	352	P	V	
		5855.4	58.45	-52.24	110.69	46.94	32.22	9.94	30.65	309	352	P	V	
		5886.4	55.29	-41.45	96.74	43.63	32.35	9.98	30.67	309	352	P	V	
		5932.6	52.66	-15.54	68.2	40.85	32.47	10.04	30.7	309	352	P	V	
														V
													V	
Remark	1. No other spurious found. 2. All results are PASS against Peak and Average limit line.													



Band 4 5725~5850MHz

WIFI 802.11ac VHT20 (Harmonic @ 3m)

WIFI Ant. 1	Note	Frequency (MHz)	Level (dBμV/m)	Over Limit (dB)	Limit Line (dBμV/m)	Read Level (dBμV)	Antenna Factor (dB/m)	Path Loss (dB)	Preamp Factor (dB)	Ant Pos (cm)	Table Pos (deg)	Peak Avg. (P/A)	Pol. (H/V)	
802.11ac VHT20 CH 149 5745MHz		11490	60.74	-13.26	74	67.95	40.48	14.5	62.19	181	23	P	H	
		11490	50.72	-3.28	54	57.93	40.48	14.5	62.19	181	23	A	H	
		17235	48.01	-20.19	68.2	47.64	40.94	18.51	59.08	100	0	P	H	
													H	
			11490	60.13	-13.87	74	67.34	40.48	14.5	62.19	217	306	P	V
			11490	50.32	-3.68	54	57.53	40.48	14.5	62.19	217	306	A	V
			17235	47.81	-20.39	68.2	47.44	40.94	18.51	59.08	100	0	P	V
													V	
802.11ac VHT20 CH 157 5785MHz		11570	60	-14	74	67.41	40.29	14.56	62.26	100	254	P	H	
		11570	50.86	-3.14	54	58.27	40.29	14.56	62.26	100	254	A	H	
		17355	51.09	-17.11	68.2	49.44	41.75	18.72	58.82	100	0	P	H	
													H	
			11570	60.2	-13.8	74	67.61	40.29	14.56	62.26	214	311	P	V
			11570	50.67	-3.33	54	58.08	40.29	14.56	62.26	214	311	A	V
			17355	49.02	-19.18	68.2	47.37	41.75	18.72	58.82	100	0	P	V
													V	
802.11ac VHT20 CH 165 5825MHz		11650	60.61	-13.39	74	68.46	39.85	14.62	62.32	188	26	P	H	
		11650	50.26	-3.74	54	58.11	39.85	14.62	62.32	188	26	A	H	
		17475	49.25	-18.95	68.2	47.2	41.73	18.88	58.56	100	0	P	H	
													H	
			11650	59.13	-14.87	74	66.98	39.85	14.62	62.32	207	306	P	V
			11650	49.45	-4.55	54	57.3	39.85	14.62	62.32	207	306	A	V
			17475	48.43	-19.77	68.2	46.38	41.73	18.88	58.56	100	0	P	V
													V	
Remark	1. No other spurious found. 2. All results are PASS against Peak and Average limit line.													



Band 4 5725~5850MHz

WIFI 802.11ac VHT40 (Band Edge @ 3m)

WIFI Ant. 1	Note	Frequency (MHz)	Level (dBμV/m)	Over Limit (dB)	Limit Line (dBμV/m)	Read Level (dBμV)	Antenna Factor (dB/m)	Path Loss (dB)	Preamp Factor (dB)	Ant Pos (cm)	Table Pos (deg)	Peak Avg. (P/A)	Pol. (H/V)
		5649.2	51.13	-17.07	68.2	40	31.8	9.85	30.52	192	250	P	H
		5698.6	53.85	-50.32	104.17	42.55	31.99	9.86	30.55	192	250	P	H
		5719.2	70.12	-40.46	110.58	58.83	32	9.86	30.57	192	250	P	H
		5725	71.81	-50.39	122.2	60.52	32	9.86	30.57	192	250	P	H
	*	5755	106.29	-	-	94.99	32.02	9.87	30.59	192	250	P	H
	*	5755	98.44	-	-	87.14	32.02	9.87	30.59	192	250	A	H
		5851.6	50.89	-67.66	118.55	39.4	32.21	9.93	30.65	192	250	P	H
		5866.6	52.11	-55.44	107.55	40.55	32.27	9.95	30.66	192	250	P	H
		5906.8	52.51	-29.12	81.63	40.78	32.41	10	30.68	192	250	P	H
		5927.2	50.85	-17.35	68.2	39.06	32.45	10.03	30.69	192	250	P	H
													H
													H
802.11ac													
VHT40													
CH 151		5632.4	52.26	-15.94	68.2	41.08	31.84	9.85	30.51	316	321	P	V
5755MHz		5689.4	56.2	-41.18	97.38	44.93	31.96	9.86	30.55	316	321	P	V
		5719	72.31	-38.21	110.52	61.02	32	9.86	30.57	316	321	P	V
		5723.8	73.95	-45.51	119.46	62.66	32	9.86	30.57	316	321	P	V
	*	5755	109.46	-	-	98.16	32.02	9.87	30.59	316	321	P	V
	*	5755	101.26	-	-	89.96	32.02	9.87	30.59	316	321	A	V
		5854.2	51.59	-61.03	112.62	40.08	32.22	9.94	30.65	316	321	P	V
		5867.2	52.24	-55.14	107.38	40.68	32.27	9.95	30.66	316	321	P	V
		5903.6	52.09	-31.91	84	40.36	32.41	10	30.68	316	321	P	V
		5926.2	51.24	-16.96	68.2	39.45	32.45	10.03	30.69	316	321	P	V
													V
													V



WIFI Ant. 1	Note	Frequency (MHz)	Level (dBμV/m)	Over Limit (dB)	Limit Line (dBμV/m)	Read Level (dBμV)	Antenna Factor (dB/m)	Path Loss (dB)	Preamp Factor (dB)	Ant Pos (cm)	Table Pos (deg)	Peak Avg. (P/A)	Pol. (H/V)
		5622	51.13	-17.07	68.2	39.93	31.86	9.85	30.51	400	298	P	H
		5682.6	52	-40.36	92.36	40.75	31.93	9.86	30.54	400	298	P	H
		5717.4	52.53	-57.54	110.07	41.23	32	9.86	30.56	400	298	P	H
		5723.6	53.56	-65.45	119.01	42.27	32	9.86	30.57	400	298	P	H
	*	5795	106.77	-	-	95.33	32.18	9.87	30.61	400	298	P	H
	*	5795	98.31	-	-	86.87	32.18	9.87	30.61	400	298	A	H
		5851.8	56.46	-61.64	118.1	44.97	32.21	9.93	30.65	400	298	P	H
		5875	53.05	-52.15	105.2	41.45	32.3	9.96	30.66	400	298	P	H
		5882.6	53.52	-46.04	99.56	41.89	32.33	9.97	30.67	400	298	P	H
		5945.8	52.62	-15.58	68.2	40.79	32.49	10.05	30.71	400	298	P	H
802.11ac													H
VHT40													H
CH 159		5631.8	51.71	-16.49	68.2	40.53	31.84	9.85	30.51	313	322	P	V
5795MHz		5694.2	53.75	-47.17	100.92	42.46	31.98	9.86	30.55	313	322	P	V
		5717.6	54.98	-55.15	110.13	43.68	32	9.86	30.56	313	322	P	V
		5722.2	55.75	-60.07	115.82	44.46	32	9.86	30.57	313	322	P	V
	*	5795	110.18	-	-	98.74	32.18	9.87	30.61	313	322	P	V
	*	5795	102.3	-	-	90.86	32.18	9.87	30.61	313	322	A	V
		5852.4	56.61	-60.12	116.73	45.11	32.21	9.94	30.65	313	322	P	V
		5857.4	55.2	-54.93	110.13	43.68	32.23	9.94	30.65	313	322	P	V
		5876	54.06	-50.4	104.46	42.45	32.3	9.97	30.66	313	322	P	V
		5935.6	52.61	-15.59	68.2	40.8	32.47	10.04	30.7	313	322	P	V
													V
													V
Remark	1. No other spurious found. 2. All results are PASS against Peak and Average limit line.												



Band 4 5725~5850MHz

WIFI 802.11ac VHT40 (Harmonic @ 3m)

WIFI Ant. 1	Note	Frequency (MHz)	Level (dBμV/m)	Over Limit (dB)	Limit Line (dBμV/m)	Read Level (dBμV)	Antenna Factor (dB/m)	Path Loss (dB)	Preamp Factor (dB)	Ant Pos (cm)	Table Pos (deg)	Peak Avg. (P/A)	Pol. (H/V)	
802.11ac VHT40 CH 151 5755MHz		11510	59	-15	74	66.22	40.47	14.52	62.21	179	22	P	H	
		11510	49.66	-4.34	54	56.88	40.47	14.52	62.21	179	22	A	H	
		17265	48.07	-20.13	68.2	47.47	41.06	18.56	59.02	100	0	P	H	
													H	
			11510	57.97	-16.03	74	65.19	40.47	14.52	62.21	215	306	P	V
			11510	49.45	-4.55	54	56.67	40.47	14.52	62.21	215	306	A	V
			17265	48.55	-19.65	68.2	47.95	41.06	18.56	59.02	100	0	P	V
802.11ac VHT40 CH 159 5795MHz		11590	58.9	-15.1	74	66.37	40.23	14.57	62.27	100	254	P	H	
		11590	49.56	-4.44	54	57.03	40.23	14.57	62.27	100	254	A	H	
		17385	50.85	-17.35	68.2	48.8	42.05	18.75	58.75	100	0	P	H	
													H	
			11590	58.38	-15.62	74	65.85	40.23	14.57	62.27	217	309	P	V
			11590	49.5	-4.5	54	56.97	40.23	14.57	62.27	217	309	A	V
			17385	49.62	-18.58	68.2	47.57	42.05	18.75	58.75	100	0	P	V
													V	
Remark	1. No other spurious found. 2. All results are PASS against Peak and Average limit line.													



Band 4 5725~5850MHz

WIFI 802.11ac VHT80 (Band Edge @ 3m)

WIFI Ant. 1	Note	Frequency (MHz)	Level (dBμV/m)	Over Limit (dB)	Limit Line (dBμV/m)	Read Level (dBμV)	Antenna Factor (dB/m)	Path Loss (dB)	Preamp Factor (dB)	Ant Pos (cm)	Table Pos (deg)	Peak Avg. (P/A)	Pol. (H/V)
		5647.6	53.72	-14.48	68.2	42.59	31.8	9.85	30.52	190	258	P	H
		5697.6	69	-34.43	103.43	57.7	31.99	9.86	30.55	190	258	P	H
		5718.6	73.09	-37.32	110.41	61.8	32	9.86	30.57	190	258	P	H
		5724.6	73.85	-47.44	121.29	62.56	32	9.86	30.57	190	258	P	H
	*	5775	103.86	-	-	92.49	32.1	9.87	30.6	190	258	P	H
	*	5775	96.18	-	-	84.81	32.1	9.87	30.6	190	258	A	H
		5850.4	71.92	-49.37	121.29	60.44	32.2	9.93	30.65	190	258	P	H
		5856	71.54	-38.98	110.52	60.03	32.22	9.94	30.65	190	258	P	H
		5878.8	64.97	-37.41	102.38	53.34	32.32	9.97	30.66	190	258	P	H
		5929.6	51.94	-16.26	68.2	40.15	32.46	10.03	30.7	190	258	P	H
													H
													H
802.11ac VHT80 CH 155 5775MHz		5648.2	56.47	-11.73	68.2	45.34	31.8	9.85	30.52	302	323	P	V
		5696.8	71.76	-31.08	102.84	60.46	31.99	9.86	30.55	302	323	P	V
		5718.6	75.52	-34.89	110.41	64.23	32	9.86	30.57	302	323	P	V
		5722	75.89	-39.47	115.36	64.6	32	9.86	30.57	302	323	P	V
	*	5775	106.76	-	-	95.39	32.1	9.87	30.6	302	323	P	V
	*	5775	99.22	-	-	87.85	32.1	9.87	30.6	302	323	A	V
		5853.2	74.7	-40.2	114.9	63.2	32.21	9.94	30.65	302	323	P	V
		5857.8	73.95	-36.06	110.01	62.43	32.23	9.94	30.65	302	323	P	V
		5875.6	67.62	-37.13	104.75	56.02	32.3	9.96	30.66	302	323	P	V
		5927.6	51.64	-16.56	68.2	39.85	32.46	10.03	30.7	302	323	P	V
													V
													V
Remark	1. No other spurious found. 2. All results are PASS against Peak and Average limit line.												



Band 4 5725~5850MHz

WIFI 802.11ac VHT80 (Harmonic @ 3m)

WIFI Ant. 1	Note	Frequency (MHz)	Level (dBμV/m)	Over Limit (dB)	Limit Line (dBμV/m)	Read Level (dBμV)	Antenna Factor (dB/m)	Path Loss (dB)	Preamp Factor (dB)	Ant Pos (cm)	Table Pos (deg)	Peak Avg. (P/A)	Pol. (H/V)	
802.11ac VHT80 CH 155 5775MHz		11550	49.87	-24.13	74	57.21	40.35	14.55	62.24	100	0	P	H	
		17325	47.99	-20.21	68.2	46.75	41.45	18.67	58.88	100	0	P	H	
													H	
													H	
			11550	49.09	-24.91	74	56.43	40.35	14.55	62.24	100	0	P	V
			17325	49.24	-18.96	68.2	48	41.45	18.67	58.88	100	0	P	V
														V
														V
Remark	1. No other spurious found. 2. All results are PASS against Peak and Average limit line.													



Emission below 1GHz
WIFI 802.11 ac VHT80 (LF @ 3m)

WIFI	Note	Frequency	Level	Over	Limit	Read	Antenna	Path	Preamp	Ant	Table	Peak	Pol.	
Ant.				Limit	Line	Level	Factor	Loss	Factor	Pos	Pos	Avg.		
1		(MHz)	(dBμV/m)	(dB)	(dBμV/m)	(dBμV)	(dB/m)	(dB)	(dB)	(cm)	(deg)	(P/A)	(H/V)	
802.11 ac VHT80 LF		72.68	28.42	-11.58	40	47.09	12.74	1.17	32.58	-	-	P	H	
		103.72	26.28	-17.22	43.5	40.61	16.61	1.36	32.3	-	-	P	H	
		124.09	26.1	-17.4	43.5	39.37	17.72	1.46	32.45	-	-	P	H	
		192.96	21.34	-22.16	43.5	36.75	15.04	1.93	32.38	-	-	P	H	
		741.01	31.29	-14.71	46	32.62	27.61	3.52	32.46	-	-	P	H	
		887.48	34.77	-11.23	46	34.24	28.52	3.93	31.92	100	0	P	H	
														H
														H
														H
														H
														H
														H
			38.73	33.02	-6.98	40	44.56	20	0.8	32.34	100	0	P	V
			62.98	32.92	-7.08	40	51.68	12.26	1.08	32.1	-	-	P	V
			72.68	30.85	-9.15	40	49.52	12.74	1.17	32.58	-	-	P	V
			95.96	26.65	-16.85	43.5	41.97	15.64	1.33	32.29	-	-	P	V
			188.11	21.94	-21.56	43.5	37.43	14.97	1.92	32.38	-	-	P	V
			891.36	38.19	-7.81	46	37.66	28.51	3.95	31.93	-	-	P	V
														V
														V
													V	
													V	
													V	
													V	
Remark	1. No other spurious found. 2. All results are PASS against limit line.													



Note symbol

*	Fundamental Frequency which can be ignored. However, the level of any unwanted emissions shall not exceed the level of the fundamental frequency.
!	Test result is over limit line.
P/A	Peak or Average
H/V	Horizontal or Vertical



A calculation example for radiated spurious emission is shown as below:

WIFI	Note	Frequency	Level	Over	Limit	Read	Antenna	Path	Preamp	Ant	Table	Peak	Pol.
Ant.				Limit	Line	Level	Factor	Loss	Factor	Pos	Pos	Avg.	
1		(MHz)	(dBμV/m)	(dB)	(dBμV/m)	(dBμV)	(dB/m)	(dB)	(dB)	(cm)	(deg)	(P/A)	(H/V)
802.11b		2390	55.45	-18.55	74	54.51	32.22	4.58	35.86	103	308	P	H
CH 01		2390	43.54	-10.46	54	42.6	32.22	4.58	35.86	103	308	A	H
2412MHz													

1. Path Loss(dB) = Cable loss(dB) + Filter loss(dB) + Attenuator loss(dB)
2. Level(dBμV/m) = Antenna Factor(dB/m) + Path Loss(dB) + Read Level(dBμV) - Preamp Factor(dB)
3. Over Limit(dB) = Level(dBμV/m) – Limit Line(dBμV/m)

For Peak Limit @ 2390MHz:

1. Level(dBμV/m)
= Antenna Factor(dB/m) + Path Loss(dB) + Read Level(dBμV) - Preamp Factor(dB)
= 32.22(dB/m) + 4.58(dB) + 54.51(dBμV) – 35.86 (dB)
= 55.45 (dBμV/m)
2. Over Limit(dB)
= Level(dBμV/m) – Limit Line(dBμV/m)
= 55.45(dBμV/m) – 74(dBμV/m)
= -18.55(dB)

For Average Limit @ 2390MHz:

1. Level(dBμV/m)
= Antenna Factor(dB/m) + Path Loss(dB) + Read Level(dBμV) - Preamp Factor(dB)
= 32.22(dB/m) + 4.58(dB) + 42.6(dBμV) – 35.86 (dB)
= 43.54 (dBμV/m)
2. Over Limit(dB) = Level(dBμV/m) – Limit Line(dBμV/m)
= 43.54(dBμV/m) – 54(dBμV/m)
= -10.46(dB)

Both peak and average measured complies with the limit line, so test result is “PASS”.



Appendix C. Radiated Spurious Emission Plots

Test Engineer :	Leo Lee, Mancy Chou and Bigshow Wang	Temperature :	23.9~25.2°C
		Relative Humidity :	53~60%

Note symbol

-L	Low channel location
-R	High channel location

Band 4 - 5725~5850MHz
WIFI 802.11a (Band Edge @ 3m)

WIFI	Band 4 5725~5850MHz Band Edge @ 3m	
ANT	802.11a CH149 5745MHz	
1	Horizontal	Fundamental
Peak	<p>Site : 03CH15-HY Condition : PEAK_BE(B4)_16-24 3m 91200_15_1620 HORIZONTAL RBW:1000.000KHz VBW:3000.000KHz SWT:Auto Detector : Peak Project : 010732</p>	<p>Site : 03CH15-HY Condition : PEAK(UNII) 3m 91200_15_1620 HORIZONTAL RBW:1000.000KHz VBW:3000.000KHz SWT:Auto Detector : Peak Project : 010732</p>



WIFI	Band 4 5725~5850MHz Band Edge @ 3m	
ANT	802.11a CH149 5745MHz	
1	Vertical	Fundamental
Peak	<p>Site : 03CH15-HY Condition : PEAK_BE(4)_16-24 3m 91200_15_1620 VERTICAL RBW:1000.000KHz VBW:3000.000KHz SWT:Auto Detector : Peak Project : 010732</p>	<p>Site : 03CH15-HY Condition : PEAK(UNII)_3m 91200_15_1620 VERTICAL RBW:1000.000KHz VBW:3000.000KHz SWT:Auto Detector : Peak Project : 010732</p>

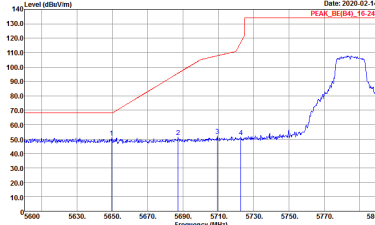
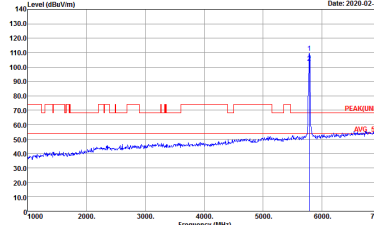
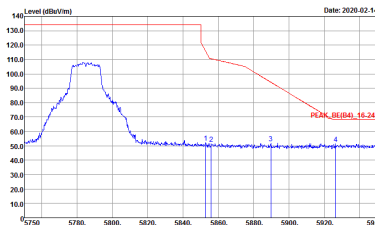

WIFI	Band 4 5725~5850MHz Band Edge @ 3m	
ANT	802.11a CH157 5785MHz	
1	Horizontal	Fundamental
<p>Peak</p>	 <p>Date: 2020-02-14 PEAK_BE(84)_15-24</p> <p>Site : 03CH15-HY Condition : PEAK_BE(84)_16-24 3m 91200_15_1620 HORIZONTAL RBW:1000.000KHz VBW:3000.000KHz SWT:Auto Detector : Peak Project : 010732</p>	 <p>Date: 2020-02-14 PEAK_UNI(84)_15-24</p> <p>Site : 03CH15-HY Condition : PEAK_UNI(84)_16-24 3m 91200_15_1620 HORIZONTAL RBW:1000.000KHz VBW:3000.000KHz SWT:Auto Detector : Peak Project : 010732</p>
<p>Peak</p>	 <p>Date: 2020-02-14 PEAK_BE(84)_16-24</p> <p>Site : 03CH15-HY Condition : PEAK_BE(84)_16-24 3m 91200_15_1620 HORIZONTAL RBW:1000.000KHz VBW:3000.000KHz SWT:Auto Detector : Peak Project : 010732</p>	<p>Left blank</p>



WIFI	Band 4 5725~5850MHz Band Edge @ 3m	
ANT	802.11a CH157 5785MHz	
1	Vertical	Fundamental
Peak	<p>Site : 03CH15-HY Condition : PEAK_BE(84)_16-24 3m 91200_15_1620 VERTICAL RBW:1000.000KHz VBW:3000.000KHz SWT:Auto Detector : Peak Project : 010732</p>	<p>Site : 03CH15-HY Condition : PEAK(UNII) 3m 91200_15_1620 VERTICAL RBW:1000.000KHz VBW:3000.000KHz SWT:Auto Detector : Peak Project : 010732</p>
Peak	<p>Site : 03CH15-HY Condition : PEAK_BE(84)_16-24 3m 91200_15_1620 VERTICAL RBW:1000.000KHz VBW:3000.000KHz SWT:Auto Detector : Peak Project : 010732</p>	Left blank



WIFI	Band 4 5725~5850MHz Band Edge @ 3m	
ANT	802.11a CH165 5825MHz	
1	Horizontal	Fundamental
Peak	<p>Site : 03CH15-HY Condition : PEAK_BE(B4)_16-24 3m 91200_15_1620 HORIZONTAL RBW:1000.000KHz VBW:3000.000KHz SWT:Auto Detector : Peak Project : 010732</p>	<p>Site : 03CH15-HY Condition : PEAK(UNII) 3m 91200_15_1620 HORIZONTAL RBW:1000.000KHz VBW:3000.000KHz SWT:Auto Detector : Peak Project : 010732</p>



WIFI	Band 4 5725~5850MHz Band Edge @ 3m	
ANT	802.11a CH165 5825MHz	
1	Vertical	Fundamental
Peak	<p>Site : 03CH15-HY Condition : PEAK_BE(B4)_16-24 3m 91200_15_1620 VERTICAL RBW:1000.000KHz VBW:3000.000KHz SWT:Auto Detector : Peak Project : 010732</p>	<p>Site : 03CH15-HY Condition : PEAK(UNII) 3m 91200_15_1620 VERTICAL RBW:1000.000KHz VBW:3000.000KHz SWT:Auto Detector : Peak Project : 010732</p>



**Band 4 5725~5850MHz
WIFI 802.11ac VHT20 (Band Edge @ 3m)**

WIFI	Band 4 5725~5850MHz Band Edge @ 3m	
ANT	802.11ac VHT20 CH149 5745MHz	
1	Horizontal	Fundamental
Peak	<p>Site : 03CH15-HY Condition : PEAK_BE(B4)_16-24 3m 91200_15_1620 HORIZONTAL Detector : Peak Project : 010732</p>	<p>Site : 03CH15-HY Condition : PEAK(UNIT) 3m 91200_15_1620 HORIZONTAL Detector : Peak Project : 010732</p>



WIFI	Band 4 5725~5850MHz Band Edge @ 3m	
ANT	802.11ac VHT20 CH149 5745MHz	
1	Vertical	Fundamental
<p>Peak</p> <p>Avg.</p>	<p>Date: 2020-02-14 PEAK_BE(4)_15_20</p> <p>Site : 03CH15-HY Condition : PEAK_BE(84)_16-24 3m 91200_15_1620 VERTICAL RBW:1000.000KHz VBW:3000.000KHz SWT:Auto Detector : Peak Project : 010732</p>	<p>Date: 2020-02-14 PEAK(UN)I</p> <p>Site : 03CH15-HY Condition : PEAK(UN)I 3m 91200_15_1620 VERTICAL RBW:1000.000KHz VBW:3000.000KHz SWT:Auto Detector : Peak Project : 010732</p>



WIFI	Band 4 5725~5850MHz Band Edge @ 3m	
ANT	802.11ac VHT20 CH157 5785MHz	
1	Horizontal	Fundamental
Peak	<p>Site : 03CH15-HY Condition : PEAK_BE(B4)_16-24 3m 91200_15_1620 HORIZONTAL Detector : Peak Project : 010732</p>	<p>Site : 03CH15-HY Condition : PEAK(UNII) 3m 91200_15_1620 HORIZONTAL Detector : Peak Project : 010732</p>
Peak	<p>Site : 03CH15-HY Condition : PEAK_BE(B4)_16-24 3m 91200_15_1620 HORIZONTAL Detector : Peak Project : 010732</p>	Left blank



WIFI	Band 4 5725~5850MHz Band Edge @ 3m	
ANT	802.11ac VHT20 CH157 5785MHz	
1	Vertical	Fundamental
<p>Peak</p>	<p>Site : 03CH15-HY Condition : PEAK_BE(84)_16-24 3m 91200_15_1620 VERTICAL RBW:1000.000KHz VBW:3000.000KHz SWT:Auto Detector : Peak Project : 010732</p>	<p>Site : 03CH15-HY Condition : PEAK_UNI(84)_16-24 3m 91200_15_1620 VERTICAL RBW:1000.000KHz VBW:3000.000KHz SWT:Auto Detector : Peak Project : 010732</p>
<p>Peak</p>	<p>Site : 03CH15-HY Condition : PEAK_BE(84)_16-24 3m 91200_15_1620 VERTICAL RBW:1000.000KHz VBW:3000.000KHz SWT:Auto Detector : Peak Project : 010732</p>	<p>Left blank</p>



WIFI	Band 4 5725~5850MHz Band Edge @ 3m	
ANT	802.11ac VHT20 CH165 5825MHz	
1	Horizontal	Fundamental
Peak	<p>Site : 03CH15-HY Condition : PEAK_BE(B4)_16-24 3m 91200_15_1620 HORIZONTAL RBW:1000.000KHz VBW:3000.000KHz SWT:Auto Detector : Peak Project : 010732</p>	<p>Site : 03CH15-HY Condition : PEAK(FUN) 3m 91200_15_1620 HORIZONTAL RBW:1000.000KHz VBW:3000.000KHz SWT:Auto Detector : Peak Project : 010732</p>



WIFI	Band 4 5725~5850MHz Band Edge @ 3m	
ANT	802.11ac VHT20 CH165 5825MHz	
1	Vertical	Fundamental
<p>Peak</p> <p>Avg.</p>	<p>Site : 03CH15-HY Condition : PEAK_BE(B4)_16-24 3m 91200_15_1620 VERTICAL RBW:1000.000KHz VBW:3000.000KHz SWT:Auto Detector : Peak Project : 010732</p>	<p>Site : 03CH15-HY Condition : PEAK(U)B 3m 91200_15_1620 VERTICAL RBW:1000.000KHz VBW:3000.000KHz SWT:Auto Detector : Peak Project : 010732</p>



Band 4 5725~5850MHz
WIFI 802.11ac VHT40 (Band Edge @ 3m)

WIFI	Band 4 5725~5850MHz Band Edge @ 3m	
ANT	802.11ac VHT40 CH151 5755MHz	
1	Horizontal	Fundamental
Peak	<p>Site : 03CH15-HY Condition : PEAK_BE(84)_16-24 3m 91200_15_1620 HORIZONTAL Detector : Peak Project : 010732</p>	<p>Site : 03CH15-HY Condition : PEAK(UNIT) 3m 91200_15_1620 HORIZONTAL Detector : Peak Project : 010732</p>
Peak	<p>Site : 03CH15-HY Condition : PEAK_BE(84)_16-24 3m 91200_15_1620 HORIZONTAL Detector : Peak Project : 010732</p>	Left blank

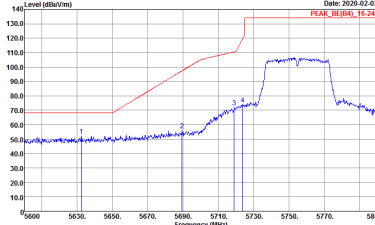
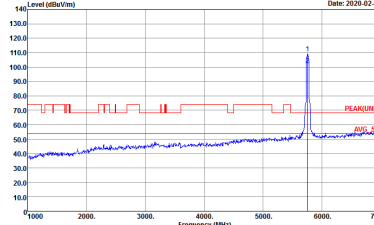
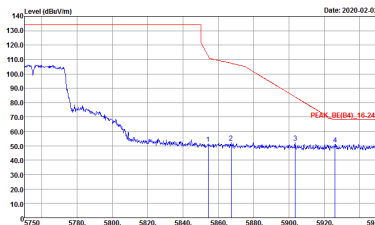

WIFI	Band 4 5725~5850MHz Band Edge @ 3m	
ANT	802.11ac VHT40 CH151 5755MHz	
1	Vertical	Fundamental
Peak	 <p>Site : 03CH15-HY Condition : PEAK_BE(84)_16-24 3m 91200_15_1620 VERTICAL Detector : Peak Project : 010732</p>	 <p>Site : 03CH15-HY Condition : PEAK(UNII) 3m 91200_15_1620 VERTICAL Detector : Peak Project : 010732</p>
Peak	 <p>Site : 03CH15-HY Condition : PEAK_BE(84)_16-24 3m 91200_15_1620 VERTICAL Detector : Peak Project : 010732</p>	Left blank



WIFI	Band 4 5725~5850MHz Band Edge @ 3m	
ANT	802.11ac VHT40 CH159 5795MHz	
1	Horizontal	Fundamental
<p>Peak</p>	<p>Site : 03CH15-HY Condition : PEAK_BE(B4)_16-24 3m 91200_15_1620 HORIZONTAL RBW:1000.000KHz VBW:3000.000KHz SWT:Auto Detector : Peak Project : 010732</p>	<p>Site : 03CH15-HY Condition : PEAK(UNII) 3m 91200_15_1620 HORIZONTAL RBW:1000.000KHz VBW:3000.000KHz SWT:Auto Detector : Peak Project : 010732</p>
<p>Peak</p>	<p>Site : 03CH15-HY Condition : PEAK_BE(B4)_16-24 3m 91200_15_1620 HORIZONTAL RBW:1000.000KHz VBW:3000.000KHz SWT:Auto Detector : Peak Project : 010732</p>	<p>Left blank</p>



WIFI	Band 4 5725~5850MHz Band Edge @ 3m	
ANT	802.11ac VHT40 CH159 5795MHz	
1	Vertical	Fundamental
Peak	<p>Site : 03CH15-HY Condition : PEAK_BE(84)_16-24 3m 91200_15_1620 VERTICAL RBW:1000.000KHz VBW:3000.000KHz SWT:Auto Detector : Peak Project : 010732</p>	<p>Site : 03CH15-HY Condition : PEAK(UNII) 3m 91200_15_1620 VERTICAL RBW:1000.000KHz VBW:3000.000KHz SWT:Auto Detector : Peak Project : 010732</p>
Peak	<p>Site : 03CH15-HY Condition : PEAK_BE(84)_16-24 3m 91200_15_1620 VERTICAL RBW:1000.000KHz VBW:3000.000KHz SWT:Auto Detector : Peak Project : 010732</p>	Left blank



Band 4 5725~5850MHz
WIFI 802.11ac VHT80 (Band Edge @ 3m)

WIFI	Band 4 5725~5850MHz Band Edge @ 3m	
ANT	802.11ac VHT80 CH155 5775MHz	
1	Horizontal	Fundamental
Peak	<p>Site : 03CH15-HY Condition : PEAK_BE(B4)_16-24 3m 91200_15_1620 HORIZONTAL Detector : Peak Project : 010732</p>	<p>Site : 03CH15-HY Condition : PEAK(UNIT) 3m 91200_15_1620 HORIZONTAL Detector : Peak Project : 010732</p>
Peak	<p>Site : 03CH15-HY Condition : PEAK_BE(B4)_16-24 3m 91200_15_1620 HORIZONTAL Detector : Peak Project : 010732</p>	Left blank



WIFI	Band 4 5725~5850MHz Band Edge @ 3m	
ANT	802.11ac VHT80 CH155 5775MHz	
1	Vertical	Fundamental
Peak	<p>Site : 03CH15-HY Condition : PEAK_BE(84)_16-24 3m 91200_15_1620 VERTICAL RBW:1000.000KHz VBW:3000.000KHz SWT:Auto Detector : Peak Project : 010732</p>	<p>Site : 03CH15-HY Condition : PEAK(UNII)_3m 91200_15_1620 VERTICAL RBW:1000.000KHz VBW:3000.000KHz SWT:Auto Detector : Peak Project : 010732</p>
Peak	<p>Site : 03CH15-HY Condition : PEAK_BE(84)_16-24 3m 91200_15_1620 VERTICAL RBW:1000.000KHz VBW:3000.000KHz SWT:Auto Detector : Peak Project : 010732</p>	Left blank



Band 4 - 5725~5850MHz
WIFI 802.11a (Harmonic @ 3m)

Table with 2 columns: Horizontal and Vertical. Each column contains a spectral plot showing Level (dBuV/m) vs Frequency (MHz) with peak and average values indicated. Includes metadata like Site, Condition, Detector, Project, and Setting.



WIFI	Band 4 5725~5850MHz Harmonic @ 3m	
ANT	802.11a CH157 5785MHz	
1	Horizontal	Vertical
Peak Avg.	<p>Site : 03CH15-HY Condition : PEAK(UNII) 3m 91200_15_1620 HORIZONTAL Detector : Peak Project : 010732</p>	<p>Site : 03CH15-HY Condition : PEAK(UNII) 3m 91200_15_1620 VERTICAL Detector : Peak Project : 010732</p>



WIFI	Band 4 5725~5850MHz Harmonic @ 3m	
ANT	802.11a CH165 5825MHz	
1	Horizontal	Vertical
Peak Avg.	<p>Site : 03CH15-HY Condition : PEAK(UNII) 3m 91200_15_1620 HORIZONTAL Detector : Peak Project : 010732</p>	<p>Site : 03CH15-HY Condition : PEAK(UNII) 3m 91200_15_1620 VERTICAL Detector : Peak Project : 010732</p>



Band 4 5725~5850MHz
WIFI 802.11ac VHT20 (Harmonic @ 3m)

Table with 2 columns: WIFI (Band 4 5725~5850MHz Harmonic @ 3m), ANT (802.11ac VHT20 CH149 5745MHz). Row 1: 1, Horizontal, Vertical. Each plot shows Level (dBu/m) vs Frequency (MHz) with Peak and Avg. markers.



WIFI	Band 4 5725~5850MHz Harmonic @ 3m	
ANT	802.11ac VHT20 CH157 5785MHz	
1	Horizontal	Vertical
Peak Avg.	<p>Site : 03CH15-HY Condition : PEAK(UNII) 3m 91200_15_1620 HORIZONTAL Detector : Peak Project : 010732 Setting : 18</p>	<p>Site : 03CH15-HY Condition : PEAK(UNII) 3m 91200_15_1620 VERTICAL Detector : Peak Project : 010732 Setting : 18</p>



WIFI	Band 4 5725~5850MHz Harmonic @ 3m	
ANT	802.11ac VHT20 CH165 5825MHz	
1	Horizontal	Vertical
Peak Avg.	<p>Site : 03CH15-HY Condition : PEAK(UNII) 3m 91200_15_1620 HORIZONTAL Detector : Peak Project : 010732</p>	<p>Site : 03CH15-HY Condition : PEAK(UNII) 3m 91200_15_1620 VERTICAL Detector : Peak Project : 010732</p>



Band 4 5725~5850MHz
WIFI 802.11ac VHT40 (Harmonic @ 3m)

WIFI	Band 4 5725~5850MHz Harmonic @ 3m	
ANT	802.11ac VHT40 CH151 5755MHz	
1	Horizontal	Vertical
Peak Avg.	<p>Site : 03CH15-HY Condition : PEAK(UNII) 3m 91200_15_1620 HORIZONTAL Detector : Peak Project : 010732</p>	<p>Site : 03CH15-HY Condition : PEAK(UNII) 3m 91200_15_1620 VERTICAL Detector : Peak Project : 010732</p>



WIFI	Band 4 5725~5850MHz Harmonic @ 3m	
ANT	802.11ac VHT40 CH159 5795MHz	
1	Horizontal	Vertical
Peak Avg.	<p>Site : 03CH15-HY Condition : PEAK(UNII) 3m 91200_15_1620 HORIZONTAL Detector : Peak Project : 010732</p>	<p>Site : 03CH15-HY Condition : PEAK(UNII) 3m 91200_15_1620 VERTICAL Detector : Peak Project : 010732</p>

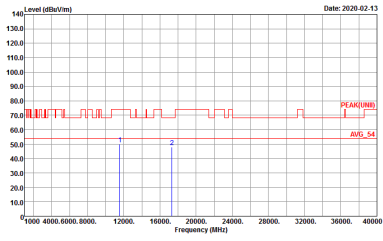
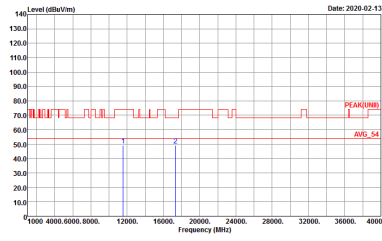

**Band 4 5725~5850MHz
WIFI 802.11ac VHT80 (Harmonic @ 3m)**

WIFI	Band 4 5725~5850MHz Harmonic @ 3m	
ANT	802.11ac VHT80 CH155 5775MHz	
1	Horizontal	Vertical
<p>Peak</p> <p>Avg.</p>	 <p>Site : 03CH15-HY Condition : PEAK(UNII) 3m 91200_15_1620 HORIZONTAL Detector : Peak Project : 010732</p>	 <p>Site : 03CH15-HY Condition : PEAK(UNII) 3m 91200_15_1620 VERTICAL Detector : Peak Project : 010732</p>



Emission below 1GHz
5GHz WIFI 802.11ac VHT80 (LF)

WIFI	5GHz 5725~5850MHz	
ANT	802.11ac VHT80 LF	
1	Horizontal	Vertical
QP / Peak	<p>Site : 03CH15-11Y Condition : QP 3m B1LOG_15_41912 HORIZONTAL Detector : Peak Project : 010732</p>	<p>Site : 03CH15-11Y Condition : QP 3m B1LOG_15_41912 VERTICAL Detector : Peak Project : 010732</p>



Appendix D. Duty Cycle Plots

Band	Duty Cycle(%)	T(us)	1/T(kHz)	VBW Setting	Duty Factor(dB)
802.11a	95.15	2060	0.49	1kHz	0.22
5GHz 802.11n HT20	94.80	1915	0.52	1kHz	0.23
5GHz 802.11n HT40	90.34	935	1.07	3kHz	0.44
5GHz 802.11ac VHT20	95.78	1930	0.52	1kHz	0.19
5GHz 802.11ac VHT40	91.35	950	1.05	3kHz	0.39
5GHz 802.11ac VHT80	85.93	464	2.16	3kHz	0.66



802.11a

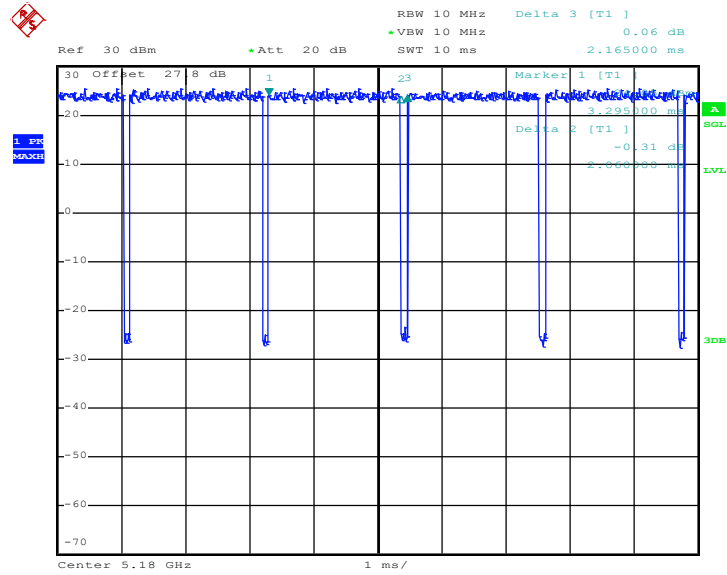

Date: 22.JAN.2020 21:05:41

802.11n HT20

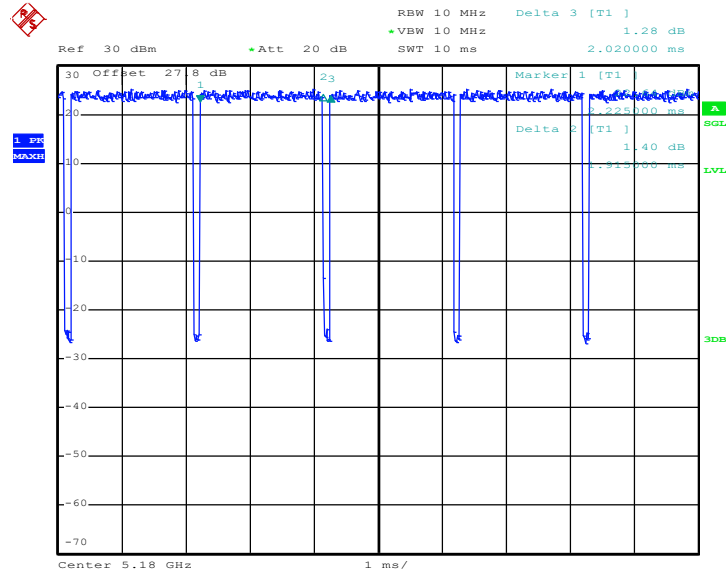

Date: 22.JAN.2020 21:06:30



802.11n HT40

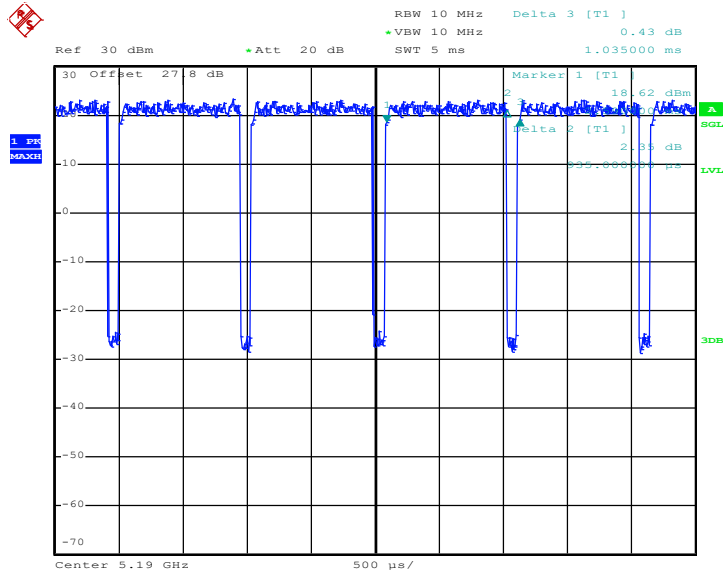

Date: 22.JAN.2020 21:07:20

802.11ac VHT20

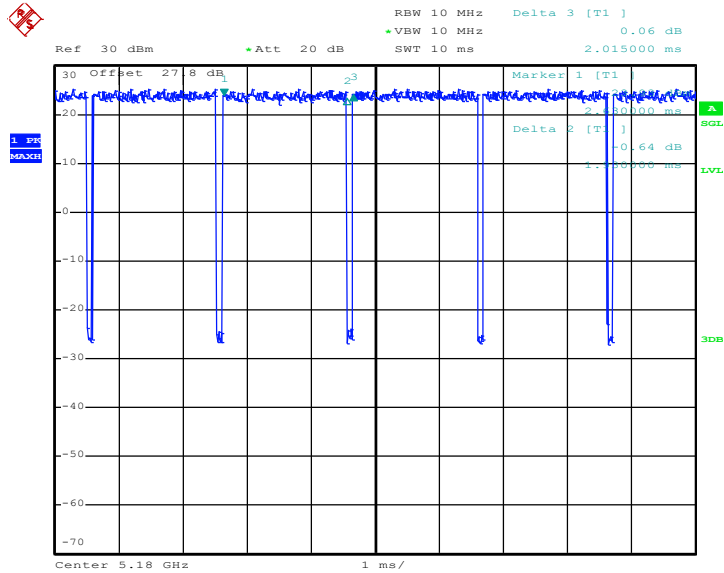

Date: 22.JAN.2020 21:08:57



802.11ac VHT40

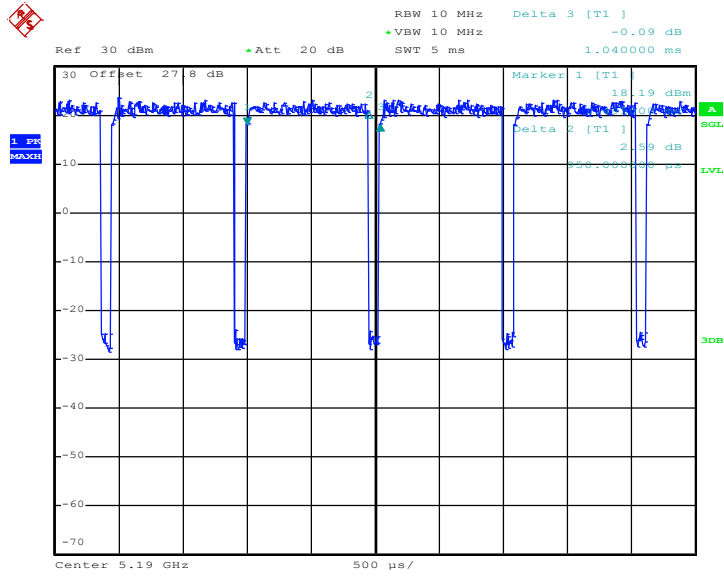

Date: 22.JAN.2020 21:09:56

802.11ac VHT80

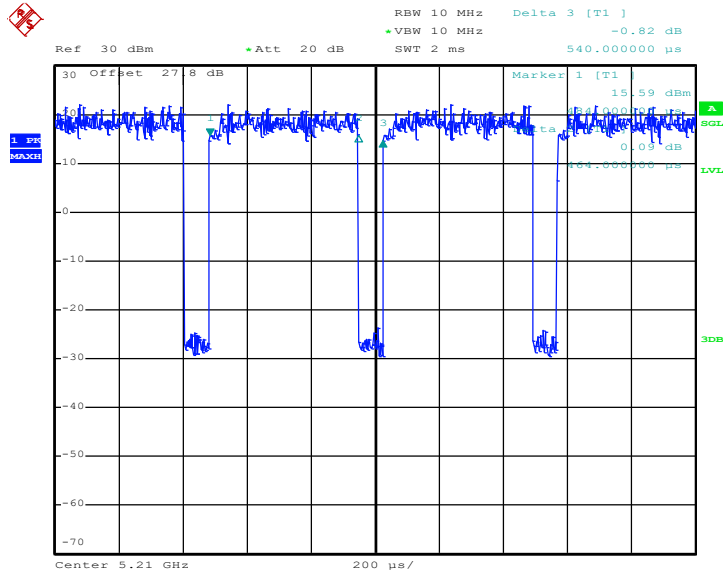

Date: 22.JAN.2020 21:11:05