

SUSTAINABILITY FACTSHEET

Ecodesign Directive (2009/125/EC)

Implementing Regulations

Canon complies with relevant Implementing Regulations (so called 'Lot') under the EU Ecodesign Directive (2009/125/EC) and similar laws in countries other than EU. The Ecodesign Directive aims to improve the energy efficiency of products.

Lot 4 Voluntary Agreement on Imaging Equipment

Canon signed a Voluntary Agreement (VA), which was established as alternatives to potential regulations under the Ecodesign Directive (2009/125/EC), on improving the environmental performance of imaging equipment in June 2011. This self-regulatory initiative is driven by imaging equipment manufacturers and was endorsed by the European Commission in January 2013 as equivalent to a binding regulation. The VA sets targets for reducing the energy consumption of printing and copying in the EU and addresses not only energy conservation, but also resource efficiency aspects, use aspects of ink, toner and paper and their recycling.

In 2014, the 16 signatories to [EuroVAprint](#) agreed new targets as VA v.5.2. Effective on 1st January 2015, 70% of TEC (typical energy consumption) and 90% of OM (operational mode) products placed on the EU market must qualify for EU ENERGY STAR® 2.0 and the targets increased by two further increments from January 2016 and January 2017.

The VA includes concrete commitments on energy; paper savings and options (duplex enabled by default); recycled paper*¹; spare parts; and information on end-of-life options for consumables. Under the VA, manufacturers also give explicit guidance to users on using printing paper responsibly.

Under the VA V.5.2 onwards, for new models placed on the EU market after 1 January 2015, signatories will make spare parts available (if these are offered) for a minimum of five years for laser products and three years for inkjet products after production ceases.

EU ErP Directive LOT 7 Information for COMMISSION REGULATION (EU) 2019/1782 (External power supplies for Camera, Video Camera and Compact Photo Printer)

	Information								
Manufacturer's name	Canon Europe N.V.								
Commercial registration number	33166721								
Address	Bovenkerkerweg 59, 1185 XB Amstelveen, The Netherlands								
Model identifier	PD-E1	AC-E6N	CA-PS700	CA-CP200 B	CA-CP200 L	CA-570 E	CA-110E	CA-946	CA-A10
Input voltage	230V								
Input AC frequency	50Hz								
Output voltage	5.0V 9.0V	8.0V	7.4V	24.0V	24.0V	8.4V	5.3V	8.4V	16.7V
Output current	3.0A 3.0A	3.0A	2.0A	1.8A	1.8A	1.5A	1.5A	3.7A	3.0A
Output power	15.0W 27.0W	24.0W	14.8W	43.2W	43.2W	12.6W	8.0W	31.1W	50.1W
Average active efficiency	83.3% 88.0%	88.1%	85.8%	88.9%	88.9%	83.7%	79.8%	88.7%	89.9%
Efficiency at low load (10 %)	78.5% 83.9%	83.7%	84.9%	83.2%	83.2%	77.3%	76.3%	88.7%	83.9%
No-load power consumption	0.05W 0.05W	0.04W	0.05W	0.07W	0.07W	0.07W	0.05W	0.04W	0.19W

COMMISSION REGULATION (EU) 2019/2021 of 1 October 2019

laying down ecodesign requirements for electronic displays pursuant to Directive 2009/125/EC of the European Parliament and of the Council, amending Commission Regulation (EC) No 1275/2008 and repealing Commission Regulation (EC) No 642/2009

Products in scope:

- DP-V3120
- DP-V2411
- DP-V1711

INFORMATION FOR TREATMENT FACILITIES

Based on Article 15 and Annex VII of the Directive 2012/19/EU of The European Parliament and of The Council (WEEE recast)

PRODUCER: CANON EUROPA N.V. Address: Bovenkerkerweg 59, 1185 XB Amstelveen, The Netherlands Phone No.: (31) 20-545-8545 WEB: http://www.canon-europe.com/	Brand/Logo Canon	Doc. # [] Original Date: 24th Feb. 2021
Scope of information sheet: [] Until 14 August 2018, product category as in Annex I of WEEE Directive 3.IT and Telecommunications equipment From 15 August 2018, product category as in Annex III of WEEE Directive Type of equipment as in Annex II (until 14 August 2018) or in Annex IV (from 15 August 2018) of WEEE Directive Producer's Product Family Video Display Single products identified by brand and model name DP-V3120, DP-V2411, DP-V1711		
Component or Material	Remarks / Location	
a. Battery (internal *) containing Mercury (Hg)/ NiCad/Lithium/ Other	<input type="checkbox"/> No <input type="checkbox"/> Yes Location: []	
b. Backlighting lamps of LCD/TFT or similar screens containing Mercury (Hg)	<input type="checkbox"/> No <input type="checkbox"/> Yes Location: []	
c. Mercury (Hg) in other applications**	<input type="checkbox"/> No <input type="checkbox"/> Yes Location: []	
d. Cadmium**	<input type="checkbox"/> No <input type="checkbox"/> Yes	
e. Gas discharge lamps	<input type="checkbox"/> No <input type="checkbox"/> Yes	
f. Plastic containing brominated flame retardants other than in Printed Circuit Assemblies ***	<input type="checkbox"/> No <input checked="" type="checkbox"/> Yes	
g. Liquid Crystal Displays with a surface greater than 100 cm ²	<input type="checkbox"/> No <input checked="" type="checkbox"/> Yes	
h. Capacitors with PCB's	<input type="checkbox"/> No <input type="checkbox"/> Yes Location: []	
i. Capacitors with substances of concern**** + height > 25 mm, diameter > 25 mm or proportionately similar volume	<input type="checkbox"/> No <input type="checkbox"/> Yes Location: []	
j. Asbestos	<input type="checkbox"/> No <input type="checkbox"/> Yes	
k. Refractory ceramic fibers	<input type="checkbox"/> No <input type="checkbox"/> Yes	
l. Radio-active substances	<input type="checkbox"/> No <input type="checkbox"/> Yes	
m. Beryllium Oxide	<input type="checkbox"/> No <input type="checkbox"/> Yes Location: []	
n. Other forms of Beryllium	<input type="checkbox"/> No <input type="checkbox"/> Yes	
o. Gasses - which fall under Regulation (EC) 2037/2000 and all hydrocarbons (HC).	<input type="checkbox"/> No <input type="checkbox"/> Yes Location: [] Type: [] Properties: [] Volume and/or weight: []	
p. Components with pressurized gas which need special attention (Pressure > 1,5 bar) *****	<input type="checkbox"/> No <input type="checkbox"/> Yes Location: [] Type: [] Pressure level: [] Discharge method: []	
q. Liquids ***** if volume > 10 cl (=100ml or equivalence in weight, e.g. for PCB, oil...)	<input type="checkbox"/> No <input type="checkbox"/> Yes Location: [] Type: [] Discharge method: []	
r. Mechanical components that store mechanical energy (i.e. springs) or equivalent parts which need special attention ***** (diameter > 10 mm and height > 25 mm or proportionally similar volume and expanding)	<input type="checkbox"/> No <input type="checkbox"/> Yes Location: []	

* Internal means that batteries can only be removed by opening the product by means of (a) tool(s).

** Substances are considered to be in the product if present above the levels specified in the [Directive 2011/65/EU \(RoHS Directive recast\)](#) or are used in applications exempted by Annex III or IV of the Directive and its amendments.

*** To be coherent with industry current standards and practices on tracking of plastic parts, [2012/19/EU Annex VII](#) requirement is understood to focus on plastic parts that weight more than 25 g.

**** Substance of concern other than PCB, to be specified/ addressed further in the context of [2012/19/EU Annex VII](#), national requirements and European developments.

***** Needs of equivalent nature as those for maintenance, service manuals and installation for safety purposes.

Canon

DP-V3120

Service Manual



REPAIR INFORMATION

CONTENTS

Chapter1 REPAIR INFORMATION

1-1. Before Disassembly	4	1-24. Front_UA Harness	27
1-2. FLOW CHART	5	1-25. FFC Connection	28
1-3. Removing the Handles	6	1-26. Removing the TCON Unit	29
1-4. Removing the Stand	7	1-27. Removing the BLIF PCB	30
1-5. Removing the Rear Cover	8	1-28. VCOM_FFC_Styling	31
1-6. Removing the Top Cover	9	1-29. Removing the Bracket_Side/Top	32
1-7. Removing the Side Cover (Left)	10	1-30. Laying the DCDC PCB Harness	33
1-8. Removing the Side Cover (Right)	11	1-31. LED-DRV_FFC	34
1-9. Removing the Bottom Cover	12	1-32. Removing the DRV UNIT	35
1-10. Removing the Holder_VESA	13	1-33. Removing the DRV UNIT 2	36
1-11. PowIF/MAIN Layer: Laying Harnesses 1	14	1-34. Laying the BL_FAN UNIT Cable 1	37
1-12. PowIF/MAIN Layer: Laying Harnesses 2	15	1-35. Laying the BL_FAN UNIT Cable 2	38
1-13. PowIF/MAIN Layer: Laying Harnesses 3	16	1-36. BL_FAN UNIT取り外し 1	39
1-14. PowIF/MAIN Layer: Laying Harnesses 4	17	1-37. Removing the BL_FAN UNIT 2	40
1-15. Removing the Holder_LAN, AC Inlet	18	1-38. Removing the Rear Cover Unit	41
1-16. Removing the MAIN PCB	19	1-39. Rear IF UNIT	42
1-17. Removing the PowIF PCB	20	1-40. Rear Cover Left Unit	43
1-18. Removing the Chassis PowIF/MAIN	21	1-41. Rear Stand Unit	44
1-19. Power Layer: Laying Harnesses 1	22	1-42. Front Stand Unit	45
1-20. Power Layer: Laying Harnesses 2	23	1-43. Removing the Bezel Unit	46
1-21. Removing the Chassis Power	24	1-44. Removing the Bezel Unit 2	47
1-22. LED DRV Layer: Laying Harnesses	25	1-45. Removing the Bezel Unit 3	48
1-23. Removing the Frame Middle	26	1-46. Removing the Bezel Unit 4	49

REPAIR INFORMATION

1. REPAIR INFORMATION

1-1. Before Disassembly

■ Required Tools and Supplies

Name	Purpose	Notes
Phillips screwdriver with torque control (bit #1), length;100mm	Disassembly and assembly	For M2 screws
Phillips screwdriver with torque control (bit #2), Length;100mm	Disassembly and assembly	For M3 screws and M4 screws
Hex key (5 mm; Hexagon width across flats)	Disassembly and assembly	For [HANDLE] Detachment
Hex Nut Screwdriver (5.5 mm; Hexagon width across flats)	Disassembly and assembly	For [TCON PCB, DRIVER PCB] Detachment
Tweezers	Disassembly and assembly	
Pole made of Styrofoam (height 8 cm)	To protect the monitor from damage	
TAPE, ROLL(NO.156A) 10MM X 30M	For [COVER, FRONT BEZEL]	Part Number:CY9-5710-000
BOND, DIABOND NO.1663G BLACK	For [KNOB, JOG] Assembly	Part Number:CY9-8129-000
BOND, THREE BOND TB1401C	DC POWER SUP, PCB取り付け用	Part Number: CY9-8011-000
CABLE, DC POWER SUPPLY	For Connecting DC POWER SUPPLY	Part Number:CY9-5713-000

■ Precautions against Electric Shock and Hot Components



• Electric shock caution mark

This mark appears on parts of the circuit board to indicate possible electric shock hazards. Before working on such parts, be sure to remove the power cord, and do not touch them.



• Hot caution mark

This mark appears on parts of the circuit board to indicate that they become hot. When the display is turned on, or even after a short time after the power is turned off, touching such parts may cause burns. Before working on such parts, be sure to remove the power cord, and do not touch them.

■ Precautions in Disassembling and Assembling the Display

- Before disassembly, be sure to remove the power cord and wait 30 minutes or more*.
- Disassembly and assembly are basically carried out with the monitor screen facing down. To protect the screen from damage, insert pole made of styrofoam between the display and the workbench (see page 7).
- Be sure to use a proper screwdriver bit that fits to the screw head.
- Follow the tightening torque specified in this manual when fastening screws.
- Use a commercially-available antistatic wrist strap when touching a circuit board.
- Connect and remove connectors carefully to avoid damaging connectors and cables.
- Return all components and wiring to their original conditions. For safety reasons, some components use insulation material, such as tubing and taping, while others are mounted off the printed circuit board. Internal wires are run in a way to prevent them from making contact with heat-source and high-voltage components (such as by using clamps). Be sure to return them to their original conditions.
- Do not disassemble any parts not listed in the disassembly instructions of this service manual. Also, do not disconnect cables and connectors.
- Wear gloves for preventing you from injury when removing a frame.

* Assembling or disassembling while there is residual charge in both ends of the aluminum electrolytic capacitor may result in electrical shock or damage to the IC components. This model does not come with a discharge pad or other such components.

REPAIR INFORMATION

1-2. FLOW CHART

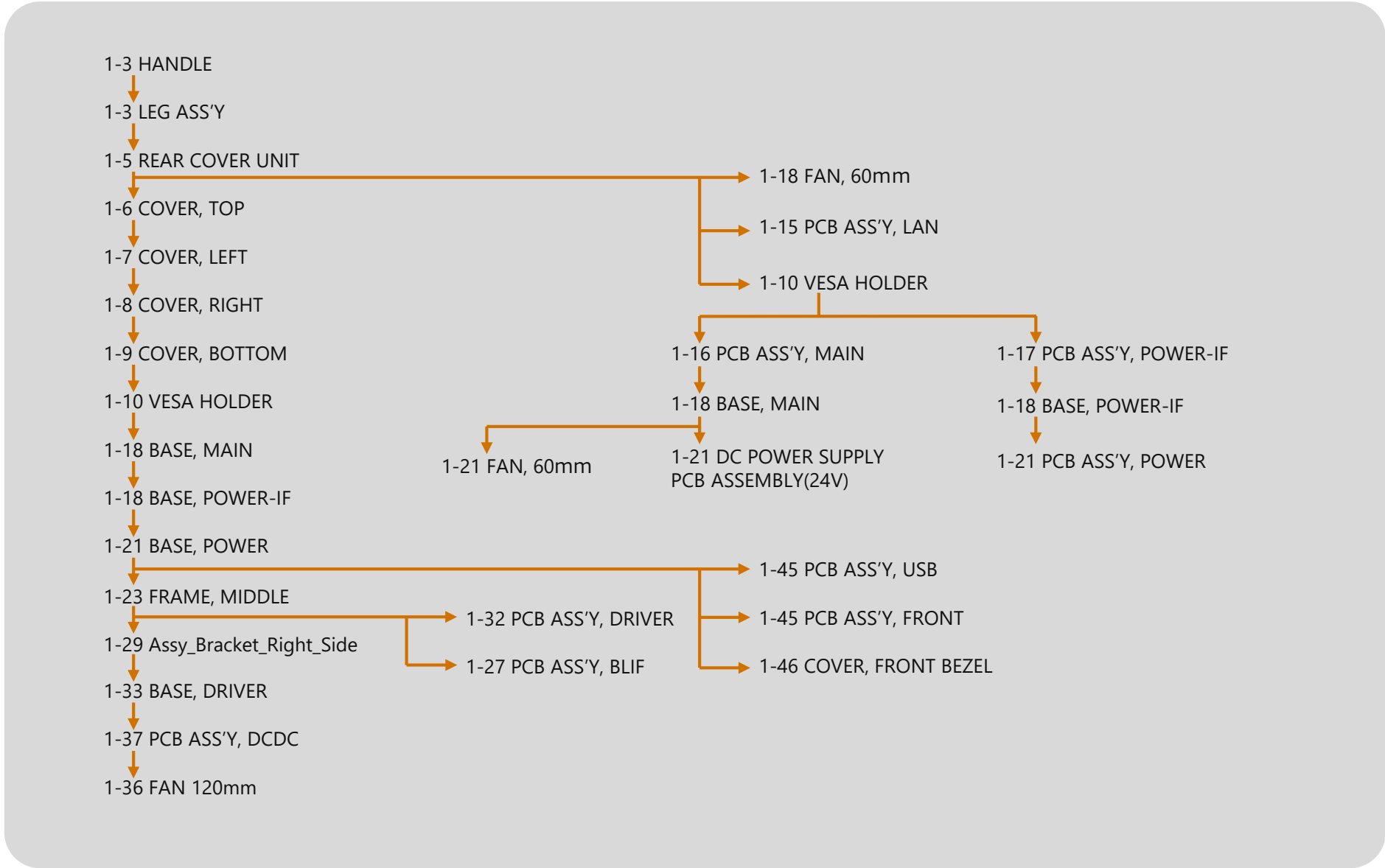

REPAIR INFORMATION

1-3. Removing the Handles

■ Disassembly procedure

1. Remove ②, and then remove ① (4 positions).

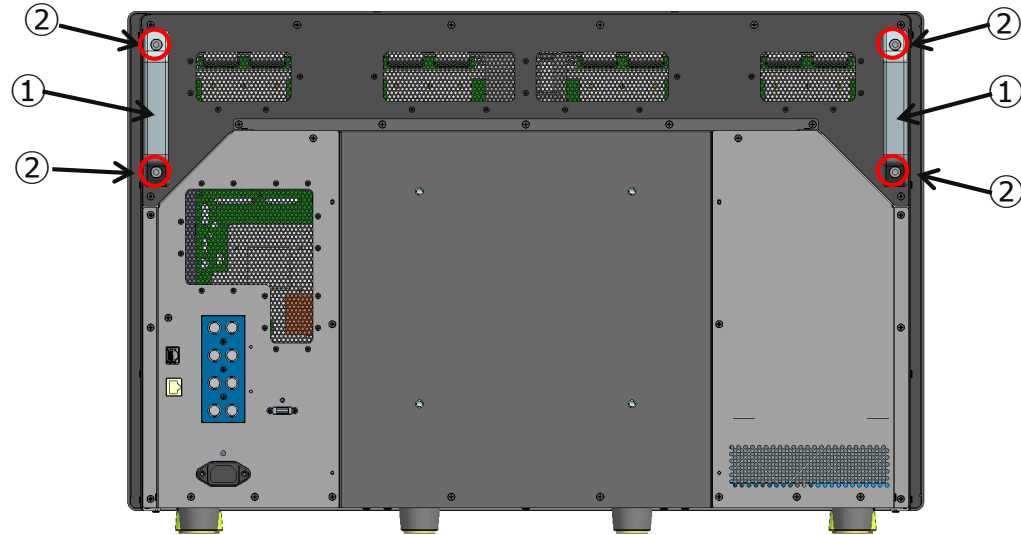

	Parts No.	Description	Qty.
①	DD1-0618-000	HANDLE	2
②	XB7-1060-169	BOLT, HEX SKT. M6X16	4

REPAIR INFORMATION

1-4. Removing the Stand

■ Disassembly procedure

1. Remove ①, and then remove the front stand unit (4 positions).
2. Remove ①, and then remove the rear stand unit (4 positions).

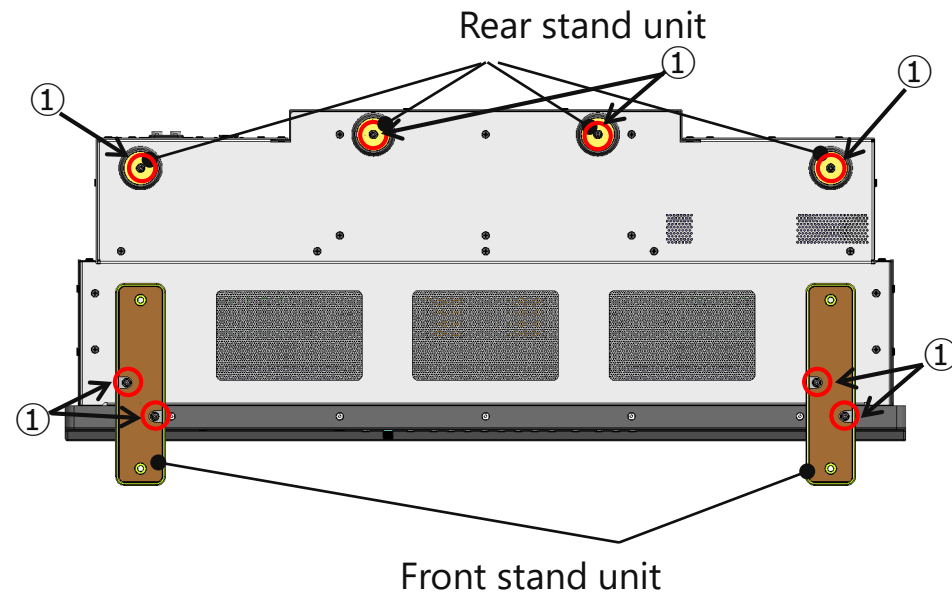

	Parts No.	Description	Qty.
①	XB2-4301-005	SCREW, W/WASHER, M3X10	8

REPAIR INFORMATION

1-5. Removing the Rear Cover

■ **Disassembly procedure**

1. Remove ① (20 positions).
2. Remove ②, and then remove the rear cover unit.

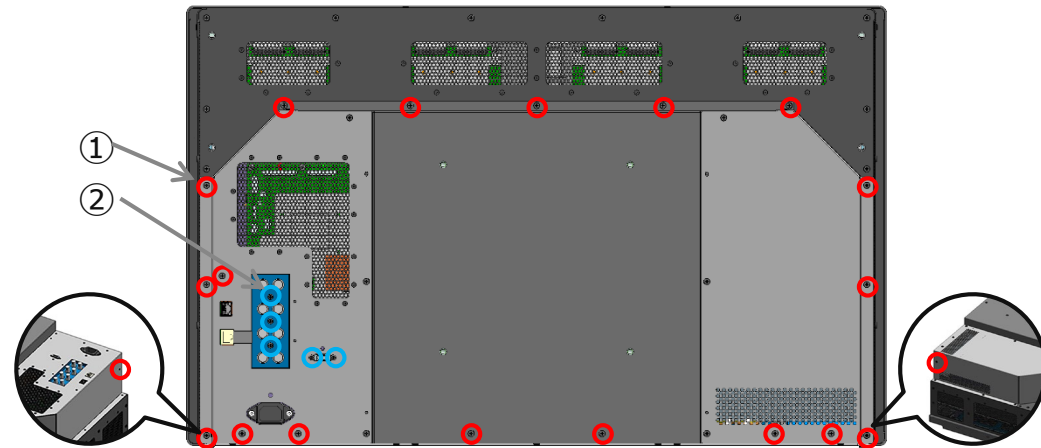

	Parts No.	Description	Qty.
①	DD1-0103-000	SCREW, M3X6	20
②	DD1-0110-000	SCREW, M3X5	5

REPAIR INFORMATION

1-6. Removing the Top Cover

■ Disassembly procedure

1. Remove ② (3 positions) and ③ (18 positions), and then remove ① (COVER, TOP).

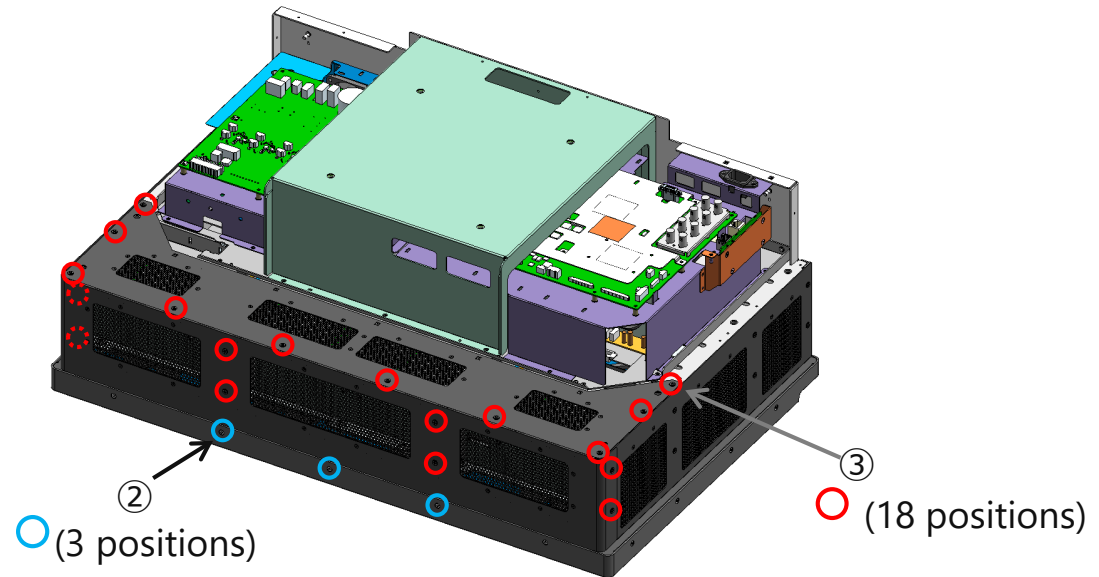

	Parts No.	Description	Qty.
①	DL1-0158-000	COVER, TOP	1
②	DD1-0346-000	SCREW, ACIN, M3X6	3
③	DD1-0103-000	SCREW, M3X6	18

REPAIR INFORMATION

1-7. Removing the Side Cover (Left)

■ **Disassembly procedure**

1. Remove ② (2 positions) and ③ (6 positions), and then remove ①.

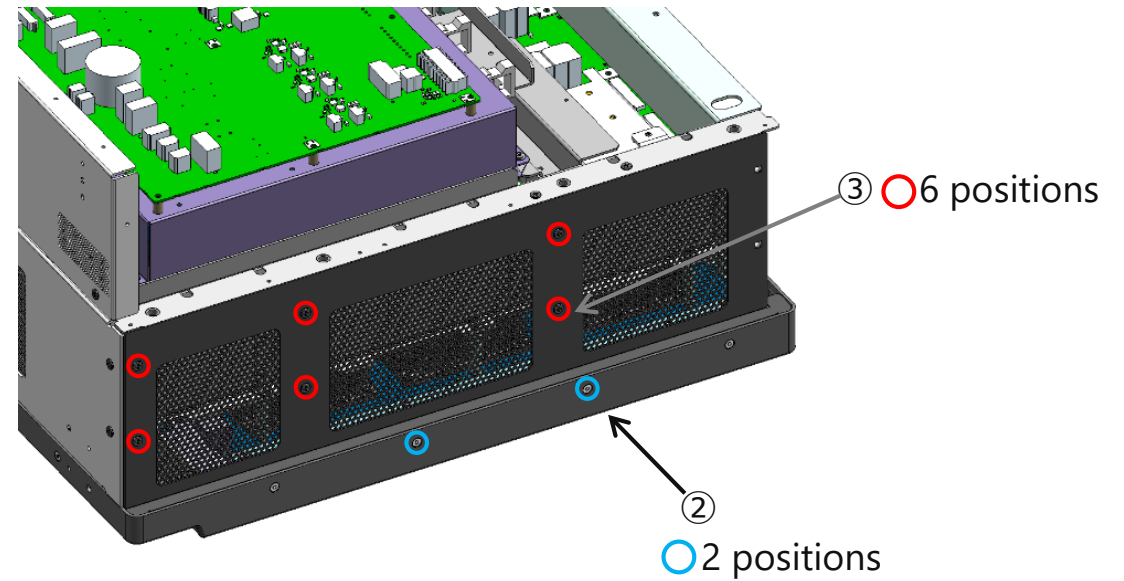

	Parts No.	Description	Qty.
①	DL1-0156-000	COVER, LEFT	1
②	DD1-0346-000	SCREW, ACIN, M3X6	2
③	DD1-0103-000	SCREW, M3X6	6

REPAIR INFORMATION

1-8. Removing the Side Cover (Right)

■ **Disassembly procedure**

1. Remove ② (2 positions) and ③ (6 positions), and then remove ①.

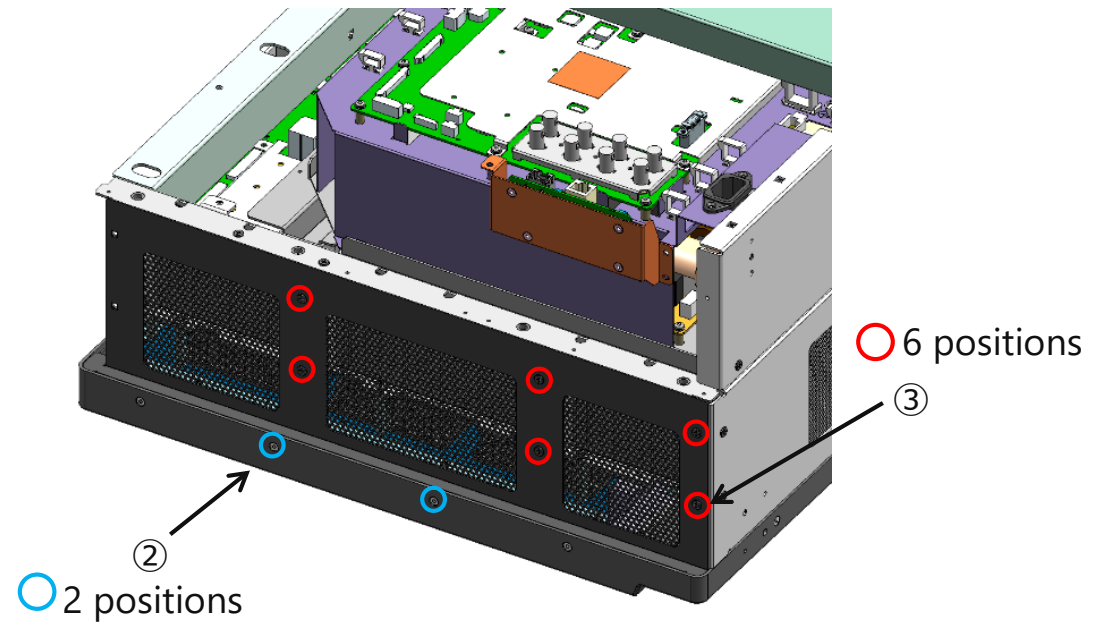

	Parts No.	Description	Qty.
①	DL1-0157-000	COVER, RIGHT	1
②	DD1-0346-000	SCREW, ACIN, M3X6	2
③	DD1-0103-000	SCREW, M3X6	6

REPAIR INFORMATION

1-9. Removing the Bottom Cover

■ Disassembly procedure

1. Remove ② (5 positions) and ③ (14 positions) and then remove ①.

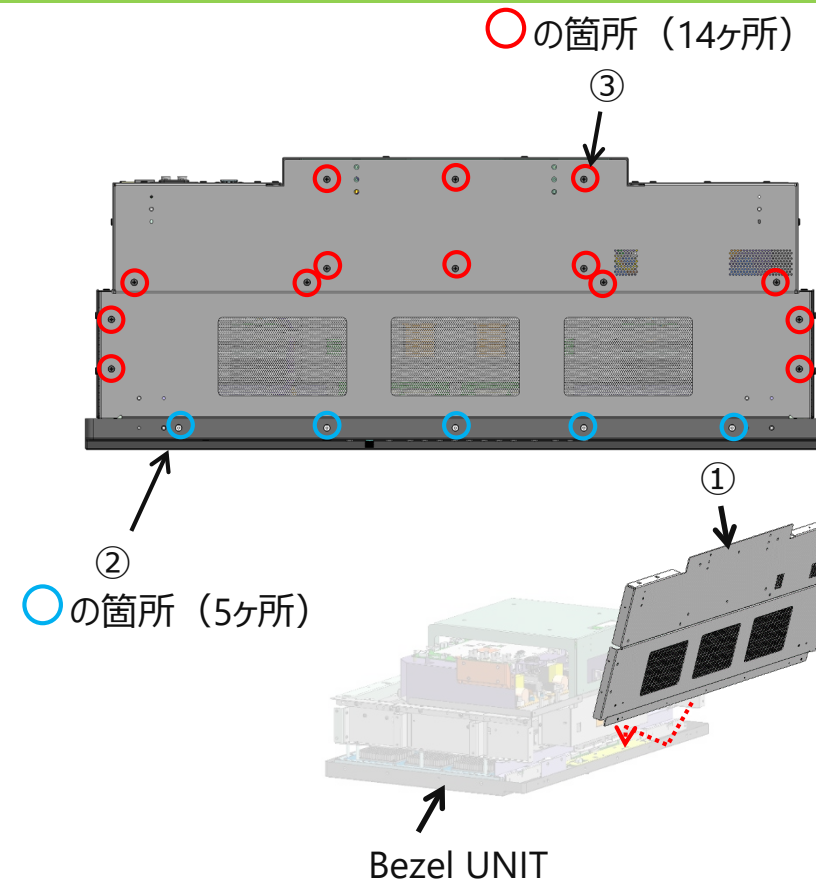

	Parts No.	Description	Qty.
①	DL1-0155-000	COVER, BOTTOM	1
②	DD1-0346-000	SCREW, ACIN, M3X6	5
③	DD1-0103-000	SCREW, M3X6	14

REPAIR INFORMATION

1-10. Removing the Holder_VESA

■ Disassembly procedure

1. Remove ②, and then remove ①.

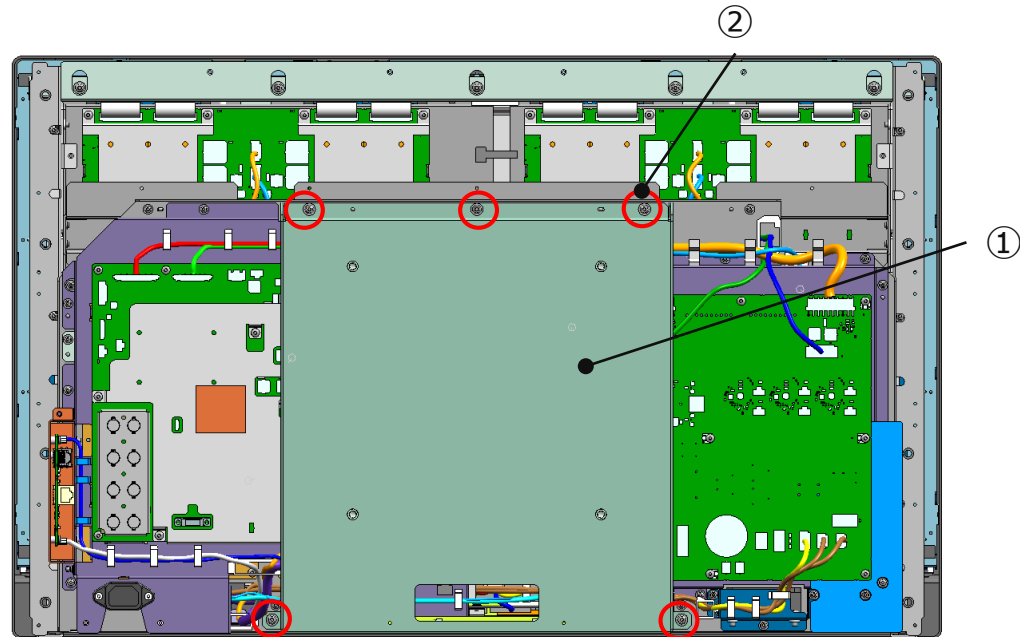

	Parts No.	Description	Qty.
①	-	Assy_Holder_VESA	1
②	XB6-7400-805	SCREW, TP, M4X8	5

REPAIR INFORMATION

1-11. PowIF/MAIN Layer: Laying Harnesses 1

■ Disassembly procedure

1. When assembling, lay PowIF/MAIN layer harnesses according to Laying Harnesses 1 to 4.

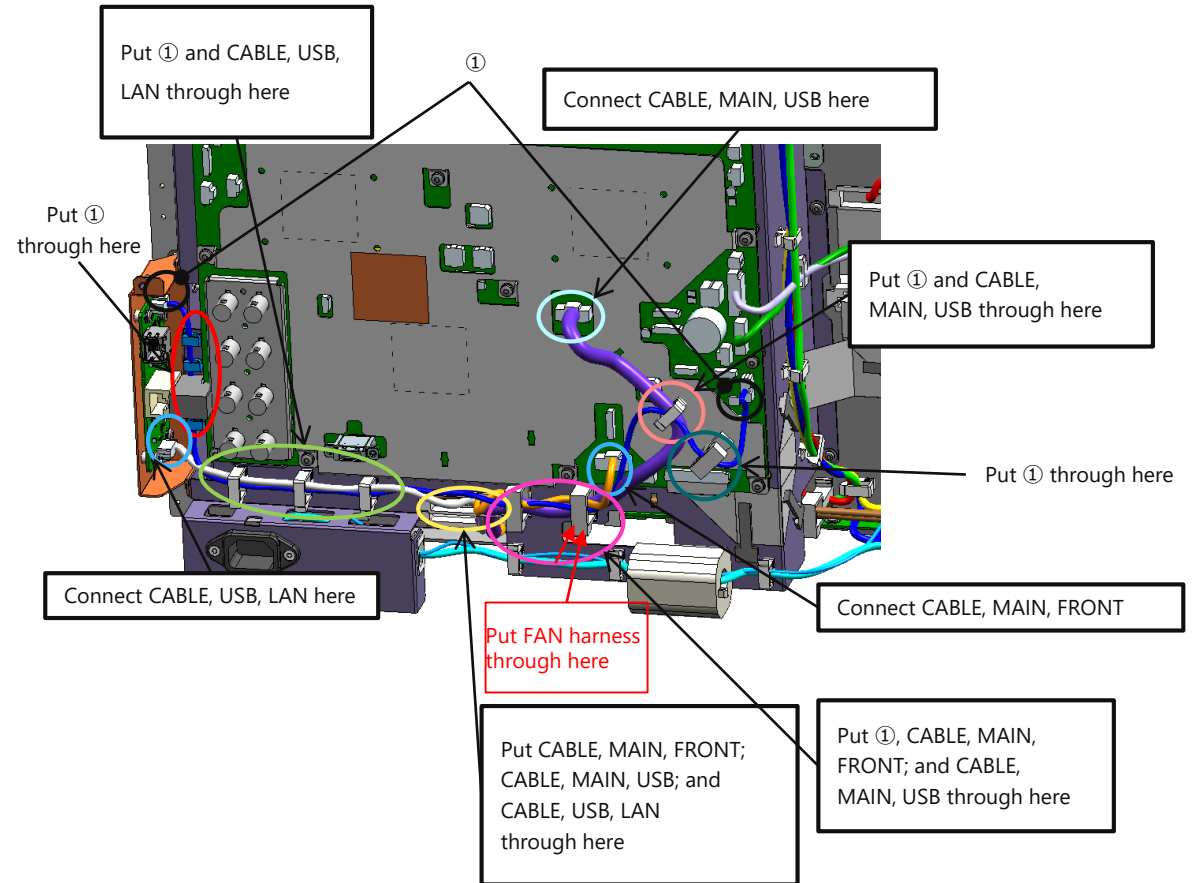

	Parts No.	Description	Qty.
①	DD2-0182-000	CABLE, MAIN, LAN	1

REPAIR INFORMATION

1-12. PowIF/MAIN Layer: Laying Harnesses 2

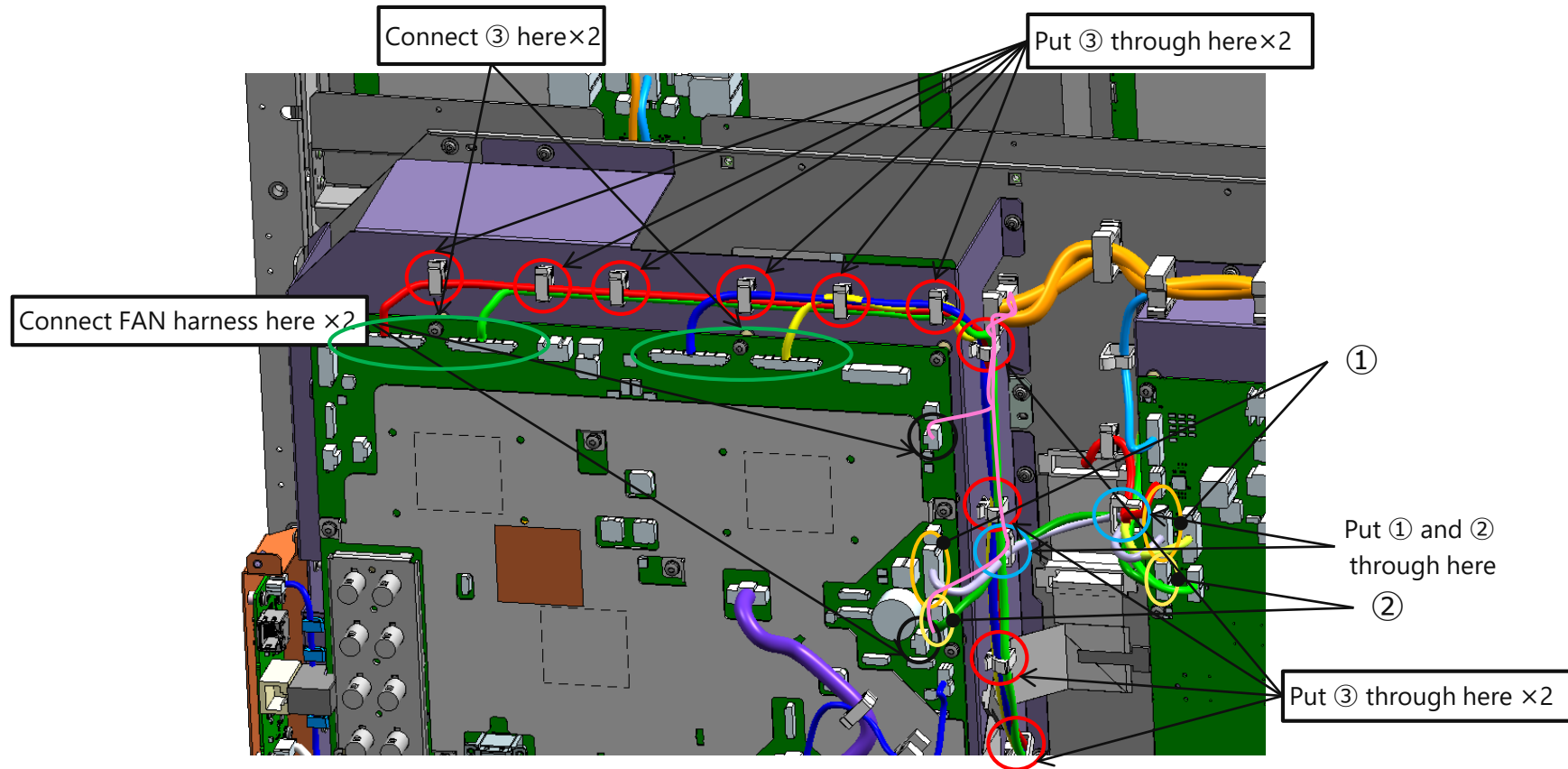

	Parts No.	Description	Qty.
①	DD2-0196-000	CABLE, POWER, MAIN (20V)	1
②	DD2-0190-000	CABLE, POWIF, MAIN	1
③	DD2-0183-000	CABLE, MAIN, TCON	2

REPAIR INFORMATION

1-13. PowIF/MAIN Layer: Laying Harnesses 3

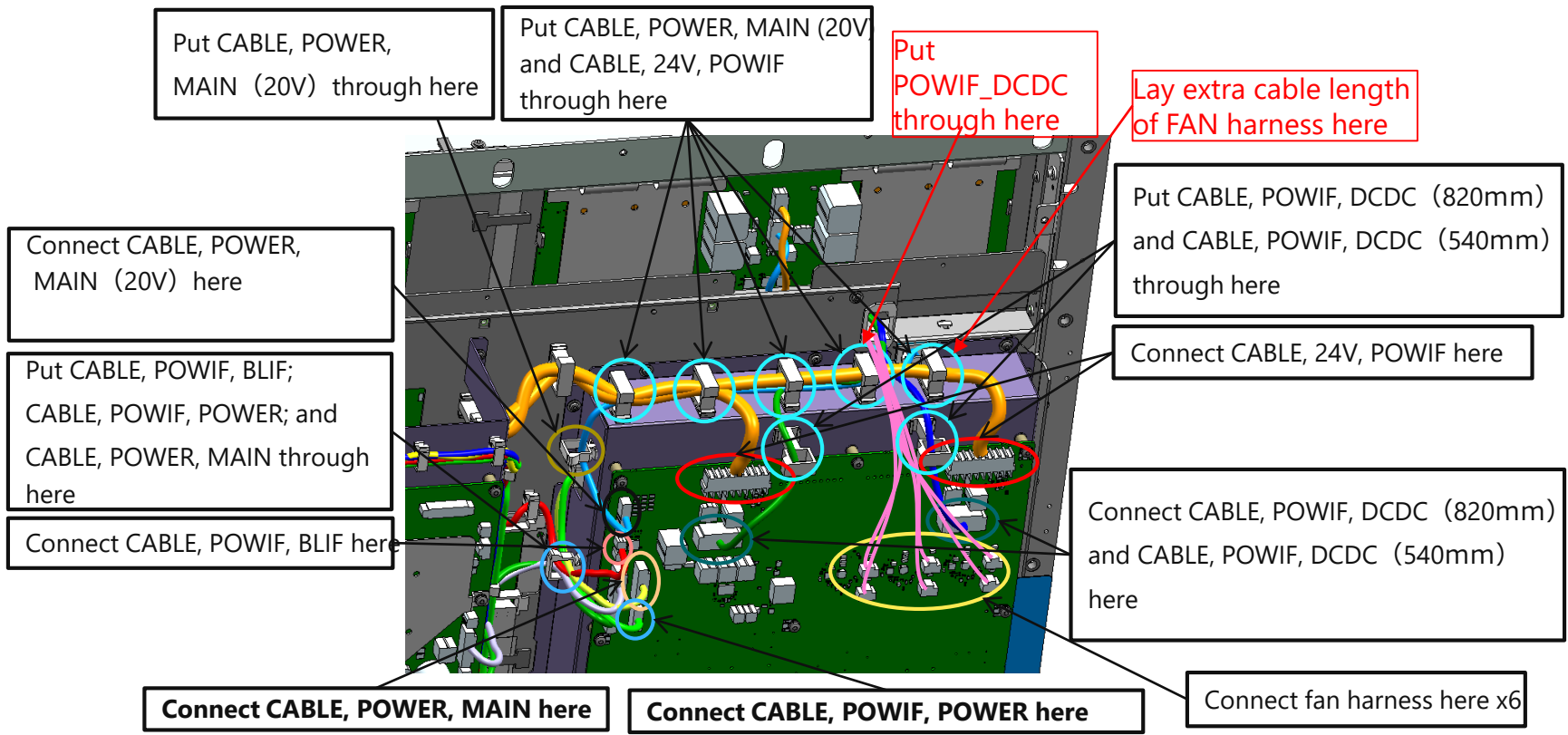

If text is in bold, connect on the inside

REPAIR INFORMATION

1-14. PowIF/MAIN Layer: Laying Harnesses 4

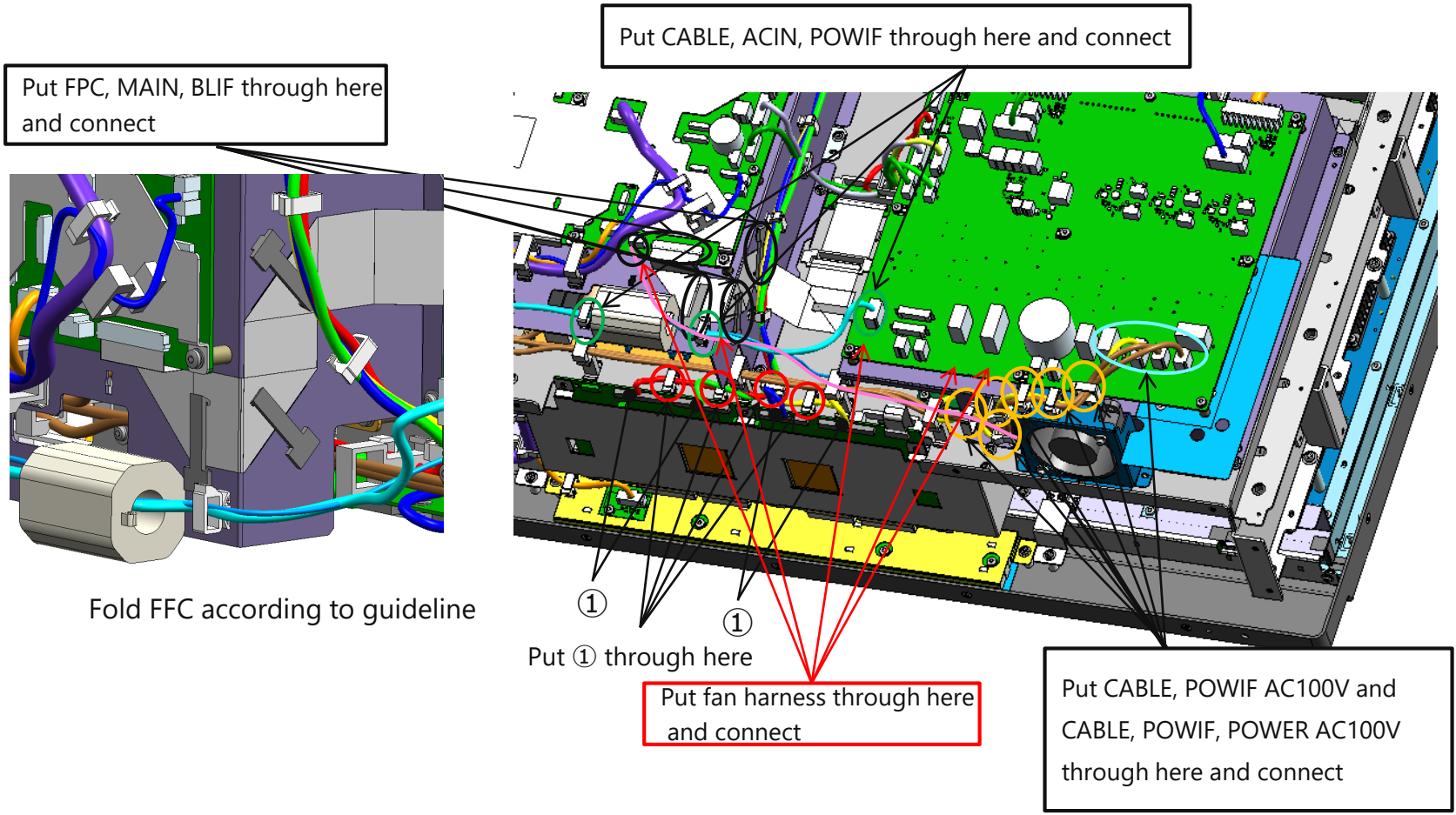

	Parts No.	Description	Qty.
①	DD2-0183-000	CABLE, MAIN, TCON	2

REPAIR INFORMATION

1-15. Removing the Holder_LAN, AC Inlet

■ Disassembly procedure

1. Fix the Holder_LAN UNIT with ①.
 2. Fix ② with ③.
- Fix the ② harness (earth cable) with a clamer or ⑥, and then fix with ④⑤.

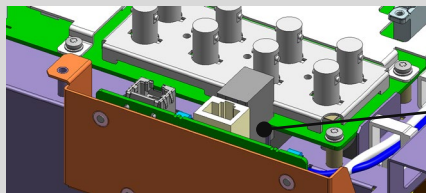

Bring the gasket into contact with the metal plate.

Holder_LAN UNIT

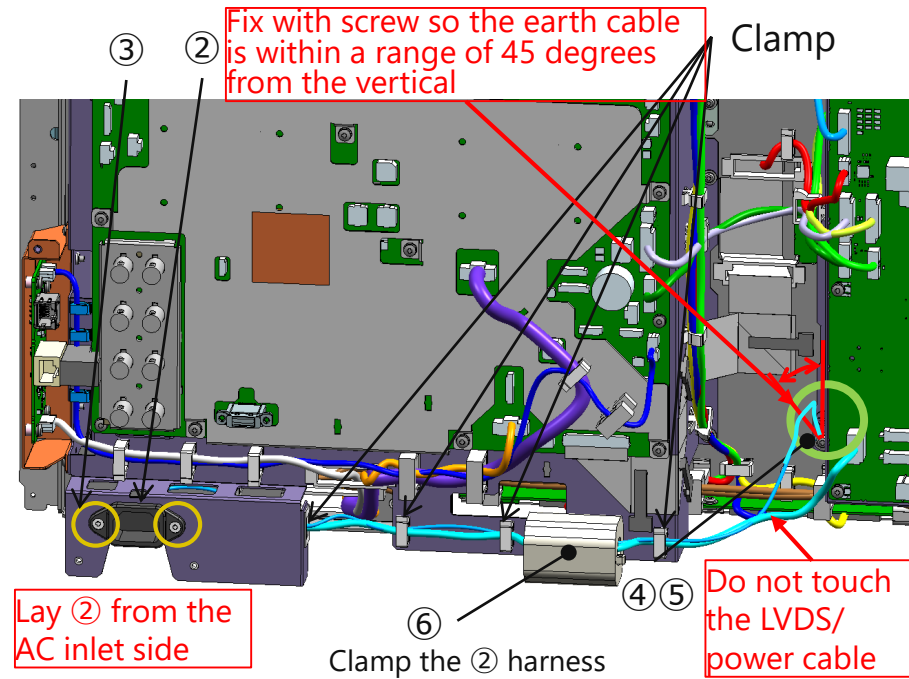
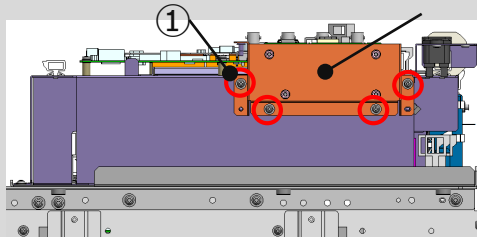

	Parts No.	Description	Qty.
①	XB6-7300-609	SCREW, TP, M3X6	4
②	DD2-0184-000	CABLE, ACIN, POWIF	1
③	DD1-0346-000	SCREW, ACIN, M3X6	2
④	XD1-4200-402	WASHER, TOOTHED LOCK, M4	1
⑤	XB6-7400-805	SCREW, TP, M4X8	1
⑥	DD1-0756-000	Ferrite_Clamp_NFT-14N	1

REPAIR INFORMATION

1-16. Removing the MAIN PCB

■ Disassembly procedure

1. Remove ③, and then remove ① and ②.

Attach according to the silkscreen printing

Attach ⑤ on top of ④. Attach to IC

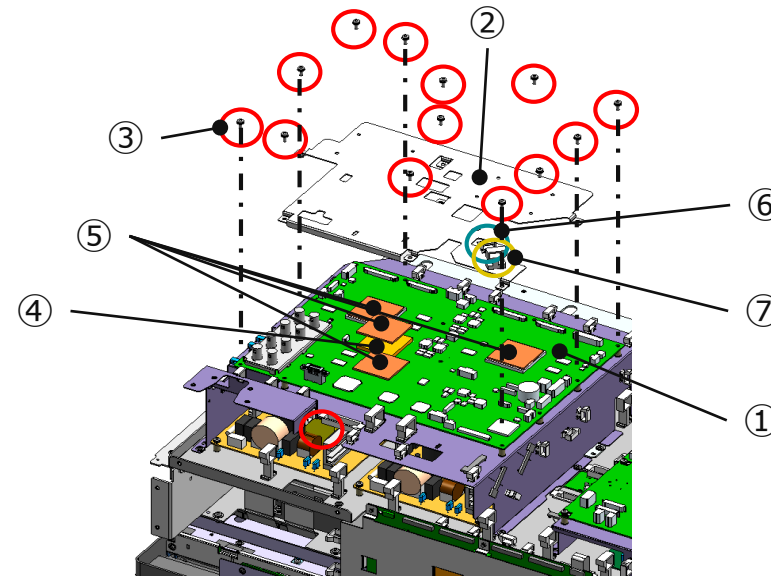
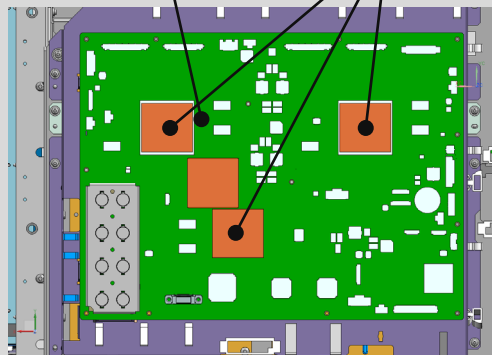

	Parts No.	Description	Qty.
①	DM1-0058-000	PCB ASS'Y, MAIN	1
②	-	Holder_HS_SYS_NT021	1
③	XB2-8300-805	SCREW,W/WASHER,M3X8	13
④	DD1-0544-000	CUSHION, MAIN3	1
⑤	DD1-0350-000	CUSHION, MAIN2	4
⑥	-	RLWT-3V0	1
⑦	-	RSPC-115S	1

REPAIR INFORMATION

1-17. Removing the PowIF PCB

■ Disassembly procedure

1. Remove ②, and then remove ①.

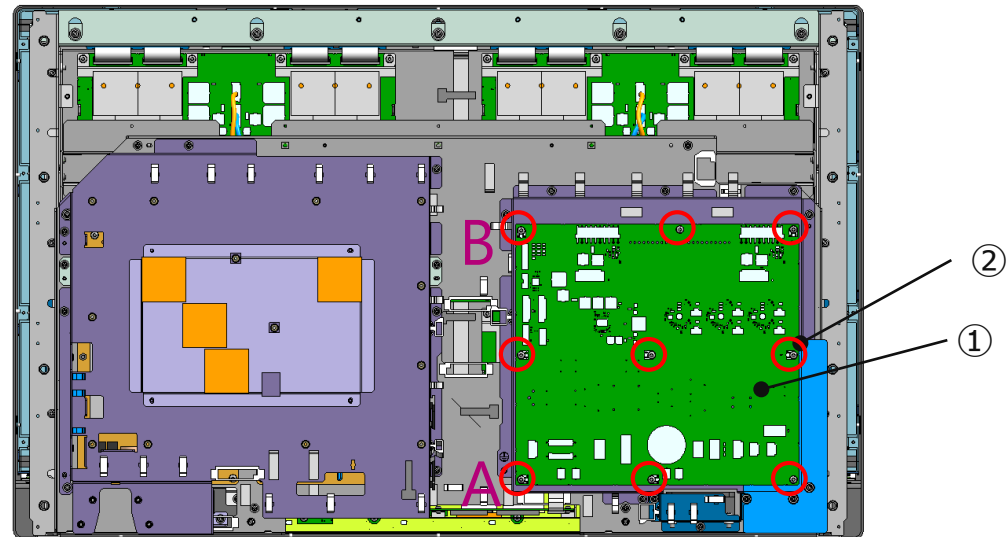

	Parts No.	Description	Qty.
①	DM1-0059-000	PCB ASS'Y, POWER-IF	1
②	XB2-8300-805	SCREW,W/WASHER,M3X8	9

REPAIR INFORMATION

1-18. Removing the Chassis PowIF/MAIN

Disassembly procedure

1. Remove ①, and then remove the Chassis_PowIF UNIT, Chassis_SYS UNIT, and Holder_FAN-POW025 UNIT.

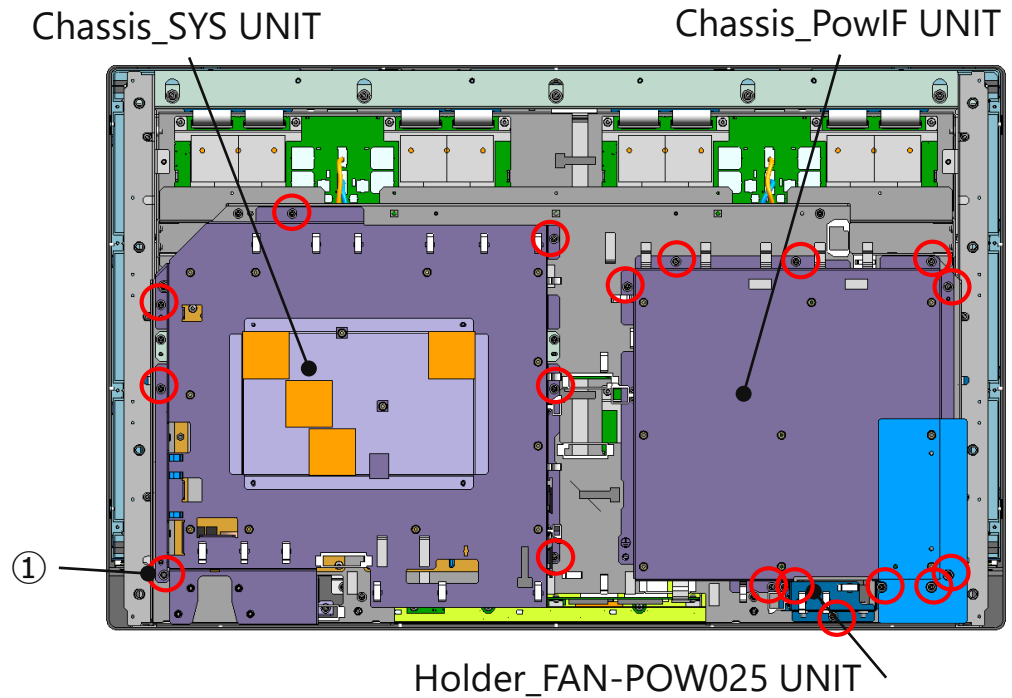

	Parts No.	Description	Qty.
①	XB6-7300-609	SCREW, TP, M3X6	18

REPAIR INFORMATION

1-19. Power Layer: Laying Harnesses 1

Note on Assembly

- When assembling, lay PowIF/MAIN layer harnesses according to Laying Harnesses 1 and 2.

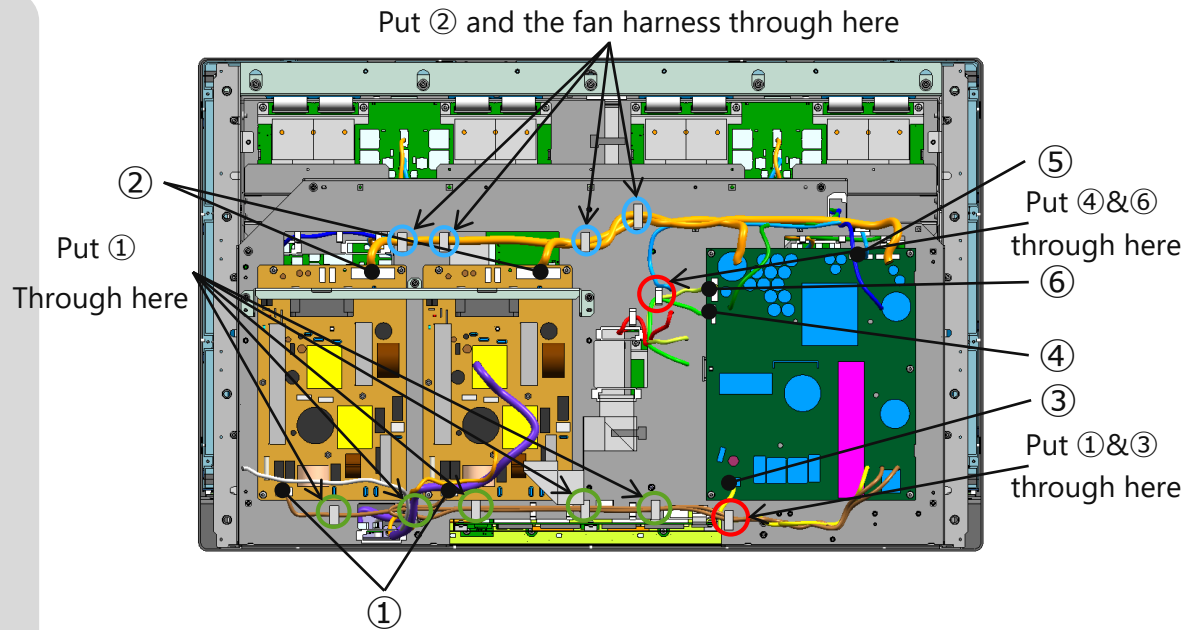

	Parts No.	Description	Qty.
①	DD2-0185-000	CABLE,, POWIF AC100V	2
②	DD2-0186-000	CABLE, 24V, POWIF	2
③	DD2-0188-000	CABLE, POWIF, POWER (AC100V)	1
④	DD2-0189-000	CABLE, POWIF, POWER (CTRL)	1
⑤	DD2-0194-000	CABLE, POWER, MAIN (12V5V)	1
⑥	DD2-0196-000	CABLE, POWER, MAIN (20V)	1

REPAIR INFORMATION

1-20. Power Layer: Laying Harnesses 2

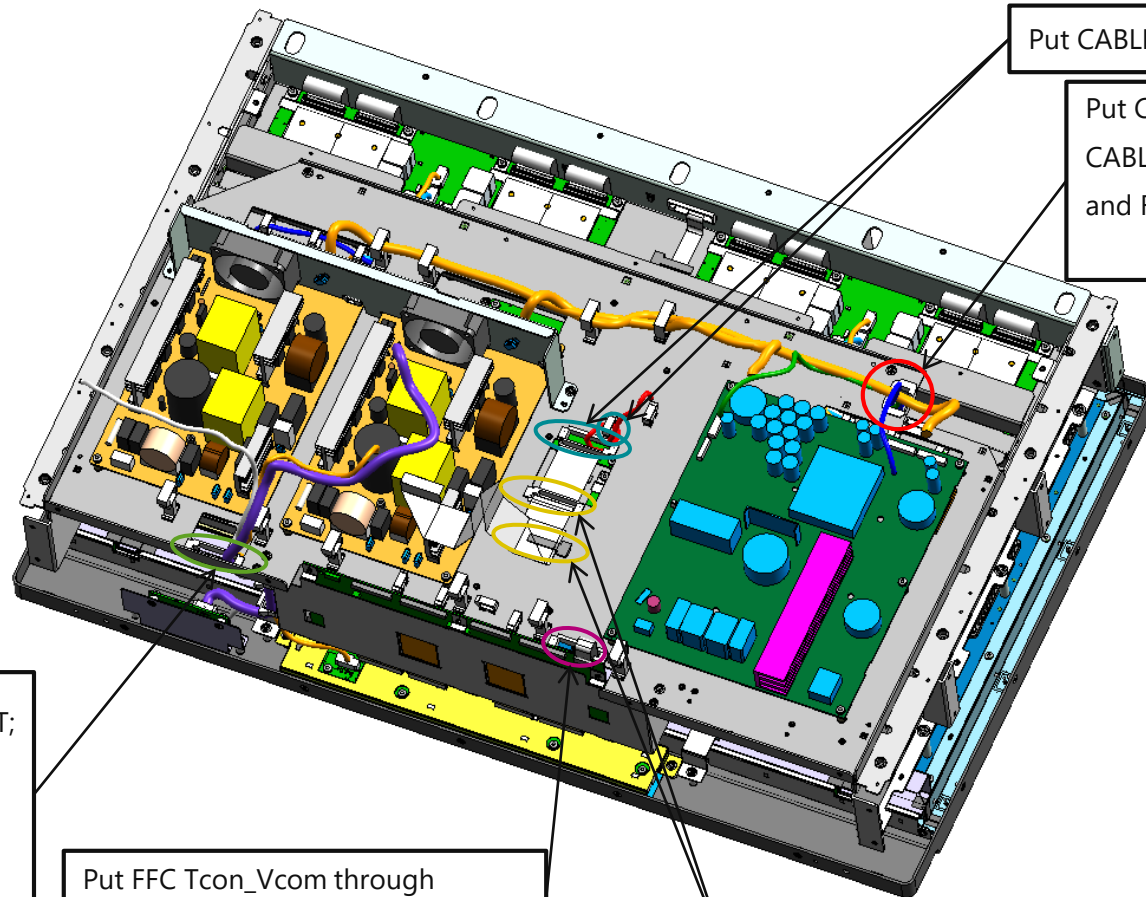

Put CABLE, MAIN, FRONT;
CABLE, MAIN, USB; and
CABLE, USB, LAN
through here

Put FFC Tcon_Vcom through
here and connect

Put FPC, MAIN, BLIF
through here

Put CABLE, POWIF, BLIF through here

Put CABLE, POWIF, DCDC (820mm) ;
CABLE, POWIF, DCDC (540mm) ;
and FAN harness x6 through here

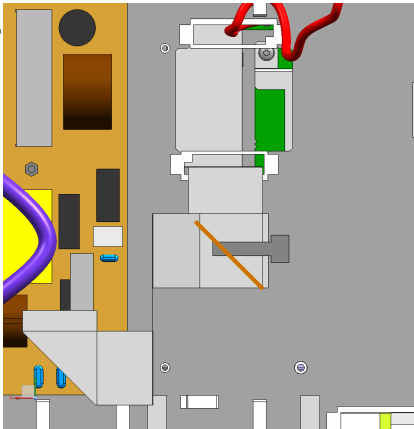

Fold the FFC
according to the
guideline

REPAIR INFORMATION

1-21. Removing the Chassis Power

■ Disassembly procedure

1. Remove ④, and then remove the Holder-FAN-POW350W UNIT.
2. Remove ③ and ⑤, and then remove ① and ②.
3. Remove ④ and ⑥ and then remove the Chassis_Power UNIT.

※When fastening ⑤x6, apply TB-1401C to half or more of the screw thread starting from the screw tip.

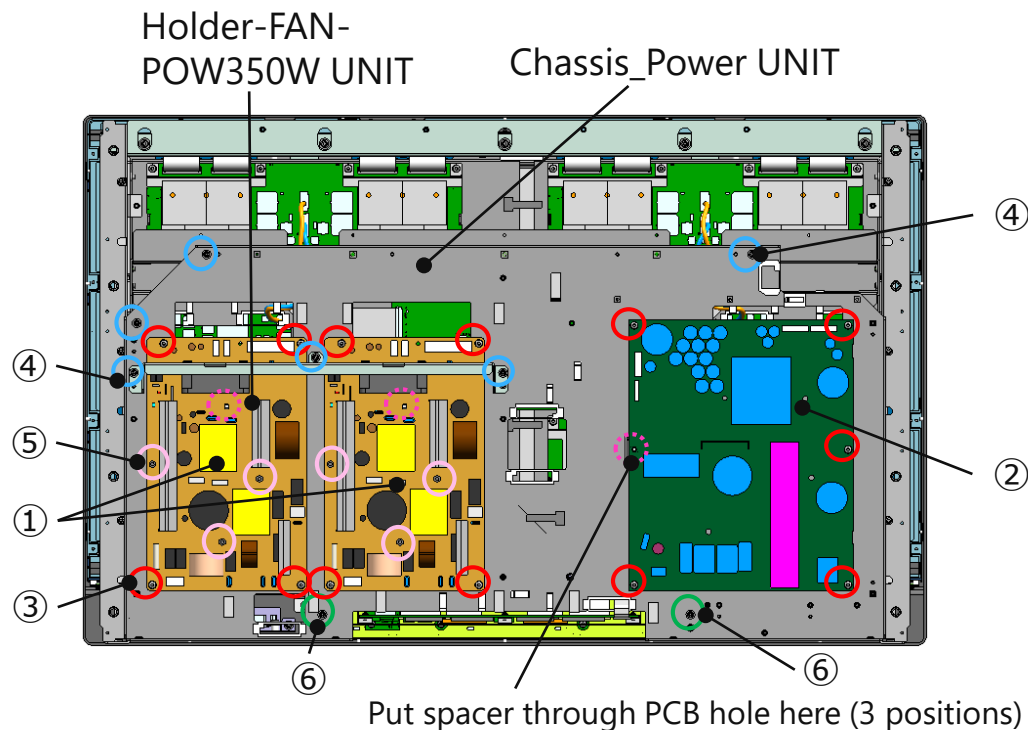
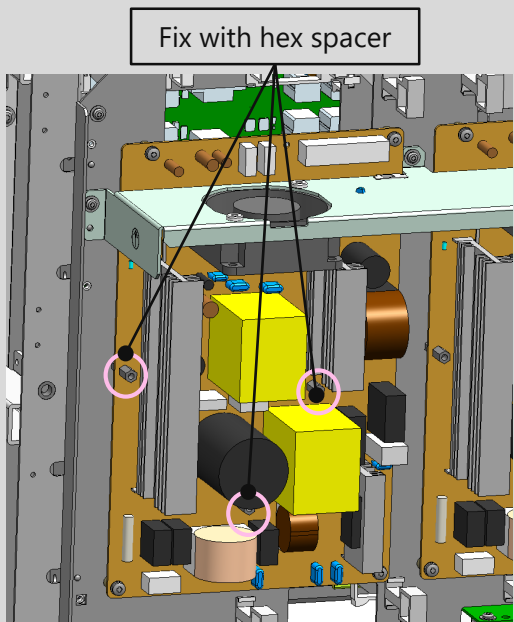

	Part No.	Description	Qty.
①	FK3-1999-000	DC POWER SUPPLY PCB ASSEMBLY (24V)	2
②	DK5-0026-000	PCB ASS'Y, POWER	1
③	XB2-8300-805	SCREW,W/WASHER,M3X8	13
④	XB6-7300-609	SCREW, TP, M3X6	6
⑤	DD1-0762-000	SCREW, HEX, M3X9.5	6
⑥	XB6-7300-405	SCREW, TP, M3X4	2

REPAIR INFORMATION

1-22. LED DRV Layer: Laying Harnesses

Note on Assembly

1. Connect the harnesses and clamp them.

(① to ④ is already listed in the display module)

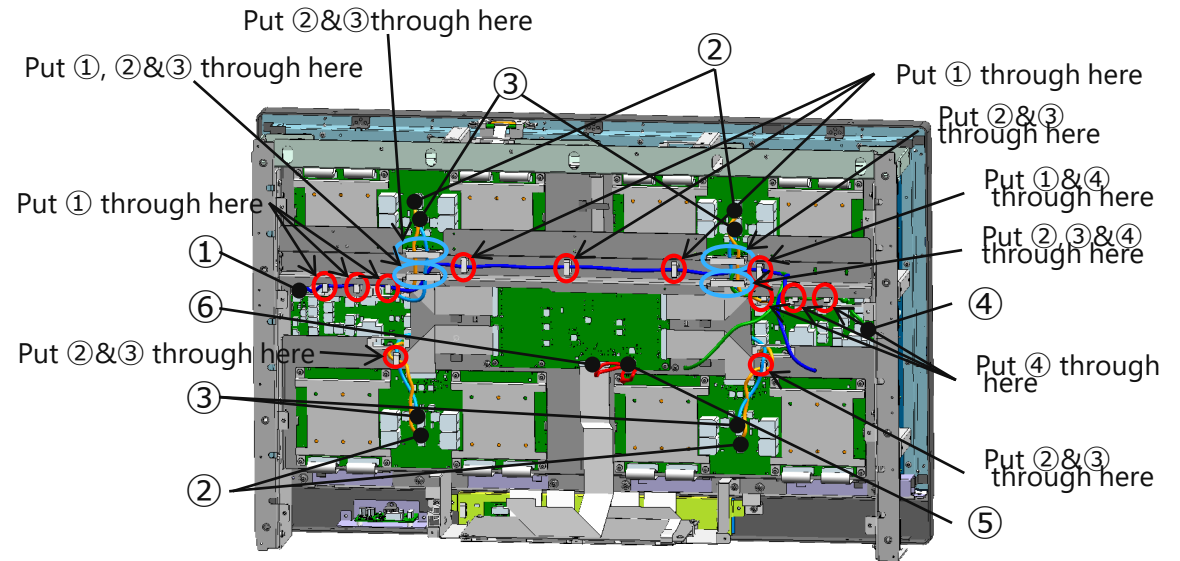

	Parts No.	Description	Qty
①	DD2-0187-000	CABLE, POWIF, DCDC (820mm)	1
②	DD2-0191-000	CABLE, DCDC, DRIVER (18pin)	4
③	DD2-0192-000	CABLE, DCDC, DRIVER (22pin)	4
④	DD2-0197-000	CABLE, POWIF, DCDC (540mm)	1
⑤	DD2-0195-000	CABLE, POWIF, BLIF	1
⑥	DD2-0200-000	FPC, MAIN, BLIF	1

REPAIR INFORMATION

1-23. Removing the Frame Middle

■ Disassembly procedure

1. Use screw ② to attach Frame_Middle Unit and ①.

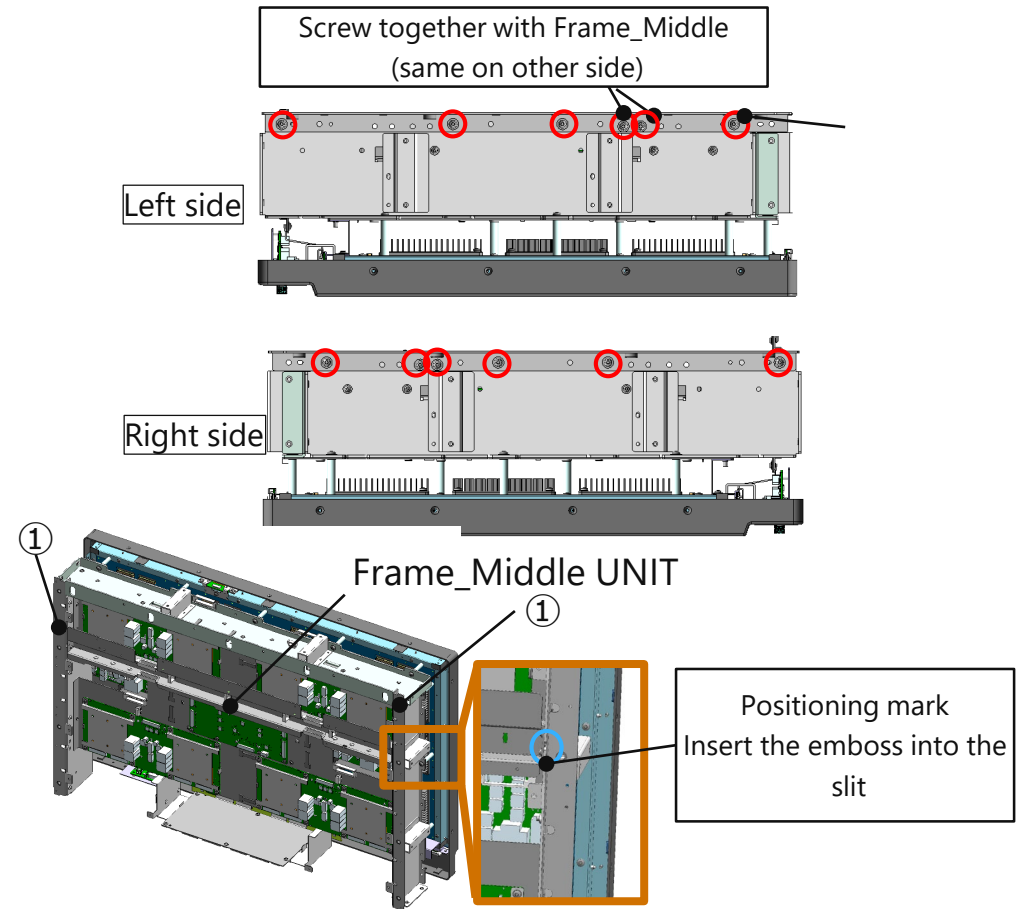

	Parts No.	Description	Qty.
①	-	Assy_Bracket_Handle_LR	2
②	XB6-7400-805	SCREW, TP, M4X8	12

REPAIR INFORMATION

1-24. Front-UA Harness

Note on Assembly

1. Take care when laying the harness cables during assembly.

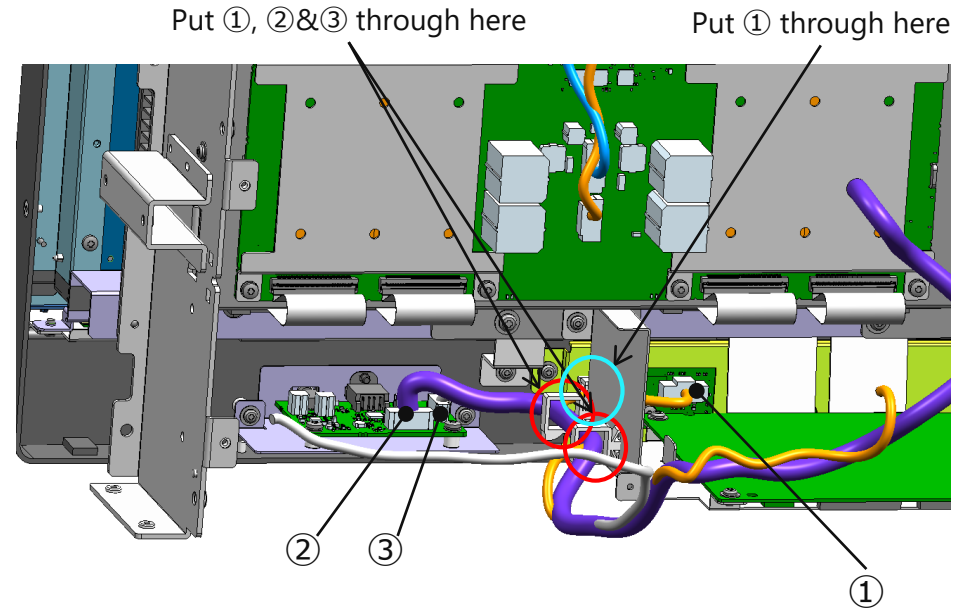

	Parts No.	Description	Qty.
①	DD2-0181-000	CABLE, MAIN, FRONT	1
②	DD2-0193-000	CABLE, MAIN, USB	1
③	DD2-0094-000	CABLE, USB, LAN	1

REPAIR INFORMATION

1-25. FFC Connection

■ Note on Assembly

1. Connect ① and ② between the panel and TCON.

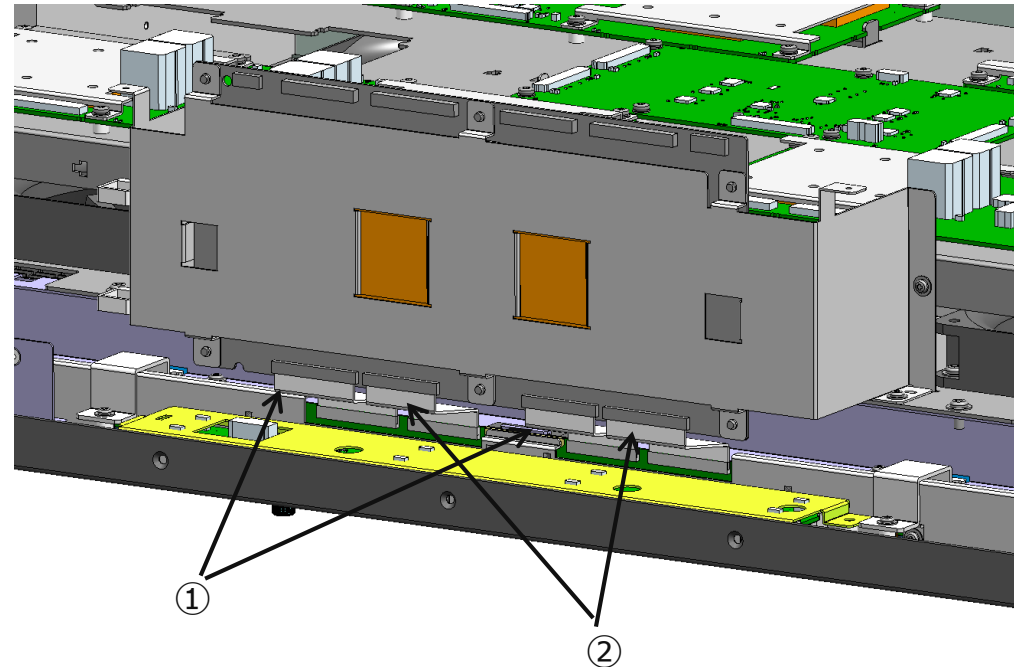

	Parts No.	Description	Qty.
①	DD2-0198-000	FPC, TCON, PANEL (60p)	2
②	DD2-0199-000	FPC, TCON, PANEL (51p)	2

REPAIR INFORMATION

1-26. Removing the TCON Unit

■ Disassembly procedure

1. Remove ① in 4 positions, and then remove the TCON unit.

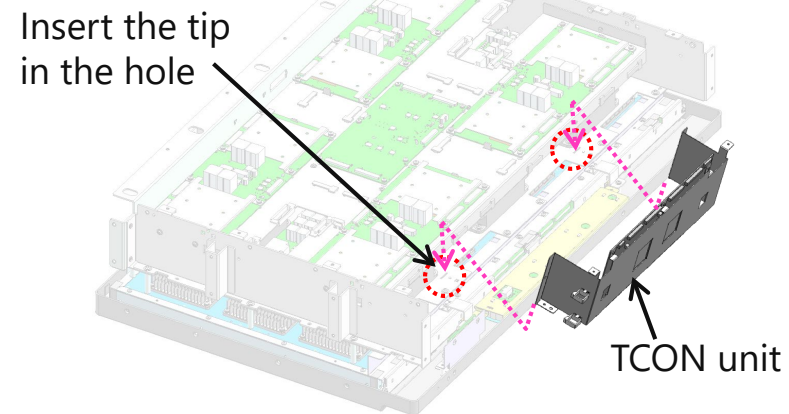
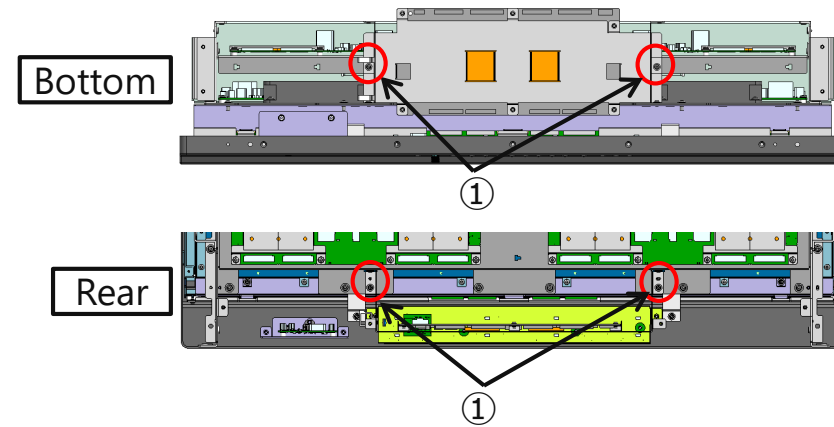

	Parts No.	Description	Qty.
③	XB6-7300-405	SCREW, TP, M3X4	4

REPAIR INFORMATION

1-27. Removing the BLIF PCB

■ Disassembly procedure

1. Remove ③, and then remove ①.

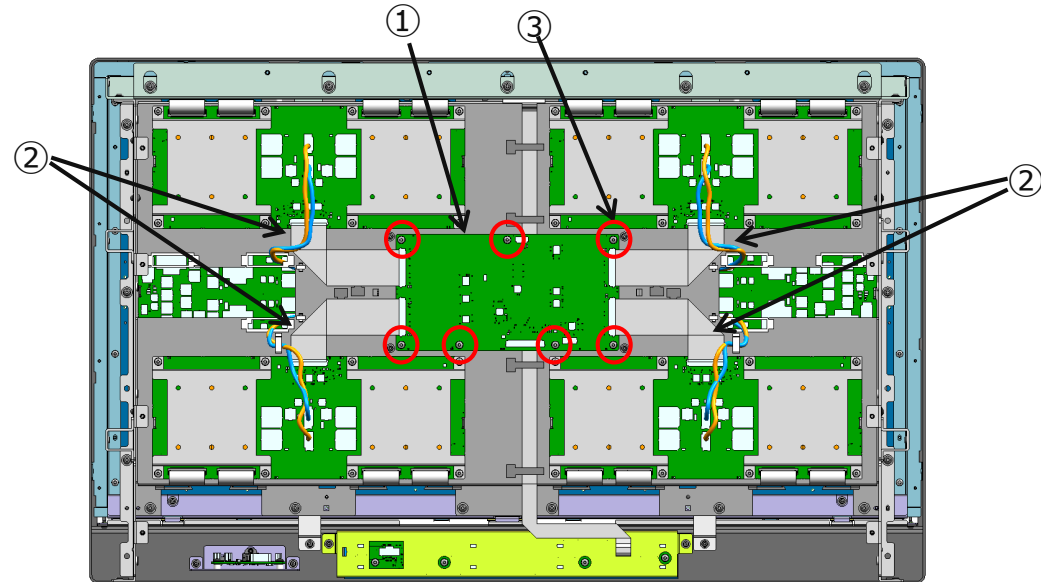

	Parts No.	Description	Qty.
①	DM1-0060-000	PCB ASS'Y, BLIF	1
②	DD2-0201-000	FPC, BLIF, DRIVER	4
③	XB2-8300-805	SCREW,W/WASHER,M3X8	7

REPAIR INFORMATION

1-28. VCOM_FFC_Styling

Note on Assembly

1. Attach ①&② to the Bracket_Top.
2. Connect ③ to the panel's Vcom PCB connector.
3. Put ③ through the clamp.
4. Attach UL tape to cover the clamp hole.
5. Attach UL tape to the screw head.

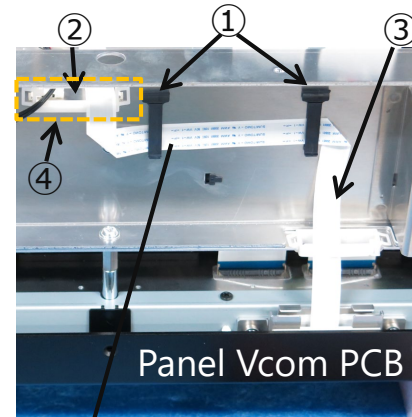

Panel Vcom PCB



⑤ UL tape

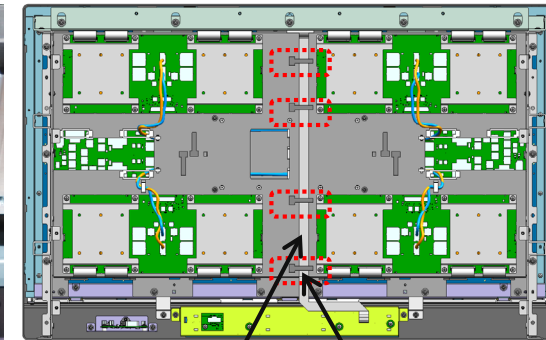

③ Clamp

	Parts No.	Description	Qty.
①	-	RFPC-25NV0B	2
②	-	TSB3509V0	1
③	DD2-0203-000	FPC, TCON, VCOM	1
④	(Expendable)	UL tape (white) 20mm×60mm	1
⑤	(Expendable)	UL tape (white) 20mm×30mm	1

REPAIR INFORMATION

1-29. Removing the Bracket_Side/Top

■ Disassembly procedure

1. Remove ④&③, and then remove the BL UNIT.

■ Note on Assembly

- When assembling ①, align to the positioning mark on the BL UNIT side.
- When assembling ①&②, insert the tab under the DRV UNIT

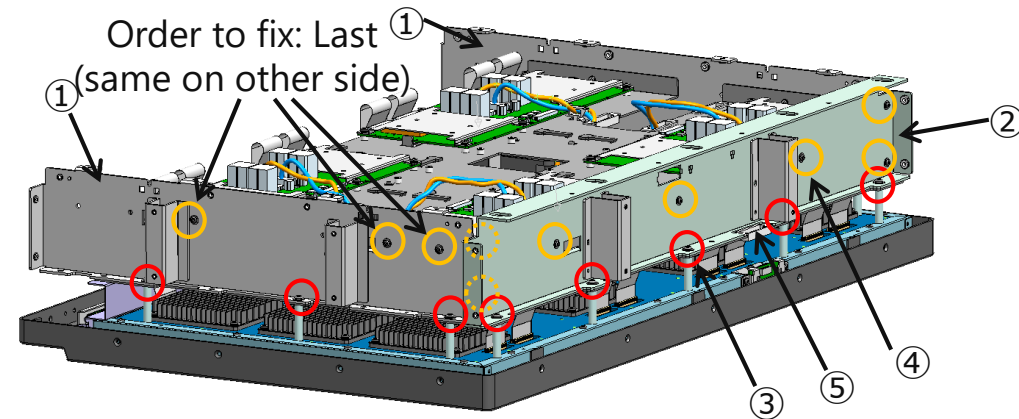
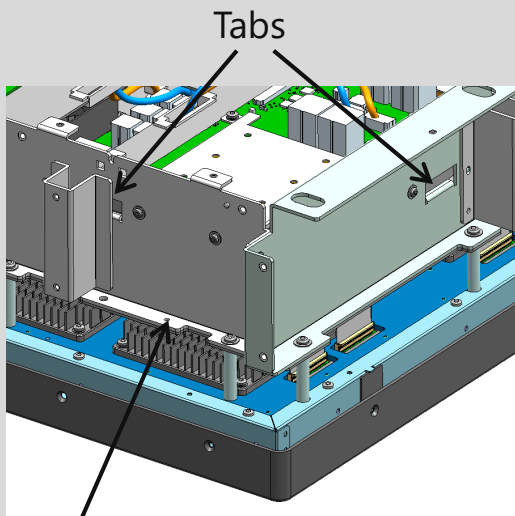

	Parts No.	Description	Qty.
①	-	Assy_Bracket_Side	2
②	-	Assy_Bracket_Top	1
③	XB6-7400-805	SCREW, TP, M4X8	11
④	XB6-7300-609	SCREW, TP, M3X6	13
⑤	DD1-0102-000	TSB3509V0	1

REPAIR INFORMATION

1-30. Laying the DCDC PCB Harness

Note on Assembly

1. Put the harnesses ① to ④ shown in **BL_FAN UNIT assembly 6** and the fan harness through the **clamps shown below**.

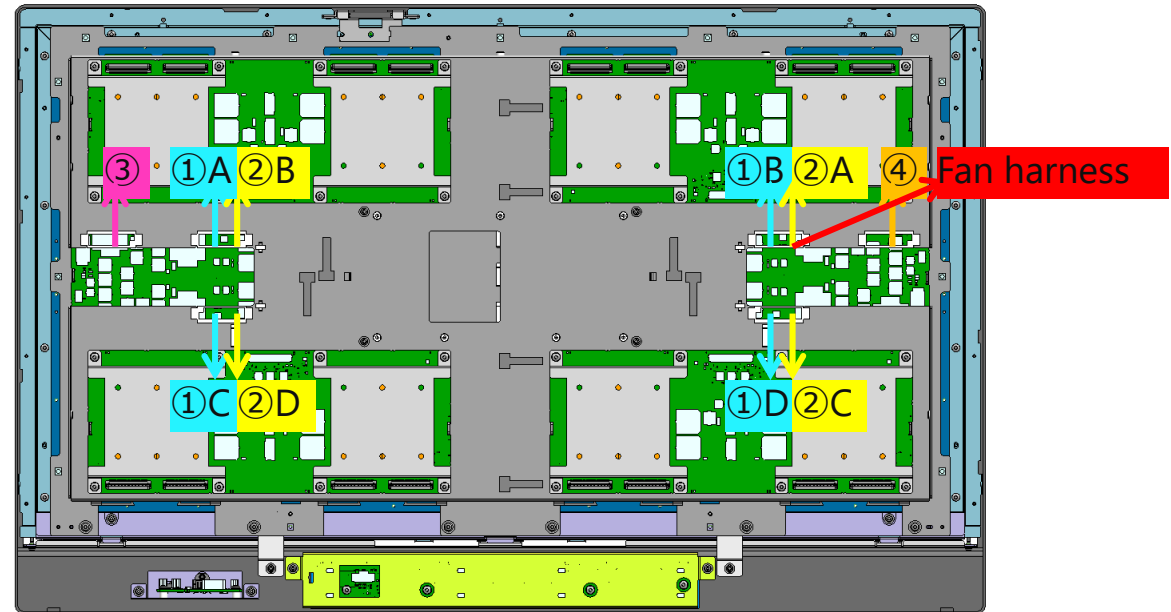

REPAIR INFORMATION

1-31. LED-DRV_FFC**■ Disassembly procedure**

1. Remove the DRV PCB's FFC from the connector.

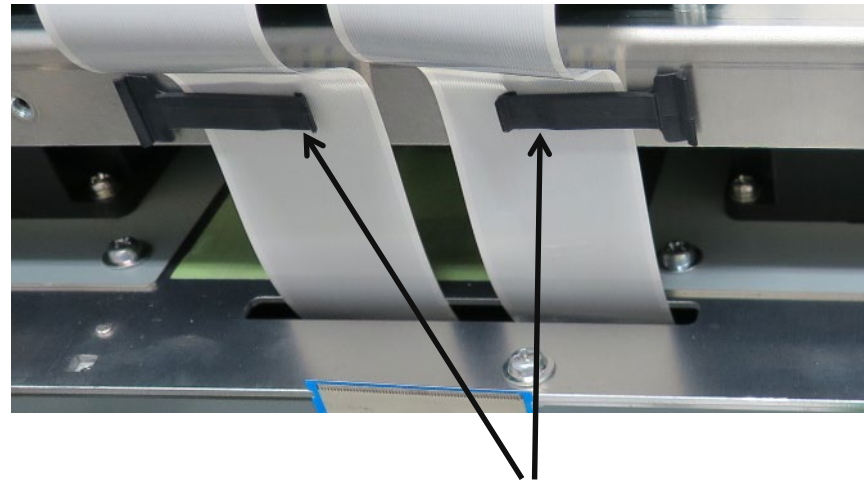
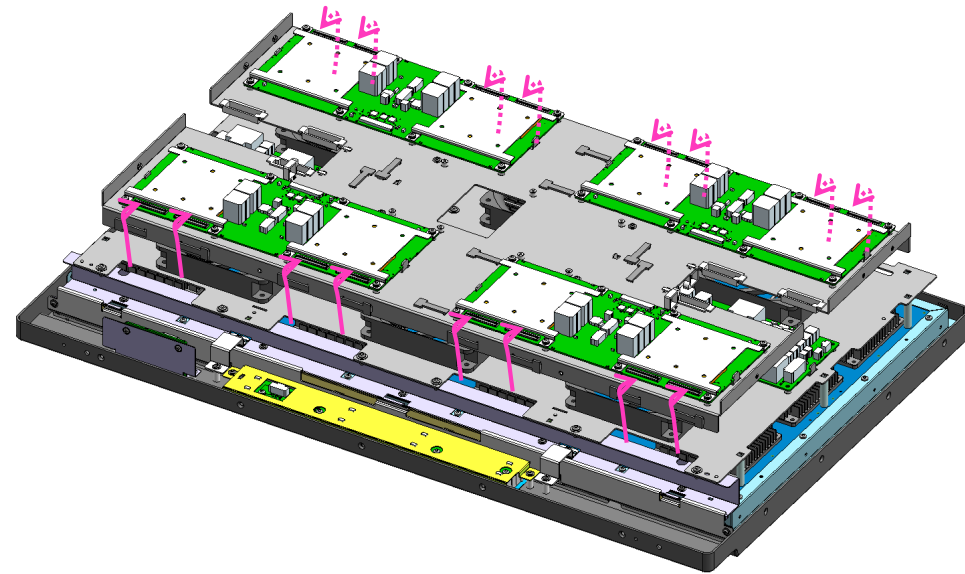

Put these parts through the clamp during assembly

REPAIR INFORMATION

1-32. Removing the DRV UNIT

■ Disassembly procedure

1. Remove ③, and then remove ①, ② and the DRV PCB.

■ Note on Assembly

1. Attach aligned to the DRV PCB mark (remove resist)

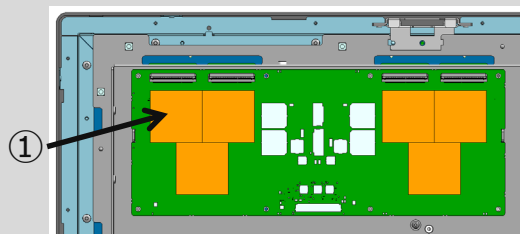

(DRV基板4枚に実施のこと)

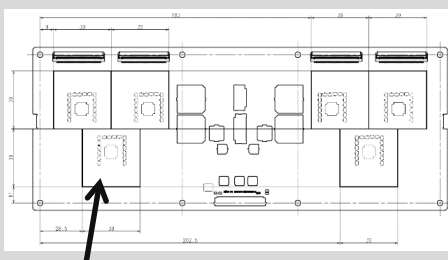

Remove resist

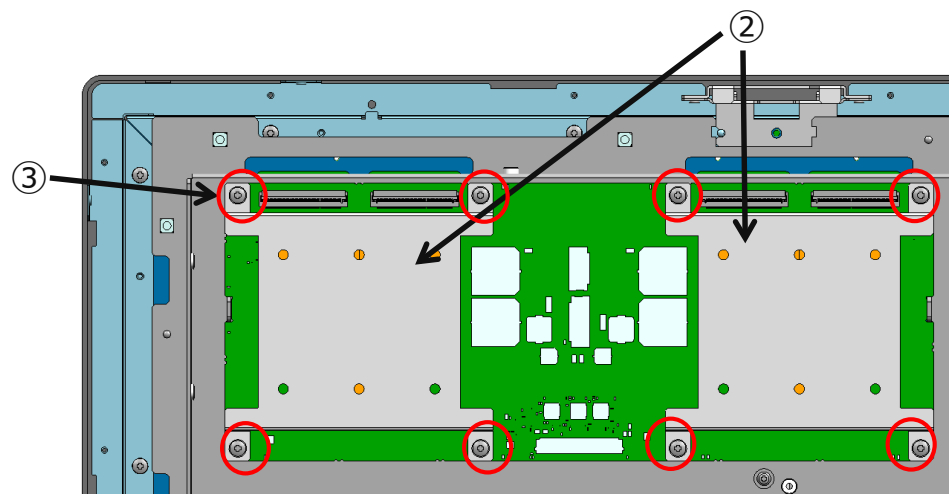

	Parts No.	Description	Qty.
①	DD1-0544-000	CUSHION, MAIN3	24
②	-	Cover_LEDDr	8
③	XB2-8300-805	SCREW,W/WASHER,M3X8	32

REPAIR INFORMATION

1-33. Removing the DRV UNIT 2

■ Disassembly procedure

1. Remove ① and then remove the Chassis_DRV UNIT.

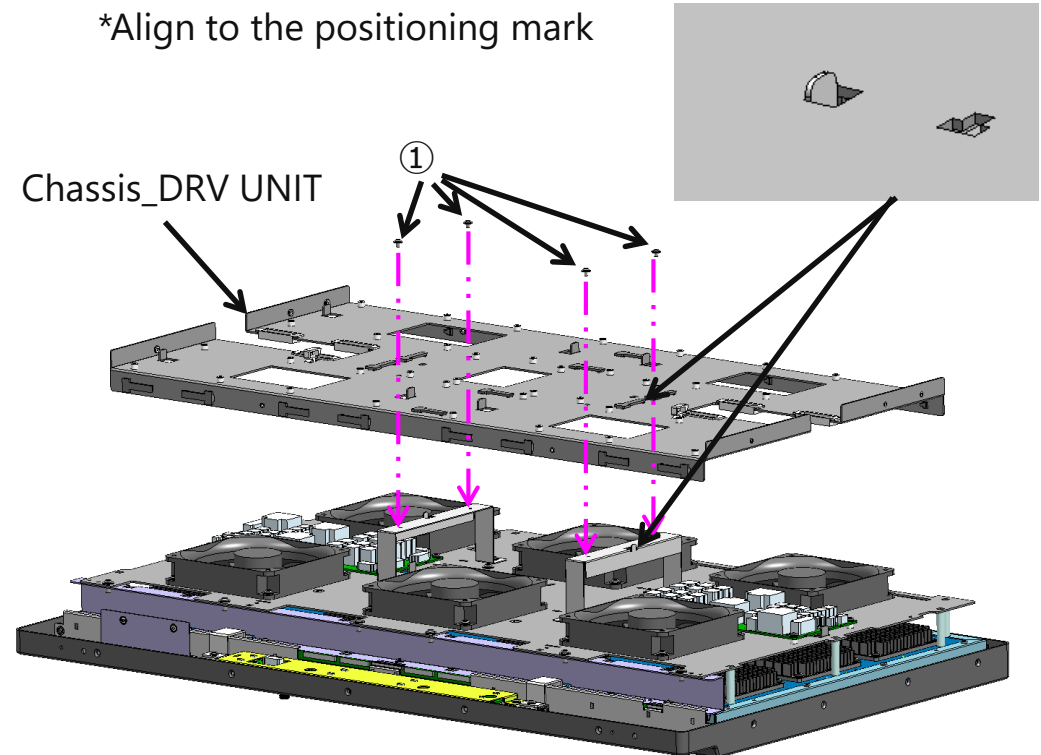

	Parts No.	Description	Qty.
①	XB6-7300-405	SCREW, TP, M3X4	4

REPAIR INFORMATION

1-34. Laying the BL_FAN UNIT Cable 1

Note on Assembly

- Put the DCDC PCB harnesses ① to ④ through the clamps as shown in the diagram.

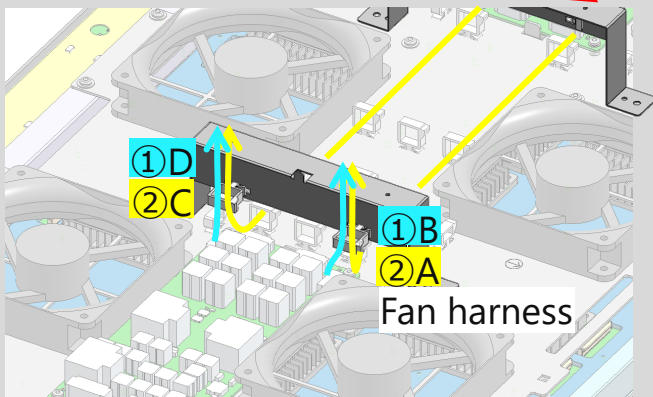
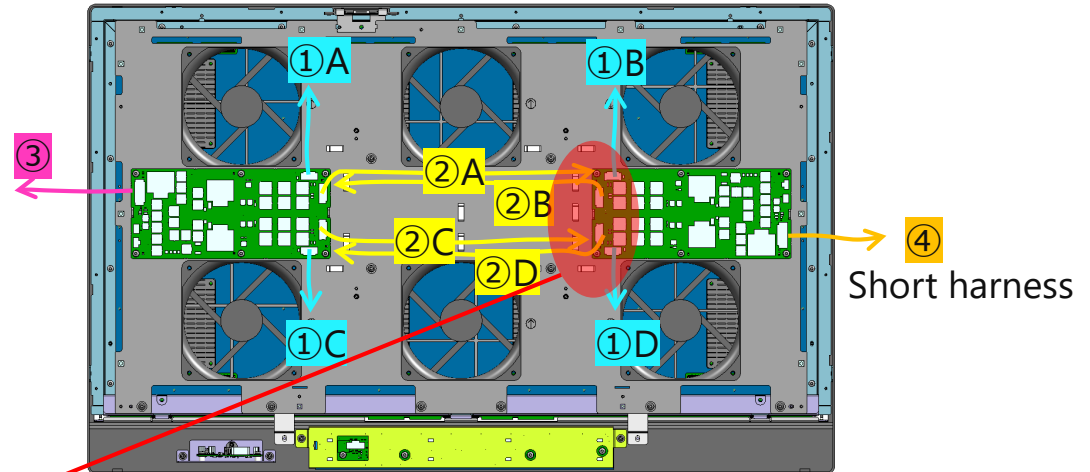

Put ①&② through each clamp.
(same for the other side, except for the FAN harness)

	Parts No.	Description	Qty.
①	DD2-0191-000	CABLE, DCDC, DRIVER (18p)	4
②	DD2-0192-000	CABLE, DCDC, DRIVER (22p)	4
③	DD2-0187-000	CABLE, POWIF, DCDC (820mm)	1
④	DD2-0197-000	CABLE, POWIF, DCDC (540mm)	1

REPAIR INFORMATION

1-35. Laying the BL_FAN UNIT Cable 2**■ Note on Assembly**

1. Put the fan harness through the clamp as shown in the diagram on the right.

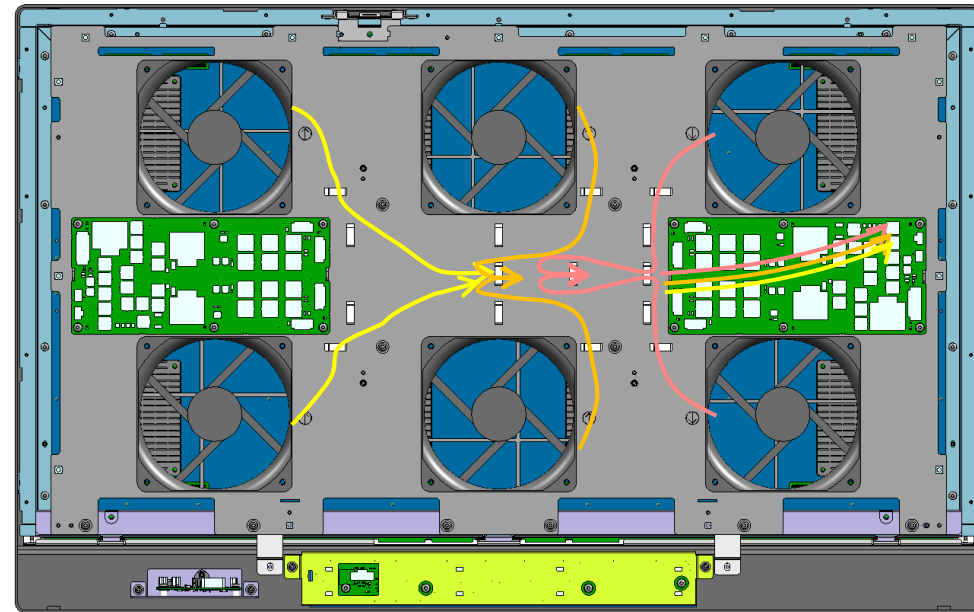

REPAIR INFORMATION

1-36. BL_FAN UNIT取り外し 1

■ Disassembly procedure

1. Remove ②, and then remove ①.

■ Note on Assembly

Put the fan's label on the BL side



Position the fan cable on the side which has engraving

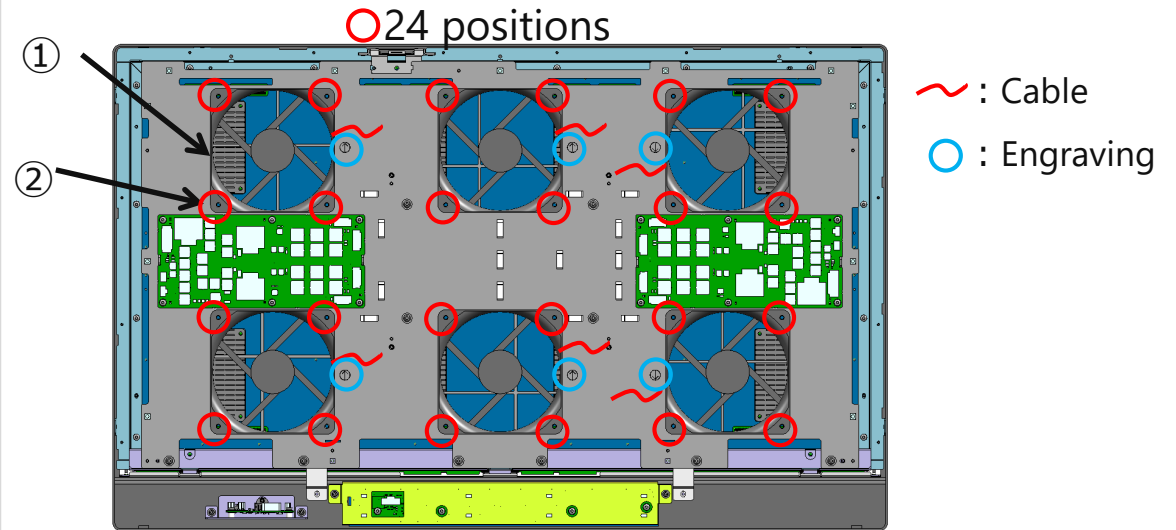

	Parts No.	Description	Qty.
①	DM6-0011-000	FAN, 120MM	6
②	XB6-7400-805	SCREW, TP, M4X8	24

REPAIR INFORMATION

1-37. Removing the BL_FAN UNIT 2

■ Disassembly procedure

1. Remove ②, and the remove ①.

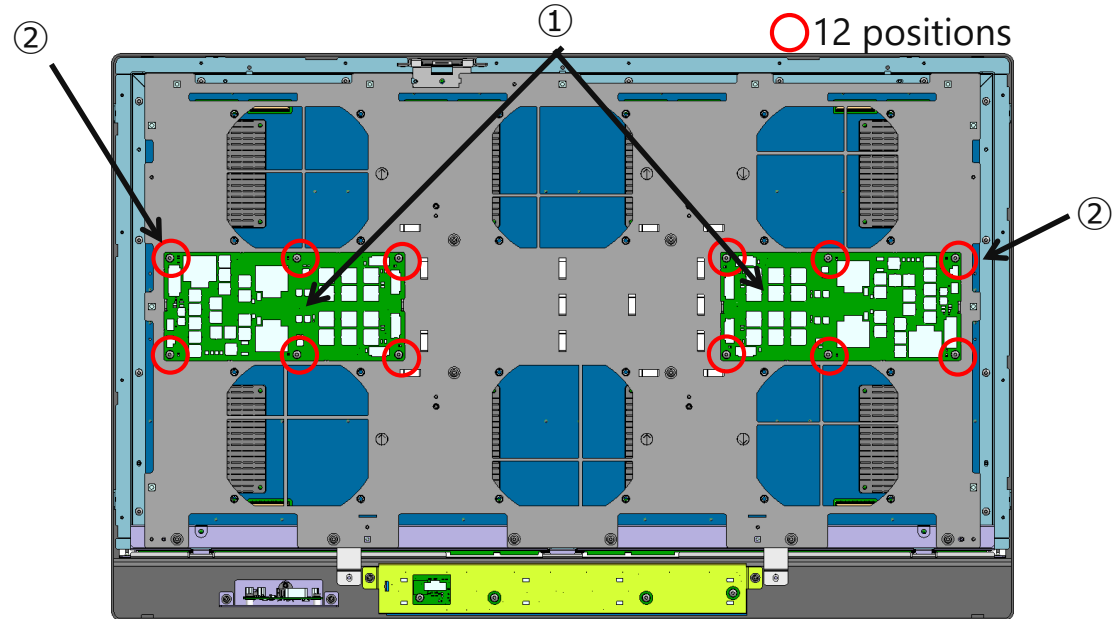

	Parts No.	Description	Qty.
①	DM1-0061-000	PCB ASS'Y, DCDC	2
②	XB2-8300-805	SCREW,W/WASHER,M3X8	12

REPAIR INFORMATION

1-38. Removing the Rear Cover Unit

■ Disassembly procedure

1. Remove ④, and then remove ①, ②, and ③.

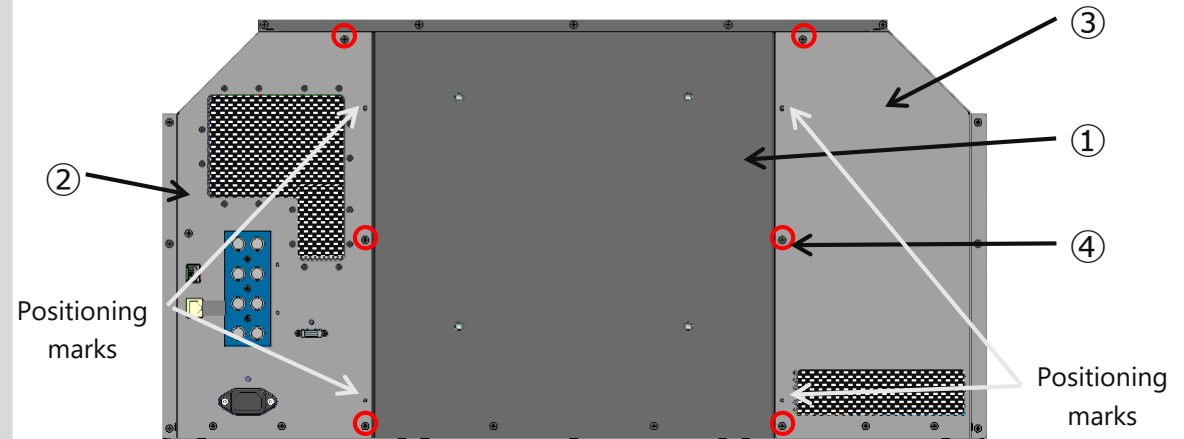

	Parts No.	Description	Qty.
①	DL1-0145-000	COVER, REAR CENTER	1
②	DL1-0166-000	COVER, REAR IF	1
③	DD1-0742-000	COVER, REAR LEFT	1
④	DD1-0103-000	SCREW, M3X6	6

REPAIR INFORMATION

1-39. Rear IF UNIT**Note on Assembly**

1. Attach ② to ① as shown in the diagram on the right.

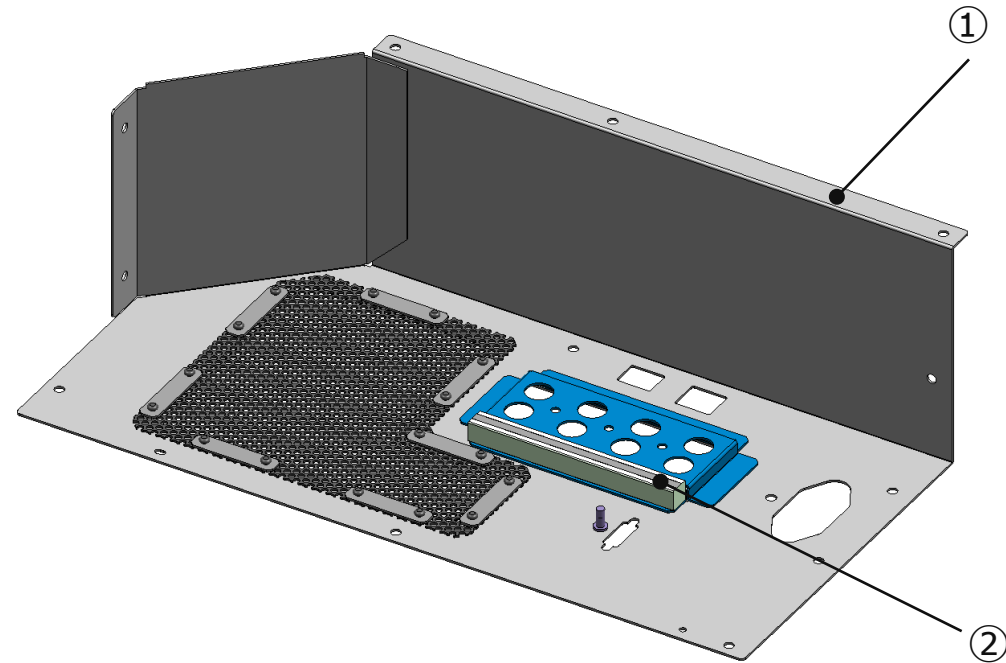

	Parts No.	Description	Qty.
①	DL1-0166-000	COVER, REAR IF	1
②	-	Gasket_Rear_NT021A	1

REPAIR INFORMATION

1-40. Rear Cover Left Unit

■ **Note on Assembly**

1. Peel off the release paper on ②, and attach ② aligned to the guidelines on ①.

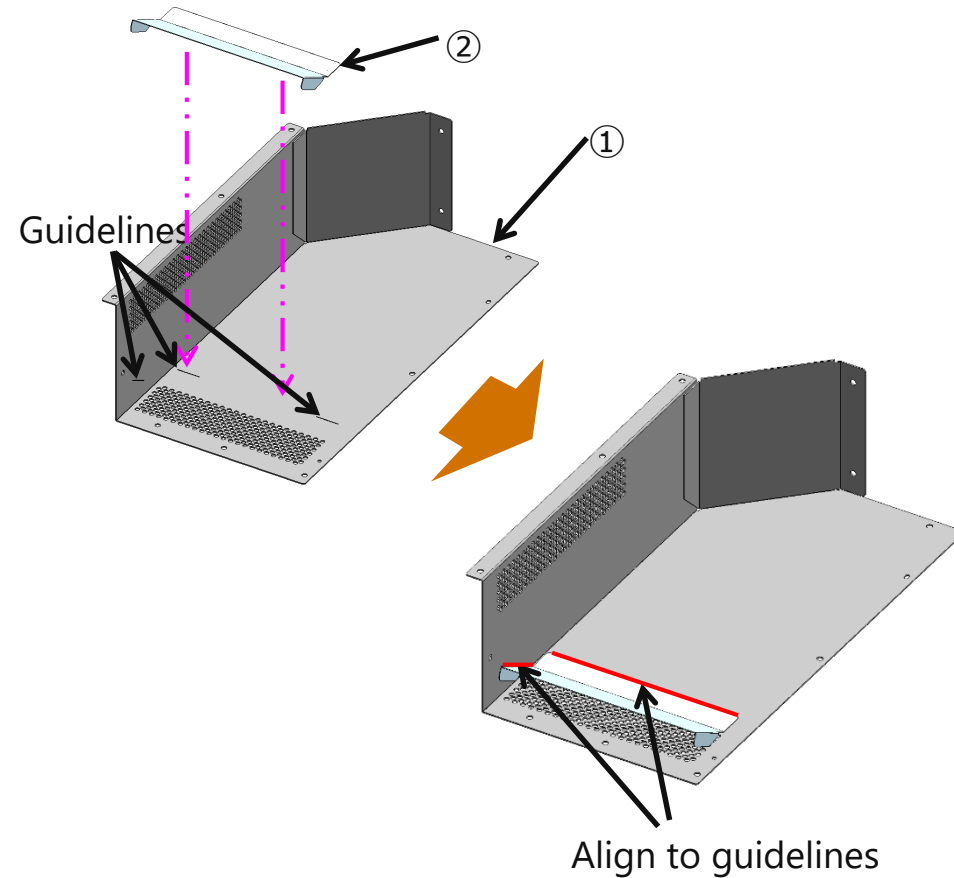

	Parts No.	Description	Qty.
①	DD1-0742-000	COVER, REAR LEFT	1
②	-	Insulator_PowUP	1

REPAIR INFORMATION

1-41. Rear Stand Unit**Note on Assembly**

1. Attach ② to ① as shown in the figure on the right (x4).

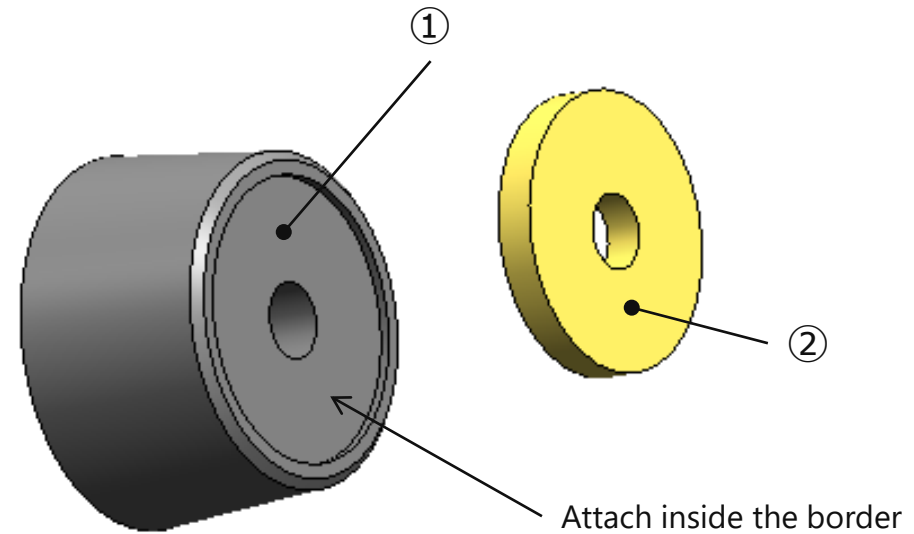

	Parts No.	Description	Qty.
①	DD1-0445-000	FOOT STAND, REAR	4
②	DD1-0060-000	PAD, FOOT	4

REPAIR INFORMATION

1-42. Front Stand Unit

■ **Note on Assembly**

1. Attach ② to ① and fasten with ③
 2. Attach ④ to ②.
- (x2)

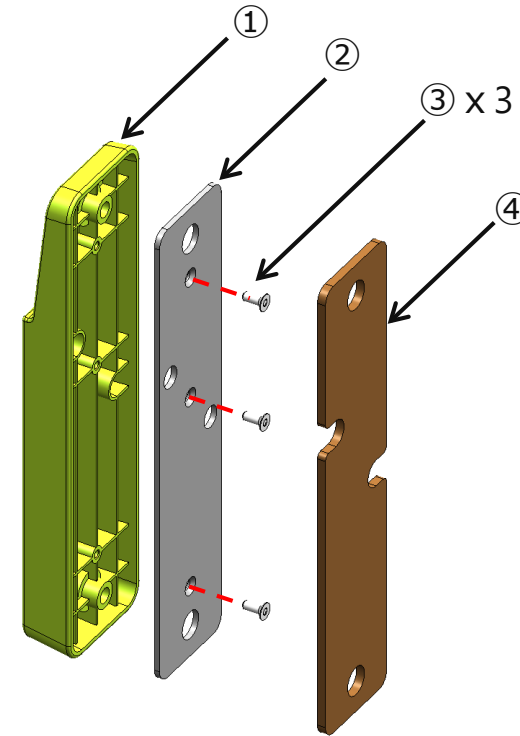

	Parts No.	Description	Qty.
①	DD1-0610-000	FOOT STAND, FRONT	2
②	DD1-0602-000	BASE, FOOT	2
③	XB4-8300-809	SCREW,W/WASHER,M3X8	6
④	DD1-0614-000	PAD, FOOT, FRONT	2

REPAIR INFORMATION

1-43. Removing the Bezel Unit 1

■ Disassembly procedure

1. Remove ②, and turn the bezel unit upside down.
2. Place the bezel unit with the left/right brackets on a platform at least 5cm high, with the LCD screen facing up.

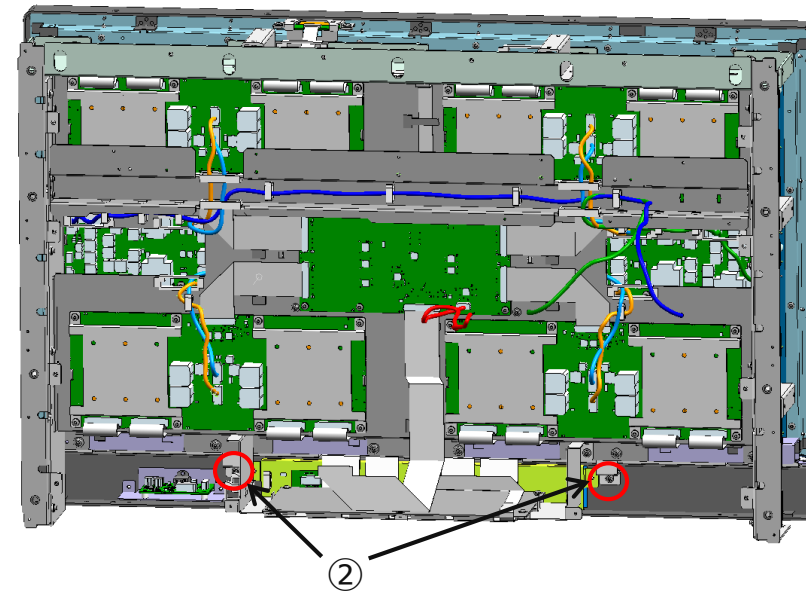
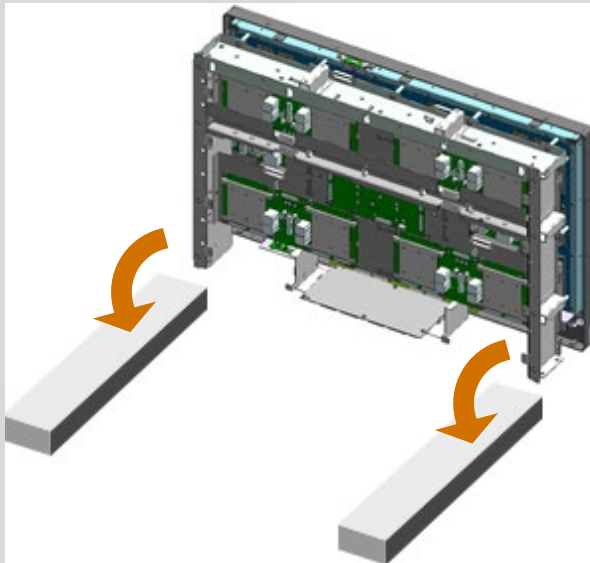

	Parts No.	Description	Qty.
①	-	Bracket_Bezel_Bottom	2
②	XB6-7300-405	Pan head screw with collar M3 x 4	4

REPAIR INFORMATION

1-44. Removing the Bezel Unit 2**■ Disassembly procedure**

1. Remove ①, and then remove the bezel unit.

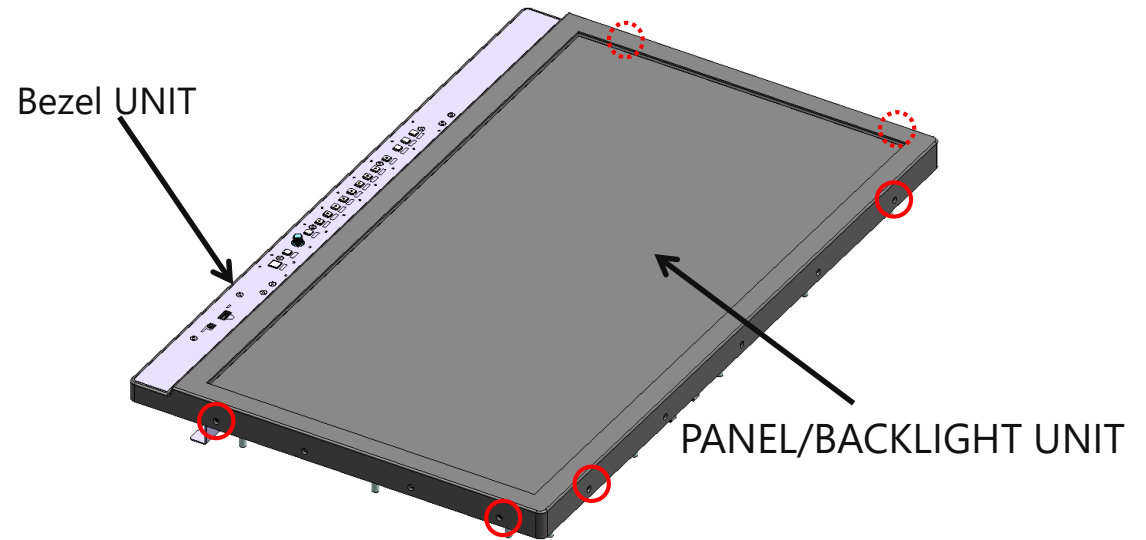

	Parts No.	Description	Qty.
①	DD1-0346-000	Screw_M3x6_SG-2353	6

REPAIR INFORMATION

1-45. Removing the Bezel Unit 3

■ Disassembly procedure

1. Remove ②, and then remove the UA unit.
2. Remove ②, and then remove ①.

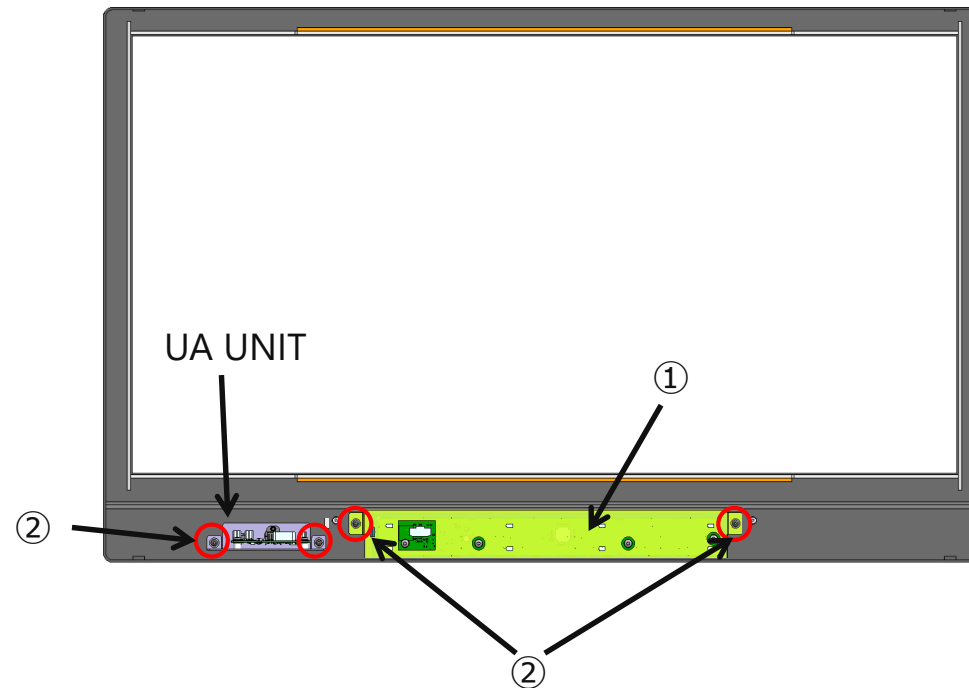

	Parts No.	Description	Qty.
①	-	Holder_Button	1
②	XB6-7300-405	Pan head screw with collar M3 x 4	4

REPAIR INFORMATION

1-46. Removing the Bezel Unit 4

■ Disassembly procedure

1. Remove ③, and then remove the front unit.
2. Remove the front unit from ②.

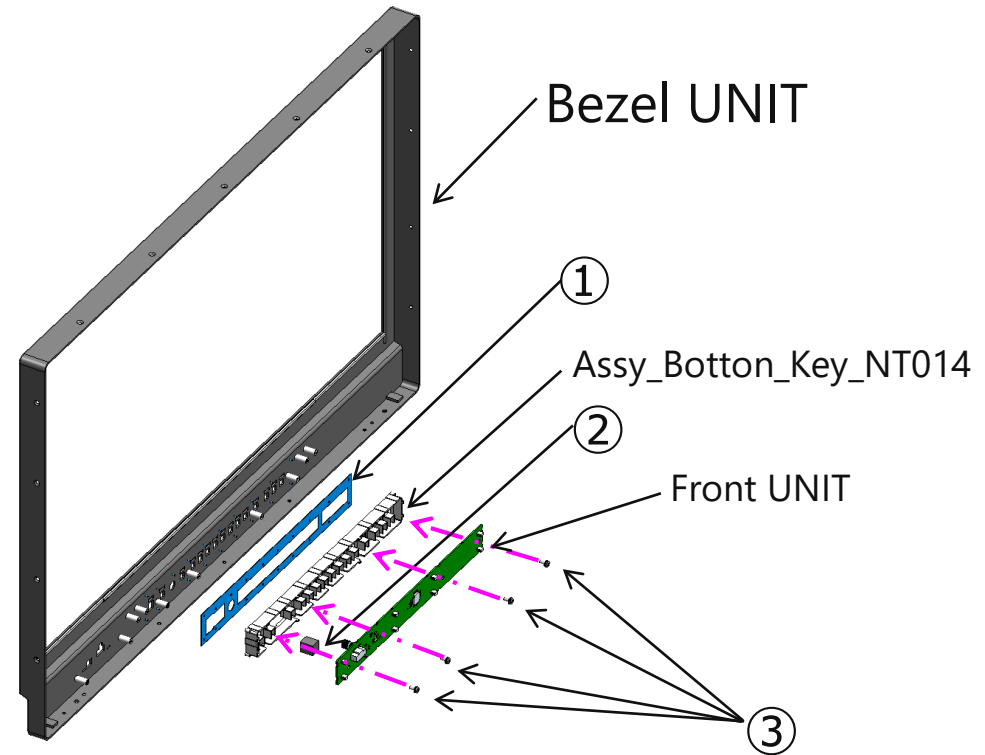

	Parts No.	Description	Qty.
①	DD1-0627-000	Sheet_ControlPanel	1
②	-	Cushion_ControlPanel	1
③	XB2-8300-805	Spring + Binding head screw with washer M3x8	4

SERVICE MANUAL

Video Display DP-V2411 (JP)

Video Display DP-V2411 (US)

Video Display DP-V2411 (EU)

Video Display DP-V2411 (CN)



Application

This Service Manual is issued by Canon Inc. for qualified persons to learn technical theory and product repair. This Service Manual covers all localities where the products are sold. For this reason, there may be information in this Service Manual that does not apply to the product sold in your locality. The following paragraph does not apply to any countries where such provisions are inconsistent with local law.

Information revision

The product mentioned in this service manual changes a part and specifications without declining. When a change occurred in the contents of this service manual, the origin of publication publishes service information by the judgment of the origin of publication. In addition, the origin of publication publishes a revised edition by the judgment of the origin of publication when a large change occurred in the contents of this service manual.

Trademarks

The product names and company names described in this Service Manual are the registered trademarks of the individual companies.

Copyright

Canon Inc. retains the copyright to this Service Manual. Reproduction, publication (including on the World Wide Web), alteration, translation into another language, or other use of the data in whole or part, contained on this Service Manual without the written consent of Canon Inc. is prohibited.

Copyright © 2018 Canon Inc.
ICB Service Promotion Dept.
30-2, Shimomaruko 3-chome, Ohta-ku,
Tokyo 146-8501, Japan

Contents

1. Before Disassembly		<u>P3</u>		
1.1	Required Tools and Supplies	<u>P3</u>		
1.2	Precautions against Electric Shock and Hot Components	<u>P3</u>		
1.3	Precautions in Disassembling and Assembling the Display	<u>P4</u>		
1.4	Areas to Clean	<u>P5</u>		
2. Structure of Display Components and Disassembly Flowchart		<u>P6</u>		
3. Disassembly		<u>P7</u>		
3.1	Preparation	<u>P8/P9</u>		
3.2	Foot Parts Detachment	<u>P9</u>		
3.3	Handle Detachment	<u>P11</u>		
3.4	Rear Cover Parts Detachment	<u>P12</u>		
3.5	Rear Frame Detachment	<u>P15</u>		
3.6	[PCB ASS Y, POWER] Cables Detachment	<u>P16</u>		
3.7	[PCB ASS Y, MAIN] Cables Detachment	<u>P17</u>		
3.8	[PCB ASS Y, POWER] Detachment	<u>P18</u>		
3.9	[PCB ASS Y, MAIN] Detachment	<u>P19</u>		
3.10	CABLE, ACIN and CABLE, DCIN Detachment	<u>P21</u>		
3.11	PCB Holder Detachment	<u>P22</u>		
3.12	[PCB ASS Y, LAN], [PCB ASS Y, USB/AUDIO] cable Detachment	<u>P23</u>		
3.13	[PCB ASS Y, TCON] and [PCB ASS Y DRIVER] cable Detachment	<u>P24</u>		
3.14	[PCB ASS Y, TCON] and [PCB ASS Y DRIVER] Detachment	<u>P25</u>		
3.15	[BKTBTM unit / Module unit/ Bezel unit] Detachment	<u>P26</u>		
3.16	[PCB ASS Y, LAN] and [PCB ASS Y, USB/AUDIO] Detachment	<u>P30</u>		
3.17	[Module unit/ Bezel unit] Detachment	<u>P31</u>		
3.18	[PCB ASS Y, MAIN] Detachment	<u>P32</u>		
4. Parts Catalog		<u>P41</u>		

1. Before Disassembly

1.1 Required Tools and Supplies

Name	Purpose	Notes
Phillips screwdriver with torque control (bit #1), Length; 100mm	Disassembly and assembly	For M2 screws
Phillips screwdriver with torque control (bit #2), Length; 100mm	Disassembly and assembly	For M3 screws and M4 screws
Hex key (5 mm; Hexagon width across flats)	Disassembly and assembly	For [HANDLE] Detachment
Hex Nut Screwdriver (5.5 mm; Hexagon width across flats)	Disassembly and assembly	For [TCON PCB, DRIVER PCB] Detachment
Tweezers	Disassembly and assembly	
Pole made of Styrofoam (height 8 cm)	To protect the monitor from damage	
TAPE, ROLL(NO.156A)10MM X 30M	For [COVER, FRONT BEZEL]	Part Number:CY9-5710-000
BOND, DIABOND NO.1663G BLACK	For [KNOB, JOG] Assembly	Part Number:CY9-8129-000
GPI CHECKER	For GPI/TALLY lamp check	Part Number:CY9-5712-000
CABLE, DC POWER SUPPLY	For Connecting DC POWER SUPPLY	Part Number:CY9-5713-000

1.2 Precautions against Electric Shock and Hot Components



•Electric shock caution mark

This mark appears on parts of the circuit board to indicate possible electric shock hazards. Before working on such parts, be sure to remove the power cord, and do not touch them.



•Hot caution mark

This mark appears on parts of the circuit board to indicate that they become hot. When the display is turned on, or even after a short time after the power is turned off, touching such parts may cause burns. Before working on such parts, be sure to remove the power cord, and do not touch them.



1.3 Precautions in Disassembling and Assembling the Display

- **Before disassembly, be sure to remove the power cord and wait 30 minutes or more*.**
- Disassembly and assembly are basically carried out with the monitor screen facing down. To protect the screen from damage, insert pole made of styrofoam between the display and the workbench (see page 7).
- Be sure to use a proper screwdriver bit that fits to the screw head.
- Follow the tightening torque specified in this manual when fastening screws.
- Use a commercially-available antistatic wrist strap when touching a circuit board.
- Connect and remove connectors carefully to avoid damaging connectors and cables.
- Return all components and wiring to their original conditions. For safety reasons, some components use insulation material, such as tubing and taping, while others are mounted off the printed circuit board. Internal wires are run in a way to prevent them from making contact with heat-source and high-voltage components (such as by using clamps). Be sure to return them to their original conditions.
- Do not disassemble any parts not listed in the disassembly instructions of this service manual. Also, do not disconnect cables and connectors.
- Wear gloves for preventing you from injury when removing a frame.

* Assembling or disassembling while there is residual charge in both ends of the aluminum electrolytic capacitor may result in electrical shock or damage to the IC components.
This model does not come with a discharge pad or other such components.



1.4 Areas to Clean

Dust accumulates on vent holes, internal fan, and their surrounding areas. Use a vacuum cleaner to clear the dust.

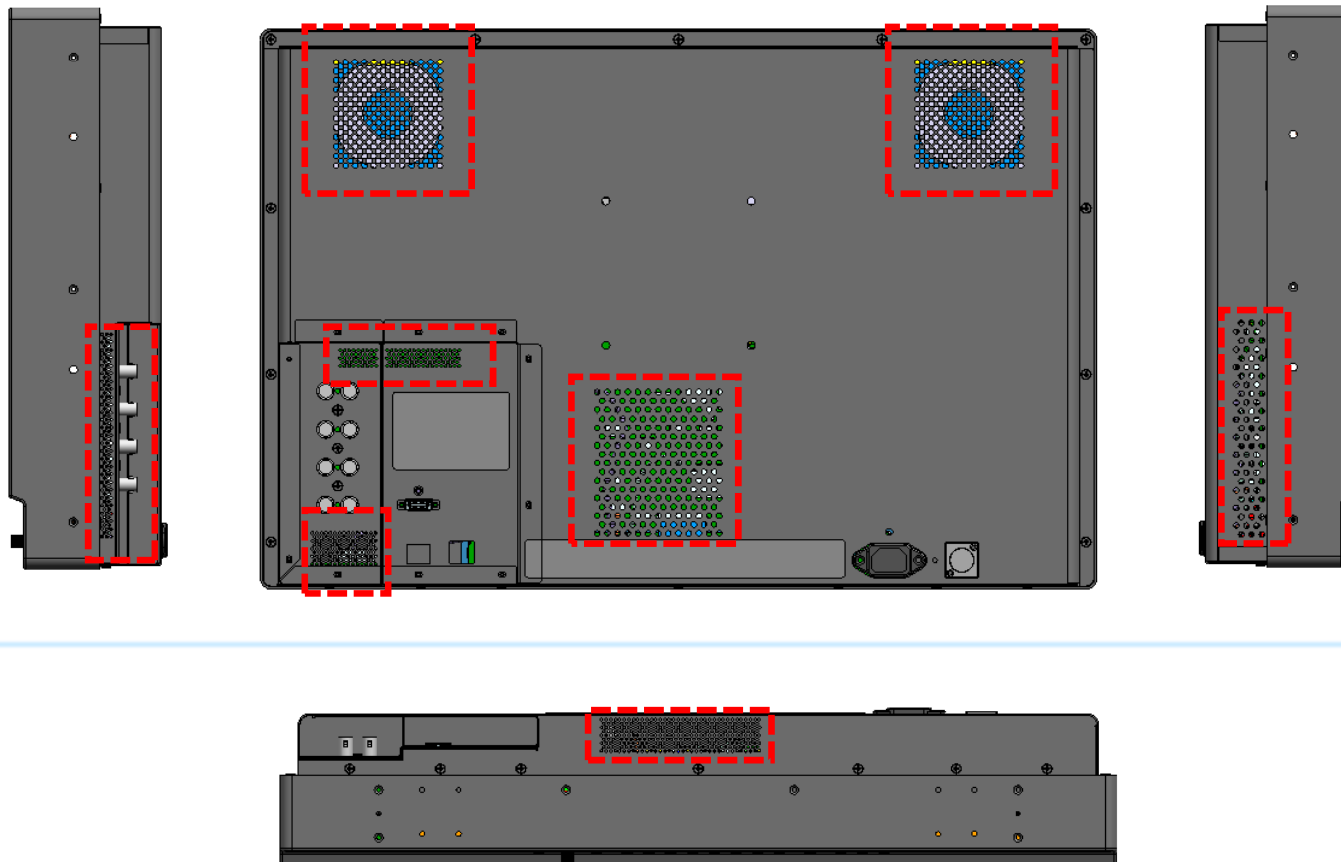

2. Structure of Display Components and Disassembly Flowchart

Disassembly		P7
3.1	Preparation	P8
3.2-1,2	Foot Parts Detachment	P9
3.3	Handle Detachment	P11
3.4	Rear Cover Parts Detachment	P12
3.5	Rear Frame Detachment	P15
3.6	[PCB ASS Y, POWER] Cables Detachment	P16
3.7	[PCB ASS Y, MAIN] Cables Detachment*	P17

Please check the each flow.



The Detachment for [PCB ASS Y, POWER] and [PCB ASS Y, MAIN]

3.8	[PCB ASS Y, POWER] Detachment	P18
3.9	[PCB ASS Y, MAIN] Detachment	P19
3.10	CABLE, ACIN and CABLE, DCIN Detachment	P21



The Detachment for [PCB ASS Y, LAN], [PCB ASS Y, TCON], [PCB ASS Y, DRIVER]

3.11	PCB Holder Detachment	P22
3.12	[PCB ASS Y, LAN], [PCB ASS Y, USB/AUDIO] cable Detachment	P23
3.13	[PCB ASS Y, TCON] and [PCB ASS Y DRIVER] cable Detachment*	P24
3.14	[PCB ASS Y, TCON] and [PCB ASS Y DRIVER] Detachment	P25
3.15-1,2	[BKTBTM unit / Module unit/ Bezel unit] Detachment BKTBTM unit only	P26
3.16	[PCB ASS Y, LAN] and [PCB ASS Y, USB/AUDIO] Detachment	P30



The Detachment for [FRONT BEZEL Parts] and [PCB ASS Y, FRONT]

3.11	PCB Holder Detachment	P20
3-15-1,2	[BKTBTM unit / Module unit/ Bezel unit] Detachment	P26
3.16	[PCB ASS Y, LAN] and [PCB ASS Y, USB/AUDIO] Detachment	P30
3.17	[Module unit/ Bezel unit] Detachment	P31
3.18	[PCB ASS Y, MAIN] Detachment	P32

Note*) Refer to Page 8 while removing connectors.



3. Disassembly

To disassemble the display, refer to section 2, "Display Components and Disassembly Flowchart," and follow the instructions in this chapter. To assemble the display, reverse the procedure.

3.1-1 Preparation

- On the workbench, place two pieces of soft material such as Styrofoam that will not damage the display body, and place the display face down on the material. Separate the pieces appropriately according to the width of the display.
- To protect the display screen from damage, make sure that the [COVER, FRONT BEZEL] around the screen are resting on the protective material.
- The pieces of protective material should be 100 to 150 mm wide, 700 to 800 mm long, and at least 50 mm high.

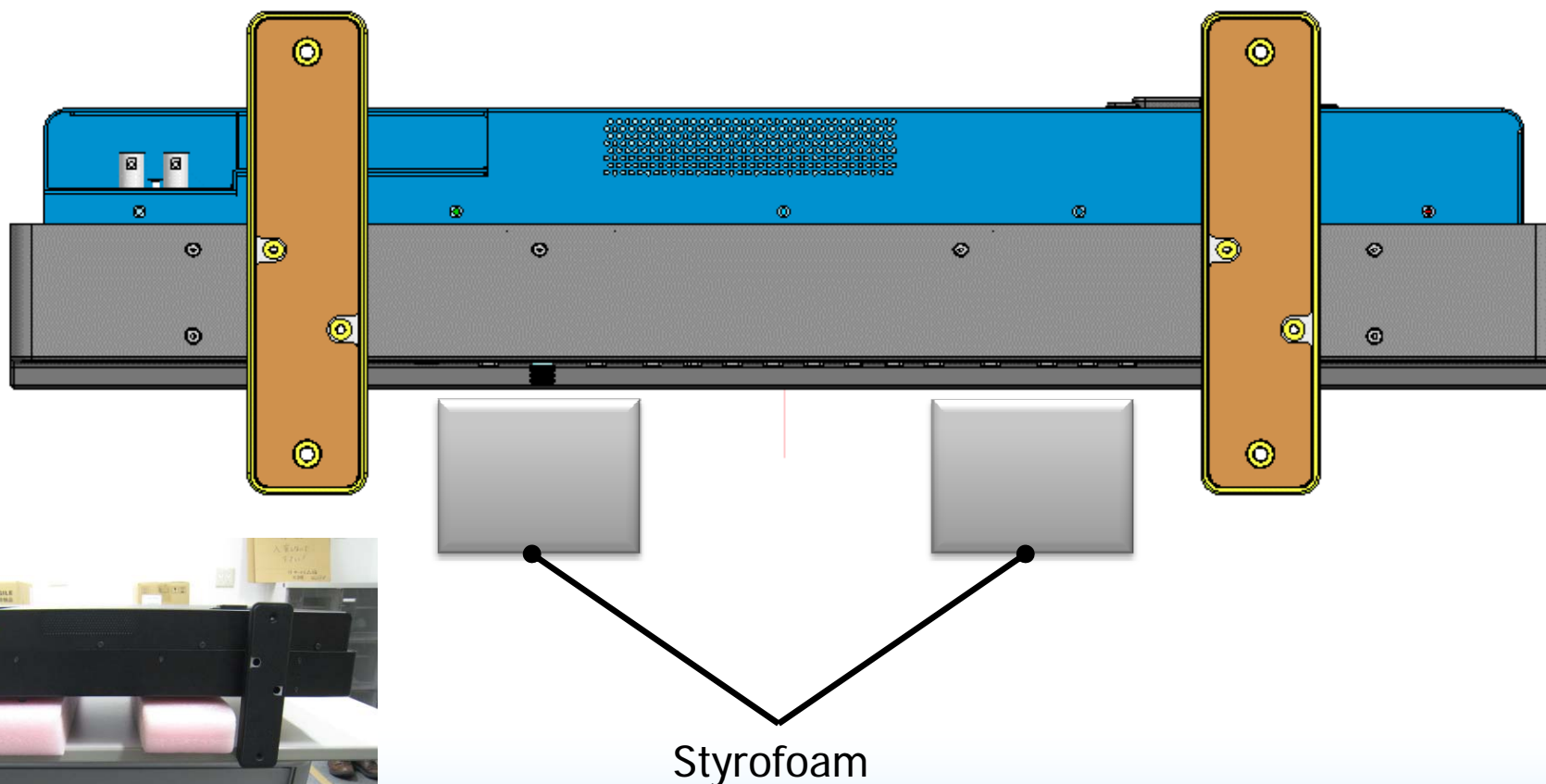

3.1-2 Caution When Removing Connector

Because the connector below is easily breakable, please adjust force to apply carefully.
(See p.17 and 24 for the relevant information.)

A

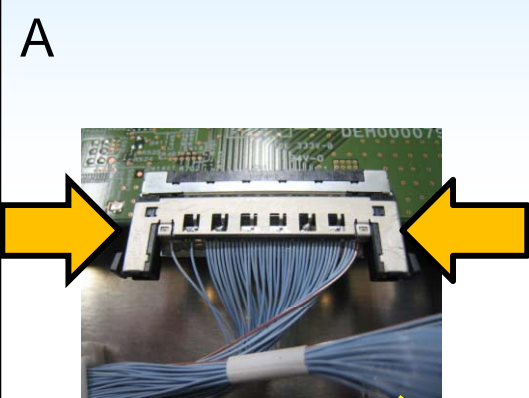

Pull out the connector while pressing the hook

B

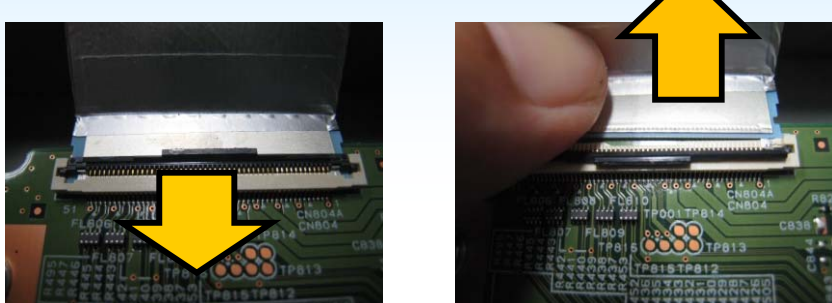

Push the hook upward, and then disengage the lock.

Pull out the cable from the connector.

C

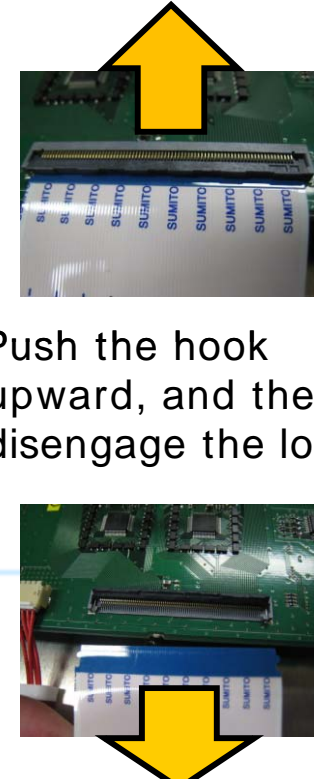

Push the hook upward, and then disengage the lock.

Pull out the cable from the connector.

D

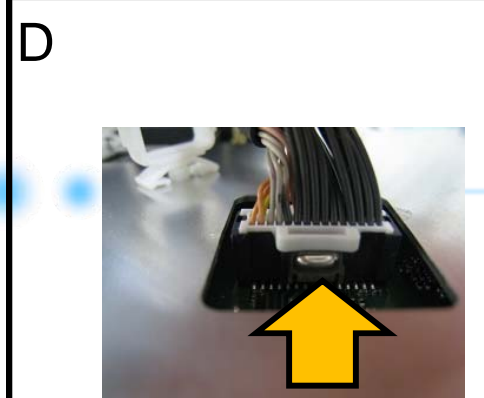

Pull out the connector while pressing the hook

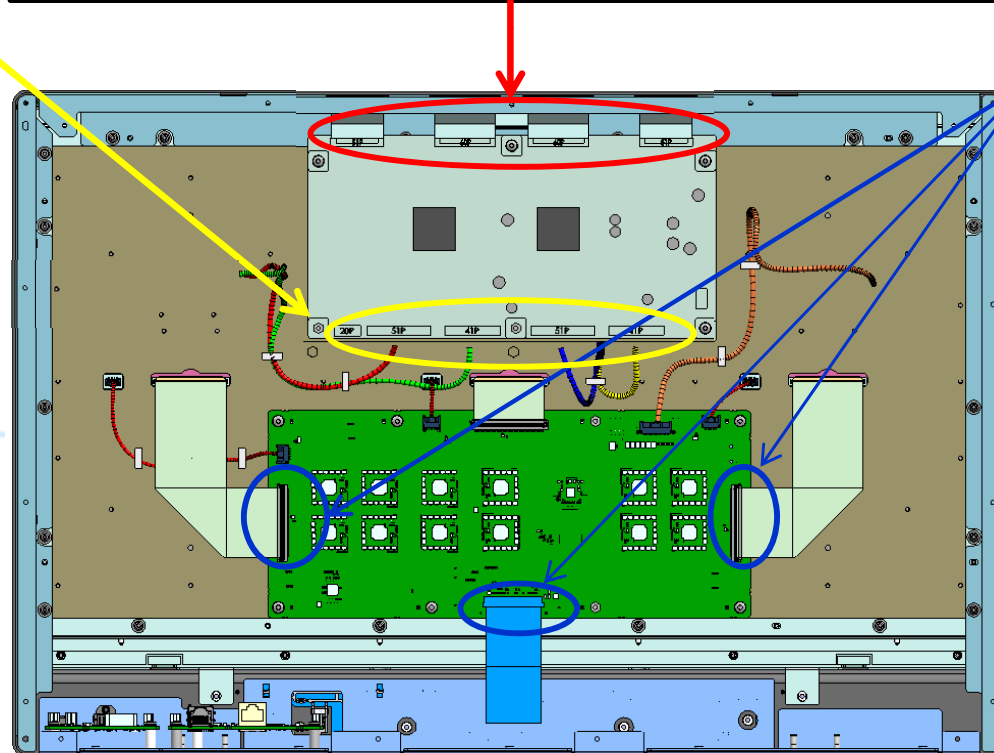

3.2 Foot Parts Detachment

1. Unfasten the four Screw-A screws, and remove the Mark .
(The tightening torque is 60 N•cm.)

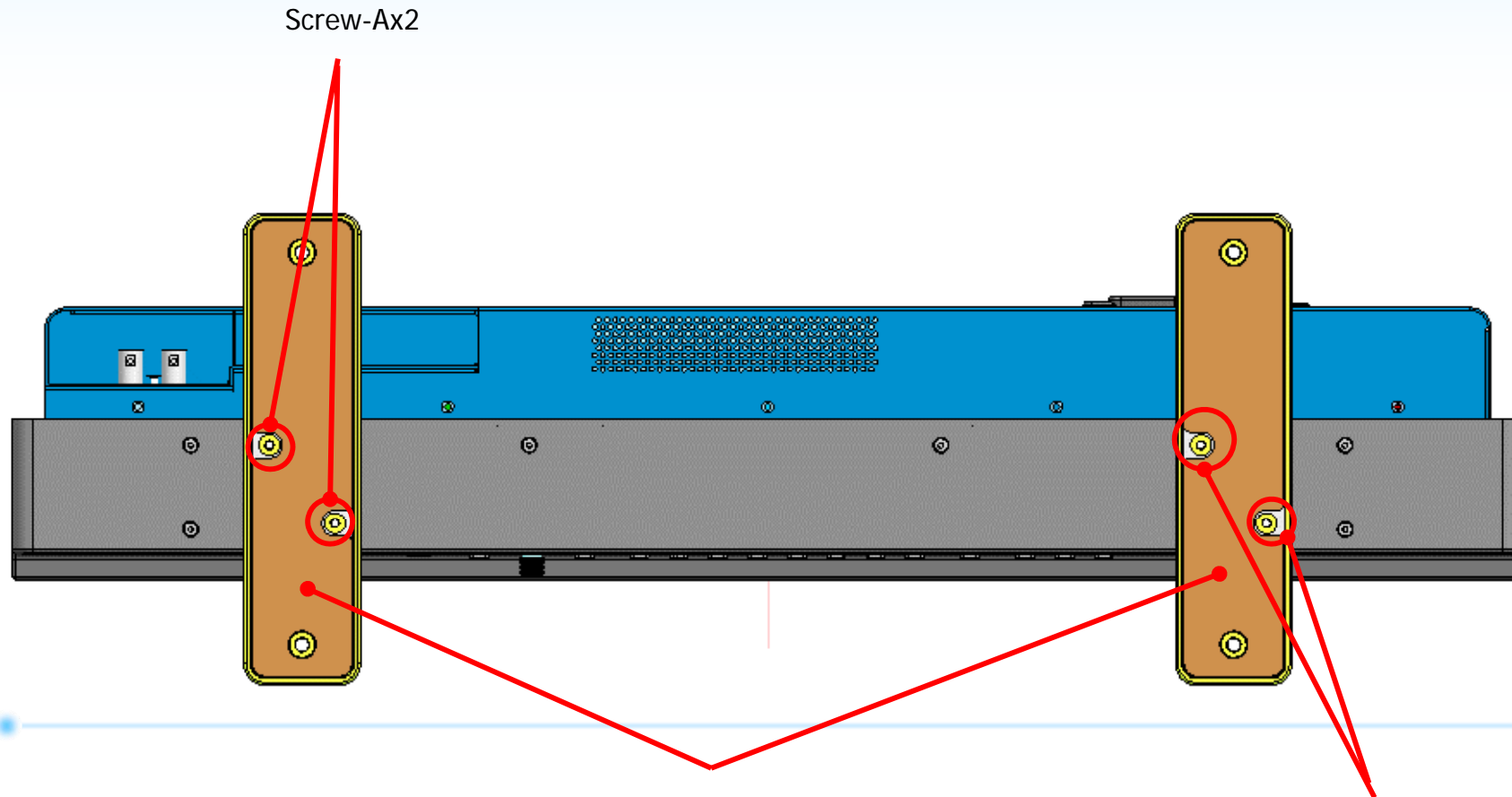

Mark	Parts No.	Description	Qty
	-	FOOT STAND ASS'Y	2
SCREW-A	XB2-4301-005	SCREW, W/SCREW-A WASHER, M3X10	4

Screw-Ax2



2. After peel off the Mark and , unfasten the three Screw-A screws, and remove the Mark .
 (The tightening torque is 40 N•cm.)

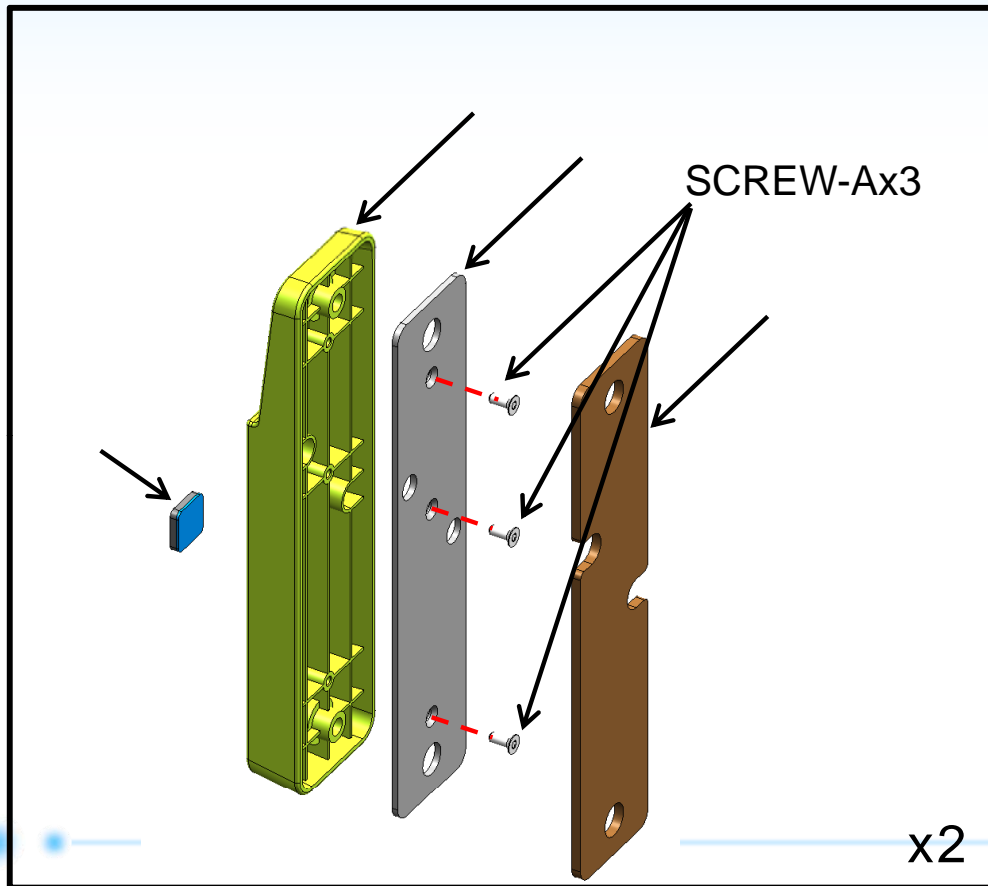

Attach the using the marking line as a guide.

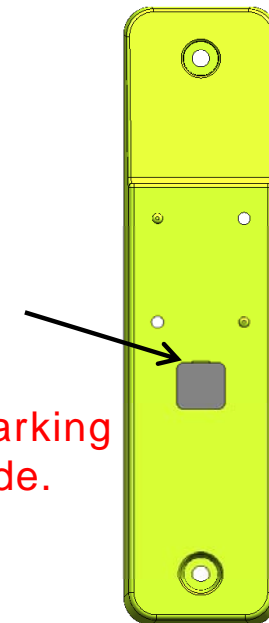

Mark	Parts No.	Description	Qty
	DD1-0610-000	FOOT STAND, FRONT	2
	DD1-0602-000	BASE, FOOT	2
	DD1-0614-000	PAD, FOOT, FRONT	2
	DD1-0660-000	CUSHION, FOOT	2
SCREW-A	XB4-8300-809	SCREW, TAP, BINDING M3X8	6



3.3 Handle Parts Detachment

1. Unfasten the two the Mark , and remove the Mark .
(The tightening torque is 200 N•cm.)

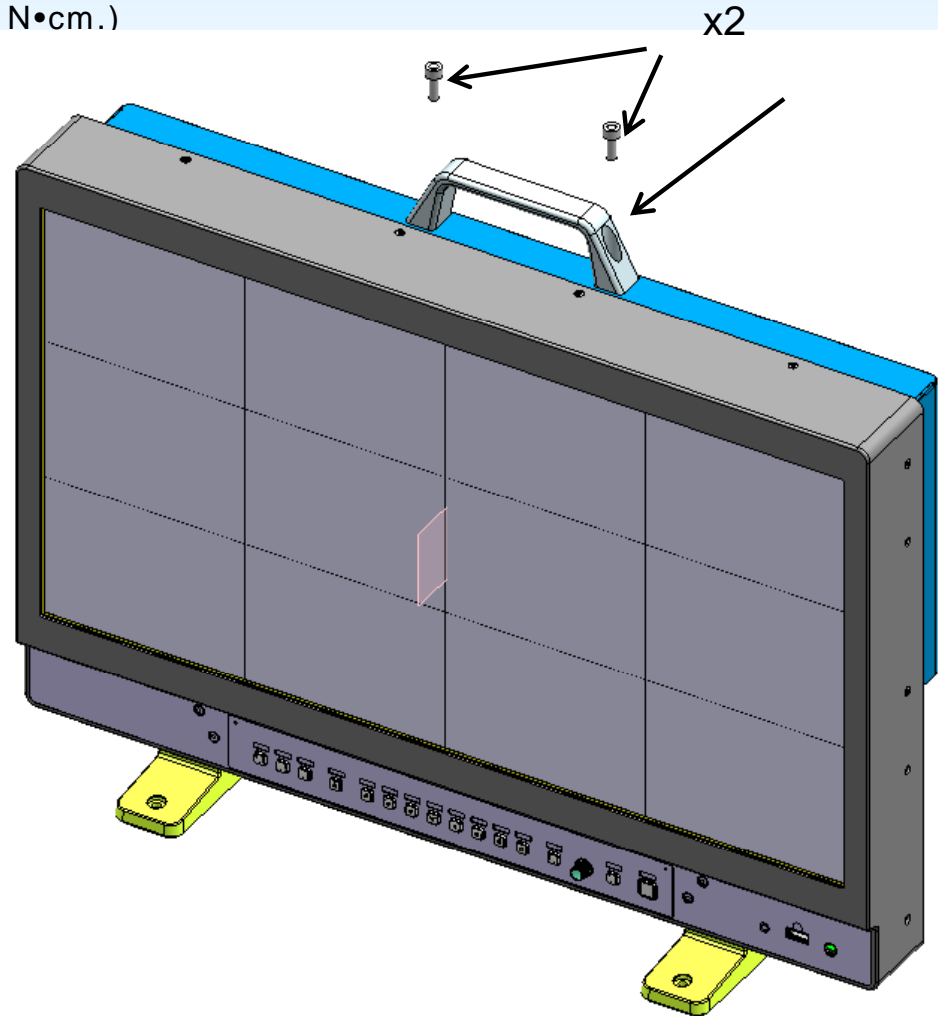

Mark	Parts No.	Description	Qty
	DD1-0618-000	HANDLE	1
	XB7-1060-169	BOLT, HEX SKT. M6X16	2



3.4 Rear Cover Parts Detachment

1. Unfasten the 17 Screw-A screws (five screws at the bottom), and the five Screw-B screws.
 (The tightening torque for Screw-A is 60 N•cm.)
 (The tightening torque for Screw-B is 40 N•cm.)

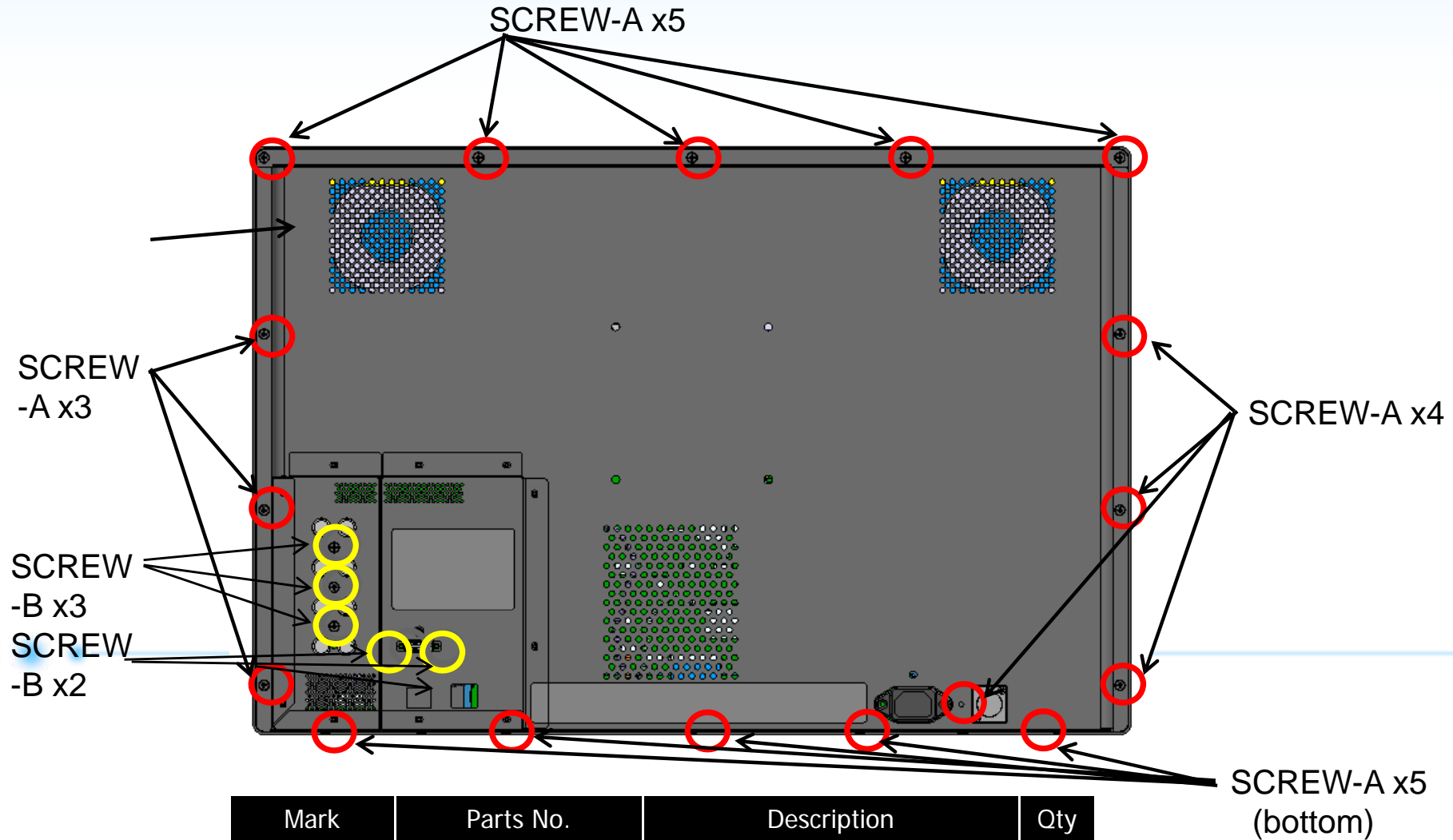

Mark	Parts No.	Description	Qty
	DL1-0129-000	COVER, REAR	1
SCREW-A	DD1-0103-000	SCREW, M3X6	17
SCREW-B	DD1-0110-000	SCREW, M3X5	5



[Note on assembly 1]

When assembling the Assy Cover Rear,
Install a screw in order of a yellow number.

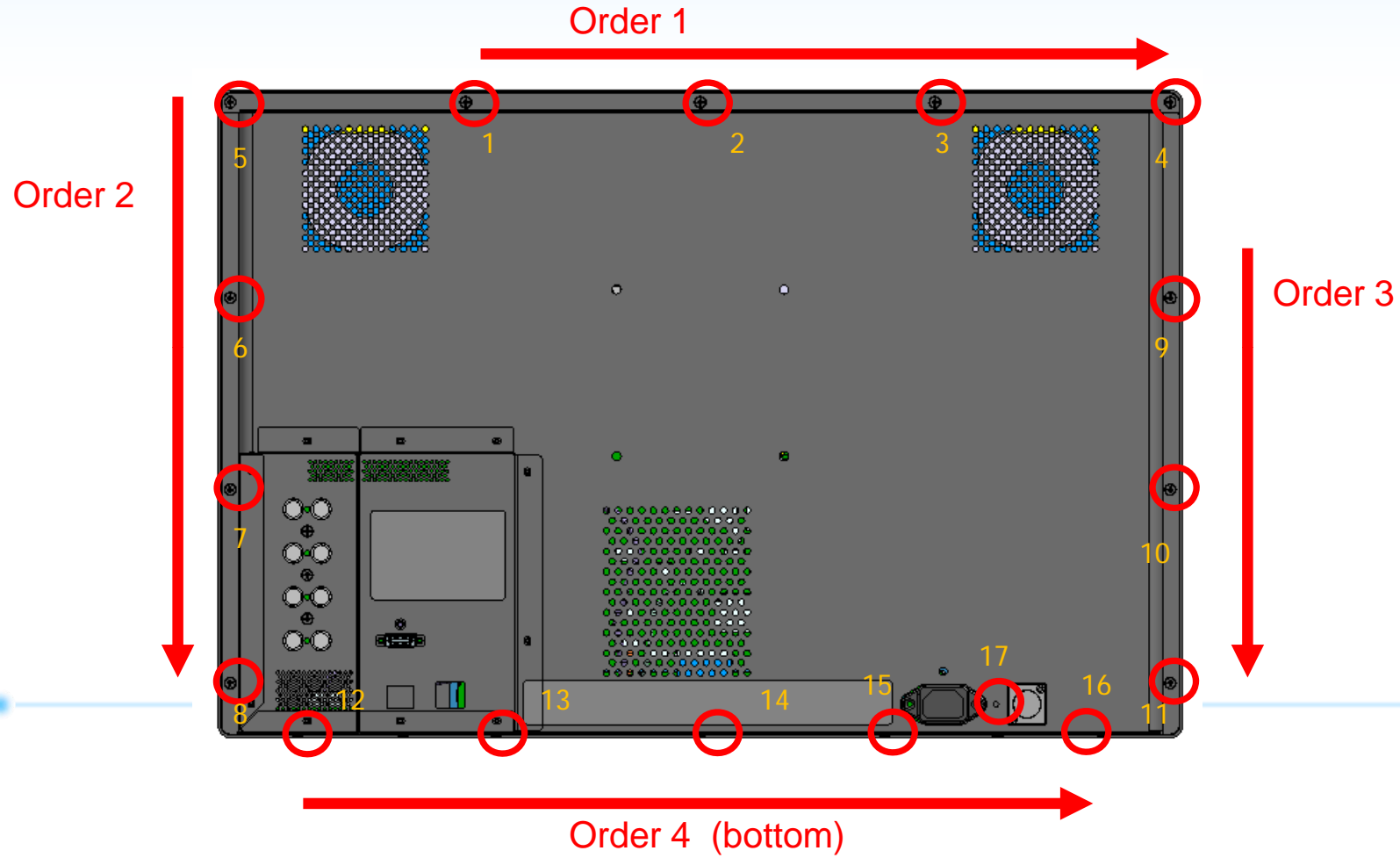

[Note on assembly 2]

When replacing [part], replace [part], and peel off the [LABEL, SERIAL] from [part] and affix it to the same label location on the [part] to be attached.

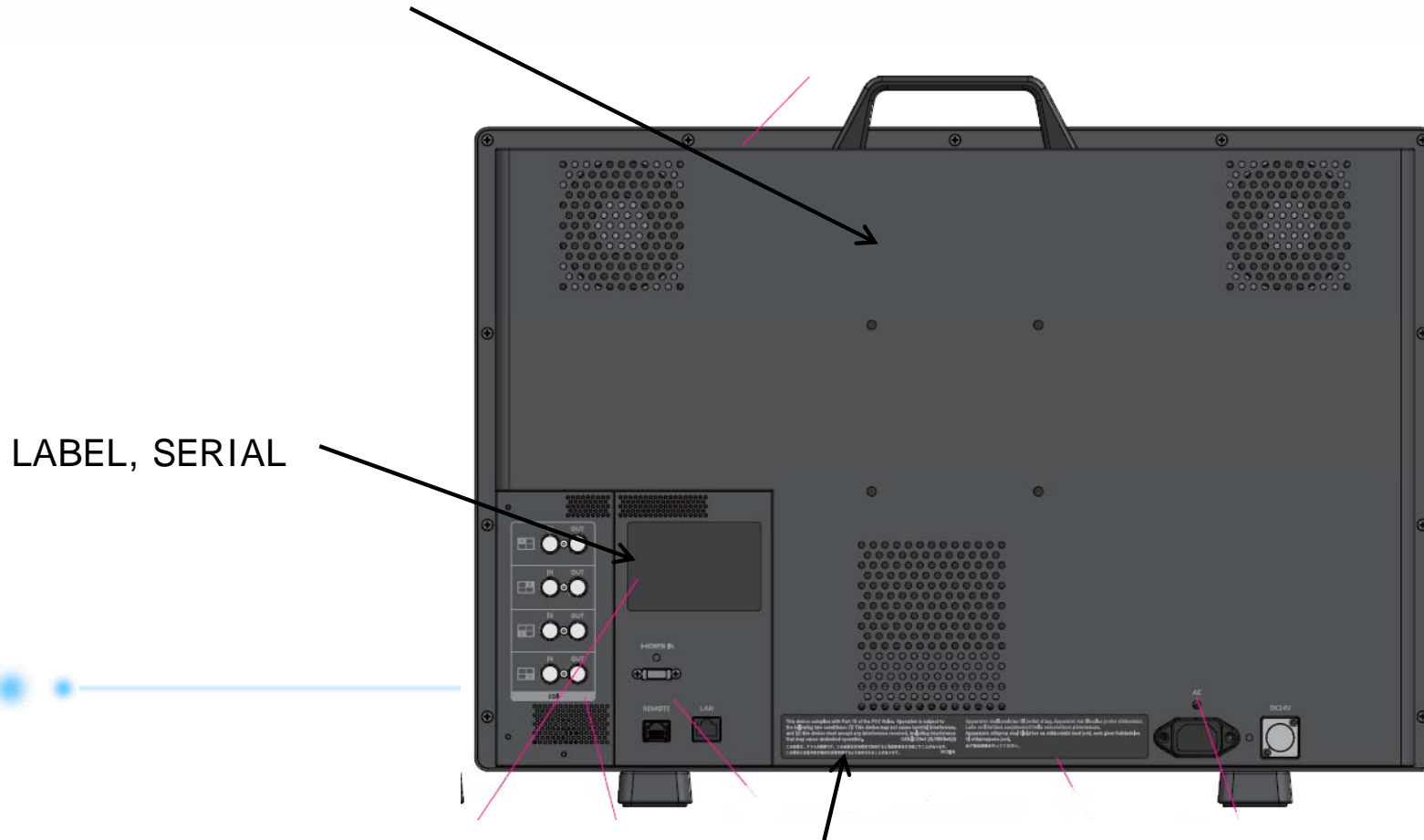

Mark	Parts No.	Description	Qty
	DD1-0652-000	Label Caution	1



3.5 Rear Frame Detachment

- 1.1. Unfasten the six Screw-A screws, and remove the Rear Frame.
(The tightening torque is 100 N•cm.)

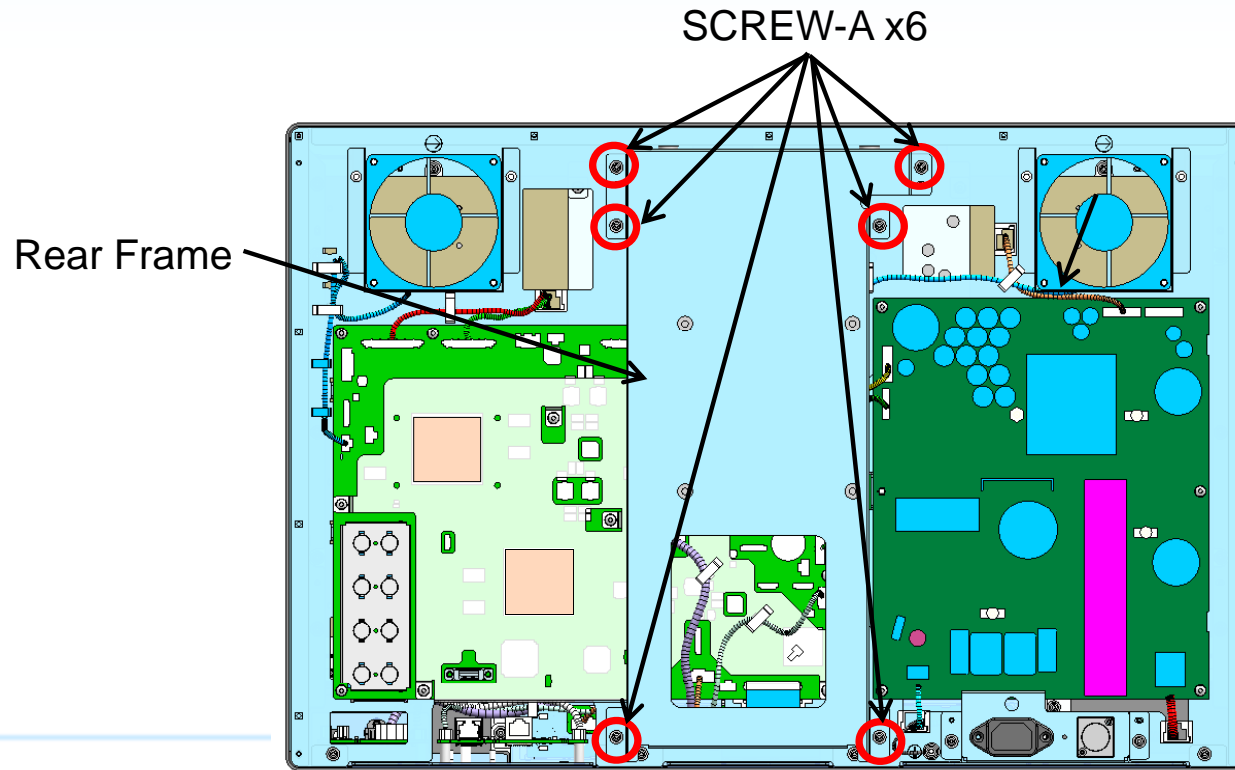

Mark	Parts No.	Description	Qty
SCREW-A	XB6-7400-805	SCREW, TP, M4X8	6



3.6 [PCB ASS Y, POWER] Cables Detachment

1.Remove the cables of the Mark to Mark from the [PCB ASS Y, POWER].

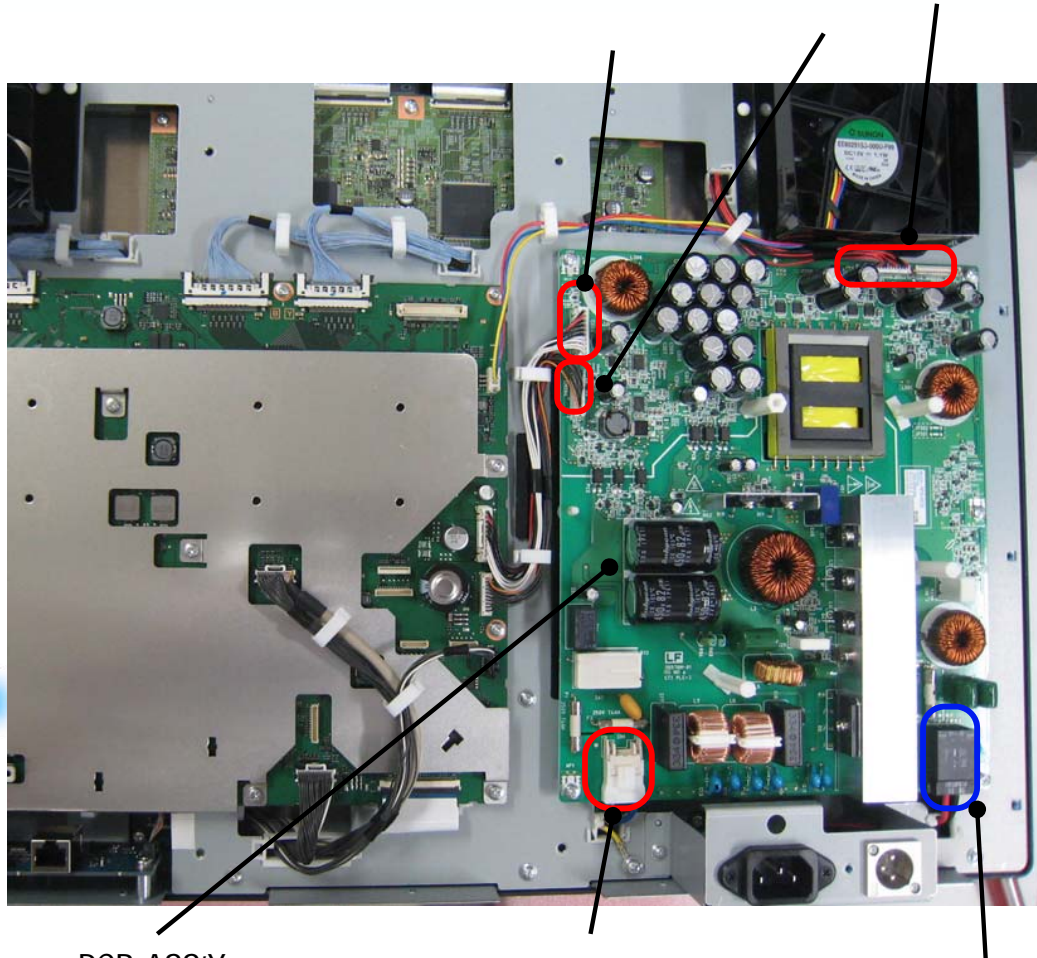

PCB ASS'Y,
POWER

Mark	Parts No.	Description	Qty
	DD2-0163-000	CABLE, POWER, MAIN1	1
	DD2-0164-000	CABLE, POWER, MAIN2	1
	DD2-0161-000	CABLE, ACIN	1
	DD2-0162-000	CABLE, DCIN	1
	DD2-0169-000	CABLE, POWER, DRIVER	1



3.7 [PCB ASS Y, MAIN] Cables Detachment

1. Remove the cables of the Mark to Mark and the two FAN Cables from the [PCB ASS Y, MAIN].

Refer to A of P7 and be careful not to damage of connector while removing connector and .
 Refer to D of P7 and be careful not to damage of connector while removing connector , and .
 Refer to C of P7 and be careful not to damage of connector while removing connector .

2. Remove the cables of the Mark from fan.

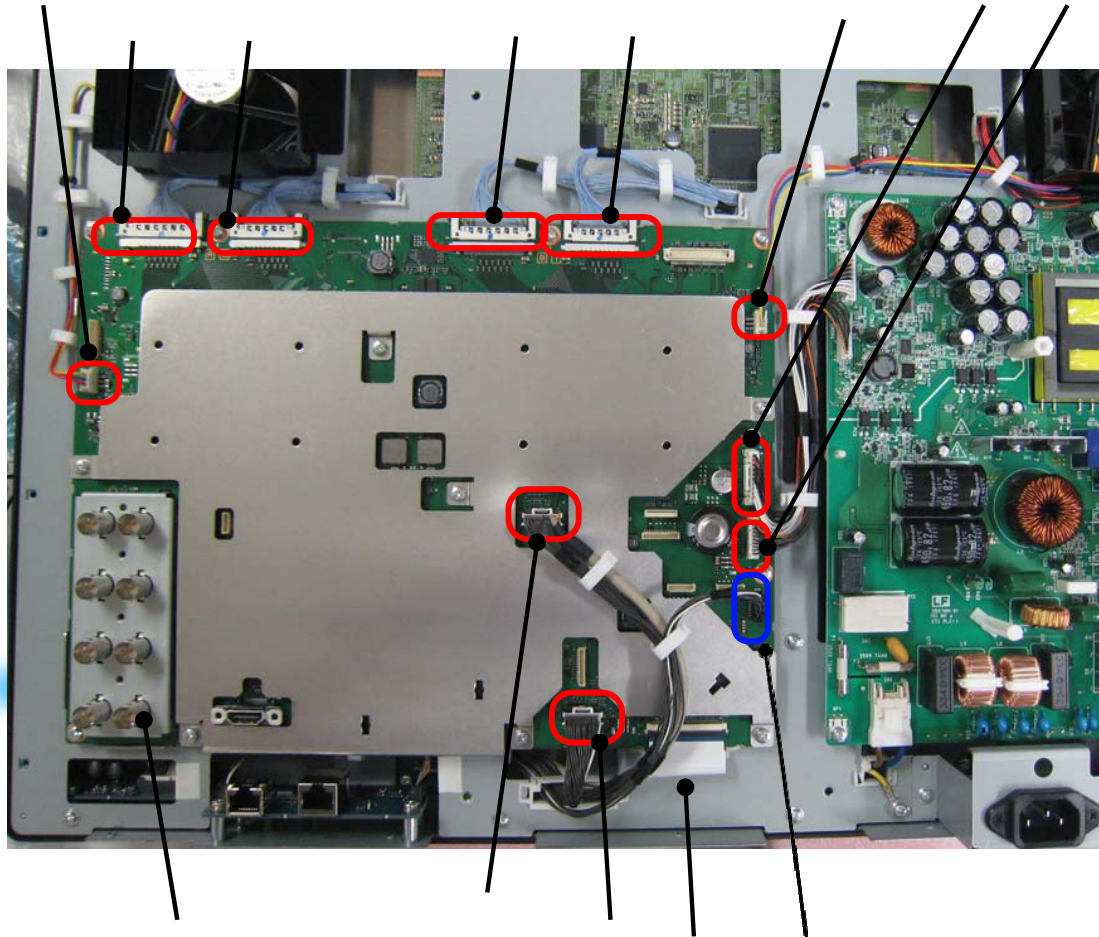

PCB ASS'Y, MAIN

Mark	Parts No.	Description	Qty
	DD2-0175-000	CABLE, MAIN, TCON1	2
	DD2-0176-000	CABLE, MAIN, TCON2	2
	DD2-0163-000	CABLE, POWER, MAIN1	1
	DD2-0164-000	CABLE, POWER, MAIN2	1
	DM6-0005-000	FAN, SYSTEM	2
	DD2-0167-000	CABLE, MAIN, USB	1
	DD2-0166-000	CABLE, MAIN, LAN	1
	DD2-0165-000	CABLE, MAIN, FRONT	1
	DD2-0100-000	FPC, IFS, MAIN	1



3.8 [PCB ASS Y, POWER] Detachment

1. Unfasten the two Screw-A screws each, and remove the two Mark .
(The tightening torque is 100 N•cm.)
2. Unfasten the five Screw-A screws, and remove the two Mark .
(The tightening torque is 60 N•cm.)

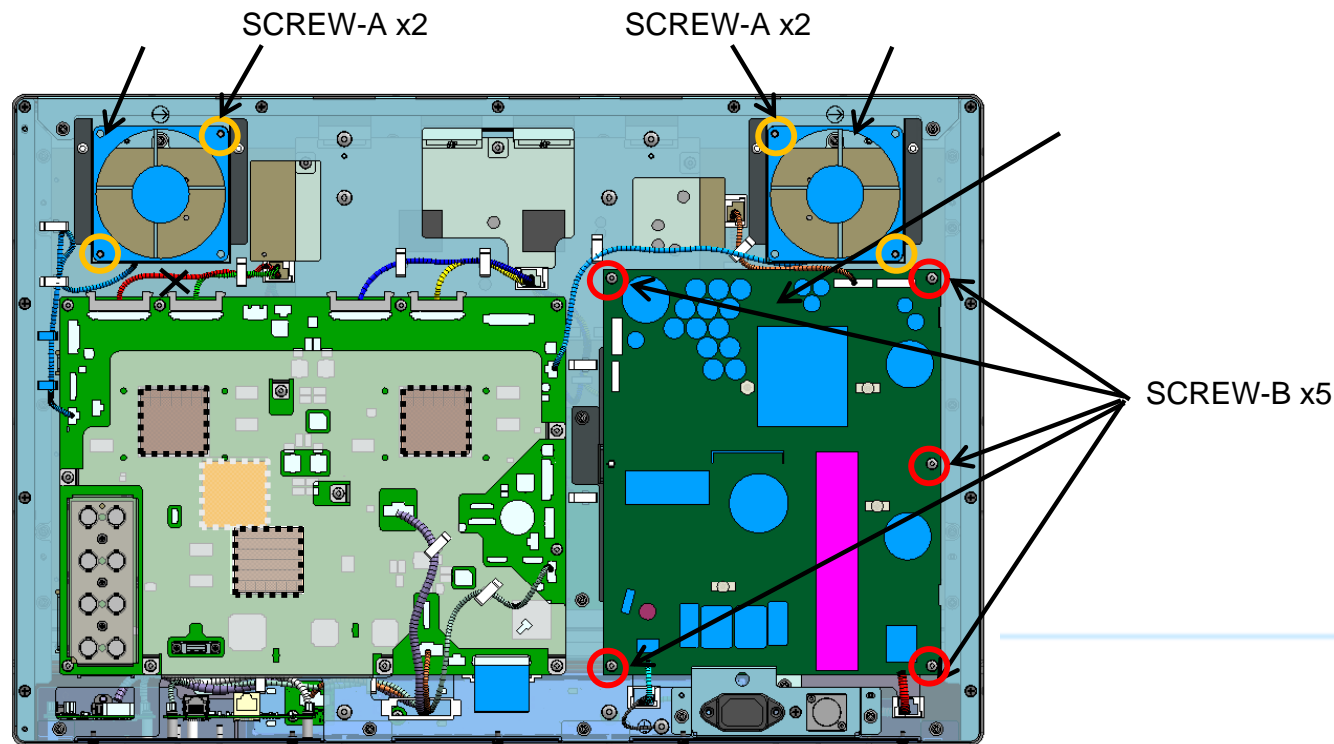

Mark	Parts No.	Description	Qty
	DM6-0005-000	FAN, SYSTEM	2
	DK5-0026-000	PCB ASS'Y, POWER	1
SCREW-A	XB2-8401-009	SCREW,W/WASHER,M4X10	4
SCREW-B	XB2-8300-805	SCREW,W/WASHER,M3X8	5



3.9 [PCB ASS Y, MAIN] Detachment

1. Unfasten the 13 Screw-B screws, and remove the two Mark and HOLDER_SYS.
 (The tightening torque is 60 N•cm.)

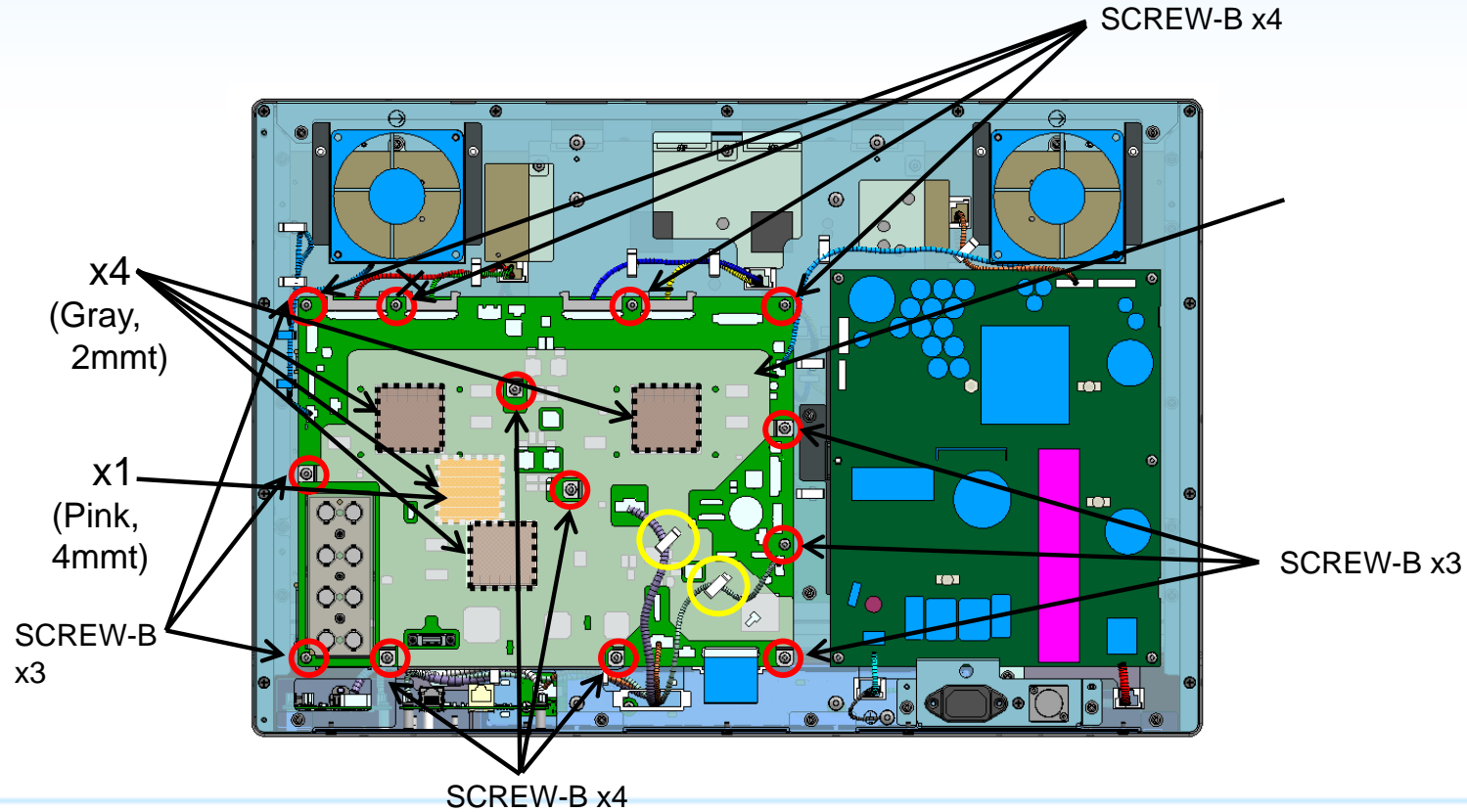

Mark	Parts No.	Description	Qty
	DM1-0052-000	PCB ASS Y, MAIN	1
	DD1-0350-000	CUSHION, MAIN2	4
	DD1-0544-000	CUSHION, MAIN3	1
SCREW-B	XB2-8300-805	SCREW, W/WASHER, M3X8	13



[Notes on cable connections to PCB ASS Y, MAIN and PCB ASS Y, POWER]

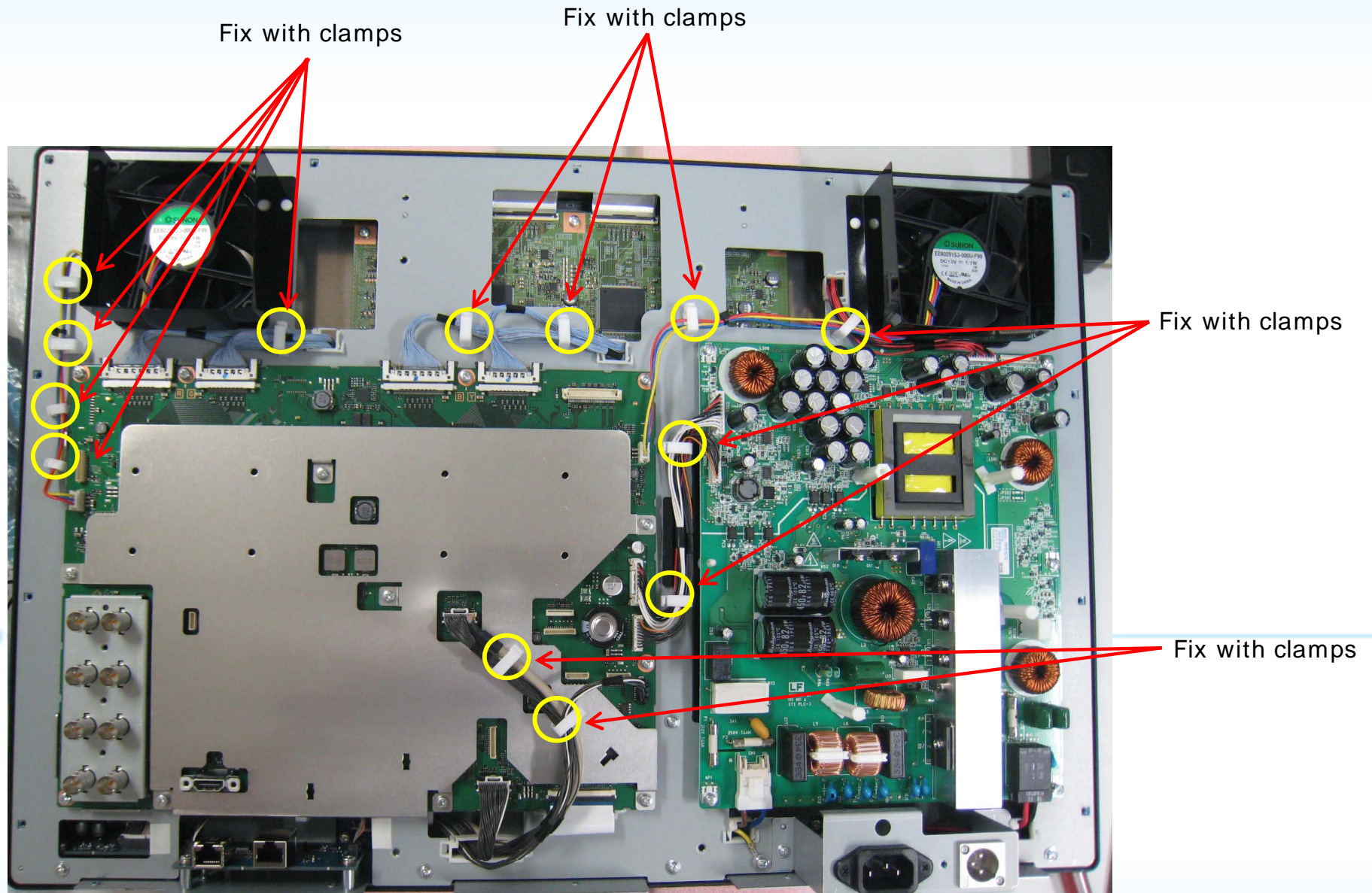

3.10 CABLE, ACIN and CABLE, DCIN Detachment

1. Unfasten the two Screw-A screws, and remove the Mark
 2. Unfasten the two Screw-B screws, and remove the Mark . At the time, remove the SCREW-C and , then remove GND terminal.
- . (The tightening torque is 60 N•cm for A and B, is 100 N•cm for C.)

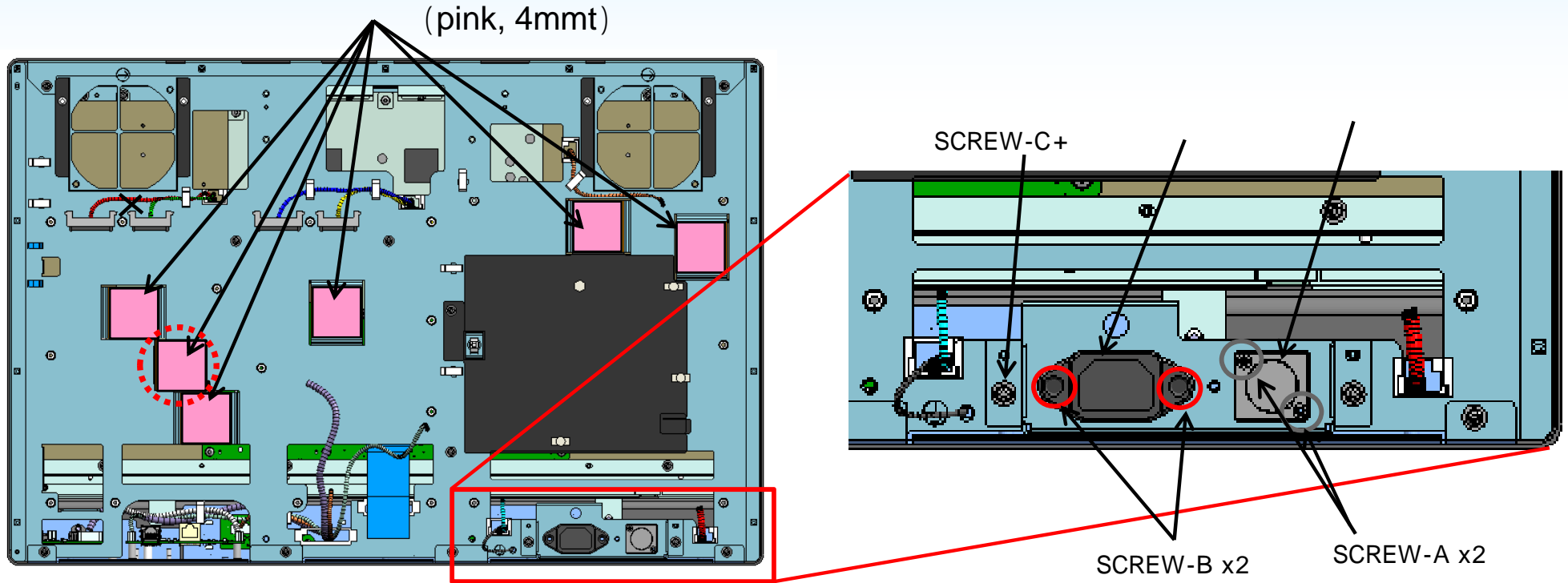

Mark	Parts No.	Description	Qty
	DD2-0162-000	CABLE, DCIN	1
	DD2-0161-000	CABLE, ACIN	1
	XD1-4200-402	WASHER, TOOTHED LOCK, M4	1
	DD1-0544-000	CUSHION, MAIN3	6
SCREW-A	XB1-2200-805	SCREW, MACH, TRUSS HEAD, M2X8	2
SCREW-B	DD1-0346-000	SCREW, ACIN, M3X6	2
SCREW-C	XB6-7400-805	SCREW, TP, M4X8	1

[Note on Assembly]
Please assemble as the below picture.



3.11 PCB Holder Parts Detachment

1. Unfasten the 10 Screw-A screws, and remove PCB Holder.
(The tightening torque is 100 N•cm.)

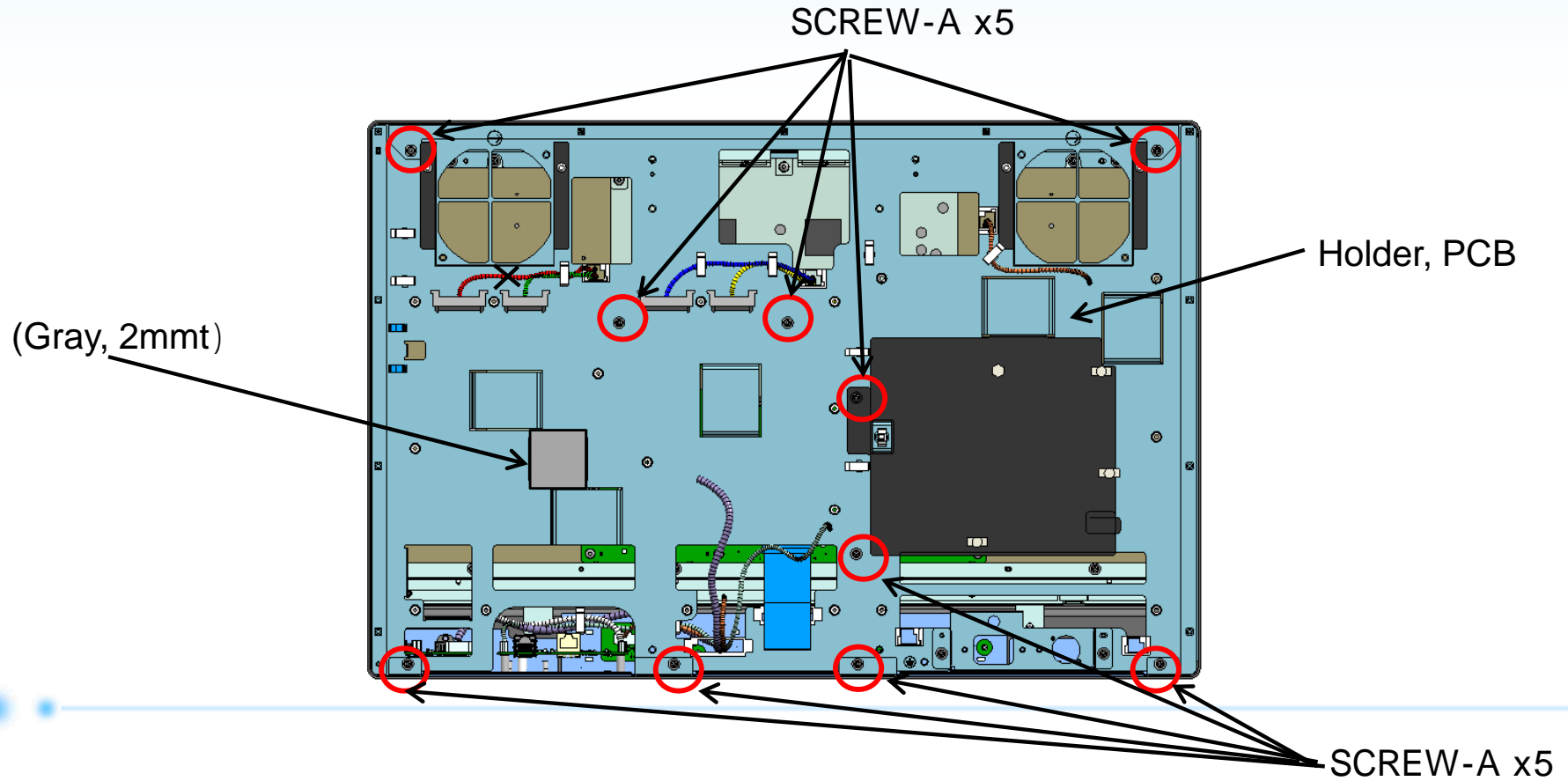

Mark	Parts No.	Description	Qty
	DD1-0350-000	CUSHION, MAIN2	1
SCREW-A	XB6-7300-405	SCREW, TP, M3X4	10



3.12 [PCB ASS Y, LAN], [PCB ASS Y, USB/AUDIO] cable Detachment

1. Remove the cables of the Mark to Mark from the [PCB ASS Y, USB/AUDIO], PCB ASS Y, LAN, and PCB ASS Y, FRONT.

2. Remove each cable , , , and from clamps.

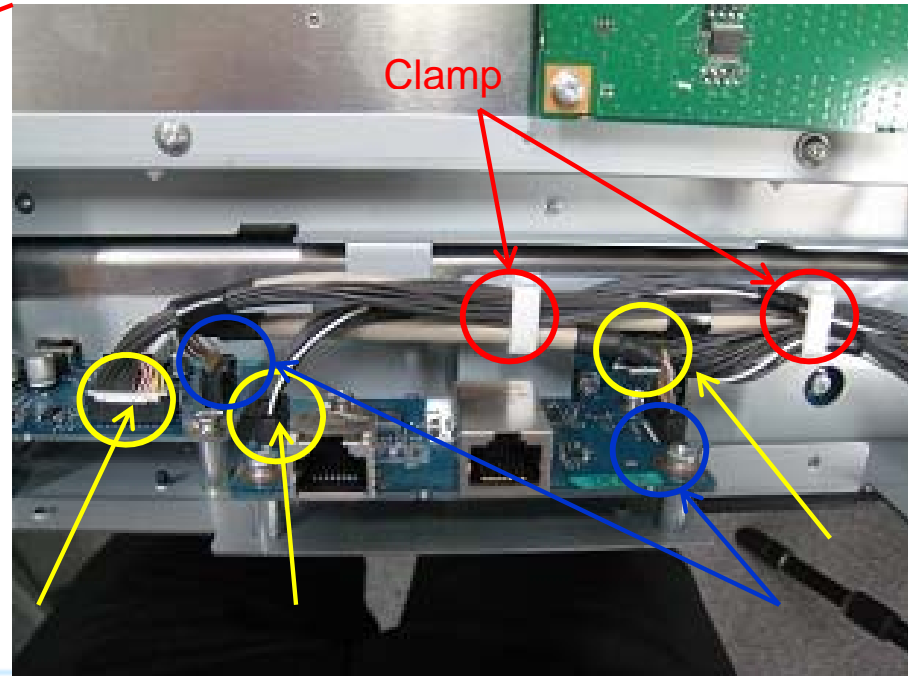
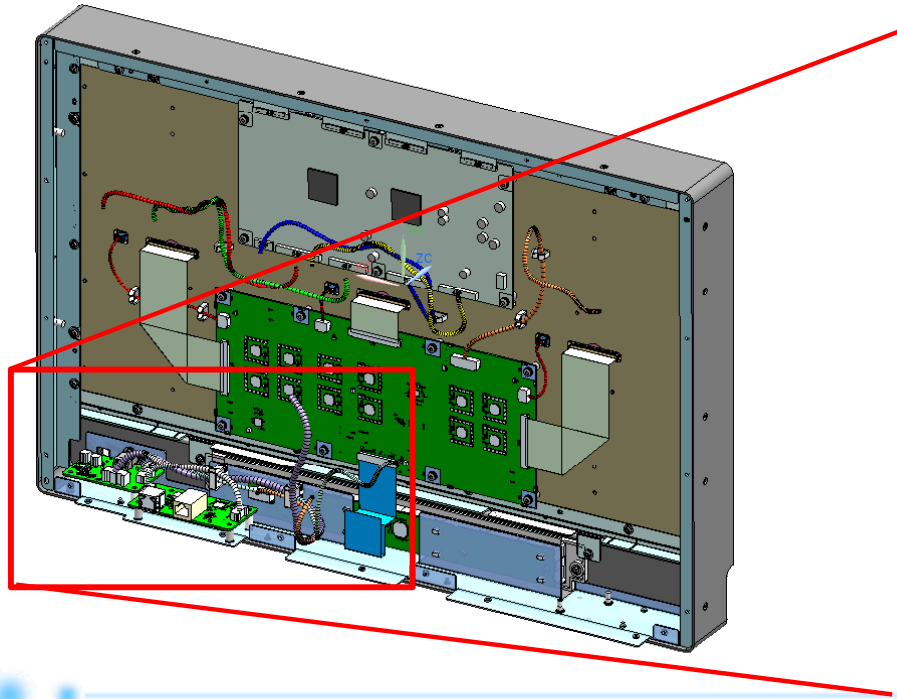

Mark	Parts No.	Description	Qty
	DD2-0167-000	CABLE, MAIN, USB	1
	DD2-0166-000	CABLE, MAIN, LAN	1
	DD2-0143-000	CABLE, USB, LAN	1
	DD2-0165-000	CABLE, MAIN, FRONT	1



3.13 [PCB ASS Y,TCON], [PCB ASS Y, DRIVER] cable Detachment

1. Remove [] and [] from clamps.
Refer to A of P7 and be careful not to damage of connector while removing connector and [].
2. Remove [] and [] from PCB ASS Y, DRIVER.
Refer to C of P7 and be careful not to damage of connector while removing connector [].
3. Remove [] and [] from PCB ASS Y, T-CON.

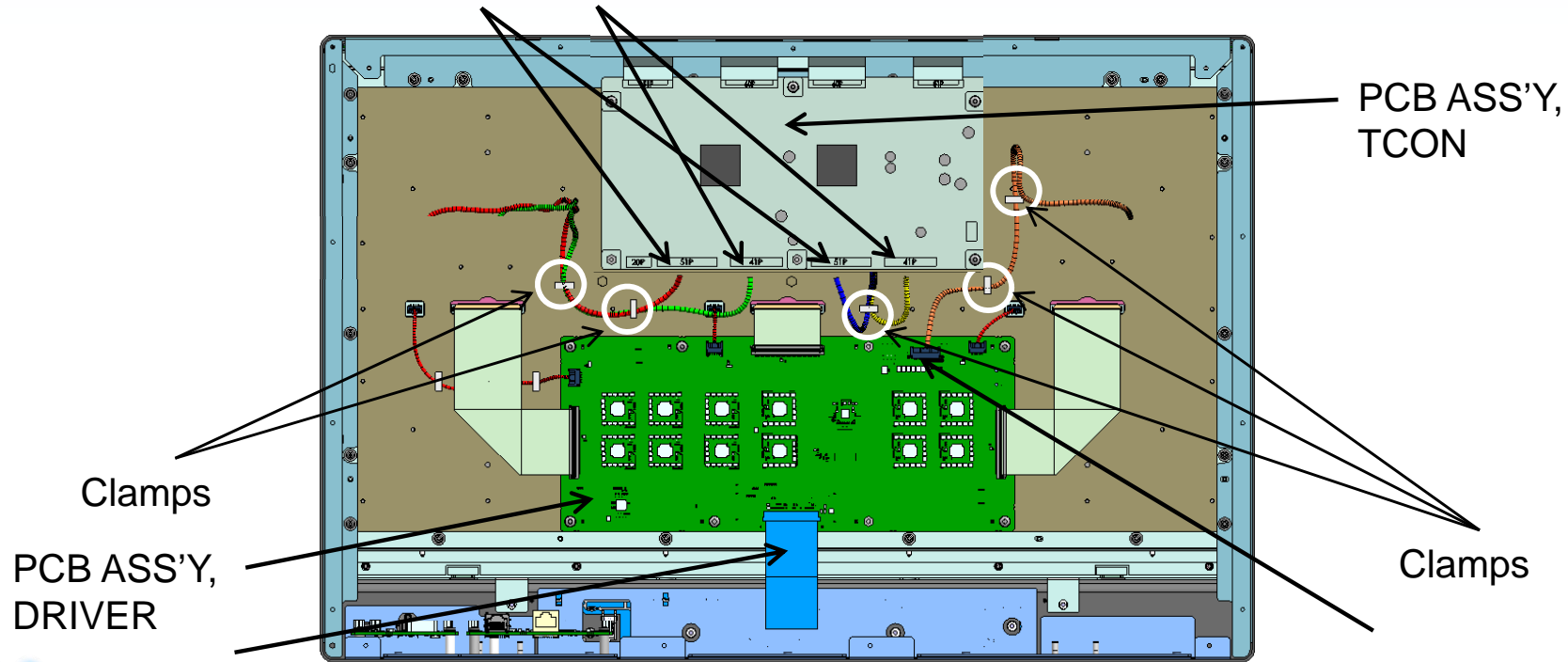

Mark	Parts No.	Description	Qty
	DD2-0176-000	CABLE, MAIN, TCON1	2
	DD2-0175-000	CABLE, MAIN, TCON2	2
	DD2-0100-000	FPC, IFS, MAIN	1
	DD2-0169-000	CABLE, POWER, DRIVER	1



3.14 [PCB ASS Y, TCON], [PCB ASS Y, DRIVER] Detachment

- Remove [] and [] from clamps.
Refer to A of P7 and be careful not to damage of connector while removing connector [] and [].
- Remove [] from clamp, and remove [] and [] from [PCB ASS Y, DRIVER].
- Unfasten the six Screw-A screws and two Screw-B screws, and remove PCB ASS Y, DRIVER. (The tightening torque for Screw-A is 60 N•cm.)
- Remove the four FPC from TCON to panel.
Refer to C of P7 and be careful not to damage of connector while removing connectors.
- Unfasten the four Screw-A screws and four Screw-B screws, and remove PCB ASS Y, T-CON. (The tightening torque for Screw-A is 60 N•cm.)

Mark	Parts No.	Description	Qty
	DK8-0002-000	PCB ASS'Y, TCON	1
	DM1-0050-000	PCB ASS'Y, DRIVER	1
	DD2-0173-000	FPC, DRIVER, LED, LONG	2
	DD2-0122-000	FPC, DRIVER, LED	1
	DD2-0170-000	CABLE, DRIVER, LED1	1
	DD2-0172-000	CABLE, DRIVER, LED2	2
SCREW-A	XB2-8300-805	SCREW,W/WASHER,M3X8	10
SCREW-B	DD1-0646-000	SCREW, HEX, M3X14	4

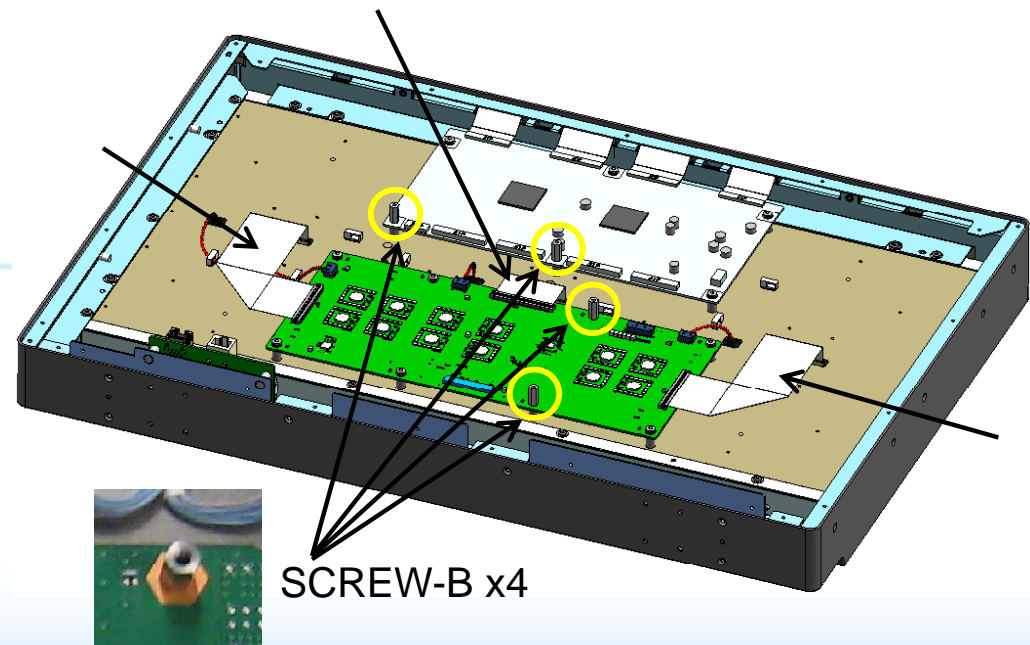
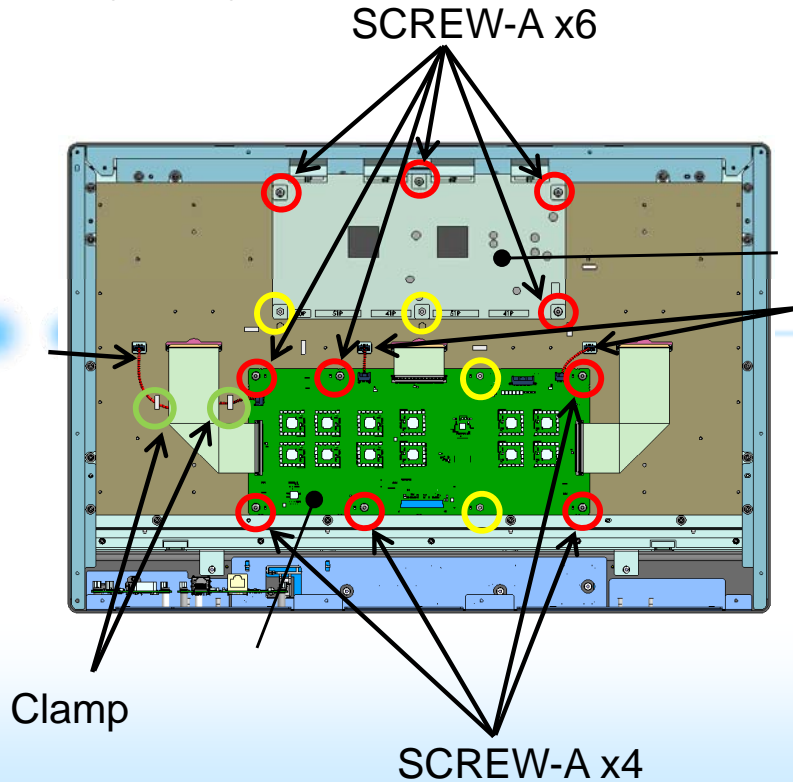

3.15-1 BKTBTM unit/ Module unit/ Bezel unit Detachment

1. Unfasten the 16 Screw-A screws at the bottom.
(The tightening torque is 40 N•cm.)

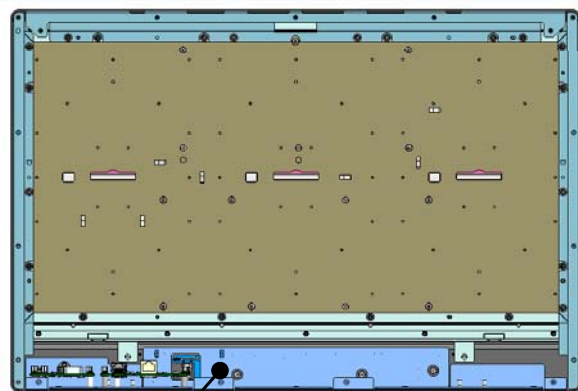

BKTBTM unit

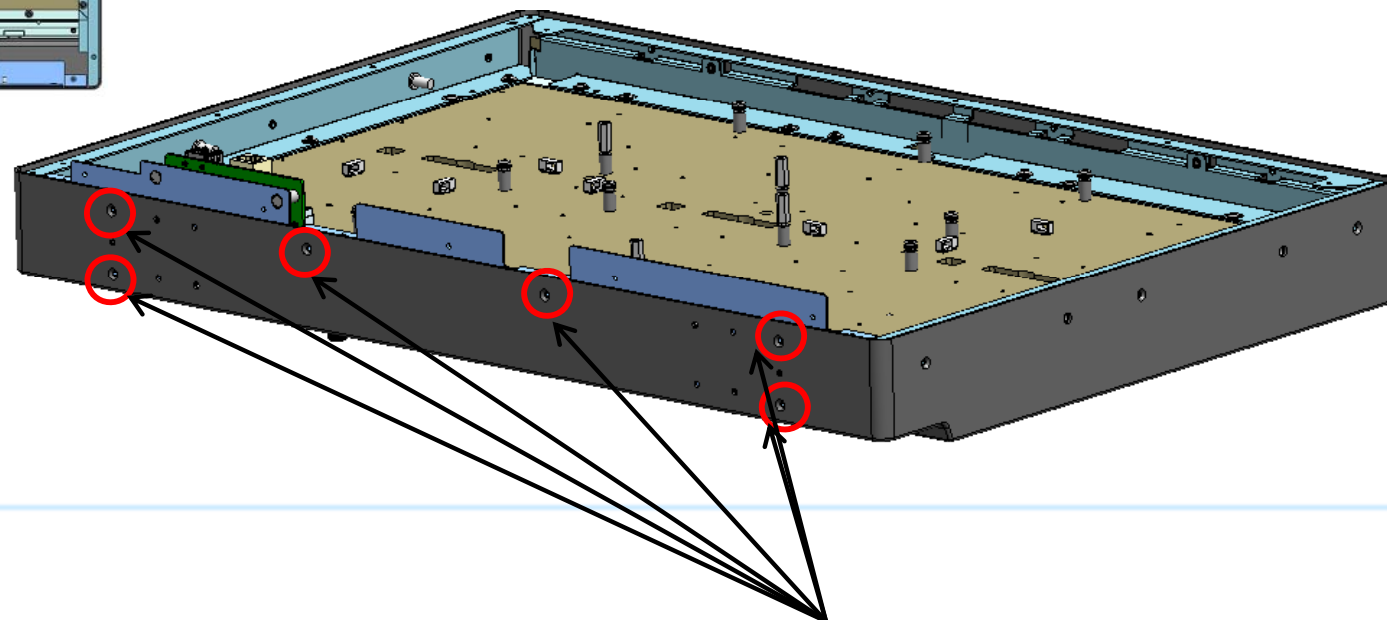

SCREW-Ax6

Mark	Parts No.	Description	Qty
SCREW-A	DD1-0648-000	SCREW, M2.5X6	6



3.15-2 BKTBTM unit/ Module unit/ Bezel unit Detachment

1. Unfasten the two Screw-A screws, and remove BKTBTM unit. (The tightening torque is 100 N•cm.)
2. Unfasten the three Screw-A screws, and remove Module unit and Bezel unit. (The tightening torque is 100 N•cm.)
3. Unfasten the three Screw-B screws at the side, and remove . (The tightening torque is 40 N•cm.)

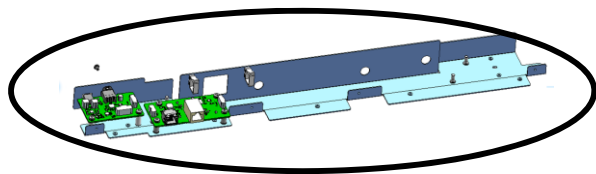
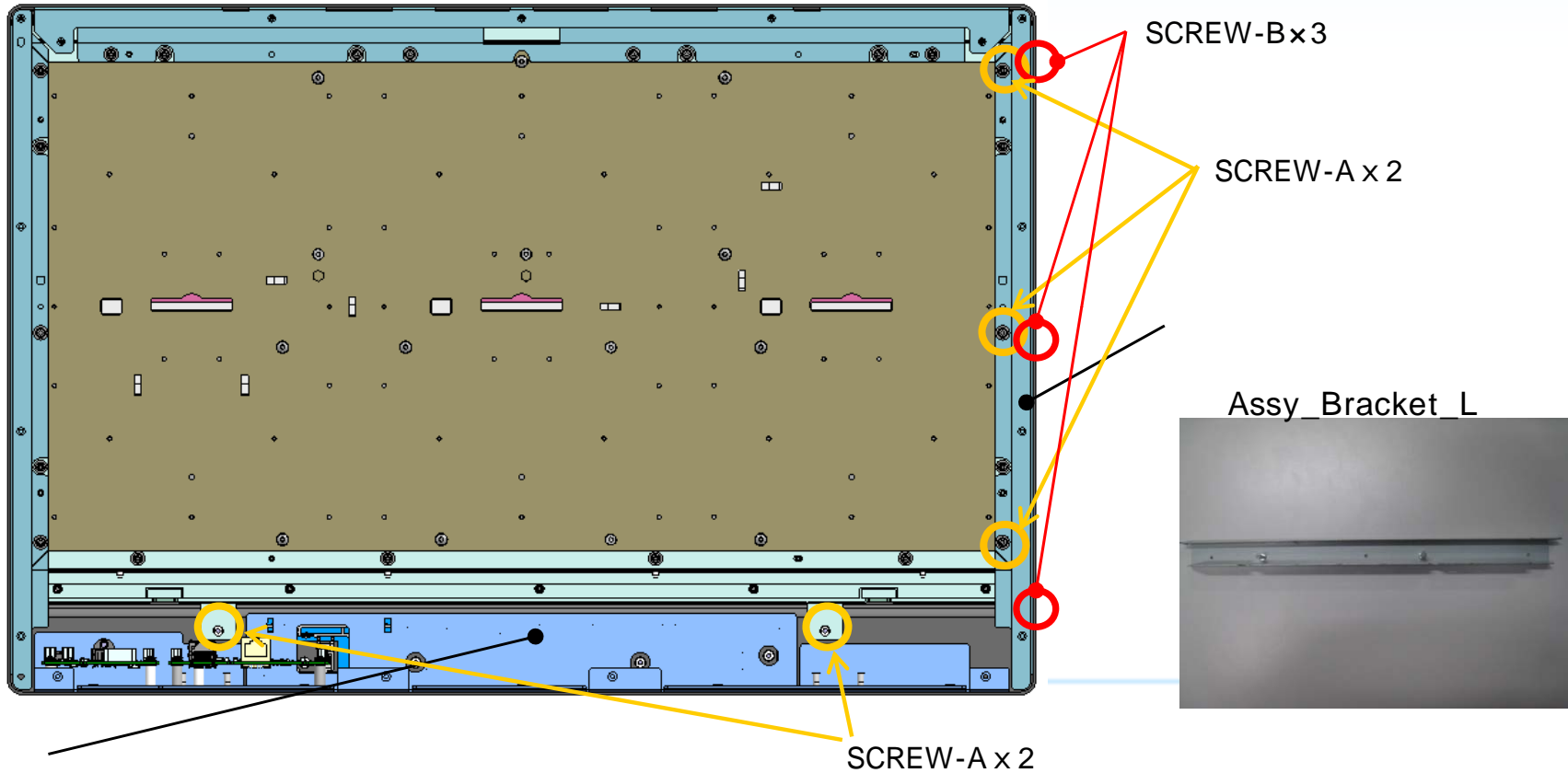

Mark	Parts No.	Description	Qty
SCREW-A	XB6-7300-405	SCREW, TP, M3X4	5
SCREW-B	DD1-0648-000	SCREW, M2.5X6	3



[Note on assembly]

When assembling the Assy Cover Rear.

Install a screw in order of a yellow number.

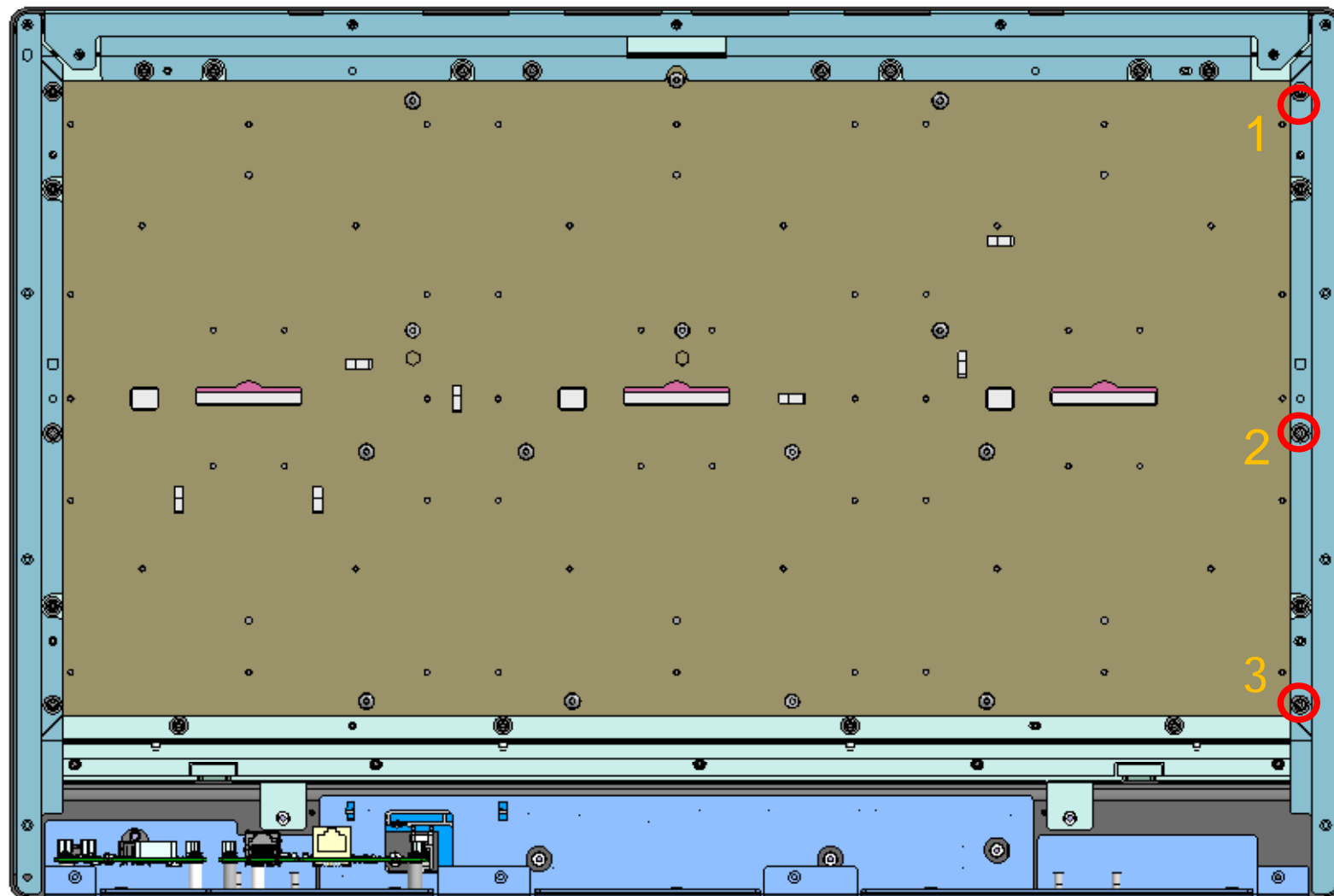

[Note on disassembly]

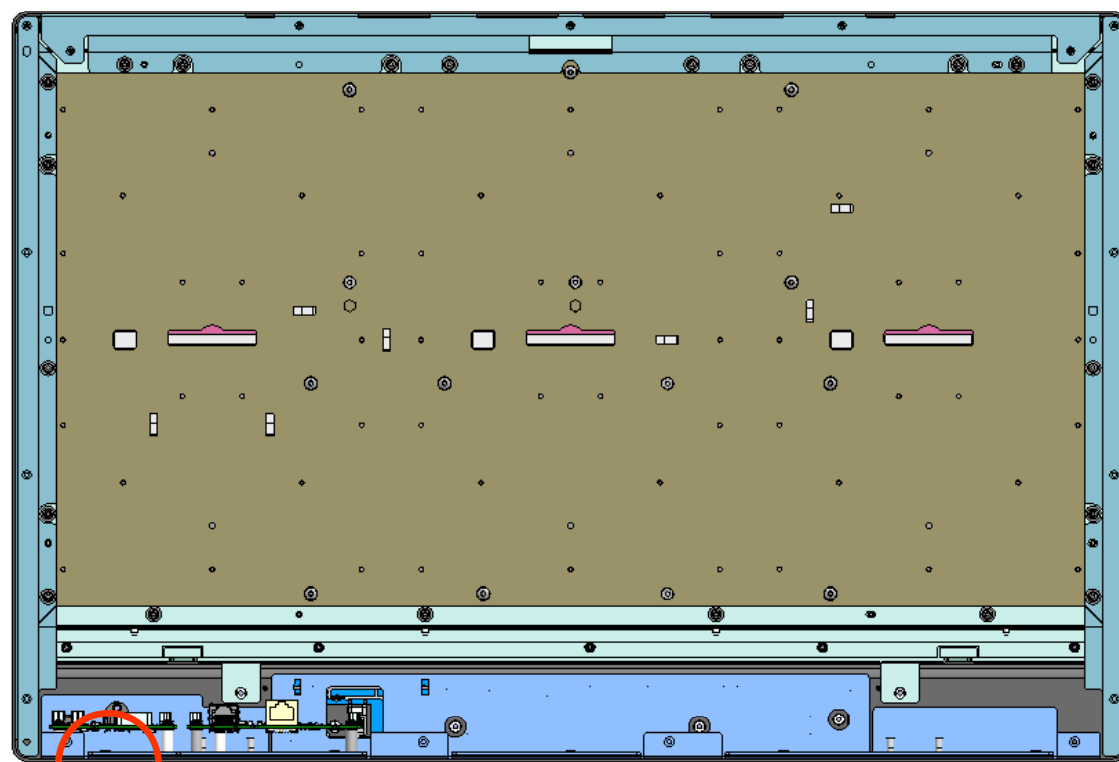

[Note on assembly]
Make sure not to have it extended beyond the convex area to determine the position.



Position determining convex area

As there is a convex area to determine the position of the bezel unit, it is less likely to come off. After removing the screws, remove the BCKBTM unit, trying to push the unit upward.



3.16 [PCB ASS'Y, USB/AUDIO] and [PCB ASS'Y, LAN] Detachment

1. Unfasten the two Screw-A screws and 1 Screw-B screw, and remove from [BKTBTM unit].
2. Unfasten the four Screw-A screws, and remove
(The tightening torque for Screw-A is 60 N•cm.)
(The tightening torque for Screw-B is 40 N•cm.)

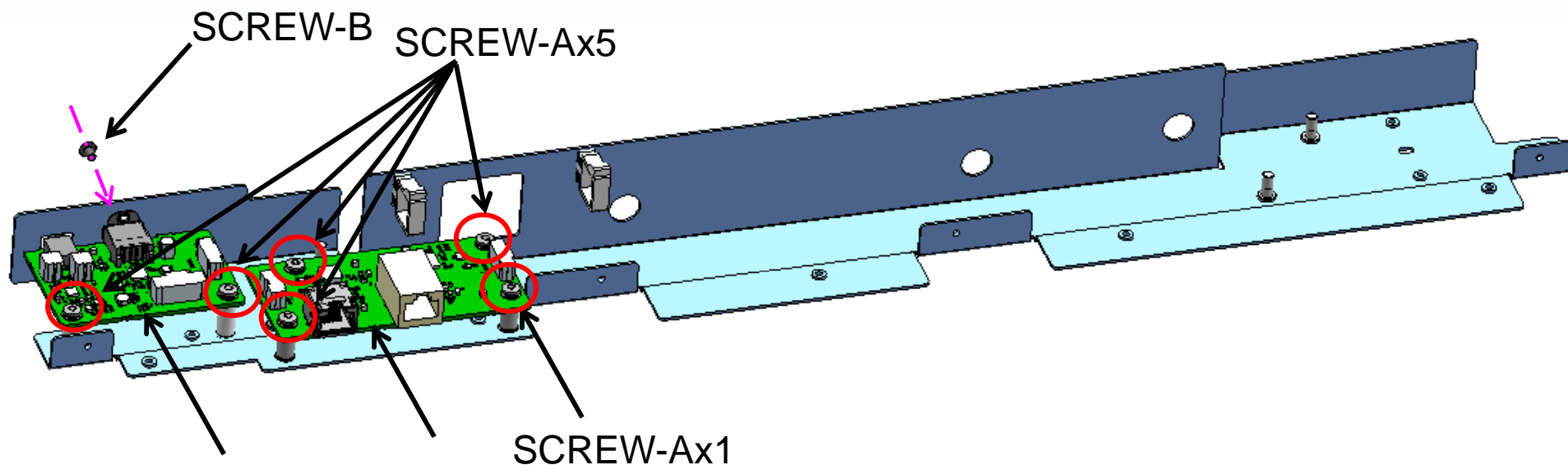

Mark	Parts No.	Description	Qty
	DM1-0048-000	PCB ASS Y, USB/AUDIO	1
	DY5-8044-000	PCB ASS Y, LAN	1
SCREW-A	XB2-8300-805	SCREW, MACH, PAN HEAD, M3X8	6
SCREW-B	DD1-0110-000	SCREW, LAMIMATE_M3x5	1



3.17 Bezel unit/ Module unit Detachment

1. Reverse the entire unit.
2. Unfasten the seven Screw-A screws, and remove Module unit and Bezel unit
(The tightening torque for Screw-A is 40 N•cm.)

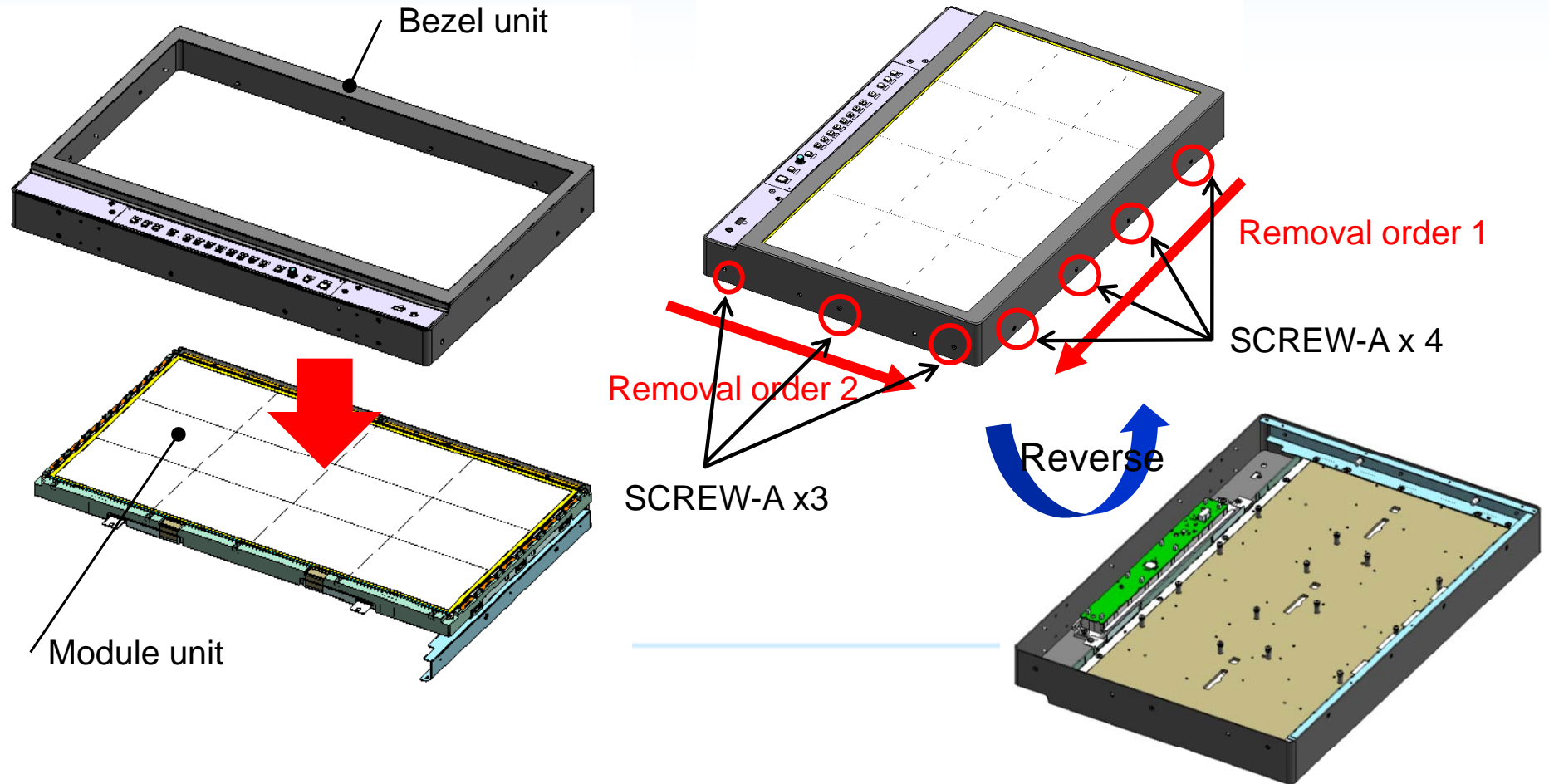

Mark	Parts No.	Description	Qty
SCREW-A	DD1-0648-000	SCREW, M2.5X6	7



3.18 [PCB ASS Y, FRONT] Detachment

Unfasten the four Screw-A screws, and remove the Mark and from .

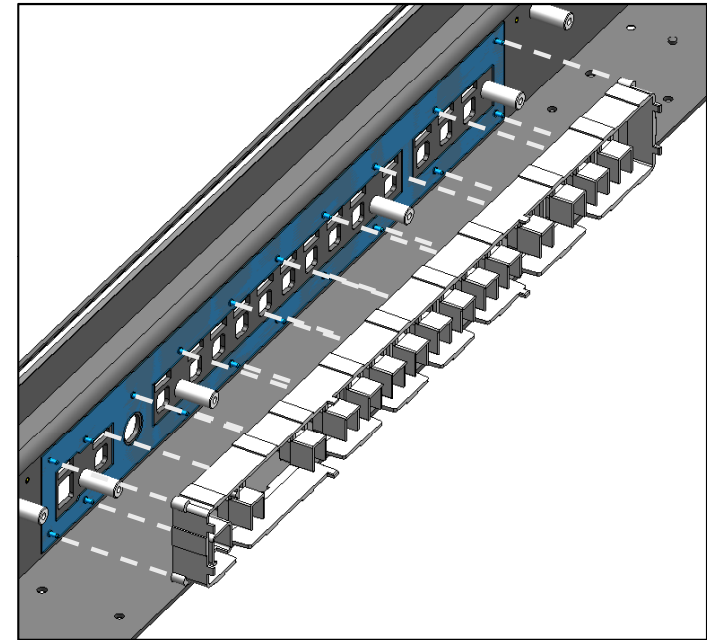
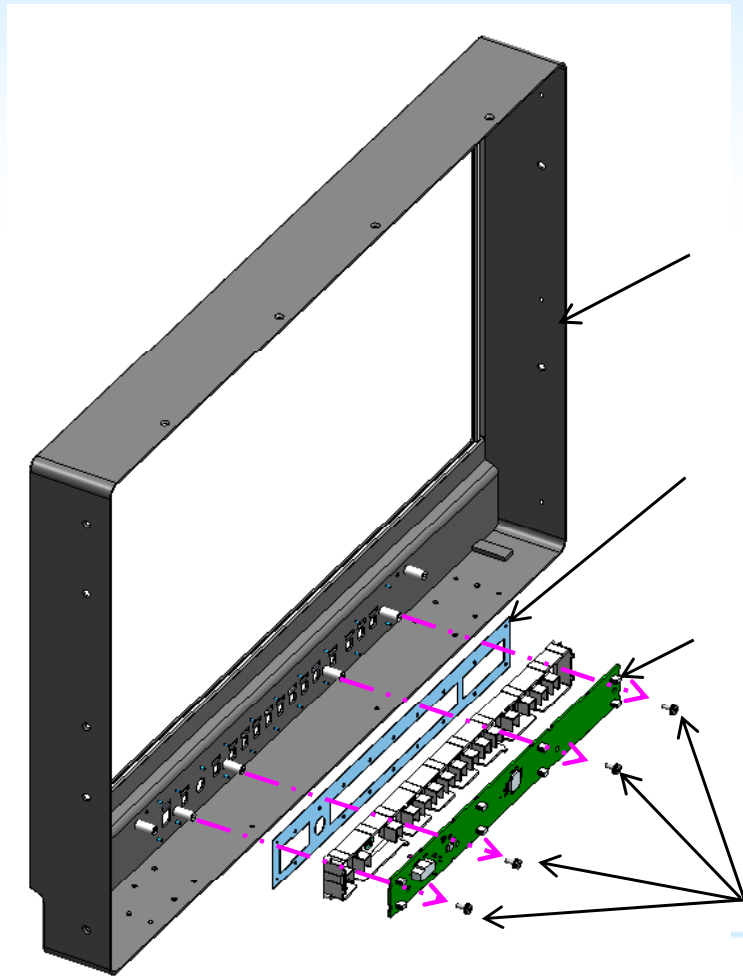

SCREW-Ax4

Mark	Parts No.	Description	Qty
	DL1-0131-000	COVER, FRONT BEZEL	1
	DD1-0627-000	SHEET, INSULATION,FRONT	1
	DM1-0049-000	PCB ASS'Y, FRONT	1
SCREW-A	XB2-8300-805	SCREW, TAP, BINDING M3X8	4



[Note on assembly 1] (Control Plate Panel Attachment)

Peel off the release paper from the center of the backside of the Plate ControlPanel, align the Plate ControlPanel with the reference holes for determining the attachment locations, and then attach the Plate ControlPanel to the FrontBezel unit.

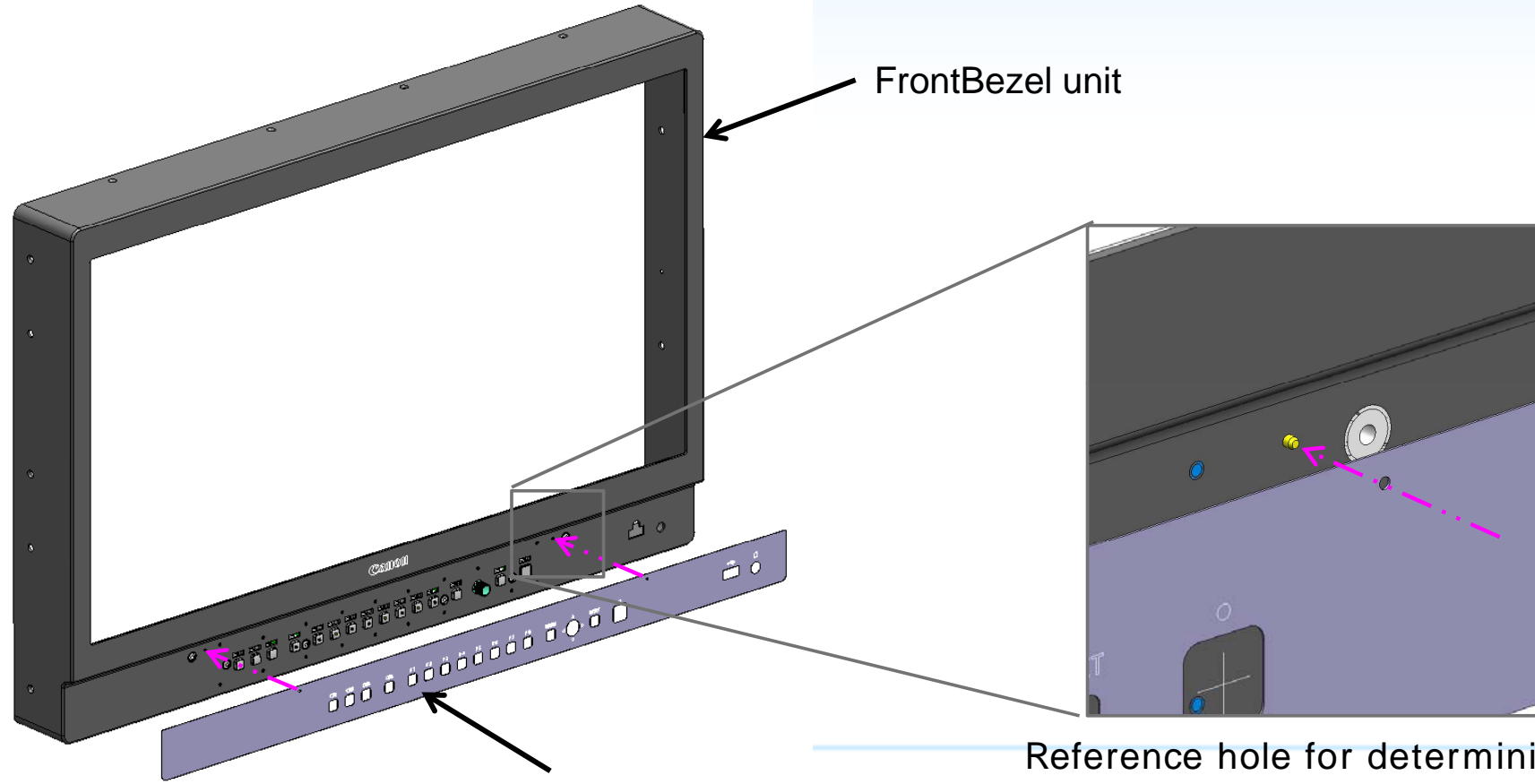

Reference hole for determining the attachment locations (two holes on the left and right)

Mark	Parts No.	Description	Qty
	DD1-0624-000	Plate ControlPanel_DP-V2411	1



[Note on assembly 2] (Bezel Sheet/Cushion Attachment)

1. Overlap the parts on the lower longer side of the FrontBezel unit in order of and to attach.
2. Attach to the both shorter sides on the left and right of the FrontBezel unit.
3. Overlap the parts on the upper longer side in order of and of the FrontBezel unit to attach.

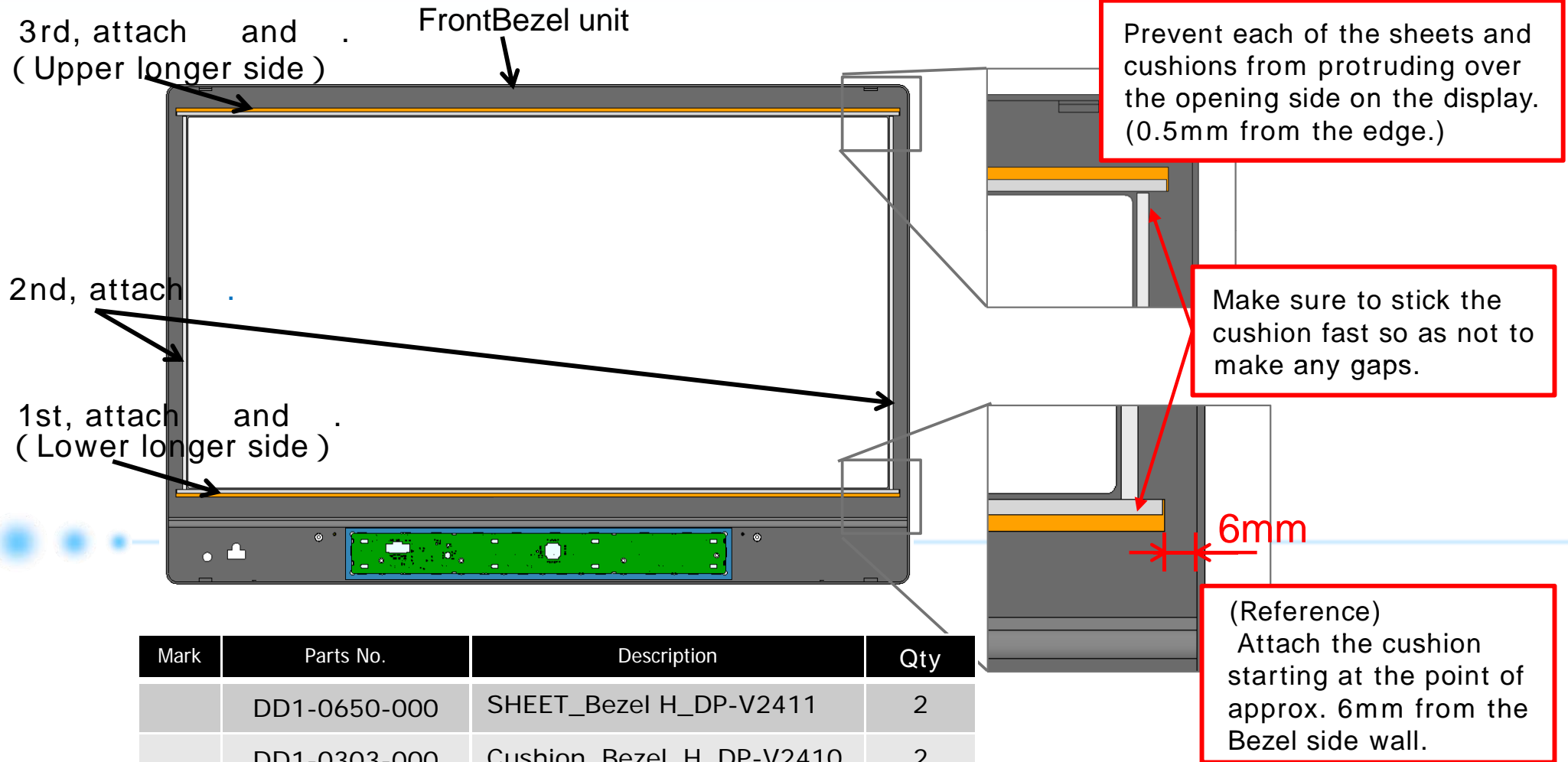

Mark	Parts No.	Description	Qty
	DD1-0650-000	SHEET_Bezel H_DP-V2411	2
	DD1-0303-000	Cushion_Bezel_H_DP-V2410	2
	DD1-0649-000	Cushion_Bezel_V_DP-V2411	2

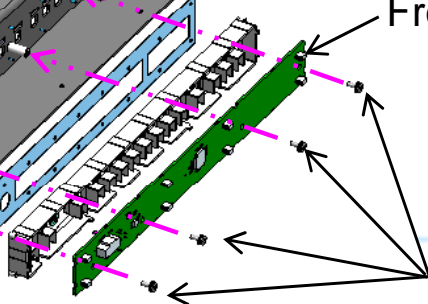
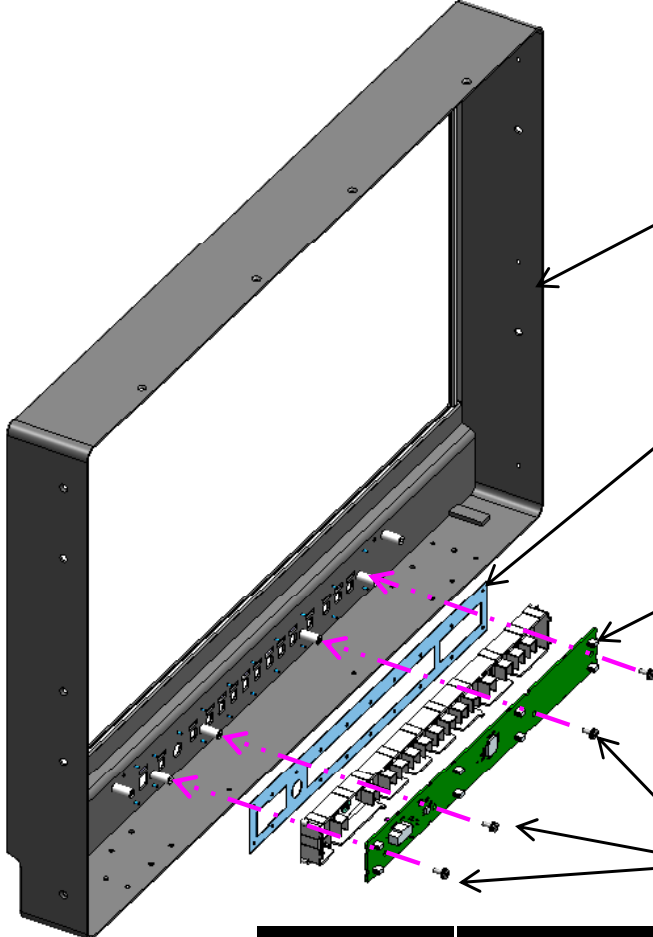

[Note on assembly 3]

1. Insert  and then Assy_Button_Key_DP-V2410 into the 19 pins on the . Then, attach the Front unit using four screws of SCREW-A. (The tightening torque for Screw-A is 60 N•cm.)

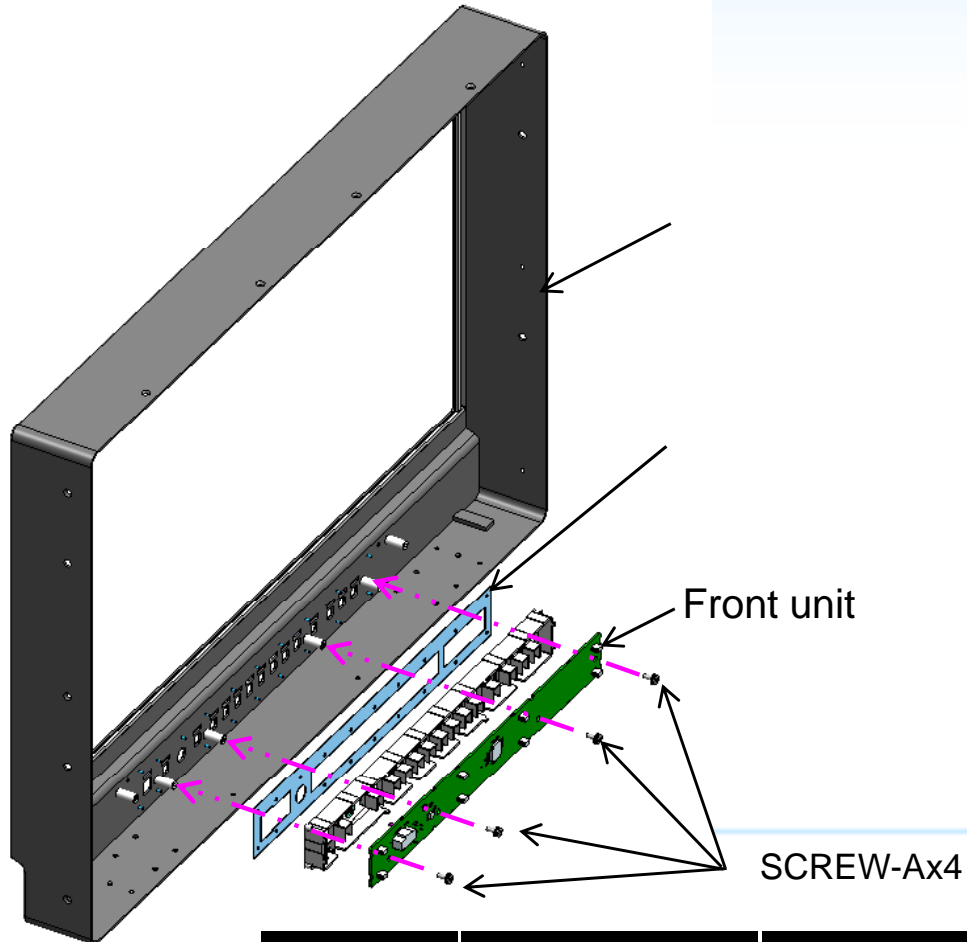

Insert into 19 pins.

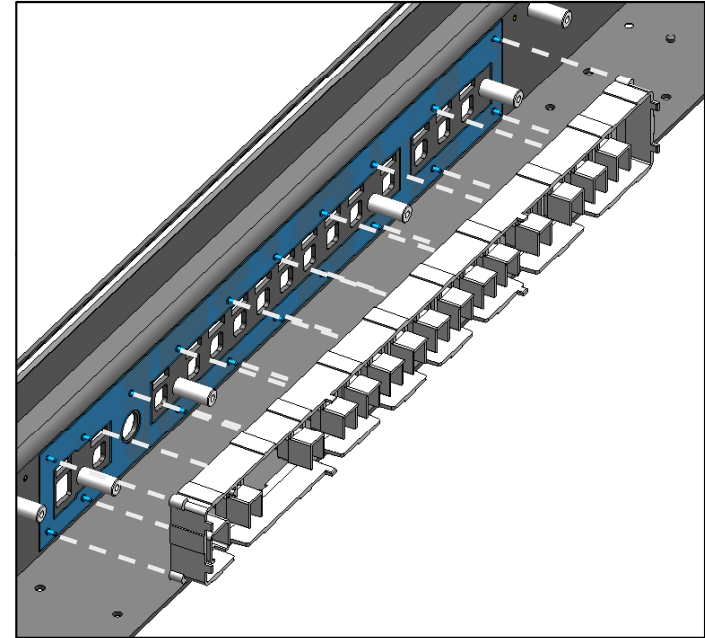

Mark	Parts No.	Description	Qty
	DL1-0131-000	COVER, FRONT BEZEL	1
	DD1-0627-000	SHEET, INSULATION, FRONT	1
	DM1-0049-000	PCB ASS'Y, FRONT	1
SCREW-A	XB2-8300-805	SCREW, TAP, BINDING M3X8	4



[Notes on assembly]

1. When exchanging PCB ASS'Y, FRONT, affix KNOB, JOG with an adhesive (DIABOND No.1663G BLACK).

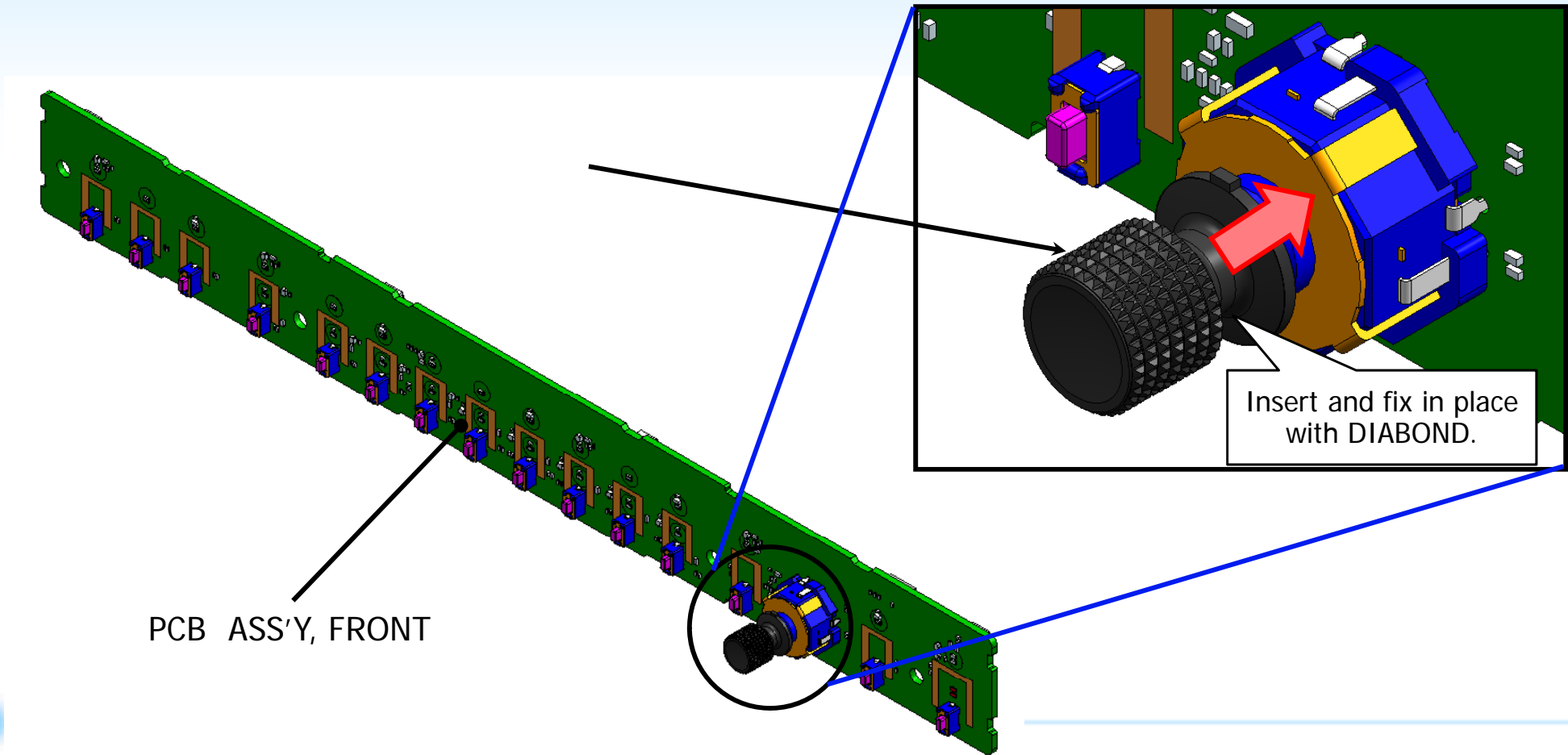

Mark	Parts No.	Description	Qty
	DD1-0310-000	KNOB, JOG	1
	DM1-0049-000	PCB ASS'Y, FRONT	1
	CY9-8129-000	DIABOND No.1663G BLACK	



PANEL/BL UNIT (DY5-8045-000) Structure

The three red frames parts don't includes in
PANEL/BACKLIGHT UNIT, DP-V2411

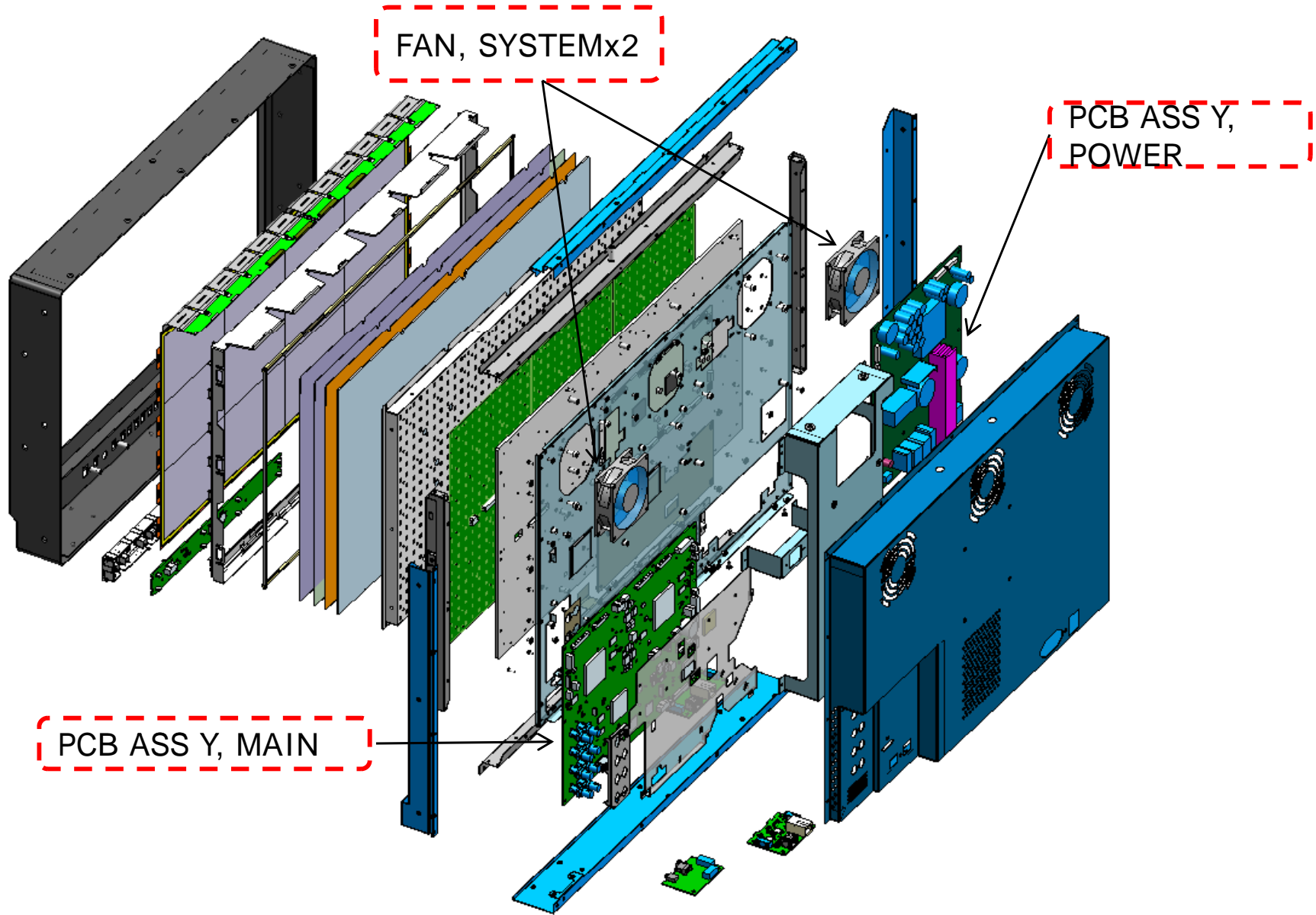

Parts Catalog

No	Contents	Page
1	Electrical Parts	<u>39</u>
2	External Parts	<u>40</u>
3	Internal Parts	<u>41</u>
4	Screws	<u>42</u>
5	Accessory	<u>43</u>



Parts List

1. Electrical Parts

New	Parts No	Description	Qty	Page
	DK5-0026-000	PCB ASS'Y, POWER	1	18
	DK8-0002-000	PCB ASS'Y, TCON	1	25
*	DM1-0048-000	PCB ASS'Y, USB/AUDIO	1	30
*	DM1-0049-000	PCB ASS'Y, FRONT	1	35
*	DM1-0050-000	PCB ASS'Y, DRIVER	1	25
*	DM1-0052-000	PCB ASS'Y, MAIN	1	19
*	DY5-8044-000	PCB ASS'Y, LAN	1	30
*	DY5-8045-000	PANEL/BACKLIGHT UNIT, DP-V2411	1	37
	DM6-0005-000	FAN, SYSTEM	2	18



Parts List

2.External Parts

New	Parts No	Description	Qty	Page
*	DD1-0310-000	KNOB, JOG	1	35
*	DD1-0602-000	BASE, FOOT	2	10
*	DD1-0610-000	FOOT STAND, FRONT	2	9,10
*	DD1-0614-000	PAD, FOOT, FRONT	2	10
*	DD1-0618-000	HANDLE	1	11
*	DD1-0652-000	LABEL, CAUTION	1	14
*	DL1-0129-000	COVER, REAR	1	12
*	DL1-0131-000	COVER, FRONT BEZEL	1	34



Parts List

3. Internal Parts

New	Parts No	Description	Qty	Page
	DD1-0303-000	CUSHION, BEZEL H	2	33
	DD1-0350-000	CUSHION, MAIN2	4	19,22
	DD1-0544-000	CUSHION, MAIN3	7	19,21
*	DD1-0624-000	SHEET,ADHESIVE,FRONT1	1	32
*	DD1-0627-000	SHEET, INSULATION,FRONT	1	34
*	DD1-0649-000	CUSHION, BEZEL V	2	33
*	DD1-0650-000	TAPE, PC(R), BEZEL H	2	33
*	DD1-0660-000	CUSHION,FOOT	2	10
	DD2-0100-000	FPC, IFS, MAIN (DRIVER -MAIN)	1	17,24
*	DD2-0122-000	FPC, DRIVER, LED	1	25
	DD2-0143-000	CABLE, USB, ETALY(USB-LAN)	1	23
*	DD2-0161-000	CABLE, ACIN	1	16,21
*	DD2-0162-000	CABLE, DCIN	1	16,21
*	DD2-0163-000	CABLE, POWER, MAIN1	1	17
*	DD2-0164-000	CABLE, POWER, MAIN2	1	17
*	DD2-0165-000	CABLE, MAIN, FRONT	1	17,23
*	DD2-0166-000	CABLE, MAIN, LAN	1	17,23
*	DD2-0167-000	CABLE, MAIN, USB	1	17,23
*	DD2-0169-000	CABLE, POWER, DRIVER	1	17
*	DD2-0170-000	CABLE, DRIVER, LED1	1	25
*	DD2-0172-000	CABLE, DRIVER, LED2	2	25
*	DD2-0173-000	FPC, DRIVER, LED, LONG	2	25
*	DD2-0175-000	CABLE, MAIN, TCON2	2	17,24
*	DD2-0176-000	CABLE, MAIN, TCON1	2	17,24



Parts List

4.Screws etc

New	Parts No	Description	Qty	Page
	DD1-0103-000	SCREW, M3X6	17	12
	DD1-0110-000	SCREW, M3X5	6	12,30
	DD1-0346-000	SCREW, ACIN, M3X6	2	21
	DD1-0646-000	SCREW, HEX, M3X14	4	25
	DD1-0648-000	SCREW, M2.5X6	16	26,27,31
	XB1-2200-805	SCREW, MACH, TRUSS HEAD, M2X8	2	21
	XB2-4301-005	SCREW, W/WASHER, M3X10	4	9
	XB2-8300-805	SCREW,W/WASHER,M3X8	38	18,25,19
*	XB2-8401-009	SCREW,W/WASHER,M4X10	4	18
	XB4-8300-809	SCREW, TAP, BINDING M3X8	4	10
	XB6-7300-405	SCREW, TP, M3X4	21	22,27
	XB6-7400-805	SCREW, TP, M4X8	7	15,21
	XB7-1060-169	BOLT, HEX SKT. M6X16	2	11
	XD1-4200-402	WASHER, TOOTHED LOCK, M4	1	21



Parts List

5. Accessory

New	Parts No	Description	Qty	Page
	D44-2005-000	ADAPTER, PLUG, PU-01	1	
	D44-2007-000	CORD, POWER, 125V	1	
	D44-2013-000	CORD, POWER, 125V	1	
	D44-2014-000	CORD, POWER, 250V	1	
	D44-2010-000	CORD, POWER, 250V	1	



AC Power Cord HT-20 / HT-21

D44-2007-000 (For JP)
D44-2013-000 (For US)
D44-2014-000 (For EU)
D44-2010-000 (For CN)



Plug Adapter PU-01

D44-2005-000



Canon

Canon

English Edition

Version 1.0

SERVICE MANUAL

Video Display DP-V1710 / 1711 (JP)

Video Display DP-V1710 / 1711 (US)

Video Display DP-V1710 / 1711 (EU)

Video Display DP-V1710 (CN)

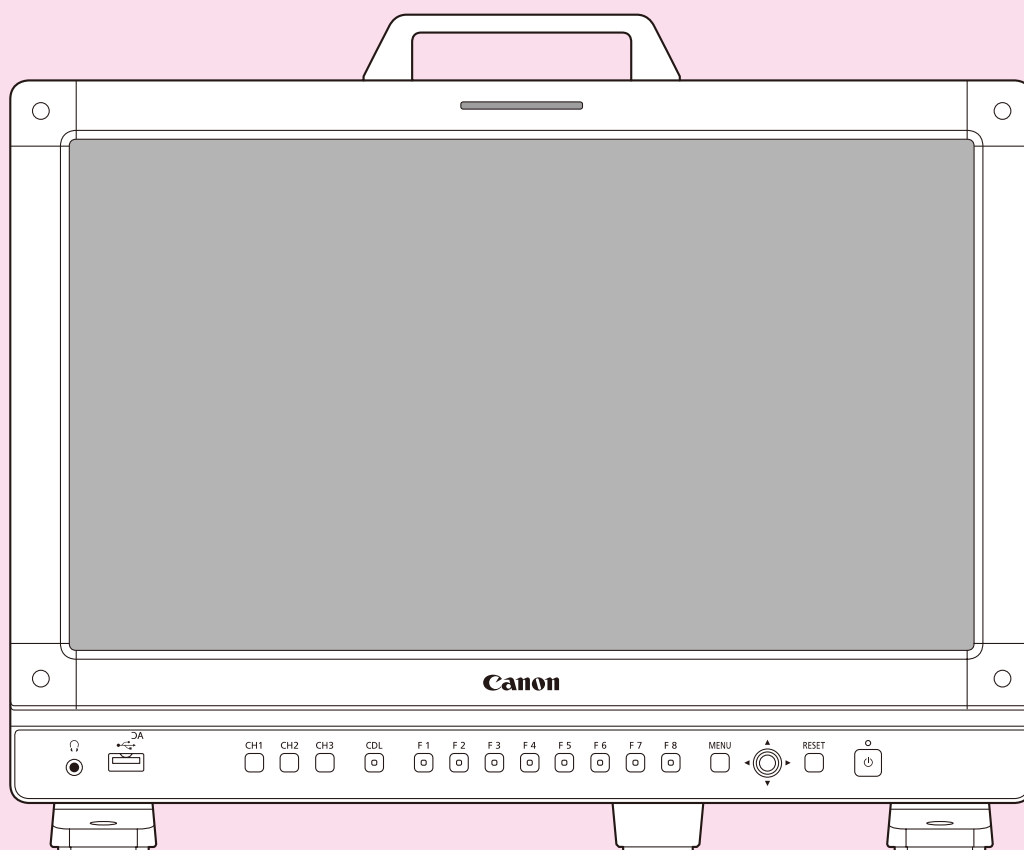

Application

This Service Manual is issued by Canon Inc. for qualified persons to learn technical theory and product repair. This Service Manual covers all localities where the products are sold. For this reason, there may be information in this Service Manual that does not apply to the product sold in your locality. The following paragraph does not apply to any countries where such provisions are inconsistent with local law.

Information revision

The product mentioned in this service manual changes a part and specifications without declining. When a change occurred in the contents of this service manual, the origin of publication publishes service information by the judgment of the origin of publication. In addition, the origin of publication publishes a revised edition by the judgment of the origin of publication when a large change occurred in the contents of this service manual.

Trademarks

The product names and company names described in this Service Manual are the registered trademarks of the individual companies.

Copyright

Canon Inc. retains the copyright to this Service Manual. Reproduction, publication (including on the World Wide Web), alteration, translation into another language, or other use of the data in whole or part, contained on this Service Manual without the written consent of Canon Inc. is prohibited.

Copyright © 2018 Canon Inc.
ICB Service Promotion Dept.
30-2, Shimomaruko 3-chome, Ohta-ku,
Tokyo 146-8501, Japan

Contents

1. Before Disassembly		<u>P3</u>
1.1	Required Tools and Supplies	<u>P3</u>
1.2	Precautions against Electric Shock and Hot Components	<u>P3</u>
1.3	Precautions in Disassembling and Assembling the Display	<u>P4</u>
1.4	Areas to Clean	<u>P5</u>
2. Structure of Display Components and Disassembly Flowchart		<u>P6</u>
3. Disassembly		<u>P7</u>
3.1	Preparation	<u>P7</u>
3.2	Foot Parts Detachment	<u>P8</u>
3.3	Handle Detachment	<u>P10</u>
3.4	Rear Cover Parts Detachment	<u>P11</u>
3.5	Rear Frame and Fan Holder Detachment	<u>P13</u>
3.6	PCB ASS Y, MAIN Detachment (Remove cables)	<u>P15</u>

3.7	AC Inlet holder Detachment	<u>P17</u>
3.8	PCB ASS Y, LAN and CABLE, ACIN, DCIN Detachment	<u>P18</u>
3.9	PCB ASS Y, MAIN Detachment	<u>P19</u>
3.10	PCB Holder Detachment	<u>P20</u>
3.11	PCB ASS Y, EDP Detachment	<u>P21</u>
3.12	PCB ASS Y, EDP Detachment	<u>P23</u>
3.13	BL Driver BD, PCB ASS Y POWFILTER AC, PCB ASS Y , POWFILTER DC and PCB ASS Y FRONT Detachment	<u>P24</u>
3.14	24V POWER SUPPLY PCB , ALL NIGHT POWER PCB, PCB ASS Y, POWFILTER AC/DC Detachment	<u>P28</u>
3.15	Preparation for FRONT BEZEL Parts Detachment	<u>P29</u>
3.16	FRONT BEZEL Parts Detachment	<u>P30</u>
3.17	PCB ASS Y, TALLY Detachment	<u>P35</u>
3.18	Control Panel Cover Parts Detachment	<u>P36</u>
4. Parts Catalog		<u>P45</u>

1. Before Disassembly

1.1 Required Tools and Supplies

Name	Purpose	Notes
Phillips screwdriver with torque control (bit #1), Length; 100mm	Disassembly and assembly	For M2 screws
Phillips screwdriver with torque control (bit #2), Length; 100mm	Disassembly and assembly	For M3 screws
Hex key (1.5 mm; Hexagon width across flats)	Disassembly and assembly	For [COVER, BEZEL CORNER] Detachment
Hex key (4 mm; Hexagon width across flats)	Disassembly and assembly	For [FAN, SYSTEM] Detachment
Hex key (6 mm; Hexagon width across flats)	Disassembly and assembly	For [HANDLE] Detachment
Needle-nose plier	Disassembly and assembly	For 5V, 12V and 24V Power Supply Detachment
Tweezers	Disassembly and assembly	
Pole made of styrofoam etc, Length; 8cm	To protect the monitor from damage	
TAPE, ROLL(NO.156A)10MM X 30M	For [COVER, FRONT BEZEL]	Part Number:CY9-5710-000
BOND, DIABOND NO.1663G BLACK	For [KNOB, JOG] Assembly	Part Number:CY9-8129-000
GPI CHECKER	For GPI/TALLY lamp check	Part Number:CY9-5712-000
CABLE, DC POWER SUPPLY	For Connecting DC POWER SUPPLY	Part Number:CY9-5713-000

1.2 Precautions against Electric Shock and Hot Components



•Electric shock caution mark

This mark appears on parts of the circuit board to indicate possible electric shock hazards. Before working on such parts, be sure to remove the power cord, and do not touch them.



•Hot caution mark

This mark appears on parts of the circuit board to indicate that they become hot. When the display is turned on, or even after a short time after the power is turned off, touching such parts may cause burns. Before working on such parts, be sure to remove the power cord, and do not touch them.



1.3 Precautions in Disassembling and Assembling the Display

- **Before disassembly, be sure to remove the power cord and wait 30 minutes or more*.**
- Disassembly and assembly are basically carried out with the monitor screen facing down. To protect the screen from damage, insert pole made of styrofoam between the display and the workbench (see page 7).
- Be sure to use a proper screwdriver bit that fits to the screw head.
- Follow the tightening torque specified in this manual when fastening screws.
- Use a commercially-available antistatic wrist strap when touching a circuit board.
- Connect and remove connectors carefully to avoid damaging connectors and cables.
- Return all components and wiring to their original conditions. For safety reasons, some components use insulation material, such as tubing and taping, while others are mounted off the printed circuit board. Internal wires are run in a way to prevent them from making contact with heat-source and high-voltage components (such as by using clamps). Be sure to return them to their original conditions.
- Do not disassemble any parts not listed in the disassembly instructions of this service manual. Also, do not disconnect cables and connectors.

* Assembling or disassembling while there is residual charge in both ends of the aluminum electrolytic capacitor may result in electrical shock or damage to the IC components.
This model does not come with a discharge pad or other such components.



1.4 Areas to Clean

Dust accumulates on vent holes, internal fan, and their surrounding areas. Use a vacuum cleaner to clear the dust.

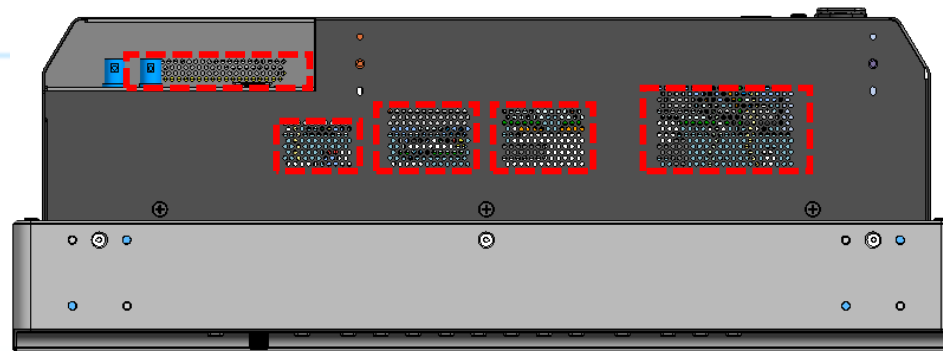
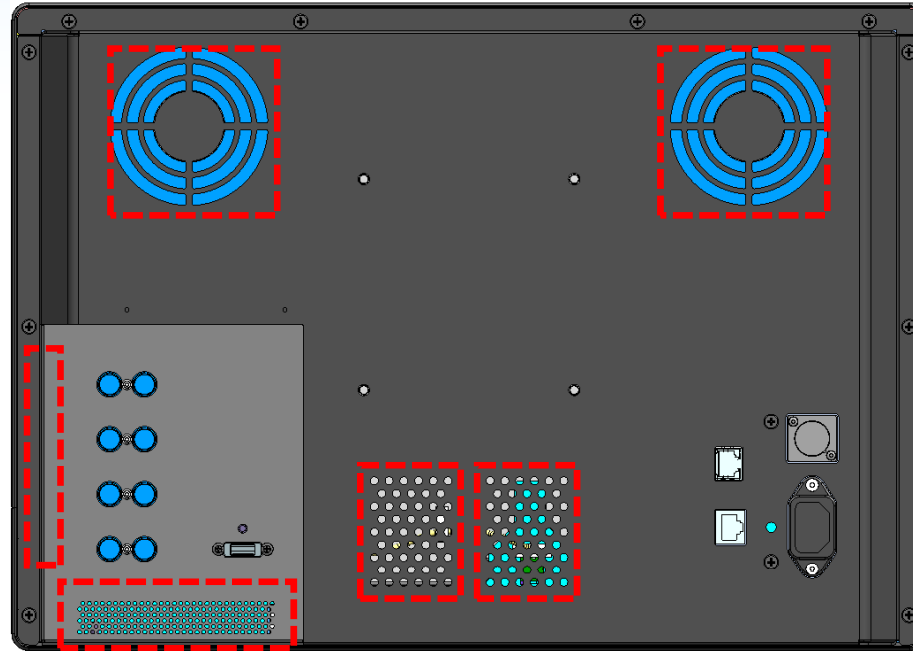

2. Structure of Display Components and Disassembly Flowchart

Disassembly		<u>P7</u>
3.1	Preparation	<u>P7</u>
3.2-1,2	Foot Parts Detachment	<u>P8</u>
3.3	Handle Detachment	<u>P10</u>
3.4	Rear Cover Parts Detachment	<u>P11</u>
3.5-1,2	Rear FrameとFAN Holder Detachment	<u>P13</u>
3.6	PCB ASS Y, MAIN Detachment (Remove cables)	<u>P15</u>
3.7	AC Inlet holder Detachment	<u>P17</u>

Please check the each flow.

 The Detachment for [PCB ASS Y, LAN] and [PCB ASS Y, MAIN]

3.8	PCB ASS Y, LAN and CABLE, ACIN, DCIN Detachment	<u>P18</u>
3.9	PCB ASS Y, MAIN Detachment	<u>P19</u>



The Detachment for [EDP BD], [24V and 5V Power Supply Boards], [POWFILTER AC and DC].

3.10	PCB Holder Detachment	<u>P20</u>
3.11	PCB ASS Y, EDP Detachment	<u>P21</u>
3.12	FAN Detachment	<u>P23</u>
3.13	BL Driver BD, PCB ASS Y POWFILTER AC,PCB ASS Y ,POWFILTER DC and PCB ASS Y FRONT Detachment	<u>P24</u>
3.14	24V POWER SUPPLY PCB , ALL NIGHT POWER PCB, PCB ASS Y, POWFILTER AC and DC Detachment	<u>P28</u>



The Detachment for [FRONT BEZEL Parts] and [Control Panel Cover Parts]

3.10	PCB Holder Detachment	<u>P20</u>
3-13-2	Remove only [CABLE, POWFILAC, POW24V] and [CABLE, POWFILAC, DRIVER].	<u>P25</u>
3.15	Preparation for FRONT BEZEL Parts Detachment	<u>P29</u>
3.16	FRONT BEZEL Parts Detachment	<u>P30</u>
3.17	PCB ASS Y, TALLY Detachment	<u>P35</u>
3.18	Control Panel Cover Parts Detachment	<u>P36</u>



3. Disassembly

To disassemble the display, refer to section 2, "Display Components and Disassembly Flowchart," and follow the instructions in this chapter. To assemble the display, reverse the procedure.

3.1 Preparation

- On the workbench, place two pieces of soft material such as Styrofoam that will not damage the display body, and place the display face down on the material. Separate the pieces appropriately according to the width of the display.
- To protect the display screen from damage, make sure that the [COVER, FRONT BEZEL] around the screen are resting on the protective material.
- The pieces of protective material should be 100 to 150 mm wide, 700 to 800 mm long, and at least 50 mm high.

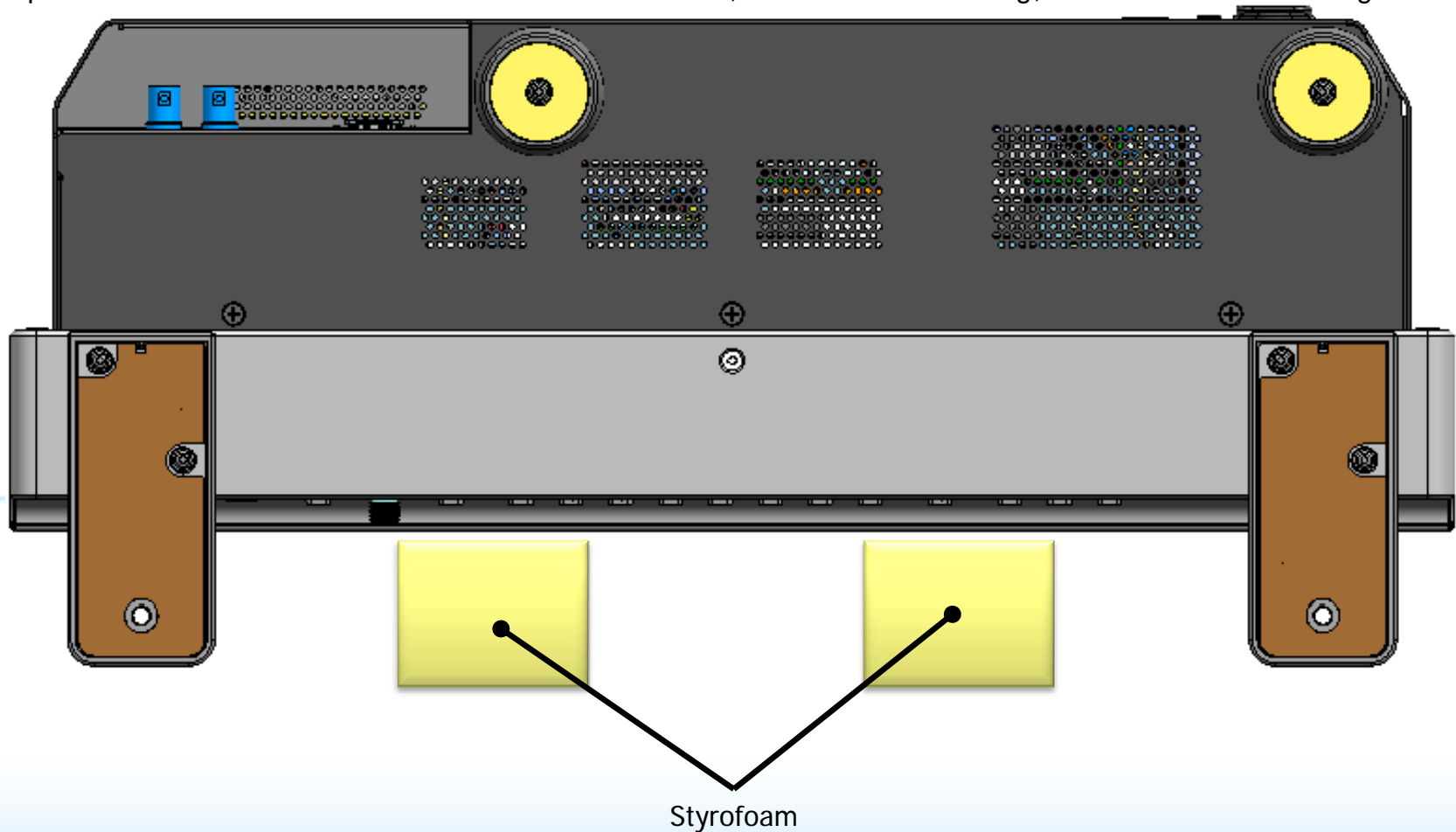

3.2 Foot Parts Detachment

1. Unfasten the two Screw-A screws, and remove the Mark .
2. Unfasten the four Screw-A screws, and remove the Mark .
(The tightening torque is 100 N•cm.)

Mark	Parts No.	Description	Qty
	-	FOOT STAND ASS'Y, REAR	2
	-	FOOT STAND ASS'Y, FRONT	2
Screw-A	XB2-4301-005	SCREW, W/WASHER, M3X10	6

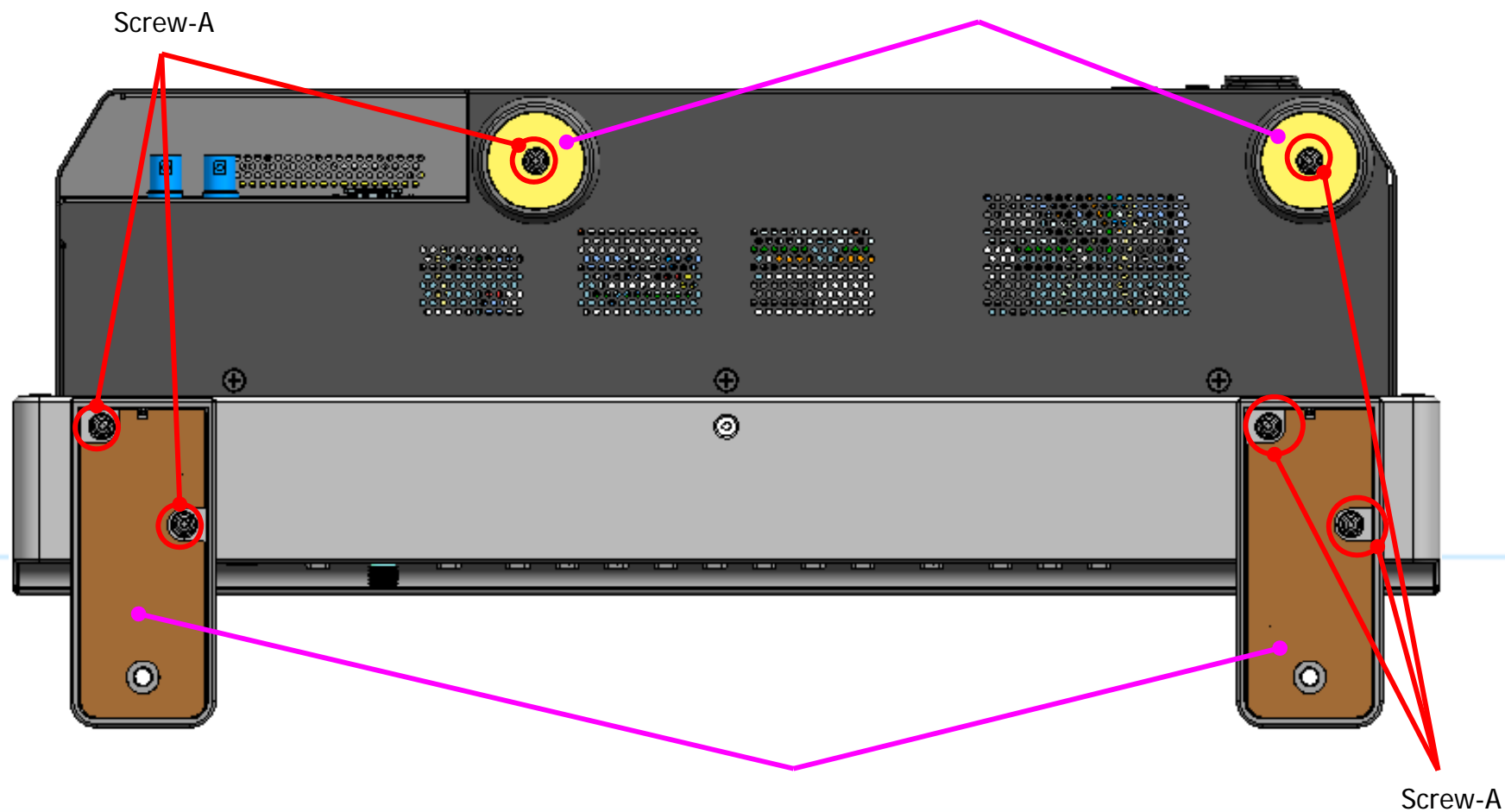

Please conduct the following disassemble when you need to change [FOOT STAND, FRONT] or [FOOT STAND, REAR].

3. After peel off the Mark , unfasten the four Screw-A screws, and remove the Mark .
(The tightening torque is 40 N•cm.)

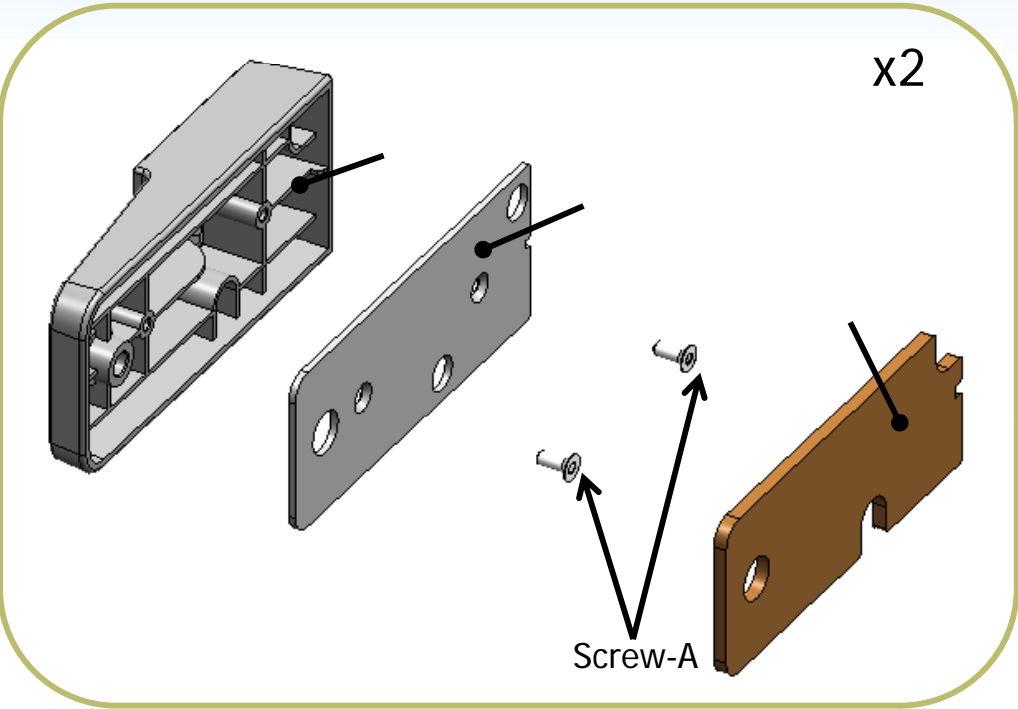

4. Peel off the Mark from the Mark .

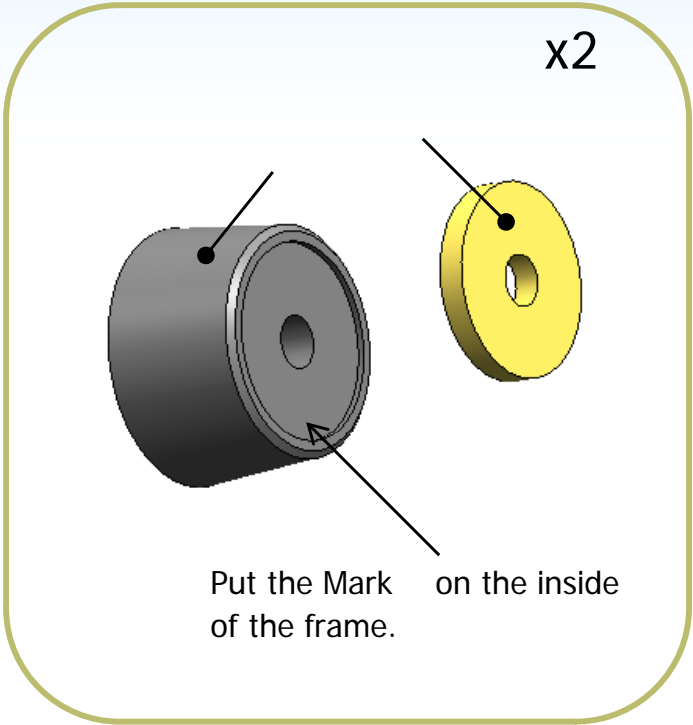

Mark	Parts No.	Description	Qty
	DD1-0447-000	FOOT STAND, FRONT	2
	DD1-0448-000	BASE, FOOT	2
	DD1-0446-000	PAD, FOOT, FRONT	2
Screw-A	XB4-8300-809	SCREW, TAP, BINDING M3X8	4

Mark	Parts No.	Description	Qty
	DD1-0445-000	FOOT STAND, REAR	2
	DD1-0060-000	PAD, FOOT	2



3.3 Handle Detachment

1. Unfasten the 2 bolts, and remove the Handle .
(The tightening torque is 100 N•cm.)

Mark	Parts No.	Description	Qty
	DD1-0555-000	HANDLE, DP-V1710	1
Bolt	XB7-1080-209	BOLT, M8x20	2

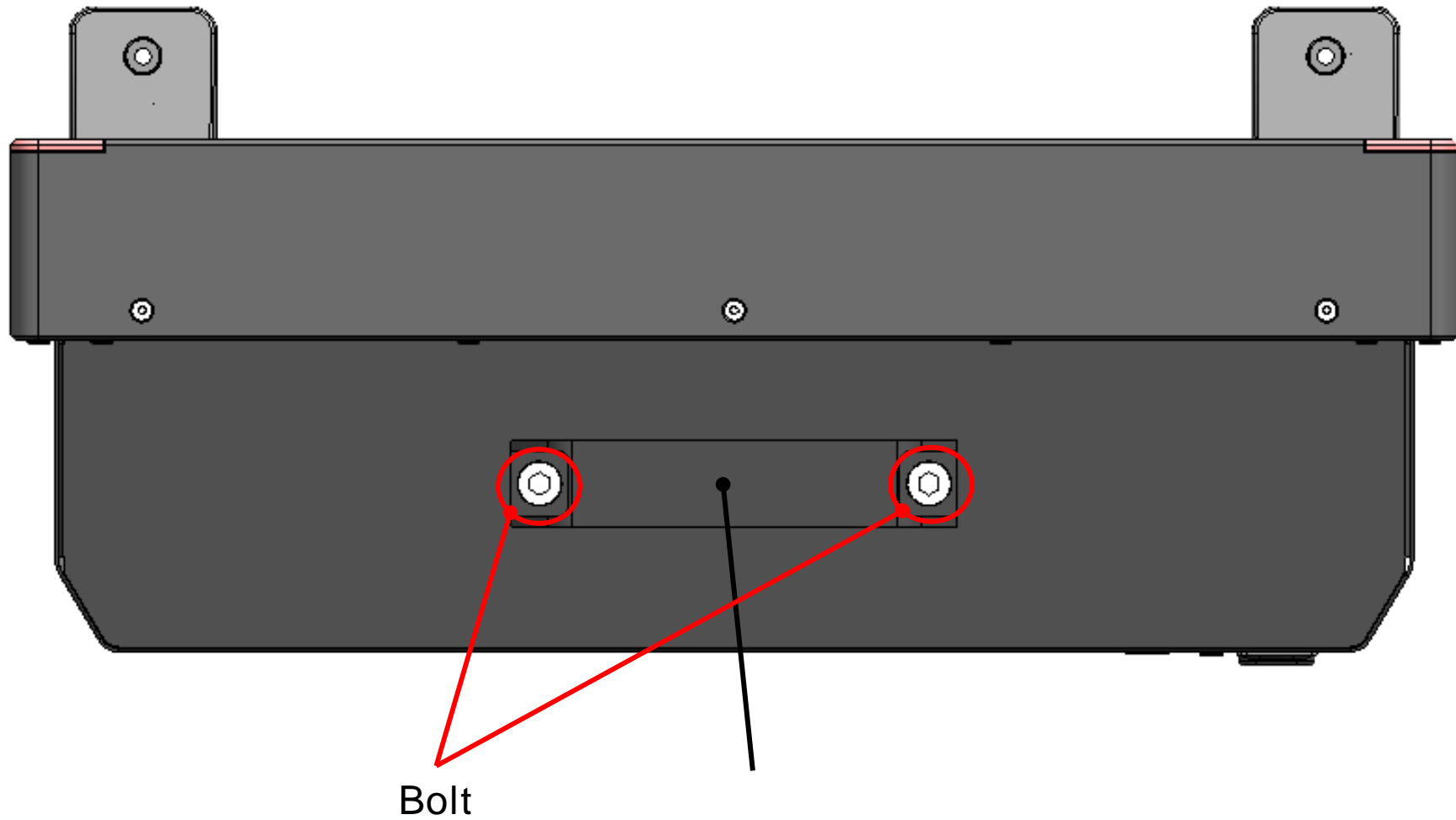

3.4 Rear Cover Parts Detachment (DP-V1710)

1. Unfasten the 15 Screw-A screws, the four Screw-B screws, and the two Screw-C screws.
 (The tightening torque for Screw-A is 60 N•cm.)
 (The tightening torque for Screw-B and Screw-C are 40 N•cm.)

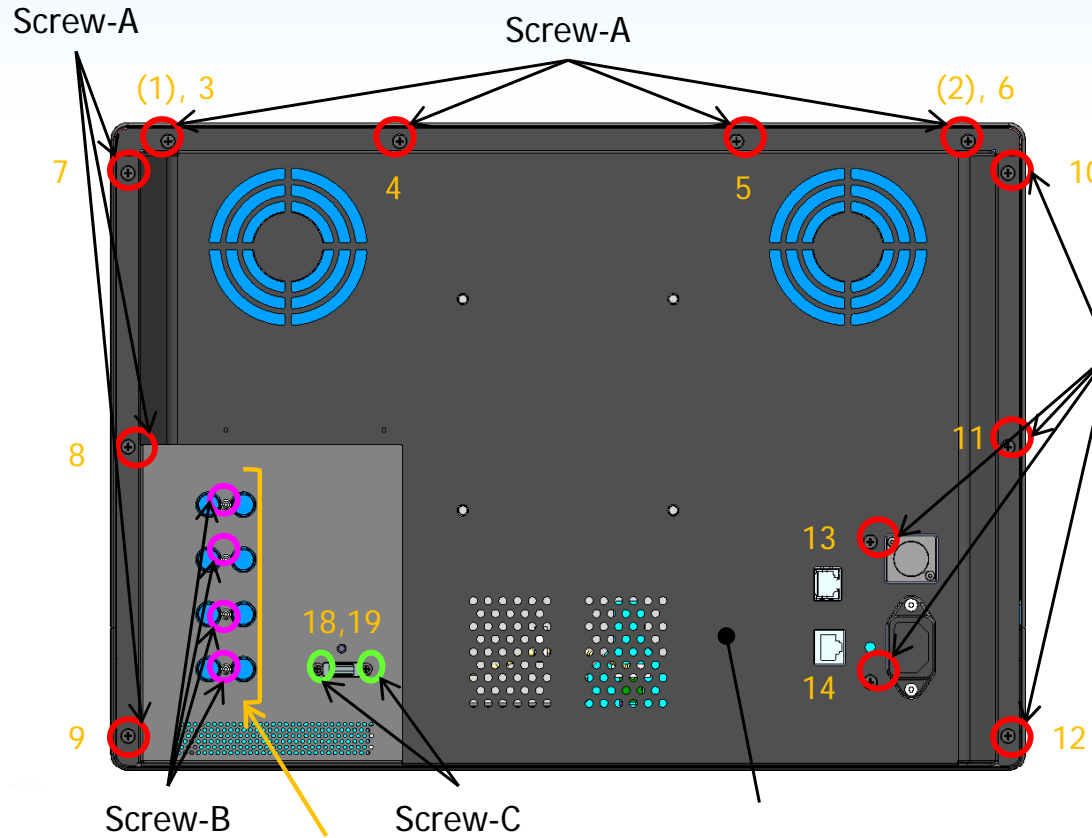

Top is 20, Second is 21, Third is 22, and Fourth is 23.

[Note on assembly]

When assembling the Mark , please install a screw in order of a yellow number. (1) and (2) are temporary installation.

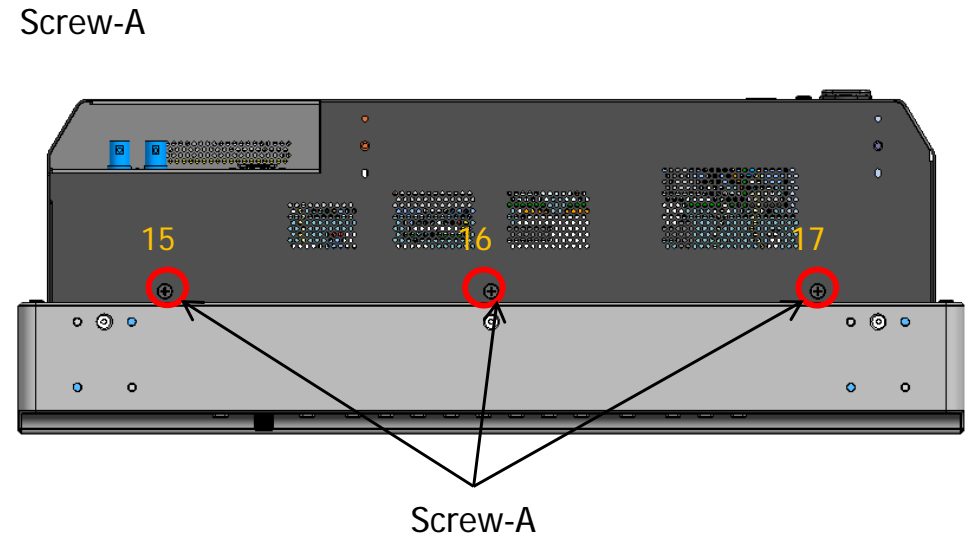

Mark	Parts No.	Description	Qty
Screw-A	DD1-0103-000	SCREW, M3X6	15
Screw-B	DD1-0120-000	SCREW, M2.6X5	4
Screw-C	DD1-0110-000	SCREW, M3X5	2
	DL1-0103-000	COVER, REAR	1



3.4 Rear Cover Parts Detachment (DP-V1711)

- Unfasten the 15 Screw-A screws, and the five Screw-C screws.
 (The tightening torque for Screw-A is 60 N•cm.)
 (The tightening torque for Screw-B and Screw-C are 40 N•cm.)

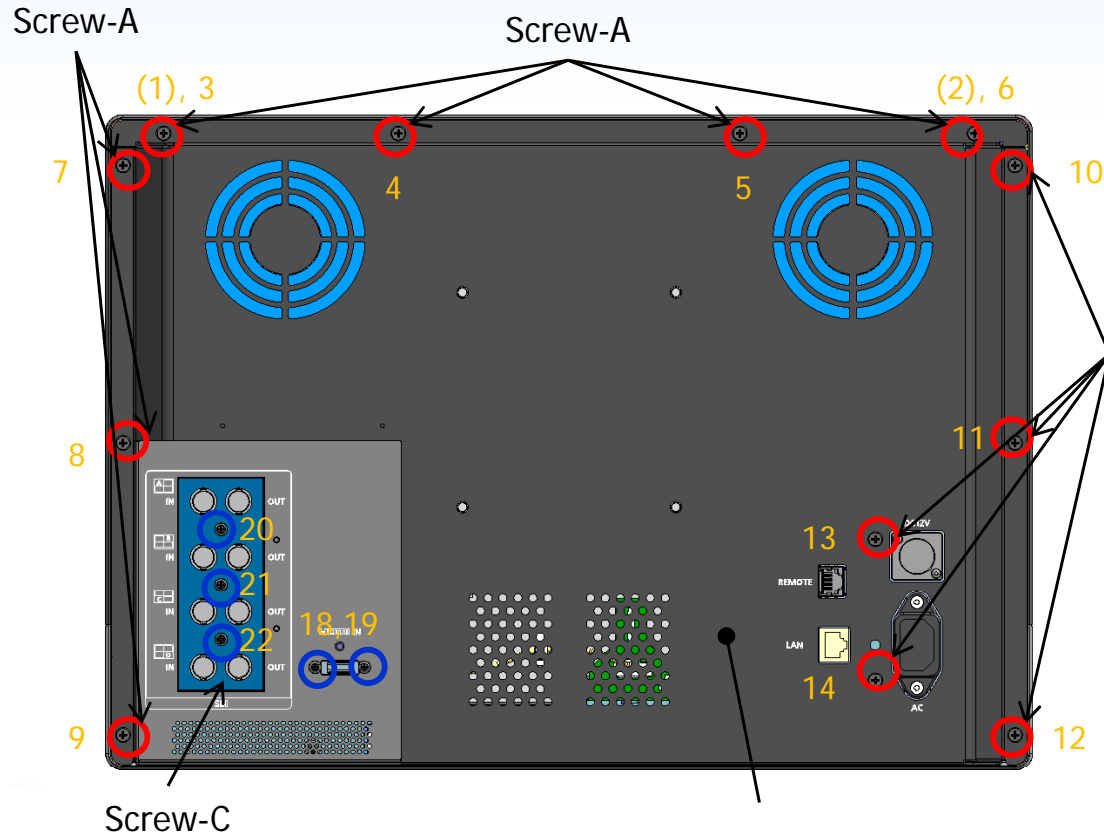

[Note on assembly]

When assembling the Mark , please install a screw in order of a yellow number. (1) and (2) are temporary installation.

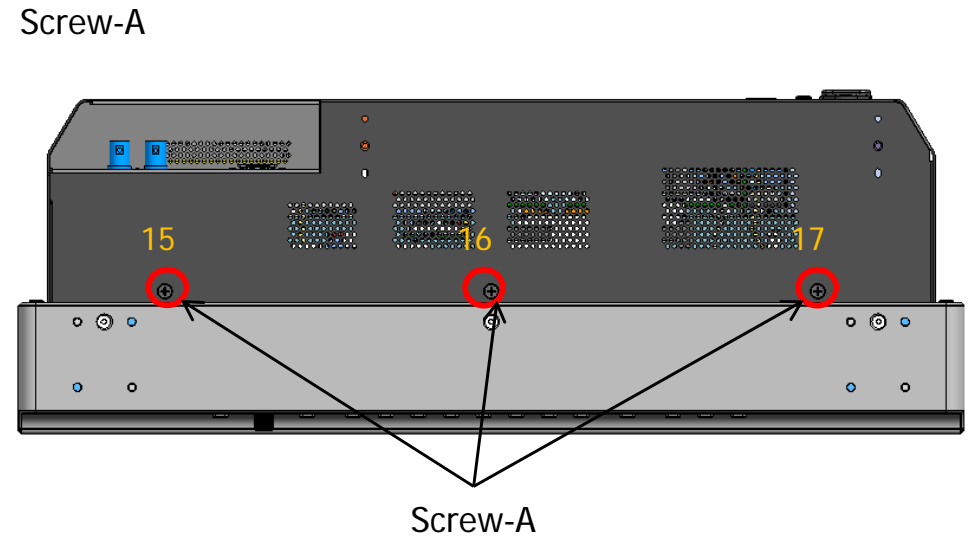

Mark	Parts No.	Description	Qty
Screw-A	DD1-0103-000	SCREW, M3X6	15
Screw-B	DD1-0120-000	SCREW, M2.6X5	0
Screw-C	DD1-0110-000	SCREW, M3X5	5
	DL1-0141-000	COVER, REAR	1



[Note on assembly] (DP-V1710)

1. When replacing , replace , and , and peel off the [LABEL, SERIAL] from and affix it to the same label location on the to be attached.

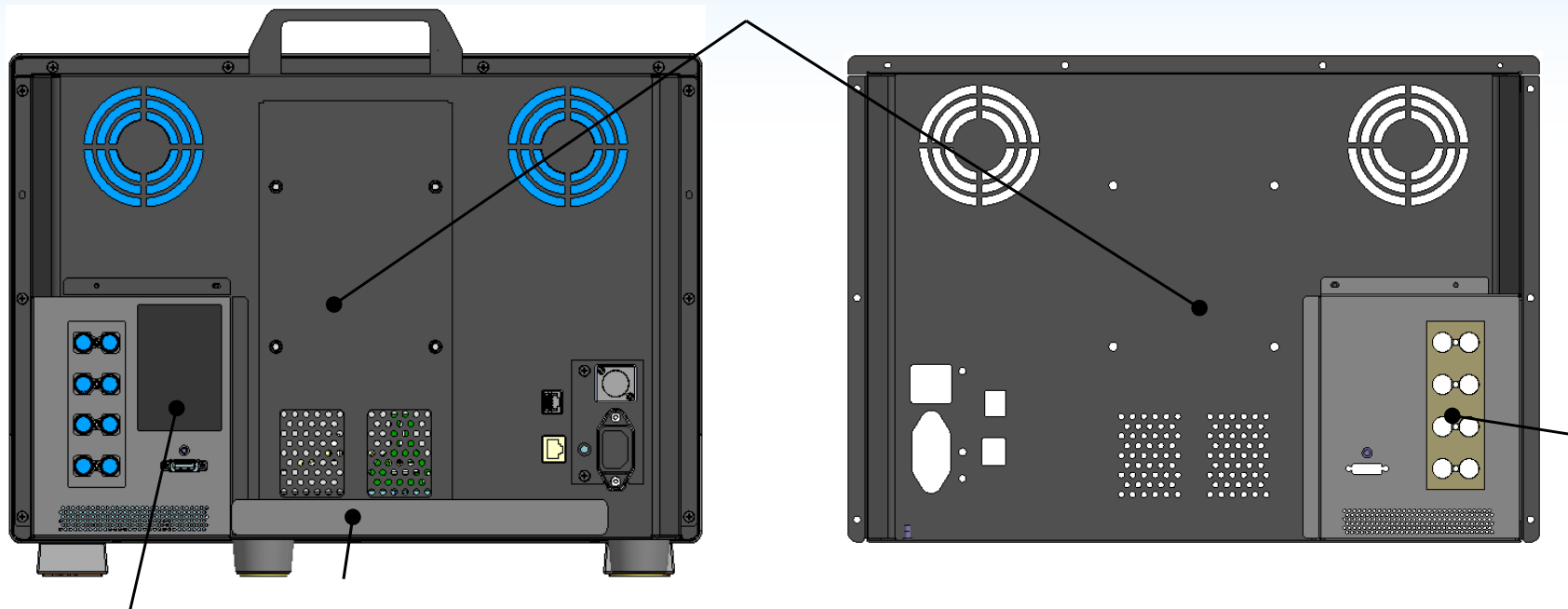

LABEL, SERIAL

Mark	Parts No.	Description	Qty
	DL1-0103-000	COVER, REAR	1
	DD1-0368-000	GASKET, EMI FOR SDI	1
	DD1-0107-001	LABEL, CAUTION	1



[Note on assembly] (DP-V1711)

- When replacing , change , and peel off the 「LABEL, SERIAL」 attached to before replacement, then attach it to the new part in the same position as it was on before replacement.
 Note: There is no need to replace GASKET, as it is not used inside of .

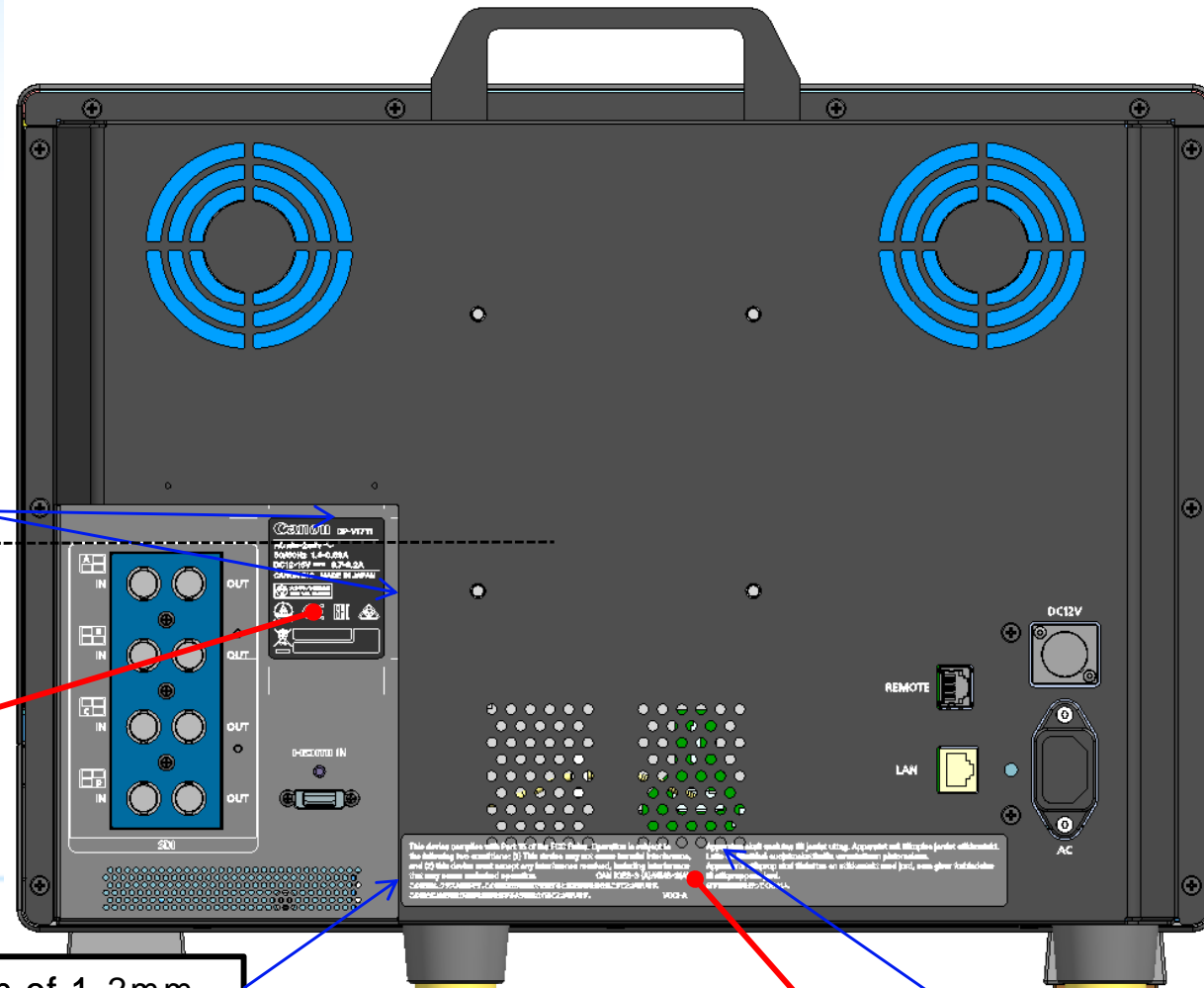

Top & Side:
 Leave a margin of approx. 5mm at both top & side when attaching.

LABEL, SERIAL

Side: Leave a margin of 1-2mm.

Top: Attach so that one row of air holes are covered.

Mark	Parts No.	Description	Qty
	DL1-0141-000	COVER, REAR	1
	DD1-0368-000	GASKET, EMI FOR SDI	0
	DD1-0652-000	LABEL, CAUTION	1



3.5 Rear Frame and Fan Holder Detachment

1. Remove 2 FAN cable connectors from PCB ASS Y,Main.
2. Unfasten the 10 Screw-A screws, and remove the Rear Frame and FAN Holder.
(The tightening torque is 100 N•cm.)

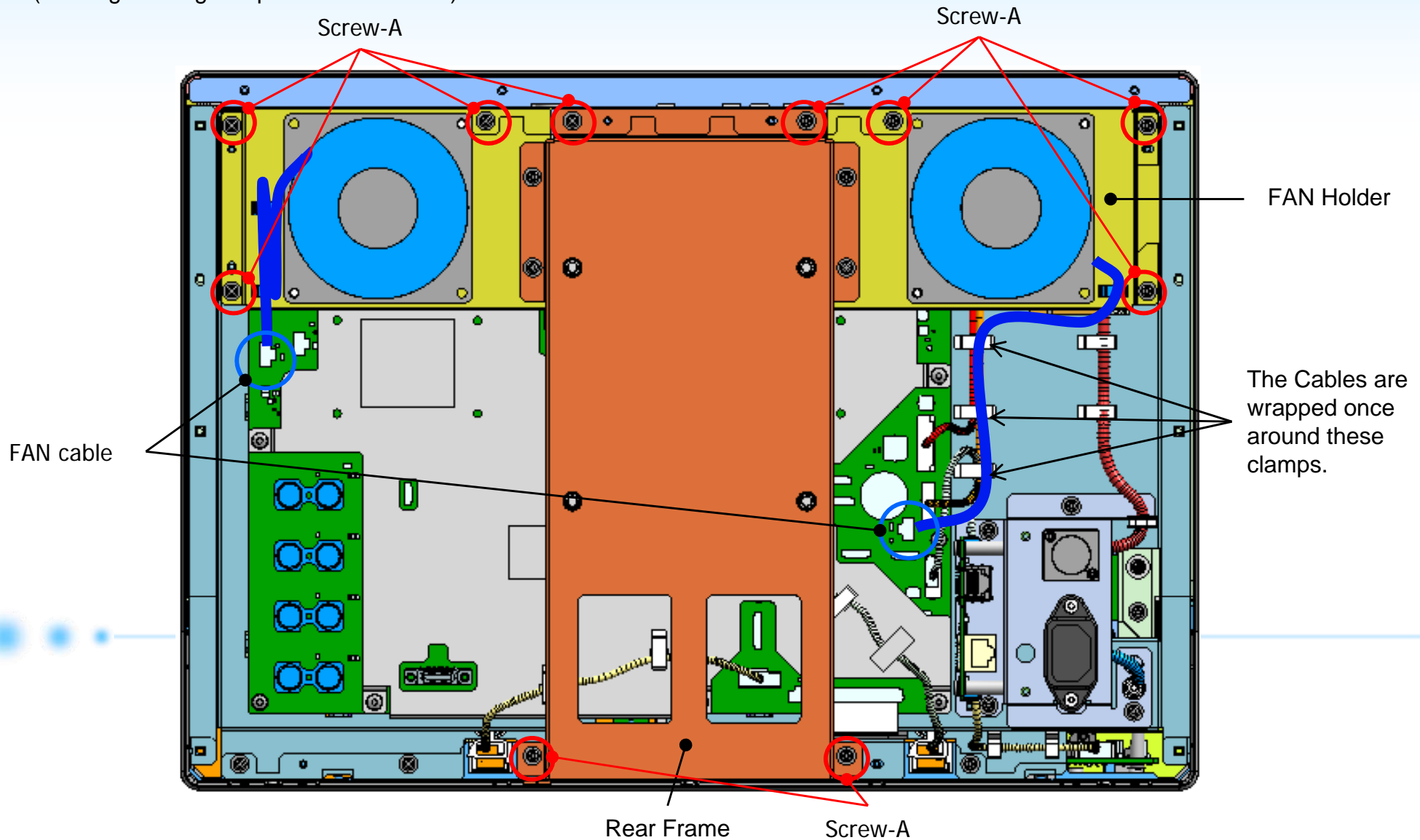

Mark	Parts No.	Description	Qty
Screw-A	XB6-7300-405	SCREW, TP, M3X4	10



3. Unfasten the 4 Bolt-B and remove 2 Fans from FAN Holder
 (The tightening torque is 100 N•cm.)

Mark	Parts No.	Description	Qty
	DM6-0005-000	FAN, SYSTEM	2
Bolt-B	XB7-1040-089	BOLT, HEX SKT. (CODE 03B) M4X8	4

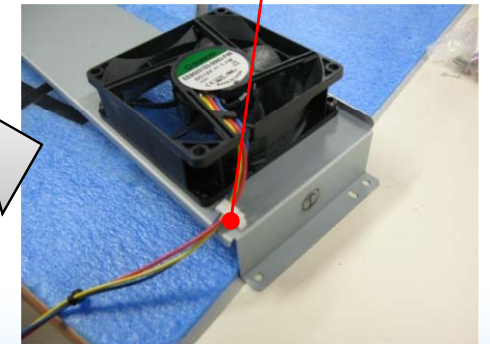
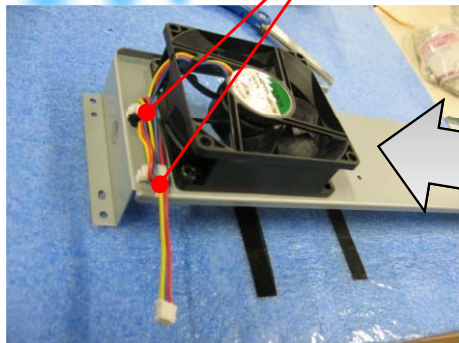
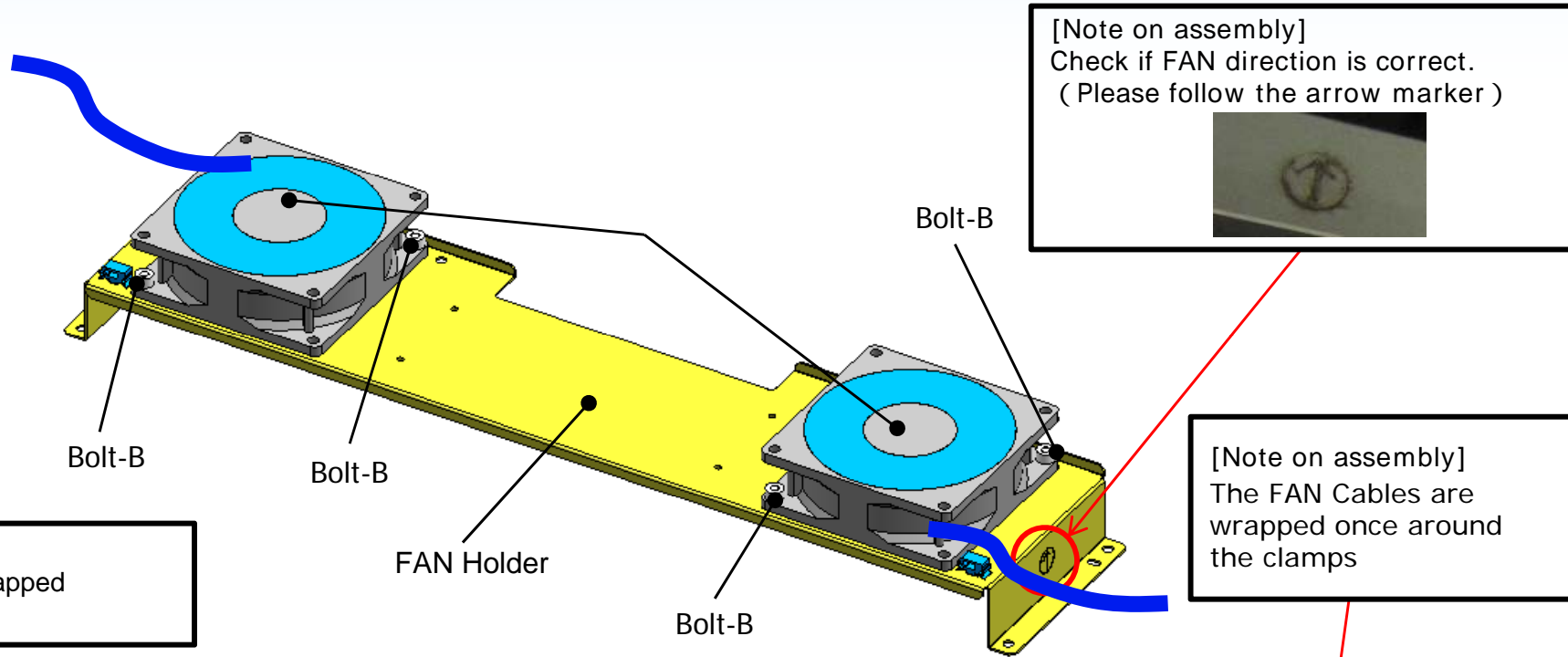

3.6 PCB ASS Y, MAIN Detachment (Remove cables)

1. Remove 12 cables and FPC from PCB ASS Y, MAIN.

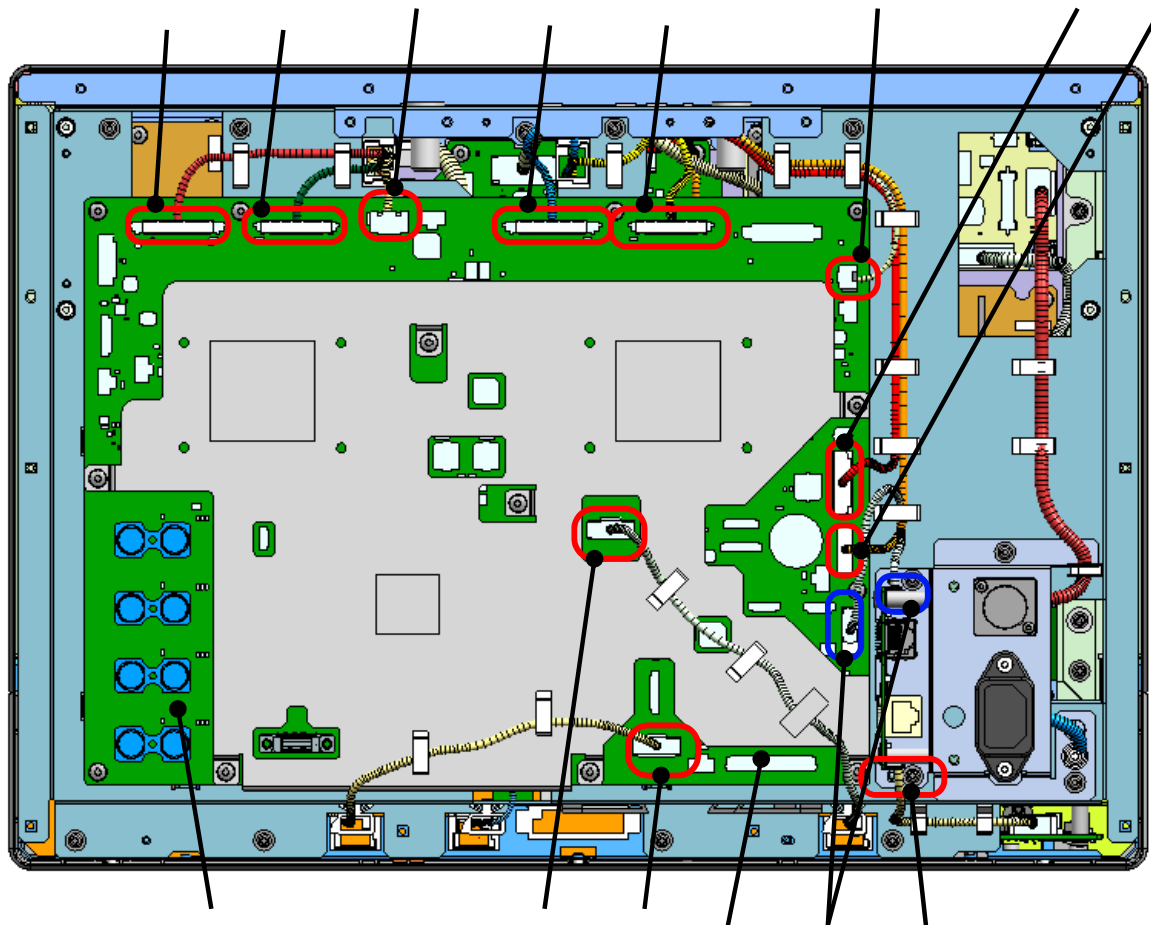

PCB ASS'Y, MAIN

Mark	Parts No.	Description	Qty
	DD2-0082-000	CABLE, MAIN, TC-R	1
	DD2-0083-000	CABLE, MAIN, TC-G	1
	DD2-0084-000	CABLE, MAIN, TC-B	1
	DD2-0085-000	CABLE, MAIN, TC-Y	1
	DD2-0139-000	CABLE, DRIVER, MAIN01	1
	DD2-0140-000	CABLE, DRIVER, MAIN02	1
	DD2-0141-000	CABLE, MAIN, TALLY	1
	DD2-0142-000	CABLE, MAIN, USB	1
	DD2-0143-000	CABLE, USB, ETALY	1
	DD2-0144-000	CABLE, MAIN, ETALY	1
	DD2-0145-000	CABLE, MAIN, FRONT	1
	DD2-0146-000	CABLE, MAIN, LV2EDP-CTRL	1
	DD2-0150-000	FPC, MAIN, DRIVER	1



[Notes on cable connections to PCB ASS Y, MAIN]

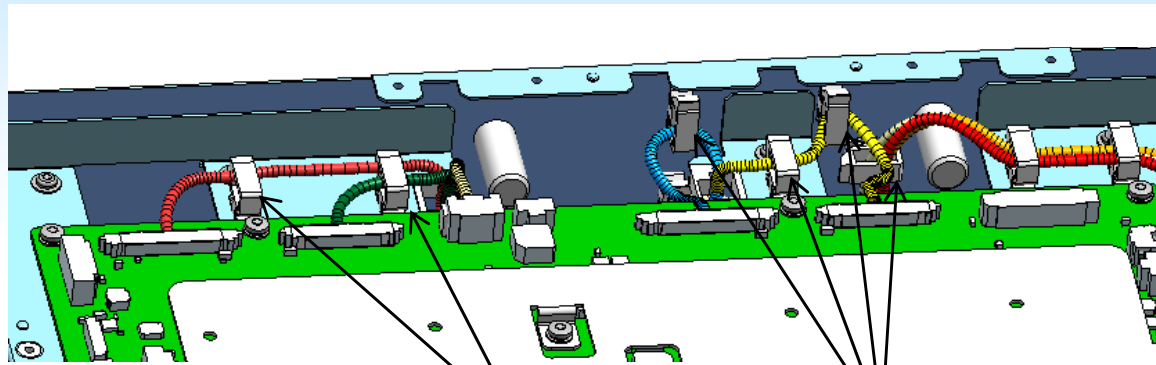

Fix with clamps

Fix with clamps

Fix with clamps

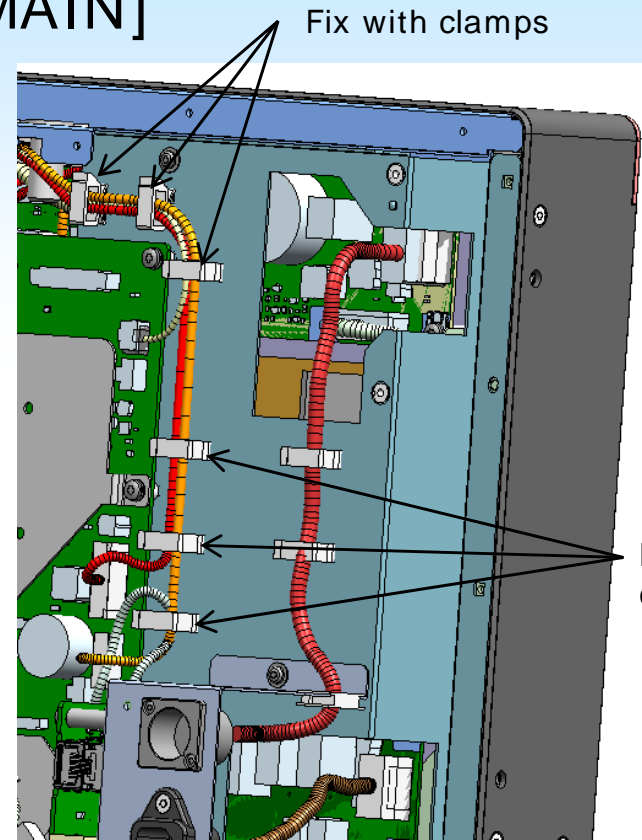

Fix with clamps

Fix with clamps

Fix with clamps

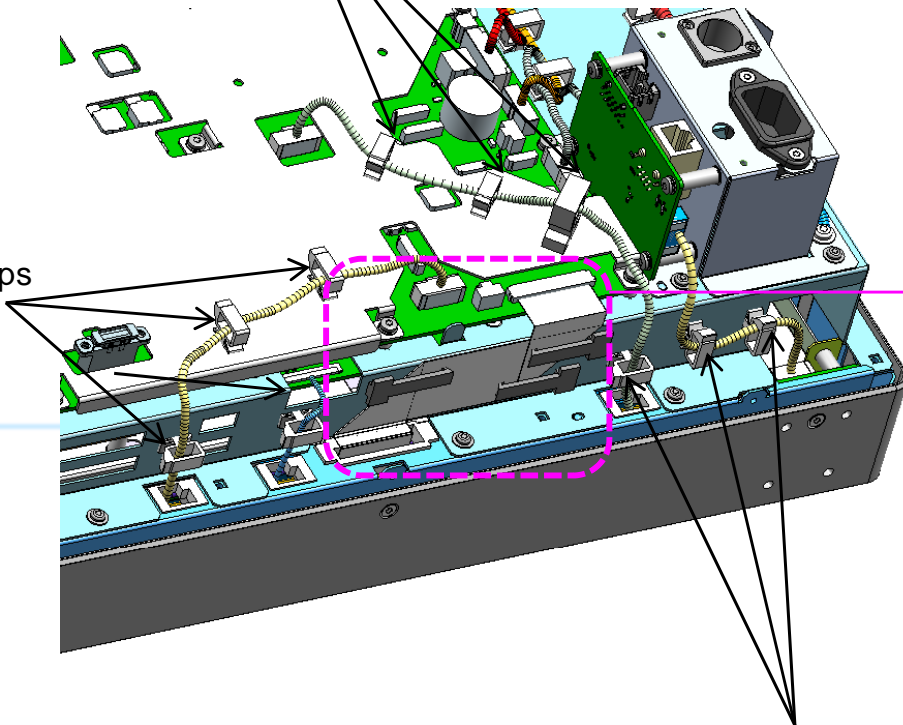

Fix with clamps

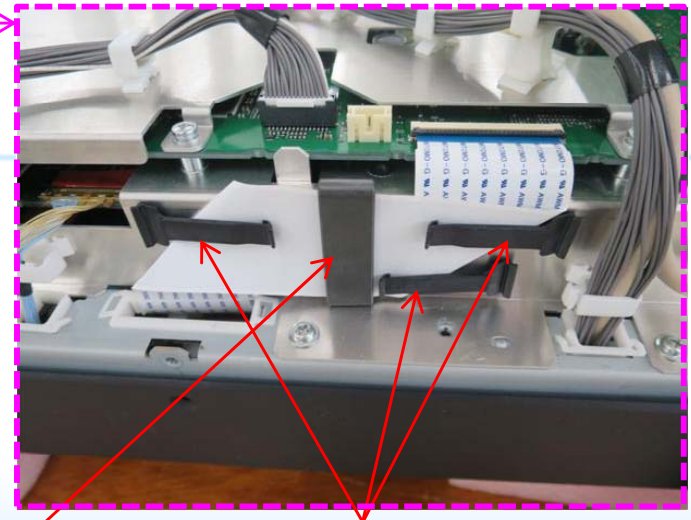

Attach the core

Fix FPC



3.7 AC Inlet holder Detachment

1. Unfasten the one Screw-A screws, and remove the Earth line of the AC Inlet Unit.
 2. Unfasten the four Screw-B screws, and remove the AC/DC Inlet holder.
- (The tightening torque for Screw-A is 100 N•cm.)
 (The tightening torque for Screw-B is 100 N•cm.)

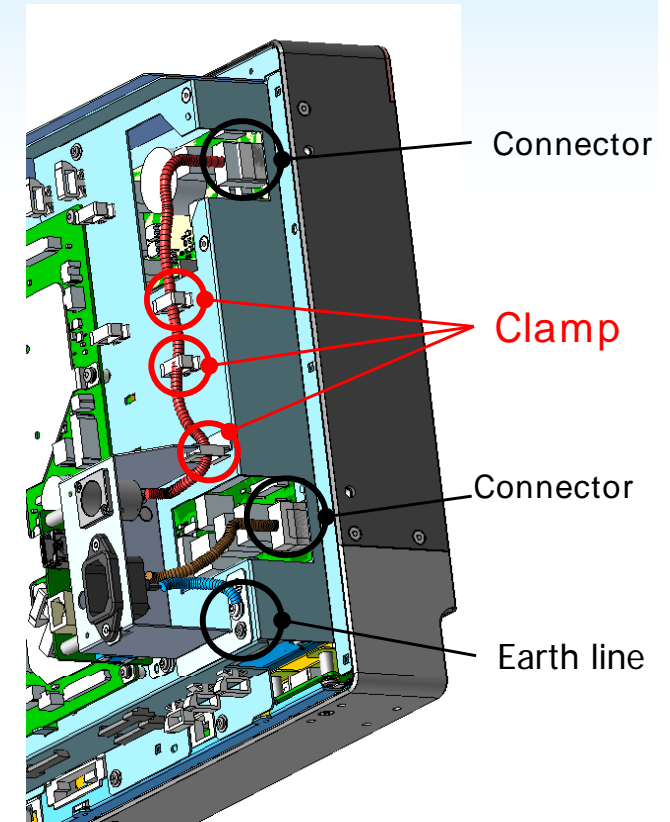
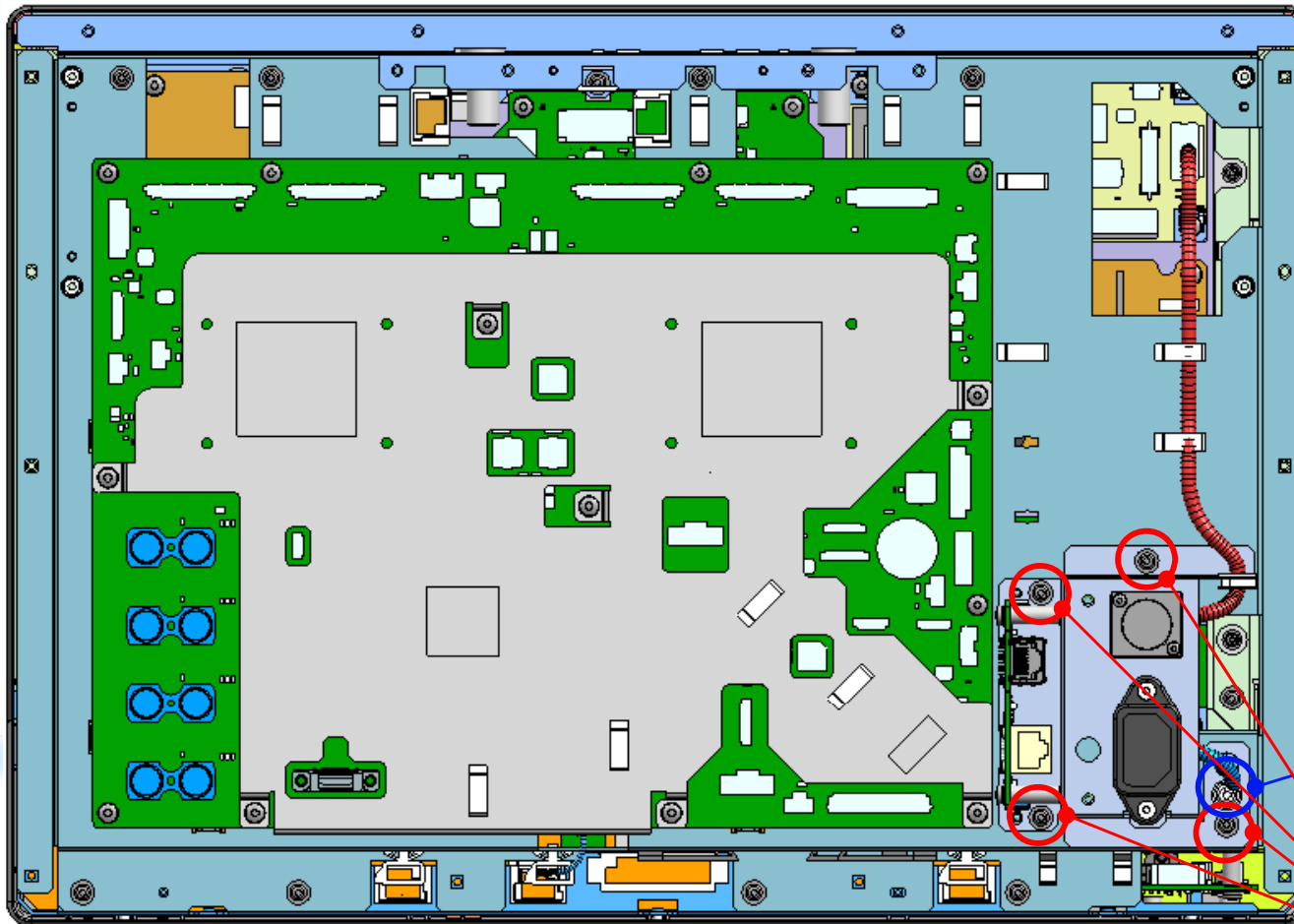

Earth line
(Washer, Screw-A)

Screw-B

Mark	Parts No.	Description	Qty
Washer	XD1-4200-402	WASHER, TOOTHED LOCK, M4	1
Screw-A	XB6-7400-805	SCREW, TP, M4X8	1
Screw-B	XB6-7300-405	SCREW, TP, M3X4	4



3.8 PCB ASS'Y, LAN and CABLE, ACIN, DCIN Detachment

1. Unfasten the four Screw-A screws, and remove the Mark from the AC/DC Inlet.
 2. Unfasten the two Screw-B screws, and remove the Mark from the AC/DC Inlet.
 3. Unfasten the two Screw-B screws, and remove the Mark from the AC/DC Inlet.
- (The tightening torque for Screw-A is 60 N•cm.)
 (The tightening torque for Screw-B is 60 N•cm.)
 (The tightening torque for Screw-B is 60 N•cm.)

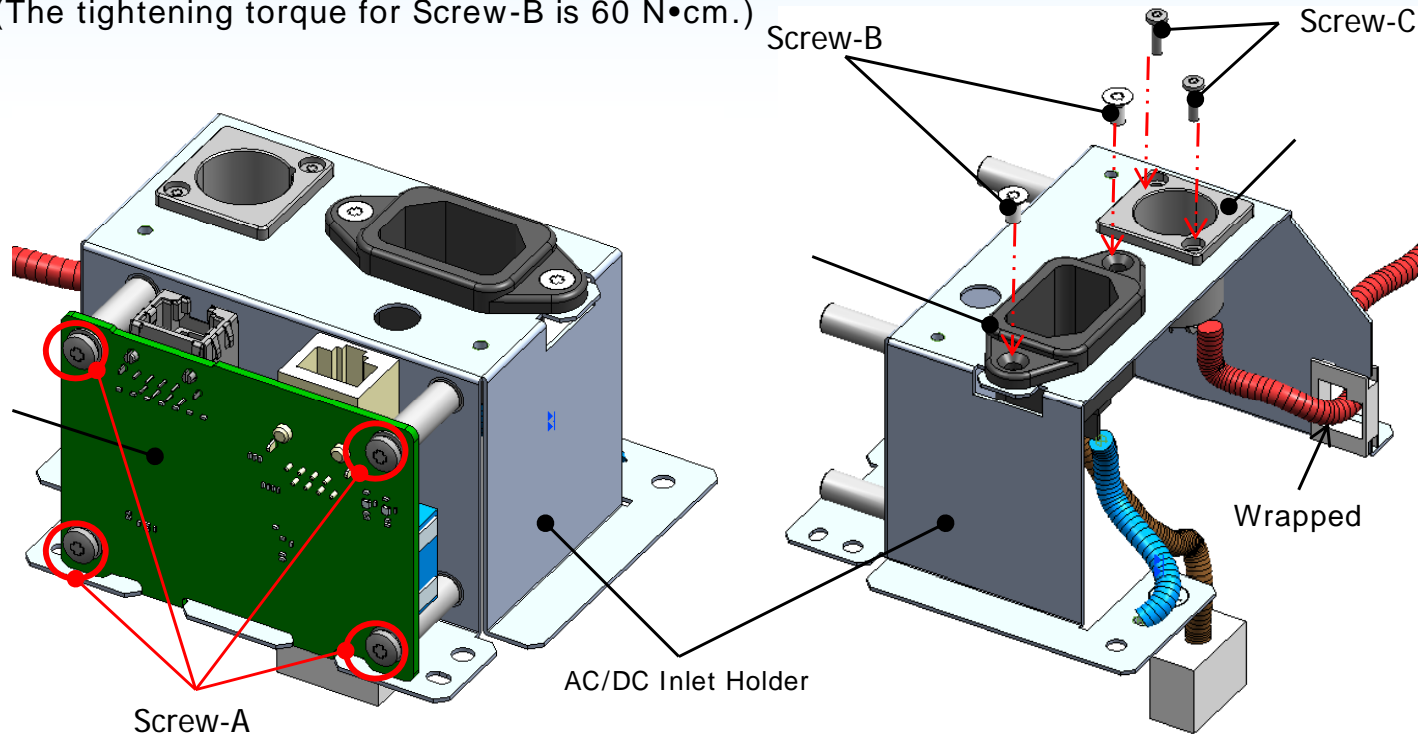

[Note on Assembly]
 Please assemble AC/DC inlet as the below picture.

Mark	Parts No.	Description	Qty
	DY5-8042-000	PCB ASS'Y, LAN	1
	DD2-0131-000	CABLE, ACIN	1
	DD2-0137-000	CABLE, DCIN	1
Screw-A	XB2-8300-805	SCREW, MACH, PAN HEAD, M3X8	4
Screw-B	DD1-0346-000	SCREW, ACIN, M3X6	2
Screw-C	XB1-2200-805	SCREW, MACH, TRUSS HEAD, M2X8	2



3.9 PCB ASS Y, MAIN Detachment (DP-V1710)

1. Unfasten the 13 Screw-A screws, and remove the HeatSink.
(The tightening torque for Screw-A is 60 N•cm.)

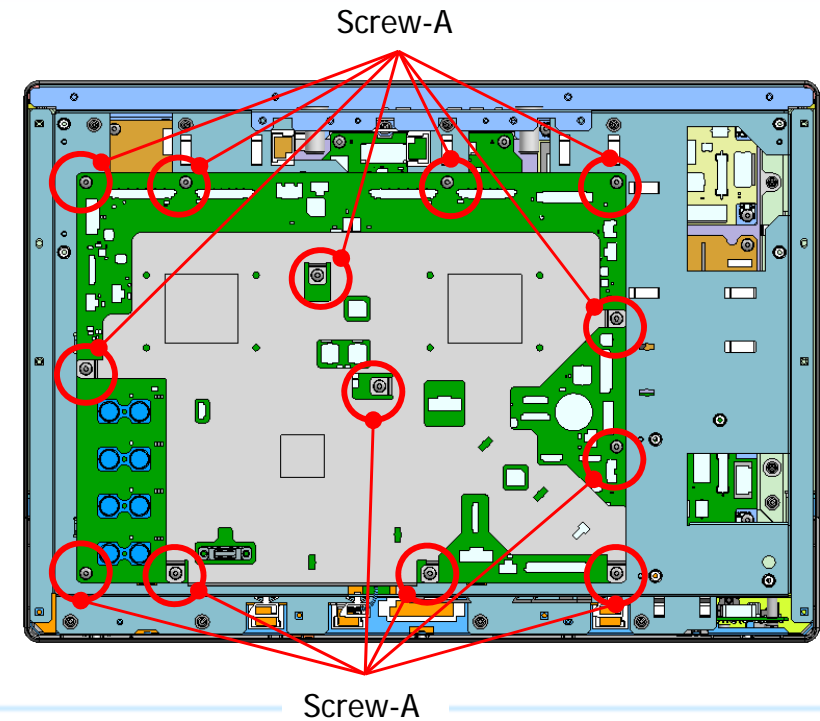
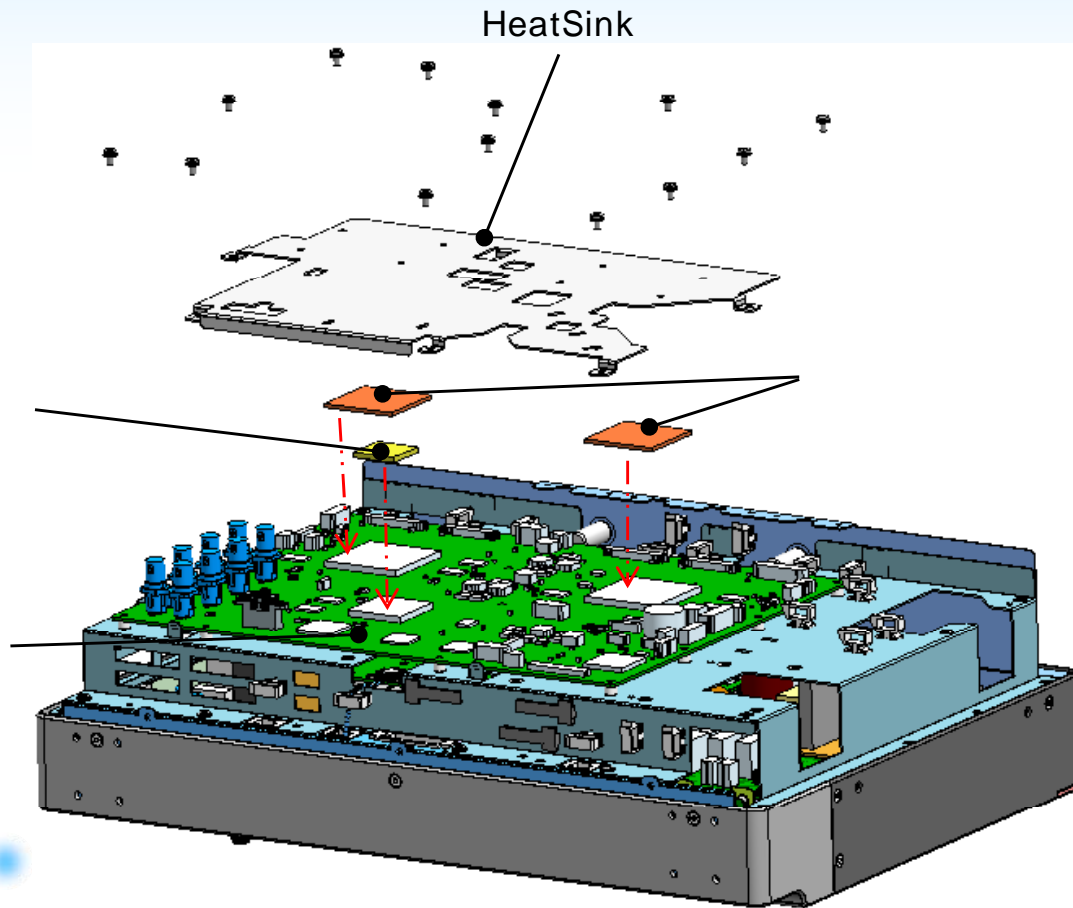

Mark	Parts No.	Description	Qty
	DM1-0036-000	PCB ASS'Y, MAIN	1
	DD1-0350-000	CUSHION, MAIN2	2
	DD1 0556 000	CUSHION, MAIN4	1
Screw-A	XB2-8300-805	SCREW, MACH, PAN HEAD, M3X8	13



3.9 PCB ASS Y, MAIN Detachment (DP-V1711)

1. Unfasten the 13 Screw-A screws, and remove the HeatSink.
(The tightening torque for Screw-A is 60 N•cm.)

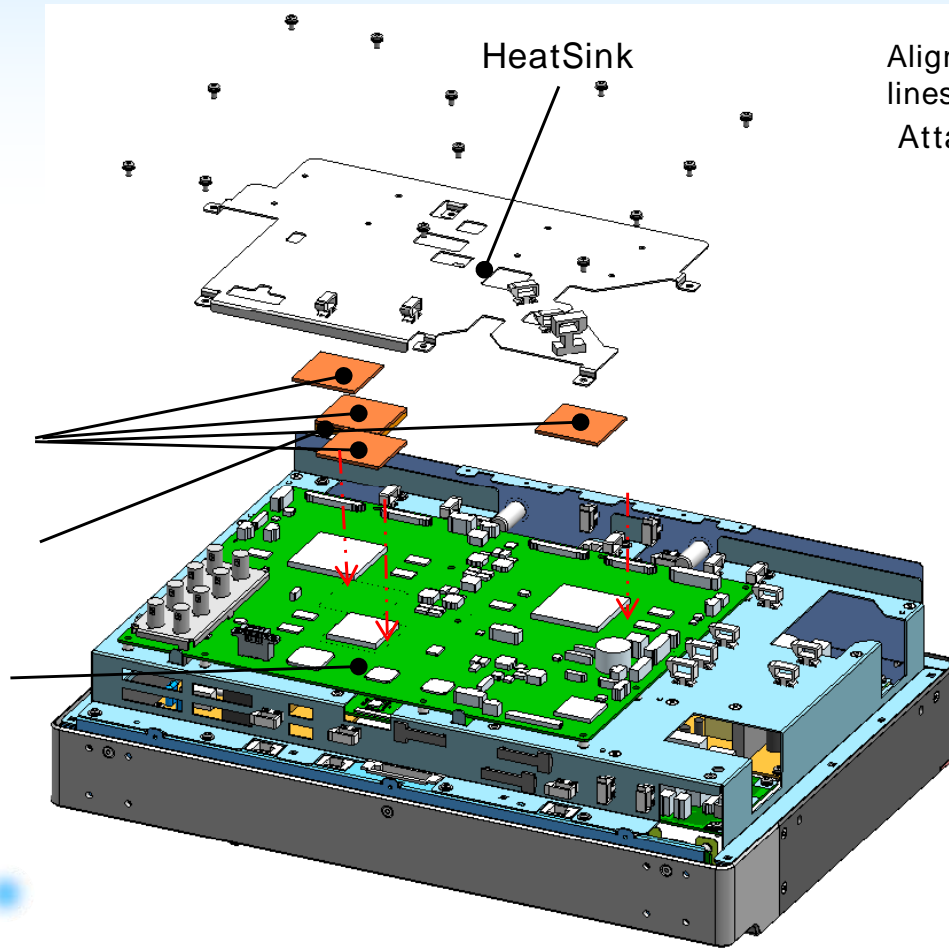

Align with the guide lines on the PCB
Attach &

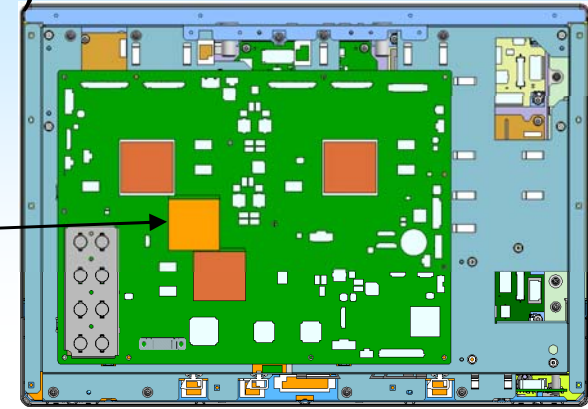

Screw-A

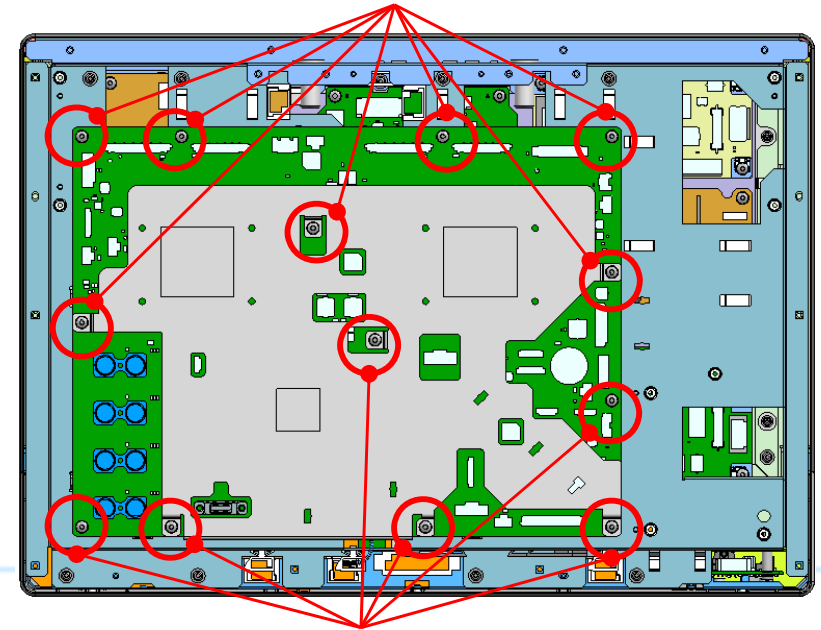

Screw-A

Mark	Parts No.	Description	Qty
	DM1-0057-000	PCB ASS'Y, MAIN	1
	DD1-0350-000	CUSHION, MAIN2	4
	DD1 0544 000	CUSHION, MAIN3	1
Screw-A	XB2-8300-805	SCREW, MACH, PAN HEAD, M3X8	13

Attach (Gray)
on (Pink) at just 1
spot, as an exception



3.10 PCB Holder Detachment (DP-V1710)

1. Remove the cables of the Mark from PCB ASS Y, EDP. (Please see the following Notes)
2. Unfasten the 8 Screw-A screws, and remove the PCB Holder. (The tightening torque for Screw-A is 100 N•cm.)

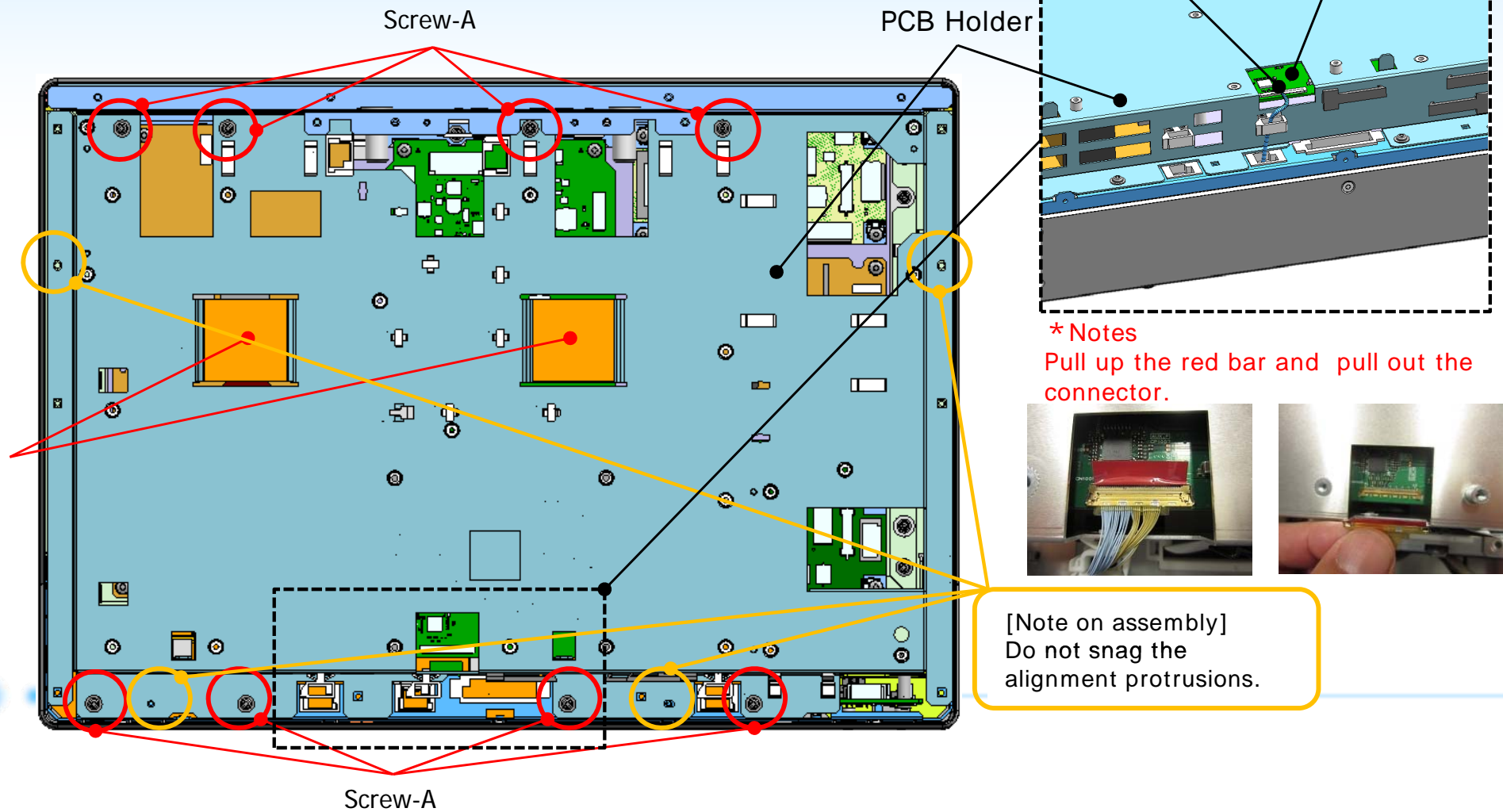

* Notes
Pull up the red bar and pull out the connector.

[Note on assembly]
Do not snag the alignment protrusions.

Mark	Parts No.	Description	Qty
	DD2-0146-000	CABLE, MAIN, LV2EDP-CTRL	1
	DD1-0544-000	CUSHION, MAIN3	2
Screw-A	XB6-7300-405	SCREW, TP, M3X4	8



3.10 PCB Holder Detachment (DP-V1711)

1. Remove the cables of the Mark from PCB ASS Y, EDP. (Please see the following Notes)
2. Unfasten the 8 Screw-A screws, and remove the PCB Holder. (The tightening torque for Screw-A is 100 N•cm.)

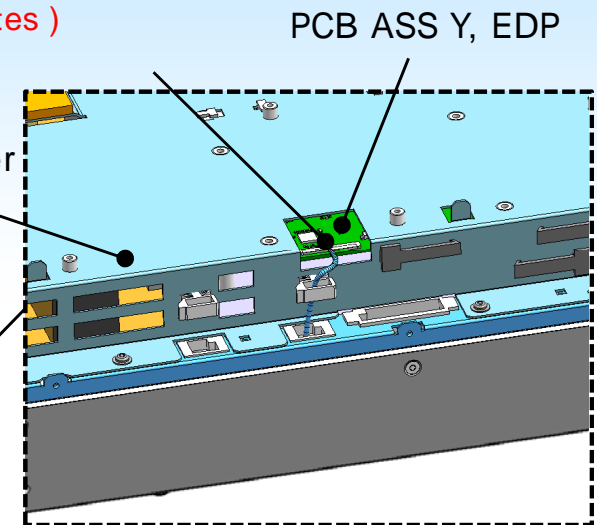
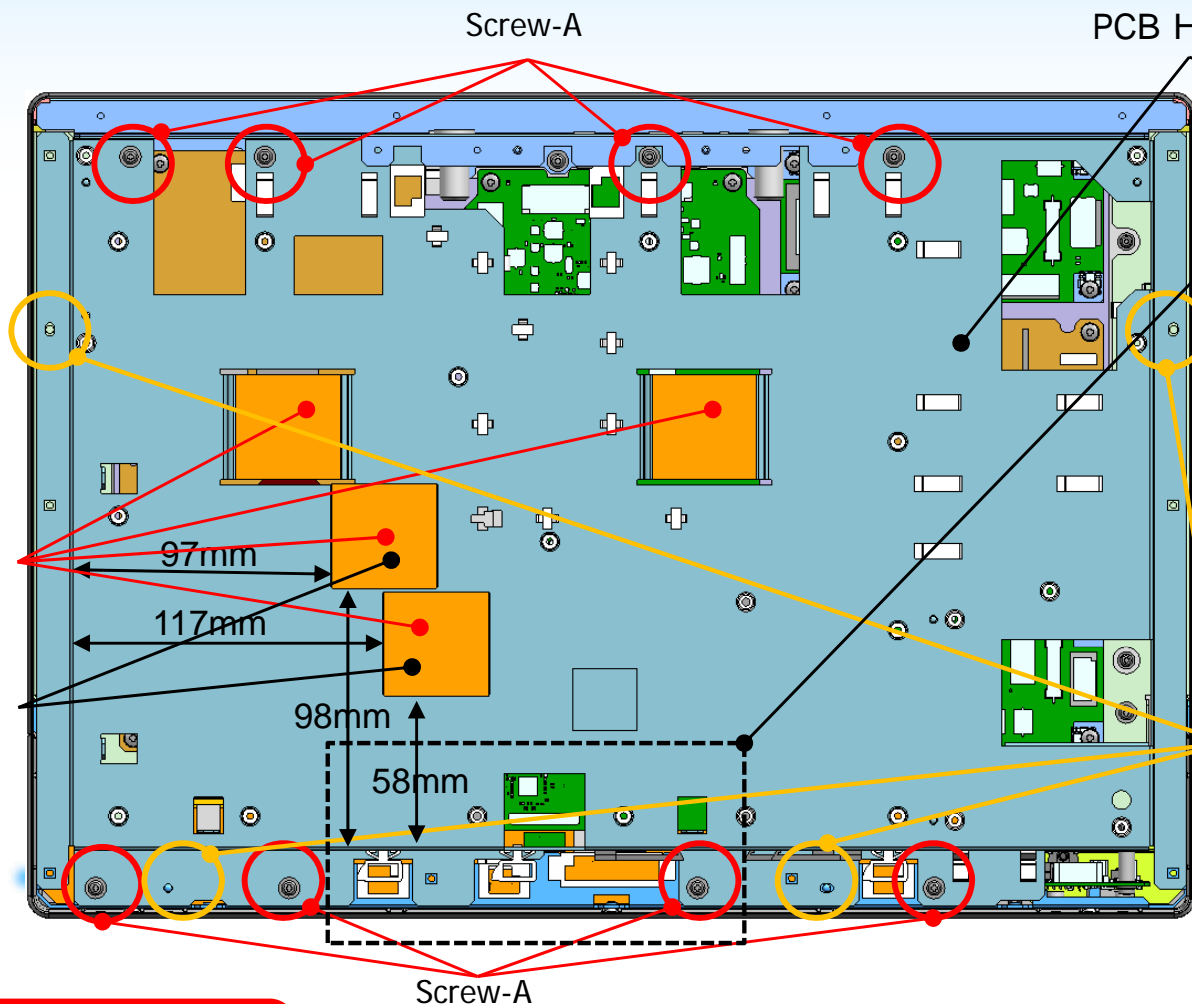

* Notes
Pull up the red bar and pull out the connector.

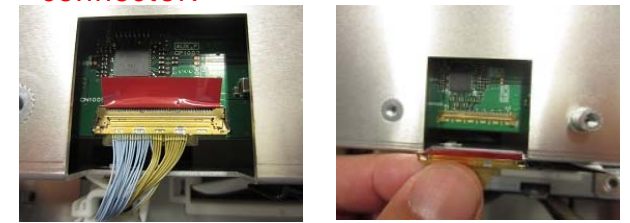

[Note on assembly]
Do not snag the alignment protrusions.

[Note on assembly]
First attach on top and then attach on bottom.

Mark	Parts No.	Description	Qty
	DD2-0146-000	CABLE, MAIN, LV2EDP-CTRL	1
	DD1-0544-000	CUSHION, MAIN3	4
	DD1-0350-000	CUSHION, MAIN2	2
Screw-A	XB6-7300-405	SCREW, TP, M3X4	8



3.11 PCB ASS Y, EDP Detachment

1. Remove the cables of the Mark and Mark from PCB ASS Y, EDP.

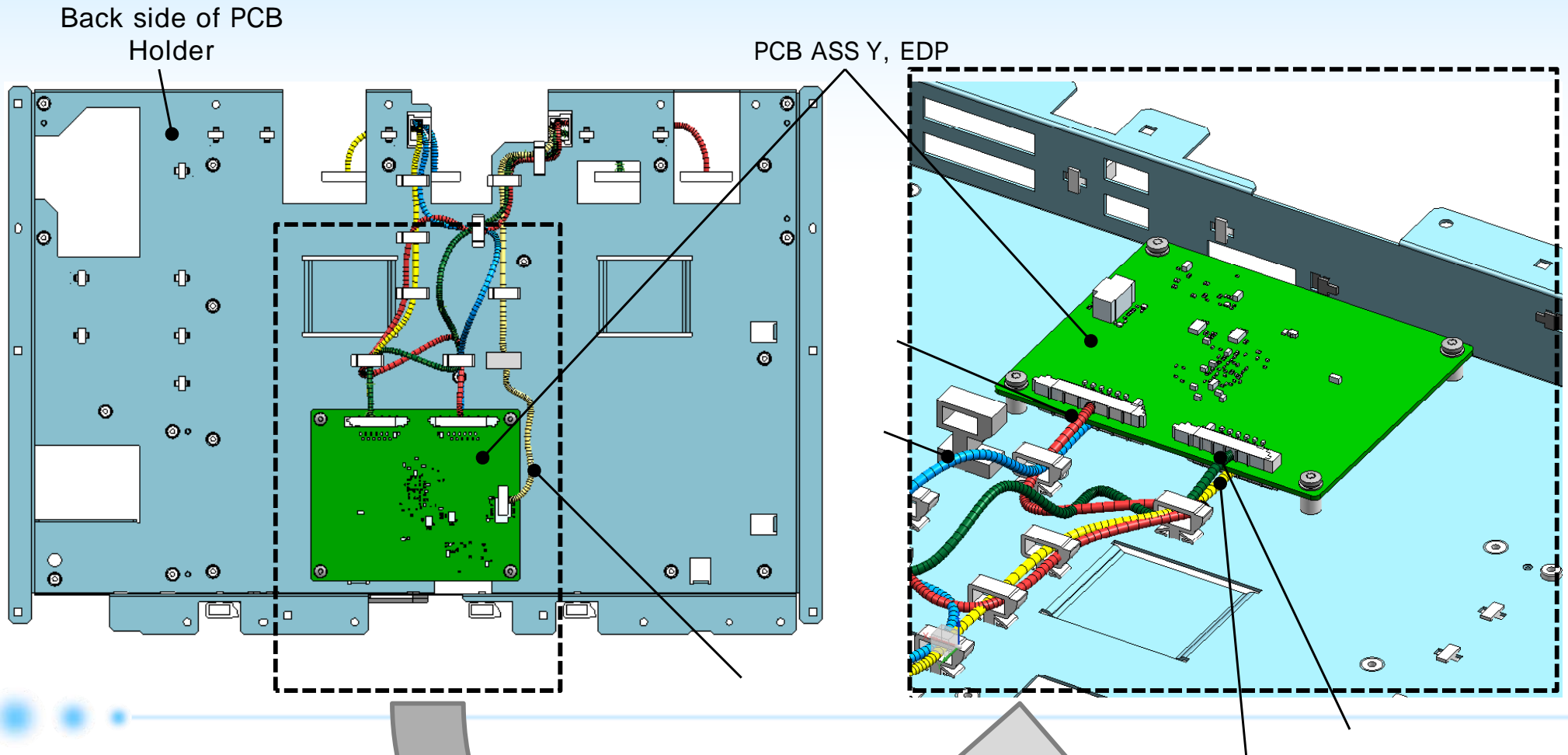

Mark	Parts No.	Description	Qty
	DD2-0082-000	CABLE, MAIN, TC-R	1
	DD2-0083-000	CABLE, MAIN, TC-G	1
	DD2-0084-000	CABLE, MAIN, TC-B	1
	DD2-0085-000	CABLE, MAIN, TC-Y	1
	DD2-0146-000	CABLE, MAIN, LV2EDP-CTRL	1



[Note on assembly]

Please fix the cables with clamps as follows.

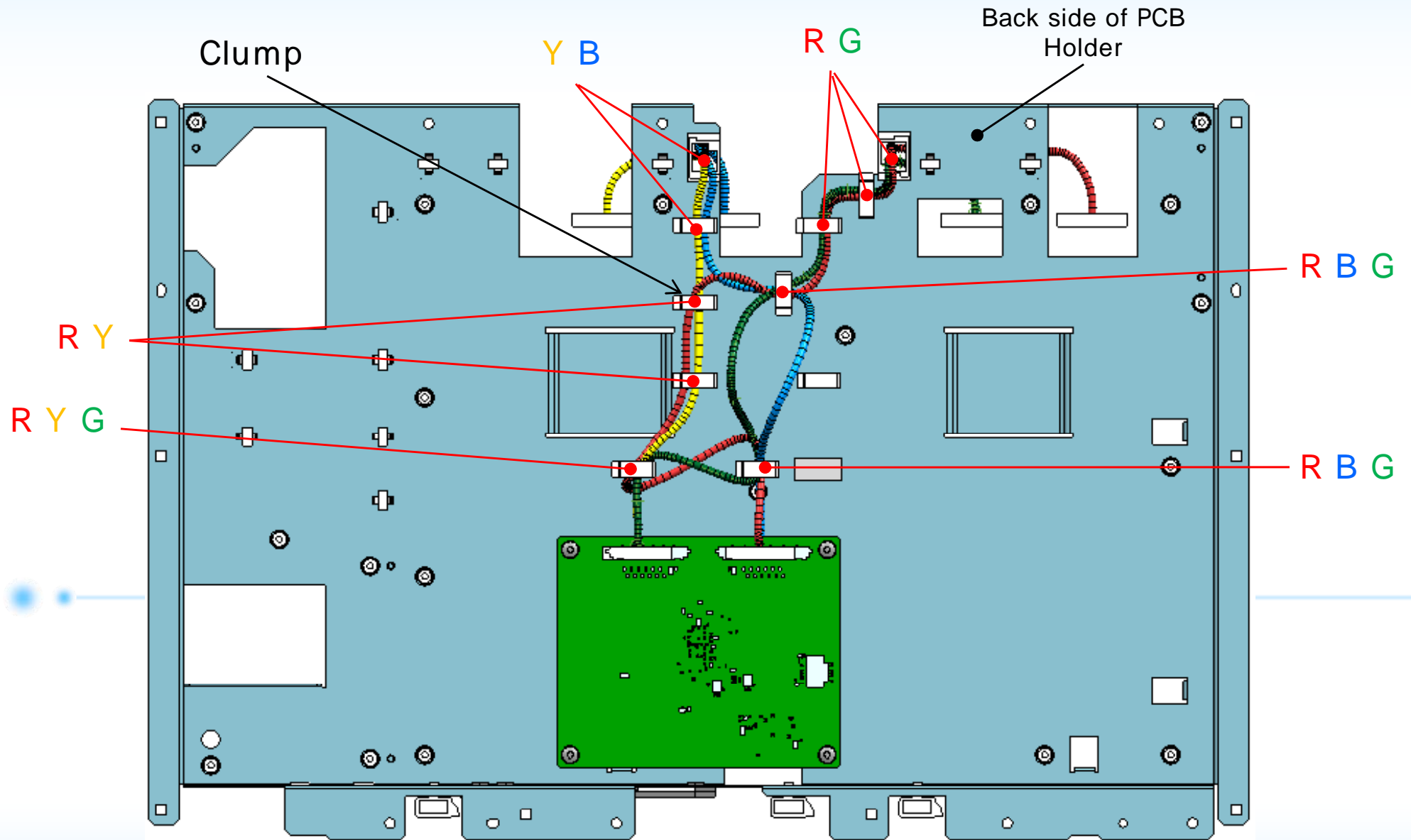

3.12 PCB ASS Y, EDP Detachment

1. Unfasten the 4 Screw-A screws, and remove the Mark from PCB Holder.
(The tightening torque is 60 N•cm.)

Mark	Parts No.	Description	Qty
	DM1-0037-000	PCB ASS'Y, EDP	1
	DD1-0556-000	CUSHION, MAIN4	2
Screw-A	XB2-8300-805	SCREW, MACH, PAN HEAD, M3X8	4

Back side of PCB Holder

[Note on assembly]
Attach 2 cushions

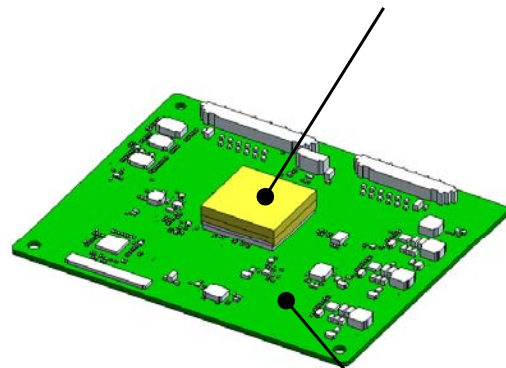

Screw-A

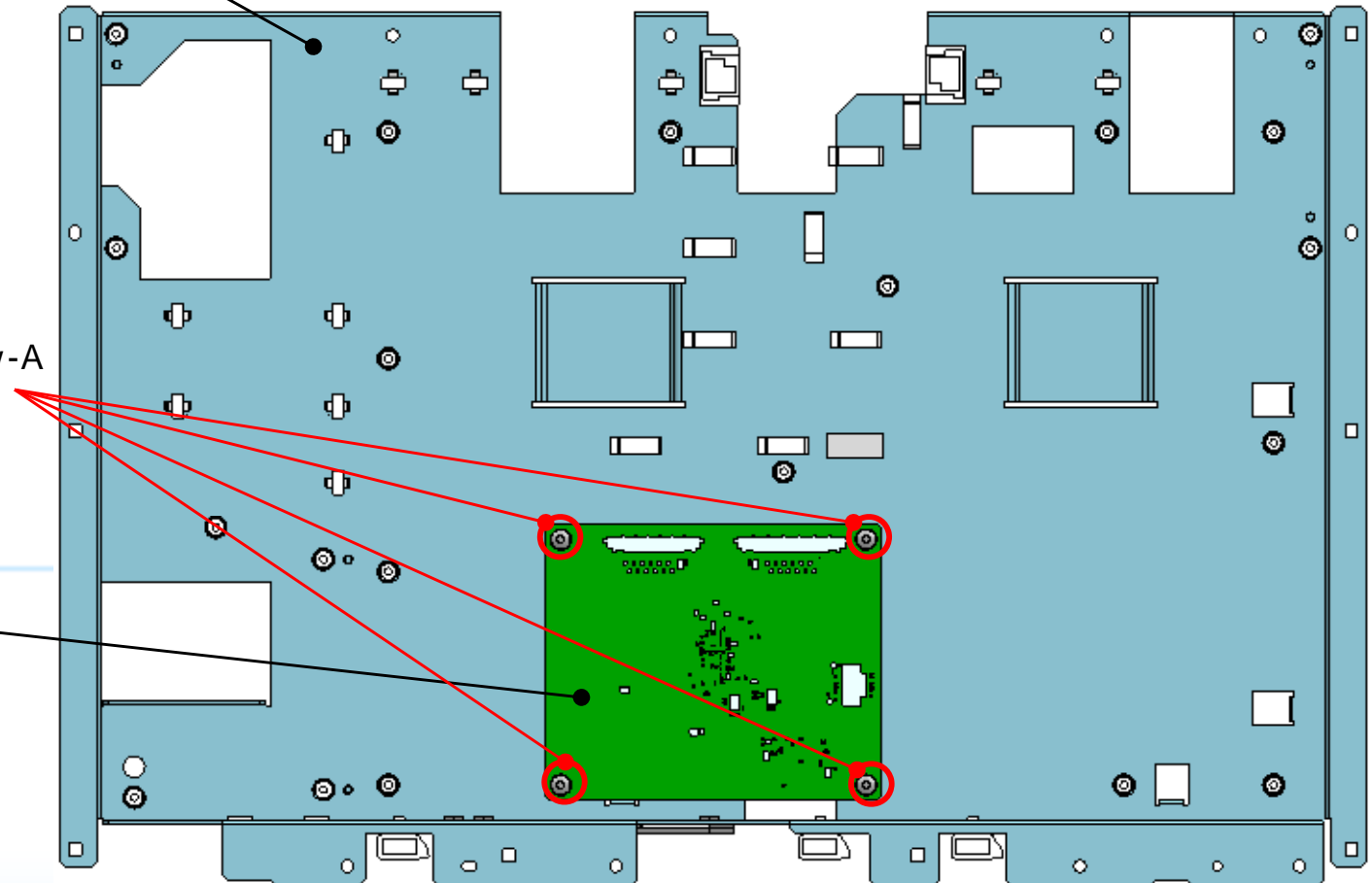

3.13 BL Driver BD, PCB ASS Y POWFILTER AC,PCB ASS Y POWFILTER DC and PCB ASS Y FRONT Detachment

1. Remove the FPC from the BL Driver BD.

Mark	Parts No.	Description	Qty
	DD2-0150-000	FPC, MAIN, DRIVER	1

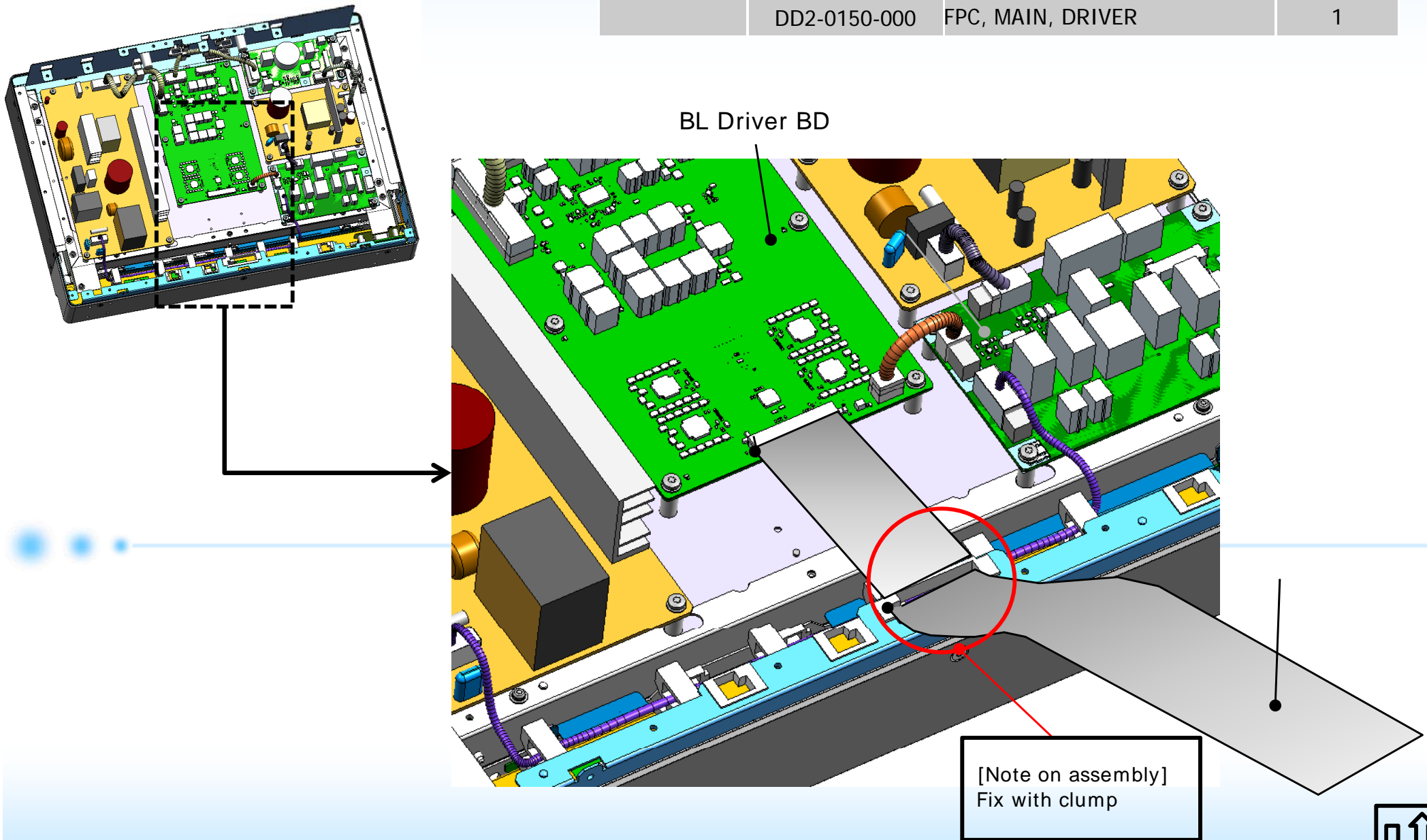

2. Remove each cables from BL Driver BD、PCB ASS Y POWFILTER AC,PCB、PCB ASS Y POWFILTER DC,PCB、24V POWER SUPPLY PCB ASSEMBLY、ALL NIGHT POWER PCB ASSEMBLY

Mark	Parts No.	Description	Qty
	DD2-0132-000	CABLE, POWFILAC, POW24V	1
	DD2-0133-000	CABLE, POW24V-DRIVER	1
	DD2-0134-000	CABLE, POWFILAC, POW5V	1
	DD2-0135-000	CABLE, POW5V, POWFILDC	1
	DD2-0136-000	CABLE, POWFILAC, DRIVER	1
	DD2-0138-000	CABLE, POWFILDC, DRIVER	1

[Note on assembly]
Please fix the cables with clamps as mark .

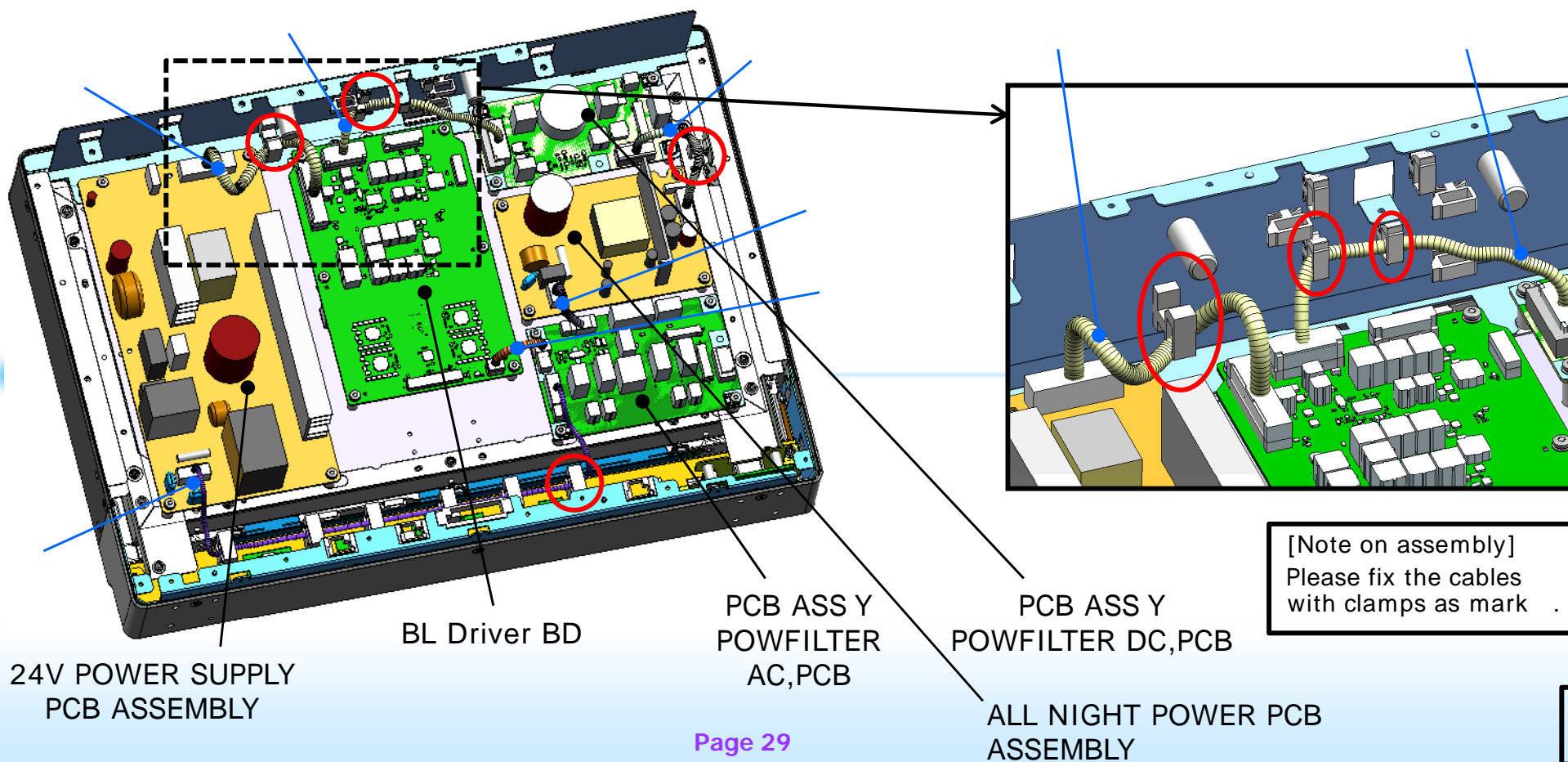

3. Remove the cables of the Mark and Mark from BL Driver BD.

Mark	Parts No.	Description	Qty
	DD2-0139-000	CABLE, DRIVER, MAIN01	1
	DD2-0140-000	CABLE, DRIVER, MAIN02	1

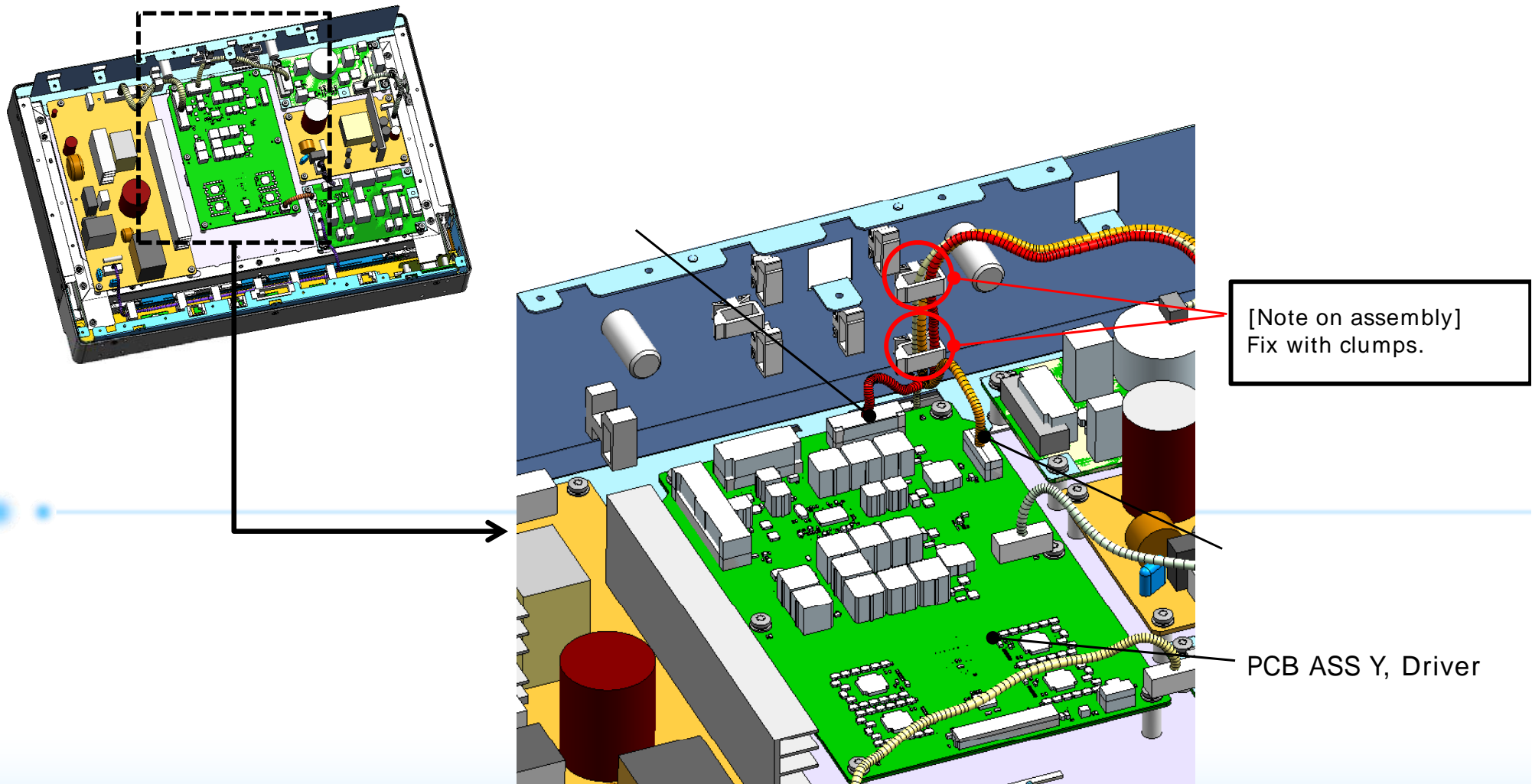

4. Remove the cables of the Mark , and Mark from PCB ASS Y, FRONT and PCB ASS Y USB/AUDIO.

Mark	Parts No.	Description	Qty
	DD2-0142-000	CABLE, MAIN, USB	1
	DD2-0143-000	CABLE, USB, ETALY	1
	DD2-0145-000	CABLE, MAIN, FRONT	1

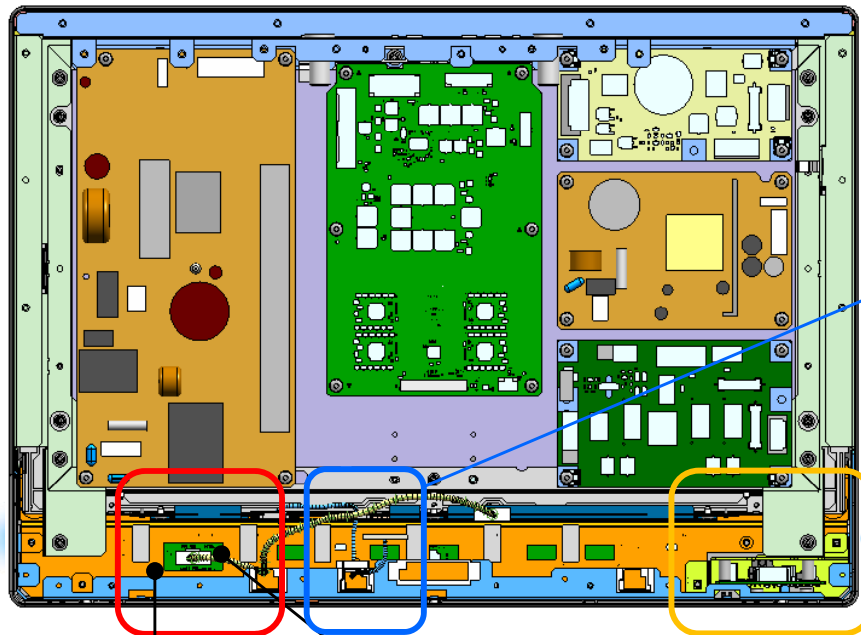

PCB ASS Y, FRONT

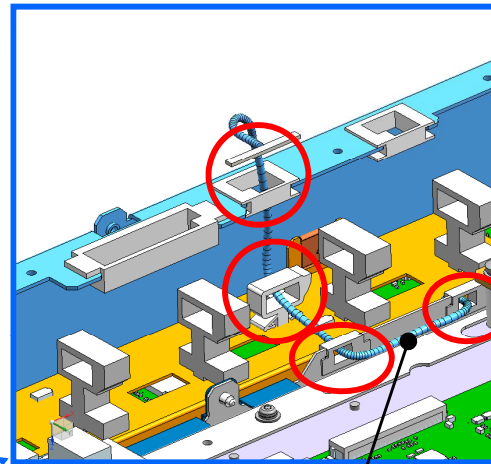

PANEL-EDP cable

[Note on assembly]
Please fix the cables with clamps as mark .

PCB ASS Y, USB/AUDIO

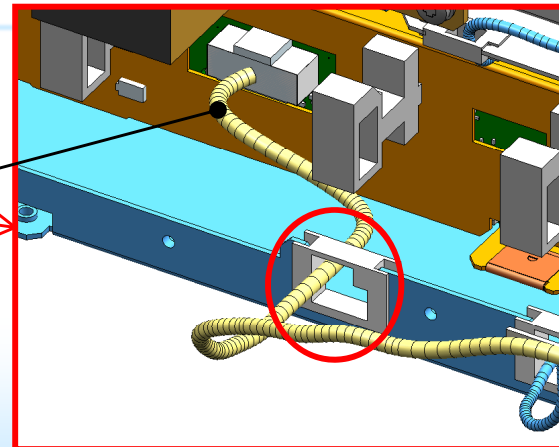
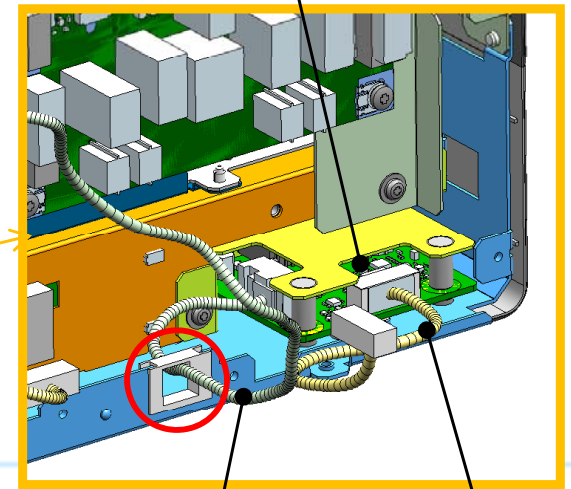

3.14 24V POWER SUPPLY PCB , ALL NIGHT POWER PCB, PCB ASS Y, POWFILTER AC/DC Detachment

1. Unfasten the 16 Screw-A screws, and remove the Mark , , and .
(The tightening torque is 60 N•cm.)

Mark	Parts No.	Description	Qty
	DM1-0045-000	PCB ASS'Y, POWFILTER DC	1
	FK3-3274-000	ALL NIGHT POWER PCB ASSEMBLY	1
	DM1-0044-000	PCB ASS'Y, POWFILTER AC	1
	FK2-6318-000	24V POWER SUPPLY PCB ASSEMBLY	1
Screw-A	XB2-8300-805	SCREW, MACH, PAN HEAD, M3X8	16

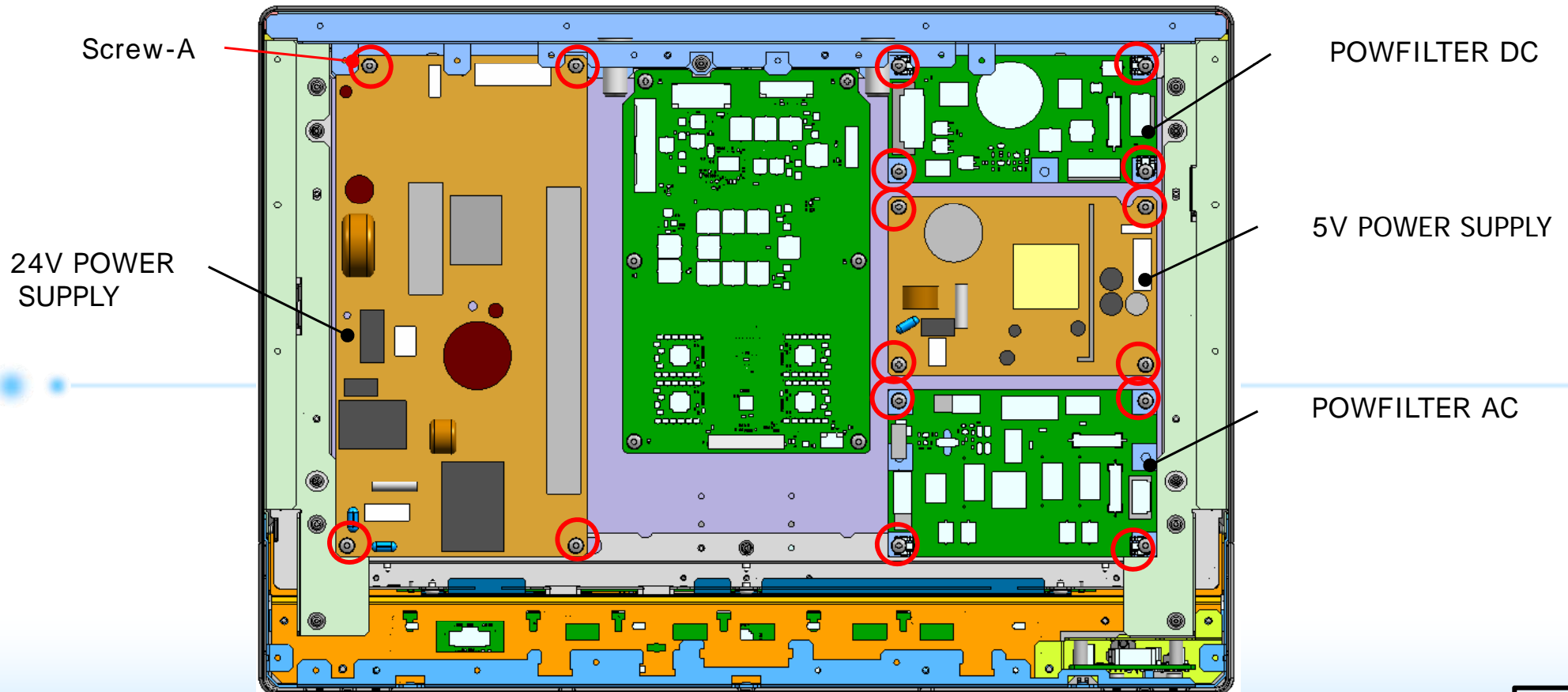

3.15 Preparation for FRONT BEZEL Parts Detachment

Since the PANEL UNIT will shift if the screen side of the main unit faces horizontally or downward when the FRONT BEZEL and Control Panel Cover have been removed, prepare in advance 8 cm blocks so that work can be performed with the main unit screen facing upward. (Styrofoam or other soft blocks, or plastic cases as shown in the photo, can also be used)

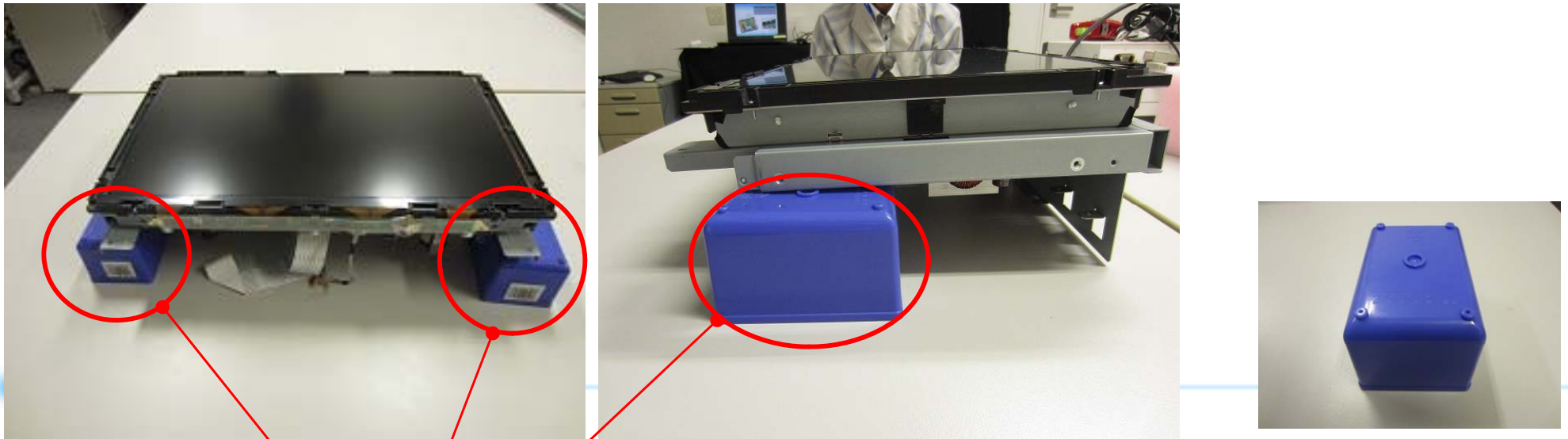

Prepare two blocks
approx. 8 cm in height



3.16 FRONT BEZEL Parts Detachment

1. Unfasten the two Screw-A screws.
2. Face the display panel up and put on a Styrofoam or something . (Refer to 3.15)
1. Unfasten the 6 Screw-B screws, and remove the FRONT BEZEL and Control Panel Cover. (The tightening torque for Screw-A is 100 N•cm.) (The tightening torque for Screw-B is 60 N•cm.)

Mark	Parts No.	Description	Qty
Screw-A	XB6-7300-405	SCREW, TP, M3X4	2
Screw-B	DD1-0346-000	SCREW, ACIN, M3X6	7

[Caution]
 The PANEL UNIT is designed to be secured by the FRONT BEZEL and can shift and come away from the frame if the FRONT BEZEL is removed. Never let the PANEL UNIT face horizontally or downward when the FRONT BEZEL and Control Panel Cover are removed as it is difficult to return the PANEL UNIT once it has come away.

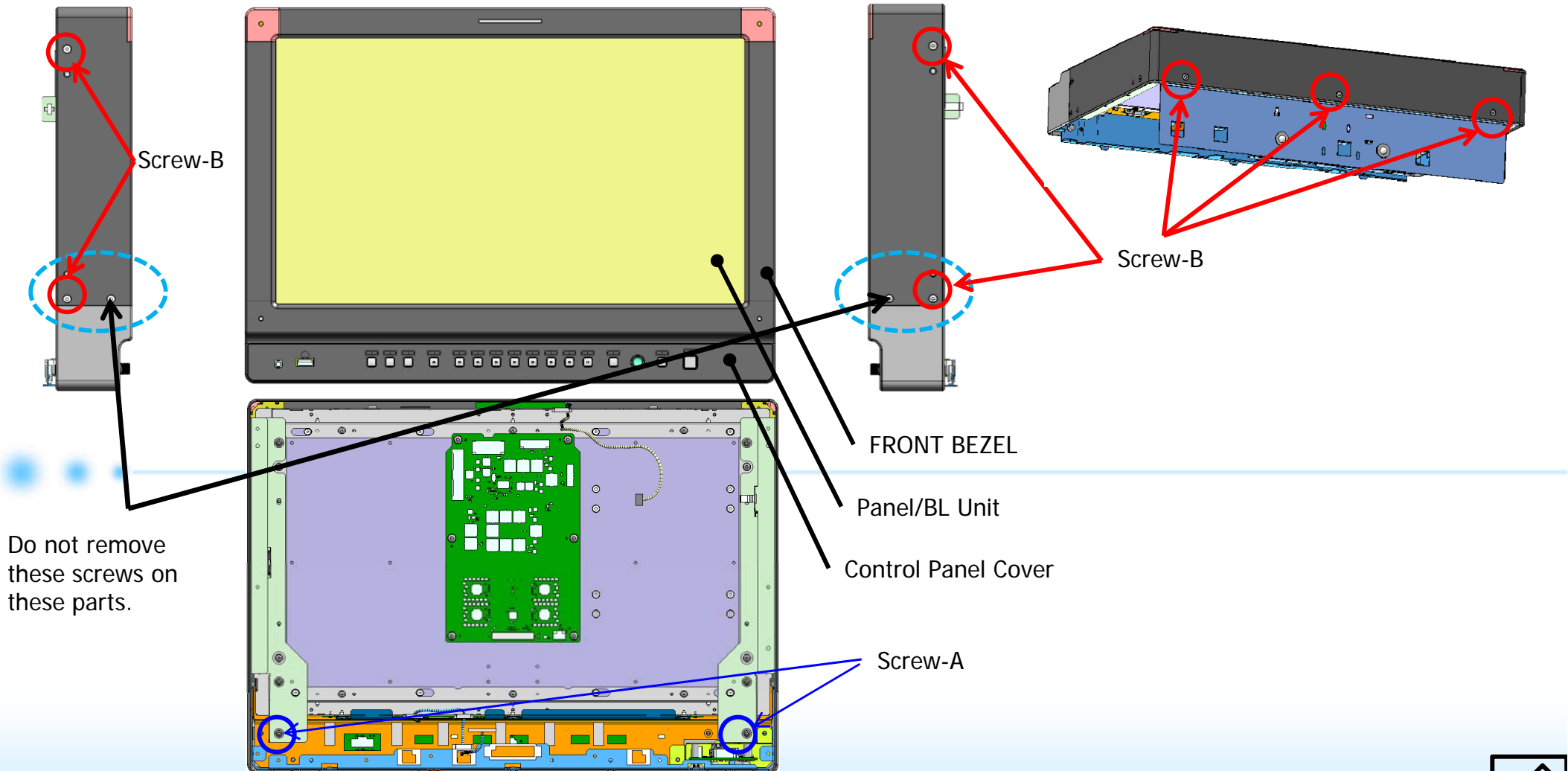

Mark	Parts No.	Description	Qty
Screw-A	DD1-0104-000	SCREW, M2X3	4
Screw-B	DD1-0346-000	SCREW, ACIN, M3X6	2
Screw-C	DD1-0344-000	SCREW, HEX M2X6	4
	DD1-0301-000	COVER, CORNER BEZEL	2
	DL1-0101-000	COVER, FRONT BEZEL	1

- Unfasten the 2 Screw-B screws, and remove the Mark from Control Panel Cover. (The tightening torque is 60 N•cm.)
- Unfasten the 2 Screw-A screws, and remove the Mark from the Mark. (The tightening torque is 13 N•cm.)

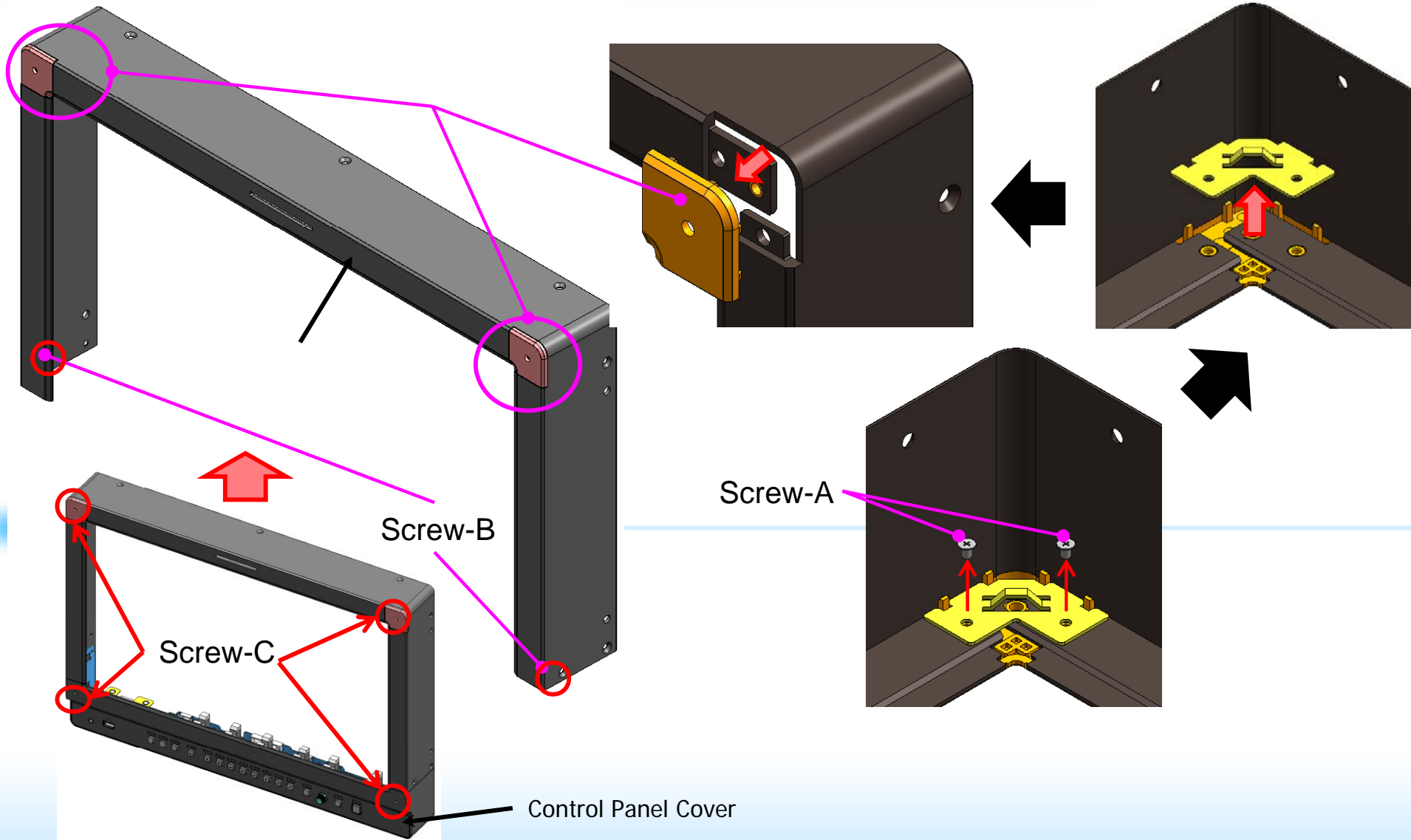

[Note on assembly1]

1. Affix two [TAPE, TALLY] on the back side of [COVER, FRONT BEZEL].

Mark	Parts No.	Description	Qty
	DD1-0508-000	INDICATOR, TALLY	1
	DD1-0564-000	TAPE, TALLY	1

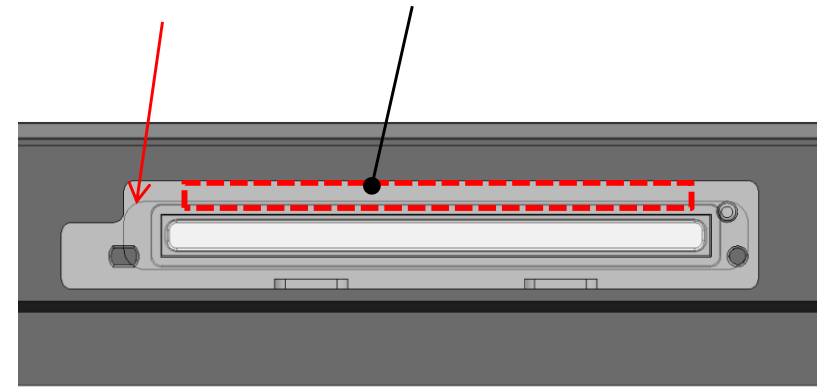
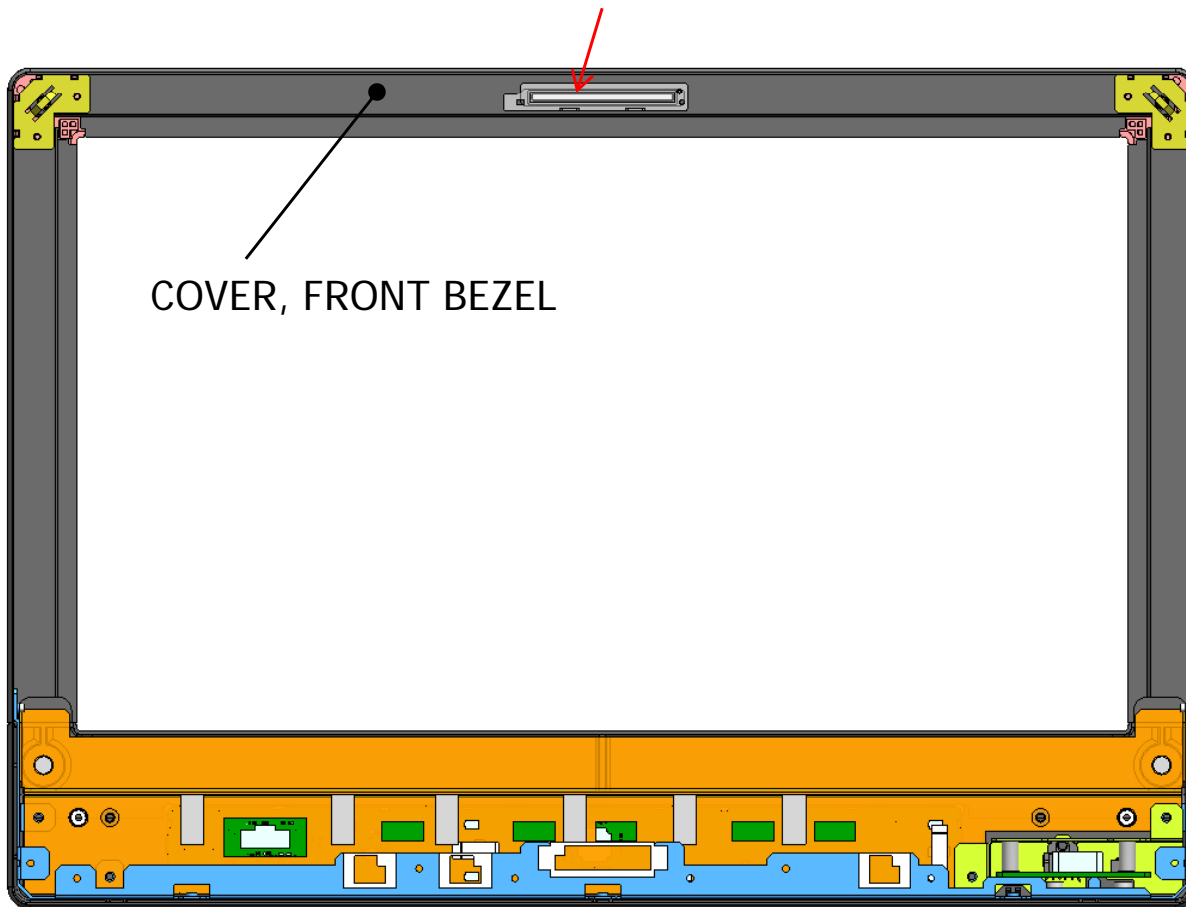

[Note on assembly2]

2. Affix two [CUSHION, BEZEL H] on the left and right of [COVER, FRONT BEZEL].

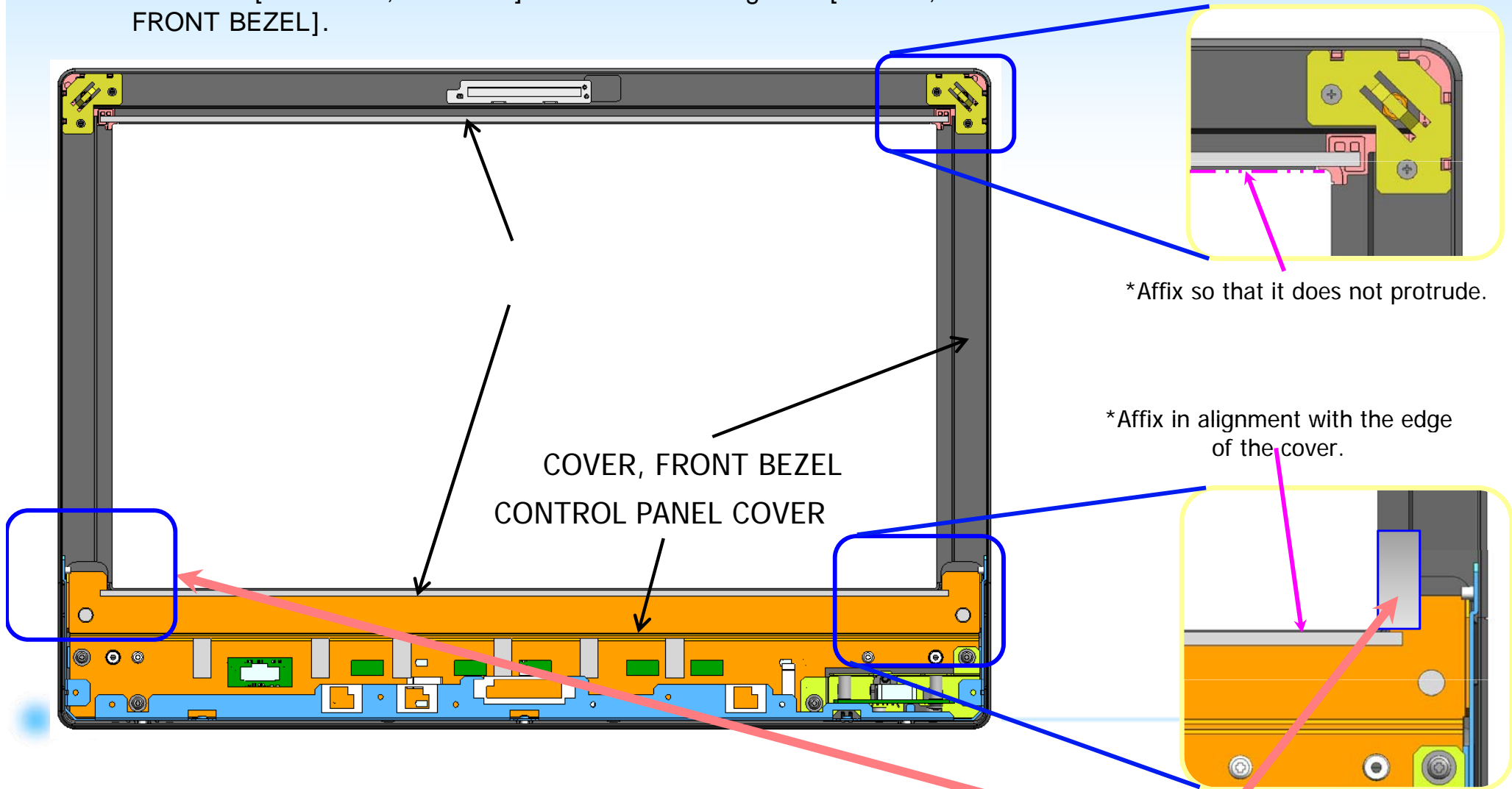

*Affix so that it does not protrude.

*Affix in alignment with the edge of the cover.

Mark	Parts No.	Description	Qty
	DD1-0542-000	CUSHION, BEZEL H	2
	CY9-5710-000	TAPE, ROLL (NO156A) 10MM X 30M	1

Cut pieces of tape from the roll (CY9-5710-000), and affix it between [CONTROL PANEL COVER] and [COVER, FRONT BEZEL]. (Light leak prevention)
Tape length: 10 mm x 30 mm



[Note on assembly3]

3. Affix two [CUSHION, BEZEL V] on the left and right of [COVER, FRONT BEZEL].

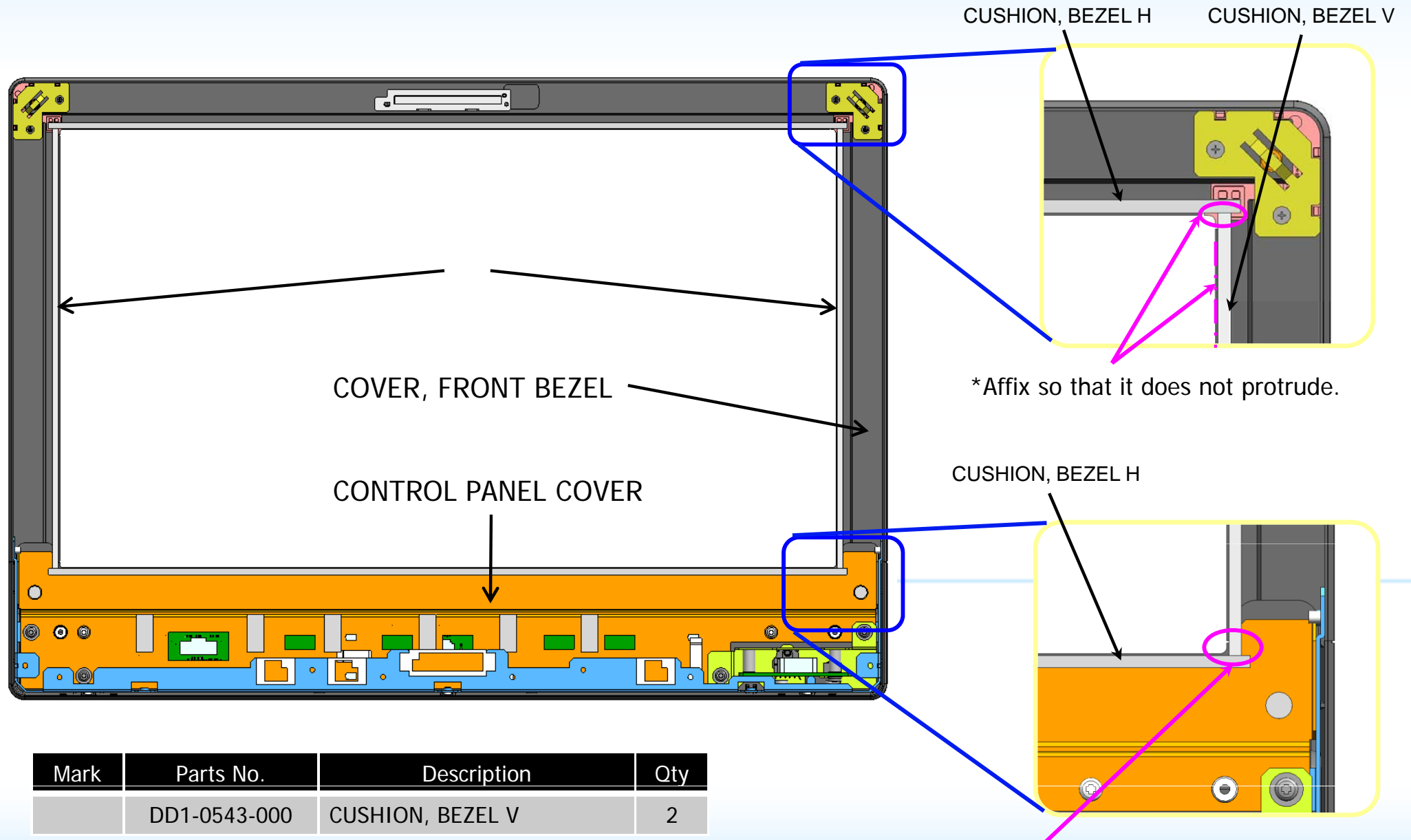

Mark	Parts No.	Description	Qty
	DD1-0543-000	CUSHION, BEZEL V	2



3.17 PCB ASS Y, TALLY Detachment

Mark	Parts No.	Description	Qty
	DM1-0041-000	PCB ASS'Y, TALLY	1
	DD2-0141-000	CABLE, MAIN, TALLY	1
Screw-A	XB1-2200-805	SCREW, MACH, TRUSS HEAD, M2X8	2

1. Unfasten the 2 Screw-A screws, and remove the Mark from .
(The tightening torque is 30 N•cm.)

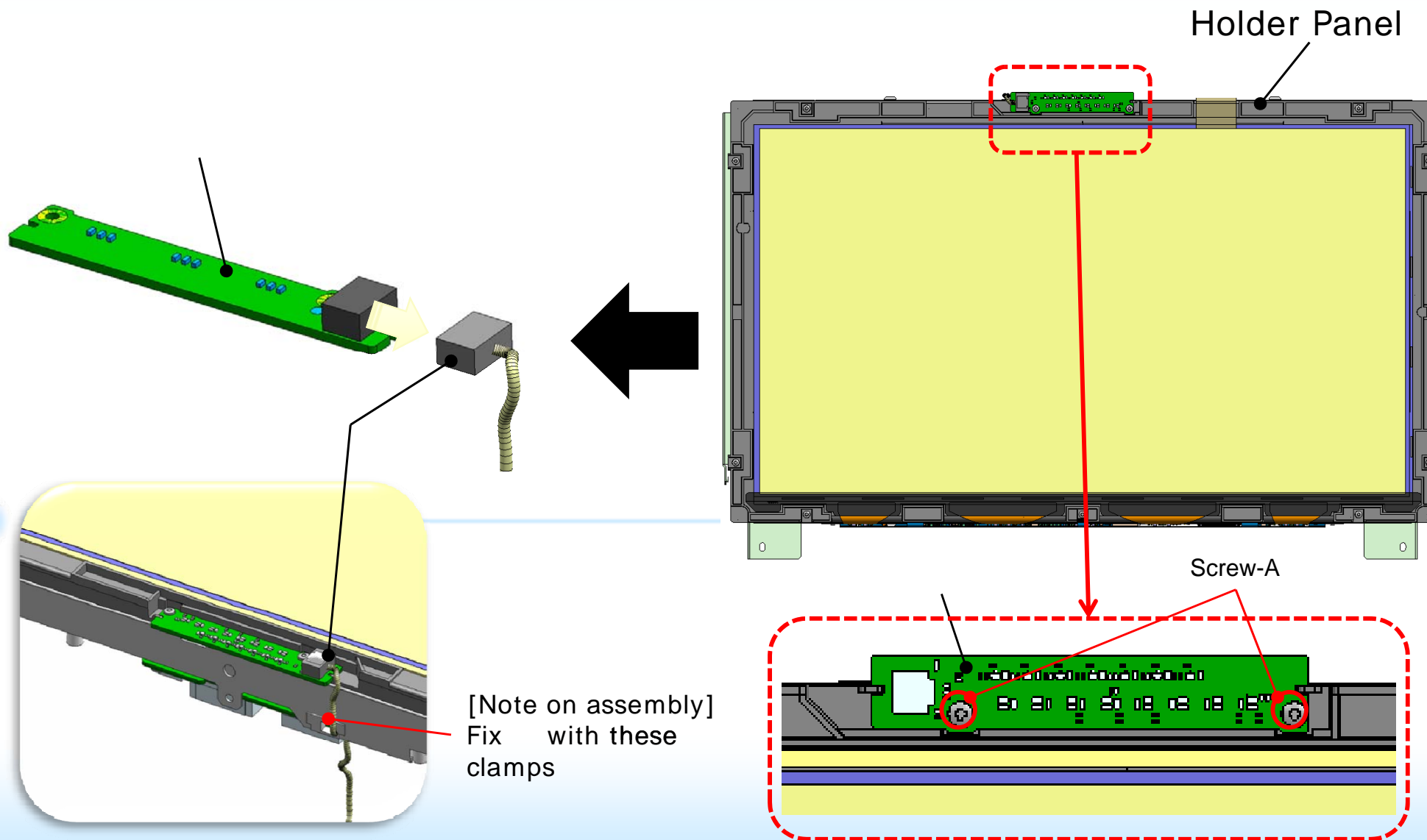

3.18 Control Panel Cover Parts Detachment

1. Unfasten the 2 Screw-A screws, and remove [USB/AUDIO Unit] from [Control Panel Cover].
(The tightening torque for Screw-A is 100 N•cm.)
2. Unfasten the 2 Screw-B screws and 1 Screw-C screw, and remove Mark from [USB/AUDIO Unit].
(The tightening torque for Screw-B is 60 N•cm.)
(The tightening torque for Screw-C is 40 N•cm.)

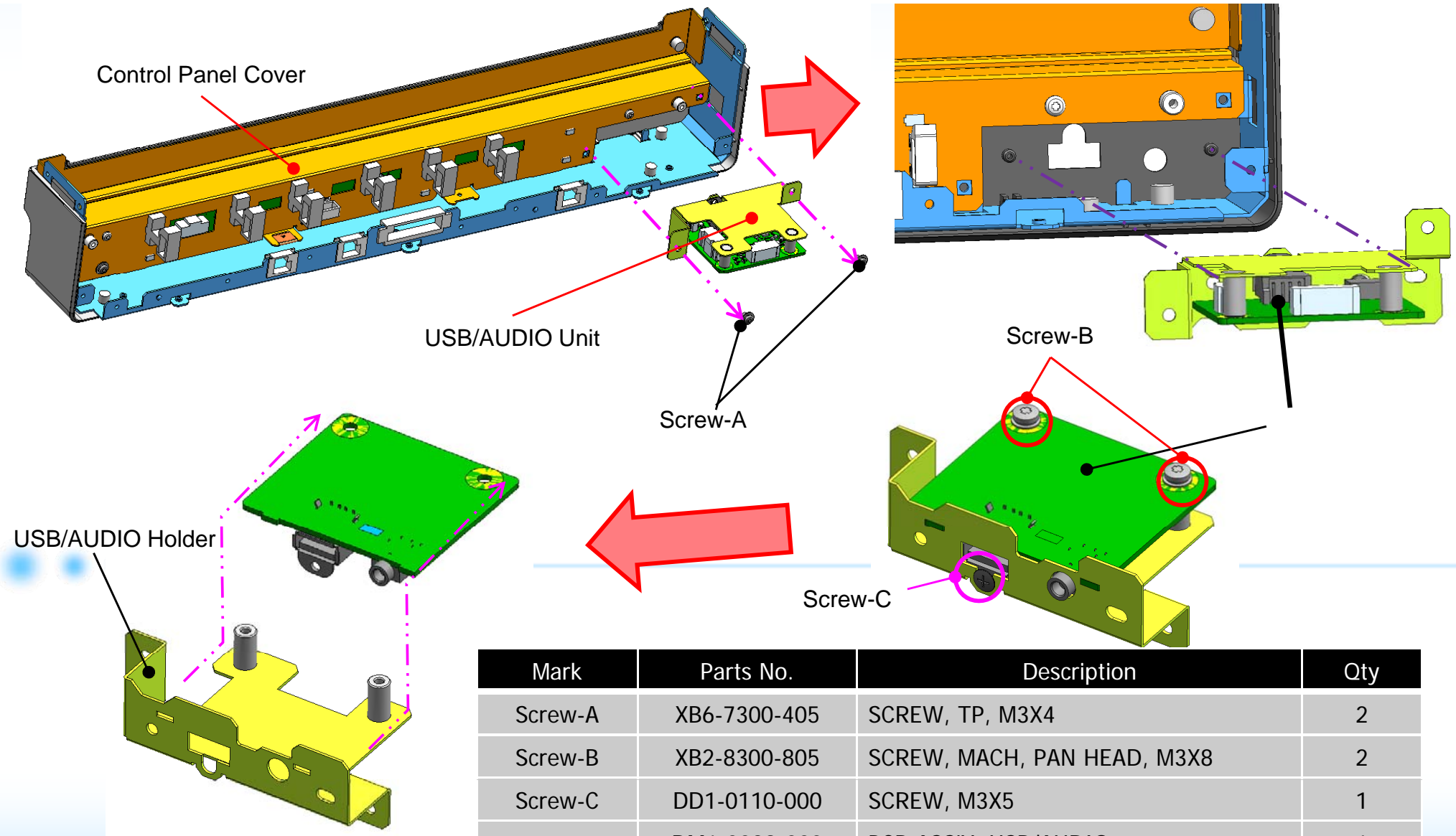

Mark	Parts No.	Description	Qty
Screw-A	XB6-7300-405	SCREW, TP, M3X4	2
Screw-B	XB2-8300-805	SCREW, MACH, PAN HEAD, M3X8	2
Screw-C	DD1-0110-000	SCREW, M3X5	1
	DM1-0039-000	PCB ASS'Y, USB/AUDIO	1



3. Remove the 3 Screw-A screws from [Control Panel Cover].
(The tightening torque is 60 N•cm.)

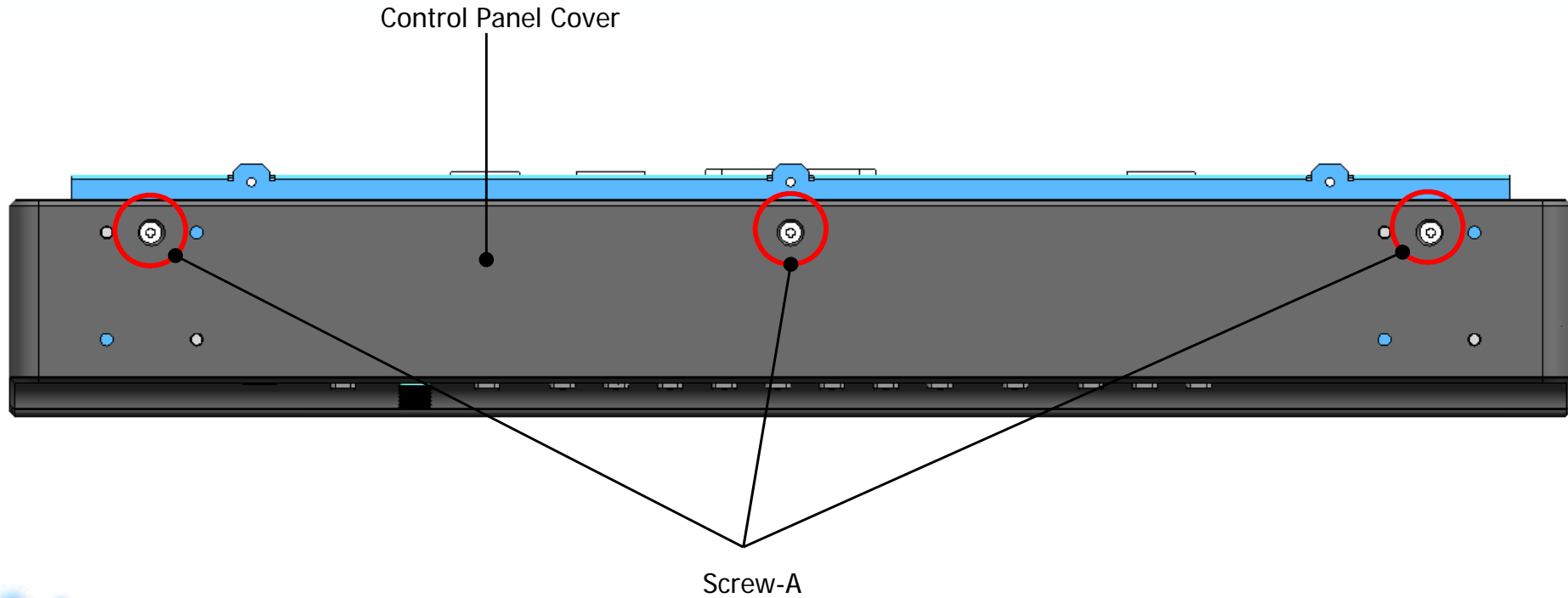

Mark	Parts No.	Description	Qty
Screw-A	DD1-0346-000	SCREW, ACIN, M3X6	3



4. Unfasten the 2 Screw-B screws and 2 Screw-C screws , and remove Frame from Control Panel Cover.
 (The tightening torque for Screw-B is 40 N•cm.)
 (The tightening torque for Screw-C is 40 N•cm.)

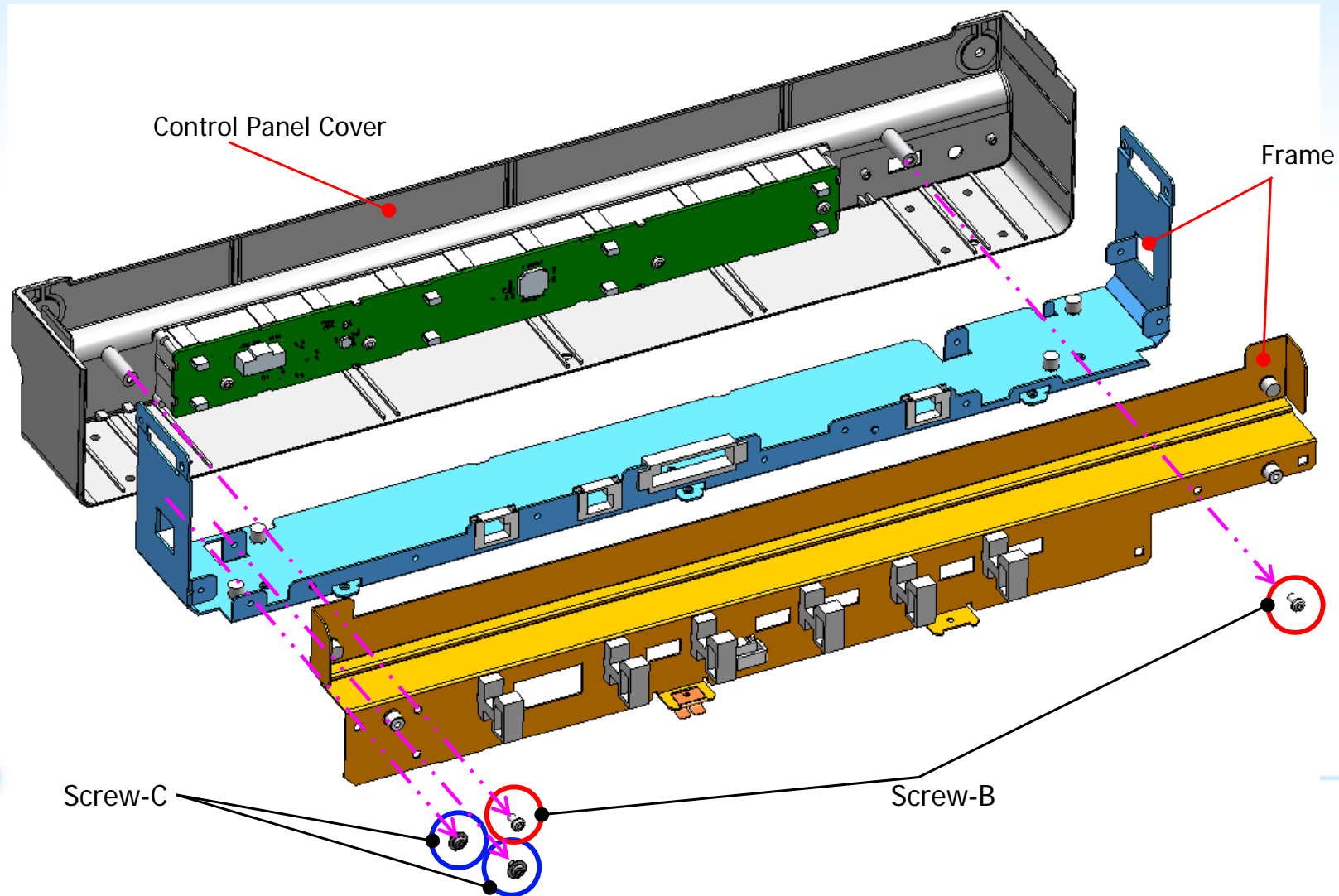

Mark	Parts No.	Description	Qty
Screw-B	XB4-7300-609	SCREW, TAP, BINDING HEAD, M3X6	2
Screw-C	XB6-7300-405	SCREW, TP, M3X4	2



5. Unfasten the 4 Screw-B screws, and remove the Mark from .
 (The tightening torque is 30 N•cm.)

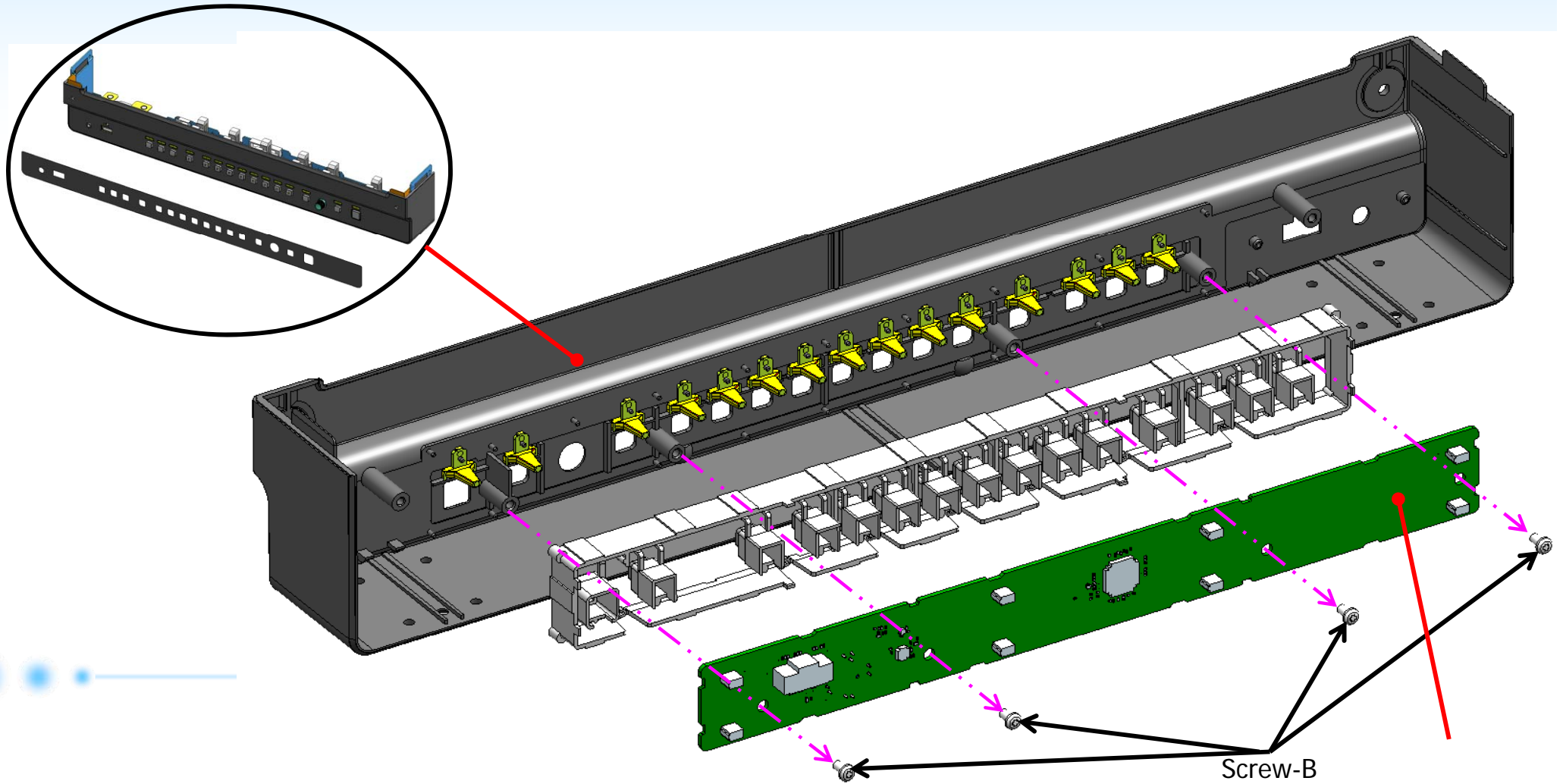

Mark	Parts No.	Description	Qty
Screw-B	XB4-7300-609	SCREW, TAP, BINDING HEAD, M3X6	4
	DM1-0038-000	PCB ASS'Y, FRONT	1
	DY5-8043-000	COVER, CONTROL PANEL	1



[Notes on assembly]

1. When exchanging PCB ASS'Y, FRONT, affix KNOB, JOG with an adhesive (DIABOND No.1663G BLACK).

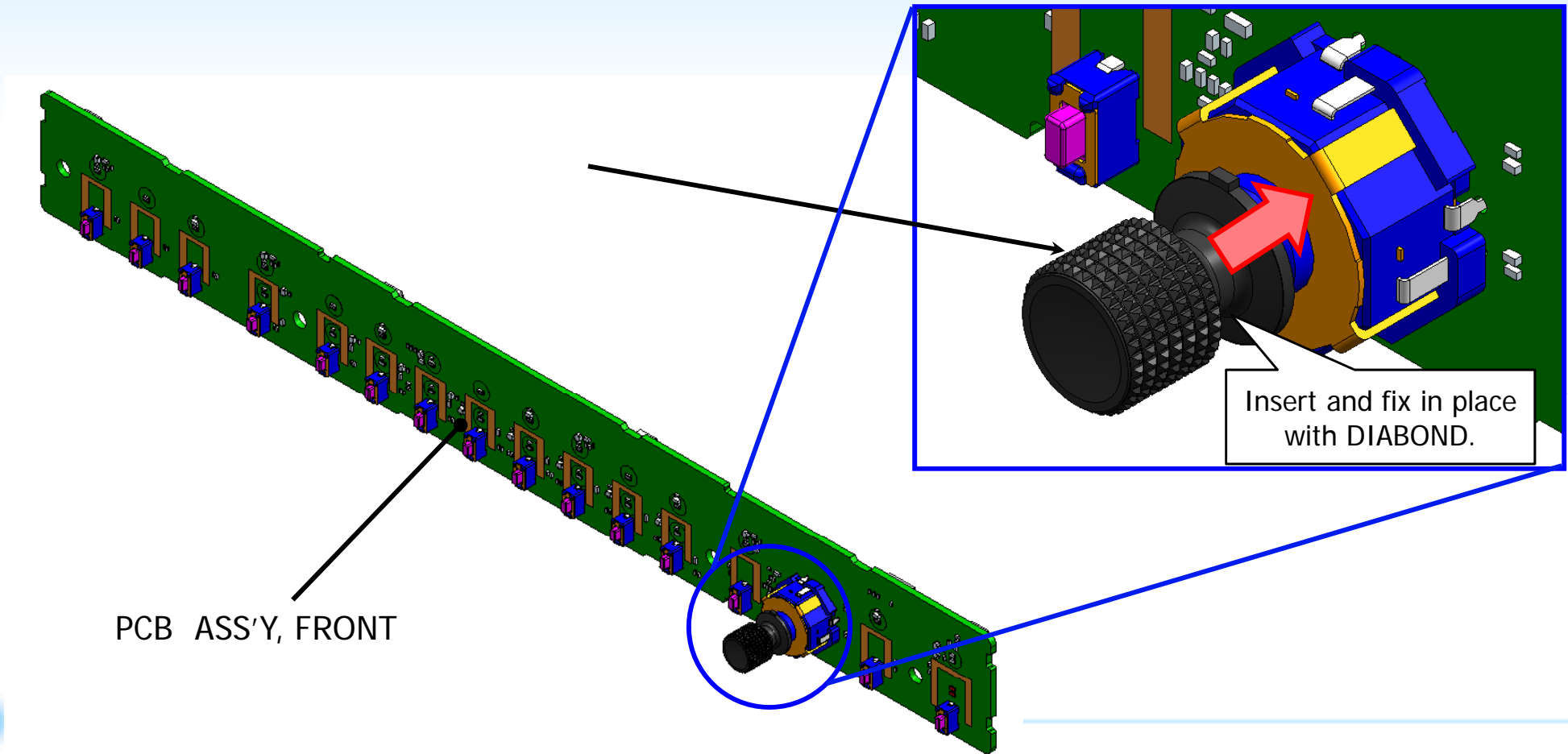

Mark	Parts No.	Description	Qty
	DD1-0310-000	KNOB, JOG	1
	CY9-8129-000	DIABOND No.1663G BLACK	



Parts Catalog for DP-V1710,1711

No	Contents	Page
1	Electrical Parts	46
2	External Parts	47
3	Internal Parts	48
4	Screws	49
5	Accessory	50



Parts List

1. Electrical Parts

New	Parts No	Description	Qty	Page
	DM1-0036-000	PCB ASS'Y, MAIN	1/0	21
*	DM1-0057-000	PCB ASS'Y, MAIN	0/1	22
	DM1-0037-000	PCB ASS'Y, EDP	1	23
	DM1-0038-000	PCB ASS'Y, FRONT	1	39
	DM1-0039-000	PCB ASS'Y, USB/AUDIO	1	36
	DM1-0041-000	PCB ASS'Y, TALLY	1	35
	DM1-0044-000	PCB ASS'Y, POWFILTER AC	1	28
	DM1-0045-000	PCB ASS'Y, POWFILTER DC	1	28
	DY5-8041-000	PANEL/BL UNIT, DP-V1710	1	51
	DY5-8042-000	PCB ASS'Y, LAN	1	18
	FK2-6318-000	24V POWER SUPPLY PCB ASSEMBLY	1	28
	FK3-3274-000	ALL NIGHT POWER PCB ASSEMBLY (5V)	1	28
	DM6-0005-000	FAN, SYSTEM	2	30
	DM1-0042-000	PCB ASS'Y, DRIVER	1	30



Parts List

2.External Parts

New	Parts No	Description	Qty	Page
	DD1-0060-000	PAD, FOOT	2	9
	DD1-0107-001	LABEL, CAUTION	1	12
	DD1-0301-000	COVER, CORNER BEZEL	2	31
	DD1-0310-000	KNOB, JOG	1	40
	DD1-0445-000	FOOT STAND, REAR	2	9
	DD1-0446-000	PAD, FOOT, FRONT	2	9
	DD1-0447-000	FOOT STAND, FRONT	2	9
	DD1-0555-000	HANDLE, DP-V1710	1	10
	DL1-0101-000	COVER, FRONT BEZEL	1	31
	DL1-0103-000	COVER, REAR	1/0	11
*	DL1-0141-000	COVER, REAR	0/1	12
	DY5-8043-000	COVER, CONTROL PANEL	1	39
	DD1-0652-000	LABEL, CAUTION	1	14



Parts List

3. Internal Parts

New	Parts No	Description	Qty	Page
	DD1-0350-000	CUSHION, MAIN2	4	19
	DD1-0368-000	GASKET, EMI FOR SDI	0	12
	DD1-0448-000	BASE, FOOT	2	9
	DD1-0508-000	INDICATOR, TALLY	1	32
	DD1-0542-000	CUSHION, BEZEL H	2	33
	DD1-0543-000	CUSHION, BEZEL V	2	34
	DD1-0544-000	CUSHION, MAIN3	4	20
	DD1-0556-000	CUSHION, MAIN4	3	19,23
	DD2-0082-000	CABLE, MAIN, TC-R	1	15,21
	DD2-0083-000	CABLE, MAIN, TC-G	1	15,21
	DD2-0084-000	CABLE, MAIN, TC-B	1	15,21
	DD2-0085-000	CABLE, MAIN, TC-Y	1	15,21
	DD2-0131-000	CABLE, ACIN	1	18
	DD2-0132-000	CABLE, POWFILAC, POW24V	1	25
	DD2-0133-000	CABLE, POW24V-DRIVER	1	25
	DD2-0134-000	CABLE, POWFILAC, POW5V	1	25
	DD2-0135-000	CABLE, POW5V, POWFILDC	1	25
	DD2-0136-000	CABLE, POWFILAC, DRIVER	1	25
	DD2-0137-000	CABLE, DCIN	1	18
	DD2-0138-000	CABLE, POWFILDC, DRIVER	1	25
	DD2-0139-000	CABLE, DRIVER, MAIN01	1	15,26
	DD2-0140-000	CABLE, DRIVER, MAIN02	1	15,26
	DD2-0141-000	CABLE, MAIN, TALLY	1	15,35
	DD2-0142-000	CABLE, MAIN, USB	1	15,27
	DD2-0143-000	CABLE, USB, ETALY	1	15,27
	DD2-0144-000	CABLE, MAIN, ETALY	1	15,44
	DD2-0145-000	CABLE, MAIN, FRONT	1	15,27
	DD2-0146-000	CABLE, MAIN, LV2EDP-CTRL	1	15,20,21
	DD2-0150-000	FPC, MAIN, DRIVER	1	15,24



Parts List

4.Screws etc

New	Parts No	Description	Qty	Page
	DD1-0103-000	SCREW, M3X6	15	11
	DD1-0104-000	SCREW, M2X3	4	31
	DD1-0110-000	SCREW, M3X5	4	11,36
	DD1-0120-000	SCREW, M2.6X5	0	11
	DD1-0344-000	SCREW, HEX M2X6	4	31
	DD1-0346-000	SCREW, ACIN, M3X6	14	18,30,31,37
	XB1-2200-805	SCREW, MACH, TRUSS HEAD, M2X8	13	18,35
	XB2-4301-005	SCREW, W/WASHER, M3X10	6	8
	XB2-8300-805	SCREW, MACH, PAN HEAD, M3X8	45	18,19,23,28,36
	XB4-7300-609	SCREW, TAP, BINDING HEAD, M3X6	6	38,39
	XB4-8300-809	SCREW, TAP, BINDING M3X8	4	9
	XB6-7300-405	SCREW, TP, M3X4	39	17,20,30,36,38
	XB6-7400-805	SCREW, TP, M4X8	1	13,17,29
	XB7-1040-089	BOLT, HEX SKT. (CODE 03B) M4X8	4	14
	XB7-1080-209	BOLT	2	10
	XD1-4200-402	WASHER, TOOTHED LOCK, M4	1	17



Parts List

5. Accessory

New	Parts No	Description	Qty	Page
	D44-2005-000	ADAPTER, PLUG, PU-01	1	50
	D44-2007-000	CORD, POWER, 125V	1	50
	D44-2013-000	CORD, POWER, 125V	1	50
	D44-2014-000	CORD, POWER, 250V	1	50
	D44-2010-000	CORD, POWER, 250V	1/0	57



AC Power Cord HT-20 / HT-21

D44-2007-000 (For JP)
D44-2013-000 (For US)
D44-2014-000 (For EU)
D44-2010-000 (For CN)



Plug Adapter PU-01

D44-2005-000



PANEL/BACKLIGHT UNIT, DP-V1710 (DY5-8041-000) Structure

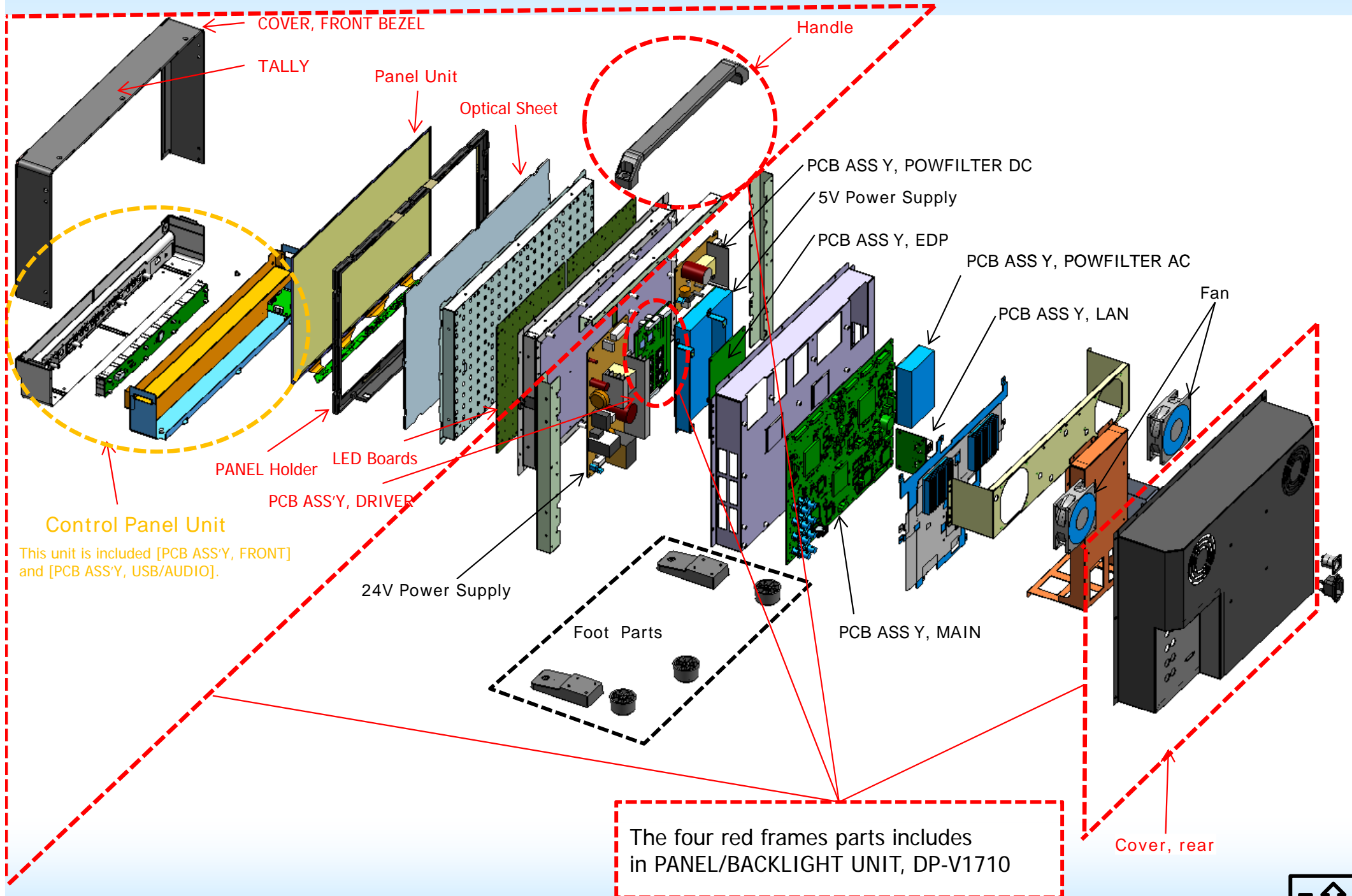

Canon

To order spare parts or to register as a repairer, please contact us at this e-mail address.

E-mail : display.support@canon-europe.com

Canon Europe Ltd.

The Square

Stockley Park

Uxbridge

Middlesex

United Kingdom UB11 1ET

Canon Europa N.V.

Bovenkerkerweg 59

1185 XB

Amstelveen

The Netherlands

Product information sheet

	Information	Value and precision	Unit	Notes
1.	Supplier's name or trade mark	Canon Inc.		
2.	Supplier's model identifier	DP-V3120		
12.	Screen resolution (pixels)	4096 x 2160	pixels	Horizontal and vertical pixels
21.	Minimum guaranteed availability of software and firmware updates	T.B.D.	date	Until at least eight years after the placing on the market of the last product

	Information	Value and precision	Unit	Notes
1.	Supplier's name or trade mark	Canon Inc.		
2.	Supplier's model identifier	DP-V2411		
12.	Screen resolution (pixels)	4096 x 2160	pixels	Horizontal and vertical pixels
21.	Minimum guaranteed availability of software and firmware updates	T.B.D.	date	Until at least eight years after the placing on the market of the last product

	Information	Value and precision	Unit	Notes
1.	Supplier's name or trade mark	Canon Inc.		
2.	Supplier's model identifier	DP-V1711		
12.	Screen resolution (pixels)	3840 x 2160	pixels	Horizontal and vertical pixels
21.	Minimum guaranteed availability of software and firmware updates	T.B.D.	date	Until at least eight years after the placing on the market of the last product