



# Maintenance and Service Guide

## **SUMMARY**

This guide provides information about spare parts, removal and replacement of parts, security, backing up, and more.

## Legal information

© Copyright 2022 HP Development Company, L.P.

Bluetooth is a trademark owned by its proprietor and used by HP Inc. under license. Chrome, Chromebook, Chrome OS, Google, and Google Drive are trademarks of Google LLC. Intel, Celeron, and vPro are trademarks of Intel Corporation or its subsidiaries in the U.S. and/or other countries. SDHC, SDXC, and microSD are trademarks or registered trademarks of SD-3C LLC. USB Type-C and USB-C are registered trademarks of USB Implementers Forum. DisplayPort™ and the DisplayPort™ logo are trademarks owned by the Video Electronics Standards Association (VESA®) in the United States and other countries.

The information contained herein is subject to change without notice. The only warranties for HP products and services are set forth in the express warranty statements accompanying such products and services. Nothing herein should be construed as constituting an additional warranty. HP shall not be liable for technical or editorial errors or omissions contained herein.

First Edition: May 2022

Document Part Number: N09678-001

### Product notice

This guide describes features that are common to most models. Some features may not be available on your computer.

Not all features are available in all editions or versions of Windows. Systems may require upgraded and/or separately purchased hardware, drivers, software or BIOS update to take full advantage of Windows functionality. Windows is automatically updated, which is always enabled. High-speed internet and Microsoft account required. ISP fees may apply and additional requirements may apply over time for updates. See <http://www.microsoft.com>. **If your product ships with Windows in S Mode:** Windows in S Mode works exclusively with apps from the Microsoft Store within Windows. Certain default settings, features, and apps cannot be changed. Some accessories and apps that are compatible with Windows may not work (including some antivirus, PDF writers, driver utilities, and accessibility apps), and performance may vary, even if you switch out of S Mode. If you switch to Windows, you cannot switch back to S Mode. Learn more at [Windows.com/SmodeFAQ](https://windows.com/SmodeFAQ).

To access the latest user guides, go to <http://www.hp.com/support>, and follow the instructions to find your product. Then select **Manuals**.

### Software terms

By installing, copying, downloading, or otherwise using any software product preinstalled on this computer, you agree to be bound by the terms of the HP End User License Agreement (EULA). If you do not accept these license terms, your sole remedy is to return the entire unused product (hardware and software) within 14 days for a full refund subject to the refund policy of your seller.

For any further information or to request a full refund of the price of the computer, please contact your seller.

## Safety warning notice

Reduce the possibility of heat-related injuries or of overheating the computer by following the practices described.

- 
- ⚠ WARNING!** To reduce the possibility of heat-related injuries or of overheating the computer, do not place the computer directly on your lap or obstruct the computer air vents. Use the computer only on a hard, flat surface. Do not allow another hard surface, such as an adjoining optional printer, or a soft surface, such as pillows or rugs or clothing, to block airflow. Also, do not allow the AC adapter to come into contact with the skin or a soft surface, such as pillows or rugs or clothing, during operation. The computer and the AC adapter comply with the user-accessible surface temperature limits defined by applicable safety standards.
-

## Important notice about Customer Self-Repair parts

Your computer includes Customer Self-Repair parts and parts that should be accessed by only an authorized service provider.



---

**IMPORTANT:** See "Removal and replacement procedures for Customer Self-Repair parts" for details.

Accessing parts described in "Removal and replacement procedures for authorized service provider parts" can damage the computer or void your warranty.

---

---

# Table of contents

<b>1 Product description</b>	<b>1</b>
<b>2 Components</b>	<b>6</b>
Right	6
Left	7
Display	9
Low blue light mode (select products only)	9
Keyboard area	10
Touchpad	10
Touchpad settings	10
Adjusting touchpad settings	10
Turning on the touchpad	10
Touchpad components	11
Lights	11
Button and fingerprint reader	12
Special keys	14
Action keys	15
Hot keys (select products only)	17
Bottom	17
Rear	18
Labels	19
<b>3 Illustrated parts catalog</b>	<b>21</b>
Computer major components	21
Display assembly subcomponents	24
Bracket kit	26
Miscellaneous parts	27
<b>4 Removal and replacement procedures preliminary requirements</b>	<b>31</b>
Tools required	31
Service considerations	31
Plastic parts	31
Cables and connectors	31
Drive handling	31
Electrostatic discharge information	32
Generating static electricity	32
Preventing electrostatic damage to equipment	33
Personal grounding methods and equipment	33
Grounding the work area	34
Recommended materials and equipment	34

Cleaning your computer .....	35
Enabling HP Easy Clean (select products only) .....	35
Removing dirt and debris from your computer.....	35
Cleaning your computer with a disinfectant .....	36
Caring for wood veneer (select products only) .....	37
Packaging and transporting guidelines .....	37
Accessing support information .....	37
<b>5 Removal and replacement procedures for Customer Self-Repair parts.....</b>	<b>40</b>
Component replacement procedures.....	40
Preparation for disassembly .....	40
Bottom cover .....	40
Battery .....	41
WLAN module .....	43
WWAN module .....	44
Solid-state drive .....	46
<b>6 Removal and replacement procedures for authorized service provider parts.....</b>	<b>48</b>
Component replacement procedures.....	48
Preparation for disassembly .....	48
Plastic brackets.....	48
Speakers .....	49
Card reader board .....	50
Heat sink .....	51
Fan .....	53
USB board .....	54
Fingerprint reader board .....	55
Power connector cable .....	56
Touchpad .....	57
RTC battery .....	58
System board.....	59
Display assembly .....	63
Keyboard with top cover.....	70
<b>7 Using Setup Utility (BIOS) .....</b>	<b>72</b>
Starting Setup Utility (BIOS) .....	72
Updating Setup Utility (BIOS) .....	72
Determining the BIOS version .....	72
Preparing for a BIOS update .....	73
Downloading a BIOS update .....	73
Installing a BIOS update .....	73
<b>8 Computer Setup (BIOS), TPM, and HP Sure Start.....</b>	<b>75</b>
Using Computer Setup .....	75
Navigating and selecting in Computer Setup .....	75
Restoring factory settings in Computer Setup .....	75
Updating the BIOS.....	76
Determining the BIOS version .....	76

Preparing for a BIOS update .....	76
Downloading a BIOS update .....	77
Installing a BIOS update .....	77
Changing the boot order using the f9 prompt .....	77
TPM BIOS settings (select products only) .....	78
Using HP Sure Start (select products only) .....	78
<b>9 Backing up, restoring, and recovering .....</b>	<b>79</b>
Backing up information and creating recovery media .....	79
Using Windows tools for backing up .....	79
Using the HP Cloud Recovery Download Tool to create recovery media (select products only) .....	79
Restoring and recovering your system .....	79
Creating a system restore .....	80
Restoring and recovery methods .....	80
Recovering using HP Recovery media .....	80
Changing the computer boot order .....	81
Using HP Sure Recover (select products only) .....	81
<b>10 Using HP PC Hardware Diagnostics .....</b>	<b>82</b>
Using HP PC Hardware Diagnostics Windows (select products only) .....	82
Using an HP PC Hardware Diagnostics Windows hardware failure ID code .....	82
Accessing HP PC Hardware Diagnostics Windows .....	82
Accessing HP PC Hardware Diagnostics Windows from HP Help and Support (select products only) .....	82
Accessing HP PC Hardware Diagnostics Windows from Support Assistant .....	83
Accessing HP PC Hardware Diagnostics Windows from the Start menu (select products only) .....	83
Downloading HP PC Hardware Diagnostics Windows .....	83
Downloading the latest HP PC Hardware Diagnostics Windows version from HP .....	83
Downloading the HP PC Hardware Diagnostics Windows from the Microsoft Store .....	83
Downloading HP Hardware Diagnostics Windows by product name or number (select products only) .....	84
Installing HP PC Hardware Diagnostics Windows .....	84
Using HP PC Hardware Diagnostics UEFI .....	84
Using an HP PC Hardware Diagnostics UEFI hardware failure ID code .....	84
Starting HP PC Hardware Diagnostics UEFI .....	85
Downloading HP PC Hardware Diagnostics UEFI to a USB flash drive .....	85
Downloading the latest HP PC Hardware Diagnostics UEFI version .....	85
Downloading HP PC Hardware Diagnostics UEFI by product name or number (select products only) .....	85
Using Remote HP PC Hardware Diagnostics UEFI settings (select products only) .....	86
Downloading Remote HP PC Hardware Diagnostics UEFI .....	86
Downloading the latest Remote HP PC Hardware Diagnostics UEFI version .....	86
Downloading Remote HP PC Hardware Diagnostics UEFI by product name or number .....	86
Customizing Remote HP PC Hardware Diagnostics UEFI settings .....	86
<b>11 Specifications .....</b>	<b>88</b>
Computer specifications .....	88
15.24 cm (16 in) display specifications .....	88
Solid-state drive specifications .....	89
<b>12 Statement of memory volatility .....</b>	<b>90</b>

Current BIOS steps .....	90
Nonvolatile memory usage .....	92
Questions and answers .....	94
Using HP Sure Start (select products only) .....	96
<b>13 Power cord set requirements .....</b>	<b>97</b>
Requirements for all countries.....	97
Requirements for specific countries and regions .....	97
<b>14 Recycling.....</b>	<b>99</b>
<b>Index .....</b>	<b>100</b>



# 1 Product description

This table provides detailed product information.

**Table 1-1 Product components and their descriptions**

Category	Description
<b>Product Name</b>	HP EliteBook 860 G9 Notebook PC
<b>Processors</b>	<b>12th Generation Intel® Core™ processors</b> <hr/> Intel® 1280P Core™ i7-(1.80 GHz base frequency, up to 4.80 GHz with Intel® Turbo Boost Technology, 24 MB cache, 14 cores) <hr/> Intel® 1270P Core™ i7-(1.60 GHz base frequency, up to 4.70 GHz with Intel® Turbo Boost Technology, 18 MB cache, 12 cores) <hr/> Intel® 1265U Core™ i7-with vPro™ Technology processor (1.80 GHz base frequency, up to 4.80 GHz with Intel® Turbo Boost Technology, 12 MB cache, 10 cores) <hr/> Intel® 1260P Core™ i7-(1.60 GHz base frequency, up to 4.60 GHz with Intel® Turbo Boost Technology, 18 MB cache, 12 cores) <hr/> Intel® 1255U Core™ i7-(1.70 GHz base frequency, up to 4.70 GHz with Intel® Turbo Boost Technology, 12 MB cache, 10 cores) <hr/> Intel® 1250P Core™ i5-(1.70 GHz base frequency, up to 4.40 GHz with Intel® Turbo Boost Technology, 18 MB cache, 12 cores) <hr/> Intel® 1245U Core™ i5-with vPro™ Technology processor (1.60 GHz base frequency, up to 4.40 GHz with Intel® Turbo Boost Technology, 12 MB cache, 10 cores) <hr/> Intel® 1240P Core™ i5-(1.70 GHz base frequency, up to 4.40 GHz with Intel® Turbo Boost Technology, 12 MB cache, 12 cores) <hr/> Intel® 1235U Core™ i5-(1.30 GHz base frequency, up to 4.40 GHz with Intel® Turbo Boost Technology, 12 MB cache, 10 cores)
<b>Graphics</b>	<b>Internal graphics</b> <hr/> unified memory architecture (UMA)
<b>Display</b>	<b>40.6 cm (16.0 in), narrow bezel, ultrawide viewing angle (UWVA)</b> <hr/> (1920 × 1200), antiglare, white light-emitting diode (WLED), 72% National Television Standards Committee (NTSC), Sure View privacy, Embedded DisplayPort (eDP) 1.2, 1000 nits <hr/> (1920 × 1200), antiglare, white light-emitting diode (WLED), 72% National Television Standards Committee (NTSC), Embedded DisplayPort (eDP) 1.2, 400 nits <hr/> (1920 × 1200), antiglare, white light-emitting diode (WLED), 45% National Television Standards Committee (NTSC), Embedded DisplayPort (eDP) 1.2, 250 nits <hr/> (1920 × 1200), antiglare, white light-emitting diode (WLED), 45% National Television Standards Committee (NTSC), Embedded DisplayPort (eDP) 1.2, 250 nits, touch-on panel (TOP)

**Table 1-1 Product components and their descriptions (continued)**

Category	Description
<b>Memory</b>	Two customer-accessible memory module slots (small outline dual in-line memory modules (SODIMMs) supporting up to 64 GB of RAM
	DDR5-4800 dual-channel support
	Supports the following configurations:
	<ul style="list-style-type: none"><li>• 64 GB (32 × 2)</li></ul>
	<ul style="list-style-type: none"><li>• 48 GB (32 + 16)</li></ul>
	<ul style="list-style-type: none"><li>• 32 GB (16 × 2)</li></ul>
	<ul style="list-style-type: none"><li>• 24 GB (16 × 1 + 8 × 1)</li></ul>
	<ul style="list-style-type: none"><li>• 16 GB (8 × 2)</li></ul>
	<ul style="list-style-type: none"><li>• 8 GB (8 × 1)</li></ul>
<b>Primary storage</b>	<b>PCIe<sup>®</sup>, (Non-Volatile Memory Express) NVMe<sup>™</sup>, M.2 2280 solid-state drives</b>
	2 TB PCIe NVMe TLC 2280 Solid State Drive
	1 TB PCIe NVMe TLC 2280 Solid State Drive
	512 GB PCIe <sup>®</sup> NVMe <sup>™</sup> TLC 2280 Self Encrypted OPAL2 Solid State Drive
	512 GB PCIe <sup>®</sup> NVMe <sup>™</sup> TLC Solid State Drive
	512 GB PCIe NVMe M.2 SSD
	256 GB PCIe NVMe TLC 2280 Self Encrypted OPAL2 Solid State Drive
	256 GB PCIe <sup>®</sup> NVMe <sup>™</sup> TLC 2280 single-sided Solid State Drive
256 GB PCIe NVMe M.2 SSD	
<b>eMMC</b>	On-board embedded MultiMedia Controller (eMMC v5.0) configurations (MLC/TLC)
	32 GB
<b>Audio and video</b>	<b>Audio brand:</b> Bang & Olufsen
	Dual speakers
	Discrete amplifiers
	Camera, 5MP RGB
	Camera, 5MP RGB 720p + IR (infrared)
	Camera privacy cover
	Supports WDR (Wide Dynamic Range)
Microphone (dual-array)	

**Table 1-1 Product components and their descriptions (continued)**

Category	Description
<b>Wireless</b>	<b>Wireless Local Area Network (WLAN)</b>
	Intel Garfield Peak 2 AX211 Wi-Fi 6e +Bluetooth 5.2 M.2 2230 (vPro)
	Intel Garfield Peak 2 AX211 Wi-Fi 6e +Bluetooth 5.2 M.2 2230 (non-vPro)
	Compatible with Miracast® devices[
	Two WLAN antennas configured at top of panel
	Supports HP Connection Optimizer (with data analytics)
	Supports Static BIOS Specific Absorption Rate (SAR) for Intel modules and Realtek modules
	Supports HP Extended Range Wireless LAN
	Supports HP LAN-Wireless Protection (WLAN/LAN/WWAN switching)
	<b>Near Field Communication (NFC) (select products only)</b>
	NFC Mirage WNC XRAV-1 Near Field Communication Module
	NFC antenna
	<b>WWAN (select products only)</b>
Patron Intel XMM 7560 R+ LTE-Advanced Pro (Cat 16) WWAN	
Kavalan Intel 5000 5G Solution WWAN	
<b>Sensors</b>	Ambient light sensor (ALS)
	Ambient color sensor (ACS)
<b>Ports</b>	HDMI v2.0a
	USB 3.1 Gen 1 Type C (supports HP Sleep & Charge) (2)
	USB 3.1 Gen 1 Type A (2)
	Thunderbolt 4
	Audio-out (headphone)/Audio-in (microphone) combo jack
<b>Power requirements</b>	<b>Battery</b>
	6 cell, 76 Whr, polymer, HP Long Life
	3 cell, 51 Whr, polymer, HP Long Life
	HP Fast Charge Technology
	<b>Smart AC adapters</b>
	100 W USB Type-C adapter, PFC, 1.8 mm
	10 W USB Type-A port
	65 W, non-PFC, slim, USB Type-C adapter, 1.8 mm
	<b>Power cord</b>
	C5, 1.0 m (3.3 ft), premium
C5, 1.0 m (3.3 ft), conventional	

**Table 1-1 Product components and their descriptions (continued)**

<b>Category</b>	<b>Description</b>
<b>Security</b>	Supports Trusted Platform Module (TPM) 2.0, firmware based
	Integrated fingerprint reader
	Nano security cable slot
<b>Operating system</b>	Windows® 10 Enterprise 64
	Windows 10 Enterprise 64
	Windows 10 Pro 64
	Windows 11 Home 64
	Windows 11 Home 64 Advanced
	Windows 11 Home 64 Advanced Single Language
	Windows 11 Home 64 Chinese Market CPPP
	Windows 11 Home 64 High-end Chinese Market CPPP
	Windows 11 Home 64 Plus
	Windows 11 Home 64 Plus Single Language
	Windows 11 Home 64 Plus Single Language Africa Market PPP
	Windows 11 Home 64 Plus Single Language APAC EM PPP
	Windows 11 Home 64 Plus Single Language India Market PPP
	Windows 11 Home 64 Plus Single Language Indonesia Market PPP
	Windows 11 Home 64 Single Language
	Windows 11 Home 64 Single Language Africa Market PPP
	Windows 11 Home 64 Single Language APAC EM PPP
	Windows 11 Home 64 Single Language India Market PPP
	Windows 11 Home 64 Single Language Indonesia Market PPP
	Windows 11 Pro 64
	Windows 11 Pro 64 Chinese Market
	Windows 11 Pro 64 Downgrade Win 10 Pro 64
	Windows 11 Pro 64 Downgrade Win 10 Pro 64 High End
	Windows 11 Pro 64 Downgrade Win 10 Pro 64 High End Chinese Market
	Windows 11 Pro 64 Downgrade Win 10 Pro 64 StF MSNA Standard
	Windows 11 Pro 64 High End
	Windows 11 Pro 64 High End Chinese Market
	Windows 11 Pro 64 StF MSNA Standard
	FreeDOS 3.0 Version

**Table 1-1** Product components and their descriptions (continued)

<b>Category</b>	<b>Description</b>
<b>Serviceability</b>	<b>End user replaceable parts</b>
	AC adapter
	Memory module
	Solid-state drive
	WLAN module
	WWAN module

## 2 Components

Your computer features top-rated components. This chapter provides details about your components, where they are located, and how they work.

### Right

Use the illustration and table to identify the components on the right side of the computer.

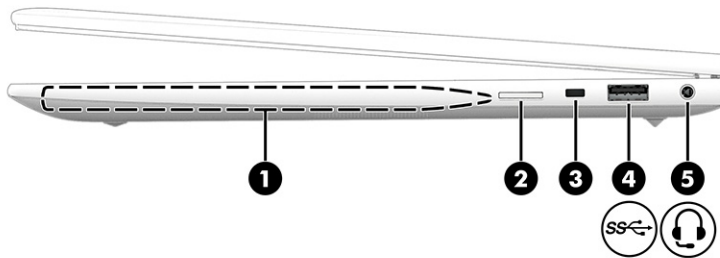

**Table 2-1** Right-side components and their descriptions

Component	Description
(1) Magnetic pen attachment area (select products only)	Holds an optional pen. <b>NOTE:</b> For more information about the pen, see the documentation provided with the pen.
(2) SIM card slot (select products only)	Supports a wireless subscriber identity module (SIM) card.
(3) Security cable slot	Attaches an optional security cable to the computer. <b>NOTE:</b> The security cable is designed to act as a deterrent, but it might not prevent the computer from being mishandled or stolen.
(4)  USB SuperSpeed 5 Gbps port	Connects a USB device, provides high-speed data transfer, and (for select products) charges small devices (such as a smartphone) when the computer is on or in Sleep mode. <b>NOTE:</b> Use a standard USB Type-A charging cable or cable adapter (purchased separately) when charging a small external device.

**Table 2-1 Right-side components and their descriptions (continued)**

Component	Description
<p>(5)  Audio-out (headphone)/Audio-in (microphone) combo jack</p>	<p>Connects optional powered stereo speakers, headphones, earbuds, a headset, or a television audio cable. Also connects an optional headset microphone. This jack does not support optional standalone microphones.</p> <p><b>WARNING!</b> To reduce the risk of personal injury, adjust the volume before putting on headphones, earbuds, or a headset. For additional safety information, see the <i>Regulatory, Safety, and Environmental Notices</i>.</p> <p>To access this guide:</p> <ul style="list-style-type: none"> <li>Select the <b>Search</b> icon (select products only) in the taskbar, type <b>HP Documentation</b> in the search box, and then select <b>HP Documentation</b>.</li> </ul> <p><b>NOTE:</b> When a device is connected to the jack, the computer speakers are disabled.</p>



## Left

Use the illustration and table to identify the components on the left side of the computer.

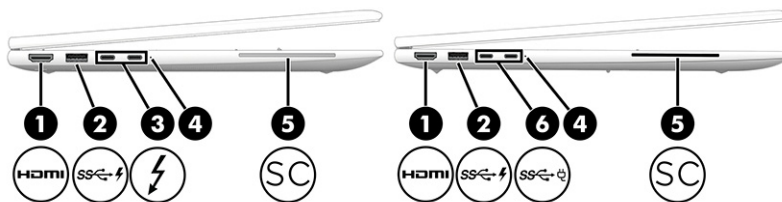

 **NOTE:** Refer to the illustration that most closely matches your computer.



**Table 2-2 Left-side components and their descriptions**

Component	Description
<p>(1)  HDMI port</p>	<p>Connects an optional video or audio device, such as a high-definition television, any compatible digital or audio component, or a high-speed High Definition Multimedia Interface (HDMI) device.</p>
<p>(2)  USB SuperSpeed 5 Gbps port with HP Sleep and Charge</p>	<p>Connects a USB device, provides high-speed data transfer, and charges small devices (such as a smartphone), even when the computer is off.</p> <p><b>NOTE:</b> Use a standard USB Type-A charging cable or cable adapter (purchased separately) when charging a small external device.</p>

**Table 2-2 Left-side components and their descriptions (continued)**

Component	Description
<p>(3)  USB Type-C® power connector and Thunderbolt™ ports with HP Sleep and Charge and DisplayPort™ output (2)( select products only)</p>	<p>Connect AC adapters that have a USB Type-C connector, supplying power to the computer and, if needed, charging the computer battery.</p> <p>– and –</p> <p>Connect USB devices, provide high-speed data transfer, and charge small devices (such as a smartphone), even when the computer is off.</p> <p><b>NOTE:</b> Use a standard USB Type-C charging cable or cable adapter (purchased separately) when charging a small external device.</p> <p>– and –</p> <p>Connect display devices that have a USB Type-C connector, providing DisplayPort output.</p> <p><b>NOTE:</b> Your computer might also support a Thunderbolt docking station.</p>
<p>(4) Battery light</p>	<p>When AC power is connected:</p> <ul style="list-style-type: none"> <li>• White: The battery charge is greater than 90 percent.</li> <li>• Amber: The battery charge is from 0 to 90 percent.</li> <li>• Off: The battery is not charging.</li> </ul> <p>When AC power is disconnected (battery not charging):</p> <ul style="list-style-type: none"> <li>• Blinking amber: The battery has reached a low battery level. When the battery has reached a critical battery level, the battery light begins blinking rapidly.</li> <li>• Off: The battery is not charging.</li> </ul>
<p>(5)  Smart card reader (select products only)</p>	<p>Supports optional smart cards.</p>
<p>(6)  USB Type-C power connector and SuperSpeed ports with HP Sleep and Charge and DisplayPort output (2)</p>	<p>Connect AC adapters that have a USB Type-C connector, supplying power to the computer and, if needed, charging the computer battery.</p> <p>– and –</p> <p>Connect USB devices, provide high-speed data transfer, and charge small devices (such as a smartphone), even when the computer is off.</p> <p><b>NOTE:</b> Use a standard USB Type-C charging cable or cable adapter (purchased separately) when charging a small external device.</p> <p>– and –</p> <p>Connect display devices that have a USB Type-C connector, providing DisplayPort output.</p>



# Display

Use the illustration and table to identify the display components.

## Low blue light mode (select products only)

Your computer display is shipped from the factory in low blue light mode for improved eye comfort and safety. Also, blue light mode automatically adjusts blue light emissions when you are using the computer at night or for reading.

**⚠ WARNING!** To reduce the risk of serious injury, read the *Safety & Comfort Guide*. It describes proper workstation setup and proper posture, health, and work habits for computer users. The *Safety & Comfort Guide* also provides important electrical and mechanical safety information. The *Safety & Comfort Guide* is available on the web at <http://www.hp.com/ergo>.

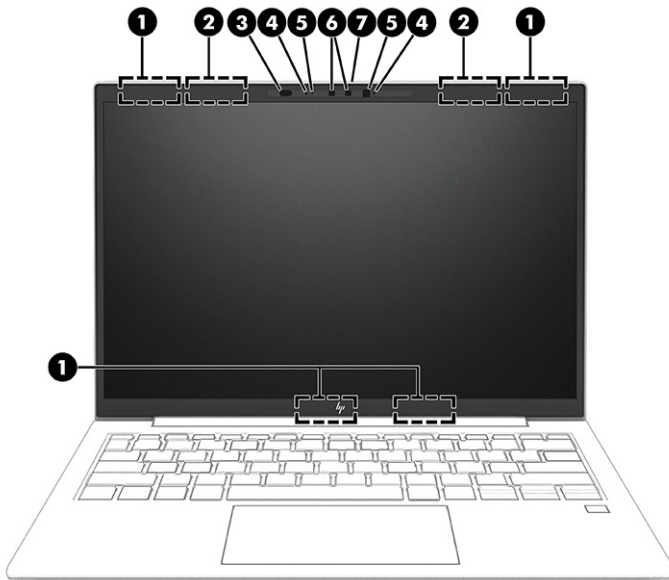

**Table 2-3** Display components and their descriptions

Component	Description
(1) WWAN antennas* (select products only)	Send and receive wireless signals to communicate with wireless wide area networks (WWANs).
(2) WLAN antennas* (select products only)	Send and receive wireless signals to communicate with wireless local area networks (WLANs).
(3) Ambient light and color sensor	Adjusts the brightness of the display, depending on the ambient light, and manages and controls the color temperature. Color temperature enables you to measure and adjust the warmth or coolness of the light source.
(4) Internal microphones (2)	Record sound.
(5) Camera light(s) (select products only)	On: One or more cameras are in use.
(6) Camera(s) (select products only)	Allow(s) you to video chat, record video, and record still images. Some cameras also allow a facial recognition logon to Windows, instead of a password logon.

**NOTE:** Camera functions vary depending on the camera hardware and software installed on your product.

**Table 2-3 Display components and their descriptions (continued)**

Component	Description
(7) Camera privacy cover (select products only)	<p>By default, the camera lens is uncovered, but you can slide the camera privacy cover to block the camera's view. To use the camera, slide the camera privacy cover in the opposite direction to reveal the lens.</p> <p><b>NOTE:</b> If you have both front-facing and rear-facing cameras, when one camera lens is revealed and ready to use, the other is concealed.</p>

\*The antennas are not visible from the outside of the computer. For optimal transmission, keep the areas immediately around the antennas free from obstructions.

For wireless regulatory notices, see the section of the *Regulatory, Safety, and Environmental Notices* that applies to your country or region.

To access this guide:

- Select the **Search** icon (select products only) in the taskbar, type `HP Documentation` in the search box, and then select **HP Documentation**.

## Keyboard area

Keyboards can vary by language.



**NOTE:** The keyboard, including the function keys and power button (select products only), is disabled in stand, tent, and tablet modes. To enable the keyboard, including the power button, change to the clamshell mode.

## Touchpad

The touchpad settings and components are described here.

### Touchpad settings

You learn how to adjust the touchpad settings and components here.

#### Adjusting touchpad settings

Use these steps to adjust touchpad settings and gestures.

1. Select the **Search** icon (select products only) in the taskbar, type `touchpad settings` in the search box, and then press `enter`.
2. Choose a setting.

#### Turning on the touchpad

Follow these steps to turn on the touchpad.

1. Select the **Search** icon (select products only) in the taskbar, type `touchpad settings` in the search box, and then press `enter`.
2. Using an external mouse, click the **Touchpad** button.

If you are not using an external mouse, press the `Tab` key repeatedly until the pointer rests on the **touchpad** button. Then press the `spacebar` to select the button.

## Touchpad components

Use the illustration and table to identify the touchpad components.

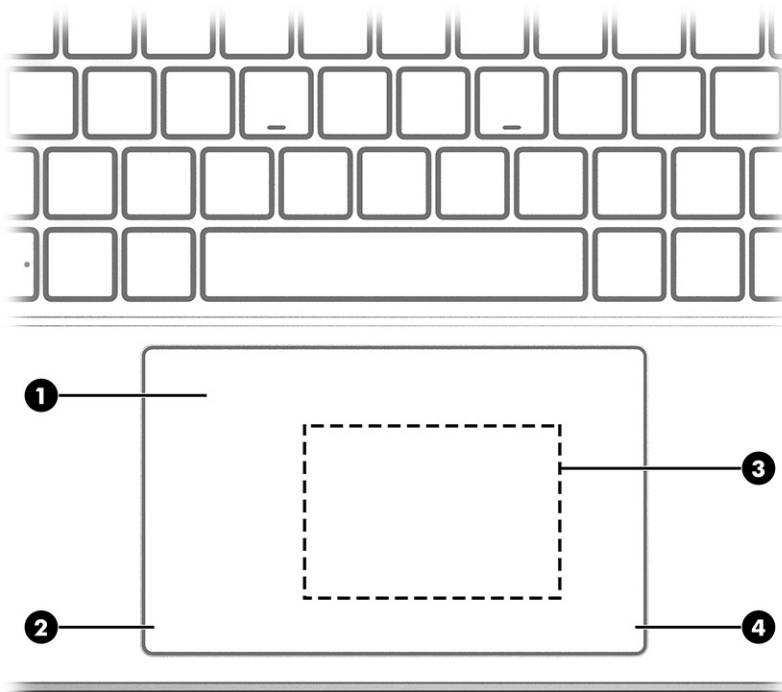

**Table 2-4** Touchpad components and their descriptions

Component	Description
(1) Touchpad zone	Reads your finger gestures to move the pointer or activate items on the screen.
(2) Left touchpad button	Functions like the left button on an external mouse.
(3) Near Field Communications (NFC) tapping area and antenna (select products only)*	Allows you to wirelessly share information when you tap it with an NFC-enabled device.
(4) Right touchpad button	Functions like the right button on an external mouse.

\*The antennas are not visible from the outside of the computer. For optimal transmission, keep the areas immediately around the antennas free from obstructions.

For wireless regulatory notices, see the section of the *Regulatory, Safety, and Environmental Notices* that applies to your country or region.

To access this guide:

- Select the **Search** icon (select products only) in the taskbar, type `HP Documentation` in the search box, and then select **HP Documentation**.



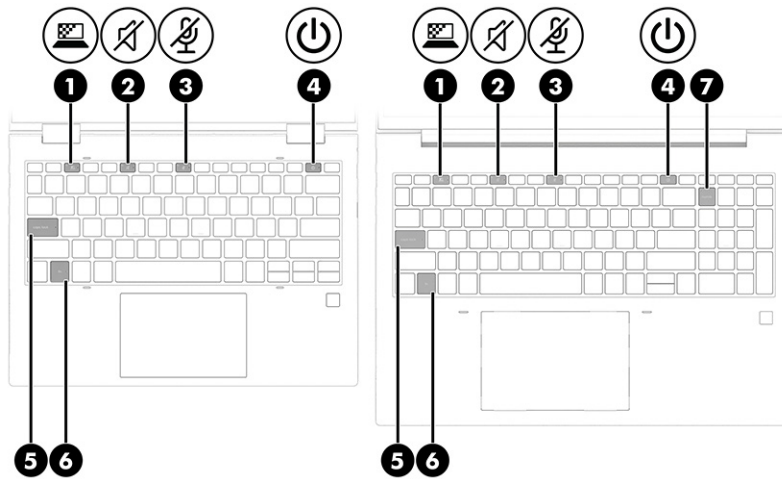

## Lights

Use the illustration and table to identify the lights on the computer.

 **NOTE:** Refer to the illustration that most closely matches your computer.



**Table 2-5** Lights and their descriptions

Component	Description
(1)  Privacy key light (select products only)	On: Privacy screen is on, which helps prevent side-angle viewing.
(2)  Mute light	<ul style="list-style-type: none"> <li>On: Computer sound is off.</li> <li>Off: Computer sound is on.</li> </ul>
(3)  Microphone mute light	<ul style="list-style-type: none"> <li>On: Microphone is off.</li> <li>Off: Microphone is on.</li> </ul>
(4)  Power light	<ul style="list-style-type: none"> <li>On: The computer is on.</li> <li>Blinking (select products only): The computer is in the Sleep state, a power-saving state. The computer shuts off power to the display and other unnecessary components.</li> <li>Off: Depending on your computer model, the computer is off, in Hibernation, or in Sleep. Hibernation is the power-saving state that uses the least amount of power.</li> </ul>
(5) Caps lock light	On: Caps lock is on, which switches the key input to all capital letters.
(6) Fn lock light	On: The <b>fn</b> key is locked. For more information, see <a href="#">Hot keys (select products only) on page 17</a> .
(7)  Num lk light	On: Num lk is on.

## Button and fingerprint reader

Fingerprint readers can be located on the touchpad, on a side panel of the computer, or on the top cover below the keyboard.



 **IMPORTANT:** To verify that your computer supports fingerprint reader sign-in, select the **Search** icon (select products only) in the taskbar, type `Sign-in options` in the search box, and then follow the on-screen

instructions. If **Fingerprint reader** is not listed as an option, then your notebook does not include a fingerprint reader.

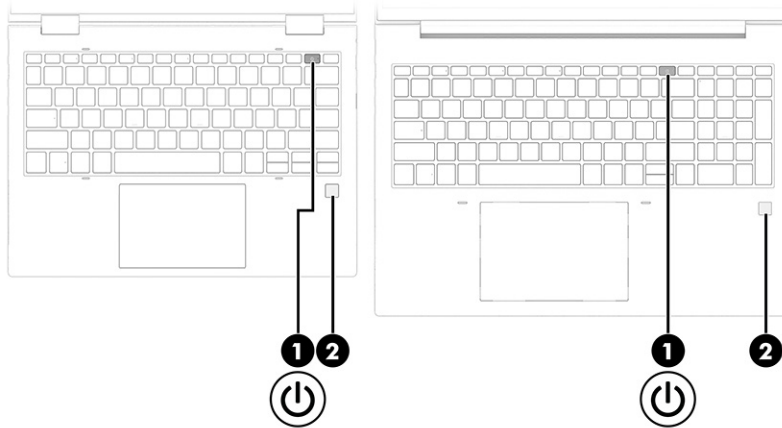
 **NOTE:** Refer to the illustration that most closely matches your computer.



**Table 2-6** Button and fingerprint reader and their descriptions

Component	Description
<p>(1)  Power button</p>	<ul style="list-style-type: none"> <li>When the computer is off, press the button briefly to turn on the computer.</li> <li>When the computer is on, press the button briefly to initiate Sleep.</li> <li>When the computer is in the Sleep state, press the button briefly to exit Sleep (select products only).</li> <li>When the computer is in Hibernation, press the button briefly to exit Hibernation.</li> </ul> <p><b>IMPORTANT:</b> Pressing and holding down the power button results in the loss of unsaved information.</p> <p>If the computer has stopped responding and shutdown procedures are ineffective, press and hold the power button for at least 4 seconds to turn off the computer.</p> <p>To learn more about your power settings, use the Power icon.</p> <ul style="list-style-type: none"> <li>Right-click the <b>Power</b> icon  and then, depending on your product, select <b>Power and sleep settings</b> or <b>Power Options</b>.</li> </ul>
<p>(2) Fingerprint reader (select products only)</p>	<p>Allows a fingerprint logon to Windows, instead of a password logon.</p> <ul style="list-style-type: none"> <li>Touch your finger to the fingerprint reader.</li> </ul> <p><b>IMPORTANT:</b> To prevent fingerprint logon issues, make sure when you register your fingerprint that all sides of your finger are registered by the fingerprint reader.</p>

## Special keys

Use the illustration and table to identify the special keys.

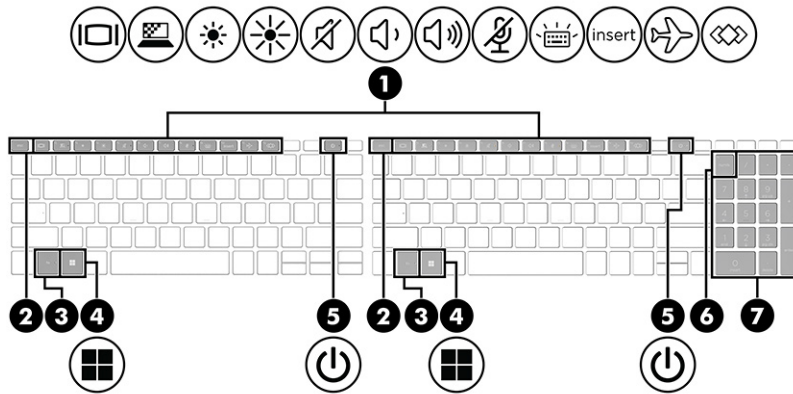

 **NOTE:** Refer to the illustration that most closely matches your computer.



**Table 2-7** Special keys and their descriptions

Component	Description
(1) Action keys	Execute frequently used system functions.  See <a href="#">Action keys on page 15</a> .
(2) <code>esc</code> key	Displays system information when pressed in combination with the <code>fn</code> key.
(3) <code>fn</code> key	Executes frequently used system functions when pressed in combination with another key. Such key combinations are called <i>hot keys</i> .  See <a href="#">Hot keys (select products only) on page 17</a> .
(4) Windows key	Opens the Start menu.  <b>NOTE:</b> Pressing the Windows key again will close the Start menu.

**Table 2-7 Special keys and their descriptions (continued)**

Component	Description
(5)  Power button	<ul style="list-style-type: none"> <li>When the computer is off, press the button briefly to turn on the computer.</li> <li>When the computer is on, press the button briefly to initiate Sleep.</li> <li>When the computer is in the Sleep state, press the button briefly to exit Sleep (select products only).</li> <li>When the computer is in Hibernation, press the button briefly to exit Hibernation.</li> </ul> <p><b>IMPORTANT:</b> Pressing and holding down the power button results in the loss of unsaved information.</p> <p>If the computer has stopped responding and shutdown procedures are ineffective, press and hold the power button for at least 4 seconds to turn off the computer.</p> <p>To learn more about your power settings, use the Power icon.</p> <ul style="list-style-type: none"> <li>Right-click the <b>Power icon</b>  and then, depending on your product, select <b>Power and sleep settings</b> or <b>Power Options</b>.</li> </ul>
(6) <a href="#">num lk</a> key	Turns the integrated numeric keypad on and off.
(7) Integrated numeric keypad	<p>A separate keypad to the right of the alphabet keyboard. When <a href="#">num lk</a> is pressed, the integrated keypad can be used like an external numeric keypad.</p> <p><b>NOTE:</b> If the keypad function is active when the computer is turned off, that function is reinstated when the computer is turned back on.</p>

## Action keys

Action keys perform specific functions and vary by computer. To determine which keys are on your computer, look at the icons on your keyboard and match them to the descriptions in this table.

- To use an action key, press and hold the key.









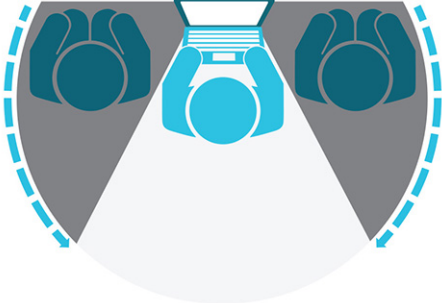

**NOTE:** On some products, you must press the [fn](#) key in combination with the action key.

**Table 2-8 Action keys and their descriptions**

Icon	Description
	Switches the screen image among display devices connected to the system. For example, if a monitor is connected to the computer, repeatedly pressing the key alternates the screen image from computer display to monitor display to simultaneous display on both the computer and the monitor.

**Table 2-8 Action keys and their descriptions (continued)**

Icon	Description
	<p>On select products, helps prevent side-angle viewing from onlookers. If needed, decrease or increase brightness for well-lit or darker environments. Press the key again to turn off the privacy screen.</p> <p><b>NOTE:</b> This feature is available only on select products. If the feature is not available on your computer, a message is displayed when you press this key.</p> <p><b>NOTE:</b> To quickly turn on the highest privacy setting, press <b>fn+p</b>.</p> <div data-bbox="483 451 927 751" style="text-align: center;">  </div>
	<p>Decreases the screen brightness incrementally as long as you hold down the key.</p>
	<p>Increases the screen brightness incrementally as long as you hold down the key.</p>
	<p>Mutes or restores speaker sound.</p>
	<p>Decreases speaker volume incrementally while you hold down the key.</p>
	<p>Increases speaker volume incrementally while you hold down the key.</p>
	<p>Mutes the microphone.</p>
	<p>Turns the keyboard backlight off or on. On select products, you can adjust the brightness of the keyboard backlight. Press the key repeatedly to adjust the brightness from high (when you first start up the computer), to low, to off. After you adjust the keyboard backlight setting, the backlight will revert to your previous setting each time you turn on the computer. The keyboard backlight will turn off after 30 seconds of inactivity. To turn the keyboard backlight back on, press any key or tap the touchpad (select products only). To conserve battery power, turn off this feature.</p>
<p>insert</p>	<p>Turns the insert function on or off.</p>
	<p>Turns the wireless feature on or off.</p> <p><b>NOTE:</b> A wireless network must be set up before a wireless connection is possible.</p>



**Table 2-8 Action keys and their descriptions (continued)**

Icon	Description
	<p>Executes frequently used tasks. Some tasks might not be available on all products.</p> <ul style="list-style-type: none"><li>• Opens an application, file, or website</li><li>• Enters frequently used text into a permanent clipboard</li><li>• Ability to change system profiles</li><li>• Ability to change system properties</li><li>• Executes user-defined key sequences</li></ul>

 **NOTE:** The action key feature is enabled at the factory. On select products only, you can disable this feature by pressing and holding the **fn** key and the left **shift** key. The fn lock light will turn on. After you have disabled the action key feature, you can still perform each function by pressing the **fn** key in combination with the appropriate action key.

## Hot keys (select products only)

A hot key is the combination of the **fn** key and another key. Use the table to identify the hot keys.

To use a hot key:

- Press the **fn** key, and then press one of the keys listed in the following table.

**Table 2-9 Hot keys and their descriptions**

Key	Description
C	Turns on scroll lock.
E	Turns on the insert function.
R	Breaks the operation.
S	Sends a programming query.
W	Pauses the operation.

## Bottom

Use the illustration and table to identify the bottom components.

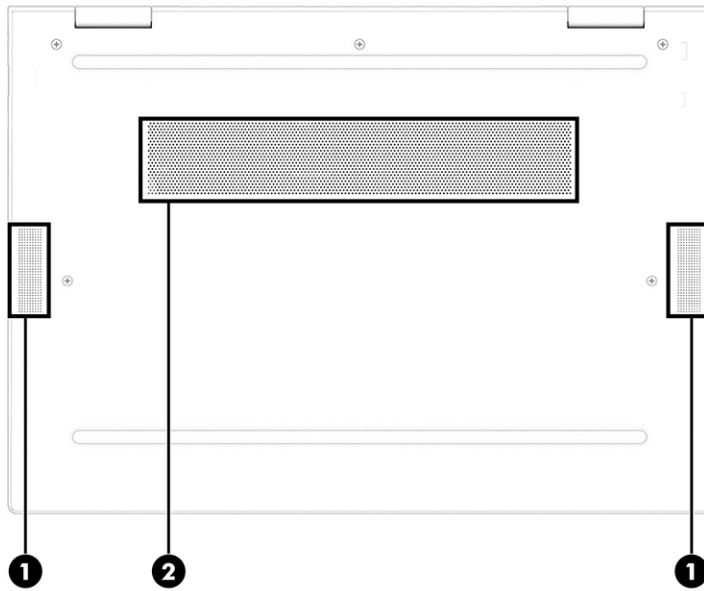

**Table 2-10** Bottom components and their descriptions

Component	Description
(1)	Speakers (2) Produce sound.
(2)	Vent Enables airflow to cool internal components.

**NOTE:** The computer fan starts up automatically to cool internal components and prevent overheating. It is normal for the internal fan to cycle on and off during routine operation.

## Rear

Use the illustration and table to identify the rear component.



**Table 2-11** Rear component and its description

Component	Description
Vent (select products only)	Enables airflow to cool internal components.

**NOTE:** The computer fan starts up automatically to cool internal components and prevent overheating. It is normal for the internal fan to cycle on and off during routine operation.

# Labels

The labels affixed to the computer provide information you might need when you troubleshoot system problems or travel internationally with the computer. Labels might be in paper form or imprinted on the product.

**IMPORTANT:** Check the following locations for the labels described in this section: the bottom of the computer, inside the battery bay, under the service door, on the back of the display, or on the bottom of a tablet kickstand.

- Service label—Provides important information to identify your computer. When contacting support, you might be asked for the serial number, the product number, or the model number. Locate this information before you contact support.

Your service label will resemble one of the examples shown below. Refer to the illustration that most closely matches the service label on your computer.

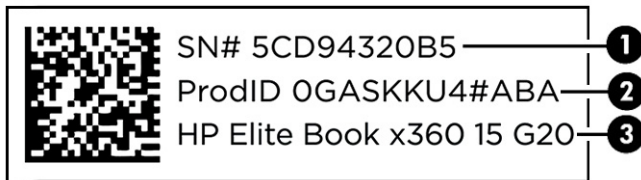

**Table 2-12** Service label components

Component
(1) Serial number
(2) Product ID
(3) HP product name

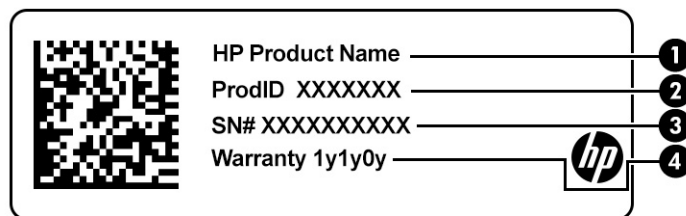

**Table 2-13** Service label components

Component
(1) HP product name
(2) Product ID
(3) Serial number
(4) Warranty period

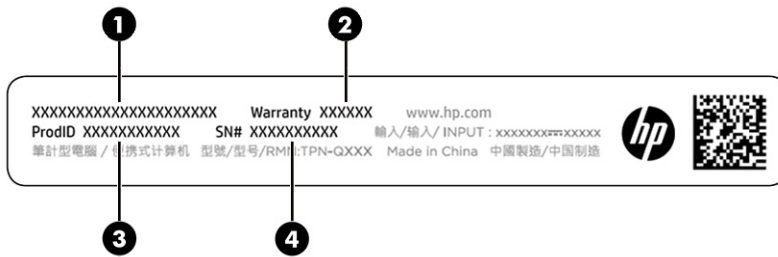

**Table 2-14 Service label components**

Component	
(1)	HP product name
(2)	Warranty period
(3)	Product ID
(4)	Serial number

- Regulatory labels—Provide regulatory information about the computer.
- Wireless certification labels—Provide information about optional wireless devices and the approval markings for the countries or regions in which the devices have been approved for use.

---

## 3 Illustrated parts catalog

Use this chapter to determine the spare parts that are available for the computer.

### Computer major components

To identify the computer major components, use this illustration and table.

---

 **NOTE:** HP continually improves and changes product parts. For complete and current information about supported parts for your computer, go to <http://partsurfer.hp.com>, select your country or region, and then follow the on-screen instructions.

 **NOTE:** Details about your computer, including model, serial number, product key, and length of warranty, are on the service tag at the bottom of your computer.

---

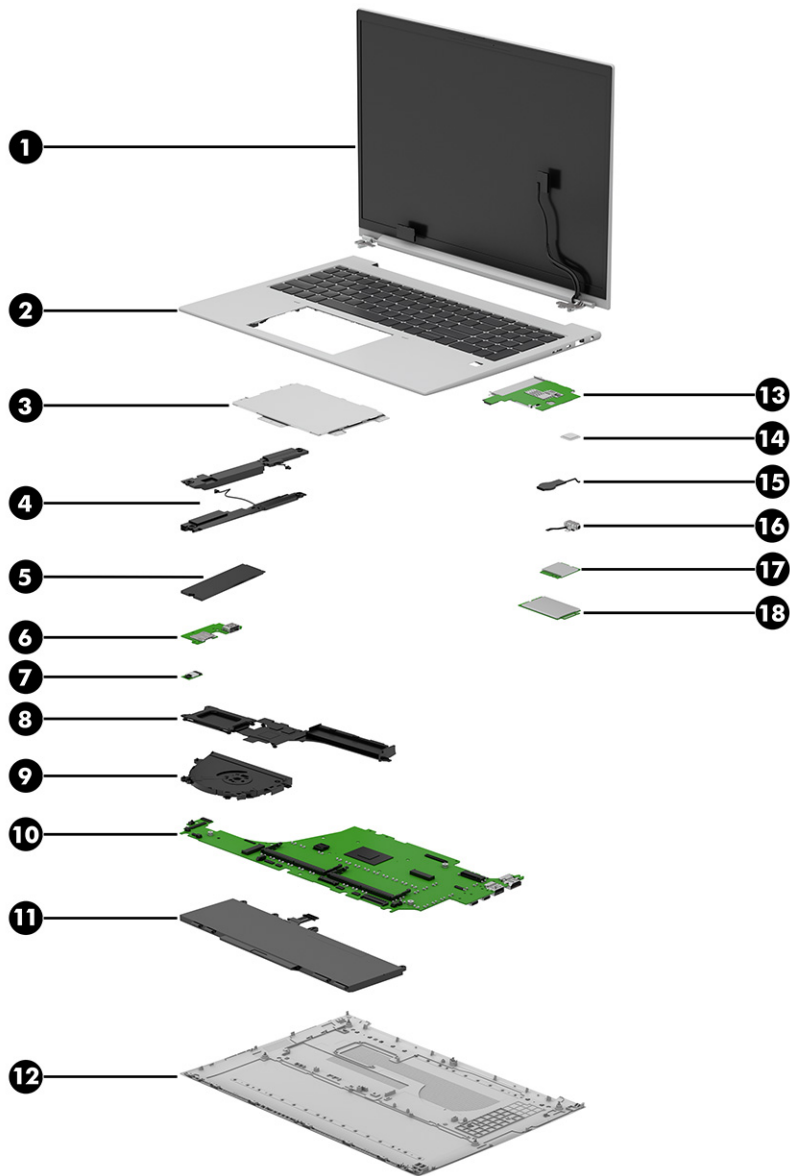

**Table 3-1 Computer major component descriptions and part numbers**

Item	Component	Spare part number
(1)	<b>Display assembly</b>  <b>NOTE:</b> Display spare parts are available as subcomponents, not as whole units. Display subcomponent spare parts are available. For spare part information, see <a href="#">Display assembly subcomponents on page 24</a> .	not available as a spare part
(2)	<b>Top cover/keyboard</b>  <b>NOTE:</b> For a detailed list of country codes, see <a href="#">Keyboard with top cover on page 70</a> .	
	Backlit	N08145-001
	Backlit with privacy	N08146-001
	Without backlight	N08147-001

**Table 3-1 Computer major component descriptions and part numbers (continued)**

Item	Component	Spare part number
(3)	<b>Touchpad</b>	N08555-001
(4)	<b>Speaker kit</b>	N08127-001
(5)	<b>Solid-state drive</b>	
	512 GB, M.2 2280, PCIe, NVMe, value	L85364-001
	256 GB, M.2 2280, PCIe, NVMe value	L85354-001
(6)	<b>USB board</b> (cables included in cable kit p/n N08556-001)	TBD
(7)	<b>NFC module</b>	M08706-001
(8)	<b>Heat sink</b> (includes replacement thermal material)	
	For use in models with UMA graphics memory (15 W)	N09037-001
	For use in models with UMA graphics memory (25 W)	N09038-001
	For use in models with discrete graphics memory	TDB
(9)	<b>Fan</b>	
	For use in models with UMA graphics memory (15 W)	N09035-001
	For use in models with UMA graphics memory (25 W)	N09036-001
	For use in models with discrete graphics memory	TBD
(10)	<b>System board</b> (includes integrated processor)	
	<b>NOTE:</b> All system board spare part kits include replacement thermal material.	
	All system boards use the following part numbers:	
	xxxxxx-001: Non-Windows operating systems	
	xxxxxx-601: Windows operating system	
	Equipped with an Intel Core i7-1265U G9 (OSR) processor, with 16 GB of system memory, discrete memory, and a Windows 11 operating system	N08217-601
	Equipped with an Intel Core i7-1265U G9 processor, with 16 GB of system memory, discrete memory, and a Windows 11 operating system	N08216-601
	Equipped with an Intel Core i7-1255U G9 processor, with 16 GB of system memory, discrete memory, and a Windows 11 operating system	N08215-601
	Equipped with an Intel Core i7-1280P G9 (OSR) processor, with 16 GB of system memory, UMA memory, and a Windows 11 operating system	N08108-601
	Equipped with an Intel Core i7-1280P G9 processor, with 16 GB of system memory, UMA memory, and a Windows 11 operating system	N08107-601
	Equipped with an Intel Core i7-1270P G9 (OSR) processor, with 16 GB of system memory, UMA memory, and a Windows 11 operating system	N08105-601
	Equipped with an Intel Core i7-1270P G9 processor, with 16 GB of system memory, UMA memory, and a Windows 11 operating system	N08104-601
	Equipped with an Intel Core i7-1260P G9 processor, with 16 GB of system memory, UMA memory, and a Windows 11 operating system	N08103-601
	Equipped with an Intel Core i5-1245U G9 (OSR) processor, with 16 GB of system memory, discrete memory, and a Windows 11 operating system	N08214-601

**Table 3-1 Computer major component descriptions and part numbers (continued)**

<b>Item</b>	<b>Component</b>	<b>Spare part number</b>
	Equipped with an Intel Core i5-1245U G9 processor, with 16 GB of system memory, discrete memory, and a Windows 11 operating system	N08213-601
	Equipped with an Intel Core i5-1235U G9 processor, with 16 GB of system memory, discrete memory, and a Windows 11 operating system	N08212-601
	Equipped with an Intel Core i5-1250P G9 (OSR) processor, with 16 GB of system memory, UMA memory, and a Windows 11 operating system	N08102-601
	Equipped with an Intel Core i5-1250P G9 processor, with 16 GB of system memory, UMA memory, and a Windows 11 operating system	N08101-601
	Equipped with an Intel Core i5-1240P G9 processor, with 16 GB of system memory, UMA memory, and a Windows 11 operating system	N08100-601
<b>(11)</b>	<b>Battery</b>	
	Battery, 3 cell, 51Whr, 4.68 Ah	M73466-005
	Battery, 6 cell, 75 Whr, 3.525 Ah	M73470-005
<b>(12)</b>	<b>Bottom cover</b>	
	Bottom cover for use in models with UMA graphics memory (15 W)	N08551-001
	Bottom cover for use in models with UMA graphics memory (25 W)	N08553-001
<b>(13)</b>	<b>Card reader</b>	N08543-001
<b>(14)</b>	<b>Fingerprint reader</b>	N02325-001
<b>(15)</b>	<b>RTC battery</b>	N15765-001
<b>(16)</b>	<b>Power connector cable</b>	N08540-001
<b>(17)</b>	<b>WLAN module</b>	
	Intel Wi-Fi 6 AX211 802.11ax (2 × 2) and Bluetooth 5.2 (non-vPro), M.2 2230	M53366-001
	Intel Wi-Fi 6 AX211 802.11ax (2 × 2) and Bluetooth 5.2 (vPro), M.2 2230	M53363-001
<b>(18)</b>	<b>WWAN module</b>	
	Intel Patron LTE with GPS, M.2	M52040-001

## Display assembly subcomponents

To identify the display assembly subcomponents, use this illustration and table.



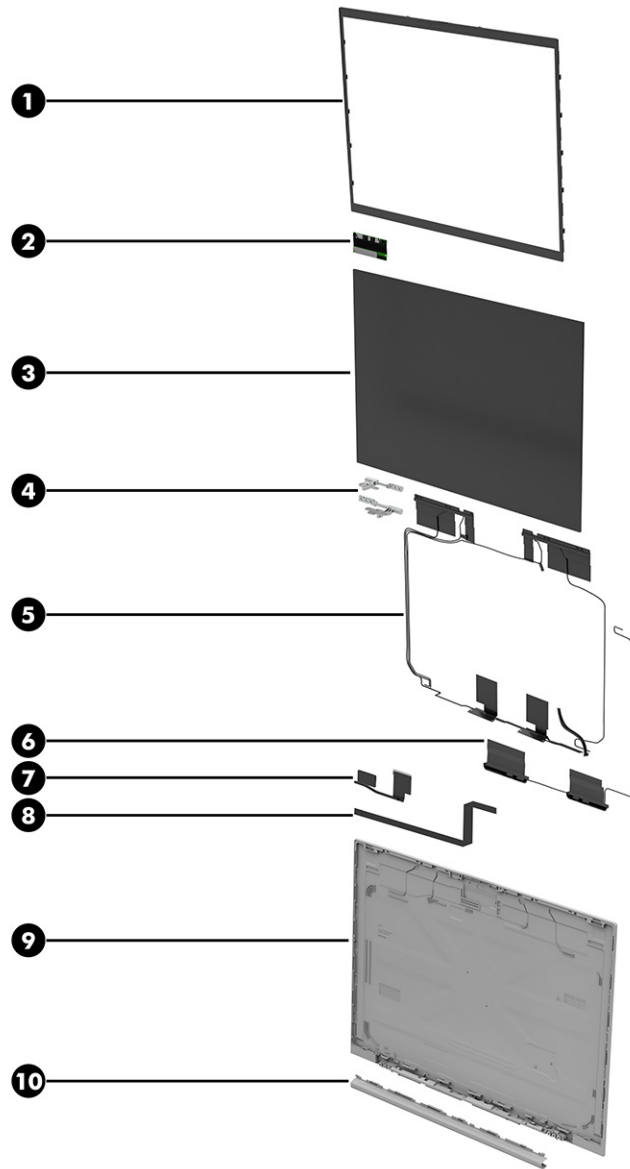

**Table 3-2 Display component descriptions and part numbers**

Item	Component	Spare part number
(1)	<b>Bezel</b>	
	For use in models with an RGB camera	N08550-001
	For use in models with an IR camera	N08549-001
(2)	<b>Camera modules</b>	
	Camera module	N09060-001
	Camera IR module	N09061-001
(3)	<b>Display panel</b>	
	Widescreen ultra extended graphics array (WUXGA), 1000 nits, privacy panel	N14763-001

**Table 3-2 Display component descriptions and part numbers (continued)**

Item	Component	Spare part number
	WUXGA, 400 nits	N14760-001
	WUXGA, 250 nits	N14761-001
	WUXGA, 250 nits Touch-on Panel (TOP)	N14762-001
(4)	<b>Hinge kit</b> (left and right)	N08130-001
(5)	<b>WWAN antennas and cables</b>	not available as a spare part
(6)	<b>WLAN antennas and cables</b>	not available as a spare part
(7)	<b>Display cable</b> (included in Display cable kit)	N08558-001
(8)	<b>Camera cable</b> (included in Display cable kit)	N08558-001
(9)	<b>Display back cover</b>	
	Models without WWAN, privacy, 250 nit panel	N08548-001
	Models with WWAN, privacy	N08547-001
	Models with WWAN, 400 nit pane	N08546-001
	Models with WWAN, 250 nit panel	N08545-001
(10)	<b>Hinge cover</b> (included in Hinge Kit)	N08130-001

## Bracket kit

To identify the bracket kit components, use this illustration and table.

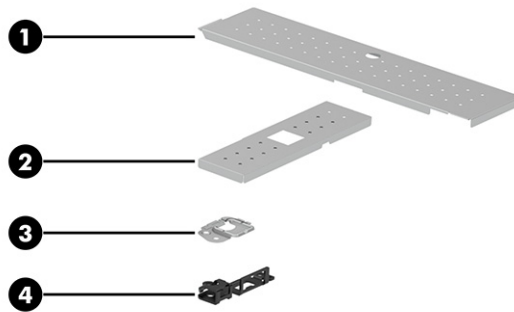

**Table 3-3 Bracket kit descriptions and part numbers**

Item	Component	Spare part number
	<b>Bracket kit</b> , includes:	N08129-001
(1)	Memory cover	
(2)	Solid-state drive cover	
(3)	Fingerprint reader bracket	
(4)	USB bracket	

**Table 3-3 Bracket kit descriptions and part numbers (continued)**

Item	Component	Spare part number
	SIM tray (not illustrated)	

## Miscellaneous parts

To identify the miscellaneous parts, use this table.

**Table 3-4 Miscellaneous part descriptions and part numbers**

Component	Spare part number
<b>AC adapters</b>	
120 W, PFC, SMART, 7.4 mm, slim	L57117-001
120 W, PFC, SMART, 7.4 mm, slim	L89695-001
120 W, PFC, SMART, 4.5 mm, slim	M95377-001
110 W, PFC, 3P, slim, USB-C, 1.8 mm	M52950-001
65 W, nPFC, slim, USB-C, straight, 1.8 m (6 ft)	L04650-850
65 W, nPFC, USB-C, RC, 1.8 m (6 ft)	L32392-001
<b>Adapters</b>	
HDMI to VGA	701943-001
HDMI to DVI	691227-001
USB 3.0 to gigabit, full duplex (FD)	914031-001
USB-Type-C to RJ45, FD	918779-001
USB-Type-C to USB-A adapter	L65254-001
<b>Kits</b>	
Screw kit	L15820-001
Screw kit	L64089-001
Screw kit	L15921-001
Hinge kit	N08130-001
Cable kit for 120 W dock	L15812-002
Cable kit, flexible flat cable (FFC)	N08557-001
Cable kit, flexible printed circuit (FPC)	N08556-001
Plastic kit	N08559-001
Miscellaneous kit	N15920-001
<b>Power adapter, duckhead</b>	
Japan	L33157-001
<b>Power cords (C5, conventional, 1.0 m [3.3 ft])</b>	
Argentina	L19357-001

**Table 3-4 Miscellaneous part descriptions and part numbers (continued)**

<b>Component</b>	<b>Spare part number</b>
Australia	L19358-001
Brazil	L19359-001
Denmark	L19360-001
Europe (Austria, Belgium, Finland, France, Germany, the Netherlands, Norway, and Sweden)	L19361-001
India	L19363-001
Israel	L19362-001
Italy	L19364-001
Japan	L19365-001
North America	L19367-001
People's Republic of China	L19368-001
South Africa	L19369-001
South Korea	L19366-001
Switzerland	L19370-001
Taiwan	L19372-001
United Kingdom	L19373-001
<b>Power cord (C5, 1.0 m [3.3 ft], premium)</b>	
Argentina	L30811-001
Australia	L22327-001 L30769-001
Brazil	L30812-001 L30770-001
Denmark	L22322-001 L30771-001
Europe (Austria, Belgium, Finland, France, Germany, the Netherlands, Norway, and Sweden)	L22321-001 L30772-001
India	L22624-001
Israel	L22323-001 L30773-001
Italy	L30813-001 L30774-001
Japan	L22330-001 L30775-001
North America	L22319-001
People's Republic of China	L21930-001

**Table 3-4 Miscellaneous part descriptions and part numbers (continued)**

<b>Component</b>	<b>Spare part number</b>
South Africa	L22325-001
	L30777-001
South Korea	L22328-001
	L30776-001
Switzerland	L22324-001
	L30778-001
Taiwan	L22329-001
	L30780-001
Thailand	L30779-001
United Kingdom	L22320-001
	L30781-001
<b>Power cord (C5, fixed duckhead, premium, 1.0 m [3.3 ft])</b>	
Thailand	L36826-001
United Kingdom	L36828-001
<b>Power cord (C5, conventional, 1.8 m [6.0 ft])</b>	
Argentina	L19357-002
Australia	L19358-002
Brazil	L19359-002
Denmark	L19360-002
Europe (Austria, Belgium, Finland, France, Germany, the Netherlands, Norway, and Sweden)	L19361-002
India	L19363-002
Israel	L19362-002
Italy	L19364-002
Japan	L19365-002
North America	L19367-002
People's Republic of China	L19368-002
South Africa	L19369-002
South Korea	L19366-002
Switzerland	L19370-002
Taiwan	L19372-002
Thailand	L19371-001
United Kingdom	L19373-002
<b>Power cords</b>	
Thailand (BUNDLE ADP+CORD, C5 1.0M, Premium)	M85419-001

**Table 3-4** Miscellaneous part descriptions and part numbers (continued)

<b>Component</b>	<b>Spare part number</b>
Denmark (C5 1.0M, conventional, for HF mobile devices)	M79264-001
Europe (Austria, Belgium, Finland, France, Germany, the Netherlands, Norway, and Sweden)	M79266-001

---

## 4 Removal and replacement procedures preliminary requirements

Use this information to properly prepare to disassemble and reassemble the computer.

### Tools required

You need the following tools to complete the removal and replacement procedures:

- Tweezers
- Nonconductive, nonmarking pry tool
- Magnetic Phillips P1 screwdriver

### Service considerations

The following sections include some of the considerations that you must keep in mind during disassembly and assembly procedures.

---

 **NOTE:** As you remove each subassembly from the computer, place the subassembly (and all accompanying screws) away from the work area to prevent damage.

---

### Plastic parts

Using excessive force during disassembly and reassembly can damage plastic parts.

### Cables and connectors

Handle cables with extreme care to avoid damage.

---

 **IMPORTANT:** When servicing the computer, be sure that cables are placed in their proper locations during the reassembly process. Improper cable placement can damage the computer.

---

Apply only the tension required to unseat or seat the cables during removal and insertion. Handle cables by the connector whenever possible. In all cases, avoid bending, twisting, or tearing cables. Be sure that cables are routed so that they cannot be caught or snagged as you remove or replace parts. Handle flex cables with extreme care; these cables tear easily.

### Drive handling

Note the following guidelines when handling drives.

---

 **IMPORTANT:** Drives are fragile components. Handle them with care. To prevent damage to the computer, damage to a drive, or loss of information, observe these precautions:

- Before removing or inserting a hard drive, shut down the computer. If you are unsure whether the computer is off or in Hibernation, turn the computer on, and then shut it down through the operating system.

- Before handling a drive, be sure that you are discharged of static electricity. While handling a drive, avoid touching the connector.
  - Before removing an optical drive, be sure that a disc is not in the drive, and be sure that the optical drive tray is closed.
  - Handle drives on surfaces covered with at least 2.54 cm (1 inch) of shock-proof foam.
  - Avoid dropping drives from any height onto any surface.
  - After removing a hard drive or an optical drive, place it in a static-proof bag.
  - Avoid exposing an internal hard drive to products that have magnetic fields, such as monitors or speakers.
  - Avoid exposing a drive to temperature extremes or liquids.
  - If a drive must be mailed, place the drive in a bubble pack mailer or other suitable form of protective packaging, and label the package “FRAGILE.”
- 

## Electrostatic discharge information

A sudden discharge of static electricity from your finger or other conductor can destroy static-sensitive devices or microcircuitry. Often the spark is neither felt nor heard, but damage occurs. An electronic device exposed to electrostatic discharge (ESD) might not appear to be affected at all and can work perfectly throughout a normal cycle. The device might function normally for a while, but it has been degraded in the internal layers, reducing its life expectancy.

Networks built into many integrated circuits provide some protection, but in many cases, the discharge contains enough power to alter device parameters or melt silicon junctions.

---

 **IMPORTANT:** To prevent damage to the device when you remove or install internal components, observe these precautions:

- Keep components in their electrostatic-safe containers until you are ready to install them.
  - Before touching an electronic component, discharge static electricity by using the guidelines described in [Personal grounding methods and equipment on page 33](#).
  - Avoid touching pins, leads, and circuitry. Handle electronic components as little as possible.
  - If you remove a component, place it in an electrostatic-safe container.
- 

## Generating static electricity

Follow these static electricity guidelines:

- Different activities generate different amounts of static electricity.
- Static electricity increases as humidity decreases.



**Table 4-1 Static electricity occurrence based on activity and humidity**

Event	Relative humidity		
	55%	40%	10%
Walking across carpet	7,500 V	15,000 V	35,000 V
Walking across vinyl floor	3,000 V	5,000 V	12,000 V
Motions of bench worker	400 V	800 V	6,000 V
Removing DIPs (dual in-line packages) from plastic tube	400 V	700 V	2,000 V
Removing DIPs from vinyl tray	2,000 V	4,000 V	11,500 V
Removing DIPs from polystyrene foam	3,500 V	5,000 V	14,500 V
Removing bubble pack from PCB (printed circuit board)	7,000 V	20,000 V	26,500 V
Packing PCBs in foam-lined box	5,000 V	11,000 V	21,000 V
Multiple electric components can be packaged together in plastic tubes, trays, or polystyrene foam.			

 **NOTE:** As little as 700 V of static electricity can degrade a product.

## Preventing electrostatic damage to equipment

Many electronic components are sensitive to ESD. Circuitry design and structure determine the degree of sensitivity.

The following packaging and grounding precautions are necessary to prevent static electricity damage to electronic components:

- To avoid hand contact, transport products in static-safe containers such as tubes, bags, or boxes.
- Protect all electrostatic parts and assemblies with conductive or approved containers or packaging.
- Keep electrostatic-sensitive parts in their containers until they arrive at static-free stations.
- Place items on a grounded surface before removing them from their container.
- Always be properly grounded when touching a sensitive component or assembly.
- Avoid contact with pins, leads, or circuitry.
- Place reusable electrostatic-sensitive parts from assemblies in protective packaging or conductive foam.

## Personal grounding methods and equipment

Using certain equipment can prevent static electricity damage to electronic components.

- **Wrist straps** are flexible straps with a maximum of  $1\text{ M}\Omega \pm 10\%$  resistance in the ground cords. To provide proper ground, a strap must be worn snug against bare skin. The ground cord must be connected and fit snugly into the banana plug connector on the grounding mat or workstation.
- You can use **heel straps, toe straps, and boot straps** at standing workstations. These straps are compatible with most types of shoes or boots. On conductive floors or dissipative floor mats, use them on both feet with a maximum of  $1\text{ M}\Omega \pm 10\%$  resistance between the operator and ground.

**Table 4-2 Static shielding protection levels**

Static shielding protection levels	
Method	Voltage
Antistatic plastic	1,500
Carbon-loaded plastic	7,500
Metallized laminate	15,000

## Grounding the work area

To prevent static damage at the work area, follow these precautions:

- Cover the work surface with approved static-dissipative material.
- Use a wrist strap connected to a properly grounded work surface and use properly grounded tools and equipment.
- Use static-dissipative mats, foot straps, or air ionizers to give added protection.
- Handle electrostatic sensitive components, parts, and assemblies by the case or PCB laminate. Handle them only at static-free work areas.
- Turn off power and input signals before inserting and removing connectors or test equipment.
- Use fixtures made of static-safe materials when fixtures must directly contact dissipative surfaces.
- Keep the work area free of nonconductive materials, such as ordinary plastic assembly aids and polystyrene foam.
- Use conductive field service tools, such as cutters, screwdrivers, and vacuums.
- Avoid contact with pins, leads, or circuitry.

## Recommended materials and equipment

HP recommends certain materials and equipment to prevent static electricity:

- Antistatic tape
- Antistatic smocks, aprons, or sleeve protectors
- Conductive bins and other assembly or soldering aids
- Conductive foam
- Conductive tabletop workstations with ground cord of  $1\text{ M}\Omega \pm 10\%$  resistance
- Static-dissipative table or floor mats with hard tie to ground
- Field service kits
- Static awareness labels
- Wrist straps and footwear straps providing  $1\text{ M}\Omega \pm 10\%$  resistance
- Material handling packages

- Conductive plastic bags
- Conductive plastic tubes
- Conductive tote boxes
- Opaque shielding bags
- Transparent metallized shielding bags
- Transparent shielding tubes

## Cleaning your computer

Cleaning your computer regularly removes dirt and debris so that your device continues to operate at its best. Use the following information to safely clean the external surfaces of your computer.

### Enabling HP Easy Clean (select products only)

HP Easy Clean helps you to avoid accidental input while you clean the computer surfaces. This software disables devices such as the keyboard, touch screen, and touchpad for a preset amount of time so that you can clean all computer surfaces.

1. Start HP Easy Clean in one of the following ways:
  - Select the **Start** menu, and then select **HP Easy Clean**.  
– or –
  - Select the **HP Easy Clean** icon in the taskbar.  
– or –
  - Select **Start**, and then select the **HP Easy Clean** tile.
2. Now that your device is disabled for a short period, see [Removing dirt and debris from your computer on page 35](#) for the recommended steps to clean the high-touch, external surfaces on your computer. After you remove the dirt and debris, you can also clean the surfaces with a disinfectant. See [Cleaning your computer with a disinfectant on page 36](#) for guidelines to help prevent the spread of harmful bacteria and viruses.

### Removing dirt and debris from your computer

Here are the recommended steps to clean dirt and debris from your computer.

For computers with wood veneer, see [Caring for wood veneer \(select products only\) on page 37](#).

1. Wear disposable gloves made of latex (or nitrile gloves, if you are latex-sensitive) when cleaning the surfaces.
2. Turn off your device and unplug the power cord and other connected external devices. Remove any installed batteries from items such as wireless keyboards.

---

 **CAUTION:** To prevent electric shock or damage to components, never clean a product while it is turned on or plugged in.

---

3. Moisten a microfiber cloth with water. The cloth should be moist, but not dripping wet.

---

 **IMPORTANT:** To avoid damaging the surface, avoid abrasive cloths, towels, and paper towels.

---

4. Wipe the exterior of the product gently with the moistened cloth.

---

 **IMPORTANT:** Keep liquids away from the product. Avoid getting moisture in any openings. If liquid makes its way inside your HP product, it can cause damage to the product. Do not spray liquids directly on the product. Do not use aerosol sprays, solvents, abrasives, or cleaners containing hydrogen peroxide or bleach that might damage the finish.

---

5. Start with the display (if applicable). Wipe carefully in one direction, and move from the top of the display to the bottom. Finish with any flexible cables, like power cord, keyboard cable, and USB cables.
6. Be sure that surfaces have completely air-dried before turning the device on after cleaning.
7. Discard the gloves after each cleaning. Clean your hands immediately after you remove the gloves.

See [Cleaning your computer with a disinfectant on page 36](#) for recommended steps to clean the high-touch, external surfaces on your computer to help prevent the spread of harmful bacteria and viruses.

## Cleaning your computer with a disinfectant

The World Health Organization (WHO) recommends cleaning surfaces, followed by disinfection, as a best practice for preventing the spread of viral respiratory illnesses and harmful bacteria.

After cleaning the external surfaces of your computer using the steps in [Removing dirt and debris from your computer on page 35](#), [Caring for wood veneer \(select products only\) on page 37](#), or both, you might also choose to clean the surfaces with a disinfectant. A disinfectant that is within HP's cleaning guidelines is an alcohol solution consisting of 70% isopropyl alcohol and 30% water. This solution is also known as rubbing alcohol and is sold in most stores.

Follow these steps when disinfecting high-touch, external surfaces on your computer:

1. Wear disposable gloves made of latex (or nitrile gloves, if you are latex-sensitive) when cleaning the surfaces.
2. Turn off your device and unplug the power cord and other connected external devices. Remove any installed batteries from items such as wireless keyboards.

---

 **CAUTION:** To prevent electric shock or damage to components, never clean a product while it is turned on or plugged in.

---

3. Moisten a microfiber cloth with a mixture of 70% isopropyl alcohol and 30% water. The cloth should be moist, but not dripping wet.

---

 **CAUTION:** Do not use any of the following chemicals or any solutions that contain them, including spray-based surface cleaners: bleach, peroxides (including hydrogen peroxide), acetone, ammonia, ethyl alcohol, methylene chloride, or any petroleum-based materials, such as gasoline, paint thinner, benzene, or toluene.

---

 **IMPORTANT:** To avoid damaging the surface, avoid abrasive cloths, towels, and paper towels.

---

4. Wipe the exterior of the product gently with the moistened cloth.

---

 **IMPORTANT:** Keep liquids away from the product. Avoid getting moisture in any openings. If liquid makes its way inside your HP product, it can cause damage to the product. Do not spray liquids directly

on the product. Do not use aerosol sprays, solvents, abrasives, or cleaners containing hydrogen peroxide or bleach that might damage the finish.

---

5. Start with the display (if applicable). Wipe carefully in one direction, and move from the top of the display to the bottom. Finish with any flexible cables, like power cord, keyboard cable, and USB cables.
6. Be sure that surfaces have completely air-dried before turning the device on after cleaning.
7. Discard the gloves after each cleaning. Clean your hands immediately after you remove the gloves.

## Caring for wood veneer (select products only)

Your product might feature high-quality wood veneer. As with all natural wood products, proper care is important for best results over the life of the product. Because of the nature of natural wood, you might see unique variations in the grain pattern or subtle variations in color, which are normal.

- Clean the wood with a dry, static-free microfiber cloth or chamois.
- Avoid cleaning products containing substances such as ammonia, methylene chloride, acetone, turpentine, or other petroleum-based solvents.
- Do not expose the wood to sun or moisture for long periods of time.
- If the wood becomes wet, dry it by dabbing with an absorbent, lint-free cloth.
- Avoid contact with any substance that might dye or discolor the wood.
- Avoid contact with sharp objects or rough surfaces that might scratch the wood.

See [Removing dirt and debris from your computer on page 35](#) for the recommended steps to clean the high-touch, external surfaces on your computer. After you remove the dirt and debris, you can also clean the surfaces with a disinfectant. See [Cleaning your computer with a disinfectant on page 36](#) for sanitizing guidelines to help prevent the spread of harmful bacteria and viruses.

## Packaging and transporting guidelines

Follow these grounding guidelines when packaging and transporting equipment:

- To avoid hand contact, transport products in static-safe tubes, bags, or boxes.
- Protect ESD-sensitive parts and assemblies with conductive or approved containers or packaging.
- Keep ESD-sensitive parts in their containers until the parts arrive at static-free workstations.
- Place items on a grounded surface before removing items from their containers.
- Always be properly grounded when touching a component or assembly.
- Store reusable ESD-sensitive parts from assemblies in protective packaging or nonconductive foam.
- Use transporters and conveyors made of antistatic belts and roller bushings. Be sure that mechanized equipment used for moving materials is wired to ground and that proper materials are selected to avoid static charging. When grounding is not possible, use an ionizer to dissipate electric charges.

## Accessing support information

To find the HP support that you need, use this information.

**Table 4-3 Support information locations**

Service consideration	Path to access information
Records of reported failure incidents stored on the computer	<p><b>Windows:</b></p> <p>Pre-operating system failures are logged in the BIOS Event Log. To view the BIOS Event Log:</p> <ol style="list-style-type: none"><li>1. Press the power button.</li><li>2. Immediately and repeatedly press <b>esc</b> when the power button light turns white.</li></ol> <p><b>NOTE:</b> If you do not press <b>esc</b> at the appropriate time, you must restart the computer and again repeatedly press <b>esc</b> when the power button light turns white to access the utility.</p> <ol style="list-style-type: none"><li>3. Press <b>f10</b> to enter the BIOS setup.</li><li>4. (On commercial products) Under the <b>Main</b> tab, select <b>BIOS event log</b>, and then select <b>View BIOS Event Log</b>.</li></ol> <p>- or -</p> <p>(On consumer products) Under the <b>Main</b> tab, select <b>System Log</b>.</p> <p>Post-operating system failures are logged in the Event Viewer.</p> <ol style="list-style-type: none"><li>1. Turn on the computer and allow the operating system to open.</li><li>2. Select the search icon  in the taskbar.</li><li>3. Type <code>Event Viewer</code>, and then press <b>enter</b>.</li><li>4. Select the log from the left panel. Details display in the right panel.</li></ol> <p><b>Chrome:</b></p> <ol style="list-style-type: none"><li>1. Go to <a href="https://support.google.com/chrome">support.google.com/chrome</a>.</li><li>2. Search <code>collect Chrome device logs</code>.</li></ol>
Technical bulletins	<p>To locate technical bulletins:</p> <ol style="list-style-type: none"><li>1. Go to <a href="https://www.hp.com">www.hp.com</a>.</li><li>2. Place the cursor over <b>Problem solving</b> to display more options.</li><li>3. Select <b>Support &amp; Troubleshooting</b>.</li><li>4. Type the serial number, product number, or product name to go to the product support page.</li><li>5. Select <b>Advisories</b> to view technical bulletins.</li></ol>
Repair professionals	<p>To locate repair professionals:</p> <ol style="list-style-type: none"><li>1. Go to <a href="https://www.hp.com">www.hp.com</a>.</li><li>2. Place the cursor over <b>Support resources</b> to display more options.</li><li>3. Select <b>Authorized service providers</b>.</li></ol>

**Table 4-3 Support information locations (continued)**

Service consideration	Path to access information
Component and diagnosis information, failure detection, and required action	To locate diagnosis information and actions: <ol style="list-style-type: none"><li data-bbox="703 312 1190 338">1. Go to <a href="http://www.hp.com/go/techcenter/pcdiags">http://www.hp.com/go/techcenter/pcdiags</a>.</li><li data-bbox="703 363 922 388">2. Select <b>Get Support</b>.</li><li data-bbox="703 413 1406 457">3. Near the bottom of the window, select <b>Notebook PCs</b>, and then select your location.</li></ol>

---

# 5 Removal and replacement procedures for Customer Self-Repair parts

This chapter provides removal and replacement procedures for Customer Self-Repair parts.

 **NOTE:** The Customer Self-Repair program is not available in all locations. Installing a part that is not supported by the Customer Self-Repair program can void your warranty. Check your warranty to determine whether Customer Self-Repair is supported in your location.

---

## Component replacement procedures

To remove and replace computer components, use these procedures.

 **NOTE:** Details about your computer, including model, serial number, product key, and length of warranty, are on the service tag at the bottom of your computer.

 **NOTE:** HP continually improves and changes product parts. For complete and current information about supported parts for your computer, go to <http://partsurfer.hp.com>, select your country or region, and then follow the on-screen instructions.

---

You must remove, replace, or loosen as many as 62 screws when you service Customer Self-Repair parts. Make special note of each screw size and location during removal and replacement.

## Preparation for disassembly

To prepare to disassemble the computer, use these steps.

See [Removal and replacement procedures preliminary requirements on page 31](#) for initial safety procedures.

1. Turn off the computer. If you are unsure whether the computer is off or in Hibernation, turn the computer on, and then shut it down through the operating system.
2. Disconnect the power from the computer by unplugging the power cord from the computer.
3. Disconnect all external devices from the computer.

## Bottom cover

To remove the bottom cover, use this procedure and illustration.

**Table 5-1** Bottom cover description and part number

Description	Spare part number
Bottom cover for use in models with UMA graphics memory (15 W)	N08551-001
Bottom cover for use in models with UMA graphics memory (25 W)	N08553-001

Before removing the bottom cover, prepare the computer for disassembly (see [Preparation for disassembly on page 40](#)).



Remove the bottom cover:

1. Remove the 5 Phillips M2.5 × 4.0 captive screws that secure the bottom cover to the computer.

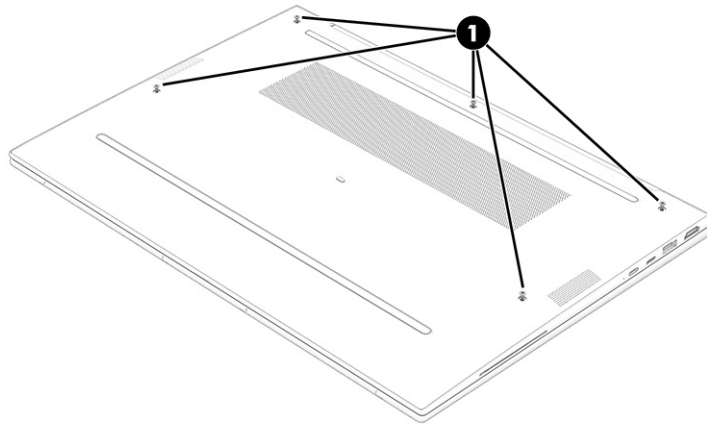

2. Use a nonmarking, nonconductive tool to release the edges of the bottom cover from the computer (1).
3. Remove the bottom cover from the computer (2).

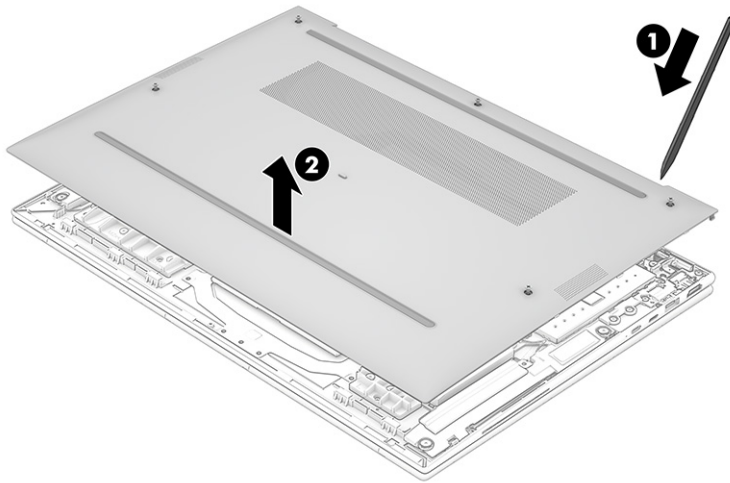

To replace the bottom cover, reverse the removal procedures.

## Battery

To remove the battery, use this procedure and illustration.

**Table 5-2 Battery description and part number**

Description	Spare part number
Battery, 3 cell, 51Whr, 4.68 Ah	M73466-005

**Table 5-2 Battery description and part number (continued)**

Description	Spare part number
Battery, 6 cell, 76 Whr, 3.525 Ah	M73470-005

 **WARNING!** To avoid personal injury and damage to the product:

- Do *not* puncture, twist, or crack the battery.
- Do *not* cause an external puncture or rupture to the battery. They can cause a short inside the battery, which can result in battery thermal runaway.
- Do *not* handle or touch the battery enclosure with sharp objects such as tweezers or pliers, which might puncture the battery.
- Do *not* compress or squeeze the battery case with tools or heavy objects stacked on top of the case. These actions can apply undue force on the battery.
- Do *not* touch the connectors with any metallic surface or object, such as metal tools, screws, or coins, which can cause shorting across the connectors.

Before removing the battery, follow these steps:

1. Prepare the computer for disassembly (see [Preparation for disassembly on page 40](#)).
2. Remove the bottom cover (see [Bottom cover on page 40](#)).

 **WARNING!** To reduce potential safety issues, use only the user-replaceable battery provided with the computer, a replacement battery provided by HP, or a compatible battery purchased from HP.

 **IMPORTANT:** Removing a battery that is the sole power source for the computer can cause loss of information. To prevent loss of information, save your work or shut down the computer through Windows before you remove the battery.

Remove the battery:

1. Disconnect the battery cable from the system board (1).
2. Remove the five Phillips M2.0 × 4.0 screws (1) that secure the battery to the computer.

3. Remove the battery from the computer (2).

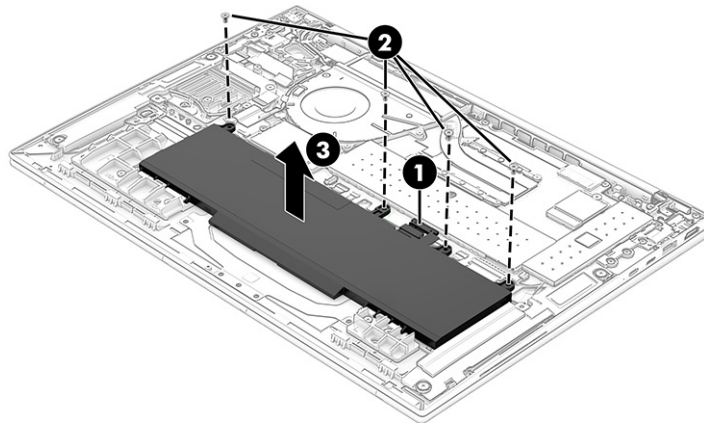

To insert the battery, reverse the removal procedures.

## WLAN module

To remove the WLAN module, use this procedure and illustration.

**Table 5-3 WLAN module descriptions and part numbers**

Description	Spare part number
Intel Wi-Fi 6 AX211 802.11ax (2 × 2) and Bluetooth 5.2 (non-vPro), M.2 2230	M53366-001
Intel Wi-Fi 6 AX211 802.11ax (2 × 2) and Bluetooth 5.2 (vPro), M.2 2230	M53363-001

 **IMPORTANT:** To prevent an unresponsive system, replace the wireless module only with a wireless module authorized for use in the computer by the governmental agency that regulates wireless devices in your country or region. If you replace the module and then receive a warning message, remove the module to restore device functionality, and then contact technical support.

Before removing the WLAN module, follow these steps:

1. Prepare the computer for disassembly (see [Preparation for disassembly on page 40](#)).
2. Remove the bottom cover (see [Bottom cover on page 40](#)).
3. Remove the battery (see [Battery on page 41](#)).

Remove the WLAN module:

1. Carefully disconnect the two antenna cables from the module (1).
2. Remove the Phillips M2.0 × 2.0 screw (2), and then remove the WLAN module (3).

 **NOTE:** Models have either one or two WLAN antennas. On models with two antennas, the #1 white WLAN antenna cable connects to the WLAN module #1 Main terminal. The #2 black WLAN antenna cable connects to the WLAN module #1 Aux terminal.

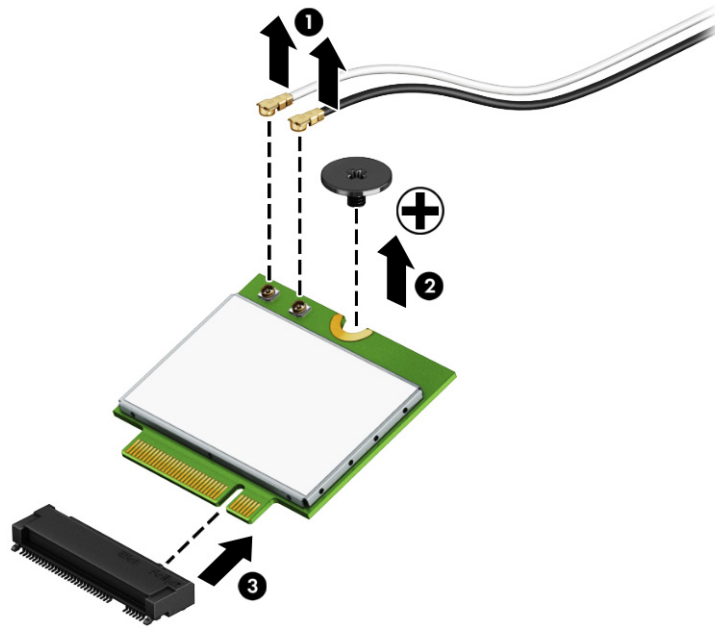

3. If the WLAN antenna is not connected to the terminal on the WLAN module, install a protective sleeve on the antenna connector, as shown in the following illustration.

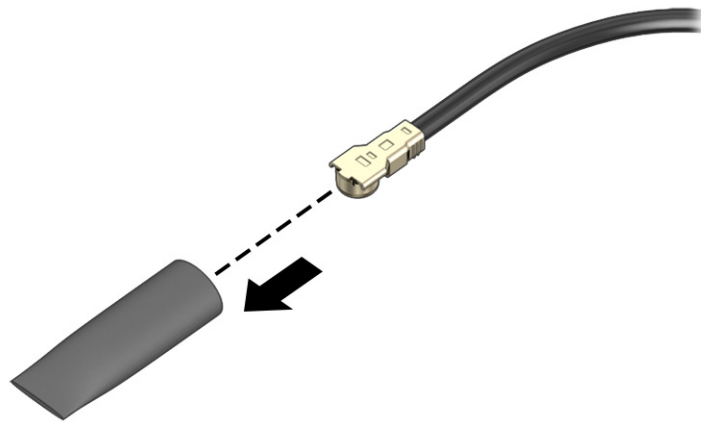

Reverse this procedure to install the WLAN module.

## WWAN module

To remove the WWAN module, use this procedure and illustration.

**Table 5-4 WWAN module descriptions and part numbers**

Description	Spare part number
Intel XMM 7560 R+ LTE-Advanced Pro (Cat 16) WWAN	M52040-001

**Table 5-4 WWAN module descriptions and part numbers (continued)**

Description	Spare part number
Intel 5000 5G WWAN	M46335-001

 **IMPORTANT:** To prevent an unresponsive system, replace the wireless module only with a wireless module authorized for use in the computer by the governmental agency that regulates wireless devices in your country or region. If you replace the module and then receive a warning message, remove the module to restore device functionality, and then contact technical support.

Before removing the WWAN module, follow these steps:

1. Prepare the computer for disassembly ([Preparation for disassembly on page 40](#)).
2. Remove the bottom cover (see [Bottom cover on page 40](#)).
3. Remove the battery (see [Battery on page 41](#)).

Remove the WWAN module:

1. Disconnect the WWAN antenna cables **(1)** from the terminals on the WWAN module.
2. Remove the Phillips M2.0 × 4.0 screw **(2)** that secures the WWAN module to the bottom cover. (The WWAN module tilts up.)
3. Remove the WWAN module **(3)** by pulling the module away from the slot at an angle.

 **NOTE:** Models have either one or two WLAN antennas. On models with two antennas, the #1 white WLAN antenna cable connects to the WLAN module #1 Main terminal. The #2 black WLAN antenna cable connects to the WLAN module #1 Aux terminal.

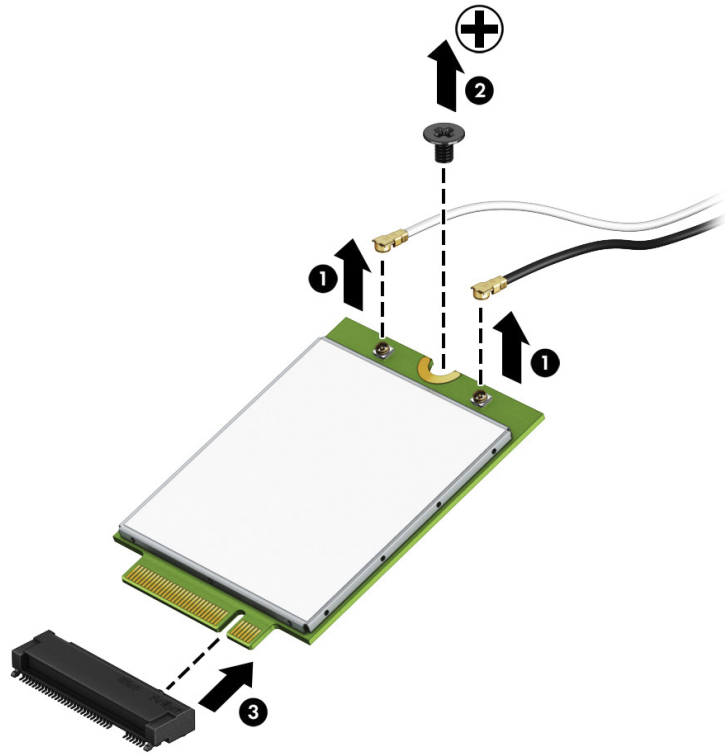

4. If the WWAN antenna is not connected to the terminal on the WWAN module, a protective sleeve must be installed on the antenna connector, as shown in the following illustration.

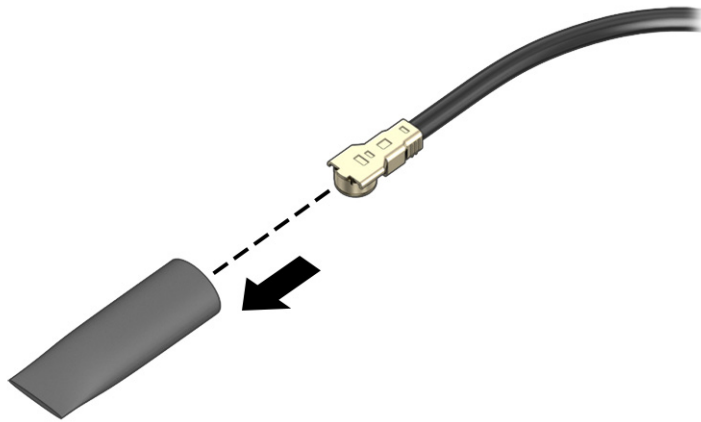

Reverse this procedure to install the WWAN module.

## Solid-state drive

To remove the M.2 solid-state drive, use this procedure and illustration.

**Table 5-5 Solid-state drive descriptions and part numbers**

Description	Spare part number
2 TB PCIe NVMe TLC 2280 Solid State Drive	M52027-001
1 TB PCIe NVMe TLC 2280 Solid State Drive	M16560-001
512 GB PCIe NVMe TLC 2280 Self Encrypted OPAL2 Solid State Drive	M52031-001
512 GB PCIe NVMe TLC Solid State Drive	M17436-001
512 GB, M.2 2280, PCIe, NVMe, value	L85364-001
256 GB PCIe NVMe TLC 2280 Self Encrypted OPAL2 Solid State Drive	M52029-001
256 GB PCIe NVMe TLC 2280 single-sided Solid State Drive	M52025-001
256 GB, M.2 2280, PCIe, NVMe value	L85354-001

Before removing the solid-state drive, follow these steps:

1. Prepare the computer for disassembly ([Preparation for disassembly on page 40](#)).
2. Remove the bottom cover (see [Bottom cover on page 40](#)).
3. Remove the battery (see [Battery on page 41](#)).

Remove the solid-state drive:

1. Remove the Phillips M2.0 × 2.0 screw (1) that secures the drive to the computer.
2. Pull the drive away from the socket to remove it (2).

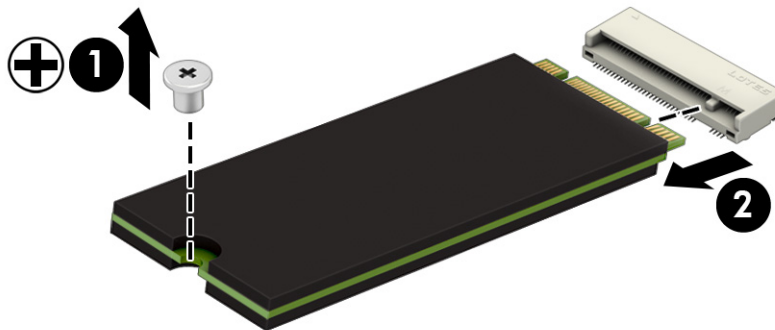

To install the solid-state drive, reverse the removal procedures.

 **NOTE:** Solid-state drives are designed with a notch to prevent incorrect insertion.

---

## 6 Removal and replacement procedures for authorized service provider parts

This chapter provides removal and replacement procedures for authorized service provider parts.

 **IMPORTANT:** Only an authorized service provider should access the components described in this chapter. Accessing these parts can damage the computer or void the warranty.

 **NOTE:** Details about your computer, including model, serial number, product key, and length of warranty, are on the service tag at the bottom of your computer.

---

### Component replacement procedures

To remove and replace computer components, use these procedures.

 **NOTE:** HP continually improves and changes product parts. For complete and current information about supported parts for your computer, go to <http://partsurfer.hp.com>, select your country or region, and then follow the on-screen instructions.

---

You must remove, replace, or loosen as many as 46 screws when you service the parts described in this chapter. Make special note of each screw size and location during removal and replacement.

### Preparation for disassembly

To remove and replace computer components, use these procedures:

For initial safety procedures, see [Removal and replacement procedures preliminary requirements on page 31](#).

1. Turn off the computer. If you are unsure whether the computer is off or in Hibernation, turn the computer on, and then shut it down through the operating system.
2. Disconnect the power from the computer by unplugging the power cord from the computer.
3. Disconnect all external devices from the computer.

### Plastic brackets

To remove the plastic brackets, use this procedure and illustration.

 **NOTE:** The bracket spare part kit includes the plastic brackets.

---

**Table 6-1** Plastic bracket kit description and part number

Description	Spare part number
Bracket kit	N08129-001

---

Before removing the plastic brackets, follow these steps:

1. Prepare the computer for disassembly ([Preparation for disassembly on page 40](#)).



2. Remove the bottom cover (see [Bottom cover on page 40](#)).
3. Remove the battery (see [Battery on page 41](#)).

Remove the plastic brackets:

- Loosen the four screws securing the left and right plastic brackets (1), and then remove the plastic brackets (2).

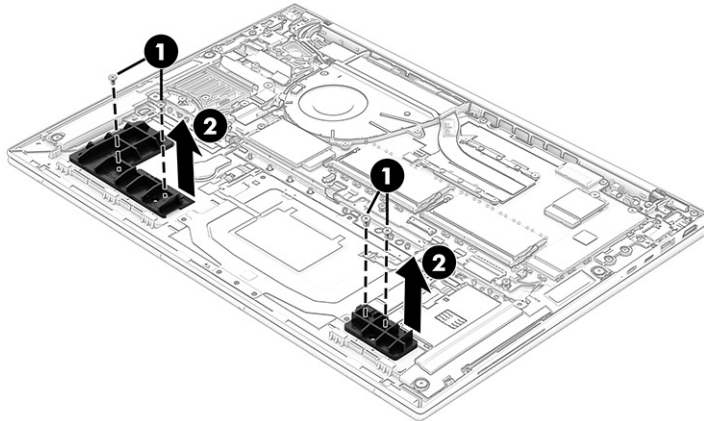

Reverse this procedure to install the plastic brackets.

## Speakers

To remove the speakers, use this procedure and illustration.

**Table 6-2** Speaker description and part number

Description	Spare part number
Speaker Kit	N08127-001

Before removing the speakers, follow these steps:

1. Prepare the computer for disassembly ([Preparation for disassembly on page 40](#)).
2. Remove the bottom cover (see [Bottom cover on page 40](#)).
3. Remove the battery (see [Battery on page 41](#)).

Remove the speakers:

1. Disconnect the speaker cables from the system board (1).
2. Remove the two Phillips M2.0 × 2.0 screws (2) that secure each speaker to the computer.

3. Remove the cable between the speakers from the clips (3), and then remove the speakers from the computer (4).

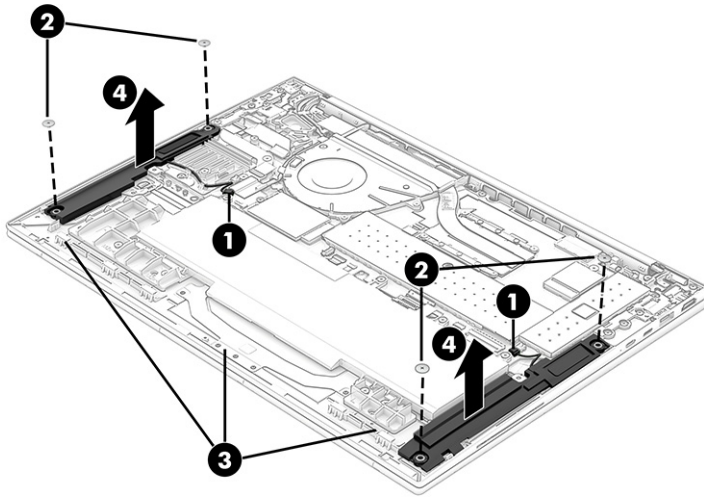

Reverse this procedure to install the speakers.

## Card reader board

To remove the card reader board, use this procedure and illustration.

**Table 6-3** Card reader board description and part number

Description	Spare part number
Card reader board	N08543-001
Card reader board cable (included in cable kit)	N08556-001 (FPC)
	N08557-001 (FFC)

Before removing the card reader board, follow these steps:

1. Prepare the computer for disassembly ([Preparation for disassembly on page 40](#)).
2. Remove the bottom cover (see [Bottom cover on page 40](#)).
3. Remove the battery (see [Battery on page 41](#)).

Remove the card reader board:

1. Disconnect the cable that secures the card reader board to the system board (1), and remove it (2).

2. Remove the three Phillips M.2.0 x 2.0 screws that secure the card reader to the computer (3), and then lift out the card reader (4).

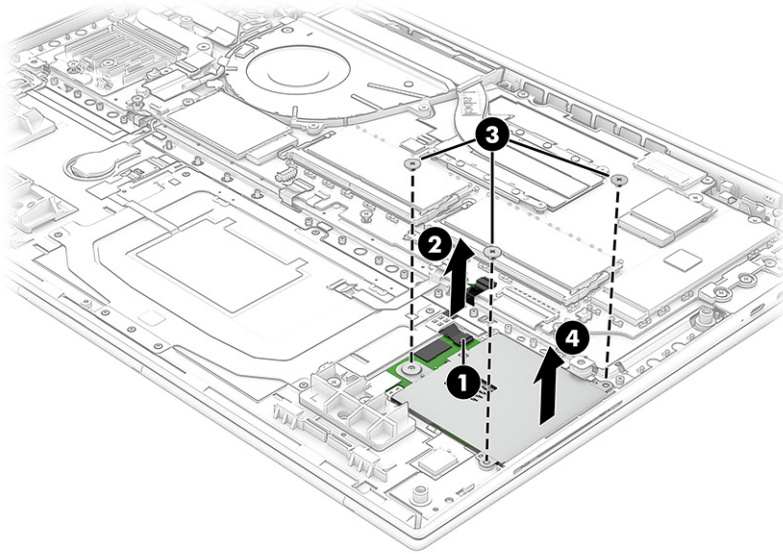

Reverse this procedure to install the card reader board.

## Heat sink

To remove the heat sink, use these procedures and illustrations.

**Table 6-4** Heat sink descriptions and part numbers

Description	Spare part number
Heat sink for use in models with UMA graphics (15 W)	N09037-001
Heat sink for use in models with UMA graphics (25 W)	N09038-001

Before removing the heat sink, follow these steps:

1. Prepare the computer for disassembly ([Preparation for disassembly on page 40](#)).
2. Remove the bottom cover (see [Bottom cover on page 40](#)).
3. Remove the battery (see [Battery on page 41](#)).

Remove the heat sink:

1. In the order indicated on the heat sink, remove the Phillips M2.0 x 4.0 screws (1) that secure the heat sink to the computer.

2. Remove the heat sink from the computer (2).

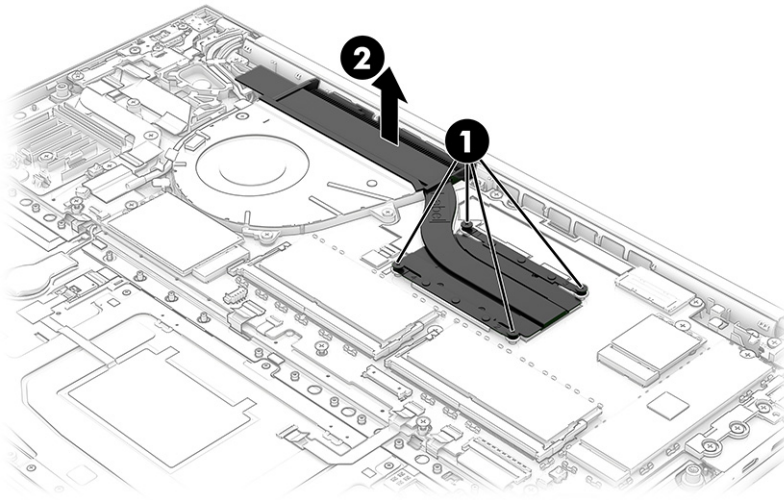

3. Thoroughly clean the thermal material from the surfaces of the heat sink and the system board components each time the heat sink is removed. Replacement thermal material is included with the heat sink and system board spare part kits. The following illustration shows the replacement thermal material locations.

Thermal paste is used on the system board components (1) and on the heat sink areas (2) that service them.

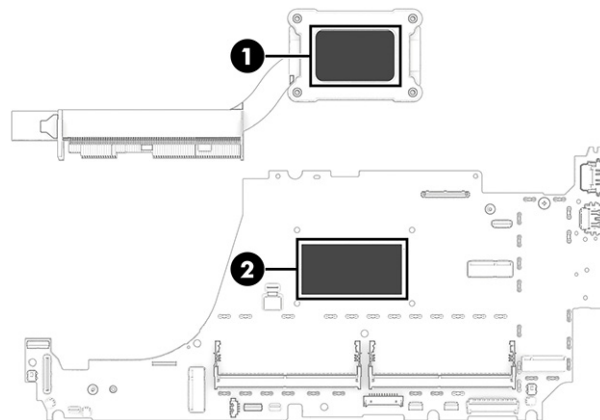

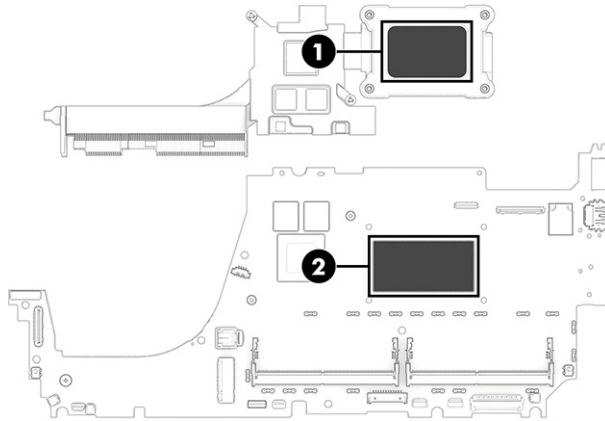

Reverse this procedure to install the heat sink.

## Fan

To remove the fan, use this procedure and illustration.

**Table 6-5 Fan description and part number**

Description	Spare part number
Fan assembly for use in models with UMA memory (15 W)	N09035-001
Fan assembly for use in models with UMA memory (25 W)	N09036-001

Before removing the fan, follow these steps:

1. Prepare the computer for disassembly ([Preparation for disassembly on page 40](#)).
2. Remove the bottom cover (see [Bottom cover on page 40](#)).
3. Remove the battery (see [Battery on page 41](#)).

Remove the fan assembly:

1. Remove the cables from the clips on the side of the fan **(1)**.
2. Remove the three Phillips M2.0 × 5.0 screws **(2)** that secure the fan to the computer.

3. Disconnect the fan cable from the system board (3), and then remove the fan from the computer (4).

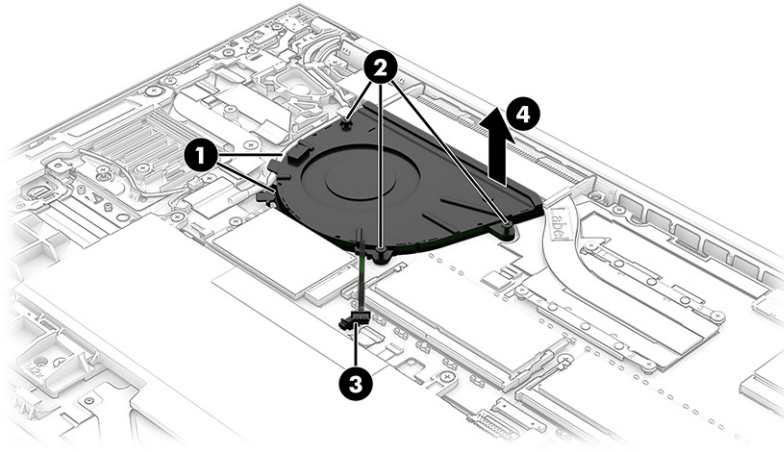

Reverse this procedure to install the fan assembly.

## USB board

To remove the USB board, use this procedure and illustration.

**Table 6-6** USB board description and part number

Description	Spare part number
USB board	TBD
Card reader board cable (included in cable kit)	N08556-001 (FPC)
	N08557-001 (FFC)

Before removing the USB board, follow these steps:

1. Prepare the computer for disassembly ([Preparation for disassembly on page 40](#)).
2. Remove the bottom cover (see [Bottom cover on page 40](#)).
3. Remove the battery (see [Battery on page 41](#)).

Remove the USB board:

1. Disconnect the smaller cable from the USB board (1).
2. Disconnect the larger cable from the ZIF connector on the USB board(2).
3. Remove the three Phillips M2.0 × 4.0 screws (3) that secure the board to the computer, and then remove the bracket from the board (4).
4. Remove the power connector cable from the USB board (5).

5. Remove the USB board from the computer (6).

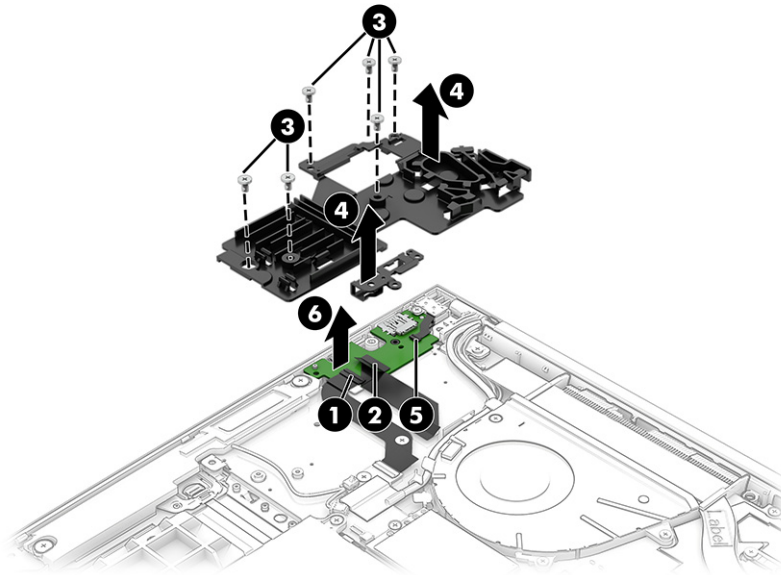

Reverse this procedure to install the USB board.

## Fingerprint reader board

To remove the fingerprint reader board, use this procedure and illustration.

**Table 6-7** Fingerprint reader board description and part number

Description	Spare part number
Fingerprint reader board	N02325-001
Fingerprint reader board cable (included in cable kit)	N08556-001 (FPC)
	N08557-001 (FFC)

Before removing the fingerprint reader board, follow these steps:

1. Prepare the computer for disassembly ([Preparation for disassembly on page 40](#)).
2. Remove the bottom cover (see [Bottom cover on page 40](#)).
3. Remove the battery (see [Battery on page 41](#)).

Remove the fingerprint reader board:

1. Remove the Phillips M2.0 × 2.0 screw (1) that secures the fingerprint reader bracket to the computer.
2. Disconnect the cable from the ZIF connector on the fingerprint reader board (2), and then remove the bracket from the computer (3).

3. Remove the board from the computer (4).

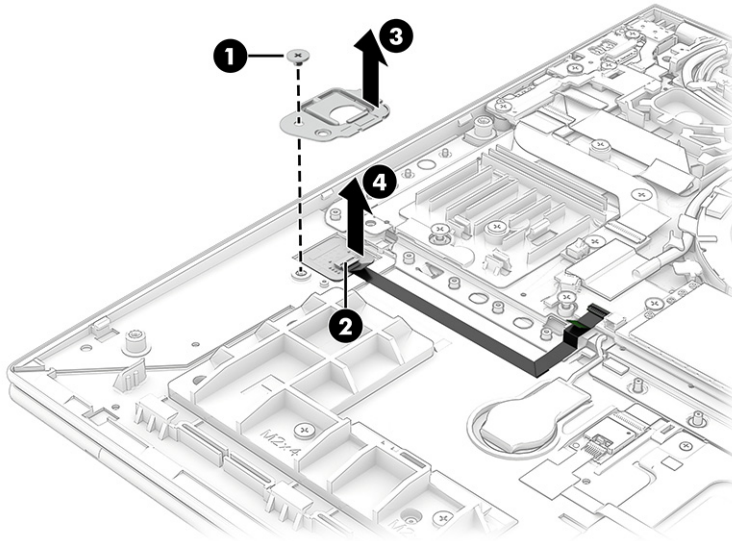

Reverse this procedure to install the fingerprint reader board.

## Power connector cable

To remove the power connector cable, use this procedure and illustration.

**Table 6-8** Power connector cable description and part number

Description	Spare part number
Power connector cable	N08540-001

Before removing the power connector cable, follow these steps:

1. Prepare the computer for disassembly ([Preparation for disassembly on page 40](#)).
2. Remove the bottom cover (see [Bottom cover on page 40](#)).
3. Remove the battery (see [Battery on page 41](#)).

Remove the power connector cable:

1. Disconnect the cable from the system board (1).
2. Remove the Phillips M2.0 × 5.0 screw (2) that secures the power connector cable to the computer.



3. Remove the power connector cable from the computer (3).

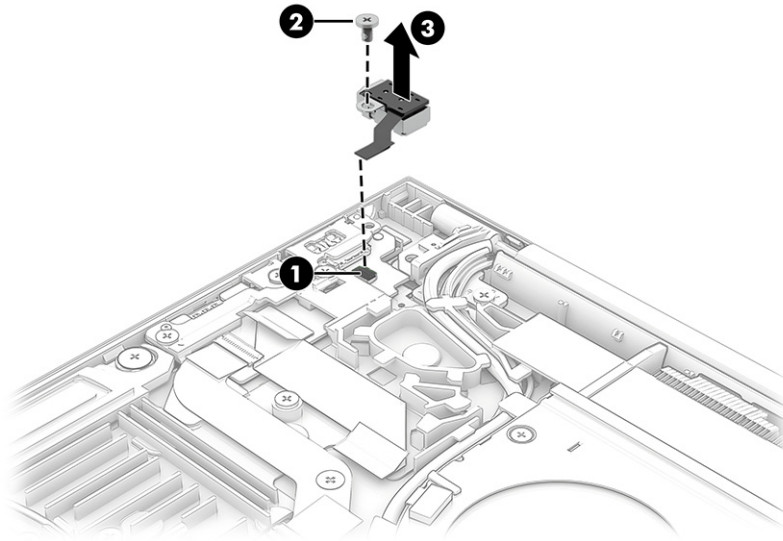

Reverse this procedure to install the power connector cable.

## Touchpad

To remove the touchpad, use this procedure and illustration.

**Table 6-9 Touchpad description and part number**

Description	Spare part number
Touchpad	N08555-001

Before removing the touchpad, follow these steps:

1. Prepare the computer for disassembly ([Preparation for disassembly on page 40](#)).
2. Remove the bottom cover (see [Bottom cover on page 40](#)).
3. Remove the battery (see [Battery on page 41](#)).

Remove the touchpad:

1. Disconnect the touchpad cable from the reverse ZIF connector on the NFC module (1).
2. Disconnect the system board cable from the ZIF connector on the touchpad (2).
3. Remove the eight Phillips M2.0 × 3.0 screws (3) that secure the touchpad bracket to the computer.

4. Remove the touchpad from the computer (2).

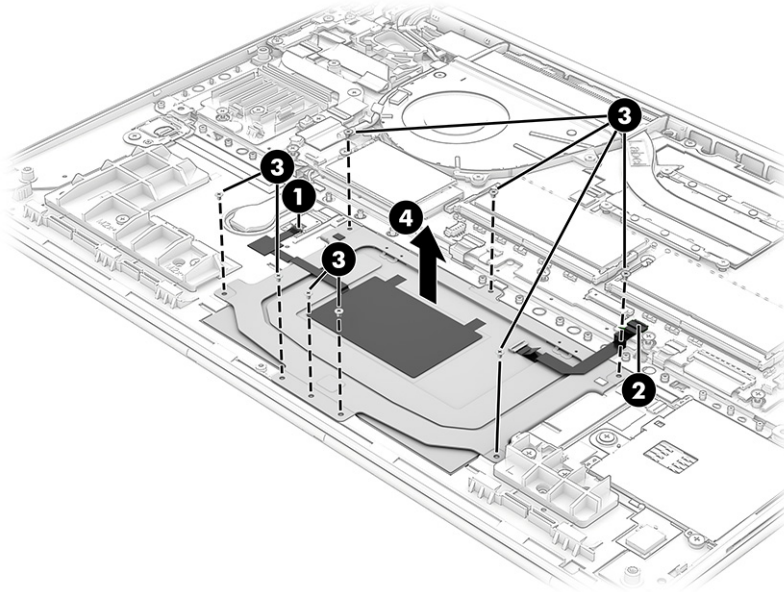

Reverse this procedure to install the touchpad.

## RTC battery

To remove the RTC battery, use this procedure and illustration.

**Table 6-10** RTC battery description and part number

Description	Spare part number
RTC battery	N15765-001

Before removing the RTC battery, follow these steps:

1. Prepare the computer for disassembly ([Preparation for disassembly on page 40](#)).
2. Remove the bottom cover (see [Bottom cover on page 40](#)).
3. Remove the battery (see [Battery on page 41](#)).

Remove the RTC battery:

1. Position the removed system board upright.

2. Disconnect the RTC battery (1), and then lift to remove it (2).

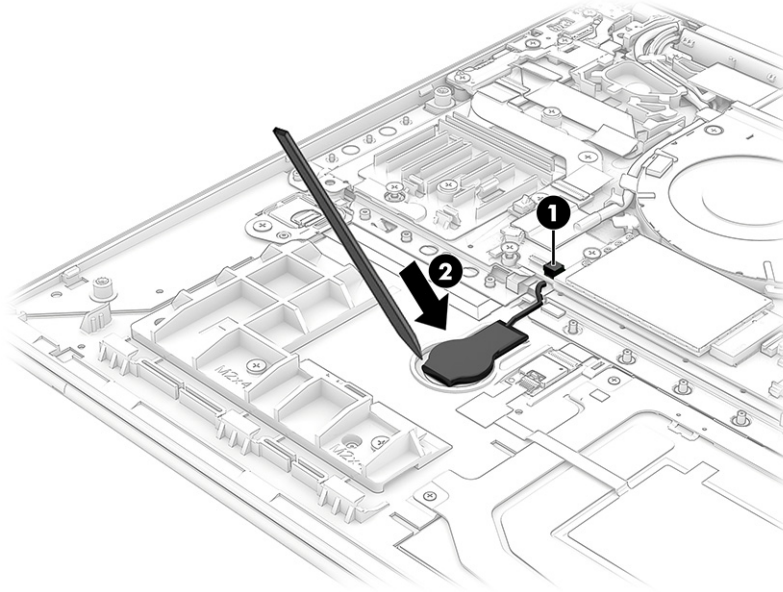

Reverse this procedure to install the RTC battery.

## System board

To remove the system board, use these procedures and illustrations.

**Table 6-11 System board descriptions and part numbers**

Description	Spare part number
<b>System board</b> (includes processor):	
All system boards use the following part numbers:	
xxxxxx-001: Non-Windows operating system	
xxxxxx-601: Windows 10 operating system	
Equipped with an Intel Core i7-1265U G9 processor, with 16 GB of system memory, discrete memory, and a Windows 11 operating system	N08216-601
Equipped with an Intel Core i7-1265U G9 (OSR) processor, with 16 GB of system memory, discrete memory, and a Windows 11 operating system	N08217-601
Equipped with an Intel Core i7-1255U G9 processor, with 16 GB of system memory, discrete memory, and a Windows 11 operating system	N08215-601
Equipped with an Intel Core i7-1280P G9 (OSR) processor, with 16 GB of system memory, UMA memory, and a Windows 11 operating system	N08108-601
Equipped with an Intel Core i7-1280P G9 processor, with 16 GB of system memory, UMA memory, and a Windows 11 operating system	N08107-601
Equipped with an Intel Core i7-1270P G9 (OSR) processor, with 16 GB of system memory, UMA memory, and a Windows 11 operating system	N08105-601
Equipped with an Intel Core i7-1270P G9 processor, with 16 GB of system memory, UMA memory, and a Windows 11 operating system	N08104-601

**Table 6-11 System board descriptions and part numbers (continued)**

Description	Spare part number
Equipped with an Intel Core i7-1260P G9 processor, with 16 GB of system memory, UMA memory, and a Windows 11 operating system	N08103-601
Equipped with an Intel Core i5-1245U G9 (OSR) processor, with 16 GB of system memory, discrete memory, and a Windows 11 operating system	N08214-601
Equipped with an Intel Core i5-1245U G9 processor, with 16 GB of system memory, discrete memory, and a Windows 11 operating system	N08213-601
Equipped with an Intel Core i5-1235U G9 processor, with 16 GB of system memory, discrete memory, and a Windows 11 operating system	N08212-601
Equipped with an Intel Core i5-1250P G9 (OSR) processor, with 16 GB of system memory, UMA memory, and a Windows 11 operating system	N08102-601
Equipped with an Intel Core i5-1250P G9 processor, with 16 GB of system memory, UMA memory, and a Windows 11 operating system	N08101-601
Equipped with an Intel Core i5-1240P G9 processor, with 16 GB of system memory, UMA memory, and a Windows 11 operating system	N08100-601

Before removing the system board, follow these steps:

1. Prepare the computer for disassembly ([Preparation for disassembly on page 40](#)).
2. Remove the bottom cover (see [Bottom cover on page 40](#)).
3. Remove the battery (see [Battery on page 41](#)).

When you replace the system board, be sure to remove the following components (as applicable) from the defective system board and install them on the replacement system board:

- WLAN module (see [WLAN module on page 43](#)).
- WWAN module (see [WWAN module on page 44](#)).
- Solid-state drive (see [Solid-state drive on page 46](#)).
- Heat sink (see [Heat sink on page 51](#)).

Remove the system board:

1. Disconnect the following cables from the system board:
  - Camera cable **(1)**
  - Antenna cables from the WWAN module (select products only) **(2)**
  - Speaker cable **(3)**
  - Keyboard cable (ZIF) **(4)**
  - Card reader cable (ZIF) **(5)**
  - Touchpad cable (ZIF) **(6)**
  - Keyboard backlight cable (ZIF) (select products only) **(7)**

- Fingerprint reader cable (ZIF) (select products only) **(8)**
- RTC battery cable **(9)**
- Antenna cables from the WLAN module **(10)**
- Speaker cable **(11)**
- Display cable **(12)**
- USB cables from the USB board **(13)**
- Power connector cable **(14)**

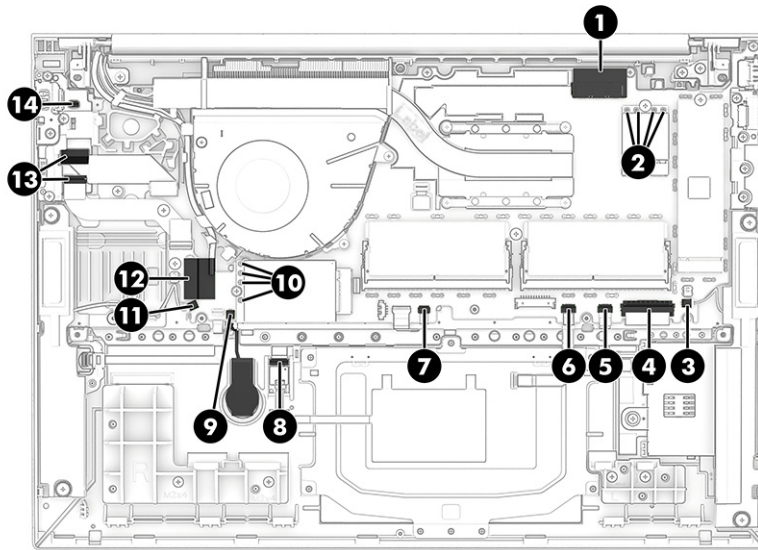

2. Remove the four Phillips M2.0 × 4.0 screws **(1)** that secure the bracket to the system board, and then remove the bracket **(2)**.

The plastic bracket is available in the Plastics Kit as spare part number N08559-001.

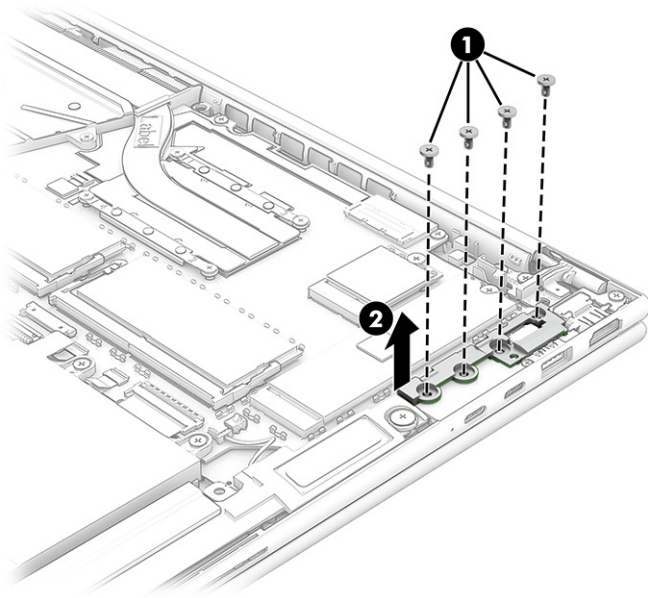

3. Remove the six screws that secure the system board to the computer: two Phillips M2.0 × 4.0 screws (1), three Phillips M2.0 × 2.0 screws (2), and the M1.6 × 4.0 screw (3).

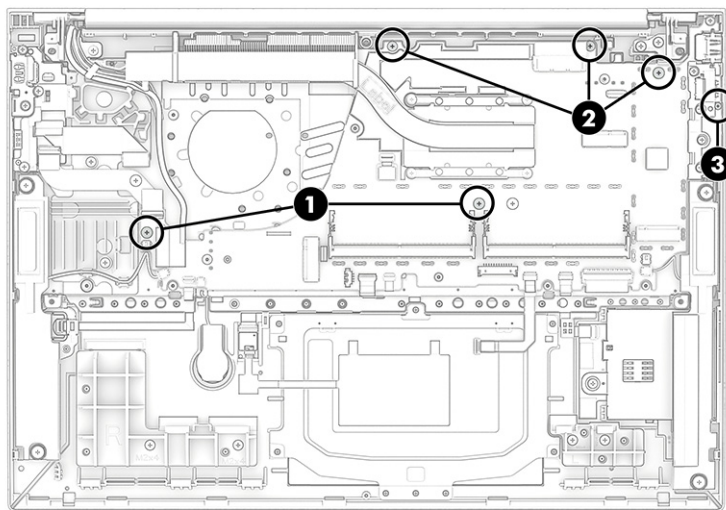

4. Remove the SIM card insert from the computer (1), lift the side of the system board upward (2), and then pull the system board away from the connectors on the side of the computer to remove it (3).

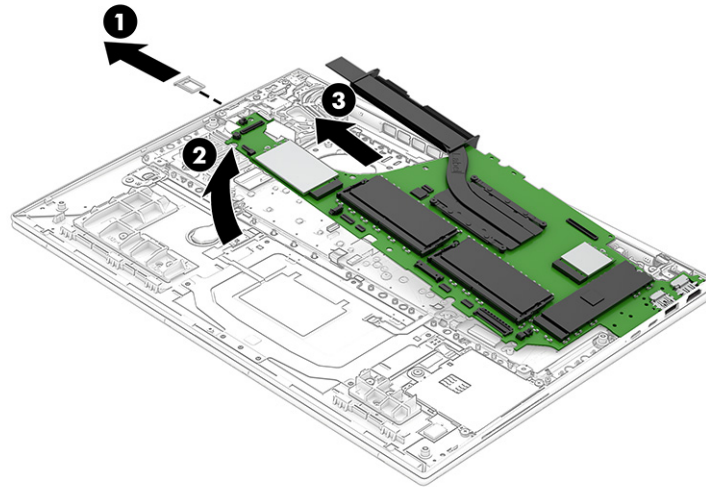

Reverse this procedure to install the system board.

## Display assembly

To remove and disassemble the display assembly, use these procedures and illustrations.

Full hinge-up displays are not available as spare parts. Spare parts for displays are available only at the subcomponent level.

Before removing the display panel, follow these steps:

1. Prepare the computer for disassembly ([Preparation for disassembly on page 40](#)).
2. Remove the bottom cover (see [Bottom cover on page 40](#)).
3. Remove the battery (see [Battery on page 41](#)).

Remove the display assembly:

1. Disconnect the webcam cable (1), disconnect the antenna cables from the WWAN module (2), and remove the cables from the clip (3).

2. Disconnect the display cable (4), remove the cables from the clips along the side of the WLAN module fan (5), and remove the cables from the clips along the side of the fan (6).

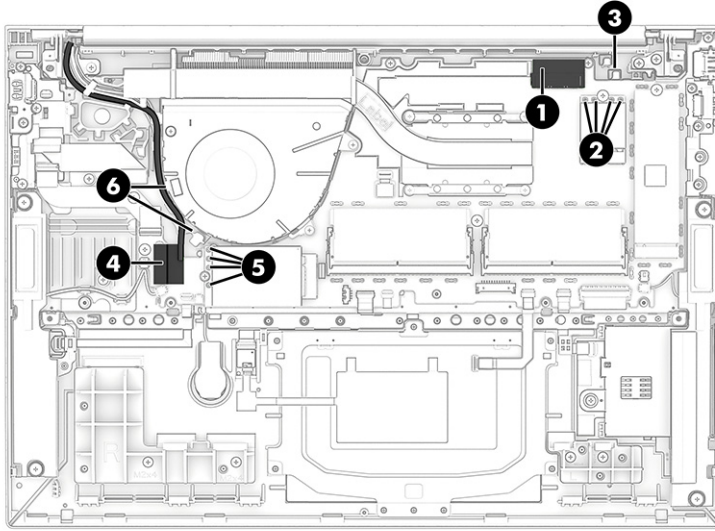

3. Remove the five Phillips M2.5 × 5.0 screws (1) that secure the display assembly to the computer.
4. Rotate the display upward to open the hinges (2).
5. Separate the display assembly from the computer (3).

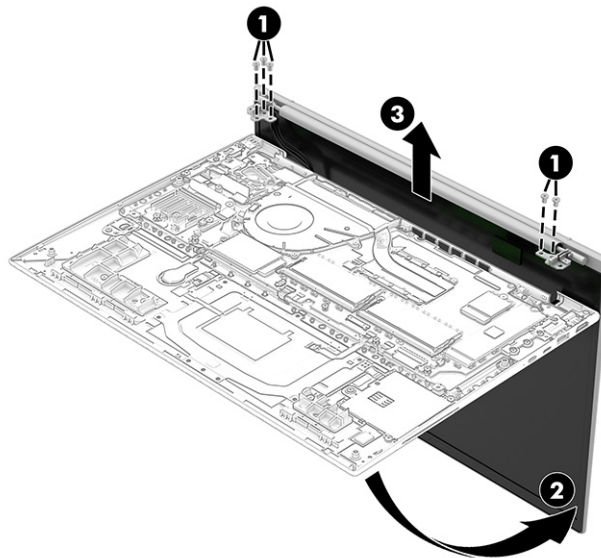

6. If you need to replace display assembly subcomponents:
  - a. Flex the top (1) and the inside edges of the left and right sides of the bezel (2) to release it.
  - b. Slide a flat tool (3) across the inside of the bottom of the bezel to release it, and then remove the bezel from the display (4).



Bezels are available as the following spare part numbers.

 **NOTE:** When replacing the bezel, be sure that the replacement bezel matches the original bezel.

N08135-001: RGB camera (with ambient light sensor)

N08550-001: RGB camera (without ambient light sensor)

N08134-001: IR camera (with ambient light sensor)

N08549-001: IR camera (without ambient light sensor)

N08136-001: Microphone

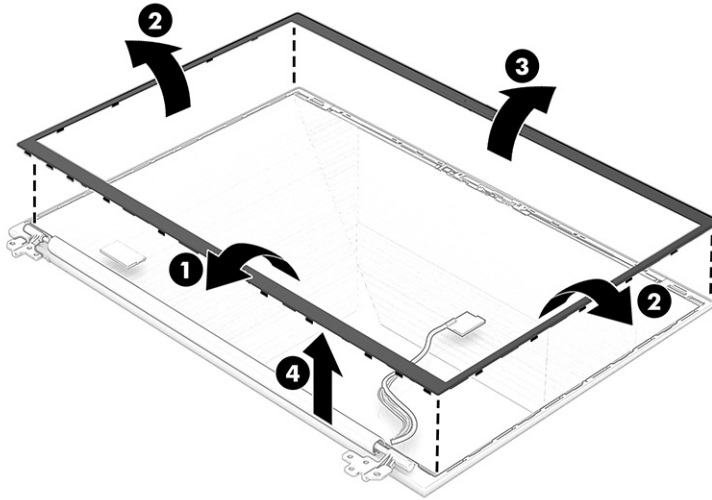

7. If you need to remove the hinges from the display enclosure:

- a. Remove the screw that secures the right side of the display hinge cover (1). Lift the display hinge cover up using a pry tool (2), and remove it (3).

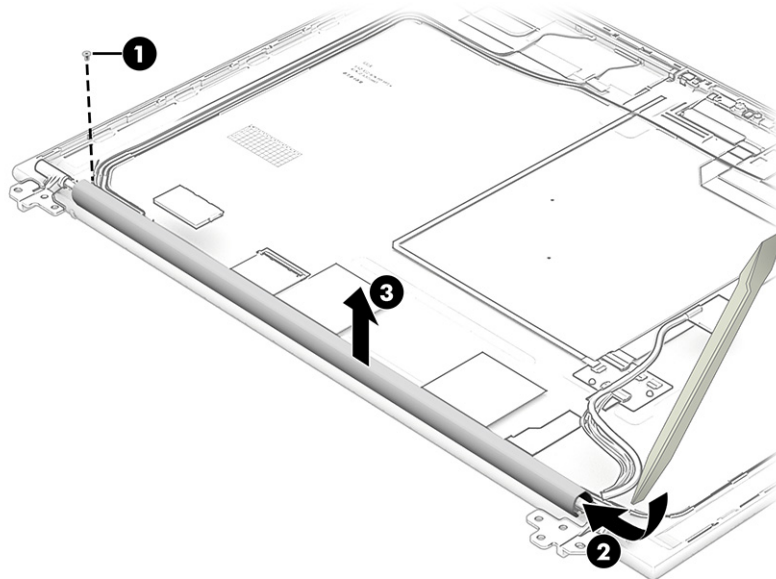

- b. Remove the three Phillips broadhead M2.0 × 2.0 screws (1) from each hinge.
- c. Remove the hinges from the display (2).

The display hinges are available as spare part number N08130-001.

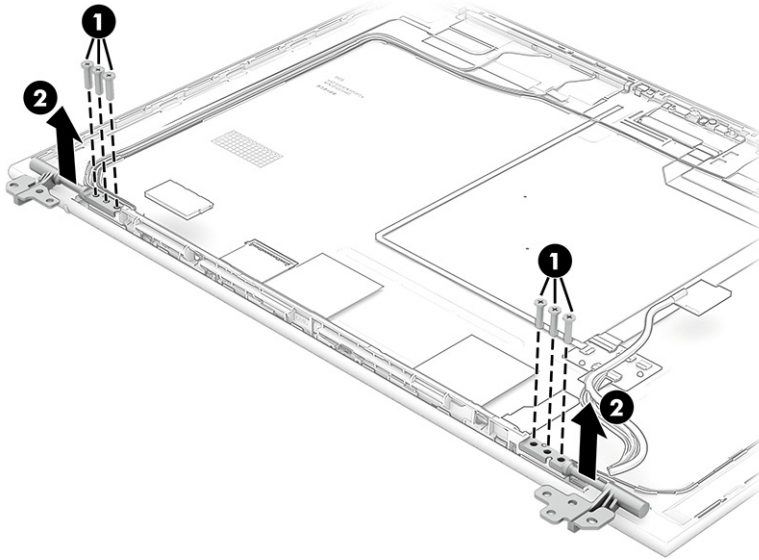

8. If you need to remove the display panel:

- a. The display panel is secured to the display enclosure with tape that is installed under the left and right sides of the panel. To remove the panel, use tweezers to grasp the end of the tape (1). While turning the tweezers, wrap the tape around the tweezers (2) as you continue to pull the tape out from behind the display panel (3). You must pull the tape multiple times before it is completely removed.
- b. Rotate the display panel over and place it next to the display enclosure (4).

Display panels are available as the following spare part numbers:

N14760-001: Widescreen ultra extended graphics array (WUXGA), BLNB, 400 nits

N14761-001: WUXGA, 250 nits

N14762-001: WUXGA, 250 nits Touch-on Panel (TOP)

N14763-001: WUXGA, 1000 nits, privacy panel

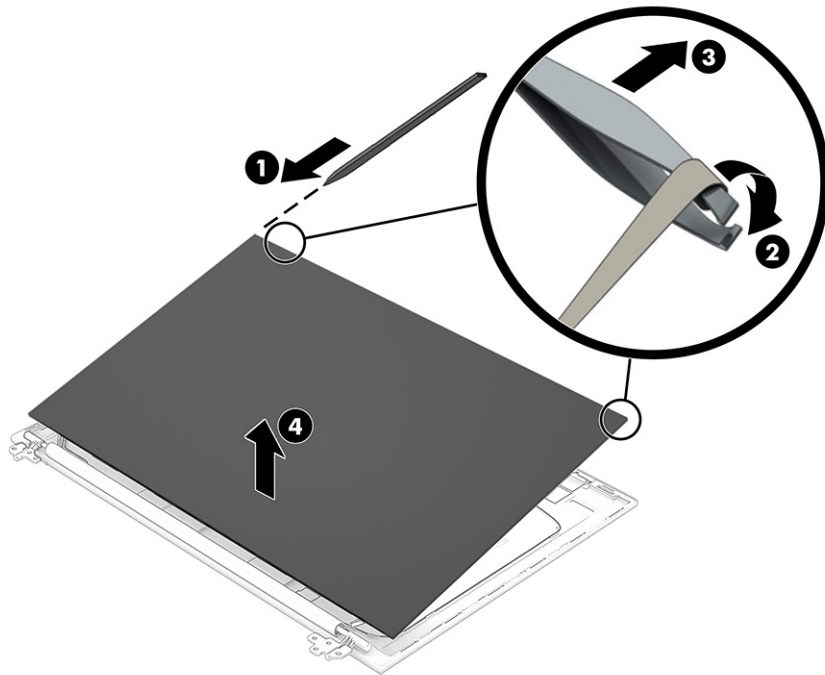

9. If you need to replace remove the microphone board from the display, disconnect the cable from the reverse ZIF connector on the board (1), and then use a tool (2) to release the board from the computer.

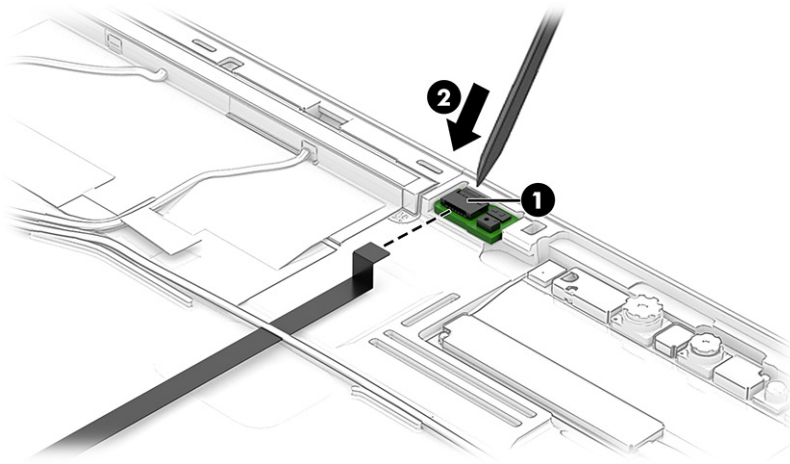

10. If you need to remove the hub board from the display:
- Disconnect the display cable from the ZIF connector (1) on the hub board.
  - Disconnect the camera cable from the ZIF connector (2) on the hub board.
  - Disconnect the smaller cable from the reverse ZIF connector on the hub board (3).
  - Release the board from the display rear cover (4). You may need to use a tool.

The hub boards are available as spare part numbers N08541-001 and N08542-001.

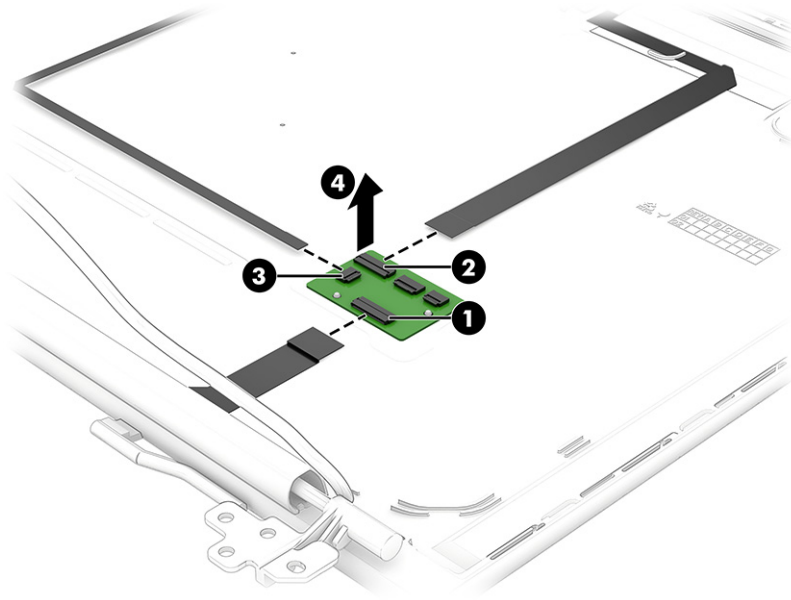

**11.** If you need to remove the camera module:

- Lift up evenly across the module using a pry tool and peel the module up from the display back cover **(1)**, and then disconnect the cable from the reverse ZIF connector on the module **(2)**. The camera module is available as spare part numbers N09060-001 and N09061-001.

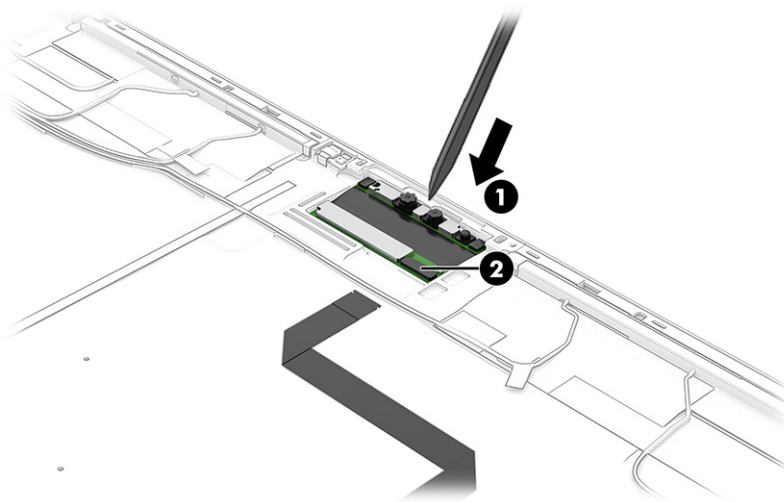

**12.** If you need to remove the display/camera cable, peel the cable off the inside of the display back cover **(1)**, remove the cable from the clips at the bottom of the display back cover **(2)**, and then remove the cable **(3)**.

Display panel cables are available in the display panel kit, as the spare part number of N08558-001.

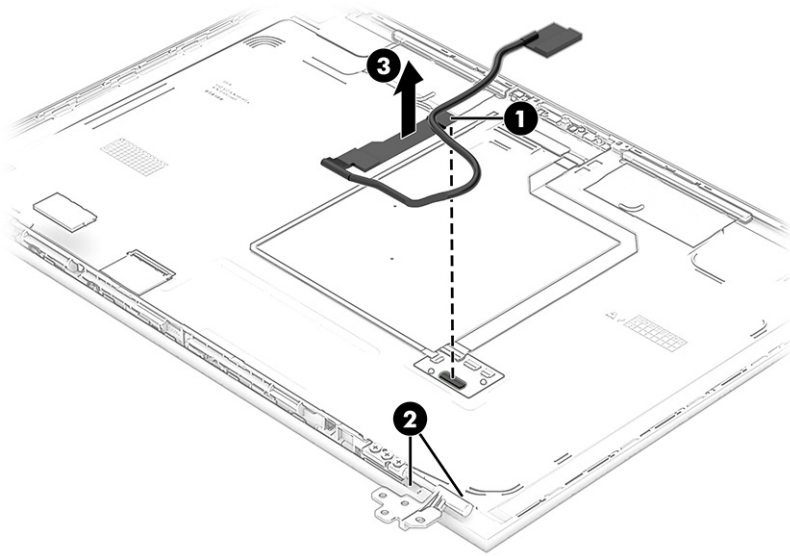

13. If you need to remove the WLAN antenna cables, peel the antennas off the inside of the display back cover (1), remove the cables from the clips at the bottom of the cover (2), and then remove the antennas and cables (3).

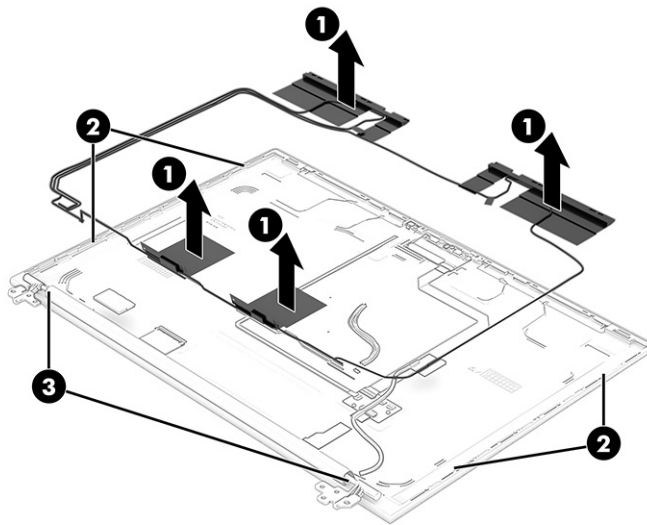

14. If you need to remove the WWAN antenna cables, peel the antennas off the inside of the display back cover (1), remove the cables from the clips at the bottom of the cover (2), and then remove the antennas and cables (3).

Display back covers are available as the following spare part numbers:

N08545-001: Models with WWAN, 250 nit panel

N08546-001: Models with WWAN, 400 nit panel

N08547-001: Models with WWAN, privacy

N08548-001: Models without WWAN, 250 nit panel

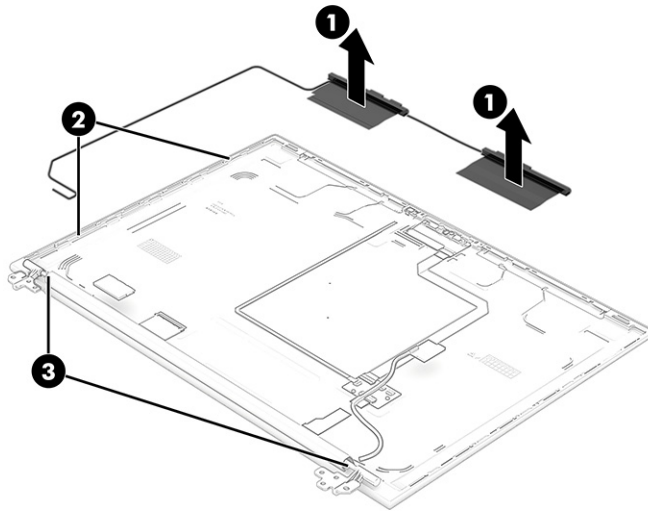

Reverse this procedure to reassemble and replace the display assembly.

## Keyboard with top cover

The top cover with keyboard remains after removing all other spare parts from the computer. In this section, the first table provides the main spare part number for the top cover/keyboards. The second table provides the country codes.

**Table 6-12 Keyboard with top cover descriptions and part numbers**

Description	Spare part number
Keyboard with top cover	N08147-001
Keyboard with top cover, backlit	N08145-001
Keyboard with top cover, backlit, for use in privacy models	N08146-001

**Table 6-13 Spare part country codes**

For use in country or region	Spare part number	For use in country or region	Spare part number	For use in country or region	Spare part number
Belgium	-A41	Iceland	-DD1	Saudi Arabia	-171
Brazil	-201	India	-D61	Slovenia	-BA1
Bulgaria	-261	Israel	-BB1	South Korea	-AD1
Chile	-161	Italy	-061	Spain	-071
Czech Republic/Slovakia	-FL1	Japan	-291	Switzerland	-BG1
Denmark, Finland, and Norway	-DH1	Kazakhstan	-DF1	Taiwan	-AB1
French Canada	-DB1	The Netherlands	-B31	Thailand	-281
France	-051	Northern Africa	-FP1	Turkey	-141
Germany	-041	Portugal	-131	Ukraine	-BD1

**Table 6-13 Spare part country codes (continued)**

<b>For use in country or region</b>	<b>Spare part number</b>	<b>For use in country or region</b>	<b>Spare part number</b>	<b>For use in country or region</b>	<b>Spare part number</b>
Greece	-151	Romania	-271	United Kingdom	-031
Hungary	-211	Russia	-251	United States	-001

---

## 7 Using Setup Utility (BIOS)

Setup Utility, or Basic Input/Output System (BIOS), controls communication between all the input and output devices on the system (such as disk drives, display, keyboard, mouse, and printer). Setup Utility (BIOS) includes settings for the types of devices installed, the startup sequence of the computer, and the amount of system and extended memory.

---

 **NOTE:** To start Setup Utility on convertible computers, your computer must be in notebook mode and you must use the keyboard attached to your notebook.

---

### Starting Setup Utility (BIOS)

You have several ways to access the Setup Utility (BIOS).

---

 **IMPORTANT:** Use extreme care when making changes in Setup Utility (BIOS). Errors can prevent the computer from operating properly.

---

- Turn on or restart the computer and quickly press **f10**.

– or –

Turn on or restart the computer, quickly press **esc**, and then press **f10** when the Start menu is displayed.

### Updating Setup Utility (BIOS)

Updated versions of Setup Utility (BIOS) might be available on the HP website. Most BIOS updates on the HP website are packaged in compressed files called *SoftPaqs*. Some download packages contain a file named *Readme.txt*, which contains information regarding installing and troubleshooting the file.

### Determining the BIOS version

To decide whether you need to update Setup Utility (BIOS), first determine the BIOS version on your computer.

To reveal the BIOS version information (also known as *ROM date* and *System BIOS*), use one of these options.

- HP Support Assistant
  1. Type `support` in the taskbar search box, and then select the **HP Support Assistant** app.  
– or –  
Select the question mark icon in the taskbar.
  2. Select **My notebook**, and then select **Specifications**.
- Setup Utility (BIOS)
  1. Start Setup Utility (BIOS) (see [Starting Setup Utility \(BIOS\) on page 72](#)).
  2. Select **Main**, and then make note of the BIOS version.
  3. Select **Exit**, select one of the options, and then follow the on-screen instructions.



- In Windows, press **ctrl+alt+s**.

To check for later BIOS versions, see [Preparing for a BIOS update on page 73](#).

## Preparing for a BIOS update

Be sure to follow all prerequisites before downloading and installing a BIOS update.

 **IMPORTANT:** To reduce the risk of damage to the computer or an unsuccessful installation, download and install a BIOS update only when the computer is connected to reliable external power using the AC adapter. Do not download or install a BIOS update while the computer is running on battery power, docked in an optional docking device, or connected to an optional power source. During the download and installation, follow these instructions:

- Do not disconnect power from the computer by unplugging the power cord from the AC outlet.
- Do not shut down the computer or initiate Sleep.
- Do not insert, remove, connect, or disconnect any device, cable, or cord.

 **NOTE:** If your computer is connected to a network, consult the network administrator before installing any software updates, especially system BIOS updates.

## Downloading a BIOS update

After you review the prerequisites, you can check for and download BIOS updates.

1. Type `support` in the taskbar search box, and then select the **HP Support Assistant** app.  
– or –  
Select the question mark icon in the taskbar.
2. Select **Updates**, and then select **Check for updates and messages**.
3. Follow the on-screen instructions.
4. At the download area, follow these steps:
  - a. Identify the most recent BIOS update and compare it to the BIOS version currently installed on your computer. If the update is more recent than your BIOS version, make a note of the date, name, or other identifier. You might need this information to locate the update later, after it has been downloaded to your hard drive.
  - b. Follow the on-screen instructions to download your selection to the hard drive.  
  
Make a note of the path to the location on your hard drive where the BIOS update is downloaded. You will need to access this path when you are ready to install the update.

## Installing a BIOS update

BIOS installation procedures vary. Follow any instructions that appear on the screen after the download is complete. If no instructions appear, follow these steps.

1. Type `file` in the taskbar search box, and then select **File Explorer**.
2. Select your hard drive designation. The hard drive designation is typically Local Disk (C:).
3. Using the hard drive path you recorded earlier, open the folder that contains the update.

4. Double-click the file that has an .exe extension (for example, *filename.exe*).  
The BIOS installation begins.
5. Complete the installation by following the on-screen instructions.



**NOTE:** After a message on the screen reports a successful installation, you can delete the downloaded file from your hard drive.

---

---

# 8 Computer Setup (BIOS), TPM, and HP Sure Start

HP provides several tools to help set up and protect your computer.

## Using Computer Setup

Computer Setup, or Basic Input/Output System (BIOS), controls communication between all the input and output devices on the system (such as hard drives, display, keyboard, mouse, and printer). Computer Setup includes settings for types of devices installed, the startup sequence of the computer, and amount of system and extended memory.

---

 **NOTE:** Use extreme care when making changes in Computer Setup. Errors can prevent the computer from operating properly.

---

To start Computer Setup, turn on or restart the computer, and when the HP logo appears, press **F10** to enter Computer Setup.

## Navigating and selecting in Computer Setup

You can navigate and select in Computer Setup using one or more methods.

- To select a menu or a menu item, use the **tab** key and the keyboard arrow keys and then press **enter**, or use a pointing device to select the item.
- To scroll up and down, select the up arrow or the down arrow in the upper-right corner of the screen, or use the up arrow key or the down arrow key on the keyboard.
- To close open dialog boxes and return to the main Computer Setup screen, press **esc**, and then follow the on-screen instructions.

To exit Computer Setup, choose one of the following methods:

- To exit Computer Setup menus without saving your changes, select **Main**, select **Ignore Changes and Exit**, and then select **Yes**.

---

 **NOTE:** If you are using arrow keys to highlight your choice, you must then press **enter**.

---

- To save your changes and exit Computer Setup menus, select **Main**, select **Save Changes and Exit**, and then select **Yes**.

---

 **NOTE:** If you are using arrow keys to highlight your choice, you must then press **enter**.

---

Your changes go into effect when the computer restarts.

## Restoring factory settings in Computer Setup

To return all settings in Computer Setup to the values that were set at the factory, follow these steps.

---

 **NOTE:** Restoring defaults will not change the hard drive mode.

---

1. Start Computer Setup. See [Using Computer Setup on page 75](#).
2. Select **Main**, select **Apply Factory Defaults and Exit**, and then select **Yes**.

---

 **NOTE:** If you are using arrow keys to highlight your choice, you must then press **enter**.

 **NOTE:** On select products, the selections might display **Restore Defaults** instead of **Apply Factory Defaults and Exit**.

---

Your changes go into effect when the computer restarts.

---

 **NOTE:** Your password settings and security settings are not changed when you restore the factory settings.

---

## Updating the BIOS

Updated versions of the BIOS might be available on the HP website. Most BIOS updates on the HP website are packaged in compressed files called *SoftPaqs*.

Some download packages contain a file named *Readme.txt*, which contains information regarding installing and troubleshooting the file.

### Determining the BIOS version

To decide whether you need to update Computer Setup (BIOS), first determine the BIOS version on your computer.

You can access BIOS version information (also known as *ROM date* and *System BIOS*) by pressing **fn+esc** (if you are already in Windows) or by using Computer Setup.

1. Start Computer Setup. See [Using Computer Setup on page 75](#).
2. Select **Main**, and then select **System Information**.
3. To exit Computer Setup menus without saving your changes, select **Main**, select **Ignore Changes and Exit**, and then select **Yes**.

---

 **NOTE:** If you are using arrow keys to highlight your choice, you must then press **enter**.

---

To check for later BIOS versions, see [Preparing for a BIOS update on page 76](#).

### Preparing for a BIOS update

Be sure to follow all prerequisites before downloading and installing a BIOS update.

---

 **IMPORTANT:** To reduce the risk of damage to the computer or an unsuccessful installation, download and install a BIOS update only when the computer is connected to reliable external power using the AC adapter. Do not download or install a BIOS update while the computer is running on battery power, docked in an optional docking device, or connected to an optional power source. During the download and installation, follow these instructions:

Do not disconnect power on the computer by unplugging the power cord from the AC outlet.

Do not shut down the computer or initiate Sleep.

Do not insert, remove, connect, or disconnect any device, cable, or cord.

---

## Downloading a BIOS update

After you review the prerequisites, you can check for and download BIOS updates.

1. Type `support` in the taskbar search box, and then select the HP Support Assistant app.  
– or –  
Select the question mark icon in the taskbar.
2. Select **Updates**, and then select **Check for updates and messages**.
3. Follow the on-screen instructions.
4. At the download area, follow these steps:
  - a. Identify the most recent BIOS update and compare it to the BIOS version currently installed on your computer. Make a note of the date, name, or other identifier. You might need this information to locate the update later, after it has been downloaded to your hard drive.
  - b. Follow the on-screen instructions to download your selection to the hard drive.  
  
Make a note of the path to the location on your hard drive where the BIOS update is downloaded. You will need to access this path when you are ready to install the update.



---

**NOTE:** If you connect your computer to a network, consult the network administrator before installing any software updates, especially system BIOS updates.

---

## Installing a BIOS update

BIOS installation procedures vary. Follow any instructions that are displayed on the screen after the download is complete. If no instructions are displayed, follow these steps.

1. Type `file` in the taskbar search box, and then select **File Explorer**.
2. Select your hard drive designation. The hard drive designation is typically Local Disk (C:).
3. Using the hard drive path you recorded earlier, open the folder that contains the update.
4. Double-click the file that has an `.exe` extension (for example, `filename.exe`).  
  
The BIOS installation begins.
5. Complete the installation by following the on-screen instructions.



---

**NOTE:** After a message on the screen reports a successful installation, you can delete the downloaded file from your hard drive.

---

## Changing the boot order using the f9 prompt

To dynamically choose a boot device for the current startup sequence, follow these steps.

1. Access the Boot Device Options menu:
  - Turn on or restart the computer, and when the HP logo appears, press **f9** to enter the Boot Device Options menu.
2. Select a boot device, press `enter`, and then follow the on-screen instructions.

## TPM BIOS settings (select products only)

TPM provides additional security for your computer. You can modify the TPM settings in Computer Setup (BIOS).

---

 **IMPORTANT:** Before enabling Trusted Platform Module (TPM) functionality on this system, you must ensure that your intended use of TPM complies with relevant local laws, regulations and policies, and approvals or licenses must be obtained if applicable. For any compliance issues arising from your operation or usage of TPM that violates the previously mentioned requirement, you shall bear all the liabilities wholly and solely. HP will not be responsible for any related liabilities.

 **NOTE:** If you change the TPM setting to Hidden, TPM is not visible in the operating system.

---

To access TPM settings in Computer Setup:

1. Start Computer Setup. See [Using Computer Setup on page 75](#).
2. Select **Security**, select **TPM Embedded Security**, and then follow the on-screen instructions.

## Using HP Sure Start (select products only)

Select computer models are configured with HP Sure Start, a technology that monitors the computer's BIOS for attacks or corruption. If the BIOS becomes corrupted or is attacked, HP Sure Start automatically restores the BIOS to its previously safe state, without user intervention.

HP Sure Start is configured and already enabled so that most users can use the HP Sure Start default configuration. Advanced users can customize the default configuration.

To access the latest documentation on HP Sure Start, go to <http://www.hp.com/support>. Select **Find your product**, and then follow the on-screen instructions.

---

## 9 Backing up, restoring, and recovering

You can use Windows tools or HP software to back up your information, create a restore point, reset your computer, create recovery media, or restore your computer to its factory state. Performing these standard procedures can return your computer to a working state faster.

---

 **IMPORTANT:** If you will be performing recovery procedures on a tablet, the tablet battery must be at least 70% charged before you start the recovery process.

 **IMPORTANT:** For a tablet with a detachable keyboard, connect the tablet to the keyboard base before beginning any recovery process.

---

### Backing up information and creating recovery media

These methods of creating recovery media and backups are available on select products only.

#### Using Windows tools for backing up

HP recommends that you back up your information immediately after initial setup. You can do this task either using Windows Backup locally with an external USB drive or using online tools.

---

 **IMPORTANT:** Windows is the only option that allows you to back up your personal information. Schedule regular backups to avoid information loss.

 **NOTE:** If computer storage is 32 GB or less, Microsoft® System Restore is disabled by default.

---

#### Using the HP Cloud Recovery Download Tool to create recovery media (select products only)

You can use the HP Cloud Recovery Download Tool to create HP Recovery media on a bootable USB flash drive.

For details:

- Go to <http://www.hp.com>, search for HP Cloud Recovery, and then select the result that matches the type of computer that you have.

---

 **NOTE:** If you cannot create recovery media yourself, contact support to obtain recovery discs. Go to <http://www.hp.com/support>, select your country or region, and then follow the on-screen instructions.

 **IMPORTANT:** HP recommends that you follow the [Restoring and recovery methods on page 80](#) to restore your computer before you obtain and use the HP recovery discs. Using a recent backup can return your machine to a working state sooner than using the HP recovery discs. After the system is restored, reinstalling all the operating system software released since your initial purchase can be a lengthy process.

---

### Restoring and recovering your system

You have several tools available to recover your system both within and outside of Windows if the desktop cannot load.

HP recommends that you attempt to restore your system using the [Restoring and recovery methods on page 80](#).

## Creating a system restore

System Restore is available in Windows. The System Restore software can automatically or manually create restore points, or snapshots, of the system files and settings on the computer at a particular point.

When you use System Restore, it returns your computer to its state at the time you made the restore point. Your personal files and documents should not be affected.

## Restoring and recovery methods

After you run the first method, test to see whether the issue still exists before you proceed to the next method, which might now be unnecessary.

1. Run a Microsoft System Restore.
2. Run Reset this PC.



---

**NOTE:** The options **Remove everything** and then **Fully clean the drive** can take several hours to complete and leave no information on your computer. It is the safest way to reset your computer before you recycle it.

---

3. Recover using HP Recovery media. For more information, see [Recovering using HP Recovery media on page 80](#).

For more information about the first two methods, see the Get Help app:

Select the **Start** button, select the **Get Help** app, and then enter the task you want to perform.



---

**NOTE:** You must be connected to the internet to access the Get Help app.

---

## Recovering using HP Recovery media

You can use HP Recovery media to recover the original operating system and software programs that were installed at the factory. On select products, it can be created on a bootable USB flash drive using the HP Cloud Recovery Download Tool.

For details, see [Using the HP Cloud Recovery Download Tool to create recovery media \(select products only\) on page 79](#).



---

**NOTE:** If you cannot create recovery media yourself, contact support to obtain recovery discs. Go to <http://www.hp.com/support>, select your country or region, and then follow the on-screen instructions.

---

To recover your system:

- Insert the HP Recovery media, and then restart the computer.



---

**NOTE:** HP recommends that you follow the [Restoring and recovery methods on page 80](#) to restore your computer before you obtain and use the HP recovery discs. Using a recent backup can return your machine to a working state sooner than using the HP recovery discs. After the system is restored, reinstalling all the operating system software released since your initial purchase can be a lengthy process.

---



## Changing the computer boot order

If your computer does not restart using the HP Recovery media, you can change the computer boot order, the order of devices listed in BIOS for startup information. You can select an optical drive or a USB flash drive, depending on the location of your HP Recovery media.

---

 **IMPORTANT:** For a tablet with a detachable keyboard, connect the tablet to the keyboard base before beginning these steps.

---

To change the boot order:

1. Insert the HP Recovery media.
2. Access the system **Startup** menu.
  - For computers or tablets with keyboards attached, turn on or restart the computer or tablet, quickly press **esc**, and then press **f9** for boot options.
  - For tablets without keyboards, turn on or restart the tablet, quickly press and hold the volume up button, and then select **f9**.

– or –

Turn on or restart the tablet, quickly press and hold the volume down button, and then select **f9**.
3. Select the optical drive or USB flash drive from which you want to boot, and then follow the on-screen instructions.

## Using HP Sure Recover (select products only)

Select computer models are configured with HP Sure Recover, a PC operating system (OS) recovery solution built into the hardware and software. HP Sure Recover can fully restore the HP OS image without installed recovery software.

Using HP Sure Recover, an administrator or user can restore the system and install:

- Latest version of the operating system
- Platform-specific device drivers
- Software applications, in the case of a custom image

To access the latest documentation for HP Sure Recover, go to <http://www.hp.com/support>. Follow the on-screen instructions to find your product and locate your documentation.

---

# 10 Using HP PC Hardware Diagnostics

You can use the HP PC Hardware Diagnostics utility to determine whether your computer hardware is running properly. The three versions are HP PC Hardware Diagnostics Windows, HP PC Hardware Diagnostics UEFI (Unified Extensible Firmware Interface), and (for select products only) Remote HP PC Hardware Diagnostics UEFI, a firmware feature.

## Using HP PC Hardware Diagnostics Windows (select products only)

HP PC Hardware Diagnostics Windows is a Windows-based utility that allows you to run diagnostic tests to determine whether the computer hardware is functioning properly. The tool runs within the Windows operating system to diagnose hardware failures.

If HP PC Hardware Diagnostics Windows is not installed on your computer, first you must download and install it. To download HP PC Hardware Diagnostics Windows, see [Downloading HP PC Hardware Diagnostics Windows on page 83](#).

## Using an HP PC Hardware Diagnostics Windows hardware failure ID code

When HP PC Hardware Diagnostics Windows detects a failure that requires hardware replacement, a 24-digit failure ID code is generated for select component tests. For interactive tests, such as keyboard, mouse, or audio and video palette, you must perform troubleshooting steps before you can receive a failure ID.

- You have several options after you receive a failure ID:
  - Select **Next** to open the Event Automation Service (EAS) page, where you can log the case.  
– or –
  - Scan the QR code with your mobile device, which takes you to the EAS page, where you can log the case.  
– or –
  - Select the box next to the 24-digit failure ID to copy your failure code and send it to support.

## Accessing HP PC Hardware Diagnostics Windows

After HP PC Hardware Diagnostics Windows is installed, you can access it from HP Support Assistant or the Start menu.

## Accessing HP PC Hardware Diagnostics Windows from HP Help and Support (select products only)

After HP PC Hardware Diagnostics Windows is installed, follow these steps to access it from HP Help and Support.

1. Select the **Start** button, and then select **HP Help and Support**.
2. Select **HP PC Hardware Diagnostics Windows**.
3. When the tool opens, select the type of diagnostic test that you want to run, and then follow the on-screen instructions.



---

**NOTE:** To stop a diagnostic test, select **Cancel**.

---

## Accessing HP PC Hardware Diagnostics Windows from Support Assistant

After HP PC Hardware Diagnostics Windows is installed, follow these steps to access it from HP Support Assistant.

1. Type `support` in the taskbar search box, and then select the **HP Support Assistant** app.  
– or –  
Select the question mark icon in the taskbar.
2. Select **Troubleshooting and fixes**.
3. Select **Diagnostics**, and then select **HP PC Hardware Diagnostics Windows**.
4. When the tool opens, select the type of diagnostic test that you want to run, and then follow the on-screen instructions.



---

**NOTE:** To stop a diagnostic test, select **Cancel**.

---

## Accessing HP PC Hardware Diagnostics Windows from the Start menu (select products only)

After HP PC Hardware Diagnostics Windows is installed, follow these steps to access it from the Start menu.

1. Select the **Start** button.
2. Right-click **HP PC Hardware Diagnostics for Windows**, select **More**, and then select **Run as administrator**.
3. When the tool opens, select the type of diagnostic test that you want to run, and then follow the on-screen instructions.



---

**NOTE:** To stop a diagnostic test, select **Cancel**.

---

## Downloading HP PC Hardware Diagnostics Windows

The HP PC Hardware Diagnostics Windows downloading instructions are provided in English only. You must use a Windows computer to download this tool because only .exe files are provided.

### Downloading the latest HP PC Hardware Diagnostics Windows version from HP

To download HP PC Hardware Diagnostics Windows from HP, follow these steps.

1. Go to <http://www.hp.com/go/techcenter/pcdiags>. The HP PC Diagnostics home page is displayed.
2. Select **Download HP Diagnostics Windows**, and then select the specific Windows diagnostics version to download to your computer or a USB flash drive.

The tool downloads to the selected location.

### Downloading the HP PC Hardware Diagnostics Windows from the Microsoft Store

You can download the HP PC Hardware Diagnostics Windows from the Microsoft Store.

1. Select the Microsoft Store app on your desktop or enter `Microsoft Store` in the taskbar search box.
2. Enter `HP PC Hardware Diagnostics Windows` in the **Microsoft Store** search box.

3. Follow the on-screen directions.

The tool downloads to the selected location.

## Downloading HP Hardware Diagnostics Windows by product name or number (select products only)

You can download HP PC Hardware Diagnostics Windows by product name or number.



**NOTE:** For some products, you might have to download the software to a USB flash drive by using the product name or number.

1. Go to <http://www.hp.com/support>.
2. Select **Software and Drivers**, select your type of product, and then enter the product name or number in the search box that is displayed.
3. In the **Diagnostics** section, select **Download**, and then follow the on-screen instructions to select the specific Windows diagnostics version to be downloaded to your computer or USB flash drive.

The tool downloads to the selected location.

## Installing HP PC Hardware Diagnostics Windows

To install HP PC Hardware Diagnostics Windows, navigate to the folder on your computer or the USB flash drive where the .exe file downloaded, double-click the .exe file, and then follow the on-screen instructions.

## Using HP PC Hardware Diagnostics UEFI

HP PC Hardware Diagnostics UEFI (Unified Extensible Firmware Interface) allows you to run diagnostic tests to determine whether the computer hardware is functioning properly. The tool runs outside the operating system so that it can isolate hardware failures from issues that are caused by the operating system or other software components.



**NOTE:** For Windows 10 S computers, you must use a Windows computer and a USB flash drive to download and create the HP UEFI support environment because only .exe files are provided. For more information, see [Downloading HP PC Hardware Diagnostics UEFI to a USB flash drive on page 85](#).

If your PC does not start in Windows, you can use HP PC Hardware Diagnostics UEFI to diagnose hardware issues.

## Using an HP PC Hardware Diagnostics UEFI hardware failure ID code

When HP PC Hardware Diagnostics UEFI detects a failure that requires hardware replacement, a 24-digit failure ID code is generated.

For assistance in solving the problem:

- Select **Contact HP**, accept the HP privacy disclaimer, and then use a mobile device to scan the failure ID code that appears on the next screen. The HP Customer Support - Service Center page appears with your failure ID and product number automatically filled in. Follow the on-screen instructions.

– or –

Contact support, and provide the failure ID code.



**NOTE:** To start diagnostics on a convertible computer, your computer must be in notebook mode, and you must use the attached keyboard.

 **NOTE:** If you need to stop a diagnostic test, press [esc](#).

---

## Starting HP PC Hardware Diagnostics UEFI

To start HP PC Hardware Diagnostics UEFI, follow this procedure.

1. Turn on or restart the computer, and quickly press [esc](#).
2. Press [f2](#).

The BIOS searches three places for the diagnostic tools, in the following order:

- a. Connected USB flash drive

 **NOTE:** To download the HP PC Hardware Diagnostics UEFI tool to a USB flash drive, see [Downloading the latest HP PC Hardware Diagnostics UEFI version on page 85](#).

---

- b. Hard drive
  - c. BIOS
3. When the diagnostic tool opens, select a language, select the type of diagnostic test you want to run, and then follow the on-screen instructions.

## Downloading HP PC Hardware Diagnostics UEFI to a USB flash drive

Downloading HP PC Hardware Diagnostics UEFI to a USB flash drive can be useful in some situations.

- HP PC Hardware Diagnostics UEFI is not included in the preinstallation image.
- HP PC Hardware Diagnostics UEFI is not included in the HP Tool partition.
- The hard drive is damaged.

 **NOTE:** The HP PC Hardware Diagnostics UEFI downloading instructions are provided in English only, and you must use a Windows computer to download and create the HP UEFI support environment because only .exe files are provided.

---

## Downloading the latest HP PC Hardware Diagnostics UEFI version

To download the latest HP PC Hardware Diagnostics UEFI version to a USB flash drive, follow this procedure.

1. Go to <http://www.hp.com/go/techcenter/pcdiags>. The HP PC Diagnostics home page is displayed.
2. Select **Download HP Diagnostics UEFI**, and then select **Run**.

## Downloading HP PC Hardware Diagnostics UEFI by product name or number (select products only)

You can download HP PC Hardware Diagnostics UEFI by product name or number (select products only) to a USB flash drive.

 **NOTE:** For some products, you might have to download the software to a USB flash drive by using the product name or number.

---

1. Go to <http://www.hp.com/support>.
2. Enter the product name or number, select your computer, and then select your operating system.

3. In the **Diagnostics** section, follow the on-screen instructions to select and download the specific UEFI Diagnostics version for your computer.

## Using Remote HP PC Hardware Diagnostics UEFI settings (select products only)

Remote HP PC Hardware Diagnostics UEFI is a firmware (BIOS) feature that downloads HP PC Hardware Diagnostics UEFI to your computer. It can then execute the diagnostics on your computer, and it might upload results to a preconfigured server.

For more information about Remote HP PC Hardware Diagnostics UEFI, go to <http://www.hp.com/go/techcenter/pcdiags>, and then select **Find out more**.

### Downloading Remote HP PC Hardware Diagnostics UEFI

HP Remote PC Hardware Diagnostics UEFI is also available as a SoftPaq that you can download to a server.

#### Downloading the latest Remote HP PC Hardware Diagnostics UEFI version

You can download the latest HP PC Hardware Diagnostics UEFI version to a USB flash drive.

1. Go to <http://www.hp.com/go/techcenter/pcdiags>. The HP PC Diagnostics home page is displayed.
2. Select **Download Remote Diagnostics**, and then select **Run**.

#### Downloading Remote HP PC Hardware Diagnostics UEFI by product name or number

You can download HP Remote PC Hardware Diagnostics UEFI by product name or number.



---

**NOTE:** For some products, you might have to download the software by using the product name or number.

---

1. Go to <http://www.hp.com/support>.
2. Select **Software and Drivers**, select your type of product, enter the product name or number in the search box that is displayed, select your computer, and then select your operating system.
3. In the **Diagnostics** section, follow the on-screen instructions to select and download the **Remote UEFI** version for the product.

### Customizing Remote HP PC Hardware Diagnostics UEFI settings

Using the Remote HP PC Hardware Diagnostics setting in Computer Setup (BIOS), you can perform several customizations.

- Set a schedule for running diagnostics unattended. You can also start diagnostics immediately in interactive mode by selecting **Execute Remote HP PC Hardware Diagnostics**.
- Set the location for downloading the diagnostic tools. This feature provides access to the tools from the HP website or from a server that has been preconfigured for use. Your computer does not require the traditional local storage (such as a hard drive or USB flash drive) to run remote diagnostics.
- Set a location for storing the test results. You can also set the user name and password that you use for uploads.
- Display status information about the diagnostics run previously.

To customize Remote HP PC Hardware Diagnostics UEFI settings, follow these steps:

1. Turn on or restart the computer, and when the HP logo appears, press **f10** to enter Computer Setup.
2. Select **Advanced**, and then select **Settings**.
3. Make your customization selections.
4. Select **Main**, and then **Save Changes and Exit** to save your settings.

Your changes take effect when the computer restarts.

# 11 Specifications

This chapter provides specifications for your computer system.

## Computer specifications

This section provides specifications for your computer. When you travel with your computer, the computer dimensions and weights, as well as input power ratings and operating specifications, provide helpful information.

**Table 11-1** Computer specifications

	Metric	U.S.
<b>Dimensions</b>		
Width	359 mm	14.13 in
Depth	251 mm	9.88 in
Height (front to back)	19 mm	0.75 in
<b>Weight</b>		
	1.74 kg	3.84 lb
<b>Input power</b>		
Operating voltage and current	19.5 V dc @ 2.31 A – 45 W	
	19.5 V dc @ 3.33 A – 65 W	
<b>Temperature</b>		
Operating	5°C to 35°C	41°F to 95°F
Nonoperating	–20°C to 60°C	–4°F to 140°F
<b>Relative humidity</b> (noncondensing)		
Operating	10% to 90%	
Nonoperating	5% to 95%	
<b>Maximum altitude</b> (unpressurized)		
Operating	–15 m to 3,048 m	–50 ft to 10,000 ft
Nonoperating	–15 m to 12,192 m	–50 ft to 40,000 ft
<b>NOTE:</b> Applicable product safety standards specify thermal limits for plastic surfaces. The device operates well within this range of temperatures.		

## 15.24 cm (16 in) display specifications

This section provides specifications for your display.



**Table 11-2 Display specifications**

	<b>Metric</b>	<b>U.S.</b>
Active diagonal size	<b>15.2 cm</b>	16 in
Resolution	1920 × 1200	
Surface treatment	Antiglare	
Brightness	250 nits	
	400 nits	
	1000 nits	
Viewing angle	UWVA	
Backlight	WLED	
Display panel interface	eDP	

## Solid-state drive specifications

This section provides specifications for your solid-state drives.

**Table 11-3 Solid-state drive specifications**

	<b>256 GB*</b>	<b>512 GB*</b>	<b>1 TB*</b>	<b>2 TB*</b>
<b>Dimensions</b>				
Height	1.0 mm	1.0 mm	1.0 mm	1.0 mm
Length	50.8 mm	50.8 mm	50.8 mm	50.8 mm
Width	28.9 mm	28.9 mm	28.9 mm	28.9 mm
Weight	< 10 g	< 10 g	< 10 g	< 10 g
<b>Interface type</b>	PCIe	PCIe	PCIe	PCIe
Ready time, maximum (to not busy)	1.0 ms	< 1.0 ms	1.0 ms	1.0 ms
Access times, logical	0.1 ms	0.1 ms	0.1 ms	0.1 ms
<b>Transfer rate</b>				
Sequential read	up to 2150 MB/s	up to 2150 MB/s	up to 2150 MB/s	up to 2150 MB/s
Random read	Up to 300,000 IOPs	Up to 300,000 IOPs	Up to 300,000 IOPs	Up to 300,000 IOPs
Sequential write	up to 1550 MB/s	up to 1550 MB/s	up to 1550 MB/s	up to 1550 MB/s
Random write	Up to 100,000 IOPs	Up to 100,000 IOPs	Up to 100,000 IOPs	Up to 100,000 IOPs
<b>Total logical sectors</b>	468,883,296	1,000,215,216	1,500,336,388	3,906,250,000
<b>Operating temperature</b>	<b>0°C to 70°C (32°F to 158°F)</b>			

\*1 GB = 1 billion bytes when referring to hard drive storage capacity. Actual accessible capacity is less. Actual drive specifications may differ slightly.

**NOTE:** Certain restrictions and exclusions apply. Contact support for details.

---

## 12 Statement of memory volatility

For general information regarding nonvolatile memory in HP business computers, and to restore nonvolatile memory that can contain personal data after the system has been turned off and the hard drive has been removed, use these instructions.

HP business computer products that use Intel®-based or AMD®-based system boards contain volatile DDR memory. The amount of nonvolatile memory present in the system depends upon the system configuration. Intel-based and AMD-based system boards contain nonvolatile memory subcomponents as originally shipped from HP, with the following assumptions:

- No subsequent modifications were made to the system.
- No applications, features, or functionality were added to or installed on the system.

Following system shutdown and removal of all power sources from an HP business computer system, personal data can remain on volatile system memory (DIMMs) for a finite period of time and also remains in nonvolatile memory. Use the following steps to remove personal data from the computer, including the nonvolatile memory found in Intel-based and AMD-based system boards.

---

 **NOTE:** If your tablet has a keyboard base, connect to the keyboard base before beginning steps in this chapter.

---

### Current BIOS steps

Use these instructions to restore nonvolatile memory.

1. Follow these steps to restore the nonvolatile memory that can contain personal data. Restoring or reprogramming nonvolatile memory that does not store personal data is neither necessary nor recommended.

- a. Turn on or restart the computer, and then quickly press **esc**.

---

 **NOTE:** If the system has a BIOS administrator password, type the password at the prompt.

---

- b. Select **Main**, select **Apply Factory Defaults and Exit**, and then select **Yes** to load defaults. The computer restarts.

- c. During the restart, press **esc** while the "Press the ESC key for Startup Menu" message is displayed at the bottom of the screen.

---

 **NOTE:** If the system has a BIOS administrator password, type the password at the prompt.

---

- d. Select the **Security** menu, select **Restore Security Settings to Factory Defaults**, and then select **Yes** to restore security level defaults. The computer reboots.

- e. During the reboot, press **esc** while the "Press the ESC key for Startup Menu" message is displayed at the bottom of the screen.

---

 **NOTE:** If the system has a BIOS administrator password, type the password at the prompt.

---

- f. If an asset or ownership tag is set, select the **Security** menu and scroll down to the **Utilities** menu. Select **System IDs**, and then select **Asset Tracking Number**. Clear the tag, and then make the selection to return to the prior menu.
- g. If a DriveLock password is set, select the **Security** menu, and scroll down to **Hard Drive Utilities** under the **Utilities** menu. Select **Hard Drive Utilities**, select **DriveLock**, and then clear the check box for **DriveLock password on restart**. Select **OK** to proceed.
- h. Select the **Main** menu, and then select **Reset BIOS Security to factory default**. Select **Yes** at the warning message. The computer reboots.
- i. During the reboot, press **esc** while the "Press the ESC key for Startup Menu" message is displayed at the bottom of the screen.



---

**NOTE:** If the system has a BIOS administrator password, type the password at the prompt.

---

- j. Select the **Main** menu, select **Apply Factory Defaults and Exit**, select **Yes** to save changes and exit, and then select **Shutdown**.
  - k. Reboot the system. If the system has a Trusted Platform Module (TPM), fingerprint reader, or both, one or two prompts will appear—one to clear the TPM and the other to Reset Fingerprint Sensor. Press or tap **f1** to accept or **f2** to reject.
  - l. Remove all power and system batteries for at least 24 hours.
2. Complete one of the following:
- Remove and retain the storage drive.  
– or –
  - Clear the drive contents by using a third-party utility designed to erase data from an SSD.  
– or –
  - Clear the contents of the drive by using the following BIOS Setup Secure Erase command option steps:



---

**NOTE:** If you clear data using Secure Erase, you cannot recover it.

---

- a. Turn on or restart the computer, and then quickly press **esc**.
- b. Select the **Security** menu and scroll down to the **esc** menu.
- c. Select **Hard Drive Utilities**.
- d. Under **Utilities**, select **Secure Erase**, select the hard drive storing the data you want to clear, and then follow the on-screen instructions to continue.  
– or –  
Clear the contents of the drive using the following Disk Sanitizer commands steps:
  - i. Turn on or restart the computer, and then quickly press **esc**.
  - ii. Select the **Security** menu and scroll down to the **Utilities** menu.
  - iii. Select **Hard Drive Utilities**.

- iv. Under **Utilities**, select **Disk Sanitizer**, select the hard drive with the data that you want to clear, and then follow the on-screen instructions to continue.

 **NOTE:** The amount of time it takes for Disk Sanitizer to run can take several hours. Plug the computer into an AC outlet before starting.

## Nonvolatile memory usage

Use this table to troubleshoot nonvolatile memory usage.

**Table 12-1** Troubleshooting steps for nonvolatile memory usage

Nonvolatile memory type	Amount (Size)	Does this memory store customer data?	Does this memory retain data when power is removed?	What is the purpose of this memory?	How is data entered into this memory?	How is this memory write-protected?
HP Sure Start flash (select models only)	8 MB	No	Yes	Provides protected backup of critical System BIOS code, EC firmware, and critical computer configuration data for select platforms that support HP Sure Start.  For more information, see <a href="#">Using HP Sure Start (select products only)</a> on page 96.	Data cannot be written to this device via the host processor. The content is managed solely by the HP Sure Start Embedded Controller.	This memory is protected by the HP Sure Start Embedded Controller.
Real Time Clock (RTC) battery backed-up CMOS configuration memory	256 bytes	No	Yes	Stores system date and time and noncritical data.	RTC battery backed-up CMOS is programmed using Computer Setup (BIOS), or by changing the Windows date & time.	This memory is not write-protected.
Controller (NIC) EEPROM	64 KB (not customer accessible)	No	Yes	Stores NIC configuration and NIC firmware.	NIC EEPROM is programmed using a utility from the NIC vendor that can be run from DOS.	A utility must be used to write data to this memory and is available from the NIC vendor. Writing data to this ROM in an inappropriate manner will render the NIC nonfunctional.

**Table 12-1 Troubleshooting steps for nonvolatile memory usage (continued)**

Nonvolatile memory type	Amount (Size)	Does this memory store customer data?	Does this memory retain data when power is removed?	What is the purpose of this memory?	How is data entered into this memory?	How is this memory write-protected?
DIMM Serial Presence Detect (SPD) configuration data	256 bytes per memory module, 128 bytes programmable (not customer accessible)	No	Yes	Stores memory module information.	DIMM SPD is programmed by the memory vendor.	Data cannot be written to this memory when the module is installed in a computer. The specific write-protection method varies by memory vendor.
System BIOS	9 MB	Yes	Yes	Stores system BIOS code and computer configuration data.	System BIOS code is programmed at the factory. Code is updated when the system BIOS is updated. Configuration data and settings are entered using the Computer Setup (BIOS) or a custom utility.	<b>NOTE:</b> Writing data to this ROM in an inappropriate manner can render the computer nonfunctional.  A utility must be used for writing data to this memory and is available on the HP website; go to <a href="http://www.hp.com/support">http://www.hp.com/support</a> . Select <b>Find your product</b> , and then follow the on-screen instructions.
Intel Management Engine Firmware (present only in select Elite or Z models. For more information, go to <a href="http://www.hp.com/support">http://www.hp.com/support</a> .  Select <b>Identify your product for manuals and specific product information</b> , and then follow the on-screen instructions.)	1.5 MB or 7 MB	Yes	Yes	Stores Management Engine Code, Settings, Provisioning Data and iAMT third-party data store.	Management Engine Code is programmed at the factory. Code is updated via Intel secure firmware update utility. Unique Provisioning Data can be entered at the factory or by an administrator using the Management Engine (MEBx) setup utility. The third-party data store contents can be populated by a remote management console or local applications that have been registered by an administrator to have access to the space.	The Intel chipset is configured to enforce hardware protection to block all direct read-write access to this area. An Intel utility must be used for updating the firmware. Only firmware updates digitally signed by Intel can be applied using this utility.
Bluetooth flash (select products only)	2 megabits	No	Yes	Stores Bluetooth configuration and firmware.	Bluetooth flash is programmed at the factory. Tools for writing data to this memory are not publicly available but can be obtained from the silicon vendor.	A utility must be used for writing data to this memory and is made available through newer versions of the driver whenever the flash requires an upgrade.

**Table 12-1 Troubleshooting steps for nonvolatile memory usage (continued)**

Nonvolatile memory type	Amount (Size)	Does this memory store customer data?	Does this memory retain data when power is removed?	What is the purpose of this memory?	How is data entered into this memory?	How is this memory write-protected?
802.11 WLAN EEPROM	4 kilobits to 8 kilobits	No	Yes	Stores configuration and calibration data.	802.11 WLAN EEPROM is programmed at the factory. Tools for writing data to this memory are not made public.	A utility must be used for writing data to this memory and is typically not made available to the public unless a firmware upgrade is necessary to address a unique issue.
Camera (select products only)	64 kilobits	No	Yes	Stores camera configuration and firmware.	Camera memory is programmed using a utility from the device manufacturer that can be run from Windows.	A utility must be used for writing data to this memory and is typically not made available to the public unless a firmware upgrade is necessary to address a unique issue.
Fingerprint reader (select products only)	512 KB flash	Yes	Yes	Stores fingerprint templates.	Fingerprint reader memory is programmed by user enrollment in HP ProtectTools Security Manager.	Only a digitally signed application can make the call to write to the flash.

## Questions and answers

Use this section to answer your questions about nonvolatile memory.

### 1. How can the BIOS settings be restored (returned to factory settings)?

 **IMPORTANT:** The restore defaults feature does not securely erase any information on your hard drive. See question and answer 6 for steps to securely erase information.

The restore defaults feature does not reset the Custom Secure Boot keys. See question and answer 7 for information about resetting the keys.

- Turn on or restart the computer, and then quickly press **esc**.
- Select **Main**, and then select **Apply Factory Defaults and Exit**.
- Follow the on-screen instructions.
- Select **Main**, select **Save Changes and Exit**, and then follow the on-screen instructions.

### 2. What is a UEFI BIOS, and how is it different from a legacy BIOS?

The Unified Extensible Firmware Interface (UEFI) BIOS is an industry-standard software interface between the platform firmware and an operating system (OS). It replaces the older BIOS architecture but supports much of the legacy BIOS functionality.

Like the legacy BIOS, the UEFI BIOS provides an interface to display the system information and configuration settings and to change the configuration of your computer before an OS is loaded. BIOS provides a secure runtime environment that supports a Graphic User Interface (GUI). In this environment, you can use either a pointing device (touch screen, touchpad, pointing stick, or USB mouse) or the keyboard to navigate and make menu and configuration selections. The UEFI BIOS also contains basic system diagnostics.

The UEFI BIOS provides functionality beyond that of the legacy BIOS. In addition, the UEFI BIOS works to initialize the computer's hardware before loading and executing the OS; the runtime environment allows the loading and execution of software programs from storage devices to provide more functionality, such as advanced hardware diagnostics (with the ability to display more detailed system information) and advanced firmware management and recovery software.

HP has provided options in Computer Setup (BIOS) to allow you to run in legacy BIOS, if required by the operating system. Examples of this requirement would be if you upgrade or downgrade the OS.

**3. Where is the UEFI BIOS located?**

The UEFI BIOS is located on a flash memory chip. You must use a utility to write to the chip.

**4. What kind of configuration data is stored on the DIMM Serial Presence Detect (SPD) memory module? How would this data be written?**

The DIMM SPD memory contains information about the memory module, such as size, serial number, data width, speed and timing, voltage, and thermal information. This information is written by the module manufacturer and stored on an EEPROM. You cannot write to this EEPROM when the memory module is installed in a computer. Third-party tools do exist that can write to the EEPROM when the memory module is not installed in a computer. Various third-party tools are available to read SPD memory.

**5. What is meant by “Restore the nonvolatile memory found in Intel-based system boards”?**

This message relates to clearing the Real Time Clock (RTC) CMOS memory that contains computer configuration data.

**6. How can the BIOS security be reset to factory defaults and erase the data?**

---

 **IMPORTANT:** Resetting results in the loss of information.

These steps do not reset Custom Secure Boot Keys. See question and answer 7 for information about resetting the keys.

---

- a. Turn on or restart the computer, and then quickly press **esc**.
- b. Select **Main**, and then select **Reset Security to Factory Defaults**.
- c. Follow the on-screen instructions.
- d. Select **Main**, select **Save Changes and Exit**, and then follow the on-screen instructions.

**7. How can the Custom Secure Boot Keys be reset?**

Secure Boot is a feature to ensure that only authenticated code can start on a platform. If you enabled Secure Boot and created Custom Secure Boot Keys, disabling Secure Boot does not clear the keys. You must also select to clear the Custom Secure Boot Keys. Use the same Secure Boot access procedure that you used to create the Custom Secure Boot Keys, but select to clear or delete all Secure Boot Keys.

- a. Turn on or restart the computer, and then quickly press **esc**.

- b. Select the **Security** menu, select **Secure Boot Configuration**, and then follow the on-screen instructions.
- c. At the **Secure Boot Configuration** window, select **Secure Boot**, select **Clear Secure Boot Keys**, and then follow the on-screen instructions to continue.

## Using HP Sure Start (select products only)

Select computer models are configured with HP Sure Start, a technology that continuously monitors your computer's BIOS for attacks or corruption.

If the BIOS becomes corrupted or is attacked, HP Sure Start restores the BIOS to its previously safe state, without user intervention. Those select computer models ship with HP Sure Start configured and enabled. HP Sure Start is configured and already enabled so that most users can use the HP Sure Start default configuration. Advanced users can customize the default configuration.

To access the latest documentation on HP Sure Start, go to <http://www.hp.com/support>.



# 13 Power cord set requirements

This chapter provides power cord requirements for countries and regions.

The wide-range input feature of the computer permits it to operate from any line voltage from 100 V ac to 120 V ac, or from 220 V ac to 240 V ac.

The three-conductor power cord set included with the computer meets the requirements for use in the country or region where the equipment is purchased.

Power cord sets for use in other countries or regions must meet the requirements of the country and region where the computer is used.

## Requirements for all countries

These power cord requirements are applicable to all countries and regions.

- The length of the power cord set must be at least **1.0 m** (3.3 ft) and no more than **2.0 m** (6.5 ft).
- All power cord sets must be approved by an acceptable accredited agency responsible for evaluation in the country or region where the power cord set will be used.
- The power cord sets must have a minimum current capacity of 10 A and a nominal voltage rating of 125 V ac or 250 V ac, as required by the power system of each country or region.
- The appliance coupler must meet the mechanical configuration of an EN 60 320/IEC 320 Standard Sheet C13 connector for mating with the appliance inlet on the back of the computer.

## Requirements for specific countries and regions

To determine power cord requirements for specific countries and regions, use this table.

**Table 13-1** Power cord requirements for specific countries and regions

Country/region	Accredited agency	Applicable note number
Argentina	IRAM	1
Australia	SAA	1
Austria	OVE	1
Belgium	CEBEC	1
Brazil	ABNT	1
Canada	CSA	2
Chile	IMQ	1
Denmark	DEMKO	1
Finland	FIMKO	1
France	UTE	1
Germany	VDE	1

**Table 13-1 Power cord requirements for specific countries and regions (continued)**

Country/region	Accredited agency	Applicable note number
India	BIS	1
Israel	SII	1
Italy	IMQ	1
Japan	JIS	3
Netherlands	KEMA	1
New Zealand	SANZ	1
Norway	NEMKO	1
People's Republic of China	CCC	4
Saudi Arabia	SASO	7
Singapore	PSB	1
South Africa	SABS	1
South Korea	KTL	5
Sweden	SEMKO	1
Switzerland	SEV	1
Taiwan	BSMI	6
Thailand	TISI	1
United Kingdom	ASTA	1
United States	UL	2

1. The flexible cord must be Type H05VV-F, three-conductor, 0.75 mm<sup>2</sup> conductor size. Power cord set fittings (appliance coupler and wall plug) must bear the certification mark of the agency responsible for evaluation in the country or region where it will be used.
2. The flexible cord must be Type SVT/SJT or equivalent, No. 18 AWG, three-conductor. The wall plug must be a two-pole grounding type with a NEMA 5-15P (15 A, 125 V ac) or NEMA 6-15P (15 A, 250 V ac) configuration. CSA or C-UL mark. UL file number must be on each element.
3. The appliance coupler, flexible cord, and wall plug must bear a T mark and registration number in accordance with the Japanese Dentori Law. The flexible cord must be Type VCTF, three-conductor, 0.75 mm<sup>2</sup> or 1.25 mm<sup>2</sup> conductor size. The wall plug must be a two-pole grounding type with a Japanese Industrial Standard C8303 (7 A, 125 V ac) configuration.
4. The flexible cord must be Type RVV, three-conductor, 0.75 mm<sup>2</sup> conductor size. Power cord set fittings (appliance coupler and wall plug) must bear the CCC certification mark.
5. The flexible cord must be Type H05VV-F three-conductor, 0.75 mm<sup>2</sup> conductor size. KTL logo and individual approval number must be on each element. Approval number and logo must be printed on a flag label.
6. The flexible cord must be Type HVCTF three-conductor, 1.25 mm<sup>2</sup> conductor size. Power cord set fittings (appliance coupler, cable, and wall plug) must bear the BSMI certification mark.
7. For 127 V ac, the flexible cord must be Type SVT or SJT 3-conductor, 18 AWG, with plug NEMA 5-15P (15 A, 125 V ac), with UL and CSA or C-UL marks. For 240 V ac, the flexible cord must be Type H05VV-F three-conductor, 0.75 mm<sup>2</sup> or 1.00 mm<sup>2</sup> conductor size, with plug BS 1363/A with BSI or ASTA marks.

---

# 14 Recycling

When a nonrechargeable or rechargeable battery has reached the end of its useful life, do not dispose of the battery in general household waste. Follow the local laws and regulations in your area for battery disposal.

HP encourages customers to recycle used electronic hardware, HP original print cartridges, and rechargeable batteries. For more information about recycling programs, see the HP website at <http://www.hp.com/recycle>.

---

# Index

- A**
  - AC adapters, spare part numbers 27
  - action keys 15
    - identifying 15
    - keyboard backlight 16
    - mute 16
    - privacy screen 16
    - programmable key 17
    - screen brightness 16
    - speaker volume 16
    - switch screen image 15
    - using 15
    - wireless 16
  - ambient light and color sensor, identifying 9
  - audio
    - adjusting volume 16
  - audio-out (headphone)/audio-in (microphone) combo jack, identifying 7
  - audio, product description 2
- B**
  - backup, creating 79
  - backups 79
  - battery
    - illustrated 24
    - spare part number 24
  - battery light 8
  - BIOS
    - determining version 72, 76
    - downloading an update 73, 76, 77
    - starting the Setup Utility 72
    - updating 72, 76
  - Bluetooth label 19
  - boot order
    - changing using the f9 prompt 77
  - boot order, changing 81
  - bottom cover
    - illustrated 24
    - removal 40
    - spare part number 24, 40
  - bracket kit
    - spare part number 26
  - bracket, plastic
    - removal 48
    - spare part numbers 48
  - buttons
    - left touchpad 11
    - power 13, 15
    - right touchpad 11
- C**
  - camera 9
    - identifying 9
  - camera light, identifying 9
  - camera privacy cover, identifying 10
  - caps lock light, identifying 12
  - card reader board
    - removal 50
    - spare part numbers 50
  - caring for your computer 35
  - cautions
    - electrostatic discharge 31, 32
  - cleaning your computer 35
    - caring for wood veneer 37
    - disinfecting 36
    - HP Easy Clean 35
    - removing dirt and debris 35
  - components
    - bottom 17
    - display 9
    - keyboard area 10
    - left side 7
    - rear 18
    - right side 6
  - computer major components 21
  - Computer Setup
    - navigating and selecting 75
    - restoring factory settings 75
    - starting 75
  - computer specifications 88
  - connector, power 8
- D**
  - display
    - specifications 88
  - display assembly
    - subcomponents 24
  - display back cover
    - illustrated 24
    - spare part number 24
  - display bezel
    - illustrated 24
    - spare part number 24
  - display cable
    - illustrated 24
    - spare part number 24
  - display components 9
  - display panel
    - illustrated 24
    - product description 1
    - spare part number 24
- E**
  - electrostatic discharge (ESD) 31, 32
    - preventing damage 31-33
  - eMMC
    - product description 2
  - esc key, identifying 14
- F**
  - fan
    - illustrated 23
    - removal 53
    - spare part number 23, 53
  - fingerprint reader board
    - removal 55
    - spare part numbers 55
  - fingerprint reader, identifying 13
  - fn key, identifying 14
  - fn lock light, identifying 12
- G**
  - graphics, product description 1
  - grounding methods 31-33
  - guidelines
    - packaging 31, 37
    - transporting 31, 37
    - workstation 31
- H**
  - hard drive
    - product description 2
    - specifications 88

- HDMI port, identifying 7
- heat sink
  - illustrated 23
  - removal 51
  - spare part number 23
  - spare part numbers 51
- hinge
  - illustrated 24
  - spare part number 24
- hinge cover
  - illustrated 24
  - spare part number 24
- hot keys
  - break 17
  - insert 17
  - microphone mute 16
  - pause 17
  - programming query 17
  - scroll lock 17
  - using 17
- HP PC Hardware Diagnostics UEFI
  - downloading 85
  - failure ID code 84
  - starting 85
  - using 84
- HP PC Hardware Diagnostics Windows
  - accessing 82, 83
  - downloading 83
  - failure ID code 82
  - installing 84
  - using 82
- HP Recovery media
  - recovery 80
- HP Sure Recover 81
- HP Sure Start 90, 96

## I

- illustrated parts catalog 21
- integrated numeric keypad, identifying 15
- internal microphones, identifying 9

## J

- jacks
  - audio-out (headphone)/audio-in (microphone) combo 7

## K

- keyboard backlight
  - action key 16
- keyboard with top cover
  - spare part numbers 70

- keypad
  - integrated numeric 15
- keys
  - action 15
  - esc 14
  - fn 14
  - num lk 15
  - Windows 14

## L

- labels
  - Bluetooth 19
  - regulatory 19
  - serial number 19
  - service 19
  - wireless certification 19
  - WLAN 19
- left side components 7
- lights
  - AC adapter and battery 8
  - battery 8
  - camera 9
  - caps lock 12
  - fn lock 12
  - microphone mute 12
  - num lk 12
  - power 12
  - privacy key 12
- lights, mute 12
- lights, num lk 12
- low blue light mode 9

## M

- magnetic pen attachment area, identifying 6
- memory
  - nonvolatile 90
  - volatile 90
- memory module
  - product description 2
- microphone
  - product description 2
- microphone mute key, identifying 16
- microphone mute light, identifying 12
- model name 1
- mute light, identifying 12
- mute volume action key 16

## N

- Near Field Communications (NFC)
  - tapping area and antenna, identifying 11
- nonvolatile memory 90
- num lk light 12
- num lk light, identifying 12

## O

- operating system, product description 4

## P

- packaging guidelines 31, 37
- ports
  - HDMI 7
  - product description 3
  - USB SuperSpeed 5 Gbps 6
  - USB SuperSpeed 5 Gbps port with HP Sleep and Charge 7
  - USB Type-C power connector and SuperSpeed port with HP Sleep and Charge 8
  - USB Type-C power connector and Thunderbolt port with HP Sleep and Charge 8
- power button, identifying 13, 15
- power connector
  - identifying USB Type-C 8
- power connector cable
  - removal 56
  - spare part numbers 56
- power cord
  - requirements for all countries 97
  - requirements for specific countries and regions 97
  - set requirements 97
- power cords, spare part numbers 27
- power lights 12
- power requirements, product description 3
- primary storage
  - product description 2
- privacy key light 12
- privacy screen action key, identifying 16
- processor
  - product description 1
- product description
  - audio 2
  - display panel 1

- eMMC 2
- graphics 1
- hard drive 2
- memory module 2
- microphone 2
- operating system 4
- ports 3
- power requirements 3
- primary storage 2
- processors 1
- product name 1
- security 4
- sensors 3
- serviceability 5
- solid-state drive 2
- video 2
- wireless 3
- product name 1
- product name and number, computer 19
- programmable key, identifying 17

**R**

- recovery 79
  - discs 80
  - media 80
  - USB flash drive 80
- recovery media 79
  - creating using HP Cloud Recovery Download Tool 79
  - creating using Windows tools 79
- regulatory information
  - regulatory label 19
  - wireless certification labels 19
- Remote HP PC Hardware Diagnostics UEFI settings
  - customizing 86
  - using 86
- removal and replacement
  - procedures 40, 48
  - solid-state drive 46
- removing personal data from
  - volatile system memory 90
- restoring 79
- restoring and recovery methods 80
- right side components 6

**S**

- screen brightness action keys 16
- Screw Kit, spare part number 27
- security cable slot, identifying 6
- security, product description 4
- sensors, product description 3

- serial number, computer 19
- service labels, locating 19
- serviceability, product description 5
- setup utility
  - navigating and selecting 75
  - restoring factory settings 75
- SIM card slot, identifying 6
- slots
  - security cable 6
  - SIM card 6
  - smart card 8
- smart card slot, identifying 8
- solid-state drive
  - illustrated 23
  - product description 2
  - removal and replacement 46
  - spare part number 23
  - specifications 89
- spare part country codes 70
- speaker
  - removal 49
  - spare part number 49
- speaker volume action keys 16
- speakers, identifying 18
- special keys, using 14
- specifications
  - computer 88
  - display 88
  - hard drive 88
  - solid-state drive 89
- static electricity 31, 32
- support information 37
- Sure Start
  - using 78
- switch screen image action key 15
- system board
  - illustrated 23
  - removal 59
  - spare part number 23
  - spare part numbers 59
- system memory, removing personal data from volatile 90
- system restore 80
- system restore point, creating 79

**T**

- top cover/keyboard
  - illustrated 22
  - spare part number 22
- touchpad
  - illustrated 23
  - removal 57
  - settings 10

- spare part number 23
- spare part numbers 57
- touchpad buttons
  - identifying 11
- touchpad zone, identifying 11
- TPM settings 78
- transporting guidelines 31, 37
- traveling with the computer 19

**U**

- USB board
  - removal 54
  - spare part number 54
- USB SuperSpeed 5 Gbps port with HP Sleep and Charge, identifying 7
- USB SuperSpeed 5 Gbps port, identifying 6
- USB Type-C power connector and SuperSpeed port with HP Sleep and Charge, identifying 8
- USB Type-C power connector and Thunderbolt port with HP Sleep and Charge, identifying 8

**V**

- vents, identifying 18
- video, product description 2
- volume
  - adjusting 16
  - mute 16

**W**

- Windows
  - backup 79
  - recovery media 79
  - system restore point 79
- Windows key, identifying 14
- Windows tools, using 79
- wireless action key 16
- wireless antennas
  - illustrated 24
  - spare part number 24
- wireless antennas, identifying 9
- wireless certification label 19
- wireless, product description 3
- WLAN antennas, identifying 9
- WLAN device 19
- WLAN label 19
- WLAN module
  - removal 43
  - spare part numbers 43
- workstation guidelines 31
- WWAN antennas, identifying 9

WWAN module  
removal 44  
spare part numbers 44