

SAMSUNG



Home Appliances 2022

Contents

Single Ovens	06
Features Glossary	09
Single Ovens Range	11
Compact Ovens & Warming Drawers	17
Features Glossary	18
Compact Ovens Range	20
Warming Drawers Range	23
Integrated Microwaves	24
Integrated Microwaves Range	25
Hobs	26
Features Glossary	27
Hobs Range	28
Hoods	32
Features Glossary	33
Hoods Range	34
Refrigeration	40
Features Glossary	46
Refrigeration Range	48
Laundry	64
Features Glossary	68
Washing Machines Range	72
Tumble Dryers Range	72
Washer Dryers Range	72
AirDressers Range	73
Dishwashers	75
Features Glossary	76
Dishwashers Range	78
Floorcare	80
Features Glossary	81
Bespoke Jet™ Range	82



Why choose Samsung Home Appliances?

We are challenging the status quo of home appliances by designing innovations that adapt to our changing homes. From fridge freezers that go way beyond keeping food fresh, to ovens that let you cook more flexibly than ever. So you can come home to appliances that work around the happy chaos of our everyday lives and are a joy to use.

#5 **BCG**
2020
Most Innovative
Companies

#5 **Interbrand**
2020
Best Global
Brands

#19 **FORTUNE**
2020
Global 500

#2 **statista**
2020
Ten Most Popular
Consumer Electronics
Brands in the UK



Your Home Appliance is with you for the journey, so enjoy long lasting performance with peace of mind.

At Samsung we pride ourselves in the quality and innovation of our appliances, that's why all refrigeration, selected laundry and cooking appliances are covered by our extended five year parts and labour warranty, so you don't have to worry about a thing. To receive the warranty customers must register within 90 days of purchase. To see the full list of eligible appliances, register your warranty and see the Terms and Conditions visit: www.samsung.com/uk/fiveyearwarranty

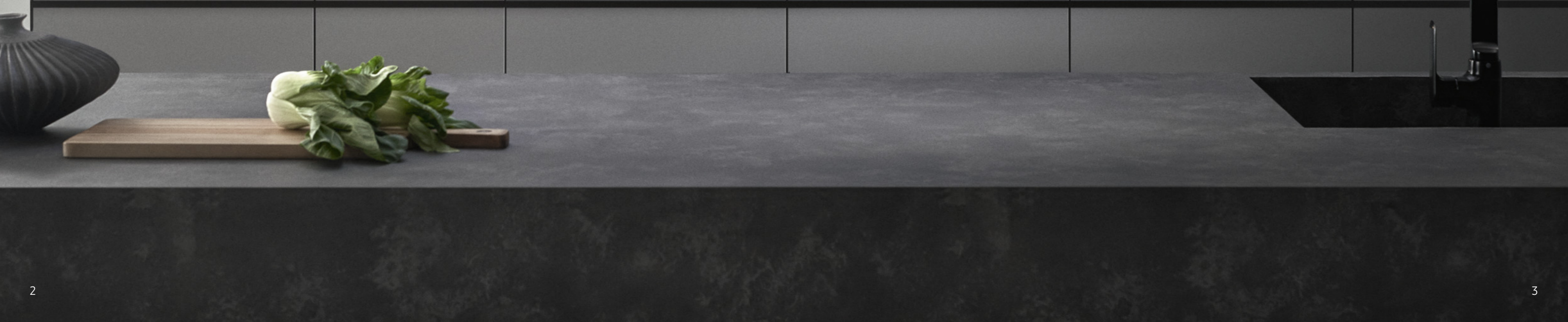

Cooking

Samsung appliances make cooking both very easy and very satisfying. Whether you're warming up leftovers, rustling up a ratatouille or having guests over for dinner, our thoughtful innovations and stylish design make cooking a pleasure.

- ▶ Single Ovens
- ▶ Compact Ovens
- ▶ Warming Drawers
- ▶ Hobs
- ▶ Hoods



Refrigeration

When your kitchen's the heart of the home, life revolves around the fridge. So why not get a centerpiece that combines super-cool tech with stylish good looks?

- ▶ French Door
- ▶ American Side-by-Side
- ▶ Integrated
- ▶ Family Hub™
- ▶ Bespoke

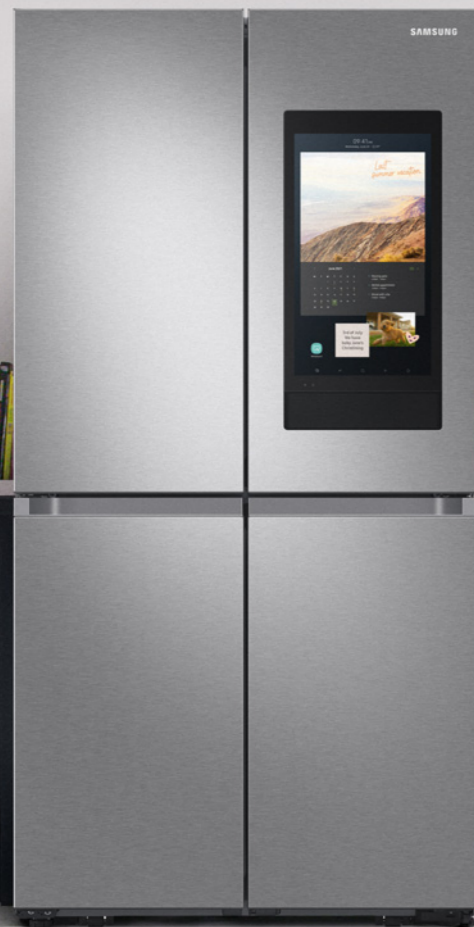

Laundry

Life doesn't always go to plan. So Samsung Laundry Appliances have tons of brilliantly useful innovations to power through your washing and drying in smarter, faster and kinder ways.

- ▶ Washing Machines
- ▶ Washer Dryers
- ▶ Tumble Dryers



Dishwashers

Loaded with slick technology, our dishwashers clean dishes like never before. From quick, everyday loads to clearing up after a dinner party, you can guarantee everything will be spot on and spotless.



Vacuum Cleaners

With the new All in one Clean Station you can clean with ease as its lightweight design also packs in incredible suction power.

- ▶ Bespoke Jet™



AirDresser

Part wardrobe, part steam cleaner, it does away with germs, dust and even smooths out wrinkles. Then you're good to go.





Infinite Line™ Ovens

Elevate your kitchen, reinvigorate your style

The Infinite Line™ of ovens transforms your single oven into two, with independent cooking zones for pulling together a full dinner party feast, all at once. Use steam to produce even more delicious results. And all the while, pre-programmed settings help you master the toughest culinary creations.

Choose from either onyx black or graphite grey. To complete the suite, there are matching compact ovens and warming drawers.

- ▶ **Steam Cooking**
Every meal will be beautiful succulent on the inside and crisp on the outside.
- ▶ **Dual Cook**
Cook two different dishes at different temperatures at once.
- ▶ **Wi-Fi functionality**
Control your oven using your phone* and have it cook a range of new recipes for you.
- ▶ **Matching Compact Ovens**
- ▶ **Matching Warming Drawers**



Onyx black



Graphite grey



*Requires SmartThings App available on Android and iOS devices. An internet connection is required.

Series 5 & 6 Ovens

Master two dishes at once

Not only can you master all manner of meals by cooking at two temperatures and settings at once, but the hinged door means you can access the full oven or just the top half – so baste the roast without your Yorkshires collapsing.

There are five Dual Cook Flex™ ovens to choose from and they are available in both black stainless steel or stainless steel. To complete the suite, there are matching compact ovens and warming drawers.

- ▶ **Dual Cook Flex™**
With a hinged Flexible Door, you can access the whole oven or just the top half without losing heat from the bottom and ruining your meal.
- ▶ **Dual Cook**
Cook two different dishes at different temperatures at once with no transfer of odour.
- ▶ **Steam Assist**
Every meal will be beautiful succulent on the inside and crisp on the outside.
- ▶ **Wi-Fi functionality**
Control your oven using your phone* and have it cook a range of new recipes for you.
- ▶ **Pyrolytic Cleaning**
Burns off grease and spills that can easily be wiped away.



Black glass



*Requires SmartThings App available on Android and iOS devices. An internet connection is required.



Feature Glossary



Auto Cook Recipes
Take the guesswork out of cooking times and temperatures. Auto Cook has it all in hand.



Bespoke Colour
Upgrade your kitchen by giving it a stylish and practical uplift. Our combi steam oven comes in 2 modern colours - Clean Navy and Satin Beige.



Catalytic Cleaning
Put the spray away. The catalytic liner banishes grease at high temperatures while you cook.

Series 4 Ovens

Divide and conquer the kitchen

For when she wants pizza and he wants pie, Dual Cook technology gives you the flexibility to divide a single oven into two. Then you can cook different meals at different temperatures and settings at the same time – all without any tastes or smells transferring.

There are three Dual Cook ovens to choose from and they are available in both black stainless steel or stainless steel. To complete the suite, there are matching compact ovens and warming drawers.



Black Glass



- ▶ **Dual Cook Flex™**
With a hinged Flexible Door, you can access the whole oven or just the top half without losing heat from the bottom and ruining your meal.
- ▶ **Dual Cook**
Cook two different dishes at different temperatures at once with no transfer of odour.
- ▶ **Pyrolytic Cleaning**
Burns off grease and spills that can easily be wiped away.
- ▶ **Steam Cleaning**
Easily loosen and remove food particles and stubborn stains.
- ▶ **Auto Cook Programmes**
Take the guesswork out of cooking times and temperatures.



Ceramic Enamel Interior
The exceptionally smooth antibacterial surface makes it easy to clean. It is also highly rust and scratch resistant so it won't discolour over time.



Dual Cook
This single, flexible oven can cook two different dishes at different temperatures at once, whenever you need to – with no taste or smells transferring.



Dual Cook Flex™
One flexible door. Two temperatures. Endless cooking combinations.



Full Steam Cooking
Master the art of healthy cooking. Try full steam and dive into delicious and nutritious meals, every time.



Meat Probe
This will actively manage the cooking process, regulating time and heat to ensure your food is always cooked to perfection.



Pro-Roasting Mode
Roast meat like a pro. One mode heats to 220°C to sear then automatically adjusts to the slow cook temperature you've set for ideal texture inside and out.

Feature Glossary



Pyrolytic Cleaning
Forget scrubbing the oven. Reaching high temperatures, pyrolytic cleaning burns off grease and spills that can easily be wiped away.



Soft Closing Door
The beautifully designed soft closing door is engineered to close both gently and quietly.



Steam Assist
Thanks to Steam Assist, every meal will be beautiful succulent on the inside and crisp on the outside.



Telescopic Rails
Sliding in and out smoothly and with hardly any effort, these telescopic rails are ideal for when you're using large pans and heavy dishes.

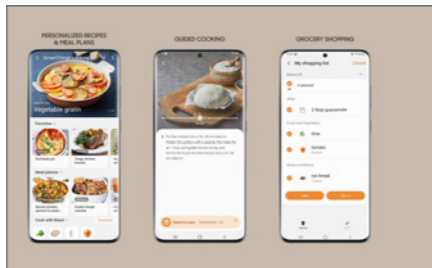

SmartThings Cooking
How's this for smart? Control your oven using your phone*1 and have it cook a range of new recipes for you.



Dual Cook Steam™
Roast, bake, or steam. This oven lets you cook in two completely different styles in two different temperatures at once.

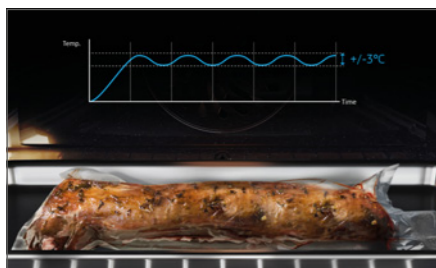

Air Sous Vide
Accurately senses the temperatures in each cavity and maintains an even temperature for a long period. So everything is cooked thoroughly, wherever it is in the oven.



Air Fry
Cook healthy, extra crispy food by using hot air circulation instead of deep frying. Enjoy the usual crunchy taste minus the extra fat.



Add Steam
Your oven fills with steam ensuring your food retains that all-important natural moisture. Your dishes will stay succulent inside and crisp and brown outside.

Infinite Line™ Onyx Black Oven Range



NV75T8549RK
Dual Cook Oven

KEY FEATURES

- Dual Cook™ technology
- Wi-Fi Compatible
- 5 Year Warranty*
- Catalytic Cleaning
- Ceramic Enamel Interior
- 50 Auto Cook Programmes
- Soft Closing Door
- Telescopic Rail
- Pro-Roasting Mode
- Steam Cleaning

ENERGY EFFICIENCY CLASS



MATCHING COMPACT OVENS

- NQ50T8939BK
- NQ50T8539BK

MATCHING WARMING DRAWER

- NL20T8100WK

ACCESSORIES

- x2 Baking Trays
- x1 Wire Rack



NV75T8579RK
Dual Cook Oven

KEY FEATURES

- Dual Cook™ technology
- Wi-Fi Compatible
- 5 Year Warranty*
- Pyrolytic Cleaning
- Ceramic Enamel Interior
- 50 Auto Cook Programmes
- Soft Closing Door
- Meat Probe
- Telescopic Rail
- Pro-Roasting Mode
- Steam Cleaning

ENERGY EFFICIENCY CLASS



MATCHING COMPACT OVENS

- NQ50T8939BK
- NQ50T8539BK

MATCHING WARMING DRAWER

- NL20T8100WK

ACCESSORIES

- x2 Baking Trays
- x1 Wire Rack



NV75T8979RK
Dual Cook Oven

KEY FEATURES

- Full Steam Cooking
- Steam Assist Cooking
- Dual Cook™ technology
- Wi-Fi Compatible
- 5 Year Warranty*
- Pyrolytic Cleaning
- Ceramic Enamel Interior
- 50 Auto Cook Programmes
- Soft Closing Door
- Meat Probe
- Telescopic Rail
- Pro-Roasting Mode
- Steam Cleaning

ENERGY EFFICIENCY CLASS



MATCHING COMPACT OVENS

- NQ50T8939BK
- NQ50T8539BK

MATCHING WARMING DRAWER

- NL20T8100WK

ACCESSORIES

- x2 Baking Trays
- x1 Wire Rack

Infinite Line™ Graphite Grey Oven Range

6 Series

5 Series



NV75T9579CD
Dual Cook Oven

KEY FEATURES

- Dual Cook™ technology
- Wi-Fi Compatible
- 5 Year Warranty*
- Pyrolytic Cleaning
- Ceramic Enamel Interior
- 50 Auto Cook Programmes
- Soft Closing Door
- Telescopic Rails
- Pro-Roasting Mode
- Steam Cleaning



NV75T9879CD
Dual Cook Oven

KEY FEATURES

- Steam Assist Cooking
- Dual Cook™ technology
- Wi-Fi Compatible
- 5 Year Warranty*
- Pyrolytic Cleaning
- Ceramic Enamel Interior
- 50 Auto Cook Programmes
- Soft Closing Door
- Meat Probe
- Telescopic Rails
- Pro-Roasting Mode
- Steam Cleaning



NV75T9979CD
Dual Cook Oven

KEY FEATURES

- Full Steam Cooking
- Steam Assist Cooking
- Dual Cook™ technology
- Wi-Fi Compatible
- 5 Year Warranty*
- Pyrolytic Cleaning
- Ceramic Enamel Interior
- 50 Auto Cook Programmes
- Soft Closing Door
- Meat Probe
- Telescopic Rails
- Pro-Roasting Mode
- Steam Cleaning

ENERGY EFFICIENCY CLASS

A+

MATCHING COMPACT OVENS
NQ50T9939BD
NQ50T9539BD

MATCHING WARMING DRAWER
NL20T8100WK

ACCESSORIES
x2 Baking Trays
x1 Wire Rack

ENERGY EFFICIENCY CLASS

A+

MATCHING COMPACT OVENS
NQ50T9939BD
NQ50T9539BD

MATCHING WARMING DRAWER
NL20T8100WK

ACCESSORIES
x1 Glass Steam Dish
x2 Baking Trays
x1 Wire Rack

ENERGY EFFICIENCY CLASS

A+

MATCHING COMPACT OVENS
NQ50T9939BD
NQ50T9539BD

MATCHING WARMING DRAWER
NL20T8100WK

ACCESSORIES
x1 Glass Steam Dish
x2 Baking Trays
x1 Wire Rack



NV7B6795JAK
Dual Cook Flex™ Oven

KEY FEATURES

- Add Steam
- Dual Cook Flex™
- 5 Year Warranty*
- Bespoke Colour
- Air Fry
- Pyrolytic Cleaning
- Smart Things Cooking
- Soft Close Door
- Food Probe
- Air Sous Vide
- Big Capacity (76L)
- Telescopic Rails (Two Levels)

ENERGY EFFICIENCY CLASS

A+

MATCHING COMPACT OVEN
NQ5B6753CAN

MATCHING WARMING DRAWER
NL20T8100WK

ACCESSORIES
x1 Tray, x1 Glass Steam Tray,
x1 Wire Rack



NV7B5775XAK
Dual Cook Flex™ Oven

KEY FEATURES

- Add Steam
- Dual Cook Flex™
- 5 Year Warranty*
- Air Fry
- Pyrolytic Cleaning
- Flexible Door
- Smart Things Cooking
- Modernised Design
- Soft Close Door
- Air Sous Vide
- Big Capacity (76L)
- Telescopic Rails (One Level)

ENERGY EFFICIENCY CLASS

A+

MATCHING COMPACT OVEN
NQ5B5763DBK

MATCHING WARMING DRAWER
NL20T8100WK

ACCESSORIES
x2 Trays, x1 Wire Rack



NV7B5675WAK
Dual Cook Oven

KEY FEATURES

- Add Steam
- Dual Cook
- 5 Year Warranty*
- Air Fry
- Pyrolytic Cleaning
- Smart Things Cooking
- Modernised Design
- Soft Close Door
- Food Probe
- Air Sous Vide
- Big Capacity (76L)
- Telescopic Rails (One Level)

ENERGY EFFICIENCY CLASS

A+

MATCHING COMPACT OVEN
NQ5B5763DBK

MATCHING WARMING DRAWER
NL20T8100WK

ACCESSORIES
x2 Trays, x1 Wire Rack

*Requires registration from www.samsung.com/uk/fiveyearwarranty within 90 days of purchase. Terms and conditions apply.

*Requires registration from www.samsung.com/uk/fiveyearwarranty within 90 days of purchase. Terms and conditions apply.

4 Series



NV7B4355KAK
Dual Cook Flex™ Oven

KEY FEATURES

- Dual Cook Flex™
- 5 Year Warranty*
- Flexible Door
- Smart Things Cooking
- Pyrolytic Cleaning
- Air Sous Vide
- Soft Close Door
- Big Capacity (76L)
- Telescopic Rail

ENERGY EFFICIENCY CLASS



MATCHING COMPACT OVEN
NQ5B4353FBK

MATCHING WARMING DRAWER
NL20T8100WK

ACCESSORIES
x1 Tray, x1 Natural Steam Tray,
x1 Wire Rack



NV7B4455UAB
Dual Cook Oven

KEY FEATURES

- Dual Cook
- 5 Year Warranty*
- Smart Things Cooking
- Pyrolytic Cleaning
- Big Capacity (76L)

ENERGY EFFICIENCY CLASS



MATCHING COMPACT OVEN
NQ5B4353FBK

MATCHING WARMING DRAWER
NL20T8100WK

ACCESSORIES
x1 Tray, x1 Natural Steam Tray,
x1 Wire Rack



NV7B4220UAK
Dual Cook Oven

KEY FEATURES

- Dual Cook
- 5 Year Warranty*
- Smart Things Cooking
- Catalytic Cleaning
- Air Sous Vide
- Soft Close Door
- Big Capacity (76L)

ENERGY EFFICIENCY CLASS



MATCHING COMPACT OVEN
NQ5B4353FBK

MATCHING WARMING DRAWER
NL20T8100WK

ACCESSORIES
x2 Trays,
x1 Wire Rack

4 Series



NV7B4530UAK
Dual Cook Flex™ Oven

KEY FEATURES

- Dual Cook Flex™
- 5 Year Warranty*
- Pyrolytic Cleaning
- Smart Things Cooking
- Flexible Door
- Air Sous Vide
- Big Capacity (76L)

ENERGY EFFICIENCY CLASS



MATCHING COMPACT OVEN
NQ5B4353FBK

MATCHING WARMING DRAWER
NL20T8100WK

ACCESSORIES
x2 Trays,
x1 Wire Rack



NV7B4430ZAB
Dual Cook Oven

KEY FEATURES

- Dual Cook
- 5 Year Warranty*
- Pyrolytic Cleaning
- Smart Things Cooking
- Air Sous Vide
- Big Capacity (76L)
- Telescopic Rails (One Level)

ENERGY EFFICIENCY CLASS



MATCHING COMPACT OVEN
NQ5B4353FBK

MATCHING WARMING DRAWER
NL20T8100WK

ACCESSORIES
x2 Trays,
x1 Wire Rack

*Requires registration from www.samsung.com/uk/fiveyearwarranty within 90 days of purchase. Terms and conditions apply.

*Requires registration from www.samsung.com/uk/fiveyearwarranty within 90 days of purchase. Terms and conditions apply.



Compact Ovens

A small but mighty second oven

Whether you're planning a big feast and need a second oven, or are short on space, a compact oven can be a lifesaver. Don't be fooled by their neat appearance. With up to 50L of cooking space, they can handle a turkey or tagine easily. And they're not just handy for preparing big meals – many can microwave and grill too. So compact ovens make a really flexible addition to your kitchen.

- ▶ **50L Capacity**
Cook more at once with the large internal capacity.
- ▶ **Steam Assist Cooking**
Every meal will be beautiful succulent on the inside and crisp on the outside.
- ▶ **Microwave Cooking**
Convenient and quick meals.
- ▶ **Grill Function**
Enjoy the browned, crispy food you love.
- ▶ **Steam Cleaning**
The inside of your oven looks good as new.
- ▶ **Auto Cook Programmes**
Take the guesswork out of cooking times and temperatures.



Graphite grey

Navy Blue



Feature Glossary



50 Litre Capacity

Catering for everyone just got a whole load easier – cook more at once with a roomy 50L capacity.



Ceramic Enamel Interior

The exceptionally smooth antibacterial surface makes it easy to clean. It is also highly rust and scratch resistant so it won't discolour over time.



Dual Fans

Two powerful fans get the oven hot fast, then circulate heat nice and evenly. With every meal thoroughly cooked, there'll be no surprises when you dish up.



Soft Closing Door

The beautifully designed soft closing door is engineered to close both gently and quietly.



Full Steam

Master the art of healthy cooking. Try full steam and dive into delicious and nutritious meals, every time.



Steam Cleaning

Cleaning your compact oven is no longer a faff thanks to easy Steam Cleaning.



Wi-Fi Compatible

How's this for smart? Control your compact oven using your phone* and have it cook a range of new recipes for you.



Add Steam

Your oven fills with steam ensuring your food retains that all-important natural moisture. Your dishes will stay succulent inside and crisp and brown outside.



Bespoke Colour

Upgrade your kitchen by giving it a stylish and practical uplift. Our combi steam oven comes in 2 modern colours - Clean Navy and Satin Beige.

*Requires SmartThings App available on Android and iOS devices. An internet connection is required.

Feature Glossary



Air Fry

Cook healthy, extra crispy food by using hot air circulation instead of deep frying. Enjoy the usual crunchy taste minus the extra fat.



Modernised Design

Now you can control and set all your preferences with a simple touch. Because who doesn't want to take shortcuts in the kitchen?

Infinite Line™ Compact Ovens Range



Onyx Black

Graphite Grey

NQ50T8539BK

Compact Oven

KEY FEATURES

- Wi-Fi Compatible
- 5 Year Warranty*
- Dual Fans
- 50L Capacity
- Ceramic Enamel Interior
- Soft Closing Door
- 35 Auto Cook Programmes
- Convection Cooking
- Microwave Cooking
- Grill Function
- Steam Cleaning

ENERGY EFFICIENCY CLASS

A+

MATCHING OVENS

NV75T8979RK
NV75T8579RK

MATCHING WARMING DRAWER

NL20T8100WK

ACCESSORIES

- x1 Ceramic Tray
- x2 Baking Trays
- x1 Wire Rack
- x1 Wire Tray Insert

NQ50T8939BK

Compact Oven

KEY FEATURES

- Steam Assist Cooking
- Wi-Fi Compatible
- 5 Year Warranty*
- Dual Fans
- 50L Capacity
- Ceramic Enamel Interior
- Soft Closing Door
- 35 Auto Cook Programmes
- Convection Cooking
- Microwave Cooking
- Grill Function
- Steam Cleaning

ENERGY EFFICIENCY CLASS

A+

MATCHING OVENS

NV75T8979RK
NV75T8579RK

MATCHING WARMING DRAWER

NL20T8100WK

ACCESSORIES

- x2 Baking Trays
- x1 Wire Rack
- x1 Steam Tray

NQ50T9539BD

Compact Oven

KEY FEATURES

- Wi-Fi Compatible
- 5 Year Warranty*
- Dual Fans
- 50L Capacity
- Ceramic Enamel Interior
- Soft Closing Door
- 35 Auto Cook Programmes
- Convection Cooking
- Microwave Cooking
- Grill Function
- Steam Cleaning

ENERGY EFFICIENCY CLASS

A+

MATCHING OVENS

NV75T9979CD
NV75T9879CD

MATCHING WARMING DRAWER

NL20T8100WK

ACCESSORIES

- x1 Ceramic Tray
- x2 Baking Trays
- x1 Wire Rack
- x1 Wire Tray Insert

NQ50T9939BD

Compact Oven

KEY FEATURES

- Steam Assist Cooking
- Wi-Fi Compatible
- 5 Year Warranty*
- Dual Fans
- 50L Capacity
- Ceramic Enamel Interior
- Soft Closing Door
- 35 Auto Cook Programmes
- Convection Cooking
- Microwave Cooking
- Grill Function
- Steam Cleaning

ENERGY EFFICIENCY CLASS

A+

MATCHING OVENS

NV75T9979CD
NV75T9879CD

MATCHING WARMING DRAWER

NL20T8100WK

ACCESSORIES

- x2 Baking Trays
- x1 Wire Rack
- x1 Steam Tray

6 Series



NQ5B6753CAN

Microwave Combi

KEY FEATURES

- Full Steam
- Add Steam
- Bespoke Colour
- Air Fry
- SmartThings Cooking
- Wi-Fi Connectivity
- Steam Cleaning
- 50L Large Capacity
- Dual Fan

MATCHING OVEN

NV7B6795AAK

MATCHING WARMING DRAWER

NL20T8100WK

ACCESSORIES

- x1 Ceramic Tray
- x1 Baking Tray
- x1 Wire Rack
- x1 Wire Tray Insert
- x1 Steam Tray
- x1 Air Fry

5 Series



NQ5B5763DBK

Simple Steam Combi

KEY FEATURES

- Modernised Design
- Bespoke Colour
- Air Fry
- SmartThings Cooking
- Wi-Fi Connectivity
- Steam Cleaning
- 50L Large Capacity

MATCHING OVEN

NV7B5775MAK
NV7B5675LAK

MATCHING WARMING DRAWER

NL20T8100WK

ACCESSORIES

- x1 Ceramic Tray
- x1 Baking Tray
- x1 Pure Steam Bowl
- x1 Wire Tray Insert
- x1 Simple Steam Tray
- x1 Air Fry

4 Series



NQ5B4353FBK

Microwave Combi

KEY FEATURES

- Air Fry
- SmartThings Cooking
- Wi-Fi Connectivity
- Steam Cleaning
- 50L Large Capacity

MATCHING OVEN

NV7B4355KAK
NV7B4455JAB
NV7B4220UAK
NV7B45305AK
NV7B4430ZAB

MATCHING WARMING DRAWER

NL20T8100WK

ACCESSORIES

- x1 Ceramic Tray
- x1 Baking Tray

*Requires registration from www.samsung.com/uk/fiveyearwarranty within 90 days of purchase. Terms and conditions apply.

*Requires registration from www.samsung.com/uk/fiveyearwarranty within 90 days of purchase. Terms and conditions apply.

Warming Drawers

Match the Warming Drawer with selected Compact Ovens to defrost, dough proof and keep food at the perfect temperature until dinner is ready

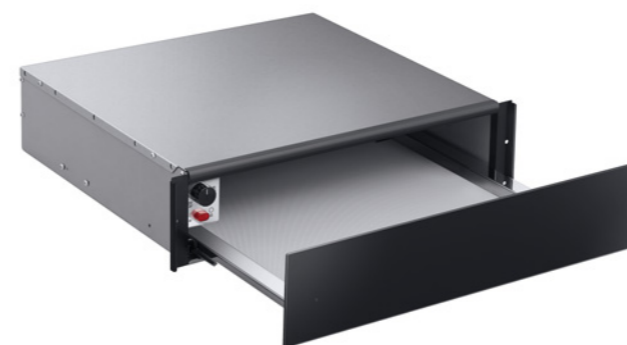

Warming Drawers Range



NL20T8100WK

Warming Drawer

KEY FEATURES

Push & Pull Door Handle

Temperature Range 30~80°C

Anti-Slip Mat

LED Status Lamp

5 Year Warranty*

*Requires registration from www.samsung.com/uk/fiveyearwarranty within 90 days of purchase. Terms and conditions apply.



Integrated Microwaves Range

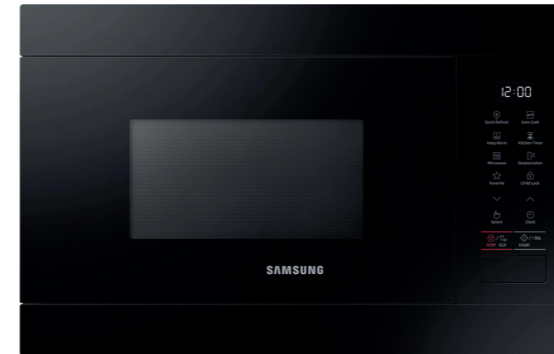

MS22M8054AK
Microwave Oven

KEY FEATURES

- 800W
- Touch Control
- 22L Capacity
- Ceramic Enamel Interior



MG22M8074AT
Microwave Oven

KEY FEATURES

- 800W
- Touch Control
- 22L Capacity
- Grill Function
- Ceramic Enamel Interior

Integrated Microwaves

All the microwave must haves, built-in

Our integrated microwaves aren't just about nailing that sleek, minimal look. They pack in all the things you expect from a microwave and more besides. From easy cleaning interiors to fuss-free defrosting.

- ▶ **Quick Defrost**
Quick Defrost lets you defrost frozen foods quickly and evenly, ensuring that it retains its original freshness and texture.
- ▶ **Deodorisation**
Our clever Deodorisation function eliminates the lingering odour of strong smelling ingredients as you cook them and leaves the interior smelling fresh.
- ▶ **Auto Cook Programmes**
Take the guesswork out of cooking times and temperatures.
- ▶ **Ceramic Enamel Interior**
Super easy to clean.



Steel & black

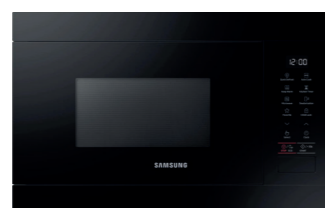

Black



Hobs

Putting flexibility on the menu

There's so much more to Samsung hobs. Our range has something to suit every style of cook whether you like to rustle up and go, or take it slow and steady. Gas, electric or induction you'll have the ultimate flexibility. Add to this next generation features that bring you supercharged heat, extra control and safety and you'll feel like your cooking on gas even when you're really not.

- ▶ **Induction with ventilation**
Create perfect meals with Dual Flex cooking zones, powerful ventilation and pre-defined hob settings.
- ▶ **Virtual Flame Technology™**
Flame-like LED lighting shows you how hot the ring is.
- ▶ **Power Boost**
A quick blast of power gets you to the hottest setting fast.
- ▶ **Flex Zone**
Make the most of your hob space and cook more flexibly.
- ▶ **Auto Connectivity***
The cooker hood turns on automatically when you activate the hob.



*Available on selected models and when paired with selected Samsung hobs

Feature Glossary

Induction



Auto Pan Detection

Not sure which pot or pan to use? Auto pan detection does the thinking for you and tells you to choose a different one if it doesn't cover enough of the cooking zone.



Flex Zone Plus

Divided into four zones for greater flexibility you can accommodate different sizes of cookware to cook the way you want.



Keep Warm

Keep warm will make sure your special chilli simmers at just the right temperature. So it's still good to go whenever you are.



Pause Function

If you're interrupted when cooking, just press the pause button to bring down the temperature. Then start again when you're ready.



Quick Start

Why wait for heat? Quick Start gets the induction hob super hot in seconds – as quick as if you're using a gas hob.



Sliding Control

Enables fast and precise control of your cooking temperatures. Simply touch and glide your finger across it to instantly set or adjust the heat levels.

Gas



Endless Design Grates

With these endless design grates you simply slide pots or pans along the seamless rails, making it easier and safer than ever to move your cookware.



Safety Shut-off

For extra peace of mind, Safety shut-off automatically turns off cooking zones that have been inactive for a while.

Ceramic



Easy to clean

There's no need to worry about messy spills and splatters. Even after the greasiest cooking, the smooth, ergonomic surface will quickly wipe clean.

Induction Hobs Range



NZ64H37070K

Induction Cooktop (60cm)

KEY FEATURES

Sliding Control
1~9 Power Level with Booster
Quick Stop
Residual Heat Indicator
New Amber Display
Cut Edge Frame
Left Front 14cm 1.25 (1.5kW)
Left Rear 22cm 2.35 (2.6kW)
Right Front 22cm 2.35 (2.6kW)
Right Rear 14cm 1.25 (1.5kW)
Total Max. Power 7.2kW



NZ64K7757BK

Induction Cooktop (60cm)

KEY FEATURES

Sliding Control
1~15 Power Level with Booster
Flex Zone Plus
Keep Warm
Quick Start/Quick Stop/Pause
2 Stage Residual Heat Indicator
New Amber Display
Front Bevelled Frame
Left 38 x 24cm 3.3 (3.6kW)
Right Front 21cm 2.2 (3.2kW)
Right Rear 14.5cm 1.4 (2.0kW)
Total Max. Power 7.2kW



NZ64N9777GK

Induction Cooktop (60cm)

KEY FEATURES

Virtual Flame Technology™
Flex Zone Plus
Auto Connectivity (with Hood) & Wi-Fi
Sliding & DirectAccess Control
1~15 Power Level with Booster
Keep Warm
Quick Start/Quick Stop/Pause
2 Stage Residual Heat Indicator
Ice Blue Display
Front Bevelled Frame
Flex Zone 38 x 24cm 3.3 (3.6kW)
Right Front 21cm 2.2 (3.2kW)
Right Rear 14.5cm 1.2 (2.0kW)
Total Max. Power 7.2kW
5 Year Warranty*

Induction Hobs Range



NZ84F7NC6AB

Induction Cooktop (80cm)

KEY FEATURES

Sliding Control
1~15 Power Level with Booster
Flex Zone
Keep Warm
Quick Stop/Pause
2 Stage Residual Heat Indicator
New Amber Display
3-side Bevelled Frame
Left 38 x 20cm 3.3 (3.6kW)
Centre 28cm 2.4 (3.6kW)
Right Rear 14.5cm 1.2 (2.0kW)
Total Max. Power 7.2kW
5 Year Warranty*



NZ84T9770EK

Induction Cooktop (80cm)

KEY FEATURES

Virtual Flame Technology™
Precise Control with Magnetic Knob
1~15 Power Level with Booster
Wide Flex Zone
Keep Warm
Quick Start/Quick Stop/Pause
2 Stage Residual Heat Indicator
Ice Blue Display
3-side Bevelled Frame
Left 38 x 20cm 3.3 (3.6kW)
Centre Rear 21cm 2.2 (3.2kW)
Right Front 14.5cm 1.2 (2.0kW)
Total Max. Power 7.0kW
5 Year Warranty*

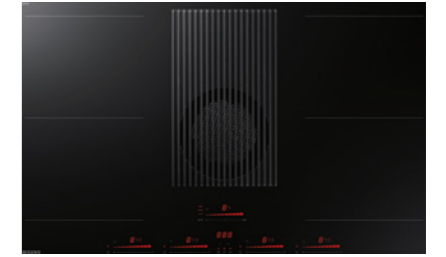

NZ84T9747VK

Induction Cooktop (80cm)

KEY FEATURES

Integrated Extractor
Sliding Control
1~9 Power Level with Booster
Flex Zone
Keep Warm
Powerful Ventilation
Flush-fit design
Easy Clean Aluminium Grease Filter
Low extraction noise
Total Max. Power 7.4kW
5 Year Warranty*

Gas Hobs Range



NA64H3000AK
Gas Cooktop (60cm)

KEY FEATURES

Rapid Burner (3.0kW)
Easy-to-Clean Tempered Glass Surface
4 Cast Iron Grate
Burner Types:
1 Rapid, 2 Semi-rapid, 1 Auxiliary
Electronic Ignition
(One Touch Ignition)
Safety Device (Flame Failure Device)
LNG/LPG Convergence Kit Included



NA64H3010AS
Gas Cooktop (60cm)

KEY FEATURES

Rapid Burner (3.3kW)
Easy-to-Clean Tempered Glass Surface
4 Cast Iron Grate
Burner Types:
1 Rapid, 2 Semi-rapid, 1 Auxiliary
Electronic Ignition
(One Touch Ignition)
Safety Device (Flame Failure Device)
LNG/LPG Convergence Kit Included



NA64H3110AS
Gas Cooktop (60cm)

KEY FEATURES

Rapid Burner (3.3kW)
Easy-to-Clean Tempered Glass Surface
Endless Design Grates
Burner Types:
1 Rapid, 2 Semi-rapid, 1 Auxiliary
Electronic Ignition
(One Touch Ignition)
Safety Device (Flame Failure Device)
LNG/LPG Convergence Kit Included

Ceramic Hobs Range



C61R1AAMST
Ceramic Cooktop

KEY FEATURES

4 Burners
Stainless Steel Frame
Powerful Cooking
Touch Control
Amber Display
Residual Heat Indicator
Total Power: 6.0kW

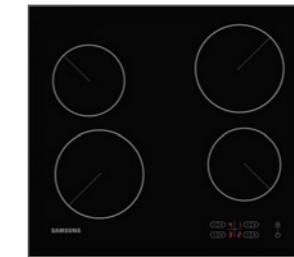

CR61R2AEE
Ceramic Cooktop

KEY FEATURES

4 Burners
Cutting Edge Frame
Powerful Cooking
Touch Control
Amber Display
Residual Heat Indicator
Total Power: 6.0kW



Hoods

Freshness is served

Our stylish wall mounted hoods are designed to work in any kitchen. But they're not all about good looks. Powerful yet quiet extraction banishes smoke, steam and odours while you're cooking – and long afterwards. Plus there's innovative features like auto connectivity with your hob and particle sensors that automatically boost the extraction power* to defeat strong cooking smells. You'll wonder how you cooked without them.



Stainless steel



Black



Feature Glossary



Auto Connectivity with hob*

Now you don't need to remember to switch your hood on. Thanks to auto connectivity on your hob, the hood turns on as soon you start cooking.



Boost Extraction

Some cooking smells linger more than others. This extra powerful extraction removes the most pungent of odours, to keep your kitchen smelling fresh.

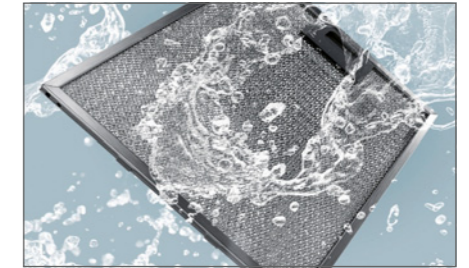

Easy Clean Grease Filters

No one likes cleaning the cooker hood. These grease filters work brilliantly to protect your hood motor. What's more, they're easy to take off and clean.



4 Extraction Speeds

When you're having prawn madras for tea you don't want the smell lingering days later. Thanks to 4 different extraction speeds you'll banish even the strongest smells.



Full Touch Control

Stay in control in the kitchen. Our full touch control hood display has a bright LCD panel that's so simple to use and easy to clean.



LED Lighting

Powerful lighting that illuminates your food, consumes less energy, and saves you money.

*Available on selected models and when paired with selected Samsung hobs.

60cm Hoods Range



NK24M1030IS

Wall-mount Hood (60cm)

KEY FEATURES

- Stainless Steel
- Push button controls
- 2 Bulb Lighting Lamps
- 3 Speed Extraction Modes
- Washable Aluminium Metallic Filters

ENERGY EFFICIENCY CLASS



- #### ACCESSORIES
- Charcoal Filter
 - Recirculation Kit



NK24M3050PS

Wall-mount Hood (60cm)

KEY FEATURES

- Stainless Steel
- Button Control
- 512m³/h Suction Power
- LED Lighting
- 3 Speed Extraction Modes
- Washable Aluminium Metallic Filters

ENERGY EFFICIENCY CLASS



- #### ACCESSORIES
- Charcoal Filter
 - Recirculation Kit



NK24M5070BM

Wall-mount Hood (60cm)

KEY FEATURES

- Black Stainless with Stylish Front
- Black Glass
- Touch Control
- High Suction Power (668m³/h)
- 2 LED Lighting
- 4 Speed Extraction Modes (3 Level x 1 Booster)
- Washable Aluminium Metallic Filter
- Saturation Indicator
- Timer Function
- 5 Year Warranty*

ENERGY EFFICIENCY CLASS



- #### ACCESSORIES
- Charcoal Filter
 - Recirculation Kit

60cm Hoods Range



NK24M5070BS

Wall-mount Hood (60cm)

KEY FEATURES

- Stainless Steel with Stylish Front
- Black Glass
- Touch Control
- High Suction Power (668m³/h)
- 2 LED Lighting
- 4 Speed Extraction Modes (3 Level x 1 Booster)
- Washable Aluminium Metallic Filter
- Saturation Indicator
- Timer Function
- 5 Year Warranty*

ENERGY EFFICIENCY CLASS



- #### ACCESSORIES
- Charcoal Filter
 - Recirculation Kit



NK24M5070CS

Wall-mount Hood (60cm)

KEY FEATURES

- Stainless Steel Glass Construction
- Touch Control
- High Suction Power (670m³/h)
- 2 LED Lighting
- 4 Speed Extraction Modes (3 Level x 1 Booster)
- Washable Aluminium Metallic Filters
- Saturation Indicator
- Timer Function

ENERGY EFFICIENCY CLASS



- #### ACCESSORIES
- Charcoal Filter
 - Recirculation Kit



NK24M7070VS

Wall-mount Hood (60cm)

KEY FEATURES

- Stainless Steel
- Touch Control
- High Suction Power (729m³/h)
- 2 LED Lighting
- 4 Speed Extraction Modes (3 Level x 1 Booster)
- Washable Aluminium Metallic Filters
- Saturation Indicator
- Timer Function
- 5 Year Warranty*

ENERGY EFFICIENCY CLASS



- #### ACCESSORIES
- Charcoal Filter
 - Recirculation Kit

60cm Hoods Range



NK24N5703BM

Wall-mount Hood (60cm)

KEY FEATURES

- Auto Connectivity (with Hob)
- Black Stainless with Stylish Front Black Glass
- High Suction Power (722m³/h)
- Touch Control
- 2 LED Lighting
- 4 Speed Extraction Modes (3 Level x 1 Booster)
- Washable Aluminium Metallic Filters
- Saturation Indicator
- Timer Function
- 5 Year Warranty*

ENERGY EFFICIENCY CLASS



- ACCESSORIES**
- Charcoal Filter
 - Recirculation Kit



NK24N5703BS

Wall-mount Hood (60cm)

KEY FEATURES

- Auto Connectivity (with Hob)
- Stainless Steel with Stylish Front Black Glass
- High Suction Power (722m³/h)
- Touch Control
- 2 LED Lighting
- 4 Speed Extraction Modes (3 Level x 1 Booster)
- Washable Aluminium Metallic Filters
- Saturation Indicator
- Timer Function
- 5 Year Warranty*

ENERGY EFFICIENCY CLASS



- ACCESSORIES**
- Charcoal Filter
 - Recirculation Kit



NK24N9804VB

Wall-mount Hood (60cm)

KEY FEATURES

- Auto Connectivity (with Hob)
- Premium Black Design
- High Suction Power (737m³/h)
- Auto Sensor
- Power Ventilation System
- Touch Control
- 1x7W LED Lighting
- 4 Speed Extraction Modes (3 Level x 1 Booster)
- Washable Aluminium Metallic Filters
- Saturation Indicator
- Timer Function
- 5 Year Warranty*

ENERGY EFFICIENCY CLASS



- ACCESSORIES**
- Charcoal Filter

*Requires registration from www.samsung.com/uk/fiveyearwarranty within 90 days of purchase. Terms and conditions apply.

90cm Hoods Range



NK36M3050PS

Wall-mount Hood (90cm)

KEY FEATURES

- Stainless Steel
- Button Control
- 512m³/h Suction Power
- LED Lighting
- 3 Speed Extraction Modes
- Washable Aluminium Metallic Filters

ENERGY EFFICIENCY CLASS



- ACCESSORIES**
- Charcoal Filter
 - Recirculation Kit



NK36M5070BM

Wall-mount Hood (90cm)

KEY FEATURES

- Black Stainless with Stylish Front Black Glass
- Touch Control
- High Suction Power (668m³/h)
- 2 LED Lighting
- 4 Speed Extraction Modes (3 Level x 1 Booster)
- Washable Aluminium Metallic Filter
- Saturation Indicator
- Timer Function
- 5 Year Warranty*

ENERGY EFFICIENCY CLASS



- ACCESSORIES**
- Charcoal Filter
 - Recirculation Kit



NK36M5070BS

Wall-mount Hood (90cm)

KEY FEATURES

- Stainless Steel with Stylish Front Black Glass
- Touch Control
- High Suction Power (668m³/h)
- 2 LED Lighting
- 4 Speed Extraction Modes (3 Level x 1 Booster)
- Washable Aluminium Metallic Filter
- Saturation Indicator
- Timer Function
- 5 Year Warranty*

ENERGY EFFICIENCY CLASS



- ACCESSORIES**
- Charcoal Filter
 - Recirculation Kit

*Requires registration from www.samsung.com/uk/fiveyearwarranty within 90 days of purchase. Terms and conditions apply.

90cm Hoods Range



NK36M5070CS

Wall-mount Hood (90cm)

KEY FEATURES

Stainless Steel Glass Construction
 Touch Control
 High Suction Power (670m³/h)
 2 LED Lighting
 4 Speed Extraction Modes
 (3 Level x 1 Booster)
 Washable Aluminium Metallic Filters
 Saturation Indicator
 Timer Function

ENERGY EFFICIENCY CLASS

B

ACCESSORIES
 Charcoal Filter
 Recirculation Kit



NK36M7070VS

Wall-mount Hood (90cm)

KEY FEATURES

Stainless Steel
 Touch Control
 High Suction Power (729m³/h)
 2 LED Lighting
 4 Speed Extraction Modes
 (3 Level x 1 Booster)
 Washable Aluminium Metallic Filters
 Saturation Indicator
 Timer Function
 5 Year Warranty*

ENERGY EFFICIENCY CLASS

B

ACCESSORIES
 Charcoal Filter
 Recirculation Kit



NK36N5703BS

Wall-mount Hood (90cm)

KEY FEATURES

Auto Connectivity (with Hob)
 Stylish Front Black Glass
 High Suction Power (722m³/h)
 Touch Control
 2 LED Lighting
 4 Speed Extraction Modes
 (3 Level x 1 Booster)
 Washable Aluminium Metallic Filters
 Saturation Indicator
 Timer Function
 5 Year Warranty*

ENERGY EFFICIENCY CLASS

A

ACCESSORIES
 Charcoal Filter

90cm Hoods Range



NK36N9804VB

Wall-mount Hood (90cm)

KEY FEATURES

Auto Connectivity (with Hob)
 Auto Sensing Control
 Black Glass
 High Suction Power (737m³/h)
 Touch Control
 LED Bar Lighting
 4 Speed Extraction Modes
 (3 Level x 1 Booster)
 Washable Aluminium Metallic Filters
 Saturation Indicator
 Timer Function
 5 Year Warranty*

ENERGY EFFICIENCY CLASS

A+

ACCESSORIES
 Charcoal Filter
 Recirculation Kit



French Style Fridge Freezers

The statement Fridge Freezers that have so many options and are ultra roomy.

There's a place for everything in our French Style Fridge Freezers thanks to super flexible compartments. And with the latest cool technology, you can even switch the fridge to a freezer during ice lolly season.

- ▶ **Metal Cooling Interior**
With the beautiful, reflective Metal Cooling Interior, the fridge looks as good on the inside as it does on the outside.
- ▶ **Family Hub™**
Keeping your food fresh is just the start. Shop for food, organise your family's schedule, even see who's at your door.
- ▶ **Twin Cooling Plus™**
Two separate air flows keep food fresher for longer.
- ▶ **SpaceMax™**
More inside for the same space outside.
- ▶ **Total No Frost**
Prevents ice build up, saving you the hassle and keeping your Fridge Freezer frost free.



Silver



Black



American Style Fridge Freezers

Stylish or spacious, why choose?

Big on the inside, stunning on the outside, it's easy to see why these American Style side by side Fridge Freezers have become so desirable this side of the pond. Better still, they're stacked with features like ice makers, water dispensers, individually cooled zones and frost free technology.

- ▶ **Metal Cooling Interior**
With the beautiful, reflective Metal Cooling Interior, the fridge looks as good on the inside as it does on the outside.
- ▶ **Family Hub™**
Keeping your food fresh is just the start. Shop for food, organise your family's schedule, even see who's at your door.
- ▶ **Twin Cooling Plus™**
Two separate air flows keep food fresher for longer.
- ▶ **SpaceMax™**
More inside for the same space outside.
- ▶ **Total No Frost**
Prevents ice build up, saving you the hassle and keeping your Fridge Freezer frost free.



Silver



Black





Bespoke Classic

Want to customise your fridge?

Bespoke Classic Fridge Freezers come in options to meet the needs of any kitchen. Create your perfect setup with our customisable colours and finishes in a variety of versatile configurations.



- ▶ **Customisable Module**
Seamlessly integrate multiple refrigeration modules to increase capacity and make the fridge freezer combo for you.
- ▶ **Customisable Design**
With custom coloured fridge freezers* and a varied choice of finishes, it's easy to express yourself and your taste with a Bespoke refrigerator.
- ▶ **SpaceMax™**
More inside for the same space outside.
- ▶ **All Around Cooling**
Every item stays ideally cooled no matter where it's stored inside.
- ▶ **Total No Frost**
Prevents ice build up, saving you the time and hassle of defrosting.
- ▶ **Power Cool & Power Freeze**
Add a burst of power to keep food at its best.

Bespoke One Door

Want to customise your fridge?

Bespoke One Door Fridges and One Door Freezers come in options to meet the needs of any kitchen. Create your perfect setup with our customisable colours and finishes in a variety of versatile configurations.



- ▶ **Customisable Module**
Seamlessly integrate multiple refrigeration modules to increase capacity and make the fridge freezer combo for you.
- ▶ **Customisable Design**
With custom coloured fridge freezers* and a varied choice of finishes, it's easy to express yourself and your taste with a Bespoke refrigerator.
- ▶ **SpaceMax™**
More inside for the same space outside.
- ▶ **All Around Cooling**
Every item stays ideally cooled no matter where it's stored inside.
- ▶ **Total No Frost**
Prevents ice build up, saving you the time and hassle of defrosting.
- ▶ **Power Cool or Power Freeze**
Add a burst of power to keep food at its best.



Integrated Fridge Freezers

Fridge Freezers that blend into your kitchen

Sometimes you just want a fridge to blend into the background. Our range of integrated Fridge Freezers slot tidily into your fitted kitchen. Behind their understated façades, there's top of the range design and technology working hard to keep things cool.



- ▶ **Total No Frost**
Prevents ice build up, saving you the hassle and keeping your Fridge Freezer frost free.
- ▶ **Twin Cooling Plus™**
Two separate air flows keep food fresher for longer.
- ▶ **CoolSelect Plus Zone**
Choose the best temperature for whatever you're storing.
- ▶ **Reversible Door**
Choose which side it opens from, making the fridge work with your kitchen.

One Door Fridges & Freezers

Keep it simple with a single door model with bags of capacity

Sometimes you just need a really big fridge or freezer. So keep it simple with a one door model with bags of capacity. Our One Door fridges and freezers have all round cooling, making every inch work hard to keep your groceries happy.



Silver

White



- ▶ **Large Capacity**
An immense capacity means more storage space and less trips to the shop to stock up.
- ▶ **Total No Frost**
Prevents ice build up, saving you the hassle and keeping your appliance frost free.
- ▶ **All Around Cooling**
Every item stays ideally cooled or frozen no matter where it's stored inside.
- ▶ **LED Lighting**
A brightly lit, stylish and energy efficient fridge or freezer. Making it easier for you to find those jars hidden on the top shelf.
- ▶ **Reversible Door**
Choose which side it opens from, making the fridge or freezer work with your kitchen.

Feature Glossary



Family Hub™

Shop for food, organise your family's schedule, even see who's at your door. These smart fridges are the centre of family life that's why we call them the Family Hub™.



Beverage Centre™

Enjoy fast and easy access to refreshingly cold and flavored water.



Dual Auto Ice Maker

Provides a choice of both Cubed Ice and Ice Bites™. Being stored in the freezer, the Dual Auto Ice Maker also helps free up fridge space.



Smart Conversion™

Storage jigsaw days are over. Convert your freezer into a fridge to store more fresh products as and when needed. It's that's simple.



CoolSelect Plus Zone

CoolSelect Plus Zone lets you choose the best temperature for whatever you're storing. Fridge or Freezer, you decide.



Reversible Doors

The Reversible Door means you can choose which side it opens from, making your Samsung fridge work with your kitchen and not against it.



SpaceMax™

Creates extra internal capacity but with the same size outside.



Total No Frost

Total No Frost prevents ice build-up, saving you the hassle and keeping your Fridge Freezer frost-free.

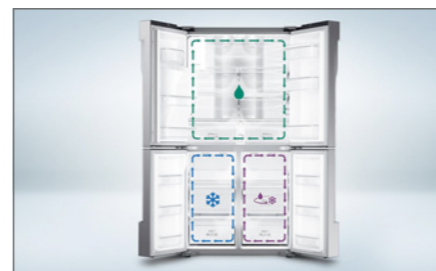

Triple Cooling System

Three separate air flows and precise temperature control to keep food fresher for longer.



Optimal & Humidity Fresh+ Zones

Keep items crisp and fresh by controlling the ideal temperature and humidity to suit your chosen food.



Water & Ice Dispenser

At the touch of a button you could be sipping ice-cold drinks.

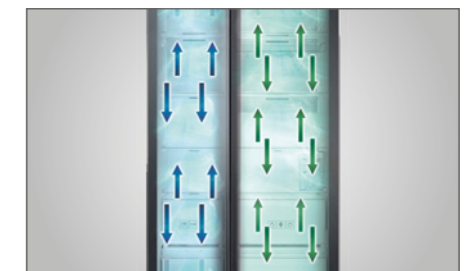

Twin Cooling Plus™

Food is kept fresher for longer thanks to separate air flows and precise temperature control.



All-around Cooling

Now you'll never lose your cool. Everything from chickens to cucumbers will be evenly chilled and stay fresh for longer.



Large Capacity

Plenty of room to store your weekly grocery shopping.



Metal Cooling Interior

With the beautiful, reflective Metal Cooling Interior, the fridge looks as good on the inside as it does on the outside.



Power Cool

Lost some cool air while stocking the fridge with your weekly shop? Top it up with a burst from Power Cool and keep your new food fresh.



Power Freeze

Don't worry about your frozen favourites defrosting on the way home from the shops. Add a burst of Power Freeze to the freezer to keep them at their best.



Wine Rack

Free up the rest of your fridge by keeping your wine in the elegant built-in wine rack.

French Style Fridge Freezers Range



RF23BB860EQN
French Style

KEY FEATURES

- Customisable Module/Combination
- Bespoke - Customisable Design
- Seamless and Sleek Design
- Beverage Centre™
- Dual Auto Ice Maker
- CoolSelect Plus Zone™
- Triple Cooling
- Metal Cooling
- Simply Stylish
- Easy Access Control & Simple LCD Display
- 5 Year Warranty*

ENERGY EFFICIENCY CLASS



RF23R62E3B1
French Style

KEY FEATURES

- Twin Cooling Plus™
- Modern Simple Design
- Fingerprint Resistant
- Plumbed Water & Ice
- EZ-Open™ Handle
- 5 Year Warranty*

ENERGY EFFICIENCY CLASS



RF23R62E3SR
French Style

KEY FEATURES

- Twin Cooling Plus™
- Modern Simple Design
- Fingerprint Resistant
- Plumbed Water & Ice
- EZ-Open™ Handle
- 5 Year Warranty*

ENERGY EFFICIENCY CLASS



French Style Fridge Freezers Range



RF65A977FB1
French Style

KEY FEATURES

- 5 Year Warranty*
- Family Hub™
- CoolSelect Plus Zone™
- Triple Cooling System
- Multi-Door Design
- Plumbed Water & Ice Dispenser
- SpaceMax™
- Total No Frost
- Metal Cooling Interior
- Digital Inverter Compressor
- Power Freeze
- Power Cool
- Wine Shelf
- LED Lighting
- Vacation Mode
- Door Alarm

ENERGY EFFICIENCY CLASS



RF65A977FSR
French Style

KEY FEATURES

- 5 Year Warranty*
- Family Hub™
- CoolSelect Plus Zone™
- Triple Cooling System
- Multi-Door Design
- Plumbed Water & Ice Dispenser
- SpaceMax™
- Total No Frost
- Metal Cooling Interior
- Digital Inverter Compressor
- Power Freeze
- Power Cool
- Wine Shelf
- LED Lighting
- Vacation Mode
- Door Alarm

ENERGY EFFICIENCY CLASS



*Requires registration from www.samsung.com/uk/fiveyearwarranty within 90 days of purchase. Terms and conditions apply.

American Style Fridge Freezers Range

American Style Fridge Freezers Range



RS50N3913SA
American Style

RS50N3913BC
American Style

RS50N3513SL
American Style

RS50N3513BC
American Style

RS50N3513S8
American Style

RS50N3513SA
American Style

KEY FEATURES

KEY FEATURES

KEY FEATURES

KEY FEATURES

KEY FEATURES

KEY FEATURES

5 Year Warranty*

5 Year Warranty*

5 Year Warranty*

5 Year Warranty*

5 Year Warranty*

5 Year Warranty*

Home Bar

Home Bar

Total No Frost

Total No Frost

Total No Frost

Total No Frost

Plumbed Water & Ice Dispenser

Plumbed Water & Ice Dispenser

All-Around Cooling

All-Around Cooling

All-Around Cooling

All-Around Cooling

Total No Frost

Total No Frost

Digital Inverter Compressor

Digital Inverter Compressor

Digital Inverter Compressor

Digital Inverter Compressor

All-Around Cooling

All-Around Cooling

Plumbed Water & Ice Dispenser

Plumbed Water & Ice Dispenser

Plumbed Water & Ice Dispenser

Plumbed Water & Ice Dispenser

Digital Inverter Compressor

Digital Inverter Compressor

Power Freeze

Power Freeze

Power Freeze

Power Freeze

Power Freeze

Power Freeze

Door Alarm

Door Alarm

Door Alarm

Door Alarm

Door Alarm

Door Alarm

Vacation Mode

Vacation Mode

Vacation Mode

Vacation Mode

Vacation Mode

Vacation Mode

Child Lock

Child Lock

Child Lock

Child Lock

Child Lock

Child Lock

Wine Rack

Wine Rack

Wine Rack

Wine Rack

Wine Rack

Wine Rack

ENERGY EFFICIENCY CLASS

F

ENERGY EFFICIENCY CLASS

F

ENERGY EFFICIENCY CLASS

F

ENERGY EFFICIENCY CLASS

F

ENERGY EFFICIENCY CLASS

F

ENERGY EFFICIENCY CLASS

F

*Requires registration from www.samsung.com/uk/fiveyearwarranty within 90 days of purchase. Terms and conditions apply.

*Requires registration from www.samsung.com/uk/fiveyearwarranty within 90 days of purchase. Terms and conditions apply.

American Style Fridge Freezers Range

American Style Fridge Freezers Range



RS50N3513WW
American Style

RS50N3413BC
American Style

RS52N3313SL
American Style

RS52N3313SA
American Style

RS52N3313WW
American Style

RS52N3213BC
American Style

KEY FEATURES

KEY FEATURES

KEY FEATURES

KEY FEATURES

KEY FEATURES

KEY FEATURES

- 5 Year Warranty*
- Total No Frost
- All-Around Cooling
- Digital Inverter Compressor
- Plumbed Water & Ice Dispenser
- Power Freeze
- Door Alarm
- Vacation Mode
- Child Lock
- Wine Rack

- 5 Year Warranty*
- Total No Frost
- All-Around Cooling
- Digital Inverter Compressor
- Non-plumbed Water Dispenser
- Power Freeze
- Door Alarm
- Vacation Mode
- Child Lock
- Wine Rack

- 5 Year Warranty*
- Total No Frost
- All-Around Cooling
- Digital Inverter Compressor
- Non-plumbed water dispenser
- Power Freeze
- Door Alarm
- Vacation Mode
- Child Lock
- Wine Rack

- 5 Year Warranty*
- Total No Frost
- All-Around Cooling
- Digital Inverter Compressor
- Non-plumbed water dispenser
- Power Freeze
- Door Alarm
- Vacation Mode
- Child Lock
- Wine Rack

- 5 Year Warranty*
- Total No Frost
- All-Around Cooling
- Digital Inverter Compressor
- Non-plumbed water dispenser
- Power Freeze
- Door Alarm
- Vacation Mode
- Child Lock
- Wine Rack

- 5 Year Warranty*
- Total No Frost
- All-Around Cooling
- Digital Inverter Compressor
- Non-plumbed water dispenser
- Power Freeze
- Door Alarm
- Vacation Mode
- Child Lock
- Wine Rack

ENERGY EFFICIENCY CLASS



ENERGY EFFICIENCY CLASS



ENERGY EFFICIENCY CLASS



ENERGY EFFICIENCY CLASS



ENERGY EFFICIENCY CLASS



ENERGY EFFICIENCY CLASS



*Requires registration from www.samsung.com/uk/fiveyearwarranty within 90 days of purchase. Terms and conditions apply.

*Requires registration from www.samsung.com/uk/fiveyearwarranty within 90 days of purchase. Terms and conditions apply.

American Style Fridge Freezers Range



RS54N3103SA
American Style

KEY FEATURES

- 5 Year Warranty*
- Total No Frost
- All-Around Cooling
- Digital Inverter Compressor
- Power Freeze
- Door Alarm
- Vacation Mode
- Child Lock

ENERGY EFFICIENCY CLASS



RS6HA8891SL
American Style

KEY FEATURES

- 5 Year Warranty*
- Family Hub™
- Twin Cooling Plus™
- Plumbed Water & Ice Dispenser
- SpaceMax™
- Total No Frost
- Metal Cooling Interior
- Digital Inverter Compressor
- Power Freeze
- Power Cool
- Wine Shelf
- LED Lighting
- Vacation Mode
- Door Alarm

ENERGY EFFICIENCY CLASS



RS67A8810S9
American Style

KEY FEATURES

- 5 Year Warranty*
- Large 609L Capacity
- Twin Cooling Plus™
- Plumbed Water & Ice Dispenser
- SpaceMax™
- Total No Frost
- Digital Inverter Compressor
- Power Freeze
- Power Cool
- Door Alarm
- Vacation Mode

ENERGY EFFICIENCY CLASS



Bespoke Classic Range

Classic 185cm Tall Fridge Freezer Metal



KEY FEATURES

- 5 Year Warranty*
- Total No Frost
- All-Around Cooling
- Digital Inverter Compressor
- SpaceMax™
- Optimal Fresh+
- Humidity Fresh+ Zone
- Power Cool
- Power Freeze
- Door Alarm
- Vacation Mode
- Reversible Door
- Child Lock
- Wine Rack

ENERGY EFFICIENCY CLASS



PAIRING KIT
RA-COOK4BAA

Freezer door panels for Classic 185cm Tall Fridge Freezer



Bespoke Pairing Kit
RA-COOK4BAA

This pairing kit provides a seamless join between Bespoke refrigeration products of the same height. It's compatible with Bespoke 185cm Fridge Freezers, 1 Door Fridges, and 1 Door Freezers.

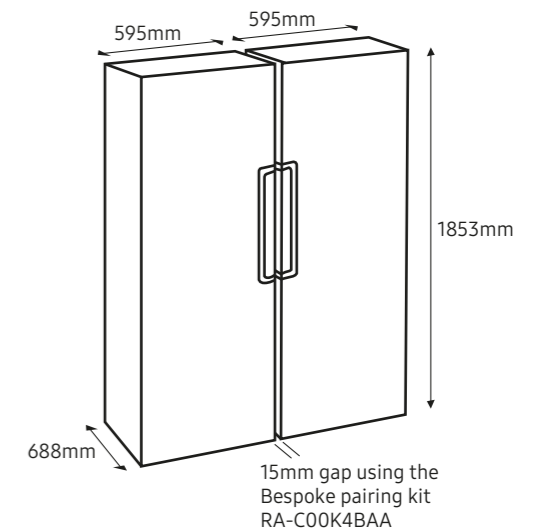

*Requires registration from www.samsung.com/uk/fiveyearwarranty within 90 days of purchase. Terms and conditions apply.

*Requires registration from www.samsung.com/uk/fiveyearwarranty within 90 days of purchase. Terms and conditions apply.

Bespoke One Door Range

One Door 185cm Tall Fridges Metal



KEY FEATURES

- 5 Year Warranty*
- Total No Frost
- All-Around Cooling
- Digital Inverter Compressor
- SpaceMax™
- Power Cool
- Door Alarm
- Vacation Mode
- Reversible Door
- Child Lock
- Wine Rack

ENERGY EFFICIENCY CLASS



PAIRING KIT
RA-COOK4BAA

One Door 185cm Tall Freezers Metal



KEY FEATURES

- 5 Year Warranty*
- Total No Frost
- All-Around Cooling
- Smart Conversion™
- Digital Inverter Compressor
- SpaceMax™
- Power Freeze
- Door Alarm
- Vacation Mode
- Reversible Door
- Child Lock

ENERGY EFFICIENCY CLASS



PAIRING KIT
RA-COOK4BAA

*Requires registration from www.samsung.com/uk/fiveyearwarranty within 90 days of purchase. Terms and conditions apply.

Bespoke One Door Range

One Door 185cm Tall Fridges Glass

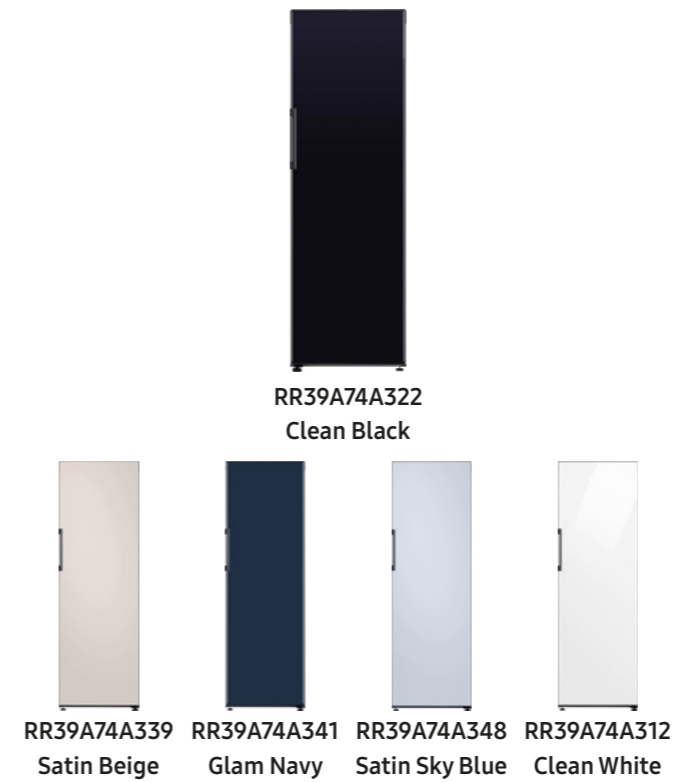

KEY FEATURES

- 5 Year Warranty*
- Total No Frost
- All-Around Cooling
- Digital Inverter Compressor
- SpaceMax™
- Power Cool
- Door Alarm
- Vacation Mode
- Reversible Door
- Child Lock
- Wine Rack

ENERGY EFFICIENCY CLASS



PAIRING KIT
RA-COOK4BAA

One Door 185cm Tall Freezers Glass



KEY FEATURES

- 5 Year Warranty*
- Total No Frost
- All-Around Cooling
- Smart Conversion™
- Digital Inverter Compressor
- SpaceMax™
- Power Freeze
- Door Alarm
- Vacation Mode
- Reversible Door
- Child Lock

ENERGY EFFICIENCY CLASS



PAIRING KIT
RA-COOK4BAA

*Requires registration from www.samsung.com/uk/fiveyearwarranty within 90 days of purchase. Terms and conditions apply.

Integrated Fridge Freezers Range



BRB26600FWW
Integrated

KEY FEATURES

- 5 Year Warranty*
- All-around Cooling
- SpaceMax™
- Total No Frost
- Door Alarm
- Vacation Mode
- Reversible Door

ENERGY EFFICIENCY CLASS

F



BRB26615EWW
Integrated

KEY FEATURES

- 5 Year Warranty*
- All-around Cooling
- SpaceMax™
- Total No Frost
- Door Alarm
- Vacation Mode
- Reversible Door
- Wine Rack

ENERGY EFFICIENCY CLASS

E



BRB26705DWW
Integrated

KEY FEATURES

- 5 Year Warranty*
- Twin Cooling Plus™
- CoolPlus Select Zone
- SpaceMax™
- Total No Frost
- Door Alarm
- Vacation Mode
- Metal Cooling Interior
- Reversible Door
- Wine Rack

ENERGY EFFICIENCY CLASS

D

One Door Fridges Range



RR39M73407F
Fridge

KEY FEATURES

- 5 Year Warranty*
- 375L Capacity
- Total No Frost
- All-Around Cooling (Multi Flow Cooling)
- Non-plumbed water dispenser
- Digital Inverter Compressor
- Power Cool
- Door Alarm
- Vacation Mode
- Child Lock
- Reversible Doors
- LED Lighting
- Pairing Kit
- Hot Stamping

ENERGY EFFICIENCY CLASS

F



RR39M7340B1
Fridge

KEY FEATURES

- 5 Year Warranty*
- 375L Capacity
- Total No Frost
- All-Around Cooling (Multi Flow Cooling)
- Non-plumbed water dispenser
- Digital Inverter Compressor
- Power Cool
- Door Alarm
- Vacation Mode
- Child Lock
- Reversible Doors
- LED Lighting
- Pairing Kit
- Hot Stamping

ENERGY EFFICIENCY CLASS

F



RR39M7340BC
Fridge

KEY FEATURES

- 5 Year Warranty*
- 375L Capacity
- Total No Frost
- All-Around Cooling (Multi Flow Cooling)
- Non-plumbed water dispenser
- Digital Inverter Compressor
- Power Cool
- Door Alarm
- Vacation Mode
- Child Lock
- Reversible Doors
- LED Lighting
- Pairing Kit
- Hot Stamping

ENERGY EFFICIENCY CLASS

F

*Requires registration from www.samsung.com/uk/fiveyearwarranty within 90 days of purchase. Terms and conditions apply.

*Requires registration from www.samsung.com/uk/fiveyearwarranty within 90 days of purchase. Terms and conditions apply.

One Door Fridges Range



RR39M7340BN

Fridge

KEY FEATURES

- 5 Year Warranty*
- 375L Capacity
- Total No Frost
- All-Around Cooling (Multi Flow Cooling)
- Non-plumbed water dispenser
- Digital Inverter Compressor
- Power Cool
- Door Alarm
- Vacation Mode
- Child Lock
- Reversible Doors
- LED Lighting
- Pairing Kit
- Hot Stamping

ENERGY EFFICIENCY CLASS



RR39M7340SA

Fridge

KEY FEATURES

- 5 Year Warranty*
- 375L Capacity
- Total No Frost
- All-Around Cooling (Multi Flow Cooling)
- Non-plumbed water dispenser
- Digital Inverter Compressor
- Power Cool
- Door Alarm
- Vacation Mode
- Child Lock
- Reversible Doors
- LED Lighting
- Pairing Kit
- Hot Stamping

ENERGY EFFICIENCY CLASS



RR39M7140SA

Fridge

KEY FEATURES

- 5 Year Warranty*
- 385L Capacity
- Total No Frost
- All-Around Cooling (Multi Flow Cooling)
- Digital Inverter Compressor
- Power Cool
- Door Alarm
- Vacation Mode
- Child Lock
- Reversible Doors
- LED Lighting
- Pairing Kit
- Hot Stamping

ENERGY EFFICIENCY CLASS



One Door Fridges Range



RR39M7140WW

Fridge

KEY FEATURES

- 5 Year Warranty*
- 385L Capacity
- Total No Frost
- All-Around Cooling (Multi Flow Cooling)
- Digital Inverter Compressor
- Power Cool
- Door Alarm
- Vacation Mode
- Child Lock
- Reversible Doors
- LED Lighting
- Pairing Kit
- Hot Stamping

ENERGY EFFICIENCY CLASS



*Requires registration from www.samsung.com/uk/fiveyearwarranty within 90 days of purchase. Terms and conditions apply.

*Requires registration from www.samsung.com/uk/fiveyearwarranty within 90 days of purchase. Terms and conditions apply.

One Door Freezers Range



RZ32M71257F
Fridge

KEY FEATURES

- Customisable Module/Combination
- Large capacity in cabinet fit
- Total No Frost
- All-around Cooling
- Fast Freeze
- Flat & Cabinet Design
- Digital Inverter Technology
- LED Lighting
- Slim Ice Maker
- 5 Year Warranty*

ENERGY EFFICIENCY CLASS



RZ32M7125B1
Fridge

KEY FEATURES

- Customisable Module/Combination
- Large capacity in cabinet fit
- Total No Frost
- All-around Cooling
- Fast Freeze
- Flat & Cabinet Design
- Digital Inverter Technology
- LED Lighting
- Slim Ice Maker
- 5 Year Warranty*

ENERGY EFFICIENCY CLASS



RZ32M7125BN
Fridge

KEY FEATURES

- Customisable Module/Combination
- Large capacity in cabinet fit
- Total No Frost
- All-around Cooling
- Fast Freeze
- Flat & Cabinet Design
- Digital Inverter Technology
- LED Lighting
- Slim Ice Maker
- 5 Year Warranty*

ENERGY EFFICIENCY CLASS



One Door Freezers Range



RZ32M7125SA
Fridge

KEY FEATURES

- Customisable Module/Combination
- Large capacity in cabinet fit
- Total No Frost
- All-around Cooling
- Fast Freeze
- Flat & Cabinet Design
- Digital Inverter Technology
- LED Lighting
- Slim Ice Maker
- 5 Year Warranty*

ENERGY EFFICIENCY CLASS



RZ32M7125WW
Fridge

KEY FEATURES

- Customisable Module/Combination
- Large capacity in cabinet fit
- Total No Frost
- All-around Cooling
- Fast Freeze
- Flat & Cabinet Design
- Digital Inverter Technology
- LED Lighting
- Slim Ice Maker
- 5 Year Warranty*

ENERGY EFFICIENCY CLASS



RZ32M71207F
Fridge

KEY FEATURES

- 5 Year Warranty*
- 315L Capacity
- Total No Frost
- All-Around Cooling (Multi Flow Cooling)
- Digital Inverter Compressor
- Power Freeze
- Door Alarm
- Vacation Mode
- Child Lock
- Reversible Doors
- Slim IceMaker
- LED Lighting
- Compatible with Fridge
- Hot Stamping

ENERGY EFFICIENCY CLASS



*Requires registration from www.samsung.com/uk/fiveyearwarranty within 90 days of purchase. Terms and conditions apply.

*Requires registration from www.samsung.com/uk/fiveyearwarranty within 90 days of purchase. Terms and conditions apply.



Save over 20% a year
 On your energy costs with a connected A rated Samsung Washing Machine*¹. Track your spending with SmartThings Energy*².



Save over £200 a year
 With a connected Samsung Heat Pump Tumble Dryer*¹. Track your spending with SmartThings Energy*².

Washing Machines

The smarter way to lighten your load

Our range of Washing Machines are a breath of freshly laundered air. From being kinder to the environment and your wallet, to whizzing through each load or adding to the wash mid cycle, your wash days will be transformed.

SmartThings



- ▶ **ecobubble™**
Wash your clothes more efficiently at cooler temperatures.
- ▶ **AddWash™**
You can quickly drop in anything you've forgotten during the wash.*³
- ▶ **Smart Control+**
Get a smarter washing experience.
- ▶ **Auto Cycle Link**
Recommends a drying cycle based on your was cycle
- ▶ **Hygiene Steam**
Eliminate 99.9% of bacteria and inactivating allergens.*⁴
- ▶ **Bubble Soak**
Deal with those stubborn stains.

*1. 21% saving based on the average energy use of Samsung A rated Washing Machines versus the average energy usage of other manufacturers' washing machines sold in major UK retailers on 01/11/22. *2. Selected models apply. SmartThings available on Android and iOS devices. A Wi-Fi connection and a Samsung account are required. *3. AddWash™ door can be opened at any time when the drum temperature is below 50 C. *4. Testing done by Intertek on Staphylococcus aureus and Escherichia coli and Dermatophagoides farinae Hughes, on 100% cotton, 3kg load, with standard powder detergent. Individual results may vary.

Tumble Dryers

Gently does it

A Tumble Dryer is a must for busy households. Our Tumble Dryers protect your clothes as they dry, so no need to worry about snagging your favourite top. As well as drying your clothes gently, they're gentler on the environment and your wallet too. And as clothes come out with less wrinkles, there's less ironing too.

SmartThings



- ▶ **OptimalDry™**
The temperature sensors adjust the drying time to save energy.
- ▶ **Quick Dry (35 mins)*³**
Quickly dry your favourite outfits for the day ahead.
- ▶ **Smart Control+**
Get a smarter drying experience.
- ▶ **Auto Cycle Link**
Recommends a drying cycle based on your was cycle
- ▶ **Wrinkle Prevent**
Fewer wrinkles, less ironing.
- ▶ **Hygiene Care**
Remove dust, mites and germs by putting your wet or dry clothes in your tumble dryer.

*1. £207 saving based on the average energy usage of Samsung Heat Pump Tumble Dryers versus the average energy usage of condenser tumble dryers sold in major UK retailers on 21/10/21, completing 260 cycles per year on an energy cost of 18.86p per kWh. *2. Selected models apply. SmartThings available on Android and iOS devices. A Wi-Fi connection and a Samsung account are required. *3. 35 minute Quick Dry cycle for a 1kg load.



Washer Dryers

Wash and dry days are no longer a chore

Getting your clothes clean is only half the battle. Our line up of Washer Dryers take the labour out of laundry by getting every basket load spotless and ready to wear.

SmartThings



- ▶ **ecobubble™**
Wash your clothes more efficiently at cooler temperatures.
- ▶ **AddWash™**
You can quickly drop in anything you've forgotten during the wash.*¹
- ▶ **Smart Control+**
Get a smarter washing experience.
- ▶ **Wash & Dry (59 mins)²**
Have your favourite outfit washed and dried in under an hour.
- ▶ **Hygiene Steam**
Eliminate 99.9% of bacteria and inactivating allergens.*³
- ▶ **Bubble Soak**
Deal with those stubborn stains.

*1. AddWash™ door can be opened at any time when the drum temperature is below 50 C. *2. 59 minute Wash & Dry cycle for a 1Kg load. *3. Testing done by Intertek on Staphylococcus aureus and Escherichia coli and Dermatophagoides farinae Hughes, on 100% cotton, 3kg load, with standard powder detergent. Individual results may vary.

AirDresser

Get that just washed feeling every day

Here's a fresh idea clothes that stay hygienically clean and fresh in between washes. Say hello to AirDresser. Part wardrobe, part steam cleaner, it does away with germs, dust and even smooths out wrinkles. Then you're good to go.



- ▶ **JetSteam**
Blasts away those lingering smells and hidden germs.
- ▶ **Deodorising Filter**
Works wonders on those lingering smells.
- ▶ **Heatpump Drying**
No more risking your delicates, HeatPump Drying takes gentle care of them.
- ▶ **Wrinkle Care**
Neater, smoother clothes.
- ▶ **Self Clean**
Eliminates germs and odours in the AirDresser.

Feature Glossary Washing Machines & Washer Dryers



ecobubble™
Make laundry less of a chore. ecobubble™ technology mixes air, water and detergent to create bubbles that wash your clothes at cooler temperatures.



AddWash™
Whether it's that stray sock you missed or extra softener, with AddWash™ door you can quickly drop in anything extra during the wash*1.

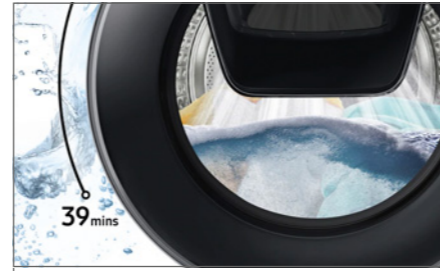

Super Speed Wash
Get an entire 5kg load of laundry clean in just 39 minutes with your Samsung washing machine.

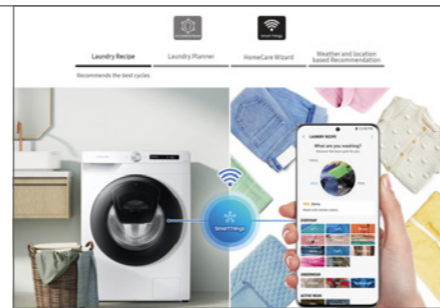
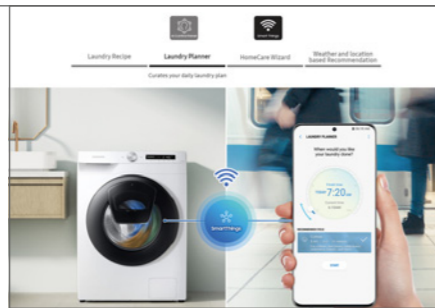
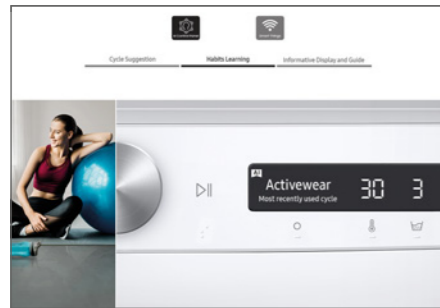

Smart Control+
With an intelligent, easy to use control panel, Samsung smart washing machines remember your family's laundry habits and suggest your favourite cycles first. From whites to bed change days, track every cycle's progress on the simply designed display. Then when the washing is done, you'll get a notification on your phone with the SmartThings app*2. Want to make things even simpler? Use the app*1 to schedule your washes and get guides to find the perfect setting.



Hygiene Steam
Banish more than just stains and odours. The Hygiene Steam cycle releases hot steam, eliminating 99.9% of bacteria and inactivating allergens*3.



15 Minute Quick Wash
This programme is particularly convenient when you are short of time and need to quickly wash up to 2kg of your favourite garments.



Fabric Care Drum
Our innovative Fabric Care Drum is designed to prevent clothes from snagging. While a cushioning layer of bubbles adds an extra level of care to your laundry.

*2. Available on Android and iOS. An internet connection is required. *1. AddWash™ door can be opened at any time when the drum temperature is below 50°C. *3. Testing done by Intertek on Staphylococcus aureus and Escherichia coli and Dermatophagoides farinae Hughes, on 100% cotton, 3kg load, with standard powder detergent. Individual results may vary.

Feature Glossary Washing Machines & Washer Dryers



Drum Clean+
Removes 99.9% of bacteria*4 from the drum and helps get rid of dirt from the door rubber seal. After 40 cycles the machine reminds you to run it.



Stay Clean Drawer
With no soap build up, your detergent flows more freely into the drum for a cleaner, fresher wash.



Bubble Soak
Whether it's cotton, synthetics or baby clothes, add a 30-minute bubble soak to your wash and deal with those stubborn stains.



Digital Inverter Technology
A quiet washing machine that's built to last, economical and has the added peace of mind of a 10-year warranty.

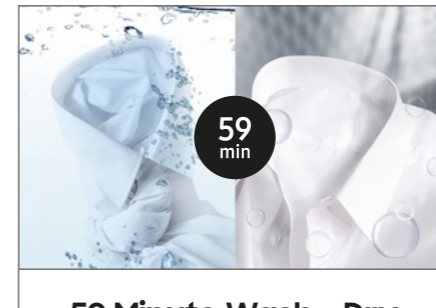

59 Minute Wash + Dry
Get your clothes washed and dried in less than an hour. It's ideal for loads of up to 1kg.

*4. Eliminates 99.9% of bacteria from the inside of the washing machine and removes dirt from the rubber gasket. Based on testing by Intertek of the Drum Clean+ cycle.

Feature Glossary Tumble Dryers



Heat Pump Technology (A+++ Energy Rating)
Heat Pump not only takes care of your clothes, but as it's energy efficient, it keeps your wallet happy too.



OptimalDry™
Who says you can't tumble dry without wasting energy? Our temperature sensors adjust the drying time to do exactly that.



35 Minute Quick Dry
This cycle dries a load of clothes in just over half an hour. How handy is that? It's ideal for loads of up to 1kg.

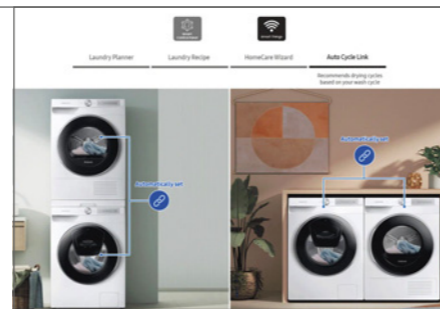
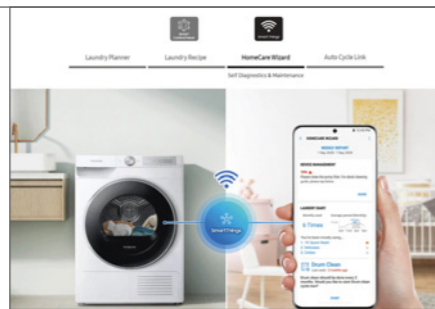

Smart Control+

With an intelligent, easy to use control panel, Samsung smart tumble dryers remember your family's laundry habits and suggest your favourite cycles first. Track every cycle's progress with the simply designed display. When the drying's done, you'll get a notification on your phone with the SmartThings app*1. Schedule your dryer and get perfect cycle guides from the app. Use the Auto Cycle Link*2 and let your washing machine recommend the right setting to your dryer.



2 in 1 Filter

The filter collects fluff, meaning the heat exchange filter needs cleaning less often. It will even remind you when it needs to be done.

*1. Available on Android and iOS. An internet connection is required. *2. Auto Cycle Link is only available when both the washing machine and tumblers dryer have Smart Control and are Wi Fi connected.

Feature Glossary AirDresser

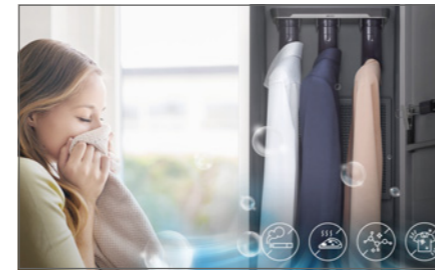

Deodorising Filter
Here's a real breath of fresh air. AirDresser's Deodorising Filter works wonders on those lingering smells!



Bespoke
Add a stylish and unique look to your home. A customisable design means you can choose a finish to suit your lifestyle and taste.

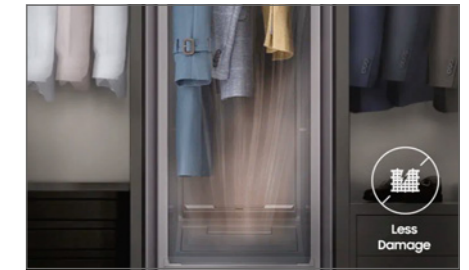

Heat Pump Drying
No more risking your delicates, let AirDresser's cool HeatPump Drying take care of them gently and quickly.

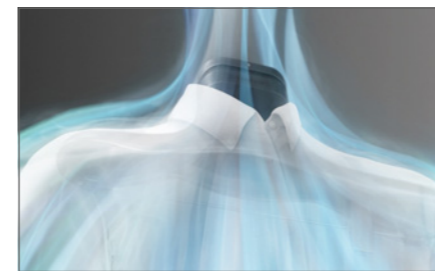

Jet Air+ Air Hanger
The Jet Air system and Air Hangers blow dust and odours from your clothes so quietly, you can sleep through the whole process.

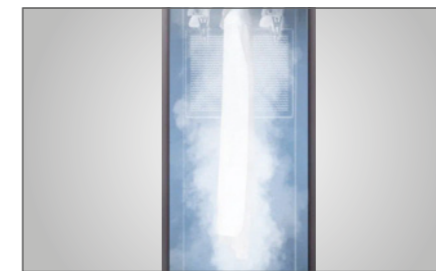

JetSteam
Blasting hot steam through its bespoke clothes hangers, it tackles those lingering odours and hidden germs. The perfect way to refresh laundry.

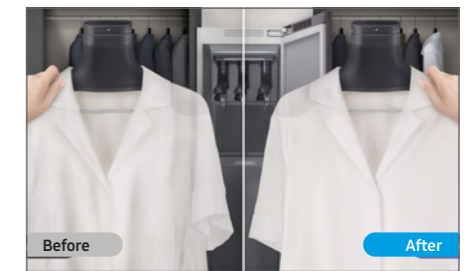

Wrinkle Care
Neater, smoother clothes, without lifting a finger... all thanks to Airdresser's Wrinkle Care system relaxing creases.

Washing Machine



WW90T554DAW
9Kg Washing Capacity

KEY FEATURES

- ecobubble™
- AddWash™
- Smart Control+
- Hygiene Steam
- 15min Quick Wash
- Fabric Care Drum
- Drum Clean
- Stay Clean Drawer
- Bubble Soak
- Digital Inverter Technology
- 5 Year Warranty*

ENERGY EFFICIENCY CLASS



MATCHING TUMBLE DRYER
DV90T5240AW

STACKING KIT
SKK-UDW

Tumble Dryer



DV90T5240AW
9Kg Drying Capacity

KEY FEATURES

- Heat Pump Technology (A+++ Energy Rating)
- OptimalDry™
- Smart Control+
- Reversible Door
- Quick Dry 35mins
- 2-in-1 Filter
- Wrinkle Prevent
- 5 Year Warranty*

ENERGY EFFICIENCY CLASS



MATCHING WASHING MACHINES
WW90T554DAW

STACKING KIT
SKK-UDW

Washer Dryers



WD80TA046BE
8Kg Washing Capacity
5Kg Drying Capacity

KEY FEATURES

- ecobubble™
- Hygiene Steam
- 15min Quick Wash
- Fabric Care Drum
- Drum Clean
- Stay Clean Drawer
- Bubble Soak
- Digital Inverter Technology
- 5 Year Warranty*

ENERGY EFFICIENCY CLASS WASH



ENERGY EFFICIENCY CLASS WASH & DRY



WD90T654DBH
9Kg Washing Capacity
6Kg Drying Capacity

KEY FEATURES

- ecobubble™
- AddWash™
- Smart Control+
- 59min Wash + Dry
- Super Speed Wash
- Hygiene Steam
- 15min Quick Wash
- Fabric Care Drum
- Drum Clean+
- Stay Clean Drawer
- Bubble Soak
- Digital Inverter Technology
- 5 Year Warranty*

ENERGY EFFICIENCY CLASS WASH



ENERGY EFFICIENCY CLASS WASH & DRY



AirDressers



KEY FEATURES

- JetSteam
- Deodorising Filter
- Heatpump Drying
- Wrinkle Care
- Jet Air + Air Hanger
- Self Clean
- SmartThings
- Soft Closing Door
- Dehumidification



DF60A8500HG

KEY FEATURES

- Bespoke
- JetSteam
- Deodorising Filter
- Fine Dust Filter
- Heatpump Drying
- Wrinkle Care
- Jet Air + Air Hanger
- Self Clean
- SmartThings
- Soft Closing Door
- Dehumidification

*Requires registration from www.samsung.com/uk/fiveyearwarranty within 90 days of purchase. Terms and conditions apply.

*Requires registration from www.samsung.com/uk/fiveyearwarranty within 90 days of purchase. Terms and conditions apply.



Integrated Dishwashers

Slots seamlessly into your life.

Our built in dishwashers are designed to fit neatly and effortlessly into the hub of your home. They're also stacked with technology to make dishwashing hassle free. From the basics done brilliantly, right up to handy little bonus features.

- ▶ **Half Load**
Run a quick, energy saving, cycle.
- ▶ **A* Wash and Dry Performance**
All our dishwashers have at least an A rating.
- ▶ **Eco Wash**
Bring down those energy bills.
- ▶ **Delicate Wash**
Protect your delicate glasses while they wash.
- ▶ **Intensive Wash**
Heavy duty loads are no match for this powerful deep cleanse.
- ▶ **Flexible Load System**
Loading the dishwasher is much easier.

Feature Glossary



Auto Door Open

Auto Door Open lets the steam escape at the end of the cycle, so every item dries perfectly.



Info Light

Check if your Samsung dishwasher is working with one quick glance! The floor Info Light projects a blue beam onto the floor when a wash cycle is in progress.

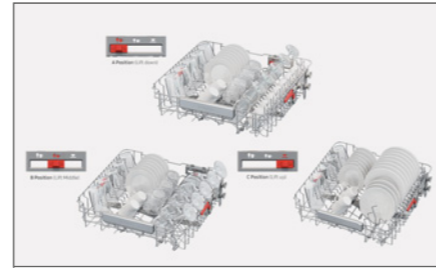

Flexible Load System

Loading the dishwasher is much less fiddly with these adjustable racks.



Flexible Third Rack

The Flexible 3rd Rack gives you extra space at the top for cutlery and utensils. So you can make the most of the space below.



Half Load

Dishwasher only half full? No problem. Run a quick half load and save energy.



Daily 55™ Cycle

Get all the everyday essentials clean, dry and ready to go in less than an hour.



Daily 60min Express Wash

If you're short on time or have lighter loads, Express Wash powers through them in an hour.

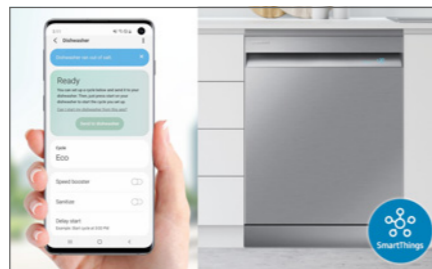

Smart Control+

Tap into handy reminders, tailored cycles and the freedom to control your dishwasher from anywhere*.

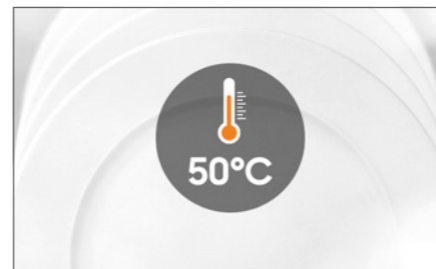

Eco Wash

For lighter loads, choose Eco Wash and bring down those energy bills.

Feature Glossary



Delicate Wash

Trust this gentle setting to protect your delicate glasses while they wash, and still come out sparkling.



Intensive Wash

Heavy duty loads are no match for the deep cleaning power of Intensive Wash.



Quick Wash

Entertaining and need clean dishes fast? The Quick Wash programme has your back.



Auto Wash

No more half cleaned crockery. Auto Wash works out the best way to get your dishes spotless, so you don't have to.



Quiet Washing

Enjoy the peace and quiet of your home while your dishwasher silently washes away in the background.



Ice Blue LED Display

The uber stylish Ice Blue LED display makes it easy to select the cycle you want.

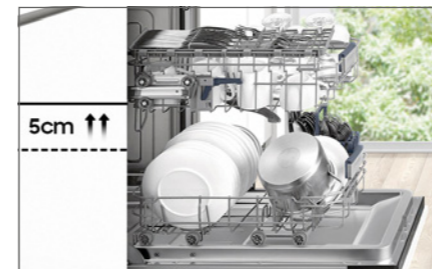

Flexible Racks

Loading the dishwasher is much less fiddly with these adjustable racks.



Flexible Interior Space

Flex your dishwasher space to fit your every load.

*. Available on Android and iOS. An internet connection is required.

Integrated Dishwashers



DW50R4040BB
Fully Built-In (Slim line)

KEY FEATURES

- 9 Place Settings
- 6 Programmes
- 46dB(A)
- Half Load
- Flexible Racks
- Flexible interior space
- Hygiene Option
- Eco Wash
- Delicate Wash
- Intensive Wash
- Quick Wash
- Normal Wash
- Ice Blue LED Display
- Delay Start
- Child Lock
- Aqua-Stop

ENERGY EFFICIENCY CLASS



DW60M5050BB
Fully Built-In (Full Size)

KEY FEATURES

- 13 Place Settings
- 5 Programmes
- 48dB(A)
- 60 minute Express Wash
- Flexible Racks
- Flexible interior space
- Half Load
- Hygiene Option
- Eco Wash
- Intensive Wash
- Delicate Wash
- Ice Blue LED Display
- Delay Start
- Child Lock
- Aqua-Stop

ENERGY EFFICIENCY CLASS



DW60M6040BB
Fully Built-In (Full Size)

KEY FEATURES

- 13 Place Settings
- 6 Programmes
- 44dB(A)
- 60 minute Express Wash
- Flexible Racks
- Flexible interior space
- Half Load
- Hygiene Option
- Auto Wash
- Eco Wash
- Intensive Wash
- Delicate Wash
- Ice Blue LED Display
- Delay Start
- Child Lock
- Aqua-Stop

ENERGY EFFICIENCY CLASS



DW60A8060BB
Fully Built-In (Full Size)

KEY FEATURES

- 14 Place Settings
- 8 / 12 Programmes
- 43dB(A)
- Auto Door Open
- 55 minute Express Wash
- Flex Load System
- Smart Things
- Flexible Racks
- Flexible interior space
- Speed Booster
- Half Load
- Metal 3rd Rack
- Self Clean Wash
- Hygiene Option
- Eco Wash
- Delicate Wash
- Intensive Wash
- Ice Blue LED Display
- Delay Start
- Child Lock
- Aqua-Stop

ENERGY EFFICIENCY CLASS





Bespoke Jet™

Lightweight power for max efficiency

With Samsung's new All in one Clean Station you can clean with ease as its lightweight design also packs in incredible suction power of up to 210W*1. Whether you're vacuuming your floors or hygienically emptying your vacuum's dustbin, enjoy exceptionally effective cleaning from start to finish.

- ▶ **All-in-one Clean station**
Does all the hard work and effectively*2 empties the dustbin using "Air Pulse" technology for maximum hygiene, while recharging the battery at the same time.
- ▶ **Multi-layered Filtration System**
The 99.999% Multi layered Filtration system traps 99.999% of dust*3 to boost your air quality.
- ▶ **Digital Inverter Motor**
Makes for a super light, yet powerful vacuum.
- ▶ **Jet Cyclone**
Enjoy clean air and consistent suction power with a high efficiency.

*1. Suction tested based on the IEC62885-2 Cl. 5.8 standard, tested at the inlet of the non motorized tool, using Jet mode. Based on internal tests. *2. Results may vary depending on individual use. Dust and hair stuck inside the grille may not be removed with a single cycle. *3. Tested internally based on IEC 62885-2, CL.5.11 using the Jet mode. Results may vary depending on actual usage. *4. Compared to the VS9000. *5. The stated run time applies to the minimum power level with a non motorized tool attached. Results may vary depending on actual usage. *6. The displayed time may differ from the actual usage time and is continuously updated every second. The usage time may shorten based on the number of uses.

Feature Glossary



All-in-one Clean station
Does all the hard work and effectively*2 empties the dustbin using "Air Pulse" technology for maximum hygiene, while recharging the battery at the same time.

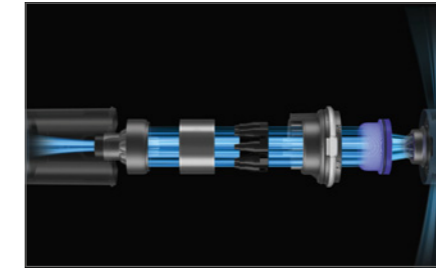

Multi-layered Filtration System
The 99.999% Multi layered Filtration system traps 99.999% of dust*3 to boost your air quality.

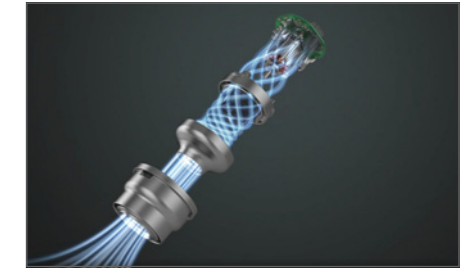

Digital Inverter Motor
Makes for a super light, yet powerful vacuum. With the improved stator, rotor and 3D fan, it's now 47%*4 lighter, delivering up to 210W*1 of suction.



Jet Cyclone
Say goodbye to unreachable dust with the extreme suction power of Samsung's Jet Cyclone.



High-Capacity Interchangeable Battery
Vacuum the whole house in one go, with up to 1 hour*5 run time, thanks to the long-lasting, removable battery



LCD Digital Display
Manually check everything is ready to go. Check which suction level you're using, how much charge you have*6, and even get troubleshooting alerts.



Lightweight Design
Gain maximum usability and reduce the strain on your wrist.



Telescopic Pipe
No more crouching or craning when you're vacuuming adjust or extend the telescopic pipe to make it more comfortable for your height.



Fully Washable Dust Bin
No bags, no mess, no hassle, emptying the dustbin is hygienic and with easy. The whole 0.5L dustbin is fully washable, so it can be kept clean and hygienic.

Bespoke Jet™



VS20A95823W
Bespoke Jet™

KEY FEATURES

- All-in-one Clean station
- Multi-layered Filtration System
- Digital Inverter Motor
- Jet Cyclone
- High-Capcity Battery
- High Efficient Motorised Brushes
- LCD Digital Display
- Lightweight Design
- Telescopic Pipe
- Interchangable Batteries
- Accessory Cradle
- Fully Washable Dust Bin
- One Click Detachable Drum
- Intuitive LED Lighting

ACCESSORIES

- Jet Dual Brush
- Pet Tool
- Combination & Crevice Tool
- Flexible Tool
- Accessory Cradle
- x1 Battery



VS20A95843W
Bespoke Jet™ Pet

KEY FEATURES

- All-in-one Clean station
- Multi-layered Filtration System
- Digital Inverter Motor
- Jet Cyclone
- High-Capcity Battery
- High Efficient Motorised Brushes
- LCD Digital Display
- Lightweight Design
- Telescopic Pipe
- Interchangable Batteries
- Accessory Cradle
- Fully Washable Dust Bin
- One Click Detachable Drum
- Intuitive LED Lighting

ACCESSORIES

- Jet Dual Brush
- Pet Tool
- Slim Action Brush
- Combination & Crevice Tool
- Flexible Tool
- Accessory Cradle
- x1 Battery



VS20A95943N
Bespoke Jet™ Complete Extra

KEY FEATURES

- All-in-one Clean station
- Multi-layered Filtration System
- Digital Inverter Motor
- Jet Cyclone
- High-Capcity Battery
- High Efficient Motorised Brushes
- LCD Digital Display
- Lightweight Design
- Telescopic Pipe
- Interchangable Batteries
- Accessory Cradle
- Fully Washable Dust Bin
- One Click Detachable Drum
- Intuitive LED Lighting

ACCESSORIES

- Jet Dual Brush
- Pet Tool
- Slim Action Brush
- Combination & Crevice Tool
- Flexible Tool
- Accessory Cradle
- x2 Batteries



VS20A95973B
Bespoke Jet™ Pro Extra

KEY FEATURES

- All-in-one Clean station
- Multi-layered Filtration System
- Digital Inverter Motor
- Jet Cyclone
- High-Capcity Battery
- High Efficient Motorised Brushes
- LCD Digital Display
- Lightweight Design
- Telescopic Pipe
- Interchangable Batteries
- Accessory Cradle
- Fully Washable Dust Bin
- One Click Detachable Drum
- Intuitive LED Lighting

ACCESSORIES

- Jet Dual Brush
- Spray Spinning Sweeper
- Pet Tool
- Combination & Crevice Tool
- Flexible Tool
- Antibacterial Reusable Pads
- Disposable Wet Pads
- Accessory Cradle
- x2 Batteries



SAMSUNG

