



Maintenance and Service Guide

SUMMARY

This guide provides information about spare parts, removal and replacement of parts, security, backing up, and more.

© Copyright 2020 HP Development Company, L.P.

AMD and Radeon are trademarks of Advanced Micro Devices, Inc. Bluetooth is a trademark owned by its proprietor and used by HP Inc. under license. Intel, Core, Thunderbolt, vPro, Xeon, and XMM are trademarks of Intel Corporation or its subsidiaries in the U.S. and/or other countries. Linux is the registered trademark of Linus Torvalds in the U.S. and other countries. Microsoft and Windows are either registered trademarks or trademarks of Microsoft Corporation in the United States and/or other countries. NVIDIA and Quadro are trademarks and/or registered trademarks of NVIDIA Corporation in the U.S. and other countries. Red Hat is a registered trademark of Red Hat, Inc. in the United States and other countries. USB Type-C and USB-C are registered trademarks of USB Implementers Forum.

The information contained herein is subject to change without notice. The only warranties for HP products and services are set forth in the express warranty statements accompanying such products and services. Nothing herein should be construed as constituting an additional warranty. HP shall not be liable for technical or editorial errors or omissions contained herein.

First Edition: September 2020

Document Part Number: M21105-001

Product notice

This guide describes features that are common to most models. Some features may not be available on your computer.

Not all features are available in all editions or versions of Windows. Systems may require upgraded and/or separately purchased hardware, drivers, software or BIOS update to take full advantage of Windows functionality. Windows 10 is automatically updated, which is always enabled. ISP fees may apply and additional requirements may apply over time for updates. Go to <http://www.microsoft.com> for details.

To access the latest user guides, go to <http://www.hp.com/support>, and follow the instructions to find your product. Then select **Manuals**.

Software terms

By installing, copying, downloading, or otherwise using any software product preinstalled on this computer, you agree to be bound by the terms of the HP End User License Agreement (EULA). If you do not accept these license terms, your sole remedy is to return the entire unused product (hardware and software) within 14 days for a full refund subject to the refund policy of your seller.

For any further information or to request a full refund of the price of the computer, please contact your seller.

Important notice about Customer Self-Repair parts

Your computer includes Customer Self-Repair parts and parts that should be accessed by only an authorized service provider.



IMPORTANT: See "Removal and replacement procedures for Customer Self-Repair parts" for details.

Accessing parts described in "Removal and replacement procedures for authorized service provider parts" can damage the computer or void your warranty.

Safety warning notice

Reduce the possibility of heat-related injuries or of overheating the computer by following the practices described.

 **WARNING!** To reduce the possibility of heat-related injuries or of overheating the computer, do not place the computer directly on your lap or obstruct the computer air vents. Use the computer only on a hard, flat surface. Do not allow another hard surface, such as an adjoining optional printer, or a soft surface, such as pillows or rugs or clothing, to block airflow. Also, do not allow the AC adapter to come into contact with the skin or a soft surface, such as pillows or rugs or clothing, during operation. The computer and the AC adapter comply with the user-accessible surface temperature limits defined by applicable safety standards.

Table of contents

1 Product description	1
2 Components	5
Right	5
Left	6
Display	7
Keyboard area	9
Touchpad	10
Touchpad settings	11
Adjusting touchpad settings	11
Turning on the touchpad	11
Touchpad components	11
Bottom	12
Top cover	13
Rear	13
Labels	14
HP TamperLock	15
Inserting a SIM card in the service bay	16
3 Illustrated parts catalog	19
Computer major components	19
Mass storage devices	26
Cables	26
Miscellaneous parts	27
4 Removal and replacement procedures preliminary requirements	31
Tools required	31
Service considerations	32
Plastic parts	32
Cables and connectors	32
Drive handling	32

Workstation guidelines	32
Electrostatic discharge information	34
Generating static electricity	34
Preventing electrostatic damage to equipment	35
Personal grounding methods and equipment	35
Grounding the work area	35
Recommended materials and equipment	36
Packaging and transporting guidelines	36

5 Removal and replacement procedures for Customer Self-Repair parts 39

Component replacement procedures	40
Preparation for disassembly	40
Service cover	40
Battery	41
Solid-state drives 3 and 4	42
Hard drive	44
WLAN module	46
WWAN module	47
Solid-state drive 2	49
Memory modules 2 and 4	51
Keyboard	54
Memory modules 1 and 3	58
Solid-state drive 1	62

6 Removal and replacement procedures for authorized service provider parts 65

Component replacement procedures	66
Preparation for disassembly	66
Bottom case	66
SD card board cable	68
SD card board	69
Fingerprint reader module cable	70
Fingerprint reader module	71
Hard drive cable	72
Touchpad cable	73
Touchpad	74
NFC module cable	75
NFC module	76
Card reader board	78
Fan/heat sink assembly	79
43.9 cm (17.3 in) display assembly	83
Beam connector	85

Graphics card	87
System board	89
RTC battery	94
I/O board	95
Speakers	97

7 Troubleshooting guide 99

Resources	99
General troubleshooting steps	101
Identify the issue	102
1. Understand the issue	103
Boot up sequence	103
Failure classification	104
2. Examine the environment	106
3. Perform a visual inspection of hardware	106
4. Update BIOS and drivers	107
Manually updating BIOS and drivers	107
Remotely deploying the BIOS and drivers	107
Analyze the issue	108
5. Remove or uninstall recently added hardware, software	108
6. HP Hardware Diagnostics and Tools	109
HP PC Hardware Diagnostics (UEFI)	109
HP BIOS Configuration Utility (BCU)	110
HP Image Diagnostic Tool	111
HP Thermal Monitor	111
Non HP diagnostics tools	111
7. Status lights, blinking light codes, troubleshooting lights, and POST error messages	112
Status lights	112
Blinking light codes	112
POST error messages	113
Resolve the issue	115
8. Hard reset	115
9. Soft reset (Default Settings)	116
10. Reseat cables and connections	116
11. Test with minimum configuration	118
Essential hardware configuration	118
Safe mode	119
12. Test with verified working configuration (hardware or operating system)	119
13. Replace the system board	119
Verify solution	120

Helpful Hints	121
At startup	121
During operation	121
Consulting with HP Service	122
Common issues and possible solutions	123
Power-on issues	124
No power	124
Intermittent power-on, shutdown, reboot	126
AC adapter issue	127
Battery not recognized, not charging	128
Battery discharges too fast	130
Burnt smell	130
POST	132
No video (with power)	132
Blinking lights	133
Diagnostic error messages	133
BIOS password	134
Performance (OS)	135
Intermittent shutdown	135
Blue screen	136
Freeze at Windows Logo (hang or lockup)	136
Electromagnetic Interference (EMI)	137
No wake up	138
Unresponsive	139
Slow performance	140
HP Smart Adapter warning message	140
Incorrect time and date	141
Display	142
Display anomalies	143
Symptom	143
Quick check	144
HP PC Hardware Diagnostics (UEFI) for video test	144
Display assembly diagram	144
Dead pixel	145
No video (internal)	145
No video (external)	145
DisplayPort/VGA	146
HDMI	146
No or bad external video via docking	147
Incorrect or missing color/distorted image	147
Touch screen	148

I/O devices	150
Keyboard	150
Keyboard pointing stick	151
Keyboard backlight	151
Touchpad	152
Network connectivity (RJ-45 jack)	152
Network connectivity wireless (WLAN)	153
WWAN	153
USB	154
Smart card reader	155
Speaker, headphone - audio issues	156
Thunderbolt (TB)	157
Storage	159
Hard drive or solid-state drive not recognized	159
No boot to operating system (no read-write error)	160
Read-write error	161
Slow performance	162
Blue screen (BSOD) error	162
Noisy hard drive	162
Mechanical	164
Noise (sound)	164
Fan runs constantly	164
Thermal shutdown (hot)	166
Additional information	168
Acronyms	168
Blinking lights and boot error codes	169
Processor not executing code	169
BIOS recovery code unable to find valid BIOS recovery image	169
Memory module error	169
Graphics Controller Error (No Controller)	170
Failure System Board Error	170
Intel Trusted Execution Technology (TXT) Error	170
Sure Start unable to find valid BIOS Boot Block image	170
Sure Start has identified a problem (Manual Recovery Policy Set)	171
POST error messages and user actions	171
Routine maintenance for performance improvement	173
Common blue screen error messages	174
Error message list	174
Bug check symbolic names	174
Microsoft general troubleshooting of Windows bug check codes	174
Use Windows Debugging Tool	176

Windows Software Development Kit (SDK)	176
Display issue: pixel anomalies	179
Cable management	180
Connector types	182
Flex cable	182
Horizontal cable insertion	182
Multiple-pin horizontal connector (LVDS cable to display panel)	183
Multiple-pin vertical connector (LVDS cable to system board)	183
8 Using Setup Utility (BIOS)	185
Starting Setup Utility (BIOS)	185
Updating Setup Utility (BIOS)	186
Determining the BIOS version	186
Preparing for a BIOS update	187
Downloading a BIOS update	187
Installing a BIOS update	187
9 Backing up, restoring, and recovering	189
Backing up information and creating recovery media	190
Using Windows tools for backing up	190
Using the HP Cloud Recovery Download Tool to create recovery media (select products only)	190
Restoring and recovering your system	191
Creating a system restore	191
Restoring and recovery methods	191
Recovering using HP Recovery media	191
Changing the computer boot order	192
Using HP Sure Recover (select products only)	192
10 Using HP PC Hardware Diagnostics	193
Downloading the HP PC Hardware Diagnostics Windows from the Microsoft Store	193
Customizing Remote HP PC Hardware Diagnostics UEFI settings	193
11 Specifications	195
Computer specifications	195
43.9 cm (17.3 in) display specifications	197
Hard drive specifications	197
Solid-state drive specifications	198
Solid-state drive specifications (SATA-3)	198

12 Statement of memory volatility	201
Current BIOS steps	201
Nonvolatile memory usage	203
Questions and answers	205
Using HP Sure Start (select products only)	207
13 Power cord set requirements	209
Requirements for all countries	209
Requirements for specific countries and regions	209
14 Recycling	213
Index	215

1 Product description

This table provides detailed product information.

Table 1-1 Product components and their descriptions

Category	Description
Product Name	HP ZBook Fury 17 G7 Mobile Workstation
Processors	Intel® Xeon™ W-10885M 2.3 GHz (5.1 GHz max turbo frequency) processor (8 cores, 16 MB L3 cache, 45 W)
	Intel Core™ i7-10850H 2.7 GHz (5.1 GHz max turbo frequency) processor (6 cores, 12 MB L3 cache, 45 W)
	Intel Core i7-10750H 2.6 GHz (5.0 GHz max turbo frequency) processor (6 cores, 12 MB L3 cache, 45 W)
	Intel Core i5-10400H 2.6 GHz (4.6 GHz max turbo frequency) processor (4 cores, 8 MB L3 cache, 45 W)
	Intel Core i5-10300H 2.5 GHz (4.5 GHz max turbo frequency) processor (4 cores, 8 MB L3 cache, 45 W)
Graphics controller	AMD® Radeon™ F19M-E85-70 graphics controller
	AMD Radeon R19M-E85-70 graphics controller
	NVIDIA® Quadro® T1000 N19P-Q1 graphics controller
	NVIDIA Quadro T2000 N19P-Q3 graphics controller
	NVIDIA Quadro N19E-Q3 graphics controller
	NVIDIA Quadro N19E-Q5 graphics controller
	NVIDIA Quadro N19E-Q1-KD-A1 graphics controller
Graphics card	AMD Radeon Professional W5500M graphics card with 4 GB memory
	AMD Radeon RX 5500M graphics card with 4 GB memory
	NVIDIA Quadro RTX 3000 graphics card with 6 GB memory
	NVIDIA Quadro RTX 4000 graphics card with 8 GB memory
	NVIDIA Quadro RTX 5000 graphics card with 16 GB memory
	NVIDIA Quadro T1000 graphics card with 4 GB memory
	NVIDIA Quadro T2000 graphics card with 4 GB memory
Display	43.9 cm (17.3 in), liquid crystal display (LCD), white light-emitting diode (WLED), UWVA, flat bezel
	Ultra high-definition (UHD) (3840×2160), BrightView, HDR-400, DCI-P3 100, eDP 1.4 + PSR 2, touchscreen display panel, equipped with full high-definition (FHD) webcam + infrared and ambient light sensor; typical brightness: 550 nits
	UHD (3840×2160), BrightView, HDR-400, DCI-P3 100, eDP 1.4 + PSR 2, touchscreen display panel, equipped with ambient light sensor; typical brightness: 550 nits

Table 1-1 Product components and their descriptions (continued)

Category	Description
	UHD (3840×2160), antiglare, HDR-400, DCI-P3 100, eDP 1.4 + PSR 2, Dream Color display panel, equipped with FHD webcam + infrared and ambient light sensor; typical brightness: 550 nits
	UHD (3840×2160), antiglare, HDR-400, DCI-P3 100, eDP 1.4 + PSR 2, Dream Color display panel, equipped with FHD webcam and ambient light sensor; typical brightness: 550 nits
	UHD (3840×2160), antiglare, HDR-400, DCI-P3 100, eDP 1.4 + PSR 2, Dream Color display panel, equipped with ambient light sensor; typical brightness: 550 nits
	UHD (3840×2160), antiglare, DCI-P3 100, eDP 1.4 + PSR 2 display panel, equipped with FHD webcam + infrared and ambient light sensor; typical brightness: 550 nits
	UHD (3840×2160), antiglare, DCI-P3 100, eDP 1.4 + PSR 2 display panel, equipped with FHD webcam and ambient light sensor; typical brightness: 550 nits
	UHD (3840×2160), antiglare, DCI-P3 100, eDP 1.4 + PSR 2 display panel, equipped with ambient light sensor; typical brightness: 550 nits
	FHD (1920×1080), antiglare, sRGB 100, eDP 1.2 display panel, equipped with FHD webcam + infrared and ambient light sensor; typical brightness: 300 nits
	FHD (1920×1080), antiglare, sRGB 100, eDP 1.2 display panel, equipped with FHD webcam and ambient light sensor; typical brightness: 300 nits
	FHD (1920×1080), antiglare, sRGB 100, eDP 1.2 display panel, equipped with ambient light sensor; typical brightness: 300 nits
Memory	<p>Four customer-accessible memory module slots supporting up to 128 GB of RAM</p> <p>DDR4-2666 dual-channel support</p> <p>NOTE: Non-ECC memory performance 2666 MHz provided same part number of memory modules, otherwise performance might drop to 2133 MHz. ECC memory performance 2666 MHz provided same part number of memory modules, otherwise performance might drop to 2400 MHz.</p> <p>Supports the following configurations:</p> <ul style="list-style-type: none"> • 128 GB (32 × 4 @ DDR4-2666 1.2 V SODIMM) • 64 GB (32 × 2 or 16 × 4 @ DDR4-2666 1.2 V SODIMM) • 64 GB (16 × 4 @ DDR4-2666 1.2 V SODIMM ECC) • 32 GB (32 × 1 or 16 × 2 or 8 × 4 @ DDR4-2666 1.2 V SODIMM) • 32 GB (32 × 1 or 16 × 2 @ DDR4-2666 1.2 V SODIMM ECC) • 16 GB (16 × 1 or 8 × 2 @ DDR4-2666 1.2 V SODIMM) • 16 GB (16 × 1 or 8 × 2 @ DDR4-2666 1.2 V SODIMM ECC) • 8 GB (8 × 1 @ DDR4-2666 1.2 V SODIMM) • 8 GB (8 × 1 @ DDR4-2666 1.2 V SODIMM ECC)
Primary storage	<p>M.2 solid-state drive:</p> <ul style="list-style-type: none"> • 512 GB, M.2 2280, Peripheral Component Interconnect Express (PCIe)-3×4, Non-Volatile Memory Express (NVMe), Secure Seal (SS) solid-state drive with three-layer cell (TLC) • 512 GB, M.2 2280, PCIe, NVMe, self-encrypted (SED) solid-state drive with TLC OPAL2 • 256 GB, M.2 2280, PCIe-3×4, NVMe, SS solid-state drive with TLC • 256 GB, M.2 2280, PCIe, NVMe, SED solid-state drive with TLC OPAL2

Table 1-1 Product components and their descriptions (continued)

Category	Description
	<p>Solid-state drive:</p> <ul style="list-style-type: none"> 2 TB, 2280, PCIe-3×4, NVMe, SS solid-state drive with TLC 1 TB, 2280, PCIe-3×4, NVMe, SS solid-state drive with TLC 512 GB, 2280, PCIe-3×4, NVMe, SED solid-state drive with TLC OPAL2 <p>Hard drives, SATA, 6.35 cm (2.5 in), 7.0 mm (0.28 in):</p> <ul style="list-style-type: none"> 2 TB, 5400 RPM 1 TB, 7200 RPM 500 GB, 7200 RPM 500 GB, 7200 RPM, Federal Information Processing Standard (FIPS), (SED), OPAL2
Audio and video	<p>Integrated FHD Camera: (on select models)</p> <p>Infrared (on select models)</p> <p>Dual-array, world-facing, digital microphone</p>
Wireless	<p>Wireless Local Area Network (WLAN)</p> <p>Intel Wi-Fi 6 AX201 ax 2×2 + Bluetooth® 5.0 MU-MIMO M.2 2230 non-vPro® MIPI + BRI WW with 2 antennas</p> <p>Intel Wi-Fi 6 AX201 ax 2×2 + Bluetooth 5.0 MU-MIMO M.2 2230 vProfessional 160 MHz MIPI + BRI WW with 2 antennas</p> <p>Intel XMM™ 7360 LTE-Advanced (Cat 9) Wireless Wide Area Network (WWAN)</p>
Near field communication (NFC)	NFC Mirage WNC XRAV-1
Keyboard/pointing devices	Dual-point keyboard with clickpad, backlit, spill-resistant, premium notebook keyboard
Power requirements	<p>Battery: 8 cell, 94 WHr long life, PL Fast Charge</p> <p>HP Smart AC adapters:</p> <p>200 watt AC adapter HP Smart (PFC, ultraslim barrel, 4.5 mm, straight-to-right angle)</p> <p>150 watt AC adapter HP Smart (PFC, slim barrel, 4.5 mm)</p> <p>120 watt AC Adapter HP Smart (PFC, slim barrel, 4.5 mm, right angle)</p> <p>Power cords:</p> <p>C13 premium, 1.0 m, with tag</p> <p>C5 premium, 1.0 m, with tag</p>
Security	Integrated fingerprint reader
Operating system	<p>Windows 10 Enterprise 64</p> <p>Windows 10 Enterprise 64 LTSC 1809 (RS5)</p> <p>Windows 10 Home 64</p> <p>Windows 10 Home 64 Advanced</p> <p>Windows 10 Home 64 Advanced Single Language</p>

Table 1-1 Product components and their descriptions (continued)

Category	Description
	Windows 10 Home 64 Chinese Market CPPP
	Windows 10 Home 64 High-End Chinese Market CPPP
	Windows 10 Home 64 Plus
	Windows 10 Home 64 Plus Single Language
	Windows 10 Home 64 Single Language
	Windows 10 Professional 64
	Windows 10 Professional 64 CBB 1903
	Windows 10 Professional 64 CBB 1909
	Windows 10 Professional 64 Chinese Market
	Windows 10 Professional 64 for Workstations Plus
	Windows 10 Professional 64 for Workstations Plus Chinese Market
	Windows 10 Professional 64 High End
	Windows 10 Professional 64 High End Chinese Market
	FreeDOS
	Red Hat® Enterprise Linux® 8 Workstation
Serviceability	End user replaceable parts:
	AC adapter
	Service cover
	Battery
	Solid-state drive
	Hard drive
	WLAN module
	WWAN module
	Memory module
	Keyboard

2 Components

Right

Use the illustration and table to identify the components on the right side of the computer.

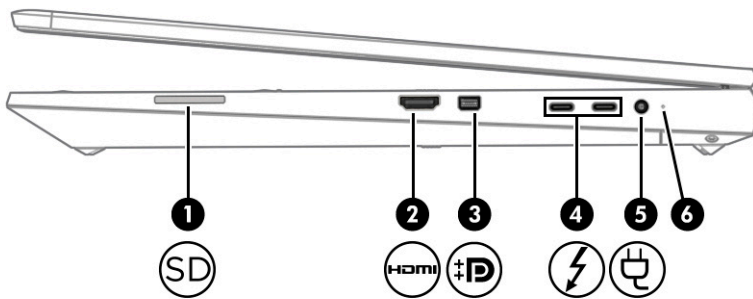

Table 2-1 Right-side components and their descriptions





Component	Description
(1)  Memory card reader	Reads optional memory cards that store, manage, share, or access information. To insert a card: <ol style="list-style-type: none">1. Hold the card label-side up, with the connectors facing the computer.2. Insert the card into the memory card reader, and then press in on the card until it is firmly seated. To remove a card: <ul style="list-style-type: none">▲ Press in on the card, and then remove it from the memory card reader.
(2)  HDMI port	Connects an optional video or audio device, such as a high-definition television, any compatible digital or audio component, or a high-speed High Definition Multimedia Interface (HDMI) device.
(3)  Dual-Mode DisplayPort™ connector	Connects an optional digital display device, such as a high-performance monitor or projector.

Table 2-1 Right-side components and their descriptions (continued)

Component	Description
(4) 	<p>USB Type-C® Thunderbolt™ ports with HP Sleep and Charge (2)</p> <p>Connect USB devices, provide high-speed data transfer, and charge small devices, even when the computer is off.</p> <p>– and –</p> <p>Connect display devices that have a USB Type-C connector, providing DisplayPort output.</p> <p>NOTE: Your computer might also support a Thunderbolt docking station.</p> <p>NOTE: Cables, adapters, or both (purchased separately) might be required.</p>
(5) 	<p>Power connector</p> <p>Connects an AC adapter.</p>
(6)	<p>Battery light</p> <p>When AC power is connected:</p> <ul style="list-style-type: none"> • White: The battery charge is greater than 90 %. • Amber: The battery charge is from 0 to 90 %. • Off: The battery is not charging. <p>When AC power is disconnected (battery not charging):</p> <ul style="list-style-type: none"> • Blinking amber: The battery has reached a low battery level. When the battery has reached a critical battery level, the battery light begins blinking rapidly. • Off: The battery is not charging.

Left

Use the illustration and table to identify the components on the left side of the computer.

 **NOTE:** Your computer might look slightly different from the following illustration.

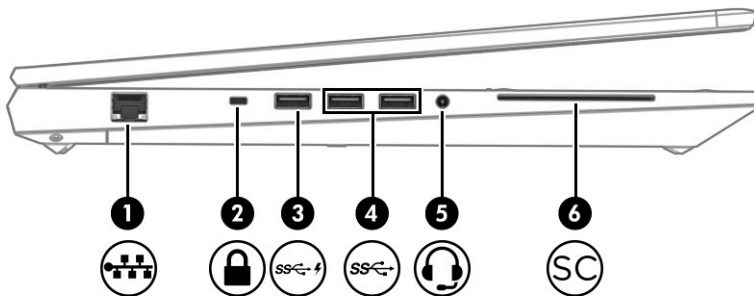







Table 2-2 Left-side components and their descriptions

Component	Description
(1)  RJ-45 (network) jack/status lights	<p>Connects a network cable.</p> <ul style="list-style-type: none"> • Green: The network is connected. • Amber: Activity is occurring on the network.
(2)  Security cable slot	<p>Attaches an optional security cable to the computer.</p> <p>NOTE: The security cable is designed to act as a deterrent, but it might not prevent the computer from being mishandled or stolen.</p>
(3)  USB SuperSpeed port with HP Sleep and Charge	<p>Connects a USB device, provides high-speed data transfer, and charges small devices, even when the computer is off.</p>
(4)  USB SuperSpeed ports	<p>Connect USB devices, provide high-speed data transfer, and (for select products) charge small devices when the computer is on or in Sleep mode.</p> <p>NOTE: Depending on your computer model, your computer might have one or two USB SuperSpeed ports.</p>
(5)  Audio-out (headphone)/Audio-in (microphone) combo jack	<p>Connects optional powered stereo speakers, headphones, earbuds, a headset, or a television audio cable. Also connects an optional headset microphone. This jack does not support optional standalone microphones.</p> <p>WARNING! To reduce the risk of personal injury, adjust the volume before putting on headphones, earbuds, or a headset. For additional safety information, see the <i>Regulatory, Safety, and Environmental Notices</i>.</p> <p>To access this guide:</p> <ul style="list-style-type: none"> ▲ Type HP Documentation in the taskbar search box, and then select HP Documentation. <p>NOTE: When a device is connected to the jack, the computer speakers are disabled.</p>
(6)  Smart card reader	<p>Supports optional smart cards.</p>

Display

Use the illustration and table to identify the display components.

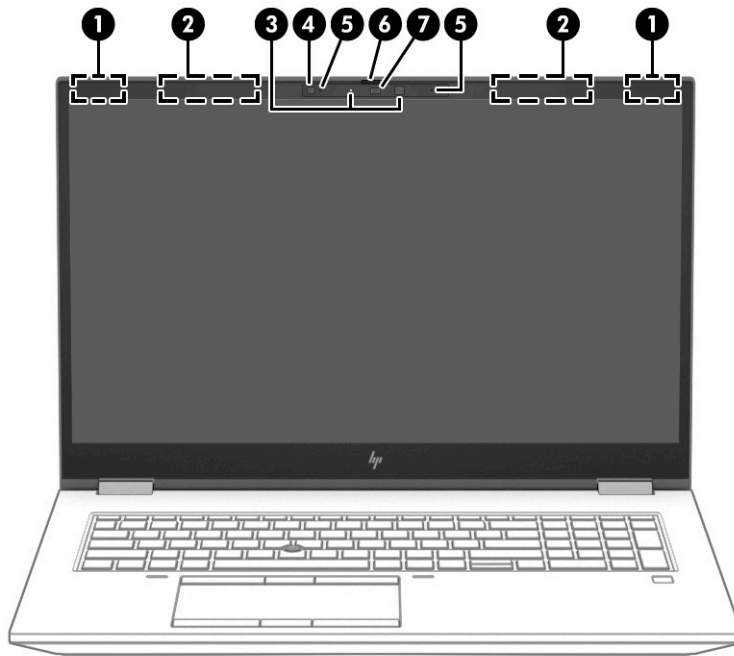

Table 2-3 Display components and their descriptions

Component	Description
(1) WWAN antennas (select products only)*[cad edit-keyboard deck antenna going away]	Send and receive wireless signals to communicate with wireless wide area networks (WWANs).
(2) WLAN antennas (select products only)*	Send and receive wireless signals to communicate with wireless local area networks (WLANs).
(3) Camera light(s) (select products only)	On: One or more cameras are in use.
(4) Ambient light sensor	Adjusts the brightness of the display, depending on the ambient light.
(5) Internal microphones (select products only)	Record sound.
(6) Camera privacy cover (select products only)	By default, the camera lens is uncovered, but you can slide the camera privacy cover to block the camera's view. To use the camera, slide the camera privacy cover in the opposite direction to reveal the lens. NOTE: If you have both front-facing and rear-facing cameras, when one camera lens is revealed and ready to use, the other is concealed.
(7) Camera(s) (select products only)	Allow(s) you to video chat, record video, and record still images. Some cameras also allow a facial recognition logon to Windows, instead of a password logon. NOTE: Camera functions vary depending on the camera hardware and software installed on your product.

*The antennas are not visible from the outside of the computer. For optimal transmission, keep the areas immediately around the antennas free from obstructions.

For wireless regulatory notices, see the section of the *Regulatory, Safety, and Environmental Notices* that applies to your country or region.

To access this guide:

- ▲ Type **HP Documentation** in the taskbar search box, and then select **HP Documentation**.

Keyboard area

Touchpad

Touchpad settings

Adjusting touchpad settings

Follow these steps to adjust the touchpad settings and gestures.

Use these steps to adjust touchpad settings and gestures.

1. Type touchpad settings in the taskbar search box, and then press **enter**.
2. Choose a setting.

Turning on the touchpad

Follow these steps to turn on the touchpad.

Follow these steps to turn on the touchpad.

1. Type touchpad settings in the taskbar search box, click the **Touchpad** button.
2. Using an external mouse, click the **Touchpad** button.

If you are not using an external mouse, press the **Tab** key repeatedly until the pointer rests on the **touchpad** button. Then press the **spacebar** to select the button.

Touchpad components

Use the illustration and table to identify the touchpad components.

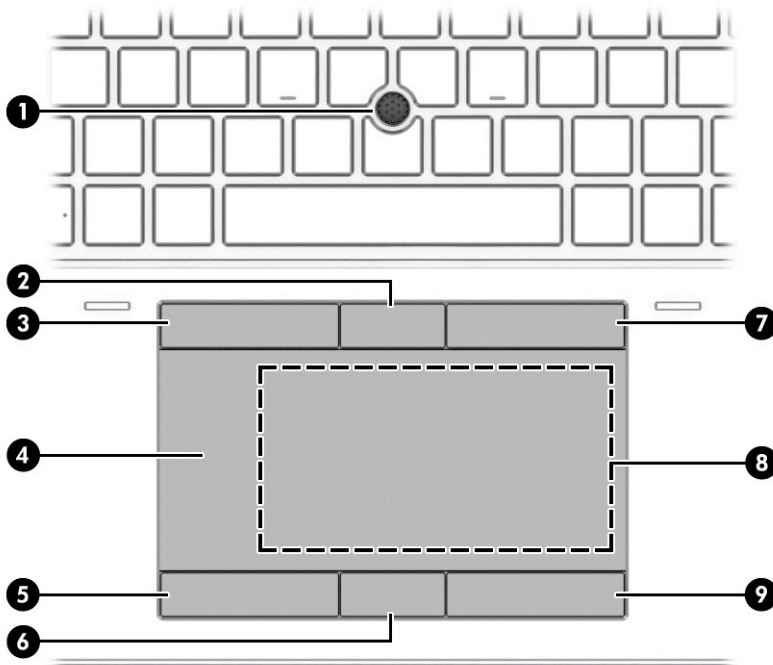

Table 2-4 Touchpad components and their descriptions

Component	Description
(1) Pointing stick	Moves the pointer on the screen.
(2) Center pointing stick button	Functions like the center button on an external mouse.
(3) Left pointing stick button	Functions like the left button on an external mouse.

Table 2-4 Touchpad components and their descriptions (continued)

Component	Description
(4) Touchpad zone	Reads your finger gestures to move the pointer or activate items on the screen.
(5) Left touchpad button	Functions like the left button on an external mouse.
(6) Center touchpad button	Functions like the center button on an external mouse.
(7) Right pointing stick button	Functions like the right button on an external mouse.
(8) Near Field Communications (NFC) tapping area and antenna (select products only)*	Allows you to wirelessly share information when you tap it with an NFC-enabled device.
(9) Right touchpad button	Functions like the right button on an external mouse.

*The antennas are not visible from the outside of the computer. For optimal transmission, keep the areas immediately around the antennas free from obstructions.

For wireless regulatory notices, see the section of the *Regulatory, Safety, and Environmental Notices* that applies to your country or region.

To access this guide:

- ▲ Type `HP Documentation` in the taskbar search box, and then select **HP Documentation**.

Bottom

Use the illustration and table to identify the bottom components.

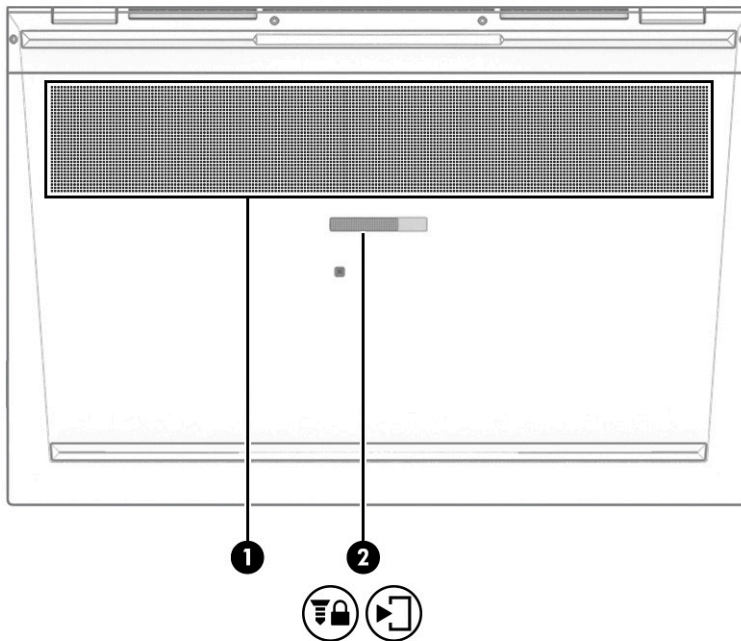



Table 2-5 Bottom components and their descriptions

Component	Description
(1) Vent	Enables airflow to cool internal components. NOTE: The computer fan starts up automatically to cool internal components and prevent overheating. It is normal for the internal fan to cycle on and off during routine operation.
(2)  Service door release latch and security screw	Releases the service door after you remove the security screw.

Top cover

Use the illustration and table to identify the top cover components.

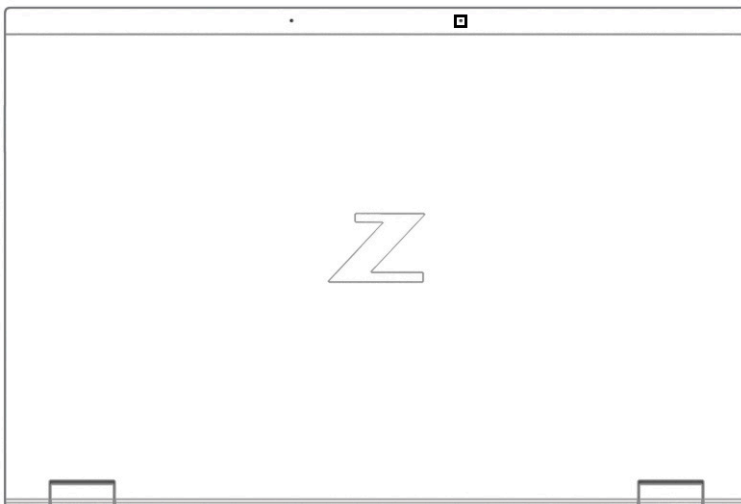

Table 2-6 Top cover component and its description

Component	Description
Internal microphone (select products only)	Records sound.

Rear

Use the illustration and table to identify the rear components.



Table 2-7 Rear component and its description

Component	Description
Vents	Enable airflow to cool internal components. NOTE: The computer fan starts up automatically to cool internal components and prevent overheating. It is normal for the internal fan to cycle on and off during routine operation.

Labels

Use the illustration and table to identify the label location and components.

The labels affixed to the computer provide information you might need when you troubleshoot system problems or travel internationally with the computer. Labels might be in paper form or imprinted on the product.

 **IMPORTANT:** Check the following locations for the labels described in this section: the bottom of the computer, inside the battery bay, under the service door, on the back of the display, or on the bottom of a tablet kickstand.

- Service label—Provides important information to identify your computer. When contacting support, you might be asked for the serial number, the product number, or the model number. Locate this information before you contact support.

Your service label will resemble one of the following examples. Refer to the illustration that most closely matches the service label on your computer.

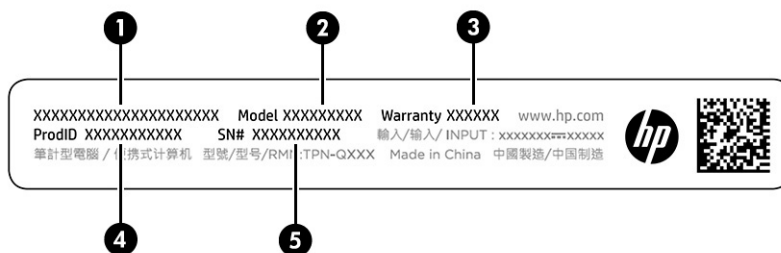

Table 2-8 Service label components and their descriptions

Component	Description
(1)	HP product name
(2)	Model name
(3)	Warranty period
(4)	Product ID
(5)	Serial number

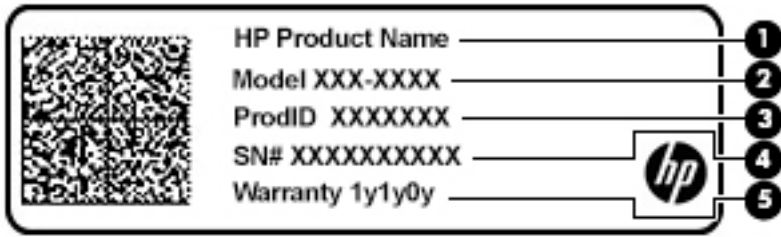

Table 2-9 Service label components and their descriptions

Component
(1) HP product name
(2) Model number
(3) Product ID
(4) Serial number
(5) Warranty period

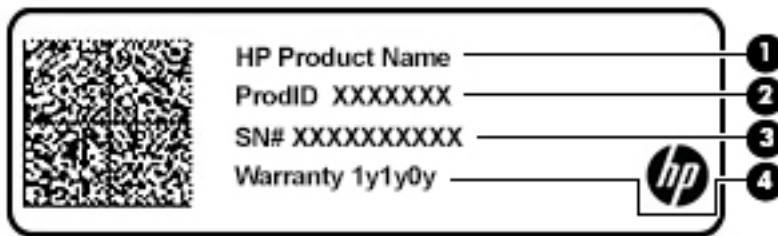

Table 2-10 Service label components and their descriptions

Component
(1) HP product name
(2) Product ID
(3) Serial number
(4) Warranty period

HP TamperLock

Use this section to understand HP TamperLock.

This computer features a security application called HP TamperLock, which alerts customers if the service cover has been removed. The application is preset to **disabled**. The customer must enable this application in the BIOS, where it is called **Smart Cover**.

If the customer enables HP TamperLock and sends in the computer for repair, the repair center will not be able to repair it. The Call Center will receive the following message:

This product is equipped with **Smart Cover** (Tamper Detection password feature.) **Ensure that the customer has disabled the Tamper Detection password in the BIOS before sending it in for repair.** If this is not done, it will delay

the repair and potentially result in a billable event. If the computer does not boot or the customer is not able to check in and disable the feature, continue with normal procedures to replace the system board.

Inserting a SIM card in the service bay

To insert a SIM card, follow these steps.

1. Turn off the computer by using the Shut down command.
2. Close the display.
3. Disconnect all external devices connected to the computer.
4. Unplug the power cord from the AC outlet.
5. Turn the computer upside down on a flat surface, with the service door toward you.
6. Remove the service door, and then remove the battery.

For steps on removing the service door and battery, see [Service cover on page 40](#) and [Battery on page 41](#).

- Slide the SIM tray cover to the right (1), open the cover (2), and then insert the SIM card into the SIM tray (3).

 **NOTE:** The SIM card in your computer might look slightly different from the illustration in this section.

 **NOTE:** To properly insert the SIM card, match the angled edge of the card with the triangle  on the tray.

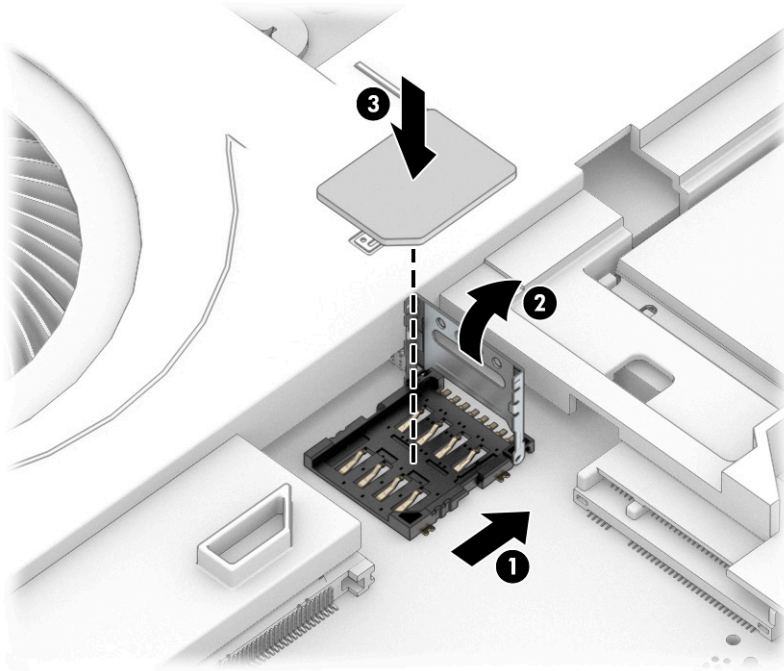

- Close the SIM tray cover (1) and slide it to the left (2).

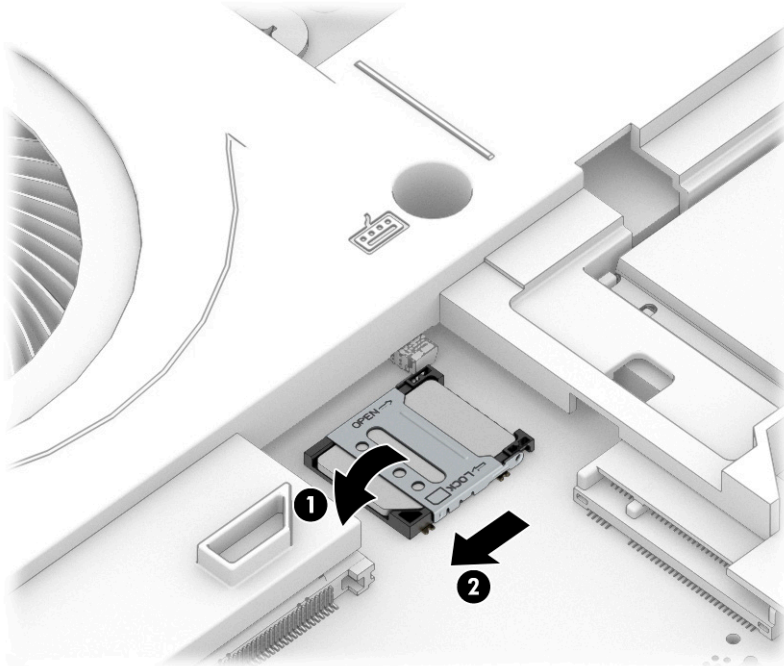

To remove the SIM card, reverse these procedures.

3 Illustrated parts catalog

Use this table to determine the spare parts that are available for the computer.

Computer major components

To identify the computer major components, use this illustration and table.

 **NOTE:** HP continually improves and changes product parts. For complete and current information about supported parts for your computer, go to <http://partsurfer.hp.com>, select your country or region, and then follow the on-screen instructions.

 **NOTE:** Details about your computer, including model, serial number, product key, and length of warranty, are on the service tag at the bottom of your computer.

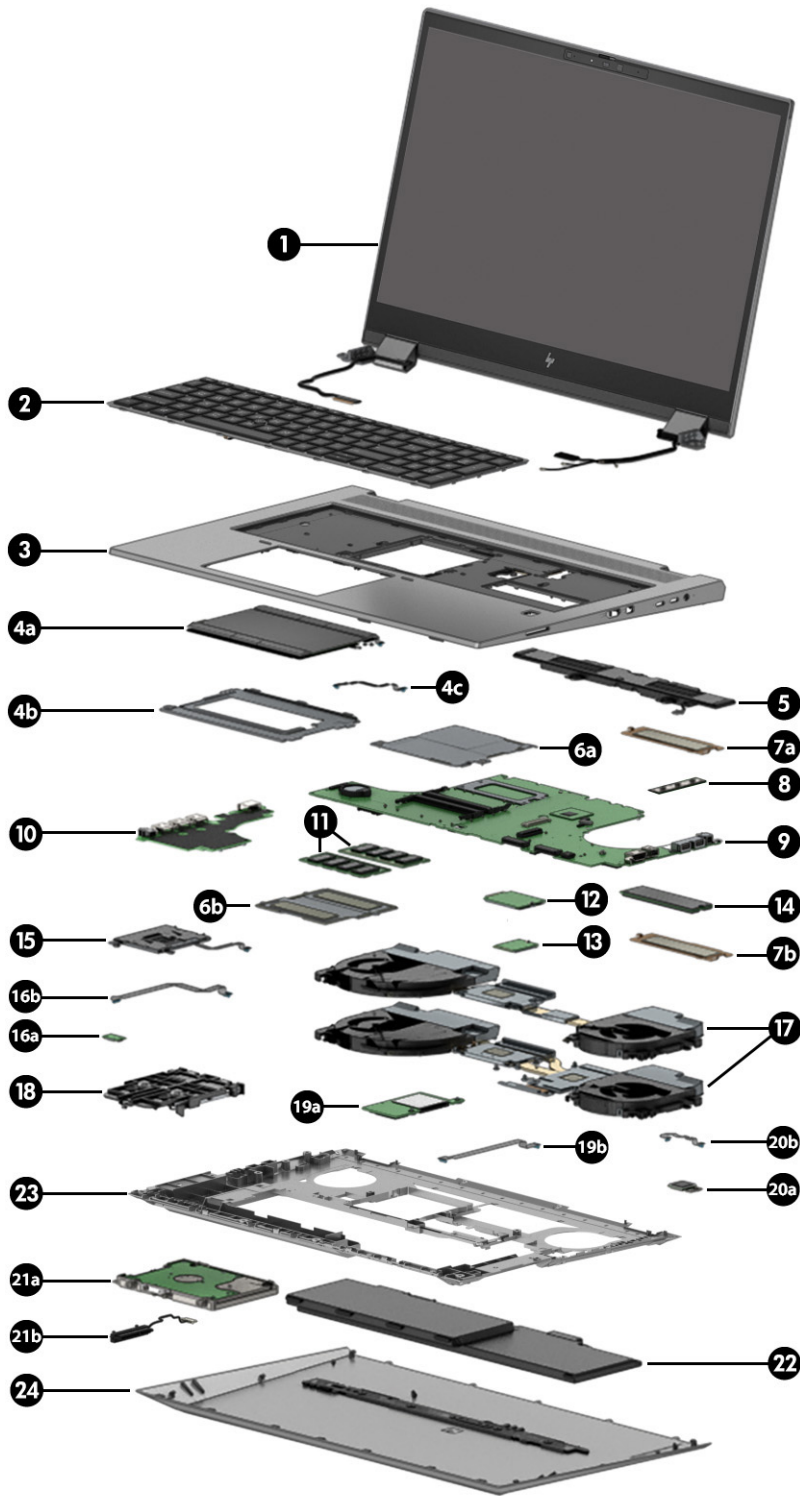

Table 3-1 Computer major component descriptions and part numbers

Item	Component	Spare part number
(1)	43.9 cm (17.3 in) display assembly:	

Table 3-1 Computer major component descriptions and part numbers (continued)

Item	Component	Spare part number
	UHD (3840×1980), Dream Vision, 550 touchscreen display assembly with webcam and infrared sensor; typical brightness: 400 nits	M20125-001
	UHD (3840×1980), Dream Vision, 550 touchscreen display assembly with webcam; typical brightness: 400 nits	M20124-001
	UHD (3840×1980), Dream Vision, 550 touchscreen display assembly; typical brightness: 400 nits	M20122-001
	UHD (3840×1980), antiglare, 550 touchscreen display assembly with HD webcam and infrared sensor; typical brightness: 400 nits	M23512-001
	UHD (3840×1980), antiglare, 550 touchscreen display assembly with HD webcam; typical brightness: 400 nits	M23511-001
	UHD (3840×1980), antiglare, 550 touchscreen display assembly; typical brightness: 400 nits	M23510-001
	FHD (1980×1080), antiglare, touchscreen display assembly with HD webcam and infrared sensor; typical brightness: 300 nits	M23508-001
	FHD (1980×1080), antiglare, touchscreen display assembly with HD webcam and ambient light sensor; typical brightness: 300 nits	M23509-001
	FHD (1980×1080), antiglare, touchscreen display assembly; typical brightness: 300 nits	M23507-001
(2)	Keyboard with backlight, clickpad, and pointing stick (includes backlight cable, clickpad cable, keyboard cable, and pointing stick cable):	
	For use in Belgium	M20128-A41
	For use in Brazil	M20128-201
	For use in Bulgaria	M20128-261
	For use in Canada	M20128-DB1
	For use in the Czech Republic and Slovakia	M20128-FL1
	For use in Denmark	M20128-081
	For use in France	M20128-051
	For use in Germany	M20128-041
	For use in Greece	M20128-151
	For use in Hungary	M20128-211
	For use in Iceland	M20128-DD1
	For use in India	M20128-D61
	For use in Israel	M20128-BB1
	For use in Italy	M20128-061
	For use in Japan	M20128-291
	For use in Latin America	M20128-161
	For use in the Netherlands	M20128-B31
	For use in Northwest Africa	M20128-FP1
	For use in Norway	M20128-091
	For use in Portugal	M20128-131

Table 3-1 Computer major component descriptions and part numbers (continued)

Item	Component	Spare part number
	For use in Romania	M20128-271
	For use in Russia	M20128-251
	For use in Saudi Arabia	M20128-171
	For use in Slovenia	M20128-BA1
	For use in South Korea	M20128-AD1
	For use in Spain	M20128-071
	For use in Sweden and Finland	M20128-B71
	For use in Switzerland	M20128-BG1
	For use in Taiwan	M20128-AB1
	For use in Thailand	M20128-281
	For use in Turkey	M20128-141
	For use in Turkey-F	M20128-541
	For use in Ukraine	M20128-BD1
	For use in the United Kingdom	M20128-031
	For use in the United States	M20128-001
(3)	Top cover	M20107-001
(4a)	Touchpad: NOTE: The touchpad spare part kit does not include the touchpad bracket or touchpad cable. The touchpad bracket is not available as a spare part. The touchpad cable is available in the Cable Kit, spare part number M20105-001.	
	For use only on computer models equipped with NFC capability (includes NFC antenna)	M38137-001
	For use only on computer models not equipped with NFC capability	M36390-001
(4b)	Touchpad bracket: The touchpad bracket is not available as a spare part.	
(4c)	Touchpad cable: The touchpad cable is available in the Cable Kit, spare part number M20105-001.	
(5)	Speakers (includes three rubber isolators)	M17067-001
	Memory module compartment cover (includes thermal material): Included in the Bracket Kit, spare part number M20094-001.	
(6a)	Memory module compartment cover under keyboard	
(6b)	Memory module compartment cover under service cover	
	Solid-state drive cover (includes thermal material): Included in the Solid-state Drive Hardware Kit, spare part number M20090-001.	
(7a)	Solid-state drive cover under keyboard	
(7b)	Solid-state drive cover under service cover	
(8)	Beam connector (includes plastic installation tool and replacement thermal material)	M25737-001
(9)	System board (includes integrated processor): NOTE: All system board spare part kits include the processor, the RTC battery, and replacement thermal material.	

Table 3-1 Computer major component descriptions and part numbers (continued)

Item	Component	Spare part number
	Equipped with an Intel Xeon W-10885M processor and the Windows 10 operating system for use on computer models with WWAN capability	M20105-601
	Equipped with an Intel Xeon W-10885M processor and a non-Windows operating system for use on computer models with WWAN capability	M20105-001
	Equipped with an Intel Xeon W-10885M processor and the Windows 10 operating system for use on computer models without WWAN capability	M20104-601
	Equipped with an Intel Xeon W-10885M processor and a non-Windows operating system for use on computer models without WWAN capability	M20104-001
	Equipped with an Intel Core i9-10885H processor and the Windows 10 operating system for use on computer models with WWAN capability	M31404-601
	Equipped with an Intel Core i9-10885H processor and a non-Windows operating system for use on computer models with WWAN capability	M31404-001
	Equipped with an Intel Core i9-10885H processor and the Windows 10 operating system for use on computer models without WWAN capability	M20103-601
	Equipped with an Intel Core i9-10885H processor and a non-Windows operating system for use on computer models without WWAN capability	M20103-001
	Equipped with an Intel Core i7-10850H processor and the Windows 10 operating system for use on computer models with WWAN capability	M31403-601
	Equipped with an Intel Core i7-10850H processor and a non-Windows operating system for use on computer models with WWAN capability	M31403-001
	Equipped with an Intel Core i7-10850H processor and the Windows 10 operating system for use on computer models without WWAN capability	M20102-601
	Equipped with an Intel Core i7-10850H processor and a non-Windows operating system for use on computer models without WWAN capability	M20102-001
	Equipped with an Intel Core i7-10750H processor and the Windows 10 operating system for use on computer models with WWAN capability	M31402-601
	Equipped with an Intel Core i7-10750H processor and a non-Windows operating system for use on computer models with WWAN capability	M31402-001
	Equipped with an Intel Core i7-10750H processor and the Windows 10 operating system for use on computer models without WWAN capability	M20101-601
	Equipped with an Intel Core i7-10750H processor and a non-Windows operating system for use on computer models without WWAN capability	M20101-001
	Equipped with an Intel Core i5-10400H processor and the Windows 10 operating system for use on computer models with WWAN capability	M31401-601
	Equipped with an Intel Core i5-10400H processor and a non-Windows operating system for use on computer models with WWAN capability	M31401-001
	Equipped with an Intel Core i5-10400H processor and the Windows 10 operating system for use on computer models without WWAN capability	M20100-601
	Equipped with an Intel Core i5-10400H processor and a non-Windows operating system for use on computer models without WWAN capability	M20100-001
	Equipped with an Intel Core i5-10300H processor and the Windows 10 operating system for use on computer models with WWAN capability	M31400-601

Table 3-1 Computer major component descriptions and part numbers (continued)

Item	Component	Spare part number
	Equipped with an Intel Core i5-10300H processor and a non-Windows operating system for use on computer models with WWAN capability	M31400-001
	Equipped with an Intel Core i5-10300H processor and the Windows 10 operating system for use on computer models without WWAN capability	M20099-601
	Equipped with an Intel Core i5-10300H processor and a non-Windows operating system for use on computer models without WWAN capability	M20099-001
	Graphics card (not illustrated):	
	AMD RX 5500M graphics card with 4 GB integrated memory	M17050-001
	AMD W 5500M graphics card with 4 GB integrated memory	M17049-001
	AMD Thermal Pad Kit (not illustrated, includes replacement thermal material)	M29533-001
	NVIDIA RTX 3000 graphics card with 6 GB integrated memory	M17051-001
	NVIDIA RTX 4000 graphics card with 8 GB integrated memory	M17052-001
	NVIDIA RTX 5000 graphics card with 16 GB integrated memory	M17053-001
	NVIDIA T1000 graphics card with 4 GB integrated memory	M17054-001
	NVIDIA T2000 graphics card with 2 GB integrated memory	M17055-001
	NVIDIA Thermal Pad Kit (not illustrated, includes replacement thermal material)	M29535-001
(10)	I/O board: (includes audio jack, 3 USB ports, and RJ45 jack)	
	For use only on vPro computer models	M20126-001
	For use only on non-vPro computer models	M20127-001
(11)	Memory module:	
	32 GB (2666 MHz, 1.2 V, DDR4)	L50384-001
	16 GB (2666 MHz, 1.2 V, DDR4, ECC)	L24981-001
	16 GB (2666 MHz, 1.2 V, DDR4)	937438-950
	8 GB (3200 MHz, 1.2 V, DDR4)	L46598-001
	8 GB (2666 MHz, 1.2 V, DDR4, ECC)	L24983-001
	Memory Module/Solid-State Drive Thermal Pad Kit	M29534-001
(12)	Intel XMM 7360 LTE-Advanced (Cat 9) WWAN module	L70670-001
(13)	WLAN module:	
	Intel Wi-Fi 6 AX201 ax 2×2 + Bluetooth 5.0 MU-MIMO M.2 2230 non-vPro MIPI+BRI WW with 2 antennas	L57250-001
	Intel Wi-Fi 6 AX201 ax 2×2 + Bluetooth 5.0 MU-MIMO M.2 2230 vPro 160MHz MIPI + BRI WW with 2 antennas	L57248-001
(14)	Solid-state drive:	
	1 TB, M.2 2280, PCIe, NVMe-3×4, SS with TLC	L85348-001
	512 GB, M.2 2280, PCIe-3×4, SS with TLC	L85360-001
	512 GB, M.2 2280, PCIe, NVMe, SED with TLC	L85368-001

Table 3-1 Computer major component descriptions and part numbers (continued)

Item	Component	Spare part number
	256 GB, M.2 2280, PCIe-3×4, SS with TLC	L85350-001
	256 GB, M.2 2280, PCIe, NVMe, SED with TLC	M07245-001
	Solid-State Drive/Memory Module Thermal Pad Kit	M29534-001
	Solid-State Drive Hardware Kit (not illustrated, includes copper plate and support plate)	M20090-001
(15)	Card reader board (includes cable)	M20106-001
(16a)	NFC module	M17065-001
	NOTE: The NFC module spare part kit does not include the NFC module cable. The NFC module cable is available in the Cable Kit, spare part number M20105-001.	
(16b)	NFC module cable: The NFC module cable is available in the Cable Kit, spare part number M20105-001.	
(17)	Fan/heat sink assembly (includes replacement thermal material):	
	For use on computer models equipped with AMD graphics subsystems	M20098-001
	For use on computer models equipped with vapor chamber graphics subsystems	M20097-001
	For use on computer models equipped with discrete graphics subsystems	M20096-001
	For use on computer models equipped with UMA graphics subsystems	M20095-001
(18)	Solid-state drive carriage	M20090-001
(19a)	SD card board	M17093-001
	NOTE: The SD card board spare part kit does not include the SD card board cable. The SD card board cable is available in the Cable Kit, spare part number M20105-001.	
(19b)	SD card board cable: The SD card board cable is available in the Cable Kit, spare part number M20105-001.	
(20a)	Fingerprint reader module	M17064-001
	NOTE: The fingerprint reader module spare part kit does not include the fingerprint reader module cable. The fingerprint reader module cable is available in the Cable Kit, spare part number M20105-001.	
(20b)	Fingerprint reader module cable: The fingerprint reader module cable is available in the Cable Kit, spare part number M20105-001.	
(21a)	Hard drive	
	NOTE: The hard drive spare part kit does not include the hard drive bracket or hard drive cable. The hard drive bracket is included in the Hard Drive Hardware Kit, spare part number M20091-001. The hard drive cable is included in the Cable Kit, spare part number M20105-001.	
	2 TB, SATA, 5400 RPM, 7.0 mm	912487-850
	1 TB, SATA, 7200 RPM, 9.5 mm	766644-001
	500 GB, SATA, 7200 RPM, 9.5 mm	703267-001
	500 GB, SATA, 7200 RPM, 9.5 mm, FIPS	820572-001
(21b)	Hard drive cable: The hard drive cable is available in the Cable Kit, spare part number M20105-001.	
	Hard drive bracket (not illustrated, the hard drive bracket is included in the Hard Drive Hardware Kit, spare part number M20091-001)	
(22)	Battery (8 cell, 94 Whr)	L86212-001

Table 3-1 Computer major component descriptions and part numbers (continued)

Item	Component	Spare part number
(23)	Bottom case	M20092-001
(24)	Service cover	M23347-001

Mass storage devices

To identify the mass storage devices, use this illustration and table.

Table 3-2 Mass storage device descriptions and part numbers

Item	Component	Spare part number
	Hard drive:	
	NOTE: The hard drive spare part kit does not include the hard drive bracket or hard drive cable. The hard drive bracket is included in the Hard Drive Hardware Kit, spare part number M20091-001. The hard drive cable is included in the Cable Kit, spare part number M20105-001.	
	2 TB, SATA, 5400 RPM, 7.0 mm	912487-850
	1 TB, SATA, 7200 RPM, 9.5 mm	766644-001
	512 GB, SATA, 7200 RPM, 9.5 mm	703267-001
	512 GB, SATA, 7200 RPM, 9.5 mm, FIPS	820572-001
	Solid-state drive:	
	1 TB, M.2 2280, PCIe, NVMe-3×4, SS with TLC	L85348-001
	512 GB, M.2 2280, PCIe-3×4, SS with TLC	L85360-001
	512 GB, M.2 2280, PCIe, NVMe, SED with TLC	L85368-001
	256 GB, M.2 2280, PCIe-3×4, SS with TLC	L85350-001
	256 GB, M.2 2280, PCIe, NVMe, SED with TLC	M07245-001

Cables

To identify the cables, use this illustration and table.

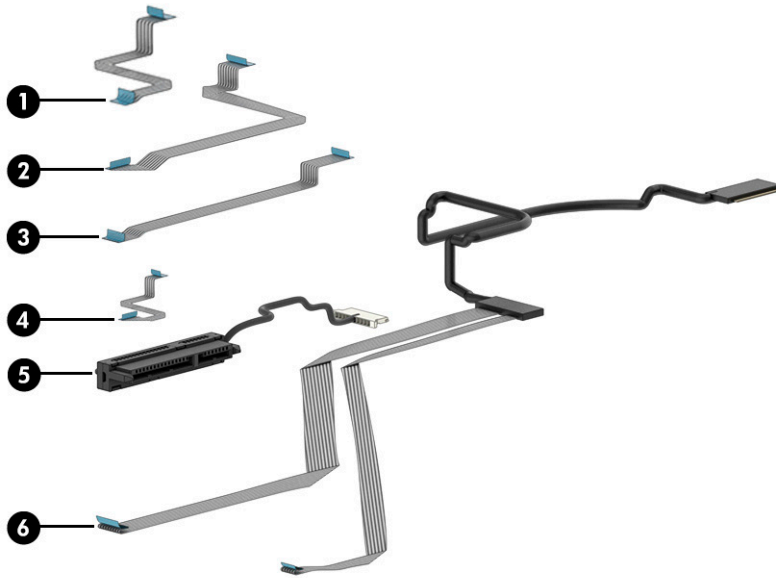

Table 3-3 Cable descriptions and part numbers

Item	Component	Spare part number
The following cables are available in the Cable Kit, spare part number M20105-001.		
(1)	Touchpad cable	
(2)	NFC module cable	
(3)	SD card board cable	
(4)	Fingerprint reader module cable	
(5)	Hard drive cable	
(6)	Webcam/microphone module cable	

Miscellaneous parts

To identify the miscellaneous parts, use this table.

Table 3-4 Miscellaneous part descriptions and part numbers

Component	Spare part number
AC adapters:	
200 W AC adapter (PFC, RC, ultraslim barrel, 3 pin, 4.5 mm)	L74881-001
150 W HP Smart adapter (PFC, slim barrel, 4.5 mm)	L32661-001
120 W HP Smart adapter (PFC, RC, slim barrel, 4.5 mm)	L41856-001
Bracket Kit (includes fingerprint bracket, memory module cover, solid-state drive cover, and switch spring)	M20094-001
Mylar Kit (includes fingerprint reader Mylar shield, memory module Mylar shield, WLAN module Mylar shield, and WWAN module Mylar shield)	M23344-001

Table 3-4 Miscellaneous part descriptions and part numbers (continued)

Component	Spare part number
Plastics Kit (includes display hinge covers, fingerprint blank bezel, SD card slot bezel, and webcam blank bezel)	M20093-001
Power cord (C13, 1.0 m, premium with tag):	
For use in Australia	100661-021
For use in Denmark	130627-014
For use in Europe	100614-016
For use in India	403440-008
For use in Israel	398062-011
For use in Japan	653326-005
For use in North America	121565-023
For use in the People's Republic of China	286496-024
For use in South Africa	187487-012
For use in South Korea	231216-015
For use in Switzerland	150304-015
For use in Taiwan	393312-008
For use in Thailand	285052-013
For use in the United Kingdom	100613-021
Power cord (C5, 1.0 m, premium with tag):	
For use in Argentina	920689-003
For use in Australia	L30769-001
For use in Brazil	L30770-001
For use in Australia	L30771-001
For use in Europe	L30772-001
For use in India	920689-016
For use in Israel	L30773-001
For use in Italy	L30774-001
For use in Japan	L30775-001
For use in North America	920689-001
For use in the People's Republic of China	920689-014
For use in South Africa	L30777-001
For use in South Korea	L30776-001
For use in Switzerland	L30778-001
For use in Taiwan	L30780-001
For use in Thailand	L30779-001

Table 3-4 Miscellaneous part descriptions and part numbers (continued)

Component	Spare part number
For use in the United Kingdom	L30781-001
Rubber Kit (includes display hinge rubber caps, microphone rubber cover, and WWAN module rubber cover)	M20114-001
Screw Kit	M20118-001

4 Removal and replacement procedures preliminary requirements

Use this information to properly prepare to disassemble and reassemble the computer.

Tools required

You need the following tools to complete the removal and replacement procedures:

- Tweezers
- Nonconductive, nonmarking pry tool
- Magnetic Phillips P1 screwdriver
- Torx T8 screwdriver

Service considerations

The following sections include some of the considerations that you must keep in mind during disassembly and assembly procedures.

 **NOTE:** As you remove each subassembly from the computer, place the subassembly (and all accompanying screws) away from the work area to prevent damage.

Plastic parts

Using excessive force during disassembly and reassembly can damage plastic parts.

Cables and connectors

Handle cables with extreme care to avoid damage.

 **IMPORTANT:** When servicing the computer, be sure that cables are placed in their proper locations during the reassembly process. Improper cable placement can damage the computer.

Apply only the tension required to unseat or seat the cables during removal and insertion. Handle cables by the connector whenever possible. In all cases, avoid bending, twisting, or tearing cables. Be sure that cables are routed so that they cannot be caught or snagged as you remove or replace parts. Handle flex cables with extreme care; these cables tear easily.

Drive handling

Note the following guidelines when handling drives.

 **IMPORTANT:** Drives are fragile components. Handle them with care. To prevent damage to the computer, damage to a drive, or loss of information, observe these precautions:

Before removing or inserting a hard drive, shut down the computer. If you are unsure whether the computer is off or in Hibernation, turn the computer on, and then shut it down through the operating system.

Before handling a drive, be sure that you are discharged of static electricity. While handling a drive, avoid touching the connector.

Before removing an optical drive, be sure that a disc is not in the drive, and be sure that the optical drive tray is closed.

Handle drives on surfaces covered with at least 2.54 cm (1 inch) of shock-proof foam.

Avoid dropping drives from any height onto any surface.

After removing a hard drive or an optical drive, place it in a static-proof bag.

Avoid exposing an internal hard drive to products that have magnetic fields, such as monitors or speakers.

Avoid exposing a drive to temperature extremes or liquids.

If a drive must be mailed, place the drive in a bubble pack mailer or other suitable form of protective packaging, and label the package “FRAGILE.”

Workstation guidelines

Follow these grounding workstation guidelines:

- Cover the workstation with approved static-shielding material.
- Use a wrist strap connected to a properly grounded work surface and use properly grounded tools and equipment.
- Use conductive field service tools, such as cutters, screw drivers, and vacuums.
- When fixtures must directly contact dissipative surfaces, use fixtures made only of static-safe materials.
- Keep the work area free of nonconductive materials, such as ordinary plastic assembly aids and polystyrene foam.
- Handle ESD-sensitive components, parts, and assemblies by the case or PCM laminate. Handle these items only at static-free workstations.
- Avoid contact with pins, leads, or circuitry.
- Turn off power and input signals before inserting or removing connectors or test equipment.

Electrostatic discharge information

A sudden discharge of static electricity from your finger or other conductor can destroy static-sensitive devices or microcircuitry. Often the spark is neither felt nor heard, but damage occurs. An electronic device exposed to electrostatic discharge (ESD) might not appear to be affected at all and can work perfectly throughout a normal cycle. The device might function normally for a while, but it has been degraded in the internal layers, reducing its life expectancy.

Networks built into many integrated circuits provide some protection, but in many cases, the discharge contains enough power to alter device parameters or melt silicon junctions.

 **IMPORTANT:** To prevent damage to the device when you remove or install internal components, observe these precautions:

Keep components in their electrostatic-safe containers until you are ready to install them.

Before touching an electronic component, discharge static electricity by using the guidelines described [Personal grounding methods and equipment on page 35](#).

Avoid touching pins, leads, and circuitry. Handle electronic components as little as possible.

If you remove a component, place it in an electrostatic-safe container.

Generating static electricity

Follow these static electricity guidelines.

- Different activities generate different amounts of static electricity.
- Static electricity increases as humidity decreases.

Table 4-1 Static electricity occurrence based on activity and humidity

Event	Relative humidity		
	55%	40%	10%
Walking across carpet	7,500 V	15,000 V	35,000 V
Walking across vinyl floor	3,000 V	5,000 V	12,000 V
Motions of bench worker	400 V	800 V	6,000 V
Removing DIPs (dual in-line packages) from plastic tube	400 V	700 V	2,000 V
Removing DIPs from vinyl tray	2,000 V	4,000 V	11,500 V
Removing DIPs from polystyrene foam	3,500 V	5,000 V	14,500 V
Removing bubble pack from PCB (printed circuit board)	7,000 V	20,000 V	26,500 V
Packing PCBs in foam-lined box	5,000 V	11,000 V	21,000 V

Multiple electric components can be packaged together in plastic tubes, trays, or polystyrene foam.

 **NOTE:** As little as 700 V can degrade a product.

Preventing electrostatic damage to equipment

Many electronic components are sensitive to ESD. Circuitry design and structure determine the degree of sensitivity. The following packaging and grounding precautions are necessary to prevent static electricity damage to electronic components.

- To avoid hand contact, transport products in static-safe containers such as tubes, bags, or boxes.
- Protect all electrostatic parts and assemblies with conductive or approved containers or packaging.
- Keep electrostatic-sensitive parts in their containers until they arrive at static-free stations.
- Place items on a grounded surface before removing them from their container.
- Always be properly grounded when touching a sensitive component or assembly.
- Avoid contact with pins, leads, or circuitry.
- Place reusable electrostatic-sensitive parts from assemblies in protective packaging or conductive foam.

Personal grounding methods and equipment

Using certain equipment can prevent static electricity damage to electronic components.

- **Wrist straps** are flexible straps with a maximum of $1\text{ M}\Omega \pm 10\%$ resistance in the ground cords. To provide proper ground, a strap must be worn snug against bare skin. The ground cord must be connected and fit snugly into the banana plug connector on the grounding mat or workstation.
- **Heel straps/Toe straps/Boot straps** can be used at standing workstations and are compatible with most types of shoes or boots. On conductive floors or dissipative floor mats, use them on both feet with a maximum of $1\text{ M}\Omega \pm 10\%$ resistance between the operator and ground.

Table 4-2 Static shielding protection levels

Static shielding protection levels	
Method	Voltage
Antistatic plastic	1,500
Carbon-loaded plastic	7,500
Metallized laminate	15,000

Grounding the work area

To prevent static damage at the work area, follow these precautions.

- Cover the work surface with approved static-dissipative material. Provide a wrist strap connected to the work surface and properly grounded tools and equipment.
- Use static-dissipative mats, foot straps, or air ionizers to give added protection.
- Handle electrostatic sensitive components, parts, and assemblies by the case or PCB laminate. Handle them only at static-free work areas.
- Turn off power and input signals before inserting and removing connectors or test equipment.
- Use fixtures made of static-safe materials when fixtures must directly contact dissipative surfaces.

- Keep work area free of nonconductive materials such as ordinary plastic assembly aids and polystyrene foam.
- Use field service tools, such as cutters, screwdrivers, and vacuums, that are conductive.

Recommended materials and equipment

HP recommends certain materials and equipment to prevent static electricity.

- Antistatic tape
- Antistatic smocks, aprons, or sleeve protectors
- Conductive bins and other assembly or soldering aids
- Conductive foam
- Conductive tabletop workstations with ground cord of $1\text{ M}\Omega \pm 10\%$ resistance
- Static-dissipative table or floor mats with hard tie to ground
- Field service kits
- Static awareness labels
- Wrist straps and footwear straps providing $1\text{ M}\Omega \pm 10\%$ resistance
- Material handling packages
- Conductive plastic bags
- Conductive plastic tubes
- Conductive tote boxes
- Opaque shielding bags
- Transparent metallized shielding bags
- Transparent shielding tubes

Packaging and transporting guidelines

Follow these grounding guidelines when packaging and transporting equipment.

- To avoid hand contact, transport products in static-safe tubes, bags, or boxes.
- Protect ESD-sensitive parts and assemblies with conductive or approved containers or packaging.
- Keep ESD-sensitive parts in their containers until the parts arrive at static-free workstations.
- Place items on a grounded surface before removing items from their containers.
- Always be properly grounded when touching a component or assembly.

- Store reusable ESD-sensitive parts from assemblies in protective packaging or nonconductive foam.
- Use transporters and conveyors made of antistatic belts and roller bushings. Be sure that mechanized equipment used for moving materials is wired to ground and that proper materials are selected to avoid static charging. When grounding is not possible, use an ionizer to dissipate electric charges.

5 Removal and replacement procedures for Customer Self-Repair parts

This chapter provides removal and replacement procedures for Customer Self-Repair parts.

 **NOTE:** The Customer Self-Repair program is not available in all locations. Installing a part that is not supported by the Customer Self-Repair program can void your warranty. Check your warranty to determine whether Customer Self-Repair is supported in your location.

Component replacement procedures

To remove and replace computer components, use these procedures.

 **NOTE:** Details about your computer, including model, serial number, product key, and length of warranty, are on the service tag at the bottom of your computer.

 **NOTE:** HP continually improves and changes product parts. For complete and current information about supported parts for your computer, go to <http://partsurfer.hp.com>, select your country or region, and then follow the on-screen instructions.

You must remove, replace, or loosen as many as 21 screws when you service Customer Self-Repair parts. Make special note of each screw size and location during removal and replacement.

Preparation for disassembly

To prepare to disassemble the computer, use these steps.

See [Removal and replacement procedures preliminary requirements on page 31](#) for initial safety procedures.

1. Turn off the computer. If you are unsure whether the computer is off or in Hibernation, turn the computer on, and then shut it down through the operating system.
2. Disconnect the power from the computer by unplugging the power cord from the computer.
3. Disconnect all external devices from the computer.

Service cover

To remove the service cover, use this procedure and illustration.

Table 5-1 Service cover description and part number

Description	Spare part number
Service cover	M23347-001

Before removing the service cover, prepare the computer for disassembly ([Preparation for disassembly on page 66](#)).

Remove the service cover:

1. Close the computer and rest it upside down on a flat work surface with the front toward you.
2. Slide the service cover release latch **(1)** to the right far enough to access the security screw.
3. If present, remove the Phillips M2.0 × 6.0 security screw **(2)** that secures the service cover release latch in place.
4. Slide the service cover release latch **(3)** all the way to the right to release the service cover.

- Slide the service cover (4) toward the front of the computer, and then remove the service cover.

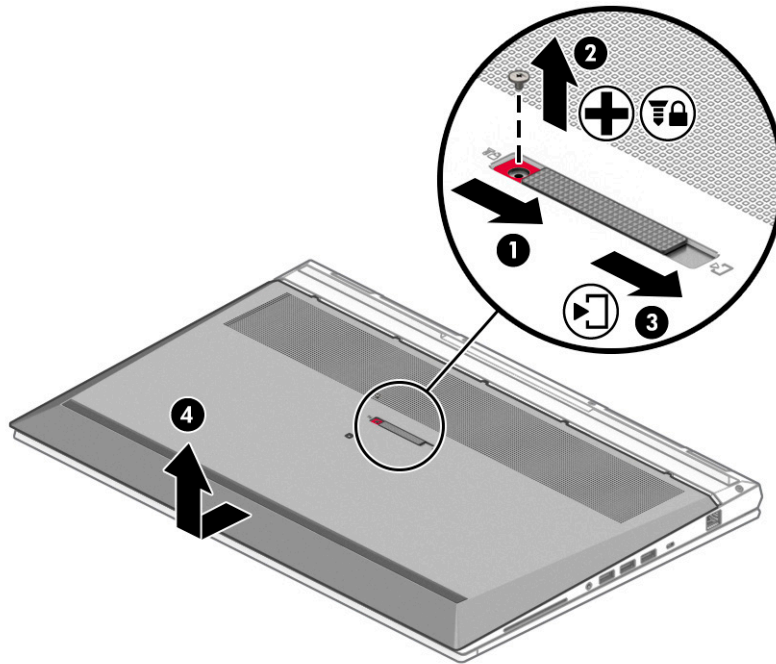

To replace the service cover, reverse the removal procedures.

Battery

To remove the battery, use this procedure and illustration.

Table 5-2 Battery description and part number

Description	Spare part number
8 cell, 94 Whr battery	L86212-001

⚠ WARNING! To avoid personal injury and damage to the product:

- Do *not* puncture, twist, or crack the battery.
- Do *not* cause an external puncture or rupture to the battery. They can cause a short inside the battery, which can result in battery thermal runaway.
- Do *not* handle or touch the battery enclosure with sharp objects such as tweezers or pliers, which might puncture the battery.
- Do *not* compress or squeeze the battery case with tools or heavy objects stacked on top of the case. These actions can apply undue force on the battery.
- Do *not* touch the connectors with any metallic surface or object, such as metal tools, screws, or coins, which can cause shorting across the connectors.

Before removing the battery, follow these steps:

1. Prepare the computer for disassembly ([Preparation for disassembly on page 66](#)).
2. Remove the service cover ([Service cover on page 40](#)).

WARNING! To reduce potential safety issues, use only the user-replaceable battery provided with the computer, a replacement battery provided by HP, or a compatible battery purchased from HP.

IMPORTANT: Removing a battery that is the sole power source for the computer can cause loss of information. To prevent loss of information, save your work or shut down the computer through Windows before you remove the battery.

Remove the battery:

1. Slide the battery latches **(1)** to the left to unlock the battery.
2. Use the tab **(2)** to swing the battery rear edge **(3)** up and forward until it rests at an angle.
3. Remove the battery **(4)** from the computer.

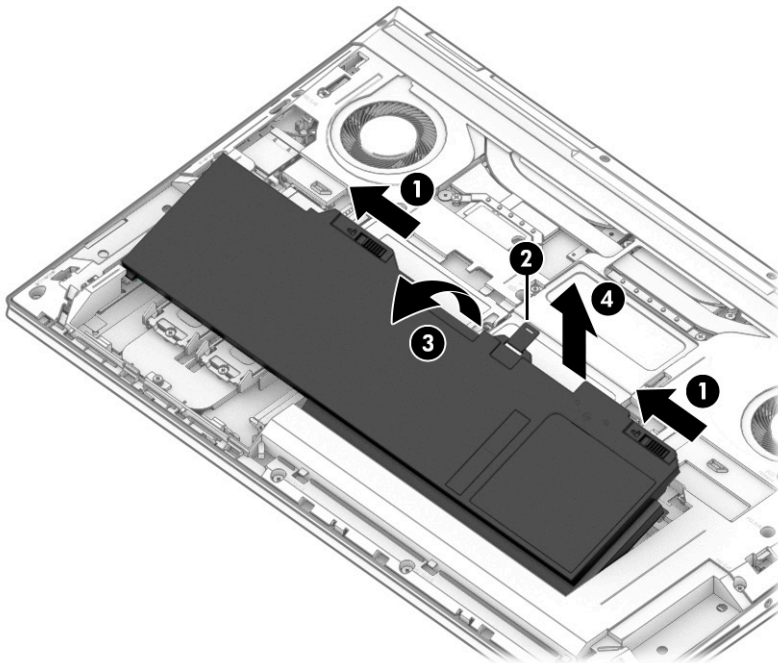

To insert the battery, reverse the removal procedures.

Solid-state drives 3 and 4

To remove solid-state drives 3 and 4, use this procedure and illustration.

Table 5-3 Solid-state drive description and part number

Description	Spare part number
1 TB, M.2 2280, PCIe, NVMe-3×4, SS with TLC	L85348-001
512 GB, M.2 2280, PCIe-3×4, SS with TLC	L85360-001
512 GB, M.2 2280, PCIe, NVMe, SED with TLC	L85368-002

Table 5-3 Solid-state drive description and part number (continued)

Description	Spare part number
256 GB, M.2 2280, PCIe-3×4, SS with TLC	L85350-001
256 GB, M.2 2280, PCIe, NVMe, SED with TLC	M07245-001

Before removing solid-state drive 3 and 4, follow these steps:

1. Prepare the computer for disassembly ([Preparation for disassembly on page 66](#)).
2. Remove the service cover ([Service cover on page 40](#)).
3. Remove the battery (see [Battery on page 41](#)).

Remove solid-state drives 3 and 4:

1. Remove the slotted 1.9 × 8.9 screw (1) that secures the solid-state drive to the solid-state drive carrier.
2. Spread the retention tabs (2) that secure the solid-state drive carrier gate.
3. Swing the solid-state drive carrier gate (3) up and back.
4. Slide the solid-state drives away from the slots (4) on the system board.

Solid-state drives are designed with a notch (5) to prevent incorrect installation.

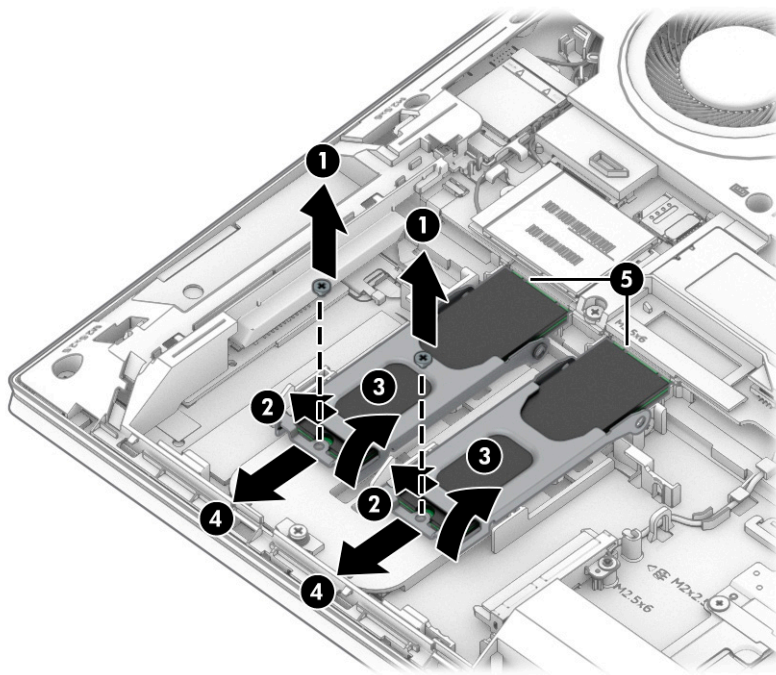

5. If it is necessary to remove the solid-state drive carrier, loosen the captive Phillips screw (1) that secures the carrier to the computer.
6. Lift the front edge of the carrier (2) until it rests at an angle.

7. Remove the carrier (3).

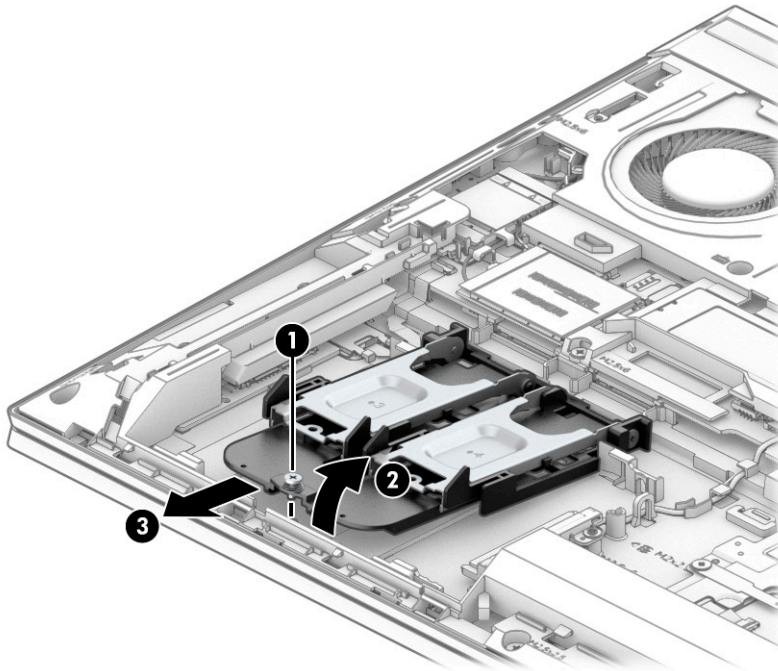

Reverse this procedure to install solid-state drives 3 and 4 and the solid-state drive carrier.

Hard drive

To remove the hard drive, use these procedures and illustrations.

Table 5-4 Hard drive, hard drive bracket and hard drive cable descriptions and part numbers

Description	Spare part number
NOTE: The hard drive spare part kit does not include the hard drive bracket or hard drive cable. The hard drive bracket is included in the Hard Drive Hardware Kit, spare part number M20091-001. The hard drive cable is included in the Cable Kit, spare part number M20105-001.	
2 TB, SATA, 5400 RPM, 7.0 mm	912487-850
1 TB, SATA, 7200 RPM, 9.5 mm	766644-001
500 GB, SATA, 7200 RPM, 9.5 mm	703267-001
500 GB, SATA, 7200 RPM, 9.5 mm, FIPS	820572-001

Before removing the hard drive, follow these steps:

1. Prepare the computer for disassembly ([Preparation for disassembly on page 66](#)).
2. Remove the service cover ([Service cover on page 40](#)).
3. Remove the battery (see [Battery on page 41](#)).
4. Remove the solid-state drive carrier (see [Solid-state drives 3 and 4 on page 42](#)).

Remove the hard drive:

1. Loosen the three Phillips screws (1) that secure the hard drive to the computer.
2. Swing the carrier bar (2) up and to the left to release the hard drive.
3. Slide the hard drive (3) to the left, and then remove the hard drive from the computer.

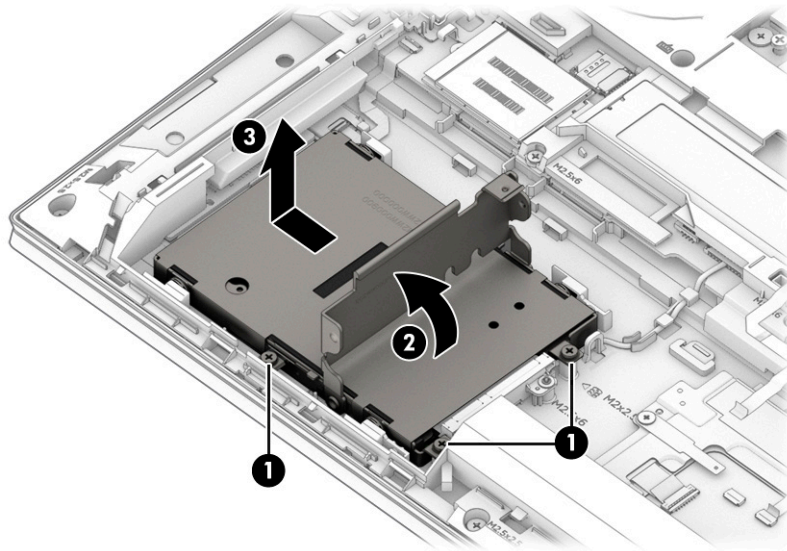

Reverse this procedure to install the hard drive.

If you must disassemble the hard drive, follow these steps:

1. Remove the four Phillips M3.0 × 3.0 screws (1) that secure the hard drive cover to the hard drive.
2. Remove the cover (2) from the hard drive.

The hard drive cover is included in the Hard Drive Hardware Kit, spare part number M20091-001.

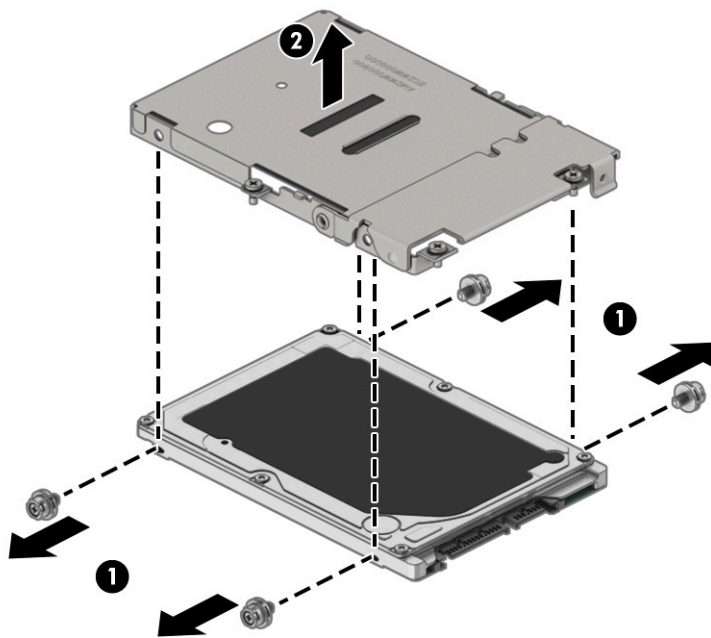

Reverse this procedure to reassemble the hard drive.

WLAN module

To remove the WLAN module, use this procedure and illustration.

Table 5-5 WLAN module descriptions and part numbers

Description	Spare part number
Intel Wi-Fi 6 AX201 ax 2×2 + Bluetooth 5.0 MU-MIMO M.2 2230 non-vPro MIPI+BRI WW with 2 antennas	L57250-001
Intel Wi-Fi 6 AX201 ax 2×2 + Bluetooth 5.0 MU-MIMO M.2 2230 vPro 160MHz MIPI + BRI WW with 2 antennas	L57248-001



IMPORTANT: To prevent an unresponsive system, replace the wireless module only with a wireless module authorized for use in the computer by the governmental agency that regulates wireless devices in your country or region. If you replace the module and then receive a warning message, remove the module to restore device functionality, and then contact technical support.

Before removing the WLAN module, follow these steps:

1. Prepare the computer for disassembly ([Preparation for disassembly on page 66](#)).
2. Remove the service cover ([Service cover on page 40](#)).
3. Remove the battery (see [Battery on page 41](#)).

Remove the WLAN module:

1. Carefully disconnect the two antenna cables **(1)** from the module.

2. Remove the Phillips M2.0 × 2.9 screw (2), and then remove the WLAN module (3).

 **NOTE:** Models have either one or two WLAN antennas. On models with two antennas, the #1 WLAN antenna cable connects to the WLAN module #1 Main terminal. The #2 WLAN antenna cable connects to the WLAN module #2 Aux terminal.

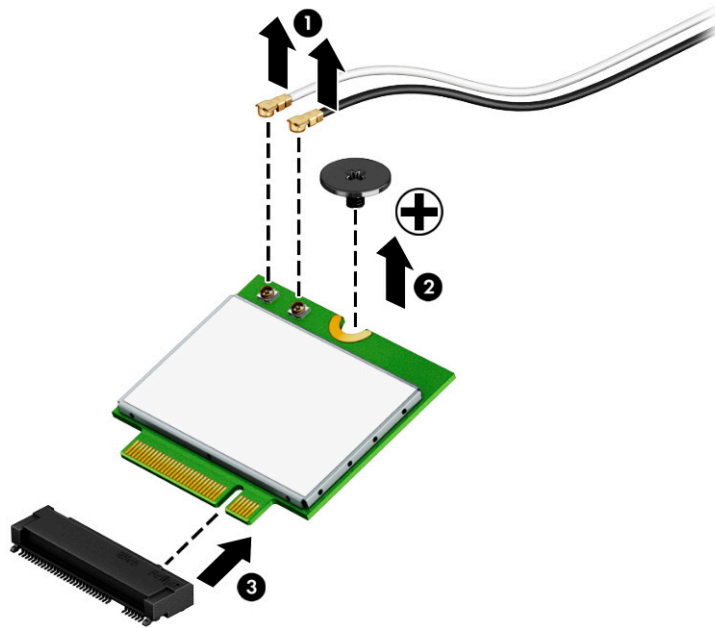

3. If the WLAN antenna is not connected to the terminal on the WLAN module, install a protective sleeve on the antenna connector, as shown in the following illustration.

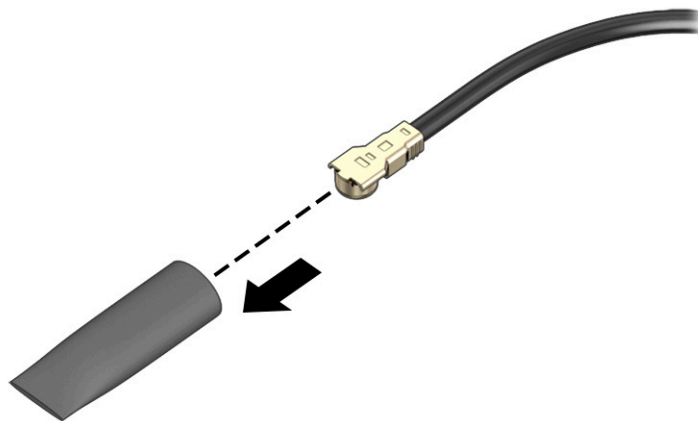

Reverse this procedure to install the WLAN module.

WWAN module

To remove the WWAN module, use this procedure and illustration.

Table 5-6 WWAN module descriptions and part numbers

Description	Spare part number
Intel XMM 7360 LTE-Advanced (Cat 9)	L70670-001

 **IMPORTANT:** To prevent an unresponsive system, replace the wireless module only with a wireless module authorized for use in the computer by the governmental agency that regulates wireless devices in your country or region. If you replace the module and then receive a warning message, remove the module to restore device functionality, and then contact technical support.

Before removing the WWAN module, follow these steps:

1. Prepare the computer for disassembly ([Preparation for disassembly on page 66](#)).
2. Remove the service cover ([Service cover on page 40](#)).
3. Remove the battery (see [Battery on page 41](#)).

Remove the WWAN module:

1. Disconnect the WWAN antenna cables (1) from the terminals on the WWAN module.
2. Remove the Phillips M2.0 × 2.0 screw (2) that secures the WWAN module to the bottom cover. (The WWAN module tilts up.)
3. Remove the WWAN module (3) by pulling the module away from the slot at an angle.

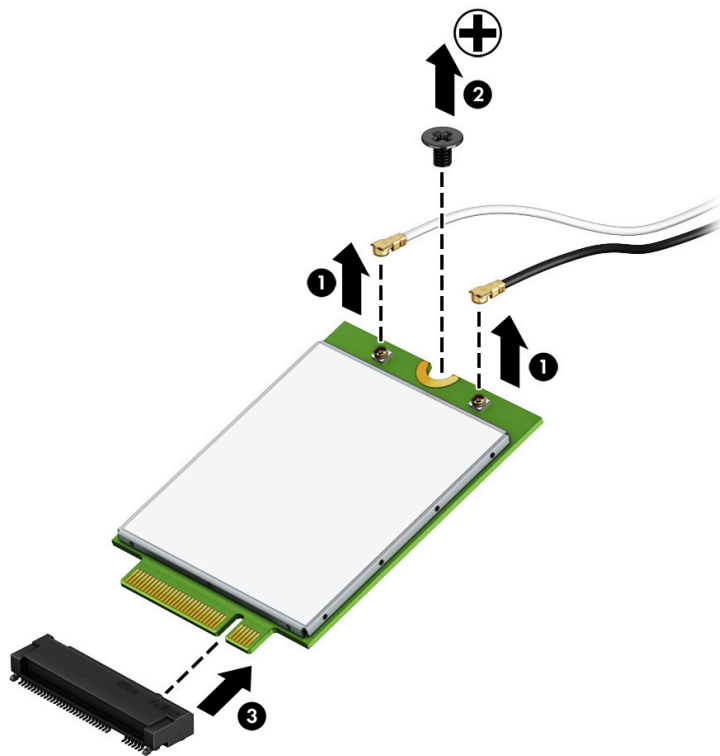

4. If the WWAN antenna is not connected to the terminal on the WWAN module, a protective sleeve must be installed on the antenna connector, as shown in the following illustration.

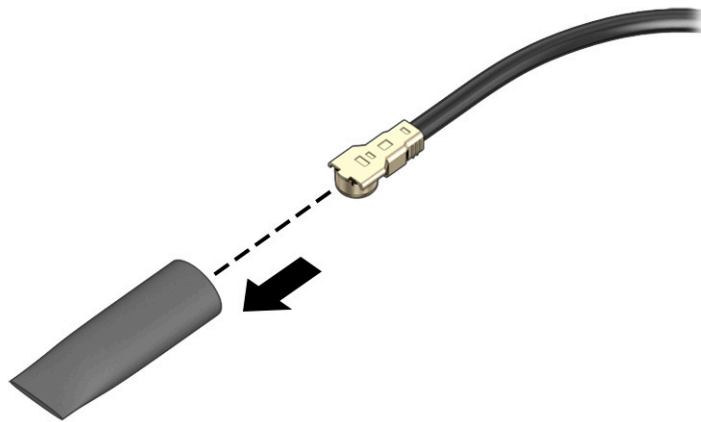

Reverse this procedure to install the WWAN module.

Solid-state drive 2

To remove solid-state drive 2, use this procedure and illustration.

Table 5-7 Solid-state drive description and part number

Description	Spare part number
Only NVMe solid-state drives can be used in solid-state drive compartment 2.	
1 TB, M.2 2280, PCIe, NVMe-3×4, SS with TLC	L85348-001
512 GB, M.2 2280, PCIe, NVMe, SED with TLC	L85368-002
256 GB, M.2 2280, PCIe, NVMe, SED with TLC	M07245-001

Before removing solid-state drive 2, follow these steps:

1. Prepare the computer for disassembly ([Preparation for disassembly on page 66](#)).
2. Remove the service cover ([Service cover on page 40](#)).
3. Remove the battery (see [Battery on page 41](#)).

Remove solid-state drive 2:

1. Remove the Phillips M2.0 × 2.9 screw **(1)** that secures the solid-state drive cover to the computer.
2. Lift the right side of the cover **(2)** until it rests at an angle.

3. Remove the cover (3) by sliding it to the left at an angle.

The solid-state drive cover is included in the Bracket Kit, spare part number M20094-001.

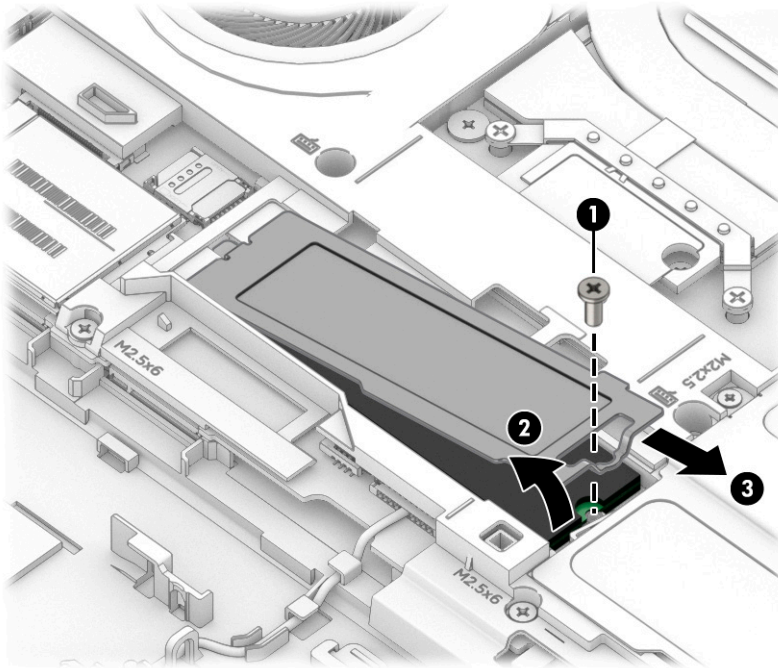

4. Pull the drive away from the socket to remove it (1).

Solid-state drives are designed with a notch (2) to prevent incorrect installation.

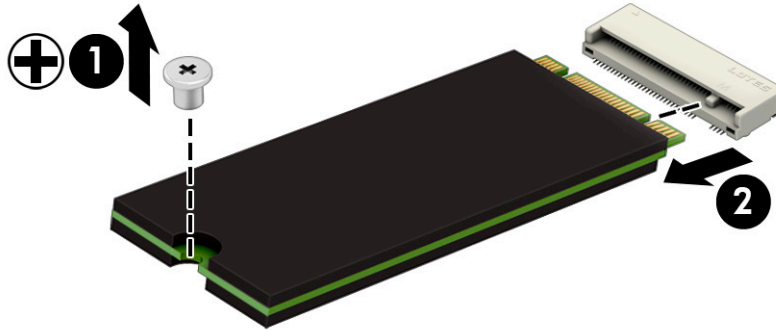

A thermal pad services solid-state drive 2 and is located on the solid-state drive compartment cover. This pad should be inspected each time that the cover is removed. This pad is intended to be reused if it is not damaged. If this pad is damaged and any residue remains on the solid-state drive (1) or the cover (2), it should be thoroughly removed and replaced.

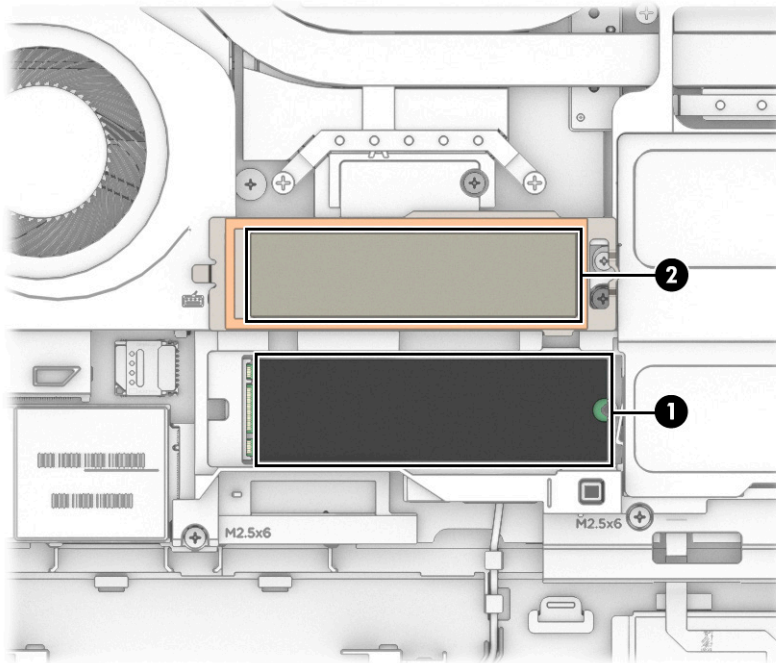

To install the solid-state drive, reverse the removal procedures.

Memory modules 2 and 4

To remove memory modules 2 and 4, use this procedure and illustration.

Table 5-8 Memory module descriptions and part numbers

Description	Spare part number
32 GB (2666 MHz, 1.2 V, DDR4)	L50384-001
16 GB (2666 MHz, 1.2 V, DDR4, ECC)	L24981-001
16 GB (2666 MHz, 1.2 V, DDR4)	937438-950
8 GB (3200 MHz, 1.2 V, DDR4)	L46598-001
8 GB (2666 MHz, 1.2 V, DDR4, ECC)	L24983-001

Before removing memory module 2 and 4, follow these steps:

1. Prepare the computer for disassembly ([Preparation for disassembly on page 66](#)).
2. Remove the service cover ([Service cover on page 40](#)).
3. Remove the battery (see [Battery on page 41](#)).

If you are replacing memory module 2 and 4, remove the existing memory module:

1. Remove the Phillips M2.0 × 2.9 screw **(1)** that secures the memory module compartment cover to the computer.

Lift the left side of the cover **(2)** and swing it up and to the right until it rests at an angle.

Remove the cover **(3)** by sliding it to the left at an angle.

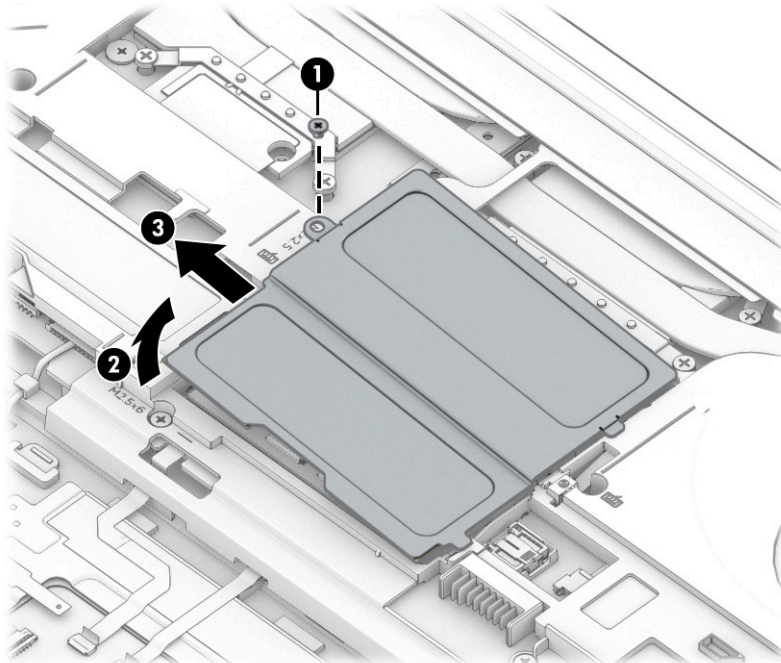

To protect a memory module after removal, place it in an electrostatic-safe container.

2. Spread the two retention clips outward **(1)** until the memory module tilts up at a 45° angle, and then remove the module **(2)**. Use the same procedure to remove all memory modules.

 **IMPORTANT:** To prevent damage to the memory module, hold the memory module by the edges only. Do not touch the components on the memory module.

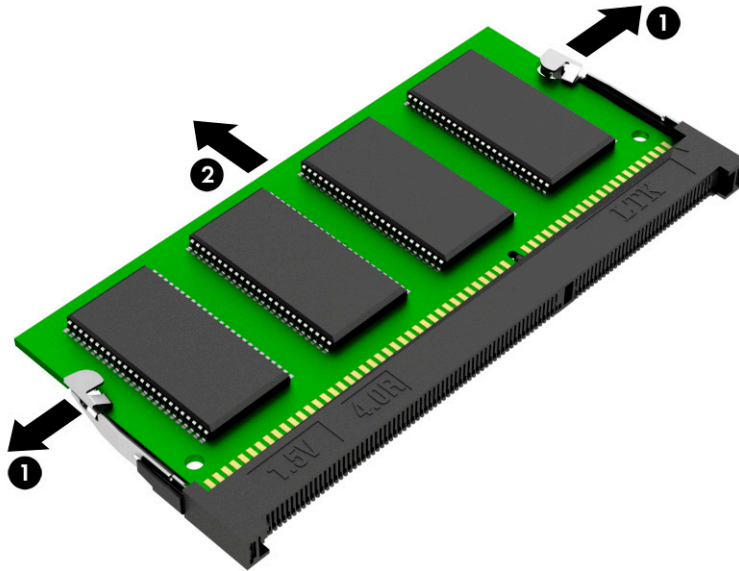

To protect a memory module after removal, place it in an electrostatic-safe container.

To install a memory module:

1. Align the notched edge of the module with the tab in the slot **(1)**, and then press the module into the slot at an angle until it is seated **(2)**.

- Press down on the module until the side retention clips snap into place (3).

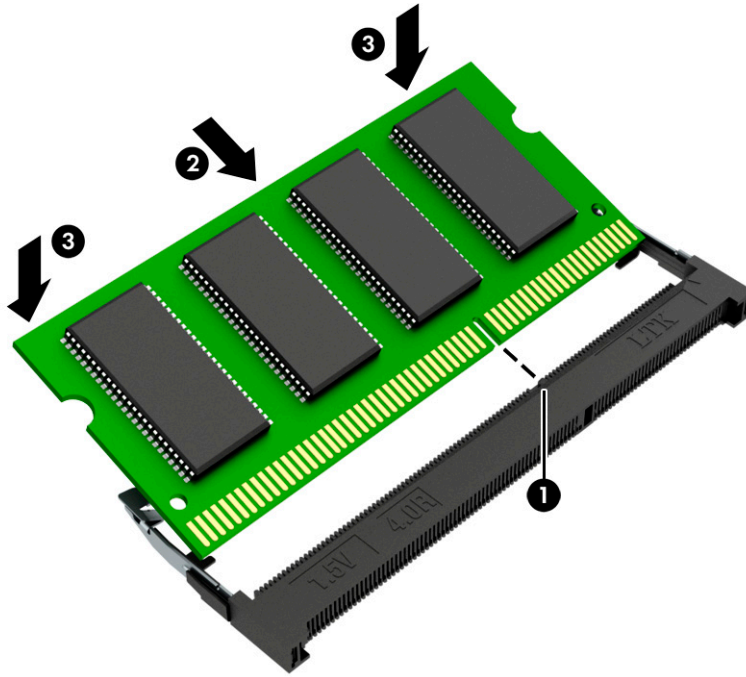

Keyboard

To remove the keyboard, use this procedure and illustration.

Table 5-9 Keyboard description and part number

For use in country/region	Spare part number	For use in country/region	Spare part number
Keyboard with backlight, clickpad, and pointing stick (includes backlight cable, clickpad cable, keyboard cable, and pointing stick cable):			
For use in Belgium	M20128-A41	For use in Norway	M20128-091
For use in Brazil	M20128-201	For use in Portugal	M20128-131
For use in Bulgaria	M20128-261	For use in Romania	M20128-271
For use in Canada	M20128-DB1	For use in Russia	M20128-251
For use in the Czech Republic and Slovakia	M20128-FL1	For use in Saudi Arabia	M20128-171
For use in Denmark	M20128-081	For use in Slovenia	M20128-BA1
For use in France	M20128-051	For use in South Africa	M20128-AD1
For use in Germany	M20128-041	For use in Spain	M20128-071
For use in Greece	M20128-151	For use in Sweden and Finland	M20128-B71
For use in Hungary	M20128-211	For use in Switzerland	M20128-BG1
For use in India	M20128-DD1	For use in Taiwan	M20128-AB1
For use in Iceland	M20128-D61	For use in Thailand	M20128-281
For use in Israel	M20128-BB1	For use in Turkey	M20128-141

Table 5-9 Keyboard description and part number (continued)

For use in country/region	Spare part number	For use in country/region	Spare part number
For use in Italy	M20128-061	For use in Turkey-F	M20128-541
For use in Japan	M20128-291	For use in Ukraine	M20128-BD1
For use in Latin America	M20128-161	For use in the United Kingdom	M20128-031
For use in the Netherlands	M20128-B31	For use in the United States	M20128-001
For use in Northwest Africa	M20128-FP1		

Before removing the keyboard, follow these steps:

1. Prepare the computer for disassembly ([Preparation for disassembly on page 66](#)).
2. Remove the service cover ([Service cover on page 40](#)).
3. Remove the battery (see [Battery on page 41](#)).

Remove the speakers:

1. Remove the three Phillips M2.5 × 6.0 screws **(1)**, identified by the keyboard icon **(2)**, that secure the keyboard to the computer.
2. Release the zero insertion force (ZIF) connector **(3)** to which the pointing stick cable is connected, and then disconnect the cable from the connector.

3. Detach the pointing stick cable (4) from the top cover. (The pointing stick cable is attached to the top cover with double-sided adhesive.)

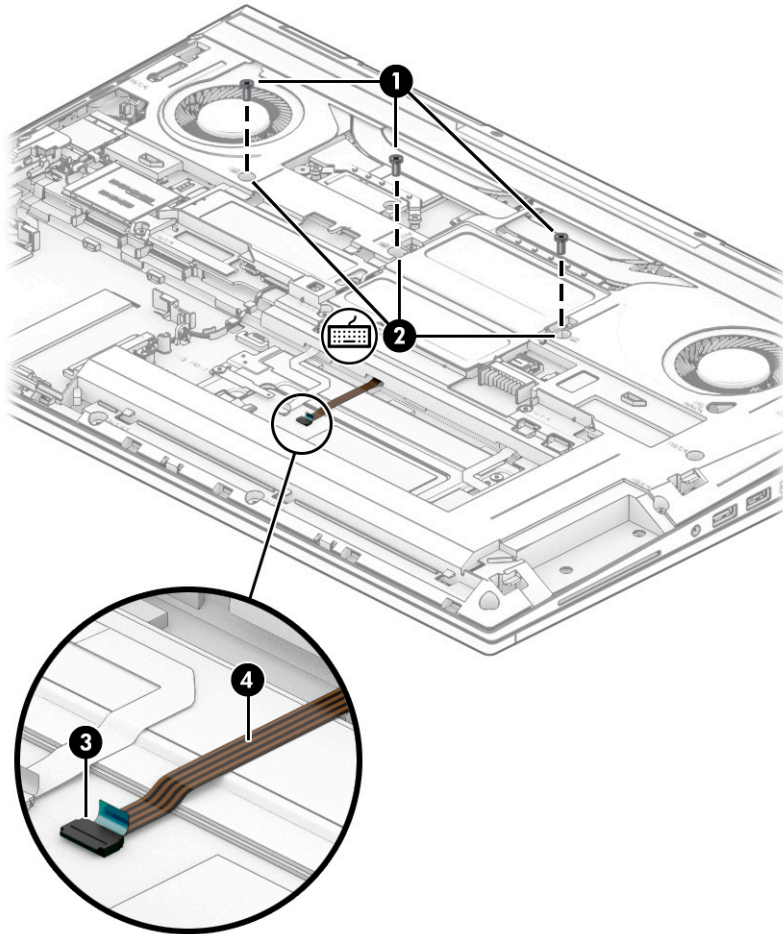

4. Open the computer.
5. Rest the open computer on its left side.

6. Insert a keyboard release tool or other thin, plastic tool through the KB release opening near the fan and release the keyboard by pressing on its back.

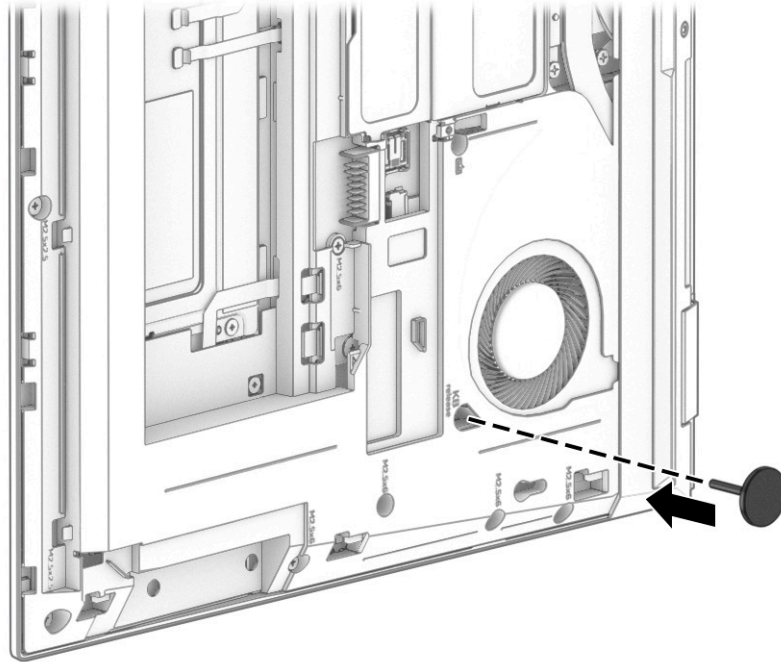

7. Rest the open computer right side up with the front toward you.
8. Swing the top edge of the keyboard **(1)** up and forward until it rests upside down on the top cover.
9. Detach the backlight cable **(2)** from the top cover. (The backlight cable is attached to the top cover with double-sided adhesive.)
10. Release the ZIF connector **(3)** to which the backlight cable is connected, and then disconnect the cable from the connector.
11. Release the ZIF connector **(4)** to which the keyboard cable is connected, and then disconnect the cable from the connector.
12. Release the pointing stick cable **(5)** through the opening in the top cover.

13. Remove the keyboard (6).

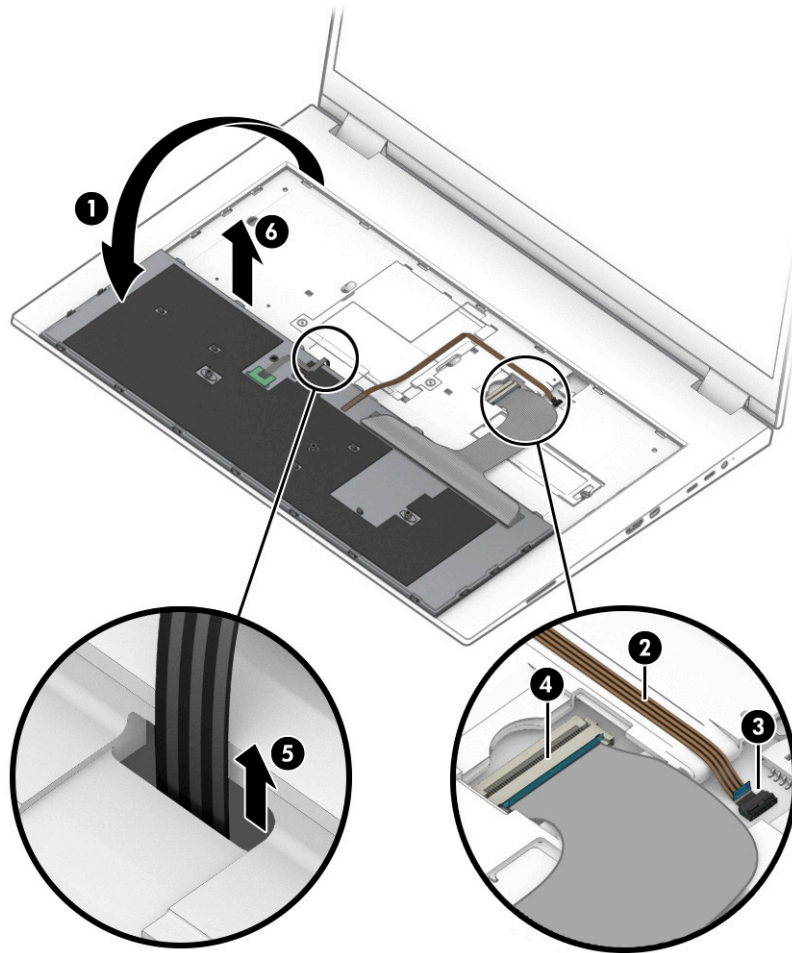

Reverse this procedure to install the keyboard.

Memory modules 1 and 3

To remove memory modules 1 and 3, use this procedure and illustration.

Table 5-10 Memory module descriptions and part numbers

Description	Spare part number
32 GB (2666 MHz, 1.2 V, DDR4)	L50384-001
16 GB (2666 MHz, 1.2 V, DDR4, ECC)	L24981-001
16 GB (2666 MHz, 1.2 V, DDR4)	937438-950
8 GB (3200 MHz, 1.2 V, DDR4)	L46598-001
8 GB (2666 MHz, 1.2 V, DDR4, ECC)	L24983-001

Before removing memory modules 1 and 3, follow these steps:

1. Prepare the computer for disassembly ([Preparation for disassembly on page 66](#)).
2. Remove the service cover ([Service cover on page 40](#)).
3. Remove the battery (see [Battery on page 41](#)).
4. Remove the keyboard (see [Keyboard on page 54](#)).

If you are replacing memory modules 1 and 3, remove the existing memory module:

1. Remove the two Phillips M2.0 × 2.9 screws **(1)** that secure the memory module compartment cover to the computer.
2. Lift the front edge of the cover **(2)** and swing it up and back until it rests at an angle.

3. Remove the cover (3) by sliding it forward and then lifting it up.

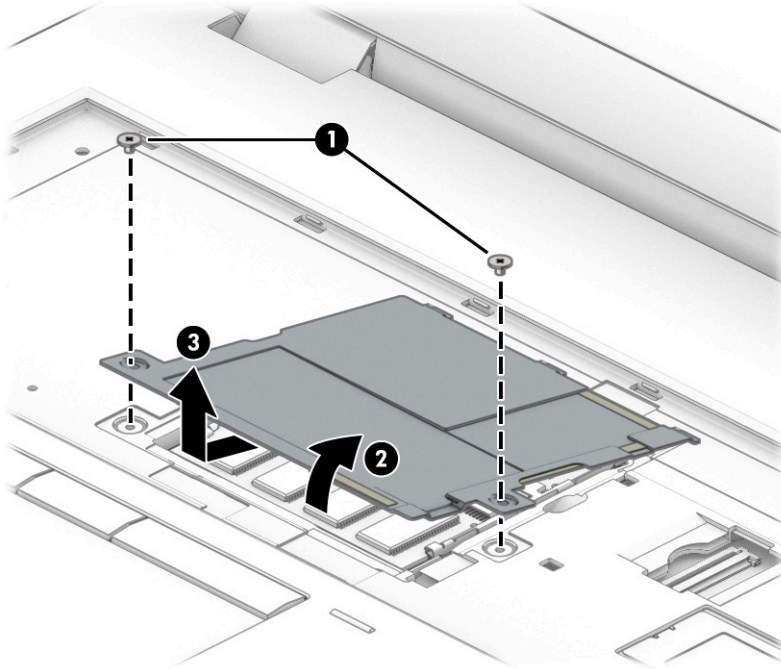

Thermal pads service memory modules 1 and 3 and are located on the memory module compartment cover. These pads should be inspected each time that the cover is removed. These pads are intended to be reused if they are not damaged. If these pads are damaged and any residue remains on the memory modules (1) or the cover (2), it should be thoroughly removed and replaced. If protective releasing paper is attached to the thermal pads, it should be removed prior to replacement.

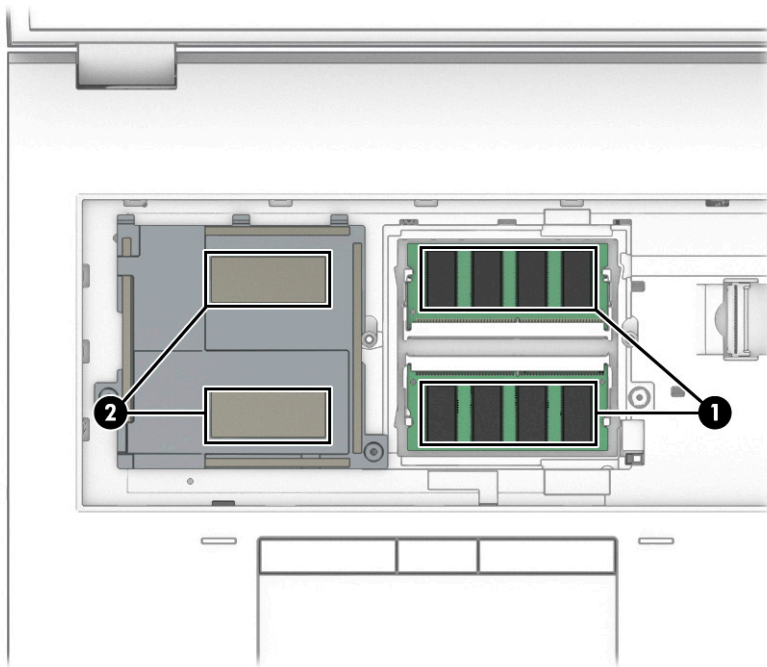

4. Spread the two retention clips outward **(1)** until the memory module tilts up at a 45° angle, and then remove the module **(2)**. Use the same procedure to remove all memory modules.

 **IMPORTANT:** To prevent damage to the memory module, hold the memory module by the edges only. Do not touch the components on the memory module.

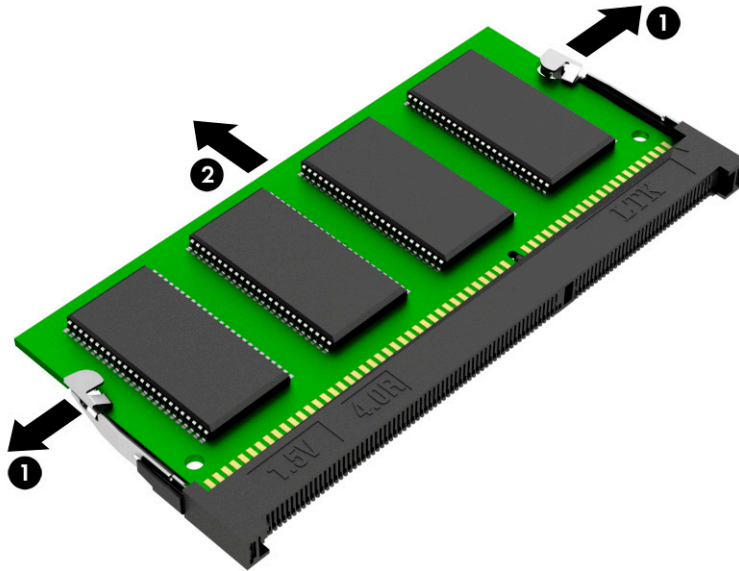

To protect a memory module after removal, place it in an electrostatic-safe container.

To install a memory module:

1. Align the notched edge of the module with the tab in the slot **(1)**, and then press the module into the slot at an angle until it is seated **(2)**.

- Press down on the module until the side retention clips snap into place (3).

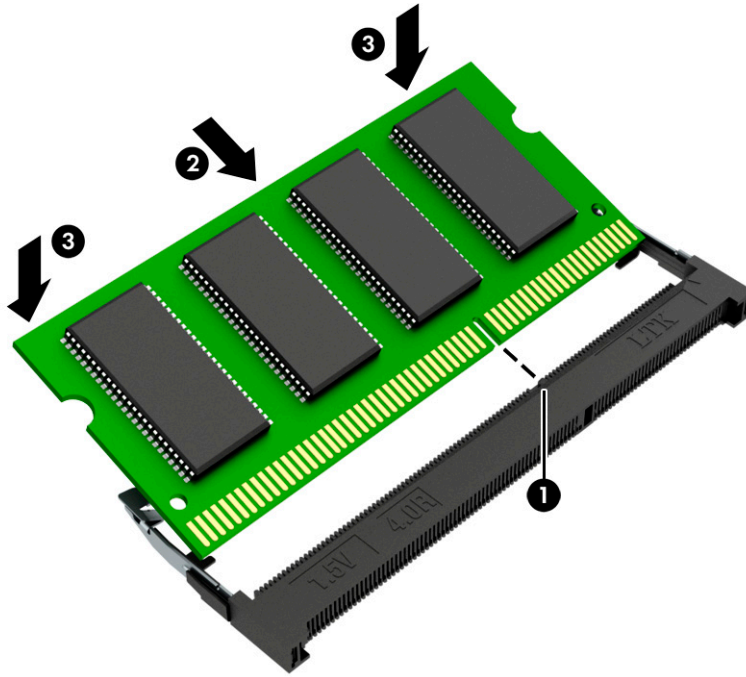

Solid-state drive 1

To remove solid-state drive 1, use this procedure and illustration.

Table 5-11 Solid-state drive description and part number

Description	Spare part number
1 TB, M.2 2280, PCIe, NVMe-3×4, SS with TLC	L85348-001
512 GB, M.2 2280, PCIe-3×4, SS with TLC	L85360-001
512 GB, M.2 2280, PCIe, NVMe, SED with TLC	L85368-002
256 GB, M.2 2280, PCIe-3×4, SS with TLC	L85350-001
256 GB, M.2 2280, PCIe, NVMe, SED with TLC	M07245-001

Before removing solid-state drive 1, follow these steps:

- Prepare the computer for disassembly ([Preparation for disassembly on page 66](#)).
- Remove the service cover ([Service cover on page 40](#)).
- Remove the battery (see [Battery on page 41](#)).
- Remove the keyboard (see [Keyboard on page 54](#)).

Remove solid-state drive 1:

- Remove the Phillips M2.0 × 2.9 screw (1) that secures the solid-state drive 1 cover to the computer.
- Lift the right side (2) of the cover until it rests at an angle.

3. Remove the cover (3) by sliding it to the right at an angle.

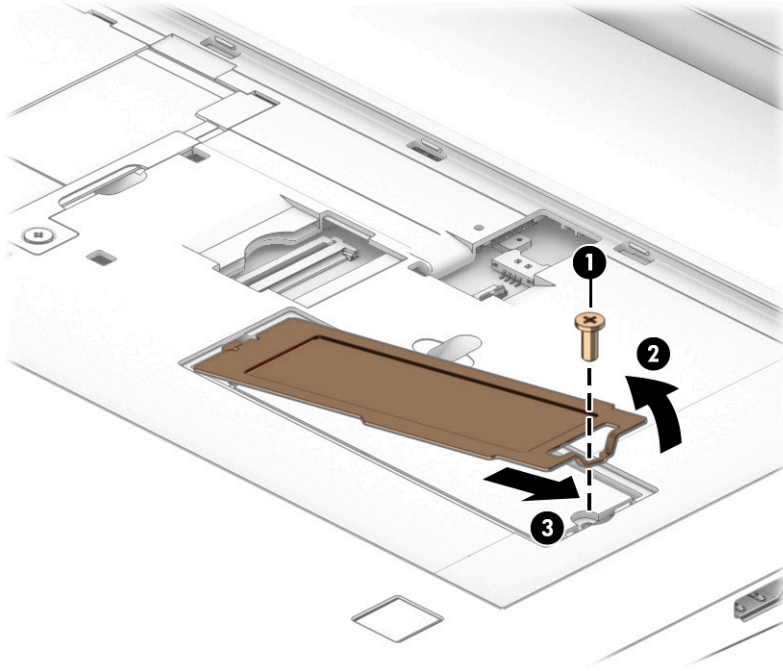

A thermal pad services solid-state drive 1 and is located on the solid-state drive cover. This pad should be inspected each time that the cover is removed. This pad is intended to be reused if it is not damaged. If this pad is damaged and any residue remains on the solid-state drive (1) or the cover (2), it should be thoroughly removed and replaced. If protective releasing paper is attached to the thermal pad, it should be removed prior to replacement.

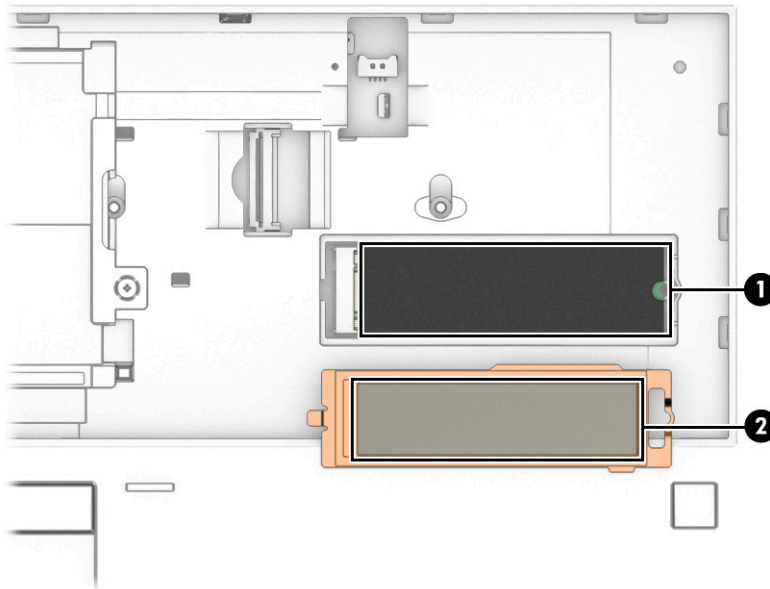

4. Pull the drive away from the socket to remove it (1).

Solid-state drives are designed with a notch (2) to prevent incorrect installation.

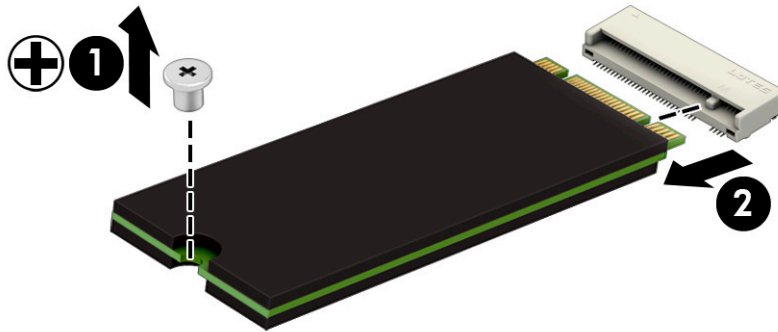

To install the solid-state drive, reverse the removal procedures.

6 Removal and replacement procedures for authorized service provider parts

This chapter provides removal and replacement procedures for authorized service provider parts.

 **IMPORTANT:** Components described in this chapter should be accessed only by an authorized service provider. Accessing these parts can damage the computer or void the warranty.

 **NOTE:** Details about your computer, including model, serial number, product key, and length of warranty, are on the service tag at the bottom of your computer.

Component replacement procedures

To remove and replace computer components, use these procedures.

 **NOTE:** HP continually improves and changes product parts. For complete and current information about supported parts for your computer, go to <http://partsurfer.hp.com>, select your country or region, and then follow the on-screen instructions.

You must remove, replace, or loosen as many as 84 screws when you service the parts described in this chapter. Make special note of each screw size and location during removal and replacement.

Preparation for disassembly

To remove and replace computer components, use these procedures.

See [Preparation for disassembly on page 40](#) for initial safety procedures.

1. Turn off the computer. If you are unsure whether the computer is off or in Hibernation, turn the computer on, and then shut it down through the operating system.
2. Disconnect the power from the computer by unplugging the power cord from the computer.
3. Disconnect all external devices from the computer.

Bottom case

To remove the bottom case, use this procedure and illustration.

Table 6-1 Bottom case description and part number

Description	Spare part number
Bottom case	M20092-001

Before removing the bottom case, follow these steps:

1. Prepare the computer for disassembly ([Preparation for disassembly on page 66](#)).
2. Remove the service cover ([Service cover on page 40](#)), and then remove the following components:
 1. Battery (see [Battery on page 41](#))
 2. Solid-state drives 3 and 4 (see [Solid-state drives 3 and 4 on page 42](#))
 3. Solid-state drive carrier (see [Solid-state drives 3 and 4 on page 42](#))
 4. Hard drive (see [Hard drive on page 44](#))
 5. Keyboard (see [Keyboard on page 54](#))

Remove the bottom case:

1. Close the computer.
2. Turn the computer upside down with the front toward you.
3. Remove the four Phillips M2.5 × 3.1 (1) screws that secure the bottom case to the computer.

4. Remove the nine Phillips M2.5 × 6.0 (2) screws that secure the bottom case to the computer.
5. Remove the four Torx8 M2.5 × 3.5 (3) screws that secure the bottom case to the computer.

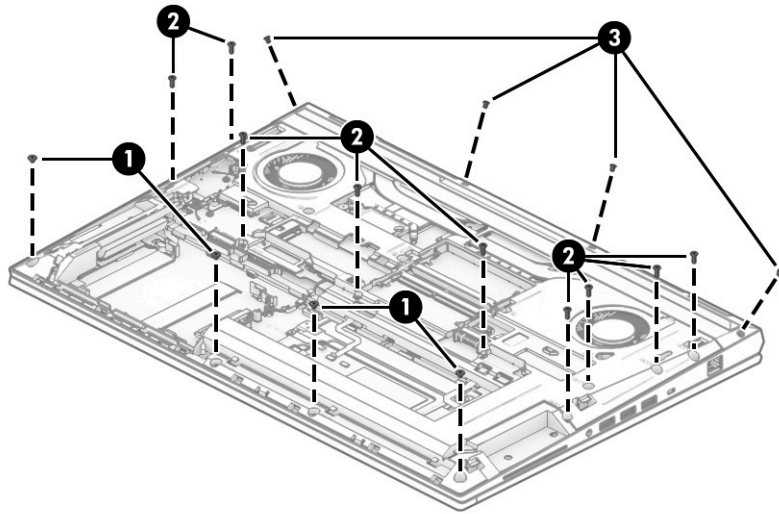

6. Insert a case utility tool (1) or similar thin plastic tool in the display hinge area and separate the bottom case from the top cover.
7. Swing the rear edge of the bottom case (2) up and forward until it rests at an angle.
8. Remove the bottom case (3).

When removing the bottom case, take care not to damage the front edge (4) and the area around the solid-state drive compartment. These areas of the bottom case have thin material and are susceptible to breakage if precautions are not taken.

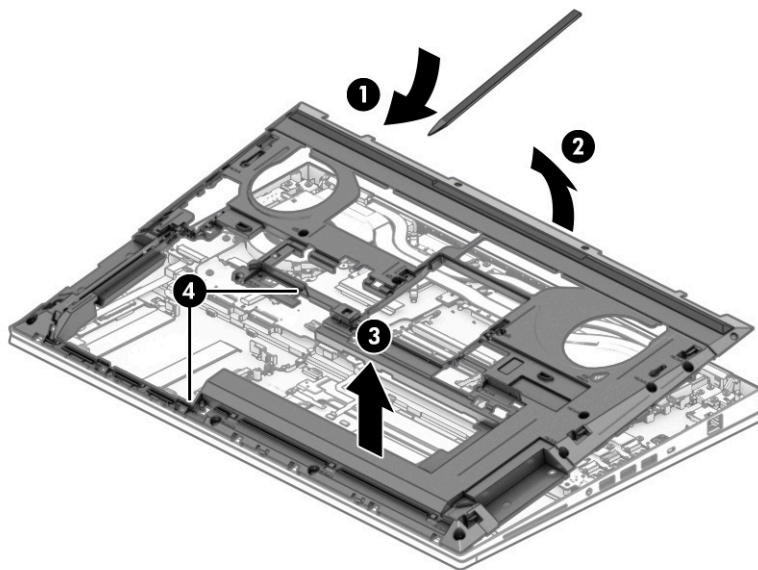

Reverse this procedure to install the bottom case.

SD card board cable

To remove the SD card board cable, use this procedure and illustration.

The SD card board cable is available in the Cable Kit, spare part number M20105-001.

Before removing the SD card board cable, follow these steps:

1. Prepare the computer for disassembly ([Preparation for disassembly on page 66](#)).
2. Remove the service cover ([Service cover on page 40](#)), and then remove the following components:
 1. Battery (see [Battery on page 41](#))
 2. Solid-state drives 3 and 4 (see [Solid-state drives 3 and 4 on page 42](#))
 3. Solid-state drive carrier (see [Solid-state drives 3 and 4 on page 42](#))
 4. Hard drive (see [Hard drive on page 44](#))
 5. Keyboard (see [Keyboard on page 54](#))
 6. Bottom case (see [Bottom case on page 66](#))

Remove the SD card board cable:

1. Detach the SD card board cable **(1)** from the top cover. (The SD card board cable is attached to the top cover with double-sided adhesive.)
2. Release the ZIF connector **(2)** to which the SD card board cable is connected, and then disconnect the SD card board cable from the system board.
3. Release the ZIF connector **(3)** to which the SD card board cable is connected, and then disconnect the SD card board cable from the SD card board.
4. Remove the SD card board cable **(4)**.

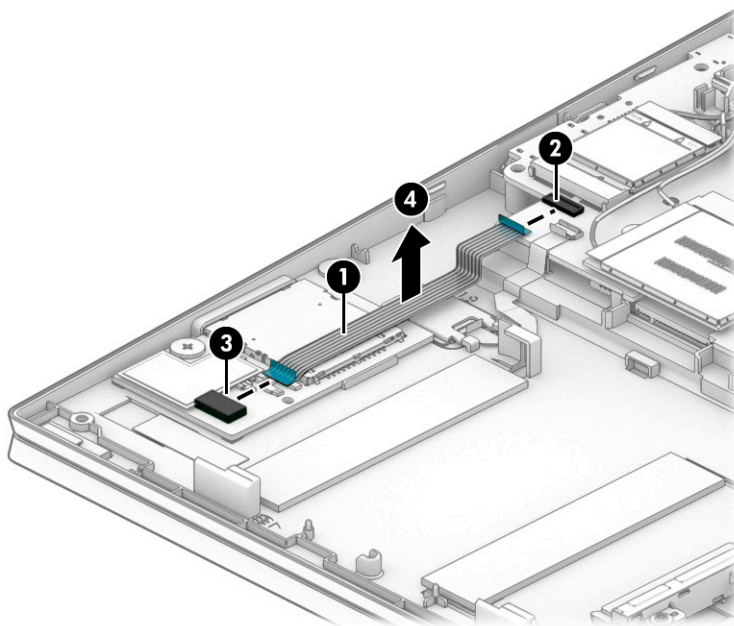

Reverse this procedure to install the SD card board cable.

SD card board

To remove the SD card board, use this procedure and illustration.



NOTE: The SD card board spare part kit includes SD card board.

Table 6-2 SD card board description and part number

Description	Spare part number
SD card board	M17093-001

NOTE: The SD card board spare part kit does not include the SD card board cable. The SD card board cable is available in the Cable Kit, spare part number M20105-001.

Before removing the SD card board, follow these steps:

1. Prepare the computer for disassembly ([Preparation for disassembly on page 66](#)).
2. Remove the service cover ([Service cover on page 40](#)), and then remove the following components:
 1. Battery (see [Battery on page 41](#))
 2. Solid-state drives 3 and 4 (see [Solid-state drives 3 and 4 on page 42](#))
 3. Solid-state drive carrier (see [Solid-state drives 3 and 4 on page 42](#))
 4. Hard drive (see [Hard drive on page 44](#))
 5. Keyboard (see [Keyboard on page 54](#))
 6. Bottom case (see [Bottom case on page 66](#))

Remove the SD card board:

1. Remove the SD card slot bezel **(1)**.

The SD card slot bezel is included in the Plastics Kit, spare part number M20093-001.
2. Detach the SD card board cable **(2)** from the top cover. (The SD card board cable is attached to the top cover with double-sided adhesive.)
3. Release the ZIF connector **(3)** to which the SD card board cable is connected, and then disconnect the SD card board cable from the system board.
4. Remove the two Phillips M2.0 × 2.9 broad head screws **(4)** that secure the SD card board to the top cover.

5. Remove the SD card board (5) and cable

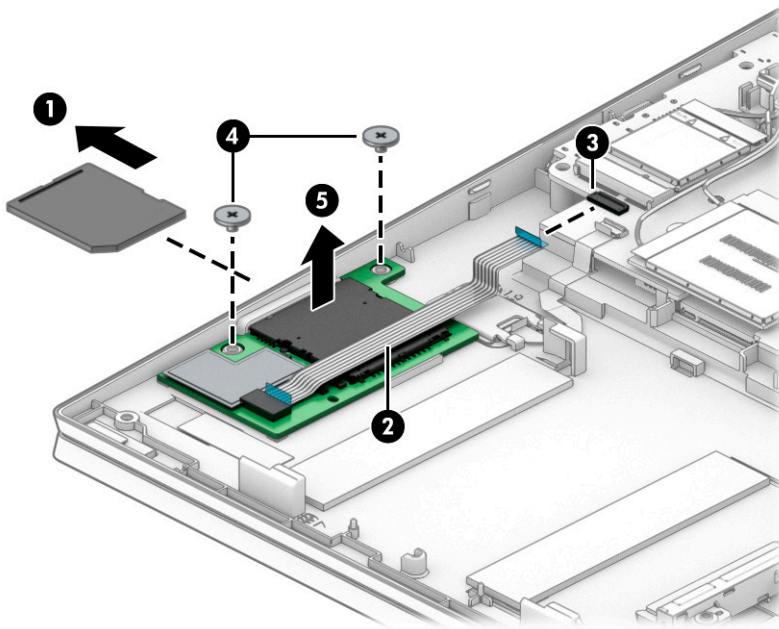

Reverse this procedure to install the SD card board and cable.

Fingerprint reader module cable

To remove the fingerprint reader module cable, use this procedure and illustration.

The fingerprint reader module cable is available in the Cable Kit, spare part number M20105-001.

Before removing the fingerprint reader module cable, follow these steps:

1. Prepare the computer for disassembly ([Preparation for disassembly on page 66](#)).
2. Remove the service cover ([Service cover on page 40](#)), and then remove the following components:
 1. Battery (see [Battery on page 41](#))
 2. Solid-state drives 3 and 4 (see [Solid-state drives 3 and 4 on page 42](#))
 3. Solid-state drive carrier (see [Solid-state drives 3 and 4 on page 42](#))
 4. Hard drive (see [Hard drive on page 44](#))
 5. Keyboard (see [Keyboard on page 54](#))
 6. Bottom case (see [Bottom case on page 66](#))

Remove the fingerprint reader module cable:

1. Release the ZIF connector (1) to which the fingerprint reader module cable is connected, and then disconnect the fingerprint reader module cable from the system board.
2. Release the ZIF connector (2) to which the fingerprint reader module cable is connected, and then disconnect the fingerprint reader module cable from the fingerprint reader module.

3. Remove the fingerprint reader module cable (3).

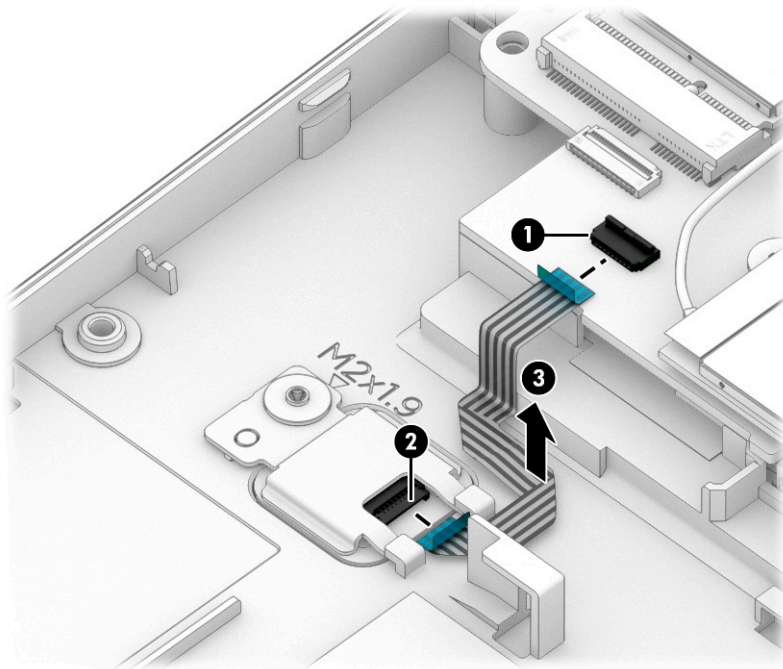

Reverse this procedure to install the fingerprint reader module cable.

Fingerprint reader module

To remove the fingerprint reader module, use this procedure and illustration.

Table 6-3 Fingerprint reader module description and part number

Description	Spare part number
Fingerprint reader module	M17064-001

NOTE: The fingerprint reader module spare part kit does not include the fingerprint reader module cable. The fingerprint reader module cable is available in the Cable Kit, spare part number M20105-001.

Before removing the fingerprint reader module, follow these steps:

1. Prepare the computer for disassembly ([Preparation for disassembly on page 66](#)).
2. Remove the service cover ([Service cover on page 40](#)), and then remove the following components:
 1. Battery (see [Battery on page 41](#))
 2. Solid-state drives 3 and 4 (see [Solid-state drives 3 and 4 on page 42](#))
 3. Solid-state drive carrier (see [Solid-state drives 3 and 4 on page 42](#))
 4. Hard drive (see [Hard drive on page 44](#))
 5. Keyboard (see [Keyboard on page 54](#))
 6. Bottom case (see [Bottom case on page 66](#))

Remove the fingerprint reader module:

1. Release the ZIF connector (1) to which the fingerprint reader module cable is connected, and then disconnect the fingerprint reader module cable from the system board.
2. Remove the Phillips M2.0 × 2.9 broad head screw (2) that secures the fingerprint reader module to the top cover.
3. Remove the fingerprint reader module bracket (3).
The fingerprint reader module bracket is included in the Bracket Kit, spare part number M20094-001.
4. Remove the fingerprint reader module (4) and cable.

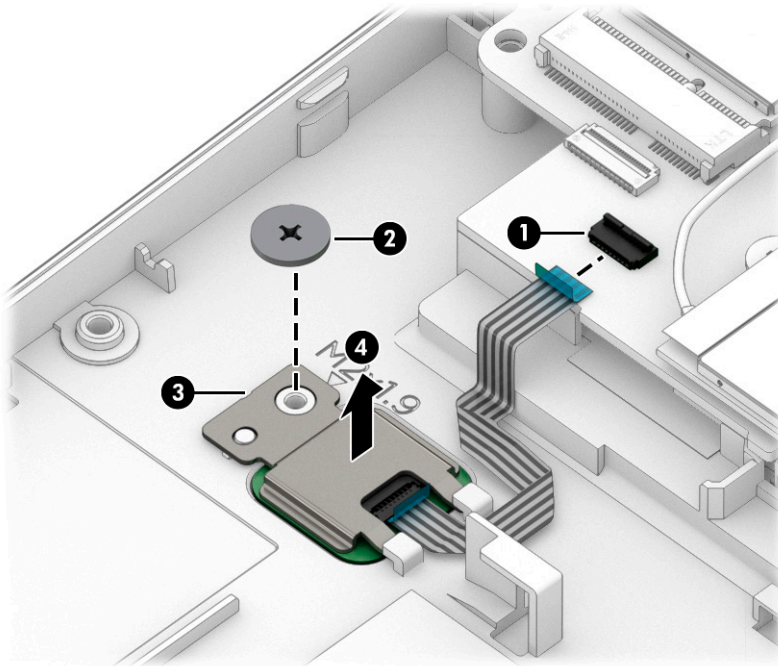

Reverse this procedure to install the fingerprint reader module and cable.

Hard drive cable

To remove the hard drive cable, use this procedure and illustration.

The hard drive cable is available in the Cable Kit, spare part number M20105-001.

Before removing the hard drive cable, follow these steps:

1. Prepare the computer for disassembly ([Preparation for disassembly on page 66](#)).
2. Remove the service cover ([Service cover on page 40](#)), and then remove the following components:
 1. Battery (see [Battery on page 41](#))
 2. Solid-state drives 3 and 4 (see [Solid-state drives 3 and 4 on page 42](#))
 3. Solid-state drive carrier (see [Solid-state drives 3 and 4 on page 42](#))
 4. Hard drive (see [Hard drive on page 44](#))

5. Keyboard (see [Keyboard on page 54](#))
6. Bottom case (see [Bottom case on page 66](#))

Remove the hard drive cable:

1. Disconnect the hard drive cable (1) from the system board.
2. Release the hard drive cable from the retention clips (2) built into the top cover.
3. Remove the two Phillips M2.5 × 6.0 screws (3) that secure the hard drive cable to the top cover.
4. Remove the hard drive cable (4).

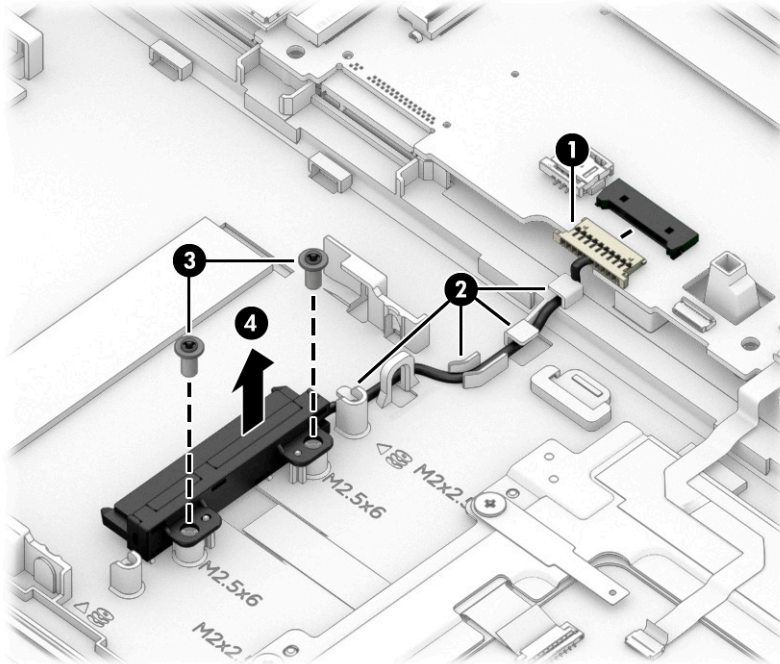

Reverse this procedure to install the hard drive cable.

Touchpad cable

To remove the touchpad cable, use this procedure and illustration.

The touchpad cable is available in the Cable Kit, spare part number M20105-001.

Before removing the touchpad cable, follow these steps:

1. Prepare the computer for disassembly ([Preparation for disassembly on page 66](#)).
2. Remove the service cover ([Service cover on page 40](#)), and then remove the following components:
 1. Battery (see [Battery on page 41](#))
 2. Solid-state drives 3 and 4 (see [Solid-state drives 3 and 4 on page 42](#))
 3. Solid-state drive carrier (see [Solid-state drives 3 and 4 on page 42](#))
 4. Hard drive (see [Hard drive on page 44](#))

5. Keyboard (see [Keyboard on page 54](#))
6. Bottom case (see [Bottom case on page 66](#))

Remove the touchpad cable:

1. Detach the touchpad cable (1) from the top cover. (The touchpad cable is attached to the top cover with double-sided adhesive.)
2. Release the ZIF connector (2) to which the touchpad cable is connected, and then disconnect the touchpad cable from the system board.
3. Release the ZIF connector (3) to which the touchpad cable is connected, and then disconnect the touchpad cable from the touchpad.
4. Remove the touchpad cable (4).

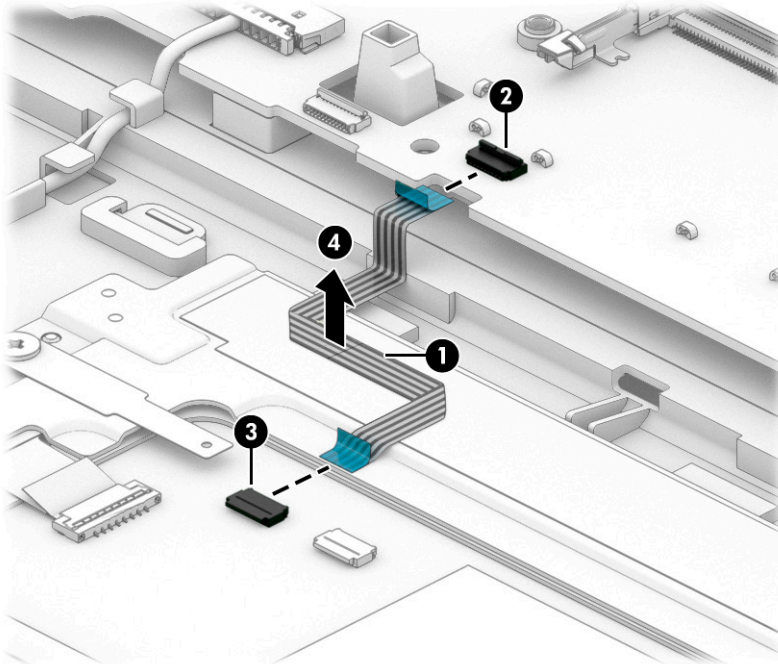

Reverse this procedure to install the touchpad cable.

Touchpad

To remove the touchpad, use this procedure and illustration.

Table 6-4 Touchpad description and part number

Description	Spare part number
NOTE: The touchpad spare part kit does not include the touchpad bracket or touchpad cable. The touchpad bracket is not available as a spare part. The touchpad cable is available in the Cable Kit, spare part number M20105-001.	
For use only on computer models equipped with NFC capability (includes NFC antenna)	M38137-001
For use only on computer models not equipped with NFC capability	M36390-001

Before removing the touchpad, follow these steps:

1. Prepare the computer for disassembly ([Preparation for disassembly on page 66](#)).
2. Remove the service cover ([Service cover on page 40](#)), and then remove the following components:
 1. Battery (see [Battery on page 41](#))
 2. Solid-state drives 3 and 4 (see [Solid-state drives 3 and 4 on page 42](#))
 3. Solid-state drive carrier (see [Solid-state drives 3 and 4 on page 42](#))
 4. Hard drive (see [Hard drive on page 44](#))
 5. Keyboard (see [Keyboard on page 54](#))
 6. Bottom case (see [Bottom case on page 66](#))

Remove the touchpad:

1. Detach the touchpad cable (1) from the top cover. (The touchpad cable is attached to the top cover with double-sided adhesive.)
2. Release the ZIF connector (2) to which the touchpad cable is connected, and then disconnect the touchpad cable from the system board.
3. Remove the four Phillips M2.0 × 2.9 screws (3) that secure the touchpad to the top cover.
4. Remove the touchpad (4).

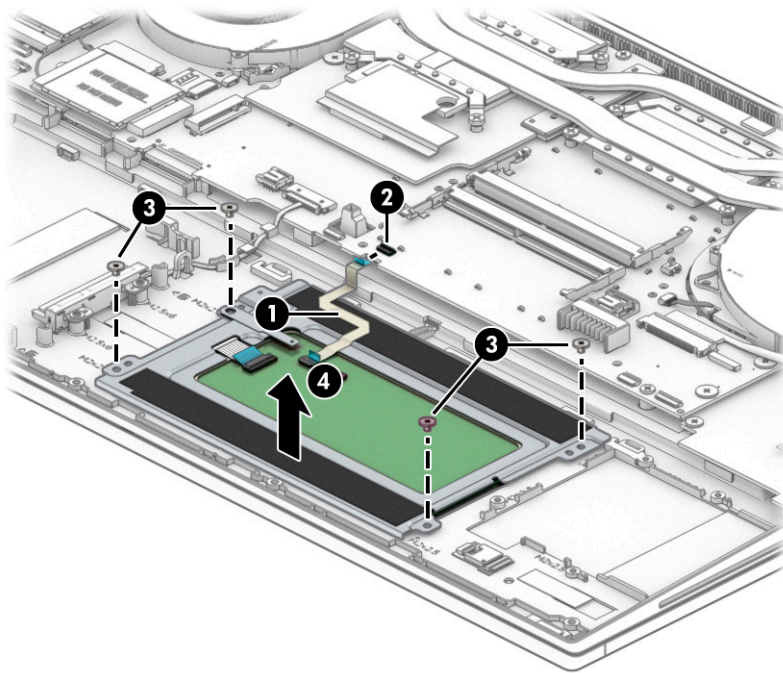

Reverse this procedure to install the touchpad.

NFC module cable

To remove the NFC module cable, use this procedure and illustration.

The NFC module cable is available in the Cable Kit, spare part number M20105-001.

Before removing the NFC module cable, follow these steps:

1. Prepare the computer for disassembly ([Preparation for disassembly on page 66](#)).
2. Remove the service cover ([Service cover on page 40](#)), and then remove the following components:
 1. Battery (see [Battery on page 41](#))
 2. Solid-state drives 3 and 4 (see [Solid-state drives 3 and 4 on page 42](#))
 3. Solid-state drive carrier (see [Solid-state drives 3 and 4 on page 42](#))
 4. Hard drive (see [Hard drive on page 44](#))
 5. Keyboard (see [Keyboard on page 54](#))
 6. Bottom case (see [Bottom case on page 66](#))

Remove the NFC module cable:

1. Release the ZIF connector **(1)** to which the NFC module cable is connected, and then disconnect the NFC module cable from the system board.
2. Release the ZIF connector **(2)** to which the NFC module cable is connected, and then disconnect the NFC module cable from the SD card board.
3. Detach the NFC module cable **(3)** from the top cover. (The NFC module cable is attached to the top cover with double-sided adhesive.)
4. Remove the NFC module cable **(4)**.

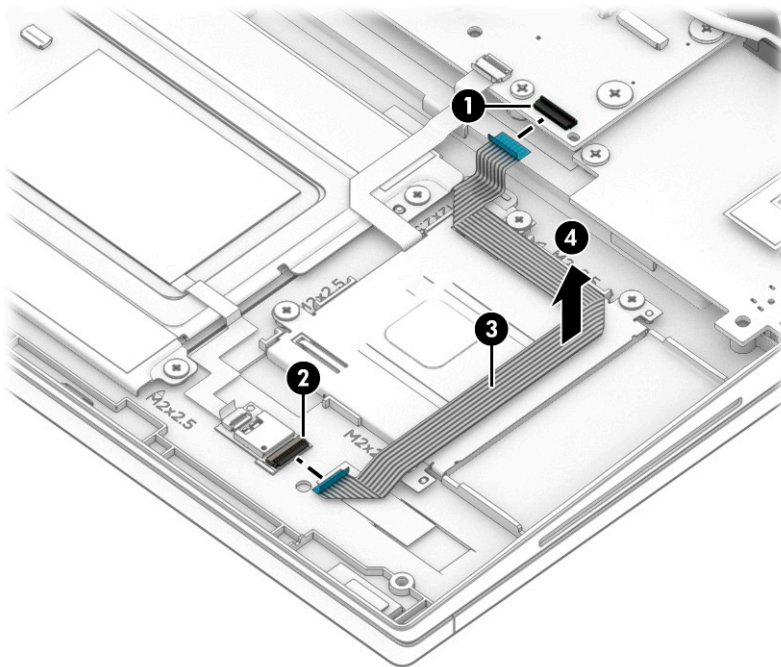

Reverse this procedure to install the NFC module cable.

NFC module

To remove the NFC module, use this procedure and illustration.



NOTE: The NFC module spare part kit includes NFC module.

Table 6-5 NFC module description and part number

Description	Spare part number
NFC module	M17065-001

NOTE: The NFC module spare part kit does not include the NFC module cable. The NFC module cable is available in the Cable Kit, spare part number M20105-001.

Before removing the NFC module, follow these steps:

1. Prepare the computer for disassembly ([Preparation for disassembly on page 66](#)).
2. Remove the service cover ([Service cover on page 40](#)), and then remove the following components:
 1. Battery (see [Battery on page 41](#))
 2. Solid-state drives 3 and 4 (see [Solid-state drives 3 and 4 on page 42](#))
 3. Solid-state drive carrier (see [Solid-state drives 3 and 4 on page 42](#))
 4. Hard drive (see [Hard drive on page 44](#))
 5. Keyboard (see [Keyboard on page 54](#))
 6. Bottom case (see [Bottom case on page 66](#))

Remove the NFC module:

1. Release the ZIF connector **(1)** to which the NFC module cable is connected, and then disconnect the NFC module cable from the system board.
2. Release the ZIF connector **(2)** to which the NFC module cable is connected, and then disconnect the NFC module cable from the NFC module.
3. Detach the NFC module cable **(3)** from the top cover. (The NFC module cable is attached to the top cover with double-sided adhesive.)

4. Detach the NFC module (4) from the top cover. (The NFC module is attached to the top cover with double-sided adhesive.)

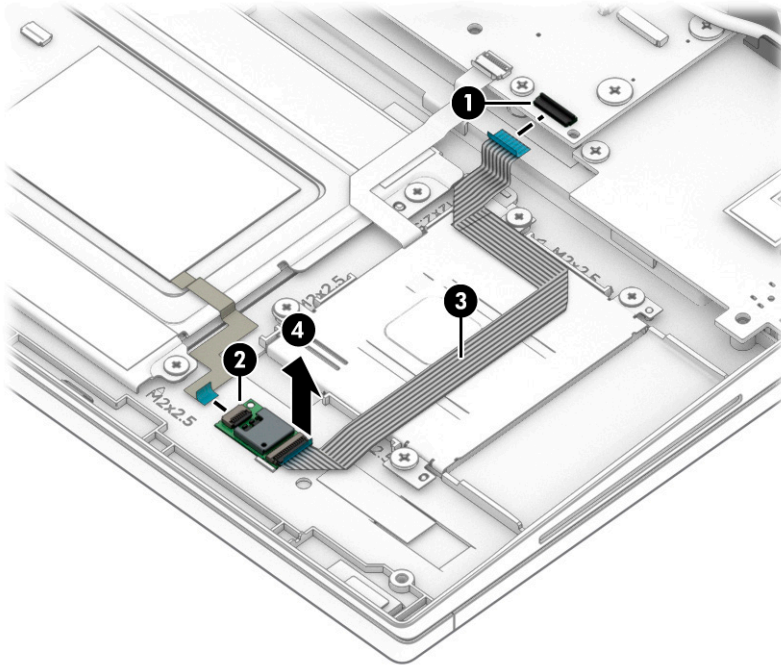

Reverse this procedure to install the NFC module and cable.

Card reader board

To remove the card reader board, use this procedure and illustration.

Table 6-6 Card reader board description and part number

Description	Spare part number
Card reader board (includes cable)	M20106-001

Before removing the card reader board, follow these steps:

1. Prepare the computer for disassembly ([Preparation for disassembly on page 66](#)).
2. Remove the service cover ([Service cover on page 40](#)), and then remove the following components:
 1. Battery (see [Battery on page 41](#))
 2. Solid-state drives 3 and 4 (see [Solid-state drives 3 and 4 on page 42](#))
 3. Solid-state drive carrier (see [Solid-state drives 3 and 4 on page 42](#))
 4. Hard drive (see [Hard drive on page 44](#))
 5. Keyboard (see [Keyboard on page 54](#))
 6. Bottom case (see [Bottom case on page 66](#))

Remove the card reader board:

1. Release the ZIF connector (1) to which the card reader board cable is connected, and then disconnect the card reader board cable from the system board.
2. Detach the card reader board cable (2) from the top cover. (The card reader board cable is attached to the top cover with double-sided adhesive.)
3. Remove the four Phillips M2.0 × 2.9 broad head screws (3) that secure the card reader board to the top cover.
4. Remove the card reader board (4) and cable.

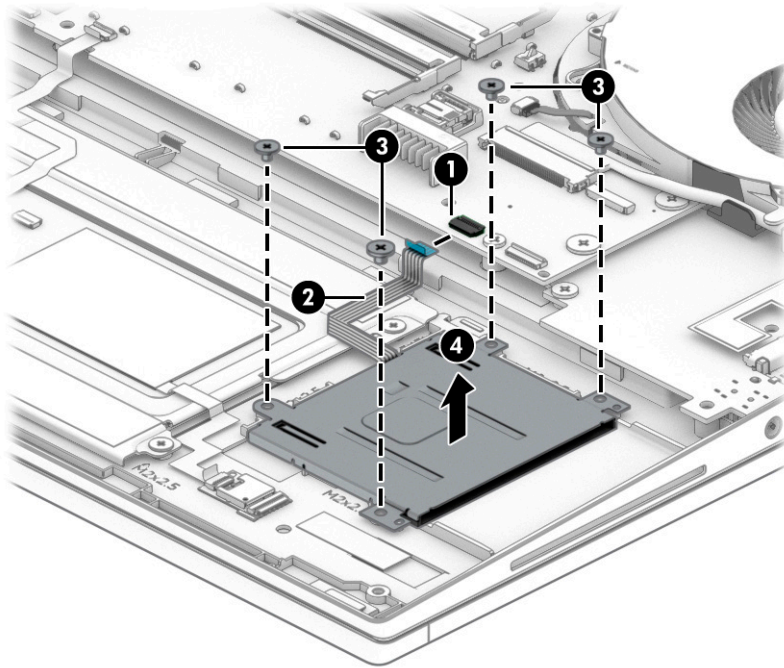

Reverse this procedure to install the card reader board and cable.

Fan/heat sink assembly

To remove the fan/heat sink assembly, use these procedures and illustrations.

Table 6-7 Fan/heat sink assembly descriptions and part numbers

Description	Spare part number
All fan/heat sink assembly spare part kits include replacement thermal material.	
For use on computer models equipped with AMD graphics cards	M20098-001
For use on computer models equipped with N19E graphics cards	M20097-001
For use on computer models equipped with N19P graphics cards	M20096-001
For use on computer models equipped with UMA graphics subsystems	M20095-001

Before removing the fan/heat sink assembly, follow these steps:

1. Prepare the computer for disassembly ([Preparation for disassembly on page 66](#)).
2. Remove the service cover ([Service cover on page 40](#)), and then remove the following components:
 1. Battery (see [Battery on page 41](#))
 2. Solid-state drives 3 and 4 (see [Solid-state drives 3 and 4 on page 42](#))
 3. Solid-state drive carrier (see [Solid-state drives 3 and 4 on page 42](#))
 4. Hard drive (see [Hard drive on page 44](#))
 5. Keyboard (see [Keyboard on page 54](#))
 6. Bottom case (see [Bottom case on page 66](#))

Remove the fan/heat sink assembly:

1. Disconnect the fan cables **(1)** from the system board.
2. Release the webcam cable **(2)** and the wireless antenna cables from the retention clips **(3)** built into the right fan.
3. Release the display panel cable from the retention clips **(4)** built into the left fan.
4. Remove the four Phillips M2.5 × 6.0 screws **(5)** that secure the the fan/heat sink assembly to the computer.
5. In the order indicated on the fan/heat sink assembly, loosen the eight captive Phillips screws **(6)** that secure the the fan/heat sink assembly to the computer.

Computer models equipped with a graphics subsystem with UMA memory have only four captive screws securing the fan/heat sink assembly to the computer.

6. Lift the front edge of the fan/heat sink assembly **(7)** until it rests at an angle.

7. Remove the fan/heat sink assembly (8) by sliding it up and forward at an angle.

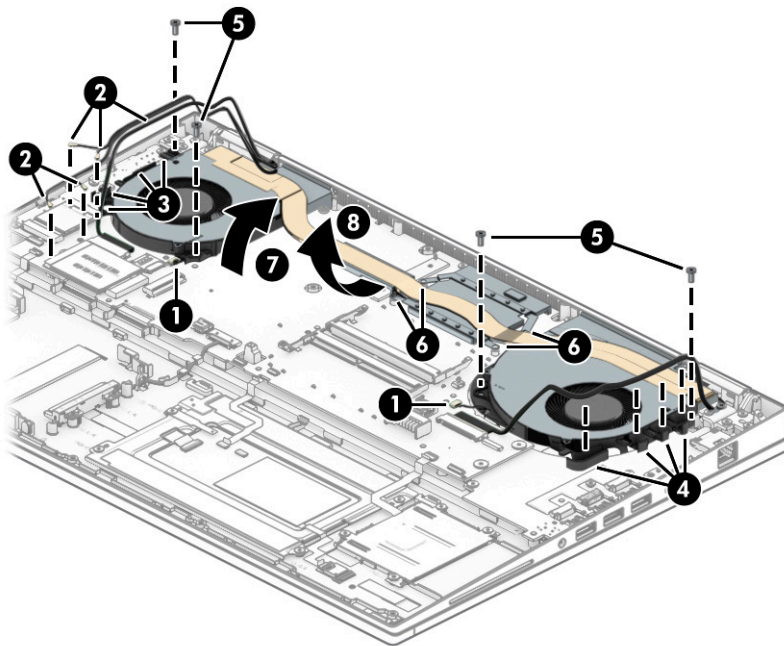
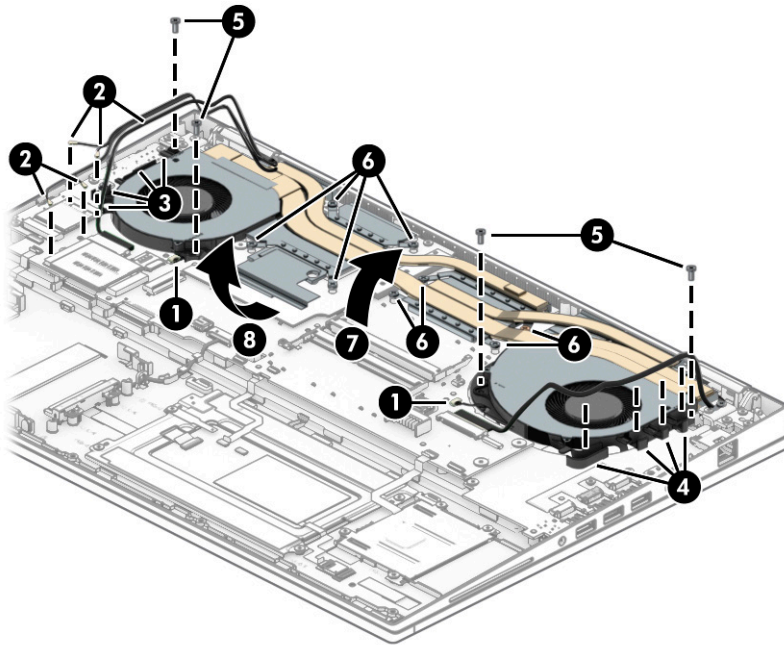

8. Thoroughly clean the thermal material from the surfaces of the fan/heat sink assembly and the system board components each time the fan/heat sink assembly is removed. Replacement thermal material is included with the fan/heat sink assembly and system board spare part kits. The following illustrations show the replacement thermal material locations.

Thermal paste is used on the processor (1) and on the fan/heat sink assembly area (2) that services the processor. Thermal pads are used on the VGA chip and other system board components (3) and the fan/heat sink assembly areas (4) that service them.

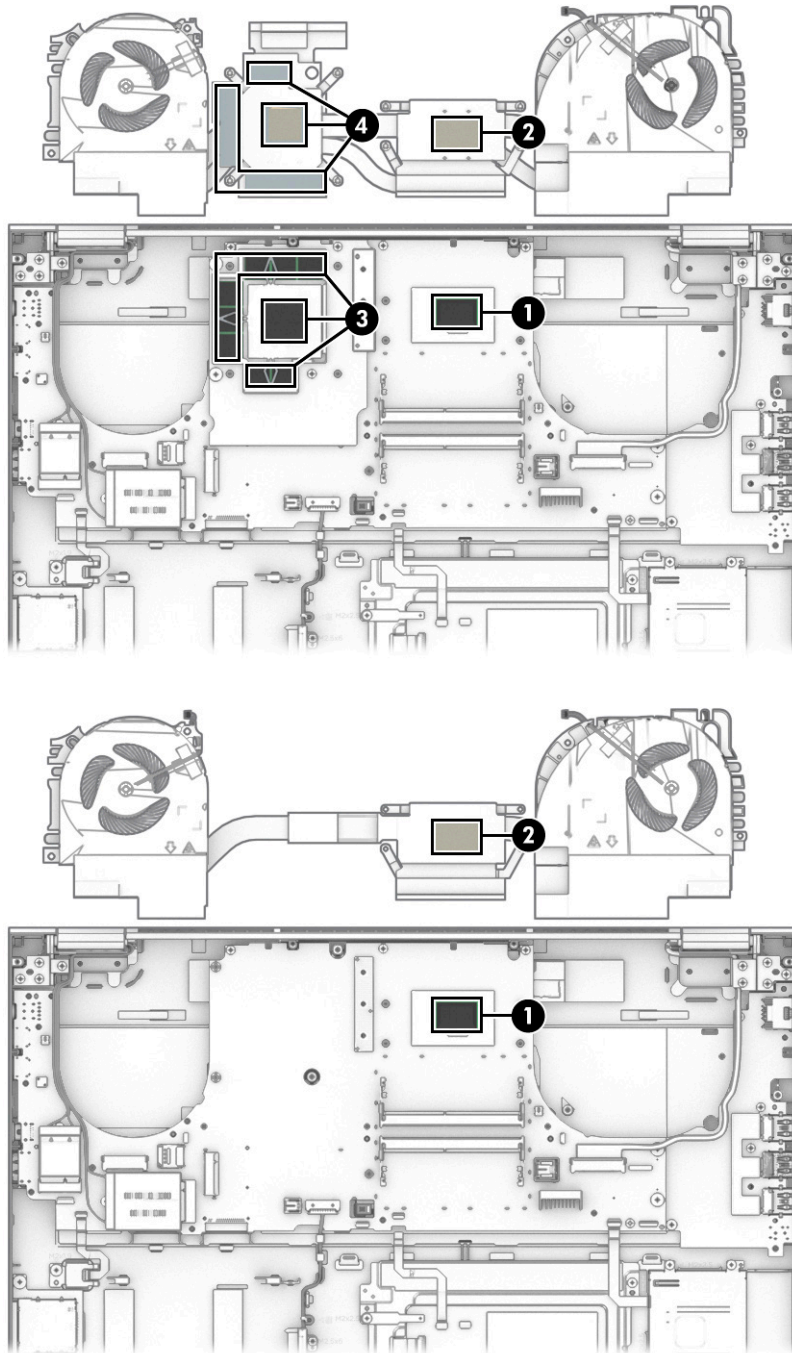

Reverse this procedure to install the fan/heat sink assembly.

43.9 cm (17.3 in) display assembly

To remove and disassemble the display assembly, use these procedures and illustrations.

The display assembly is available as both a full hinge-up assembly and at the the subcomponent level. Full hinge-up assembly spare part information is presented in the following table. Subcomponent level spare part information is available in the subcomponent level disassembly subsection.

Table 6-8 43.9 cm (17.3 in) display assembly description and part numbers

Description	Spare part number
UHD (3840×1980), Dream Vision, 550 touchscreen display assembly with webcam and infrared sensor; typical brightness: 400 nits	M20125-001
UHD (3840×1980), Dream Vision, 550 touchscreen display assembly with webcam; typical brightness: 400 nits	M20124-001
UHD (3840×1980), Dream Vision, 550 touchscreen display assembly; typical brightness: 400 nits	M20122-001
UHD (3840×1980), antiglare, 550 touchscreen display assembly with HD webcam and infrared sensor; typical brightness: 400 nits	M23512-001
UHD (3840×1980), antiglare, 550 touchscreen display assembly with HD webcam; typical brightness: 400 nits	M23511-001
UHD (3840×1980), antiglare, 550 touchscreen display assembly; typical brightness: 400 nits	M23510-001
FHD (1980×1080), antiglare, touchscreen display assembly with HD webcam and infrared sensor; typical brightness: 300 nits	M23508-001
FHD (1980×1080), antiglare, touchscreen display assembly with HD webcam and ambient light sensor; typical brightness: 300 nits	M23509-001
FHD (1980×1080), antiglare, touchscreen display assembly; typical brightness: 300 nits	M23507-001

Before removing the display assembly, follow these steps:

1. Prepare the computer for disassembly ([Preparation for disassembly on page 66](#)).
2. Remove the service cover ([Service cover on page 40](#)), and then remove the following components:
 1. Battery (see [Battery on page 41](#))
 2. Solid-state drives 3 and 4 (see [Solid-state drives 3 and 4 on page 42](#))
 3. Solid-state drive carrier (see [Solid-state drives 3 and 4 on page 42](#))
 4. Hard drive (see [Hard drive on page 44](#))
 5. Keyboard (see [Keyboard on page 54](#))
 6. Bottom case (see [Bottom case on page 66](#))
 7. Fan/heat sink assembly (see [Fan/heat sink assembly on page 79](#))

Remove the display assembly:

1. Remove the WLAN module Mylar shield (1) and the WWAN module Mylar shield.

The WLAN/WWAN module Mylar shields are included in the Mylar Kit, spare part number M23349-001.

2. Disconnect the wireless antenna cables (2) from the WLAN module and the WWAN module.

The #1/white WLAN antenna cable connects to the WLAN module **#1/Main** terminal. The #2/black WLAN antenna cable connects to the WLAN module **#2/Aux** terminal. The #5/blue WWAN antenna cable connects to the WWAN module **#5/Main** terminal. The #6/red WWAN antenna cable connects to the WWAN module **#6/Aux** terminal.

3. Disconnect the webcam module cable (3) from the system board.

4. Release the webcam module cable and the wireless antenna cables from the retention clips (4) built into the top cover.

5. Disconnect the display panel cable (5) from the system board.

6. Release the display panel cable from the retention clips (6) built into the top cover.

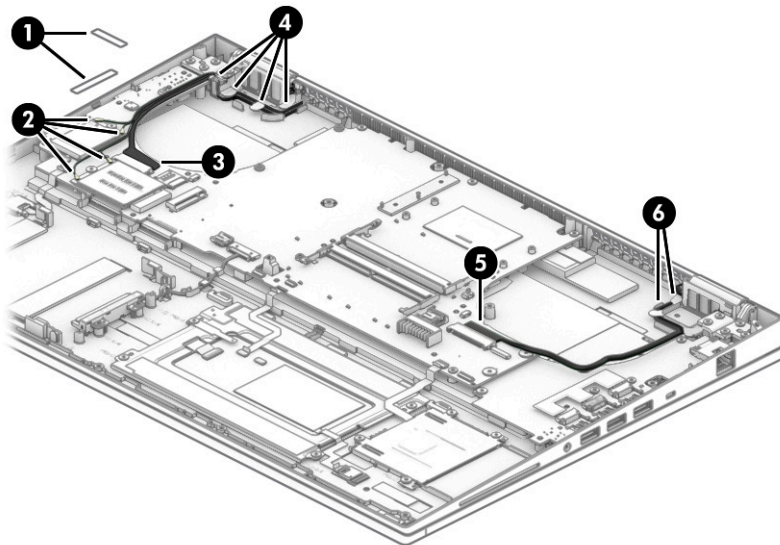

7. Remove the nine Phillips M2.5 × 6.0 screws (1) that secure the display assembly to the computer.

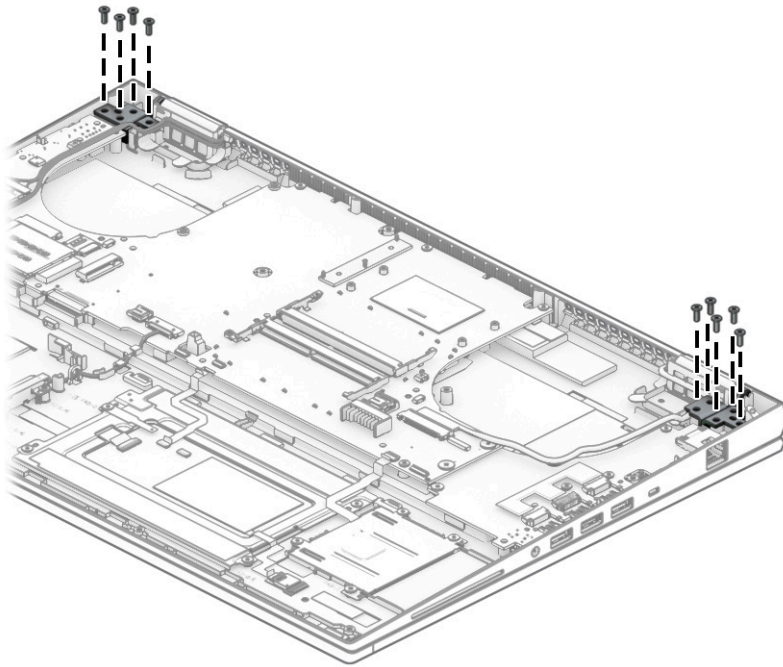

8. Swing the top edge of the display assembly (1) away from the top cover. (The top cover disengages from the display assembly hinges.)
9. Separate the display assembly (2) from the top cover.

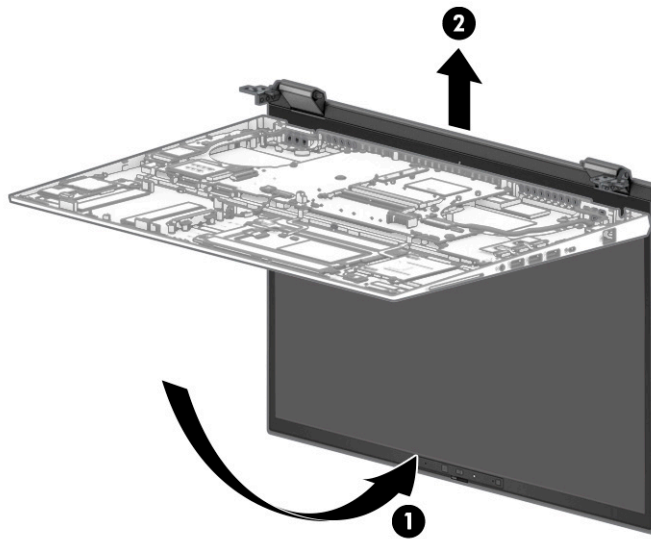

Reverse this procedure to replace the display assembly.

Beam connector

To remove the beam connector, use this procedure and illustration.

Table 6-9 Beam connector description and part number

Description	Spare part number
Beam connector (includes plastic installation tool and replacement thermal material)	M25737-001

The beam connector ships attached to a plastic installation tool which is packaged inside a sealed plastic container. Extra precautions have been taken to prevent any unnecessary contact with the pins on the beam connector, which are delicate. Take every precaution not to directly touch the beam connector when installing the beam connector.

Before removing the beam connector, follow these steps:

1. Prepare the computer for disassembly ([Preparation for disassembly on page 66](#)).
2. Remove the service cover ([Service cover on page 40](#)), and then remove the following components:
 1. Battery (see [Battery on page 41](#))
 2. Solid-state drives 3 and 4 (see [Solid-state drives 3 and 4 on page 42](#))
 3. Solid-state drive carrier (see [Solid-state drives 3 and 4 on page 42](#))
 4. Hard drive (see [Hard drive on page 44](#))
 5. Keyboard (see [Keyboard on page 54](#))
 6. Bottom case (see [Bottom case on page 66](#))
 7. Fan/heat sink assembly (see [Fan/heat sink assembly on page 79](#))

Remove the beam connector assembly:

1. Remove the three Phillips M2.0 × 2.9 broad head screws (1) that secure the beam connector and bracket to the computer.
2. Remove the beam connector bracket (2).

The beam connector bracket will be reused when installing the new beam connector.

3. Remove the beam connector (3).

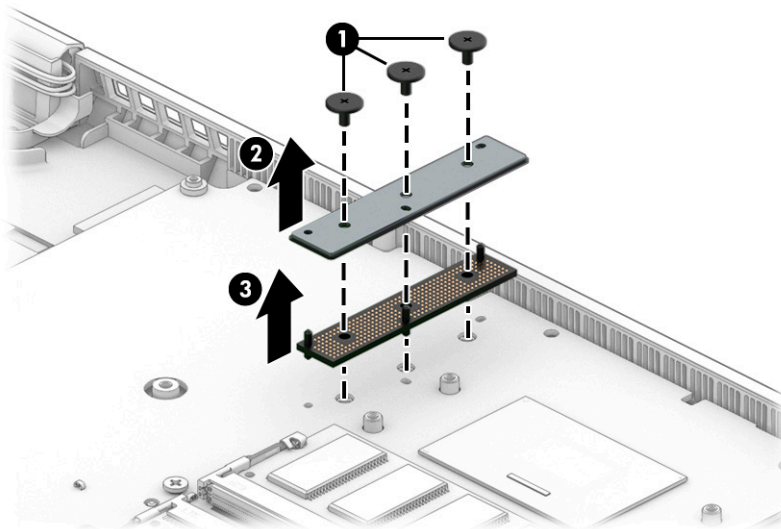

4. Align the pins on the replacement beam connector with the holes in the system board, and then carefully install the beam connector (1) onto the socket on the system board.
5. Without moving the beam connector, press the installation tool release tabs (2) together to release the beam connector.
6. Remove the installation tool (3).

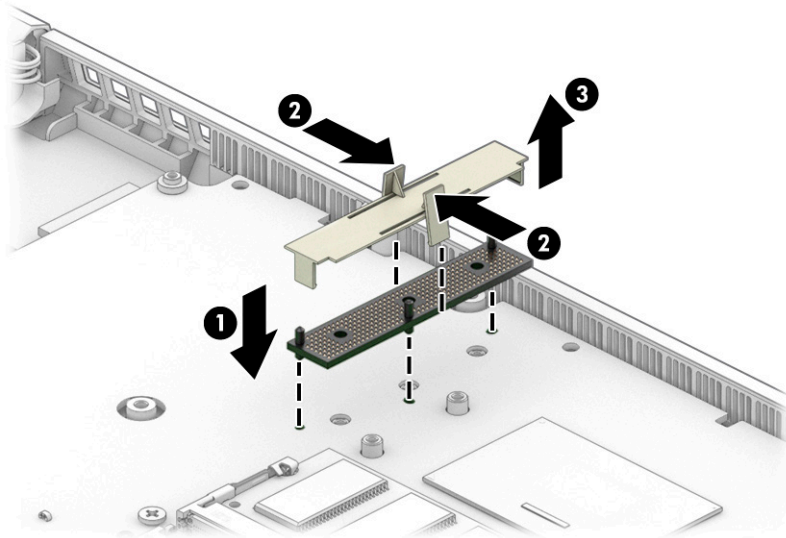

7. Align the holes on the beam connector bracket with the pins on the beam connector, and then install the beam connector bracket (1).
8. Install the three Phillips M2.0 × 2.9 broad head screws (2) to secure the beam connector and bracket to the computer.

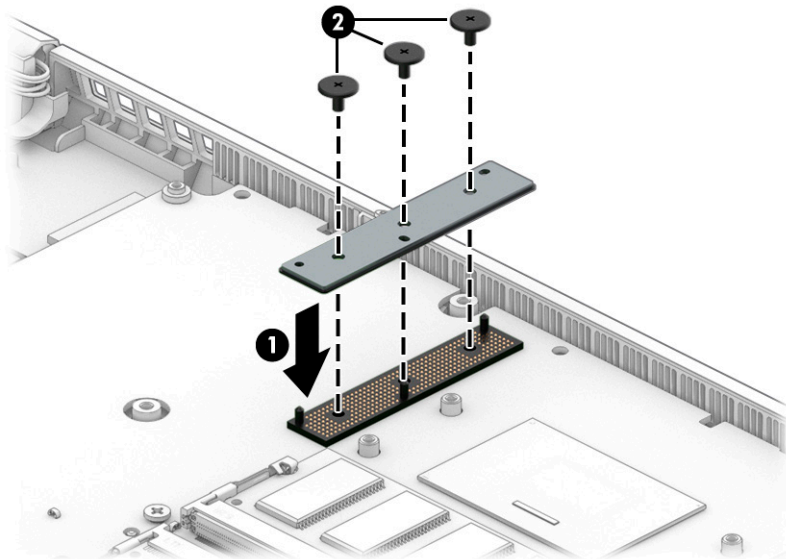

Graphics card

To remove the graphics card, use this procedure and illustration.

Table 6-10 Graphics card descriptions and part numbers

Description	Spare part number
AMD RX 5500M graphics card with 4 GB integrated memory	M17050-001
AMD W 5500M graphics card with 4 GB integrated memory	M17049-001
AMD Thermal Pad Kit	M29533-001
NVIDIA RTX 3000 graphics card with 6 GB integrated memory	M17051-001
NVIDIA RTX 4000 graphics card with 8 GB integrated memory	M17052-001
NVIDIA RTX 5000 graphics card with 16 GB integrated memory	M17053-001
NVIDIA T1000 graphics card with 4 GB integrated memory	M17054-001
NVIDIA T2000 graphics card with 2 GB integrated memory	M17055-001
NVIDIA Thermal Pad Kit	M29535-001

Before removing the graphics card, follow these steps:

1. Prepare the computer for disassembly ([Preparation for disassembly on page 66](#)).
2. Remove the service cover ([Service cover on page 40](#)), and then remove the following components:
 1. Battery (see [Battery on page 41](#))
 2. Solid-state drives 3 and 4 (see [Solid-state drives 3 and 4 on page 42](#))
 3. Solid-state drive carrier (see [Solid-state drives 3 and 4 on page 42](#))
 4. Hard drive (see [Hard drive on page 44](#))
 5. Keyboard (see [Keyboard on page 54](#))
 6. Bottom case (see [Bottom case on page 66](#))
 7. Fan/heat sink assembly (see [Fan/heat sink assembly on page 79](#))
 8. Beam connector (see [Beam connector on page 85](#))

Remove the graphics card:

1. Remove the two Phillips M2.0 × 2.9 screws (1) that secure the graphics card to the system board.

- Slide the graphics card (2) away from the system board slot and remove it.

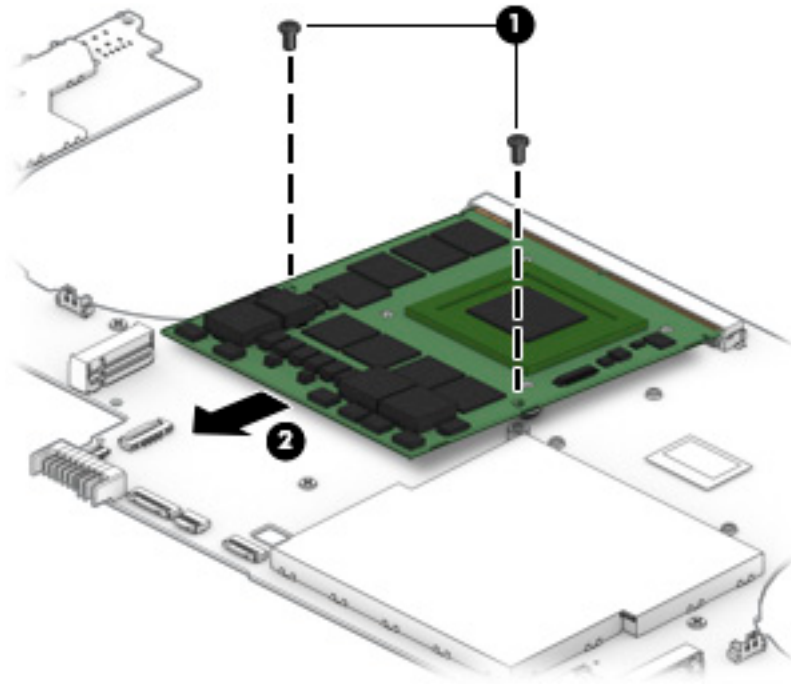

Reverse this procedure to install the graphics card.

System board

To remove the system board, use these procedures and illustrations.

Table 6-11 System board descriptions and part numbers

Description	Spare part number
NOTE: All system board spare part kits include the processor, the RTC battery, and replacement thermal material.	
Equipped with an Intel Xeon W-10885M processor and the Windows 10 operating system for use on computer models with WWAN capability	M20105-601
Equipped with an Intel Xeon W-10885M processor and a non-Windows operating system for use on computer models with WWAN capability	M20105-001
Equipped with an Intel Xeon W-10885M processor and the Windows 10 operating system for use on computer models without WWAN capability	M20104-601
Equipped with an Intel Xeon W-10885M processor and a non-Windows operating system for use on computer models without WWAN capability	M20104-001
Equipped with an Intel Core i9-10885H processor and the Windows 10 operating system for use on computer models with WWAN capability	M31404-601
Equipped with an Intel Core i9-10885H processor and a non-Windows operating system for use on computer models with WWAN capability	M31404-001
Equipped with an Intel Core i9-10885H processor and the Windows 10 operating system for use on computer models without WWAN capability	M20103-601
Equipped with an Intel Core i9-10885H processor and a non-Windows operating system for use on computer models without WWAN capability	M20103-001

Table 6-11 System board descriptions and part numbers (continued)

Description	Spare part number
Equipped with an Intel Core i7-10850H processor and the Windows 10 operating system for use on computer models with WWAN capability	M31403-601
Equipped with an Intel Core i7-10850H processor and a non-Windows operating system for use on computer models with WWAN capability	M31403-001
Equipped with an Intel Core i7-10850H processor and the Windows 10 operating system for use on computer models without WWAN capability	M20102-601
Equipped with an Intel Core i7-10850H processor and a non-Windows operating system for use on computer models without WWAN capability	M20102-001
Equipped with an Intel Core i7-10750H processor and the Windows 10 operating system for use on computer models with WWAN capability	M31402-601
Equipped with an Intel Core i7-10750H processor and a non-Windows operating system for use on computer models with WWAN capability	M31402-001
Equipped with an Intel Core i7-10750H processor and the Windows 10 operating system for use on computer models without WWAN capability	M20101-601
Equipped with an Intel Core i7-10750H processor and a non-Windows operating system for use on computer models without WWAN capability	M20101-001
Equipped with an Intel Core i5-10400H processor and the Windows 10 operating system for use on computer models with WWAN capability	M31401-601
Equipped with an Intel Core i5-10400H processor and a non-Windows operating system for use on computer models with WWAN capability	M31401-001
Equipped with an Intel Core i5-10400H processor and the Windows 10 operating system for use on computer models without WWAN capability	M20100-601
Equipped with an Intel Core i5-10400H processor and a non-Windows operating system for use on computer models without WWAN capability	M20100-001
Equipped with an Intel Core i5-10300H processor and the Windows 10 operating system for use on computer models with WWAN capability	M31400-601
Equipped with an Intel Core i5-10300H processor and a non-Windows operating system for use on computer models with WWAN capability	M31400-001
Equipped with an Intel Core i5-10300H processor and the Windows 10 operating system for use on computer models without WWAN capability	M20099-601
Equipped with an Intel Core i5-10300H processor and a non-Windows operating system for use on computer models without WWAN capability	M20099-001

Before removing the system board, follow these steps:

1. Prepare the computer for disassembly ([Preparation for disassembly on page 66](#)).
2. Remove the service cover ([Service cover on page 40](#)), and then remove the following components:
 1. Battery (see [Battery on page 41](#))
 2. Solid-state drives 3 and 4 (see [Solid-state drives 3 and 4 on page 42](#))
 3. Solid-state drive carrier (see [Solid-state drives 3 and 4 on page 42](#))
 4. Hard drive (see [Hard drive on page 44](#))

5. Keyboard (see [Keyboard on page 54](#))
6. Memory module compartment cover for memory module 1 and 3 (see [Memory modules 1 and 3 on page 58](#))
7. Solid-state drive 1 (see [Solid-state drive 1 on page 62](#))
8. Bottom case (see [Bottom case on page 66](#))

When you replace the system board, be sure to remove the following components (as applicable) from the defective system board and install them on the replacement system board:

- WLAN module (see [WLAN module on page 46](#)).
- WWAN module (see [WWAN module on page 47](#)).
- Solid-state drive 2 (see [Solid-state drive 2 on page 49](#)).
- Memory modules (see [Memory modules 2 and 4 on page 51](#) and [Memory modules 1 and 3 on page 58](#)).
- Fan/heat sink assembly (see [Fan/heat sink assembly on page 79](#)).

Remove the system board:

1. Turn the computer right side up with the front toward you.
2. Open the computer.
3. Disconnect the speaker cable from the system board.

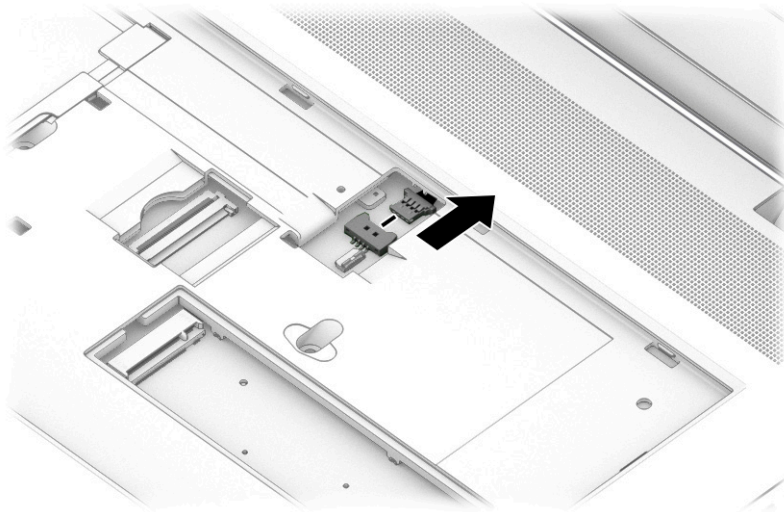

4. Close the computer.
5. Turn the computer upside down with the front toward you.
6. Remove the WLAN module Mylar shield **(1)**.
7. Disconnect the wireless antenna cables **(2)** from the WLAN module.

The WLAN module Mylar shield is included in the Mylar Kit, spare part number M23344-001.

The #1 WLAN antenna cable connects to the WLAN module **#1/Main** terminal. The #2 WLAN antenna cable connects to the WLAN module **#2/Aux** terminal.

8. Release the webcam cable and the wireless antenna cables from the retention clips **(3)** built into the right fan.
9. Disconnect the webcam cable **(4)** and the display panel cable **(5)** from the system board:
10. Release the display panel cable from the retention clips **(6)** built into the left fan.
11. Disconnect the following cables from the system board:
 - NFC module cable (ZIF) **(7)**
 - Card reader board cable (ZIF) **(8)**
 - Touchpad cable (ZIF) **(9)**
 - Hard drive cable **(10)**
12. Remove the WWAN module Mylar shield **(11)**.
The WWAN module Mylar shield is included in the Mylar Kit, spare part number M23344-001.
13. Disconnect the wireless antenna cables **(12)** from the WWAN module.
The #5/blue WWAN antenna cable connects to the WWAN module **#5/Main** terminal. The #6/red WWAN antenna cable connects to the WWAN module **#6/Aux** terminal.
14. Disconnect the following cables from the system board:
 - Fingerprint reader module cable (ZIF) **(13)**
 - SD card board cable (ZIF) **(14)**

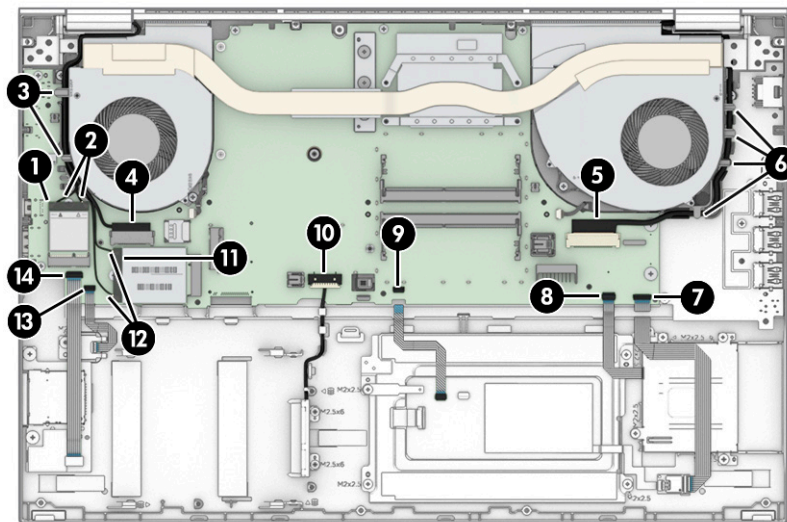

15. Remove the following screws:
 - Five Phillips M2.5 × 6.0 screws **(1)** that secure the system board to the computer
 - Four Phillips M2.5 × 6.0 screws **(2)** that secure the fans to the computer
 - Two Phillips M2.0 × 2.9 screws **(3)** that secure the system board to the computer

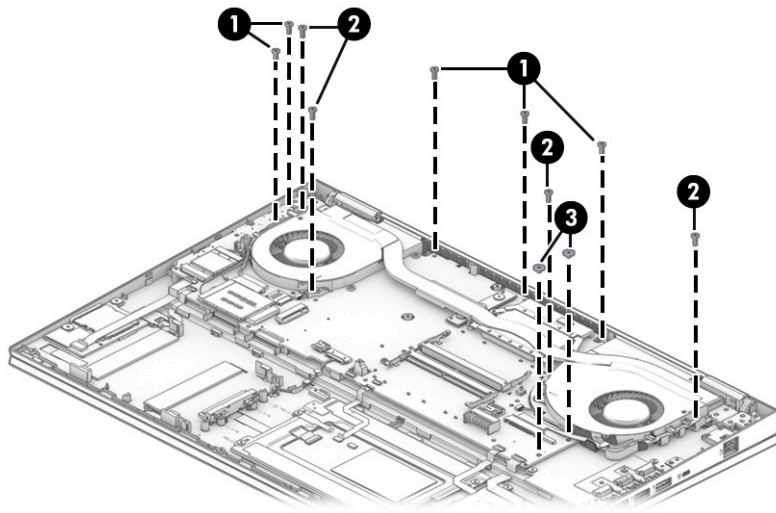

16. Lift the front/right edge of the system board (1) until it rests at an angle.
When the system board is released, it is disconnected (2) from the I/O board (2).

17. Remove the system board (3).

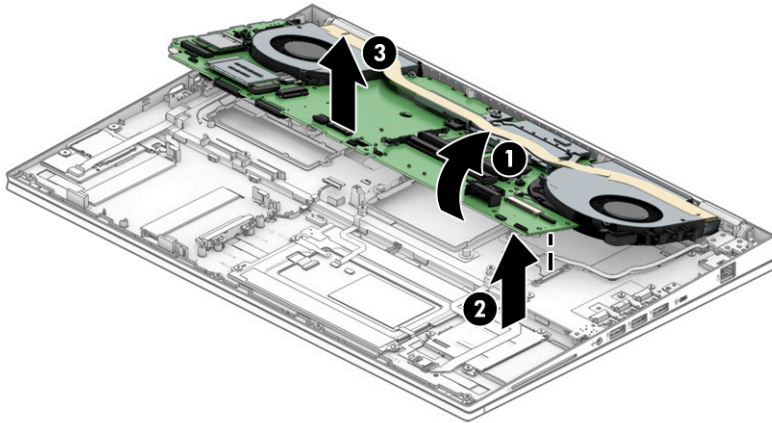

A thermal pad services the chip (1) on the top of the system board and is located on the heat sink (2) built into the top cover. This pad should be inspected each time that the cover is removed. This pad is intended to be reused if it is not damaged. If this pad is damaged and any residue remains on the system board chip or top cover, it should be thoroughly removed and replaced. If protective releasing paper is attached to the thermal pad, it should be removed prior to replacement.

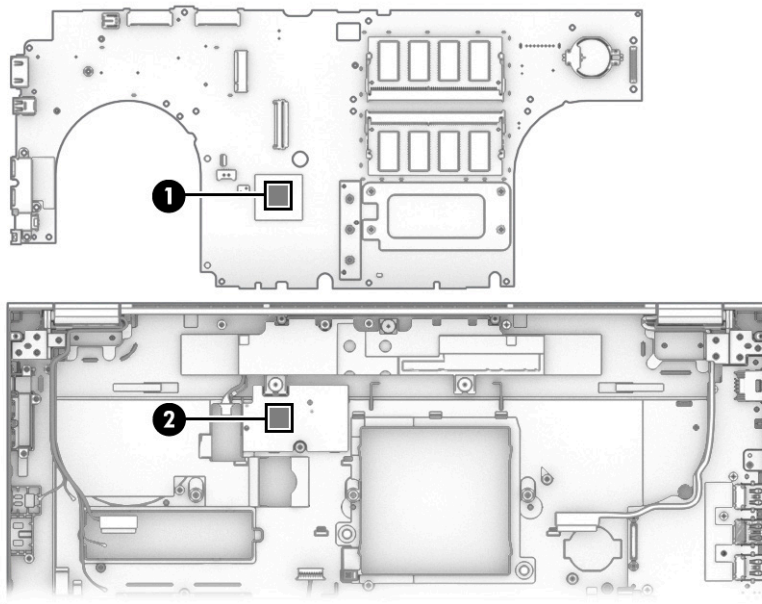

Reverse this procedure to install the system board.

RTC battery

To remove the RTC battery, use this procedure and illustration.

Table 6-12 RTC battery description and part number

Description	Spare part number
RTC battery	xxxxxx-001

Before removing the RTC battery, follow these steps:

1. Prepare the computer for disassembly ([Preparation for disassembly on page 66](#)).
2. Remove the service cover ([Service cover on page 40](#)), and then remove the following components:
 1. Battery (see [Battery on page 41](#))
 2. Solid-state drives 3 and 4 (see [Solid-state drives 3 and 4 on page 42](#))
 3. Solid-state drive carrier (see [Solid-state drives 3 and 4 on page 42](#))
 4. Hard drive (see [Hard drive on page 44](#))
 5. Keyboard (see [Keyboard on page 54](#))
 6. Fan/heat sink assembly (see [Fan/heat sink assembly on page 79](#))
 7. System board (see [System board on page 89](#))

Remove the RTC battery:

1. Turn the removed system board upside down with the front toward you.
2. Insert a case utility tool (**1**) or similar thin plastic tool into the slot on the RTC battery socket and remove the RTC battery (**2**) from the socket.

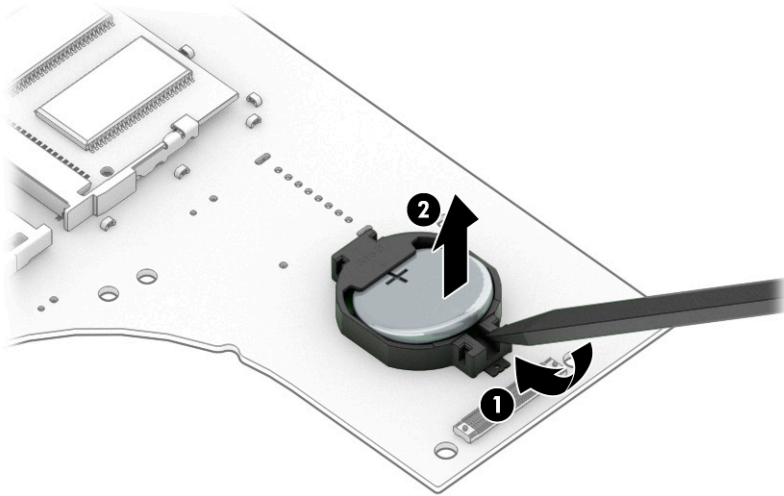

Reverse this procedure to install the RTC battery.

I/O board

To remove the I/O board, use this procedure and illustration.

Table 6-13 I/O board description and part number

Description	Spare part number
NOTE: The I/O board includes an I/O board includes audio jack, 3 USB ports, and a RJ45 jack.	
For use only on vPro computer models	M20126-001
For use only on non-vPro computer models	M20127-001

Before removing the I/O board, follow these steps:

1. Prepare the computer for disassembly ([Preparation for disassembly on page 66](#)).
2. Remove the service cover ([Service cover on page 40](#)), and then remove the following components:
 1. Battery (see [Battery on page 41](#))
 2. Solid-state drives 3 and 4 (see [Solid-state drives 3 and 4 on page 42](#))
 3. Solid-state drive carrier (see [Solid-state drives 3 and 4 on page 42](#))
 4. Hard drive (see [Hard drive on page 44](#))
 5. Keyboard (see [Keyboard on page 54](#))
 6. Fan/heat sink assembly (see [Fan/heat sink assembly on page 79](#))
 7. System board (see [System board on page 89](#))

Remove the I/O board:

1. Remove the three Phillips M2.5 × 6.0 screws **(1)** that secure the I/O board to the computer.
2. Remove the Phillips M2.5 × 3.6 screw **(2)** that secures the I/O board to the computer.

3. Remove the I/O board (3).

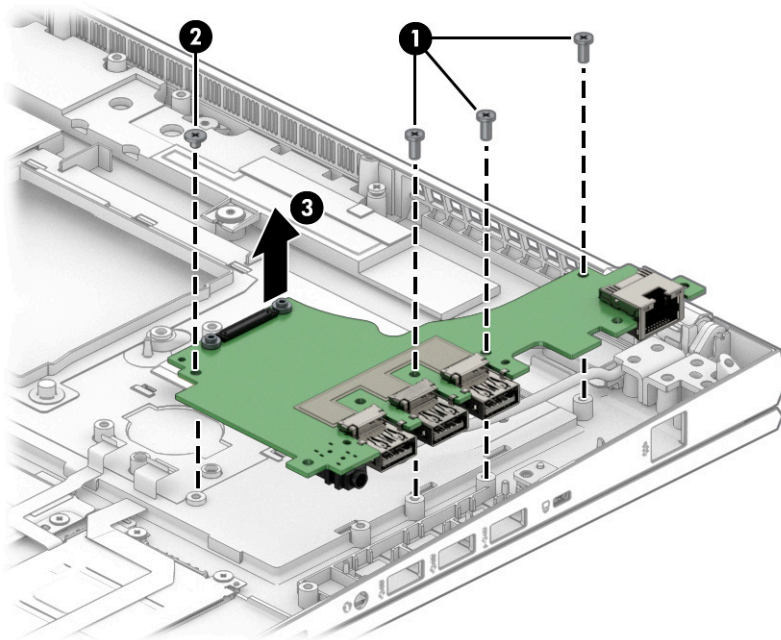

When removing or replacing the I/O board, make sure the security lock bracket is installed correctly, as shown in the following illustration. The security lock bracket is included in the Bracket Kit, spare part number M20094-001.

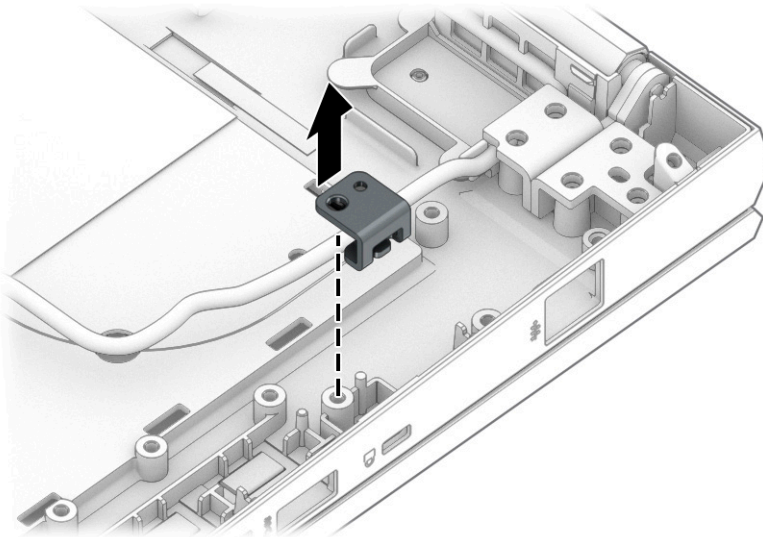

Reverse this procedure to install the I/O board.

Speakers

To remove the speakers, use this procedure and illustration.

Table 6-14 Speaker description and part number

Description	Spare part number
Speaker Kit (includes three rubber isolators)	M17067-001

Before removing the speakers, follow these steps:

1. Prepare the computer for disassembly ([Preparation for disassembly on page 66](#)).
2. Remove the service cover ([Service cover on page 40](#)), and then remove the following components:
 1. Battery (see [Battery on page 41](#))
 2. Solid-state drives 3 and 4 (see [Solid-state drives 3 and 4 on page 42](#))
 3. Solid-state drive carrier (see [Solid-state drives 3 and 4 on page 42](#))
 4. Hard drive (see [Hard drive on page 44](#))
 5. Keyboard (see [Keyboard on page 54](#))
 6. Bottom case (see [Bottom case on page 66](#))
 7. System board (see [System board on page 89](#))

Remove the speakers:

1. Remove the three Phillips M2.0 × 2.9 broad head screws (1) that secure the speakers to the top cover.
2. Remove the speakers from the computer (2).

When removing the speakers, make note of the location of the rubber isolator locations (3). The absence of or damage to these isolators can result in degraded speaker performance.

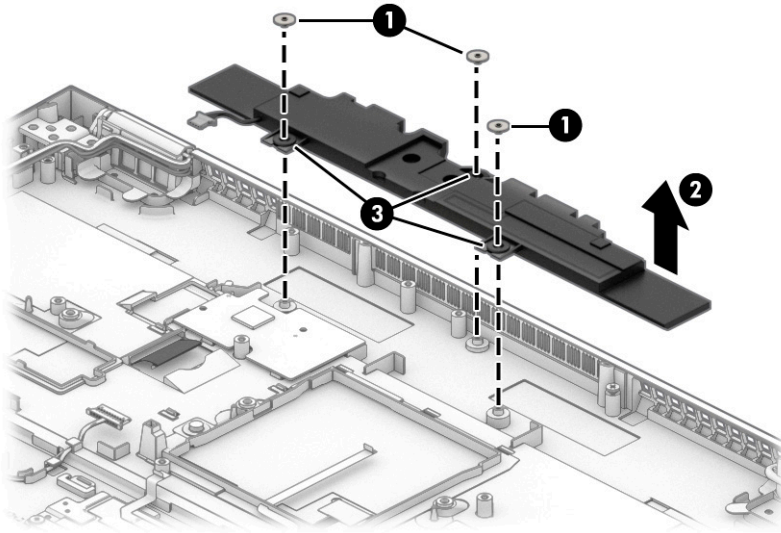

Reverse this procedure to install the speakers.

7 Troubleshooting guide

This chapter primarily focuses on troubleshooting HP Mobile Workstations. The information is provided so that you can solve problems yourself or at least narrow down the number of possible causes.

Based on some of the most common symptoms, this chapter identifies logical steps and available resources or tools for resolving an issue. HP recommends that you follow the instructions carefully, observe safety precautions, and note any observations or results. Capturing this information can help identify and resolve the problem more quickly.

 **WARNING!** To reduce the risk of electric shock or damage to the equipment:

- Do not disable the power cord grounding plug. The grounding plug is an important safety feature.
- Plug the power cord into a grounded (earthed) outlet that is easily accessible at all times.
- Disconnect power from the equipment by unplugging the power cord from the AC outlet.
- Before disassembling notebooks, always disconnect power and remove the battery.

 **IMPORTANT:** Static electricity can damage the electronic components of the computer. To prevent damage to the computer, carefully observe the electrostatic discharge precautions.

- Discharge static electricity by briefly touching a grounded metal object before you begin.
- Work on a static-free mat.
- Wear a static strap to ensure that any accumulated electrostatic charge is discharged from your body to the ground.
- Create a common ground for the equipment that you are working on by connecting the static-free mat, static strap, and peripheral units to that piece of equipment.
- For more information, see [Electrostatic discharge information on page 34](#).

IMPORTANT: The computer includes customer self-repair parts and parts that should be accessed only by an authorized service provider. Accessing parts described in the chapter titled "Removal and replacement procedures for authorized service provider only parts" can damage the computer or void the computer warranty.

Resources

Use this table to locate troubleshooting resources.

Table 7-1 Troubleshooting resources and their descriptions

HP Resource Tool	Description	Link
HP Elite Support	Provides live HP Premium support (available 24/7) to Elite computers.	http://www8.hp.com/us/en/ads/elite-products/overview.html
HP Customer Support	Provides important support, such as warranty, support cases, drivers, Customer Advisories, Customer and Security Bulletins, and Product Change Notices.	https://support.hp.com/us-en/contact-hp
Subscribers Choice	Allows you to sign up for HP product updates.	http://www8.hp.com/us/en/subscribe/
HP Support Forums	Provide discussions about HP products and issues.	http://h30434.www3.hp.com/psg/
Service Access Workbench (SAW) (available for technicians and Business Partners only)	Provides navigable content intended for use by internal and outsourced call center staff and can be a resource for support and product division professionals.	http://sawpro.atlanta.hp.com/km/saw/home.do
Vendors' web sites	Provide additional information for associated components such as Intel (processor, WLAN), Microsoft (Windows 7, 8, 10), AMD®/NVIDIA® (GPU), and so on.	http://www.intel.com/content/www/us/en/homepage.html http://www.amd.com http://www.nvidia.com

General troubleshooting steps

This section helps you become familiar with troubleshooting methodology and efficiently resolve problems.

Proceed through the steps in the following table until the issue is resolved, and then move on to the next step that is relevant to the issue. For example, if you resolve a memory issue using the HP PC Diagnostics (UEFI) tool in step 6, you can then move on to step 10 to reseat the memory into its memory slot.



NOTE: You can ignore troubleshooting steps that do not apply to your issue.

Table 7-2 Troubleshooting methodology and general troubleshooting steps

Identify issue	Analyze issue	Resolve issue	Verify solution
1. Understand the issue on page 103	5. Remove or uninstall recently added hardware, software on page 108	8. Hard reset on page 115	Verify solution on page 120
2. Examine the environment on page 106	6. HP Hardware Diagnostics and Tools on page 109	9. Soft reset (Default Settings) on page 116	
3. Perform a visual inspection of hardware on page 106	7. Status lights, blinking light codes, troubleshooting lights, and POST error messages on page 112	10. Reseat cables and connections on page 116	
4. Update BIOS and drivers on page 107		11. Test with minimum configuration on page 118	
		12. Test with verified working configuration (hardware or operating system) on page 119	
		13. Replace the system board on page 119	

Identify the issue

Use these guidelines to correctly determine the problem.

1. Understand the issue

It is important to understand the issue that occurred, including related symptoms. It helps to understand the basic computer boot-up sequence as well as the failure itself.

Boot up sequence

The computer performs several steps after you press the power button or restart the computer.

It is important to understand where in the boot-up sequence the symptoms occur. The following table lists the phases of the boot-up sequence and explains the symptoms that may occur in each phase. For example, a blue screen error (BSOD) often occurs during the performance phase.

Table 7-3 Boot-up sequence and associated failures

Item	Procedure
Startup	<p>After you press the power button, the computer boots after all internal power rails (such as 5 V, 3.3 V) are stable.</p> <p>Confirm that power lights are on and fan is spinning.</p> <p>Common issues: all lights are off; troubleshooting lights are on; computer does not boot; video is absent.</p>
POST (UEFI/BIOS)	<p>Power-On Self-Test (POST) verifies that hardware components (such as processor, hard drive, memory) are functional. When POST is complete, the HP logo appears briefly and then disappears.</p> <p>If there are errors, the computer may exhibit blinking lights and POST error messages, and so on.</p> <p>Common issues: lights blink; error message appears; system hangs (lock up or freezes)</p>
Performance (operating system)	<p>System boots to operating system, and Windows logo screen appears.</p> <p>Common issues: hangs, blue screen, distorted video, driver conflict, slow performance, display issue (dead pixel), I/O issue (no speaker sound), wireless/audio unavailable, noise.</p> <p>See Analyze the issue on page 108 table for detailed troubleshooting information.</p>

Failure classification

Failure classification is a breakdown of different types of failures and symptoms that could occur during the boot-up sequence.

[Failure classification by boot-up sequence on page 104](#) and [Failure classification by hardware devices on page 105](#) represent the failure classification for common notebook failures.

[Failure classification by boot-up sequence on page 104](#) categorizes failures by the boot-up sequence.

1. Power-on: Common issues are no power, recycle, or reboot.
2. POST: Common issues are no boot (despite power), light flash, or diagnostics error.
3. Performance: Common issues are Intermittent Loss of Power, Blue Screen, Hang. In many cases, issues can be identified and associated with particular hardware (for example, display or storage).

[Failure classification by hardware devices on page 105](#) categorizes failures by hardware:

- Display
- I/O (input/output) devices
- Storage
- Mechanical

A single symptom can be listed under different groups. For example, No Video can belong to (1) power-on or (4) display; but flickering when turned on should be listed in (4) display. Or, in another example, a blue screen can be caused by a driver conflict in performance (4), but it can also be caused by a defective hard drive under (6) storage. Therefore, failures that share similar symptoms are noted.

If possible, make a record of the failure symptom, the phase of the boot-up sequence where the failure occurs, and the most likely location in the failure tree ([Failure classification by boot-up sequence on page 104](#) and [Failure classification by hardware devices on page 105](#)). This record helps isolate the issue and indicate the next steps. For example, when the computer is running the operating system, it can experience an issue with (4) display, (5) I/O devices (keyboard, wireless, and so on), (6) storage, or (7) mechanical components (stuck buttons, thermal shutdown, and so on).



NOTE: *Uncategorized* is used if an issue found is not listed. For example, Bluetooth is offered on certain hardware configurations; therefore, you can classify a Bluetooth issue under I/O Device if needed.

Failure classification by boot-up sequence

Use this table to locate failure classification information.

Table 7-4 Failure classification by boot-up sequence

1. Power-on	2. POST	3. Performance
1. No power on page 124	1. No video (with power) on page 132	1. Intermittent shutdown on page 135^a
2. Intermittent power-on, shutdown, reboot on page 126^a	2. Blinking lights on page 133	2. Blue screen on page 136^b
3. AC adapter issue on page 127	3. Diagnostic error messages on page 133	3. Freeze at Windows Logo (hang or lockup) on page 136
4. Battery not recognized, not charging on page 128	4. BIOS password on page 134	4. Electromagnetic Interference (EMI) on page 137
5. Battery discharges too fast on page 130		5. No wake up on page 138
6. Burnt smell on page 130		6. Unresponsive on page 139
		7. Slow performance on page 140^c
		8. HP Smart Adapter warning message on page 140
		9. Incorrect time and date on page 141

^{a,b,c} similar symptoms

Failure classification by hardware devices

To determine failure by device, use this table.

Table 7-5 Failure classification by hardware devices

4. Display	5. I/O devices	6. Storage	7. Mechanical
1. Display anomalies on page 143	1. Keyboard on page 150	1. Hard drive or solid-state drive not recognized on page 159	1. Noise (sound) on page 164
2. Dead pixel on page 145	2. Keyboard pointing stick on page 151	2. No boot to operating system (no read-write error) on page 160	2. Fan runs constantly on page 164
3. No video (internal) on page 145^d	3. Keyboard backlight on page 151	3. Read-write error on page 161	3. Thermal shutdown (hot) on page 166
4. No video (external) on page 145^d	4. Touchpad on page 152	4. Slow performance on page 162^c	
5. DisplayPort/VGA on page 146	5. Network connectivity (RJ-45 jack) on page 152	5. Blue screen (BSOD) error on page 162^b	
6. HDMI on page 146	6. Network connectivity wireless (WLAN) on page 153	6. Noisy hard drive on page 162	
7. No or bad external video via docking on page 147	7. WWAN on page 153		
8. Incorrect or missing color/distorted image on page 147	8. USB on page 154		
9. Touch screen on page 148	9. Smart card reader on page 155		
	10. Speaker, headphone - audio issues on page 156		
	11. Thunderbolt (TB) on page 157		

^{b,c,d} similar symptoms

2. Examine the environment

It is important to examine the computer's environment. If you can quickly identify the cause of the issue, fewer resolution steps might be needed. Perform the following environment inspections:

- Check all cables and connections to be sure that no connections are loose.
- Confirm that power sources are good, such as AC outlet or adapter (110 V/220 V ac), power strip. Test with a verified working AC outlet.
- Check for compatibility issues between the computer and third-party devices, peripherals, uncertified devices, incompatible hardware (for instance, Mac OS device). Incompatibility can result in blue screen errors, improper operation, and so on.
- Isolate the computer from sources of electromagnetic interference (EMI), such as cell phones, two-way radios, floor mats, fans (and other electronic motors). EMI may contribute to a display freeze issue or lock-up.

3. Perform a visual inspection of hardware

Perform a physical inspection of the computer.

- Look for abnormalities such as a cracked display, dented battery, broken latches for battery bay, keyboard key caps popped out, dust over connectors, liquid spill over keyboard.
- Look for signs of drop, movement, or vibration that may cause internal and external loose connections.

4. Update BIOS and drivers

Whenever possible, update to the latest BIOS, firmware, and drivers before troubleshooting.



IMPORTANT: Note that some customer company policies prohibit updates. Check your company policy before taking action.

The updates may include fixes for your computer issues, and they may also enhance system performance. HP continually improves the update process to make it easier. You can update the BIOS locally through a manual process, through an automatic installation, or through a remote installation on multiple units.

Manually updating BIOS and drivers

Use this information to update the BIOS.

- To manually update the BIOS and drivers, see the Setup Utility (BIOS) chapter.
- See the specific BIOS update installation instructions that accompany the download.

Remotely deploying the BIOS and drivers

Instead of manually searching for and downloading each SoftPaq, users and IT personnel can use two tools to identify and download all appropriate SoftPaqs for the selected HP models.

- HP SoftPaq Download Manager (SDM) is a software tool that streamlines the download, extraction, and installation process of SoftPaqs, including BIOS and drivers.
- HP System Software Manager (SSM) is a software tool that simplifies the deployment of SoftPaqs to HP computers.

Analyze the issue

Use these steps to evaluate and interpret the problem.

5. Remove or uninstall recently added hardware, software

HP has designed this computer and validated it using a full-range hardware and software qualification matrix. If an issue appears to have started recently, it may be related to the recent addition of hardware or software.

A good method to determine the root cause is to remove recently added components or uninstall applications one at a time and restart the computer when necessary.



IMPORTANT: After you have completed the process of uninstalling hardware or software and are ready to reinstall, be sure that the new device is seated properly and all cables are correctly connected. After installing the device, restart the computer, and make sure the new device is turned on. In addition, if the new device is a root cause of a problem, it could cause a conflict in drivers or incompatibility issues with other installed programs. For any new hardware you have added, be sure to install the latest drivers available from the device vendor website.

6. HP Hardware Diagnostics and Tools

HP offers diagnostics and tools to diagnose hardware failure. This section describes how to use some of these tools. Make sure to check for the latest versions before use.

HP PC Hardware Diagnostics (UEFI)

HP PC Hardware Diagnostics is a Unified Extensible Firmware Interface (UEFI) that allows you to run diagnostic tests to determine whether the computer hardware is functioning properly.

The HP PC Hardware Diagnostics (UEFI) tool is built within BIOS (basic memory and hard drive diagnostics only), or within new hard drives themselves. These drives contain more advanced versions of the diagnostic tool than the BIOS-based version.

In addition, for HP authorized service partners and IT professionals who need to support a mixed environment of older and newer HP/Compaq PCs, the HP PC Hardware Diagnostics Tool (http://www8.hp.com/us/en/campaigns/hpsupportassistant/pc-diags.html?jumpid=va_r602_us/en/any/pps/pl_ot_ob_ds_pd/HP_PC_Hardware_Diagnostics_cc/dt) supports a wide range of HP computers.

The tool runs outside the operating system so that it can isolate hardware failures from software issues, whether caused by the operating system or applications. In reality, you can determine many problems using this tool if the issue is a defective part or a loose connection (for example, reseating the keyboard cable after the tool reports a keyboard error).

The tool has three major functions:

- System Tests check the computer's hardware to verify that everything is functioning properly. If your system won't boot into Windows, try the Quick System Test. For more comprehensive testing, use the Extensive System Test option. If the System Test did not detect a hardware problem, continue with the Component Tests.
 - Component Tests focus on selected hardware components in your computer.
 - Firmware Management update your computer's BIOS to the latest version (available separately) or rolls back to a previous version.
1. Turn on or restart the computer, quickly press the **esc** key on the computer, and then press **f2**. The BIOS searches three places for the diagnostic tools, in the following order:
 - 1. Connected USB drive
 - 2. Hard drive
 - 3. BIOS

- When the diagnostic tool opens, use the keyboard arrow keys to select the type of diagnostic test you want to run, and then follow the on-screen instructions.

Screen capture appearance may vary.

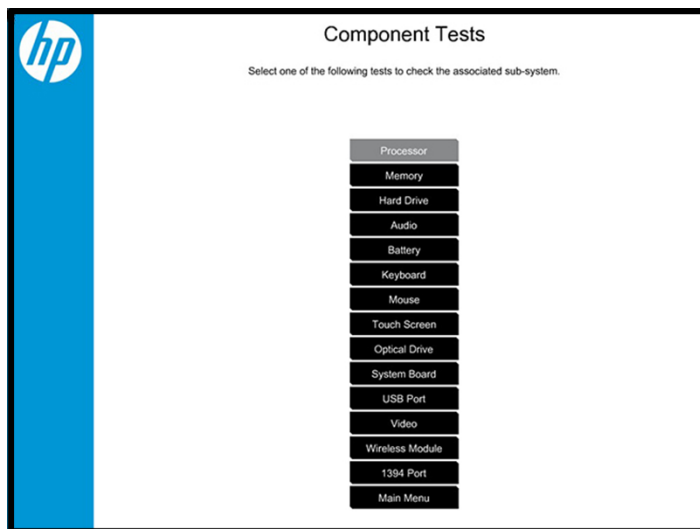
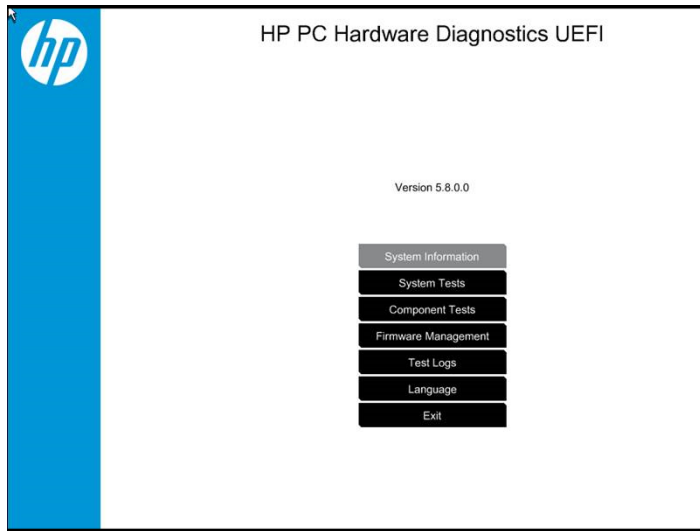

 **NOTE:** Use this tool, especially when the computer cannot boot to Windows.

 **NOTE:** If a component fails a test, write down the information so that it is available when you contact support. The information is also available in **Test Logs** on the Main Menu.

For more information, see [Using HP PC Hardware Diagnostics on page 193](#)

HP BIOS Configuration Utility (BCU)

HP BCU is a free utility that captures the BIOS settings and their values. This tool provides a text file of the computer's BIOS configuration. This file can help identify any settings that may be contributing to an issue.

In some cases, it may help to compare this BIOS text file to the default settings of the computer.

For more information, see the http://ftp.hp.com/pub/caps-softpaq/cmit/whitepapers/BIOS_Configuration_UTILITY_User_Guide.pdf.



NOTE: HP recommends that you reset BIOS before trying BCU. Resetting the BIOS is always available and relatively quick to try, whereas BCU takes extra time and effort.

HP Image Diagnostic Tool

Available to HP Authorized Support Partners (ASPs) and users, this tool collects information about the current state of the computer, including product serial number, platform and BIOS information, and information about user-installed software and hardware components.

Access this tool at <ftp://ftp.hp.com/pub/idr/ImageDiags/>. HP encourages you to review the report before sending it to support. The report may assist you with diagnostics and solutions to problems you encounter.

HP Thermal Monitor

You can use HP Thermal Monitor to stress the processor and GPU and monitor the temperature values of various components in the system.



NOTE: Available only to authorized service providers and technicians.

The components that are currently monitored include the processor, GPU, ACPI thermal zones, hard drive, and battery. The tool reads the temperatures of the components, logs the data, and helps to determine whether the computer would overheat in the event of thermal shutdown, fan spinning loud, and so on.

Non HP diagnostics tools

Refer to the following diagnostic tools for troubleshooting help.

Windows-to-Go USB

Windows-To-Go USB is a Microsoft-based tool for Enterprise editions of Windows that can help in troubleshooting. You can find a process online about how to create a live Windows USB drive. For more information, see <https://technet.microsoft.com/en-us/library/hh831833.aspx>.

Intel Processor Diagnostic Tool

Determine what processor is in your computer and verify the processor operating frequency. The tool also tests specific processor features and performs a stress test on the processor. For more information, see http://www.intel.com/support/processors/sb/CS-031726.htm?iid=subhdr+tools_procdiagtool.

7. Status lights, blinking light codes, troubleshooting lights, and POST error messages

Carefully observe any behavior that the computer may be exhibiting: status lights, blinking lights, and POST error messages during boot. It is important to understand what these indicators mean.

Status lights

The following table describes basic lights on the computer.

Table 7-6 Power button functions and lights and their descriptions

Component	Description
Power button	<p>When the computer is off, press the button to turn on the computer.</p> <p>When the computer is on, press the button briefly to initiate Sleep (Windows) or Suspend (Linux®).</p> <p>When the computer is in the Sleep state, press the button briefly to exit Sleep (Windows) or Suspend (Linux).</p> <p>When the computer is in Hibernation, press the button briefly to exit Hibernation.</p> <p>IMPORTANT: Pressing and holding down the power button results in the loss of unsaved information.</p> <p>If the computer stops responding and operating system shutdown procedures are ineffective, press and hold the power button.</p>
Front power light	<p>On: The computer is on.</p> <p>Blinking: The computer is in the Sleep state.</p> <p>Off: The computer is off.</p>
Front AC adapter and battery light	<p>White: The computer is connected to external power, and the battery is charged from 90% to 99%.</p> <p>Amber: The computer is connected to external power, and the battery is charged from 0 to 90%.</p> <p>Blinking amber: A battery that is the only available power source has reached a low battery level. When the battery reaches a critical battery level, the battery light blinks rapidly. By default, the critical battery level is defined in Power Options as 5%.</p> <p>Off: The battery is fully charged.</p>
Front hard drive light	<p>Blinking white: The hard drive is being accessed.</p> <p>Amber: HP 3D DriveGuard has temporarily parked the hard drive.</p>
Rear AC adapter light	<p>White: The computer is connected to external power.</p> <p>Off: The computer is not connected to external power.</p>

Blinking light codes

During startup, the computer may not boot properly. If this occurs, blinking light codes can help identify the cause.

The computer uses the following blinking lights to identify a hardware component that reports an error during startup. For more information, see [Blinking lights and boot error codes on page 169](#).

Table 7-7 Blinking light codes and what they mean

Blink codes	Error
Amber battery light: blinks 1 Hz continuously	Embedded controller unable to load firmware
Caps and num lk lights = 1 blink	Processor not executing code
Caps and num lk lights = 2 blinks	BIOS recovery code unable to find valid BIOS recovery image
Caps and num lk lights = 3 blinks	Memory module error
Caps and num lk lights = 4 blinks	Graphics controller error
Caps and num lk lights = 5 blinks	System board error
Caps and num lk lights = 6 blinks	Intel Trusted Execution Technology (TXT) Error
Caps and num lk lights = 7 blinks	Sure Start unable to find valid BIOS Boot Block image
Caps and num lk lights = 8 blinks	Sure Start has identified a problem (Manual Recovery Policy Set)

POST error messages

The Power-On Self-Test (POST) is a series of diagnostic tests that runs automatically when the computer is turned on. If the POST encounters a problem, visual error messages are displayed before the operating system starts.

POST checks the following items to ensure that the computer system is functioning properly:

- Memory
- Processors
- BIOS
- Mass storage devices
- Fans

The following table describes errors encountered during HP PC Hardware Diagnostics (UEFI).

Table 7-8 System diagnostics failure codes and actions to address the failure

Test description	Failure description	Error code	Suggested user actions
Startup Test	Memory module	200	Attempt to reseat the memory module, and then repeat the test. For details on troubleshooting issues related to the memory module, search for support documentation at http://www.hp.com/support .
Startup Test	Hard Disk 1 SMART	301	Attempt to reseat the hard drive, and repeat the test. The hard drive may have failed.
Boot Device Manager	Boot device not found	3F0	Reset BIOS. Then reseat the hard drive, and repeat the test.
BIOS Recovery	BIOS Recovery Occurred	500	This message indicates that BIOS recovery was completed successfully. No further action is required.
BIOS Application	BIOS Application Error	501	The BIOS installation may have become corrupted. Download the latest version of the BIOS and install it. If reinstalling the BIOS fails, contact support for further assistance.

Table 7-8 System diagnostics failure codes and actions to address the failure (continued)

Test description	Failure description	Error code	Suggested user actions
CMOS Recovery	CMOS Recovery Occurred	502	This message indicates that CMOS recovery was completed successfully. No further action is required.
Battery Check	Primary Battery Replace	601	This message indicates that the primary battery has very low capacity. Search for support documentation at http://www.hp.com/support for details on using the HP Support Assistant to verify the battery capacity and, if necessary, order a replacement.
Wireless Modules	Not installed or responding	701	Reseat the wireless LAN adapter module and antennas. Because seating or reseating a wireless LAN adapter is unique to each computer model, see the WLAN module removal section in the removal and replacement chapter for further details. Contact support if third-party wireless adapters are installed in the computer.
Fan	Fan not operating correctly	90B	The system fan may be malfunctioning. Replace the fan.

Resolve the issue

The following sections help you fix the issue.

8. Hard reset

A hard reset (or forced reset) erases all information in the computer's memory and may restore functionality. Resetting the computer forces the system to clear and reestablish the connections between the BIOS and the hardware.

For more information, see <http://support.hp.com/us-en/document/c01684768>.

Performing a hard reset might fix the following common conditions:

- Windows stops responding.
- Computer stops before Windows loads, indicated by incomplete startup, blinking cursor on a black background, and errors relating to operating system not found or a missing drive.
- Display suddenly goes blank and stays blank.
- Software freezes.
- Keyboard stops responding.
- The computer does not exit Sleep or Suspend state.
- An external device stops responding. Turn off the power to that device in addition to performing the steps in this document.

Before performing a hard reset, you must disconnect or remove all peripheral devices. Start and test the computer by itself, and if the problem is not resolved, reconnect one peripheral device at a time. To resolve the startup or operational problem, run HP Support Assistant, or manually install all updated drivers from Microsoft and HP.

Before beginning, turn the computer over and look for a battery compartment door (service door). On some platforms, the battery is considered removable but not accessible.

1. Turn off the computer.
2. Remove the computer from any port replicator or docking station.
3. Disconnect all external connected peripheral devices such as USB storage devices, external displays, and printers.
4. Unplug the AC adapter from the computer.
5. Disconnect the battery.
6. Press and hold the power button for at least 15 seconds to drain residual power.
7. Reconnect the battery and plug the AC adapter back into the computer, but do not connect any of the peripheral devices.
8. Press the power button to turn on the computer.

9. If a startup menu appears, use the arrow keys to select **Start Windows Normally**, and then press the [enter](#) key.
10. After reconnecting each of the peripheral devices, run Windows Update and HP Support Assistant to update all device drivers.

CMOS refers to the battery-powered semiconductor chip located on computer's system board. Notebooks store low-level settings like the system time and hardware settings in CMOS. Sometimes you must clear CMOS, which requires removing and reinserting the 3 V RTC battery for a short time (a few minutes before reinserting), in addition to removing the AC adapter and battery.

 **NOTE:** Clearing the CMOS should only be performed for troubleshooting purposes. There is no reason to clear CMOS if the computer is working properly.

You must remove the notebook service door to access the CMOS battery. If the computer has a replaceable RTC battery, see the RTC battery replacement section for the battery removal or replacement.

9. Soft reset (Default Settings)

If your computer has issues booting, has errors during boot, has issues after you add hardware, or has other abnormal system behaviors that you cannot resolve through any other methods (for example, hard reset), it may be necessary to reset the system BIOS to default settings.

 **NOTE:** Some company policies prohibit updates or changes. Check whether the computer has custom BIOS settings before taking action.

To load BIOS to default settings: Reboot the computer, and then press **f10 > Main > Restore defaults**. For more information, see <http://support.hp.com>, and the search for **BIOS Setup Utility Information and Menu Options**.

10. Reseat cables and connections

Many problems are caused by improper connections or loose connections because of abnormal movement and vibration.

 **NOTE:** Before disassembling the computer to reseat cables and connections, always disconnect power and remove the battery, or disconnect a nonremovable battery.

See [Cable management on page 180](#) and [Connector types on page 182](#) for suggested cable management practices when you remove and install components.

You can access and reseat connections for Customer Self-Repair (CSR) parts. Examples of reseating hardware include:

- Reseating the battery into the battery bay can resolve no-battery found and no-charging issues.
- Reseating memory modules can resolve memory error, no-boot, and blue screen issues.
- Reseating the hard drive can resolve a POST error 3F0 (no boot device) issue (see [POST error messages and user actions on page 171](#)).
- Reseating the keyboard cable can resolve an unrecognized keys error.
- Reseating the wireless module and antenna cable can resolve a wireless connection issue.

For field replaceable units (FRUs), authorized service providers can try the following steps. For more information, see [Removal and replacement procedures for authorized service provider parts on page 65](#).

- Reseating the fan cable can fix POST error 90B (no fan detected) issue (see [POST error messages and user actions on page 171](#)).
- Reseating the power cable can fix a no-boot issue.
- Reseating the daughterboards can resolve their functional issues. Some models may have items such as a power button board, VGA board, and others.
- Reseating graphics cables and panel connectors can fix distorted or flickering video.
- Replacing thermal pads may resolve thermal power-down issue.

11. Test with minimum configuration

The factory-shipped computer (hardware configuration and preinstalled operating system image) is well tested and ready for use. Therefore, using the original factory hardware configuration or booting to operating system safe mode often resolves issues quickly.

- Disconnect any external USB storage, remove any discs in optical drives, remove the computer from a docking station, remove external video, and others.
- In addition to removing recently added components, you can narrow the issue down further with a minimum configuration. For example, if HP PC Diagnostics reports a memory error, test one memory module at a time to isolate the defective module.
- If the computer does not successfully boot the operating system, booting to safe mode may help identify the following possible causes of the issue.

Essential hardware configuration

If none of the previous steps resolve the issue, start the computer with essential hardware only. The purpose is to remove as much as hardware as possible while still maintaining the computer's ability to turn on.

 **NOTE:** This step is to be used by authorized service providers only. HP will not honor the warranty for a system tested with the system board removed without the heat sink or fan.

This essential configuration is often used to troubleshoot power-on related issues, such as no-boot, reboot, and freezing issues.

The essential hardware consists of the following components:

- System board
- AC adapter (unplug nonremovable battery or remove battery)
- Processor (and heat sink or fan). (Processor may be integrated into the system board.)
- Memory (one verified working memory DIMM)
- Graphics card (if no VGA port is available on the system board). Platform may have both Intel integrated graphics and discrete graphics. Therefore, you might not need a discrete graphics card.
- External VGA monitor
- External USB keyboard
- External mouse

 **NOTE:** After you remove the service door, disconnect all connections (internal keyboard, display, discrete GPU, hard drive or solid-state drive, daughterboards, and so on) to achieve the essential hardware configuration. **Do not** disassemble the system board from its enclosure at this time.

Reverse the previous procedure by reinstalling each piece of hardware removed, one piece at a time, and testing your computer after each installation. Because your computer works with only the essential hardware installed, those parts must be working properly. This means that one of the hardware components removed is causing the computer to fail. By installing each device back into the computer and testing each time, you eventually identify the failing hardware.

Safe mode

A driver conflict often results in a blue screen error message. Booting in safe mode can resolve many issues in Windows because safe mode forces the computer to load a limited version of Windows which contains only essential files.

Safe mode is useful for troubleshooting problems with programs and drivers that might not start correctly or that might prevent Windows from starting correctly. If a problem does not reappear when you start in safe mode, eliminate the default settings and basic device drivers as possible causes. Refer to the following links for how to start your computer in safe mode:

- <http://support.hp.com/us-en/document/c01835750>
- <http://support.hp.com/us-en/document/c03439317>

12. Test with verified working configuration (hardware or operating system)

One troubleshooting technique that can quickly isolate an issue is using a verified working part while testing. A good example is to use an external keyboard, mouse, or VGA monitor when you have issues with an internal keyboard, touchpad, or display.

Testing with a verified working AC adapter can identify an error caused by a faulty one. Similarly, testing with a verified working operating system can determine bad behaviors of the current operating system. See [Non HP diagnostics tools on page 111](#) for instructions about obtaining and using a Windows-To-Go USB.



NOTE: In some situations, more than one item may contribute to a problem.

13. Replace the system board

Only authorized service providers may replace the system board. This should not be considered an initial step taken to resolve an issue.

Review and perform all steps discussed previously before replacing the system board. [4. Update BIOS and drivers on page 107](#), [7. Status lights, blinking light codes, troubleshooting lights, and POST error messages on page 112](#), [8. Hard reset on page 115](#), and [9. Soft reset \(Default Settings\) on page 116](#), or [10. Reseat cables and connections on page 116](#) can resolve many system board issues without requiring the effort of replacing unnecessary hardware.



IMPORTANT: System board failure is not common. Do not replace the system board until you have tried all other troubleshooting options.



NOTE: Determine whether a previous service case might be related to the current problem. For example, a fan detection issue could be caused by a loose connection resulting from previous service.



TIP: Without an RTC battery (3 V coin-cell battery), the computer automatically reboots. This feature is useful when the power connector cable (between external AC adapter and system board) is defective.

 **NOTE:** Most of the time, effective troubleshooting can prevent a system board replacement.

Situations that can prevent resolution of the issue:

- The information provided about the issue omits key details, including any actions taken before the issue occurred.
 - BIOS, software, and drivers have not been updated.
 - Cables or connections are loose.
 - Technician is unaware of information available from the HP Support website (CA - Customer Advisory).
 - The issue is related to existing or known issues that might be identified in existing support articles.
 - Technician might have omitted steps in the provided repair instructions (for example, Spare Part Replacement Instructions).
 - Skipping one of steps from Troubleshooting Methodology table results in No Defect Found (NDF)/No Fault Found (NFF)/No Issue Detected (NID) messages.
-

Verify solution

Confirm that the implemented solution works.

- Reboot the system or device, and try to complete the task that produced the issue.
- If a part has been replaced, verify other basic functions. For example, GPU replacement requires keyboard removal. Therefore, it is good practice to verify all basic components to be sure that the solution is complete.
- Explain to the customer why the issue occurred and what was done to resolve it. If the solution you used was in an HP public document, provide the document information to the customer, letting them know they can locate it on <http://www.hp.com>. Also, tell them that there are other solutions available on the website. Advise the customer to check the website first when they have an issue. It might save them time calling in.
- Document the correct issue. Update the case with as many details as possible for other agents and engineers to analyze and study for lessons learned.

Helpful Hints

After you become familiar with the troubleshooting steps, use the helpful hints before running diagnostics and troubleshooting.

At startup

These steps provide simple, useful checks that you can perform when troubleshooting.

 **TIP:** If you have installed an operating system other than the factory-installed operating system, go to <http://www.hp.com/go/quickspecs> and verify that it is supported on your system.

1. Be sure that the computer is plugged into a working AC outlet.
2. Be sure that power is connected to the docking station if you use a dock.
3. Be sure that the AC adapter light is on.
4. Be sure that the AC adapter is connected when you update BIOS to avoid BIOS corruption.
5. Be sure that the computer is turned on, the rear power light is solid white (connected to an external power source), and the front power light is solid white (normal operation).
6. Remove all optical and flash drives from your system before turning it on.
7. Be sure that the boot option is set to a working operating system drive.
8. Be sure that externally connected monitors are turned on and their power lights are on. Not all monitors are equipped with lights to indicate their functionality.
9. Turn up the brightness and contrast controls of a display or external display device if the screen is dim.

During operation

The following steps provide simple, useful checks that you can perform when troubleshooting.

1. To wake the computer:
 - a. Press the power button or any key on the keyboard.
 - b. If the system remains in the Sleep (Windows), Suspend (Linux), or Hibernate state, shut down the system by pressing and holding the power button for at least 4 seconds.
 - c. If the system does not shut down, unplug the power cord, wait a few seconds, and then plug it in again. Then press the power button again to restart the system.
2. Look for blinking lights on the computer. The blinking lights could be error codes that help diagnose the problem.
3. Check all cables for loose or incorrect connections (external devices, power cords, dock, and so on).
4. After installing a non-Plug and Play expansion board or other option, reconfigure the computer. For example, if you upgrade to a solid-state drive, you might have to reconfigure the boot order.
5. Be sure that all required device drivers have been installed. For example, if you have connected a printer, you must install a printer driver.
6. If there is a network connection issue, plug another computer with a different cable into the network connection. There might be a problem with the network plug or cable.

7. If hardware has recently been installed, remove it and determine whether the computer functions properly.
8. If software has recently been installed, uninstall it and determine whether the computer functions properly.
9. If the screen is blank, confirm the display choice by pressing **Windows logo**  + **p** and set to screen only.
Or plug an external monitor into a different video port on the computer, if one is available, and close the computer lid.
10. Verify that the latest version of BIOS, drivers, and software are installed. A new release might support new features or fix the problem.
11. Press the **caps lock** or **num lk** key. If the **caps lock** or **num lk** light toggles on or off, the keyboard is likely operating correctly.
12. Press the touchpad On/Off button light. If the light toggles on or off, the touchpad is likely operating correctly.

Consulting with HP Service

If further HP support is required, this information may be requested when you call. So it may be helpful to take notes.

- Technical support registration number (if applicable)
- Product serial number
- Product model name and number
- Product identification number
- Applicable error messages
- Add-on boards or hardware
- Third-party hardware or software
- Operating system type and revision level

Common issues and possible solutions

This section contains common issues, symptoms, and a series of tables that describe possible solutions to issues from Failure Classification tables. The following sections identify the issue with symptoms and solutions to resolve an issue.

Power-on issues

Use the following sections to troubleshooting power issues.

No power

When a unit experiences no power, there are several contributing factors to consider. Be sure to consider all symptoms related to this behavior when troubleshooting.

Table 7-9 Issues, possible causes, and fixes

Items	Procedures
<i>Symptoms</i>	<i>Possible causes</i>
<ul style="list-style-type: none">• Computer does not start• Display is black or blank• No fan noise• No hard drive spinning• Lights do not glow	<p>Failed power input to the computer (external power source, AC adapter, faulty battery).</p> <p>Bad connection to the computer (bad power button, power connector).</p> <p>Defective parts (memory, hard drive, graphics) or failed system board.</p>
	<i>Troubleshooting steps</i>
	Perform quick check
	Remove all external devices, including docking station.
	Verify external power source (2. Examine the environment on page 106).
	Perform a hard reset (8. Hard reset on page 115).
	Verify AC adapter
	Verify the battery before verifying the AC adapter. However, you can verify the AC adapter first, before opening the service door for a battery check.
	<ul style="list-style-type: none">• Verify AC adapter is compatible with product. Verify that the part number is for this computer if possible.• Verify AC adapter and power cord are good (no physical damage, bent middle ID pin).• Verify AC adapter works on a verified working computer.• Plug in AC adapter and power on computer without battery.• Inspect power port on computer side for any damage, dust, or debris.• Check power light (7. Status lights, blinking light codes, troubleshooting lights, and POST error messages on page 112). Rear power light indicates external power to the computer is good.

Table 7-9 Issues, possible causes, and fixes (continued)

Items	Procedures
	<p>Verify battery condition and status</p> <ol style="list-style-type: none"> 1. Check battery condition (overall result, cycle life, voltage) using HP PC Hardware Diagnostics (UEFI) tool. 2. Verify that battery is installed properly in battery bay without a gap and that latch locks are tight (for models with removable batteries). 3. Check battery status light (7. Status lights, blinking light codes, troubleshooting lights, and POST error messages on page 112). Be sure that battery is not fully discharged, preventing system from booting. 4. Determine whether the computer can turn on with battery only. 5. Remove service door and test with a verified working battery. If the computer boots, inspect original battery before replacement. 6. Test battery with a verified working computer to verify that it works. 7. If the computer still does not boot, remove battery and boot on AC power only.

The following steps are for authorized providers or technicians.

	<p>Verify AC adapter – voltage</p> <ol style="list-style-type: none"> 1. Measure DC voltage output, which should be approximately 19.5 V dc. Acceptable voltage range is from 18.5 to 20.5 V dc. 2. If the DC voltage is out of range, replace the AC adapter. <p>NOTE: This action requires a digital voltmeter.</p>
--	---

NOTE: Select models include a power cable between the system board and chassis power connector.



<p>Verify power button, power connector</p> <ol style="list-style-type: none"> 1. Be sure that power button is not stuck. 2. Reseat power connector cable (if applicable). 3. Replace new power connector cable (if the cable exists and is defective) 4. To isolate faulty power connector cable and power button, technicians can short power-on pads or pins to turn on the computer. Contact HP Engineering for this information. 	
--	--

	<p>Verify blinking lights (7. Status lights, blinking light codes, troubleshooting lights, and POST error messages on page 112)</p> <p>At this point, there should be sufficient power from the AC adapter to the system board. Expect to hear the fan spinning and see blinking lights or error messages (for example, faulty memory, HDD).</p>
--	---

	<p>Verify system board</p> <ol style="list-style-type: none"> 1. Test essential hardware configuration (11. Test with minimum configuration on page 118, 12. Test with verified working configuration (hardware or operating
--	--

Table 7-9 Issues, possible causes, and fixes (continued)

Items	Procedures
	<p>system) on page 119, 13. Replace the system board on page 119) by removing nonessential parts.</p> <p>2. If the computer still does not boot, replace system board.</p>
Tips	<p>Computer automatically boots without pressing power button when the RTC 3 V battery is removed. Therefore, after the service door and RTC 3 V battery are removed, you do not have to press power button from top side.</p> <p>In essential hardware configuration, mWS G1 and G2 may require discrete graphics processing unit (GPU) to boot. However, mWS G3 can boot with integrated graphics.</p>

Intermittent power-on, shutdown, reboot

Use this information to troubleshoot power-on, shutdown, and reboot issues.

Table 7-10 Issues, possible causes, and fixes

Items	Procedures
<i>Symptoms</i>	<i>Possible causes</i>
<ul style="list-style-type: none"> Does not always turn on Intermittently hangs Intermittently shuts down Spontaneously reboots 	<p>Electrical short, fluctuating power source, unstable power rails, loose connections, bent pins, stray wires, dust, obvious damage, nearly faulty parts (bulging or leaking capacitor).</p> <p>Potentially turn into a no-power issue (No power on page 124).</p>
	<i>Troubleshooting steps</i>
	<ol style="list-style-type: none"> Visually check power ports on both AC adapter and computer sides. Inspect power sources: <ol style="list-style-type: none"> Verify that the AC adapter is working correctly. Use a confirmed working adapter to test. Verify that battery is not depleted while system is in the Sleep state. Test with a confirmed working battery.

The following steps are for authorized providers or technicians.

- Follow actions in [No power on page 124](#).
 - Be sure that AC adapter has correct DC voltage.
 - Verify battery: test with a confirmed working battery.
 - Verify that power button is not stuck.
 - Verify that power connector is not loose.
 - Remedy loose connections and reseat major components (processor, memory, GPU, hard drive, solid-state drive, and others).
- Perform visual check for loose connections, bent pins, stray wires, dust, nearly faulty parts (bulging or leaking capacitor).
- Test **essential hardware configuration** ([11. Test with minimum configuration on page 118](#))

Table 7-10 Issues, possible causes, and fixes (continued)

Items	Procedures
	<ol style="list-style-type: none"> a. If system boots, reinstall nonessential hardware one component at a time to isolate issue. b. If system does not boot, replace essential hardware with verified working parts, one component at a time. If system still does not boot, replace system board.

AC adapter issue

Use this information to troubleshoot AC adapter issues.

Table 7-11 Issues, possible causes, and fixes

	Solution
<i>Symptoms</i>	<i>Possible causes</i>
<ul style="list-style-type: none"> • No sign of power 	AC adapter and others (for example, external power source).
<ul style="list-style-type: none"> • No boot 	<i>Troubleshooting steps</i>
<ul style="list-style-type: none"> • No rear power light 	Quick check
<ul style="list-style-type: none"> • No front power light 	<ol style="list-style-type: none"> 1. Verify external power source (2. Examine the environment on page 106).
<ul style="list-style-type: none"> • Battery does not charge when AC adapter is connected 	<ol style="list-style-type: none"> 2. Remove all external devices, including docking station. 3. Perform a hard reset for the computer (8. Hard reset on page 115). 4. Disconnect and reassemble the power cord and adapter in case the adapter experienced short circuit, over current, over temperature events. 5. Use a verified working adapter. If the computer operates normally, there is a problem with the original adapter. 6. Verify that the AC adapter works on a verified working computer. If the computer operates normally, there is no problem with the adapter. See HP Smart Adapter warning message on page 140 for further information.

Table 7-11 Issues, possible causes, and fixes (continued)

Solution	
Verify AC adapter	
	<ol style="list-style-type: none"> 1. Remove working battery. 2. Verify that AC adapter is compatible with product. Verify that part number is for this computer if possible. 3. Inspect AC adapter and power cord for physical damage, bent middle ID pin. 4. Plug in AC adapter and power the computer without battery. 5. Inspect the power port on computer side for any damage, dust, debris. 6. Check power light (7. Status lights, blinking light codes, troubleshooting lights, and POST error messages on page 112). Rear power light indicates that external power to the computer is good. 7. If there is still no rear power light or no boot, replace the AC adapter.
Tips	<p>The HP Smart AC adapter has a special pin in the middle, called the ID pin, for power rating and throttling. If this pin is broken, the rear power light turns on, but the power button and front power lights blink continuously, and the computer does not turn on. Third-party AC adapters do not work with the computer.</p> <p>Use the AC adapter that came with the computer for better performance.</p>

Battery not recognized, not charging

Use this information to troubleshoot battery issues.

Table 7-12 Issues, possible causes, and fixes

Items	Procedures
<i>Symptoms</i>	<i>Possible causes</i>
<ul style="list-style-type: none"> • No battery status light 	Defective AC adapter , battery, or both.
<ul style="list-style-type: none"> • Blinking amber (critically low battery level) 	NOTE: Before proceeding, verify that the computer can boot to BIOS or Windows with a good AC adapter.
<ul style="list-style-type: none"> • No boot without AC adapter 	

Table 7-12 Issues, possible causes, and fixes (continued)

Items	Procedures
	<p><i>Troubleshooting steps</i></p> <p>Visual inspections</p> <ol style="list-style-type: none"> 1. Inspect battery connectors for any signs of damage. 2. Verify that battery is installed properly in battery bay without gap or obstructions and latch locks are tight. Reseat battery (for models with removable batteries). 3. Determine whether battery gets hot (batteries heat up when charging, but not too hot to touch). <p>Check battery warranty to see whether the battery is new or its warranty is expired. Battery capacity degrades over time.</p> <p>Verify front battery status light</p> <ol style="list-style-type: none"> 1. Battery status light is off: battery not recognized. 2. Battery status light is blinking amber: critically low battery level. <p>Reset</p> <ol style="list-style-type: none"> 1. Hard reset (8. Hard reset on page 115) 2. Soft reset (9. Soft reset (Default Settings) on page 116) <p>Verify AC adapter</p> <ol style="list-style-type: none"> 1. Determine whether the computer needs the AC adapter to boot and operate. Sometimes, an intermittently bad AC adapter and loose connection between adapter and computer results in inability to charge battery, which causes short run time. 2. Inspect AC adapter to verify that it is functioning. 3. Test with a working AC adapter and confirm whether battery is charging. 4. Be sure that battery is fully charged (AC adapter plugged in at least 2.5 hours). <p>Diagnostics: HP tools report results such as passed, calibrate, weak, replace, no battery, and unknown, and they suggest corresponding actions.</p> <p>Use HP Hardware Diagnostics (UEFI) (6. HP Hardware Diagnostics and Tools on page 109)</p> <p>HP PC Hardware Diagnostics (UEFI) is a good tool to use to isolate and determine faulty battery, especially for quickly discharging (short life) battery.</p> <ol style="list-style-type: none"> 1. Verify that battery is recognized and charging. 2. Verify battery condition if battery cycle life is past its life expectancy (that is, past 1000-cycle life and 3-year warranty). Battery might need to be replaced. 3. If issue remains, test with a verified working battery and verify battery status lights and battery conditions. 4. If issue remains, replace system board. 5. Verify the new replacement.
Tips	<p>See the computer user guide for instructions regarding battery maintenance and increasing battery life. Also see http://support.hp.com/us-en/document/c01297640?jumpid=hpr_r1002_usen_link3.</p>

Battery discharges too fast

Use this information to troubleshoot battery issues.

Table 7-13 Issues, possible causes, and fixes

Items	Procedures
<i>Symptoms</i>	<i>Possible causes</i>
Battery has good status light but discharges too fast	AC adapter, battery, or both.
	<i>Troubleshooting steps</i>
	Verify AC adapter
	Determine whether the computer needs the AC adapter to boot and operate. Sometimes an intermittently bad AC adapter and loose connection between adapter and computer results in the inability to charge the battery and causes short runtime.
	<ol style="list-style-type: none">1. Inspect AC adapter to verify that it is working.2. Test with AC adapter alone and with a verified working AC adapter.
	Verify battery: Because battery capacity can degrade over time, check the warranty coverage. Run a battery test to confirm whether issue is hardware related.
	<ol style="list-style-type: none">1. Review battery power plans in Control Panel > Power Options that may consume more energy and discharge battery faster. Resetting default to Power Saver option can conserve battery power.2. Determine whether any graphics are processing.3. Verify battery maintenance and operations. Leaving the battery at a high level of charge in a high-temperature environment for extended periods accelerates the loss of capacity.4. Test and calibrate battery using HP PC Hardware Diagnostics (UEFI).5. Verify battery life cycle using HP Support Assistant tool.
	If battery cycle life is past its life expectancy (past the 1000-cycle life and 3-year warranty), the battery might need to be replaced.
	<ol style="list-style-type: none">6. Compare discharge time with a verified working battery (remove AC adapter) using Hardware Diagnostics (UEFI)>Hard Drive Tests>Extensive Test>Loop until error.
Tips	To conserve battery power, turn off Wireless On-Off button and other peripherals and USB devices, applications, processes (in Task Manager) when not in use; also, reduce screen brightness.
	Follow HP instructions about how to maintain battery and increase battery life. Also reference http://support.hp.com/us-en/document/c01297640?jumpid=hpr_r1002_usen_link3 .

Burnt smell

Use this information to troubleshoot burnt-odor issues.

Table 7-14 Issues, possible causes, and fixes

Items	Procedures
<i>Symptoms</i>	<i>Possible causes</i>
Emits smoke, burnt smell	Defective on-board components.
	<i>Troubleshooting steps</i>
	General visual inspection
	<ol style="list-style-type: none">1. Disconnect the computer from power source (AC adapter and battery).2. Inspect for visual damage on AC adapter and battery. Test on a known working computer to isolate issue. If issue follows AC adapter or battery, replace it.3. Inspect any sign of liquid spill on the computer (back of keyboard).
The following steps are for authorized providers or technicians.	
	Further inspection on components
	<ol style="list-style-type: none">1. Inspect further sources internally after disassembling chassis, such as burnt or damaged components.2. If the issue persists, replace boards, AC adapter, and battery for safety concern, and report issues to HP.

POST

Use the following sections to troubleshoot Power-on Self Test issues.

No video (with power)

Use this information to troubleshoot video issues.

Table 7-15 Issues, possible causes, and fixes

Items	Procedures
<i>Symptoms</i>	<i>Possible causes</i>
<ul style="list-style-type: none">• No video (black or blank image) but have power• Light activity• No error messages• Fan noise• Hard drive light blinking and hard drive noise	<p>Failed display</p> <p>Failed critical components (memory, hard drive, system board)</p> <p>Loose connection</p> <p>Recently added hardware</p> <p>NOTE: These suggestions assume that the computer has not previously been set up for multiple displays.</p>
	<i>Troubleshooting steps</i>
	Quick check
	<ol style="list-style-type: none">1. Verify that system light activity is OK.2. Remove all external devices, including docking station. Recently added hardware or applications may cause graphics driver conflict and result in loss of video.3. Perform hardware reset (8. Hard reset on page 115) and verify that HP Logo is presented correctly on display screen when pressing f10.4. Test with external monitor via VGA port (or DisplayPort, HDMI, or other). Press power button and close the computer lid to force video output to external video. If unsuccessful, contact HP service.5. If external video is OK, update BIOS, software, and drivers (4. Update BIOS and drivers on page 107), and perform soft reset (9. Soft reset (Default Settings) on page 116) if needed. Go to next step to verify display.
	Verify display
	<ul style="list-style-type: none">• When booting to Windows, determine whether image appears on display screen (via Windows Screen Solutions or Windows logo  + p for display switcher).• If there is video on the display, disconnect external display device, open the computer lid, and restart.
The following steps are for authorized providers or technicians.	

Table 7-15 Issues, possible causes, and fixes (continued)

Items	Procedures
	<ol style="list-style-type: none"> 1. Reseat display cable connection on system board. 2. Reseat display cable connection on display panel side. 3. Examine and reseat major components, such as hard drive and memory. 4. Test with minimum configuration (11. Test with minimum configuration on page 118) by removing hard drive to isolate operating system issues and testing video in F10 Setup. 5. If video is present, restart and retest the computer. 6. If video is present but bad, go to Display on page 142 section. 7. If issue persists (no video), test with external video. 8. If issue persists, test or replace a confirmed working display. 9. If issue persists, replace discrete graphics card. 10. If issue persists, replace system board because of defective video function.
Tips	Swipe a metal piece (screwdriver) over wireless or mute buttons to act as if closing lid to force video output to external display device.

Blinking lights

Use this information to interpret blinking lights on the computer.

Table 7-16 Issues, possible causes, and fixes

Items	Procedures
<i>Symptoms</i>	<i>Possible causes</i>
Lights blink on keyboard caps lock/num lock keys	Blinking lights on startup usually indicate a problem with basic functionality of a critical component (processor, BIOS, graphics cards, memory, and so on) because of a loose connection, defective parts, or recently added parts.
	<i>Troubleshooting steps</i>
	<ol style="list-style-type: none"> 1. Check for any blink patterns. Count the number of blinks in a sequence, followed by a pause for a few seconds. 2. See status, blinking lights, and error message (7. Status lights, blinking light codes, troubleshooting lights, and POST error messages on page 112) for corrective actions. 3. If internal hardware components (such as memory, hard drive) have been recently added, a component may not be connected properly. Remove and reseat new components (10. Reseat cables and connections on page 116) one at a time.
Note	Because the display might not be functional, lights are used to indicate an error.

Diagnostic error messages

Use the information in the table to help you understand diagnostic error messages.

Table 7-17 Issues, possible causes, and fixes

Items	Procedures
<i>Symptoms</i>	<i>Possible causes</i>
<ul style="list-style-type: none">• Computer has power• POST error message displays (Windows logo has not yet appeared)	Diagnostic error messages indicate a problem. There may be a problem with the instruction being sent from the BIOS to a hardware component (for example, keyboard failures), or incompatible hardware. Can usually be resolved by installing updated firmware for the component.
	<i>Troubleshooting steps</i>
	<ol style="list-style-type: none">1. See 7. Status lights, blinking light codes, troubleshooting lights, and POST error messages on page 112 for corrective actions. An example of a POST error message might be "Boot Device Not Found."2. If there is power, you might be able to access BIOS. Reset BIOS to its default condition. (9. Soft reset (Default Settings) on page 116)3. Restore hardware to its original condition (for example, bootable solid-state drive instead of hard drive).4. Reseat suspected components and verify connection.5. Test suspected components using HP PC Hardware Diagnostics (UEFI) tool.
Note	An Error Message means that the system has finished BIOS hardware validation and is ready to launch the Startup Menu . To access the Startup Menu for further options, press the esc key while restarting the computer.

BIOS password

Use the information in the table to troubleshoot BIOS password issues.

Table 7-18 Issues, possible causes, and fixes

Items	Procedures
<i>Symptoms</i>	<i>Possible causes</i>
Some sections are unavailable (grayed out)	You must use an administrator password.
	<i>Troubleshooting steps</i>
	<ol style="list-style-type: none">1. Review F10 BIOS Setup Overview to determine which features must be enabled.2. Your BIOS settings may be managed by a BIOS administrator password setup.3. If you lost or forgot the user password, contact your IT personnel.
Reference	HP F10 Setup Overview http://h10032.www1.hp.com/ctg/Manual/c04460979 http://h10032.www1.hp.com/ctg/Manual/c04685655 2015 Business PC models: see the HP PC BIOS F10 Setup Guide at http://support.hp.com .

Performance (OS)

Most software problems occur as a result of certain situations.

- The application was not installed or configured correctly.
- There is insufficient memory available to run the application.
- There is a conflict between applications.

Make sure that all the necessary device drivers are installed.

If an operating system other than the factory operating system is installed, check whether the operating system is supported and the application is certified for the version of the operating system.

HP ships and supports Windows 7 with BIOS Legacy boot mode and Windows 8 and 10 with BIOS UEFI boot mode. Therefore, HP recommends that you switch BIOS boot mode from Legacy to UEFI Native for clean Windows 8 or 10 installations, or to UEFI Hybrid (if available) for upgrading the option from Windows 7 to Windows 8 or 10. UEFI Windows 8 or 10 avoids many unexpected behaviors (for instance, blue screen error, graphics or video issues) in the BIOS Legacy setting.

Intermittent shutdown

Use this information to troubleshoot shutdown issues.

Table 7-19 Issues, possible causes, and fixes

Items	Procedures
<i>Symptoms</i>	<i>Possible causes</i>
<ul style="list-style-type: none">• Shutdown during startup• Shutdown during operation	<p>It is often difficult to troubleshoot an intermittent issue. Possible causes include:</p> <p>Power-related issue: defective or insufficient power sources, poor connection.</p> <p>OS Custom Setting: Energy Saver (Power Management).</p> <p>Thermal-related issue: thermal sensors reach limits.</p> <p>Hardware related issue, voltage, out-of-range current, electrical short.</p>
	<i>Troubleshooting steps</i>
	<ol style="list-style-type: none">1. Update BIOS and drivers. (4. Update BIOS and drivers on page 107)2. Perform hard reset (8. Hard reset on page 115)3. Perform soft reset (9. Soft reset (Default Settings) on page 116)
	Power-related issue
	<ol style="list-style-type: none">1. Verify functionality of AC adapter alone. If it does not work, test with a verified working adapter.2. Verify battery alone. Verify that battery is not depleted. Test battery using HP PC Hardware Diagnostics (UEFI) tool.3. Verify connection of power button and cable.

Table 7-19 Issues, possible causes, and fixes (continued)

Items	Procedures
	OS custom settings <ol style="list-style-type: none">1. Advise users to reset power options and close all applications that are not in use, including applications in the background.2. Test with a confirmed working operating system to isolate custom settings by users or any conflicting applications that cause shutdown.
The following steps are for authorized providers or technicians.	
	Thermal-related issue <ol style="list-style-type: none">1. Verify thermal condition:<ol style="list-style-type: none">a. Test fan using HP PC Hardware Diagnostics (UEFI) tool (6. HP Hardware Diagnostics and Tools on page 109)b. Check fan and connection. Reseat fan cable.c. Be sure that no obstructions or dust are in heat sink fan, fin, or vent.d. Test with a verified working fan.e. Remove old thermal compound and pads and replace with new compound and pads.2. Verify thermal solution:<ul style="list-style-type: none">o Use Thermal Monitor tool (available only to authorized service providers/technicians) to perform stress test (processor and GPU) (6. HP Hardware Diagnostics and Tools on page 109), and verify that thermal sensors are within limits after thermal condition is serviced.
	Hardware-related issue <ol style="list-style-type: none">1. Check for any signs of loose connections, bent pins, stray wires, dust, nearly faulty parts (bulging/leaking capacitor).2. Verify that lights are solid.3. If shutdown is reproducible, test essential hardware configuration:<ol style="list-style-type: none">a. If no issue with hardware configuration, reinstall one nonessential component at a time to determine faulty hardware.b. If issue persists, replace essential hardware with a confirmed working part, one at a time. If the computer does not boot, replace system board.
Tips	Intermittent issues are difficult to reproduce and troubleshoot. It is important to record details about shutdown frequencies, system configuration (3D video application), and operating conditions.

Blue screen

Use this information to troubleshoot blue screen issues.

Freeze at Windows Logo (hang or lockup)

Use the following information to troubleshoot hang or lockup issues.

Table 7-20 Issues, possible causes, and fixes

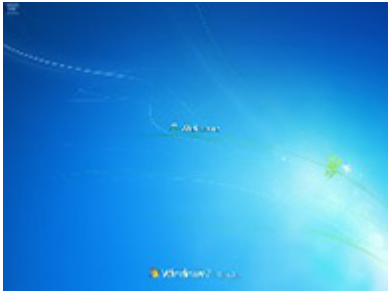
Items	Procedures
<p data-bbox="276 268 371 300"><i>Symptoms</i></p> <ul data-bbox="276 321 699 552" style="list-style-type: none"><li data-bbox="276 321 699 352">• Has power, light activity, fan spinning<li data-bbox="276 373 699 405">• HP Logo displays briefly<li data-bbox="276 426 699 478">• Attempt to boot to operating system and freeze/hang at Windows logo<li data-bbox="276 499 699 552">• No response to pressing num lk or caps lock key	<p data-bbox="722 268 858 300"><i>Possible causes</i></p> <p data-bbox="722 321 1465 394">Conflict of instructions from multiple programs or drivers; installing a new hardware or program that is not compatible (may also cause a blue screen error—see blue screen issue).</p>
	<p data-bbox="722 888 914 919"><i>Troubleshooting steps</i></p> <p data-bbox="722 940 1345 972">Perform the following steps one at a time to verify normal boot process:</p> <ol data-bbox="722 993 1465 1686" style="list-style-type: none"><li data-bbox="722 993 1465 1045">1. Disconnect all external peripherals, and perform a hard reset (8. Hard reset on page 115).<li data-bbox="722 1066 1465 1098">2. Perform soft reset (9. Soft reset (Default Settings) on page 116).<li data-bbox="722 1119 1465 1245">3. Update BIOS and drivers (4. Update BIOS and drivers on page 107).<ol data-bbox="770 1171 1465 1245" style="list-style-type: none"><li data-bbox="770 1171 1465 1203">a. Roll back to previous version may be necessary.<li data-bbox="770 1224 1465 1245">b. Go to safe mode to install drivers.<li data-bbox="722 1266 1465 1318">4. Run Hardware Diagnostics (6. HP Hardware Diagnostics and Tools on page 109) to isolate hardware issue.<li data-bbox="722 1339 1465 1392">5. Undo recent changes in Windows (5. Remove or uninstall recently added hardware, software on page 108).<li data-bbox="722 1413 1465 1465">6. Reseat cables and connections (10. Reseat cables and connections on page 116).<li data-bbox="722 1486 1465 1518">7. Start Windows in safe mode (11. Test with minimum configuration on page 118).<li data-bbox="722 1539 1465 1570">8. Use Startup Repair Windows to fix Windows damaged files.<li data-bbox="722 1591 1465 1686">9. Test with essential hardware configuration (11. Test with minimum configuration on page 118) with a verified working operating system (for instance, USB Windows-To-Go, if available, to isolate the software issue).
<p data-bbox="276 1707 323 1738">Tips</p>	<p data-bbox="722 1707 1409 1738">For more information, see http://support.hp.com/us-en/document/c03671001.</p>

Electromagnetic Interference (EMI)

Use this information to troubleshoot EMI issues.

Table 7-21 Issues, possible causes, and fixes

Items	Procedures
<i>Symptoms</i>	<i>Possible causes</i>
System locks up, freezes in certain physical area or location	Electromagnetic interference (EMI).
	<i>Troubleshooting steps</i>
	<ol style="list-style-type: none">1. See (2. Examine the environment on page 106). Pay attention to external power source, high-frequency signals such as cell phones, microwave ovens.2. Move the computer to different locations nearby to determine where it fails and where it does not fail.3. Test with a verified working computer in original factory configuration.4. Consult with support.

No wake up

Use this information to troubleshoot wake-up issues.

Table 7-22 Issues, possible causes, and fixes

Items	Procedures
<i>Symptoms</i>	<i>Possible causes</i>
When resuming from a power management state the computer may display:	Power-saving mode; multiple-display setting.
<ul style="list-style-type: none">• Blank screen• Some light activity	

Table 7-22 Issues, possible causes, and fixes (continued)

Items	Procedures
	<i>Troubleshooting steps</i>
	<ol style="list-style-type: none">1. Verify that front power light (7. Status lights, blinking light codes, troubleshooting lights, and POST error messages on page 112) is blinking (indicating Sleep state). Press power button to exit Sleep.2. Reset BIOS to default (associated with OS Power Management in Power Menu) (4. Update BIOS and drivers on page 107)3. Check power management settings in Windows Power Options. Disable Sleep options if the issue is resolved.

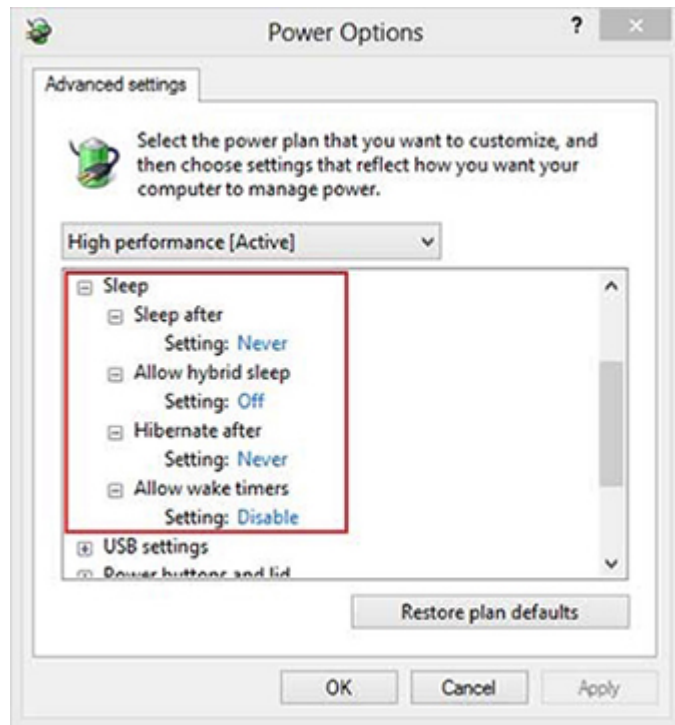

4. Screen saver is set. Press any key or touch touchpad to resume.
5. Verify that Display Choice is set to external video only. Toggle screen control key combination **fn + f4** or **Windows logo + P**.

Tips

If you are using a docking station, set your notebook display as a primary display. When the computer is undocked, you may think it is in a power-saving state, but the screen image may actually appear on an external display device in the docking configuration.

Unresponsive

Use this information to troubleshoot issues with responsiveness.

Table 7-23 Issues, possible causes, and fixes

Items	Procedures
<i>Symptom</i>	<i>Possible causes</i>
Unresponsive	Program in use has stopped responding to commands.
	<i>Troubleshooting steps</i>
	<ol style="list-style-type: none">1. If possible, use the Windows Task Manager to isolate and terminate the offending process.2. Attempt the normal Windows shutdown procedure.3. Restart the computer using the power button.

Slow performance

Use this information to troubleshoot performance issues.

Table 7-24 Issues, possible causes, and fixes

Items	Procedures
<i>Symptom</i>	<i>Possible causes</i>
Slow performance when performing small tasks, or even in idle mode	Processor is hot or hard drive is full.
	<i>Troubleshooting steps</i>
	Processor is hot
	<ol style="list-style-type: none">1. Verify that airflow to the computer is not blocked.2. Verify that chassis fans are connected and working properly. Some fans operate only when needed.3. Verify that the processor heat sink is installed properly.
	Hard drive is full
	<ol style="list-style-type: none">1. Transfer data from the hard drive to create more space on the hard drive. Microsoft recommends at least 200 MB to sync system files.2. Perform disk defragmentation to consolidate fragmented data on the hard drive so it works more efficiently.
Tips	See Routine maintenance for performance improvement on page 173). See http://windows.microsoft.com/en-us/windows-8/free-up-disk-space . See http://windows.microsoft.com/en-us/windows/optimize-windows-better-performance#optimize-windows-better-performance=windows-vista .

HP Smart Adapter warning message

Use this information to troubleshoot power adapter warning messages.

Table 7-25 Issues, possible causes, and fixes

Items	Procedures
<i>Symptom</i>	<i>Possible causes</i>
Warning message appears in window	Less powerful AC adapter, BIOS out of date.
	
	<i>Troubleshooting steps</i>
	<ol style="list-style-type: none"> 1. Update BIOS, which may contain information that assigns an appropriate adapter for the configuration. 2. Update the latest HP Hotkey Support software from Drivers website. 3. Be sure that the power source is sufficient (where adapter is connected). 4. Use appropriate AC adapter (often supplied with system) for optimum system performance. 5. Test with a verified working AC adapter. 6. Test the adapter on a verified working computer. 7. Contact HP for configuration details.
Note	<p>HP Smart AC adapter warning message: informs you that as power demands increase, the notebook may not perform at full capacity, which may result in longer battery-charging time. In cases of extreme power demands, the system may also throttle back the processor, or with systems that have a discrete video subsystem, a video balance mode may occur to further balance the power needs of the system.</p> <p>Because system processor functions always have priority over battery charging, charging delays occur first.</p>

Incorrect time and date

Use the following information to troubleshoot time and date issues.

Table 7-26 Issues, possible causes, and fixes

Item	Procedure
<i>Symptom</i>	<i>Possible cause</i>
Incorrect date and time	Real-time clock (RTC) battery might need replacement.
	<i>Troubleshooting steps</i>
	<ol style="list-style-type: none"> 1. Reset the date and time in the operating system Control Panel. 2. Replace the RTC battery. 3. Verify that date and time are correct.

Display

Use these sections to troubleshoot display issues.

Display anomalies

The display panel is a field-replaceable unit (FRU) and must be replaced by only authorized technicians. However, HP highly recommends that users and technicians observe symptoms and use the HP PC Hardware Diagnostics (UEFI) tool before any replacement.

Symptom

This section includes common display issues with symptoms:



- Blank or black video
- Incorrect color, missing color, distorted image
- Flickering image
- Vertical lines (because of LDVS, decreased signal integrity, and data loss)
- Dead pixel (because of display liquid, internal transistor, and others)
- Horizontal lines (because of video memory)
- Distorted when hot (because of thermal issue)
- Cracked screen/image (physical damage)
- Light leakage/bleeding

Contact support for assistance.

- Humming noise (due to frequency settings)

Contact support for assistance.

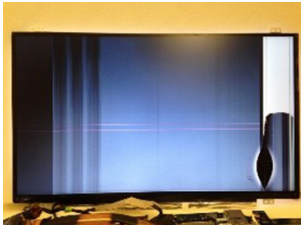
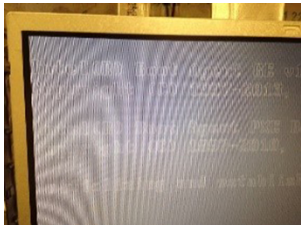
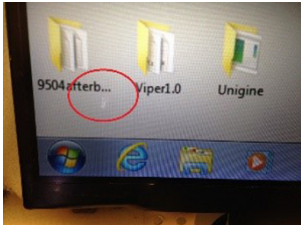
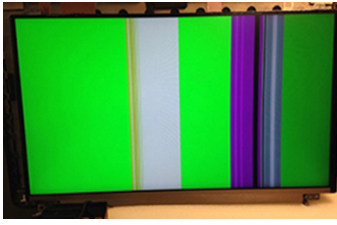
Table 7-27 Display anomaly illustrations

Display anomalies		
		
Cracked screen	Cracked image	Blurred image
		
Dead pixel	Vertical lines	Horizontal lines

Quick check

Use these steps to check the display.

- Visually examine the display for cracked screen, liquid crystal leak, dirty spots on glass, and other issues.
- Reset and update BIOS and docking firmware.
- Update operating system (OS), graphics or video drivers (Intel, AMD, NVIDIA, and others).

For custom images, HP highly recommends upgrading or installing Windows in UEFI mode (or Legacy disabled) to fully support hybrid graphics and avoid unexpected behaviors (for example, blue screen error, graphics or video issues) in the BIOS Legacy setting.

- Configure Windows settings (Power options, Screen brightness, Personalization, Screen resolution, and so on).
- Test with a verified working external display.
- Boot to Windows in safe mode.
- Test with a verified working operating system (for instance, shipping image).

HP PC Hardware Diagnostics (UEFI) for video test

Use this tool to quickly determine if the display issue is related to a real hardware issue.

To start HP PC Hardware Diagnostics (UEFI) ([6. HP Hardware Diagnostics and Tools on page 109](#)), when the computer is at boot, press the **F2** key, select **Component Tests**, and then select **Video**.

There are three options:

- **Video Memory Check:** to test video memory
- **Palette Check:** to test the three video color components (red, green, blue)
- **Dead Pixel Check:** to check dead pixels in eight different colors (Dead Pixel Check is available with the HP PC Diagnostics 3-in-1 USB Key tool)

Review the video troubleshooting in the following Display section for specific issues and possible solutions. For additional information about display problems, see documentation provided by the product manufacturer.

Display assembly diagram

The display assembly diagram shows basic video components: system board, graphics cards, display cables, display connectors, operating system (OS), graphics driver, and LCD display panel. Any component or a combination of these components can contribute to a video issue.

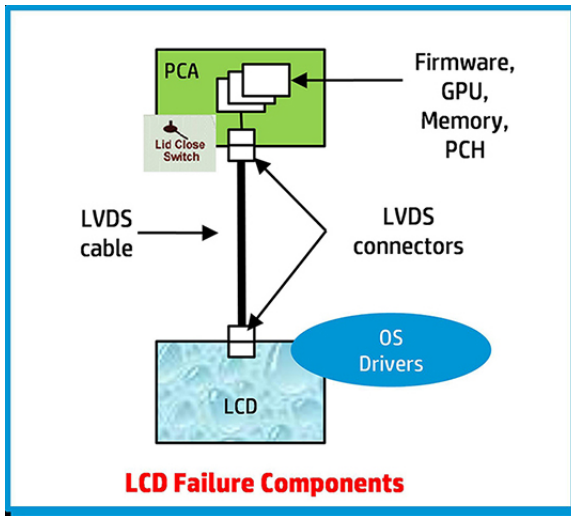

NOTE: The lid close switch is a Hall-effect sensor located in the top cover. When the display is closed, the sensor acts like a switch is closed. A notebook can force a video output to an external monitor, or go to hibernation or standby mode through power management. If the display screen does not light up when the display is open, the lid close switch (Hall-effect sensor) could be faulty.

Dead pixel

Display panel may show one or more pixels that are not properly lit when displaying a single color over the screen area. Use HP PC Hardware Diagnostics (UEFI) tool to determine those defective pixels.

There is no solution for dead pixels. See [Display issue: pixel anomalies on page 179](#) for the HP dead pixel policy.

No video (internal)

Use this information to troubleshoot video issues.

Table 7-28 Issues, possible causes, and fixes

Items	Procedures
<i>Symptoms</i>	<i>Possible causes</i>
No internal video with certain programs (for example, video-intensive games)	Display resolution, brightness, faulty lid switch, running a program requiring a higher resolution than the display screen can support. Faulty lid switch may put the system into Sleep or Hibernation mode.
	<i>Troubleshooting steps</i>
	Use an external monitor with higher resolution. Test with external monitor using HDMI or HP port. Press the power button and close the computer lid to force video output to external video. If there is still no video, contact support.
References	See section No video (with power) on page 132 for display information.

No video (external)

Use this information to troubleshoot external video issues.

Table 7-29 Issues, possible causes, and fixes

Items	Procedures
<i>Symptom</i>	<i>Possible causes</i>
No image on external monitor	External monitor, resolution, display configuration, drivers.
	<i>Troubleshooting steps</i>
	<ol style="list-style-type: none">1. Be sure external monitor is compatible with the computer.2. Be sure that external monitor is turned on.3. Press any key to exit the power-saving mode.4. Adjust the brightness of the monitor.5. Test with a verified working monitor.6. Test the monitor via internal ports (VGA, DP ports).7. Install latest video driver.8. Reset the screen resolution as described in the documentation.9. Configure display choice, and then force output to external video by closing the notebook lid or pressing fn + f4 to switch screen output.

DisplayPort/VGA

Use this information to troubleshoot DisplayPort and VGA issues.

See [No video \(external\) on page 145](#).

HDMI

Use this information to troubleshoot HDMI issues.

Table 7-30 Issues, possible causes, and fixes

Items	Procedures
<i>Symptoms</i>	<i>Possible causes</i>
<ul style="list-style-type: none">• Display issue• Sound issue	Cable, connection, settings.
	<i>Troubleshooting steps</i>
	Quick Check
	<ol style="list-style-type: none">1. Verify that the HDMI device input source is set correctly (for example, HDMI1).2. Be sure you are using the correct HDMI cable.3. Check connection and reconnect the HDMI cable.4. Verify whether sound output is configured correctly in Control Panel > Sound Manager.

Table 7-30 Issues, possible causes, and fixes (continued)

Items	Procedures
	<ol style="list-style-type: none"> 1. Perform hard reset (4. Update BIOS and drivers on page 107). 2. Update BIOS and drivers (4. Update BIOS and drivers on page 107) when you hear sound but do not see video on HDTV.
References	http://support.hp.com/us-en/document/c01186408

No or bad external video via docking

Use this information to troubleshoot video issues while docking.

Table 7-31 Issues, possible causes, and fixes

Items	Procedures
<i>Symptoms</i>	<i>Possible causes</i>
No or bad image on external monitor via ports of docking station (such as VGA, DP, TB, display port, and others)	Rooted from system board, software or drivers, dock connectors, docking station hardware or firmware, dock video ports (DP, VGA, and others).
	<i>Troubleshooting steps</i>
	<ol style="list-style-type: none"> 1. Be sure that external monitor is turned on. 2. Be sure that external monitor is compatible with the computer. 3. If applicable, plug the dock in different Type-C ports. For more information, see the technical white paper titled "HP Elite Dock with Thunderbolt 3 & HP ZBook Dock with Thunderbolt 3." Go to http://www.hp.com/ and search for HP ZBook Thunderbolt 3 Dock User Guide. 4. If the screen image is distorted, try a DP-to-VGA adapter. Connect the adapter to each DisplayPort and VGA port of the dock. 5. Test the monitor via internal ports (such as VGA, DP, HDMI, and others). 6. Verify that dock connectors of the notebook and the dock are clean, without dust, debris (for example, using air duster). 7. Ideally, use a verified working operating system or system connected to the dock to isolate the issue of the current operating system. 8. Ideally, use a verified working docking station to isolate the faulty dock. 9. Update latest dock firmware. Follow the installation instructions carefully. You may want to try a DP-to-VGA adapter if you have a distorted screen image. Connect the adapter to each DisplayPort of the dock. If you still cannot update the dock, attempt to update it on a confirmed working notebook before having the dock replaced.
Note	See the technical white paper titled "Multiple displays on HP ZBook Mobile Workstations" from HP platform support website. Go to http://h20195.www2.hp.com/v2/getpdf.aspx/4aa5-2657enw .

Incorrect or missing color/distorted image

Use this information to troubleshoot image issues.

Table 7-32 Issues, possible causes, and fixes

Items	Procedures
<i>Symptoms</i>	<i>Possible causes</i>
System works normally but the display shows:	Loose connection, display cable, display, graphics card.
<ul style="list-style-type: none">• Missing or strange color• Image distortion	<i>Troubleshooting steps</i> Verify with external monitor <ol style="list-style-type: none">1. Use combination fn + f4 to enable output to external monitor.2. Close the lid. <p>If the external monitor also shows incorrect color, it is graphics card issue. Test with a verified working graphics card.</p> <hr/> Verify monitor cable and cable connection (Monitor disassembly is required.) <p>Be sure the monitor cables are not pinched or damaged.</p> <p>Be sure the monitor cables have good connection at both ends (system board and display panel).</p> <ul style="list-style-type: none">• If moving cables affects the image, the monitor cable is the cause of the issue. Test with a confirmed working cable.• If moving cables does not affect the image, the monitor has an issue. Test with a confirmed working monitor.

Touch screen

Use this information to troubleshoot touch screen issues.

Table 7-33 Issues, possible causes, and fixes

Items	Procedures
<i>Symptoms</i>	<i>Possible causes</i>
Unresponsive	Dirt and smudge, driver, touch display configuration, power management.
Inaccurate	<i>Troubleshooting steps</i> Quick check <p>Turn off the computer, spray glass cleaner onto a soft, damp cloth, and gently wipe the screen to remove dirt and smudge.</p> <p>NOTE: Do not spray cleaner directly onto the screen.</p>

Table 7-33 Issues, possible causes, and fixes (continued)

Items	Procedures
Configure the touch display in Control Panel > Tablet PC Settings	<ol style="list-style-type: none">1. Restart the computer.2. Verify touch screen and graphics drivers.3. Configure the touch display to identify the screen as a touch screen as shown in the image at left.4. Calibrate the screen and reset if touch functionality is still not working correctly.5. Perform diagnostic test in HP Hardware Diagnostics under Component Tests > Touch Screen. If the diagnostics tests pass but the touch screen still does not respond, continue following the steps.6. Adjust the power management settings for your touch screen. If the touch screen stops working after waking from sleep, adjust the power management settings so that the touch screen device stays active while the computer is in Sleep mode.7. Perform Microsoft System Restore, and restore to a time when the system was working.8. Perform HP System Recovery if none of the previous actions resolve the issue.
References	https://support.hp.com/us-en/document/c03488148

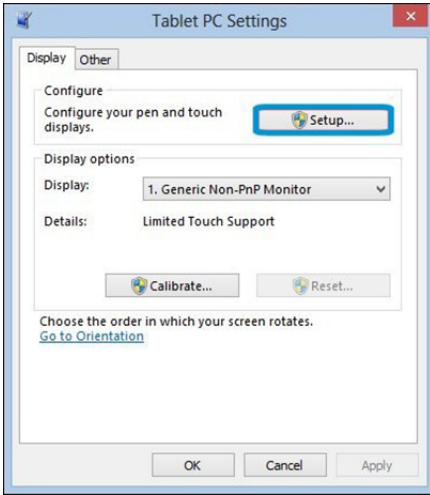

I/O devices

Use this information to troubleshoot I/O device issues.

NOTE:

- Make sure external devices are supported and compliant (for example, USB Type-C, Thunderbolt 3, PCI Express).
- If you have problems with external devices not provided by HP, contact device manufacturers for compatibility and latest drivers before troubleshooting (for example, USB devices, Thunderbolt devices, PCI express card reader, VGA, display, HDMI monitors, speakers).
- Be sure I/O devices are properly inserted into the I/O ports, and then be sure that Windows Device Manager recognizes the I/O devices.

Keyboard

Use this information to troubleshoot keyboard issues.

Table 7-34 Issues, possible causes, and fixes

Items	Procedures
<i>Symptoms</i>	<i>Possible causes</i>
Keystrokes not recognized	Dust trapped under keycap, loose keycap, loose keyboard connection, defective keyboard.
Characters not matched	
	<i>Troubleshooting steps</i>
	<ol style="list-style-type: none">1. Inspect the keyboard for any signs of dust, liquid, or debris trapped under sticky keys that might prevent keystroke recognition.2. Check for incomplete connection between keyboard and system board by verifying that caps lock or num lk light turns on when you press the key.3. Verify whether the keyboard is recognized in Windows Device Manager, and verify whether the keyboard driver is installed properly.4. Test with a working external keyboard (such as a USB keyboard). Also test in Windows for special keys (caps lock, shift, ctrl, fn, Windows, alt) if necessary.5. Test with HP PC Hardware Diagnostics (UEFI) to isolate a hardware issue from a software issue.6. Verify that BIOS is up to date. If so, resetting BIOS to default may help.7. Test with a verified working operating system, or restore the operating system to be sure that the issue is not caused by items such as different language settings, sticky keys feature, and so on.8. Verify that keyboard flex cables are fully inserted and in good condition.

The following steps are for authorized providers and technicians.

Table 7-34 Issues, possible causes, and fixes (continued)

Items	Procedures
	<ol style="list-style-type: none"> 1. Verify whether keyboard flex cable is in good condition (no delamination or torn cable end, no missing or cracked tracks, pads). 2. Verify that keyboard flex cable ends are fully inserted and aligned with connectors on system board, and those connector tabs are properly closed. Reseat cables. 3. Replace new internal keyboard and retest.
Tips	If a key works only when pressed with force, inspect and remove debris trapped under keycap.

Keyboard pointing stick

Use this information to troubleshoot pointing stick issues.

Table 7-35 Issues, possible causes, and fixes

Items	Procedures
<i>Symptom</i>	<i>Possible causes</i>
Point stick not working properly	Dust trapped under point stick, loose point stick cap.
	<i>Troubleshooting steps</i>
	<ol style="list-style-type: none"> 1. Inspect for any signs of dust or liquid spill that prevents point stick from working. 2. Check whether point stick cap is loose, and reseat it if necessary.

The following steps are for authorized providers and technicians.

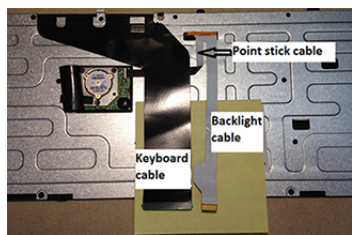

Example of back of keyboard, including keyboard, point stick, and backlight cables.

1. Verify whether keyboard flex cables are in good condition (no delamination or torn cable end, no missing or cracked tracks, pads).
2. Verify that keyboard flex cable ends are fully inserted and aligned with connectors on system board and back of keyboard, and that connector tabs are properly closed.
3. Reseat point stick cables.

Keyboard backlight

Use this information to troubleshoot keyboard backlight issues.

Table 7-36 Issues, possible causes, and fixes

Items	Procedures
<i>Symptom</i>	<i>Possible causes</i>
Backlight function not working properly	Backlight disabled, loose connection.

Table 7-36 Issues, possible causes, and fixes (continued)

Items	Procedures
	<i>Troubleshooting steps</i>
	NOTE: Not all notebook computers have backlit keyboards.
	A keyboard function key lets you turn the light on and off. Verify whether backlit feature is not disabled by pressing a combination of fn + backlit key.
The following steps are for authorized providers or technicians.	
	<ol style="list-style-type: none"> 1. Verify whether backlight flex cables are in good condition (no delamination or torn cable end, no missing or cracked tracks or pads). 2. Verify that backlight flex cable ends are fully inserted and aligned with connectors on system board and that connector tabs are properly closed. 3. Reseat backlight cable.

Touchpad

Use this information to troubleshoot touchpad issues.

Table 7-37 Issues, possible causes, and fixes

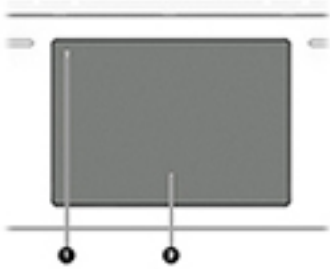
Items	Procedures
<i>Symptoms</i>	<i>Possible causes</i>
Not working properly	Touchpad turned off, driver, settings.
(1) Touchpad on/off button	<i>Troubleshooting steps</i>
(2) Touchpad	<ol style="list-style-type: none"> 1. Ensure touchpad on/off light is not amber (disabled). Double tap to enable. 2. Verify whether touchpad device is listed in Device Manager > Mice and other pointing devices. 3. Install the latest touchpad driver. 4. Adjust touchpad settings (Control Panel > Mouse). 5. Test touchpad controller using the HP PC Hardware Diagnostics (UEFI) tool (f2 > Component Tests > Mouse Test > Pointer Test & Drag and Drop Test).
	
The following steps are for authorized service providers/technicians.	
	<ol style="list-style-type: none"> 1. Check the touchpad cable for damage or a loose connection, and then reseat the touchpad cable. 2. If issue persists, replace the touchpad and verify the change.

Network connectivity (RJ-45 jack)

Use this information to troubleshoot network issues.

Table 7-38 Issues, possible causes, and fixes

Items	Procedures
<i>Symptoms</i>	<i>Possible causes</i>
<ul style="list-style-type: none">• Unable to find networks (yellow bang)• Connection dropouts• Slow performance	Network source, cable, connection, RJ-45 (network) jack, driver, settings.
	<i>Troubleshooting steps</i>
	Quick Check: verify the network status lights that supposed to flash when there is network activity.

Network connectivity wireless (WLAN)

Use this information to troubleshoot wireless connectivity issues.

Table 7-39 Issues, possible causes, and fixes

Items	Procedures
<i>Symptoms</i>	<i>Possible causes</i>
<ul style="list-style-type: none">• Unable to find networks (yellow bang)• Connection dropouts• Slow performance	Network source, cable, connection, wireless module, driver, settings.
The following steps are for authorized providers or technicians.	
	<ol style="list-style-type: none">1. Verify that the wireless module and its antenna cables are fully inserted and in good condition (see WLAN module removal and replacement section). Reseat wireless module and antenna connection.2. Verify the module antenna cable connection is not loose.3. Verify that antenna cables are properly connected to the MAIN and AUX terminals (see WLAN module removal and replacement section).

WWAN

Use this information to troubleshoot WWAN issues.

Table 7-40 Issues, possible causes, and fixes

Items	Procedures
<i>Symptom</i>	<i>Possible causes</i>
Unable to find networks or service	Network source, cable, connection, driver, settings.

Table 7-40 Issues, possible causes, and fixes (continued)

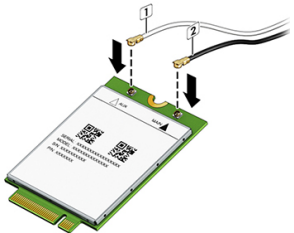
Items	Procedures
	<p data-bbox="580 260 778 289"><i>Troubleshooting steps</i></p> <ol data-bbox="580 310 1117 499" style="list-style-type: none"><li data-bbox="580 310 954 340">1. Update to the latest driver and utility.<li data-bbox="580 361 1117 390">2. Check with network service provider for signal coverage.<li data-bbox="580 411 906 441">3. Be sure signal strength is good.<li data-bbox="580 462 925 491">4. Be sure that your service is active.
<p data-bbox="245 512 794 541">The following steps are for authorized providers or technicians.</p>	
	<ul data-bbox="580 554 1442 693" style="list-style-type: none"><li data-bbox="580 554 1149 583">• Verify module and antenna cable connections are not loose.<li data-bbox="580 604 1442 693">• Verify antenna cables are properly connected to the correct terminals. For example, the antenna cable labeled 1 connects to the Main terminal labeled 1. The antenna cable labeled 2 connects to the Aux terminal labeled 2.

USB

Use this information to troubleshoot USB port issues.

Table 7-41 Issues, possible causes, and fixes

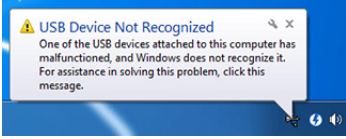
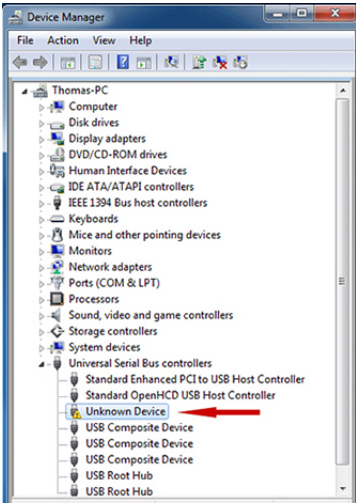
Items	Procedures
<p><i>Symptoms</i></p> <ul style="list-style-type: none"> • USB devices are not recognized • USB devices are not charging 	<p><i>Possible causes</i></p> <p>USB devices do not have the latest software drivers or port insufficient power, or the devices are not compliant.</p> <p>NOTE: USB Type-C uses a different connector entirely.</p>
<p>Examples of USB device Not Recognized</p>  	<p><i>Troubleshooting steps</i></p> <ol style="list-style-type: none"> 1. Unplug the USB device. Restart the computer (wait for 2–5 minutes) to reset the USB port or hub in case of a power surge. 2. Perform a soft reset (9. Soft reset (Default Settings) on page 116), and verify if the USB device is recognized. 3. Verify whether the USB device is recognized in Device Manager > Universal Serial Bus Controller, or the USB is recognized without a yellow warning symbol, or bang. 4. Verify whether the latest USB driver, USB chipset driver, or both are installed. You can remove or reinstall the USB driver. 5. Be sure the USB device is supported, for example, USB 3.0 device requires more power draw (0.9 A) from a USB port than a USB 2.0 device (0.5 A). As a result, identify the USB charging port to be used for charging a USB device, or an external AC power adapter might be required for an external USB storage device to work properly. 6. Test with verified working USB devices (keyboard, mouse, USB key) to be sure USB ports are functional. 7. Test the USB device on a verified working computer to be sure the USB device is not malfunctioning.

Smart card reader

Use this information to troubleshoot smart card reader issues.

Table 7-42 Issues, possible causes, and fixes

Items	Procedures
<p><i>Symptoms</i></p> <ul style="list-style-type: none"> • Not recognized • Unable to write 	<p><i>Possible causes</i></p> <p>Physical damage, incorrect insertion, dirt, driver, malfunctioning card reader.</p> <p>NOTE: Some cards have a read-write security switch on the card. Be sure that switch is set to Write Enabled before attempting to write data to it.</p>

Table 7-42 Issues, possible causes, and fixes (continued)

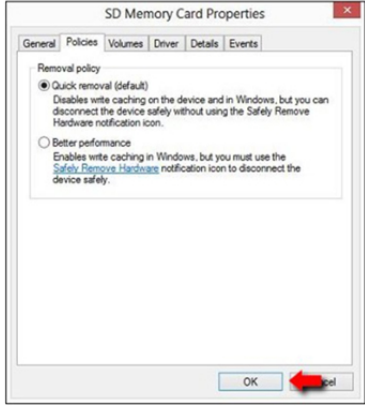
Items	Procedures
<p>Card Reader Removal Policy</p> 	<p><i>Troubleshooting steps</i></p> <ol style="list-style-type: none"> 1. Verify card reader removal policy. 2. Make sure there is no physical damage to the card. 3. Inspect the ends of the memory cards for dirt or material closing a hole or spoiling a metal contact. Clean the contacts with a lint-free cloth and small amounts of isopropyl alcohol. Replace the memory card if necessary. 4. Reinstall and update the drivers for the card reader. 5. Make sure the smart card reader is compliant with ISO 7816 Class A, B, and C. 6. Reinsert the card reader with correct face as described in its documentation. 7. Check reader function with a verified working card.

IMPORTANT: If the card reader has an in-use indicator light, do not insert or remove memory cards while the light is flashing. Doing so might cause loss of data on the card or might permanently damage the card reader.

Speaker, headphone - audio issues

Use this information to troubleshoot audio issues.

Table 7-43 Issues, possible causes, and fixes

Items	Procedures
<p><i>Symptoms</i></p> <ul style="list-style-type: none"> • No sound from external or internal speakers • Distorted sound, too soft, too loud, intermittent 	<p><i>Possible causes</i></p> <p>Volume turned down, sound card not recognized, malfunctioning hardware, electronic interference.</p>

Table 7-43 Issues, possible causes, and fixes (continued)

Items	Procedures
	<p><i>Troubleshooting steps</i></p> <ol style="list-style-type: none"> 1. Remove any device connected to the audio jack to enable the internal speaker. 2. Close all open programs. 3. Adjust volume by pressing fn + f6 or f7. Be sure that volume button light is not amber (mute). <p style="text-align: center;">- or -</p> <p>Adjust Windows volume control by clicking the speaker icon on the Windows taskbar. Be sure that the sound is not muted.</p> <ol style="list-style-type: none"> 4. Verify that the sound card is detected in Windows Device Manager. 5. Reinstall the latest audio driver. 6. Test audio device using HP PC Hardware Diagnostics (UEFI) tool (f2 > Component Tests > Audio). 7. Test with a verified working operating system. If issue is resolved, restore full operating system. 8. Test with verified working external speakers or headset. 9. Reseat internal speaker connections. 10. Test with verified working internal speakers. 11. Replace internal speakers.
No sound from headphones	<ol style="list-style-type: none"> 1. Adjust volume by pressing fn + f6 or f7. Be sure that volume button light is not amber (mute). Or adjust Windows volume control by clicking the speaker icon on the Windows taskbar. Be sure that the sound it not muted. 2. Check headphone cable connection. 3. Test with a verified working audio board. 4. Replace audio board and verify the change.
No sound from external speakers	<ol style="list-style-type: none"> 1. Verify that external speakers are turned on. 2. Disconnect headphones from headphone jack. 3. Adjust volume by pressing fn + f6 or f7. Be sure that volume button light is not amber (mute). <p style="text-align: center;">- or -</p> <p>Adjust Windows volume control by clicking the speaker icon on the Windows taskbar. Be sure that the sound is not muted.</p> <ol style="list-style-type: none"> 4. Check for possible interference devices nearby that might affect the audio (cell phone or portable communications handset.)

Thunderbolt (TB)

Use this information to troubleshoot Thunderbolt issues.

Table 7-44 Issues, possible causes, and fixes

Items	Procedures
<i>Symptom</i>	<i>Possible causes</i>
Thunderbolt device not working	BIOS, drivers, and user settings.
	<i>Troubleshooting steps</i>
	<ol style="list-style-type: none">1. Update to the latest BIOS and choose appropriate TB Port settings.2. Reset User Account Settings to default.3. Update Intel Thunderbolt software that includes firmware version (for TB controller), driver version (operating system driver), and application version.

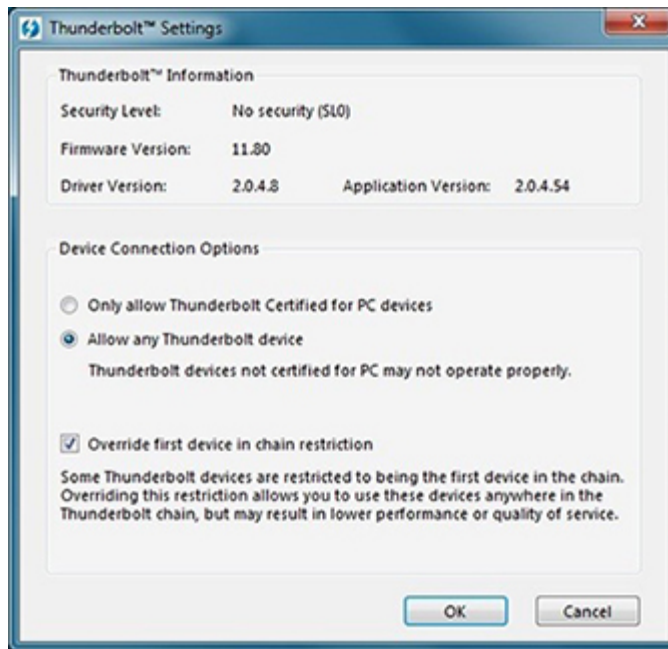

4. Verify that Windows Device Manager detects the TB device.
5. Verify cable connection to TB port.
6. Test with a verified working TB board, if possible.

NOTE: Thunderbolt is new technology. Thunderbolt cable and Thunderbolt device must be compatible with Windows. To determine whether your device is Thunderbolt Certified for Windows, see <https://thunderbolttechnology.net/products>.

Storage

Use this information to troubleshoot storage issues.

NOTE:

- Back up all critical data before troubleshooting the drive.
- Before contacting support, HP recommends that you run a drive (HDD, SSD, M.2 drive) test using the HP PC Hardware Diagnostics (UEFI) tool on the suspected failed drive.
- Diagnose the hard drive using BIOS, Diagnostics built in the shipping image, or an external USB (http://www8.hp.com/us/en/campaigns/hpsupportassistant/pc-diags.html?jumpid=va_r602_us/en/any/pps/pl_ot_ob_ds_pd/HP_PC_Hardware_Diagnostics_cc/dt).
- HP recommends the drive quick test to quickly (less than 10 minutes) identify the malfunctioning drive. If the issue still exists, run Extensive Test (more than 2 hours, or loop mode, which runs until an error occurs).
- If any test fails, record failure code and contact support for instructions about how to order a replacement hard drive.
- If all of the tests pass, the hard drive is not damaged. As a rule, HP will not replace a hard drive under warranty that does not fail the HP Hard Drive Self-Test.
- If there is no physical problem with the hard drive (or memory), then try reinstalling the Windows operating system to troubleshoot the problem.

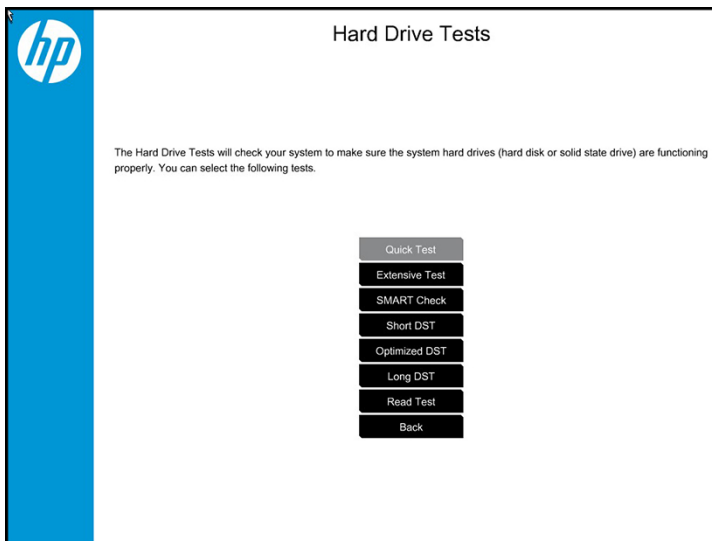

Hard drive or solid-state drive not recognized

Use this information to troubleshoot storage device issues.

Table 7-45 Issues, possible causes, and fixes

Items	Procedures
<i>Symptom</i>	<i>Possible causes</i>
Hard drive is not recognized during POST	Loose connection, faulty hard drive, faulty drive configuration/BIOS setting.
	<i>Troubleshooting steps</i>
	<ol style="list-style-type: none">1. Perform a hard reset (8. Hard reset on page 115).2. Reset BIOS to default.3. Verify hard drive connection and flex cable. Reseat hard drive and cable connection. For multiple storage devices, keep the primary drive with the operating system and remove other devices.4. Use the HP Hardware Diagnostics tool to verify that the drive is recognized and test it.5. If the hard drive fails diagnostics, record failure and have the drive replaced.6. Identify when the issue is related to software. If the hard drive passes diagnostics, test the drive on a verified working computer. If the failure follows the drive, reinstall the operating system to make sure that software is not an issue.7. Test with a verified working hard drive. If it is still not recognized, the system board is faulty.
	NOTE: If the drive is seen in BIOS and Diagnostics, try a secure erase before replacing a drive as this might resolve related issues.

No boot to operating system (no read-write error)

Use this information to troubleshoot issues with booting to the operating system.

Table 7-46 Issues, possible causes, and fixes

Items	Procedures
<i>Symptoms</i>	<i>Possible causes</i>
<ul style="list-style-type: none">• POST error message: Boot Device not found (3F0)• Hang when booting to operating system	Operating system, loose connection, faulty hard drive, BIOS configuration, Secure Boot.

Table 7-46 Issues, possible causes, and fixes (continued)

Items	Procedures
	<i>Troubleshooting steps</i>
	<ol style="list-style-type: none"> 1. Verify whether Secure Boot is enabled in BIOS. Secure Boot prevents legacy boot devices from starting the computer, including bootable CDs and DVDs. For more information, see http://support.hp.com/us-en/document/c03653226. 2. Reset BIOS to default. Be sure that BIOS Boot Mode in Boot Option is set up properly for bootable device and its operating system (for example, UEFI Native for Windows 8). Another example, choosing Legacy Boot Order for an UEFI device causes "Boot Device not found (3F0)" error. 3. Verify hard drive connection and flex cable. Reseat connection. For multiple storage devices, keep the primary drive with the operating system and remove other devices. 4. Use PC Hardware Diagnostics tool to test. Record failure code and have the hard drive replaced. 5. If there is no error, reinstall the operating system using HP Restore. 6. Test with a verified working operating system hard drive, if available.
Note	If there is a hard drive POST error message, see POST error messages and user actions on page 171 .

Read-write error

Use this information to troubleshoot read and write errors.

Table 7-47 Issues, possible causes, and fixes

Items	Procedures
<i>Symptoms</i>	<i>Possible causes</i>
<ul style="list-style-type: none"> • POST error message (for example, error code 301) 	Loose connection, faulty hardware.
<ul style="list-style-type: none"> • Hang when working on data, files, documents 	<i>Troubleshooting steps</i> <ol style="list-style-type: none"> 1. Perform a hard reset (8. Hard reset on page 115). 2. Reset BIOS to default (9. Soft reset (Default Settings) on page 116). 3. Verify the drive connection and flex cable. Reseat connection (10. Reseat cables and connections on page 116). 4. Use the HP Hardware Diagnostics tool to test. If failed, record failure code and have the hard drive replaced. 5. If no error with HP PC Hardware Diagnostics (UEFI) tool, try to repair the hard drive and its files in Windows (using command "CHKDSK /f /x /x"). Use HP Restore to reinstall the operating system, if needed. 6. Test with a verified working hard drive. If it is not recognized, the system board is faulty.
Note	If there is a hard drive POST error message, see POST error messages and user actions on page 171 .

Slow performance

Use this information to troubleshoot performance issues.

Table 7-48 Issues, possible causes, and fixes

Items	Procedures
<i>Symptoms</i>	<i>Possible causes</i>
Slow performance even when performing small read-write operations	Operating system files, hard drive is full.
	<i>Troubleshooting steps</i>
	<ol style="list-style-type: none">1. Transfer data from the hard drive to create more space. Microsoft recommends at least 200 MB to sync system files.2. Perform disk defragmentation to consolidate fragmented data on the hard drive so that it works more efficiently.
	NOTE: Do not defragment an SSD.
Tips & tricks	For optimal system performance, place your operating system and all of your most commonly used applications and files on the fastest hard drive (solid-state drive) and fastest areas on the drive (primary partition of 200 GB max).
	See Routine maintenance for performance improvement on page 173 .

Blue screen (BSOD) error

A faulty hard drive can cause a blue screen error. Perform the drive tests using the HP Diagnostics Tool to make sure that the drive is functional.

If all of the tests are successful, see [Common blue screen error messages on page 174](#) for detailed troubleshooting steps.

Noisy hard drive

Use this information to troubleshoot a noisy hard drive.

 **IMPORTANT:** Because an SSD has no moving parts, it does not make loud or clicking noises.

Depending on type and rotational speed, some hard drives make more noise than others.

Not all noises are related to the fan or hard drive.

Table 7-49 Issues, possible causes, and fixes

Items	Procedures
<i>Symptoms</i>	<i>Possible causes</i>
<ul style="list-style-type: none">• Loud noise from hard drive• Clicking noise from hard drive• Still boots to operating system and operates normally	BIOS, hard drive firmware, driver, faulty drive, power supply (AC adapter).

Table 7-49 Issues, possible causes, and fixes (continued)

Items	Procedures
	<i>Troubleshooting steps</i>
	<ol style="list-style-type: none"><li data-bbox="644 310 1015 338">1. Update BIOS and hard drive firmware.<li data-bbox="644 361 1374 415">2. Examine AC adapter to be sure that it is not faulty or overloaded. Disconnect all peripherals (USB storages, dock, and others).<li data-bbox="644 438 1027 466">3. Remove hard drive to isolate the noise.<li data-bbox="644 489 1461 564">4. Test the hard drive on a verified working computer if the noise continues. If the hard drive makes the same noise or clicking sounds, the sounds are either normal sounds for the hard drive or a fault with the hard drive.<li data-bbox="644 588 1426 615">5. Verify original hard drive connection and flex cable. Reseat hard drive and connection.<li data-bbox="644 638 1426 693">6. Run HP PC Hardware Diagnostics (UEFI). If failed, record failure code and replace hard drive replace.<li data-bbox="644 716 1406 772">7. If you find no error with HP PC Hardware Diagnostics (UEFI), perform disk defragmentation. Some hard drives make a clicking noise when highly fragmented.
Tips	<p data-bbox="644 795 1461 871">For optimal system performance, place your operating system and all of your most commonly used applications and files on the fastest hard drive or solid-state drive and on the fastest areas on the drive (primary partition of 200 GB max).</p> <p data-bbox="644 894 1254 926">See Routine maintenance for performance improvement on page 173).</p>

Mechanical

Use this information to troubleshoot mechanical issues.

Noise (sound)

Use this information to troubleshoot abnormal noise issues.

Table 7-50 Issues, possible causes, and fixes

Items	Procedures
<i>Symptoms</i>	<i>Possible causes</i>
Computer emits abnormal noise	Aside from basic components (power adapter, supply, fan, speaker, hard drive, optical drive, display panel, external devices), it is also common for electronic components to produce noise. <i>Troubleshooting steps</i> <ol style="list-style-type: none">1. Inspect external power source and change to verified working one.2. Determine whether the noise comes from AC power adapter. Test with a verified working AC adapter. Disconnect external devices and all cables connected to the computer to isolate issue to computer only.
Noisy fan	Determine whether the noise comes from the fan. Disconnect the fan briefly to isolate whether noise originates from fan. If noise is absent with fan disconnected, see Fan runs constantly on page 164 .
Noisy hard drive	Determine whether the noise comes from the hard drive. See Noisy hard drive on page 162 .
Noisy optical drive	<ol style="list-style-type: none">1. Determine whether the noise comes from an optical drive.2. Remove CD/DVD from the optical drive.
Noisy speaker	<ol style="list-style-type: none">1. Determine whether the noise comes from speaker.2. Test with a verified working external headset/speaker.
Noisy display	Determine whether the noise comes from display panel (humming noise). Change display frequency settings. See Display on page 142 .
The section below is intended for authorized service providers and technicians.	
	<ol style="list-style-type: none">1. After disassembling the chassis, inspect components of the interior for excessive wear or damage.2. If noise issues persist, proceed with process of elimination for battery, AC adapter, or boards.

Fan runs constantly

Use this information to troubleshoot a constantly running fan.

Table 7-51 Issues, possible causes, and fixes

Items	Procedures
<i>Symptoms</i>	<i>Possible causes</i>
<ul style="list-style-type: none">• Fan never stops running• Generates heat• Decreased computer performance	<ul style="list-style-type: none">• BIOS not up to date.• Thermal condition (fan, air flow)—fan might not be defective but must run constantly to remove excess heat generated by electrical components.• Inappropriate configuration.
	<i>Troubleshooting steps</i>
	General actions
	<ol style="list-style-type: none">1. Verify whether BIOS is set to Fan Always on while on AC Power F10 Setup. When booting the computer, press f10 to open Setup, and then select Advanced > Built-In Device Options Menu.2. Update BIOS and drivers (4. Update BIOS and drivers on page 107) and reset BIOS to default. BIOS can implement new fan characteristics and updates for other components.3. Perform a hard reset (8. Hard reset on page 115). Performing a hard reset can reset recorded thermal values in memory.
	Thermal-related issue
	<ol style="list-style-type: none">1. Verify that fan is spinning. Reseat fan cable before moving to next step.<ol style="list-style-type: none">a. Check fan and connection. Reseat fan cable.b. Be sure that no obstructions or dust are in heat sink fan, heat sink fin, or vent.c. Test fan using HP PC Hardware Diagnostics (UEFI) tool (6. HP Hardware Diagnostics and Tools on page 109). Be sure that the fan is not producing loud noise and that fan blades spin correctly.d. Test with a verified working fan.e. Replace the fan.2. Verify thermal solution<p>Use Thermal Monitor tool (available only to authorized service providers and technicians) (HP Thermal Monitor on page 111) to run stress test (processor and GPU) and verify that thermal sensors are within limits after thermal condition is serviced.</p>

Table 7-51 Issues, possible causes, and fixes (continued)

Items	Procedures
	<p>User configuration</p> <p>Change Power Options in Windows (for example, choosing Balanced mode instead of High performance). High performance and extensive graphics might cause the fan run constantly to release the heat.</p>
Notes	<p>BIOS currently omits fan presence detection to shorten boot time delay less than four seconds. Therefore, the fan error is generated based on previous boot to operating system that found system fan error.</p> <p>Fan often is part of thermal solution, including heat sink, heat sink fin/muffler, and thermal grease. Fan replacement requires reboot and fan function verification using HP PC Hardware Diagnostics (UEFI) tool.</p> <p>For more information, see the following links:</p> <ul style="list-style-type: none"> • http://support.hp.com/us-en/document/c01007591. • https://support.hp.com/us-en/document/c01657439.

Thermal shutdown (hot)

Use this information to troubleshoot a thermal shutdown.

Table 7-52 Issues, possible causes, and fixes

Items	Procedures
<i>Symptoms</i>	<i>Possible causes</i>
Similar to fan runs constantly issue (Fan runs constantly on page 164)	BIOS not up to date, thermal condition (fan, air flow)
<ul style="list-style-type: none"> • System shutdown • Abnormal heat • Continually running fan • Decreased computer performance 	<p><i>Troubleshooting steps</i></p> <ol style="list-style-type: none"> 1. Update BIOS and drivers (4. Update BIOS and drivers on page 107) and reset BIOS to default. BIOS can implement new fan characteristics and updates for other component. 2. Perform a hard reset (8. Hard reset on page 115). Performing a hard reset can reset recorded thermal values in memory. 3. Determine whether you are using a correct AC adapter. 4. Be sure to turn power off completely when putting a notebook in a travel bag.
	<p>Thermal-related issue</p> <ol style="list-style-type: none"> 1. Verify thermal condition: <ol style="list-style-type: none"> a. Check fan and connection. Check if fan is spinning when computer is on. Reseat fan cable. b. Be sure that no obstructions or dust are in heat sink fan, fin, or vent. c. Be sure that the notebook is not sitting on a hot surface that blocks vent intakes. d. Test fan using HP PC Hardware Diagnostics (UEFI) tool (6. HP Hardware Diagnostics and Tools on page 109). Be sure that the fan is not producing a loud noise and that fan blades spin correctly.

Table 7-52 Issues, possible causes, and fixes (continued)

Items	Procedures
	<ul style="list-style-type: none"><li data-bbox="683 260 1007 285">e. Test with a verified working fan.<li data-bbox="683 310 1406 336">f. Remove old thermal compound and pads, and replace properly with new pads. <p data-bbox="635 361 887 386">2. Verify thermal solution:</p> <ul style="list-style-type: none"><li data-bbox="683 411 1442 487">o Use Thermal Monitor tool (available only to authorized service providers and technicians) to run stress test (processor and GPU), and verify that thermal sensors are within limits after thermal condition is serviced.
Note	See https://support.hp.com/us-en/document/c01657439 .

Additional information

The following sections provide additional information that you can use during the troubleshooting process.

Acronyms

These acronyms are used in this chapter.

Blue screen (BSOD)—A Windows error screen that can occur if a problem causes your computer to shut down or restart unexpectedly. When you experience this type of error, you cannot see items such as the Start menu or the taskbar when your computer is turned on. Instead you might see a blue screen with a message that your computer ran into a problem and needs to restart.

CPU—Central processing unit

DIMM—Dual in-line memory module

Daughterboard—Type of circuit board that plugs into or is attached to the system board or similar expansion card to extend its features and services.

GPU—Graphics processor unit

GTS—General Troubleshooting Step

HDD—Hard drive

KB—Keyboard

LVDS—Low-Voltage Differential Signaling

MSG—Maintenance and Service Guide

mWS—Mobile Workstations

WS—Workstations

OS—Operating system

PC—Personal computer

POST—Power-On Self-Test

SSD—Solid-state drive

TSG—Troubleshooting Guide

UEFI—Unified Extensible Firmware Interface

WLAN—Wireless local area network

WWAN—Wireless wide area network

Blinking lights and boot error codes

In some cases, when the host processor is not executing code or does not have the necessary code to drive the display, light blink codes inform you of a problem.

The following information is from the white paper <http://h10032.www1.hp.com/ctg/Manual/c04685655>.

Table 7-53 Blinking lights and boot error codes

Blink codes	Error
Amber battery light: blinks 1 Hz continuously	Embedded Controller unable to load firmware
Caps and num lk lights = 1 blink	Processor not executing code
Caps and num lk lights = 2 blinks	BIOS recovery code unable to find valid BIOS recovery image
Caps and num lk lights = 3 blinks	Memory module error
Caps and num lk lights = 4 blinks	Graphics controller error
Caps and num lk lights = 5 blinks	System board error
Caps and num lk lights = 6 blinks	Intel Trusted Execution Technology (TXT) Error
Caps and num lk lights = 7 blinks	Sure Start unable to find valid BIOS Boot Block image
Caps and num lk lights = 8 blinks	Sure Start has identified a problem (Manual Recovery Policy Set)

Processor not executing code

This computer experienced a problem due to the failure of certain code to execute, resulting in a failed startup of the processor.

The issue could be related to the processor or the system board in the computer. If the processor is socketed, be sure that the processor is seated correctly in the socket. If this error reoccurs, see [General troubleshooting steps on page 101](#).

 **NOTE:** The computer attempts to notify you of this problem through a series of blinking lights. When you attempt to turn on the computer from an Off or Hibernated state, lights associated with the **caps lock** and **num lk** keys both **blink once**, followed by a pause, and then continue in a repeating pattern.

BIOS recovery code unable to find valid BIOS recovery image

This computer has experienced a problem in locating a valid BIOS image, resulting in a failed startup.

You can resolve this problem by placing a clean copy of the system BIOS on a USB key or in the appropriate hard drive directory and performing a reboot. If this error reoccurs, see [General troubleshooting steps on page 101](#).

 **NOTE:** The computer attempts to notify you of this problem through a series of blinking lights. When you attempt to turn on the computer from an Off or Hibernated state, lights associated with the **caps lock** and **num lk** keys both **blink twice**, followed by a pause, and then continue in a repeating pattern.

Memory module error

This computer has experienced a memory initialization problem resulting in a failed startup. This issue might be related to the memory modules in the computer. You can resolve this problem by ensuring that memory modules are correctly inserted and seated.

If this error reoccurs, you must use a service event to determine the source of the error (memory modules or system board) and take the appropriate corrective action.

 **NOTE:** The computer attempts to notify you of this problem through a series of blinking lights. When you attempt to turn on the computer from an Off or Hibernated state, lights associated with the [caps lock](#) and [num lock](#) keys both **blink three times**, followed by a pause, and then continue in a repeating pattern.

Graphics Controller Error (No Controller)

This computer has experienced a graphics controller initialization problem resulting in a failed startup. This issue might be related to the graphics controller in your machine.

You can resolve this problem by ensuring that the graphics controller module is seated correctly in machines with modular graphics. If this error reoccurs, you must use a service event to identify the source of the error and take the appropriate corrective action.

 **NOTE:** The computer attempts to notify you of this problem through a series of blinking lights. When you attempt to turn on the computer from an Off or Hibernated state, lights associated with the [caps lock](#) and [num lock](#) keys both **blink four times**, followed by a pause, and then continue in a repeating pattern.

Failure System Board Error

This computer has experienced a system board initialization problem resulting in a failed startup. This issue might be related to the system board in the computer. You must use a service event to identify the source of the error and take the appropriate corrective action.

 **NOTE:** The computer attempts to notify you of this problem through a series of blinking lights. When you attempt to turn on the computer from an Off or Hibernated state, lights associated with the [caps lock](#) and [num lock](#) keys both **blink five times**, followed by a pause, and then continue in a repeating pattern.

Intel Trusted Execution Technology (TXT) Error

This computer has experienced a problem related to the Intel Trusted Execution Technology resulting in a failed startup. The error occurs when three situations are true:

- The Intel Trusted Execution Technology (TXT) has been enabled on the computer.
- Policies have been set to prevent startup if the BIOS measurement has changed.
- The BIOS measurement has changed.

For more information about Intel TXT, go to <http://www.intel.com/content/dam/www/public/us/en/documents/white-papers/trusted-execution-technology-security-paper.pdf>.

You must use a service event to resolve this issue.

 **NOTE:** The computer attempts to notify you of this problem through a series of blinking lights. When you attempt to turn on the computer from an Off or Hibernated state, lights associated with the [caps lock](#) and [num lock](#) keys both **blink six times**, followed by a pause, and then continue in a repeating pattern.

Sure Start unable to find valid BIOS Boot Block image

This computer has experienced a problem in locating a valid BIOS image, resulting in a failed startup. You must use a service event to identify the source of the error and take appropriate corrective action.

 **NOTE:** The computer attempts to notify you of this problem through a series of blinking lights. When you attempt to turn on the computer from an Off or Hibernated state, lights associated with the **caps lock** and **num lk** keys both **blink seven times**, followed by a pause, and then continue in a repeating pattern.

Sure Start has identified a problem (Manual Recovery Policy Set)

This computer has experienced a problem in locating a valid BIOS image, resulting in a failed startup. HP Sure Start normally repairs this type of issue; however, on this computer HP Sure Start has been configured to operate in manual mode key sequence.

To proceed with the repair, press and hold the following keys: **esc + up arrow + down arrow**. To avoid the need for this manual recovery step, set the HP Sure Start recovery policy to automatic. If this error reoccurs, you must use a service event to identify the source of the error and take appropriate corrective action.

 **NOTE:** The computer attempts to notify you of this problem through a series of blinking lights. When you attempt to turn on the computer from an Off or Hibernated state, lights associated with the **caps lock** and **num lk** keys both **blink eight times**, followed by a pause, and then continue in a repeating pattern.

POST error messages and user actions

Use this information to determine the meaning of POST error messages.

Table 7-54 POST error messages and user actions to address the error

Test description	Failure descriptions	Error code	Possible user actions
Product information	Invalid value	00A	Contact support for assistance.
Startup test	Memory module	200	Attempt to reseat the memory module and then repeat the test. Search http://www.hp.com/support for details about troubleshooting issues related to the memory module. If the memory module still fails, contact support.
Startup test	Hard Disk 1 SMART	301	Attempt to reseat the hard drive and repeat the test. The hard disk drive might have failed. Contact support for assistance.
Startup test	Hard Disk 2 SMART	302	The hard drive might have failed. Contact support for assistance.
Startup test	Hard Disk 1 Quick	303	The hard drive might have failed. Contact support for assistance.
Startup test	Hard Disk 2 Quick	304	The hard drive might have failed. Contact support for assistance.
Run-in test	Memory module	200	Attempt to reseat the memory module and then repeat the test. Search http://www.hp.com/support for details about troubleshooting issues related to the memory module. If the memory module still fails, contact support.
Run-in test	Hard Disk 1 SMART	301	Attempt to reseat the hard drive and repeat the test. The hard drive might have failed. Contact support for assistance.
Run-in test	Hard Disk 2 SMART	302	The hard drive might have failed. Contact support for assistance.
Run-in test	Hard Disk 1 Quick	303	The hard drive might have failed. Contact support for assistance.
Run-in test	Hard Disk 2 Quick	304	The hard drive might have failed. Contact support for assistance.

Table 7-54 POST error messages and user actions to address the error (continued)

Test description	Failure descriptions	Error code	Possible user actions
Hard Disk Test	Hard Disk 1 SMART	301	Attempt to reseal the hard drive and repeat the test. The hard drive might have failed. Contact support for assistance.
Hard Disk Test	Hard Disk 2 SMART	302	The hard drive might have failed. Contact support for assistance.
Hard Disk Test	Hard Disk 1 Quick	303	The hard drive might have failed. Contact support for assistance.
Hard Disk Test	Hard Disk 2 Quick	304	The hard drive might have failed. Contact support for assistance.
Hard Disk Test	Hard Disk 1 Full	305	The hard drive might have failed. Contact support for assistance.
Hard Disk Test	Hard Disk 2 Full	306	The hard drive might have failed. Contact support for assistance.
Boot Device Manager	Boot device not found	3F0	This code indicates a potential problem with the hard drive. Run the hard drive test. See https://support.hp.com/emea_africa-en/document/c01443371 for more information.
Boot Device Manager	Hard Disk 1 Error	3F1	Indicates a potential problem with the hard drive. Run the hard drive test. See https://support.hp.com/emea_africa-en/document/c01443371 for more information.
Boot Device Manager	Hard Disk 2 Error	3F2	This code indicates a potential problem with the hard drive. Run the hard drive test. See https://support.hp.com/emea_africa-en/document/c01443371 for more information.
Boot Device Manager	Hard Disk 1 SMART	301	This code indicates a potential problem with the hard drive. Run the hard drive test. See https://support.hp.com/emea_africa-en/document/c01443371 for more information.
Boot Device Manager	Hard Disk 2 SMART	302	This code indicates a potential problem with the hard drive. Run the hard drive test. See https://support.hp.com/emea_africa-en/document/c01443371 for more information.
BIOS Recovery	BIOS Recovery Occurred	500	This message indicates that BIOS recovery was completed successfully. No further action is required.
BIOS Application	BIOS Application Error	501	The BIOS installation might have become corrupted. Download the latest version of the BIOS and install it. See 4. Update BIOS and drivers on page 107 for more information. If reinstalling the BIOS fails, contact support for further assistance.
CMOS Recovery	CMOS Recovery Occurred	502	This message indicates that CMOS recovery was completed successfully. No further action is required.
Battery Check	Primary Battery Replace	601	This code indicates that the primary battery has very low capacity. Search http://www.hp.com/support for details about using the HP Support Assistant to verify the battery capacity and, if necessary, order a replacement.

Table 7-54 POST error messages and user actions to address the error (continued)

Test description	Failure descriptions	Error code	Possible user actions
Battery Check	Secondary Battery Replace	602	This indicates that the secondary battery has very low capacity. Search http://www.hp.com/support for details about using the HP Support Assistant to verify the battery capacity and, if necessary, order a replacement.
Wireless Module	Not installed or responding	701	Reseat the wireless LAN adapter module, if your notebook supports it. Because seating or reseating a wireless LAN adapter is unique to each computer model.
Fan	Fan not operating correctly	90B	The system fan might be malfunctioning. For information about troubleshooting heat-related issues, see http://support.hp.com/us-en/document/c01007591 . A hard reset can sometimes restore the system fan to working order. See https://support.hp.com/us-en/document/c01684768 for details. If the system fan continues to malfunction, contact support.

Routine maintenance for performance improvement

The table presents a summary of the suggested times for performing the routine maintenance tasks that are described in this document.

Table 7-55 Routine maintenance tasks to improve performance

Tasks	Weekly	Monthly	Occasionally
Perform a system tune up.	X		
Run Windows Update.	X		
Scan for and remove viruses.	X		
Scan for and remove spyware and adware.	X		
Empty the Recycle Bin.	X		
Delete temporary Internet files.	X		
Back up user files.		X	
Create a restore point.		X	
Defragment the hard drive.		X	
Run Scan Disk.		X	
Clean the exterior of the computer.			X
Close programs that are not being used.			X
Prevent programs from loading at startup.			X
Remove rear cover and clean fan blades and vents with compressed air.			X

Common blue screen error messages

The following sections define blue screen error messages.

Error message list

For an example of a Bug Check Code Reference, use this image.

For more information, see [https://msdn.microsoft.com/en-us/library/windows/hardware/hh994433\(v=vs.85\).aspx](https://msdn.microsoft.com/en-us/library/windows/hardware/hh994433(v=vs.85).aspx).

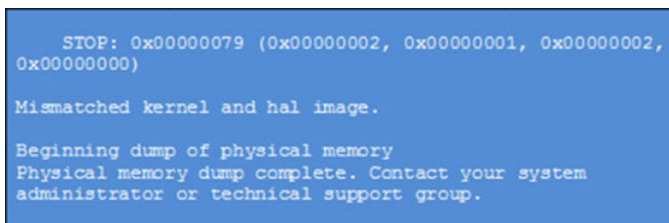

```
STOP: 0x00000079 (0x00000002, 0x00000001, 0x00000002,
0x00000000)

Mismatched kernel and hal image.

Beginning dump of physical memory
Physical memory dump complete. Contact your system
administrator or technical support group.
```

Note that the hexadecimal number following the word "STOP" is called the bug check code or Stop code.

Bug check symbolic names

Each bug check code also has an associated symbolic name.

In the example, the screen shows [https://msdn.microsoft.com/en-us/library/windows/hardware/ff559209\(v=vs.85\).aspx](https://msdn.microsoft.com/en-us/library/windows/hardware/ff559209(v=vs.85).aspx)

Microsoft general troubleshooting of Windows bug check codes

Use this information to troubleshoot Windows bug codes.

- If you recently added hardware to the system, try removing or replacing it. Or check with the manufacturer to see if any patches are available.
- Try running HP PC Hardware Diagnostics (UEFI).
- Check with the manufacturer to see if an updated system BIOS or firmware is available.
- Be sure that any expansion board is properly seated and all cables are completely connected.
- Confirm that any new hardware that is installed is compatible with the installed version of Windows.
- If new device drivers or system services have been added recently, try removing or updating them.

 **NOTE:** Use safe mode when removing or disabling components. Safe mode loads only the minimum required drivers and system services during the Windows startup. To enter safe mode, restart your computer and press **f8** at the menu that displays the operating system choices. At the resulting **Windows Advanced Options** menu, choose **Safe Mode**.

- Run a virus detection program. Viruses can infect all types of hard drives formatted for Windows, and resulting drive corruption can generate system bug check codes. Be sure that the virus detection program checks the Master Boot Record for infections.
- Verify that the system has the latest service pack installed. To detect which service pack, if any, is installed on your system, click **Start**, click **Run**, type `winvver`, and then press **enter**. The **About Windows** dialog box displays the Windows version number and the version number of the service pack, if one has been installed.

- Disable BIOS memory options such as caching or shadowing.
- Check the System Log and Application Log in Event Viewer to see if any additional error messages have been logged recently. These might pinpoint the cause of the error.

Use Windows Debugging Tool

Debugging Tools for Windows are the primary tools used by Microsoft software developers to analyze and resolve errors that result in memory dumps.

Use the tool ([https://msdn.microsoft.com/library/windows/hardware/ff551063%20\(v=vs.85\).aspx](https://msdn.microsoft.com/library/windows/hardware/ff551063%20(v=vs.85).aspx)) to determine the cause of the error. Follow general steps for downloading, setting up, and using the Windows 10 debugging tool. A similar process is used for Windows 7 or Windows 8.

 **NOTE:** The following screen shots provide only an example of the tool. Specifics shown are not representative of all applications of the debugging tool. This is a Microsoft tool supported by Microsoft.

Windows Software Development Kit (SDK)

Use these steps to download and use the Windows SDK.

1. Download the SDK from the following link:
<https://dev.windows.com/en-US/downloads/windows-10-sdk>
2. Set up the SDK in the configuration window (Windows 10 shown).

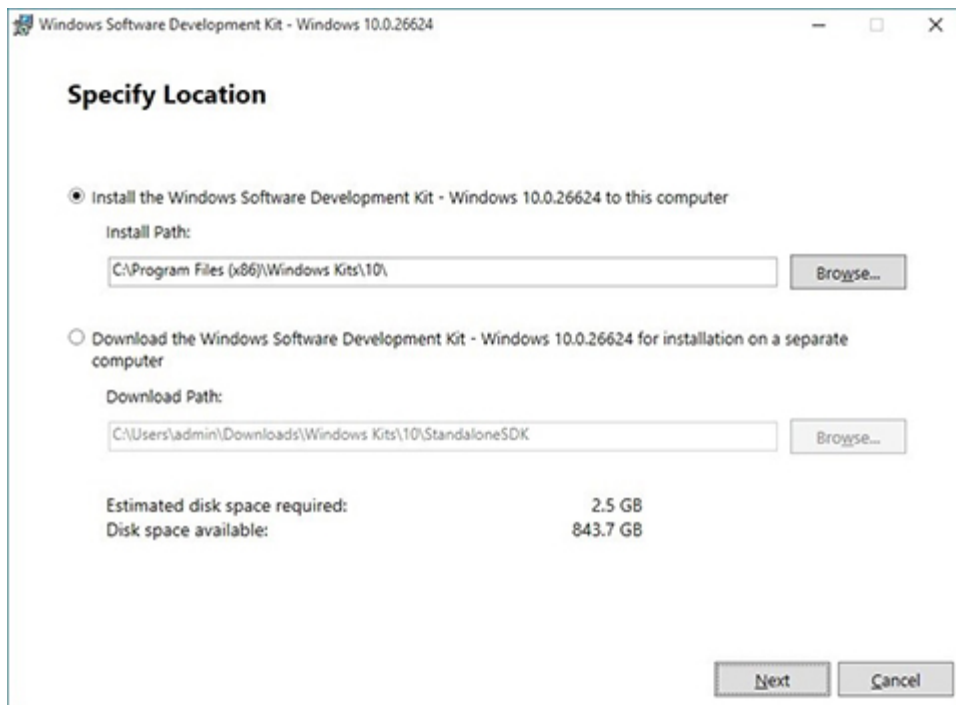

3. Select features to install.

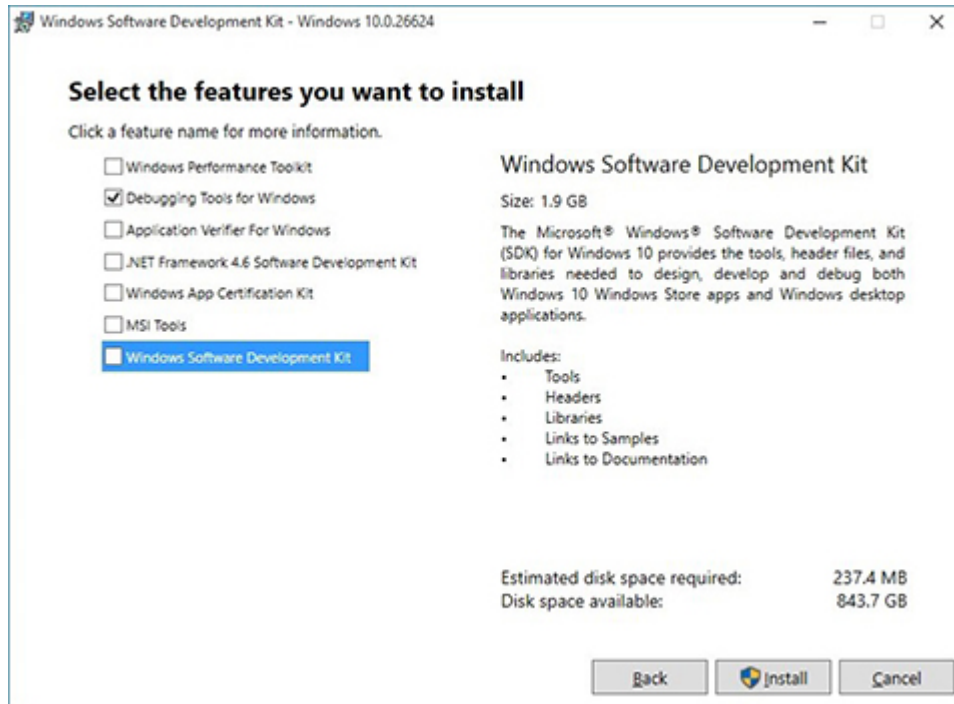

4. Run the SDK as an administrator.

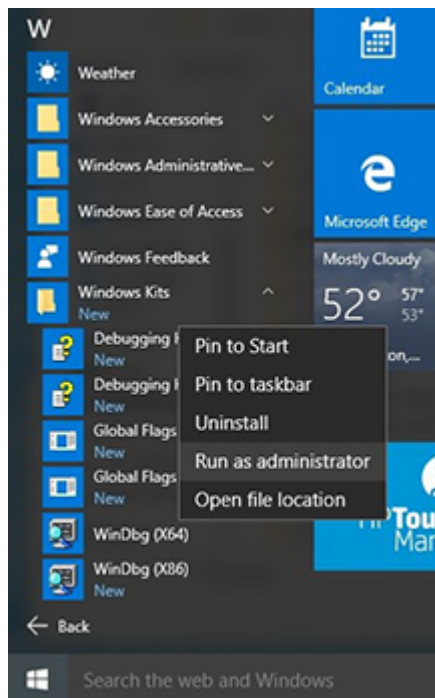

5. Set the symbol path. Select **File > Symbol File Path**.

- In the **Symbol path** box, type `SRV*C:\Windows\symbol_cache*http://msdl.microsoft.com/download/symbols`.
- Save the workspace.

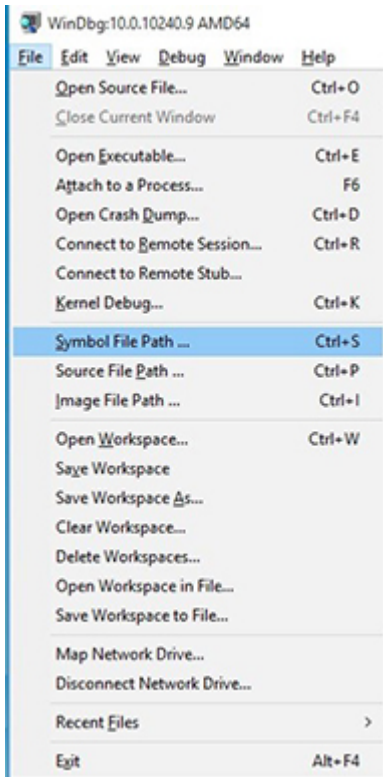

6. Open the crash dump file.

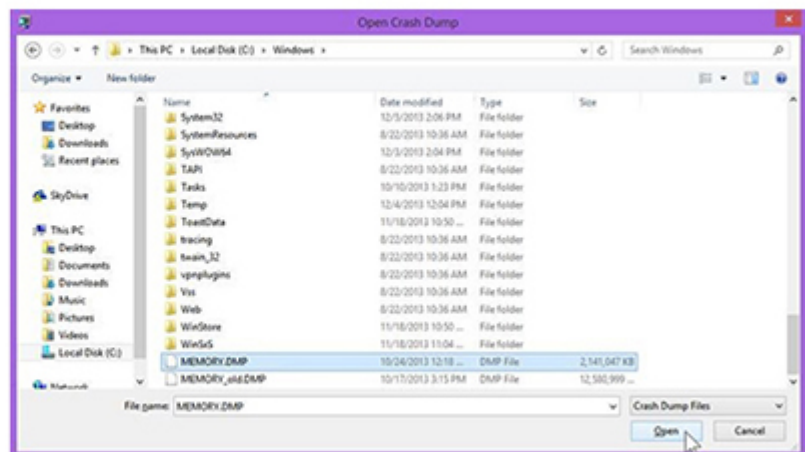
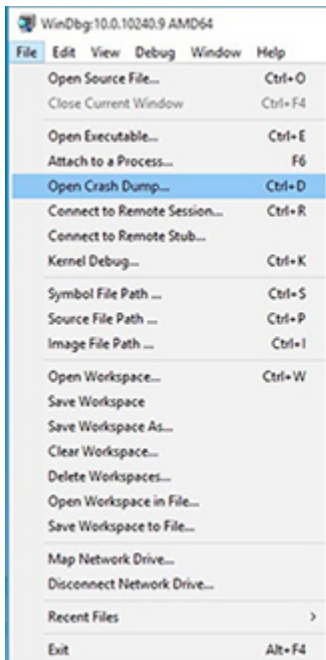

- Analyze the file. In the following memory dump sample, look for Bug Check 0x3B. The ATKMAG driver needs to be investigated for further root cause.

Lookup for Bug Check 0xC2.

```

1: kd> !analyze -v
.....
*
*                               Bugcheck Analysis                               *
*
*
*
.....

SYSTEM_SERVICE_EXCEPTION (3b)
An exception happened while executing a system service routine.
Arguments:
Arg1: 00000000c0000005, Exception code that caused the bugcheck
Arg2: fffff806d927acf, Address of the instruction which caused the bugcheck
Arg3: fffff80020e4e500, Address of the context record for the exception that caused the bugcheck
Arg4: 0000000000000000, zero.

Debugging Details:
-----
BUGCHECK_P1: c0000005
BUGCHECK_P2: fffff806d927acf
BUGCHECK_P3: fffff80020e4e500
BUGCHECK_P4: 0
EXCEPTION_CODE: (NTSTATUS) 0xc0000005 - The instruction at 0x%p referenced memory at 0x%p. The memory

FAULTING_IP:
atikmpag+2facf
fffff800`6d927acf 4539bc2434030000 cmp     dword ptr [r12+334h],r15d

...

SYMBOL_STACK_INDEX: 0
SYMBOL_NAME: atikmpag+2facf
FOLLOWUP_NAME: MachineOwner
MODULE_NAME: atikmpag
IMAGE_NAME: atikmpag.sys
DEBUG_FLR_IMAGE_TIMESTAMP: 55479b42
STACK_COMMAND: .cxr 0xfffff80020e4e500 ; kb
BUCKET_ID_FUNC_OFFSET: 2facf
FAILURE_BUCKET_ID: 0x3B_atikmpag!Unknown_Function
BUCKET_ID: 0x3B_atikmpag!Unknown_Function
PRIMARY_PROBLEM_CLASS: 0x3B_atikmpag!Unknown_Function
ANALYSIS_SOURCE: KM
FAILURE_ID_HASH_STRING: km:0x3b_atikmpag!unknown_function
FAILURE_ID_HASH: {adb80875-801c-005a-68e8-645bb2f2c848}

```

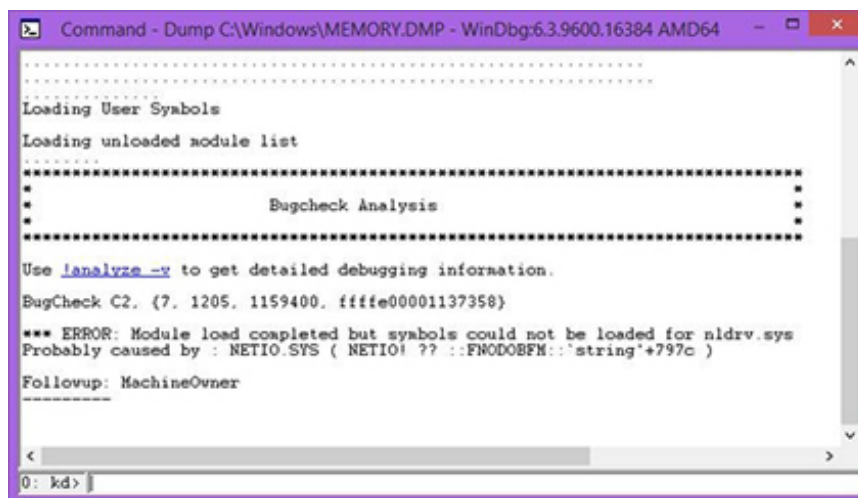

```

Command - Dump C:\Windows\MEMORY.DMP - WinDbg:6.3.9600.16384 AMD64
.....
Loading User Symbols
Loading unloaded module list
.....
*
*                               Bugcheck Analysis                               *
*
*
*
.....

Use !analyze -v to get detailed debugging information.

BugCheck C2, {7, 1205, 1159400, fffff80001137358}

*** ERROR: Module load completed but symbols could not be loaded for nldr.sys
Probably caused by : NETIO.SYS ( NETIO! ?? ::FNODOBFN::'string'+797c )

Followup: MachineOwner
-----
0: kd>

```

Display issue: pixel anomalies

All HP notebook displays adhere to strict quality and reliability specifications. A small percentage of display panels might have minor cosmetic manufacturing anomalies or irregularities such as bright or dark dots in the viewable area. These cosmetic imperfections are common to all display panel types, not specifically HP products.

All display panel defects should be examined at the highest possible resolution using both the brightest and darkest possible backgrounds, because some subpixel failures might not be readily visible under certain conditions.

- Type 1: Bright dot on a dark background = Always On
- Type 2: Dark dot on a bright background = Always Off
- Combination = in any combination and any color that are always on or off

Use the HP PC Hardware Diagnostics (UEFI) tool to determine numbers of pixels and their distance. HP uses the following set of criteria when damaged displays are submitted for warranty coverage.

Source: <http://support.hp.com/us-en/document/c00035844>

Table 7-56 Electrical defect criteria

Panel resolution	Accept	Reject
Subpixel faults		
VGA, SVGA, SD, WSVGA, XGA, 720p, SD+, WXGA, HD	N ≤ 2 Type 1 N ≤ 2 Type 2	N ≥ 3 Type 1
WXGA+, SXGA+, HD+, SXGA+	N ≤ 3 Type 1 N ≤ 3 Type 2	N ≥ 4 Type 1
WSXGA+, UXGA, FHD, WUXGA	N ≤ 4 Type 1 N ≤ 4 Type 2	N ≥ 5 Type 1
QHD, QHD+, WQXGA, UD	N ≤ 5 Type 1 N ≤ 5 Type 2	N ≥ 6 Type 1
Electrical defect clusters (defects within a 5x5 pixel block)		
Minimum distance between ANY allowable defects (unless otherwise specified)	S ≥ 25 mm	S < 25 mm
Cluster with 2 or more subpixels with subpixel faults		Not allowed
Dim lines		Not allowed
Cross lines on/off		Not allowed
Horizontal lines on/off		Not allowed
Vertical lines on/off		Not allowed

 **NOTE:** Examine all LCD panel defects at the highest possible resolution using both the brightest and darkest possible backgrounds, because some subpixel failures might not be readily visible under certain conditions.

 **NOTE:** Contact support for assistance if issues are not listed.

Cable management

Proper routing of the internal cables is critical to the operation of the computer. Follow good cable management practices when you have to remove and install components.

- Handle cables with care to avoid damage.
- Apply only the tension required to seat or unseat cables during insertion or removal from the connector.
- When possible, handle cables by the connector or pull-strap.
- Route cables in such a way that they cannot be caught or snagged by parts being removed or replaced.
- Keep cables away from direct contact with major heat sources, such as the heat sink. (Some air flow guides have a cable guide that lets you route cables safely around the heat sink.)
- Do not jam cables on top of daughterboards or memory modules (DIMMs). Circuit cards and DIMMs are not designed to take excessive pressure.
- Keep cables clear of any movable or rotating parts (such as a fan) to prevent them from being cut or crimped when the component is lowered into its normal position.
- In all cases, avoid bending or twisting the cables. Do not bend any cable sharply. A sharp bend can break the internal wires.
- Do not rely on components like the keyboard or service door to push cables down internally. Always position the cables to lie properly by themselves or in the cable guides and chassis areas designed for cable routing.



IMPORTANT: Always release connector latch before removing the cable. Otherwise, pulling the cable could damage the cable pins and result in a failed device.

Connector types

There are several types of connectors on the system board with different requirements for cable removal or insertion.

 **IMPORTANT:** Do not touch connector pins and connector gold fingers directly with bare hands.

Flex cable

Use this information to properly use flex cables.

When connecting flex cables to a ZIF connector, rotate the latch to 90°, push the cable completely, evenly into the connector, and then close the latch.

When removing flex cables from a ZIF connector on the system board, you must release the latch before removing the cable. Always follow these steps:

1. Flip the connector latch 90° to release the cable.
2. Grasp the cable end of the connector and pull it straight out.

 **IMPORTANT:** Always release connector latch before removing the cable. Otherwise, pulling the cable could damage the cable pins and result in a failed device.

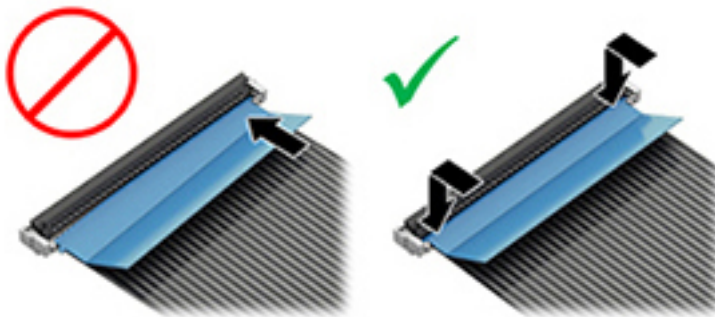

Horizontal cable insertion

Use flat tool to pull connector evenly. Do not pull on cable to remove.

Slide connector into receptacle on same horizontal plane as board and use a flat tool to push evenly into receptacle.

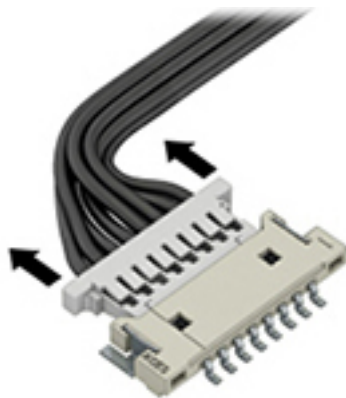

Multiple-pin horizontal connector (LVDS cable to display panel)

Use these procedures to properly insert and remove a multiple-pin horizontal connector.

Insert procedure:

1. Slide connector evenly into receptacle on same horizontal plane as PCB connector.
2. Pull lock bar to insert and push both side connector horizontally to firmly lock.
3. Tape down lock bar over the panel to hold in position.

Reverse the previous procedure to remove the connector:

1. Remove tape.
2. Pull up bar (pull tape) and release the lock with the PCB connector.
3. Pull to the direction in parallel with PCB to withdraw the connector.

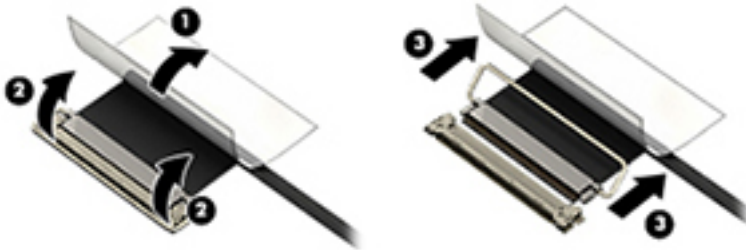

Multiple-pin vertical connector (LVDS cable to system board)

Use this procedure to properly insert and remove a multiple-pin vertical connector.

- Remove the connector gasket before removing the connector.
- If the connector has a plastic pull tab, pull the tab to disconnect. Otherwise, use flat tool under the connector to remove evenly. Do not pull on the cable to remove.
- Press evenly when reseating, reconnecting, or installing the connector.

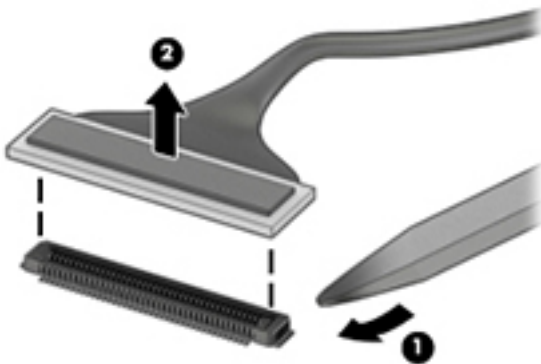

For more information about cable management, see [Cable management on page 180](#).

8 Using Setup Utility (BIOS)

Setup Utility, or Basic Input/Output System (BIOS), controls communication between all the input and output devices on the system (such as disk drives, display, keyboard, mouse, and printer). Setup Utility (BIOS) includes settings for the types of devices installed, the startup sequence of the computer, and the amount of system and extended memory.

 **NOTE:** To start Setup Utility on convertible computers, your computer must be in notebook mode and you must use the keyboard attached to your notebook.

Starting Setup Utility (BIOS)

You have several ways to access the Setup Utility (BIOS).

 **IMPORTANT:** Use extreme care when making changes in Setup Utility (BIOS). Errors can prevent the computer from operating properly.

▲ Turn on or restart the computer and quickly press **f10**.

– or –

Turn on or restart the computer, quickly press **esc**, and then press **f10** when the Start menu is displayed.

Updating Setup Utility (BIOS)

Updated versions of Setup Utility (BIOS) might be available on the HP website. Most BIOS updates on the HP website are packaged in compressed files called *SoftPaqs*. Some download packages contain a file named *Readme.txt*, which contains information regarding installing and troubleshooting the file.

Determining the BIOS version

To decide whether you need to update Setup Utility (BIOS), first determine the BIOS version on your computer.

To reveal the BIOS version information (also known as *ROM date* and *System BIOS*), use one of these options.

- HP Support Assistant
 1. Type `support` in the taskbar search box, and then select the **HP Support Assistant** app.
– or –
Select the question mark icon in the taskbar.
 2. Select **My notebook**, and then select **Specifications**.
- Setup Utility (BIOS)
 1. Start Setup Utility (BIOS) (see [Starting Setup Utility \(BIOS\) on page 185](#)).
 2. Select **Main**, and then make note of the BIOS version.
 3. Select **Exit**, select one of the options, and then follow the on-screen instructions.
- In Windows, press `ctrl+alt+s`.

To check for later BIOS versions, see [Preparing for a BIOS update on page 187](#).

Preparing for a BIOS update

Be sure to follow all prerequisites before downloading and installing a BIOS update.

 **IMPORTANT:** To reduce the risk of damage to the computer or an unsuccessful installation, download and install a BIOS update only when the computer is connected to reliable external power using the AC adapter. Do not download or install a BIOS update while the computer is running on battery power, docked in an optional docking device, or connected to an optional power source. During the download and installation, follow these instructions:

- Do not disconnect power from the computer by unplugging the power cord from the AC outlet.
- Do not shut down the computer or initiate Sleep.
- Do not insert, remove, connect, or disconnect any device, cable, or cord.

 **NOTE:** If your computer is connected to a network, consult the network administrator before installing any software updates, especially system BIOS updates.

Downloading a BIOS update

After you review the prerequisites, you can check for and download BIOS updates.

1. Type `support` in the taskbar search box, and then select the **HP Support Assistant** app.
– or –
Select the question mark icon in the taskbar.
2. Select **Updates**, and then select **Check for updates and messages**.
3. Follow the on-screen instructions.
4. At the download area, follow these steps:
 - a. Identify the most recent BIOS update and compare it to the BIOS version currently installed on your computer. If the update is more recent than your BIOS version, make a note of the date, name, or other identifier. You might need this information to locate the update later, after it has been downloaded to your hard drive.
 - b. Follow the on-screen instructions to download your selection to the hard drive.

Make a note of the path to the location on your hard drive where the BIOS update is downloaded. You will need to access this path when you are ready to install the update.

Installing a BIOS update

BIOS installation procedures vary. Follow any instructions that appear on the screen after the download is complete. If no instructions appear, follow these steps.

1. Type `file` in the taskbar search box, and then select **File Explorer**.
2. Select your hard drive designation. The hard drive designation is typically Local Disk (C:).
3. Using the hard drive path you recorded earlier, open the folder that contains the update.

4. Double-click the file that has an .exe extension (for example, *filename.exe*).

The BIOS installation begins.

5. Complete the installation by following the on-screen instructions.



NOTE: After a message on the screen reports a successful installation, you can delete the downloaded file from your hard drive.

9 Backing up, restoring, and recovering

You can use Windows tools or HP software to back up your information, create a restore point, reset your computer, create recovery media, or restore your computer to its factory state. Performing these standard procedures can return your computer to a working state faster.

 **IMPORTANT:** If you will be performing recovery procedures on a tablet, the tablet battery must be at least 70% charged before you start the recovery process.

IMPORTANT: For a tablet with a detachable keyboard, connect the tablet to the keyboard base before beginning any recovery process.

Backing up information and creating recovery media

These methods of creating recovery media and backups are available on select products only.

Using Windows tools for backing up

HP recommends that you back up your information immediately after initial setup. You can do this task either using Windows Backup locally with an external USB drive or using online tools.

 **IMPORTANT:** Windows is the only option that allows you to back up your personal information. Schedule regular backups to avoid information loss.

 **NOTE:** If computer storage is 32 GB or less, Microsoft System Restore is disabled by default.

Using the HP Cloud Recovery Download Tool to create recovery media (select products only)

You can use the HP Cloud Recovery Download Tool to create HP Recovery media on a bootable USB flash drive.

For details:

▲ Go to <http://www.hp.com/support>, search for HP Cloud Recovery, and then select the result that matches the type of computer that you have.

 **NOTE:** If you cannot create recovery media yourself, contact support to obtain recovery discs. Go to <http://www.hp.com/support>, select your country or region, and then follow the on-screen instructions.

 **IMPORTANT:** HP recommends that you follow the [Restoring and recovery methods on page 191](#) to restore your computer before you obtain and use the HP recovery discs. Using a recent backup can return your machine to a working state sooner than using the HP recovery discs. After the system is restored, reinstalling all the operating system software released since your initial purchase can be a lengthy process.

Restoring and recovering your system

You have several tools available to recover your system both within and outside of Windows if the desktop cannot load.

HP recommends that you attempt to restore your system using the [Restoring and recovery methods on page 191](#).

Creating a system restore

System Restore is available in Windows. The System Restore software can automatically or manually create restore points, or snapshots, of the system files and settings on the computer at a particular point.

When you use System Restore, it returns your computer to its state at the time you made the restore point. Your personal files and documents should not be affected.

Restoring and recovery methods

After you run the first method, test to see whether the issue still exists before you proceed to the next method, which might now be unnecessary.

1. Run a Microsoft System Restore.
2. Run Reset this PC.
3. Recover using HP Recovery media. For more information, see [Recovering using HP Recovery media on page 191](#).

For more information about the first two methods, see the Get Help app:

Select the **Start** button, select the **Get Help** app, and then enter the task you want to perform.



NOTE: You must be connected to the internet to access the Get Help app.

Recovering using HP Recovery media

You can use HP Recovery media to recover the original operating system and software programs that were installed at the factory. On select products, it can be created on a bootable USB flash drive using the HP Cloud Recovery Download Tool.

For details, see [Using the HP Cloud Recovery Download Tool to create recovery media \(select products only\) on page 190](#).



NOTE: If you cannot create recovery media yourself, contact support to obtain recovery discs. Go to <http://www.hp.com/support>, select your country or region, and then follow the on-screen instructions.

To recover your system:

- ▲ Insert the HP Recovery media, and then restart the computer.



NOTE: HP recommends that you follow the [Restoring and recovery methods on page 191](#) to restore your computer before you obtain and use the HP recovery discs. Using a recent backup can return your machine to a working state sooner than using the HP recovery discs. After the system is restored, reinstalling all the operating system software released since your initial purchase can be a lengthy process.

Changing the computer boot order

If your computer does not restart using the HP Recovery media, you can change the computer boot order, the order of devices listed in BIOS for startup information. You can select an optical drive or a USB flash drive, depending on the location of your HP Recovery media.

 **IMPORTANT:** For a tablet with a detachable keyboard, connect the tablet to the keyboard base before beginning these steps.

To change the boot order:

1. Insert the HP Recovery media.
2. Access the system **Startup** menu.
 - For computers or tablets with keyboards attached, turn on or restart the computer or tablet, quickly press **esc**, and then press **f9** for boot options.
 - For tablets without keyboards, turn on or restart the tablet, quickly press and hold the volume up button, and then select **f9**.

– or –

Turn on or restart the tablet, quickly press and hold the volume down button, and then select **f9**.
3. Select the optical drive or USB flash drive from which you want to boot, and then follow the on-screen instructions.

Using HP Sure Recover (select products only)

Select computer models are configured with HP Sure Recover, a PC OS recovery solution built into the hardware and software. HP Sure Recover can fully restore the HP OS image without installed recovery software.

Using HP Sure Recover, an administrator or user can restore the system and install:

- Latest version of the operating system
- Platform-specific device drivers
- Software applications, in the case of a custom image

To access the latest documentation for HP Sure Recover, go to <http://www.hp.com/support>. Follow the on-screen instructions to find your product and locate your documentation.

10 Using HP PC Hardware Diagnostics

You can use the HP PC Hardware Diagnostics utility to determine whether your computer hardware is running properly. The three versions are HP PC Hardware Diagnostics Windows, HP PC Hardware Diagnostics UEFI (Unified Extensible Firmware Interface), and (for select products only) Remote HP PC Hardware Diagnostics UEFI, a firmware feature.

Downloading the HP PC Hardware Diagnostics Windows from the Microsoft Store

You can download the HP PC Hardware Diagnostics Windows from the Microsoft Store.

1. Select the Microsoft Store app on your desktop or enter `Microsoft Store` in the taskbar search box.
2. Enter `HP PC Hardware Diagnostics Windows` in the **Microsoft Store** search box.
3. Follow the on-screen directions.

The tool downloads to the selected location.

Customizing Remote HP PC Hardware Diagnostics UEFI settings

Using the Remote HP PC Hardware Diagnostics setting in Computer Setup (BIOS), you can perform several customizations.

- Set a schedule for running diagnostics unattended. You can also start diagnostics immediately in interactive mode by selecting **Execute Remote HP PC Hardware Diagnostics**.
- Set the location for downloading the diagnostic tools. This feature provides access to the tools from the HP website or from a server that has been preconfigured for use. Your computer does not require the traditional local storage (such as a hard drive or USB flash drive) to run remote diagnostics.
- Set a location for storing the test results. You can also set the user name and password that you use for uploads.
- Display status information about the diagnostics run previously.

To customize Remote HP PC Hardware Diagnostics UEFI settings, follow these steps:

1. Turn on or restart the computer, and when the HP logo appears, press **F10** to enter Computer Setup.
2. Select **Advanced**, and then select **Settings**.

3. Make your customization selections.
4. Select **Main**, and then **Save Changes and Exit** to save your settings.

Your changes take effect when the computer restarts.

11 Specifications

This chapter provides specifications for your computer.

Computer specifications

This section provides specifications for your computer. When traveling with your computer, the computer dimensions and weights, as well as input power ratings and operating specifications, provide helpful information.

Table 11-1 Computer specifications

	Metric	U.S.
Dimensions		
Width	39.84 cm	15.69 in
Depth	26.71 cm	10.52 in
Height (front to back)	2.69 cm	1.06 in
Weight (varies by configuration and components)	2.97 kg	6.53 lb
Input power		

Table 11-1 Computer specifications (continued)

	Metric	U.S.
Operating voltage and current	5 V dc @ 2 A / 12 V dc @ 3 A / 15 V dc @ 3 A – 45 W USB-C	
	5 V dc @ 3 A / 9 V dc @ 3 A / 12 V dc @ 3.75 A / 15 V dc @ 3 A – 45 W USB-C	
	5 V dc @ 3 A / 9 V dc @ 3 A / 10 V dc @ 3.75 A / 12 V dc @ 3.75 A / 15 V dc @ 3 A / 20 V dc @ 2.25 A – 45 W USB-C	
	5 V dc @ 3 A / 9 V dc @ 3 A / 12 V dc @ 5 A / 15 V dc @ 4.33 A / 20 V dc @ 3.25 A – 65 W USB-C	
	5 V dc @ 3 A / 9 V dc @ 3 A / 10 V dc @ 5 A / 12 V dc @ 5 A / 15 V dc @ 4.33 A / 20 V dc @ 3.25 A – 65 W USB-C	
	5 V dc @ 3 A / 9 V dc @ 3 A / 10 V dc @ 5 A / 12 V dc @ 5 A / 15 V dc @ 5 A / 20 V dc @ 4.5 A – 90 W USB-C	
	19.5 V dc @ 2.31 A – 45 W	
	19.5 V dc @ 3.33 A – 65 W	
	19.5 V dc @ 4.62 A – 90 W	
	19.5 V dc @ 6.15 A – 120 W	
	19.5 V dc @ 6.9 A – 135 W	
	19.5 V dc @ 7.70 A – 150 W	
	19.5 V dc @ 10.3 A – 200 W	
	19.5 V dc @ 11.8 A – 230 W	
	19.5 V dc @ 16.92 A – 330 W	
Temperature		
Operating	5°C to 35°C	41°F to 95°F
Nonoperating	-20°C to 60°C	-4°F to 140°F
Relative humidity (noncondensing)		
Operating	10% to 90%	
Nonoperating	5% to 95%	
Maximum altitude (unpressurized)		
Operating	-15 m to 3,048 m	-50 ft to 10,000 ft
Nonoperating	-15 m to 12,192 m	-50 ft to 40,000 ft
NOTE: Applicable product safety standards specify thermal limits for plastic surfaces. The device operates well within this range of temperatures.		

43.9 cm (17.3 in) display specifications

This section provides specifications for your display.

Table 11-2 Display specifications

	Metric	U.S.
Active diagonal size	43.9 cm	17.3 in
Resolution	1920 × 1080 (FHD) 3840 × 2160 (UHD)	
Surface treatment	Antiglare (FHD, UHD panels) Brightview (WLED panel)	
Brightness	300 nits (FHD) 550 nits (UHD panel)	
Viewing angle	UWVA	
Backlight	WLED	
Display panel interface	eDP	

Hard drive specifications

This section provides specifications for your hard drives.

Table 11-3 Hard drive specifications

	500 GB*	750 GB*
Dimensions		
Height	9.5 mm	9.5 mm
Width	70 mm	70 mm
Weight	107 g max	102 g max
Interface type	SATA	SATA
Transfer rate	300 MB/s	300 MB/s
Security	ATA security	ATA security
Seek times (typical read, including setting)		
Single track	1.5 ms	1.1 ms
Average	12.0 ms	12.0 ms
Maximum	22.0 ms	21.0 ms
Logical blocks	976,752,240	1,465,149,168
Disk rotational speed	5400 rpm	5400 rpm
Operating temperature	0°C to 60°C (0°F to 140°F)	0°C to 60°C (0°F to 140°F)

Table 11-3 Hard drive specifications (continued)

	500 GB*	750 GB*
*Size refers to hard drive storage capacity. Actual accessible capacity is less. Actual drive specifications can differ slightly.		
NOTE: Certain restrictions and exclusions apply. Contact support for details.		

Solid-state drive specifications

This section provides specifications for your solid-state drives.

Table 11-4 Solid-state drive specifications

	256 GB*	512 GB*	1 TB*
Dimensions			
Height	1.0 mm	1.0 mm	1.0 mm
Length	50.8 mm	50.8 mm	50.8 mm
Width	28.9 mm	28.9 mm	28.9 mm
Weight	< 10 g	< 10 g	< 10 g
Interface type			
	PCIe	PCIe	PCIe
Ready time, maximum (to not busy)	1.0 ms	< 1.0 ms	1.0 ms
Access times, logical	0.1 ms	0.1 ms	0.1 ms
Transfer rate			
Sequential read	up to 2150 MB/s	up to 2150 MB/s	up to 2150 MB/s
Random read	Up to 300,000 IOPs	Up to 300,000 IOPs	Up to 300,000 IOPs
Sequential write	up to 1550 MB/s	up to 1550 MB/s	up to 1550 MB/s
Random write	Up to 100,000 IOPs	Up to 100,000 IOPs	Up to 100,000 IOPs
Total logical sectors	468,883,296	1,000,215,216	1,500,336,388
Operating temperature	0°C to 70°C (32°F to 158°F)		
*1 GB = 1 billion bytes when referring to hard drive storage capacity. Actual accessible capacity is less. Actual drive specifications may differ slightly.			
NOTE: Certain restrictions and exclusions apply. Contact support for details.			

Solid-state drive specifications (SATA-3)

This section provides specifications for your solid-state drive.

Table 11-5 Solid-state drive specifications

	128 GB*
Dimensions	
Height	1.35 mm

Table 11-5 Solid-state drive specifications (continued)

	128 GB*
Weight	< 10 g
Interface type	SATA-3
Ready time, maximum (to not busy)	1.0 ms
Access times, logical	0.1 ms
Transfer rate	up to 540 MB/s
Total logical sectors	234,441,648
Operating temperature	0°C to 70°C (32°F to 158°F)
<p>*1 GB = 1 billion bytes when referring to hard drive storage capacity. Actual accessible capacity is less. Actual drive specifications may differ slightly.</p>	
<p>NOTE: Certain restrictions and exclusions apply. Contact support for details.</p>	

12 Statement of memory volatility

For general information regarding nonvolatile memory in HP Business computers, and to restore nonvolatile memory that can contain personal data after the system has been turned off and the hard drive has been removed, use these instructions.

HP Business computer products that use Intel®-based or AMD®-based system boards contain volatile DDR memory. The amount of nonvolatile memory present in the system depends upon the system configuration. Intel-based and AMD-based system boards contain nonvolatile memory subcomponents as originally shipped from HP, with the following assumptions:

- No subsequent modifications were made to the system.
- No applications, features, or functionality were added to or installed on the system.

Following system shutdown and removal of all power sources from an HP Business computer system, personal data can remain on volatile system memory (DIMMs) for a finite period of time and also remains in nonvolatile memory. Use the following steps to remove personal data from the computer, including the nonvolatile memory found in Intel-based and AMD-based system boards.

 **NOTE:** If your tablet has a keyboard base, connect to the keyboard base before beginning steps in this chapter.

Current BIOS steps

Use these instructions to restore nonvolatile memory.

1. Follow these steps to restore the nonvolatile memory that can contain personal data. Restoring or reprogramming nonvolatile memory that does not store personal data is neither necessary nor recommended.

- a. Turn on or restart the computer, and then quickly press **esc**.

 **NOTE:** If the system has a BIOS administrator password, enter the password at the prompt.

- b. Select **Main**, select **Apply Factory Defaults and Exit**, and then select **Yes** to load defaults. The computer restarts.
- c. During the restart, press **esc** while the "Press the ESC key for Startup Menu" message is displayed at the bottom of the screen.

 **NOTE:** If the system has a BIOS administrator password, enter the password at the prompt.

- d. Select the **Security** menu, select **Restore Security Settings to Factory Defaults**, and then select **Yes** to restore security level defaults. The computer reboots.

- e. During the reboot, press **esc** while the "Press the ESC key for Startup Menu" message is displayed at the bottom of the screen.



NOTE: If the system has a BIOS administrator password, enter the password at the prompt.

- f. If an asset or ownership tag is set, select the **Security** menu and scroll down to the **Utilities** menu. Select **System IDs**, and then select **Asset Tracking Number**. Clear the tag, and then make the selection to return to the prior menu.
- g. If a DriveLock password is set, select the **Security** menu, and scroll down to **Hard Drive Utilities** under the **Utilities** menu. Select **Hard Drive Utilities**, select **DriveLock**, and then clear the check box for **DriveLock password on restart**. Select **OK** to proceed.
- h. Select the **Main** menu, and then select **Reset BIOS Security to factory default**. Click **Yes** at the warning message. The computer reboots.
- i. During the reboot, press **esc** while the "Press the ESC key for Startup Menu" message is displayed at the bottom of the screen.



NOTE: If the system has a BIOS administrator password, enter the password at the prompt.

- j. Select the **Main** menu, select **Apply Factory Defaults and Exit**, select **Yes** to save changes and exit, and then select **Shutdown**.
 - k. Reboot the system. If the system has a Trusted Platform Module (TPM), fingerprint reader, or both, one or two prompts will appear—one to clear the TPM and the other to Reset Fingerprint Sensor. Press or tap **f1** to accept or **f2** to reject.
 - l. Remove all power and system batteries for at least 24 hours.
2. Complete one of the following:
- Remove and retain the storage drive.
– or –
 - Clear the drive contents by using a third-party utility designed to erase data from an SSD.
– or –
 - Clear the contents of the drive by using the following BIOS Setup Secure Erase command option steps:

If you clear data using Secure Erase, you cannot recover it.

- a. Turn on or restart the computer, and then quickly press **esc**.
- b. Select the **Security** menu and scroll down to the **esc** menu.
- c. Select **Hard Drive Utilities**.
- d. Under **Utilities**, select **Secure Erase**, select the hard drive storing the data you want to clear, and then follow the on-screen instructions to continue.

– or –

Clear the contents of the drive using the following Disk Sanitizer commands steps:

- i. Turn on or restart the computer, and then quickly press **esc**.
- ii. Select the **Security** menu and scroll down to the **Utilities** menu.
- iii. Select **Hard Drive Utilities**.
- iv. Under **Utilities**, select **Disk Sanitizer**, select the hard drive with the data that you want to clear, and then follow the on-screen instructions to continue.

 **NOTE:** The amount of time it takes for Disk Sanitizer to run can take several hours. Plug the computer into an AC outlet before starting.

Nonvolatile memory usage

Use this table to troubleshooting nonvolatile memory usage.

Table 12-1 Troubleshooting steps for nonvolatile memory usage

Nonvolatile memory type	Amount (Size)	Does this memory store customer data?	Does this memory retain data when power is removed?	What is the purpose of this memory?	How is data entered into this memory?	How is this memory write-protected?
HP Sure Start flash (select models only)	8 MB	No	Yes	Provides protected backup of critical System BIOS code, EC firmware, and critical computer configuration data for select platforms that support HP Sure Start. For more information, see Using HP Sure Start (select products only) on page 207 .	Data cannot be written to this device via the host processor. The content is managed solely by the HP Sure Start Embedded Controller.	This memory is protected by the HP Sure Start Embedded Controller.
Real Time Clock (RTC) battery backed-up CMOS configuration memory	256 bytes	No	Yes	Stores system date and time and noncritical data.	RTC battery backed-up CMOS is programmed using Computer Setup (BIOS), or by changing the Windows date & time.	This memory is not write-protected.
Controller (NIC) EEPROM	64 KB (not customer accessible)	No	Yes	Stores NIC configuration and NIC firmware.	NIC EEPROM is programmed using a utility from the NIC vendor that can be run from DOS.	A utility must be used to write data to this memory and is available from the NIC vendor. Writing data to this ROM in an inappropriate manner will render the NIC non-functional.

Table 12-1 Troubleshooting steps for nonvolatile memory usage (continued)

Nonvolatile memory type	Amount (Size)	Does this memory store customer data?	Does this memory retain data when power is removed?	What is the purpose of this memory?	How is data entered into this memory?	How is this memory write-protected?
DIMM Serial Presence Detect (SPD) configuration data	256 bytes per memory module, 128 bytes programmable (not customer accessible)	No	Yes	Stores memory module information.	DIMM SPD is programmed by the memory vendor.	Data cannot be written to this memory when the module is installed in a computer. The specific write-protection method varies by memory vendor.
System BIOS	9 MB	Yes	Yes	Stores system BIOS code and computer configuration data.	System BIOS code is programmed at the factory. Code is updated when the system BIOS is updated. Configuration data and settings are entered using the Computer Setup (BIOS) or a custom utility.	NOTE: Writing data to this ROM in an inappropriate manner can render the computer non-functional. A utility must be used for writing data to this memory and is available on the HP website; go to http://www.hp.com/support . Select Find your product , and then follow the on-screen instructions.
Intel Management Engine Firmware (present only in select Elite or Z models. For more information, go to http://www.hp.com/support . Select Identify your product for manuals and specific product information , and then follow the on-screen instructions.)	1.5 MB or 7 MB	Yes	Yes	Stores Management Engine Code, Settings, Provisioning Data and iAMT third-party data store.	Management Engine Code is programmed at the factory. Code is updated via Intel secure firmware update utility. Unique Provisioning Data can be entered at the factory or by an administrator using the Management Engine (MEBx) setup utility. The third-party data store contents can be populated by a remote management console or local applications that have been registered by an administrator to have access to the space.	The Intel chipset is configured to enforce hardware protection to block all direct read-write access to this area. An Intel utility must be used for updating the firmware. Only firmware updates digitally signed by Intel can be applied using this utility.
Bluetooth flash (select products only)	2 megabits	No	Yes	Stores Bluetooth configuration and firmware.	Bluetooth flash is programmed at the factory. Tools for writing data to this memory are not publicly available but can be obtained from the silicon vendor.	A utility must be used for writing data to this memory and is made available through newer versions of the driver whenever the flash requires an upgrade.
802.11 WLAN EEPROM	4 kilobits to 8 kilobits	No	Yes	Stores configuration and calibration data.	802.11 WLAN EEPROM is programmed at the factory. Tools for writing data to this memory are not made public.	A utility must be used for writing data to this memory and is typically not made available to the public unless a firmware upgrade is necessary to address a unique issue.

Table 12-1 Troubleshooting steps for nonvolatile memory usage (continued)

Nonvolatile memory type	Amount (Size)	Does this memory store customer data?	Does this memory retain data when power is removed?	What is the purpose of this memory?	How is data entered into this memory?	How is this memory write-protected?
Camera (select products only)	64 kilobits	No	Yes	Stores camera configuration and firmware.	Camera memory is programmed using a utility from the device manufacturer that can be run from Windows.	A utility must be used for writing data to this memory and is typically not made available to the public unless a firmware upgrade is necessary to address a unique issue.
Fingerprint reader (select products only)	512 KB flash	Yes	Yes	Stores fingerprint templates.	Fingerprint reader memory is programmed by user enrollment in HP ProtectTools Security Manager.	Only a digitally signed application can make the call to write to the flash.

Questions and answers

Use this section to answer your questions about nonvolatile memory.

1. How can the BIOS settings be restored (returned to factory settings)?



IMPORTANT: The restore defaults feature does not securely erase any data on your hard drive. See question and answer 6 for steps to securely erase data.

The restore defaults feature does not reset the Custom Secure Boot keys. See question and answer 7 for information about resetting the keys.

- a. Turn on or restart the computer, and then quickly press **esc**.
- b. Select **Main**, and then select **Apply Factory Defaults and Exit**.

- c. Follow the on-screen instructions.
- d. Select **Main**, select **Save Changes and Exit**, and then follow the on-screen instructions.

2. What is a UEFI BIOS, and how is it different from a legacy BIOS?

The Unified Extensible Firmware Interface (UEFI) BIOS is an industry-standard software interface between the platform firmware and an operating system (OS). It replaces the older BIOS architecture but supports much of the legacy BIOS functionality.

Like the legacy BIOS, the UEFI BIOS provides an interface to display the system information and configuration settings and to change the configuration of your computer before an OS is loaded. BIOS provides a secure runtime environment that supports a Graphic User Interface (GUI). In this environment, you can use either a pointing device (touch screen, touchpad, pointing stick, or USB mouse) or the keyboard to navigate and make menu and configuration selections. The UEFI BIOS also contains basic system diagnostics.

The UEFI BIOS provides functionality beyond that of the legacy BIOS. In addition, the UEFI BIOS works to initialize the computer's hardware before loading and executing the OS; the runtime environment allows the loading and execution of software programs from storage devices to provide more functionality, such as advanced hardware diagnostics (with the ability to display more detailed system information) and advanced firmware management and recovery software.

HP has provided options in Computer Setup (BIOS) to allow you to run in legacy BIOS, if required by the operating system. Examples of this requirement would be if you upgrade or downgrade the OS.

3. Where is the UEFI BIOS located?

The UEFI BIOS is located on a flash memory chip. You must use a utility to write to the chip.

4. What kind of configuration data is stored on the DIMM Serial Presence Detect (SPD) memory module? How would this data be written?

The DIMM SPD memory contains information about the memory module, such as size, serial number, data width, speed and timing, voltage, and thermal information. This information is written by the module manufacturer and stored on an EEPROM. You cannot write to this EEPROM when the memory module is installed in a computer. Third-party tools do exist that can write to the EEPROM when the memory module is not installed in a computer. Various third-party tools are available to read SPD memory.

5. What is meant by "Restore the nonvolatile memory found in Intel-based system boards"?

This message relates to clearing the Real Time Clock (RTC) CMOS memory that contains computer configuration data.

6. How can the BIOS security be reset to factory defaults and erase the data?

 **IMPORTANT:** Resetting results in the loss of information.

These steps do not reset Custom Secure Boot Keys. See question and answer 7 for information about resetting the keys.

- a. Turn on or restart the computer, and then quickly press **esc**.
- b. Select **Main**, and then select **Reset Security to Factory Defaults**.

- c. Follow the on-screen instructions.
 - d. Select **Main**, select **Save Changes and Exit**, and then follow the on-screen instructions.
7. **How can the Custom Secure Boot Keys be reset?**
- Secure Boot is a feature to ensure that only authenticated code can start on a platform. If you enabled Secure Boot and created Custom Secure Boot Keys, disabling Secure Boot does not clear the keys. You must also select to clear the Custom Secure Boot Keys. Use the same Secure Boot access procedure that you used to create the Custom Secure Boot Keys, but select to clear or delete all Secure Boot Keys.
- a. Turn on or restart the computer, and then quickly press **esc**.
 - b. Select the **Security** menu, select **Secure Boot Configuration**, and then follow the on-screen instructions.
 - c. At the **Secure Boot Configuration** window, select **Secure Boot**, select **Clear Secure Boot Keys**, and then follow the on-screen instructions to continue.

Using HP Sure Start (select products only)

Select computer models are configured with HP Sure Start, a technology that continuously monitors your computer's BIOS for attacks or corruption.

If the BIOS becomes corrupted or is attacked, HP Sure Start restores the BIOS to its previously safe state, without user intervention. Those select computer models ship with HP Sure Start configured and enabled. HP Sure Start is configured and already enabled so that most users can use the HP Sure Start default configuration. Advanced users can customize the default configuration.

To access the latest documentation on HP Sure Start, go to <http://www.hp.com/support>.

13 Power cord set requirements

This chapter provides power cord requirements for countries and regions.

The wide-range input feature of the computer permits it to operate from any line voltage from 100 V ac to 120 V ac, or from 220 V ac to 240 V ac.

The 3-conductor power cord set included with the computer meets the requirements for use in the country or region where the equipment is purchased.

Power cord sets for use in other countries or regions must meet the requirements of the country and region where the computer is used.

Requirements for all countries

These power cord requirements are applicable to all countries and regions.

- The length of the power cord set must be at least **1.0 m** (3.3 ft) and no more than **2.0 m** (6.5 ft).
- All power cord sets must be approved by an acceptable accredited agency responsible for evaluation in the country or region where the power cord set will be used.
- The power cord sets must have a minimum current capacity of 10 A and a nominal voltage rating of 125 V ac or 250 V ac, as required by the power system of each country or region.
- The appliance coupler must meet the mechanical configuration of an EN 60 320/IEC 320 Standard Sheet C13 connector for mating with the appliance inlet on the back of the computer.

Requirements for specific countries and regions

To determine power cord requirements for specific countries and regions, use this table.

Table 13-1 Power cord requirements for specific countries and regions

Country/region	Accredited agency	Applicable note number
Argentina	IRAM	1
Australia	SAA	1
Austria	OVE	1
Belgium	CEBEC	1
Brazil	ABNT	1
Canada	CSA	2

Table 13-1 Power cord requirements for specific countries and regions (continued)

Country/region	Accredited agency	Applicable note number
Chile	IMQ	1
Denmark	DEMKO	1
Finland	FIMKO	1
France	UTE	1
Germany	VDE	1
India	BIS	1
Israel	SII	1
Italy	IMQ	1
Japan	JIS	3
The Netherlands	KEMA	1
New Zealand	SANZ	1
Norway	NEMKO	1
The People's Republic of China	CCC	4
Saudi Arabia	SASO	7
Singapore	PSB	1
South Africa	SABS	1
South Korea	KTL	5
Sweden	SEMKO	1
Switzerland	SEV	1
Taiwan	BSMI	6
Thailand	TISI	1
The United Kingdom	ASTA	1

Table 13-1 Power cord requirements for specific countries and regions (continued)

Country/region	Accredited agency	Applicable note number
The United States	UL	2
<ol style="list-style-type: none">1. The flexible cord must be Type H05VV-F, 3-conductor, 0.75 mm² conductor size. Power cord set fittings (appliance coupler and wall plug) must bear the certification mark of the agency responsible for evaluation in the country or region where it will be used.2. The flexible cord must be Type SVT/SJT or equivalent, No. 18 AWG, 3-conductor. The wall plug must be a two-pole grounding type with a NEMA 5-15P (15 A, 125 V ac) or NEMA 6-15P (15 A, 250 V ac) configuration. CSA or C-UL mark. UL file number must be on each element.3. The appliance coupler, flexible cord, and wall plug must bear a T mark and registration number in accordance with the Japanese Dentori Law. The flexible cord must be Type VCTF, 3-conductor, 0.75 mm² or 1.25 mm² conductor size. The wall plug must be a two-pole grounding type with a Japanese Industrial Standard C8303 (7 A, 125 V ac) configuration.4. The flexible cord must be Type RVV, 3-conductor, 0.75 mm² conductor size. Power cord set fittings (appliance coupler and wall plug) must bear the CCC certification mark.5. The flexible cord must be Type H05VV-F 3-conductor, 0.75 mm² conductor size. KTL logo and individual approval number must be on each element. Approval number and logo must be printed on a flag label.6. The flexible cord must be Type HVCTF 3-conductor, 1.25 mm² conductor size. Power cord set fittings (appliance coupler, cable, and wall plug) must bear the BSMI certification mark.7. For 127 V ac, the flexible cord must be Type SVT or SJT 3-conductor, 18 AWG, with plug NEMA 5-15P (15 A, 125 V ac), with UL and CSA or C-UL marks. For 240 V ac, the flexible cord must be Type H05VV-F 3-conductor, 0.75 mm² or 1.00 mm² conductor size, with plug BS 1363/A with BSI or ASTA marks.		

14 Recycling

When a nonrechargeable or rechargeable battery has reached the end of its useful life, do not dispose of the battery in general household waste. Follow the local laws and regulations in your area for battery disposal.

HP encourages customers to recycle used electronic hardware, HP original print cartridges, and rechargeable batteries. For more information about recycling programs, see the HP website at <http://www.hp.com/recycle>.

Index

A

- AC adapters, spare part numbers 27
- ambient light sensor, identifying 7
- audio-out (headphone)/audio-in (microphone) combo jack, identifying 5, 6

B

- backup, creating 189
- backups 189, 190
- battery light 5
- beam connector
 - removal 85
 - spare part number 85
- BIOS
 - determining version 186
 - downloading an update 187
 - starting the Setup Utility 185
 - updating 186
- boot order, changing 192
- bottom case
 - removal 66
 - spare part number 66
- Bracket Kit
 - spare part number 22
- buttons
 - center pointing stick 11
 - center touchpad 11
 - left pointing stick 11
 - left touchpad 11
 - right pointing stick 11
 - right touchpad 11

C

- Cable Kit
 - spare part number 26
- camera
 - identifying 7
- camera light, identifying 7

- camera privacy cover, identifying 7
- card reader board
 - removal 78
 - spare part number 78
- cautions
 - electrostatic discharge 31, 34
- components
 - bottom 12
 - display 7
 - keyboard 9
 - label 14
 - left side 6
 - rear 13
 - right side 5
 - top cover 13
 - touchpad 10
 - touchpad settings 11
- computer major components 19
- computer specifications 195
- connector, power 5
- connectors
 - Dual-Mode DisplayPort 5

D

- display
 - specifications 195, 197
- display assembly
 - illustrated 20
 - removal 83
 - spare part numbers 20, 83
- display components 7
- Dual-Mode DisplayPort, identifying 5

E

- electrostatic discharge (ESD) 31, 34
 - preventing damage 31, 34, 35

F

- fan/heat sink assembly
 - removal 79
 - spare part numbers 79
- fingerprint reader module
 - removal 71, 72
 - spare part numbers 71
- fingerprint reader module bracket
 - removal 72
- fingerprint reader module cable
 - illustrated 26
 - removal 70
 - spare part number 26
 - spare part numbers 70

G

- graphics card
 - removal 87
 - spare part numbers 87
- grounding methods 31, 34, 35
- guidelines
 - packaging 31, 36
 - transporting 31, 36
 - workstation 31, 32

H

- hard drive
 - removal 44
 - spare part numbers 26, 44
 - specifications 195, 197
- hard drive bracket
 - spare part number 26
- hard drive cable
 - illustrated 26
 - removal 72
 - spare part number 26
 - spare part numbers 72
- Hard Drive Hardware Kit
 - spare part number 26

- HDMI port, identifying 5
- HP PC Hardware Diagnostics Windows
 - downloading 193
- HP Recovery media
 - recovery 191
- HP Sure Recover 192
- HP Sure Start 201, 207
- HP TamperLock 15

I

- I/O board
 - removal 95
 - spare part numbers 95
- illustrated parts catalog 19
- internal microphone, identifying 13
- internal microphones, identifying 7

J

- jacks
 - audio-out (headphone)/audio-in (microphone) combo 5
 - network 6
 - RJ-45 (network) 6

K

- keyboard
 - product description 3
 - removal 54
 - spare part numbers 54
- keyboard components 9

L

- label components 14
- latches
 - service door release 12
- left side components 6
- lights
 - AC adapter and battery 5
 - battery 5
 - camera 7
 - RJ-45 (network) 6

M

- memory
 - nonvolatile 201
 - volatile 201
- memory card reader, identifying 5
- memory module
 - removal 51, 58
- memory module 1
 - removal 58

- memory module 2
 - removal 51
- memory module 3
 - removal 58
- memory module 4
 - removal 51
- memory module compartment cover
 - removal 52
- memory module cover
 - illustrated 22
 - spare part number 22
- memory modules
 - spare part numbers 51, 58

N

- Near Field Communications (NFC) 11
- network jack, identifying 6
- NFC module
 - removal 76
 - spare part number 76
- NFC module cable
 - illustrated 26
 - removal 75
 - spare part number 26, 75
- nonvolatile memory 201

P

- packaging guidelines 31, 36
- pointing device, product description 3
- pointing stick buttons
 - identifying 11
- pointing stick, identifying 11
- ports
 - Dual-Mode DisplayPort 5
 - HDMI 5
 - USB SuperSpeed 6
 - USB SuperSpeed port with HP Sleep and Charge 6
 - USB Type-C Thunderbolt port with HP Sleep and Charge 5
- power connector
 - identifying 5
- power cord
 - requirements for all countries 209
 - requirements for specific countries and regions 209
 - set requirements 209

- power cords, spare part numbers 27
- product description
 - keyboard 3
 - pointing device 3

R

- recovery 189, 191
 - discs 191
 - media 191
 - USB flash drive 191
- recovery media 190
 - creating using HP Cloud Recovery Download Tool 190
 - creating using Windows tools 190
- Remote HP PC Hardware Diagnostics UEFI settings
 - customizing 193
- removal and replacement
 - procedures 39, 66
- removing personal data from volatile system memory 201
- restoring 189
- right side components 5
- RJ-45 (network) jack, identifying 6
- RJ-45 (network) lights, identifying 6

S

- Screw Kit, spare part number 27
- SD card board
 - removal 69
 - spare part number 69
- SD card board cable
 - illustrated 26
 - removal 68
 - spare part number 26, 68
- SD card slot bezel
 - removal 69
 - spare part number 69
- security cable slot, identifying 6
- security lock bracket
 - installation 97
 - spare part number 97
- service cover
 - removal 40
 - spare part number 40
- service door release latch 12
- service door security screw 12
- settings
 - touchpad 11

- SIM card, inserting 16
- slots
 - security cable 6
 - smart card 6
- smart card slot, identifying 6
- solid-state drive
 - removal 42, 49, 62
 - spare part numbers 26, 42, 49, 62
 - specifications 198
- solid-state drive 1
 - removal 62
- solid-state drive 2
 - removal 49
- solid-state drive 3
 - removal
 - removal 42
 - solid-state drive 4
 - removal 42
- solid-state drive carrier
 - removal 43
- solid-state drive cover
 - illustrated 22
 - removal 49
 - spare part number 22, 50
- Solid-state Drive Hardware Kit
 - spare part number 22
- speaker
 - removal 97
 - spare part numbers 97
- specifications
 - computer 195
 - display 195, 197
 - hard drive 195, 197
 - solid-state drive 198
- static electricity 31, 34
- system board
 - removal 89
 - spare part numbers 89
- system memory, removing personal data from volatile 201
- system restore 191
- system restore point, creating 190

T

- TamperLock 15
- touchpad
 - removal 74
 - settings 11
 - spare part numbers 74

- touchpad buttons
 - identifying 11
- touchpad cable
 - illustrated 26
 - removal 73
 - spare part number 26, 73
- touchpad components 10
- touchpad settings 11
- touchpad turning on 11
- touchpad zone, identifying 11
- transporting guidelines 31, 36
- turning on
 - touchpad 11

U

- USB SuperSpeed port with HP Sleep and Charge, identifying 6
- USB SuperSpeed port, identifying 6
- USB Type-C Thunderbolt port with HP Sleep and Charge, identifying 5

V

- vent, identifying 13
- vents, identifying 12
- video
 - Dual-Mode DisplayPort 5

W

- webcam/microphone module cable
 - illustrated 26
 - spare part number 26
- Windows
 - backup 189
 - recovery media 189
 - system restore point 190
- Windows tools, using 190
- wireless antennas, identifying 7
- WLAN antennas, identifying 7
- WLAN module
 - removal 46
 - spare part numbers 46
- WLAN module Mylar shield
 - removal 91
 - spare part number 91
- workstation guidelines 31, 32
- WWAN antennas, identifying 7
- WWAN module
 - removal 47
 - spare part number 47

- WWAN module Mylar shield
 - removal 92
 - spare part number 92

