



HP ZBook 17 G4 Mobile Workstation
HP ZBook 17 G4

Maintenance and Service Guide

© Copyright 2017 HP Development Company, L.P.

NVIDIA and Quadro are trademarks and/or registered trademarks of NVIDIA Corporation in the U.S. and other countries. Red Hat Enterprise Linux is a registered trademark of Red Hat, Inc. in the United States and other countries. Bluetooth is a trademark owned by its proprietor and used by HP Inc. under license. Intel, Pentium, and Core are trademarks of Intel Corporation in the U.S. and other countries. Windows is either a registered trademark or trademark of Microsoft Corporation in the United States and/or other countries.

Product notice

This guide describes features that are common to most models. Some features may not be available on your computer.

Not all features are available in all editions of Windows. This computer may require upgraded and/or separately purchased hardware, drivers and/or software to take full advantage of Windows functionality. See <http://www.microsoft.com> for details.

The information contained herein is subject to change without notice. The only warranties for HP products and services are set forth in the express warranty statements accompanying such products and services. Nothing herein should be construed as constituting an additional warranty. HP shall not be liable for technical or editorial errors or omissions contained herein.

First Edition: March 2017

Document Part Number: 917650-001

Important Notice about Customer Self-Repair Parts

 **CAUTION:** Your computer includes Customer Self-Repair parts and parts that should only be accessed by an authorized service provider. See Chapter 5, "Removal and replacement procedures for Customer Self-Repair parts," for details. Accessing parts described in Chapter 6, "Removal and replacement procedures for authorized service provider parts," can damage the computer or void your warranty.

Safety warning notice

 **WARNING!** To reduce the possibility of heat-related injuries or of overheating the device, do not place the device directly on your lap or obstruct the device air vents. Use the device only on a hard, flat surface. Do not allow another hard surface, such as an adjoining optional printer, or a soft surface, such as pillows or rugs or clothing, to block airflow. Also, do not allow the AC adapter to contact the skin or a soft surface, such as pillows or rugs or clothing, during operation. The device and the AC adapter comply with the user-accessible surface temperature limits defined by the International Standard for Safety of Information Technology Equipment (IEC 60950-1).

Table of contents

1 Product description	1
2 External component identification	7
Locating hardware	7
Locating software	7
Right	7
Left	9
Display	10
Top	11
TouchPad	11
Lights	12
Buttons and fingerprint reader	13
Special function keys	14
Using the hot keys	15
Bottom	16
Front	17
Locating system information	17
3 Illustrated parts catalog	19
Computer major components	19
Display assembly subcomponents	22
Miscellaneous parts	23
4 Removal and replacement procedures preliminary requirements	24
Tools required	24
Service considerations	24
Plastic parts	24
Cables and connectors	25
Drive handling	25
Grounding guidelines	26
Electrostatic discharge damage	26
Packaging and transporting guidelines	27
Workstation guidelines	27
Equipment guidelines	28

5 Removal and replacement procedures for Customer Self-Repair parts	29
Component replacement procedures	29
Service door	30
Battery	31
Base enclosure	33
Hard drive(s) and internal frame	33
Solid-state drives (M.2)	38
WLAN module	40
WWAN module	42
Memory module	44
6 Removal and replacement procedures for authorized service provider parts	47
Component replacement procedures	47
RTC battery	48
Speakers	49
TouchPad	50
Smart card reader and frame	51
Fingerprint reader board	53
Fan	54
Heat sink	56
Discrete graphics board	59
Display LED board	60
Keyboard	62
System board	64
Display assembly	68
Top cover	74
7 Troubleshooting guide	75
Resources	76
General troubleshooting steps	76
Identify the issue	77
1. Understand the issue	77
Boot up sequence	77
Failure classification	77
2. Examine the environment	79
3. Perform a visual inspection of hardware	80
4. Update BIOS and drivers	80
Manually updating BIOS and drivers	80
Remotely deploying BIOS and drivers	80
Analyze the issue	80

5. Remove or uninstall recently added hardware, software	80
6. HP Hardware Diagnostics and Tools	81
HP PC Hardware Diagnostics (UEFI)	81
HP Support Assistant (HPSA)	83
HP BIOS Configuration Utility (BCU)	84
HP Image Diagnostic Tool	84
HP Thermal Monitor	84
Non HP diagnostics tools	84
7. Status lights, blinking light codes, troubleshooting lights, and POST error messages	85
Status lights	85
Interpreting system validation diagnostic front panel LEDs and audible codes	86
POST error messages	87
Power Good (Troubleshooting) lights	89
Resolve the issue	90
8. Hard reset	90
9. Soft reset (Default Settings)	91
10. Reseat cables and connections	91
11. Test with minimum configuration	92
Essential hardware configuration	92
Safe mode	93
12. Test with verified working configuration (hardware and/or operating system)	93
13. Replace the system board	93
Verify solution	94
Helpful Hints	94
At startup	94
During operation	95
Consulting with HP Service	95
Common issues and possible solutions	96
Power-on issues	96
No Power	96
Intermittent power-on, shutdown, reboot	98
AC adapter issue	100
Battery not recognized, not charging	100
Battery discharges too fast	102
Burnt smell	103
POST	103
No video (with power)	103
Blinking lights	104
Diagnostics error messages	105

BIOS password	106
Performance (OS)	106
Intermittent shutdown	107
Blue screen	108
Freeze at Windows Logo (hang/lockup)	110
Electromagnetic Interference (EMI)	111
No wake up	112
Unresponsive	113
Slow performance	113
HP Smart Adapter warning message	114
Incorrect time and date	114
Display	115
Display anomalies	115
Symptom	115
Quick check	116
HP PC Hardware Diagnostics (UEFI) for video test	116
Display assembly diagram	117
Dead pixel	117
No video (internal)	117
No video (external)	118
DisplayPort/VGA	118
HDMI	118
No or bad external video via docking	119
Incorrect or missing color/distorted image	119
Touch screen	120
I/O devices	121
Keyboard	121
Keyboard point stick	122
Keyboard backlight	122
TouchPad	123
Network Connectivity Ethernet (RJ-45 jack)	123
Network connectivity wireless (WLAN)	124
WWAN	125
USB	126
Smart card reader	127
Speaker, headphone - audio issues	128
Thunderbolt (TB)	129
Thunderbolt 3 dock	130
Storage	131
Hard drive/solid-state drive not recognized	133
No boot to operating system (no read/write error)	133

Read-write error	134
Slow performance	134
Blue screen (BSOD) error	134
Noisy hard drive	135
Mechanical	136
Fan error message - 90B	136
Noise (sound)	137
Fan runs constantly	138
Thermal shutdown (hot)	139
Stuck power button	140
Additional information	140
Acronyms	140
Blinking lights and boot error codes	142
Processor not executing code	142
BIOS recovery code unable to find valid BIOS recovery image	142
Memory module error	142
Graphics Controller Error (No Controller)	143
Failure - System Board Error	143
Intel Trusted Execution Technology (TXT) Error	143
Sure Start unable to find valid BIOS Boot Block image	143
Sure Start has identified a problem (Manual Recovery Policy Set)	144
POST Error Messages and User Actions	144
Routine Maintenance for Performance Improvement	146
Common Blue Screen Error Messages	146
Error message list	146
Bug check symbolic names	146
Microsoft general troubleshooting of Windows bug check codes	147
Use Windows Debugging Tool	147
Windows Software Development Kit (SDK)	148
Display Issue: Pixel Anomalies	152
Cable management	153
Connector types	154
8 Using HP PC Hardware Diagnostics (UEFI)	156
Downloading HP PC Hardware Diagnostics (UEFI) to a USB device	156
Additional BIOS crisis recovery tool	157
9 Specifications	158
Computer specifications	158

10 Power cord set requirements	159
Requirements for all countries	159
Requirements for specific countries and regions	160
11 Statement of memory volatility	162
Nonvolatile memory usage	164
Questions and answers	166
Using HP Sure Start (select models only)	167
12 Recycling	168
Index	169

1 Product description

Category	Description
Product Name	HP ZBook 17 G4 Mobile Workstation
Processors	7th Generation Intel® Core™ i5 Processor, Kaby Lake, quad-core, BGA: Core i5-7300HQ (2.5 GHz (up to 3.5 GHz)/2400 MHz/ 6 MB L3 cache/45W) Core i5-7440HQ (2.8 GHz (up to 3.8 GHz)/2400 MHz/6 MB L3 cache/45W) 7th Generation Intel® Core™ i7 Processor, Kaby Lake, quad-core, BGA: Core i7-7700HQ (2.8 GHz (up to 3.8 GHz)/2400 MHz/6 MB L3 cache/45W) Core i7-7820HQ (2.9 GHz (up to 3.9 GHz)/2400 MHz/8 MB L3 cache/45W) 7th Generation Intel® XEON Processor, Kaby Lake, quad-core, BGA: Xeon E3-1505M v6 (3.0 GHz (up to 4.0 GHz)/2400 MHz/8 MB L3 cache/45W) Xeon E3-1535M v6 (3.1 GHz (up to 4.2 GHz)/2400 MHz/8 MB L3 cache/45W)
Chipset	Intel Kabylake-H CM238
Graphics	Intel UMA Graphics - with shared video memory GT2 Integrated Graphics Discrete MXM Daughter card: NVIDIA N17P-Q1 4GB GDDR5 (256Mb x 32, 1.35V, 6Gbps, Qty 4) NVIDIA N17P-Q3 4GB GDDR5 (256Mb x 32, 1.35V, 5Gbps Qty 4) NVIDIA N17E-Q1 6GB GDDR5 (256Mb x 32, 1.35V, 7Gbps) procured from NVIDIA as MXM card complete assembly NVIDIA N17E-Q3 8GB GDDR5 (256Mb x 32, 1.35V, 7Gbps) procured FROM NVIDIA as MXM card complete assembly AMD Baffin XT GL 4GB GDDR5 (256Mb x 32, 1.5V, 1500MHz to 1750MHz, Qty 4)128-bit FBW Supports "No Discrete Graphics" option Supports Hybrid (Switchable) Graphics Supports NVIDIA Optimus Technology Supports AMD Enduro Technology Supports Open GL Supports DisplayPort 1.2 (supported thru Thunderbolt 3) Total displays support up to 4 discrete; 3 UMA (through Trump Docking Station) Supports NVIDIA Mosaic Technology Supports AMD Eyefinity
Panel	All panels are 16:9 aspect ratio 17.3" (LED backlight): 17.3" HD+ AG LED SVA, (1600 x 900 resolution, 220nits, 60%CG, eDP, flat)

Category	Description
	17.3" HD+ AG LED SVA with camera, (1600 x 900 resolution, 220nits, 60%CG, eDP, flat)
	17.3" FHD AG LED UWVA, (1920 x 1080 resolution, 300nits, 72%CG, eDP, flat)
	17.3" FHD AG LED UWVA with camera, (1920 x 1080 resolution, 300nits, 72%CG, dDP, flat)
	17.3" FHD AG LED UWVA Touch with camera, (1920 x 1080 resolution, 300nits, 72%CG slim, eDP+PSR) INCLUDE TOUCH AND DIRECT BONDING SA, not available with WWAN
	17.3" UHD AG "RG phosphors + B-LED " UWVA Dream Color 3 - 10 bit, (3840 x 2160 resolution, 300nits, 95% NTSC) NOT available with WWAN / UMA Graphics / 1 DIMM Memory
	17.3" UHD AG "RG phosphors + B-LED " UWVA Dream Color 3 with camera - 10 bit, (3840 x 2160 resolution, 300nits, 95% NTSC) NOT available with WWAN / UMA Graphics / 1 DIMM Memory
Memory	<p>Four SODIMM slots (Three or Four SODIMM module combination only available with Quad Core processors) (4) slots are customer accessible / upgradeable</p> <p>DDR4-2400 SODIMMS</p> <p>Supports Dual Channel Memory</p> <p>Supports up to 64GB</p> <p>System Supports the following configurations:</p> <p>DDR4-2400 SODIMMS</p> <p>8192MB Total System Memory (8192MB x 1), available with Core processor only</p> <p>8192MB Total System Memory (4096MB x 2), available with Core processor only</p> <p>16384MB Total System Memory (8192MB x 2), available with Core processor only</p> <p>16384MB Total System Memory (4096MB x 4), available with Core processor only</p> <p>16384MB Total System Memory (16384MB x 1), available with Core processor only</p> <p>32768MB Total System Memory (16384MB x 2), available with Core processor only</p> <p>32768MB Total System Memory (8192MB x 4), available with Core processor only</p> <p>65536MB Total System Memory (16384MB x 4), available with Core processor only</p> <p>ECC DDR4-2400:</p> <p>8192MB Total System Memory (8192MB x 1), available with Xeon processor only</p> <p>16384MB Total System Memory (8192MB x 2), available with Xeon processor only</p> <p>16384MB Total System Memory (16384MB x 1), available with Xeon processor only</p> <p>32768MB Total System Memory (16384MB x 2), available with Xeon processor only</p> <p>32768MB Total System Memory (8192MB x 4), available with Xeon processor only</p> <p>65536MB Total System Memory (16384MB x 4), available with Xeon processor only</p> <p>All other combinations test only</p> <p>Standard Memory - (12GB (4GB+4GB+4GB, 8GB+4GB); 16GB (4GB+4GB+8GB); 20GB (8GB+4GB+4GB+4GB; 8GB+8GB+4GB); 24GB (16GB+8GB, 4GB+4GB+8GB+8GB, 8GB+8GB+8GB, 4GB+4GB+16GB); 28GB (16GB+4GB+4GB+4GB); 32GB (16GB+4GB+4GB, 16GB+8GB+8GB); 36GB(16GB+16GB+4GB); 40GB(16GB+16GB+4GB+4GB, 16GB+8GB+8GB+8GB, 16GB+16GB+8GB); 48GB(16GB+16GB+8GB+8GB, 16GB+16GB+16GB))</p> <p>ECC Memory - 24GB (16GB+8GB, 8GB+8GB+8GB); 32GB (16GB+8GB+8GB); 40GB(16GB+8GB+8GB+8GB, 16GB+16GB+8GB); 48GB(16GB+16GB+8GB+8GB, 16GB+16GB+16GB))</p>
Primary M.2 Storage	<p>M.2 (NGFF) SS/DS Solid State Drive (2280), set as primary storage if selected</p> <p>SATA:</p>

Category	Description
	<p>512 GB SATA-3 SS TLC SSD FIPS-140-2</p> <p>256 GB SATA-3 Self-Encrypting Drive (Opal 2) TLC</p> <p>PCIe:</p> <p>256 GB PCIe (NVMe) TLC, HP Z Turbo Drive</p> <p>256 GB PCIe (NVMe) MLC, HP Z Turbo Drive</p> <p>512 GB PCIe (NVMe) MLC, HP Z Turbo Drive</p> <p>1 TB PCIe (NVMe) MLC, HP Z Turbo Drive</p> <p>512 GB PCIe (NVMe) TLC Opal 2, HP Z Turbo Drive2</p>
Secondary M.2 Storage	<p>M.2 (NGFF) SS/DS Solid State Drive (2280), only available if primary M.2 is selected</p> <p>SATA:</p> <p>512 GB SATA-3 SS TLC SSD FIPS-140-2</p> <p>256 GB SATA-3 Self-Encrypting Drive (Opal 2) TLC</p> <p>PCIe:</p> <p>256 GB PCIe (NVMe) TLC, HP Z Turbo Drive, not available if primary M.2 SATA drive is selected</p> <p>256 GB PCIe (NVMe) MLC, HP Z Turbo Drive, not available if primary M.2 SATA drive is selected</p> <p>512 GB PCIe (NVMe) MLC, HP Z Turbo Drive, not available if primary M.2 SATA drive is selected</p> <p>1 TB PCIe (NVMe) MLC, HP Z Turbo Drive, not available if primary M.2 SATA drive is selected</p> <p>512 GB PCIe (NVMe) TLC Opal 2, HP Z Turbo Drive2, not available if primary M.2 SATA drive is selected</p>
Primary 2.5" SATA Storage	<p>Primary 2.5" Storage is not a required category if PCIe SSD is selected</p> <p>Supports SATA, 7mm/9.5mm, 2.5" HDDs</p> <p>SATA, 2.5" HDDs:</p> <p>Support 3D DriveGuard</p> <p>500 GB 7200 rpm Self Encrypting Drive (SED, FIPS-140-2) or equivalent OPAL 2</p> <p>500 GB 7200 rpm</p> <p>500 GB 7200 rpm Self Encrypting Drive (SED) OPAL 2</p> <p>1TB 7200rpm</p> <p>500 GB 5400 rpm Hybrid 8GB cache</p> <p>2.5" SSD</p> <p>256 GB SATA TLC</p> <p>1TB SATA TLC</p> <p>primary HDD/SSD carrier only (no drive included), required selection if SATA storage is not selected</p>
Secondary 2.5" SATA Storage	<p>2.5" Storage is not a required category if M.2 SSD is selected, only available if primary 2.5" SATA is selected</p> <p>Supports SATA, 7mm/9.5mm, 2.5" HDDs</p> <p>SATA, 2.5" HDDs:</p> <p>Support 3D DriveGuard</p> <p>500 GB 7200 rpm Self Encrypting Drive (SED, FIPS-140-2) or equivalent OPAL 2</p>

Category	Description
	<p>500 GB 7200 rpm</p> <p>500 GB 7200 rpm Self Encrypting Drive (SED) OPAL 2</p> <p>1TB 7200rpm</p> <p>500 GB 5400 rpm Hybrid 8GB cache</p> <p>2.5" SSD</p> <p>256 GB SATA TLC</p> <p>1TB SATA TLC</p> <p>primary HDD/SSD carrier only (no drive included), required selection if secondary SATA storage is not selected</p>
Audio and video	<p>HP Bang & Olufsen Audio</p> <p>Intel SST Audio, supported on Win 10</p> <p>Microphone (Dual Array, configuration tied to camera)</p> <p>Camera (720p HD)</p> <p>Supports "No Camera" option</p> <p>Stereo Speakers (2)</p>
Ethernet	<p>Intel I219LM (Jacksonville-LM) 10/100/1000 Ethernet NIC (Intel® I219 Gigabit Network Connection)</p> <p>S3/S4/S5 wake on LAN</p> <p>The following support HBMA (via UEFI PXE boot and Windows OS): embedded NIC, Trump, Ace Plus, Bert, and Ernie.</p> <p>The following dongles only support S3 wake on LAN: Ace Plus.</p>
Wireless	<p>WPAN Bluetooth:</p> <p>BT4.2 only supported via Combo card</p> <p>WLAN:</p> <p>WLAN options via Minicard:</p> <p>Intel Dual band wireless-AC 8265 802.11AC 2x2 WiFi + BT 4.2 Combo Adaptor (vPro) - Windstorm Peak</p> <p>Intel Dual band wireless-AC 8265 802.11AC 2x2 WiFi + BT 4.2 Combo Adaptor (non-vPro)- Windstorm Peak, not available with iAMT</p> <p>WLAN Antennas (2) (configured at top of panel on all units)</p> <p>Bluetooth Disabled IOPT, available with Combo WLAN</p> <p>Supports "No WLAN/No BT" option</p> <p>Support for HP Sure Connect</p> <p>Support for Miracast</p> <p>WWAN:</p> <p>SIM Module (3FF/micro SIM): (user Accessible behind battery), SIM slot 100% attach</p> <p>Foxconn MDM9625 LTE/EVDO/HSPA+ NGFF (Amstel) Foxconn HP It4120 LTE/EVDO/HSPA+ w/GPS M.2 (Amstel), HP It4120 Qualcomm® Snapdragon™ X5 LTE Mobile Broadband Module</p> <p>Huawei HP It4132, LTE/HSPA+ 4G w/GPS M.2 (Macan)</p> <p>Fibocom HP hs3210 WW HSPA+ w/o GPS (Wrangler 2)</p> <p>WWAN Antennas (2) (world wide 5 band, configured at top of panel on all units except UHD)</p>

Category	Description
	<p>Supports "No WWAN" option, include platform specific SA WWAN screw</p> <p>Supports WWAN After Market Option</p>
External media cards	Integrated SD UHS-II flash media slot (Realtek) - supports SD, SDHC, SDXC
Ports	<p>VGA (Dsub 15 pin) supporting:</p> <p>1920 x 1200 external resolution @ 75Hz</p> <p>Hot Plug / Unplug and auto detect</p> <p>(2) USB Type-C (Thunderbolt 3)</p> <p>(1) HDMI (2.0)</p> <p>(1) USB 3.0 Charging Port (S3/S5)</p> <p>(3) USB 3.0 Ports</p> <p>RJ-45 / Ethernet</p> <p>Combo mic-in / Stereo Headphone Jack</p> <p>Multi-Pin AC Port</p>
Docking	<p>Docking Support:</p> <p>HP Thunderbolt Docking Station</p>
Keyboard/pointing devices	<p>Keyboard:</p> <p>Full sized Chiclet (Island-style) keyboard w/ separate numeric keypad:</p> <p>Backlit keyboard with separate numeric keypad</p> <p>Win 10 Dual Point (3 pick buttons point stick x 3 pick buttons touchpad)</p> <p>DuraKeys</p> <p>Spill Resistant with drain</p> <p>Touchpad requirements:</p> <p>On/Off button</p> <p>Glass with chemical etched surface</p> <p>Supports 2-way scroll</p> <p>Taps enabled as default</p> <p>Gestures enabled by default - 2 Finger Scrolling, 2 Finger Zoom (Pinch)</p> <p>Image sensor touchpad</p>
Power requirements	<p>Battery:</p> <p>6-cell HP Long Life Prismatic 96 Whr (4.21 Ahr), 606080</p> <p>AC adapter (4.5mm DC jack)</p> <p>200W SLIM Smart AC Adapter</p> <p>Power Cord (localized)</p> <p>3-wire plug (with ground pin) (C13) (1.8m)</p>
Security	<p>Supports Security Lock</p> <p>TPM 2.0 (Infineon; soldered down)</p> <p>Fingerprint Reader, 100% attach for RCTO</p>

Category	Description
	<p>Supports "No Fingerprint Reader" option</p> <p>Integrated Smart Card Reader (Active) (Alcor), 100% attach</p> <p>BIOS Preboot power on - BIOS option (Password, Fingerprint)</p> <p>Drive Encryption preboot option - (Password, Fingerprint, Selected Smartcards)</p>
Operating system	<p>Windows 10 - Redstone 1</p> <p>Preinstalled:</p> <p>Win 10 Home 64 High-end</p> <p>Win 10 Home 64 High-end Single Language</p> <p>Win 10 Home High End 64 Chinese Market - CPPP, only available for People's Republic of China</p> <p>Win 10 Pro 64</p> <p>FreeDOS 2.0</p> <p>Restore Media:</p> <p>Win 10 DRDVD</p> <p>Win 10 DRUSB</p> <p>Win 10 Pro 64 OSUSB</p> <p>Win 10 Pro 64 OSDVD</p> <p>Certified:</p> <p>Microsoft WHQL</p> <p>Red Hat Enterprise Linux (RHEL)</p> <p>Supported:</p> <p>Red Hat Enterprise Linux (RHEL) 7.x 64bit</p> <p>Web-only Support:</p> <p>Windows 10 Enterprise 64</p> <p>Win 10 Enterprise 64 LTSB 1507</p> <p>Tested and Documented:</p> <p>Windows 7 Pro 64</p> <p>Windows 7 Enterprise 64</p>
Serviceability	<p>End user replaceable parts:</p> <p>AC Adapter</p> <p>Battery</p> <p>Hard Drive/SSD</p> <p>M.2 SSD</p> <p>Memory</p> <p>WLAN</p> <p>WWAN</p>

2 External component identification

Locating hardware

To find out what hardware is installed on your computer:

- ▲ Type `device manager` in the taskbar search box, and then select the **Device Manager** app.

A list displays all the devices installed on your computer.

For information about system hardware components and the system BIOS version number, press `fn+esc` (select products only).

Locating software

To find out what software is installed on your computer:



- ▲ Select the **Start** button, and then select **All apps**.



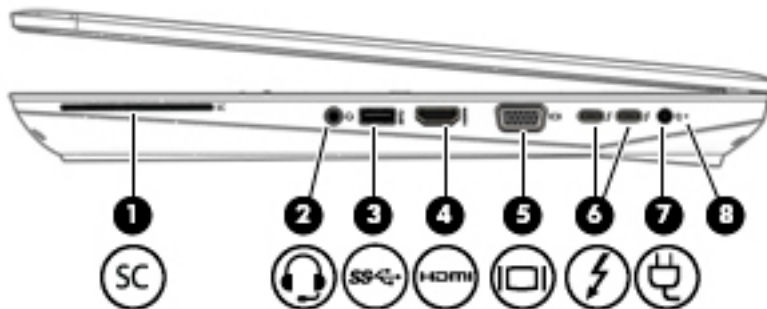

– or –

Right-click the **Start** button, and then select **Programs and Features**.

Right





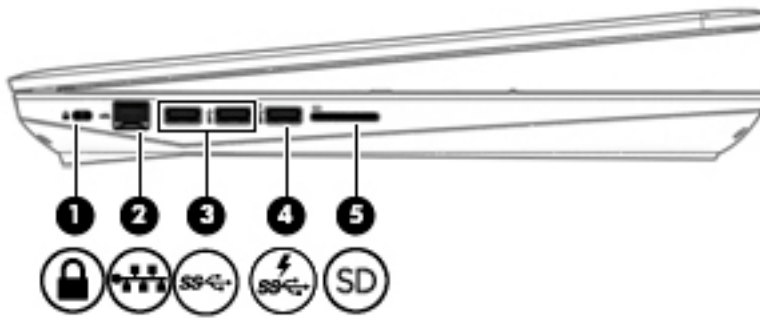

Component	Description
(1)  Smart card reader	Supports optional Smart cards.
(2)  Audio-out (headphone)/Audio-in (microphone) combo jack	Connects optional powered stereo speakers, headphones, earbuds, a headset, or a television audio cable. Also connects an optional headset microphone. This jack does not support optional standalone microphones.

Component	Description
	<p>WARNING! To reduce the risk of personal injury, adjust the volume before putting on headphones, earbuds, or a headset. For additional safety information, refer to the <i>Regulatory, Safety, and Environmental Notices</i>.</p> <p>To access this guide:</p> <ol style="list-style-type: none"> 1. Type <code>support</code> in the taskbar search box, and then select the HP Support Assistant app. – or – Click the question mark icon in the taskbar. 2. Select My PC, select the Specifications tab, and then select User Guides. <p>NOTE: When a device is connected to the jack, the computer speakers are disabled.</p>
<p>(3) </p>	<p>USB 3.0 port</p> <p>Connects an optional USB device, such as a keyboard, mouse, external drive, printer, scanner or USB hub.</p>
<p>(4) </p>	<p>HDMI port</p> <p>Connects an optional video or audio device, such as a high-definition television, any compatible digital or audio component, or a high-speed High Definition Multimedia Interface (HDMI) device.</p>
<p>(5) </p>	<p>External monitor port</p> <p>Connects an external VGA monitor or projector.</p>
<p>(6) </p>	<p>USB Type-C (Thunderbolt-3-enabled) ports (2)</p> <p>Connect any USB device with a Type-C connector.</p> <p>NOTE: USB Type-C ports charge products such as cell phones, laptops, tablets, and MP3 players, even when the computer is off. Also, some USB Type-C ports connect DisplayPort, VGA, HDMI, Thunderbolt™, and other video devices to provide video output.</p> <p>NOTE: Adapters (purchased separately) may be required.</p>
<p>(7) </p>	<p>Power connector</p> <p>Connects an AC adapter.</p>
<p>(8)</p>	<p>Battery light</p> <p>When AC power is connected:</p> <ul style="list-style-type: none"> • White: The battery charge is greater than 90 percent. • Amber: The battery charge is from 0 to 90 percent. • Off: The battery is not charging. <p>When AC power is disconnected (battery not charging):</p> <ul style="list-style-type: none"> • Blinking amber: The battery has reached a low battery level. When the battery has reached a critical battery level, the battery light begins blinking rapidly. • Off: The battery is not charging.

Left



Component	Description
(1)  Security cable slot	Attaches an optional security cable to the computer. NOTE: The security cable is designed to act as a deterrent, but it may not prevent the computer from being mishandled or stolen.
(2)  RJ-45 (network) jack/status lights	Connects a network cable. <ul style="list-style-type: none"> Green (left): The network is connected. Amber (right): Activity is occurring on the network.
(3)  USB 3.0 ports (2)	Connect an optional USB device, such as a keyboard, mouse, external drive, printer, scanner or USB hub.
(4)  USB 3.0 charging (powered) port	Connects an optional USB device, such as a keyboard, mouse, external drive, printer, scanner or USB hub. Standard USB ports will not charge all USB devices or will charge using a low current. Some USB devices require power and require you to use a powered port. NOTE: USB charging ports can also charge select models of cell phones and MP3 players, even when the computer is off.
(5)  Memory card reader	Reads optional memory cards that store, manage, share, or access information.

Display

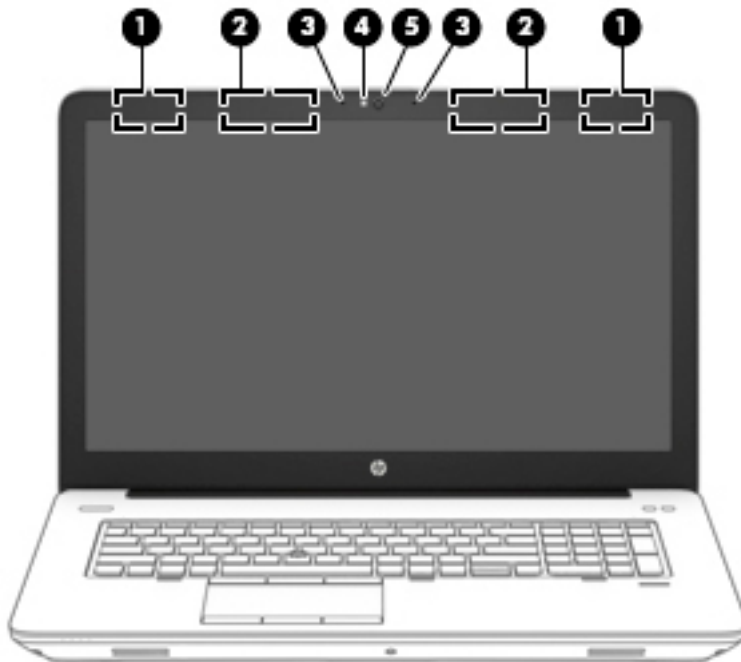

Component	Description
(1) WLAN antennas*	Send and receive wireless signals to communicate with wireless local area networks (WLANs). The internal antennas for your product will be located within this area.
(2) WWAN antennas (select products only)*	Send and receive wireless signals to communicate with wireless wide area networks (WWANs). The internal antennas for your product will be located within this area.
(3) Internal microphones (2)	Record sound.
(4) Webcam light (select products only)	On: The webcam is in use.
(5) Webcam (select products only)	Records video and captures photographs. Some models allow you to video conference and chat online using streaming video. To use the webcam: ▲ Type <code>camera</code> in the taskbar search box, and then select Camera .

*The antennas are not visible from the outside of the computer. For optimal transmission, keep the areas immediately around the antennas free from obstructions.

For wireless regulatory notices, see the section of the *Regulatory, Safety, and Environmental Notices* that applies to your country or region.

To access this guide:

1. Type `support` in the taskbar search box, and then select the **HP Support Assistant** app.

– or –

Click the question mark icon in the taskbar.

2. Select **My PC**, select the **Specifications** tab, and then select **User Guides**.

Top



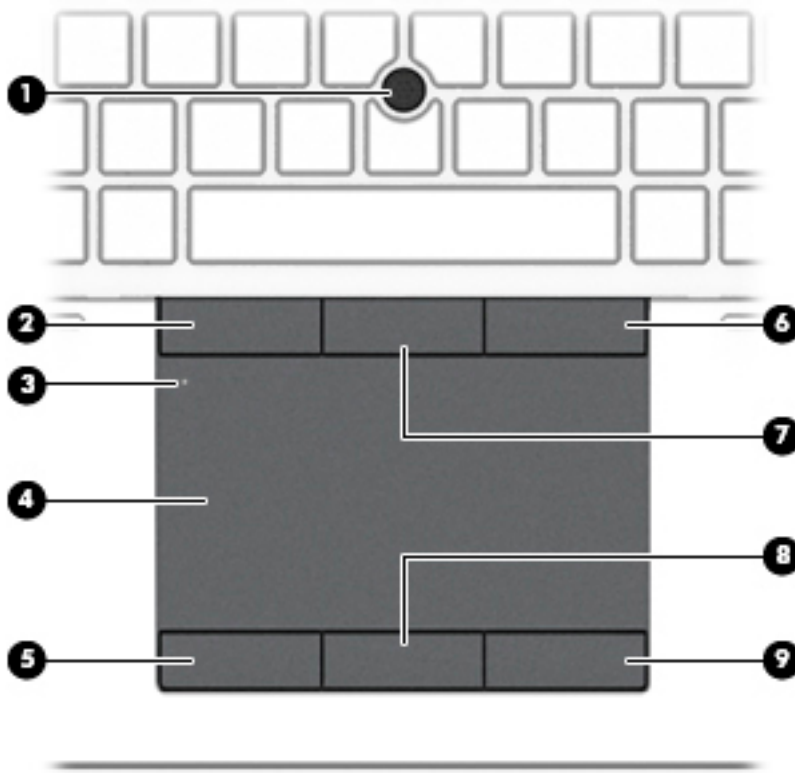

TouchPad

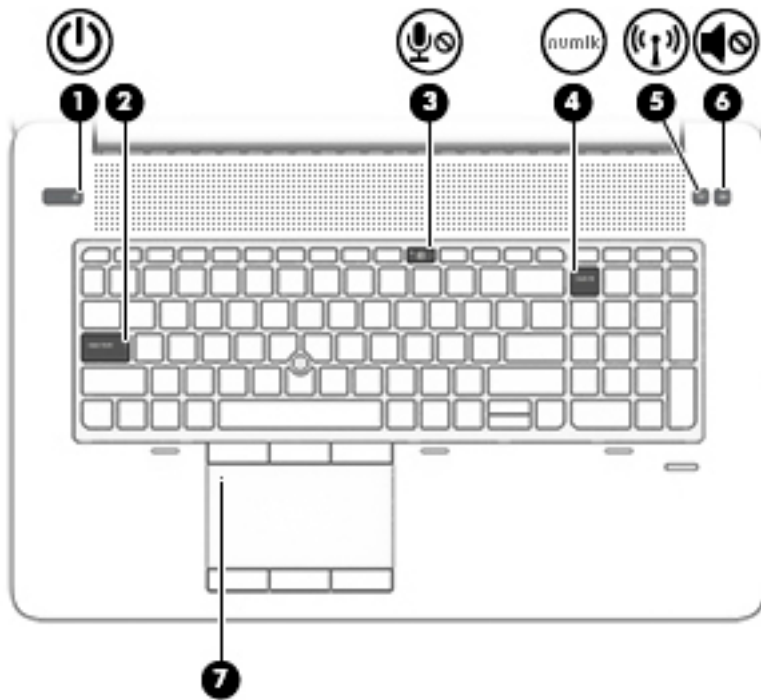

Component	Description
(1) Pointing stick	Moves the pointer and selects or activates items on the screen.
(2) Left pointing stick button	Functions like the left button on an external mouse.
(3) TouchPad on/off button	Turns the TouchPad on and off.
(4) TouchPad zone	Reads your finger gestures to move the pointer or activate items on the screen.
(5) Left TouchPad button	Functions like the left button on an external mouse.
(6) Right pointing stick button	Functions like the right button on an external mouse.
(7) Center pointing stick button	Functions like the center button on an external mouse.
(8) Center TouchPad button	Functions like the center button on an external mouse.
(9) Right TouchPad button	Functions like the right button on an external mouse.



Lights

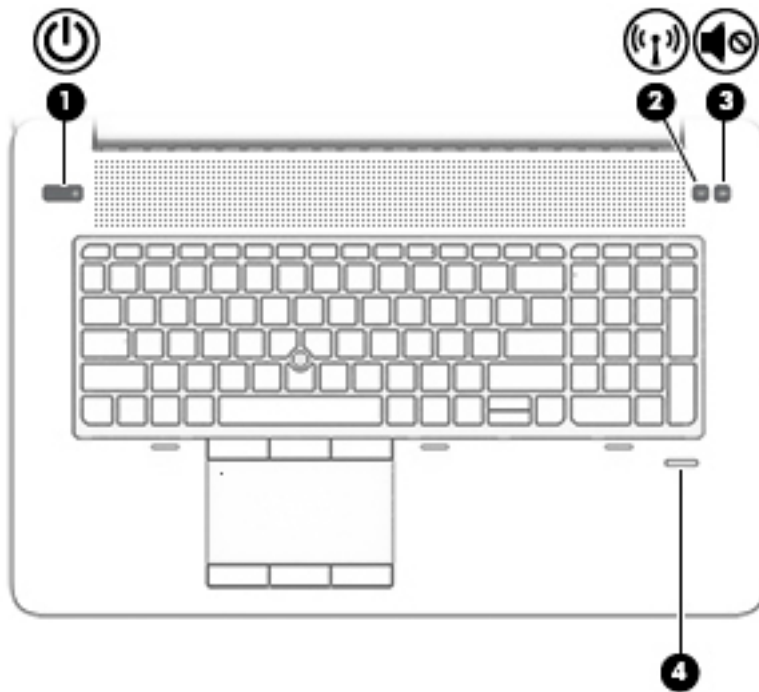

Component	Description
(1) 	<p>Power light</p> <ul style="list-style-type: none"> On: The computer is on. Blinking: The computer is in the Sleep state, a power-saving state. The computer shuts off power to the display and other unneeded components. Off: The computer is off or in Hibernation. Hibernation is a power-saving state that uses the least amount of power.
(2)	<p>Caps lock light</p> <p>On: Caps lock is on, which switches the key input to all capital letters.</p>
(3) 	<p>Microphone mute light</p> <ul style="list-style-type: none"> Amber: microphone sound is off. Off: microphone sound is on.
(4)	<p>Num lock light</p> <p>On: Num lock is on.</p>
(5) 	<p>Wireless light</p> <p>On: An integrated wireless device, such as a wireless local area network (WLAN) device and/or a Bluetooth® device, is on.</p> <p>NOTE: On some models, the wireless light is amber when all wireless devices are off.</p>
(6) 	<p>Mute light</p> <ul style="list-style-type: none"> Amber: Computer sound is off. Off: Computer sound is on.
(7)	<p>TouchPad light</p> <ul style="list-style-type: none"> On: The TouchPad is off. Off: The TouchPad is on.

Buttons and fingerprint reader



Component	Description
(1)  Power button	<ul style="list-style-type: none"> • When the computer is off, press the button to turn on the computer. • When the computer is on, press the button briefly to initiate Sleep. • When the computer is in the Sleep state, press the button briefly to exit Sleep. • When the computer is in Hibernation, press the button briefly to exit Hibernation. <p>CAUTION: Pressing and holding down the power button results in the loss of unsaved information.</p> <p>If the computer has stopped responding and shutdown procedures are ineffective, press and hold the power button for at least 5 seconds to turn off the computer.</p> <p>To learn more about your power settings, see your power options.</p> <p>▲ Type <code>power</code> in the taskbar search box, and then select Power and sleep settings.</p> <p>– or –</p> <p>Right-click the Start button, and then select Power Options.</p>
(2)  Wireless button	<p>Turns the wireless feature on or off but does not establish a wireless connection. A wireless network must be set up before a wireless connection is possible.</p>
(3)  Volume mute button	<p>Mutes and restores speaker sound.</p>
(4) Fingerprint reader (select products only)	<p>Allows a fingerprint logon to Windows®, instead of a password logon.</p>

Special function keys

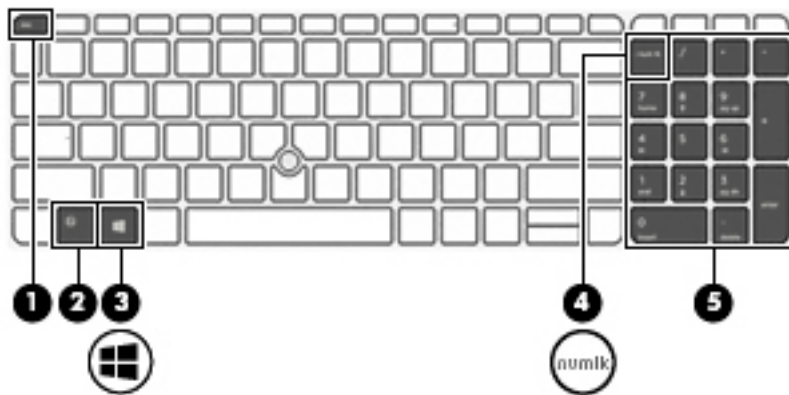









Component	Description
(1) esc key	Displays system information when pressed in combination with the fn key.
(2) fn key	Executes frequently used system functions when pressed in combination with a function key, the num lock key, or the esc key. See Using the hot keys on page 15 .
(3)  Windows key	Opens the Start menu. NOTE: Pressing the Windows key again will close the Start menu.
(4) num lock key	Turns the numeric keypad on and off.
(5) Integrated numeric keypad	A separate keypad to the right of the alphabet keyboard that enables you to add, subtract, and perform other numeric tasks. When num lock is on, the integrated keypad can be used like an external numeric keypad.

Using the hot keys

To use a hot key:

- ▲ Press the **fn** key, and then press the correct function key represented by the icons below.

Press fn +function key	Description
	Initiates Sleep, which saves your information in system memory. The display and other system components turn off and power is conserved. To exit Sleep, briefly press the power button. CAUTION: To reduce the risk of information loss, save your work before initiating Sleep.
	Turns the keyboard backlight off or on. NOTE: To conserve battery power, turn off this feature.
	Switches the screen image between display devices connected to the system. For example, if a monitor is connected to the computer, repeatedly pressing this key alternates the screen image from the computer display to the monitor display to a simultaneous display on both the computer and the monitor.
	Decreases the screen brightness incrementally as long as you hold down the key.
	Increases the screen brightness incrementally as long as you hold down the key.
	Decreases speaker volume incrementally while you hold down the key.
	Increases speaker volume incrementally while you hold down the key.
	Mutes the microphone.



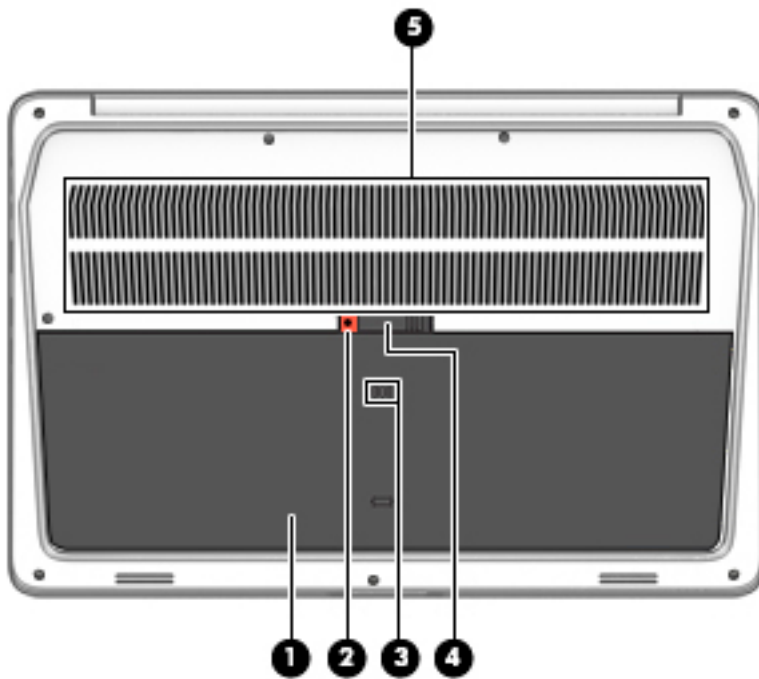

Bottom

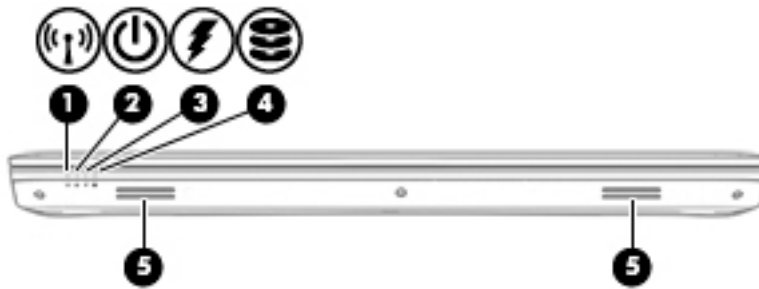

Component	Description
(1) Service door	<p>Provides access to the hard drive bay, the WLAN module slot, the WWAN module slot, and the memory module slots.</p> <p>CAUTION: To prevent an unresponsive system, replace the wireless module only with a wireless module authorized for use in the computer by the governmental agency that regulates wireless devices in your country or region. If you replace the module and then receive a warning message, remove the module to restore computer functionality, and then contact support.</p> <p>▲ Type <code>support</code> in the taskbar search box, and then select the HP Support Assistant app.</p> <p>- or -</p> <p>Click the question mark icon in the taskbar.</p>
(2) Service door release screws	Releases the service door.
(3) Vents	<p>Enable airflow to cool internal components.</p> <p>NOTE: The computer fan starts up automatically to cool internal components and prevent overheating. It is normal for the internal fan to cycle on and off during routine operation.</p>
(4) Spill drain	Allows spilled liquids, such as sodas or coffee, to drain out of the computer.

Front



Component	Description
(1)  Wireless light	<p>On: An integrated wireless device, such as a wireless local area network (WLAN) device and/or a Bluetooth® device, is on.</p> <p>NOTE: On some models, the wireless light is amber when all wireless devices are off.</p>
(2)  Power light	<ul style="list-style-type: none"> On: The computer is on. Blinking: The computer is in the Sleep state, a power-saving state. The computer shuts off power to the display and other unneeded components. Off: The computer is off or in Hibernation. Hibernation is a power-saving state that uses the least amount of power.
(3)  Battery light	<p>When AC power is connected:</p> <ul style="list-style-type: none"> White: The battery charge is greater than 90 percent. Amber: The battery charge is from 0 to 90 percent. Off: The battery is not charging. <p>When AC power is disconnected (battery not charging):</p> <ul style="list-style-type: none"> Blinking amber: The battery has reached a low battery level. When the battery has reached a critical battery level, the battery light begins blinking rapidly. Off: The battery is not charging.
(4)  Drive light	<ul style="list-style-type: none"> Blinking white: The hard drive is being accessed. Amber: HP 3D DriveGuard has temporarily parked the hard drive.
(5) Speakers	Produce sound.

Locating system information

Important system information is located on the bottom edge of the tablet or on the keyboard base. You may need the information when travelling internationally or when you contact support:

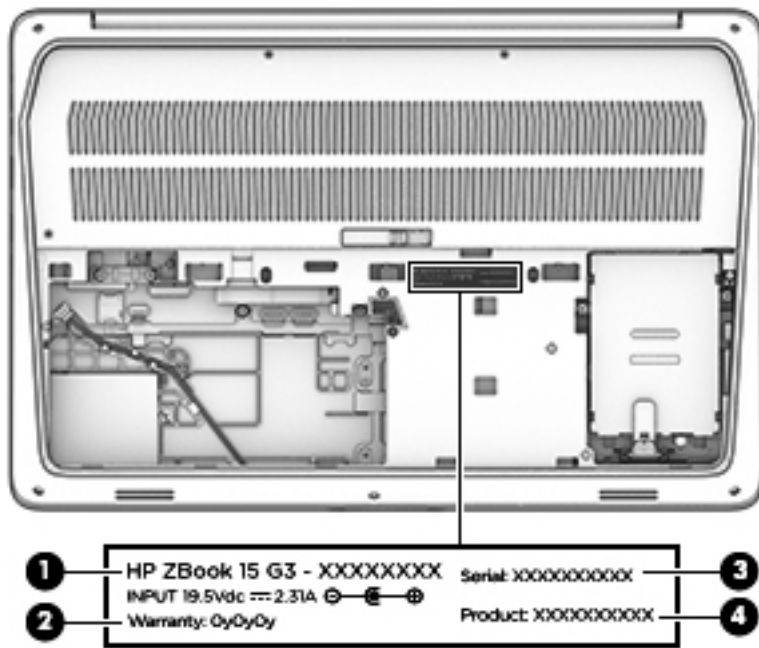

- (1): Serial number
- (2): Product number
- (3): Model number
- (4): Warranty period



Using Windows, briefly press the **fn+esc** key combination to display the System Information screen, which provides the product name and serial number of your computer, as well as information about the memory, processor, BIOS, and keyboard.

3 Illustrated parts catalog

Computer major components

-
-  **NOTE:** HP continually improves and changes product parts. For complete and current information on supported parts for your computer, go to <http://partsurfer.hp.com>, select your country or region, and then follow the on-screen instructions.
 -  **NOTE:** Details about your computer, including model, serial number, product key, and length of warranty, are on the service tag at the bottom of your computer. See [Locating system information on page 17](#) for details.
-

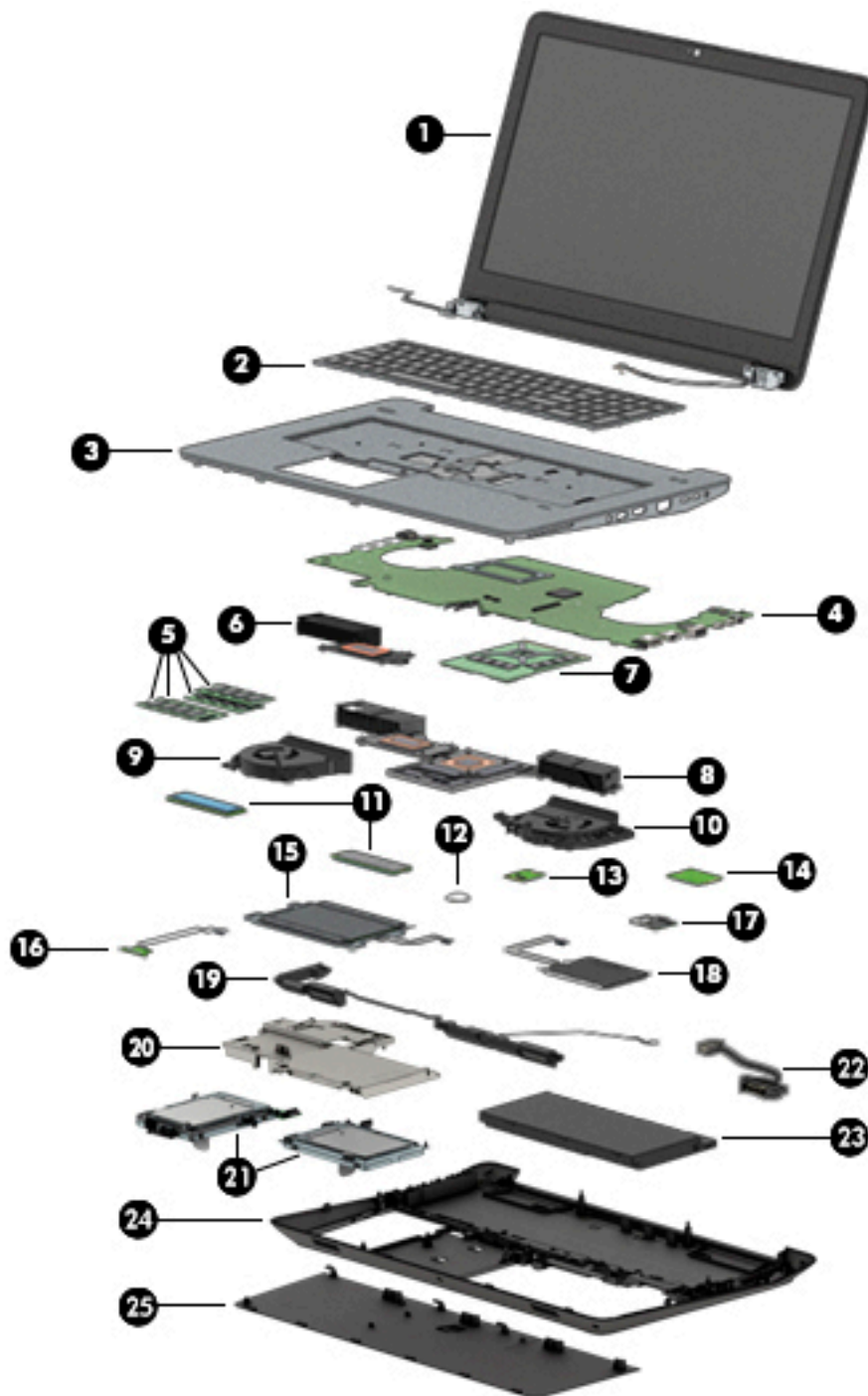

Item	Component	Spare part number
(1)	Display panel (See Display assembly subcomponents on page 22)	
(2)	Keyboard (See)	848311-001
(3)	Top cover	929011-001
(4)	System board (see System board on page 64)	
(5)	Memory (See Memory module on page 44)	

Item	Component	Spare part number
(6)	Heat sink for models with UMA graphics (see Heat sink on page 56)	
(7)	Graphics board (see Discrete graphics board on page 59)	
(8)	Heat sink (see Heat sink on page 56)	
(9)	Fan (see Fan on page 54)	
(10)	Fan (see Fan on page 54)	
(11)	Solid-state drives (2) (see Solid-state drives (M.2) on page 38)	
(12)	RTC battery	922847-001
(13)	WLAN module (see WLAN module on page 40)	
(14)	WWAN module (see WWAN module on page 42)	
(15)	TouchPad (includes cable)	929011-001
(16)	LED board (includes cable)	
(17)	Fingerprint reader (includes cable)	850116-001
(18)	Smart card reader (includes cable)	
(19)	Speaker Kit (includes cable)	848361-001
(20)	Internal frame	906119-001
(21)	Hard drives (2) (see Hard drive(s) and internal frame on page 33)	
(22)	Battery cable	907156-001
(23)	Battery	852711-850
(24)	Base enclosure	906112-001
(25)	Service door	906121-001

Display assembly subcomponents

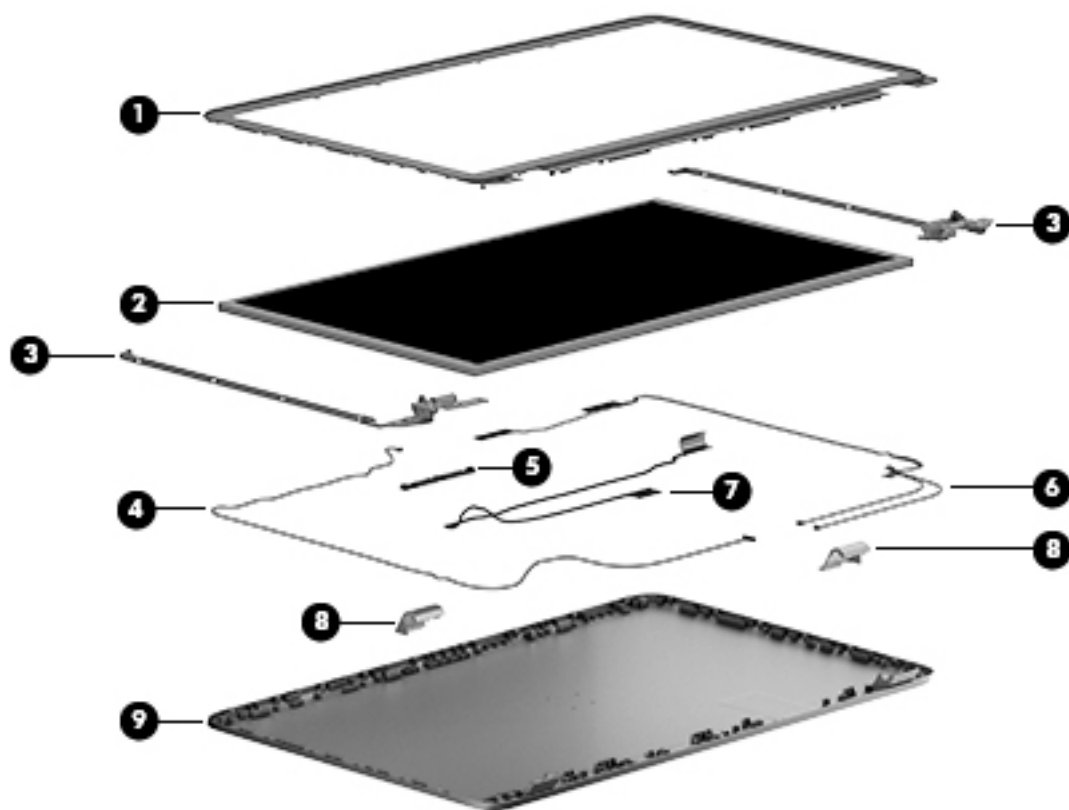

Item	Component	Spare part number
(1)	Bezel	
	LCD bezel with magnet FHD 17	848368-001
	LCD bezel with camera	850119-001
(2)	Panel	
	LCD HU 17.3 FHD UWVA AG with camera and touch screen	921322-001
	Display HU DRM3 UHD UWVA	921323-001
	Display HU DRM3 UHD UWVA f/CAM	921324-001
	Raw panel 17.3 FHDAGWLEDUWVA300eDP Flat AK	819347-002
	Raw panel 17.3 HD+AGWLEDSVA 220eDP Flat AK	819348-002
(3)	Hinge	906120-001
(4)	Display cable	848379-001
(5)	Webcam	819336-006
(6)	WWAN antenna	848347-001
(7)	WLAN antenna	848346-001
(8)	Hinge covers (included with hinges)	
(9)	Back cover	926796-001

Miscellaneous parts

Component	Spare part number
HP USB-C to DisplayPort adapter	831753-001
200W PFC SMART 4.5mm SLIM 3P AC adapter	835888-001
Cable kit	848372-001
HP ZBook Thunderbolt 3 power cable A	855116-001
HP Business Top Load Case	718550-001
HP Executive Slim Top Load Case	838256-001
HP Elite USB-C Docking Station	844549-001
HP USB Laser Mouse	674318-001
HP Comfort Grip Wireless Mouse	691922-001
HP Ultrathin Bluetooth Mouse	811730-001
Microphone board	854110-001
Power cord	
For use in Argentina	401328-001
For use in Australia and New Zealand	100661-001
For use in Brazil	438723-001
For use in Denmark	130627-008
For use in Europe	100614-009
For use in India	403440-001
For use in Israel	398062-001
For use in Italy	109197-008
For use in Japan	139867-004
For use in the People's Republic of China	286496-001
For use in South Africa	187487-005
For use in South Korea	231216-001
For use in Switzerland	150304-008
For use in Thailand	285052-001
For use in Taiwan	393312-001
For use in the United Kingdom and Singapore	100613-008
AC power cord, unshielded	121565-001
Screw kit	922848-001

4 Removal and replacement procedures preliminary requirements

Tools required

You will need the following tools to complete the removal and replacement procedures:

- Flat-bladed screwdriver
- Magnetic screwdriver
- Phillips P0 and Torx8 T8 screwdrivers

Service considerations

The following sections include some of the considerations that you must keep in mind during disassembly and assembly procedures.



NOTE: As you remove each subassembly from the computer, place the subassembly (and all accompanying screws) away from the work area to prevent damage.

Plastic parts



CAUTION: Using excessive force during disassembly and reassembly can damage plastic parts. Use care when handling the plastic

Cables and connectors

⚠ CAUTION: When servicing the computer, be sure that cables are placed in their proper locations during the reassembly process. Improper cable placement can damage the computer.

Cables must be handled with extreme care to avoid damage. Apply only the tension required to unseat or seat the cables during removal and insertion. Handle cables by the connector whenever possible. In all cases, avoid bending, twisting, or tearing cables. Be sure that cables are routed in such a way that they cannot be caught or snagged by parts being removed or replaced. Handle flex cables with extreme care; these cables tear easily.

Drive handling

⚠ CAUTION: Drives are fragile components that must be handled with care. To prevent damage to the computer, damage to a drive, or loss of information, observe these precautions:

Before removing or inserting a hard drive, shut down the computer. If you are unsure whether the computer is off or in Hibernation, turn the computer on, and then shut it down through the operating system.

Before handling a drive, be sure that you are discharged of static electricity. While handling a drive, avoid touching the connector.

Before removing an optical drive, be sure that a disc is not in the drive and be sure that the optical drive tray is closed.

Handle drives on surfaces covered with at least one inch of shock-proof foam.

Avoid dropping drives from any height onto any surface.

After removing a hard drive or an optical drive, place it in a static-proof bag.

Avoid exposing an internal hard drive to products that have magnetic fields, such as monitors or speakers.

Avoid exposing a drive to temperature extremes or liquids.

If a drive must be mailed, place the drive in a bubble pack mailer or other suitable form of protective packaging and label the package "FRAGILE."

Grounding guidelines

Electrostatic discharge damage

Electronic components are sensitive to electrostatic discharge (ESD). Circuitry design and structure determine the degree of sensitivity. Networks built into many integrated circuits provide some protection, but in many cases, ESD contains enough power to alter device parameters or melt silicon junctions.

A discharge of static electricity from a finger or other conductor can destroy static-sensitive devices or microcircuitry. Even if the spark is neither felt nor heard, damage may have occurred.

An electronic device exposed to ESD may not be affected at all and can work perfectly throughout a normal cycle. Or the device may function normally for a while, then degrade in the internal layers, reducing its life expectancy.

⚠ CAUTION: To prevent damage to the computer when you are removing or installing internal components, observe these precautions:

Keep components in their electrostatic-safe containers until you are ready to install them.

Before touching an electronic component, discharge static electricity by using the guidelines described in this section.

Avoid touching pins, leads, and circuitry. Handle electronic components as little as possible.

If you remove a component, place it in an electrostatic-safe container.

The following table shows how humidity affects the electrostatic voltage levels generated by different activities.

⚠ CAUTION: A product can be degraded by as little as 700 V.

Typical electrostatic voltage levels			
Event	Relative humidity		
	10%	40%	55%
Walking across carpet	35,000 V	15,000 V	7,500 V
Walking across vinyl floor	12,000 V	5,000 V	3,000 V
Motions of bench worker	6,000 V	800 V	400 V
Removing DIPS from plastic tube	2,000 V	700 V	400 V
Removing DIPS from vinyl tray	11,500 V	4,000 V	2,000 V
Removing DIPS from plastic foam	14,500 V	5,000 V	3,500 V
Removing bubble pack from PCB	26,500 V	20,000 V	7,000 V
Packing PCBs in foam-lined box	21,000 V	11,000 V	5,000 V

Packaging and transporting guidelines

Follow these grounding guidelines when packaging and transporting equipment:

- To avoid hand contact, transport products in static-safe tubes, bags, or boxes.
- Protect ESD-sensitive parts and assemblies with conductive or approved containers or packaging.
- Keep ESD-sensitive parts in their containers until the parts arrive at static-free workstations.
- Place items on a grounded surface before removing items from their containers.
- Always be properly grounded when touching a component or assembly.
- Store reusable ESD-sensitive parts from assemblies in protective packaging or nonconductive foam.
- Use transporters and conveyors made of antistatic belts and roller bushings. Be sure that mechanized equipment used for moving materials is wired to ground and that proper materials are selected to avoid static charging. When grounding is not possible, use an ionizer to dissipate electric charges.

Workstation guidelines

Follow these grounding workstation guidelines:

- Cover the workstation with approved static-shielding material.
- Use a wrist strap connected to a properly grounded work surface and use properly grounded tools and equipment.
- Use conductive field service tools, such as cutters, screwdrivers, and vacuums.
- When fixtures must directly contact dissipative surfaces, use fixtures made only of static safe materials.
- Keep the work area free of nonconductive materials, such as ordinary plastic assembly aids and plastic foam.
- Handle ESD-sensitive components, parts, and assemblies by the case or PCM laminate. Handle these items only at static-free workstations.
- Avoid contact with pins, leads, or circuitry.
- Turn off power and input signals before inserting or removing connectors or test equipment.

Equipment guidelines

Grounding equipment must include either a wrist strap or a foot strap at a grounded workstation.

- When seated, wear a wrist strap connected to a grounded system. Wrist straps are flexible straps with a minimum of one megohm $\pm 10\%$ resistance in the ground cords. To provide proper ground, wear a strap snugly against the skin at all times. On grounded mats with banana-plug connectors, use alligator clips to connect a wrist strap.
- When standing, use foot straps and a grounded floor mat. Foot straps (heel, toe, or boot straps) can be used at standing workstations and are compatible with most types of shoes or boots. On conductive floors or dissipative floor mats, use foot straps on both feet with a minimum of one megohm resistance between the operator and ground. To be effective, the conductive equipment must be worn in contact with the skin.

The following grounding equipment is recommended to prevent electrostatic damage:

- Antistatic tape
- Antistatic smocks, aprons, and sleeve protectors
- Conductive bins and other assembly or soldering aids
- Nonconductive foam
- Conductive tabletop workstations with ground cords of one megohm resistance
- Static-dissipative tables or floor mats with hard ties to the ground
- Field service kits
- Static awareness labels
- Material-handling packages
- Nonconductive plastic bags, tubes, or boxes
- Metal tote boxes
- Electrostatic voltage levels and protective materials

The following table lists the shielding protection provided by antistatic bags and floor mats.

Material	Use	Voltage protection level
Antistatic plastics	Bags	1,500 V
Carbon-loaded plastic	Floor mats	7,500 V
Metallized laminate	Floor mats	5,000 V

5 Removal and replacement procedures for Customer Self-Repair parts

 **NOTE:** The Customer Self-Repair program is not available in all locations. Installing a part not supported by the Customer Self-Repair program may void your warranty. Check your warranty to determine if Customer Self-Repair is supported in your location.

 **NOTE:** HP continually improves and changes product parts. For complete and current information on supported parts for your computer, go to <http://partsurfer.hp.com>, select your country or region, and then follow the on-screen instructions.

Component replacement procedures

 **NOTE:** Please read and follow the procedures described here to access and replace Customer Self-Repair parts successfully.

 **NOTE:** Details about your computer, including model, serial number, product key, and length of warranty, are on the service tag on the bottom of your computer. See [Locating system information on page 17](#) for details.

This chapter provides removal and replacement procedures for Customer Self-Repair parts.

There are as many as 30 screws that must be removed, replaced, and/or loosened when servicing Customer Self-Repair parts. Make special note of each screw size and location during removal and replacement.

Service door

Description	Spare part number
Service door	906121-001

Before removing the service door, follow these steps:

1. Turn off the computer. If you are unsure whether the computer is off or in Hibernation, turn the computer on, and then shut it down through the operating system.
2. Disconnect the power from the computer by unplugging the power cord from the computer.
3. Disconnect all external devices from the computer.

Remove the service door:

1. Position the computer upside down on a flat surface.
2. Slide the latch **(1)** to release the service door.
3. Remove the service door **(2)**.

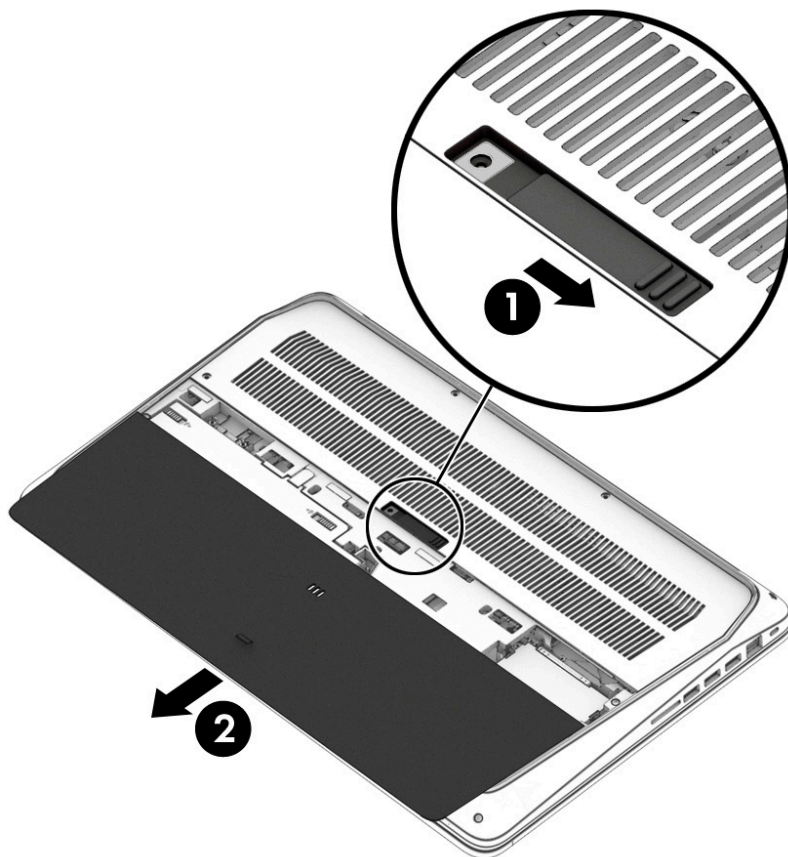

Reverse this procedure to install the service door.

Battery

Description	Spare part number
6 cell HP Long Life Prismatic 96 Whr (4.21 Ahr) Li-ion battery	852711-850
Battery cable	907156-001

Before removing the battery, follow these steps:

1. Turn off the computer. If you are unsure whether the computer is off or in Hibernation, turn the computer on, and then shut it down through the operating system.
2. Disconnect the power from the computer by unplugging the power cord from the computer.
3. Disconnect all external devices from the computer.
4. Remove the service door (see [Service door on page 30](#)).

Remove the battery:

- ⚠ WARNING!** To reduce potential safety issues, use only the user-replaceable battery provided with the computer, a replacement battery provided by HP, or a compatible battery purchased from HP.
- ⚠ CAUTION!** Removing a user-replaceable battery that is the sole power source for the computer can cause loss of information. To prevent loss of information, save your work or shut down the computer through Windows before removing the battery.

1. Remove the three Phillips screws (**3**) that secure the battery to the computer.
2. Pull the battery tab (**4**) to remove the battery from the computer.

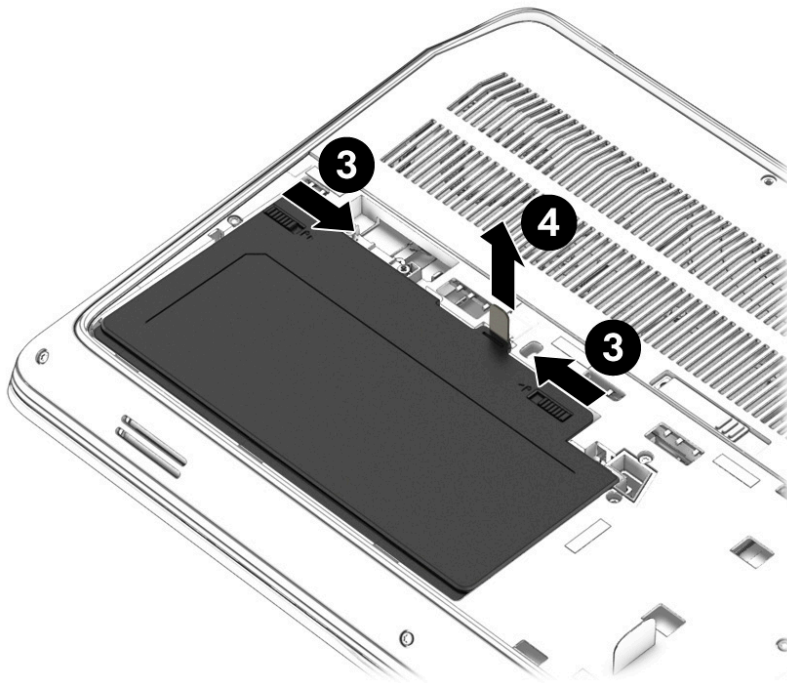

Remove the battery cable:

- ▲ Release the battery cable from the guides **(1)**, disconnect the battery cable from the system board **(2)**, and then remove the cable **(3)**.

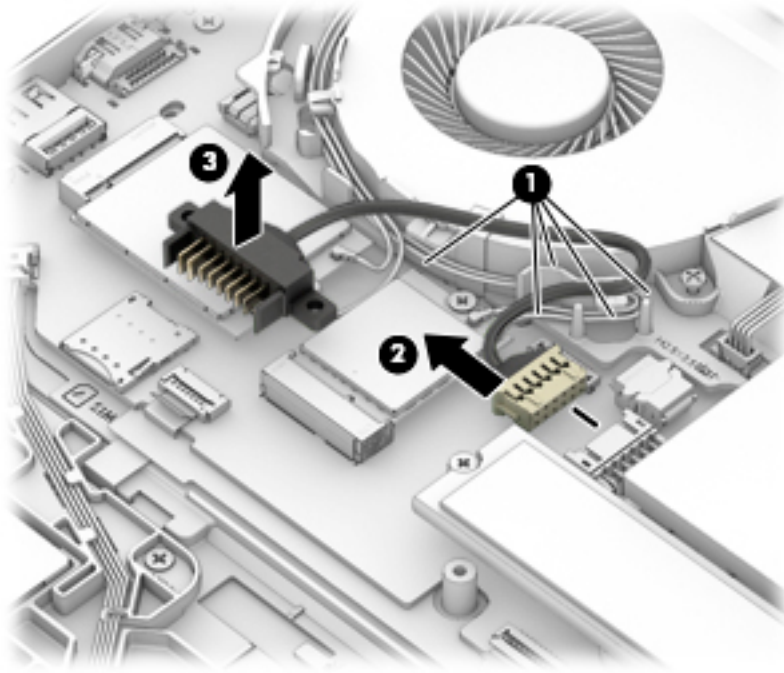

Reverse this procedure to install the battery cable and the battery.

Base enclosure

Description	Spare part number
Base enclosure	906112-001

Before removing the base enclosure, follow these steps:

1. Turn off the computer. If you are unsure whether the computer is off or in Hibernation, turn the computer on, and then shut it down through the operating system.
2. Disconnect the power from the computer by unplugging the power cord from the computer.
3. Disconnect all external devices from the computer.
4. Remove the following components:
 - a. Service door (see [Service door on page 30](#)).
 - b. Battery (see [Battery on page 31](#)).

Remove the base enclosure:

1. Loosen 14 Torx screws(1), and then remove 2 Phillips screws(2) from the base enclosure.
2. Using a plastic tool (3), loosen the base enclosure, and then remove it from the computer (4).

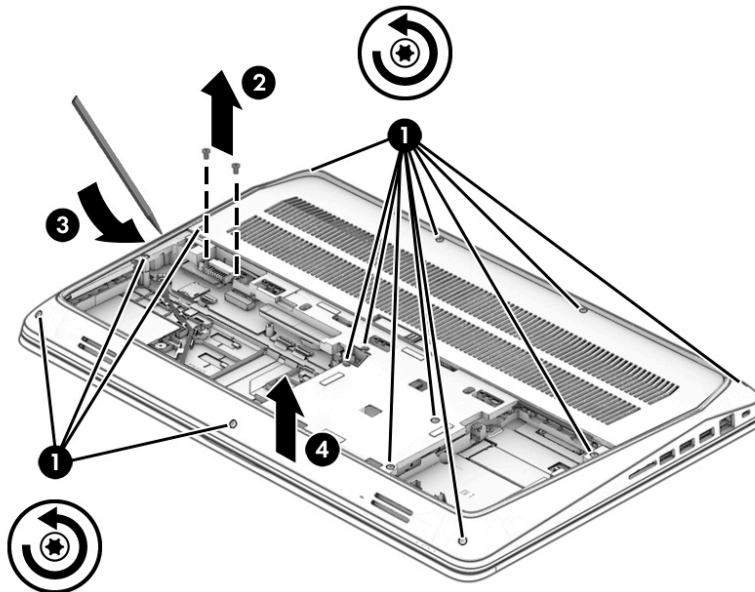

Reverse this procedure to install the base enclosure.

Hard drive(s) and internal frame

 **NOTE:** The hard drive spare kit does not include the hard drive bracket or hard drive cable. The hard drive bracket, screws, and hard drive cable are included in the Hard Drive Hardware Kit, spare part number 848351-001.

Description	Spare part number
500 GB 7200 RPM RAW 7mm	703267-002
500 GB 5400 RPM SATA RAW Hybrid 8 GB cache 7 mm	732000-002
1 TB 7200 RPM SATA RAW 9.5 mm	766644-002
500 GB 7200 RPM SATA FIPS RAW 7 mm	820572-002
500 GB 7200 RPM SATA RAW SED 7 mm	820573-002
HDD Hardware Kit	906117-001
Internal frame	906119-001
HDD connector bracket	907157-001
HDD board	929012-001

Before removing the hard drive, follow these steps:

1. Shut down the computer. If you are unsure whether the computer is off or in Hibernation, turn the computer on, and then shut it down through the operating system.
2. Disconnect the power from the computer by unplugging the power cord from the computer.
3. Disconnect all external devices from the computer.
4. Remove the following components:
 - a. Service door (see [Service door on page 30](#)).
 - b. Battery (see [Battery on page 31](#)).
 - c. Base enclosure (see [Base enclosure on page 33](#)).

Remove the hard drive:

1. Disconnect the hard drive connector **(1)**.
2. Remove 2 Phillips screws **(2)** from the hard drive bracket.
3. Loosen the four captive screws **(3)** that secure the hard drive to the bottom cover.

4. Lift the tab **(4)**, and remove the primary hard drive **(5)**.

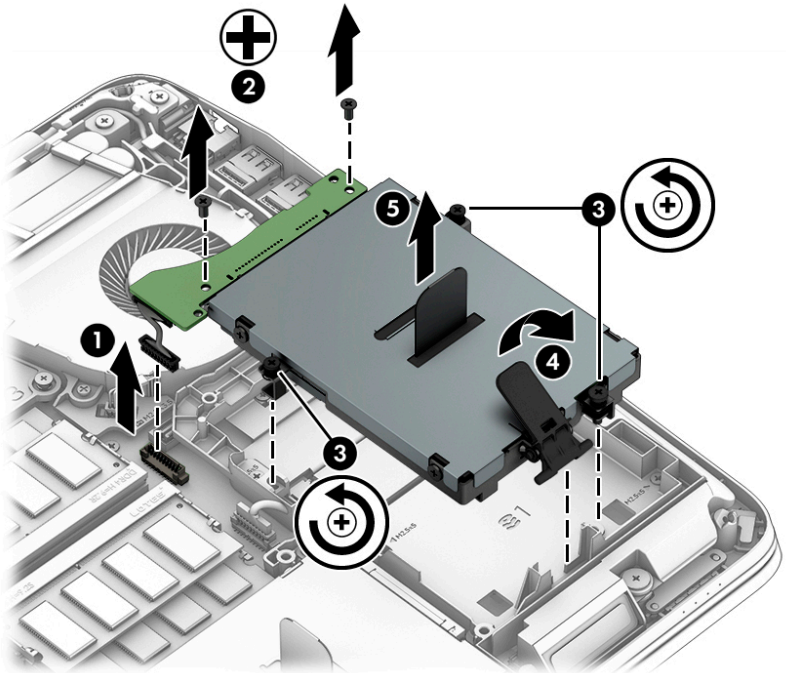

5. If it is necessary to replace the hard drive connector adapter on the primary hard drive, slide the adapter **(1)** off of the front end of the hard drive, and then remove the cable from the adapter **(2)**.

Remove the internal frame:

- ▲ Remove 3 screws **(1)**, and then remove the internal frame **(2)**.

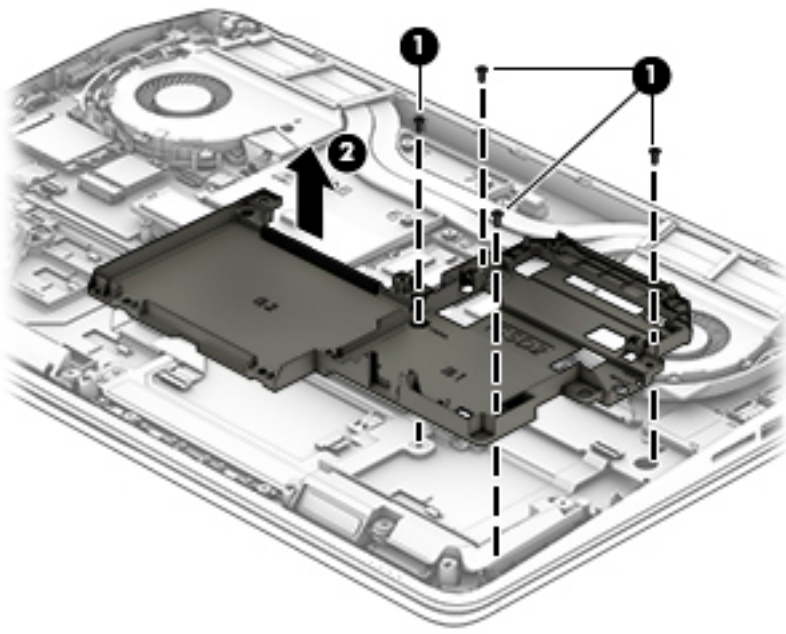

Remove the secondary hard drive (select products only):

1. Disconnect the hard drive connector **(1)**.
2. Remove 2 Phillips screws **(2)** from the hard drive bracket.

3. Loosen the four captive screws **(3)** that secure the hard drive to the bottom cover.
4. Lift the tab **(4)**, and remove the primary hard drive **(5)**.

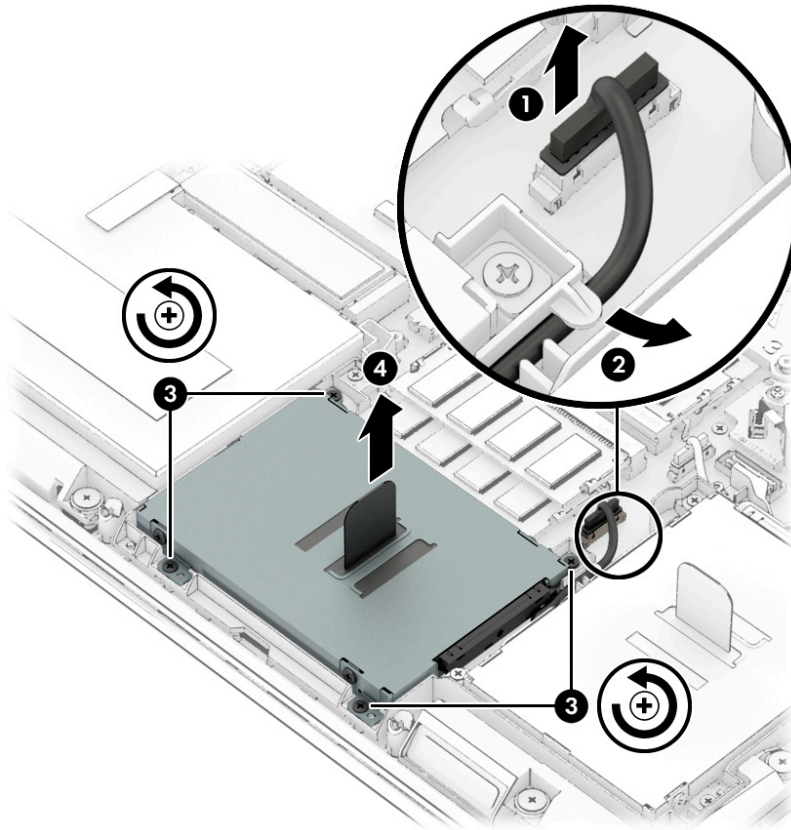

Remove the hard drive bracket(s):

1. If it is necessary to replace the primary hard drive bracket, remove 4 screws **(2)** from the hard drive, and then lift the bracket straight up **(3)** to remove the bracket from the hard drive.

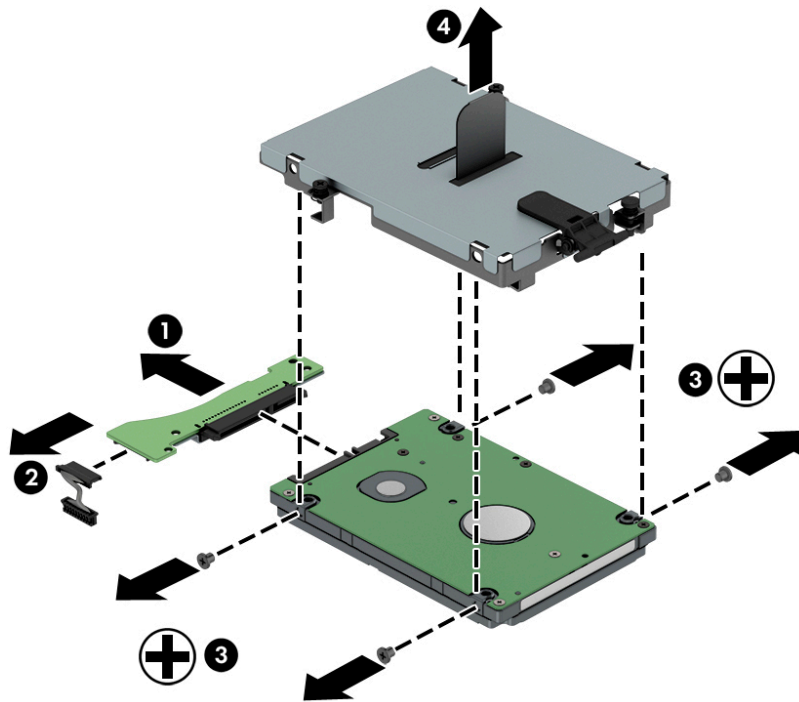

2. If it is necessary to replace the secondary hard drive bracket, remove the connector from the bracket (1), remove 4 screws (2) from the hard drive, and then lift the bracket straight up (3) to remove the bracket from the hard drive.

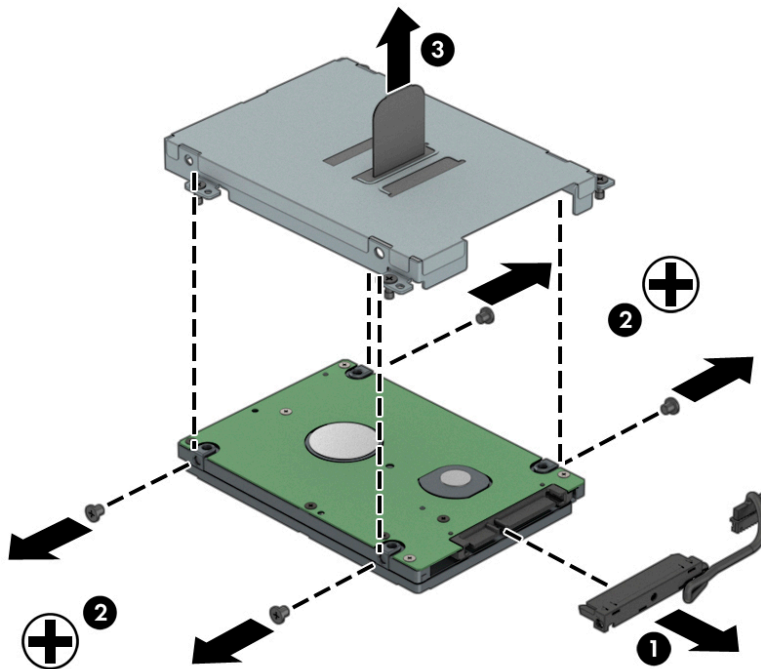

Reverse this procedure to reassemble and install the hard drive(s) and the internal frame.

Solid-state drives (M.2)

Description	Spare part number
256 GB, Turbo Drive, G2, MLC	921331-001
512 GB, M2 SATA-3, FIPS, TLC	921332-001
256 GB, SATA-3 self-encrypting drive (SED), Opal 2, TLC	921333-001
256 GB, Turbo Drive, G2, TLC	921334-001
512 GB, Turbo Drive, G2, MLC	921335-001
512 GB, Turbo Drive, G2, self-encrypting drive (SED), Opal 2, TLC	921336-001
1 TB, Turbo Drive, G2, MLC	921337-001
256 GB, SATA, TLC	921338-001
1 TB, SATA-3, TLC	926788-001

Before removing the SSD, follow these steps:

1. Turn off the computer. If you are unsure whether the computer is off or in Hibernation, turn the computer on, and then shut it down through the operating system.
2. Disconnect the power from the computer by unplugging the power cord from the computer.
3. Disconnect all external devices from the computer.
4. Remove the following components:
 - a. Service door (see [Service door on page 30](#)).
 - b. Battery (see [Battery on page 31](#)).
 - c. Base enclosure (see [Base enclosure on page 33](#)).
 - d. Hard drive(s) and internal frame (see [Hard drive\(s\) and internal frame on page 33](#)).

Remove the SSD:



NOTE: The secondary SSD is only available if a primary SSD is installed.

1. Remove the Phillips screw **(1)** that secures the solid-state drive to the system board.
2. Remove the SSD **(2)** by pulling the drive away from the slot at an angle.

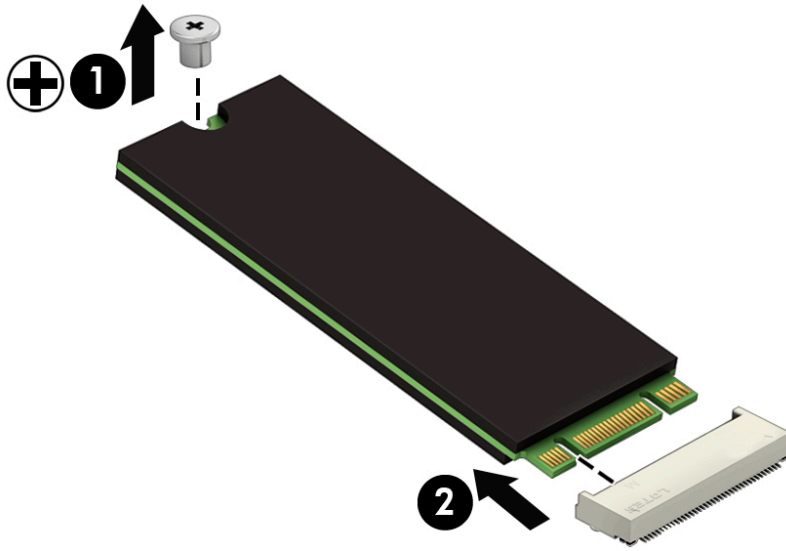

Reverse this procedure to install the solid-state drive.

WLAN module

Description	Spare part number
Intel Dual Band Wireless-AC 8265 3rd Gen Intel 802.11ac, Dual Band, 2x2 Wi-Fi + Bluetooth 4.2	910264-852
Intel Dual Band Wireless-AC 8265 3rd Gen Intel 802.11ac, Dual Band, 2x2 Wi-Fi + Bluetooth 4.2 (non-vPro)	918855-852

 **CAUTION:** To prevent an unresponsive system, replace the wireless module only with a wireless module authorized for use in the computer by the governmental agency that regulates wireless devices in your country or region. If you replace the module and then receive a warning message, remove the module to restore device functionality, and then contact technical support.

Before removing the WLAN module, follow these steps:

1. Turn off the computer. If you are unsure whether the computer is off or in Hibernation, turn the computer on, and then shut it down through the operating system.
2. Disconnect the power from the computer by unplugging the power cord from the computer.
3. Disconnect all external devices from the computer.
4. Remove the following components:
 - a. Service door (see [Service door on page 30](#)).
 - b. Battery (see [Battery on page 31](#)).
 - c. Base enclosure (see [Base enclosure on page 33](#)).
 - d. Hard drive(s) and internal frame (see [Hard drive\(s\) and internal frame on page 33](#)).
 - e. Solid-state drive(s) (see [Solid-state drives \(M.2\) on page 38](#)).

Remove the WLAN module:

1. Disconnect the WLAN antenna cables **(1)** from the terminals on the WLAN module.



NOTE: The WLAN antenna cable labeled “1” connects to the WLAN module “Main” terminal labeled “1”. The WLAN antenna cable labeled “2” connects to the WLAN module “Aux” terminal labeled “2”.

2. Remove the Phillips screw **(2)** that secures the WLAN module to the system board. (The WLAN module tilts up.)

3. Remove the WLAN module (3) by pulling the module away from the slot at an angle.

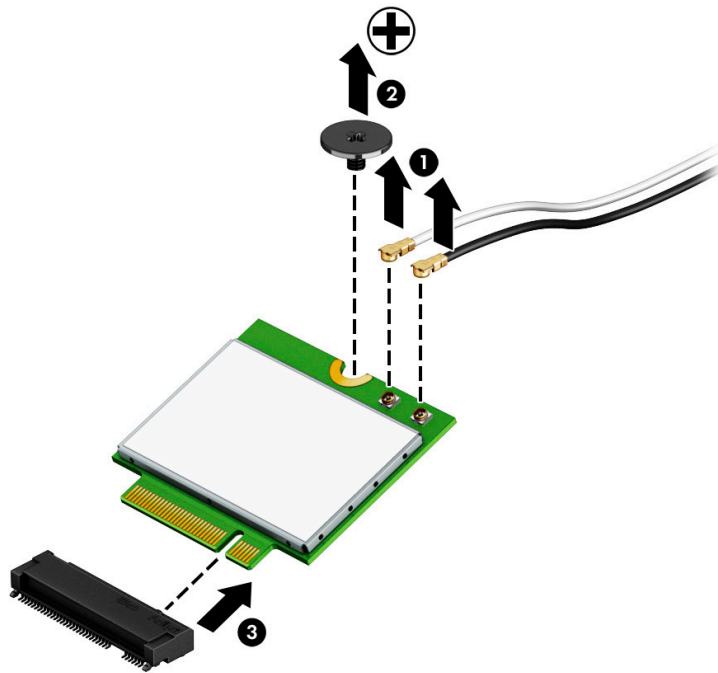

 **NOTE:** If the WLAN antenna cables are not connected to the terminals on the WLAN module, protective sleeves should be installed on the antenna connectors, as shown in the following illustration.

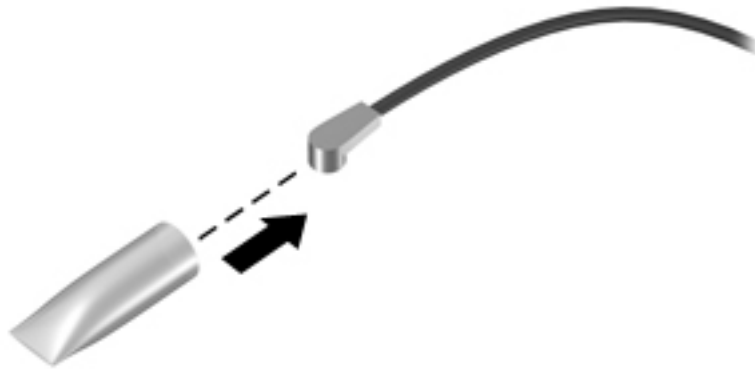

Reverse this procedure to install the WLAN module.

WWAN module



NOTE: The WWAN module and the WLAN module are not interchangeable.

Description	Spare part number
T77W595 LTE M.2 with GPS	800870-001
HSPA+M.2	918670-852
ME906S LTE with GPS M.2	918671-852

Before removing the WWAN module, follow these steps:

1. Turn off the computer. If you are unsure whether the computer is off or in Hibernation, turn the computer on, and then shut it down through the operating system.
2. Disconnect the power from the computer by unplugging the power cord from the computer.
3. Disconnect all external devices from the computer.
4. Remove the following components:
 - a. Service door (see [Service door on page 30](#)).
 - b. Battery (see [Battery on page 31](#)).
 - c. Base enclosure (see [Base enclosure on page 33](#)).
 - d. Hard drive(s) and internal frame (see [Hard drive\(s\) and internal frame on page 33](#)).
 - e. Solid-state drive(s) (see [Solid-state drives \(M.2\) on page 38](#)).
 - f. WLAN module (see [WLAN module on page 40](#)).

Remove the WWAN module:

1. Disconnect the WWAN antenna cables **(1)** from the terminals on the WWAN module.





NOTE: The red WWAN antenna cable is connected to the WWAN module “Main” terminal. The blue WWAN antenna cable is connected to the WWAN module “Aux” terminal.

2. Remove the Phillips screw **(2)** that secures the WWAN module to the base enclosure.

3. Remove the WWAN module (3) by pulling the module away from the slot.

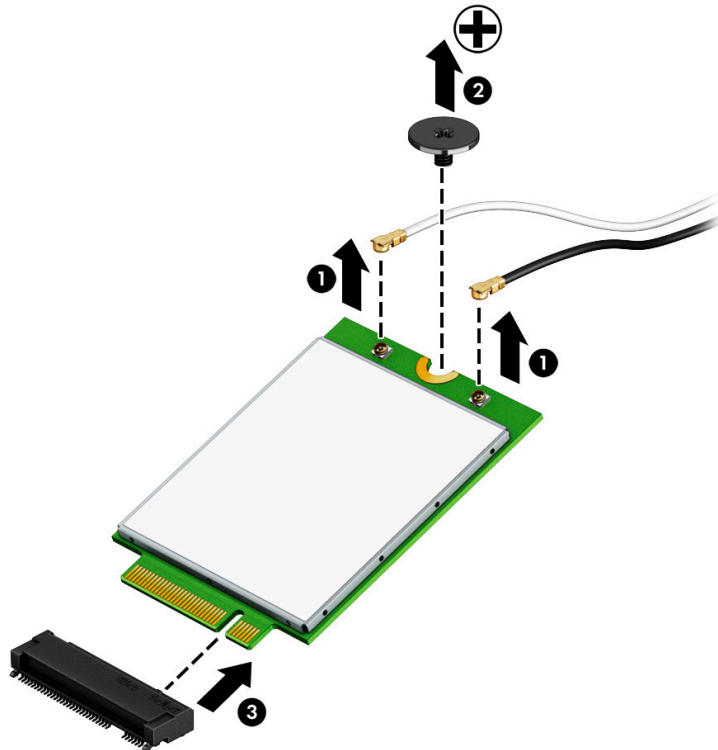
 **NOTE:** WWAN modules are designed with a notch to prevent incorrect insertion.



 **NOTE:** If the WWAN antennas are not connected to the terminals on the WWAN module, the protective sleeves must be installed on the antenna connectors, as shown in the following illustration.

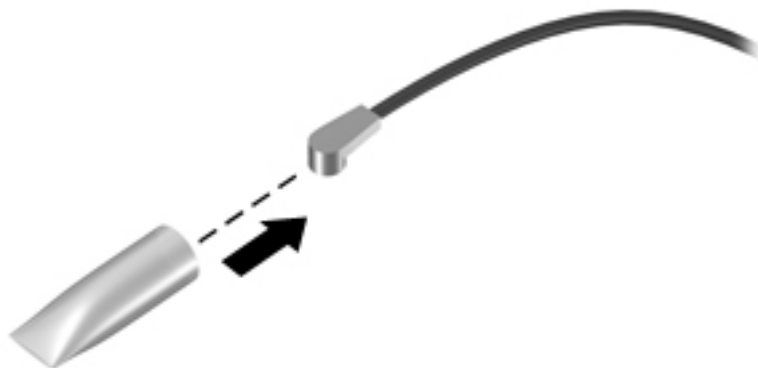

Reverse this procedure to install the WWAN module.

Memory module

Description	Spare part number
DDR4-2400:	
16 GB	865396-852
8 GB	862398-852
4 GB	862397-852
ECC DDR4-2133:	
16 GB, ECC	835886-001
8 GB, ECC	835887-001

Update BIOS before adding memory modules

Before adding new memory, be sure to update the computer to the latest BIOS.

 **CAUTION:** Failure to update the computer to the latest BIOS prior to installing new memory may result in various system problems.

To update BIOS:

1. Navigate to <http://www.hp.com>.
2. Select **Support > Support & drivers**.
3. In the **Enter my HP model number** box, type the computer model information, and then select **Find my product**.
-or-
Select **Identify now**.
4. Select the link for the computer model.
5. Select the language and the operating system.
6. Under the downloads heading, select the **BIOS** link.
7. Select the link for the most recent BIOS.
8. Select the **Download** button, and then follow the on-screen instructions.

Before removing a memory module, follow these steps:

1. Turn off the computer. If you are unsure whether the computer is off or in Hibernation, turn the computer on, and then shut it down through the operating system.
2. Disconnect the power from the computer by unplugging the power cord from the computer.
3. Disconnect all external devices from the computer.
4. Remove the following components:
 - a. Service door (see [Service door on page 30](#)).
 - b. Battery (see [Battery on page 31](#)).
 - c. Base enclosure (see [Base enclosure on page 33](#)).

- d. Hard drive(s) and internal frame (see [Hard drive\(s\) and internal frame on page 33](#)).
- e. Solid-state drive(s) (see [Solid-state drives \(M.2\) on page 38](#)).
- f. WLAN module (see [WLAN module on page 40](#)).
- g. WWAN module (see [WWAN module on page 42](#)).

Remove the memory module:

1. Identify the location of the memory module slots **(1) – (4)**. The system memory must be installed in the order shown. The BIOS checks for this and will not boot if the memory is not installed into the correct slots. The BIOS will display a message in POST notifying the user that the system memory is not installed in the proper order.

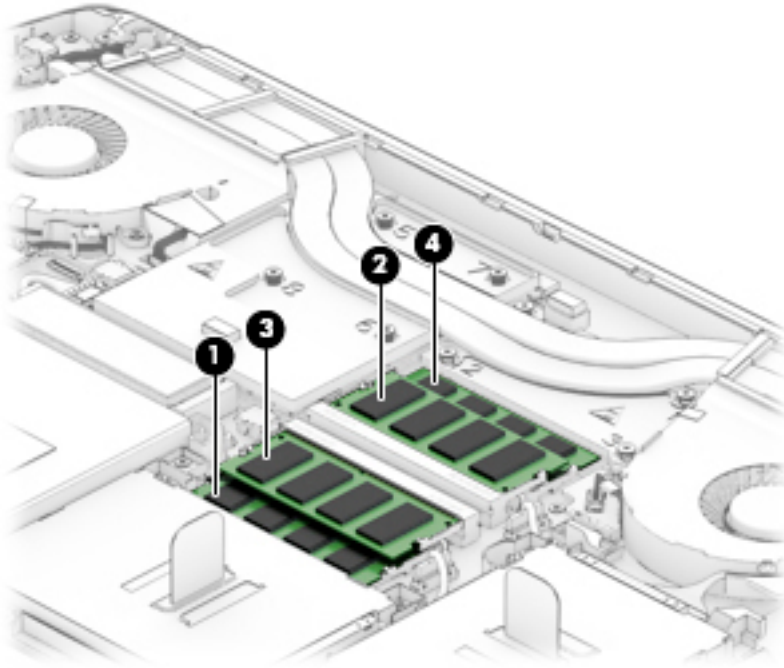

2. Spread the retaining tabs **(1)** on each side of the memory module slot to release the memory module. (The memory module tilts up.)

3. Remove the memory module **(2)** by pulling the module away from the slot at an angle.

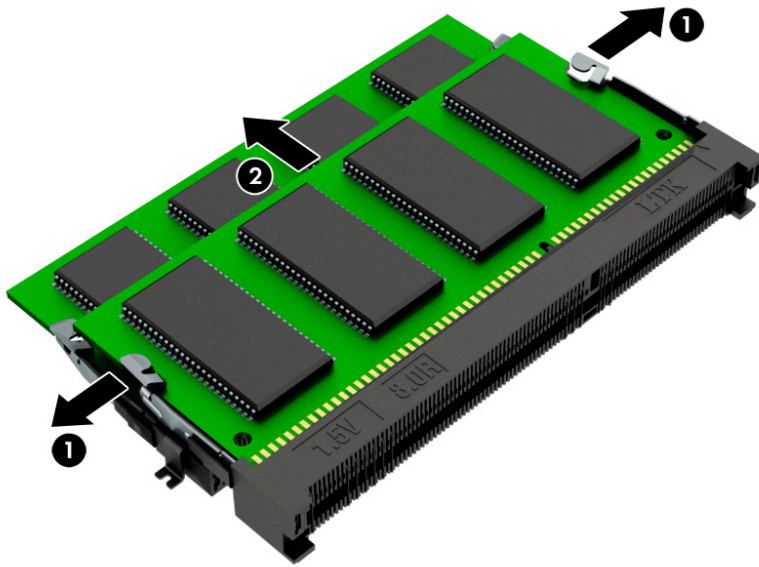

Reverse this procedure to install a memory module.

6 Removal and replacement procedures for authorized service provider parts

 **CAUTION:** Components described in this chapter should be accessed only by an authorized service provider. Users who access these parts can damage the computer or void the warranty.

 **NOTE:** HP continually improves and changes product parts. For complete and current information on supported parts for your computer, go to <http://partsurfer.hp.com>, select your country or region, and then follow the on-screen instructions.

Component replacement procedures

There are as many as 88 screws that must be removed, replaced, and/or loosened when servicing the parts described in this chapter. Make special note of each screw size and location during removal and replacement.

RTC battery

Description	Spare part number
RTC battery (includes cable and double-sided adhesive)	922847-001

Before removing the RTC battery, follow these steps:

1. Turn off the computer. If you are unsure whether the computer is off or in Hibernation, turn the computer on, and then shut it down through the operating system.
2. Disconnect the power from the computer by unplugging the power cord from the computer.
3. Disconnect all external devices from the computer.
4. Remove the following components:
 - a. Service door (see [Service door on page 30](#)).
 - b. Battery (see [Battery on page 31](#)).
 - c. Base enclosure (see [Base enclosure on page 33](#)).

Remove the RTC battery:

1. Disconnect the RTC battery cable **(1)** from the system board.
2. Using a plastic tool, detach the RTC battery **(2)** from the base enclosure and remove it from the computer. (The RTC battery is attached to the base enclosure with double-sided adhesive.)

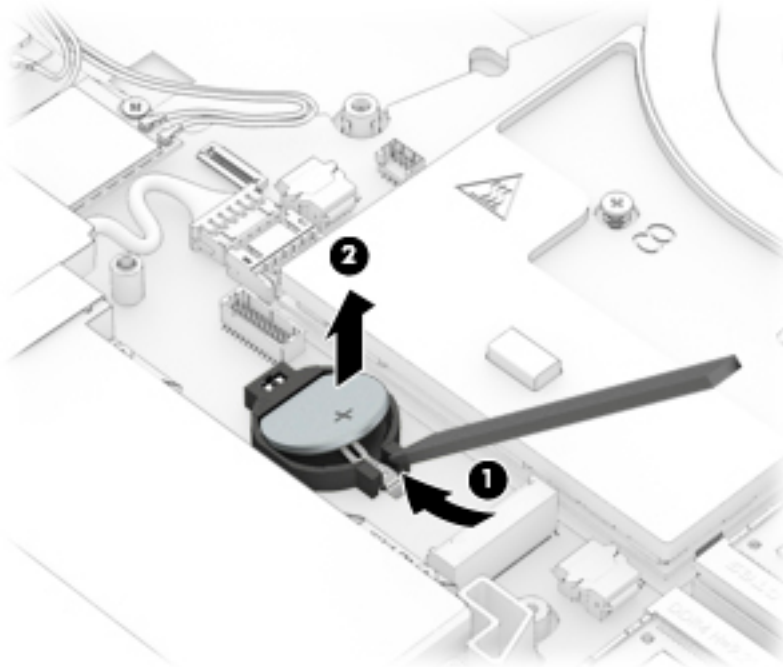

Reverse this procedure to install the RTC battery.

Speakers

Description	Spare part number
Speakers (includes cable)	848361-001

Before removing the speakers, follow these steps:

1. Turn off the computer. If you are unsure whether the computer is off or in Hibernation, turn the computer on, and then shut it down through the operating system.
2. Disconnect the power from the computer by unplugging the power cord from the computer.
3. Disconnect all external devices from the computer.
4. Remove the following components:
 - a. Service door (see [Service door on page 30](#)).
 - b. Battery (see [Battery on page 31](#)).
 - c. Base enclosure (see [Base enclosure on page 33](#)).
 - d. Hard drive(s) and internal frame (see [Hard drive\(s\) and internal frame on page 33](#)).

Remove the speakers:

1. Remove the two Phillips screws **(1)** that secure the right speaker to the computer.
2. Remove the right speaker **(2)**.
3. Disconnect the speaker cable from the system board **(3)**, and then release the cable from the guides **(4)** securing it to the computer.
4. Remove the two Phillips screws **(5)** that secure the left speaker to the computer.
5. Remove the left speaker **(6)**.

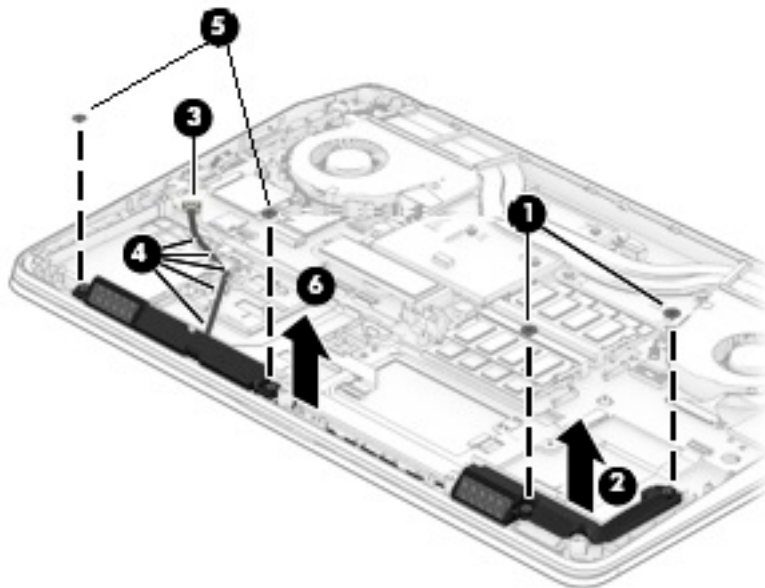

Reverse this procedure to install the speakers.

TouchPad

Description	Spare part number
TouchPad module (includes cable)	924810-001

Before removing the TouchPad, follow these steps:

1. Turn off the computer. If you are unsure whether the computer is off or in Hibernation, turn the computer on, and then shut it down through the operating system.
2. Disconnect the power from the computer by unplugging the power cord from the computer.
3. Disconnect all external devices from the computer.
4. Remove the following components:
 - a. Service door (see [Service door on page 30](#)).
 - b. Battery (see [Battery on page 31](#)).
 - c. Base enclosure (see [Base enclosure on page 33](#)).
 - d. Hard drive(s) and internal frame (see [Hard drive\(s\) and internal frame on page 33](#)).
 - e. Right speaker (see [Speakers on page 49](#)).

Remove the TouchPad:

1. Open the zero insertion force (ZIF) connector **(1)** on the system board to release the TouchPad ribbon cable.
2. Carefully remove the ribbon cable **(2)** from the adhesive securing it to the computer.
3. Remove the three Phillips screws **(3)** that secure the TouchPad.
4. Lift the TouchPad **(4)** up at an angle, and then remove the TouchPad **(5)** from the computer.

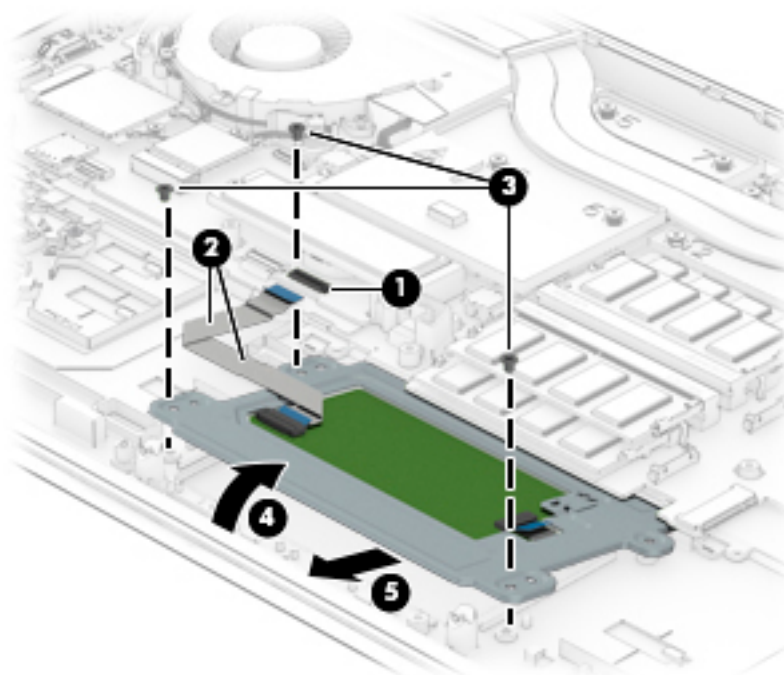

Reverse this procedure to install the TouchPad.

Smart card reader and frame

Description	Spare part number
Smart card reader	

Before removing the smart card reader, follow these steps:

1. Turn off the computer. If you are unsure whether the computer is off or in Hibernation, turn the computer on, and then shut it down through the operating system.
2. Disconnect the power from the computer by unplugging the power cord from the computer.
3. Disconnect all external devices from the computer.
4. Remove the following components:
 - a. Service door (see [Service door on page 30](#)).
 - b. Battery (see [Battery on page 31](#)).
 - c. Base enclosure (see [Base enclosure on page 33](#)).

Remove the smart card reader:

1. Remove 3 Phillips screws (**1**), release the cable from the routing (**2**), and then lift the bracket to remove it (**3**).

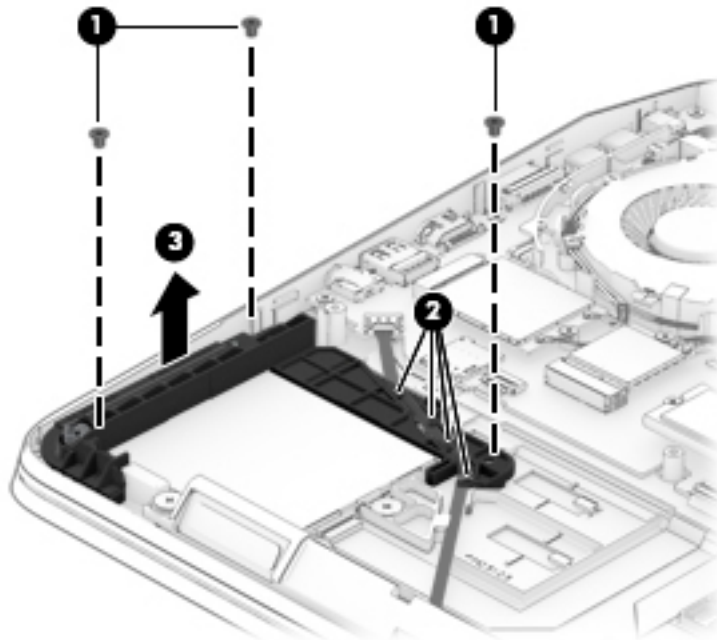

2. Disconnect the smart card reader cable from the system board (1), lift the cable (2), remove 2 Phillips screws (3), and then lift the smart card reader to remove it (4).

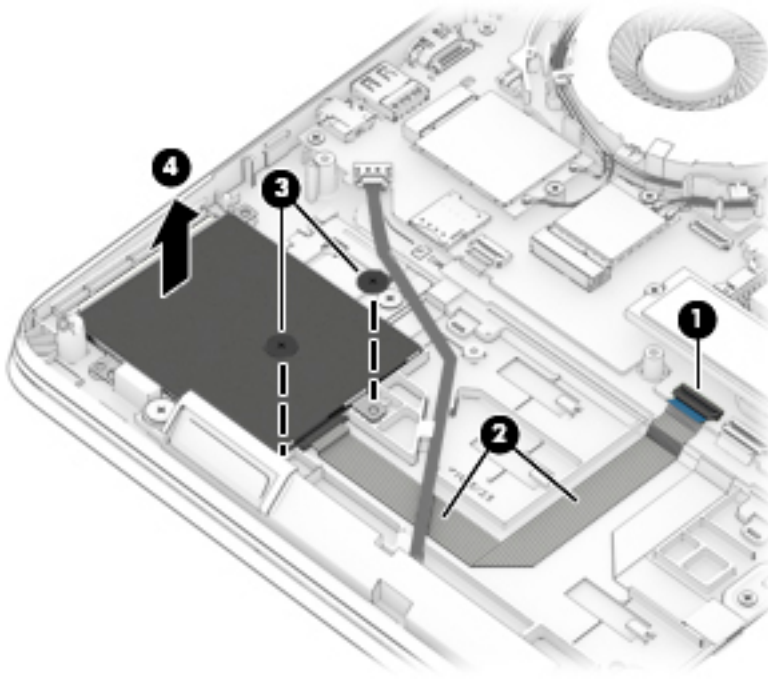

Reverse this procedure to install the smart card reader.

Fingerprint reader board

Description	Spare part number
Fingerprint reader board bracket (part of the bracket kit)	848360-001
Fingerprint reader board	850116-001

Before removing the fingerprint reader board, follow these steps:

1. Turn off the computer. If you are unsure whether the computer is off or in Hibernation, turn the computer on, and then shut it down through the operating system.
2. Disconnect the power from the computer by unplugging the power cord from the computer.
3. Disconnect all external devices from the computer.
4. Remove the following components:
 - a. Service door (see [Service door on page 30](#)).
 - b. Battery (see [Battery on page 31](#)).
 - c. Base enclosure (see [Base enclosure on page 33](#)).
 - d. Hard drive(s) and internal frame (see [Hard drive\(s\) and internal frame on page 33](#)).
 - e. Smart card frame and smart card reader (see [Smart card reader and frame on page 51](#)).

Remove the fingerprint reader board:

1. Remove the Phillips screw **(1)** that secures the fingerprint reader board bracket to the computer.
2. Lift the bracket up **(2)** and then slide the bracket off the fingerprint reader **(3)**.
3. Open the ZIF connector **(4)** on the system board to release the fingerprint reader cable.
4. Carefully lift the ribbon cable **(5)** to release it from adhesive securing it to the computer.

5. Release the fingerprint reader (6) from the double-sided tape and remove it from the computer.

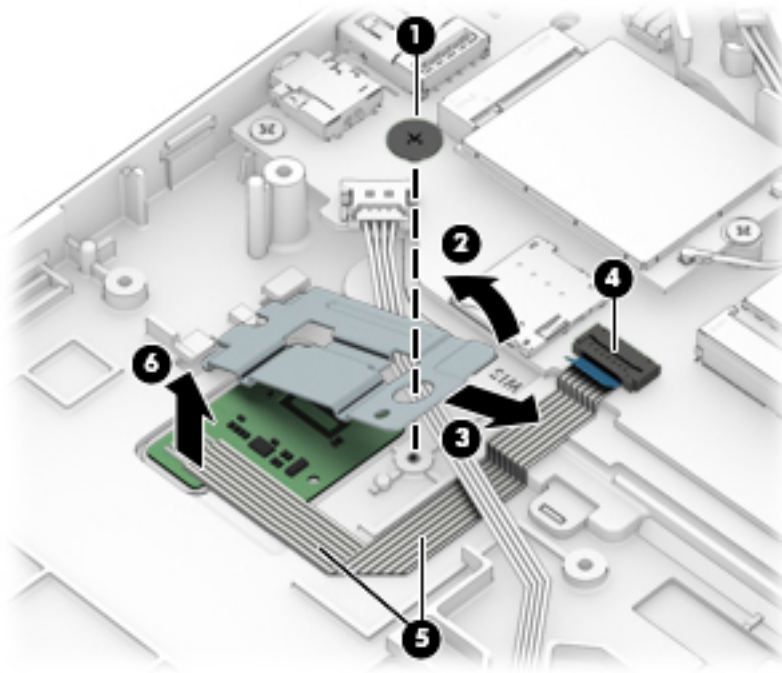

Reverse this procedure to install the fingerprint reader board.

Fan

Description	Spare part number
CPU fan (includes replacement thermal material)	848377-001
GPU Fan (includes replacement thermal material) (This fan is included as a blank for models with UMA graphics memory.):	
<ul style="list-style-type: none"> • For use only with models with discrete graphics memory 	848378-001
<ul style="list-style-type: none"> • For models with UMA graphics memory 	848376-001

Before removing the fans, follow these steps:

1. Turn off the computer. If you are unsure whether the computer is off or in Hibernation, turn the computer on, and then shut it down through the operating system.
2. Disconnect the power from the computer by unplugging the power cord from the computer.
3. Disconnect all external devices from the computer.
4. Remove the following components:
 - a. Service door (see [Service door on page 30](#)).
 - b. Battery (see [Battery on page 31](#)).
 - c. Base enclosure (see [Base enclosure on page 33](#)).
 - d. Hard drive(s) and internal frame (see [Hard drive\(s\) and internal frame on page 33](#)).
 - e. WLAN module (see [WLAN module on page 40](#)).

- f. WWAN module (see [WWAN module on page 42](#)).
- g. Speakers (see [Speakers on page 49](#)).

Remove the CPU (right) fan:

1. Release the fan connection **(1)** on the CPU (right) fan, and then loosen the two captive screws **(2)** securing the CPU fan to the computer.
2. Release the display cable **(3)** and remove it from the guides around the fan, and then remove the fan **(4)** from the computer.

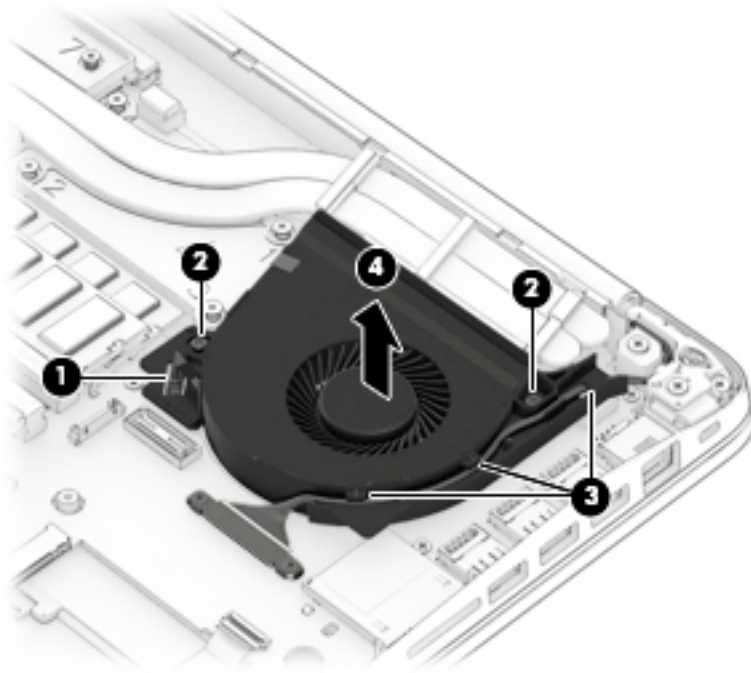

Remove the GPU (left) fan:

1. Release the connector **(1)** on the GPU (left) fan, and then loosen the two captive screws **(2)** securing the GPU fan to the computer.

2. Release the WWAN cable and WLAN cable (3) from the routing around the fan, and then remove the fan (4) from the computer.

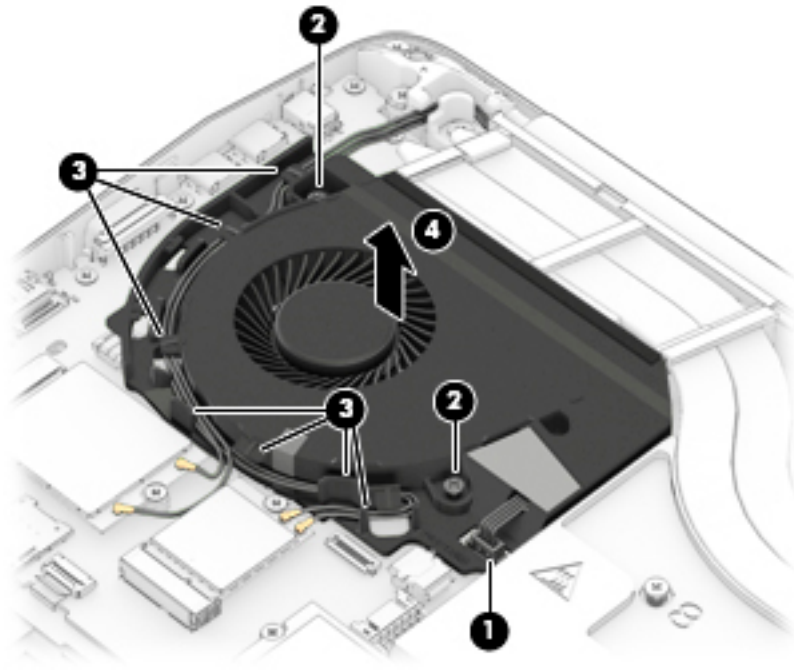

Reverse this procedure to install the CPU (right) and GPU (left) fans.

Heat sink

Description	Spare part number
Heat sink for use only with models with NVIDIA N17EQ1 discrete graphics memory	922842-001
Heat sink for use only with models with NVIDIA N17PQ1 discrete graphics memory	922843-001
Heat sink for use only with models with NVIDIA N17PQ3 discrete graphics memory	922844-001
Heat sink for use only with models with AMD UMA graphics memory	922845-001
Heat sink for use only with models with UMA graphics memory	922846-001

Before removing the heat sink, follow these steps:

1. Turn off the computer. If you are unsure whether the computer is off or in Hibernation, turn the computer on, and then shut it down through the operating system.
2. Disconnect the power from the computer by unplugging the power cord from the computer.
3. Disconnect all external devices from the computer.
4. Remove the following components:
 - a. Service door (see [Service door on page 30](#)).
 - b. Battery (see [Battery on page 31](#)).
 - c. Base enclosure (see [Base enclosure on page 33](#)).

- d. Hard drive(s) and internal frame (see [Hard drive\(s\) and internal frame on page 33](#)).
- e. Fans (see [Fan on page 54](#)).

Remove the heat sink:

Heat sink for use with models with discrete graphics memory

1. Remove the screws in the order shown (1 – 8) and then remove the heat sink (9) from the system board.

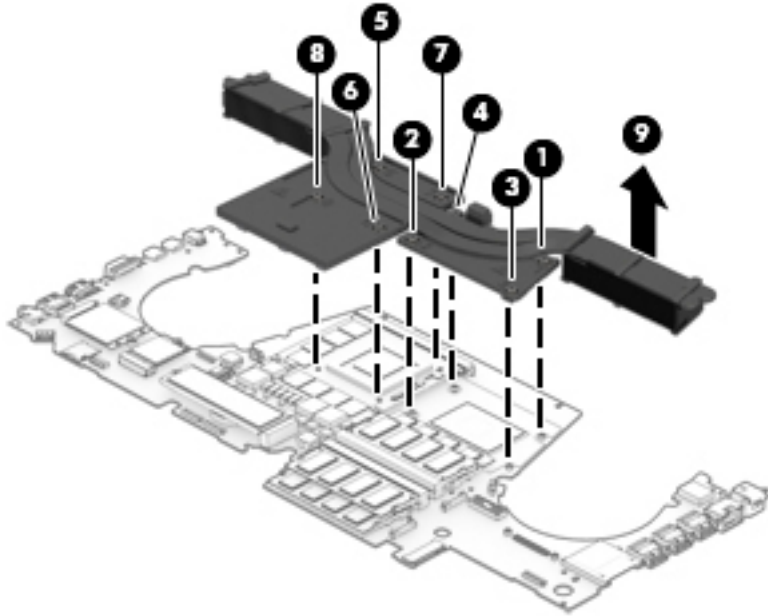

2. The following illustration shows the replacement thermal material locations. The thermal material must be thoroughly cleaned from the surfaces of the heat sink and the system board components each time the heat sink is removed. Replacement thermal material is included with the heat sink and system board spare part kits.

Thermal paste is used on the system board components **(2), (4), (6)** and on the heat sink areas **(1), (3), (5)** that service them.

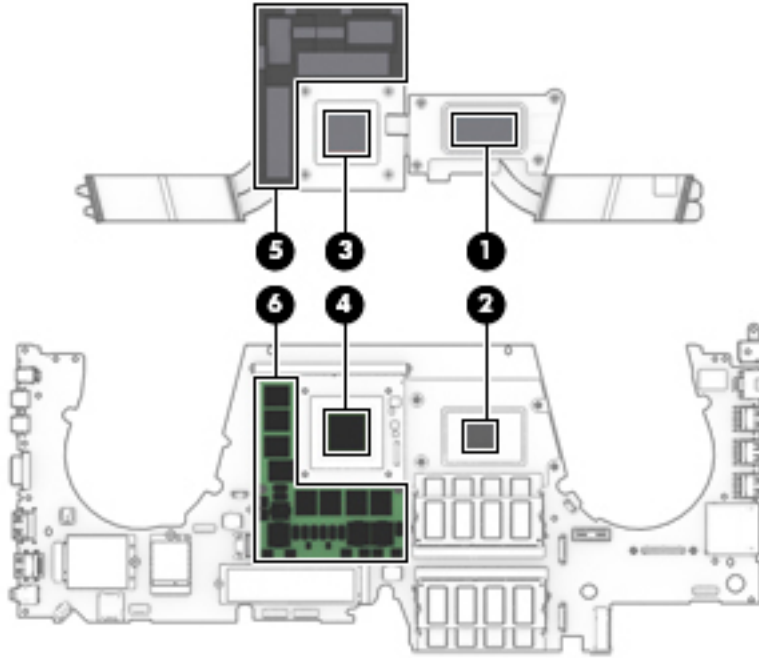

Heat sink for use with models with UMA graphics memory

1. Loosen the screws in the numbered order shown **(1, 2, 3, 4)**, and then remove the heat sink **(5)** from the system board.

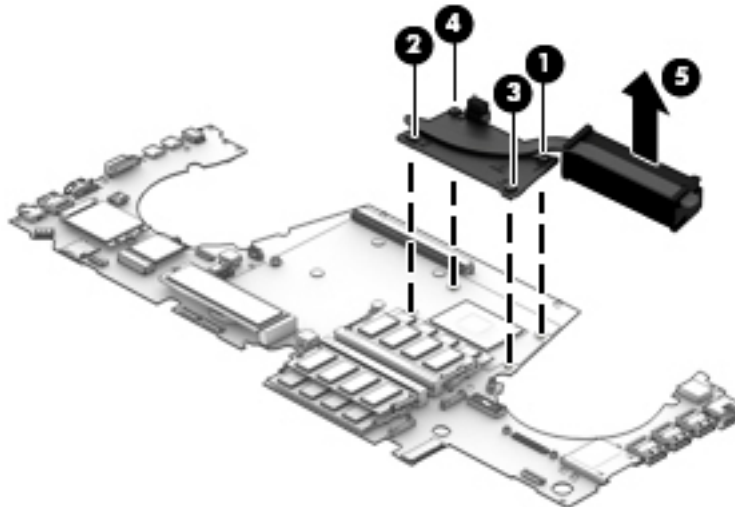

2. The following illustration shows the replacement thermal material locations. The thermal material must be thoroughly cleaned from the surfaces of the heat sink and the system board components each time the heat sink is removed. Replacement thermal material is included with the heat sink and system board spare part kits.

Thermal paste is used on the system board component **(1)** and on the heat sink area **(2)** that services it.

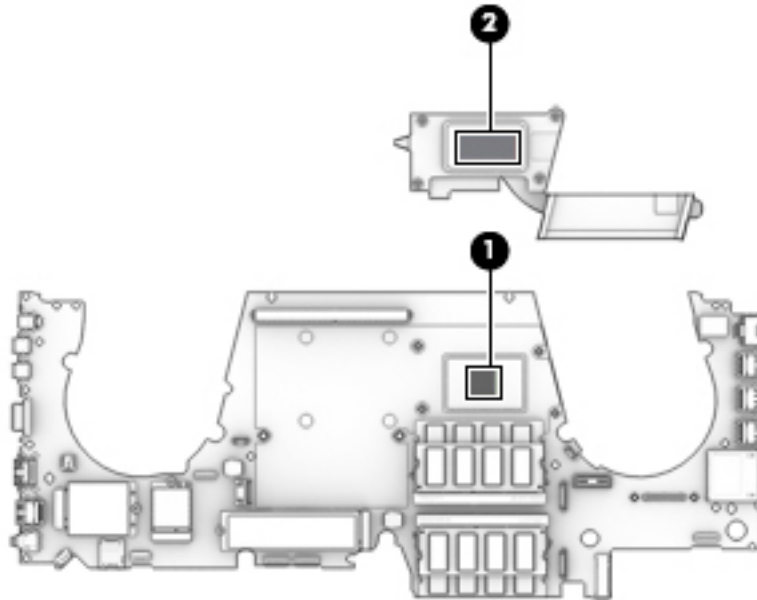

Reverse this procedure to install the heat sink.

Discrete graphics board

Description	Spare part number
NVIDIA Quadro M12000 with 4 GB graphics subsystem memory	917108-001
NVIDIA Quadro M2200 with 4 GB graphics subsystem memory	917109-001
NVIDIA Quadro M3000M: NVIDIA N16E-Q1 with 4 GB GDDR5 graphics subsystem memory	917109-001
NVIDIA Quadro P3000 with 6 GB graphics subsystem memory	917110-001
NVIDIA Quadro P4000 with 8 GB graphics subsystem memory	917111-001
NVIDIA Quadro P5000 with 16 GB graphics subsystem memory	917112-001
AMD Radion Pro WX 4170M with 4 GB GDDR5 graphics subsystem memory	917107-001

Before removing the discrete graphics board, follow these steps:

1. Turn off the computer. If you are unsure whether the computer is off or in Hibernation, turn the computer on, and then shut it down through the operating system.
2. Disconnect the power from the computer by unplugging the power cord from the computer.
3. Disconnect all external devices from the computer.
4. Remove the following components: .

- a. Service door (see [Service door on page 30](#)).
- b. Battery (see [Battery on page 31](#)).
- c. Base enclosure (see [Base enclosure on page 33](#)).
- d. Hard drive(s) (see [Hard drive\(s\) and internal frame on page 33](#)).
- e. Fans (see [Fan on page 54](#)).
- f. Heat sink (see [Heat sink on page 56](#)).

Remove the discrete graphics board:

- ▲ Remove the two screws **(1)** securing the board to the system board, and then remove the discrete graphics board **(2)**.

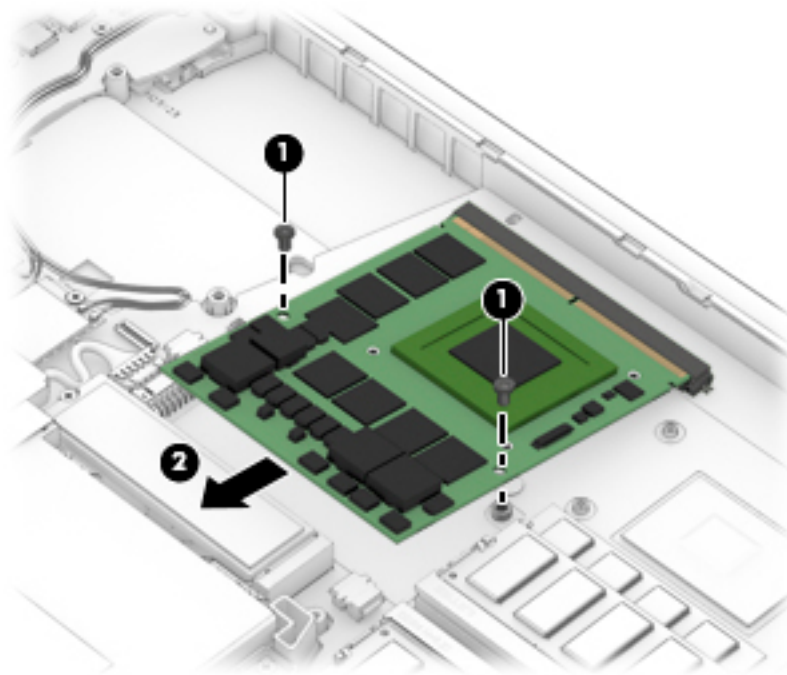

Reverse this procedure to install the discrete graphics board.

Display LED board

Description	Spare part number
Display LED board	

Before removing the display LED board, follow these steps:

1. Turn off the computer. If you are unsure whether the computer is off or in Hibernation, turn the computer on, and then shut it down through the operating system.
2. Disconnect the power from the computer by unplugging the power cord from the computer.
3. Disconnect all external devices from the computer.
4. Remove the following components:

- a. Service door (see [Service door on page 30](#)).
- b. Battery (see [Battery on page 31](#)).
- c. Base enclosure (see [Base enclosure on page 33](#)).
- d. Hard drive(s) and internal frame (see [Hard drive\(s\) and internal frame on page 33](#)).
- e. RTC battery (see [RTC battery on page 48](#)).
- f. Right speaker and metal speaker frame (see [Speakers on page 49](#)).

Remove the display LED board:

1. Open the ZIF connector **(1)** on the system board to release the display LED board ribbon cable, and then release the ribbon cable **(2)** from the adhesive securing it to the computer.
2. Remove the screw **(3)** securing the board to the computer, and then remove the display LED board **(4)**.

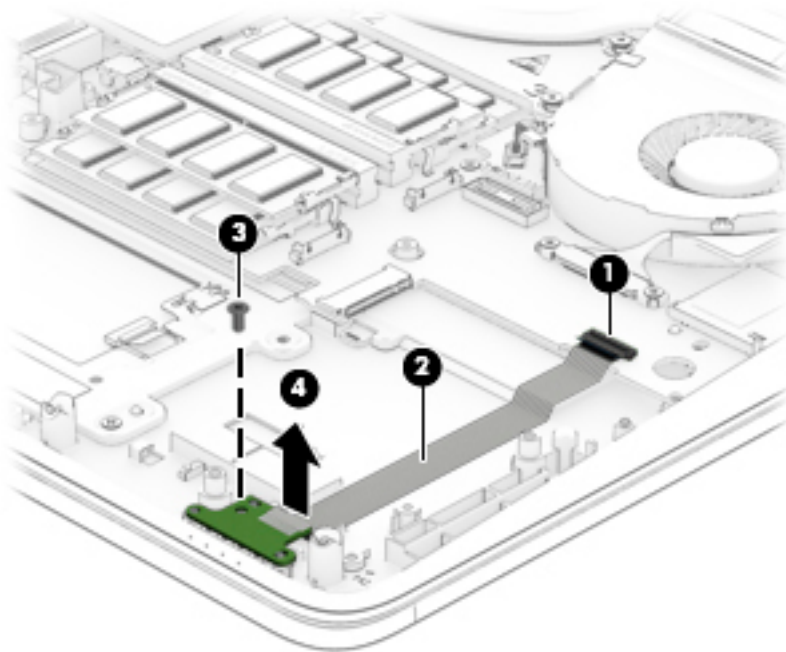

Reverse this procedure to install the display LED board.

Keyboard

For use in country or region	Spare part number	For use in country or region	Spare part number
Keyboard with backlight:			
For use in Belgium	848311-A41	For use in Northwest Africa	848311-FP1
For use in Brazil	848311-201	For use in Norway	848311-091
For use in Bulgaria	848311-261	For use in Portugal	848311-131
For use in Canada	848311-DB1	For use in Romania	848311-271
For use in the Czech Republic and Slovakia	848311-FL1	For use in Russia	848311-251
For use in Denmark	848311-081	For use in Saudi Arabia	848311-171
For use in France	848311-051	For use in Slovenia	848311-BA1
For use in Germany	848311-041	For use in South Korea	848311-AD1
For use in Greece	848311-151	For use in Spain	848311-071
For use in Hungary	848311-211	For use in Sweden and Finland	848311-B71
For use in Iceland	848311-DD1	For use in Switzerland	848311-BG1
For use in India	848311-D61	For use in Taiwan	848311-AB1
For use internationally	848311-B31	For use in Thailand	848311-281
For use in Israel	848311-BB1	For use in Turkey	848311-141
For use in Italy	848311-061	For use in the United Kingdom and Singapore	848311-031
For use in Japan	848311-291	For use in the United States	848311-001
For use in Latin America	848311-161		

Before removing the keyboard, follow these steps:

1. Turn off the computer. If you are unsure whether the computer is off or in Hibernation, turn the computer on, and then shut it down through the operating system.
2. Disconnect the power from the computer by unplugging the power cord from the computer.
3. Disconnect all external devices from the computer.
4. Service door (see [Service door on page 30](#)).
 - a. Battery (see [Battery on page 31](#)).
 - b. Base enclosure (see [Base enclosure on page 33](#)).
 - c. Hard drive(s) and internal frame (see [Hard drive\(s\) and internal frame on page 33](#)).

Remove the keyboard:

1. Partially open the computer.
2. Rest and secure the computer on its left side and remove the two screws **(1)** securing the keyboard to the computer.

3. Insert a thin tool **(2)** into the keyboard release hole beside the second fan, and then press on the back of the keyboard until the keyboard disengages from the computer.

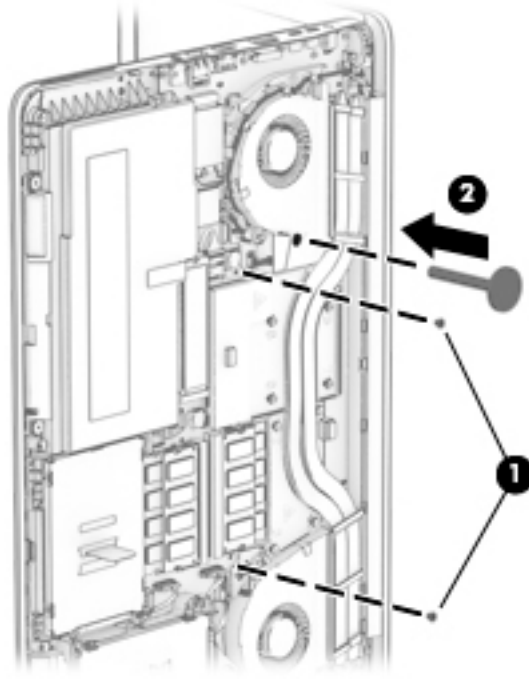

4. Swing the keyboard up and forward until it rests upside down on the palm rest.



5. Open the ZIF connector **(1)** on the system board to release the keyboard ribbon cable.
6. Open the ZIF connector **(2)** on the system board to release the backlight cable.
7. Open the ZIF connector **(3)** on the system board to release the pointing stick cable.

8. Remove the keyboard (4).

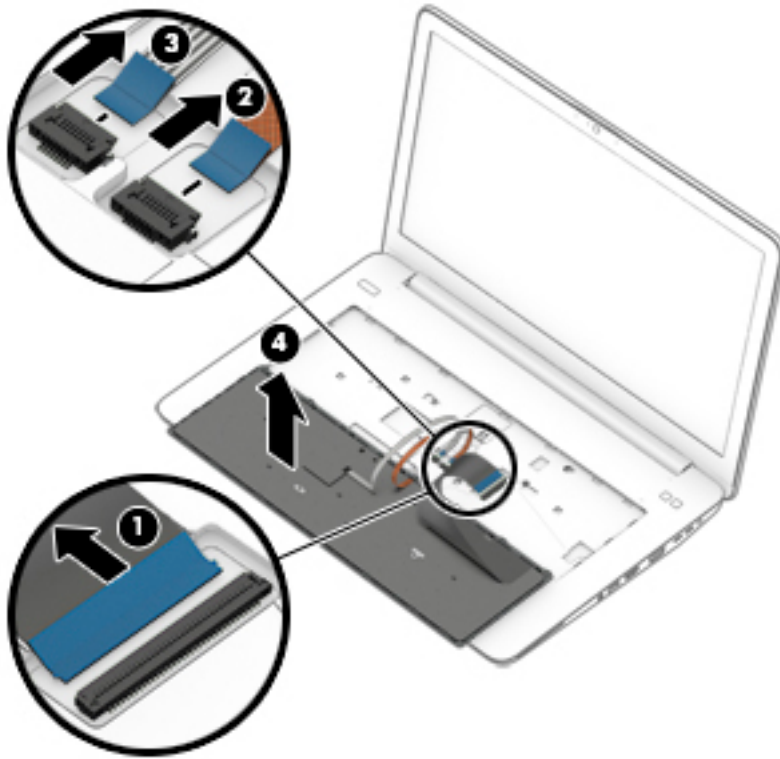

Reverse this procedure to install the keyboard.

System board

 **NOTE:** The system board spare part kit includes battery connector bracket and replacement thermal material.

All system boards use the following part numbers:

xxxxxx-001: Windows 7 or non-Windows operating systems

xxxxxx-601: Windows 10 operating system

Description	Spare part number
Intel Core i5-7300HQ processor	921325-xxx
Intel Core i5-7440HQ processor	921326-xxx
Intel Core i7-7700HQ processor	921327-xxx
Intel Core i7-7820HQ processor	921328-xxx
E3-1535M processor	921329-xxx
E3-1505M processor	921330-xxx

Before removing the system board, follow these steps:

1. Turn off the computer. If you are unsure whether the computer is off or in Hibernation, turn the computer on, and then shut it down through the operating system.
2. Disconnect the power from the computer by unplugging the power cord from the computer.
3. Disconnect all external devices from the computer.
4. Remove any SD card or SD blank from the computer.
5. Remove the following components:
 - a. Service door (see [Service door on page 30](#)).
 - b. Battery (see [Battery on page 31](#)).
 - c. Base enclosure (see [Base enclosure on page 33](#)).
 - d. Hard drive(s) and internal frame (see [Hard drive\(s\) and internal frame on page 33](#)).
 - e. WLAN module (see [WLAN module on page 40](#)).
 - f. WWAN module (see [WWAN module on page 42](#)).
 - g. Memory modules (see [Memory module on page 44](#)).
 - h. Solid-state drive(s) (see [Solid-state drives \(M.2\) on page 38](#)).
 - i. Fans (see [Fan on page 54](#)).
 - j. Heat sink (see [Heat sink on page 56](#)).
 - k. Discrete graphics board (see [Discrete graphics board on page 59](#)).
 - l. Keyboard (see [Keyboard on page 62](#)).

 **NOTE:** When replacing the system board, be sure that the following components are removed from the defective system board and installed on the replacement system board:

- WLAN module (see [WLAN module on page 40](#))
- WWAN module (see [WWAN module on page 42](#))
- Memory module (see [Memory module on page 44](#))
- Heat sink (see [Heat sink on page 56](#))

 **NOTE:** You do not have to remove the heat sink to remove the system board.

Remove the system board:

1. Disconnect the following cables from the system board (note the routing location of the cables when removing them):
 - (1) Speaker cable
 - (2) WWAN cable
 - (3) WLAN cable
 - (4) Fingerprint reader cable
 - (5) Smart Card reader cable
 - (6) Touchpad cable
 - (7) Display LED board cable

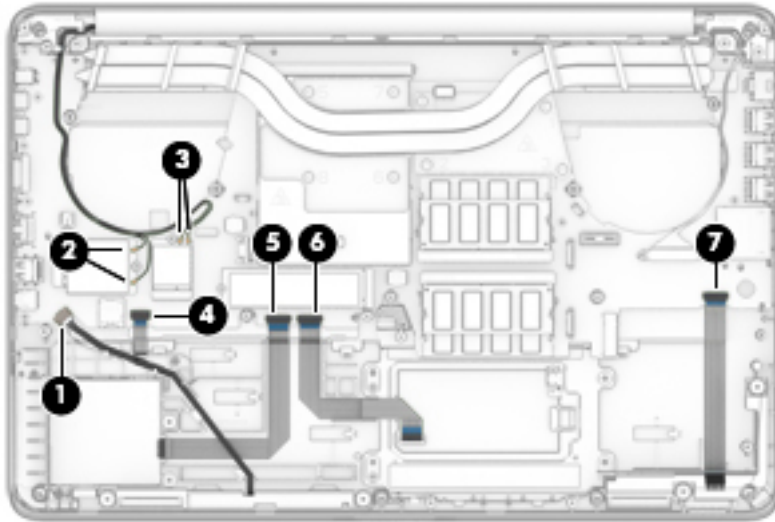

2. Remove the eight Phillips screws **(1)** securing the system board edges.
 3. Remove the two Phillips screws **(2)** securing the system board.
 4. Remove the two Phillips screws **(3)** securing the display cable bracket, and then remove the bracket **(4)**.
-
-  **NOTE:** Use flat tool under the connector to remove evenly. Do not pull on the cable to remove.
5. Release the connector **(5)** for the display cable.

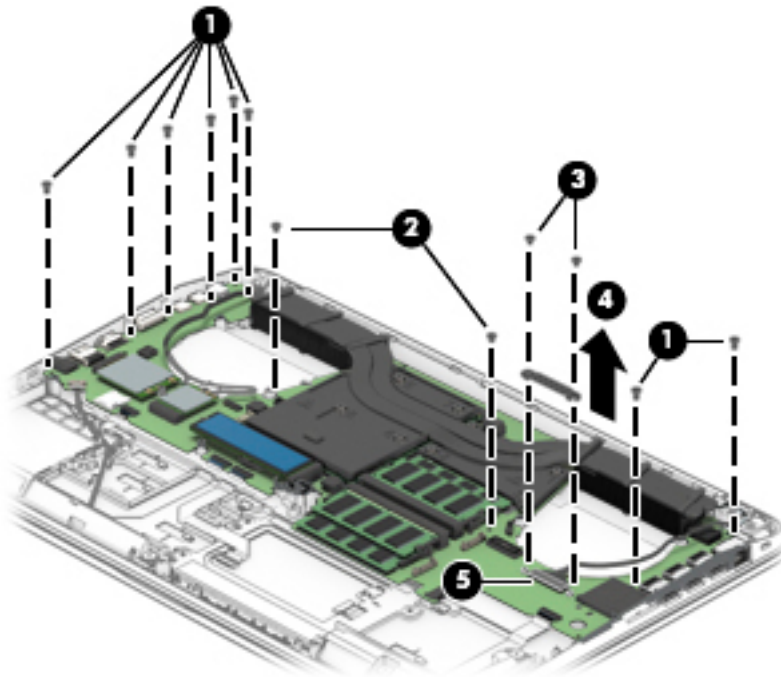

6. Lift the side of the system board **(1)** and slide system board **(2)** at angle away from the computer to remove it.

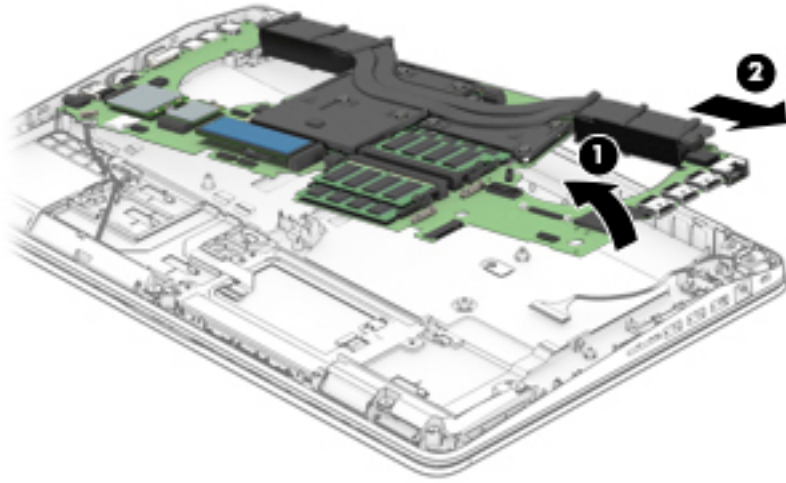

Reverse this procedure to install the system board.

Display assembly

 **NOTE:** The Dream Color display assembly is spared as a whole unit assembly only. The LED display assembly is spared at the subcomponent level only. For more LED display assembly spare part information, see the individual removal subsections.

Description	Spare part number
17.3 FHD, UWVA AG with camera and touch screen	921322-001
17.3 in UHD, Dream Color 3 UWVA	921323-001
17.3 in UHD, Dream Color 3 UWVA f/camera	921324-001
Raw panel 17.3 FHDAGWLEDUWVA300eDP Flat AK	819347-002
Raw panel 17.3 HD+AGWLEDSVA 220eDP Flat AK	819348-002
Hinge	906120-001
LCD bezel with magnet	848368-001
Bezel with camera	850119-001
LCD cable	848379-001
Webcam, 1p DM U2 Mjpeg 720p CTS Vaughn	819336-006
Microphone board	854110-001

To remove the display assembly and access the LED display assembly subcomponents, follow these steps:

1. Turn off the computer. If you are unsure whether the computer is off or in Hibernation, turn the computer on, and then shut it down through the operating system.
2. Disconnect the power from the computer by unplugging the power cord from the computer.
3. Disconnect all external devices from the computer.
4. Remove the following components:
 - a. Service door (see [Service door on page 30](#)).
 - b. Battery (see [Battery on page 31](#)).

Remove the display assembly:

1. Remove the six Phillips screws **(1)** that secure each hinge to the computer.
2. Open the computer as far as possible.

3. Separate the display from the computer (2).

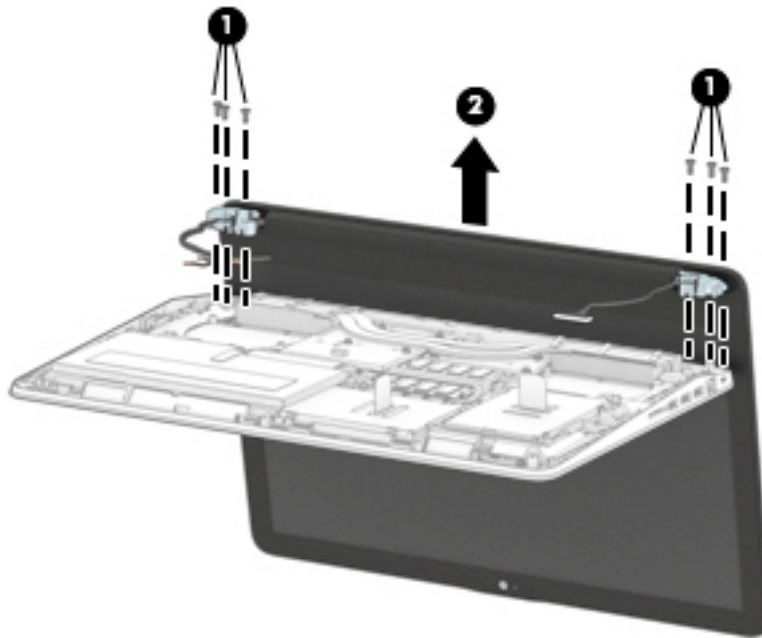

4. If it is necessary to replace the display bezel or any of the LED display assembly subcomponents:
 - a. Use a plastic tool to disengage the bezel starting at the top (1), left and right sides (2), and bottom (3).
 - b. Remove the display bezel (4).

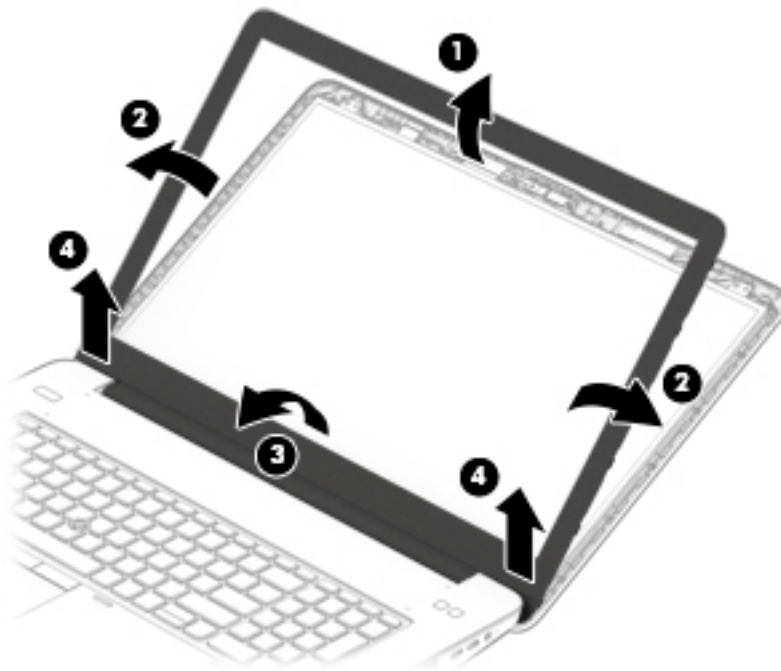

5. If it is necessary to replace the display panel:
 - a. Remove the four Phillips screws (1) that secure the display panel to the display enclosure.

⚠ CAUTION: Before turning the display panel upside down, make sure the work surface is clear of tools, screws, and any other foreign objects. Failure to follow this caution can result in damage to the display panel.

- b. Lift the top edge of the display panel **(2)** and swing it up and forward until it rests upside down in front of the display enclosure.

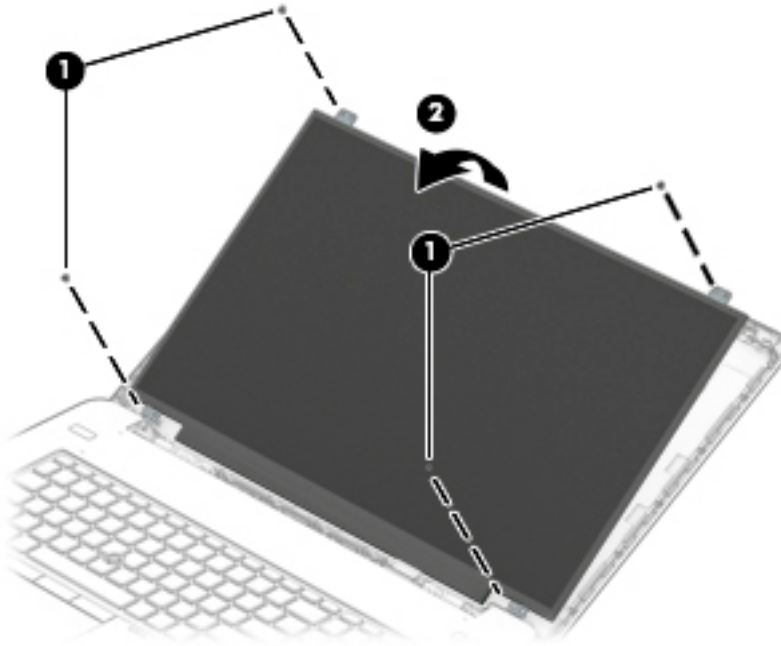

- c. Lift the tape **(1)**, and then disconnect the display panel cable **(2)** from the display panel.
- d. Remove the display panel display panel **(3)**.

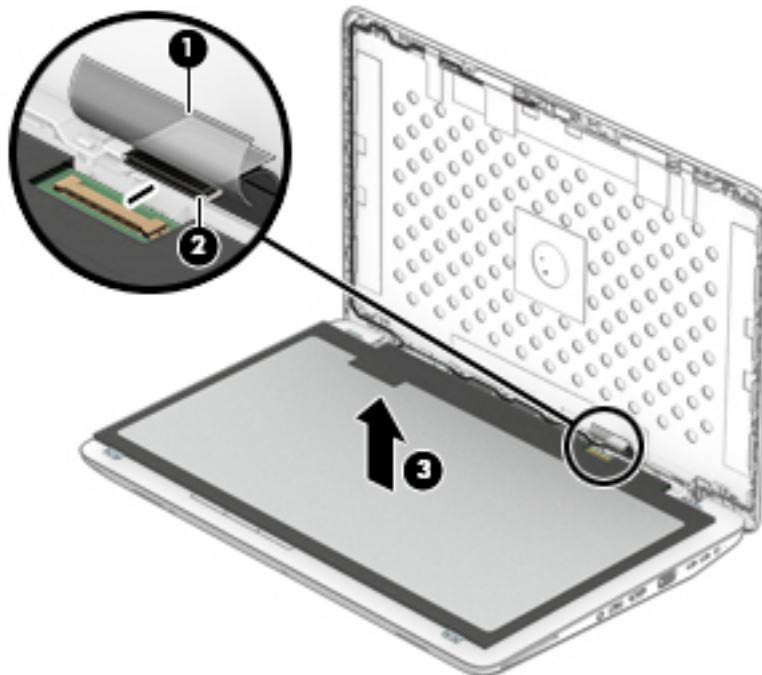

- 6. If it is necessary to replace the webcam module or microphone module:

 **NOTE:** The webcam module and microphone module are similar in appearance and installed in the same location. The removal procedures are the same for both modules.

 **CAUTION:** Handle the module with caution. This module has a thin profile and is susceptible to damage when not handled carefully.

- a. Detach the webcam or microphone module **(1)** from the display enclosure. (The module is attached to the display enclosure with double-sided adhesive.)
- b. Remove the tape **(2)** covering the cable.
- c. Disconnect the module cable **(3)** from the module.

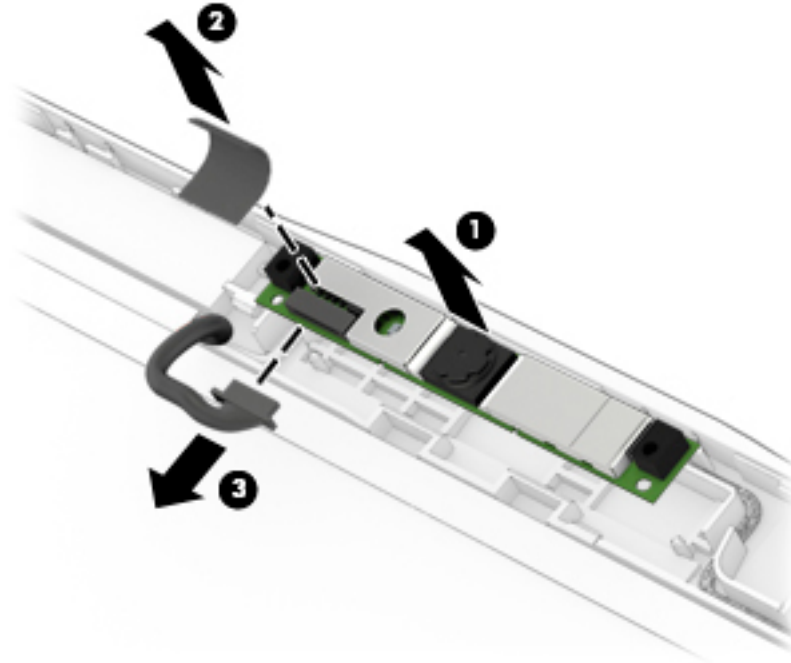

7. If it is necessary to replace the Dream Color calibration board:
 - a. Disconnect the calibration board cable **(1)** from the board.

9. If it is necessary to replace the WLAN antennas:
- Lift and remove the WLAN antennas (1) off the display enclosure.
 - Release the antenna cables (2) from the routing path of the display enclosure.
 - Remove the WLAN antennas (3) from the bottom of the display enclosure.
- The antennas are available using spare part number 848346-001.

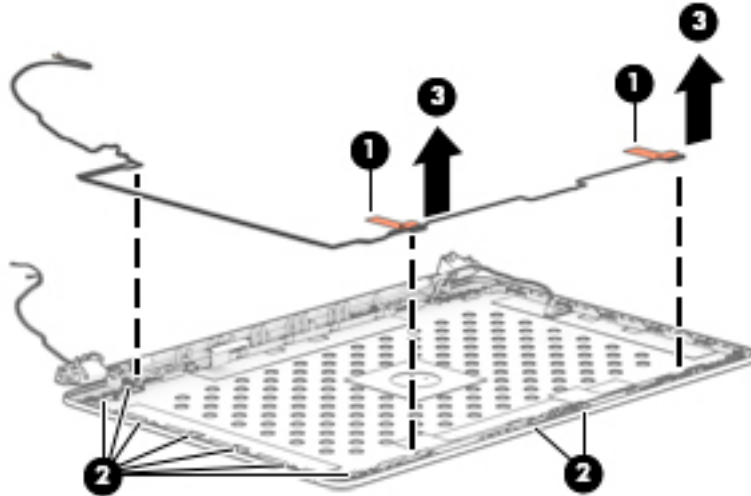

10. If it is necessary to replace the WWAN antennas:
- Lift and remove the WWAN antennas (1) off the display enclosure.
 - Remove the antenna cables (2) from the routing path of the display enclosure.
 - Remove the WWAN antennas (3) from the bottom of the display enclosure.
- The antennas are available using spare part number 848347-001.

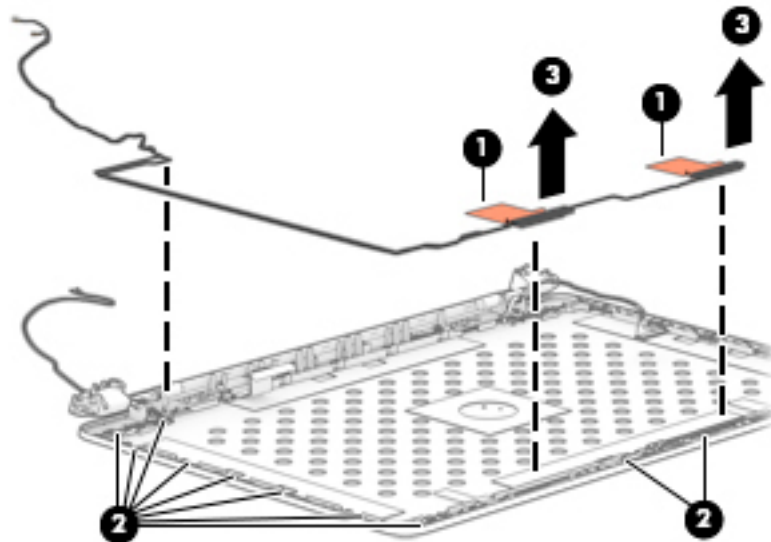

11. If it is necessary to replace the display cable:

- a. Disconnect the end of the display cable (1) from the connector securing it to the display enclosure.
- b. Disconnect display cable (2) from the small connector securing it to the display enclosure.
- c. Release the cable (3) from the routing path along the display enclosure.
- d. Remove the cable (4).

The display cable is available using spare part number 848379-001.

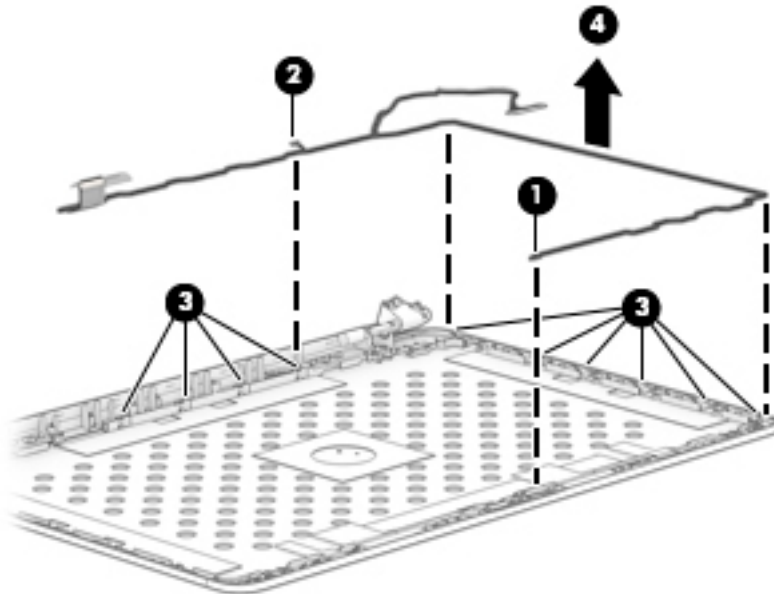

Reverse this procedure to reassemble and install the display assembly.

Top cover

Description	Spare part number
Top cover	929011-001

The top cover spare remains after removing all other spare parts.

7 Troubleshooting guide

This chapter is primarily focused on troubleshooting HP Mobile Workstations and HP Notebooks. The information is provided so that you can solve problems yourself or at least narrow down what may be causing the problem. Based on some of the most common symptoms, this chapter helps to identify logical steps and available resources or tools for resolving an issue. HP recommends that you follow the instructions carefully, observe safety precautions, and note any observations or results. Capturing this information may help identify and resolve the problem faster.

 **WARNING!** To reduce the risk of electric shock or damage to the equipment:

- Do not disable the power cord grounding plug. The grounding plug is an important safety feature.
- Plug the power cord into a grounded (earthed) outlet that is easily accessible at all times.
- Disconnect power from the equipment by unplugging the power cord from the AC outlet.
- Before disassembling notebooks, always disconnect power and remove the battery.

 **CAUTION:** Static electricity can damage the electronic components of the computer. To prevent damage to the computer, carefully observe the electrostatic discharge precautions.

- Discharge static electricity by briefly touching a grounded metal object before you begin.
- Work on a static-free mat.
- Wear a static strap to ensure that any accumulated electrostatic charge is discharged from your body to the ground.
- Create a common ground for the equipment you are working on by connecting the static-free mat, static strap, and peripheral units to that piece of equipment.
- Refer to the Electrostatic Discharge Section of the Maintenance & Service Guide for more information.

CAUTION: The computer includes customer self-repair parts and parts that should only be accessed by an authorized service provider. See the chapter titled "Removal and replacement procedures for Customer Self-Repair parts," for details. Accessing parts described in the chapter titled "Removal and replacement procedures for authorized service provider only parts" can damage the computer or void the computer warranty.

Resources

HP Resource Tool	Description	Link
HP Elite Support	Provides live HP Premium support (available 24/7) to Elite computers.	http://www8.hp.com/us/en/ads/elite-products/overview.html
HP Support Center	Provides important support, such as warranty, support cases, drivers, Customer Advisories, Customer and Security Bulletins, and Product Change Notices.	http://h20565.www2.hp.com/portal/site/hpsc
HP Troubleshooting Support page	Provides troubleshooting information for your specific HP computer.	http://www8.hp.com/us/en/troubleshooting.html
Troubleshooting Problems with Docking Stations	Provides troubleshooting information for HP docking stations.	http://support.hp.com/us-en/document/c03247469
HP Elite Dock with Thunderbolt 3 and HP ZBook Dock with Thunderbolt 3	Provides troubleshooting information for your specific docking station	http://h20565.www2.hp.com/hpsc/doc/public/display?sp4ts_oid=9822172&docLocale=en_US&docId=emr_na-c05060909
Subscribers Choice	Allows you to sign up for HP product updates.	http://www8.hp.com/us/en/subscribe/
HP Support Forums	Provide discussions about HP products and issues.	http://h30434.www3.hp.com/psg/
Service Access Workbench (SAW) (Available for technicians and Business Partners only)	Provides navigable content intended for use by internal and outsourced call center staff and can be a resource for support and product division professionals.	http://sawpro.atlanta.hp.com/km/saw/home.do
Vendors' web sites	Provide additional information for associated components such as Intel (processor, WLAN), Microsoft (Windows 7/8/10), AMD/NVidia (GPU), and so on.	http://www.intel.com/content/www/us/en/homepage.html http://www.microsoft.com http://www.amd.com http://www.nvidia.com

General troubleshooting steps

A basic logic should be used when troubleshooting computer issues. This section will help you become familiar with troubleshooting methodology and efficiently resolve problems. Proceed through the steps in the following table until the issue is resolved, and then move on to the next step that is relevant to the issue. For example, if you resolve a memory issue using the HP PC Diagnostics (UEFI) tool in step 6, you can then move on to step 10 to reseat the memory into its memory slot.



NOTE: General troubleshooting steps do not have to be followed in a specific order.

Table 7-1 Troubleshooting methodology and general troubleshooting steps

Identify issue	Analyze issue	Resolve issue	Verify solution
1. Understand the issue on page 77	5. Remove or uninstall recently added hardware, software on page 80	8. Hard reset on page 90	Verify solution on page 94
2. Examine the environment on page 79	6. HP Hardware Diagnostics and Tools on page 81	9. Soft reset (Default Settings) on page 91	
3. Perform a visual inspection of hardware on page 80		10. Reseat cables and connections on page 91	

Table 7-1 Troubleshooting methodology and general troubleshooting steps

Identify issue	Analyze issue	Resolve issue	Verify solution
4. Update BIOS and drivers on page 80	7. Status lights, blinking light codes, troubleshooting lights, and POST error messages on page 85	11. Test with minimum configuration on page 92 12. Test with verified working configuration (hardware and/or operating system) on page 93 13. Replace the system board on page 93	

Identify the issue

1. Understand the issue

It is important to understand the issue that occurred, including related symptoms. It helps to understand the basic computer boot-up sequence as well as the failure itself. The boot-up sequence and associated failures are described below.

Boot up sequence

The computer performs several steps after you press the power button or restart the computer.

It is important to understand where in the boot-up sequence the symptoms occur. The following table lists the phases of the boot-up sequence and explains the symptoms that may occur in each phase. For example, a blue screen error (BSOD) often occurs during the performance phase.

Table 7-2 Boot-up sequence

Item	Description
Power-on	<p>After power button is pressed, the computer boots after all internal power rails (i.e., 5V, 3.3V) are stable.</p> <p>Confirm that power lights are on fan is spinning.</p> <p>Next step: If the computer experiences a power-on issue, see “Verify Power Good (Troubleshooting) lights” in No Power on page 96.</p> <p>Common issues: all lights are off; troubleshooting lights are on; does not boot; video is absent.</p>
POST (UEFI/BIOS)	<p>Power-On Self-Test (POST) verifies that hardware components (processor, hard drive, memory, etc.) are functional. When POST is complete, the HP logo displays briefly and then disappears.</p> <p>If there are errors, the computer may exhibit blinking lights and POST error messages</p> <p>Common issues: lights blink, error message appears, hangs.</p>
Performance (operating system)	<p>System boots to operating system, and Windows logo screen appears..</p> <p>Common issues: hangs (lock up/freezes), blue screen, video distorted, driver conflict, slow performance, display issue (dead pixel), I/O issue (no speaker sound), wireless/audio unavailable, noise.</p> <p>See Analyze the issue on page 80 table below for detailed troubleshooting information).</p>

Failure classification

Failure classification is a breakdown of different types of failures and symptoms that could occur during the boot-up sequence. Table 3 and table 4 represent the failure classification for common notebook failures.

Table 3 categorizes failures by the boot-up sequence.

1. Power-on: Common issues are No Power, Recycle/Reboot, etc.
2. POST: Common issues are No Boot (have power), Light Flash or Diagnostics Error.
3. Performance: Common issues are Intermittent Loss of Power, Blue Screen, Hang, etc. In many cases, issues may be identified and associated with a particular hardware (i.e., display, storage).

Table 4 categorizes failures by hardware.

4. Display
5. I/O devices (Input/Output)
6. Storage
7. Mechanical

A single symptom can be listed under different groups. For example, No Video can belong to (1) Power-on or (4) Display; but Flickering when powered should be listed in (4) Display. Or, in another example, a blue screen can be caused by a driver conflict in Performance (4), but it can also be caused by a defective hard drive under (6) Storage. Therefore, failures that share similar symptoms are noted..

If possible, make a record of the failure symptom, the phase of the boot-up sequence where the failure occurs, and the most likely location in the failure tree ([Table 7-3 Failure classification by boot-up sequence on page 78](#) and [Table 7-4 Failure classification by hardware devices and mechanical on page 79](#)). This will help isolate the issue and indicate the next steps. For example, when the computer is running the operating system, it may experience an issue with (4) Display, (5) I/O devices (keyboard, wireless, and so on), (6) Storage, or (7) Mechanical components (stuck buttons, thermal shutdown, and so on).



NOTE: “Uncategorized” is used if an issue found is not listed. For example, Bluetooth is offered on certain hardware configurations; therefore, a Bluetooth issue can be classified under “I/O Device” if needed.

Failure classification by boot-up sequence

Table 7-3 Failure classification by boot-up sequence

1. Power-on	2. POST	3. Performance
1. No Power on page 96	1. No video (with power) on page 103	1. Intermittent shutdown on page 107^a
2. Intermittent power-on, shutdown, reboot on page 98^a	2. Blinking lights on page 104	2. Blue screen (BSOD) error on page 134^b
3. AC adapter issue on page 100	3. Diagnostics error messages on page 105	3. Freeze at Windows Logo (hang/lockup) on page 110
4. Battery not recognized, not charging on page 100	4. BIOS password on page 106	4. Electromagnetic Interference (EMI) on page 111
5. Battery discharges too fast on page 102		5. No wake up on page 112
6. Burnt smell on page 103		6. Unresponsive on page 113
		7. Slow performance on page 113^c
		8. HP Smart Adapter warning message on page 114
		9. Incorrect time and date on page 114

^{a,b,c} similar symptoms

Failure classification by hardware devices and mechanical

Table 7-4 Failure classification by hardware devices and mechanical

4. Display	5. I/O devices	6. Storage	7. Mechanical
1. Display anomalies on page 115	1. Keyboard on page 121	1. Hard drive/solid-state drive not recognized on page 133	1. Fan error message - 90B on page 136
2. Dead pixel on page 117	2. Keyboard point stick on page 122	2. No boot to operating system (no read/write error) on page 133	2. Noise (sound) on page 137
3. No video (internal) on page 117^d	3. Keyboard backlight on page 122	3. Read-write error on page 134	3. Fan runs constantly on page 138
4. No video (external) on page 118^d	4. TouchPad on page 123	4. Slow performance on page 113^c	4. HP Thermal Monitor on page 84
5. DisplayPort/VGA on page 118	5. Network Connectivity Ethernet (RJ-45 jack) on page 123	5. Blue screen (BSOD) error on page 134^b	5. Stuck power button on page 140
6. HDMI on page 118	6. Network connectivity wireless (WLAN) on page 124	6. Noisy hard drive on page 135	
7. No or bad external video via docking on page 119	7. WWAN on page 125		
8. Incorrect or missing color/distorted image on page 119	8. USB on page 126		
9. Touch screen on page 120	9. Smart card reader on page 127		
	10. Speaker, headphone - audio issues on page 128		
	11. Thunderbolt (TB) on page 129		
	12. Thunderbolt 3 dock on page 130		

^{b,c,d} similar symptoms

2. Examine the environment

It is important to examine the computer's environment. If you can quickly identify the cause of the issue, fewer resolution steps may be needed. Perform the following environment inspections:

- Check all cables and connections to be sure that there are no loose connections.
- Confirm that power sources are good, such as wall power type/adaptor (110V/220V ac), power strip. Test with a verified working AC outlet.
- Check for compatibility issues between the computer and third-party devices, peripherals, noncertified devices, incompatible hardware (i.e., Mac OS device). Incompatibility can result in blue screen errors, improper operation, and so on.
- Isolate the computer from sources of electromagnetic interference (EMI), such as cell phones, 2-way radios, floor mats, fans (and other electronic motors). EMI may contribute to a display freeze issue or lock-up.

3. Perform a visual inspection of hardware

It is important to do a visual inspection of the hardware itself. Perform physical inspection of the computer:

- Look for abnormalities such as a cracked display, dented battery, broken latches for battery bay, keyboard key caps popped out, dust over connectors, liquid spill over keyboard, etc.
- Look for signs of drop, movement, or vibration that may cause internal and external loose connections.

4. Update BIOS and drivers

 **IMPORTANT:** Whenever possible, update to the latest BIOS, firmware, and drivers before troubleshooting.

Note that some customer company policies prohibit updates. Check your company policy before taking action.

The updates may include fixes for your computer issues, and they may also enhance system performance. HP continually improves the update process to make it easier. The BIOS update can be done locally through a manual process, through an automatic installation, or through a remote installation on multiple units.

Manually updating BIOS and drivers

- See the Computer Setup chapters to manually update BIOS and drivers.
- Refer to specific BIOS update installation instructions that accompany the download.

Remotely deploying BIOS and drivers

Instead of manually searching for and downloading each SoftPaq, users and IT personnel can use two tools to identify and download all appropriate SoftPaqs for the selected HP models.

- HP SoftPaq Download Manager (SDM) is a software tool designed to streamline the download, extraction, and installation process of SoftPaqs, including BIOS and drivers.
- HP System Software Manager (SSM) is a software tool designed to simplify the deployment of SoftPaqs to HP computers.

Analyze the issue

5. Remove or uninstall recently added hardware, software

HP has designed this computer and validated it using a full-range hardware and software qualification matrix. If an issue appears to have started recently, it may be related to the recent addition of hardware or software. A good method to determine the root cause is to remove recently added components or uninstall applications one at a time and restart the computer when necessary.

 **IMPORTANT:** After you have completed the process of uninstalling hardware or software and are ready to reinstall, when installing a new device be sure that it is seated properly and all cables are correctly connected. After installing the device, restart the computer and make sure the new device is powered on. In addition, if the new device is a root cause of a problem, it could cause a conflict in drivers or incompatibility issues with other programs installed. For any new hardware you have added, be sure to install the latest drivers available from the device vendor website.

6. HP Hardware Diagnostics and Tools

HP offers different diagnostics and tools to diagnose hardware failure. This section describes how to use some of these tools. Make sure to check for the latest versions before use.

HP PC Hardware Diagnostics (UEFI)

HP PC Hardware Diagnostics is a Unified Extensible Firmware Interface (UEFI) that allows you to run diagnostic tests to determine whether the computer hardware is functioning properly. The HP PC Hardware Diagnostics (UEFI) tool is built within BIOS (basic memory and hard drive diagnostics only), or within new hard drives themselves. These drives contain more advanced versions of the diagnostic tool than the BIOS-based version.

In addition, for HP authorized service partners and IT professionals who need to support a mixed environment of older and newer HP/Compaq PCs, the HP PC Diagnostics 3-in-1 USB Key at http://www8.hp.com/us/en/campaigns/hpsupportassistant/pc-diags.html?jumpid=va_r602_us/en/any/pps/pl_ot_ob_ds_pd/HP_PC_Hardware_Diagnostics_cc/dt is a diagnostic tool that supports a wide range of HP Desktop and Notebook computers.

The tool runs outside the operating system so that it can isolate hardware failures from issues that are caused by the operating system or other software components. In reality, many problems can be determined using this tool if the issue is a defective part or a loose connection (i.e., reseating keyboard cable after the tool reports a keyboard error).

The tool has three major functions:

- **System Tests** - Check the computer's hardware to assure everything is functioning properly. If your system won't boot into Windows, try the Quick System Test. For more comprehensive testing, use the Extensive System Test option. If the System Test did not detect a hardware problem, continue with the Component Tests.
- **Component Tests** – Focus on selected hardware components in your computer.
- **Firmware Management** – Update your computer's BIOS to the latest version (available separately) or roll back to a previous version.

To start HP PC Hardware Diagnostics (UEFI):

1. Turn on or restart the computer, quickly press the **esc** button on the computer, and then press **F2**. The BIOS searches three places for the diagnostic tools, in the following order:
 - a. Connected USB drive
 - b. Hard drive
 - c. BIOS

2. When the diagnostic tool opens, use the keyboard arrow keys to select the type of diagnostic test you want to run, and then follow the on-screen instructions.

Screen shot appearance may vary.

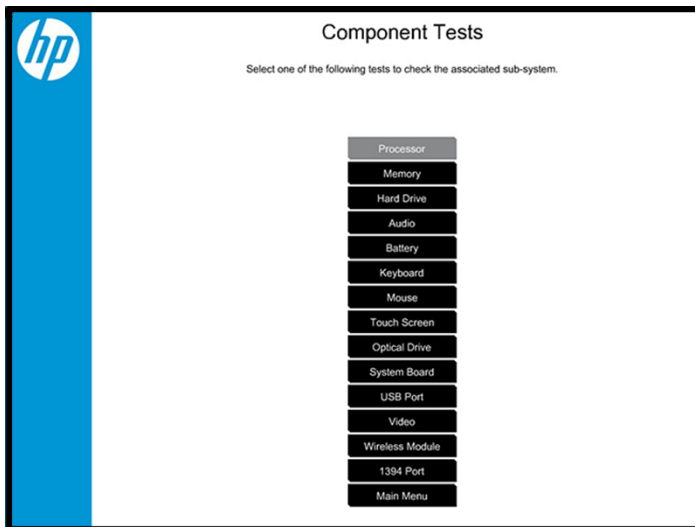
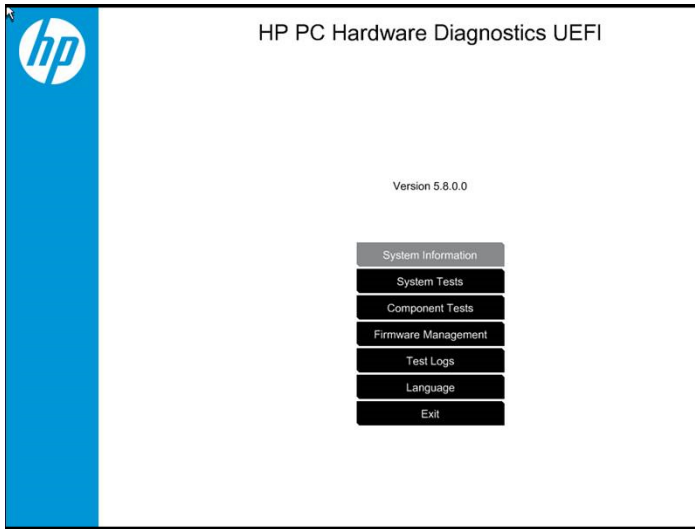

 **NOTE:** Users should utilize this tool, especially when the computer cannot boot to Windows.

 **NOTE:** If a component fails a test, write down the information so it is available when contacting support. The information is also available in **Test Logs** on the Main Menu.

For more information, see the chapter titled “Using HP PC Hardware Diagnostics (UEFI).”

HP Support Assistant (HPSA)

HP Support Assistant (HPSA) helps you maintain peak performance and resolve problems through automatic updates, built-in diagnostics, and a variety of assistance options. HPSA is preinstalled on every new HP PC with Windows 7, Windows 8, or Windows 10. HP is continually improving this tool. Please verify the latest version is installed to receive the most benefit. For more information, see <http://www.hp.com/go/hpsupportassistant>.

 **NOTE:** HPSA can be used only if the computer boots into Windows. If the computer does not boot into Windows, use HP PC Hardware Diagnostics (UEFI) instead.

HPSA also integrates diagnostics and tools that help resolve issues. See example screen shots as follows.

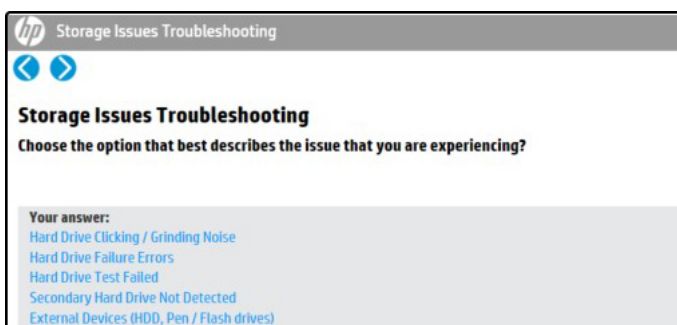
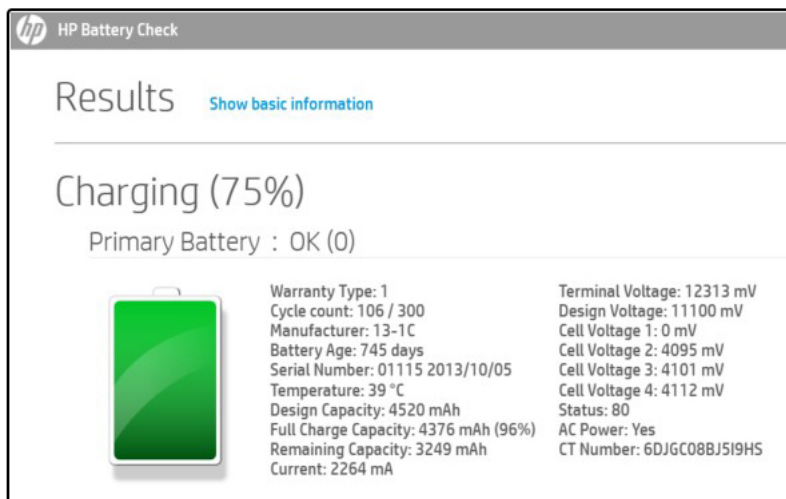
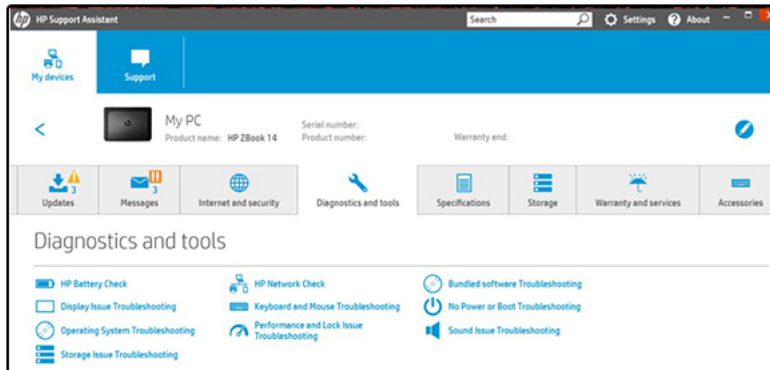

HP BIOS Configuration Utility (BCU)

HP BCU is a free utility that captures the BIOS settings and their values. This tool provides a text file of the computer's BIOS configuration. This can help identify any settings that may be contributing to an issue.

In some cases, it may help to compare this BIOS text file to the default settings of the computer.

For more information, see the HP BIOS Configuration Utility (BCU) User guide at http://ftp.hp.com/pub/caps-softpaq/cmit/whitepapers/BIOS_Configuration_UTILITY_User_Guide.pdf.



NOTE: HP recommends that you reset BIOS before trying BCU. Resetting the BIOS is always available and relatively quick to try, whereas BCU takes extra time and effort.

HP Image Diagnostic Tool

Available to HP Authorized Support Partners (ASPs) and users from the HP public ftp site at <ftp://ftp.hp.com/pub/idr/ImageDiags/>, this tool collects information about the current state of the computer, including product serial number, platform and BIOS information, and information about user-installed software and hardware components. HP encourages you to review the report before sending it to support. The report may assist you with diagnostics and solutions to problems you encounter.

HP Thermal Monitor



NOTE: Available only to authorized service providers/technicians.

Available only for HP internal use, HP Thermal Monitor can be used to stress the processor and GPU and monitor the temperature values of various components in the system. The components that are currently monitored include the processor, GPU, ACPI thermal zones, hard drive, and battery. The tool reads the temperatures of the components, logs the data, and helps to determine whether the computer would overheat in the event of thermal shutdown, fan spinning loud, etc.

Non HP diagnostics tools

Windows-to-Go USB

Windows-To-Go USB is a Microsoft-based tool for Enterprise editions of Windows that can help in troubleshooting. You can find a process online about how to create a live Windows USB drive. For more information, see <https://technet.microsoft.com/en-us/library/hh831833.aspx>.

Intel Processor Diagnostic Tool

Determine what processor is in your computer and verify the processor operating frequency. The tool also tests specific processor features and performs a stress test on the processor. For more information, see http://www.intel.com/support/processors/sb/CS-031726.htm?iid=subhdr+tools_procdiagtool.

7. Status lights, blinking light codes, troubleshooting lights, and POST error messages

Carefully observe any behavior the computer may be exhibiting: status lights, blinking lights, and POST error messages during boot. It is important to understand what these indicators mean.

Status lights

See the chapter titled “External Component Identification” for light locations. The following table describes basic lights on the computer.

Component	Description
Power button	<p>When the computer is off, press the button to turn on the computer.</p> <p>When the computer is on, press the button briefly to initiate Sleep (Windows) or Suspend (Linux).</p> <p>When the computer is in the Sleep state, press the button briefly to exit Sleep (Windows) or Suspend (Linux).</p> <p>When the computer is in Hibernation, press the button briefly to exit Hibernation.</p> <p>CAUTION: Pressing and holding down the power button results in the loss of unsaved information.</p> <p>If the computer has stopped responding and operating system shutdown procedures are ineffective, press and hold the power button.</p>
Front power light	<p>On: The computer is on.</p> <p>Blinking: The computer is in the Sleep state.</p> <p>Off: The computer is off.</p>
Battery light	<p>White: The computer is connected to external power and the battery is charged from 90 to 99 percent.</p> <p>Amber: The computer is connected to external power and the battery is charged from 0 to 90 percent.</p> <p>Blinking amber: A battery that is the only available power source has reached a low battery level. When the battery reaches a critical battery level, the battery light begins blinking rapidly. By default, the critical battery level is defined in Power Options as 5%.</p> <p>Off: The battery is fully charged.</p>
Front hard drive light	<p>Blinking white: The hard drive is being accessed.</p> <p>Amber: HP 3D DriveGuard has temporarily parked the hard drive.</p>
Rear AC adapter light	<p>White: The computer is connected to external power.</p> <p>Off: The computer is not connected to external power.</p>

Interpreting system validation diagnostic front panel LEDs and audible codes

During the system validation phase that occurs at system startup, the BIOS validates the functionality of the following subsystems and conditions:

- AC adapter
- System board power
- Processor failure
- BIOS corruption
- Memory failure
- Graphics failure
- System board failure
- BIOS authentication failure

If an error is detected, specific patterns of long and short blinks, accompanied by long and short beeps (where applicable) are used to identify the error. These patterns will make up a two part code:

- Major – the category of the error
- Minor – the specific error within the category



NOTE: Single beep/blink codes are not used.

Number of long beeps/blinks	Error category
1	Not used
2	BIOS
3	Hardware
4	Thermal
5	System board

Patterns of blink/beep codes are determined by using the following parameters:

- 1 second pause occurs after the last major blink.
- 2 second pause occurs after the last minor blink.
- Beep error code sequences occur for the first 5 iterations of the pattern and then stop.
- Blink error code sequences continue until the computer is unplugged or the power button is pressed.



NOTE: Not all diagnostic lights and audible codes are available on all models.

The red LED blinks to represent the major error category (long blinks). The white LED blinks to represent the minor error category (short blinks). For example, '2.3' indicates 2 long red blinks and 3 short white blinks to communicate the processor is not detected. CAP/NUM Blink = 2 indicates CAP/NUM will blink 2 cycles, each cycle has one 2.3 sequence.

Component tested	Major/minor code	Error condition	Caps Lock/Num Lock LED	Action
BIOS	2.2	The main area (DXE) of BIOS has become corrupted and there is no recovery binary image available	CAP/NUM Blink = 2	Contact service for system board replacement.
	2.3	The embedded controller policy requires the user to enter a key sequence (SureStart 2.0)	CAP/NUM Blink = 8	Perform SureStart manual recovery if boot block: Up Arrow + Down Arrow + ESC.
	2.4	The embedded controller is recovering the boot block or DXE.	Battery LED White and Amber blinking	Wait for DXE recovery to complete.
Hardware	3.2	The embedded controller has timed out waiting for BIOS to return from memory initialization	CAP/NUM Blink = 3	Reseat the memory modules. If the issue persists, try replacing the memory modules. Possible RAM or system board failure.
	3.3	The embedded controller has timed out waiting for BIOS to return from graphics initialization	CAP/NUM Blink = 4	If the system has an MXM module, try a different MXM module. Otherwise, the board most likely needs to be replaced.
	3.4	The system board displays a power failure (crowbar)	CAP/NUM Blink = 5	Check power cable connections, or verify that any external power adapter has sufficient capacity for system.
System board	5.2	The embedded controller cannot find valid firmware	CAP/NUM Blink = 7 (2 BB failure) Battery LED Blinking = 1 Hz (3 B failure)	Contact service for system board replacement.
	5.3	The embedded controller has timed out waiting for the BIOS	CAP/NUM Blink = 1	Contact service for system board replacement.

POST error messages

The Power-On Self-Test (POST) is a series of diagnostic tests that runs automatically when the computer is powered on. If the POST encounters a problem, visual error messages are displayed before the operating system starts. POST checks the following items to ensure that the computer system is functioning properly:

- Memory
- Processors
- BIOS
- Mass storage devices
- Fans

The following table describes key Post Error messages. For more detailed information, see [POST Error Messages and User Actions on page 144](#).

Table 7-5 System diagnostics failure codes and user actions

Test description	Failure description	Error code	Suggested user actions
Wireless Module not supported	The system has detected a wireless module installed in the system that is not supported and has been disabled. WLAN Module ID (702) WWAN Module ID (703) Bluetooth Module ID (704) GPS Module ID (705)	70x	Remove non-supported component.
Front Audio Not Connected	Front audio cable has been detached or unseated from the system motherboard.	100	Reseat the front audio cable on the system board.
Startup Test	Hard Disk 1 SMART	301	Attempt to reseat the hard drive and repeat the test. The hard drive may have failed.
Boot Device Manager	Boot device not found	3F0	Reset BIOS. Then reseat the hard drive and repeat the test.
BIOS Recovery	BIOS Recovery Occurred	500	This message indicates that BIOS recovery was completed successfully. No further action is required.
BIOS Application	BIOS Application Error	501	The BIOS installation may have become corrupted. Download the latest version of the BIOS and install it. If reinstalling the BIOS fails, contact support for further assistance.
CMOS Recovery	CMOS Recovery Occurred	502	This message indicates that CMOS recovery was completed successfully. No further action is required.
Battery Check	Primary Battery Replace	601	This message indicates that the primary battery has very low capacity. See "Checking the Status of the Battery" http://h20566.www2.hp.com/hpsc/doc/public/display?docLocale=en_US&docId=emr_na-c00821536 for details on using the HP Support Assistant to verify the battery capacity and, if necessary, order a replacement.
Wireless Modules	Not installed or responding	701	Reseat the wireless LAN adapter module and antennas. Because seating or reseating a wireless LAN adapter is unique to each computer model, see the WLAN module removal section in the removal and replacement chapter for further details. Contact support if third-party wireless adapters are installed in the computer.
Keyboard Error	Keyboard has malfunctioned.	800	Replace the keyboard.
CPU Fan Not Detected	CPU fan is not connected or may have malfunctioned.	900	Check the fan connection. If properly connected, replace the fan.
Chassis Fan Not Detected	Chassis fan is not connected or may have malfunctioned.	901	Check the fan connection. If properly connected, replace the fan.
Chassis Fan Not Detected (Rear)			

Table 7-5 System diagnostics failure codes and user actions (continued)

Test description	Failure description	Error code	Suggested user actions
Chassis Fan Not Detected (Front)			
Fan	Fan not operating correctly	90B	The system fan may be malfunctioning. Replace the fan.
System Temperature	Thermal shutdown has occurred.	90D	The System BIOS has detected your machine was previously shut down to avoid overheating. Overheating may occur if the cooling vents are blocked or the operating temperature exceeds the system specifications. The machine should return to normal operation once the situation is resolved.
Fan Speed Failure	The system has detected that a cooling fan may not be working properly.	90F	Try the following: <ul style="list-style-type: none">• Press Enter to clear the message and boot to the Windows desktop.• Shut down Windows.• Clean the exterior of the vents to remove dust build-up while the computer is Off.• Check for a BIOS update.

Power Good (Troubleshooting) lights

HP has added troubleshooting power lights to mobile workstations to help troubleshoot power-on issues. The lights indicate when the system board power rails are unstable and/or the system needs a hardware reset.

Power good lights

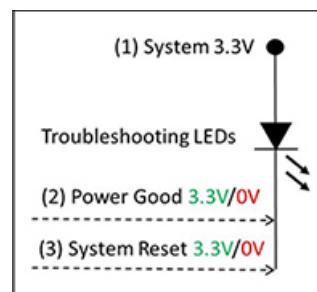
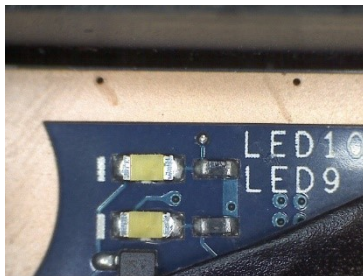

Troubleshooting lights diagram

These lights should be visible after removing the service door or bottom cover. Consult with support for platform-specific locations of the lights.

- Example: System board is good. Lights that turn on briefly (< 1 second) and immediately turn off indicate normal function. In this case, system (3.3V), power good (3.3V), and system reset (3.3V) are all good and troubleshooting lights should not be lit. However, other external lights should be lit as normal afterward.

Troubleshooting lights	External lights	Action	Note
Off	On	Do not replace system board	No power-on issue
On	Off	Replace board	Power-on issue

- Example: System board needs replacement. When (1) system 3.3V exists, but one power rail is bad then (2) power good is low (0V), and troubleshooting lights will turn on.

After you press the system power button, troubleshooting lights will turn on for 5 seconds and turn off. The system external lights will not light up. Follow general troubleshooting steps (i.e., remove recently added hardware, test with minimum configuration, etc.) prior to replacing the system board.

Resolve the issue

8. Hard reset

A hard reset or forced reset (<http://support.hp.com/us-en/document/c01684768>) erases all information in the computer's memory and may restore functionality. Resetting the computer forces the system to clear and reestablish the connections between the BIOS and the hardware.



IMPORTANT: Battery removal is NOT necessary for a hard reset on G3 or G4 mobile workstations. Follow the instructions for a computer with a non-removable battery.

Performing a hard reset might fix the following common conditions:

- Windows stops responding.
- Computer stops before Windows loads, indicated by incomplete boot-up, blinking cursor on a black background, and errors relating to operating system not found or a missing drive.
- Display suddenly goes blank and stays blank.
- Software freezes.
- Keyboard stops responding.
- The computer does not exit Sleep or Suspend state.
- An external device stops responding. Turn off the power to that device in addition to performing the steps in this document.

Before performing a hard reset, you must disconnect or remove all peripheral devices. You should start and test the computer by itself, and if the problem is not resolved, reconnect one peripheral device at a time. To resolve the startup or operational problem, run HP Support Assistant, or manually install all updated drivers from Microsoft and HP.

Before beginning, turn the computer over and look for a battery compartment door (service door). For 2015 platforms, the battery is considered removable but not accessible. See the battery section for how to remove/unplug the battery.

To perform a hard reset on a computer with a sealed or non removable battery, use the following steps:

1. Turn off the computer.
2. Remove the computer from any port replicator or docking station.
3. Disconnect all external connected peripheral devices such as USB storage devices, external displays, and printers.
4. Unplug the AC adapter from the computer.

5. Press and hold the power button for at least 15 seconds to drain residual power.
6. Plug the AC adapter back into the computer, but do not connect any of the peripheral devices.
7. Press the power button to turn on the computer.
8. If a startup menu appears, use the arrow keys to select **Start Windows Normally**, and then press the **Enter** key.
9. After reconnecting each of the peripheral devices, run Windows Update and HP Support Assistant to update all device drivers.

Clear CMOS

CMOS refers to the battery-powered, semiconductor chip located on computer's system board. Notebooks store low-level settings like the system time and hardware settings in CMOS. Sometimes it is necessary to clear CMOS, which requires removing and reinserting the 3V RTC battery for a short period of time (a few minutes before reinserting), in addition to removing the AC adapter and battery.

 **NOTE:** Clearing the CMOS should only be performed for troubleshooting purposes. There is no reason to clear CMOS if the computer is working properly.

The notebook service door must be removed to access the CMOS battery. See the RTC battery replacement section for the battery removal/replacement.

9. Soft reset (Default Settings)

 **NOTE:** Some company policies prohibit updates or changes. Check whether the computer has custom BIOS settings before taking action.

If your computer is having issues booting, has errors during boot, is running into issues after adding hardware, or you are having other abnormal system behaviors that cannot be resolved through any other methods (i.e., hard reset), it may be necessary to reset the system BIOS to default settings.

To load BIOS to default settings: Reboot the computer, and then press **F10 > Main > Restore defaults**. For more information, see the BIOS F10 Setup technical white paper at <http://support.hp.com>, enter your computer model, and then go to **Manuals > White papers > HP PC BIOS F10 Setup Guide**.

10. Reseat cables and connections

 **NOTE:** Before disassembling the computer to reseat cables and connections, always disconnect power and remove the battery or disconnect a non removable battery.

Many problems are caused by improper connections or loose connections due to abnormal movement and vibration. See [Cable management on page 153](#) and [Connector types on page 154](#) for suggested cable management practices when removing and installing components.

You can access and reseat connections for Customer Self-Repair (CSR) parts (see the “Removal and replacement procedures for Customer Self-Repair parts” chapter for details). Examples of reseating hardware include:

- Reseating the battery into the battery bay can resolve no-battery found and no-charging issues.
- Reseating memory modules can resolve memory error, no-boot, and blue screen issues.
- Reseating the hard drive can resolve a POST error 3F0 (no boot device) issue (see [POST Error Messages and User Actions on page 144](#)).
- Reseating the keyboard cable can resolve an unrecognized keys error.
- Reseating the wireless module and antenna cable can resolve a wireless connection issue.

For field replaceable units (FRUs), authorized service providers can try the following steps (for more information, see the "Removal and replacement procedures for authorized service provider parts" chapter).

- Reseating the fan cable can fix POST error 90B (no fan detected) issue (see [POST Error Messages and User Actions on page 144](#)).
- Reseating the power cable can fix a no boot issue.
- Reseating the daughterboards (some models may have a power button board, VGA board, etc.) can resolve their functional issues.
- Reseating graphics cables and panel connectors can fix distorted/flickering video.
- Replacing thermal pads may resolve thermal power-down issue.

11. Test with minimum configuration

The factory-shipped computer (hardware configuration and preinstalled operating system image) is well tested and ready for use. Therefore, using the original factory hardware configuration and/or booting to operating system safe mode often resolves issues quickly.

- Disconnect any external USB storage, remove any discs in optical drives, remove the computer from a docking station, remove external video, etc.
- In addition to removing recently added components, the issue can be narrowed down further with a minimum configuration. For example, if HP PC Diagnostics reports a memory error, test one memory module at a time to isolate the defective module.
- If the computer does not successfully boot the operating system, booting to safe mode may help identify what may be causing the issue as described below.

Essential hardware configuration



NOTE: This step is to be used by authorized service providers only. HP will not honor the warranty for a system tested with the system board removed without the heat sink, fan, etc.

If none of the steps above resolve the issue, start the computer with essential hardware only. The purpose is to remove as much as hardware as possible while still maintaining the computer's ability to turn on.

This essential configuration is often used to troubleshoot power-on related issues, such as no-boot, reboot, and freezing issues.

The essential hardware consists of the following:

- System board
- AC adapter (unplug nonremovable battery or remove battery)
- Processor (and heat sink/fan). (Processor may be integrated into the system board.)
- Memory (one verified working memory DIMM)
- Graphics card (if no VGA port is available on the system board). Platform may have both Intel integrated graphics and discrete graphics. Therefore, discrete graphics card may not be needed.
- External VGA monitor
- External USB keyboard
- External mouse

 **NOTE:** After the service door is removed, disconnect all connections (internal keyboard, display, discrete GPU, hard drive/solid-state drive, daughterboards, etc.) to achieve the essential hardware configuration above. DO NOT disassemble the system board from its enclosure at this time.

Reverse the procedure above by reinstalling each piece of hardware removed, one piece at a time, and testing your computer after each installation. Since your computer works with only the essential hardware installed, those parts must be working properly. This means that one of the hardware components removed is causing the computer to not work properly. By installing each device back into the computer and testing each time, the failing hardware will eventually be identified.

Safe mode

A driver conflict often results in a blue screen error message. Therefore, booting in safe mode can resolve many issues in Windows because safe mode forces the computer to load a limited version of Windows which only contains essential files. Safe mode is useful for troubleshooting problems with programs and drivers that might not start correctly or that might prevent Windows from starting correctly.

If a problem does not reappear when you start in safe mode, eliminate the default settings and basic device drivers as possible causes. Refer to the links below for how to start your computer in safe mode:

- HP PCs – Windows 7 Safe Mode: <http://support.hp.com/us-en/document/c01835750>
- HP PCs – Windows Safe Mode (Windows 10, 8): <http://support.hp.com/us-en/document/c03439317>

12. Test with verified working configuration (hardware and/or operating system)

One troubleshooting technique that can quickly isolate an issue is using a verified working part while testing. A good example is to use an external keyboard, mouse, or VGA monitor when you have issues with an internal keyboard, TouchPad, or display. Testing with a verified working AC adapter can identify an error caused by a faulty one. Similarly, testing with a verified working operating system can determine bad behaviors of the current operating system. See [Non HP diagnostics tools on page 84](#) for instructions about obtaining and using a Windows-To-Go USB.

 **NOTE:** In some situations, more than one item may contribute to a problem.

13. Replace the system board

The system board may be replaced only by authorized service providers. This should not be considered an initial step taken to resolve an issue. Review and perform all steps discussed previously before replacing the system board. [4. Update BIOS and drivers on page 80](#), [7. Status lights, blinking light codes, troubleshooting lights, and POST error messages on page 85](#), [8. Hard reset on page 90](#), and [9. Soft reset \(Default Settings\) on page 91](#), and/or [10. Reseat cables and connections on page 91](#) can resolve many system board issues without requiring the effort of replacing unnecessary hardware.

Review [Table 7-1 Troubleshooting methodology and general troubleshooting steps on page 76](#) for appropriate troubleshooting steps.

 **IMPORTANT:** System board failure is not common. Do not replace the system board until you have tried all other troubleshooting options.

 **NOTE:** Determine whether a previous service case might be related to the current problem. For example, a fan detection issue may be caused by a loose connection resulting from previous service.

 **TIP:** Without an RTC battery (3V coin-cell battery), the computer automatically reboots. This is a useful feature when the power connector cable (between external AC adapter and system board) is defective.

 **NOTE:** Most of the time, effective troubleshooting can prevent a system board replacement.

Items that may prevent resolution of the issue:

- The information provided about the issue omits key details, including any actions taken before the issue occurred.
 - BIOS, software, and drivers have not been updated.
 - Cables or connections are loose.
 - Technician is unaware of information available from the HP Support website (i.e., CA - Customer Advisory).
 - The issue is related to existing or known issues that may be identified in existing support articles.
 - Technician may have omitted steps in the provided repair instructions (e.g., Spare Part Replacement Instructions).
 - Skipping one of steps from Troubleshooting Methodology table results in No Defect Found (NDF)/No Fault Found (NFF)/No Issue Detected (NID) messages.
-

Verify solution

- Verify that the implemented solution works. Reboot the system or device and try to complete the task that produced the issue.
- If a part has been replaced, verify other basic functions. For example, GPU replacement requires keyboard removal. Therefore, it is good practice to verify all basic components to be sure that the solution is complete.
- Explain to the customer why the issue occurred and what was done to resolve it. If the solution you used was in an HP Public document, provide the document information to the customer, letting them know it can be located on www.hp.com. Also, tell them that there are other solutions available on the website. Advise the customer to check the website first when they have an issue. It may save them time calling in.
- Document the correct issue. Update the case with as many details as possible for other agents and engineering to analyze and study for lessons learned.

Helpful Hints

After you become familiar with the general troubleshooting steps above ([General troubleshooting steps on page 76](#)), follow the helpful hints below before running diagnostics and troubleshooting.

At startup

 **TIP:** If you have installed an operating system other than the factory-installed operating system, go to <http://http://www.hp.com/go/quickspecs> and verify that it is supported on your system.

1. Be sure that the computer is plugged into a working AC outlet.
2. Be sure that power is connected to the docking station if a dock is used.
3. Be sure that the AC adapter light is on.
4. Be sure that the AC adapter is connected when you update BIOS to avoid BIOS corruption.
5. Be sure that the computer is turned on, the rear power light is solid white (connected to an external power source) and the front power light is solid white (normal operation).
6. Remove all optical and flash drives from your system before turning it on.

7. Be sure that the boot option is set to a working operating system drive.
8. Be sure that externally connected monitors are turned on and their power lights are on. Not all monitors are equipped with lights to indicate their functionality.
9. Turn up the brightness and contrast controls of a display or external display device if the screen is dim.

During operation

1. To wake the computer:
 - a. Press the power button or any key on the keyboard.
 - b. If the system remains in the Sleep (Windows), Suspend (Linux), or Hibernate state, shut down the system by pressing and holding the power button for at least four seconds.
 - c. If the system does not shut down, unplug the power cord, wait a few seconds, and then plug it in again. Then press the power button again to restart the system. If it does not turn on, press the power button to start the computer.
2. Look for blinking lights on the computer. The blinking lights could be error codes that will help diagnose the problem.
3. Check all cables for loose or incorrect connections (external devices, power cords, dock, etc.).
4. After installing a non-Plug and Play expansion board or other option, reconfigure the computer. For example, if you upgrade to a solid-state drive, you may need to reconfigure the boot order.
5. Be sure that all required device drivers have been installed. For example, if you have connected a printer, you must install a printer driver.
6. If there is a network connection issue, plug another computer with a different cable into the network connection. There might be a problem with the network plug or cable.
7. If hardware has recently been installed, remove it and determine whether the computer functions properly.
8. If software has recently been installed, uninstall it and determine whether the computer functions properly.
9. If the screen is blank, confirm the display choice by pressing **Windows logo**  + **P** and set to screen only. Or plug an external monitor into a different video port on the computer if one is available and close the computer lid.
10. Verify that the latest version of BIOS, drivers, and software are installed. A new release might support new features or fix the problem.
11. Press the **caps lock** and/or **num lock** key. If the **caps lock** and/or **num lock** light toggles on or off, the keyboard is likely operating correctly.
12. Press the TouchPad On/Off button light. If the light toggles on or off, the TouchPad is likely operating correctly.

Consulting with HP Service

If further HP support is required, a lot of the following information may be requested when you call, so it may be helpful to take notes.

- Technical support registration number (if applicable)
- Product serial number

- Product model name and number
- Product identification number
- Applicable error messages
- Add-on boards or hardware
- Third-party hardware or software
- Operating system type and revision level

Common issues and possible solutions

This section contains common issues, symptoms, and a series of tables that describe possible solutions to issues from [Failure classification on page 77](#) tables. The following sections identify the issue with symptoms and solutions to resolve an issue.

Power-on issues

No Power

When a unit experiences no power there are several contributing factors to consider. Be sure to consider all symptoms related to this behavior in troubleshooting.

<i>Symptoms</i>	<i>Possible causes</i>
<ul style="list-style-type: none"> • Computer does not start • Display is black or blank • No fan noise • No hard drive spinning • Lights do not glow 	<ul style="list-style-type: none"> Failed power input to the computer (external power source, AC adapter, faulty battery). Bad connection to the computer (bad power button, power connector). Defective parts (memory, hard drive, graphics) or failed system board.
	<p><i>Troubleshooting steps</i></p> <p>Perform quick check</p> <p>Remove all external devices, including docking station.</p> <p>Verify external power source (2. Examine the environment on page 79).</p> <p>Perform a hard reset (8. Hard reset on page 90).</p>



Verify AC adapter

It is preferable to verify the battery before verifying the AC adapter. However, you can verify the AC adapter first, before opening the service door for a battery check.

- Verify AC adapter is compatible with product. Verify that the part number is for this computer if possible.
- Verify AC adapter and power cord are good (no physical damage, bent middle ID pin).
- Verify AC adapter works on a verified working computer.
- Plug in AC adapter and power on computer without battery.
- Inspect power port on computer side for any damage, dust, or debris.



- Check power light ([7. Status lights, blinking light codes, troubleshooting lights, and POST error messages on page 85](#)). Rear power light indicates external power to the computer is good.

NOTE: Refer to battery replacement section for removing/replacing the battery

Verify battery condition/status

1. Check battery condition (overall result, cycle life, voltage, etc.) using HP PC Hardware Diagnostics (UEFI) or HPSA tools.
2. Verify that battery is installed properly in battery bay without a gap and that latch locks are tight (for models with removable batteries).
3. Check battery status light ([7. Status lights, blinking light codes, troubleshooting lights, and POST error messages on page 85](#)). Be sure that battery is not fully discharged, preventing system from booting.
4. Determine whether the computer can turn on with battery only.
5. Remove service door and test with a verified working battery. If the computer boots, inspect original battery before replacement.
6. Test battery with a verified working computer to verify that it is OK.
7. If there is still no boot, remove battery and boot on AC power only.

The sections below are intended for authorized service providers/technicians.

Verify AC adapter – voltage

1. Measure DC voltage output that should be around 19.5 VDC and acceptable voltage range is from 18.5 – 20.5 VDC.
2. If the DC voltage is out of range, replace the AC adapter.

NOTE: This action requires a digital voltmeter.

NOTE: 2015 mWS does not have the power cable between system board and power connector on chassis



Verify power button, power connector

1. Be sure that power button is not stuck.
2. Reseat power connector cable (if applicable).
3. Replace new power connector cable (if the cable exists and is defective)
4. To isolate faulty power connector cable and power button, technicians can short power-on pads/pins to power up the computer. Contact HP Engineering for this information.

Verify blinking lights ([7. Status lights, blinking light codes, troubleshooting lights, and POST error messages on page 85](#))

At this point, there should be sufficient power from the AC adapter to the system board. Expect to hear the fan spinning and see blinking lights or error messages (i.e., faulty memory, HDD, etc)

Verify Power Good (Troubleshooting) lights

1. Verify if the system board has power-on issue related. If there is no power-on issue, move to next steps. For more information, see [Power Good \(Troubleshooting\) lights on page 89](#).
2. Verify all connections and reseat parts ([10. Reseat cables and connections on page 91](#)).

Verify system board

1. Test essential hardware configuration ([11. Test with minimum configuration on page 92](#), [12. Test with verified working configuration \(hardware and/or operating system\) on page 93](#), [13. Replace the system board on page 93](#)) by removing nonessential parts.
2. If there is still no boot, replace system board.

Tips and tricks

Computer automatically boots without pressing power button when RTC 3V battery has been removed. Therefore, after the service door and RTC 3V battery are removed, no need to press power button from top side.

In essential hardware configuration, mWS G1 and G2 may require discrete GPU to boot. However, mWS G3 can boot with integrated graphics.

See "Overview of How to Troubleshoot Problems When a Computer Does Not Start Up or Boot Properly" at http://h20566.www2.hp.com/hpsc/doc/public/display?docLocale=en_US&docId=emr_na-c01443371

Intermittent power-on, shutdown, reboot

Symptoms

- Does not always turn on
- Intermittently hangs
- Intermittently shuts down
- Spontaneously reboots

Possible causes

Electrical short, fluctuating power source, unstable power rails, loose connections, bent pins, stray wires, dust, obvious damage, nearly faulty parts (bulging/leaking capacitor).

Potentially will turn into a no power issue soon ([No Power on page 96](#)).

Troubleshooting steps

1. Make sure drivers are updated.
2. Visually check power ports on both AC adapter and computer sides.
3. Inspect power sources:
 - a. Verify AC adapter working correctly. Use a confirmed working adapter to test.
 - b. Verify that battery is not depleted while system is in Sleep state. Test with a confirmed working battery.

The sections below are intended for authorized service providers/technicians.

1. Follow actions in [No Power on page 96](#).
 - a. Be sure that AC adapter has correct DC voltage.
 - b. Verify battery - test with a confirmed working battery.
 - c. Verify that power button is not stuck.
 - d. Verify that power connector is not loose.
 - e. Verify that Power Good LEDs are solid.
 - f. Remedy loose connections and reseat major components (processor, memory, GPU, hard drive/solid-state drive, etc).
2. Perform visual check for loose connections, bent pins, stray wires, dust, nearly faulty parts (bulging/leaking capacitor).
3. Test **essential hardware configuration** ([11. Test with minimum configuration on page 92](#))

-
-
- a.** If system boots, reinstall nonessential hardware one component at a time to isolate issue.
 - b.** If system does not boot, replace essential hardware with verified working parts, one component at a time. If system still does not boot, replace system board.
-

AC adapter issue

Solution	
Symptoms	Possible causes
<ul style="list-style-type: none">No sign of powerNo bootNo rear power lightNo front power lightBattery does not charge when AC adapter is connected	AC adapter and others (i.e., external power source)
	Troubleshooting steps
	Quick check
	<ol style="list-style-type: none">Verify external power source (2. Examine the environment on page 79).Remove all external devices, including docking station.Perform a hard reset for the computer (8. Hard reset on page 90).Disconnect and reassemble the power cord and adapter in case the adapter experienced short circuit, over current, over temperature events.Use a verified working adapter. If the computer operates normally, there is a problem with the original adapter.Verify that the AC adapter works on a verified working computer. If the computer operates normally, there is no problem with the adapter. See HP Smart Adapter warning message on page 114 for further information.
	Verify AC adapter
	<ol style="list-style-type: none">Remove working battery.Verify that AC adapter is compatible with product. Verify that part number is for this computer if possible.Inspect AC adapter and power cord for physical damage, bent middle ID pin.Plug in AC adapter and power the computer without battery.Inspect the power port on computer side for any damage, dust, debris.Check power light (7. Status lights, blinking light codes, troubleshooting lights, and POST error messages on page 85). Rear power light indicates that external power to the computer is good.If there is still no rear power light or no boot, replace the AC adapter.
Tips and tricks	<p>The HP Smart AC adapter has a special pin in the middle, called the ID pin, for power rating and throttling purpose. If this pin is broken, the rear power light will be on but the power button and front power lights will blink continuously and the computer will not turn on. Third party AC adapter will not work on the computer.</p> <p>Use the AC adapter that came with the computer for better performance.</p> <p>See “HP Notebook PCs - Testing and Using the AC Power Adapter” at http://h20564.www2.hp.com/hpsc/doc/public/display?docId=emr_na-c00363266</p>

Battery not recognized, not charging

Symptoms	Possible causes
<ul style="list-style-type: none">No battery status lightBlinking amber (critically low battery level)	Defective AC adapter and/or battery.
	NOTE: Before proceeding, verify that the computer can boot to BIOS or Windows with a good AC adapter.

-
- No boot without AC adapter
-

Troubleshooting steps

Visual inspections

1. Inspect battery connectors for any signs of damage.
2. Verify that battery is installed properly in battery bay without gap or obstructions and latch locks are tight. Reseat battery (for models with removable batteries).
3. Determine whether battery gets hot (batteries heat up when charging, but not too hot to touch).

Check battery warranty to see whether the battery is new or its warranty is expired. Battery capacity degrades over time.

Verify front battery status light

1. Battery status light is off: battery not recognized.
2. Battery status light is blinking amber: critically low battery level.

Reset

1. Hard reset ([8. Hard reset on page 90](#))
2. Soft reset ([9. Soft reset \(Default Settings\) on page 91](#))

Verify AC adapter

1. Determine whether the computer needs the AC adapter to boot and operate. Sometimes, intermittently bad AC adapter and loose connection between adapter and computer results in inability to charge battery which causes short run time.
2. Inspect AC adapter to verify that it is functioning.
3. Test with a working AC adapter and confirm whether battery is charging.
4. Be sure that battery is fully charged (AC adapter plugged in at least 2.5 hours).

Diagnostics: HP tools will report results such as passed, calibrate, weak, replace, no battery and unknown, and suggest corresponding actions.

Use HP Hardware Diagnostics (UEFI) ([6. HP Hardware Diagnostics and Tools on page 81](#))

- HP PC Hardware Diagnostics (UEFI) is a good tool to use to isolate and determine faulty battery, especially for quickly discharging (short life) battery.

Use HP Support Assistant tools in Windows ([HP Support Assistant \(HPSA\) on page 83](#))

1. Verify that battery is recognized and charging.
2. Verify battery condition if battery cycle life is over specs (i.e., long life of 1000-cycle life and 3-year warranty). Battery may have premature capacity loss within its cycle life or warranty.
3. If issue remains, test with a verified working battery and verify battery status lights and battery conditions.
4. If issue remains, replace system board.
5. Verify the new replacement.

Tips and tricks

See the computer user guide for instructions regarding battery maintenance and increasing battery life.

- Reference “HP Notebook Mobile Workstations - Improving Battery Performance (Windows 10, 8, 7, Vista)”: http://support.hp.com/us-en/document/c01297640?jumpid=hpr_r1002_usen_link3

- Reference video “Testing and Calibrating the Battery on PC Notebooks”:
<http://www8.hp.com/h22157/video-gallery/us/en/customer-care/2536294556001/testing-and-calibrating-the-battery-on-hp-notebook-pcs-in-windows-8/video/>

Battery discharges too fast

Symptoms

Battery has good status light but discharges too fast

Possible causes

AC adapter and/or battery.

Troubleshooting steps

Verify AC adapter

Determine whether the computer needs the AC adapter to boot and operate. Sometimes, intermittently bad AC adapter and loose connection between adapter and computer results in inability to charge battery and causes short run time.

1. Inspect AC adapter to verify that it is working.
2. Test with AC adapter alone and with a verified working AC adapter.

Verify battery: Battery capacity can degrade over time, so check the warranty coverage. Run a battery test to confirm if issue is hardware-related.

1. Review battery power plans in **Control Panel > Power Options** that may consume more energy and discharge battery faster. Resetting default to **Power Saver** option can conserve battery power.
2. Determine whether any graphics processing is running.
3. Verify battery maintenance and operations. Leaving the battery at a high level of charge in a high-temperature environment for extended periods accelerates the loss of capacity.
4. Test and calibrate battery using HP PC Hardware Diagnostics (UEFI).
5. Verify battery life cycle using HP Support Assistant tool.

If battery cycle life is over specs (long life battery of 1000-cycle life and 3-year warranty), battery may have capacity loss beyond its lifecycle or warranty.
6. Compare discharge time with a verified working battery (remove AC adapter) using **Hardware Diagnostics (UEFI) > Hard Drive Tests > Extensive Test > Loop until error**.

Tips and tricks

To conserve battery power, turn off Wireless On-Off button and other peripherals/USB devices, applications, processes (in Task Manager) when not in use; also, reduce screen brightness.

Follow HP instructions of how to maintain battery and increase battery life.

Reference “HP Notebook Mobile Workstations - Improving Battery Performance (Windows 10, 8, 7, Vista)” at http://support.hp.com/us-en/document/c01297640?jumpid=hpr_r1002_usen_link3

Reference video “Testing and Calibrating the Battery on PC Notebooks” at:
<http://www8.hp.com/h22157/video-gallery/us/en/customer-care/2536294556001/testing-and-calibrating-the-battery-on-hp-notebook-pcs-in-windows-8/video/>

Burnt smell

<i>Symptoms</i>	<i>Possible causes</i>
Emits smoke, burnt smell	Defective on-board components.
	<i>Troubleshooting steps</i>
	General visual inspection
	<ol style="list-style-type: none">1. Disconnect the computer from power source (AC adapter and battery).2. Inspect for visual damage on AC adapter and battery. Test on a known working computer to isolate issue. If issue follows AC adapter or battery, replace it.3. Inspect any sign of liquid spill on the computer (back of keyboard).
The sections below are intended for authorized service providers/technicians.	
	Further inspection on components
	<ol style="list-style-type: none">1. Inspect further sources internally after disassembling chassis, such as burnt or damaged components.2. If the issue persists, replace boards, AC adapter, and battery for safety concern and report issues to HP.

POST

No video (with power)

<i>Symptoms</i>	<i>Possible causes</i>
<ul style="list-style-type: none">• No video (black/blank image) but have power• Light activity• No error messages• Fan noise• Hard drive light blinking and hard drive noise	<p>Failed display</p> <p>Failed critical components (memory, hard drive, system board)</p> <p>Loose connection</p> <p>Recently added hardware</p> <p>NOTE: Assume the computer has not previously been set up for multiple displays.</p>
	<i>Troubleshooting steps</i>
	Quick check
	<ol style="list-style-type: none">1. Verify that system light activity is OK.2. Remove all external devices, including docking station. Recently added hardware and/or applications may cause graphics driver conflict and result in loss of video.3. Perform hardware reset (8. Hard reset on page 90) and verify that HP Logo is presented correctly on display screen when pressing F10.4. Test with external monitor via VGA port (or DisplayPort, HDMI, etc). Press power button and close the computer lid to force video output to external video. If unsuccessful, contact HP service.

-
-
5. If external video is OK, update BIOS, software, and drivers ([4. Update BIOS and drivers on page 80](#)) and perform soft reset ([9. Soft reset \(Default Settings\) on page 91](#)) if needed. Go to next step to verify display.
-

Verify display

- When booting to Windows, determine whether image appears on display screen (via Windows Screen Solutions or [Windows logo](#)  + P for display switcher).
 - If there is video on display, disconnect external display device, open the computer lid and restart.
-

The sections below are intended for authorized service providers/technicians.

1. Verify Power Good lights are on to be sure that system board power is functional.
 2. Reseat display cable connection on system board.
 3. Reseat display cable connection on display panel side.
 4. Examine and reseat major components, such as hard drive, memory.
 5. Test with minimum configuration ([11. Test with minimum configuration on page 92](#)) by removing hard drive to isolate operating system issues and testing video in F10 Setup.
 6. If video is present, restart and retest the computer.
 7. If video is present but bad, go to [Display on page 115](#) section.
 8. If issue persists (no video), test with external video.
 9. If issue persists, test or replace a confirmed working display.
 10. If issue persists, replace discrete graphics card.
 11. If issue persists, replace system board due to defective video function.
-

Tips and tricks

Swipe a metal piece (screwdriver) over wireless/mute buttons to act as if closing lid to force video output to external display device. See the “External component identification – Display” section for location of the magnetic sensor.

Blinking lights

Symptoms

Lights blink on keyboard [caps lock/num lock](#) keys

Possible causes

Blinking lights on startup usually indicate a problem with basic functionality of a critical component (processor, BIOS, graphics cards, memory, etc.) due to loose connection, defective parts, or recently added parts.

Troubleshooting steps

1. Check for any blink patterns. Count the number of blinks in a sequence, followed by a pause for a few seconds.
 2. See Status, Blinking Lights, and Error Message ([7. Status lights, blinking light codes, troubleshooting lights, and POST error messages on page 85](#)) for corrective actions.
 3. If internal hardware components (memory, hard drive, etc.) have been recently added, a component may not be connected properly. Remove and reseat new components ([10. Reseat cables and connections on page 91](#)) one at a time.
-

Note

Since the display may not be functional, lights are used to indicate an error.

Diagnostics error messages

<i>Symptoms</i> <ul style="list-style-type: none">• Computer has power• POST error message displays (Windows logo has not yet appeared)	<i>Possible causes</i> <p>Diagnostic error messages indicate a problem. There may be a problem with the instruction being sent from the BIOS to a hardware component (e.g., keyboard failures), or incompatible hardware. Can usually be resolved by installing updated firmware for the component.</p>
<i>Troubleshooting steps</i>	
<ol style="list-style-type: none">1. See 7. Status lights, blinking light codes, troubleshooting lights, and POST error messages on page 85 for corrective actions. An example of a POST error message is shown below.	
	
<ol style="list-style-type: none">2. If there is power, you may be able to access BIOS. Reset BIOS to its default condition. (9. Soft reset (Default Settings) on page 91)3. Restore hardware to its original condition (i.e., bootable solid-state drive instead of hard drive).4. Reseat suspected components and verify connection.5. Test suspected components using HP PC Hardware Diagnostics (UEFI) tool.	
Note	An Error Message means the system has finished BIOS hardware validation and is ready to launch the Startup Menu . To access the Startup Menu for further options, press the Esc key while restarting the computer.

BIOS password

Symptoms

Some sections are unavailable (grayed out)

Possible causes

BIOS administration password is required.

Troubleshooting steps

1. Review F10 BIOS Setup Overview to determine which features must be enabled.
2. Your BIOS settings may be managed by a BIOS administrator password setup.
3. If you lost or forgot user password, contact your IT personnel.
4. If you lost or forgot administrator password, contact HP service to reset the password. This process requires a unique UUID.

Reference

HP F10 Setup Overview

HP Business Notebook and Desktop PC F10 setup overview – 2012 and 2013 Business PC models: <http://h10032.www1.hp.com/ctg/Manual/c04460979>

HP Business Notebook and Desktop PC F10 setup overview – 2014 Business PC models: <http://h10032.www1.hp.com/ctg/Manual/c04685655>

2015 Business PC models – see the BIOS F10 Setup technical white paper at <http://support.hp.com>, enter your computer model, and then go to **Manuals > White papers > HP PC BIOS F10 Setup Guide**.

Performance (OS)



NOTE: Most software problems occur as a result of the following:

- The application was not installed or configured correctly.
- There is insufficient memory available to run the application.
- There is a conflict between applications.

Make sure that all the needed device drivers are installed.

If an operating system other than the factory operating system is installed, check whether the operating system is supported and the application is certified for the version of the operating system.

HP ships and supports Windows 7 with BIOS Legacy boot mode and Windows 8, 10 with BIOS UEFI boot mode. Therefore, HP recommends that you switch BIOS boot mode from Legacy to UEFI Native for clean Windows 8, 10 installations, or to UEFI Hybrid (if available) for upgrading the option from Windows 7 to Windows 8, 10. UEFI Windows 8, 10 avoids many unexpected behaviors (i.e., blue screen error, graphics/video issues) in the BIOS Legacy setting.

Intermittent shutdown

<i>Symptoms</i>	<i>Possible causes</i>
<ul style="list-style-type: none">• Shutdown during startup• Shutdown during operation	<p>It is often difficult to troubleshoot an intermittent issue. Possible causes include the following:</p> <p>Power-related issue: defective or insufficient power sources, poor connection.</p> <p>OS Custom Setting: Energy Saver (Power Management).</p> <p>Thermal-related issue: thermal sensors reach limits.</p> <p>Hardware related issue: voltage, out-of-range current; electrical short.</p>
	<p><i>Troubleshooting steps</i></p> <ol style="list-style-type: none">1. Update BIOS and drivers. (4. Update BIOS and drivers on page 80) CAUTION: Do not attempt to update BIOS if the computer is shutting down at startup, as running a BIOS update could corrupt the BIOS and require a system board replacement if the system powers down during the procedure. The computer should be stable enough to go through several start/restart cycles without issue before attempting a BIOS update.2. Perform hard reset (8. Hard reset on page 90)3. Perform soft reset (9. Soft reset (Default Settings) on page 91)
	<p>Power related issue</p> <ol style="list-style-type: none">1. Verify functionality of AC adapter alone. If no functionality, test with a verified working adapter.2. Verify battery alone. Verify that battery is not depleted. Test battery using HP PC Hardware Diagnostics (UEFI) tool.3. Verify connection of power button, power cable.
	<p>OS custom settings</p> <ol style="list-style-type: none">1. Advise users to reset power options and close all applications that are not in use, including applications in the background.2. Test with a confirmed working operating system to isolate custom settings by users or any conflicting applications that cause shutdown.

The sections below are intended for authorized service providers/technicians.

Thermal-related issue

1. Verify thermal condition:
 - a. Test fan using HP PC Hardware Diagnostics (UEFI) tool ([6. HP Hardware Diagnostics and Tools on page 81](#))
 - b. Check fan and connection. Reseat fan cable.
 - c. Be sure that no obstructions or dust are in heat sink fan, fin, or vent.
 - d. Test with a verified working fan.
 - e. Remove old thermal compound and pads and replace with new compound and pads.
2. Verify thermal solution:
 - Use Thermal Monitor tool (available only to authorized service providers/technicians) to perform stress test (processor and GPU) ([6. HP Hardware](#)

[Diagnostics and Tools on page 81](#)) and verify that thermal sensors are within limits after thermal condition is serviced.

Hardware related issue

1. Check for any signs of loose connections, bent pins, stray wires, dust, nearly faulty parts (bulging/leaking capacitor).
 2. Verify that lights are solid.
 3. If shutdown is reproducible, test essential hardware configuration:
 - a. If no issue with hardware configuration, reinstall one non essential component at a time to determine faulty hardware.
 - b. If issue persists, replace essential hardware with a confirmed working part, one at a time. If no boot, replace system board.
-

Tips and tricks

Intermittent issue is difficult to reproduce and troubleshoot. It is important to record details on shutdown frequencies, system configuration (3D video application) and operating conditions.

Blue screen

Symptoms

- Have power, light activity, fan spinning
- HP Logo displays briefly
- Fails to boot into Windows operating system, displays blue screen, and then crashes, restarts, or stops responding

Possible causes

Recent changes: conflict of instructions from multiple programs or just added hardware.

Incompatible hardware and driver.

Poor connection (hard drive, memory).

Hardware malfunctioning due to overheating (GPU, processor).

Defective hardware (memory, hard drive).

Important Notes & Resources

Troubleshooting steps

There are many different ways to troubleshoot a blue screen error. Therefore, you need to identify working configuration (Windows 7/8/10) and specific symptoms of the failure in order to narrow down the issue. Refer to [Blue screen \(BSOD\) error on page 134](#).



Recommended resources

Microsoft knowledge base:

Resolving Blue Screen errors in Windows: <http://windows.microsoft.com/en-us/windows-8/resolve-windows-blue-screen-errors>

HP Troubleshooting Error Messages on a blue screen:

HP Notebook PCs - Troubleshooting Error Messages on a Blue Screen that may Occur During Startup or Boot: http://h20566.www2.hp.com/hpsc/doc/public/display?docLocale=en_US&docId=emr_na-c00372711

Overview of General Troubleshooting Steps for a blue screen error

1. Note the blue screen error message and what activity was performed at the time.
2. Perform a hard reset ([8. Hard reset on page 90](#)) after disconnecting all external peripherals.
3. Reset BIOS to default ([9. Soft reset \(Default Settings\) on page 91](#)) to prevent booting to another device.
4. Run HP Hardware Diagnostics ([6. HP Hardware Diagnostics and Tools on page 81](#)) to isolate major faulty hardware issues.
 - HP PC Hardware Diagnostics (UEFI) tool to test hard drive, memory and system.
 - Thermal Monitor (available only to authorized service providers/technicians) tool to monitor temperature limits of processor and GPU. See “HP Thermal Monitor” in [6. HP Hardware Diagnostics and Tools on page 81](#).
5. Remove or undo recently added hardware ([5. Remove or uninstall recently added hardware, software on page 80](#)). For example, incompatible memory or new solid-state drive storage.
6. Reseat cables and connections ([10. Reseat cables and connections on page 91](#)). Pay attention to proper installation of memory and hard drive.
7. Verify that a minimum of at least 100 MB of free space is available on your Windows partition.
8. If you can start Windows:
 - a. Update BIOS and drivers ([4. Update BIOS and drivers on page 80](#)) to support updates for incompatibilities.
 - b. Get all the latest updates, using Windows Update.
 - c. Undo recent changes:
 - Startup using Last Known Good Configuration.
 - Use System Restore.
 - Roll back device driver in Device Manager.
 - d. Check for specific Error Message. See [Common Blue Screen Error Messages on page 146](#).
 - e. Boot to safe mode ([11. Test with minimum configuration on page 92](#)) to troubleshoot issues.
9. If you cannot start Windows:
 - a. Boot to safe mode. ([11. Test with minimum configuration on page 92](#))
 - b. Use Startup Repair to fix Windows startup files.
 - c. Undo recent changes using System Restore to revert to a previous “working” state.
 - d. Check for specific STOP error by analyzing Crash Dump (retrieved via a bootable USB). See [Use Windows Debugging Tool on page 147](#).
 - e. Restore computer using System Recovery or image backup to factory settings.
10. Lastly, test with essential hardware configuration ([11. Test with minimum configuration on page 92](#)) along with a verified working operating system (i.e., USB Windows-To-Go), if available, to isolate the software issue.

Tips & tricks

In some cases, the computer may reboot automatically before you have time to read the blue screen.

To identify the error message itself, disable the automatic restart using one of the following methods:

Right-click on **My Computer**, and then select **Properties** > **Advanced**. Under **Startup and Recovery**, select **Settings**. Clear the **Automatically Restart** check box.

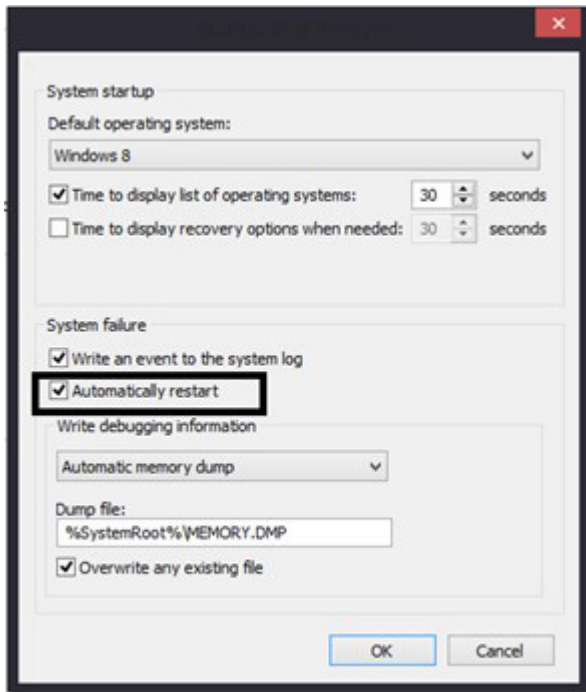

Windows Advanced Boot Option

Windows 7:

1. Press **F8** to open the Windows Advanced Boot Option screen.
2. Select **Disable automatic restart on system failure** to view error messages.

Windows 8:

1. Press **F11** (System Recovery) to open the Windows Advanced Boot Option screen.
2. Select **Startup Settings** to view error messages.

Freeze at Windows Logo (hang/lockup)

Symptoms

- Has power, light activity, fan spinning
- HP Logo displays briefly
- Attempt to boot to operating system and freeze/hang at Windows logo
- No response to pressing [num lock](#) or [caps lock](#) key

Possible causes

Conflict of instructions from multiple programs or drivers; installing a new hardware or program that is not compatible (may also cause a blue screen error—see blue screen issue).



Troubleshooting steps

Follow suggested steps below one at a time to verify normal boot process:

1. Disconnect all external peripherals, and perform a hard reset ([8. Hard reset on page 90](#)).
2. Perform soft reset ([9. Soft reset \(Default Settings\) on page 91](#)).
3. Update BIOS and drivers ([4. Update BIOS and drivers on page 80](#)).
 - a. Roll back to previous version may be necessary.
 - b. Go to safe mode to install drivers.
4. Run Hardware Diagnostics ([6. HP Hardware Diagnostics and Tools on page 81](#)) to isolate hardware issue.
5. Undo recent changes in Windows ([5. Remove or uninstall recently added hardware, software on page 80](#)).
6. Reseat cables and connections ([10. Reseat cables and connections on page 91](#)).
7. Start Windows in safe mode ([11. Test with minimum configuration on page 92](#)).
8. Use Startup Repair Windows to fix Windows damaged files.
9. Test with essential hardware configuration ([11. Test with minimum configuration on page 92](#)) along with a verified working operating system (i.e., USB Windows-To-Go) if available to isolate the software issue.

Tips and tricks

For more information, see “HP PCs - Using Task Manager (Windows 10, 8)” at <http://support.hp.com/us-en/document/c03671001>.

Electromagnetic Interference (EMI)

Symptoms

System locks up, freezes in certain physical area or location

Possible causes

Electromagnetic interference (EMI).

Troubleshooting steps

1. See ([2. Examine the environment on page 79](#)). Pay attention to external power source, high-frequency signals such as cell phones, microwave ovens.
 2. Move the computer to different locations nearby to determine where it fails and where it does not fail.
 3. Test with a verified working computer in original factory configuration.
 4. Consult with support.
-

No wake up

Symptoms

When resuming from a power management state the computer may display:

- Blank screen
- Some light activity

Possible causes

Power-saving mode; multiple-display setting.

Troubleshooting steps

1. Verify that front power light ([7. Status lights, blinking light codes, troubleshooting lights, and POST error messages on page 85](#)) is blinking (indicating Sleep state). Press power button to exit Sleep.
2. Reset BIOS to default (associated with **OS Power Management** in **Power Menu**) ([4. Update BIOS and drivers on page 80](#))
3. Verify power management settings in Windows **Power Options**. Disable Sleep options if the issue is resolved.

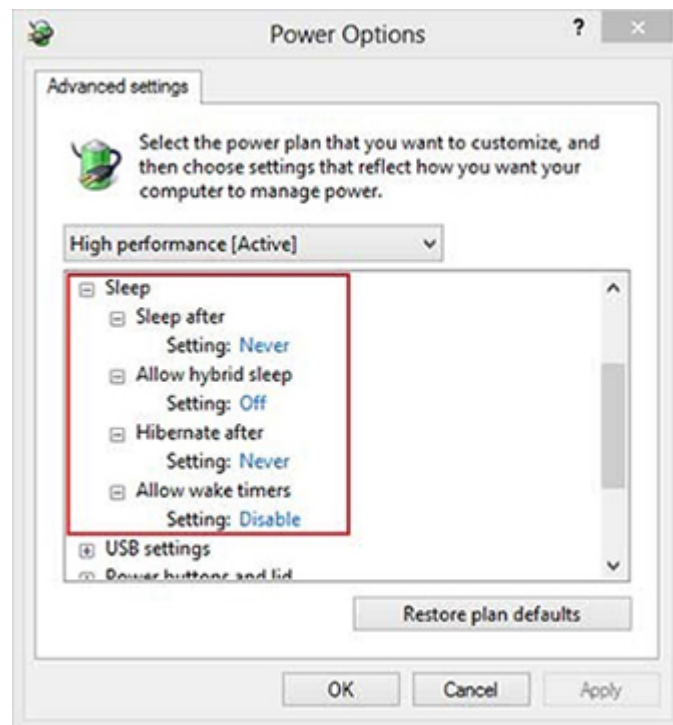

4. Screen saver is set. Press any key or touch TouchPad to resume.
5. Verify that Display Choice is set to external video only. Toggle screen control key combination **Fn + F4** or **Windows logo**  **+P**.

Tips and tricks

If you are using a docking station, set your notebook display as a primary display. When the computer is not docked, you may think it is in a power-saving state, but the screen image may actually display on an external display device in the docking configuration.

The order in which the computer shows video is as follows:

1. Auto: (default). When set to Auto, hybrid graphics is disabled for certain Linux operating systems.
2. Hybrid graphics: Both integrated and discrete graphics are used.
3. Discrete graphics: Only discrete graphics is used.

Unresponsive

<i>Symptom</i>	<i>Possible causes</i>
Unresponsive	Program in use has stopped responding to commands.
	<i>Troubleshooting steps</i>
	<ol style="list-style-type: none">1. If possible, use the Windows Task Manager to isolate and terminate the offending process.2. Attempt the normal Windows shutdown procedure.3. Restart the computer using the power button.

Slow performance

<i>Symptom</i>	<i>Possible causes</i>
Slow performance when performing small tasks, or even in idle mode	Processor is hot or hard drive is full.
	<i>Troubleshooting steps</i>
	Processor is hot
	<ol style="list-style-type: none">1. Verify that airflow to the computer is not blocked.2. Verify that chassis fans are connected and working properly. Some fans operate only when needed.3. Verify that the processor heat sink is installed properly.
	Hard drive is full
	<ol style="list-style-type: none">1. Transfer data from the hard drive to create more space on the hard drive. Microsoft recommends at least 200 MB to sync system files.2. Perform disk defragmentation to consolidate fragmented data on the hard drive so it will work more efficiently.
	Also see Slow performance on page 134 .
Tips and tricks	See “Improving System Performance” at http://h20564.www2.hp.com/hpsc/doc/public/display?docLocale=en_US&docId=emr_na-c00816938 (see Routine Maintenance for Performance Improvement on page 146).
	See “Tips to free up drive space on your PC” at http://windows.microsoft.com/en-us/windows-8/free-up-disk-space .
	See “Optimize Windows for better performance” at http://windows.microsoft.com/en-us/windows/optimize-windows-better-performance#optimize-windows-better-performance=windows-vista .

HP Smart Adapter warning message

Symptom

Warning message displayed in Window

Possible causes

Less powerful AC adapter, BIOS out of date.



Troubleshooting steps

1. Update BIOS that may contain a table that assigns an appropriate adapter for a certain configuration.
2. Update the latest **HP Hotkey Support** software from Drivers website.
3. Verify sufficient power source (where adapter is connected).
4. Use appropriate AC adapter (often supplied with system) for optimum system performance.
5. Test with a verified working AC adapter.
6. Test the adapter on a verified working computer.
7. Contact HP for configuration details.

Note

HP Smart AC adapter warning message: informs you that as power demands increase, the notebook may not perform at full capacity, which may result in longer battery-charging time. In cases of extreme power demands, the system may also throttle back the processor, or with systems that have a discrete video sub-system, a video balance mode may occur to further balance the power needs of the system.

System processor functions always have priority over battery charging, so charging delays will occur first.

Incorrect time and date

Symptom

Incorrect date and time

Possible cause

Real-time clock (RTC) battery might need replacement.

Troubleshooting steps

1. Reset the date and time in the operating system Control Panel.
2. Replace the RTC battery.
3. Verify that date and time are correct.

Display

Display anomalies

The display panel is a field replaceable unit (FRU) and must be replaced by only authorized technicians. However, HP highly recommends that users and technicians observe specific symptom vs. generic symptoms and utilize the HP PC Hardware Diagnostics (UEFI) tool before any replacement.

Symptom

Common display issues with symptoms:

- Blank/black video
- Incorrect/missing color/distorted image
- Flickering image
- Vertical lines (due to LDVS, decreased signal integrity, and data loss)
- Dead pixel (due to display liquid, internal transistor, etc.)
- Horizontal lines (due to video memory)
- Distorted when hot (due to thermal issue)
- Cracked screen/image (physical damage)
- Light leakage/bleeding

Contact support for assistance.

- Humming noise (due to frequency settings)

Contact support for assistance.

Screen examples

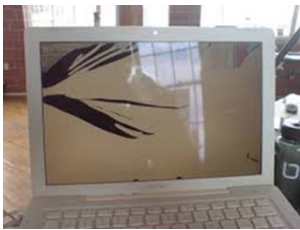

Cracked screen

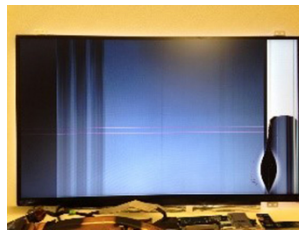

Cracked image

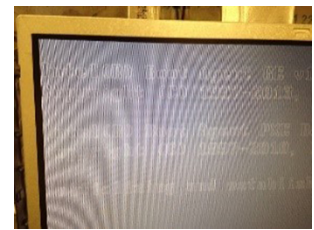

Blurred image

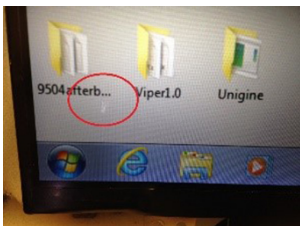

Dead pixel

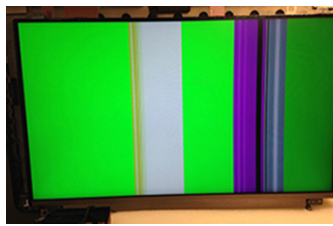

Vertical lines

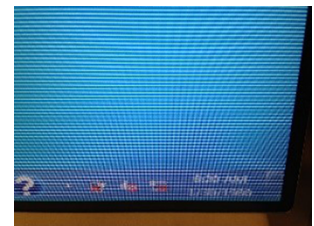

Horizontal lines

Quick check

- Visually examine the display for cracked screen, liquid crystal leak, dirty spots on glass, etc.
- Reset and update BIOS and docking firmware.
- Update operating system (OS), graphics/video drivers (Intel/AMD/NVidia, etc).

For custom images, HP highly recommends upgrading or installing Windows in UEFI mode (or Legacy disabled) to fully support hybrid graphics and avoid unexpected behaviors (i.e., blue screen error, graphics/video issues) in the BIOS Legacy setting.

- Configure Windows settings (Power options, Screen brightness, Personalization, Screen resolution, etc.).
- Test with a verified working external display.
- Boot to Windows in safe mode.
- Test with a verified working operating system (i.e., shipping image).

HP PC Hardware Diagnostics (UEFI) for video test

Use this tool to quickly determine if the display issue is related to a real hardware issue.

To start HP PC Hardware Diagnostics (UEFI) ([6. HP Hardware Diagnostics and Tools on page 81](#)), when the computer is at boot, press the **F2** key, select **Component Tests**, and then select **Video**.

There are three options:

- **Video Memory Check:** to test video memory
- **Palette Check:** to test the three video color components (red, green, blue)
- **Dead Pixel Check:** to check dead pixels in eight different colors (Dead Pixel Check is available with the “HP PC Diagnostics 3-in-1 USB Key” tool)

Review the video troubleshooting in the Display section below for specific issues and possible solutions. For additional information about display problems, refer to documentation provided by the product manufacturer.

Display assembly diagram

The display assembly diagram shows basic video components: system board, graphics cards, display cables, display connectors, operating system (OS), graphics driver, and LCD display panel. Any component or a combination of these components can contribute to a video issue.

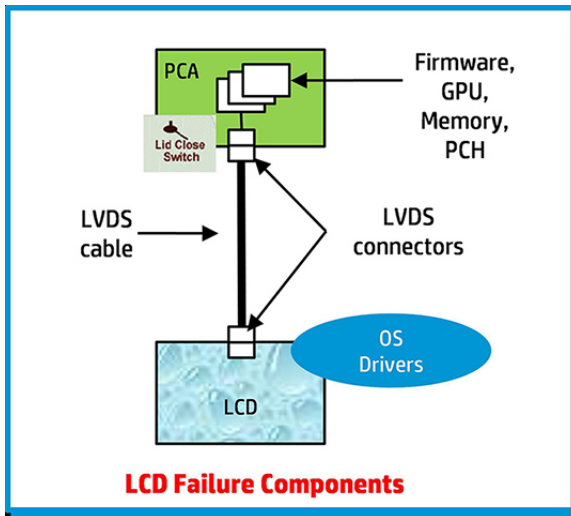

NOTE: The lid close switch is a Hall-effect sensor located in the top cover. When the display is closed, the sensor acts like a switch is closed. A notebook can force a video output to an external monitor, or go to hibernation or standby mode through power management. If the display screen does not light up when the display is open, the lid close switch (Hall-effect sensor) could be faulty.

Dead pixel

Display panel may show one or more pixels that are not properly lit when displaying a single color over the screen area. Use HP PC Hardware Diagnostics (UEFI) tool to determine those defective pixels. There is no solution for dead pixels. Refer to [Display Issue: Pixel Anomalies on page 152](#) for the HP dead pixel policy.

No video (internal)

<i>Symptoms</i>	<i>Possible causes</i>
No internal video with certain programs (i.e., video-intensive games)	Display resolution, brightness, faulty lid switch, running a program requiring a higher resolution than the display screen can support.. Faulty lid switch may put the system into Sleep or Hibernation mode.
	<i>Troubleshooting steps</i>
	Use an external monitor with higher resolution. Test with external monitor using HDMI or HP port. Press the power button and close the computer lid to force video output to external video. If there is still no video, contact support.
References	See section No video (with power) on page 103 for display information.

No video (external)

<i>Symptom</i>	<i>Possible causes</i>
No image on external monitor	External monitor, resolution, display configuration, drivers.
	<i>Troubleshooting steps</i>
	<ol style="list-style-type: none">1. Be sure external monitor is compatible with the computer.2. Be sure that external monitor is turned on.3. Press any key to get out power saving mode.4. Adjust the brightness of the monitor.5. Test with a verified working monitor.6. Test the monitor via internal ports (VGA, DP ports).7. Install latest video driver.8. Reset the screen resolution as described in the documentation.9. Configure display choice, and then force output to external video by closing the notebook lid or pressing Fn + F4 to switch screen output.

DisplayPort/VGA

See [No video \(external\) on page 118](#).

HDMI

<i>Symptoms</i>	<i>Possible causes</i>
<ul style="list-style-type: none">• Display issue• Sound issue	Cable, connection, settings.
	<i>Troubleshooting steps</i>
	Quick Check
	<ol style="list-style-type: none">1. Verify HDMI device input source is set correctly (i.e., HDMI1).2. Be sure you are using the correct HDMI cable.3. Check connection and reconnect the HDMI cable.4. Verify if sound output is configured correctly in Control Panel > Sound Manager.
	<ol style="list-style-type: none">1. Perform hard reset (4. Update BIOS and drivers on page 80).2. Update BIOS and drivers (4. Update BIOS and drivers on page 80) when sound is heard but no video on HDTV.
References	HP Notebook PCs - Troubleshooting HDMI Display and Sound Issues: http://support.hp.com/us-en/document/c01186408

No or bad external video via docking

<i>Symptoms</i>	<i>Possible causes</i>
No or bad image on external monitor via ports of docking station (VGA, DP, TB, display port, etc.)	Rooted from system board, software/drivers, dock connectors, docking station hardware/firmware, dock video ports (DP, VGA, etc).
	<i>Troubleshooting steps</i>
	<ol style="list-style-type: none">1. Refer to the Thunderbolt Dock troubleshooting guide at http://h20565.www2.hp.com/hpsc/doc/public/display?sp4ts.oid=9822172&docLocale=en_US&docId=emr_na-c05060909.2. Be sure that external monitor is powered on.3. Be sure that external monitor is compatible with the computer.4. If applicable, plug the dock in different Type-C ports. For more information, see the technical white paper titled "HP ZBook 65/150/200 W Thunderbolt 3 Dock User Guide." Go to http://support.hp.com/, enter your model number, and then click Manuals > Technical white papers.5. If the screen image is distorted, try a DP-to-VGA adapter. Connect the adapter to each DisplayPort and VGA port of the dock.6. Test the monitor via internal ports (VGA, DP, HDMI, etc.).7. Verify that dock connectors of the notebook and the dock are clean, without dust, debris (e.g., using air duster).8. Ideally, use a verified working operating system/system connected to the dock to isolate the issue of the current operating system.9. Ideally, use a verified working docking station to isolate the faulty dock.10. Update latest dock firmware. Be sure to follow the installation instructions carefully. You may want to try a DP-to-VGA adapter if you have a distorted screen image. Connect the adapter to each DisplayPort of the dock. If you still cannot update the dock, attempt to update it on a confirmed working notebook before having the dock replaced.
Note	See the technical white paper titled "Multiple displays on HP ZBook Mobile Workstations" from HP platform support website. Go to http://support.hp.com/ , enter your model number, and then click Manuals > Technical white papers .

Incorrect or missing color/distorted image

<i>Symptoms</i>	<i>Possible causes</i>
System works normally but the display shows:	Loose connection, display cable, display, graphics card.
<ul style="list-style-type: none">• Missing or strange color• Image distortion	<i>Troubleshooting steps</i>
	Verify with external monitor (i.e., VGA)
	<ol style="list-style-type: none">1. Use combination Fn + F4 to enable output to external monitor.2. Close the lid.

If the external monitor also shows incorrect color, it is graphics card issue. Test with a verified working graphics card.

Verify display cable and cable connection—Display disassembly is required.

Be sure that external display cables are not pinched or damaged.

Be sure that external display cables have good connection at both ends (system board and display panel).

- If moving cables affects the image, it is display cable. Test with a confirmed working cable.
 - If moving cables does not affect the image, is display issue. Test with a confirmed working display
-

Touch screen

Symptoms

Unresponsive

Inaccurate

Possible causes

Dirt and smudge, driver, touch display configuration, power management.

Troubleshooting steps

Quick check

Turn off the computer, spray glass cleaner onto a soft, damp cloth, and gently wipe the screen to remove dirt and smudge.

NOTE: Do not spray cleaner directly onto the screen.

Configure the touch display in **Control Panel > Tablet PC Settings**

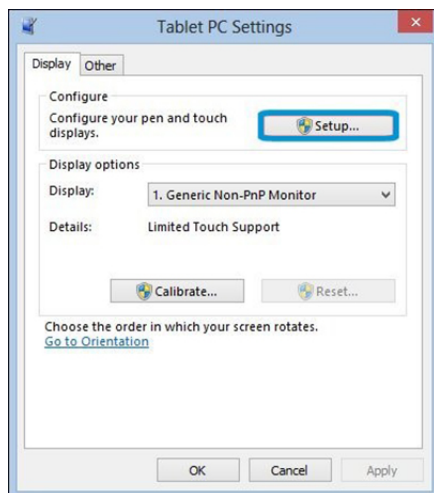

1. Restart the computer.
2. Verify touch screen and graphics drivers.
3. Configure the touch display to identify the screen as a touch screen as shown in the image at left.
4. Calibrate the screen and reset if touch functionality is still not working correctly.
5. Perform diagnostic test in HP Hardware Diagnostics under **Component Tests > Touch Screen**.

If the diagnostics tests pass but the touch screen still does not respond, continue following the steps.

6. Adjust the power management settings for your touch screen.

If the touch screen stops working after waking from sleep, adjust the power management settings so that the touch screen device stays active while the computer is in sleep mode.

7. Perform Microsoft System Restore and restore to a time when the system was working.
 8. Perform HP System Recovery if none of the above actions resolves the issue.
-

References

HP Notebook PCs - Touch Screen Issues (Windows 10): <http://support.hp.com/us-en/document/c04789449>

HP Notebook PCs - Touch Screen Issues (Windows 8): <http://support.hp.com/us-en/document/c04676089>

I/O devices



NOTE:

- Make sure external devices are supported and compliant (i.e., USB Type C, Thunderbolt 3, PCI Express, etc).
- If you have problems with external devices not provided by HP, contact device manufacturers for compatibility and latest drivers prior to troubleshooting (i.e., USB devices, Thunderbolt devices, PCI Express Card reader, VGA/Display/HDMI monitors, Speakers, etc).
- Be sure I/O devices are properly inserted into the I/O ports, and then be sure the I/O devices are recognized by Windows Device Manager.

Keyboard

<i>Symptoms</i>	<i>Possible causes</i>
Keystrokes not recognized	Dust trapped under keycap, loose keycap, loose keyboard connection, defective keyboard.
Characters not matched	
	<i>Troubleshooting steps</i>
	<ol style="list-style-type: none">1. Inspect the keyboard for any signs of dust, liquid, or debris trapped under sticky keys that might prevent keystroke recognition.2. Check for incomplete connection between keyboard and system board by verifying that caps lock or num lock light turns on when key is pressed.3. Verify whether the keyboard is recognized in Windows Device Manager and verify whether the keyboard driver is installed properly.4. Test with a working external keyboard (i.e., USB keyboard). Also test in Windows for special keys (Caps Lock, Shift, Ctrl, Fn, Windows, Alt) if necessary.5. Test with HP PC Hardware Diagnostics (UEFI) to isolate a hardware issue from a software issue.6. Verify that BIOS is up to date. If so, resetting BIOS to default may help.7. Test with verified working operating system or restore operating system to be sure that the issue is not caused by different language settings, sticky keys feature, etc.8. Verify that keyboard flex cables are fully inserted and in good condition.
The sections below are intended for authorized service providers/technicians.	
	<ol style="list-style-type: none">1. Verify if keyboard flex cable is in good condition (no delamination or torn cable end, no missing or cracked tracks, pads).2. Verify keyboard flex cable ends are fully inserted and aligned with connectors on system board, and those connector tabs are properly closed. Reseat cables.3. Replace new internal keyboard and retest.
Tips and tricks	A key only works when pressed with force. Inspect and remove debris trapped under keycap.

Keyboard point stick

<i>Symptom</i>	<i>Possible causes</i>
Point stick not working properly	Dust trapped under point stick, loose point stick cap.
	<i>Troubleshooting steps</i>
	<ol style="list-style-type: none">1. Inspect any signs of dust, liquid spill that prevent point stick from working.2. Check whether point stick cap is loose and reseal it if necessary.

The sections below are intended for authorized service providers/technicians.

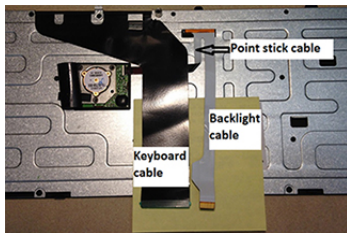

1. Verify whether keyboard flex cables are in good condition (no delamination or torn cable end, no missing or cracked tracks, pads).
2. Verify keyboard flex cable ends are fully inserted and aligned with connectors on system board and back of keyboard and that connector tabs are properly closed.
3. Reseat point stick cables.

Example of back of keyboard, including keyboard, point stick, and backlight cables.

Keyboard backlight

<i>Symptom</i>	<i>Possible causes</i>
Backlight function not working properly	Backlight disabled, loose connection.
	<i>Troubleshooting steps</i>
	NOTE: Not all notebook computers have backlit keyboards. A keyboard function key lets you turn the light on and off. Verify if backlit feature is not disabled by pressing a combination of Fn + Backlit key.

The sections below are intended for authorized service providers/technicians.

1. Verify if backlight flex cables are in good condition (no delamination or torn cable end, no missing or cracked tracks, pads).
 2. Verify backlight flex cable ends are fully inserted and aligned with connectors on system board and that connector tabs are properly closed.
 3. Reseat backlight cable.
-

TouchPad

<i>Symptoms</i>	<i>Possible causes</i>
Not working properly	On/Off enabled, driver, settings.
<i>Troubleshooting steps</i>	
<ol style="list-style-type: none"> 1. Ensure touchpad On/Off light is not amber (disabled). Double touch to enable. 2. Verify if touchpad device is listed in Device Manager > Mice and other pointing devices. 3. Install the latest touchpad driver. 4. Adjust touchpad settings (Control Panel > Mouse). 5. Test touchpad controller using the HP PC Hardware Diagnostics (UEFI) tool (F2 > Component Tests > Mouse Test > Pointer Test & Drag and Drop Test). 	
The sections below are intended for authorized service providers/technicians.	
<ol style="list-style-type: none"> 1. Check the touchpad cable for damage or a loose connection, and then reseal the touchpad cable. 2. If issue persists, replace the touchpad and verify the change. 	

Network Connectivity Ethernet (RJ-45 jack)

<i>Symptoms</i>	<i>Possible causes</i>
<ul style="list-style-type: none"> • Unable to find networks (yellow bang) • Connection dropouts • Slow performance 	Network source, cable, connection, RJ-45 port, driver, settings.
<i>Troubleshooting steps</i>	
Quick Check: verify the network status lights that supposed to flash when there is network activity.	
<p>HP Support Assistant tool - No network detected in HPSA</p>  <p>The screenshot shows the HP Network Check utility window. The 'Network status' section on the left shows a red 'X' icon. The main area displays 'Connection Status' with a red warning triangle and the message 'No network detected (10)'. Below this, under 'Possible Root Causes', there are two items: 'No network detected (10)' and 'No Preferred networks selected (207)', both with green checkmarks.</p>	<ol style="list-style-type: none"> 1. Turn off the computer's wireless feature (press wireless button). 2. Verify that networking source with recommended distance to the base is less than 300 feet. 3. Examine the Ethernet cable for damage. Test with a verified working cable. 4. Test with different networks and jacks and check with IT for hardware compatibility settings. 5. Connect a verified working RJ-45 cable directly to the computer to isolate other related issues (e.g., router, switch, docking station). 6. Verify Ethernet port lights (RJ-45): <ul style="list-style-type: none"> – Green (left): network is connected. – Amber (right): network is showing activity. 7. Test with HP Support Assistant in Windows.

8. Diagnose with HP PC Hardware Diagnostics (UEFI) to isolate a hardware issue from a software issue.
9. Examine Ethernet ports on the computer, docking station, and wall for damage, dust, obstructions.
10. **Update drivers:** Verify that Ethernet module is displayed in Device Manager and be sure that device driver is up to date. If updating drivers does not help, try rolling back to previous drivers.
11. **Reset BIOS to Default:** If other devices can connect to network, but computer cannot connect, a BIOS setting might be the cause of the problem. Restore BIOS to default.
12. Test with verified working operating system or perform operating system recovery to verify that the issue is not caused by customized settings.
13. Replace system board and verify that the issue is fixed.

Network connectivity wireless (WLAN)

Symptoms

- Unable to find networks (yellow bang)
- Connection dropouts
- Slow performance

Possible causes

Network source, cable, connection, wireless module, driver, settings.

HP Support Assistant tool - No network detected in HPSA



Wireless Adapter Properties - U-APSD support

Troubleshooting steps

1. Turn off the computer's wired network (remove RJ-45 cable).
2. Examine environment for interference, such as cell phone or microwave, that may emit high frequencies (above 1 GHz).
3. Verify wireless source by moving computer closer to the wireless base/router.
4. Test with different wireless networks and check with your IT department for hardware compatibility, settings.
5. Verify that the wireless light is on. If the light is amber, press the wireless button to enable the wireless device.
6. Test with HP Support Assistant in Windows.
7. Diagnose with HP PC Hardware Diagnostics (UEFI) to isolate a hardware issue from a software issue.
8. **Update drivers:** Verify that wireless module is displayed in Device Manager and be sure that wireless drivers are up to date using www.hp.com or HP Support Assistant. If updating drivers does not help, try rolling back to previous drivers.
9. **Reset BIOS to Default:** If other devices can connect to your wireless network, but your computer cannot connect, a BIOS setting might be the cause of the problem. Restore BIOS to default.
10. Configure power management advanced settings as necessary.

In the example to the left, **U-APSD support** (Unscheduled Automatic Power Save Delivery) is changed to **Disabled** to resolve an incompatible access

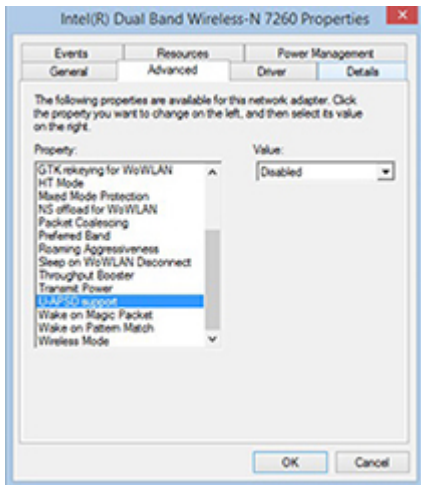

point. If disabling U-APSD improves the throughput issue, check with the access point provider for updated firmware that resolves the issue.

11. Test with verified working operating system or perform operating system recovery to verify that the issue is not caused by customized settings.
12. Test with a verified working wireless module.

The sections below are intended for authorized service providers/technicians.

1. Verify that the wireless module and its antenna cables are fully inserted and in good condition (see WLAN module removal and replacement section). Reseat wireless module and antenna connection.
2. Verify module antenna cable connection are not loose.
3. Verify antenna cables are properly connected to the MAIN and AUX terminals (see WLAN module removal and replacement section).

WWAN

Symptom	Possible causes
Unable to find networks/service	Network source, cable, connection, driver, settings.
	<i>Troubleshooting steps</i>
	<ol style="list-style-type: none"> 1. Update to the latest driver and utility. 2. Check with network service provider for signal coverage. 3. Make sure signal strength is good. 4. Make sure your service is active.

The sections below are intended for authorized service providers/technicians.

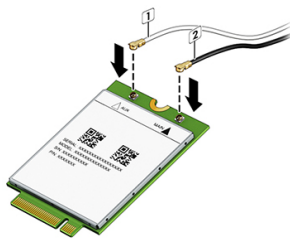

- Verify module and antenna cable connections are not loose.
- Verify antenna cables are properly connected to the correct terminals. For example, the antenna cable labeled “1” connects to the “Main” terminal labeled “1”. The antenna cable labeled “2” connects to the “Aux” terminal labeled “2”.

Symptoms

- USB devices are not recognized
- USB devices are not charging

Possible causes

USB devices do not have the latest software drivers, port insufficient power, or not compliant.

NOTE: USB Type-C uses a different connector entirely

Examples of USB device Not Recognized

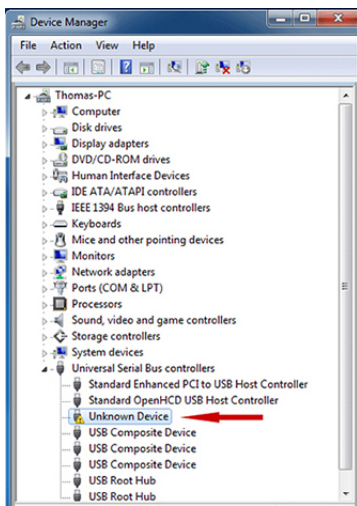
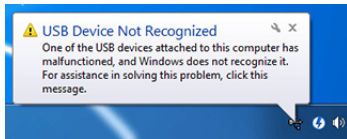

Troubleshooting steps

1. Unplug USB device and/or restart the computer (wait for 2-5 minutes) to reset USB port/hub in case of power surge.
2. Soft Reset ([9. Soft reset \(Default Settings\) on page 91](#)) and verify if USB device is recognized.
3. Verify if USB device is recognized in **Device Manager > Universal Serial Bus Controller**, or USB is recognized without Yellow bang.
4. Verify if the latest USB driver or/and USB chipset driver are installed. USB driver could be removed and reinstalled.
5. Make sure USB device is supported, for example, USB 3.0 device requires more power drawn (0.9A) from USB port than USB 2.0 device (0.5A). As a result, identify USB charging port to be used for charging a USB device, or an external AC power adapter may be required for an external USB storage to work properly.
6. Test with verified working USB devices (keyboard, mouse, USB key) to make sure USB ports are functional.
7. Test USB device on a verified working computer to make sure USB device is not malfunctioning.

Smart card reader

Symptoms

- Not recognized
- Unable to write

Possible causes

Physical damage, incorrect insertion, dirt, driver, malfunctioning card reader.

NOTE: Some cards have a read/write security switch on the card. Make sure that switch is set to “write enabled” before attempting to write data to it.

Card Reader Removal Policy

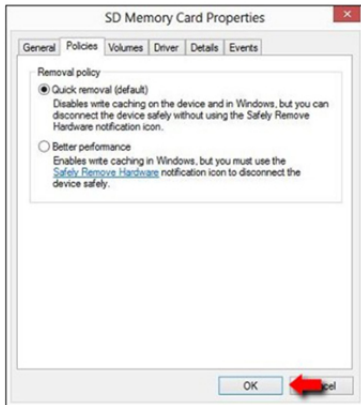

Troubleshooting steps

1. Verify card reader removal policy.
2. Make sure there is no physical damage to the card.
3. Inspect the ends of the memory cards for dirt or material closing a hole or spoiling a metal contact. Clean the contacts with a lint-free cloth and small amounts of isopropyl alcohol. Replace the memory card if necessary.
4. Reinstall and update the drivers for the card reader.
5. Make sure the smart card reader is compliant with ISO 7816 Class A, B, and C.
6. Reinsert the card reader with correct face as described in its documentation.
7. Check reader function with a verified working card.

CAUTION: If the card reader has an in-use indicator light, do not insert or remove memory cards while the light is flashing. Doing so may cause loss of data on the card or may permanently damage the card reader.

Speaker, headphone - audio issues



Symptoms

- No sound from external or internal speakers
- Distorted sound, too soft, too loud, intermittent

Possible causes

Volume turned down, sound card not recognized, malfunctioning hardware, electronic interference.



Troubleshooting steps

1. Remove any device connected to the Audio jack to enable the internal speaker.
2. Close all open programs.
3. Adjust volume by pressing **Fn** +  or . Be sure that volume button light is not amber (mute).



- or -

Adjust Windows volume control by clicking the speaker icon on the Windows taskbar. Be sure that the sound is not muted.
4. Verify that sound card is detected in Windows Device Manager.
5. Reinstall the **latest audio driver**.
6. Test audio device using HP PC Hardware Diagnostics (UEFI) tool (**F2** > **Component Tests** > **Audio**).
7. Test with a verified working operating system. If issue is resolved, restore full operating system.
8. Test with verified working external speakers or headset.
9. Reseat internal speaker connections.
10. Test with verified working internal speakers.
11. Replace internal speakers.

No sound from headphones

1. Adjust volume by pressing **Fn** +  or . Be sure that volume button light is not amber (mute). Or adjust Windows volume control by clicking the speaker icon on the Windows taskbar. Be sure that the sound it not muted.
2. Check headphone cable connection.
3. Test with a verified working audio board.
4. Replace audio board and verify the change.

No sound from external speakers

1. Verify that external speakers are turned on.
2. Disconnect headphones from headphone jack.
3. Adjust volume by pressing **Fn** +  or . Be sure that volume button light is not amber (mute).

- or -

Adjust Windows volume control by clicking the speaker icon on the Windows taskbar. Be sure that the sound is not muted.
4. Check for possible interference devices nearby that may impact the audio (cell phone or portable communications handset.)

Thunderbolt (TB)

<i>Symptom</i>	<i>Possible causes</i>
Thunderbolt device not working	BIOS, drivers, and user settings.

Troubleshooting steps

1. Update to the latest BIOS and choose appropriate TB Port settings.
2. Reset **User Account Settings** to default.
3. Update Intel Thunderbolt software that includes firmware version (for TB controller), driver version (operating system driver), and application version.

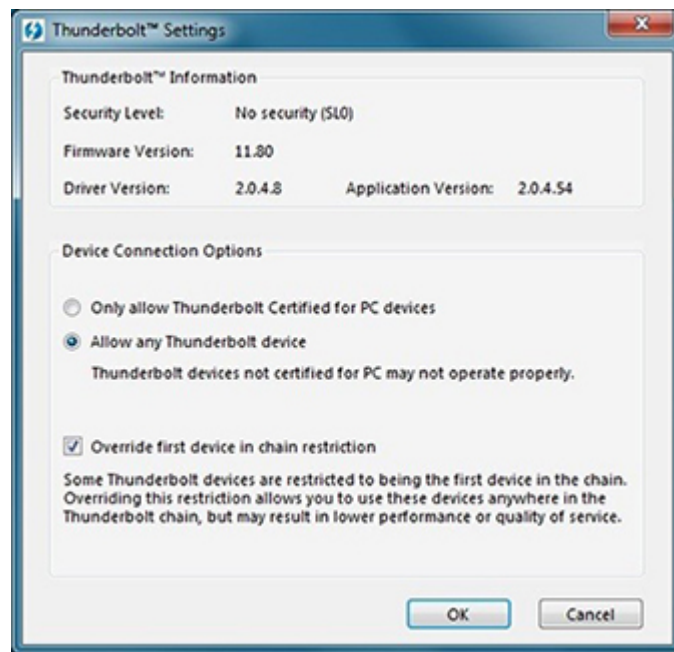

4. Verify that TB device is detected in Windows Device Manager.

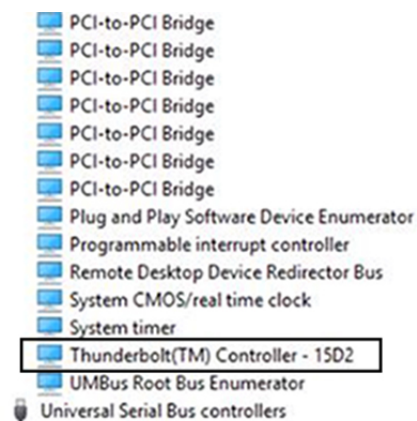

5. Verify TB port, cable and connection.
6. Test with a verified working TB board, if possible.

NOTE: Thunderbolt is new technology. Thunderbolt cable and Thunderbolt device must be compatible with Windows. To determine whether your device is Thunderbolt Certified for Windows, see <https://thunderbolttechnology.net/products>.

Thunderbolt 3 dock

Symptom

Thunderbolt dock and devices not working

Possible causes

System BIOS, firmware, drivers, user settings, Thunderbolt dock firmware and driver, or hardware issues.

Troubleshooting steps

1. Important: review dock user guide and documents in references section for best practices.

Refer to “HP Elite Dock with Thunderbolt 3 and HP ZBook Dock with Thunderbolt 3 - Using and Troubleshooting the Dock” at http://h20565.www2.hp.com/hpsc/doc/public/display?sp4ts.oid=9822172&docLocale=en_US&docId=emr_na-c05060909 for detailed instructions on how to troubleshoot common problems.

Docking and undocking (i.e., unplug the dock before putting notebook into Standby).

Connecting and disconnecting the dock.

Connecting external devices to the dock.

Configuring an external monitor.

Sleep, hibernation, shutdown, and restart.

Troubleshooting common problems.

2. Important: update to the latest BIOS, firmware, and drivers for both system and the dock.

Latest BIOS version for your computer.

Intel Thunderbolt Secure Connect driver.

Intel Thunderbolt firmware update utility.

Intel graphics drivers.

AMD or NVIDIA graphics driver (depends on notebook configuration).

Ethernet controller driver.

Conexant Audio USB driver.

ASMedia eXtensible host controller driver – dock is required to be plugged in.

Dock: Thunderbolt 3 Dock firmware – dock is required to be plugged in.

3. Visual inspection.

Inspect TB ports on your computer for any signs of damage.

Inspect dock cables on both ends and dock ports for any signs of damage.

4. Verify status light.

Verify system AC adapter light is on. Follow steps below if there is no AC adapter light.

Verify AC adapter by connecting AC adapter directly to the system.

Verify dock power light is on.

Verify TB cable and devices are properly connected. Use a verified working TB cable to insure there is a good connection between the dock and system.

Use a verified working dock. If the computer operates normally, there is a problem with the original dock.

References

Go to <http://support.hp.com/>, enter your model name or model number, or search for user guide titled "HP ZBook 150W Dock with Thunderbolt 3" or "HP ZBook 200W Dock with Thunderbolt 3", and then click **Manuals > Technical white papers**.

Advisory: HP ZBook Dock with Thunderbolt 3 - HP Mobile Workstation May Not Detect ZBook Thunderbolt Dock: http://h20564.www2.hp.com/hpsc/doc/public/display?docId=emr_na-c05178033

Storage

**NOTE:**

- Back up all critical data prior to drive troubleshooting.
 - Prior to contacting support, HP recommends that you run a drive (HDD, SSD, M.2 drive) test using the HP PC Hardware Diagnostics (UEFI) tool on the suspected failed drive.
 - Diagnose the hard drive using BIOS, Diagnostics built in the shipping image, or an external USB (HP PC Diagnostics 3-in-1 USB Key at http://www8.hp.com/us/en/campaigns/hpsupportassistant/pc-diags.html?jumpid=va_r602_us/en/any/pps/pl_ot_ob_ds_pd/HP_PC_Hardware_Diagnostics_cc/dt).
 - The drive quick test is recommended to quickly (less than 10 minutes) identify the malfunctioning drive. If the issue still exists, run Extensive Test (more than 2 hours, or loop mode, which will run until an error occurs).
 - If any test fails, record failure code and contact support for instructions on how to order a replacement hard drive.
 - If all of the tests pass, the hard drive is not damaged. As a rule, HP will not replace a hard drive under warranty that does not fail the HP Hard Drive Self-Test.
 - If there is no physical problem with the hard drive (or memory), then try reinstalling the Windows operating system to troubleshoot the problem.
-

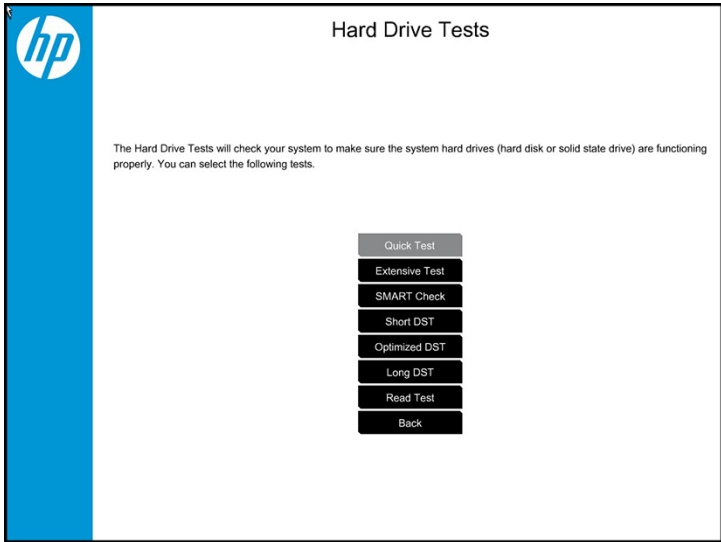

Hard drive/solid-state drive not recognized

<i>Symptom</i>	<i>Possible causes</i>
Hard drive is not recognized during POST	Loose connection, faulty hard drive, faulty drive configuration/BIOS setting.
	<i>Troubleshooting steps</i>
	<ol style="list-style-type: none">1. Perform a hard reset (8. Hard reset on page 90).2. Reset BIOS to default.3. Verify hard drive connection and flex cable. Reseat hard drive and cable connection. For multiple storage devices, keep the primary drive with the operating system and remove other devices.4. Use the HP Hardware Diagnostics tool to verify the drive is recognized and test it.5. If the hard drive fails diagnostics, record failure and have the drive replaced.6. Identify when the issue is related to software. If the hard drive passes diagnostics, test the drive on a verified working computer. If the failure follows the drive, reinstall the operating system to make sure software is not an issue.7. Test with a verified working hard drive. If it is still not recognized, the system board is faulty.
	NOTE: If the drive is seen in BIOS and Diagnostics, try a secure erase prior to replacing a drive as this may resolve related issues.

No boot to operating system (no read/write error)

<i>Symptoms</i>	<i>Possible causes</i>
<ul style="list-style-type: none">• Post error message: Boot Device not found (3F0)• Hang when booting to operating system	Operating system, loose connection, faulty hard drive, BIOS configuration, Secure Boot.
	<i>Troubleshooting steps</i>
	<ol style="list-style-type: none">1. Verify if Secure Boot is enabled in BIOS. Secure Boot prevents legacy boot devices from starting the computer, including bootable CDs and DVDs. For more information, see "HP PCs - Secure Boot (Windows 8)" at http://support.hp.com/us-en/document/c03653226.2. Reset BIOS to default. Be sure that BIOS Boot Mode in Boot Option is set up properly for bootable device and its operating system (i.e., UEFI Native for Windows 8). Another example, choosing Legacy Boot Order for an UEFI device will cause "Boot Device not found (3F0)" error.3. Verify hard drive connection and flex cable. Reseat connection. For multiple storage devices, keep the primary drive with the operating system and remove other devices.4. Use PC Hardware Diagnostics tool to test. Record failure code and have the hard drive replaced.5. If there is no error, reinstall the operating system using HP Restore.6. Test with a verified working operating system hard drive, if available.
Note	If there is a hard drive POST error message, see POST Error Messages and User Actions on page 144 .

Read-write error

<i>Symptoms</i>	<i>Possible causes</i>
<ul style="list-style-type: none">• Post error message (i.e., error code 301)• Hang when working on data, files, documents	<p>Loose connection, faulty hardware.</p> <hr/> <p><i>Troubleshooting steps</i></p> <ol style="list-style-type: none">1. Perform a hard reset (8. Hard reset on page 90).2. Reset BIOS to default (9. Soft reset (Default Settings) on page 91).3. Verify drive connection and flex cable. Reseat connection (10. Reseat cables and connections on page 91).4. Use the HP Hardware Diagnostics tool to test. If failed, record failure code and have the hard drive replaced.5. If no error with HP PC Hardware Diagnostics (UEFI) tool, try to repair the hard drive and its files in Windows (using command “CHKDSK /f /r /x”). Use HP Restore to reinstall the operating system, if needed.6. Test with a verified working hard drive. If it is not recognized, the system board is faulty.
Note	If there is a hard drive POST error message, see POST Error Messages and User Actions on page 144 .

Slow performance

<i>Symptoms</i>	<i>Possible causes</i>
Slow performance even when performing small read/write operations	<p>Operating system files, hard drive is full.</p> <hr/> <p><i>Troubleshooting steps</i></p> <ol style="list-style-type: none">1. Transfer data from the hard drive to create more space. Microsoft recommends at least 200 MB to sync system files.2. Perform disk defragmentation to consolidate fragmented data on the hard drive so it will work more efficiently. <p>NOTE: Do not defrag an SSD.</p>
Tips & tricks	<p>For optimal system performance, you need to place your operating system and all of your most commonly used applications and files in the fastest hard drive (solid-state drive) and fastest areas on the drive (primary partition of 200 GB max).</p> <p>See “Improving System Performance” at http://h20564.www2.hp.com/hpsc/doc/public/display?docLocale=en_US&docId=emr_na-c00816938. Also see Routine Maintenance for Performance Improvement on page 146).</p>

Blue screen (BSOD) error

Faulty hard drive may cause blue screen error. Perform the drive tests using the HP Diagnostics Tool to make sure the drive is functional. If all of the tests pass, see [Common Blue Screen Error Messages on page 146](#) for detailed troubleshooting steps.

Noisy hard drive

 **IMPORTANT:** An SSD has no moving parts, so it does not make loud or clicking noise.

Depending on type and rotational speed, some hard drives will make more noise than others.

Not all noises are related to the fan or hard drive.

<i>Symptoms</i>	<i>Possible causes</i>
<ul style="list-style-type: none">• Loud noise from hard drive• Clicking noise from hard drive• Still boots to operating system and operates normally	<p>BIOS, hard drive firmware, driver, faulty drive, power supply (AC adapter).</p> <hr/> <p><i>Troubleshooting steps</i></p> <ol style="list-style-type: none">1. Update BIOS and hard drive firmware.2. Examine AC adapter to be sure that it is not faulty or overloaded. Disconnect all peripherals (USB storages, dock, etc.).3. Remove hard drive to isolate the noise.4. Test the hard drive on a verified working computer if the noise continues. If the hard drive makes the same noise or clicking sounds, the sounds are either normal sounds for the hard drive or a fault with the hard drive.5. Verify original hard drive connection and flex cable. Reseat hard drive and connection.6. Run HP PC Hardware Diagnostics (UEFI). If failed, record failure code and have the hard drive replaced.7. If no error with HP PC Hardware Diagnostics (UEFI), perform disk defragmentation (some hard drives make a clicking noise when highly fragmented).
Tips & tricks	<p>For optimal system performance, place your operating system and all of your most commonly used applications and files on the fastest hard drive or solid-state drive and on the fastest areas on the drive (primary partition of 200 GB max).</p> <p>See “Improving System Performance” at http://h20564.www2.hp.com/hpsc/doc/public/display?docLocale=en_US&docId=emr_na-c00816938. Also, see Routine Maintenance for Performance Improvement on page 146).</p>

Mechanical

Fan error message - 90B

Symptoms

Fan error 90B at boot

CAUTION: May lead to system shutdown, data loss or possible system damage.

Possible causes

Defective fan; out-of-date BIOS.

- The system fan is not spinning or not spinning properly (loose connection, fan is stuck or defective).
- The temperature inside the case is too high, and the fan cannot spin fast enough to remove the heat due to an obstruction to air flow.



Troubleshooting steps

General actions

1. Update BIOS and drivers ([4. Update BIOS and drivers on page 80](#)) or reset BIOS to default. BIOS may implement new fan characteristics and updates for other components.
2. Perform a hard reset ([8. Hard reset on page 90](#)). Performing a hard reset can reset recorded thermal values in memory.

Thermal-related issue

1. Verify thermal condition:
 - a. Check fan and connection. Reseat fan cable.
 - b. Be sure that no obstructions or dust are in heat sink fan, fin, or vent.
 - c. Test fan using HP PC Hardware Diagnostics (UEFI) tool ([6. HP Hardware Diagnostics and Tools on page 81](#)). Be sure that the fan is not producing loud noise and that fan blades spin correctly.
 - d. Test with a verified working fan.
 - e. Remove old thermal compound and pads, and replace properly with new pads.
2. Verify thermal solution
 - ▲ Use Thermal Monitor tool (available only to authorized service providers/ technicians) to run stress test (processor and GPU) and verify that thermal sensors are within limits after thermal condition is serviced.

Note

BIOS currently omits fan presence detection to shorten boot time delay less than four seconds. Therefore, the fan error is generated based on previous boot to operating system that found system fan error.

Fan often is part of thermal solution, including heat sink, fin/ muffler, and thermal grease. Fan replacement requires reboot and fan function verification using HP PC Hardware Diagnostics (UEFI) tool.

See "Reducing Heat Inside the PC to Prevent Overheating" at http://h20564.www2.hp.com/hpsc/doc/public/display?docLocale=en_US&docId=emr_na-c01657439.

Noise (sound)

<i>Symptoms</i>	<i>Possible causes</i>
Computer emits abnormal noise	Aside from basic components (power adapter/supply, fan, speaker, hard drive, optical drive, display panel, external devices), it is also common for electronic components to produce noise. <i>Troubleshooting steps</i> <ol style="list-style-type: none">1. Inspect external power source and change to verified working one.2. Determine whether the noise comes from AC power adapter. Test with a verified working AC adapter. Disconnect external devices and all cables connected to the computer to isolate issue to computer only.
Noisy fan	Determine whether the noise comes from the fan. Disconnect the fan briefly to isolate whether noise originates from fan. If noise is absent with fan disconnected, refer to Fan runs constantly on page 138 .
Noisy hard drive	Determine whether the noise comes from the hard drive. See Noisy hard drive on page 135 .
Noisy optical drive	<ol style="list-style-type: none">1. Determine whether the noise comes from an optical drive.2. Remove CD/DVD from the optical drive.
Noisy speaker	<ol style="list-style-type: none">1. Determine whether the noise comes from speaker.2. Test with a verified working external headset/speaker.
Noisy display	Determine whether the noise comes from display panel (humming noise). Change display frequency settings. See Display on page 115 .
The section below is intended for authorized service providers/technicians.	
	<ol style="list-style-type: none">1. After disassembling the chassis, inspect components of the interior for excessive wear or damage.2. If noise issues persist, proceed with process of elimination for battery, AC adapter, or boards.

Fan runs constantly

Symptoms

- Fan never stops running
- Generates heat
- Decreased computer performance

Possible causes

- BIOS not up to date.
- Thermal condition (fan, air flow)--fan may not be defective but must run constantly to remove excess heat generated by electrical components.
- Inappropriate configuration.

Troubleshooting steps

General actions

1. Verify whether BIOS is set to **Fan Always on while on AC Power** F10 Setup. When booting the computer, press **F10** to open Setup, and then select **Advanced > Built-In Device Options Menu**.
2. Update BIOS and drivers ([4. Update BIOS and drivers on page 80](#)) and reset BIOS to default. BIOS may implement new fan characteristics and updates for other components.
3. Perform a hard reset ([8. Hard reset on page 90](#)). Performing a hard reset can reset recorded thermal values in memory.

Thermal-related issue

1. Verify fan is spinning. Reseat fan cable before moving to next step.
 - a. Check fan and connection. Reseat fan cable.
 - b. Be sure that no obstructions or dust are in heat sink fan, heat sink fin, or vent.
 - c. Test fan using HP PC Hardware Diagnostics (UEFI) tool ([6. HP Hardware Diagnostics and Tools on page 81](#)). Be sure that the fan is not producing loud noise and that fan blades spin correctly.
 - d. Test with a verified working fan.
 - e. Replace the fan.
2. Verify thermal solution

Use Thermal Monitor tool (available only to authorized service providers/technicians) ([HP Thermal Monitor on page 84](#)) to run stress test (processor and GPU) and verify that thermal sensors are within limits after thermal condition is serviced.

User configuration

Change Power Options in Windows (i.e., choosing **Balanced mode** instead of **High performance**). High performance and extensive graphics may cause the fan run constantly to release the heat.

Notes

BIOS currently omits fan presence detection to shorten boot time delay less than four seconds. Therefore, the fan error is generated based on previous boot to operating system that found system fan error.

Fan often is part of thermal solution, including heat sink, heat sink fin/muffler, and thermal grease. Fan replacement requires reboot and fan function verification using HP PC Hardware Diagnostics (UEFI) tool.

For more information, see the following links:

- HP Notebook PCs - Fan is Noisy and Spins Constantly, PC is Warmer than Normal: http://support.hp.com/us-en/document/c01007591http://h20564.www2.hp.com/hpsc/doc/public/display/docLocale=en_US&docId=emr_na-c01657439.

- Reducing Heat Inside the PC to Prevent Overheating: http://h20564.www2.hp.com/hpsc/doc/public/display?docLocale=en_US&docId=emr_na-c01657439.
- Improving System Performance: http://h20564.www2.hp.com/hpsc/doc/public/display?docLocale=en_US&docId=emr_na-c00816938.

Thermal shutdown (hot)

<i>Symptoms</i>	<i>Possible causes</i>
Similar to fan runs constantly issue (Fan runs constantly on page 138)	BIOS, drivers not up to date, thermal condition (fan, air flow)
<ul style="list-style-type: none"> • System shutdown • Abnormal heat • Continually running fan • Decreased computer performance 	<p><i>Troubleshooting steps</i></p> <ol style="list-style-type: none"> 1. Update BIOS and drivers (4. Update BIOS and drivers on page 80) and reset BIOS to default. BIOS may implement new fan characteristics and updates for other component. <p>NOTE: Studio model is shipped with Intel Dynamic Platform and Thermal Framework (DPTF) driver that provides system temperature and power utilization information for the system thermal protection to function properly. When DPTF driver is installed, ensure DPTF is also enabled in F10 BIOS (by default).</p> 2. Perform a hard reset (8. Hard reset on page 90). Performing a hard reset can reset recorded thermal values in memory. 3. Determine whether you are using a correct AC adapter. 4. Be sure to turn power off completely when putting a notebook in a travel bag. <p>NOTE: It is normal for the system to get warm in F10 BIOS mode after a period of time (i.e., one hour) because there is no power management in a non-operating system environment.</p>
	<p>Thermal-related issue</p> <ol style="list-style-type: none"> 1. Verify thermal condition: <ol style="list-style-type: none"> a. Check fan and connection. Reseat fan cable. b. Be sure that no obstructions or dust are in heat sink fan, fin, or vent. c. Be sure that the notebook is not sitting on a hot surface that blocks vent intakes. d. Test fan using HP PC Hardware Diagnostics (UEFI) tool (6. HP Hardware Diagnostics and Tools on page 81). Be sure that the fan is not producing a loud noise and that fan blades spin correctly. e. Test with a verified working fan. f. Remove old thermal compound and pads, and replace properly with new pads. 2. Verify thermal solution: <ul style="list-style-type: none"> ○ Use Thermal Monitor tool (available only to authorized service providers/ technicians) to run stress test (processor and GPU) and verify that thermal sensors are within limits after thermal condition is serviced.
Note	See "Reducing Heat Inside the PC to Prevent Overheating" at http://h20564.www2.hp.com/hpsc/doc/public/display?docLocale=en_US&docId=emr_na-c01657439 .

Stuck power button

Symptoms

- Rear power indicator light is on
- Will not turn on when power button is pressed
- Automatically powers on

Possible causes

Sticky or defective power button.

Troubleshooting steps

General actions

1. Perform a hard reset ([8. Hard reset on page 90](#)).
2. Perform a soft reset if system can turn on.

The sections below are intended for authorized service providers/technicians.

1. Disassemble the unit.
 2. Inspect power button on the top cover and on the system board to make sure these buttons move freely.
-

Additional information

The following sections provide additional information that can be used during the troubleshooting process.

Acronyms

The following acronyms are used in this chapter.

Blue screen (BSOD)—A Windows error screen that can occur if a problem causes your computer to shut down or restart unexpectedly. When you experience this type of error, you will not be able to see items such as the Start menu or the taskbar when your computer is turned on. Instead you might see a blue screen with a message that your computer ran into a problem and needs to restart.

CPU—Central processing unit

DIMM—Dual in-line memory module

Daughterboard—Type of circuit board that plugs into or is attached to the system board or similar expansion card to extend its features and services.

GPU—Graphics processor unit

GTS—General Troubleshooting Step

HDD—Hard drive

KB—Keyboard

LVDS—Low-Voltage Differential Signaling

MSG—Maintenance and Service Guide

mWS—Mobile Workstations

WS—Workstations

OS—Operating system

PC—Personal computer

POST—Power-On Self-Test

SSD—Solid-state drive

TSG—Troubleshooting Guide

UEFI—Unified Extensible Firmware Interface

WLAN—Wireless local area network

WWAN—Wireless wide area network

Blinking lights and boot error codes

The information below is from the white paper “HP Business Notebook and Desktop PC F10 Setup, 2014 Business PC models” at <http://h10032.www1.hp.com/ctg/Manual/c04685655>.

In some cases, when the host processor is not executing code or does not have the necessary code to drive the display, light blink codes inform you of a problem.

Table 7-6 Boot-error codes

Blink codes	Error
Amber battery light: blinks 1 Hz continuously	Embedded Controller unable to load firmware
Caps/num lock lights = 1 blink	Processor not executing code
Caps/num lock lights = 2 blinks	BIOS recovery code unable to find valid BIOS recovery image
Caps/num lock lights = 3 blinks	Memory module error
Caps/num lock lights = 4 blinks	Graphics controller error
Caps/num lock lights = 5 blinks	System board error
Caps/num lock lights = 6 blinks	Intel Trusted Execution Technology (TXT) Error
Caps/num lock lights = 7 blinks	Sure Start unable to find valid BIOS Boot Block image
Caps/num lock lights = 8 blinks	Sure Start has identified a problem (Manual Recovery Policy Set)

Processor not executing code

This computer has experienced a problem due to the failure of certain code to execute, resulting in a failed startup of the processor. The issue could be related to the processor or the system board in the computer. If the processor is socketed, be sure that the processor is seated correctly in the socket. If this error reoccurs, refer to [General troubleshooting steps on page 76](#).

 **NOTE:** The computer will attempt to notify you of this problem through a series of blinking lights. When you attempt to turn on the computer from an “Off” or “Hibernated” state, lights associated with the [caps lock](#) and [num lock](#) keys will both **blink once** followed by a pause, and then continue in a repeating pattern.

BIOS recovery code unable to find valid BIOS recovery image

This computer has experienced a problem in locating a valid BIOS image, resulting in a failed startup. This problem may be resolved by placing a clean copy of the system BIOS on a USB key or in the appropriate hard drive directory and performing a reboot. If this error reoccurs, refer to [General troubleshooting steps on page 76](#).

 **NOTE:** The computer will attempt to notify you of this problem through a series of blinking lights. When you attempt to turn on the computer from an “Off” or “Hibernated” state, lights associated with the [caps lock](#) and [num lock](#) keys will both **blink twice** followed by a pause, and then continue in a repeating pattern.

Memory module error

This computer has experienced a memory initialization problem resulting in a failed startup. This issue may be related to the memory modules in the computer. This problem may be resolved by ensuring that memory modules are correctly inserted and seated. If this error reoccurs, a service event is required to determine the source of the error (memory modules or system board) and take the appropriate corrective action.

 **NOTE:** The computer will attempt to notify you of this problem through a series of blinking lights. When you attempt to turn on the computer from an “Off” or “Hibernated” state, lights associated with the [caps lock](#) and [num lock](#) keys will both **blink three times** followed by a pause, then continue in a repeating pattern.

Graphics Controller Error (No Controller)

This computer has experienced a graphics controller initialization problem resulting in a failed startup. This issue may be related to the graphics controller in your machine. This problem may be resolved by ensuring that the graphics controller module is seated correctly in machines with modular graphics. If this error reoccurs, a service event is required to identify the source of the error and take the appropriate corrective action.

 **NOTE:** The computer will attempt to notify you of this problem through a series of blinking lights. When you attempt to turn on the computer from an “Off” or “Hibernated” state, lights associated with the [caps lock](#) and [num lock](#) keys will both **blink four times** followed by a pause, then continue in a repeating pattern.

Failure - System Board Error

This computer has experienced a system board initialization problem resulting in a failed startup. This issue may be related to the system board in the computer. A service event is required to identify the source of the error and take the appropriate corrective action.

 **NOTE:** The computer will attempt to notify you of this problem through a series of blinking lights. When you attempt to turn on the computer from an “Off” or “Hibernated” state, lights associated with the [caps lock](#) and [num lock](#) keys will both **blink five times** followed by a pause, then continue in a repeating pattern.

Intel Trusted Execution Technology (TXT) Error

This computer has experienced a problem related to the Intel Trusted Execution Technology resulting in a failed startup. The error occurs when all of the following are true:

- The Intel Trusted Execution Technology (TXT) has been enabled on the computer.
- Policies have been set to prevent startup if the BIOS measurement has changed.
- The BIOS measurement has changed.

For more information about Intel TXT, go to <http://www.intel.com/content/dam/www/public/us/en/documents/white-papers/trusted-execution-technology-security-paper.pdf>.

A service event is required to resolve this issue.

 **NOTE:** The computer will attempt to notify you of this problem through a series of blinking lights. When you attempt to turn on the computer from an “Off” or “Hibernated” state, lights associated with the [caps lock](#) and [num lock](#) keys will both **blink six times** followed by a pause, then continue in a repeating pattern.

Sure Start unable to find valid BIOS Boot Block image

This computer has experienced a problem in locating a valid BIOS image, resulting in a failed startup. A service event is required to identify the source of the error and take appropriate corrective action.

 **NOTE:** The computer will attempt to notify you of this problem through a series of blinking lights. When you attempt to turn on the computer from an “Off” or “Hibernated” state, lights associated with the [caps lock](#) and [num lock](#) keys will both **blink seven times** followed by a pause, then continue in a repeating pattern.

Sure Start has identified a problem (Manual Recovery Policy Set)

This computer has experienced a problem in locating a valid BIOS image, resulting in a failed startup. HP Sure Start will normally repair this type of issue; however, on this computer HP Sure Start has been configured to operate in manual mode key sequence. To proceed with the repair, press and hold the following keys: <ESC> +<UP arrow>+<DOWN arrow>. To avoid the need for this manual recovery step, set the HP Sure Start recovery policy to automatic. If this error reoccurs, a service event is required to identify the source of the error and take appropriate corrective action.

 **NOTE:** The computer will attempt to notify you of this problem through a series of blinking lights. When you attempt to turn on the computer from an “Off” or “Hibernated” state, lights associated with the **caps lock** and **num lock** keys will both **blink eight times** followed by a pause, then continue in a repeating pattern.

POST Error Messages and User Actions

Test description	Failure descriptions	Error code	Possible user actions
Product information	Invalid value	00A	Contact support for assistance.
Startup test	Memory module	200	Attempt to reseat the memory module and then repeat the test. See “Overview of How to Troubleshoot Problems When a Computer Does Not Start Up or Boot Properly” at http://h20566.www2.hp.com/hpsc/doc/public/display?docLocale=en_US&docId=emr_na-c01443371 for details on troubleshooting issues related to the memory module. If the memory module still fails, contact support.
Startup test	Hard Disk 1 SMART	301	Attempt to reseat the hard drive and repeat the test. The hard disk drive may have failed. Contact support for assistance.
Startup test	Hard Disk 2 SMART	302	The hard drive may have failed. Contact support for assistance.
Startup test	Hard Disk 1 Quick	303	The hard drive may have failed. Contact support for assistance.
Startup test	Hard Disk 2 Quick	304	The hard drive may have failed. Contact support for assistance.
Run-in test	Memory module	200	Attempt to reseat the memory module and then repeat the test. See “Overview of How to Troubleshoot Problems When a Computer Does Not Start Up or Boot Properly” at http://h20566.www2.hp.com/hpsc/doc/public/display?docLocale=en_US&docId=emr_na-c01443371 for details on troubleshooting issues related to the memory module. If the memory module still fails, contact support.
Run-in test	Hard Disk 1 SMART	301	Attempt to reseat the hard drive and repeat the test. The hard drive may have failed. Contact support for assistance.
Run-in test	Hard Disk 2 SMART	302	The hard drive may have failed. Contact support for assistance.
Run-in test	Hard Disk 1 Quick	303	The hard drive may have failed. Contact support for assistance.
Run-in test	Hard Disk 2 Quick	304	The hard drive may have failed. Contact support for assistance.
Hard Disk Test	Hard Disk 1 SMART	301	Attempt to reseat the hard drive and repeat the test. The hard drive may have failed. Contact support for assistance.
Hard Disk Test	Hard Disk 2 SMART	302	The hard drive may have failed. Contact support for assistance.
Hard Disk Test	Hard Disk 1 Quick	303	The hard drive may have failed. Contact support for assistance.

Test description	Failure descriptions	Error code	Possible user actions
Hard Disk Test	Hard Disk 2 Quick	304	The hard drive may have failed. Contact support for assistance.
Hard Disk Test	Hard Disk 1 Full	305	The hard drive may have failed. Contact support for assistance.
Hard Disk Test	Hard Disk 2 Full	306	The hard drive may have failed. Contact support for assistance.
Boot Device Manager	Boot device not found	3F0	Indicates a potential problem with the hard drive. Please run the hard drive test. See “Testing a Hard Disk using the Built in Self Test “ at http://h20566.www2.hp.com/hpsc/doc/public/display?docLocale=en_US&docId=emr_na-c00439024 for more information.
Boot Device Manager	Hard Disk 1 SMART	301	Indicates a potential problem with the hard drive. Run the hard drive test. See “Testing a Hard Disk using the Built in Self Test “ at http://h20566.www2.hp.com/hpsc/doc/public/display?docLocale=en_US&docId=emr_na-c00439024 for more information.
Boot Device Manager	Hard Disk 2 SMART	302	Indicates a potential problem with the hard drive. Run the hard drive test. See “Testing a Hard Disk using the Built in Self Test” at http://h20566.www2.hp.com/hpsc/doc/public/display?docLocale=en_US&docId=emr_na-c00439024 for more information.
BIOS Recovery	BIOS Recovery Occurred	500	This message indicates that BIOS recovery was completed successfully. No further action is required.
BIOS Application	BIOS Application Error	501	The BIOS installation may have become corrupted. Download the latest version of the BIOS and install it. See 4. Update BIOS and drivers on page 80 for more information. If reinstalling the BIOS fails, contact support for further assistance.
CMOS Recovery	CMOS Recovery Occurred	502	This message indicates that CMOS recovery was completed successfully. No further action is required.
Battery Check	Primary Battery Replace	601	This indicates that the primary battery has very low capacity. See “Checking the Status of the Battery” at http://h20566.www2.hp.com/hpsc/doc/public/display?docLocale=en_US&docId=emr_na-c00821536 for details on using the HP Support Assistant to verify the battery capacity and, if necessary, order a replacement.
Battery Check	Secondary Battery Replace	602	This indicates that the secondary battery has very low capacity. See “Checking the Status of the Battery” at http://h20566.www2.hp.com/hpsc/doc/public/display?docLocale=en_US&docId=emr_na-c00821536 for details on using the HP Support Assistant to verify the battery capacity and, if necessary, order a replacement.
Wireless Module	Not installed or responding	701	Reseat the wireless LAN adapter module, if your notebook supports it. Because seating or reseating a wireless LAN adapter is unique to each computer model. For more information, see the chapter titled “Removal and replacement procedures for Customer Self-Repair parts.”
Fan	Fan not operating correctly	90B	The system fan may be malfunctioning. For information on troubleshooting heat-related issues, see “HP Notebook PCs - Fan is Noisy and Spins Constantly, PC is Warmer than Normal” at http://support.hp.com/us-en/document/c01007591 . A hard reset can sometimes restore the system fan to working order. See “Use Hard Reset to Resolve Hardware and Software Issues” at http://h20566.www2.hp.com/hpsc/doc/public/display?docLocale=en_US&docId=emr_na-c01684768 for details. If the system fan continues to malfunction, contact support.

Routine Maintenance for Performance Improvement

See “HP Notebook PCs - Improving the Performance of Your Computer” at http://h20564.www2.hp.com/hpsc/doc/public/display?docLocale=en_US&docId=emr_na-c00816938.

The following table presents a summary of the suggested times for performing the routine maintenance tasks described in this document.

Tasks	Weekly	Monthly	Occasionally
Perform a system tune up.	X		
Run Windows Update.	X		
Scan for and remove viruses.	X		
Scan for and remove spyware and adware.	X		
Empty the Recycle Bin.	X		
Delete temporary Internet files.	X		
Back up user files.		X	
Create a restore point.		X	
Defragment the hard drive.		X	
Run Scan Disk.		X	
Clean the exterior of the computer.			X
Close programs that are not being used.			X
Prevent programs from loading at startup.			X

Common Blue Screen Error Messages

Error message list

The following image shows an example of one possible Bug Check (Blue Screen) Code Reference from Microsoft at [https://msdn.microsoft.com/en-us/library/windows/hardware/hh994433\(v=vs.85\).aspx](https://msdn.microsoft.com/en-us/library/windows/hardware/hh994433(v=vs.85).aspx):

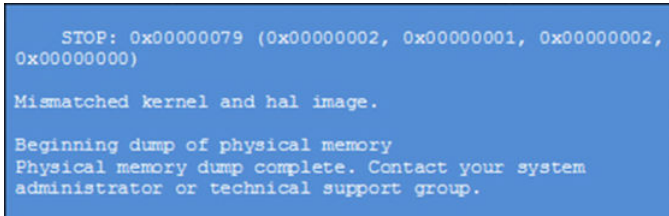

```
STOP: 0x00000079 (0x00000002, 0x00000001, 0x00000002, 0x00000000)
Mismatched kernel and hal image.
Beginning dump of physical memory
Physical memory dump complete. Contact your system
administrator or technical support group.
```

The hexadecimal number following the word "STOP" is called the bug check code or Stop code. This is the most important item on the screen.

Bug check symbolic names

Each bug check code also has an associated symbolic name. In the example, the screen shows “bug check 0x79 (MISMATCHED_HAL)”. See [https://msdn.microsoft.com/en-us/library/windows/hardware/ff559209\(v=vs.85\).aspx](https://msdn.microsoft.com/en-us/library/windows/hardware/ff559209(v=vs.85).aspx).

Microsoft general troubleshooting of Windows bug check codes

- If you recently added hardware to the system, try removing or replacing it. Or check with the manufacturer to see if any patches are available.
- Try running HP PC Hardware Diagnostics (UEFI).
- Check with the manufacturer to see if an updated system BIOS or firmware is available.
- Be sure that any expansion board is properly seated and all cables are completely connected.
- Confirm that any new hardware that is installed is compatible with the installed version of Windows.
- If new device drivers or system services have been added recently, try removing or updating them.



NOTE: Use safe mode when removing or disabling components. Safe mode loads only the minimum required drivers and system services during the Windows startup. To enter safe mode, restart your computer and press **F8** at the menu that displays the operating system choices. At the resulting **Windows Advanced Options** menu, choose **Safe Mode**.

- Run a virus detection program. Viruses can infect all types of hard drives formatted for Windows, and resulting drive corruption can generate system bug check codes. Be sure that the virus detection program checks the Master Boot Record for infections.
- Verify that the system has the latest service pack installed. To detect which service pack, if any, is installed on your system, click **Start**, click **Run**, type `winver`, and then press **Enter**. The **About Windows** dialog box displays the Windows version number and the version number of the service pack, if one has been installed.
- Disable BIOS memory options such as caching or shadowing.
- Check the System Log and Application Log in Event Viewer to see if any additional error messages have been logged recently. These might pinpoint the cause of the error.

Use Windows Debugging Tool

The Windows Debugger ([https://msdn.microsoft.com/library/windows/hardware/ff551063%20\(v=vs.85\).aspx](https://msdn.microsoft.com/library/windows/hardware/ff551063%20(v=vs.85).aspx)) is one of the primary tools used by Microsoft software developers to analyze and resolve errors that result in memory dumps. Use the tool to determine the cause of the error. Follow general steps for downloading, setting up, and using the Windows 10 debugging tool. A similar process is used for Windows 7 or Windows 8.



NOTE: The following screen shots provide only an example of the tool. Specifics shown are not representative of all applications of the debugging tool. This is a Microsoft tool supported by Microsoft.

Windows Software Development Kit (SDK)

1. Download the SDK from the following link:
<https://dev.windows.com/en-US/downloads/windows-10-sdk>
2. Set up the SDK in the configuration window (Windows 10 shown).

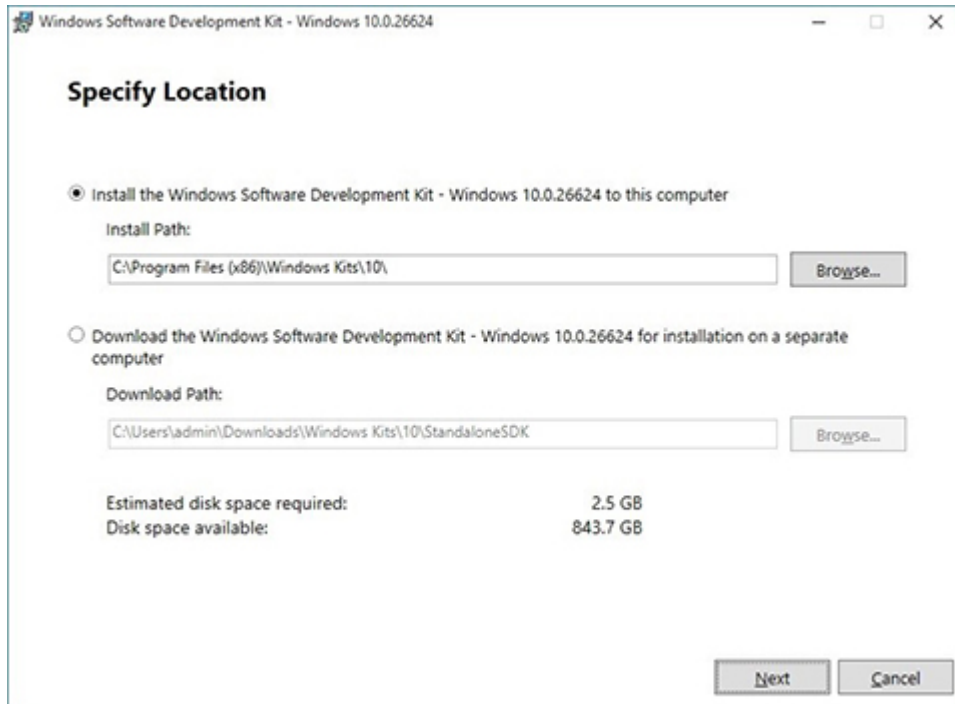

3. Select features to install.

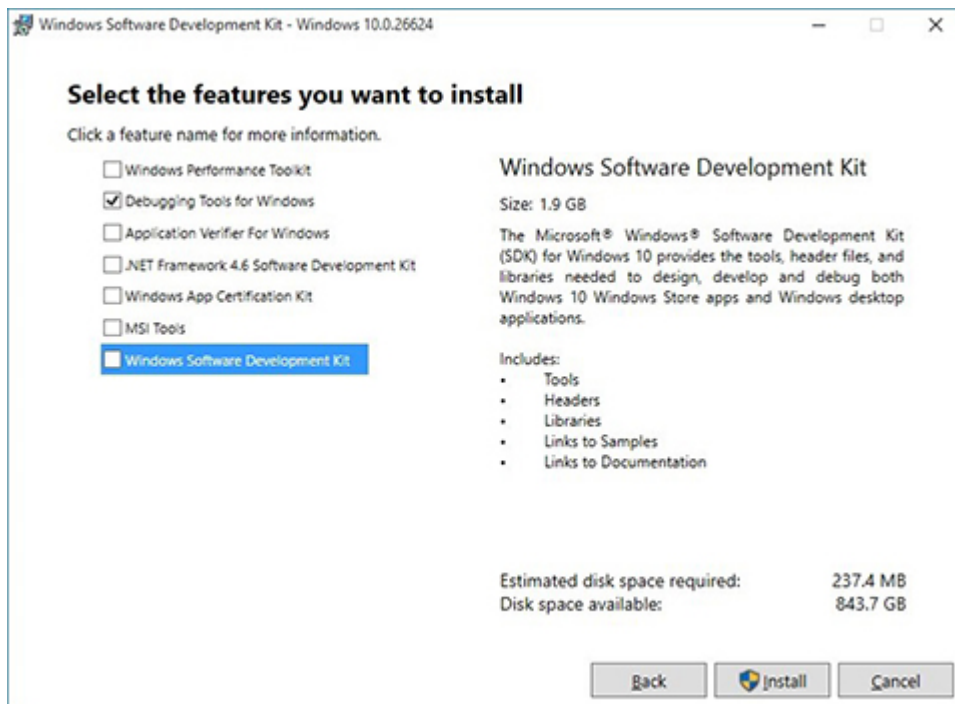

4. Run the SDK as an administrator.

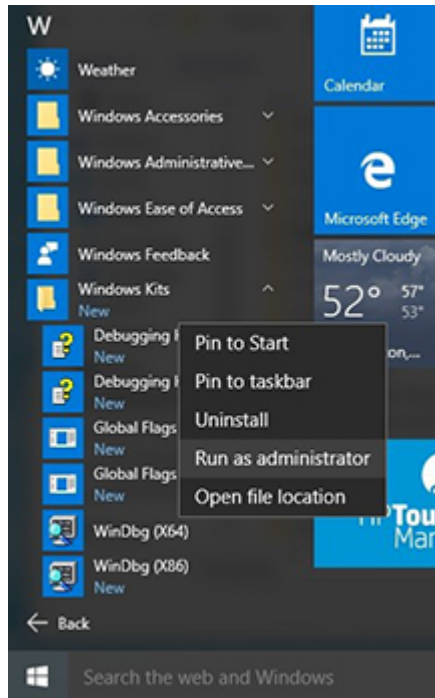

5. Set the symbol path. Select **File > Symbol File Path**.

- In the **Symbol path** box, type `SRV*C:\Windows\symbol_cache*http://msdl.microsoft.com/download/symbols`.
- Save the workspace.

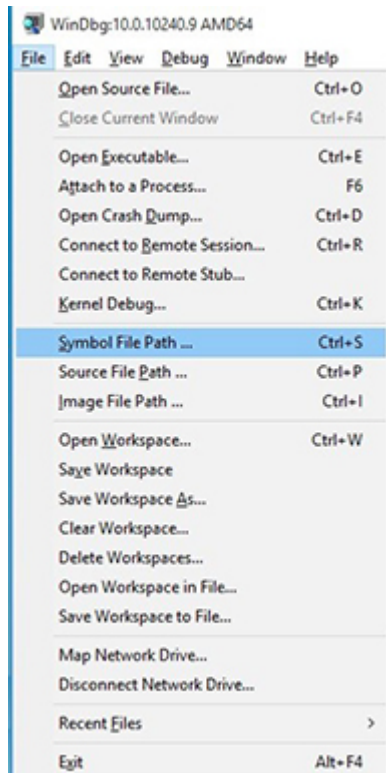

6. Open the crash dump file.

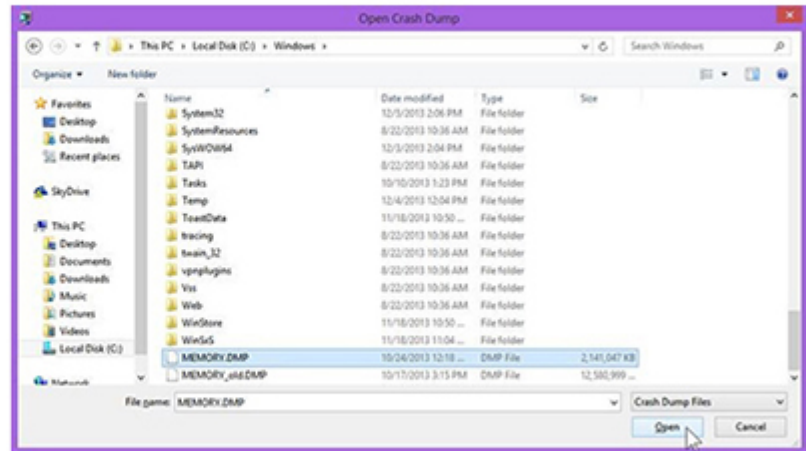
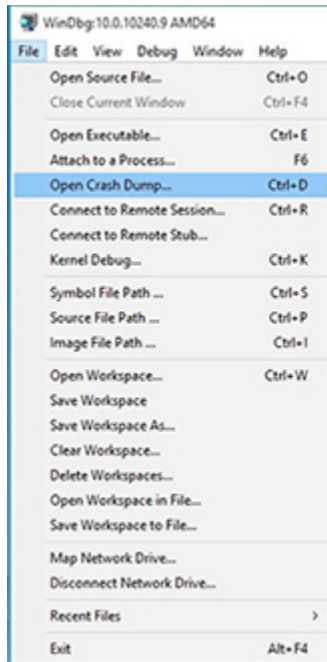

- Analyze the file. In the following memory dump sample, look for Bug Check 0x3B. The ATKMAG driver needs to be investigated for further root cause.

Lookup for Bug Check 0xC2.

```
1: kd> !analyze -v
.....
*
*                               Bugcheck Analysis
*
*
*
.....

SYSTEM_SERVICE_EXCEPTION (3b)
An exception happened while executing a system service routine.
Arguments:
Arg1: 0000000c00000005, Exception code that caused the bugcheck
Arg2: fffff8006d927acf, Address of the instruction which caused the bugcheck
Arg3: fffffd00020e4e500, Address of the context record for the exception that caused the bugcheck
Arg4: 0000000000000000, zero.

Debugging Details:
-----
BUGCHECK_P1: c0000005
BUGCHECK_P2: fffff8006d927acf
BUGCHECK_P3: fffffd00020e4e500
BUGCHECK_P4: 0
EXCEPTION_CODE: (NTSTATUS) 0xc0000005 - The instruction at 0x%p referenced memory at 0x%p. The memory

FAULTING_IP:
atikmpag+2facf
fffff800`6d927acf 4539bc2434030000 cmp     dword ptr [r12+334h],r15d
...

SYMBOL_STACK_INDEX: 0
SYMBOL_NAME: atikmpag+2facf
FOLLOWUP_NAME: MachineOwner
MODULE_NAME: atikmpag
IMAGE_NAME: atikmpag.sys
DEBUG_FLR_IMAGE_TIMESTAMP: 55479b42
STACK_COMMAND: .cxr 0xffffd00020e4e500 ; kb
BUCKET_ID_FUNC_OFFSET: 2facf
FAILURE_BUCKET_ID: 0x3b_atikmpag!Unknown_Function
BUCKET_ID: 0x3b_atikmpag!Unknown_Function
PRIMARY_PROBLEM_CLASS: 0x3b_atikmpag!Unknown_Function
ANALYSIS_SOURCE: KM
FAILURE_ID_HASH_STRING: km:0x3b_atikmpag!unknown_function
FAILURE_ID_HASH: {adb00875-801c-005a-68e8-645bb2f2c848}
```

```
Command - Dump C:\Windows\MEMORY.DMP - WinDbg.6.3.9600.16384 AMD64
.....
Loading User Symbols
Loading unloaded module list
.....
*
*                               Bugcheck Analysis
*
*
*
.....

Use !analyze -v to get detailed debugging information.
BugCheck C2, {7, 1205, 1159400, fffff0001137350}
*** ERROR: Module load completed but symbols could not be loaded for nldr.sys
Probably caused by : NETIO.SYS ( NETIO! ?? ::FNODOBFN::'string'+797c )

Followup: MachineOwner
-----
<
0: kd>
```

Display Issue: Pixel Anomalies

All HP notebook displays adhere to strict quality and reliability specifications. A small percentage of display panels may have minor cosmetic manufacturing anomalies or irregularities such as bright or dark dots in the viewable area. These cosmetic imperfections are common to all display panel types and are not specific to any HP model or product line.

All display panel defects should be examined at the highest possible resolution using both the brightest and darkest possible backgrounds, because some sub-pixel failures may not be readily visible under certain conditions.

- Type 1: Bright dot on a dark background = Always On
- Type 2: Dark dot on a bright background = Always Off
- Combination = in any combination and any color that are always on or off

Use the HP PC Hardware Diagnostics (UEFI) tool to determine numbers of pixels and their distance. HP uses the following set of criteria when damaged displays are submitted for warranty coverage.

Source: HP Notebook PCs and Tablets - About LCD Panel Defects and Terminology for Notebook PCs and Tablets (<http://support.hp.com/us-en/document/c00035844>).

Table 7-7 Electrical defect allowances

Panel resolution	Accept	Reject
Sub-pixel faults		
VGA, SVGA, SD, WSVGA, XGA, 720p, SD+, WXGA, HD	N ≤ 2 Type 1 N ≤ 2 Type 2	N ≥ 3 Type 1
WXGA+, SXGA+, HD+, SXGA+	N ≤ 3 Type 1 N ≤ 3 Type 2	N ≥ 4 Type 1
WSXGA+, UXGA, FHD, WUXGA	N ≤ 4 Type 1 N ≤ 4 Type 2	N ≥ 5 Type 1
QHD, QHD+, WQXGA, UD	N ≤ 5 Type 1 N ≤ 5 Type 2	N ≥ 6 Type 1
Electrical defect clusters (defects within a 5x5 pixel block)		
Minimum distance between ANY allowable defects (unless otherwise specified)	S ≥ 25 mm	S < 25 mm
Cluster with 2 or more sub-pixels with sub-pixel faults		Not allowed
Dim lines		Not allowed
Cross line(s) on/off		Not allowed
Horizontal line(s) on/off		Not allowed
Vertical line(s) on/off		Not allowed

 **NOTE:** All LCD panel defects should be examined at the highest possible resolution using both the brightest and darkest possible backgrounds, as some sub-pixel failures may not be readily visible under certain conditions.

 **NOTE:** Contact support for assistance if issues are not listed.

Cable management

Proper routing of the internal cables is critical to the operation of the computer. Follow good cable management practices when removing and installing components.

- Handle cables with care to avoid damage.
- Apply only the tension required to seat or unseat cables during insertion or removal from the connector.
- When possible, handle cables by the connector or pull-strap.
- Route cables in such a way that they cannot be caught or snagged by parts being removed or replaced.
- Keep cables away from direct contact with major heat sources, such as the heat sink. (Some air flow guides have a cable guide that lets you route cables safely around the heat sink.)
- Do not jam cables on top of daughterboards or memory modules (DIMMs). Circuit cards and DIMMs are not designed to take excessive pressure.
- Keep cables clear of any movable or rotating parts (such as a fan) to prevent them from being cut or crimped when the component is lowered into its normal position.
- In all cases, avoid bending or twisting the cables. Do not bend any cable sharply. A sharp bend can break the internal wires.
- Do not rely on components like the keyboard or service door to push cables down internally. Always position the cables to lay properly by themselves or in the cable guides and chassis areas designed for cable routing.

 **CAUTION:** Always release connector latch before removing the cable. Otherwise, pulling the cable could damage the cable pins and result in a failed device.

Connector types

 **IMPORTANT:** Connector pins and connector gold fingers should not be touched directly with bare hands.

There are several different types of connectors on the system board with different requirements for cable removal or insertion.

Flex cable

When connecting flex cables, push the cable completely, evenly into the connector.

When removing flex cables from a ZIF connector on the system board, always follow these steps:

1. Squeeze on the top of the retaining latch attached to the cable end of the connector.
2. Grasp the cable end of the connector and pull it straight out.

 **CAUTION:** Always release connector latch before removing the cable. Otherwise, pulling the cable could damage the cable pins and result in a failed device.

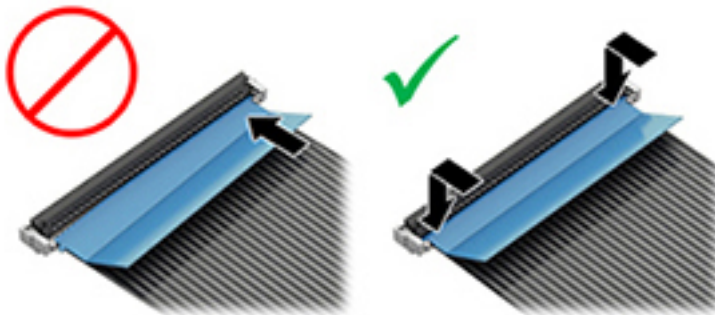

Horizontal installation cable

Use flat tool to pull connector evenly. Do not pull on cable to remove.

Slide connector into receptacle on same horizontal plane as board and use flat tool to push evenly into receptacle.

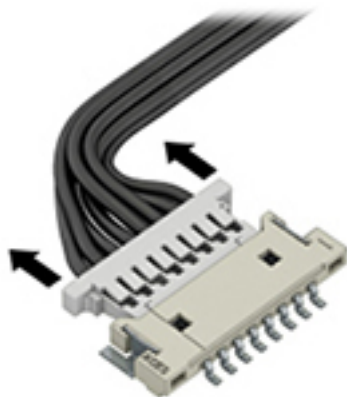

Multi-pin horizontal insert connector (LVDS cable to display panel)

Insert procedure:

1. Slide connector evenly into receptacle on same horizontal plane as PCB connector.
2. Pull lock bar to insert and push both side connector horizontally to firmly lock.
3. Tape down lock bar over the panel to hold in position.

Reverse the procedure above to remove the connector:

1. Remove tape.
2. Pull up bar (pull tape) and release the lock with the PCB connector.
3. Pull to the direction in parallel with PCB to withdraw the connector.

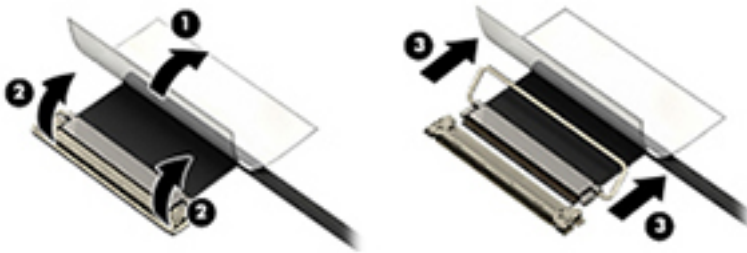

Multi-pin vertical insert connector (LVDS cable to system board)

- Remove the connector gasket prior to removing the connector.
- Use flat tool under the connector to remove evenly. Do not pull on the cable to remove.
- Press evenly when reseating/reconnecting/installing the connector.

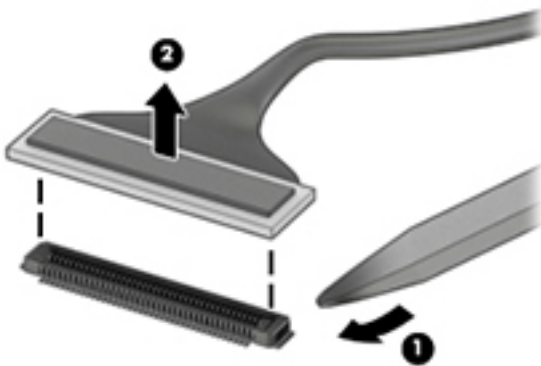

For more information about cable management, see [Cable management on page 153](#).

8 Using HP PC Hardware Diagnostics (UEFI)

HP PC Hardware Diagnostics is a Unified Extensible Firmware Interface (UEFI) that allows you to run diagnostic tests to determine whether the computer hardware is functioning properly. The tool runs outside the operating system so that it can isolate hardware failures from issues that are caused by the operating system or other software components.

When HP PC Hardware Diagnostics (UEFI) detects a failure that requires hardware replacement, a 24-digit Failure ID code is generated. This ID code can then be provided to support to help determine how to correct the problem.

 **NOTE:** To start diagnostics on a convertible computer, your computer must be in notebook mode and you must use the keyboard attached.

To start HP PC Hardware Diagnostics (UEFI), follow these steps:

1. Turn on or restart the computer, and quickly press *esc*.
2. Press *f2*.

The BIOS searches three places for the diagnostic tools, in the following order:

- a. Connected USB drive

 **NOTE:** To download the HP PC Hardware Diagnostics (UEFI) tool to a USB drive, see [Downloading HP PC Hardware Diagnostics \(UEFI\) to a USB device on page 156](#).

- b. Hard drive

- c. BIOS

3. When the diagnostic tool opens, select the type of diagnostic test you want to run, and then follow the on-screen instructions.

 **NOTE:** If you need to stop a diagnostic test, press *esc*.

Downloading HP PC Hardware Diagnostics (UEFI) to a USB device

 **NOTE:** The HP PC Hardware Diagnostics (UEFI) download instructions are provided in English only, and you must use a Windows computer to download and create the HP UEFI support environment because only .exe files are offered.

There are two options to download HP PC Hardware Diagnostics to a USB device.

Download the latest UEFI version

1. Go to <http://www.hp.com/go/techcenter/pcdiags>. The HP PC Diagnostics home page is displayed.
2. In the HP PC Hardware Diagnostics section, select the **Download** link, and then select **Run**.

Download any version of UEFI for a specific product

1. Go to <http://www.hp.com/support>.
2. Select **Get software and drivers**.

3. Enter the product name or number.

– or –

Select **Identify now** to let HP automatically detect your product.

4. Select your computer, and then select your operating system.
5. In the **Diagnostic** section, follow the on-screen instructions to select and download the UEFI version you want.

Additional BIOS crisis recovery tool

HP provides a BIOS crisis recovery tool through the HP PC Hardware Diagnostics 3-in-1 USB key. This tool can be used by HP authorized service providers to recover systems that have failed due to a corrupted BIOS. For more information about using the 3-in-1 USB key for BIOS crisis recovery, go to <http://www.hp.com/go/techcenter/pcdiags>. Additional information is included in the web-based training offered by HP University. See the modules that cover HP PC Hardware Diagnostics (UEFI).

9 Specifications

Computer specifications

	Metric	U.S.
Dimensions		
Width	42 cm	16.5 in
Depth	28 cm	11 in
Height (front to back)	3.33 cm	1.31 in
Weight	3.52, 3.55, or 3.63 kg (depending on configuration)	7.75, 7.85, or 8.0 lb. (depending on configuration)
Input power		
Operating voltage and current	19.5 V dc @ 10.3 A – 200 W	
Temperature		
Operating	5°C to 35°C	41°F to 95°F
Nonoperating	-20°C to 60°C	-4°F to 140°F
Relative humidity (noncondensing)		
Operating	10% to 90%	
Nonoperating	5% to 95%	
Maximum altitude (unpressurized)		
Operating	-15 m to 3,048 m	-50 ft to 10,000 ft
Nonoperating	-15 m to 12,192 m	-50 ft to 40,000 ft
NOTE: Applicable product safety standards specify thermal limits for plastic surfaces. The device operates well within this range of temperatures.		

10 Power cord set requirements

The wide-range input feature of the computer permits it to operate from any line voltage from 100 to 120 V ac, or from 220 to 240 V ac.

The 3-conductor power cord set included with the computer meets the requirements for use in the country or region where the equipment is purchased.

Power cord sets for use in other countries or regions must meet the requirements of the country and region where the computer is used.

Requirements for all countries

The following requirements are applicable to all countries and regions:

- The length of the power cord set must be at least **1.0 m** (3.3 ft) and no more than **2.0 m** (6.5 ft).
- All power cord sets must be approved by an acceptable accredited agency responsible for evaluation in the country or region where the power cord set will be used.
- The power cord sets must have a minimum current capacity of 10 A and a nominal voltage rating of 125 or 250 V ac, as required by the power system of each country or region.
- The appliance coupler must meet the mechanical configuration of an EN 60 320/IEC 320 Standard Sheet C13 connector for mating with the appliance inlet on the back of the computer.

Requirements for specific countries and regions

Country/region	Accredited agency	Applicable note number
Argentina	IRAM	1
Australia	SAA	1
Austria	OVE	1
Belgium	CEBEC	1
Brazil	ABNT	1
Canada	CSA	2
Chile	IMQ	1
Denmark	DEMKO	1
Finland	FIMKO	1
France	UTE	1
Germany	VDE	1
India	ISI	1
Israel	SII	1
Italy	IMQ	1
Japan	JIS	3
The Netherlands	KEMA	1
New Zealand	SANZ	1
Norway	NEMKO	1
The People's Republic of China	CCC	4
Saudi Arabia	SASO	7
Singapore	PSB	1
South Africa	SABS	1
South Korea	KTL	5
Sweden	SEMKO	1
Switzerland	SEV	1
Taiwan	BSMI	6
Thailand	TISI	1
The United Kingdom	ASTA	1
The United States	UL	2

1. The flexible cord must be Type H05VV-F, 3-conductor, 0.75 mm² conductor size. Power cord set fittings (appliance coupler and wall plug) must bear the certification mark of the agency responsible for evaluation in the country or region where it will be used.
2. The flexible cord must be Type SVT/SJT or equivalent, No. 18 AWG, 3-conductor. The wall plug must be a two-pole grounding type with a NEMA 5-15P (15 A, 125 V ac) or NEMA 6-15P (15 A, 250 V ac) configuration. CSA or C-UL mark. UL file number must be on each element.

Country/region	Accredited agency	Applicable note number
3.	The appliance coupler, flexible cord, and wall plug must bear a “T” mark and registration number in accordance with the Japanese Dentori Law. The flexible cord must be Type VCTF, 3-conductor, 0.75 mm ² or 1.25 mm ² conductor size. The wall plug must be a two-pole grounding type with a Japanese Industrial Standard C8303 (7 A, 125 V ac) configuration.	
4.	The flexible cord must be Type RVV, 3-conductor, 0.75 mm ² conductor size. Power cord set fittings (appliance coupler and wall plug) must bear the CCC certification mark.	
5.	The flexible cord must be Type H05VV-F 3-conductor, 0.75 mm ² conductor size. KTL logo and individual approval number must be on each element. Corset approval number and logo must be printed on a flag label.	
6.	The flexible cord must be Type HVCTF 3-conductor, 1.25 mm ² conductor size. Power cord set fittings (appliance coupler, cable, and wall plug) must bear the BSMI certification mark.	
7.	For 127 V ac, the flexible cord must be Type SVT or SJT 3-conductor, 18 AWG, with plug NEMA 5-15P (15 A, 125 V ac), with UL and CSA or C-UL marks. For 240 V ac, the flexible cord must be Type H05VV-F 3-conductor, 0.75 mm ² or 1.00 mm ² conductor size, with plug BS 1363/A with BSI or ASTA marks.	

11 Statement of memory volatility

The purpose of this chapter is to provide general information regarding nonvolatile memory in HP Business PCs. This chapter also provides general instructions for restoring nonvolatile memory that can contain personal data after the system has been powered off and the hard drive has been removed.

HP Business PC products that use Intel®-based or AMD®-based system boards contain volatile DDR memory. The amount of nonvolatile memory present in the system depends upon the system configuration. Intel-based and AMD-based system boards contain nonvolatile memory subcomponents as originally shipped from HP, assuming that no subsequent modifications have been made to the system and assuming that no applications, features, or functionality have been added to or installed on the system.

Following system shutdown and removal of all power sources from an HP Business PC system, personal data can remain on volatile system memory (DIMMs) for a finite period of time and will also remain in nonvolatile memory. Use the steps below to remove personal data from the PC, including the nonvolatile memory found in Intel-based and AMD-based system boards.

1. Follow steps (a) through (j) below to restore the nonvolatile memory that can contain personal data. Restoring or reprogramming nonvolatile memory that does not store personal data is neither necessary nor recommended.

- a. Turn on or restart the computer, and then press **esc** while the “Press the ESC key for Startup Menu” message is displayed at the bottom of the screen.



NOTE: If the system has a BIOS administrator password, enter the password at the prompt.

- b. Select **Main**, select **Restore Defaults**, and then select **Yes** to load defaults.
- c. Select the **Security** menu, select **Restore Security Level Defaults**, and then select **Yes** to restore security level defaults.
- d. If an asset or ownership tag is set, select the **Security** menu and scroll down to the **Utilities** menu. Select **System IDs**, and then select **Asset Tracking Number**. Clear the tag, and then make the selection to return to the prior menu.
- e. If a DriveLock password is set, select the **Security** menu, and scroll down to **Hard Drive Tools** under the **Utilities** menu. Select **Hard Drive Tools**, select **DriveLock**, then clear the check box for **DriveLock password on restart**. Select **OK** to proceed.
- f. If an Automatic DriveLock password is set, select the **Security** menu, scroll down to **Hard Drive Tools** under the **Utilities** menu. Select **Hard Drive Tools**, scroll down to **Automatic DriveLock**, then select the desired hard drive and disable protection. At the automatic drive lock warning screen, select **Yes** to continue. Repeat this procedure if more than one hard drive has an Automatic DriveLock password.
- g. Select the **Main** menu, and then select **Reset BIOS Security to factory default**. Click **Yes** at the warning message.
- h. Select the **Main** menu, select **Save Changes and Exit**, select **Yes** to save changes and exit, and then select **Shutdown**.

- i. Reboot the system. If the system has a Trusted Platform Module (TPM) and/or fingerprint reader, one or two prompts will appear—one to clear the TPM and the other to Reset Fingerprint Sensor; press or tap **F1** to accept or **F2** to reject.
 - j. Remove all power and system batteries for at least 24 hours.
2. Complete one of the following:
- Remove and retain the storage drive.
 - or –
 - Clear the drive contents by using a third-party utility designed to erase data from an SSD.
 - or –
 - Clear the contents of the drive by using the following BIOS Setup Secure Erase command option steps:

 **IMPORTANT:** If you clear data using Secure Erase, it cannot be recovered.

- a. Turn on or restart the computer, and then press **esc** while the “Press the ESC key for Startup Menu” message is displayed at the bottom of the screen.
 - b. Select the **Security** menu and scroll down to the **Utilities** menu.
 - c. Select **Hard Drive Tools**.
 - d. Under **Utilities**, select **Secure Erase**, select the hard drive storing the data you want to clear, and then follow the on-screen instructions to continue.
- or –
- Clear the contents of the drive by using the following Disk Sanitizer command steps:

 **IMPORTANT:** If you clear data using Disk Sanitizer, it cannot be recovered.

 **NOTE:** The amount of time it takes for Disk Sanitizer to run can take several hours. Plug the computer into an AC outlet before starting.

- a. Turn on or restart the computer, and then press **esc** while the “Press the ESC key for Startup Menu” message is displayed at the bottom of the screen.
- b. Select the **Security** menu and scroll down to the **Utilities** menu.
- c. Select **Hard Drive Tools**.
- d. Under **Utilities**, select **Disk Sanitizer**, select the hard drive storing the data you want to clear, and then follow the on-screen instructions to continue.

Nonvolatile memory usage

Nonvolatile memory type	Amount (Size)	Does this memory store customer data?	Does this memory retain data when power is removed?	What is the purpose of this memory?	How is data input into this memory?	How is this memory write-protected?
HP Sure Start flash (select models only)	2 MBytes	No	Yes	Provides protected backup of critical System BIOS code, EC firmware, and critical PC configuration data for select platforms that support HP Sure Start. For more information, see Using HP Sure Start (select models only) on page 167.	Data cannot be written to this device via the host processor. The content is managed solely by the HP Sure Start Embedded Controller.	This memory is protected by the HP Sure Start Embedded Controller.
Real Time Clock (RTC) battery backed-up CMOS configuration memory	256 Bytes	No	Yes	Stores system date and time and noncritical data.	RTC battery backed-up CMOS is programmed using the Computer Setup (BIOS), or changing the Microsoft Windows date and time.	This memory is not write-protected.
Controller (NIC) EEPROM	64 KBytes (not customer accessible)	No	Yes	Stores NIC configuration and NIC firmware.	NIC EEPROM is programmed using a utility from the NIC vendor that can be run from DOS.	A utility is required to write data to this memory and is available from the NIC vendor. Writing data to this ROM in an inappropriate manner will render the NIC non-functional.
DIMM Serial Presence Detect (SPD) configuration data	256 Bytes per memory module, 128 Bytes programmable (not customer accessible)	No	Yes	Stores memory module information.	DIMM SPD is programmed by the memory vendor.	Data cannot be written to this memory when the module is installed in a PC. The specific write-protection method varies by memory vendor.
System BIOS	4 MBytes to 5 MBytes	Yes	Yes	Stores system BIOS code and PC configuration data.	System BIOS code is programmed at the factory. Code is updated when the system BIOS is updated. Configuration data and settings are input using the Computer Setup (BIOS) or a custom utility.	NOTE: Writing data to this ROM in an inappropriate manner can render the PC non-functional. A utility is required for writing data to this memory and is available on the HP website; go to http://www.hp.com/support , and select your country. Select Drivers &

Nonvolatile memory type	Amount (Size)	Does this memory store customer data?	Does this memory retain data when power is removed?	What is the purpose of this memory?	How is data input into this memory?	How is this memory write-protected?
Intel Management Engine Firmware (present in only specific ZBook and EliteBook models. For more information, go to http://www.hp.com/support , and select your country. Select Drivers & Downloads , and then follow the on-screen instructions.)	1.5 MBytes or 5 MBytes	Yes	Yes	Stores Management Engine Code, Settings, Provisioning Data and iAMT third-party data store.	Management Engine Code is programmed at the factory. Code is updated via Intel secure firmware update utility. Unique Provisioning Data can be entered at the factory or by an administrator using the Management Engine (MEBx) setup utility. The third-party data store contents can be populated by a remote management console or local applications that have been registered by an administrator to have access to the space.	Downloads , and then follow the on-screen instructions. The Intel chipset is configured to enforce hardware protection to block all direct read/write access to this area. An Intel utility is required for updating the firmware. Only firmware updates digitally signed by Intel can be applied using this utility.
Bluetooth flash	2 Mbit	No	Yes	Stores Bluetooth configuration and firmware.	Bluetooth flash is programmed at the factory. Tools for writing data to this memory are not publicly available but can be obtained from the silicon vendor.	A utility is required for writing data to this memory and is made available through newer versions of the driver whenever the flash requires an upgrade.
802.11 WLAN EEPROM	4 Kbit to 8 Kbit	No	Yes	Stores configuration and calibration data.	802.11 WLAN EEPROM is programmed at the factory. Tools for writing data to this memory are not made public.	A utility is required for writing data to this memory and is usually not made available to the public unless a firmware upgrade is necessary to address a unique issue.
Web camera	64 Kbit	No	Yes	Stores webcam configuration and firmware.	Webcam memory is programmed using a utility from the device manufacturer that can be run from Windows.	A utility is required for writing data to this memory and is usually not made available to the public unless a firmware upgrade is necessary to address a unique issue.
Fingerprint reader	512 KByte flash	Yes	Yes	Stores fingerprint templates.	Fingerprint reader memory is programmed by user enrollment in HP ProtectTools Security Manager.	Only a digitally signed application can make the call to write to the flash.

Questions and answers

1. How can the BIOS settings be restored (returned to factory settings)?



IMPORTANT: Restore defaults does not securely erase any data on your hard drive. See question and answer 6 for steps to securely erase data.

Restore defaults does not reset the Custom Secure Boot keys. See question and answer 7 for information about resetting the keys.

- a. Turn on or restart the computer, and then press **esc** while the “Press the ESC key for Startup Menu” message is displayed at the bottom of the screen.
- b. Select **Main**, and then select **Restore defaults**.
- c. Follow the on-screen instructions.
- d. Select **Main**, select **Save Changes and Exit**, and then follow the on-screen instructions.

2. What is a UEFI BIOS, and how is it different from a legacy BIOS?

The Unified Extensible Firmware Interface (UEFI) BIOS is an industry-standard software interface between the platform firmware and an operating system (OS). It is a replacement for the older BIOS architecture, but supports much of the legacy BIOS functionality.

Like the legacy BIOS, the UEFI BIOS provides an interface to display the system information and configuration settings and to change the configuration of your computer before an OS is loaded. BIOS provides a secure run-time environment that supports a Graphic User Interface (GUI). In this environment, you can use either a pointing device (Touchscreen, TouchPad, pointing stick, or USB mouse) or the keyboard to navigate and make menu and configuration selections. The UEFI BIOS also contains basic system diagnostics.

The UEFI BIOS provides functionality beyond that of the legacy BIOS. In addition, the UEFI BIOS works to initialize the computer’s hardware before loading and executing the OS; the run-time environment allows the loading and execution of software programs from storage devices to provide more functionality, such as advanced hardware diagnostics (with the ability to display more detailed system information) and advanced firmware management and recovery software.

HP has provided options in Computer Setup (BIOS) to allow you to run in legacy BIOS, if required by the operating system. Examples of this requirement would be if you upgrade or downgrade the OS.

3. Where does the UEFI BIOS reside?

The UEFI BIOS resides on a flash memory chip. A utility is required to write to the chip.

4. What kind of configuration data is stored on the DIMM Serial Presence Detect (SPD) memory module? How would this data be written?

The DIMM SPD memory contains information about the memory module, such as size, serial number, data width, speed/timing, voltage, and thermal information. This information is written by the module manufacturer and stored on an EEPROM. This EEPROM cannot be written to when the memory module is installed in a PC. Third-party tools do exist that can write to the EEPROM when the memory module is not installed in a PC. Various third-party tools are available to read SPD memory.

5. What is meant by “Restore the nonvolatile memory found in Intel-based system boards”?

This message relates to clearing the Real Time Clock (RTC) CMOS memory that contains PC configuration data.

6. How can the BIOS security be reset to factory defaults and data erased?

 **IMPORTANT:** Resetting will result in the loss of information.

These steps will not reset Custom Secure Boot Keys. See question and answer 7 for information about resetting the keys.

- a. Turn on or restart the computer, and then press **esc** while the “Press the ESC key for Startup Menu” message is displayed at the bottom of the screen.
- b. Select **Main**, and then select **Reset BIOS Security to Factory Default**.
- c. Follow the on-screen instructions.
- d. Select **Main**, select **Save Changes and Exit**, and then follow the on-screen instructions.

7. How can the Custom Secure Boot Keys be reset?

Secure Boot is a feature to ensure that only authenticated code can start on a platform. If you enabled Secure Boot and created Custom Secure Boot Keys, simply disabling Secure Boot will not clear the keys. You must also select to clear the Custom Secure Boot Keys. Use the same Secure Boot access procedure you used to create the Custom Secure Boot Keys, but make the selection to clear or delete all Secure Boot Keys.

- a. Turn on or restart the computer, and then press **esc** while the “Press the ESC key for Startup Menu” message is displayed at the bottom of the screen.
- b. Select the **Security** menu, select **Secure Boot Configuration**, and then follow the on-screen instructions.
- c. At the **Secure Boot Configuration** window, select **Secure Boot**, select **Clear Secure Boot Keys**, and then follow the on-screen instructions to continue.

Using HP Sure Start (select models only)

Select computer models are configured with HP Sure Start, a technology that continuously monitors your computer's BIOS for attacks or corruption. If the BIOS becomes corrupted or is attacked, HP Sure Start restores the BIOS to its previously safe state, without user intervention. Those select computer models ship with HP Sure Start configured and enabled. HP Sure Start is configured and already enabled so that most users can use the HP Sure Start default configuration. The default configuration can be customized by advanced users.

To access the latest documentation on HP Sure Start, go to <http://www.hp.com/support>, and select your country. Select **Drivers & Downloads**, and then follow the on-screen instructions.

12 Recycling

When a non-rechargeable or rechargeable battery has reached the end of its useful life, do not dispose of the battery in general household waste. Follow the local laws and regulations in your area for battery disposal.

HP encourages customers to recycle used electronic hardware, HP original print cartridges, and rechargeable batteries. For more information about recycling programs, see the HP Web site at <http://www.hp.com/recycle>.

Index

A

AC adapter
 spare part number 23
antennas
 removal 73
 spare part number 73
anti-magnetic speaker bracket
 spare part number 53
audio, product description 4
audio-out (headphone)/audio-in
(microphone) combo jack,
 identifying 7

B

back cover, spare part number 22
base enclosure
 removal 33
 spare part number 21, 33
battery
 removal 31
 spare part number 21
 spare part numbers 31
battery cable
 spare part number 21
battery light 8, 17
bezel
 spare part number 22
bracket kit
 spare part number 53
broadband module
 spare part numbers 42
buttons
 center pointing stick 11
 center TouchPad 11
 left TouchPad 11
 power 13
 right pointing stick 11
 right TouchPad 11
 TouchPad on/off 11

C

cable kit, spare part number 23
calibration board
 removal 71
caps lock light, identifying 12

case, spare part number 23
chipset, product description 1
components
 bottom 16
 display 10
 front 17
 left side 9
 right side 7
 top 11
computer major components 19
computer specifications 158
connector, power 8

D

discrete graphics board
 removal 59
 spare part numbers 59
display assembly
 removal 68
 spare part numbers 68
 subcomponents 22
display bezel
 removal 69
display cable
 spare part number 22, 74
display hinges
 removal 72
 spare part number 72
display LED board
 removal 60
 spare part numbers 60
display panel
 product description 1
 removal 69
 spare part numbers 20
docking station, spare part number
 23
docking, product description 5
drive light 17

E

esc key, identifying 14
Ethernet, product description 4
external monitor port 8

F

fan
 removal 54
 spare part numbers 21, 54
fan/heat sink assembly
 spare part numbers 54
fingerprint reader
 spare part number 21
fingerprint reader board
 removal 53
 spare part number 53
fingerprint reader board bracket
 removal 53
fingerprint reader, identifying 13
fn key, identifying 14

G

graphics board
 spare part number 21
graphics, product description 1

H

hard drive
 product description 3
 removal 33
 spare part numbers 21, 33
hard drive, identifying 16
HDMI port, identifying 8
heat sink
 removal 56
 spare part number 21
 spare part numbers 56
hinge
 spare part number 22
hinge covers, spare part number 22
hot keys
 Sleep 15
 using 15
HP PC Hardware Diagnostics (UEFI)
 using 156
HP Sure Start 167
HP USB-C to DisplayPort adapter,
 spare part numbers 23
HP ZBook Thunderbolt 3 power cable
 A, spare part number 23

- I**
 - integrated numeric keypad, identifying 14
 - integrated webcam light, identifying 10
 - internal frame
 - spare part number 21
 - internal microphones, identifying 10
- J**
 - jacks
 - audio-out (headphone)/audio-in (microphone) combo 7
 - network 9
 - RJ-45 (network) 9
- K**
 - Keyboard
 - spare part numbers 20
 - keyboard
 - product description 5
 - removal 62
 - spare part numbers 62
 - keypad
 - integrated numeric 14
 - keys
 - esc 14
 - fn 14
 - Windows key 14
- L**
 - labels
 - serial number 17
 - LED board
 - spare part number 21
 - left pointing stick button, identifying 11
 - lights
 - battery 8, 17
 - caps lock 12
 - drive 17
 - microphone mute 12
 - num lock 12
 - power 12, 17
 - RJ-45 (network) 9
 - TouchPad 12
 - webcam 10
 - wireless 12, 17
 - locating information
 - hardware 7
 - software 7
 - M**
 - memory
 - nonvolatile 162
 - spare part number 20
 - volatile 162
 - memory card reader, identifying 9
 - memory module
 - identifying 16
 - product description 2
 - removal 44
 - spare part numbers 44
 - microphone
 - product description 4
 - microphone board, spare part number 23
 - microphone module
 - removal 70
 - microphone mute light, identifying 12
 - model name 1
 - mouse, spare part number 23
 - N**
 - network jack, identifying 9
 - nonvolatile memory 162
 - num lock light 12
 - O**
 - operating system, product description 6
 - P**
 - panel
 - spare part number 22
 - plastics kit 30
 - spare part number 21
 - pointing device, product description 5
 - pointing stick 11
 - ports
 - external monitor 8
 - HDMI 8
 - product description 5
 - USB 3.0 charging (powered) 9
 - USB Type-C (Thunderbolt-enabled) 8
 - power button, identifying 13
 - power connector, identifying 8
 - power cord
 - requirements for all countries 159
 - requirements for specific countries and regions 160
 - set requirements 159
 - power cord, spare part number 23
 - power lights 12, 17
 - power requirements, product description 5
 - processor
 - product description 1
 - product description
 - audio 4
 - chipset 1
 - display panel 1
 - docking 5
 - Ethernet 4
 - external media cards 5
 - graphics 1
 - hard drive 3
 - keyboard 5
 - memory module 2
 - microphone 4
 - operating system 6
 - pointing device 5
 - ports 5
 - power requirements 5
 - processors 1
 - product name 1
 - security 5
 - serviceability 6
 - SSD 2, 3
 - video 4
 - wireless 4
 - product name 1
 - product name and number, computer 17
 - R**
 - regulatory information 17
 - removal/replacement
 - procedures 29, 47
 - removing personal data from volatile system memory 162
 - RJ-45 (network) jack, identifying 9
 - RJ-45 (network) lights, identifying 9

RTC battery
removal 48
spare part number 21, 48

S

security cable slot, identifying 9
security, product description 5
serial number 17
serial number, computer 17
service cover
spare part number 21
service door
removal 30
spare part number 21, 30
serviceability, product description 6
slots
security cable 9
smart card 7
smart card
slot 7
smart card reader 51
spare part number 21
solid-state drive
removal 38
spare part numbers 38
solid-state drives
spare part number 21
speaker kit
spare part number 21
speakers
removal 49
spare part number 49
speakers, identifying 17
specifications
computer 158
spill drain, identifying 16
SSD
product description 2, 3
system board
removal 64
spare part number 20
spare part numbers 64
system information
locating 17
system memory, removing personal
data from volatile 162

T

Top cover
spare part numbers 20

top cover
spare part number 74
TouchPad
buttons 11
removal 50
spare part number 21, 50
TouchPad light, identifying 12
TouchPad on/off button,
identifying 11
TouchPad zone
identifying 11

U

USB 3.0 charging (powered),
identifying 9
USB 3.0 port 8, 9
USB ports, identifying 8, 9
USB Type-C (Thunderbolt-3-enabled)
port, identifying 8

V

vents, identifying 16
video, product description 4

W

warranty period 17
webcam 10
spare part number 22
webcam light, identifying 10
webcam module
removal 70
webcam, identifying 10
Windows key, identifying 14
wireless antennas, identifying 10
wireless light 12, 17
wireless, product description 4
WLAN antennas, identifying 10
WLAN module
removal 40
spare part number 21
spare part numbers 40
WWAN antenna, spare part number
22
WWAN antennas, identifying 10
WWAN module
removal 42
spare part number 21
spare part numbers 42